



## Clustering for the Firepower 4100/9300

Clustering lets you group multiple threat defense nodes together as a single logical device. A cluster provides all the convenience of a single device (management, integration into a network) while achieving the increased throughput and redundancy of multiple devices.



**Note** Some features are not supported when using clustering. See [Unsupported Features with Clustering, on page 55](#).

- [About Clustering on the Firepower 4100/9300 Chassis, on page 1](#)
- [Licenses for Clustering, on page 5](#)
- [Requirements and Prerequisites for Clustering, on page 6](#)
- [Clustering Guidelines and Limitations, on page 9](#)
- [Configure Clustering, on page 13](#)
- [FXOS: Remove a Cluster Node, on page 39](#)
- [Management Center: Manage Cluster Members, on page 41](#)
- [Management Center: Monitoring the Cluster, on page 46](#)
- [Management Center: Troubleshooting the Cluster, on page 51](#)
- [Examples for Clustering, on page 54](#)
- [Reference for Clustering, on page 55](#)
- [History for Clustering, on page 67](#)

## About Clustering on the Firepower 4100/9300 Chassis

When you deploy a cluster on the Firepower 4100/9300 chassis, it does the following:

- For native instance clustering: Creates a *cluster-control link* (by default, port-channel 48) for node-to-node communication.

For multi-instance clustering: You should pre-configure subinterfaces on one or more cluster-type EtherChannels; each instance needs its own cluster control link.

For a cluster isolated to security modules within one Firepower 9300 chassis, this link utilizes the Firepower 9300 backplane for cluster communications.

For clustering with multiple chassis, you need to manually assign physical interface(s) to this EtherChannel for communications between chassis.

- Creates the cluster bootstrap configuration within the application.

When you deploy the cluster, the chassis supervisor pushes a minimal bootstrap configuration to each unit that includes the cluster name, cluster control link interface, and other cluster settings.

- Assigns data interfaces to the cluster as *Spanned* interfaces.

For a cluster isolated to security modules within one Firepower 9300 chassis, spanned interfaces are not limited to EtherChannels, like it is for clustering with multiple chassis. The Firepower 9300 supervisor uses EtherChannel technology internally to load-balance traffic to multiple modules on a shared interface, so any data interface type works for Spanned mode. For clustering with multiple chassis, you must use Spanned EtherChannels for all data interfaces.



---

**Note** Individual interfaces are not supported, with the exception of a management interface.

---

- Assigns a management interface to all units in the cluster.

See the following sections for more information about clustering.

## Bootstrap Configuration

When you deploy the cluster, the Firepower 4100/9300 chassis supervisor pushes a minimal bootstrap configuration to each unit that includes the cluster name, cluster control link interface, and other cluster settings.

## Cluster Members

Cluster members work together to accomplish the sharing of the security policy and traffic flows.

One member of the cluster is the **control** unit. The control unit is determined automatically. All other members are **data** units.

You must perform all configuration on the control unit only; the configuration is then replicated to the data units.

Some features do not scale in a cluster, and the control unit handles all traffic for those features. .

## Cluster Control Link

For native instance clustering: The cluster control link is automatically created using the Port-channel 48 interface.

For multi-instance clustering: You should pre-configure subinterfaces on one or more cluster-type EtherChannels; each instance needs its own cluster control link.

For a cluster isolated to security modules within one Firepower 9300 chassis, this interface has no member interfaces. This Cluster type EtherChannel utilizes the Firepower 9300 backplane for cluster communications. For clustering with multiple chassis, you must add one or more interfaces to the EtherChannel.

For a cluster with two chassis, do not directly connect the cluster control link from one chassis to the other chassis. If you directly connect the interfaces, then when one unit fails, the cluster control link fails, and thus

the remaining healthy unit fails. If you connect the cluster control link through a switch, then the cluster control link remains up for the healthy unit.

Cluster control link traffic includes both control and data traffic.

## Size the Cluster Control Link

If possible, you should size the cluster control link to match the expected throughput of each chassis so the cluster control link can handle the worst-case scenarios.

Cluster control link traffic is comprised mainly of state update and forwarded packets. The amount of traffic at any given time on the cluster control link varies. The amount of forwarded traffic depends on the load-balancing efficacy or whether there is a lot of traffic for centralized features. For example:

- NAT results in poor load balancing of connections, and the need to rebalance all returning traffic to the correct units.
- When membership changes, the cluster needs to rebalance a large number of connections, thus temporarily using a large amount of cluster control link bandwidth.

A higher-bandwidth cluster control link helps the cluster to converge faster when there are membership changes and prevents throughput bottlenecks.



**Note** If your cluster has large amounts of asymmetric (rebalanced) traffic, then you should increase the cluster control link size.

## Cluster Control Link Redundancy

The following diagram shows how to use an EtherChannel as a cluster control link in a Virtual Switching System (VSS), Virtual Port Channel (vPC), StackWise, or StackWise Virtual environment. All links in the EtherChannel are active. When the switch is part of a redundant system, then you can connect firewall interfaces within the same EtherChannel to separate switches in the redundant system. The switch interfaces are members of the same EtherChannel port-channel interface, because the separate switches act like a single switch. Note that this EtherChannel is device-local, not a Spanned EtherChannel.

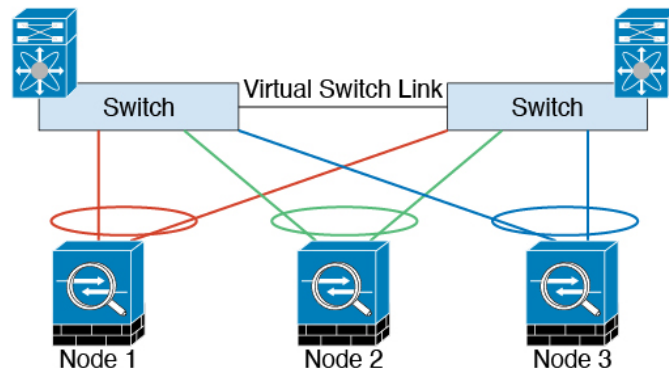

## Cluster Control Link Reliability for Inter-Chassis Clustering

To ensure cluster control link functionality, be sure the round-trip time (RTT) between units is less than 20 ms. This maximum latency enhances compatibility with cluster members installed at different geographical sites. To check your latency, perform a ping on the cluster control link between units.

The cluster control link must be reliable, with no out-of-order or dropped packets; for example, for inter-site deployment, you should use a dedicated link.

## Cluster Control Link Network

The Firepower 4100/9300 chassis auto-generates the cluster control link interface IP address for each unit based on the chassis ID and slot ID: `127.2.chassis_id.slot_id`. For multi-instance clusters, which typically use different VLAN subinterfaces of the same EtherChannel, the same IP address can be used for different clusters because of VLAN separation. The cluster control link network cannot include any routers between units; only Layer 2 switching is allowed.

## Management Network

We recommend connecting all units to a single management network. This network is separate from the cluster control link.

## Management Interface

You must assign a Management type interface to the cluster. This interface is a special individual interface as opposed to a Spanned interface. The management interface lets you connect directly to each unit. This Management logical interface is separate from the other interfaces on the device. It is used to set up and register the device to the Secure Firewall Management Center. It uses its own local authentication, IP address, and static routing. Each cluster member uses a separate IP address on the management network that you set as part of the bootstrap configuration.

## Cluster Interfaces

For a cluster isolated to security modules within one Firepower 9300 chassis, you can assign both physical interfaces or EtherChannels (also known as port channels) to the cluster. Interfaces assigned to the cluster are Spanned interfaces that load-balance traffic across all members of the cluster.

For clustering with multiple chassis, you can only assign data EtherChannels to the cluster. These Spanned EtherChannels include the same member interfaces on each chassis; on the upstream switch, all of these interfaces are included in a single EtherChannel, so the switch does not know that it is connected to multiple devices.

You can use regular firewall interfaces or IPS-only interfaces (inline sets or passive interfaces).

Individual interfaces are not supported, with the exception of a management interface.

## Spanned EtherChannels

You can group one or more interfaces per chassis into an EtherChannel that spans all chassis in the cluster. The EtherChannel aggregates the traffic across all the available active interfaces in the channel.

For regular firewall interfaces: A Spanned EtherChannel can be configured in both routed and transparent firewall modes. In routed mode, the EtherChannel is configured as a routed interface with a single IP address. In transparent mode, the IP address is assigned to the BVI, not to the bridge group member interface.

The EtherChannel inherently provides load balancing as part of basic operation.

For multi-instance clusters, each cluster requires dedicated data EtherChannels; you cannot use shared interfaces or VLAN subinterfaces.

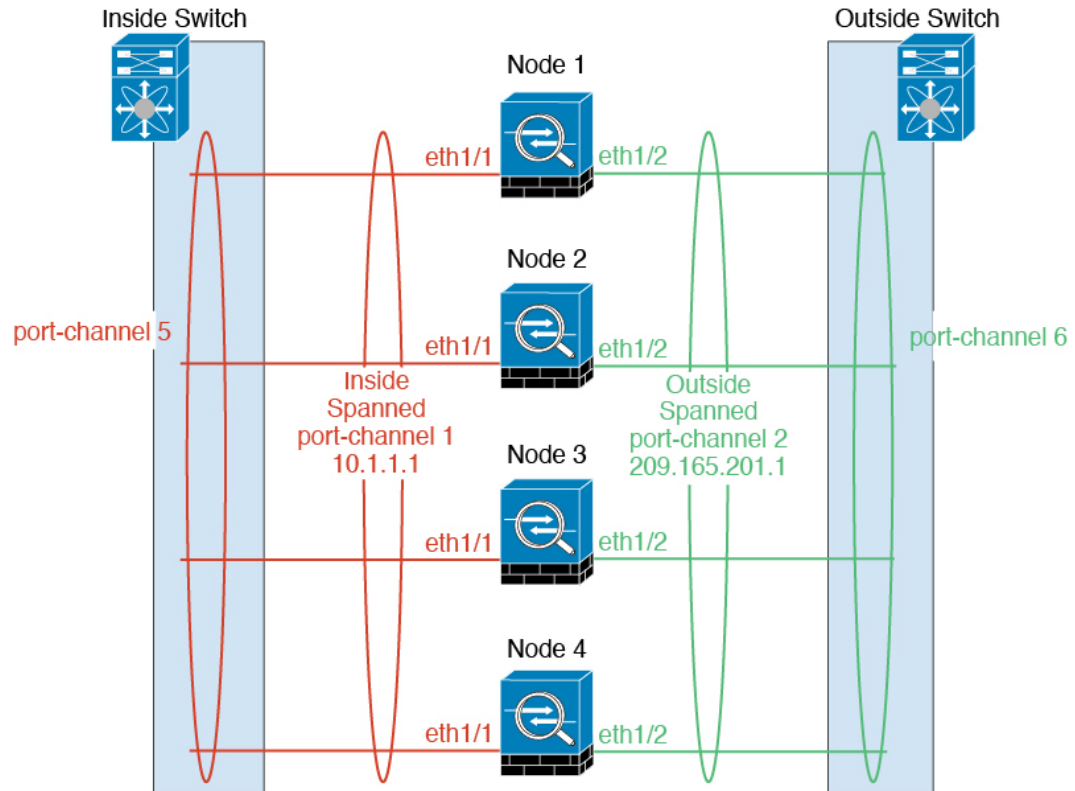

## Connecting to a Redundant Switch System

We recommend connecting EtherChannels to a redundant switch system such as a VSS, vPC, StackWise, or StackWise Virtual system to provide redundancy for your interfaces.

## Configuration Replication

All nodes in the cluster share a single configuration. You can only make configuration changes on the control node (with the exception of the bootstrap configuration), and changes are automatically synced to all other nodes in the cluster.

## Licenses for Clustering

You assign feature licenses to the cluster as a whole, not to individual nodes. However, each node of the cluster consumes a separate license for each feature. The clustering feature itself does not require any licenses.

When you add a cluster node to the management center, you can specify the feature licenses you want to use for the cluster. You can modify licenses for the cluster in the **Devices > Device Management > Cluster > License** area.



---

**Note** If you add the cluster before the management center is licensed (and running in Evaluation mode), then when you license the management center, you can experience traffic disruption when you deploy policy changes to the cluster. Changing to licensed mode causes all data units to leave the cluster and then rejoin.

---

## Requirements and Prerequisites for Clustering

### Cluster Model Support

The Threat Defense supports clustering on the following models:

- Firepower 9300— You can include up to 16 nodes in the cluster. For example, you can use 1 module in 16 chassis, or 2 modules in 8 chassis, or any combination that provides a maximum of 16 modules. Supports clustering with multiple chassis and clustering isolated to security modules within one chassis.
- Firepower 4100—Supported for up to 16 nodes using clustering with multiple chassis.

### User Roles

- Admin
- Access Admin
- Network Admin

### Clustering Hardware and Software Requirements

All chassis in a cluster:

- Native instance clustering—For the Firepower 4100: All chassis must be the same model. For the Firepower 9300: All security modules must be the same type. For example, if you use clustering, all modules in the Firepower 9300 must be SM-40s. You can have different quantities of installed security modules in each chassis, although all modules present in the chassis must belong to the cluster including any empty slots.
- Container instance clustering—We recommend that you use the same security module or chassis model for each cluster instance. However, you can mix and match container instances on different Firepower 9300 security module types or Firepower 4100 models in the same cluster if required. You cannot mix Firepower 9300 and 4100 instances in the same cluster. For example, you can create a cluster using an instance on a Firepower 9300 SM-56, SM-48, and SM-40. Or you can create a cluster on a Firepower 4145 and a 4125.

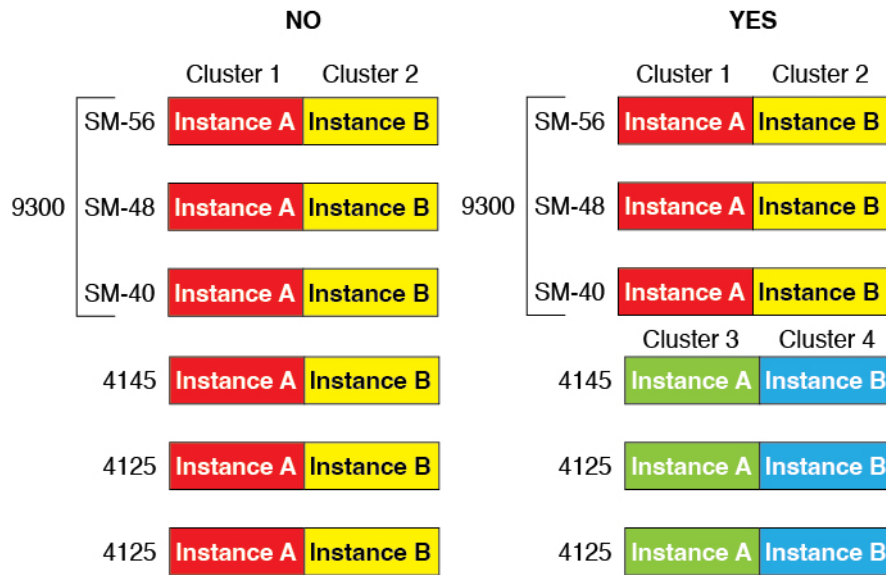

- Must run the identical FXOS and application software except at the time of an image upgrade. Mismatched software versions can lead to poor performance, so be sure to upgrade all nodes in the same maintenance window.
- Must include the same interface configuration for interfaces you assign to the cluster, such as the same Management interface, EtherChannels, active interfaces, speed and duplex, and so on. You can use different network module types on the chassis as long as the capacity matches for the same interface IDs and interfaces can successfully bundle in the same spanned EtherChannel. Note that all data interfaces must be EtherChannels in clusters with multiple chassis. If you change the interfaces in FXOS after you enable clustering (by adding or removing interface modules, or configuring EtherChannels, for example), then perform the same changes on each chassis, starting with the data nodes, and ending with the control node.
- Must use the same NTP server. For threat defense, the management center must also use the same NTP server. Do not set the time manually.

**Multi-Instance Clustering Requirements**

- No intra-security-module/engine clustering—For a given cluster, you can only use a single container instance per security module/engine. You cannot add 2 container instances to the same cluster if they are running on the same module.

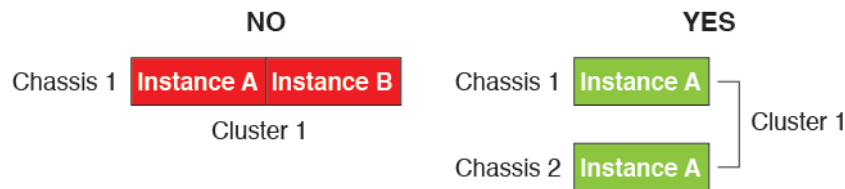

- Mix and match clusters and standalone instances—Not all container instances on a security module/engine need to belong to a cluster. You can use some instances as standalone or High Availability nodes. You can also create multiple clusters using separate instances on the same security module/engine.

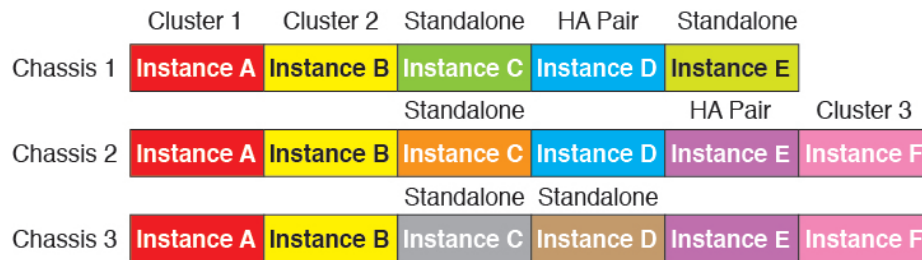

- All 3 modules in a Firepower 9300 must belong to the cluster—For the Firepower 9300, a cluster requires a single container instance on all 3 modules. You cannot create a cluster using instances on module 1 and 2, and then use a native instance on module 3, or example.



- Match resource profiles—We recommend that each node in the cluster use the same resource profile attributes; however, mismatched resources are allowed when changing cluster nodes to a different resource profile, or when using different models.
- Dedicated cluster control link—For clusters with multiple chassis, each cluster needs a dedicated cluster control link. For example, each cluster can use a separate subinterface on the same cluster-type EtherChannel, or use separate EtherChannels.

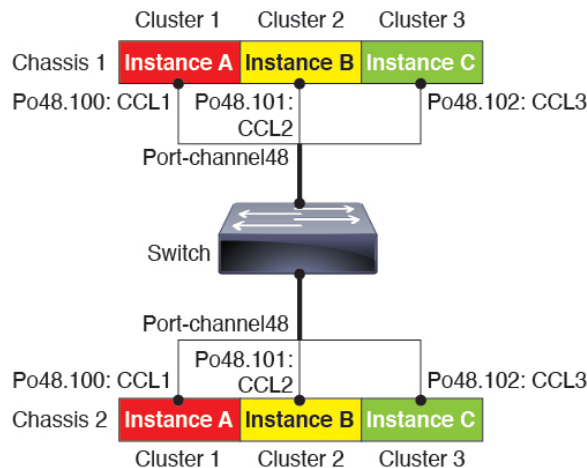

- No shared interfaces—Shared-type interfaces are not supported with clustering. However, the same Management and Eventing interfaces can be used by multiple clusters.
- No subinterfaces—A multi-instance cluster cannot use FXOS-defined VLAN subinterfaces. An exception is made for the cluster control link, which can use a subinterface of the Cluster EtherChannel.
- Mix chassis models—We recommend that you use the same security module or chassis model for each cluster instance. However, you can mix and match container instances on different Firepower 9300



security module types or Firepower 4100 models in the same cluster if required. You cannot mix Firepower 9300 and 4100 instances in the same cluster. For example, you can create a cluster using an instance on a Firepower 9300 SM-56, SM-48, and SM-40. Or you can create a cluster on a Firepower 4145 and a 4125.

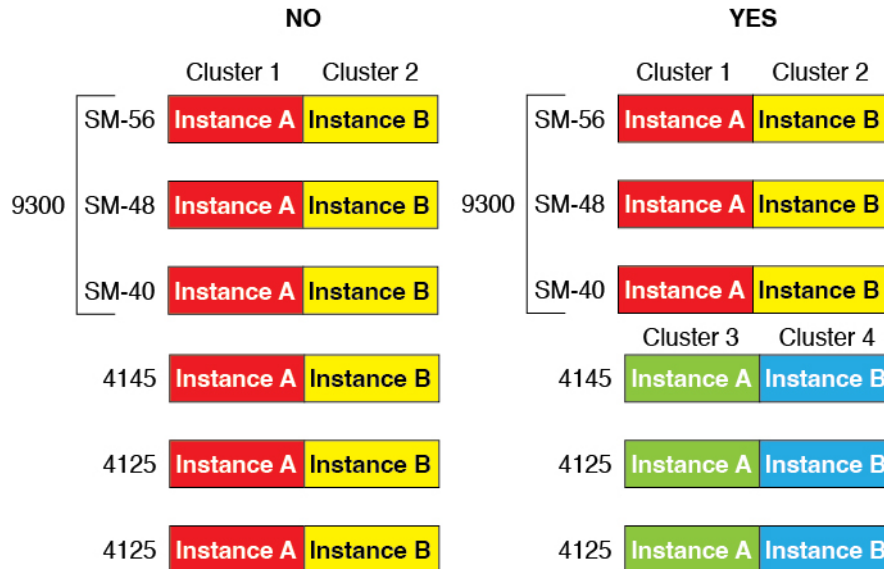

- Maximum 6 nodes—You can use up to six container instances in a cluster.

### Switch Requirements

- Be sure to complete the switch configuration and successfully connect all the EtherChannels from the chassis to the switch(es) before you configure clustering on the Firepower 4100/9300 chassis.
- For supported switch characteristics, see [Cisco FXOS Compatibility](#).

## Clustering Guidelines and Limitations

### Switches for Clustering

- Make sure connected switches match the MTU for both cluster data interfaces and the cluster control link interface. You should configure the cluster control link interface MTU to be at least 100 bytes higher than the data interface MTU, so make sure to configure the cluster control link connecting switch appropriately. Because the cluster control link traffic includes data packet forwarding, the cluster control link needs to accommodate the entire size of a data packet plus cluster traffic overhead. In addition, we do not recommend setting the cluster control link MTU between 2561 and 8362; due to block pool handling, this MTU size is not optimal for system operation.
- For Cisco IOS XR systems, if you want to set a non-default MTU, set the IOS XR interface MTU to be 14 bytes higher than the cluster device MTU. Otherwise, OSPF adjacency peering attempts may fail unless the **mtu-ignore** option is used. Note that the cluster device MTU should match the IOS XR *IPv4* MTU. This adjustment is not required for Cisco Catalyst and Cisco Nexus switches.

- On the switch(es) for the cluster control link interfaces, you can optionally enable Spanning Tree PortFast on the switch ports connected to the cluster unit to speed up the join process for new units.
- On the switch, we recommend that you use one of the following EtherChannel load-balancing algorithms: **source-dest-ip** or **source-dest-ip-port** (see the Cisco Nexus OS and Cisco IOS-XE **port-channel load-balance** command). Do not use a **vlan** keyword in the load-balance algorithm because it can cause unevenly distributed traffic to the devices in a cluster.
- If you change the load-balancing algorithm of the EtherChannel on the switch, the EtherChannel interface on the switch temporarily stops forwarding traffic, and the Spanning Tree Protocol restarts. There will be a delay before traffic starts flowing again.
- Switches on the cluster control link path should not verify the L4 checksum. Redirected traffic over the cluster control link does not have a correct L4 checksum. Switches that verify the L4 checksum could cause traffic to be dropped.
- Port-channel bundling downtime should not exceed the configured keepalive interval.
- On Supervisor 2T EtherChannels, the default hash distribution algorithm is adaptive. To avoid asymmetric traffic in a VSS design, change the hash algorithm on the port-channel connected to the cluster device to fixed:
 

```
router(config)# port-channel id hash-distribution fixed
```

Do not change the algorithm globally; you may want to take advantage of the adaptive algorithm for the VSS peer link.
- Firepower 4100/9300 clusters support LACP graceful convergence. So you can leave LACP graceful convergence enabled on connected Cisco Nexus switches.
- When you see slow bundling of a Spanned EtherChannel on the switch, you can enable LACP rate fast for an individual interface on the switch. FXOS EtherChannels have the LACP rate set to fast by default. Note that some switches, such as the Nexus series, do not support LACP rate fast when performing in-service software upgrades (ISSUs), so we do not recommend using ISSUs with clustering.

### EtherChannels for Clustering

- In Catalyst 3750-X Cisco IOS software versions earlier than 15.1(1)S2, the cluster unit did not support connecting an EtherChannel to a switch stack. With default switch settings, if the cluster unit EtherChannel is connected cross stack, and if the control unit switch is powered down, then the EtherChannel connected to the remaining switch will not come up. To improve compatibility, set the **stack-mac persistent timer** command to a large enough value to account for reload time; for example, 8 minutes or 0 for indefinite. Or, you can upgrade to more a more stable switch software version, such as 15.1(1)S2.
- Spanned vs. Device-Local EtherChannel Configuration—Be sure to configure the switch appropriately for Spanned EtherChannels vs. Device-local EtherChannels.
  - Spanned EtherChannels—For cluster unit *Spanned* EtherChannels, which span across all members of the cluster, the interfaces are combined into a single EtherChannel on the switch. Make sure each interface is in the same channel group on the switch.

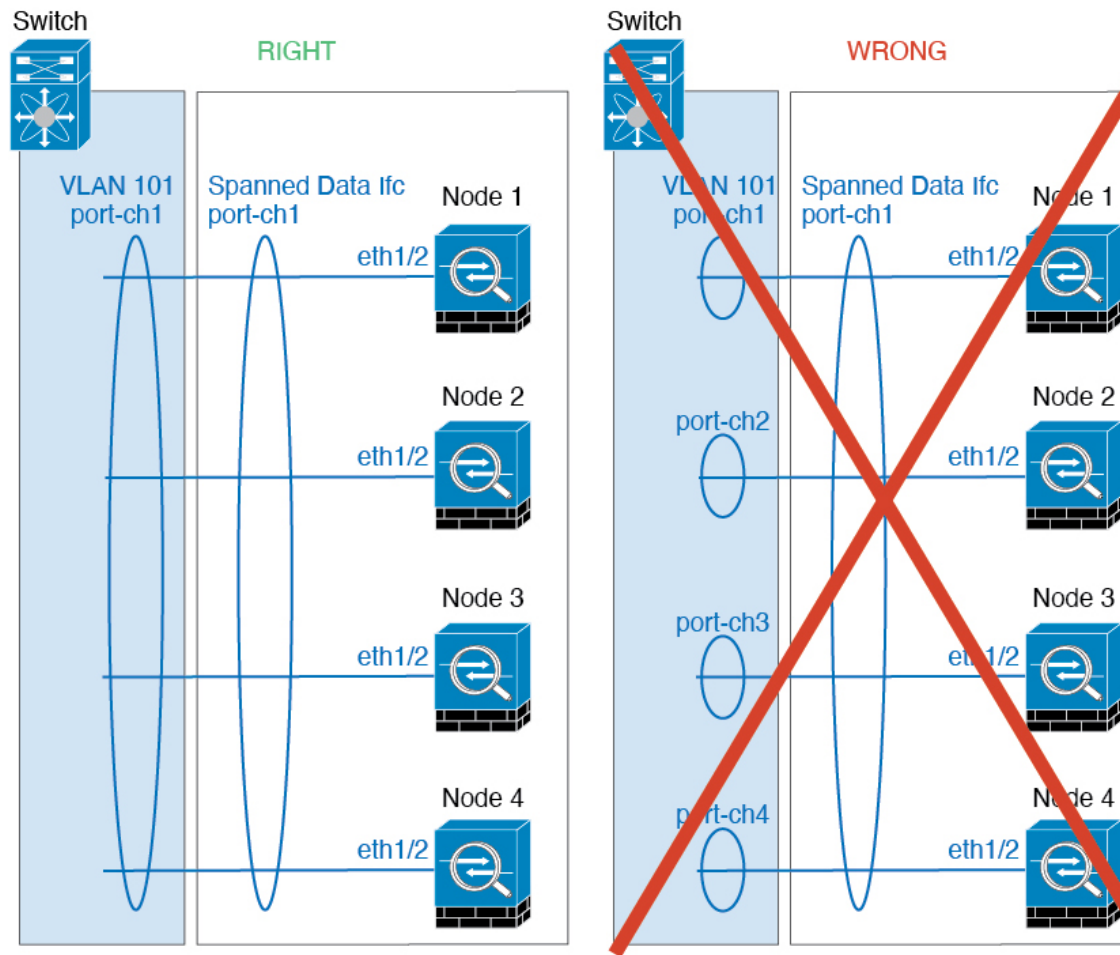

- Device-local EtherChannels—For cluster unit *Device-local* EtherChannels including any EtherChannels configured for the cluster control link, be sure to configure discrete EtherChannels on the switch; do not combine multiple cluster unit EtherChannels into one EtherChannel on the switch.

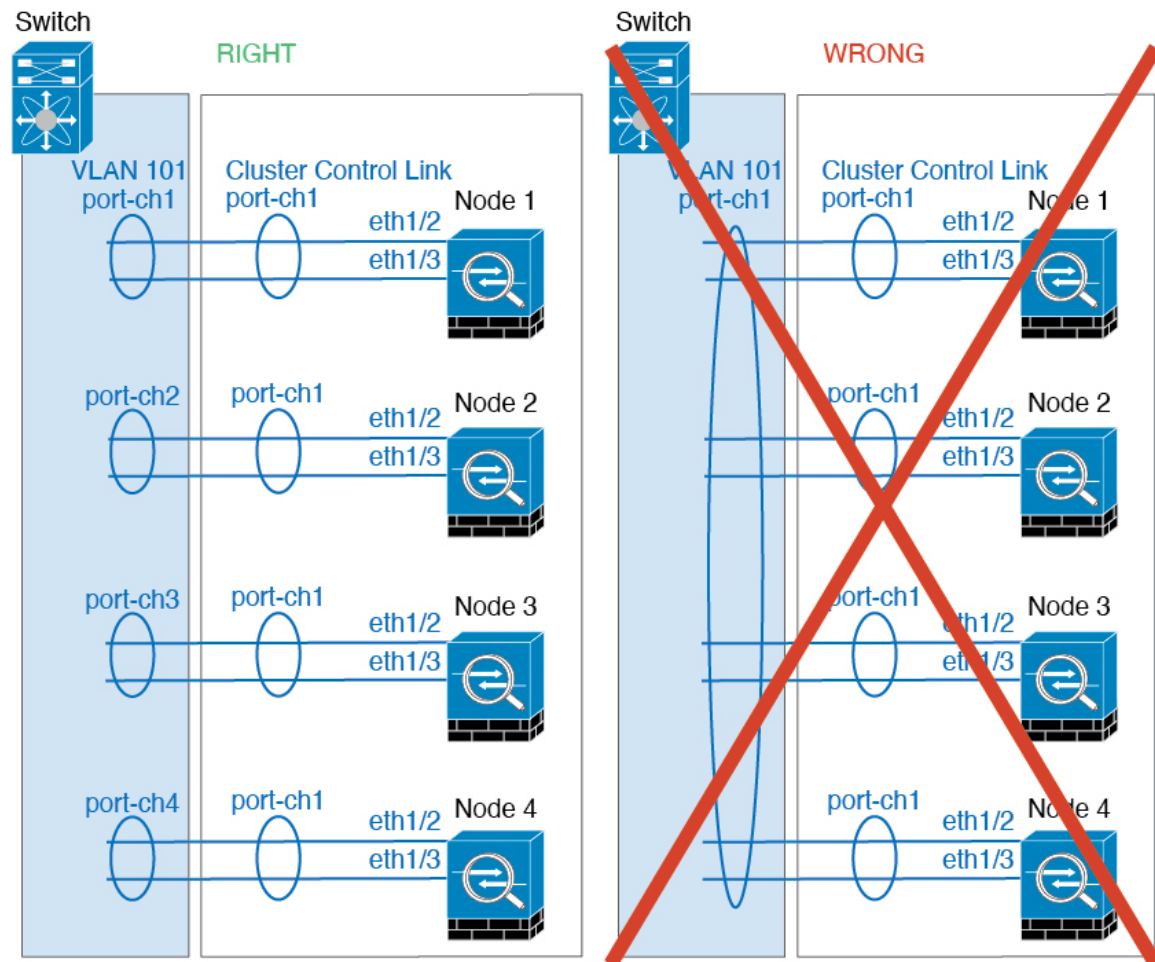

### Additional Guidelines

- When significant topology changes occur (such as adding or removing an EtherChannel interface, enabling or disabling an interface on the Firepower 4100/9300 chassis or the switch, adding an additional switch to form a VSS, vPC, StackWise, or StackWise Virtual) you should disable the health check feature, and also disable interface monitoring for the disabled interfaces. When the topology change is complete, and the configuration change is synced to all units, you can re-enable the health check feature.
- When adding a unit to an existing cluster, or when reloading a unit, there will be a temporary, limited packet/connection drop; this is expected behavior. In some cases, the dropped packets can hang connections; for example, dropping a FIN/ACK packet for an FTP connection will make the FTP client hang. In this case, you need to reestablish the FTP connection.
- If you use a Windows 2003 server connected to a Spanned EtherChannel interface, when the syslog server port is down, and the server does not throttle ICMP error messages, then large numbers of ICMP messages are sent back to the cluster. These messages can result in some units of the cluster experiencing high CPU, which can affect performance. We recommend that you throttle ICMP error messages.
- We recommend connecting EtherChannels to a VSS, vPC, StackWise, or StackWise Virtual for redundancy.

- Within a chassis, you cannot cluster some security modules and run other security modules in standalone mode; you must include all security modules in the cluster.
- For decrypted TLS/SSL connections, the decryption states are not synchronized, and if the connection owner fails, then decrypted connections will be reset. New connections will need to be established to a new unit. Connections that are not decrypted (they match a do-not-decrypt rule) are not affected and are replicated correctly.

### Defaults

- The cluster health check feature is enabled by default with the holdtime of 3 seconds. Interface health monitoring is enabled on all interfaces by default.
- The cluster auto-rejoin feature for a failed cluster control link is set to unlimited attempts every 5 minutes.
- The cluster auto-rejoin feature for a failed data interface is set to 3 attempts every 5 minutes, with the increasing interval set to 2.
- Connection replication delay of 5 seconds is enabled by default for HTTP traffic.

## Configure Clustering

You can easily deploy the cluster from the Firepower 4100/9300 supervisor. All initial configuration is automatically generated for each unit. You can then add the units to the management center and group them into a cluster.

### FXOS: Add a Threat Defense Cluster

In native mode: You can add a cluster to a single Firepower 9300 chassis that is isolated to security modules within the chassis, or you can use multiple chassis.

In multi-instance mode: You can add one or more clusters to a single Firepower 9300 chassis that are isolated to security modules within the chassis (you must include an instance on each module), or add one or more clusters on multiple chassis.

For clusters on multiple chassis, you must configure each chassis separately. Add the cluster on one chassis; you can then copy the bootstrap configuration from the first chassis to the next chassis for ease of deployment.

### Create a Threat Defense Cluster

You can easily deploy the cluster from the Firepower 4100/9300 chassis supervisor. All initial configuration is automatically generated for each unit.

For clustering on multiple chassis, you must configure each chassis separately. Deploy the cluster on one chassis; you can then copy the bootstrap configuration from the first chassis to the next chassis for ease of deployment.

In a Firepower 9300 chassis, you must enable clustering for all 3 module slots, or for container instances, a container instance in each slot, even if you do not have a module installed. If you do not configure all 3 modules, the cluster will not come up.

## Before you begin

- Download the application image you want to use for the logical device from Cisco.com, and then upload that image to the Firepower 4100/9300 chassis.
- For container instances, if you do not want to use the default profile, add a resource profile according to [Add a Resource Profile for Container Instances](#).
- For container instances, before you can install a container instance for the first time, you must reinitialize the security module/engine so that the disk has the correct formatting. Choose **Security Modules** or **Security Engine**, and click the Reinitialize icon (⚙️). An existing logical device will be deleted and then reinstalled as a new device, losing any local application configuration. If you are replacing a native instance with container instances, you will need to delete the native instance in any case. You cannot automatically migrate a native instance to a container instance.
- Gather the following information:
  - Management interface ID, IP addresses, and network mask
  - Gateway IP address
  - management center IP address and/or NAT ID of your choosing
  - DNS server IP address
  - Threat Defense hostname and domain name

## Procedure

---

### Step 1

Configure interfaces.

- a) Add at least one Data type interface or EtherChannel (also known as a port-channel) before you deploy the cluster. See [Add an EtherChannel \(Port Channel\)](#) or [Configure a Physical Interface](#).

For clustering on multiple chassis, all data interfaces must be Spanned EtherChannels with at least one member interface. Add the same EtherChannels on each chassis. Combine the member interfaces from all cluster units into a single EtherChannel on the switch. See [Clustering Guidelines and Limitations, on page 9](#) for more information about EtherChannels.

For multi-instance clustering, you cannot use FXOS-defined VLAN subinterfaces or data-sharing interfaces in the cluster. Only application-defined subinterfaces are supported. See [FXOS Interfaces vs. Application Interfaces](#) for more information.

- b) Add a Management type interface or EtherChannel. See [Add an EtherChannel \(Port Channel\)](#) or [Configure a Physical Interface](#).

The management interface is required. Note that this management interface is not the same as the chassis management interface that is used only for chassis management (in FXOS, you might see the chassis management interface displayed as MGMT, management0, or other similar names).

For clustering on multiple chassis, add the same Management interface on each chassis.

For multi-instance clustering, you can share the same management interface across multiple clusters on the same chassis, or with standalone instances.

- c) For clustering on multiple chassis, add a member interface to the cluster control link EtherChannel (by default, port-channel 48). See [Add an EtherChannel \(Port Channel\)](#).

Do not add a member interface for a cluster isolated to security modules within one Firepower 9300 chassis. If you add a member, the chassis assumes this cluster will be using multiple chassis, and will only allow you to use Spanned EtherChannels, for example.

On the **Interfaces** tab, the port-channel 48 cluster type interface shows the **Operation State** as **failed** if it does not include any member interfaces. For a cluster isolated to security modules within one Firepower 9300 chassis, this EtherChannel does not require any member interfaces, and you can ignore this Operational State.

Add the same member interfaces on each chassis. The cluster control link is a device-local EtherChannel on each chassis. Use separate EtherChannels on the switch per device. See [Clustering Guidelines and Limitations, on page 9](#) for more information about EtherChannels.

For multi-instance clustering, you can create additional Cluster type EtherChannels. Unlike the Management interface, the cluster control link is *not* sharable across multiple devices, so you will need a Cluster interface for each cluster. However, we recommend using VLAN subinterfaces instead of multiple EtherChannels; see the next step to add a VLAN subinterface to the Cluster interface.

- d) For multi-instance clustering, add VLAN subinterfaces to the cluster EtherChannel so you have a subinterface for each cluster. See [Add a VLAN Subinterface for Container Instances](#).

If you add subinterfaces to a Cluster interface, you cannot use that interface for a native cluster.

- e) (Optional) Add an eventing interface. See [Add an EtherChannel \(Port Channel\)](#) or [Configure a Physical Interface](#).

This interface is a secondary management interface for the threat defense devices. To use this interface, you must configure its IP address and other parameters at the threat defense CLI. For example, you can separate management traffic from events (such as web events). See the **configure network** commands in the threat defense command reference.

For clustering on multiple chassis, add the same eventing interface on each chassis.

## Step 2

Choose **Logical Devices**.

## Step 3

Click **Add > Cluster**, and set the following parameters:

**Figure 1: Native Cluster**

Label	Value
I want to:	Create New Cluster
Device Name:	cluster1
Template:	Cisco Secure Firewall Threat Defense
Image Version:	7.3.0.1676
Instance Type:	Native

Figure 2: Multi-Instance Cluster

- a) Choose **I want to:** > **Create New Cluster**
- b) Provide a **Device Name**.

This name is used internally by the chassis supervisor to configure management settings and to assign interfaces; it is not the device name used in the application configuration.

- c) For the **Template**, choose **Cisco Firepower Threat Defense**.
- d) Choose the **Image Version**.
- e) For the **Instance Type**, choose either **Native** or **Container**.

A native instance uses all of the resources (CPU, RAM, and disk space) of the security module/engine, so you can only install one native instance. A container instance uses a subset of resources of the security module/engine, so you can install multiple container instances.

- f) (Container Instance only) For the **Resource Type**, choose one of the resource profiles from the drop-down list.

For the Firepower 9300, this profile will be applied to each instance on each security module. You can set different profiles per security module later in this procedure; for example, if you are using different security module types, and you want to use more CPUs on a lower-end model. We recommend choosing the correct profile before you create the cluster. If you need to create a new profile, cancel out of the cluster creation, and add one using [Add a Resource Profile for Container Instances](#).

**Note** If you assign a different profile to instances in an established cluster, which allows mismatched profiles, then apply the new profile on the data nodes first; after they reboot and come back up, you can apply the new profile to the control node.

- g) Click **OK**.

You see the Provisioning - *device name* window.

**Step 4** Choose the interfaces you want to assign to this cluster.



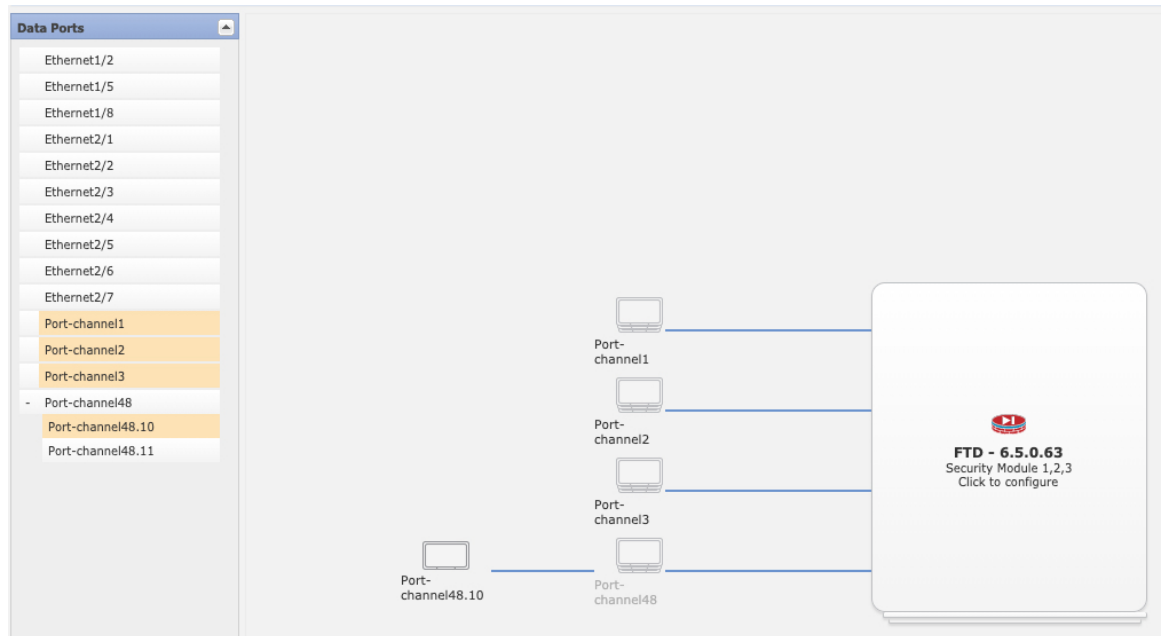

For native mode clustering: All valid interfaces are assigned by default. If you defined multiple Cluster type interfaces, deselect all but one.

For multi-instance clustering: Choose each data interface you want to assign to the cluster, and also choose the Cluster type port-channel or port-channel subinterface.

**Step 5** Click the device icon in the center of the screen.

A dialog box appears where you can configure initial bootstrap settings. These settings are meant for initial deployment only, or for disaster recovery. For normal operation, you can later change most values in the application CLI configuration.

**Step 6** On the **Cluster Information** page, complete the following.

Figure 3: Native Cluster

Cisco Secure Firewall Threat Defense - Bootstrap Configuration

Cluster Information | Interface Information | Settings | Agreement

**Security Module**  
Security Module - 1, Security Module - 2, Security Module - 3

**Interface Information**

Chassis ID: 1

Site ID: 1

Cluster Key: \*\*\*\*

Confirm Cluster Key: \*\*\*\*

Cluster Group Name: cluster1

Management Interface: Ethernet1/4

CCL Subnet IP: Eg:x.x.0.0

OK Cancel

Figure 4: Multi-Instance Cluster

Cisco Secure Firewall Threat Defense - Bootstrap Configuration

Cluster Information | Interface Information | Settings | Agreement

**Resource Profile Selection**

Security Module 1: (72 Cores Available) Default-Small

Security Module 2: (46 Cores Available) Default-Small

Security Module 3: Default-Small

**Interface Information**

Chassis ID: 1

Site ID: 1

Cluster Key: \*\*\*\*

Confirm Cluster Key: \*\*\*\*

Cluster Group Name: mi-cluster-1

Management Interface: Ethernet1/4

CCL Subnet IP: Eg:x.x.0.0

OK Cancel

- (Container Instance for the Firepower 9300 only) In the **Security Module (SM) and Resource Profile Selection** area, you can set a different resource profile per module; for example, if you are using different security module types, and you want to use more CPUs on a lower-end model.
- For clustering on multiple chassis, in the **Chassis ID** field, enter a chassis ID. Each chassis in the cluster must use a unique ID.

This field only appears if you added a member interface to cluster control link Port-Channel 48.

- For inter-site clustering, in the **Site ID** field, enter the site ID for this chassis between 1 and 8. FlexConfig feature. Additional inter-site cluster customizations to enhance redundancy and stability, such as director

localization, site redundancy, and cluster flow mobility, are only configurable using the management center FlexConfig feature.

- d) In the **Cluster Key** field, configure an authentication key for control traffic on the cluster control link.

The shared secret is an ASCII string from 1 to 63 characters. The shared secret is used to generate the key. This option does not affect datapath traffic, including connection state update and forwarded packets, which are always sent in the clear.

- e) Set the **Cluster Group Name**, which is the cluster group name in the logical device configuration.

The name must be an ASCII string from 1 to 38 characters.

**Important** From 2.4.1, spaces in cluster group name will be considered as special characters and may result in error while deploying the logical devices. To avoid this issue, you must rename the cluster group name without a space.

- f) Choose the **Management Interface**.

This interface is used to manage the logical device. This interface is separate from the chassis management port.

If you assign a Hardware Bypass-capable interface as the Management interface, you see a warning message to make sure your assignment is intentional.

- g) (Optional) Set the **CCL Subnet IP** as *a.b.0.0*.

By default, the cluster control link uses the 127.2.0.0/16 network. However, some networking deployments do not allow 127.2.0.0/16 traffic to pass. In this case, specify any /16 network address on a unique network for the cluster, except for loopback (127.0.0.0/8), multicast (224.0.0.0/4), and internal (169.254.0.0/16) addresses. If you set the value to 0.0.0.0, then the default network is used.

The chassis auto-generates the cluster control link interface IP address for each unit based on the chassis ID and slot ID: *a.b.chassis\_id.slot\_id*.

**Step 7** On the **Settings** page, complete the following.

Cisco Secure Firewall Threat Defense - Bootstrap Configuration ? ×Cluster Information   Interface Information   Settings   Agreement

Management type of application instance:	FMC
Search domains:	cisco.com
Firewall Mode:	Routed
DNS Servers:	10.89.5.67
Fully Qualified Hostname:	td2.cisco.com
Password:	.....
Confirm Password:	.....
Registration Key:	....
Confirm Registration Key:	....
CDO Onboard:	
Confirm CDO Onboard:	
Firepower Management Center IP:	10.89.5.35
Firepower Management Center NAT ID:	test
Eventing Interface:	

OK   Cancel

- a) In the **Registration Key** field, enter the key to be shared between the management center and the cluster members during registration.

You can choose any text string for this key between 1 and 37 characters; you will enter the same key on the management center when you add the threat defense.

- b) Enter a **Password** for the threat defense admin user for CLI access.
- c) In the **Firepower Management Center IP** field, enter the IP address of the managing management center. If you do not know the management center IP address, leave this field blank and enter a passphrase in the **Firepower Management Center NAT ID** field.
- d) (Optional) For a container instance, **Permit Expert mode from FTD SSH sessions: Yes** or **No**. Expert Mode provides threat defense shell access for advanced troubleshooting.

If you choose **Yes** for this option, then users who access the container instance directly from an SSH session can enter Expert Mode. If you choose **No**, then only users who access the container instance from the FXOS CLI can enter Expert Mode. We recommend choosing **No** to increase isolation between instances.

Use Expert Mode only if a documented procedure tells you it is required, or if the Cisco Technical Assistance Center asks you to use it. To enter this mode, use the **expert** command in the threat defense CLI.

- e) (Optional) In the **Search Domains** field, enter a comma-separated list of search domains for the management network.
- f) (Optional) From the **Firewall Mode** drop-down list, choose **Transparent** or **Routed**.

In routed mode, the threat defense is considered to be a router hop in the network. Each interface that you want to route between is on a different subnet. A transparent firewall, on the other hand, is a Layer 2 firewall that acts like a “bump in the wire,” or a “stealth firewall,” and is not seen as a router hop to connected devices.

The firewall mode is only set at initial deployment. If you re-apply the bootstrap settings, this setting is not used.

- g) (Optional) In the **DNS Servers** field, enter a comma-separated list of DNS servers.  
The threat defense uses DNS if you specify a hostname for the management center, for example.
- h) (Optional) In the **Firepower Management Center NAT ID** field, enter a passphrase that you will also enter on the management center when you add the cluster as a new device.

Normally, you need both IP addresses (along with a registration key) for both routing purposes and for authentication: the management center specifies the device IP address, and the device specifies the management center IP address. However, if you only know one of the IP addresses, which is the minimum requirement for routing purposes, then you must also specify a unique NAT ID on both sides of the connection to establish trust for the initial communication and to look up the correct registration key. You can specify any text string as the NAT ID, from 1 to 37 characters. The management center and device use the registration key and NAT ID (instead of IP addresses) to authenticate and authorize for initial registration.

- i) (Optional) In the **Fully Qualified Hostname** field, enter a fully qualified name for the threat defense device.  
Valid characters are the letters from a to z, the digits from 0 to 9, the dot (.), and the hyphen (-); maximum number of characters is 253.
- j) (Optional) From the **Eventing Interface** drop-down list, choose the interface on which events should be sent. If not specified, the management interface will be used.  
To specify a separate interface to use for events, you must configure an interface as a *firepower-eventing* interface. If you assign a Hardware Bypass-capable interface as the Eventing interface, you see a warning message to make sure your assignment is intentional.

### Step 8

On the **Interface Information** page, configure a management IP address for each security module in the cluster. Select the type of address from the **Address Type** drop-down list and then complete the following for each security module.

**Note** You must set the IP address for all 3 module slots in a chassis, even if you do not have a module installed. If you do not configure all 3 modules, the cluster will not come up.

Cisco Secure Firewall Threat Defense - Bootstrap Configuration

Cluster Information **Interface Information** Settings Agreement

Address Type: IPv4 only

**Security Module 1**  
 IPv4  
 Management IP: 10.89.5.20  
 Network Mask: 255.255.255.192  
 Gateway: 10.89.5.1

**Security Module 2**  
 IPv4  
 Management IP: 10.89.5.21  
 Network Mask: 255.255.255.192  
 Gateway: 10.89.5.1

**Security Module 3**  
 IPv4  
 Management IP: 10.89.5.22  
 Network Mask: 255.255.255.192  
 Gateway: 10.89.5.1

OK Cancel

- In the **Management IP** field, configure an IP address.  
Specify a unique IP address on the same network for each module.
- Enter a **Network Mask** or **Prefix Length**.
- Enter a **Network Gateway** address.

**Step 9** On the **Agreement** tab, read and accept the end user license agreement (EULA).

**Step 10** Click **OK** to close the configuration dialog box.

**Step 11** Click **Save**.

The chassis deploys the logical device by downloading the specified software version and pushing the bootstrap configuration and management interface settings to the application instance. Check the **Logical Devices** page for the status of the new logical device. When the logical device shows its **Status** as **online**, you can add the remaining cluster chassis, or for a cluster isolated to security modules within one Firepower 9300 chassis, start configuring the cluster in the application. You may see the "Security module not responding" status as part of the process; this status is normal and is temporary.

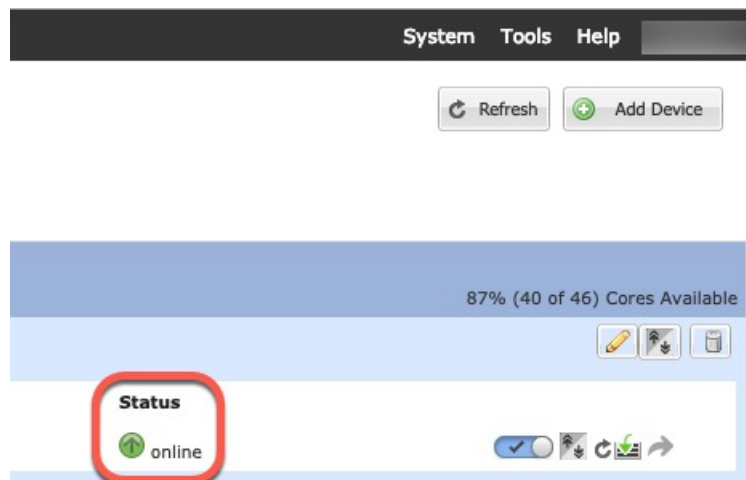

**Step 12**

For clustering on multiple chassis, add the next chassis to the cluster:

- a) On the first chassis of the chassis manager, click the **Show Configuration icon** at the top right; copy the displayed cluster configuration.
- b) Connect to the chassis manager on the next chassis, and add a logical device according to this procedure.
- c) Choose **I want to: > Join an Existing Cluster**.
- d) Click **OK**.
- e) In the **Copy Cluster Details** box, paste in the cluster configuration from the first chassis, and click **OK**.
- f) Click the device icon in the center of the screen. The cluster information is mostly pre-filled, but you must change the following settings:

- **Chassis ID**—Enter a unique chassis ID.
- **Site ID**—For inter-site clustering, enter the site ID for this chassis between 1 and 8. Additional inter-site cluster customizations to enhance redundancy and stability, such as director localization, site redundancy, and cluster flow mobility, are only configurable using the management center FlexConfig feature.
- **Cluster Key**—(Not prefilled) Enter the same cluster key.
- **Management IP**—Change the management address for each module to be a unique IP address on the same network as the other cluster members.

Click **OK**.

- g) Click **Save**.

The chassis deploys the logical device by downloading the specified software version and pushing the bootstrap configuration and management interface settings to the application instance. Check the **Logical Devices** page for each cluster member for the status of the new logical device. When the logical device for each cluster member shows its **Status as online**, you can start configuring the cluster in the application. You may see the "Security module not responding" status as part of the process; this status is normal and is temporary.

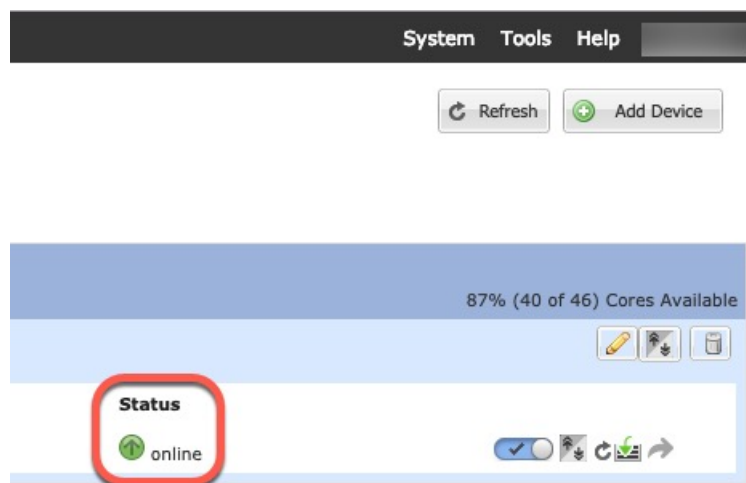
**Step 13**

Add the control unit to the management center using the management IP address.

All cluster units must be in a successfully-formed cluster on FXOS prior to adding them to management center.

The management center then automatically detects the data units.

## Add More Cluster Nodes

Add or replace the threat defense cluster node in an existing cluster. When you add a new cluster node in FXOS, the management center adds the node automatically.



**Note** The FXOS steps in this procedure only apply to adding a new *chassis*; if you are adding a new module to a Firepower 9300 where clustering is already enabled, the module will be added automatically.

### Before you begin

- In the case of a replacement, you must delete the old cluster node from the management center. When you replace it with a new node, it is considered to be a new device on the management center.
- The interface configuration must be the same on the new chassis. You can export and import FXOS chassis configuration to make this process easier.

### Procedure

**Step 1** If you previously upgraded the threat defense image using the management center, perform the following steps *on each chassis in the cluster*.

When you upgraded from the management center, the startup version in the FXOS configuration was not updated, and the standalone package was not installed on the chassis. Both of these items need to be set manually so the new node can join the cluster using the correct image version.

**Note** If you only applied a patch release, you can skip this step. Cisco does not provide standalone packages for patches.

- Install the running threat defense image on the chassis using the **System > Updates** page.
- Click **Logical Devices** and click the Set Version icon (⚙️). For a Firepower 9300 with multiple modules, set the version for each module.

The **Startup Version** shows the original package you deployed with. The **Current Version** shows the version you upgraded to.

- In the **New Version** drop-down menu, choose the version that you uploaded. This version should match the **Current Version** displayed, and will set the startup version to match the new version.
- On the new chassis, make sure the new image package is installed.

**Step 2** On an existing cluster chassis chassis manager, click **Logical Devices**.

**Step 3** Click the **Show Configuration icon** at the top right; copy the displayed cluster configuration.

**Step 4** Connect to the chassis manager on the new chassis, and click **Add > Cluster**.

**Step 5** For the **Device Name**, provide a name for the logical device.

**Step 6** Click **OK**.

**Step 7** In the **Copy Cluster Details** box, paste in the cluster configuration from the first chassis, and click **OK**.



**Step 8** Click the device icon in the center of the screen. The cluster information is partly pre-filled, but you must fill in the following settings:

**Figure 5: Cluster Information**

Cisco Secure Firewall Threat Defense - Bootstrap Configuration

Cluster Information Interface Information Settings Agreement

Security Module

Security Module - 1, Security Module - 2, Security Module - 3

Interface Information

Chassis ID:

Site ID:

Cluster Key:

Confirm Cluster Key:

Cluster Group Name:

Management Interface:

CCL Subnet IP:

OK Cancel

Figure 6: Interface Information

Cisco Secure Firewall Threat Defense - Bootstrap Configuration

Cluster Information **Interface Information** Settings Agreement

Address Type: IPv4 only

**Security Module 1**

Management IP:

Network Mask: 255.255.255.192

Gateway: 10.89.5.1

**Security Module 2**

Management IP:

Network Mask: 255.255.255.192

Gateway: 10.89.5.1

**Security Module 3**

Management IP:

Network Mask: 255.255.255.192

Gateway: 10.89.5.1

OK Cancel

Figure 7: Settings

Cisco Secure Firewall Threat Defense - Bootstrap Configuration

Cluster Information Interface Information **Settings** Agreement

Management type of application instance: FMC

Search domains: cisco.com

Firewall Mode: Routed

DNS Servers: 72.163.47.11

Fully Qualified Hostname:

Password:

Confirm Password:

Registration Key:

Confirm Registration Key:

CDO Onboard:

Confirm CDO Onboard:

Firepower Management Center IP: 10.89.5.35

Firepower Management Center NAT ID: 93002

Eventing Interface:

OK Cancel

- **Chassis ID**—Enter a *unique* chassis ID.

- **Site ID**—For inter-site clustering, enter the site ID for this chassis between 1 and 8. This feature is only configurable using the management center FlexConfig feature.
- **Cluster Key**—Enter the *same* cluster key.
- **Management IP**—Change the management address for each module to be a *unique* IP address on the same network as the other cluster members.
- **Fully Qualified Hostname**—Enter the *same* hostname.
- **Password**—Enter the *same* password.
- **Registration Key**—Enter the *same* registration key.

Click **OK**.

**Step 9** Click **Save**.

The chassis deploys the logical device by downloading the specified software version and pushing the bootstrap configuration and management interface settings to the application instance. Check the **Logical Devices** page for each cluster member for the status of the new logical device. When the logical device for each cluster member shows its **Status** as **online**, you can start configuring the cluster in the application. You may see the "Security module not responding" status as part of the process; this status is normal and is temporary.

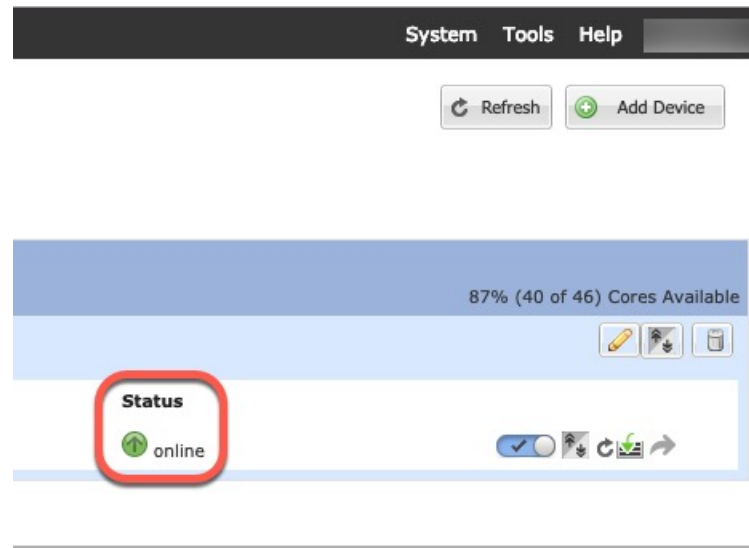

## Management Center: Add a Cluster

Add one of the cluster units as a new device to the Secure Firewall Management Center; the management center auto-detects all other cluster members.

### Before you begin

- All cluster units must be in a successfully-formed cluster on FXOS prior to adding the cluster to the management center. You should also check which unit is the control unit. Refer to the chassis manager **Logical Devices** screen or use the threat defense **show cluster info** command.

## Procedure

### Step 1

In the management center, choose **Devices > Device Management**, and then choose **Add > Add Device** to add the control unit using the unit's management IP address you assigned when you deployed the cluster.

**Figure 8: Add Device**

Add Device ?

CDO Managed Device

Host:†

Display Name:

Registration Key:\*

Group:

Access Control Policy:\*

Smart Licensing

Note: All virtual Firewall Threat Defense devices require a performance tier license. Make sure your Smart Licensing account contains the available licenses you need. It's important to choose the tier that matches the license you have in your account. Click [here](#) for information about the Firewall Threat Defense performance-tiered licensing. Until you choose a tier, your Firewall Threat Defense virtual defaults to the FTDv50 selection.

Performance Tier (only for Firewall Threat Defense virtual 7.0 and above):

Malware  
 Threat  
 URL Filtering

Advanced

Unique NAT ID:†

Transfer Packets

- a) In the **Host** field, enter the IP address or hostname of the control unit.

We recommend adding the control unit for the best performance, but you can add any unit of the cluster.

If you used a NAT ID during device setup, you may not need to enter this field. For more information, see [NAT Environments](#).

- b) In the **Display Name** field, enter a name for the control unit as you want it to display in the management center.

This display name is not for the cluster; it is only for the control unit you are adding. You can later change the name of other cluster members and the cluster display name.

- c) In the **Registration Key** field, enter the same registration key that you used when you deployed the cluster in FXOS. The registration key is a one-time-use shared secret.
- d) (Optional) Add the device to a device **Group**.
- e) Choose an initial **Access Control Policy** to deploy to the device upon registration, or create a new policy.

If you create a new policy, you create a basic policy only. You can later customize the policy as needed.

**New Policy**

---

Name:

Description:

Select Base Policy:

Default Action:  
 Block all traffic  
 Intrusion Prevention  
 Network Discovery

Snort3:

- f) Choose licenses to apply to the device.
- g) If you used a NAT ID during device setup, expand the **Advanced** section and enter the same NAT ID in the **Unique NAT ID** field.
- h) Check the **Transfer Packets** check box to allow the device to transfer packets to the management center.

This option is enabled by default. When events like IPS or Snort are triggered with this option enabled, the device sends event metadata information and packet data to the management center for inspection. If you disable it, only event information will be sent to the management center but packet data is not sent.

- i) Click **Register**.

The management center identifies and registers the control unit, and then registers all data units. If the control unit does not successfully register, then the cluster is not added. A registration failure can occur if the cluster was not up on the chassis, or because of other connectivity issues. In this case, we recommend that you try re-adding the cluster unit.

The cluster name shows on the **Devices > Device Management** page; expand the cluster to see the cluster units.

<input type="checkbox"/>	Name	Model	Vers...	Chassis	Licenses	Access Control Policy	Auto RollBack	
<input type="checkbox"/>	▼ Ungrouped (2)							
<input type="checkbox"/>	<div style="display: flex; align-items: center;"> <span style="color: green; font-weight: bold;">10.10.1.12</span> <span style="border: 1px solid gray; padding: 2px; margin-left: 5px;">Snort 3</span> </div> <div style="font-size: small; margin-top: 2px;">10.10.1.12 - Routed</div>	FTDv for VMware	7.3.0	N/A	Essentials	wfx_automation1	⏪	✎ ⋮
<input type="checkbox"/>	▼ TD_Cluster (1) Cluster							✎ ⋮
<input checked="" type="checkbox"/>	<div style="display: flex; align-items: center;"> <span style="color: green; font-weight: bold;">10.10.1.13(Control)</span> <span style="border: 1px solid gray; padding: 2px; margin-left: 5px;">Snort 3</span> </div> <div style="font-size: small; margin-top: 2px;">10.10.1.13 - Routed</div>	FTDv for VMware	7.3.0	N/A	Essentials	wfx_automation1	N/A	⋮

A unit that is currently registering shows the loading icon.

<input type="checkbox"/>	▼ TD_Cluster (1) Cluster
<input checked="" type="checkbox"/>	<div style="display: flex; align-items: center;"> <span style="color: green; font-weight: bold;">10.10.1.13(Control)</span> <span style="border: 1px solid gray; padding: 2px; margin-left: 5px;">Snort 3</span> </div> <div style="font-size: small; margin-top: 2px;">10.10.1.13 - Routed</div>

You can monitor cluster unit registration by clicking the **Notifications** icon and choosing **Tasks**. The management center updates the Cluster Registration task as each unit registers. If any units fail to register, see [Reconcile Cluster Members, on page 46](#).

Deploy			
Deployments	Upgrades	Health	Tasks
3 total	0 running	3 success	0 warnings 0 failures
<input checked="" type="checkbox"/>	10.10.1.12	Deployment to device successful.	1m 54s
<input checked="" type="checkbox"/>	10.10.1.13	Deployment to device successful.	1m 3s
<input checked="" type="checkbox"/>	TD_Cluster	Deployment to device successful.	35s

**Step 2** Configure device-specific settings by clicking the **Edit** (✎) for the cluster.



Most configuration can be applied to the cluster as a whole, and not member units in the cluster. For example, you can change the display name per unit, but you can only configure interfaces for the whole cluster.

**Step 3** On the **Devices > Device Management > Cluster** screen, you see **General**, **License**, **System**, and **Health** settings.

TD Native Cluster	
Cisco Firepower Threat Defense for VMware	
Cluster	Device Routing Interfaces Inline Sets DHCP VTEP
	10.10.1.13
	10.10.1.13
General	System

See the following cluster-specific items:

- **General > Name**—Change the cluster display name by clicking the **Edit** (✎).

Cluster	Device	Routing	Interfaces	Inline Sets	DHCP	VTEP
<b>General</b> 						
Name:	TD_Cluster					
Transfer Packets:	Yes					
Status:						
Control:	10.10.1.13					
Cluster Live Status:	<a href="#">View</a>					

Then set the **Name** field.

General	
Name:	<input type="text" value="TD Native Cluster"/>
Transfer Packets:	<input type="checkbox"/>
Compliance Mode:	
Performance Profile:	
TLS Crypto Acceleration:	
Force Deploy:	→
<input type="button" value="Cancel"/> <input type="button" value="Save"/>	

- **General > View cluster status**—Click the **View cluster status** link to open the **Cluster Status** dialog box.

Cluster Device Routing Interfaces Inline Sets DHCP VTEP

**General**

Name: i TD Native Cluster

Transfer Packets: Yes

Status: ●

Control: 10.10.1.13

Cluster Live Status: View

The **Cluster Status** dialog box also lets you retry data unit registration by clicking **Reconcile**.

Cluster Status (2 Nodes) ? x

Status	Device Name	Unit Name	Chassis URL
In Sync.	10.89.5.20	unit-1-1	<a href="https://firepower-9300.c...">https://firepower-9300.c...</a>
In Sync.	10.89.5.21	unit-1-2	<a href="https://firepower-9300.c...">https://firepower-9300.c...</a>

Dated: 14 Jan 2020 | 01:51:51

- **General > Troubleshoot**—You can generate and download troubleshooting logs, and you can view cluster CLIs. See [Management Center: Troubleshooting the Cluster, on page 51](#).

**Figure 9: Troubleshoot**

**General**

Name: i clusterVFTD

Transfer Packets: Yes

Status: ●

Control: 10.10.43.21

Cluster Live Status: View

Troubleshoot:

- **License**—Click **Edit** () to set license entitlements.



**Step 4** On the **Devices > Device Management > Devices**, you can choose each member in the cluster from the top right drop-down menu and configure the following settings.

- **General > Name**—Change the cluster member display name by clicking the **Edit** (✎).

General	
Name:	10.89.5.21
Transfer Packets:	Yes
Mode:	routed
Compliance Mode:	None
TLS Crypto Acceleration:	Enabled

Then set the **Name** field.

General ?

---

Name:

Transfer Packets:

Mode: routed

Compliance Mode: None

Performance Profile: Default

TLS Crypto Acceleration: Disabled

Force Deploy: →

- **Management > Host**—If you change the management IP address in the device configuration, you must match the new address in the management center so that it can reach the device on the network; edit the **Host** address in the **Management** area.

Management	
Host:	10.89.5.20
Status:	✓

## Management Center: Configure Cluster, Data Interfaces

This procedure configures basic parameters for each data interface that you assigned to the cluster when you deployed it in FXOS. For clustering on multiple chassis, data interfaces are always Spanned EtherChannel

interfaces. For the cluster control link interface for a cluster isolated to security modules within one Firepower 9300 chassis, you must increase the MTU from the default.



**Note** When using Spanned EtherChannels for clustering on multiple chassis, the port-channel interface will not come up until clustering is fully enabled. This requirement prevents traffic from being forwarded to a unit that is not an active unit in the cluster.

### Procedure

**Step 1** Choose **Devices > Device Management**, and click **Edit** (✎) next to the cluster.

**Step 2** Click **Interfaces**.

**Step 3** Configure the cluster control link.

For clustering on multiple chassis, set the cluster control link MTU to be at least 100 bytes higher than the highest MTU of the data interfaces. Because the cluster control link traffic includes data packet forwarding, the cluster control link needs to accommodate the entire size of a data packet plus cluster traffic overhead.

We suggest setting the MTU to the maximum of 9184; the minimum value is 1400 bytes. For example, because the maximum MTU is 9184, then the highest data interface MTU can be 9084, while the cluster control link can be set to 9184.

For native clusters: The cluster control link interface is Port-Channel48 by default. If you don't know which interface is the cluster control link, check the FXOS configuration for chassis for the Cluster-type interface assigned to the cluster.

- a) Click **Edit** (✎) for the cluster control link interface.
- b) On the **General** page, in the **MTU** field, enter a value between 1400 and 9184 but not between 2561 and 8362. Due to block pool handling, this MTU size is not optimal for system operation. We suggest using the maximum, 9184.
- c) Click **OK**.

**Step 4** Configure data interfaces.

- a) (Optional) For regular firewall interfaces, configure VLAN subinterfaces on the data interface. The rest of this procedure applies to the subinterfaces. See [Add a Subinterface](#).
- b) Click **Edit** (✎) for the data interface.
- c) Configure the name and other parameters. For regular firewall interfaces, see [Configure Routed Mode Interfaces](#) or, for transparent mode, [Configure Bridge Group Interfaces](#). For IPS-only interfaces, see [Inline Sets and Passive Interfaces](#).

**Note** If the cluster control link interface MTU is not at least 100 bytes higher than the data interface MTU, you will see an error that you must reduce the MTU of the data interface. See, [Step 3, on page 34](#) to increase the cluster control link MTU, after which you can continue configuring the data interfaces.

- d) For clustering on multiple chassis, set a manual global MAC address for the EtherChannel. Click **Advanced**, and in the **Active Mac Address** field, enter a MAC address in H.H.H format, where H is a 16-bit hexadecimal digit.

For example, the MAC address 00-0C-F1-42-4C-DE would be entered as 000C.F142.4CDE. The MAC address must not have the multicast bit set, that is, the second hexadecimal digit from the left cannot be an odd number.

Do not set the **Standby Mac Address**; it is ignored.

You must configure a MAC address for a Spanned EtherChannel to avoid potential network connectivity problems. With a manually-configured MAC address, the MAC address stays with the current control unit. If you do not configure a MAC address, then if the control unit changes, the new control unit uses a new MAC address for the interface, which can cause a temporary network outage.

e) Click **OK**. Repeat the above steps for other data interfaces.

**Step 5** Click **Save**.

You can now go to **Deploy > Deployment** and deploy the policy to assigned devices. The changes are not active until you deploy them.

## Management Center: Configure Cluster Health Monitor Settings

The **Cluster Health Monitor Settings** section of the **Cluster** page displays the settings described in the table below.

**Figure 10: Cluster Health Monitor Settings**

Cluster Health Monitor Settings			
<b>Timeouts</b>			
Hold Time			3 s
Interface Debounce Time			9000 ms
<b>Monitored Interfaces</b>			
Service Application			Enabled
Unmonitored Interfaces			None
<b>Auto-Rejoin Settings</b>			
	Attempts	Interval Between Attempts	Interval Variation
Cluster Interface	-1	5	1
Data Interface	3	5	2
System	3	5	2

**Table 1: Cluster Health Monitor Settings Section Table Fields**

Field	Description
<b>Timeouts</b>	

Field	Description
Hold Time	Between .3 and 45 seconds; The default is 3 seconds. To determine node system health, the cluster nodes send heartbeat messages on the cluster control link to other nodes. If a node does not receive any heartbeat messages from a peer node within the hold time period, the peer node is considered unresponsive or dead.
Interface Debounce Time	Between 300 and 9000 ms. The default is 500 ms. The interface debounce time is the amount of time before the node considers an interface to be failed, and the node is removed from the cluster.
<b>Monitored Interfaces</b>	The interface health check monitors for link failures. If all physical ports for a given logical interface fail on a particular node, but there are active ports under the same logical interface on other nodes, then the node is removed from the cluster. The amount of time before the node removes a member from the cluster depends on the type of interface and whether the node is an established node or is joining the cluster.
Service Application	Shows whether the Snort and disk-full processes are monitored.
Unmonitored Interfaces	Shows unmonitored interfaces.
<b>Auto-Rejoin Settings</b>	
Cluster Interface	Shows the auto-rejoin settings after a cluster control link failure.
<i>Attempts</i>	Between -1 and 65535. The default is -1 (unlimited). Sets the number of rejoin attempts.
<i>Interval Between Attempts</i>	Between 2 and 60. The default is 5 minutes. Defines the interval duration in minutes between rejoin attempts.
<i>Interval Variation</i>	Between 1 and 3. The default is 1x the interval duration. Defines if the interval duration increases at each attempt.
Data Interfaces	Shows the auto-rejoin settings after a data interface failure.
<i>Attempts</i>	Between -1 and 65535. The default is 3. Sets the number of rejoin attempts.
<i>Interval Between Attempts</i>	Between 2 and 60. The default is 5 minutes. Defines the interval duration in minutes between rejoin attempts.
<i>Interval Variation</i>	Between 1 and 3. The default is 2x the interval duration. Defines if the interval duration increases at each attempt.
System	Shows the auto-rejoin settings after internal errors. Internal failures include: application sync timeout; inconsistent application statuses; and so on.
<i>Attempts</i>	Between -1 and 65535. The default is 3. Sets the number of rejoin attempts.
<i>Interval Between Attempts</i>	Between 2 and 60. The default is 5 minutes. Defines the interval duration in minutes between rejoin attempts.

Field	Description
<i>Interval Variation</i>	Between 1 and 3. The default is 2x the interval duration. Defines if the interval duration increases at each attempt.



**Note** If you disable the system health check, fields that do not apply when the system health check is disabled will not show.

You can change these settings from this section.

You can monitor any port-channel ID, single physical interface ID, as well as the Snort and disk-full processes. Health monitoring is not performed on VLAN subinterfaces or virtual interfaces such as VNIs or BVIs. You cannot configure monitoring for the cluster control link; it is always monitored.

### Procedure

- Step 1** Choose **Devices > Device Management**.
- Step 2** Next to the cluster you want to modify, click **Edit** (✎).
- Step 3** Click **Cluster**.
- Step 4** In the **Cluster Health Monitor Settings** section, click **Edit** (✎).
- Step 5** Disable the system health check by clicking the **Health Check** slider.

**Figure 11: Disable the System Health Check**

When any topology changes occur (such as adding or removing a data interface, enabling or disabling an interface on the node or the switch, or adding an additional switch to form a VSS or vPC) you should disable the system health check feature and also disable interface monitoring for the disabled interfaces. When the topology change is complete, and the configuration change is synced to all nodes, you can re-enable the system health check feature and monitored interfaces.

- Step 6** Configure the hold time and interface debounce time.

- **Hold Time**—Set the hold time to determine the amount of time between node heartbeat status messages, between .3 and 45 seconds; The default is 3 seconds.
- **Interface Debounce Time**—Set the debounce time between 300 and 9000 ms. The default is 500 ms. Lower values allow for faster detection of interface failures. Note that configuring a lower debounce time increases the chances of false-positives. When an interface status update occurs, the node waits the number of milliseconds specified before marking the interface as failed, and the node is removed from the cluster. In the case of an EtherChannel that transitions from a down state to an up state (for example, the switch reloaded, or the switch enabled an EtherChannel), a longer debounce time can prevent the interface from appearing to be failed on a cluster node just because another cluster node was faster at bundling the ports.

**Step 7**

Customize the auto-rejoin cluster settings after a health check failure.

**Figure 12: Configure Auto-Rejoin Settings**

▼ Auto-Rejoin Settings

---

**Cluster Interface**

Attempts  Range: 0-65535 (-1 for unlimited number of attempts)

Interval Between Attempts  Range: 2-60 minutes between rejoin attempts

Interval Variation  Range: 1-3. Defines if the interval duration increases. 1 (no change); 2 (2 x the previous duration), or 3 (3 x the previous duration).

**Data Interface**

Attempts  Range: 0-65535 (-1 for unlimited number of attempts)

Interval Between Attempts  Range: 2-60 minutes between rejoin attempts

Interval Variation  Range: 1-3. Defines if the interval duration increases. 1 (no change); 2 (2 x the previous duration), or 3 (3 x the previous duration).

**System**

Attempts  Range: 0-65535 (-1 for unlimited number of attempts)

Interval Between Attempts  Range: 2-60 minutes between rejoin attempts

Interval Variation  Range: 1-3. Defines if the interval duration increases. 1 (no change); 2 (2 x the previous duration), or 3 (3 x the previous duration).

Set the following values for the **Cluster Interface**, **Data Interface**, and **System** (internal failures include: application sync timeout; inconsistent application statuses; and so on):

- **Attempts**—Sets the number of rejoin attempts, between -1 and 65535. **0** disables auto-rejoining. The default for the **Cluster Interface** is -1 (unlimited). The default for the **Data Interface** and **System** is 3.
- **Interval Between Attempts**—Defines the interval duration in minutes between rejoin attempts, between 2 and 60. The default value is 5 minutes. The maximum total time that the node attempts to rejoin the cluster is limited to 14400 minutes (10 days) from the time of last failure.
- **Interval Variation**—Defines if the interval duration increases. Set the value between 1 and 3: **1** (no change); **2** (2 x the previous duration), or **3** (3 x the previous duration). For example, if you set the interval duration to 5 minutes, and set the variation to 2, then the first attempt is after 5 minutes; the 2nd attempt is 10 minutes (2 x 5); the 3rd attempt 20 minutes (2 x 10), and so on. The default value is **1** for the **Cluster Interface** and **2** for the **Data Interface** and **System**.

- Step 8** Configure monitored interfaces by moving interfaces in the **Monitored Interfaces** or **Unmonitored Interfaces** window. You can also check or uncheck **Enable Service Application Monitoring** to enable or disable monitoring of the Snort and disk-full processes.

*Figure 13: Configure Monitored Interfaces*

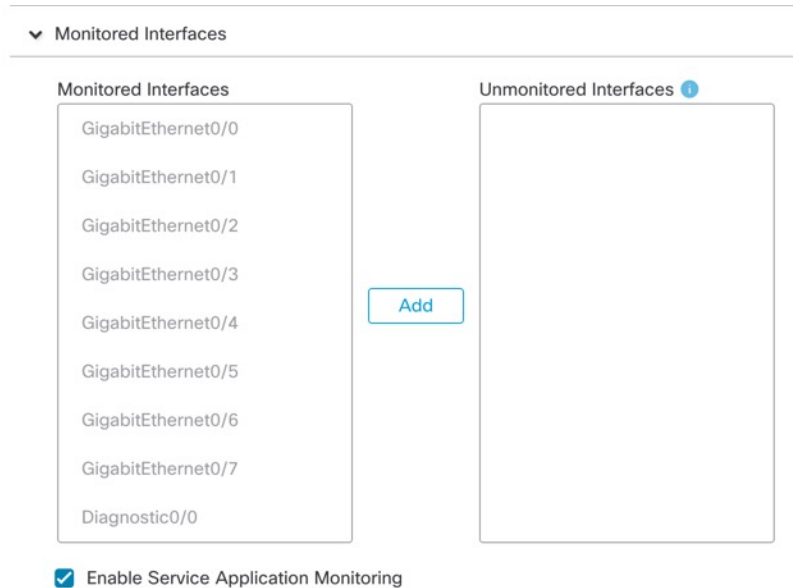

The interface health check monitors for link failures. If all physical ports for a given logical interface fail on a particular node, but there are active ports under the same logical interface on other nodes, then the node is removed from the cluster. The amount of time before the node removes a member from the cluster depends on the type of interface and whether the node is an established node or is joining the cluster. Health check is enabled by default for all interfaces and for the Snort and disk-full processes.

You might want to disable health monitoring of non-essential interfaces.

When any topology changes occur (such as adding or removing a data interface, enabling or disabling an interface on the node or the switch, or adding an additional switch to form a VSS or vPC) you should disable the system health check feature and also disable interface monitoring for the disabled interfaces. When the topology change is complete, and the configuration change is synced to all nodes, you can re-enable the system health check feature and monitored interfaces.

- Step 9** Click **Save**.
- Step 10** Deploy configuration changes; see [Deploy Configuration Changes](#).

## FXOS: Remove a Cluster Node

The following sections describe how to remove nodes temporarily or permanently from the cluster.

## Temporary Removal

A cluster node will be automatically removed from the cluster due to a hardware or network failure, for example. This removal is temporary until the conditions are rectified, and it can rejoin the cluster. You can also manually disable clustering.

To check whether a device is currently in the cluster, check the cluster status on the chassis manager **Logical Devices** page:

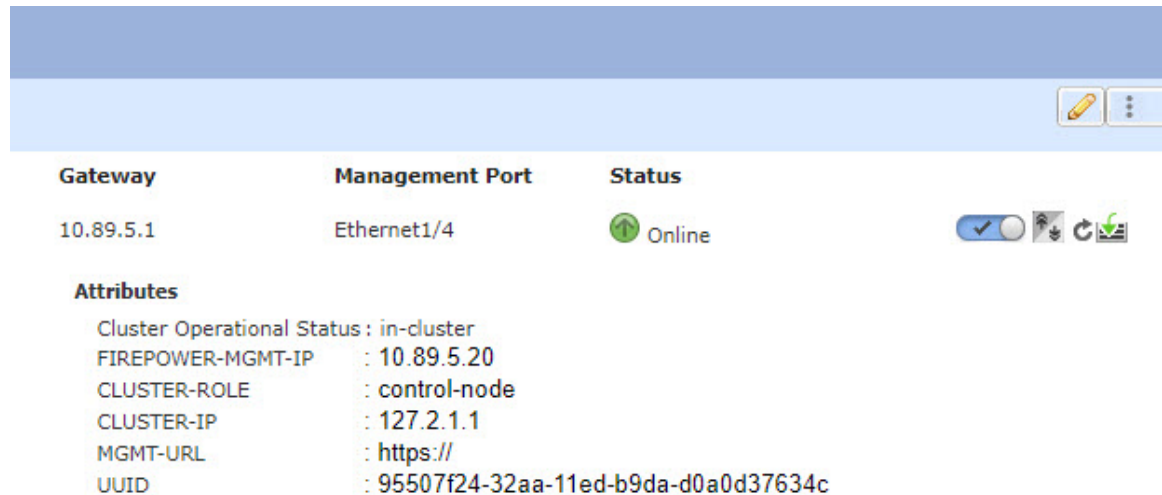

Gateway	Management Port	Status
10.89.5.1	Ethernet1/4	Online

**Attributes**



- Cluster Operational Status : in-cluster
- FIREPOWER-MGMT-IP : 10.89.5.20
- CLUSTER-ROLE : control-node
- CLUSTER-IP : 127.2.1.1
- MGMT-URL : https://
- UUID : 95507f24-32aa-11ed-b9da-d0a0d37634c

For threat defense using the management center, you should leave the device in the management center device list so that it can resume full functionality after you reenables clustering.

- Disable clustering in the application—You can disable clustering using the application CLI. Enter the **cluster remove unit name** command to remove any node other than the one you are logged into. The bootstrap configuration remains intact, as well as the last configuration synced from the control node, so you can later re-add the node without losing your configuration. If you enter this command on a data node to remove the control node, a new control node is elected.

When a device becomes inactive, all data interfaces are shut down; only the Management interface can send and receive traffic. To resume traffic flow, re-enable clustering. The Management interface remains up using the IP address the node received from the bootstrap configuration. However if you reload, and the node is still inactive in the cluster, the Management interface is disabled.

To reenables clustering, on the threat defense enter **cluster enable**.

- Disable the application instance—In the chassis manager on the **Logical Devices** page, click the **Slider enabled** () . You can later reenables it using the **Slider disabled** () .
- Shut down the security module/engine—In the chassis manager on the **Security Module/Engine** page, click the **Power Off icon**.
- Shut down the chassis—In the chassis manager on the **Overview** page, click the **Shut Down icon**.

## Permanent Removal

You can permanently remove a cluster node using the following methods.



For threat defense using the management center, be sure to remove the node from the management center device list after you disable clustering on the chassis.

- Delete the logical device—In the chassis manager on the **Logical Devices** page, click the **Delete** (  ). You can then deploy a standalone logical device, a new cluster, or even add a new logical device to the same cluster.
- Remove the chassis or security module from service—If you remove a device from service, you can add replacement hardware as a new node of the cluster.

## Management Center: Manage Cluster Members

After you deploy the cluster, you can change the configuration and manage cluster members.

### Add a New Cluster Member

When you add a new cluster member in FXOS, the Secure Firewall Management Center adds the member automatically.

#### Before you begin

- Make sure the interface configuration is the same on the replacement unit as for the other chassis.

#### Procedure

- 
- Step 1** Add the new unit to the cluster in FXOS. See the [FXOS configuration guide](#).
- Wait for the new unit to be added to the cluster. Refer to the chassis manager **Logical Devices** screen or use the threat defense **show cluster info** command to view cluster status.
- Step 2** The new cluster member is added automatically. To monitor the registration of the replacement unit, view the following:
- **Cluster Status** dialog box (which is available from the **Devices > Device Management More** (  ) icon or from the **Devices > Device Management > Cluster** tab > **General** area > **Cluster Live Status** link)—A unit that is joining the cluster on the chassis shows "Joining cluster..." After it joins the cluster, the management center attempts to register it, and the status changes to "Available for Registration". After it completes registration, the status changes to "In Sync." If the registration fails, the unit will stay at "Available for Registration". In this case, force a re-registration by clicking **Reconcile**.
  - **System status > Tasks** —The management center shows all registration events and failures.
  - **Devices > Device Management**—When you expand the cluster on the devices listing page, you can see when a unit is registering when it has the loading icon to the left.
-

## Replace a Cluster Member

You can replace a cluster member in an existing cluster. The management center auto-detects the replacement unit. However, you must manually delete the old cluster member in the management center. This procedure also applies to a unit that was reinitialized; in this case, although the hardware remains the same, it appears to be a new member.

### Before you begin

- Make sure the interface configuration is the same on the replacement unit as for other chassis.

### Procedure

**Step 1** For a new chassis, if possible, backup and restore the configuration from the old chassis in FXOS.

If you are replacing a module in a Firepower 9300, you do not need to perform these steps.

If you do not have a backup FXOS configuration from the old chassis, first perform the steps in [Add a New Cluster Member](#), on page 41.

For information about all of the below steps, see the [FXOS configuration guide](#).

- Use the configuration export feature to export an XML file containing logical device and platform configuration settings for your Firepower 4100/9300 chassis.
- Import the configuration file to the replacement chassis.
- Accept the license agreement.
- If necessary, upgrade the logical device application instance version to match the rest of the cluster.

**Step 2** In the management center for the old unit, choose **Devices > Device Management > More (⋮) > Delete**.

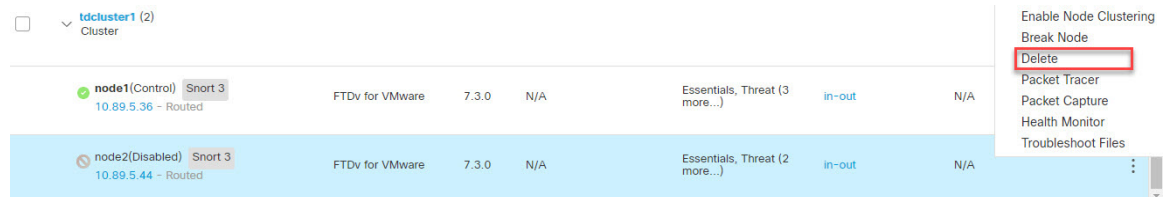

**Step 3** Confirm that you want to delete the unit.

The unit is removed from the cluster and from the management center devices list.

**Step 4** The new or reinitialized cluster member is added automatically. To monitor the registration of the replacement unit, view the following:

- **Cluster Status** dialog box (**Devices > Device Management > More (⋮)** icon or **Devices > Device Management > Cluster** page > **General** area > **Cluster Live Status** link)—A unit that is joining the cluster on the chassis shows "Joining cluster..." After it joins the cluster, the management center attempts to register it, and the status changes to "Available for Registration". After it completes registration, the status changes to "In Sync." If the registration fails, the unit will stay at "Available for Registration". In this case, force a re-registration by clicking **Reconcile All**.

- **System (⚙) > Tasks**—The management center shows all registration events and failures.

- **Devices > Device Management**—When you expand the cluster on the devices listing page, you can see when a unit is registering when it has the loading icon to the left.

## Deactivate a Member

You may want to deactivate a member in preparation for deleting the unit, or temporarily for maintenance. This procedure is meant to temporarily deactivate a member; the unit will still appear in the management center device list.



**Note** When a unit becomes inactive, all data interfaces are shut down; only the Management interface can send and receive traffic. To resume traffic flow, reenable clustering. The Management interface remains up using the IP address the unit received from the bootstrap configuration. However if you reload, and the unit is still inactive in the cluster, the management interface is disabled. You must use the console for any further configuration.

### Procedure

**Step 1** For the unit you want to deactivate, choose **Devices > Device Management > More (⋮) > Disable Clustering**.

Unit Name	IP Address	Role	Model	Version	Security Module	Essentials, IPS	Interfaces	Other
chassis1-mod1	10.89.5.20	Snort 3	Firepower 9300 with FTD	7.3.0	fp9300-docs.cisco.com Security Module - 1	Essentials, IPS (3 more...)	in-out	N/A
chassis2-mod1(Control)	10.89.5.11	Snort 3	Firepower 9300 with FTD	7.3.0	FP9300-2.cisco.com.4 Security Module - 1	Essentials, IPS (3 more...)	in-out	N/A
chassis2-mod2	10.89.5.12	Snort 3	Firepower 9300 with FTD	7.3.0	FP9300-2.cisco.com.4 Security Module - 2	Essentials, IPS (3 more...)	in-out	N/A

You can also deactivate a unit from the **Cluster Status** dialog box (**Devices > Device Management > More (⋮) > Cluster Live Status**).

**Step 2** Confirm that you want to disable clustering on the unit.

The unit will show **(Disabled)** next to its name in the **Devices > Device Management** list.

Unit Name	IP Address	Role
td-cluster1 (2)	Cluster	
10.89.5.21 (Disabled)	10.89.5.21	Routed
9300-1 (Master)	10.89.5.20	Routed

**Step 3** To reenable clustering, see [Rejoin the Cluster](#), on page 44.

## Rejoin the Cluster

If a unit was removed from the cluster, for example for a failed interface or if you manually disabled clustering, you must manually rejoin the cluster. Make sure the failure is resolved before you try to rejoin the cluster. See [Rejoining the Cluster, on page 62](#) for more information about why a unit can be removed from a cluster.

### Procedure

**Step 1** For the unit you want to reactivate, choose **Devices > Device Management > More (⋮) > Enable Clustering**.

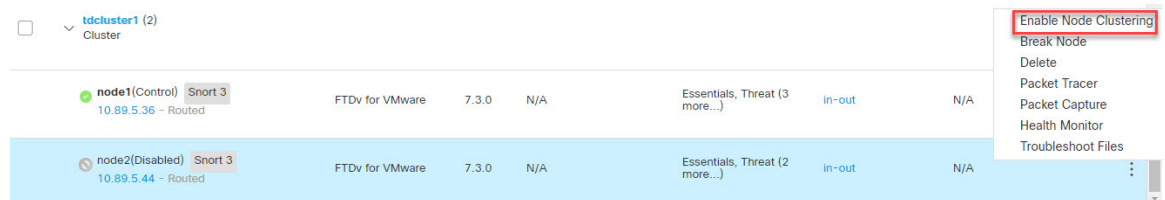

You can also reactivate a unit from the **Cluster Status** dialog box (**Devices > Device Management > More (⋮) > Cluster Live Status**).

**Step 2** Confirm that you want to enable clustering on the unit.

## Unregister a Data Node

If you need to permanently remove a cluster node (for example, if you remove a module on the Firepower 9300, or remove a chassis), then you should unregister it from the management center.

Do not unregister the node if it is still a healthy part of the cluster, or if you only want to disable the node temporarily. To remove it permanently from the cluster in FXOS, see [FXOS: Remove a Cluster Node, on page 39](#). If you unregister it from the management center, and it is still part of the cluster, it will continue to pass traffic, and could even become the control node—a control node that the management center can no longer manage.

### Before you begin

To manually deactivate the node, see [Deactivate a Member, on page 43](#). Before you unregister a node, the node must be inactive, either manually or because of a health failure.

### Procedure

**Step 1** Make sure the node is ready to be unregistered from the management center. On **Devices > Device Management**, make sure the node shows **(Disabled)**.

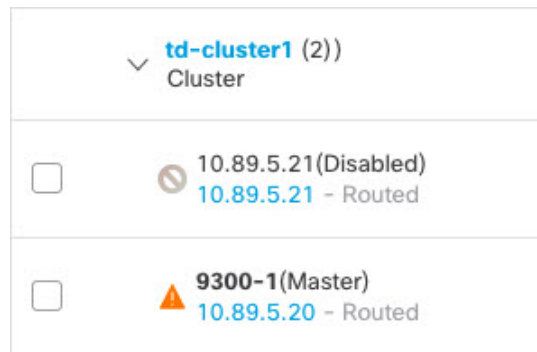

You can also view each node's status on the **Cluster Status** dialog box available from **More** (⋮). If the status is stale, click **Reconcile All** on the **Cluster Status** dialog box to force an update.

**Step 2** In the management center for the data node you want to delete, choose **Devices > Device Management > More** (⋮) > **Unregister**.

**Step 3** Confirm that you want to unregister the node.

The node is removed from the cluster and from the management center devices list.

## Change the Control Unit



**Caution** The best method to change the control unit is to disable clustering on the control unit, wait for a new control election, and then re-enable clustering. If you must specify the *exact* unit you want to become the control unit, use the procedure in this section. Note that for centralized features, if you force a control unit change, then all connections are dropped, and you have to re-establish the connections on the new control unit.

To change the control unit, perform the following steps.

### Procedure

**Step 1** Open the **Cluster Status** dialog box by choosing **Devices > Device Management > More** (⋮) > **Cluster Live Status**.

You can also access the **Cluster Status** dialog box from **Devices > Device Management > Cluster page > General area > Cluster Live Status** link.

**Step 2** For the unit you want to become the control unit, choose **More** (⋮) > **Change Role to Control**.

**Step 3** You are prompted to confirm the role change. Check the checkbox, and click **OK**.

## Reconcile Cluster Members

If a cluster member fails to register, you can reconcile the cluster membership from the chassis to the Secure Firewall Management Center. For example, a data unit might fail to register if the management center is occupied with certain processes, or if there is a network issue.

### Procedure

---

**Step 1** Choose **Devices > Device Management > More** (⋮) for the cluster, and then choose **Cluster Live Status** to open the **Cluster Status** dialog box.

You can also open the **Cluster Status** dialog box from the **Devices > Device Management > Cluster** page > **General** area > **Cluster Live Status** link.

**Step 2** Click **Reconcile All**.

For more information about the cluster status, see [Management Center: Monitoring the Cluster, on page 46](#).

---

## Management Center: Monitoring the Cluster

You can monitor the cluster in Secure Firewall Management Center and at the threat defense CLI.

- **Cluster Status** dialog box, which is available from the **Devices > Device Management > More** (⋮) icon or from the **Devices > Device Management > Cluster** page > **General** area > **Cluster Live Status** link.

### Cluster Status

Overall Status: Clustering is disabled for 1 node(s)

Nodes details (2) Refresh Reconcile All

Status	Device Name	Unit Name	Chassis URL
In Sync	node1 <span>Control</span>	node1	N/A
Clustering is disabled	node2	node2	N/A

Summary History

ID: 0 CCL IP: 10.10.10.1  
 Site ID: N/A CCL MAC: 000c.29bb.d7bb  
 Serial No: 9A4MK10VUVF Module: NGFWv  
 Last join: 19:17:26 UTC Jul 18 2022 Resource: 16 cores / 32256 MB RAM  
 Last leave: N/A

Summary History

Timestamp	From State	To State	Event
21:15:13 UTC Jul 18 2022	SLAVE_APP_SYNC	DISABLED	Slave application configuration sync timeout
20:55:10 UTC Jul 18 2022	DISABLED	ELECTION	Enabled from kickout timer
20:55:10 UTC Jul 18 2022	ELECTION	ONCALL	Event: Cluster unit node1 state is MASTER
20:55:10 UTC Jul 18 2022	ONCALL	SLAVE_COLD	Received cluster control message

Dated: 08:56:56 | 09 Sep 2022 Close

The Control unit has a graphic indicator identifying its role.

Cluster member **Status** includes the following states:

- **In Sync.**—The unit is registered with the management center.
- **Pending Registration**—The unit is part of the cluster, but has not yet registered with the management center. If a unit fails to register, you can retry registration by clicking **Reconcile All**.
- **Clustering is disabled**—The unit is registered with the management center, but is an inactive member of the cluster. The clustering configuration remains intact if you intend to later re-enable it, or you can delete the unit from the cluster.
- **Joining cluster...**—The unit is joining the cluster on the chassis, but has not completed joining. After it joins, it will register with the management center.

For each unit, you can view the **Summary** or the **History**.

For each unit from the **More** () menu, you can perform the following status changes:

- **Disable Clustering**
- **Enable Clustering**

- **Change Role to Control**

- **System** (⚙️) > **Tasks** page.

The **Tasks** page shows updates of the Cluster Registration task as each unit registers.

- **Devices** > **Device Management** > *cluster\_name*.

When you expand the cluster on the devices listing page, you can see all member units, including the control unit shown with its role next to the IP address. For units that are still registering, you can see the loading icon.

- **show cluster** {**access-list** [*acl\_name*] | **conn** [count] | **cpu** [usage] | **history** | **interface-mode** | **memory** | **resource usage** | **service-policy** | **traffic** | **xlate count**}

To view aggregated data for the entire cluster or other information, use the **show cluster** command.

- **show cluster info** [**auto-join** | **clients** | **conn-distribution** | **flow-mobility counters** | **goid** [*options*] | **health** | **incompatible-config** | **loadbalance** | **old-members** | **packet-distribution** | **trace** [*options*] | **transport** { **asp** | **cp** }]

To view cluster information, use the **show cluster info** command.

## Cluster Health Monitor Dashboard

### Cluster Health Monitor

When a threat defense is the control node of a cluster, the management center collects various metrics periodically from the device metric data collector. The cluster health monitor is comprised of the following components:

- **Overview dashboard**—Displays information about the cluster topology, cluster statistics, and metric charts:
  - The topology section displays a cluster's live status, the health of individual threat defense, threat defense node type (control node or data node), and the status of the device. The status of the device could be *Disabled* (when the device leaves the cluster), *Added out of box* (in a public cloud cluster, the additional nodes that do not belong to the management center), or *Normal* (ideal state of the node).
  - The cluster statistics section displays current metrics of the cluster with respect to the CPU usage, memory usage, input rate, output rate, active connections, and NAT translations.



---

**Note** The CPU and memory metrics display the individual average of the data plane and snort usage.

---

- The metric charts, namely, CPU Usage, Memory Usage, Throughput, and Connections, diagrammatically display the statistics of the cluster over the specified time period.
- **Load Distribution dashboard**—Displays load distribution across the cluster nodes in two widgets:



- The Distribution widget displays the average packet and connection distribution over the time range across the cluster nodes. This data depicts how the load is being distributed by the nodes. Using this widget, you can easily identify any abnormalities in the load distribution and rectify it.
- The Node Statistics widget displays the node level metrics in table format. It displays metric data on CPU usage, memory usage, input rate, output rate, active connections, and NAT translations across the cluster nodes. This table view enables you to correlate data and easily identify any discrepancies.
- Member Performance dashboard—Displays current metrics of the cluster nodes. You can use the selector to filter the nodes and view the details of a specific node. The metric data include CPU usage, memory usage, input rate, output rate, active connections, and NAT translations.
- CCL dashboard—Displays, graphically, the cluster control link data namely, the input, and output rate.
- Troubleshooting and Links — Provides convenient links to frequently used troubleshooting topics and procedures.
- Time range—An adjustable time window to constrain the information that appears in the various cluster metrics dashboards and widgets.
- Custom Dashboard—Displays data on both cluster-wide metrics and node-level metrics. However, node selection only applies for the threat defense metrics and not for the entire cluster to which the node belongs.

## Viewing Cluster Health

You must be an Admin, Maintenance, or Security Analyst user to perform this procedure.

The cluster health monitor provides a detailed view of the health status of a cluster and its nodes. This cluster health monitor provides health status and trends of the cluster in an array of dashboards.

### Before you begin

- Ensure you have created a cluster from one or more devices in the management center.

### Procedure

- 
- Step 1** Choose **System** (⚙️) > **Health** > **Monitor**.  
Use the Monitoring navigation pane to access node-specific health monitors.
- Step 2** In the device list, click **Expand** (➤) and **Collapse** (⏏) to expand and collapse the list of managed cluster devices.
- Step 3** To view the cluster health statistics, click on the cluster name. The cluster monitor reports health and performance metrics in several predefined dashboards by default. The metrics dashboards include:
- Overview — Highlights key metrics from the other predefined dashboards, including its nodes, CPU, memory, input and output rates, connection statistics, and NAT translation information.
  - Load Distribution — Traffic and packet distribution across the cluster nodes.

- Member Performance — Node-level statistics on CPU usage, memory usage, input throughput, output throughput, active connection, and NAT translation.
- CCL — Interface status and aggregate traffic statistics.

You can navigate through the various metrics dashboards by clicking on the labels. For a comprehensive list of the supported cluster metrics, see [Cisco Secure Firewall Threat Defense Health Metrics](#).

**Step 4** You can configure the time range from the drop-down in the upper-right corner. The time range can reflect a period as short as the last hour (the default) or as long as two weeks. Select **Custom** from the drop-down to configure a custom start and end date.

Click the refresh icon to set auto refresh to 5 minutes or to toggle off auto refresh.

**Step 5** Click on deployment icon for a deployment overlay on the trend graph, with respect to the selected time range. The deployment icon indicates the number of deployments during the selected time-range. A vertical band indicates the deployment start and end time. For multiple deployments, multiple bands/lines appear. Click on the icon on top of the dotted line to view the deployment details.

**Step 6** (For node-specific health monitor) View the **Health Alerts** for the node in the alert notification at the top of page, directly to the right of the device name.

Hover your pointer over the **Health Alerts** to view the health summary of the node. The popup window shows a truncated summary of the top five health alerts. Click on the popup to open a detailed view of the health alert summary.

**Step 7** (For node-specific health monitor) The device monitor reports health and performance metrics in several predefined dashboards by default. The metrics dashboards include:

- Overview — Highlights key metrics from the other predefined dashboards, including CPU, memory, interfaces, connection statistics; plus disk usage and critical process information.
- CPU — CPU utilization, including the CPU usage by process and by physical cores.
- Memory — Device memory utilization, including data plane and Snort memory usage.
- Interfaces — Interface status and aggregate traffic statistics.
- Connections — Connection statistics (such as elephant flows, active connections, peak connections, and so on) and NAT translation counts.
- Snort — Statistics that are related to the Snort process.
- ASP drops — Statistics related to the dropped packets against various reasons.

You can navigate through the various metrics dashboards by clicking on the labels. See [Cisco Secure Firewall Threat Defense Health Metrics](#) for a comprehensive list of the supported device metrics.

**Step 8** Click the plus sign (+) in the upper right corner of the health monitor to create a custom dashboard by building your own variable set from the available metric groups.

For cluster-wide dashboard, choose Cluster metric group, and then choose the metric.

---

## Cluster Metrics

The cluster health monitor tracks statistics that are related to a cluster and its nodes, and aggregate of load distribution, performance, and CCL traffic statistics.

**Table 2: Cluster Metrics**

Metric	Description	Format
CPU	Average of CPU metrics on the nodes of a cluster (individually for data plane and snort).	percentage
Memory	Average of memory metrics on the nodes of a cluster (individually for data plane and snort).	percentage
Data Throughput	Incoming and outgoing data traffic statistics for a cluster.	bytes
CCL Throughput	Incoming and outgoing CCL traffic statistics for a cluster.	bytes
Connections	Count of active connections in a cluster.	number
NAT Translations	Count of NAT translations for a cluster.	number
Distribution	Connection distribution count in the cluster for every second.	number
Packets	Packet distribution count in the cluster for every second.	number

## Management Center: Troubleshooting the Cluster

You can use the **CCL Ping** tool to make sure the cluster control link is operating correctly. You can also use the following tools that are available for devices and clusters:

- Troubleshooting files—If a node fails to join the cluster, a troubleshooting file is automatically generated. You can also generate and download troubleshooting files from the **Devices > Device Management > Cluster > General** area. See [Generate Troubleshooting Files](#).

You can also generate files from the **Device Management** page by clicking **More** (⋮) and choosing **Troubleshoot Files**.

- CLI output—From the **Devices > Device Management > Cluster > General** area, you can view a set of pre-defined CLI outputs that can help you troubleshoot the cluster. The following commands are automatically run for the cluster:
  - **show running-config cluster**
  - **show cluster info**
  - **show cluster info health**
  - **show cluster info transport cp**

- **show version**
- **show asp drop**
- **show counters**
- **show arp**
- **show int ip brief**
- **show blocks**
- **show cpu detailed**
- **show interface *ccl\_interface***
- **ping *ccl\_ip* size *ccl\_mtu* repeat 2**

You can also enter any **show** command in the Command field. See [View CLI Output](#) for more information.

## Perform a Ping on the Cluster Control Link

You can check to make sure all the cluster nodes can reach each other over the cluster control link by performing a ping. One major cause for the failure of a node to join the cluster is an incorrect cluster control link configuration; for example, the cluster control link MTU may be set higher than the connecting switch MTUs.

### Procedure

---

- Step 1** Choose **Devices > Device Management**, click the **More** (⋮) icon next to the cluster, and choose **> Cluster Live Status**.

Figure 14: Cluster Status

Cluster Status ?

---

Overall Status: Cluster has all nodes in sync

Nodes details (2) Refresh Reconcile All

	Status	Device Name	Unit Name	Chassis URL	
>	In Sync.	172.16.0.50 <span>Control</span>	172.16.0.50	N/A	⋮
>	In Sync.	172.16.0.51	172.16.0.51	N/A	⋮

Dated: 11:52:26 | 20 Dec 2021 Close

**Step 2** Expand one of the nodes, and click **CCL Ping**.

Figure 15: CCL Ping

Cluster Status ?

---

Overall Status: Clustering is disabled for 1 node(s)

Nodes details (3) Refresh Reconcile All

	Status	Device Name	Unit Name	Chassis URL	
▼	In Sync.	10.10.43.21 <span>Control</span>	10.10.43.21	N/A	⋮
<div style="border: 1px solid #ccc; padding: 5px;"> <span>Summary</span> <span>History</span> <span style="border: 2px solid red; padding: 2px;">CCL Ping</span> </div> <p>ping 10.10.3.2 size 1654                      Sending 5, 1654-byte ICMP Echos to 10.10.3.2, timeout is 2 seconds:                      ??????                      Success rate is 0 percent (0/5)</p>					
>	Clustering is disabled	10.10.43.22	10.10.43.22	N/A	⋮

Dated: 18:38:41 | 01 Mar 2023 Close

The node sends a ping on the cluster control link to every other node using a packet size that matches the maximum MTU.

## Examples for Clustering

These examples include typical deployments.

### Firewall on a Stick

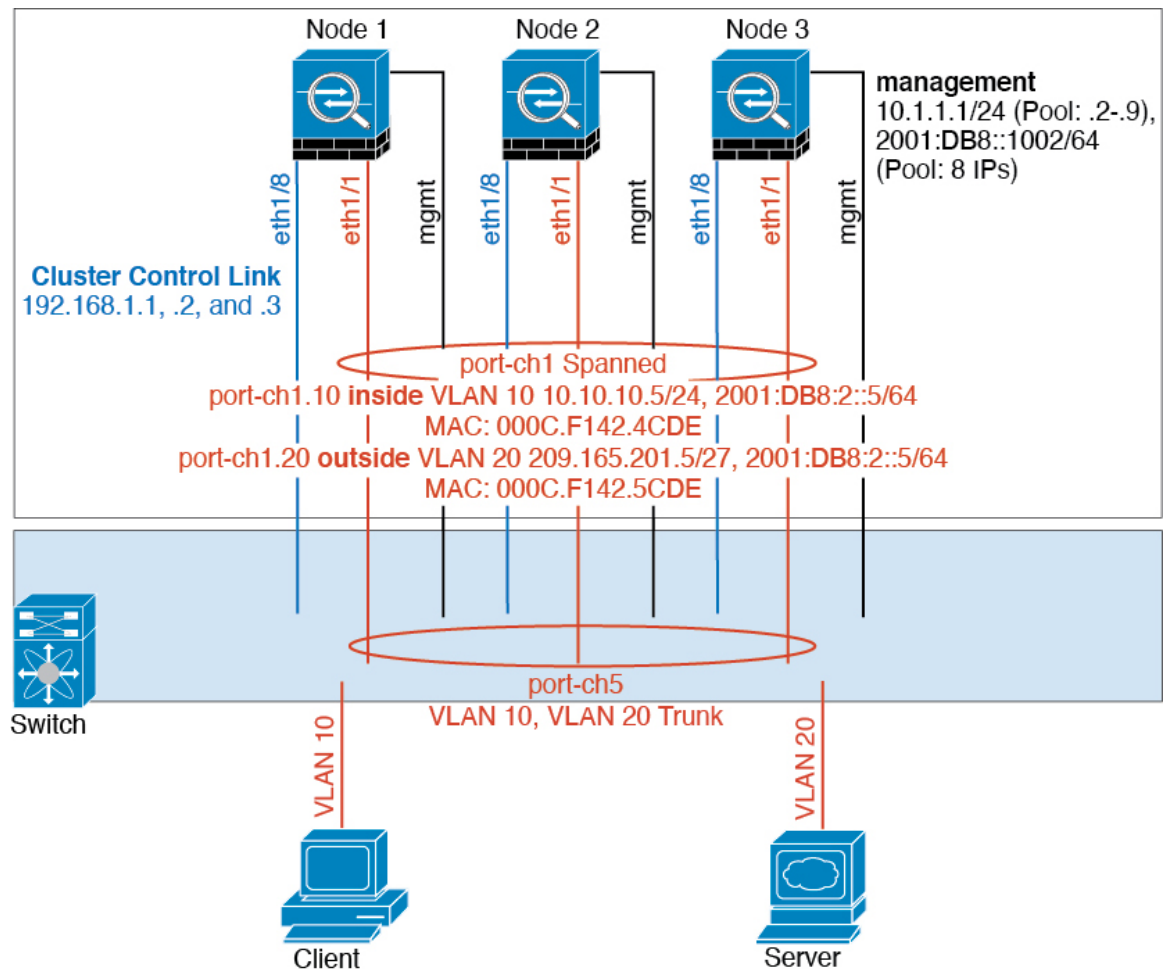

Data traffic from different security domains are associated with different VLANs, for example, VLAN 10 for the inside network and VLAN 20 for the outside network. Each has a single physical port connected to the external switch or router. Trunking is enabled so that all packets on the physical link are 802.1q encapsulated. This is the firewall between VLAN 10 and VLAN 20.

When using Spanned EtherChannels, all data links are grouped into one EtherChannel on the switch side. If the becomes unavailable, the switch will rebalance traffic between the remaining units.

## Traffic Segregation

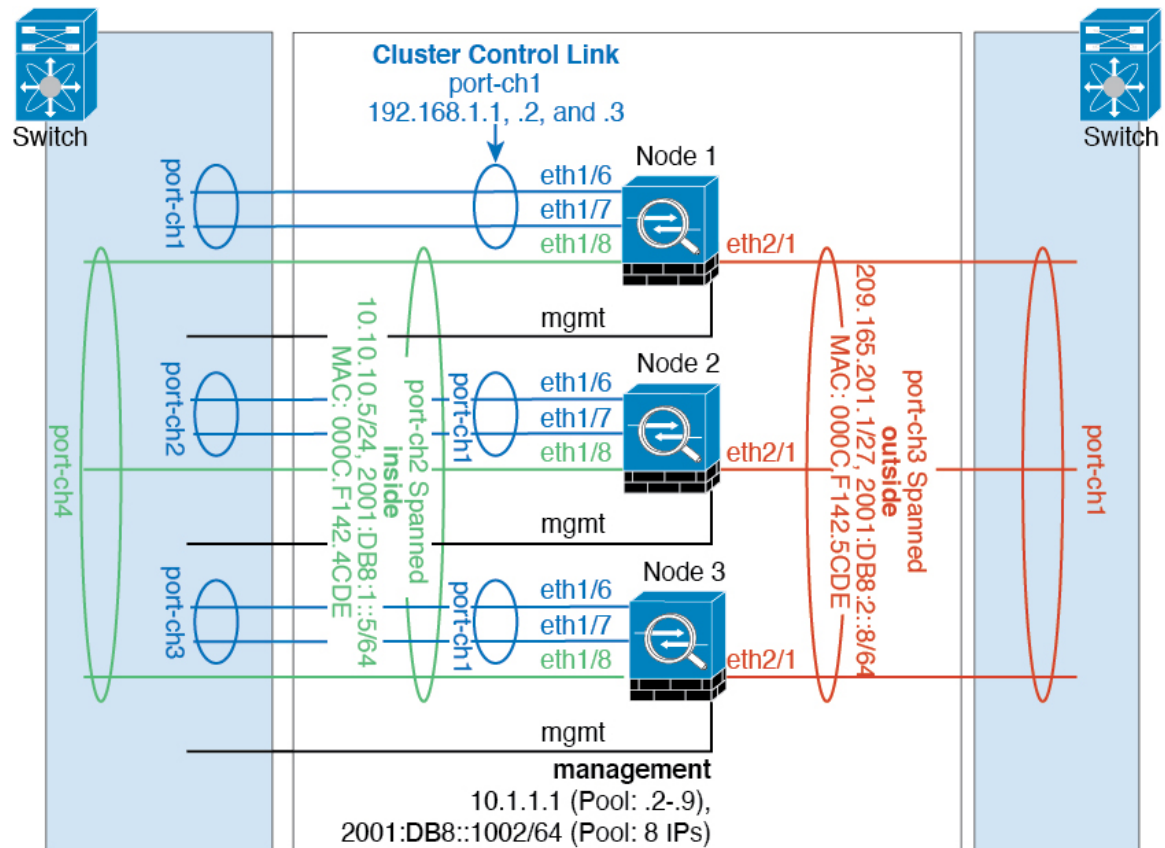

You may prefer physical separation of traffic between the inside and outside network.

As shown in the diagram above, there is one Spanned EtherChannel on the left side that connects to the inside switch, and the other on the right side to outside switch. You can also create VLAN subinterfaces on each EtherChannel if desired.

## Reference for Clustering

This section includes more information about how clustering operates.

## Threat Defense Features and Clustering

Some threat defense features are not supported with clustering, and some are only supported on the control unit. Other features might have caveats for proper usage.

## Unsupported Features with Clustering

These features cannot be configured with clustering enabled, and the commands will be rejected.



---

**Note** To view FlexConfig features that are also not supported with clustering, for example WCCP inspection, see the [ASA general operations configuration guide](#). FlexConfig lets you configure many ASA features that are not present in the management center GUI. See [FlexConfig Policies](#).

---

- Remote access VPN (SSL VPN and IPsec VPN)
- DHCP client, server, and proxy. DHCP relay is supported.
- Virtual Tunnel Interfaces (VTIs)
- High Availability
- Integrated Routing and Bridging
- Management Center UCAPL/CC mode

## Centralized Features for Clustering

The following features are only supported on the control node, and are not scaled for the cluster.



---

**Note** Traffic for centralized features is forwarded from member nodes to the control node over the cluster control link.

If you use the rebalancing feature, traffic for centralized features may be rebalanced to non-control nodes before the traffic is classified as a centralized feature; if this occurs, the traffic is then sent back to the control node.

For centralized features, if the control node fails, all connections are dropped, and you have to re-establish the connections on the new control node.

---



---

**Note** To view FlexConfig features that are also centralized with clustering, for example RADIUS inspection, see the [ASA general operations configuration guide](#). FlexConfig lets you configure many ASA features that are not present in the management center GUI. See [FlexConfig Policies](#).

---

- The following application inspections:
  - DCERPC
  - ESMTTP
  - NetBIOS
  - PPTP
  - RSH
  - SQLNET
  - SUNRPC



- TFTP
- XDMCP
- Static route monitoring
- Site-to-site VPN
- IGMP multicast control plane protocol processing (data plane forwarding is distributed across the cluster)
- PIM multicast control plane protocol processing (data plane forwarding is distributed across the cluster)
- Dynamic routing

## Connection Settings

Connection limits are enforced cluster-wide. Each node has an estimate of the cluster-wide counter values based on broadcast messages. Due to efficiency considerations, the configured connection limit across the cluster might not be enforced exactly at the limit number. Each node may overestimate or underestimate the cluster-wide counter value at any given time. However, the information will get updated over time in a load-balanced cluster.

## Dynamic Routing and Clustering

The routing process only runs on the control unit, and routes are learned through the control unit and replicated to secondaries. If a routing packet arrives at a data unit, it is redirected to the control unit.

**Figure 16: Dynamic Routing**

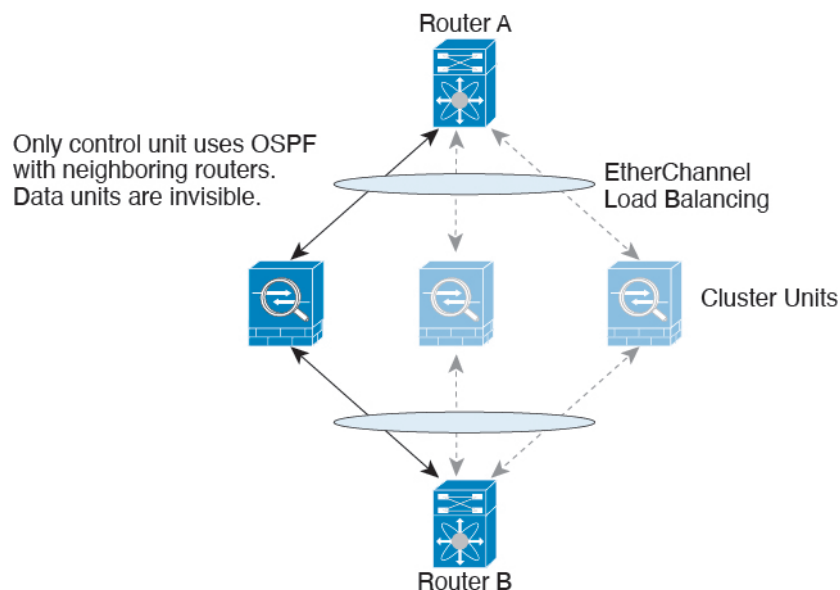

After the data units learn the routes from the control unit, each unit makes forwarding decisions independently. The OSPF LSA database is not synchronized from the control unit to data units. If there is a control unit switchover, the neighboring router will detect a restart; the switchover is not transparent. The OSPF process picks an IP address as its router ID. Although not required, you can assign a static router ID to ensure a

consistent router ID is used across the cluster. See the OSPF Non-Stop Forwarding feature to address the interruption.

## FTP and Clustering

- If FTP data channel and control channel flows are owned by different cluster members, then the data channel owner will periodically send idle timeout updates to the control channel owner and update the idle timeout value. However, if the control flow owner is reloaded, and the control flow is re-hosted, the parent/child flow relationship will not longer be maintained; the control flow idle timeout will not be updated.

## Multicast Routing and Clustering

The control unit handles all multicast routing packets and data packets until fast-path forwarding is established. After the connection is established, each data unit can forward multicast data packets.

## NAT and Clustering

NAT can affect the overall throughput of the cluster. Inbound and outbound NAT packets can be sent to different threat defenses in the cluster, because the load balancing algorithm relies on IP addresses and ports, and NAT causes inbound and outbound packets to have different IP addresses and/or ports. When a packet arrives at the threat defense that is not the NAT owner, it is forwarded over the cluster control link to the owner, causing large amounts of traffic on the cluster control link. Note that the receiving node does not create a forwarding flow to the owner, because the NAT owner may not end up creating a connection for the packet depending on the results of security and policy checks.

If you still want to use NAT in clustering, then consider the following guidelines:

- PAT with Port Block Allocation—See the following guidelines for this feature:
  - Maximum-per-host limit is not a cluster-wide limit, and is enforced on each node individually. Thus, in a 3-node cluster with the maximum-per-host limit configured as 1, if the traffic from a host is load-balanced across all 3 nodes, then it can get allocated 3 blocks with 1 in each node.
  - Port blocks created on the backup node from the backup pools are not accounted for when enforcing the maximum-per-host limit.
  - On-the-fly PAT rule modifications, where the PAT pool is modified with a completely new range of IP addresses, will result in xlate backup creation failures for the xlate backup requests that were still in transit while the new pool became effective. This behavior is not specific to the port block allocation feature, and is a transient PAT pool issue seen only in cluster deployments where the pool is distributed and traffic is load-balanced across the cluster nodes.
  - When operating in a cluster, you cannot simply change the block allocation size. The new size is effective only after you reload each device in the cluster. To avoid having to reload each device, we recommend that you delete all block allocation rules and clear all xlates related to those rules. You can then change the block size and recreate the block allocation rules.
- NAT pool address distribution for dynamic PAT—When you configure a PAT pool, the cluster divides each IP address in the pool into port blocks. By default, each block is 512 ports, but if you configure port block allocation rules, your block setting is used instead. These blocks are distributed evenly among the nodes in the cluster, so that each node has one or more blocks for each IP address in the PAT pool. Thus, you could have as few as one IP address in a PAT pool for a cluster, if that is sufficient for the number

of PAT'ed connections you expect. Port blocks cover the 1024-65535 port range, unless you configure the option to include the reserved ports, 1-1023, on the PAT pool NAT rule.

- Reusing a PAT pool in multiple rules—To use the same PAT pool in multiple rules, you must be careful about the interface selection in the rules. You must either use specific interfaces in all rules, or "any" in all rules. You cannot mix specific interfaces and "any" across the rules, or the system might not be able to match return traffic to the right node in the cluster. Using unique PAT pools per rule is the most reliable option.
- No round-robin—Round-robin for a PAT pool is not supported with clustering.
- No extended PAT—Extended PAT is not supported with clustering.
- Dynamic NAT xlates managed by the control node—The control node maintains and replicates the xlate table to data nodes. When a data node receives a connection that requires dynamic NAT, and the xlate is not in the table, it requests the xlate from the control node. The data node owns the connection.
- Stale xlates—The xlate idle time on the connection owner does not get updated. Thus, the idle time might exceed the idle timeout. An idle timer value higher than the configured timeout with a refcnt of 0 is an indication of a stale xlate.
- No static PAT for the following inspections—
  - FTP
  - RSH
  - SQLNET
  - TFTP
  - XDMCP
  - SIP
- If you have an extremely large number of NAT rules, over ten thousand, you should enable the transactional commit model using the **asp rule-engine transactional-commit nat** command in the device CLI. Otherwise, the node might not be able to join the cluster.

## SIP Inspection and Clustering

A control flow can be created on any node (due to load balancing); its child data flows must reside on the same node.

## SNMP and Clustering

You should always use the Local address, and not the Main cluster IP address for SNMP polling. If the SNMP agent polls the Main cluster IP address, if a new control node is elected, the poll to the new control node will fail.

When using SNMPv3 with clustering, if you add a new cluster node after the initial cluster formation, then SNMPv3 users are not replicated to the new node. You must remove the users, and re-add them, and then redeploy your configuration to force the users to replicate to the new node.

## Syslog and Clustering

- Each node in the cluster generates its own syslog messages. You can configure logging so that each node uses either the same or a different device ID in the syslog message header field. For example, the hostname configuration is replicated and shared by all nodes in the cluster. If you configure logging to use the hostname as the device ID, syslog messages generated by all nodes look as if they come from a single node. If you configure logging to use the local-node name that is assigned in the cluster bootstrap configuration as the device ID, syslog messages look as if they come from different nodes.

## TLS/SSL Connections and Clustering

The decryption states of TLS/SSL connections are not synchronized, and if the connection owner fails, then the decrypted connections will be reset. New connections will need to be established to a new unit. Connections that are not decrypted (they match a do-not-decrypt rule) are not affected and are replicated correctly.

## Cisco TrustSec and Clustering

Only the control node learns security group tag (SGT) information. The control node then populates the SGT to data nodes, and data nodes can make a match decision for SGT based on the security policy.

## VPN and Clustering

Site-to-site VPN is a centralized feature; only the control unit supports VPN connections.



---

**Note** Remote access VPN is not supported with clustering.

---

VPN functionality is limited to the control unit and does not take advantage of the cluster high availability capabilities. If the control unit fails, all existing VPN connections are lost, and VPN users will see a disruption in service. When a new control unit is elected, you must reestablish the VPN connections.

When you connect a VPN tunnel to a Spanned interface address, connections are automatically forwarded to the control unit.

VPN-related keys and certificates are replicated to all units.

## Performance Scaling Factor

When you combine multiple units into a cluster, you can expect the total cluster performance to be approximately 80% of the maximum combined throughput.

For example, for TCP throughput, the Firepower 9300 with 3 SM-40 modules can handle approximately 135 Gbps of real world firewall traffic when running alone. For 2 chassis, the maximum combined throughput will be approximately 80% of 270 Gbps (2 chassis x 135 Gbps): 216 Gbps.

## Control Unit Election

Members of the cluster communicate over the cluster control link to elect a control unit as follows:

1. When you deploy the cluster, each unit broadcasts an election request every 3 seconds.

2. Any other units with a higher priority respond to the election request; the priority is set when you deploy the cluster and is not configurable.
3. If after 45 seconds, a unit does not receive a response from another unit with a higher priority, then it becomes the control unit.



---

**Note** If multiple units tie for the highest priority, the cluster unit name and then the serial number is used to determine the control unit.

---

4. If a unit later joins the cluster with a higher priority, it does not automatically become the control unit; the existing control unit always remains as the control unit unless it stops responding, at which point a new control unit is elected.
5. In a "split brain" scenario when there are temporarily multiple control units, then the unit with highest priority retains the role while the other units return to data unit roles.



---

**Note** You can manually force a unit to become the control unit. For centralized features, if you force a control unit change, then all connections are dropped, and you have to re-establish the connections on the new control unit.

---

## High Availability Within the Cluster

Clustering provides high availability by monitoring chassis, unit, and interface health and by replicating connection states between units.

### Chassis-Application Monitoring

Chassis-application health monitoring is always enabled. The Firepower 4100/9300 chassis supervisor checks the threat defense application periodically (every second). If the threat defense device is up and cannot communicate with the Firepower 4100/9300 chassis supervisor for 3 seconds, the threat defense device generates a syslog message and leaves the cluster.

If the Firepower 4100/9300 chassis supervisor cannot communicate with the application after 45 seconds, it reloads the threat defense device. If the threat defense device cannot communicate with the supervisor, it removes itself from the cluster.

### Unit Health Monitoring

Each unit periodically sends a broadcast keepaliveheartbeat packet over the cluster control link. If the control node does not receive any keepaliveheartbeat packets or other packets from a data node within the configurable timeout period, then the control node removes the data node from the cluster. If the data nodes do not receive packets from the control node, then a new control node is elected from the remaining node.

If nodes cannot reach each other over the cluster control link because of a network failure and not because a node has actually failed, then the cluster may go into a "split brain" scenario where isolated data nodes will elect their own control nodes. For example, if a router fails between two cluster locations, then the original control node at location 1 will remove the location 2 data nodes from the cluster. Meanwhile, the nodes at location 2 will elect their own control node and form their own cluster. Note that asymmetric traffic may fail

in this scenario. After the cluster control link is restored, then the control node that has the higher priority will keep the control node's role. See [Control Unit Election, on page 60](#) for more information.

## Interface Monitoring

Each node monitors the link status of all hardware interfaces in use, and reports status changes to the control node. For clustering on multiple chassis, Spanned EtherChannels use the cluster Link Aggregation Control Protocol (cLACP). Each chassis monitors the link status and the cLACP protocol messages to determine if the port is still active in the EtherChannel, and informs the threat defense application if the interface is down. When you enable health monitoring, all physical interfaces are monitored by default (including the main EtherChannel for EtherChannel interfaces). Only named interfaces that are in an Up state can be monitored. For example, all member ports of an EtherChannel must fail before a *named* EtherChannel is removed from the cluster. You can optionally disable monitoring per interface.

If a monitored interface fails on a particular node, but it is active on other nodes, then the node is removed from the cluster. The amount of time before the threat defense device removes a node from the cluster depends on whether the node is an established member or is joining the cluster. The threat defense device does not monitor interfaces for the first 90 seconds that a node joins the cluster. Interface status changes during this time will not cause the threat defense device to be removed from the cluster. For an established member, the node is removed after 500 ms.

For clustering on multiple chassis, if you add or delete an EtherChannel from the cluster, interface health-monitoring is suspended for 95 seconds to ensure that you have time to make the changes on each chassis.

## Decorator Application Monitoring

When you install a decorator application on an interface, such as the Radware DefensePro application, then both the threat defense device and the decorator application must be operational to remain in the cluster. The unit does not join the cluster until both applications are operational. Once in the cluster, the unit monitors the decorator application health every 3 seconds. If the decorator application is down, the unit is removed from the cluster.

## Status After Failure

When a node in the cluster fails, the connections hosted by that node are seamlessly transferred to other nodes; state information for traffic flows is shared over the control node's cluster control link.

If the control node fails, then another member of the cluster with the highest priority (lowest number) becomes the control node.

The threat defense automatically tries to rejoin the cluster, depending on the failure event.



---

**Note** When the threat defense becomes inactive and fails to automatically rejoin the cluster, all data interfaces are shut down; only the Management interface can send and receive traffic.

---

## Rejoining the Cluster

After a cluster member is removed from the cluster, how it can rejoin the cluster depends on why it was removed:

- Failed cluster control link when initially joining—After you resolve the problem with the cluster control link, you must manually rejoin the cluster by re-enabling clustering.
- Failed cluster control link after joining the cluster—The threat defense automatically tries to rejoin every 5 minutes, indefinitely.
- Failed data interface—The threat defense automatically tries to rejoin at 5 minutes, then at 10 minutes, and finally at 20 minutes. If the join is not successful after 20 minutes, then the threat defense application disables clustering. After you resolve the problem with the data interface, you have to manually enable clustering.
- Failed node—If the node was removed from the cluster because of a node health check failure, then rejoining the cluster depends on the source of the failure. For example, a temporary power failure means the node will rejoin the cluster when it starts up again as long as the cluster control link is up. The threat defense application attempts to rejoin the cluster every 5 seconds.
- Internal error—Internal failures include: application sync timeout; inconsistent application statuses; and so on.
- Failed configuration deployment—If you deploy a new configuration from management center, and the deployment fails on some cluster members but succeeds on others, then the nodes that failed are removed from the cluster. You must manually rejoin the cluster by re-enabling clustering. If the deployment fails on the control node, then the deployment is rolled back, and no members are removed. If the deployment fails on all data nodes, then the deployment is rolled back, and no members are removed.
- Failed Chassis-Application Communication—When the threat defense application detects that the chassis-application health has recovered, it tries to rejoin the cluster automatically.

## Data Path Connection State Replication

Every connection has one owner and at least one backup owner in the cluster. The backup owner does not take over the connection in the event of a failure; instead, it stores TCP/UDP state information, so that the connection can be seamlessly transferred to a new owner in case of a failure. The backup owner is usually also the director.

Some traffic requires state information above the TCP or UDP layer. See the following table for clustering support or lack of support for this kind of traffic.

**Table 3: Features Replicated Across the Cluster**

Traffic	State Support	Notes
Up time	Yes	Keeps track of the system up time.
ARP Table	Yes	—
MAC address table	Yes	—
User Identity	Yes	—
IPv6 Neighbor database	Yes	—
Dynamic routing	Yes	—
SNMP Engine ID	<b>No</b>	—

## How the Cluster Manages Connections

Connections can be load-balanced to multiple nodes of the cluster. Connection roles determine how connections are handled in both normal operation and in a high availability situation.

### Connection Roles

See the following roles defined for each connection:

- **Owner**—Usually, the node that initially receives the connection. The owner maintains the TCP state and processes packets. A connection has only one owner. If the original owner fails, then when new nodes receive packets from the connection, the director chooses a new owner from those nodes.
- **Backup owner**—The node that stores TCP/UDP state information received from the owner, so that the connection can be seamlessly transferred to a new owner in case of a failure. The backup owner does not take over the connection in the event of a failure. If the owner becomes unavailable, then the first node to receive packets from the connection (based on load balancing) contacts the backup owner for the relevant state information so it can become the new owner.

As long as the director (see below) is not the same node as the owner, then the director is also the backup owner. If the owner chooses itself as the director, then a separate backup owner is chosen.

For clustering on the Firepower 9300, which can include up to 3 cluster nodes in one chassis, if the backup owner is on the same chassis as the owner, then an additional backup owner will be chosen from another chassis to protect flows from a chassis failure.

- **Director**—The node that handles owner lookup requests from forwarders. When the owner receives a new connection, it chooses a director based on a hash of the source/destination IP address and ports (see below for ICMP hash details), and sends a message to the director to register the new connection. If packets arrive at any node other than the owner, the node queries the director about which node is the owner so it can forward the packets. A connection has only one director. If a director fails, the owner chooses a new director.

As long as the director is not the same node as the owner, then the director is also the backup owner (see above). If the owner chooses itself as the director, then a separate backup owner is chosen.

ICMP/ICMPv6 hash details:

- For Echo packets, the source port is the ICMP identifier, and the destination port is 0.
  - For Reply packets, the source port is 0, and the destination port is the ICMP identifier.
  - For other packets, both source and destination ports are 0.
- **Forwarder**—A node that forwards packets to the owner. If a forwarder receives a packet for a connection it does not own, it queries the director for the owner, and then establishes a flow to the owner for any other packets it receives for this connection. The director can also be a forwarder. Note that if a forwarder receives the SYN-ACK packet, it can derive the owner directly from a SYN cookie in the packet, so it does not need to query the director. (If you disable TCP sequence randomization, the SYN cookie is not used; a query to the director is required.) For short-lived flows such as DNS and ICMP, instead of querying, the forwarder immediately sends the packet to the director, which then sends them to the owner. A connection can have multiple forwarders; the most efficient throughput is achieved by a good load-balancing method where there are no forwarders and all packets of a connection are received by the owner.





**Note** We do not recommend disabling TCP sequence randomization when using clustering. There is a small chance that some TCP sessions won't be established, because the SYN/ACK packet might be dropped.

- **Fragment Owner**—For fragmented packets, cluster nodes that receive a fragment determine a fragment owner using a hash of the fragment source IP address, destination IP address, and the packet ID. All fragments are then forwarded to the fragment owner over the cluster control link. Fragments may be load-balanced to different cluster nodes, because only the first fragment includes the 5-tuple used in the switch load balance hash. Other fragments do not contain the source and destination ports and may be load-balanced to other cluster nodes. The fragment owner temporarily reassembles the packet so it can determine the director based on a hash of the source/destination IP address and ports. If it is a new connection, the fragment owner will register to be the connection owner. If it is an existing connection, the fragment owner forwards all fragments to the provided connection owner over the cluster control link. The connection owner will then reassemble all fragments.

## New Connection Ownership

When a new connection is directed to a node of the cluster via load balancing, that node owns both directions of the connection. If any connection packets arrive at a different node, they are forwarded to the owner node over the cluster control link. If a reverse flow arrives at a different node, it is redirected back to the original node.

## Sample Data Flow for TCP

The following example shows the establishment of a new connection.

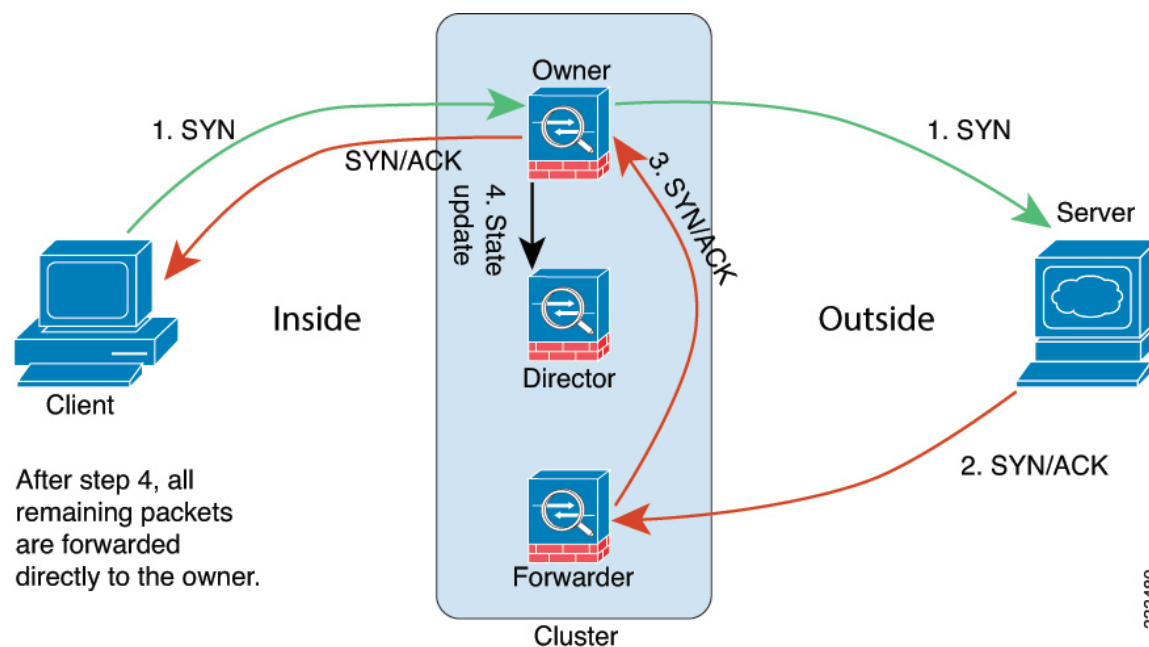

1. The SYN packet originates from the client and is delivered to one threat defense (based on the load balancing method), which becomes the owner. The owner creates a flow, encodes owner information into a SYN cookie, and forwards the packet to the server.
2. The SYN-ACK packet originates from the server and is delivered to a different threat defense (based on the load balancing method). This threat defense is the forwarder.
3. Because the forwarder does not own the connection, it decodes owner information from the SYN cookie, creates a forwarding flow to the owner, and forwards the SYN-ACK to the owner.
4. The owner sends a state update to the director, and forwards the SYN-ACK to the client.
5. The director receives the state update from the owner, creates a flow to the owner, and records the TCP state information as well as the owner. The director acts as the backup owner for the connection.
6. Any subsequent packets delivered to the forwarder will be forwarded to the owner.
7. If packets are delivered to any additional nodes, it will query the director for the owner and establish a flow.
8. Any state change for the flow results in a state update from the owner to the director.

## Sample Data Flow for ICMP and UDP

The following example shows the establishment of a new connection.

1. *Figure 17: ICMP and UDP Data Flow*

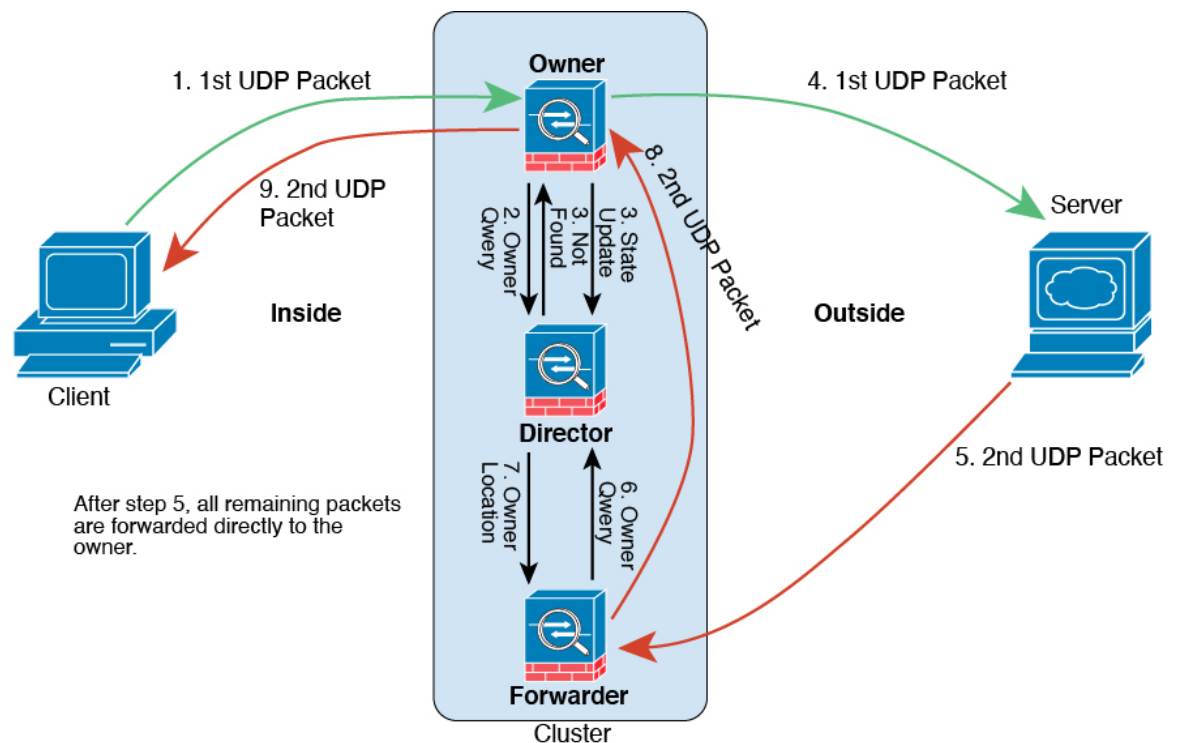

The first UDP packet originates from the client and is delivered to one threat defense (based on the load balancing method).

2. The node that received the first packet queries the director node that is chosen based on a hash of the source/destination IP address and ports.
3. The director finds no existing flow, creates a director flow and forwards the packet back to the previous node. In other words, the director has elected an owner for this flow.
4. The owner creates the flow, sends a state update to the director, and forwards the packet to the server.
5. The second UDP packet originates from the server and is delivered to the forwarder.
6. The forwarder queries the director for ownership information. For short-lived flows such as DNS, instead of querying, the forwarder immediately sends the packet to the director, which then sends it to the owner.
7. The director replies to the forwarder with ownership information.
8. The forwarder creates a forwarding flow to record owner information and forwards the packet to the owner.
9. The owner forwards the packet to the client.

## History for Clustering

Table 4:

Feature	Minimum Management Center	Minimum Threat Defense	Details
Cluster control link ping tool.	7.2.6/7.4.1	Any	<p>You can check to make sure all the cluster nodes can reach each other over the cluster control link by performing a ping. One major cause for the failure of a node to join the cluster is an incorrect cluster control link configuration; for example, the cluster control link MTU may be set higher than the connecting switch MTUs.</p> <p>New/modified screens: <b>Devices &gt; Device Management &gt; More (⋮) &gt; Cluster Live Status</b></p> <p>Other version restrictions: Not supported with management center Version 7.3.x or 7.4.0.</p>
Troubleshooting file generation and download available from Device and Cluster pages.	7.4.1	7.4.1	<p>You can generate and download troubleshooting files for each device on the Device page and also for all cluster nodes on the Cluster page. For a cluster, you can download all files as a single compressed file. You can also include cluster logs for the cluster for cluster nodes. You can alternatively trigger file generation from the <b>Devices &gt; Device Management &gt; More (⋮) &gt; Troubleshoot Files</b> menu.</p> <p>New/modified screens:</p> <ul style="list-style-type: none"> <li>• <b>Devices &gt; Device Management &gt; Device &gt; General</b></li> <li>• <b>Devices &gt; Device Management &gt; Cluster &gt; General</b></li> </ul>

Feature	Minimum Management Center	Minimum Threat Defense	Details
View CLI output for a device or device cluster.	7.4.1	Any	You can view a set of pre-defined CLI outputs that can help you troubleshoot the device or cluster. You can also enter any <b>show</b> command and see the output.  New/modified screens: <b>Devices &gt; Device Management &gt; Cluster &gt; General</b>
Cluster health monitor settings.	7.3.0	Any	You can now edit cluster health monitor settings.  New/Modified screens: <b>Devices &gt; Device Management &gt; Cluster &gt; Cluster Health Monitor Settings</b>  <b>Note</b> If you previously configured these settings using FlexConfig, be sure to remove the FlexConfig configuration before you deploy. Otherwise the FlexConfig configuration will overwrite the management center configuration.
Cluster health monitor dashboard.	7.3.0	Any	You can now view cluster health on the cluster health monitor dashboard.  New/Modified screens: <b>System (⚙️) &gt; Health &gt; Monitor</b>
Support for 16-node clusters.	7.2.0	7.2.0	You can now configure 16 node clusters for the Firepower 4100/9300. Previously, the maximum was 6 units.  New/Modified screens: none.  Supported platforms: Firepower 4100/9300
Cluster deployment for firewall changes completes faster.	7.1.0	7.1.0	Cluster deployment for firewall changes now completes faster.  New/Modified screens: none.
Improved PAT port block allocation for clustering.	7.0.0	7.0.0	The improved PAT port block allocation ensures that the control unit keeps ports in reserve for joining nodes, and proactively reclaims unused ports. To best optimize the allocation, you can set the maximum nodes you plan to have in the cluster using the <b>cluster-member-limit</b> command using FlexConfig. The control unit can then allocate port blocks to the planned number of nodes, and it will not have to reserve ports for extra nodes you don't plan to use. The default is 16 nodes. You can also monitor syslog 747046 to ensure that there are enough ports available for a new node.  New/Modified commands: <b>cluster-member-limit</b> (FlexConfig), <b>show nat pool cluster [summary]</b> , <b>show nat pool ip detail</b>
Cluster deployment for Snort changes completes faster, and fails faster when there is an event.	6.7.0	6.7.0	Cluster deployment for Snort changes now completes faster. Also, when a cluster has an event that causes a management center deployment to fail, the failure now occurs more quickly.  New/Modified screens: none.

Feature	Minimum Management Center	Minimum Threat Defense	Details
Improved cluster management.	6.7.0	6.7.0	<p>Management Center has improved cluster management functionality that formerly you could only accomplish using the CLI, including:</p> <ul style="list-style-type: none"> <li>• Enable and disable cluster units</li> <li>• Show cluster status from the Device Management page, including History and Summary per unit</li> <li>• Change the role to the control unit</li> </ul> <p>New/Modified screens:</p> <ul style="list-style-type: none"> <li>• <b>Devices &gt; Device Management &gt; More</b> menu</li> <li>• <b>Devices &gt; Device Management &gt; Cluster &gt; General</b> area &gt; <b>Cluster Live Status</b> link <b>Cluster Status</b></li> </ul> <p>Supported platforms: Firepower 4100/9300</p>
Multi-instance clustering.	6.6.0	6.6.0	<p>You can now create a cluster using container instances. On the Firepower 9300, you must include one container instance on each module in the cluster. You cannot add more than one container instance to the cluster per security engine/module. We recommend that you use the same security module or chassis model for each cluster instance. However, you can mix and match container instances on different Firepower 9300 security module types or Firepower 4100 models in the same cluster if required. You cannot mix Firepower 9300 and 4100 instances in the same cluster.</p> <p>New/Modified FXOS commands: <b>set port-type cluster</b></p> <p>New/modified Firepower Chassis Manager screens:</p> <ul style="list-style-type: none"> <li>• <b>Logical Devices &gt; Add Cluster</b></li> <li>• <b>Interfaces &gt; All Interfaces &gt; Add New</b> drop-down menu &gt; <b>Subinterface &gt; Type</b> field</li> </ul> <p>Supported platforms: threat defense on the Firepower 4100/9300</p>
Configuration sync to data units in parallel.	6.6.0	6.6.0	<p>The control unit now syncs configuration changes with data units in parallel by default. Formerly, syncing occurred sequentially.</p> <p>New/Modified screens: none.</p>
Messages for cluster join failure or eviction added to <b>show cluster history</b> .	6.6.0	6.6.0	<p>New messages were added to the <b>show cluster history</b> command for when a cluster unit either fails to join the cluster or leaves the cluster.</p> <p>New/Modified commands: <b>show cluster history</b></p> <p>New/Modified screens: none.</p>

Feature	Minimum Management Center	Minimum Threat Defense	Details
Initiator and responder information for Dead Connection Detection (DCD), and DCD support in a cluster.	6.5.0	6.5.0	<p>If you enable Dead Connection Detection (DCD), you can use the <b>show conn detail</b> command to get information about the initiator and responder. Dead Connection Detection allows you to maintain an inactive connection, and the <b>show conn</b> output tells you how often the endpoints have been probed. In addition, DCD is now supported in a cluster.</p> <p>New/Modified commands: <b>show conn</b> (output only).</p> <p>Supported platforms: threat defense on the Firepower 4100/9300</p>
Adding clusters is easier.	6.3.0	6.3.0	<p>You can now add any unit of a cluster to the management center, and the other cluster units are detected automatically. Formerly, you had to add each cluster unit as a separate device, and then group them into a cluster. Adding a cluster unit is also now automatic. Note that you must delete a unit manually.</p> <p>New/Modified screens:</p> <p><b>Devices &gt; Device Management &gt; Add</b> drop-down menu &gt; <b>Device &gt; Add Device</b> dialog box</p> <p><b>Devices &gt; Device Management &gt; Cluster</b> tab &gt; <b>General</b> area &gt; <b>Cluster Registration Status &gt; Current Cluster Summary</b> link &gt; <b>Cluster Status</b> dialog box</p> <p>Supported platforms: threat defense on the Firepower 4100/9300</p>
Support for site-to-site VPN with clustering as a centralized feature.	6.2.3.3	6.2.3.3	<p>You can now configure site-to-site VPN with clustering. Site-to-site VPN is a centralized feature; only the control unit supports VPN connections.</p> <p>Supported platforms: threat defense on the Firepower 4100/9300</p>
Automatically rejoin the cluster after an internal failure.	6.2.3	6.2.3	<p>Formerly, many internal error conditions caused a cluster unit to be removed from the cluster, and you were required to manually rejoin the cluster after resolving the issue. Now, a unit will attempt to rejoin the cluster automatically at the following intervals: 5 minutes, 10 minutes, and then 20 minutes. Internal failures include: application sync timeout; inconsistent application statuses; and so on.</p> <p>New/Modified command: <b>show cluster info auto-join</b></p> <p>No modified screens.</p> <p>Supported platforms: threat defense on the Firepower 4100/9300</p>

Feature	Minimum Management Center	Minimum Threat Defense	Details
Clustering on multiple chassis for 6 modules; Firepower 4100 support.	6.2.0	6.2.0	<p>With FXOS 2.1.1, you can now enable clustering on multiple chassis of the Firepower 9300 and 4100. For the Firepower 9300, you can include up to 6 modules. For example, you can use 1 module in 6 chassis, or 2 modules in 3 chassis, or any combination that provides a maximum of 6 modules. For the Firepower 4100, you can include up to 6 chassis.</p> <p><b>Note</b> Inter-site clustering is also supported. However, customizations to enhance redundancy and stability, such as site-specific MAC and IP addresses, director localization, site redundancy, and cluster flow mobility, are only configurable using the FlexConfig feature.</p> <p>No modified screens.</p> <p>Supported platforms: threat defense on the Firepower 4100/9300</p>
Clustering on multiple modules with one Firepower 9300 chassis.	6.0.1	6.0.1	<p>You can cluster up to 3 security modules within the Firepower 9300 chassis. All modules in the chassis must belong to the cluster.</p> <p>New/Modified screens:</p> <p><b>Devices &gt; Device Management &gt; Add &gt; Add Cluster</b></p> <p><b>Devices &gt; Device Management &gt; Cluster</b></p> <p>Supported platforms: threat defense on the Firepower 9300</p>

