



Layer 1 Simulation

Although WAE Design focuses on IP/MPLS Layer 3 (L3) network views and traffic, you can also create and view Layer 1 (L1) topologies for a more complete view of the network. Using the L3 and L1 topologies together, you can specify how L3 circuits route over L1 links. These Layer 3-to-Layer 1 associations let you simulate individual L1 link and L1 node failures, or include L1 links and L1 node failures in a Simulation Analysis to determine the effects on L3 traffic. Additionally, you can include L1 links and L1 nodes in SRLGs. With this interaction of layers, you can better design the network to meet performance requirements.



Note Aside from this chapter, throughout this guide the term *circuit* means a circuit with L3 properties. In this chapter, for purposes of clarity, *L3 circuit* and *L1 circuit* refer to objects defined in the Circuits and L1 Circuits tables, respectively, whereas *circuit* refers to the actual network element.

This section contains the following topics:

- [L1 and L3 Views, on page 1](#)
- [L1 Topology, on page 3](#)
- [L1 Simulations, on page 5](#)
- [Relationships Between L1 and L3, on page 18](#)
- [Delay and Distance, on page 22](#)
- [L1 Failures, on page 24](#)
- [Inactive State, on page 29](#)
- [L1 Simulation Analysis, on page 30](#)
- [Creating L1 Topology, on page 32](#)
- [Creating L1 and L3 Mappings, on page 40](#)
- [Visualizing the L1 Network, on page 45](#)

L1 and L3 Views

[Figure 1: Comparison of L1 and L3 Views, on page 2](#) shows an example L1 view in comparison to an L3 view. Notice the different uses of circuits. In the L3 view, L3 circuits are relevant to IP/MPLS routing and show traffic. The L1 view shows the physical topology with no traffic; if selected, it also shows the L1 circuit paths taken across the L1 links. L3 is the default view unless the plan file does not contain L3 nodes.

To more easily find relationships between L3 and L1 objects, right-click the object and choose the appropriate filter.

Alternate Views

To alternate between L1 and L3 views, use one of these methods:

- Click the L1/L3 toggle button in the top left of the Visualization toolbar.
- Choose **View > Layer 1 View** or **View > Layer 3 View**.
- Use keyboard shortcuts **Ctrl-1** for L1 and **Ctrl-3** for L3. (On a Mac, use **Alt-1** and **Alt-3**.)

Figure 1: Comparison of L1 and L3 Views

Layer 1 View

Shows physical topology and L1 links, but does not show traffic. A-B shows a selected L1 circuit path.

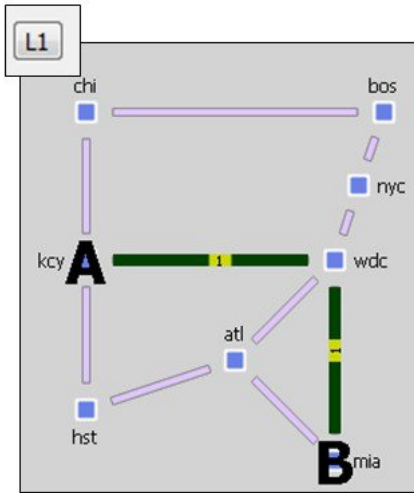

Layer 3 View

Shows IP/MPLS topology and routing, including measured and simulated traffic on L3 circuits.

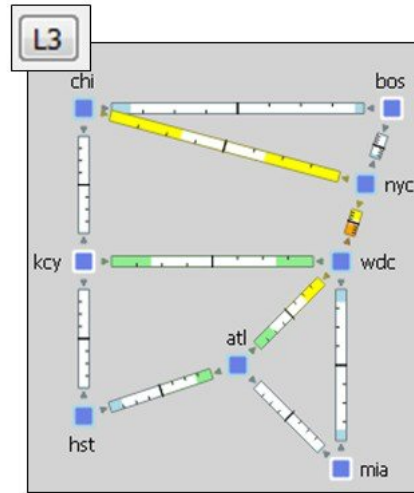

380921

Multi-Layer Views

To show relationships between the L1 and L3 views, you can simultaneously view both of them in either view (Figure 2: Multi-Layer (Combined Layer 1 and Layer 3) Views, on page 3). If you are in the L1 view, L3 objects appear in the background. If you are in the L3 view, L1 objects appear in the background. Additionally, the L3-L1 links, which model the physical relationship between L3 nodes and L1 nodes, are visualized (Figure 3: L1-L3 Link Visualization, on page 3).

In the Plot Options dialog box, click the **Layer 1** tab, and then choose options to determine whether to show Layer 1 objects in the Layer 3 view. For more information, see [Editing L1 Plot Options, on page 46](#).

The ability to move, select, and edit properties for an object in the background is toggled on and off with **View > Preferences > Enable Selection of Background Objects**.

Figure 2: Multi-Layer (Combined Layer 1 and Layer 3) Views

A-B shows a selected L1 circuit path in both views

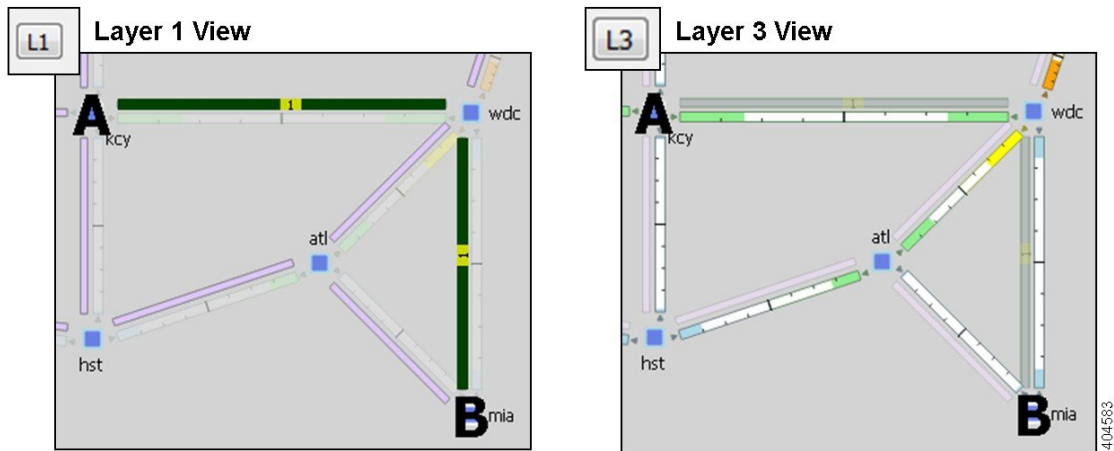
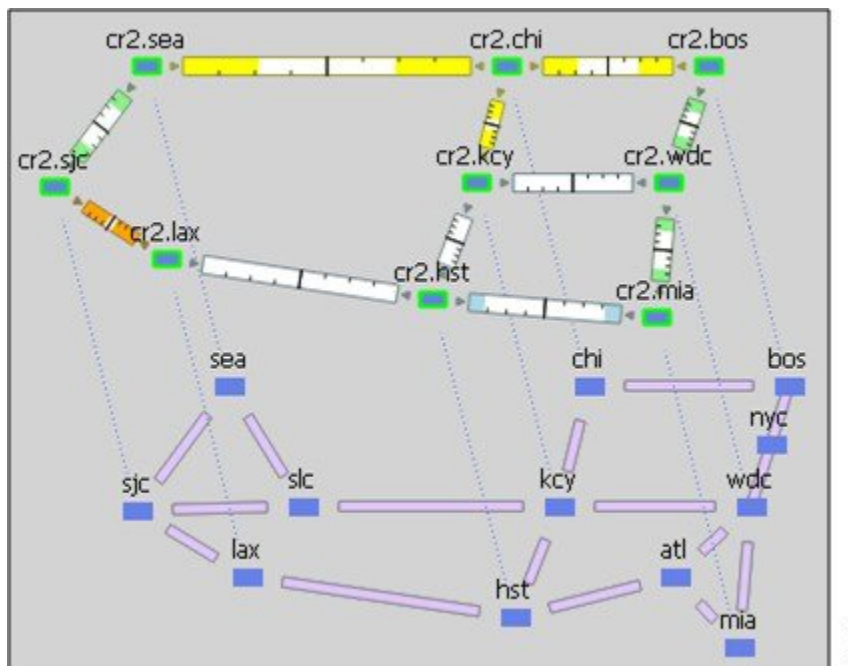

Figure 3: L1-L3 Link Visualization



L1 Topology

An L1 topology consists of a unique set of objects (Table 1: L1 Objects, on page 4) that are distinct from IP/MPLS L3 topology and objects. However, two of the objects, L1 circuits and L3 circuits, represent the same circuit.

- An L3 circuit contains L3 properties of the circuit.

- An L1 circuit contains L1 properties, specifically L1 routing, of the circuit.

You can create the objects and generate an L1 topology in WAE Design using these methods:

- Import an L1 topology from another plan file. This method creates the same L1 topology and the same L1 link, L1 circuit, L1 port, and L3 mappings as in the source file. You can also copy an L1 topology from a plan file. To import an L1 topology, choose **File > Import > Layer 1**.
- Construct an L1 topology based on all or part of an existing L3 topology in the same plan file. This method creates an L1 topology that mirrors the L3 one, and automatically generates the mappings between the L1 and L3 objects. For more information, see [Creating L1 Topology from L3 Topology, on page 32](#).
- Individually create the L1 ports, L1 nodes, L1 links, L1 circuits, L1 circuit paths, and L1 circuit path hops. You can add both L1 nodes and L1 links to SRLGs for simulation purposes. This is typically done to represent ducts containing multiple fiber segments, where a break in the duct could cause multiple L1 link failures, and thus potentially multiple L3 circuit failures for each of these L1 links. The end of this chapter contains several sections on manually creating L1 objects.
- Create the L1 topology directly in the tables in the plan file, such as by editing the L1 tables (**Edit > Plan Tables as Database**) or by creating the table in the plan file using a text editor.

L1 Objects

Table 1: L1 Objects

L1 Object	Description
L1 port	Models L1 ports and is listed in the L1 Ports table. The source and destination for L1 circuits are L1 ports. Each L1 port can belong to only one L1 circuit. An L1 port can be associated with an L3 port.
L1 node	Models L1 devices and is listed in the L1 Nodes table. When selected, they become a darker shade of blue.
L3-L1 link	Models the physical relationship between an L3 node and an L1 node. If showing both L1 and L3 objects, these appear as light blue dotted lines. If selected, they are solid black lines.
L1 link	Models the fiber segments connecting the L1 nodes. These are listed in the L1 Links table and are highlighted in blue when selected. L1 circuits are routed over L1 links, which is how these L1 links can be associated with the IP/MPLS topology in the L3 view.
L1 link waypoint	Models network devices (that are not L1 nodes) that reside in the L1 link path. Each waypoint has coordinates that identify a point on an L1 link. They are used for visualization purposes and for calculations executed by the Latency and Distance initializer. They are not used in simulations. They appear as dots on the L1 link, and they become darker when selected.
L1 circuit	Models the L1 properties of a circuit, such as which L1 ports are connected to it and the physical path and distance. These are listed in the L1 Circuits table and are highlighted in green when selected. Each L1 circuit can be associated with an L3 circuit directly or indirectly.

L1 Object	Description
L1 circuit path	Models the paths available for the L1 circuits. These are listed in the L1 Circuit Paths table and are highlighted in green when selected. The number on the highlighted path indicates the Path Option number.
L1 circuit path hop	Models the L1 node or L1 links in the L1 circuit path. These are listed in the L1 Circuit Path Hops table.
Actual L1 circuit path hop	Discovered L1 circuit path hops.

L1 links, L1 nodes, and L1 ports can be failed, set to an inactive state, and included in Simulation Analysis to calculate a worst-case failure analysis. Additionally, L1 links and L1 nodes can both be included in SRLGs, which in turn can also be failed and included in Simulation Analysis. These capabilities let you assess the effect of L1 outages on the IP/MPLS network, thus improving your ability to design around and plan for potential service disruptions.

L1 Waypoints

Waypoints are only viewable in the geographic view, and by default, they are visible in the network plot. There is an option to show or hide them in the Layer 1 tab of the Plot Options dialog box.



- The Order property represents the proximity to L1 node A, where 1 is the closest waypoint to the L1 node A and each subsequent number is farther away.
- Default Longitude and Latitude properties are based on the L1 link on which they are created, though you can change them.

Sites

All sites are listed in the Sites table whether they contain L1 nodes, L3 nodes, or both. To determine how many L1 nodes, if any, are in a site, show the L1 Node Count column. By default, sites containing only L1 nodes appear only in the L1 view, and sites containing only L3 nodes appear only in the L3 view. You can change this default in the Plot Options dialog box. Empty sites appear in both views.

L1 Simulations

When reading the L1 tables, the derived Established and Routed properties indicate simulation capabilities.

- Established—Identifies whether an L1 circuit or L1 circuit path is routed when there are no failures. Note that while an L1 circuit or L1 circuit path has Established equals F (false), it might be routable under failures.
- Routed—Identifies whether and how an L1 circuit or L1 circuit path is routed:
 - Unrouted
 - Actual (if being routed through actual L1 circuit path hops)

- Simulated (if being routed and not using actual L1 circuit path hops)



Note You can configure the number of attempted routes for L1 circuit paths. Increasing the number of attempted routes allows for more paths to be explored, thereby potentially reducing the number of unrouted L1 circuits. This increases the overall computation time. To configure the number of route attempts, choose **Edit > Network Options** and set the **Number of Attempts to Route L1 Circuit Paths** parameter.

Active L1 Path Selection

Because multiple L1 circuit paths can be routed for a single L1 circuit, WAE Design uses the Active Path Sim property to determine which L1 circuit path to use to set the derived properties for each L1 circuit, such as Distance Sim and Delay Sim. The Active Path Sim property is copied from the user-specified Active Path property if it has been set and if it is routable.

Standby Paths and Path Options

The user-specified L1 circuit path's Standby property sets the path to standby (T) or non-standby (F). The user-configurable Path Option property is an integer that identifies the order in which the routing of L1 circuit paths is explored. The lower the value, the higher the priority to route the L1 circuit path.

If other L1 circuit paths must be explored, the standby L1 circuit path with the lowest Path Option value is used provided it is routable. If it is not routable, attempts are made for each Path Option with the next lowest value (next highest priority). If none of the standby L1 circuit paths are routable, WAE Design then follows the same procedure with non-standby L1 circuit paths, starting with the one with the highest priority Path Option.



Note Non-standby L1 circuit paths reroute under failure only you check the **Network Options > Layer 1 rerouting convergence under failures** check box. For more information, see [Resiliency Under L1 Failures, on page 26](#).

L1 Circuit Path Routing Order

- WAE Design always tries to route L1 circuit paths that have their Standby property set to T (true), regardless of whether they are set as the active path. If they are routable, they are routed in the order of this priority:
 - Actual L1 circuit path hops have first priority. Note that while these are not discovered by WAE, if they are discovered through another means, you can manually add them using the Actual tab of the L1 circuit paths Properties dialog box or by adding an <ActualL1CircuitPathHops> table to the .txt plan file.
 - L1 circuits paths with explicit central frequency IDs or central frequency IDs defined through L1 circuit path hops are then routed. For information on central frequency IDs, see [Central Frequency ID Assignments, on page 14](#).

- Thereafter, L1 circuit paths that do not have central frequency ID properties set explicitly or through L1 circuit path hops are routed.
- After attempting to route standby L1 circuit paths, WAE Design determines whether and how to route non-standby L1 circuit paths (Standby property set to F).
 - WAE Design determines if the non-standby L1 circuit path should route by checking the following L1 circuit properties in this order.

If the L1 circuit Active Path property is set to this L1 circuit path, WAE Design tries to route the non-standby L1 circuit path.

If the number of routed L1 circuit paths is less than the associated L1 circuit's Min Routed Paths property, WAE Design tries to route the non-standby L1 circuit paths.

- Non-standby L1 circuit paths are routed based on their Path Option setting (lower numbers are routed first). For each of these paths, the route order is based on the same criteria as described above for standby L1 circuit paths (actual L1 circuit path hops, then central frequency ID values, and then L1 circuit path hops that do not have central frequency ID values).

Within each of the above routing instances, WAE Design routes the L1 circuit path based on the following criteria regardless of whether the L1 circuit path is standby or non-standby.

- Routes are based on the lowest Setup Priority value and then deterministically. For example, among L1 circuit paths with actual L1 circuit path hops, those with higher Setup Priority are routed first. See .
- L1 circuit paths that do not require automatic wavelength assignments to route have higher priority than those that do. For information on the Auto Spectrum Assignment property, see [Central Frequency ID Assignments, on page 14](#).

Viewing L1 Circuit Paths

To view the actual paths or simulated paths of L1 circuits, choose **View > L1 Circuits**. Note that given the priority of routing, if the actual L1 circuit path hops path is valid, the actual and simulated paths are the same. You can also choose to view the shortest latency path from this menu.

Rerouted simulated L1 circuit paths show automatically when they are rerouted due to failures, regardless of whether you are showing simulated paths.

Actual L1 Circuit Path

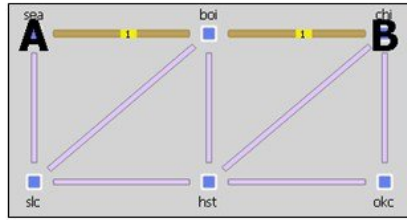

Shortest Latency L1 Circuit Path

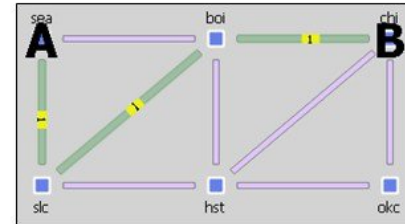

Simulated L1 Circuit Path

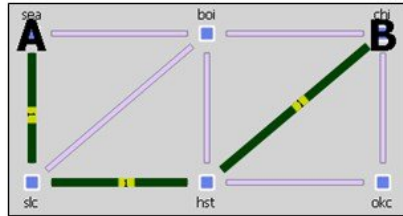

Simulated L1 Circuit Path Rerouted Under Failure

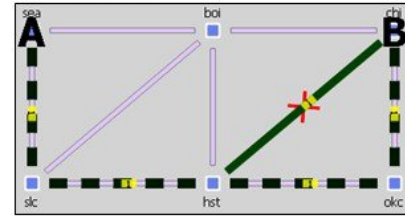

383000

L1 Circuit Path Hops

You can force an L1 circuit path to choose a different route by setting one or more node hops or link hops.

Node Hops	Link Hops
<ul style="list-style-type: none"> • Loose—The path must pass through the node, but the node does not have to be connected directly to the previous hop. • Strict—The node must be directly connected to the previous node. • Exclude—This node cannot be in the path. 	<ul style="list-style-type: none"> • Strict—The L1 link must be in the path in the specified order. • Exclude—This L1 link cannot be in the path.

Generally, node hops are used for simplicity, but link hops are useful for when you need to distinguish between two parallel L1 links. To do this, set a loose hop on the L1 node preceding the link hop, and then set a strict hop on the parallel L1 link over which you want to route this L1 circuit.

You can set L1 circuit path hops in an L1 circuit path Properties dialog box. Because WAE Design always uses the shortest path, remember to set as many hops as needed to achieve the desired path, and put them in the order of the desired path. The L1 Circuits Path Hops table identifies the path and the steps.



Note Because L1 circuits paths are bidirectional, to simulate L1 circuit path hops WAE Design automatically adds the initial L1 node in the path as a strict hop.

Example: [Figure 4: Shortest L1 Circuit Paths Versus Paths Determined by L1 Circuit Path Hops, on page 9](#) shows an example of a default shortest path being used, as well as an alternate circuit path created using a loose nyc node hop. It also demonstrates that you could achieve the same path by setting only an exclude link hop on wdc-bos.

Figure 4: Shortest L1 Circuit Paths Versus Paths Determined by L1 Circuit Path Hops

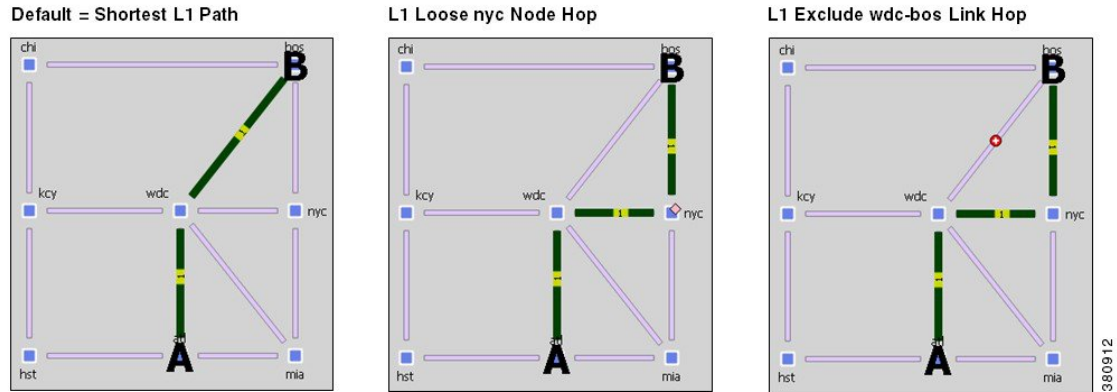

For More Information...	See...
Automate the process of setting up L1 circuit hops	Explicit L1 Circuit Paths Initializer, on page 9
Set L1 circuit hops per L1 node or L1 link	Creating Individual L1 Circuit Path Hops, on page 37

Explicit L1 Circuit Paths Initializer

The Explicit L1 Circuit Paths Initializer automates the process of creating explicitly routed L1 circuit paths.

- Step 1** Choose one or more L1 circuit paths. If you select none, the default is to create L1 circuit path hops for all L1 circuit paths.
- Step 2** Choose **Initializers > Explicit L1 Circuit Paths**, or right-click an L1 circuit path and choose **Explicit L1 Circuit Path Initializer**.
- Step 3** Choose whether to use all L1 circuit paths, those selected in the table, or those with specific tags.
- Step 4** Click **OK**.

L1 Circuit Route Reports

You can create reports on L1 circuits based on the L1 circuit path identified as the Active Path Sim for each L1 circuit. Additionally, the report contains all other columns in an L1 Circuits table, though they are initially hidden.

- Step 1** Choose **Tools > Reports > Layer 1 Circuit Routes**.
 - Step 2** Click **OK**.
- After closing the report, you can access it again by choosing **Window > Reports**.
- To export the report, right-click the **Routes** report name in the Reports navigation pane, and choose **Export**.

L1 Link Metrics

When L1 circuit paths are routed over L1 links, by default they are established along the shortest path between the L1 nodes. This shortest path is defined as the path with the lowest metric, and the metric of an L1 circuit path is defined as the sum of the L1 link metrics in the path. To move L1 circuit paths away from an L1 link, raise the metric on that L1 link.

Because you can simultaneously edit multiple L1 link Metric properties, this method is useful for altering numerous L1 circuit paths at a time. For exact path specification per L1 circuit path, however, you must set explicit L1 circuit path hops.

L1 Link



If the two shortest L1 circuit paths have the same metric, WAE Design chooses one arbitrarily provided no other properties impact the route.

Note that in contrast to an interface IGP metric, this L1 metric does not represent an actual configurable quantity in the network.

Example: [Figure 5: Example Effect of L1 Link Metric on Routing L1 Circuits, on page 10](#) shows an example L1 circuit from sjc to kcy. When the sjc-slz L1 link has a metric of 2.7, the shortest L1 circuit path is sjc-slz-kcy. By raising the sjc-slz metric, the shortest L1 circuit path becomes sjc-sea-slz-kcy.

Figure 5: Example Effect of L1 Link Metric on Routing L1 Circuits

L1 Links		
L1 Node A	L1 Node B	Metric
kcy	slz	12.000
sea	sjc	7.500
sjc	slz	2.700
sea	slz	8.000

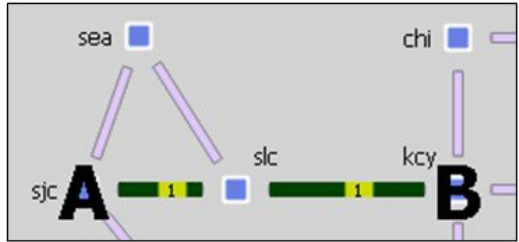

L1 Links		
L1 Node A	L1 Node B	Metric
kcy	slz	12.000
sea	sjc	7.500
sjc	slz	20.700
sea	slz	8.000

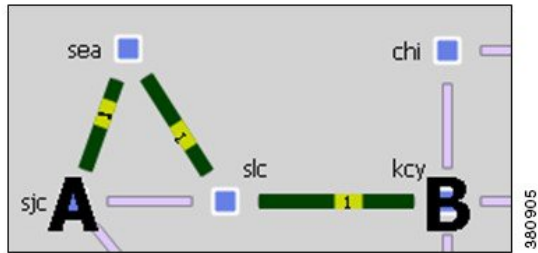

L1 Link Metric Initializer

The L1 Link Metric Initializer sets L1 metrics based on L1 link distances. WAE Design calculates the metric by multiplying each L1 link's Distance value by the multiplier you specify. You also set a minimum value for the resulting metric. WAE Design then uses the higher of the two values.

Example: If the L1 Distance value is 7, the multiplier value is 3, and the minimum value is 1, the resulting L1 metric is 21 (Distance * Multiplier). However, if the minimum value were 25, the resulting L1 metric would be 25.

Step 1

Make your selections.

- Choose one or more L1 links.
- If you make no selections, metrics are calculated for all L1 links.

Step 2

Choose **Initializers** > **Layer 1 Metric**, or right-click an L1 link and choose **Initialize L1 Metric**.

Step 3

Enter a multiplier and minimum value, and click **OK**.

L1 Circuit Path Setup Priority

The Setup Priority property identifies the order in which L1 circuit paths are routed when they share the same L1 link. The lower the number, the higher the priority. [Figure 7: Example Spectrum Blocking, on page 17](#) shows an example of rerouting L1 circuit paths based on Setup Priority.

L1 Circuit Path

To set the Setup Priority, right-click one or more L1 circuit paths and choose **Properties**. This value appears in the L1 Circuit Paths table in the Setup Priority column.

L1 Circuit Wavelengths

The L1 circuit central frequency ID (wavelength) properties include those that identify transmission feasibility and central frequency ID assignments.

Using these properties, you can answer questions like:

- Can I add an L3 circuit that uses a specific L1 circuit?
- How will my network choose a new L1 circuit path under L1 failure?
- Can I modify an existing L1 circuit for an L3 circuit?
- How many available wavelengths are there in my L1 topology?
- What happens to the network when there are L1 failures? Does optical restoration select a new L1 circuit path, and if so, which path?

Transmission Feasibility

In a real network, the quality of an L1 circuit deteriorates as it passes through L1 links. Using feasibility properties, WAE Design lets you simulate this weakening of L1 circuits to determine if they have degraded to the point of being unroutable.

Feasibility Property	Description
L1 Link	
Noise	Identifies unidirectional properties for L1 Links. <ul style="list-style-type: none"> NoiseAtoB (default is undefined): The noise introduced by L1 Link from L1 Node A to L1 Node B in dB. NoiseBtoA (default is undefined): The noise introduced by L1 Link from L1 Node B to L1 Node A in dB.
NoiseSigma	Identifies unidirectional properties for L1 Links. <ul style="list-style-type: none"> NoiseSigmaAtoB (default is undefined): The noise sigma introduced by L1 Link from L1 Node A to L1 Node B in dB. NoiseSigmaBtoA (default is undefined): The noise sigma introduced by L1 Link from L1 Node B to L1 Node A in dB.
L1 Circuit	
Feasibility Metric Sim	This is copied from the Feasibility Metric Sim of the active L1 circuit path.
Feasible Transmission	Identifies whether the L1 circuit can be transmitted. This is copied from the Feasible Transmission of the active L1 circuit path. If all L1 circuit paths have a higher Feasibility Metric Sim than Feasibility Limit, this value is F (false), and the L1 circuit cannot route.
L1 Circuit Path	
Feasibility Metric Sim	The simulated Feasibility Metric of the L1 Circuit Path in dB.
Feasibility Limit	Identifies the acceptable quality of the L1 circuit path.
Feasibility Acceptance Threshold	Identifies the acceptance threshold used in calculating the L1 circuit path feasibility metric. Lower thresholds increase the risk that the L1 circuit path is not feasible in the network. The default is 3.
Feasible Transmission	Identifies whether the L1 circuit path can be transmitted. If the L1 circuit path's Feasibility Limit is more than the sum of the Feasibility Metrics for the L1 links that the L1 circuit path traverses, this value is T (true) and the L1 circuit path can route. <p>Note This property does not apply if an L1 circuit uses actual L1 circuit path hops.</p>

Routing Based on Feasibility Properties

Feasibility properties affect routing as follows:

- If there is no Feasibility Limit, the shortest path is based on the L1 link Metric property, and Feasible Transmission is set to “na.”
- The shortest L1 circuit path is based on the L1 links that result in a L1 circuit path’s Feasibility Metric Sim value that is lower than the L1 circuit path’s Feasibility Limit. The Feasible Transmission of the L1 circuit path is set to T (true).
- If the L1 circuit path Feasibility Metric Sim is higher than the Feasibility Limit, it is not routed, and the Feasible Transmission is set to F (false) except when actual L1 circuit path hops exist.

Example: [Figure 6: Example Effects of L1 Link Feasibility on Routing L1 Circuit Paths](#), on page 13 shows a series of changes to the Feasibility Limit on an L1 circuit path. The L1 Links table—which shows the amount of noise, in decibels—does not change in any of the following scenarios.

- Row 1 shows that the Feasibility Limit of the L1 circuit path is set to –10 dB. Because the simulated feasibility metric (Feasibility Metric Sim) is lower than the Feasibility Limit, the L1 circuit path follows the shortest path, from sea to boi.
- Row 2 shows that the Feasibility Limit of the L1 circuit path decreases to –11.5 dB, and the path follows a longer route (sea-slc-boi) to stay under the limit.
- Row 3 shows that the Feasibility Limit of the L1 circuit path decreases to –12 dB, thus making it impossible for the path to route. The Feasibility Metric Sim changes to “na.”

Figure 6: Example Effects of L1 Link Feasibility on Routing L1 Circuit Paths

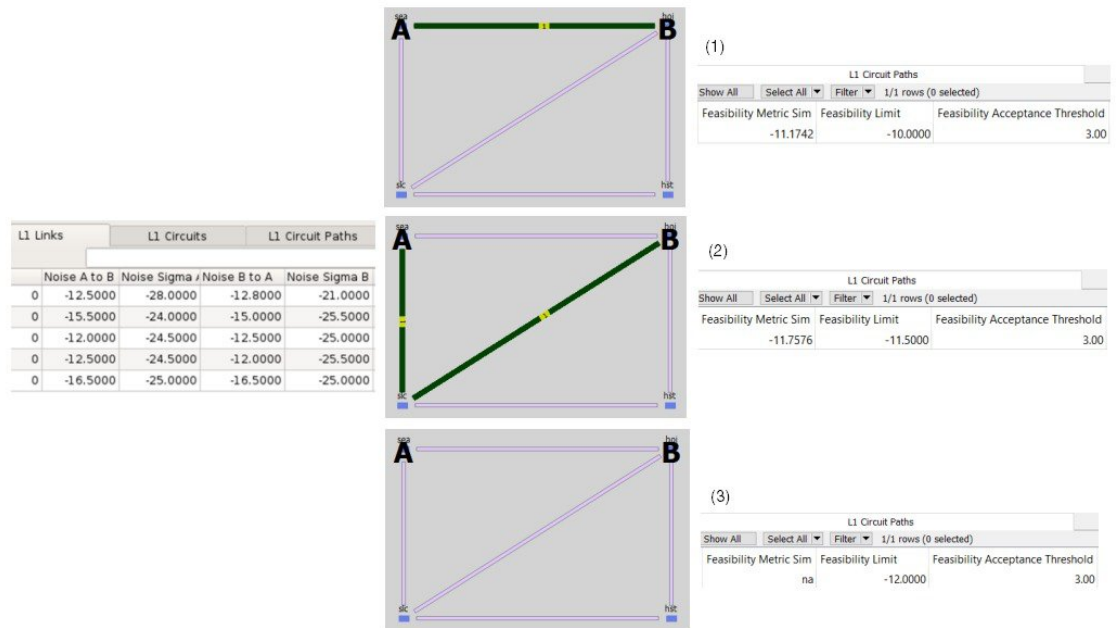

Spectrum Modeling

L1 Circuits can be assigned spectrum of variable sizes.

Each Spectrum Grid is identified by Anchor Frequency, Central frequency granularity, and Central Frequency ID Blocked list. The Frequency ID Lower Bound and Frequency ID Upper Bound represent the lower and upper bounds on available central frequency IDs.

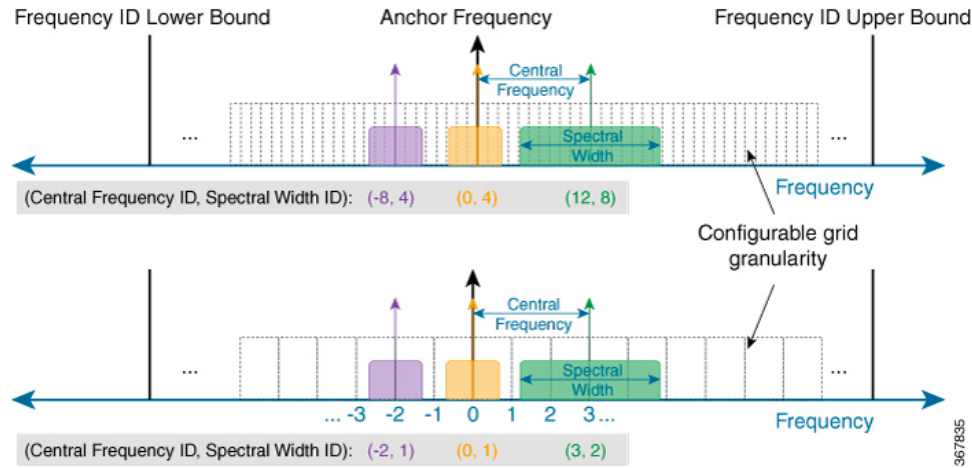

To define the spectrum grids, choose **Edit > Network Options**. On the Edit Network Options dialog box, click **Advanced** tab and update the values under Spectrum Grid section.

Central Frequency ID Assignments

Because multiple L1 Circuit Paths are transmitted in the same fiber, it is required that they each occupy a different part of the spectrum as they cross an L1 link. The portion of the spectrum that an L1 Circuit Path occupies is determined by its Central Frequency ID and Spectral Width ID. The Central Frequency ID identifies the central frequency of the L1 circuit path in terms of its distance from the Anchor Frequency of the defined grid. The Spectral Width ID defines the size of the L1 Circuit Path around this central frequency. This is expressed in integer increments corresponding to double the Central Frequency Granularity.

In WAE Design, the Central Frequency ID property identifies the L1 circuit path wavelength. To simulate changes in the Central Frequency ID values (regenerators) along an L1 circuit path, you can manually set Central Frequency ID values for each L1 circuit path hop.

- Each L1 circuit path traversing an L1 link must have a unique Central Frequency ID while on that L1 link. If more than one L1 circuit path has the same Central Frequency ID as they cross the L1 link, *Spectrum blocking* occurs. That is, the L1 circuit path with the highest Setup Priority property (lowest number) is routed, and the others are blocked.

To determine which L1 links are causing the spectrum blocking, right-click any L1 circuit path whose Spectrum Blocking value is T (True), and choose **Filter to Spectrum Blocking L1 Links**.

- Each L1 circuit path must use the same Central Frequency ID value on all L1 links that it traverses unless Central Frequency ID values are set on the L1 circuit path hops. This requirement is called the *spectrum continuity constraint*.

Feasibility Property	Description
L1 Circuit	

Feasibility Property	Description
Central Frequency ID Sim	<p>Simulated ID of the initial central frequency, which is copied from the Central Frequency ID Sim of the active L1 circuit path.</p> <p>This value is set to “na” if no L1 circuit path can be routed.</p>
Spectrum Blocking	<p>True (T) means the L1 circuit cannot be routed because there is spectrum blocking on all of its L1 circuit paths.</p>
Prefer Lower Frequency IDs	<p>Specifies if the spectrum assignment algorithm prefers lower Frequency IDs. The default is True (T).</p>
L1 Circuit Path	
Central Frequency ID	<p>The ID of the initial central frequency of the L1 Circuit Path..</p> <ul style="list-style-type: none"> • If there is no Central Frequency ID value entered, the central frequency ID value of the most recently used L1 circuit path hop is copied here. • If there are no L1 circuit path hops or if there are no Central Frequency ID assigned to L1 circuit path hops, this value is set to “na.”
Spectral Width ID	<p>The spectral width of the L1 Circuit Path in integer increments corresponding to double the Central Frequency Granularity.</p> <p>This value is set to 1 if it is not explicitly set.</p>
Central Frequency ID Sim	<p>Simulated ID of the initial central frequency , which is copied from one of these values in this order of priority:</p> <ul style="list-style-type: none"> • Central Frequency ID Sim value of the first actual L1 circuit path hop. • Central Frequency ID Sim value of the first L1 circuit path hop. • Central Frequency ID value of the L1 circuit path. <p>If Auto Spectrum Assignment is invoked, WAE Design changes the Central Frequency ID Sim in order to route the L1 circuit path.</p> <p>This value is set to “na” if the L1 circuit path cannot be routed.</p>
Central Frequency Sim	<p>The simulated initial central wavelength of the L1 Circuit Path.</p>
Spectral Width	<p>The spectral width of the L1 Circuit Path in GHz.</p>
Spectrum Blocking	<p>True (T) means this L1 circuit path cannot be routed either because it has the same central frequency ID value as another L1 circuit path going over an L1 link.</p>
Auto Spectrum Assigment	<p>If spectrum blocking occurs and if Auto Spectrum Assigment is T (true), the L1 circuit path tries to use another central frequency if it is available.</p> <p>This property is useful for simulating optical restoration when there are L1 failures.</p>
L1 Circuit Path Hop	

Feasibility Property	Description
Central Frequency ID	<p>The user-specified wavelength of the L1 circuit hop.</p> <p>The central frequency is used for all of the subsequent hops if no other change is specified.</p> <p>This value is set to “na” if it is not explicitly set.</p>
Central Frequency ID Sim	<p>Simulated wavelength number, which is copied from one of these values in this order of priority:</p> <ul style="list-style-type: none"> • The hop’s Central Frequency ID value. • The Central Frequency ID of the first preceding L1 circuit path hop that has a Central Frequency ID value. • The Central Frequency ID property of its L1 circuit path. <p>When you manually create L1 circuit path hops, WAE Design automatically creates the first L1 circuit path hop to be the first L1 node in the path. It also copies the L1 circuit path’s Central Frequency ID Sim value to this hop.</p> <p>If Auto Spectrum Assignment is used, this value is set to the Central Frequency ID Sim value of the L1 circuit path.</p> <p>This value is set to “na” if no Central Frequency ID values have been specified for this L1 circuit path hop or if the L1 circuit path cannot be routed.</p>

Routing Based on Central Frequency IDs

Central Frequency ID properties affect L1 circuit path routing as follows:

- If the Central Frequency ID is not set and cannot be derived, or if there is no spectrum blocking, the L1 circuit path is routed.
- If there is spectrum blocking, WAE Design checks the Auto Spectrum Assignment property for each L1 circuit path.
 - If F (false), the L1 circuit path is not routed.
 - If T (true), WAE Design tries to route the L1 circuit path on the first central frequency that is continuously available on all L1 links over which it is routed. If no such central frequency is found, the L1 circuit path is not routed.
- Spectral Width ID properties affect L1 Circuit path routing by defining how much spectrum must be available around the Central Frequency.

Note that the Export Spectrum Utilization tool lets you create and export a file that identifies all of the L1 circuit Central Frequency ID Sim values being used on each L1 link. Choose **File > Export > Spectrum Utilization**.

Example: [Figure 7: Example Spectrum Blocking, on page 17](#) shows two L1 circuit paths attempting to route over a common L1 link (chi-nyc).

- Path Option 1 uses sea-boi-chi-nyc.
- Path Option 2 uses sea-slc-hst-okc-chi-nyc.

Both have a Central Frequency ID value of 7. Both have Auto Spectrum Assignment set to F (false). Path Option 1 can route due to its lower Setup Priority value. Path Option 2 cannot route due to Spectrum Blocking being T (true). Notice that the Established column is F (false) and the Routed column is Unrouted.

Example: [Figure 8: Example Auto Spectrum Assignment, on page 17](#) shows that Path Option 2 can route after its Auto Spectrum Assignment property is set to T (true). As a result, its Central Frequency ID Sim automatically changes to an unused Central Frequency ID value so that there is no spectrum blocking. The Spectrum Blocking column changes to F (false), the Established to T (true), and the Routed to Simulated. The reason Path Option 1 can still route, even though its Auto Spectrum Assignment is still set to F, is because it has a lower Setup Priority value. Thus, WAE Design uses Central Frequency ID 7 for this path.

Figure 7: Example Spectrum Blocking

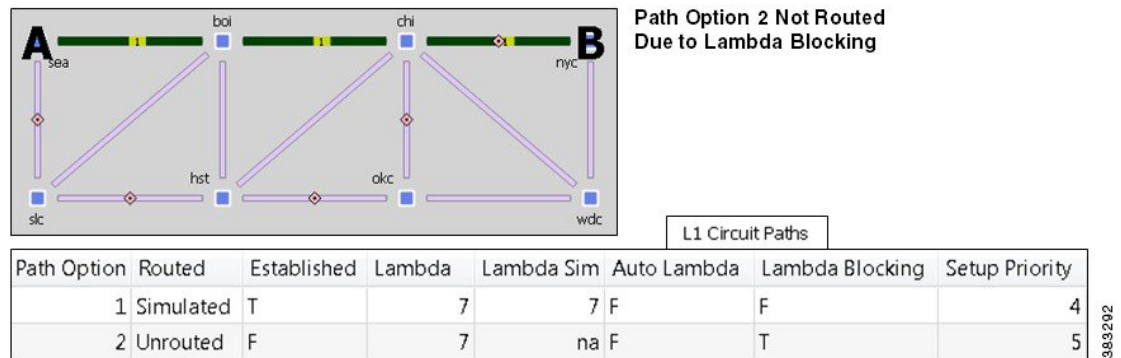
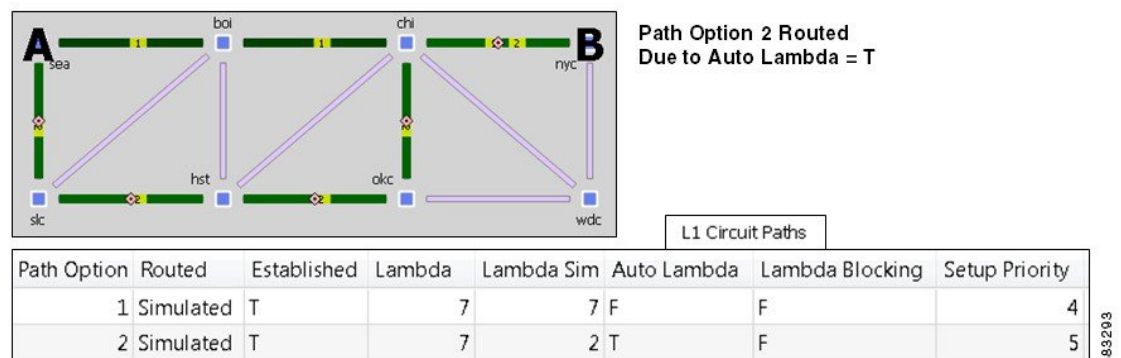

Figure 8: Example Auto Spectrum Assignment



Central Frequency ID Exclude List

Central Frequency Exclude list indicates the list of frequency IDs that may not serve as Central Frequency IDs for L1 Circuit Paths. Central Frequency ID Exclude lists may be set globally for the entire plan file or locally for each L1 Link. Local settings override global settings.

To set a global exclude list choose **Edit > Network Options**. On the Edit Network Options dialog box, click **Advanced** tab and select a list from the **Central Frequency ID Exclude List** dropdown.

To add an excluded frequency list for an L1 link, right-click one or more L1 links and choose **Properties**. To create a new exclude list, see [Creating Central Frequency ID Exclude List, on page 39](#).

L1 Diversity Constraints

L1 Circuits can be configured to be disjoint from other L1 Circuits. This helps in speedy recovery when network failures occur.

WAE Design only supports mutual diversity between two L1 circuits. This means, each L1 circuit can only have one diversity constraint defined. For example, L1 Circuit A and L1 Circuit B can be specified to be diverse from each other. But WAE design does not support setting of L1 Circuit A to be diverse from L1 Circuit B and L1 Circuit B diverse from L1 Circuit C.

You can specify different levels of diversity. L1 Circuit Path can be set to be diverse in terms of L1 Links, L1 Nodes, and SRLGs.

The diversity constraints apply to all L1 Circuit Paths of L1 Circuits. For example, if L1 Circuit A and L1 Circuit B are specified to be diverse from each other with each L1 Circuit having two L1 Circuit Paths, then both L1 Circuit Paths of Circuit A will be diverse from both Circuit Paths of Circuit B.



Note If a fully disjoint path is not found, the L1 Circuit Path is not routed.

Relationships Between L1 and L3

Relationships between L1 and L3 objects can be created in multiple ways. [Figure 9: Configurable L1 and L3 Relationships, on page 19](#) shows the relationships that can be directly configured.

- You can create L3-L1 links to model the physical relationship between L3 nodes and L1 nodes as shown in [Figure 3: L1-L3 Link Visualization, on page 3](#).
- You can directly map L1 ports to L3 ports.
- You can directly map L1 circuits to L3 circuits, or these associations can be formed indirectly. Once associated with L1 circuits, L3 circuits inherit properties, such as Delay and Distance, from L1 circuits. Additionally, these associations let you see the effect that failed and inactive L1 links, L1 nodes, and L1 ports have on the L3 network.

The basis of indirect L1-L3 relationships is the fact that every L1 circuit must have two L1 ports and that you can optionally map these L1 ports to L3 ports.

- When L1 ports are mapped to L3 ports that are associated with L3 circuits, L1 circuits become indirectly associated with those same L3 circuits.
- Similarly, when L1 ports are mapped to L3 ports that are associated with L3 port circuits, L1 circuits become indirectly associated with those same L3 port circuits.
- Two L3 ports are implicitly connected (1) if they are connected to two interfaces on the same L3 circuit and (2) if they are mapped to L1 ports that are connected to an L1 circuit.

Note that you can enhance the visualization of L1 and L3 relationships by viewing both layers simultaneously.

Figure 9: Configurable L1 and L3 Relationships

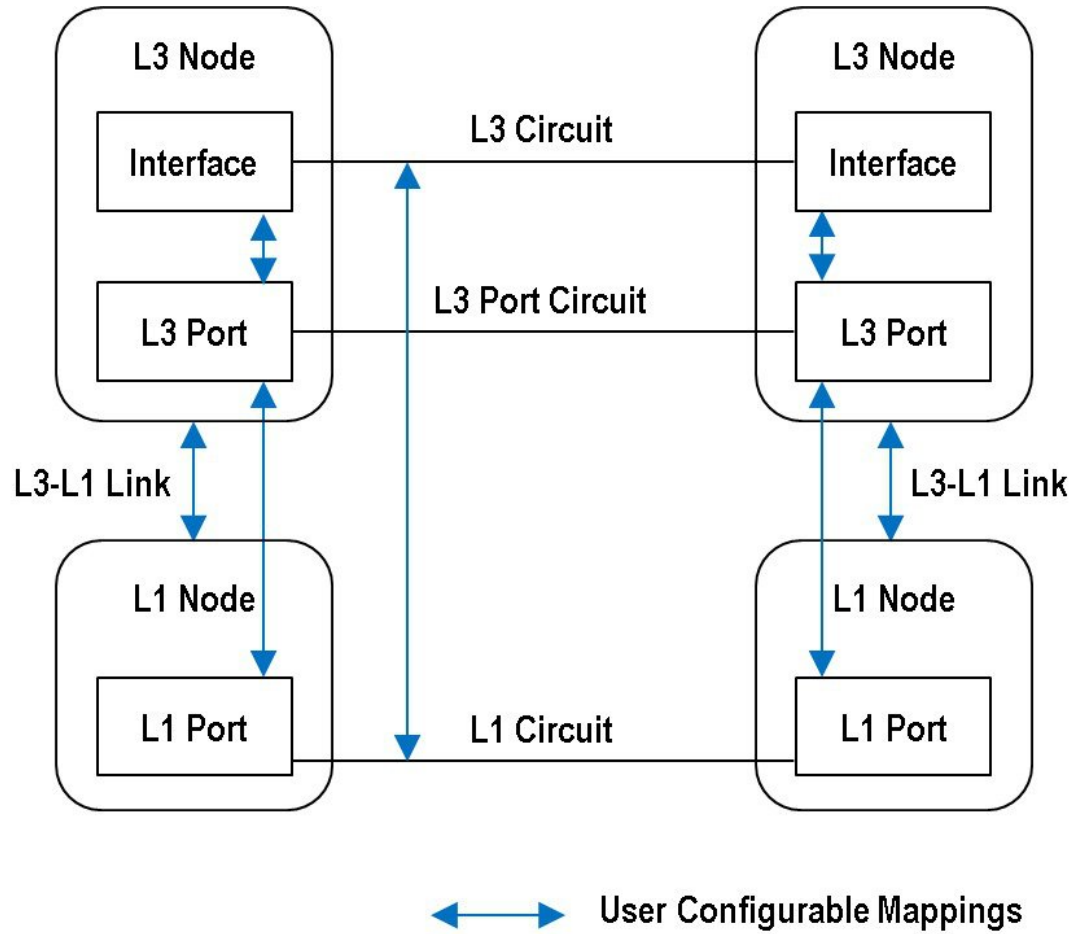

407030

For More Information...	See...
Directly map L1 circuits to L3 circuits	Mapping an L1 Circuit to an L3 Circuit, on page 44
Directly map L1 ports to L3 ports	Mapping an L1 Circuit to an L3 Port Circuit, on page 45
Create L3-L1 links	Creating L3-L1 Links Between Nodes, on page 40
View L1 and L3 layers simultaneously	Multi-Layer Visualization, on page 46

Example Relations Between L1 Link and L3 Circuit

This example demonstrates the dynamics between an L1 link and L3 circuits. [Figure 10: Relationship Between L1 Links and L1 Circuits, on page 21](#) shows an L1 link named key-slc that is filtered to its associated L1 circuits. Each L1 circuit path has one L1 circuit path (labeled “1” on the path) where the end L1 nodes are labeled A and B. [Figure 11: Relationship Between L1 Circuits and L3 Circuits, on page 22](#) shows the association of these L1 circuits with L3 circuits.

Example Relations Between L1 Link and L3 Circuit

This L1 Link...	Is Used By These L1 Circuits...	Which Are Mapped to These L3 Circuits
key-slc	chi-sea	cr1.chi-cr2.sea
	chi-sjc	cr2.chi-cr1.sjc
	kcy-sjc	cr1.sjc-cr1.kcy

Figure 10: Relationship Between L1 Links and L1 Circuits

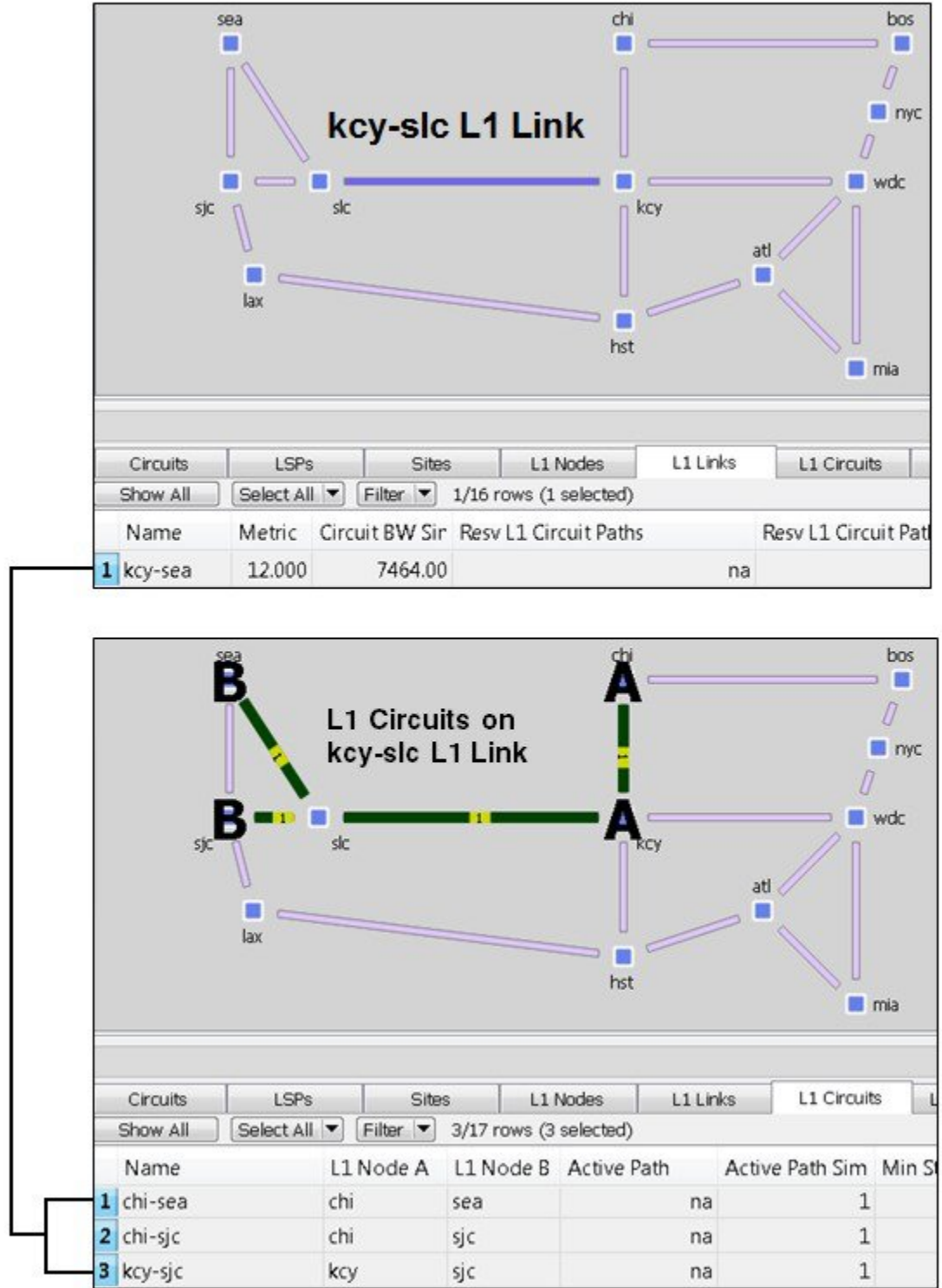

380923

Figure 11: Relationship Between L1 Circuits and L3 Circuits

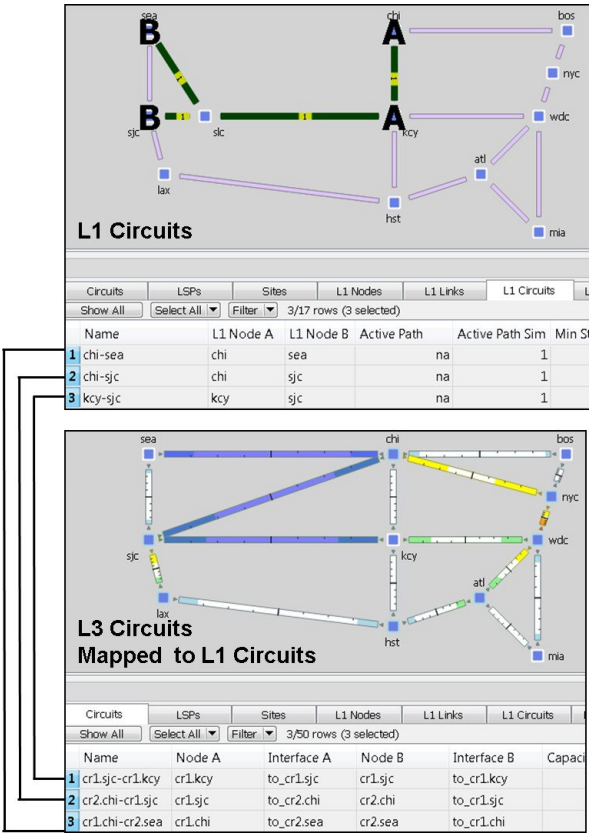

L3 View Showing the Same Mapped L3 Circuits with L1 Circuits Selected in the Background

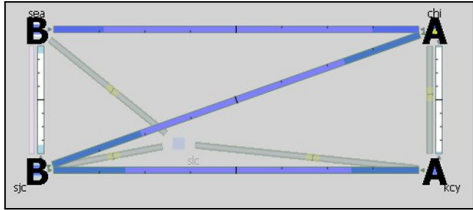

380941

Delay and Distance

Both Delay and Distance are properties that can be set in the L1 link and L1 circuit path Properties dialog boxes. To automate the process of setting these, use the Latency and Distance Initializer. For more information on simulated Delay and Distance, including the Latency and Distance Initializer, see [Simulation](#).

L1 Link

Distance:	1119.38
Delay:	5.57

L1 Circuit Path

Delay:	7.5	Distance:	2000
--------	-----	-----------	------

38 09 41

Column	Description
L1 Links	
Delay	One-way transmission latency over the L1 link in milliseconds (ms).
Distance	Distance of the L1 link in kilometers (km).
L1 Circuits	
Delay Sim	<ul style="list-style-type: none"> • (Derived) This valued is copied from the L1 circuit path Delay Sim column of the active path. • If no L3 Delay is explicitly set for the L3 circuit, the Delay Sim column in the (L3) Circuits table is copied from the Delay Sim column of the mapped L1 circuit, which is based on the L1 circuit path being used as the active path.
Distance Sim	<ul style="list-style-type: none"> • (Derived) This valued is copied from the L1 circuit path Distance Sim column of the active path. • If no L3 Distance is explicitly set for the L3 circuit, the Distance Sim column in the (L3) Circuits table is copied from the Distance Sim column of the mapped L1 circuit, which is based on the L1 circuit path being used as the active path.
L1 Circuit Paths	
Delay	One-way transmission latency over the L1 circuit path in milliseconds (ms).
Delay Sim	(Derived) If the L1 circuit path Delay value is entered, it is copied to the Delay Sim column. Otherwise, this is set to the sum of the delays of the L1 links over which this L1 circuit path is routed.
Distance	Distance of the L1 circuit path in kilometers (km).
Distance Sim	(Derived) If the L1 circuit path Distance value is entered, it is copied to the Distance Sim column. Otherwise, this is set to the sum of the distances of the L1 links over which this L1 circuit path is routed.

Example: [Figure 12: Example Effect of L1 Link Delay and Distance, on page 24](#) shows how L1 link Delay and Distance properties affect L1 circuit path properties (and thus, L1 circuit properties), and how they can potentially affect L3 circuit properties.

- One L1 circuit, which is mapped to an L3 circuit, has two L1 circuit paths.
- Because the active L1 circuit path (Path Option 2) has neither a Delay, nor a Distance set, its Delay Sim and Distance Sim columns are derived by adding together the Distance and Delay values of the L1 links over which it traverses. The combined Delay of these three L1 links is 6.880 ms, and the combined Distance is 900 km. The L1 circuit inherits these in its Distance Sim and Delay Sim columns.
- Because the L3 circuit mapped to the L1 circuit does not have a Delay or Distance property, its Delay Sim and Distance Sim values are copied from the L1 circuit Delay Sim and Distance Sim columns.
- Note that if the L1 circuit's active path were to change to 1 (Path Option 1), the L1 circuit and its mapped L3 circuit would have a Distance Sim of 1400 km and a Delay Sim of 10.880.

Figure 12: Example Effect of L1 Link Delay and Distance

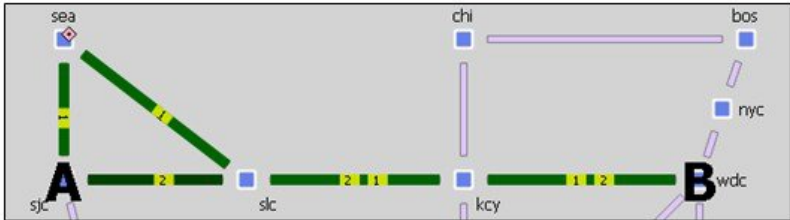

L1 Links				
Name	L1 Node A	L1 Node B	Distance	Delay
L1link-sea-sjc	sea	sjc	200.000	2.00
L1link-sea-slc	sea	slc	400.000	3.00
L1link-kcy-wdc	kcy	wdc	300.000	1.00
L1link-sjc-slc	sjc	slc	100.000	1.00
L1link-kcy-slc	kcy	slc	500.000	4.88

L1 Circuit Paths							
L1 Circuit	L1 Node A	L1 Node B	Path Option	Distance	Distance Sim	Delay	Delay Sim
sjc-wdc	sjc	wdc	1	na	1400.000	na	10.880
sjc-wdc	sjc	wdc	2	na	900.000	na	6.880

L1 Circuits					
Name	L1 Node A	L1 Node B	Active Path Sim	Distance Sim	Delay Sim
sjc-wdc	sjc	wdc	2	900.000	6.880

Circuits								
Name	Node A	Interface A	Node B	Interface B	Delay	Delay Sim	Distance	Distance Sim
cr1.sjc-cr1.wdc	cr1.sjc	to_cr1.wdc	cr1.wdc	to_cr1.sjc	na	6.88	na	900.00

380904

L1 Failures

L1 links, L1 nodes, and L1 ports can be set to failed states similarly to L3 circuits and nodes in the L3 topology.



Note For detailed information about visual representations of failure, inactive, and non-operational states, see [Plot Legend for Design Layouts](#). For information on how to fail objects and recover them from failures, and how to set objects to active or inactive state, see [Simulation](#).

L1 Failure Effects on L3

L3 circuits are rerouted due to L1 failures if the L3 circuit is mapped to an L1 circuit that would traverse a failed L1 node or L1 link under normal operations.

Example: Drawing upon the example L1 link, L1 circuits, and L3 circuits relationships shown in [Figure 10: Relationship Between L1 Links and L1 Circuits, on page 21](#) and [Figure 11: Relationship Between L1 Circuits and L3 Circuits, on page 22](#) [Figure 13: Example Effect of Failing an L1 Link or L1 Node on L3 Circuits, on page 25](#), shows the effects of failing the key-slc L1 link. It also shows the effect of an slc L1 node failure. If an L1 node fails, the connected L1 links are non-operational. In this example, both the L1 link and L1 node failure have the effect of making the same L3 circuits non-operational.

Example: Drawing upon the example in [Figure 13: Example Effect of Failing an L1 Link or L1 Node on L3 Circuits, on page 25](#), [Figure 14: Example Effect of Rerouting L1 Circuit Paths, on page 26](#) demonstrates what occurs if the key-sjc L1 circuit path is rerouted. The L1 circuit path takes a southern route, and the L3 circuit continues to route traffic. The L3 view continues to show active routing, and by selecting the mapped L3 circuit, you can switch to the L1 view to see both the original (solid green) and rerouted, rerouted L1 path (dashed lined). Alternatively, you could see the impact of the L1 failure directly in the L3 view by showing L1 objects in the background ([Figure 15: Multi-Layer View of Rerouting L1 Circuit Paths, on page 26](#)). Note that the L3 circuit Delay Sim value (in the Circuits table) might change due to the rerouting of the L1 circuit path.

Figure 13: Example Effect of Failing an L1 Link or L1 Node on L3 Circuits

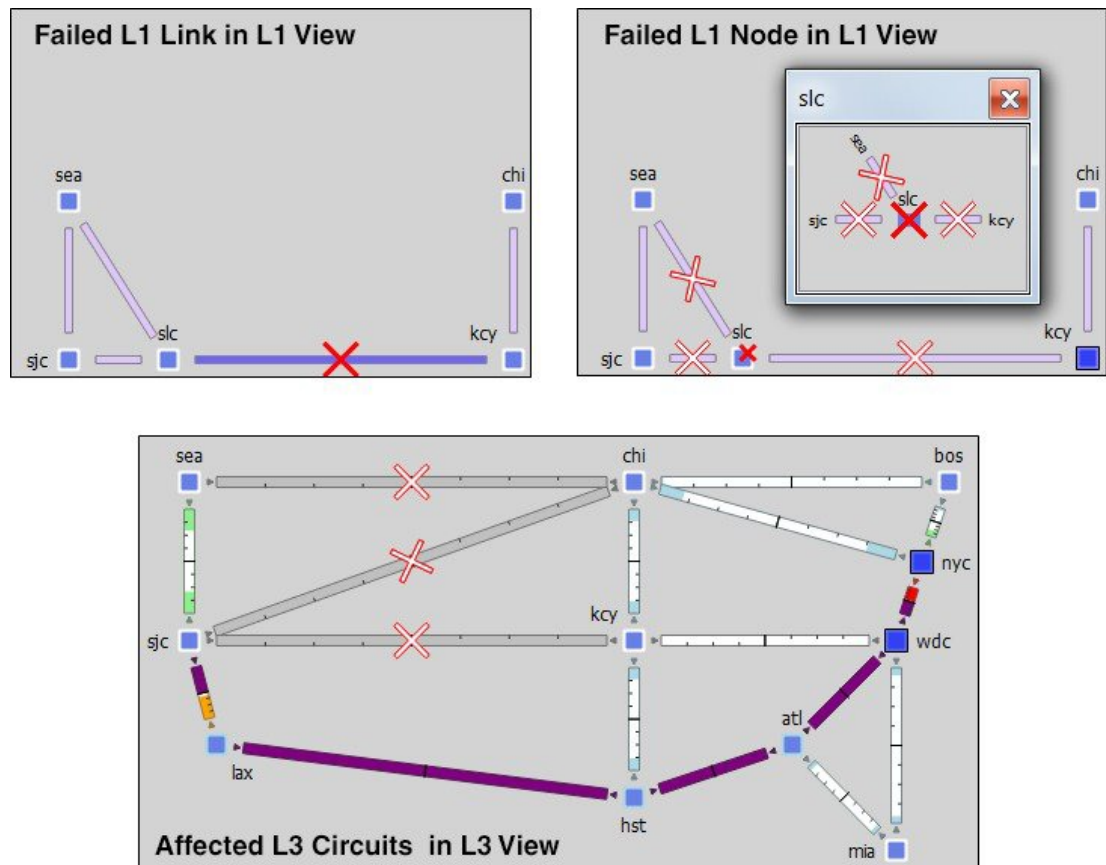

380908

Figure 14: Example Effect of Rerouting L1 Circuit Paths

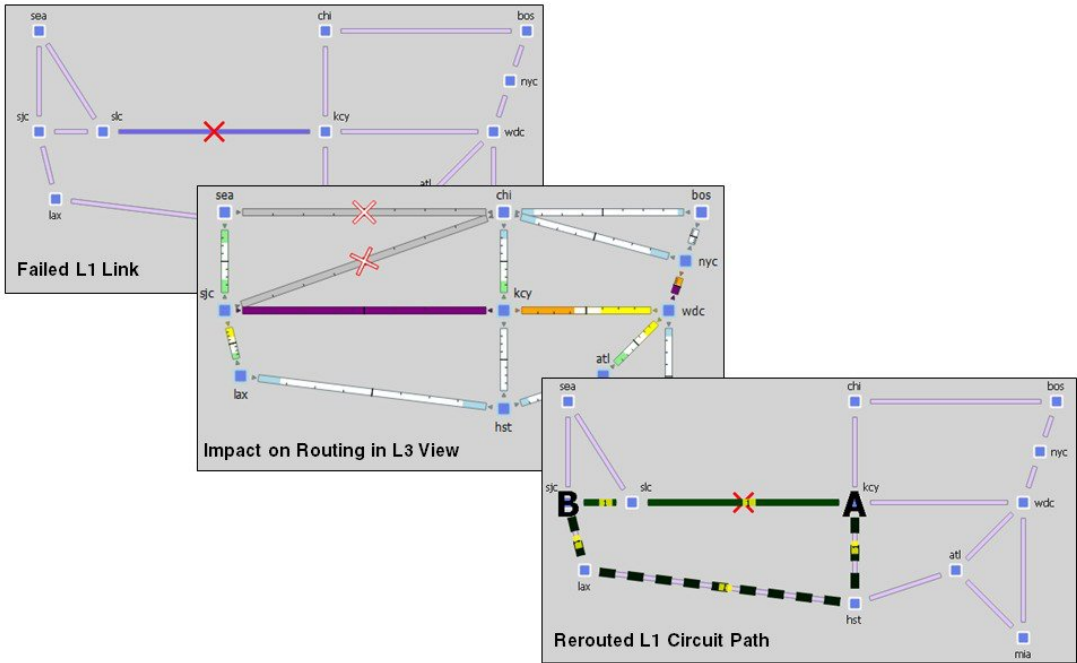

380900

Figure 15: Multi-Layer View of Rerouting L1 Circuit Paths

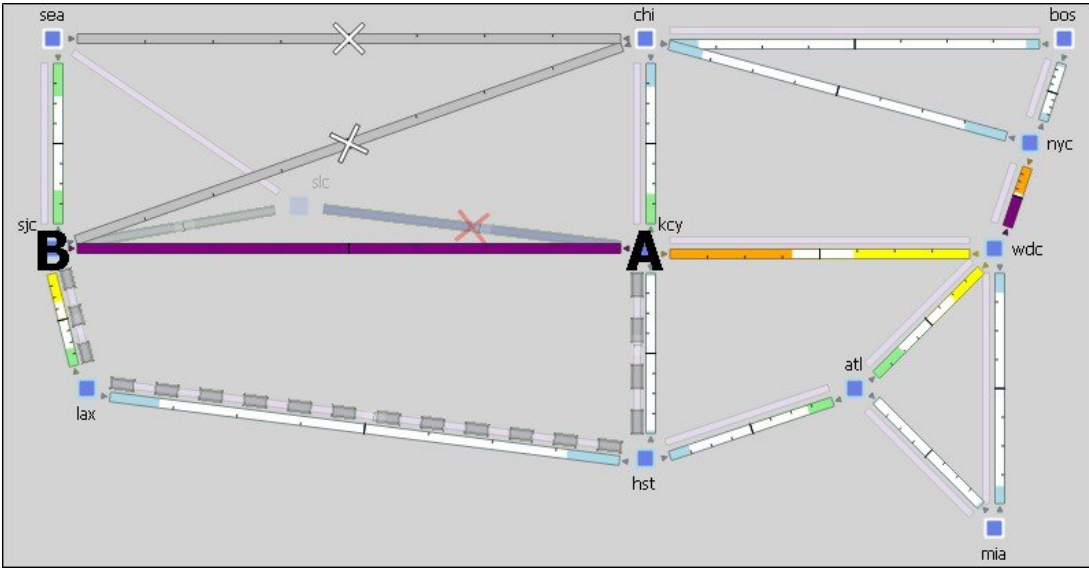

404644

Resiliency Under L1 Failures

L1 circuit paths can be rerouted around failures using either standby (static) or non-standby (dynamic) L1 circuit paths. If no restrictions are specified with respect to path hops, this reroute takes the best path available based on L1 link metrics.

- Standby L1 circuit paths are always established (available) to route. If there are multiple standby L1 circuit paths, WAE Design tries to route each available standby L1 circuit path based on their Path Option values (the lower the value, the higher the priority). In this way you can simulate optical circuit protection, such as might be configured for 1+1 protection (one primary and one backup path).
- The rerouting of non-standby L1 circuit paths under failure is determined by the “Layer 1 rerouting convergence under failures” check box.



If this check box is unchecked, non-standby L1 circuit paths do not try to route when failures occur. L3 convergence can be set to different modes, and each one can be combined with this L1 convergence mode. For example, when combined with setting the L3 simulation convergence mode to Fast Reroute, deselecting this L1 network option is useful for determining the impact on traffic before L1 and L3 restoration has occurred.

If this option is selected, non-standby L1 circuit paths are dynamically available. That is, they are available only if WAE Design tried to route all standby paths and if the number of routed standby paths is less than the L1 circuit’s Min Routed Paths property. Thereafter, WAE Design tries to route each non-standby L1 circuit path in the order of its Path Option value. This behavior models optical circuit restoration. When combined with an L3 simulation convergence mode of IP and LSP Convergence, you can model the impact failures have on traffic after both L3 and L1 have reconverged.

Regardless of this L1 network option setting, standby L1 circuit paths that are not affected by the failure continue to route. For details on how L1 circuit paths are routed, see [L1 Simulations, on page 5](#).

Example: This example assumes that the “Layer 1 rerouting convergence under failures” check box is checked. The L1C_chi-atl L1 circuit has three L1 circuit paths ([Figure 16: Example of Dynamic Non-Standby Path Routing Under Failure, on page 28](#)).

- Path Option 1 is standby, and has no hops.
- Path Option 2 is standby, and has a strict key hop, and an exclude hst hop.
- Path Option 3 is non-standby and has no hops.

The non-standby Path Option 3 is not routed until both standby paths are unroutable due to failure. Notice the Routed column changes for all three paths, indicating which paths are routable or simulated. Also notice that the Established column remains consistent. This is because whether or not an L1 circuit path is available for routing under normal operation has no bearing on whether it is routable under failure.

In this example, if the “Layer 1 rerouting convergence under failures” check box is unchecked, Path Option 3 does not try to reroute ([Figure 17: Example of Non-Standby Path Not Rerouting Under Failure, on page 28](#)).

Figure 16: Example of Dynamic Non-Standby Path Routing Under Failure

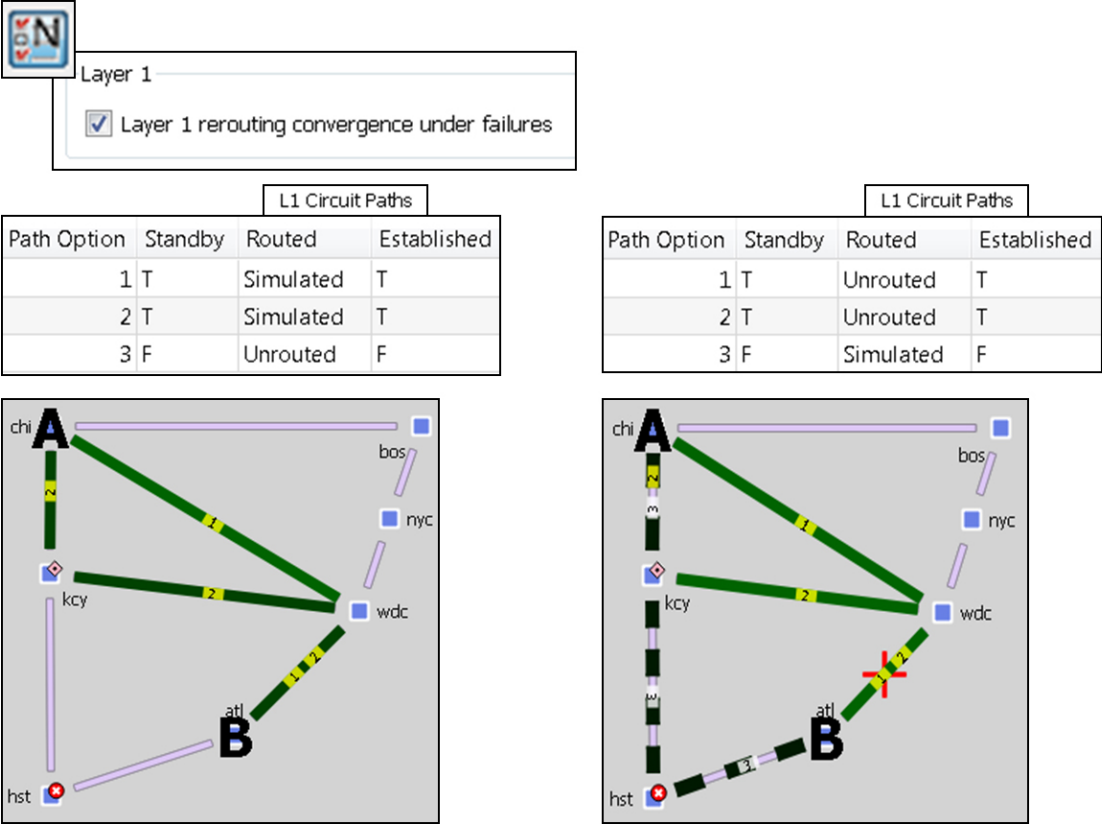
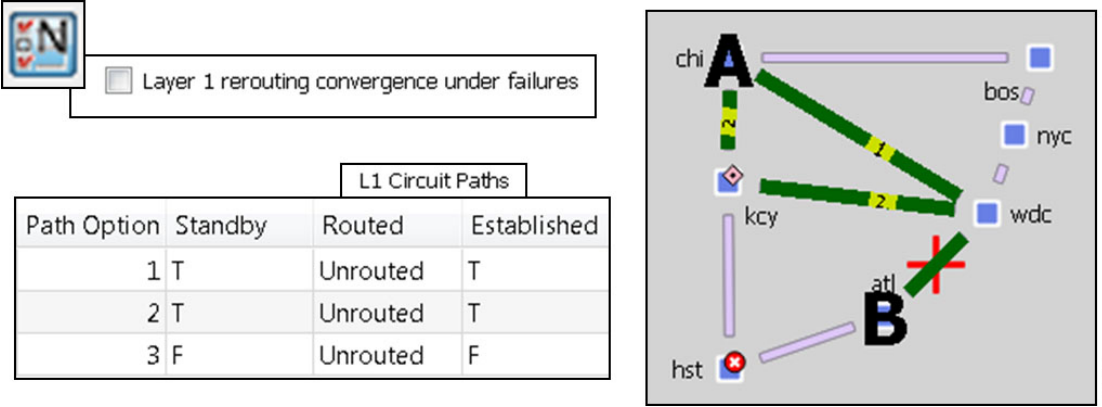

Figure 17: Example of Non-Standby Path Not Rerouting Under Failure



Minimum Routed Paths

The number of L1 circuit paths that WAE Design tries to route is defined by the L1 circuit's Min Routed Paths property. If the number of routed standby paths is less than the Min Routed Paths property, WAE Design tries to route non-standby paths. This can be useful when modeling 1+1+R resilience schemes.

Example: [Figure 18: Example Resilience Scheme Using Minimum Routed Paths Property, on page 29](#) shows an L1 circuit with Min Routed Paths set to 1. It has three L1 circuit paths; two are standby and one is non-standby. When one standby L1 circuit path cannot be rerouted under failure, there is no attempt to route the non-standby path. By changing the Min Routed Path to 2, the non-standby path is routed.

Figure 18: Example Resilience Scheme Using Minimum Routed Paths Property

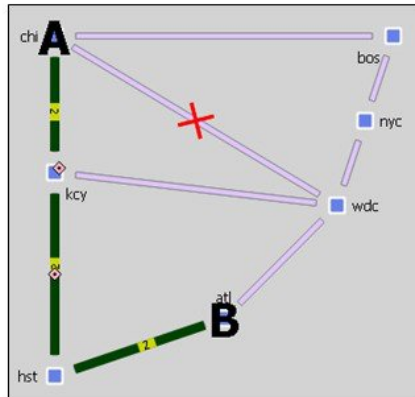

L1 Circuits			
Active Path Sim	Min Routed Paths	Operational	Routed
2	1	T	Simulated

L1 Circuit Paths				
Path Option	Standby	Routed	Established	Operational
1	T	Unrouted	T	F
2	T	Simulated	T	T
3	F	Unrouted	F	F

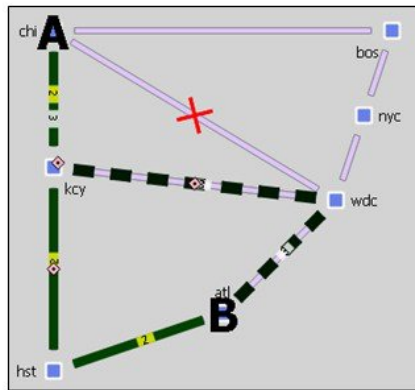

L1 Circuits			
Active Path Sim	Min Routed Paths	Operational	Routed
2	2	T	Simulated

L1 Circuit Paths				
Path Option	Standby	Routed	Established	Operational
1	T	Unrouted	T	F
2	T	Simulated	T	T
3	F	Simulated	F	T

353653

Inactive State

L1 links, L1 nodes, and L1 ports can be set to inactive states similarly to L3 circuits and nodes in the L3 topology. Setting an L1 link or L1 node to inactive reroutes L1 circuit paths using that L1 link or L1 node. It has no effect on the operational state of L3 circuits unless the L1 circuit path cannot be rerouted, in which case the associated L3 circuit becomes operationally down. Note that the L3 circuit Delay Sim value (in the Circuits table) might change due to the rerouting of an L1 circuit path.

Example: [Figure 19: Example Reroute of L1 Circuit when L1 Link or L1 Node is Inactive, on page 30](#) shows a rerouted hst-wdc L1 circuit path when an L1 link that it traverses is set to inactive. The same L1 circuit path reroute occurs as a result of the atl L1 node being set to inactive.

Figure 19: Example Reroute of L1 Circuit when L1 Link or L1 Node is Inactive

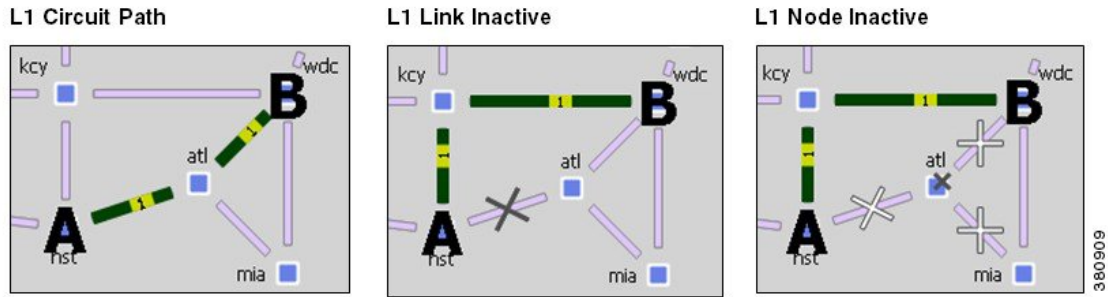

L1 Simulation Analysis

L1 links and L1 nodes can be included in Simulation Analysis either as single objects or as part of SRLGs. L1 ports can be included as single objects.

Worst-Case Simulations

When included in the Simulation Analysis, their impact on L3 worst-case traffic utilization is reflected in the L3 Worst-Case Traffic view. Similarly, if an L1 link or L1 node is the cause of worst-case traffic utilization, it is reflected in the WC Failure column in the Interfaces and Circuits tables.

The L1 Links table updates the following columns when you include L1 links or L1 nodes in the Simulation Analysis:

- WC Num L1 Circuit Paths—Number of L1 circuit paths that traverse this L1 link under worst-case L1 failure simulations.
- WC Util Sim—Number of L1 circuit paths that traverse this L1 link under worst-case L1 failure simulations as a percentage of the maximum number of L1 circuit paths that can traverse this L1 link without failures.

Number of L1 circuit paths that traverse this L1 link under worst-case L1 failure simulations / Max L1 Circuit Paths (property value)

The following columns are updated in the L1 Nodes table:

- Num L1 Circuit Paths—Number of L1 circuit paths with paths through the L1 node.
- WC Failures—Failures that cause the worst-case number of L1 circuit paths.
- WC Num L1 Circuit Paths— Number of L1 circuit paths that traverse this L1 node under worst-case L1 failure simulations.

Failure Impact

The L1 Failure Impact view is available upon running a Simulation Analysis on L1 links. The L1 links are colored according to the maximum L3 interface traffic utilization level that would be caused should an L1 link fail. Similarly, L1 node border colors show the maximum L3 interface traffic utilization level that would

be caused should an L1 node fail. The color indicates the resulting L3 utilization and severity of the L3 congestion.

Example: In the L1 Failure Impact view, if the chi-bos L1 link shows a utilization of 80-90% and its color representation is orange, then if that chi-bos L1 link were to fail, one or more L3 interfaces would react by exceeding a 80% utilization level.



Note The network plot in the L1 Failure Impact view does not show utilizations unless L1 links or L1 nodes are included in Simulation Analysis.

If you are showing only an L1 view, site borders show the maximum utilization level that would be caused elsewhere in the network if L1 nodes within it fail or if intrasite L1 links within it fail. If you are showing a multi-layer (L1 and L3) view, site borders show the maximum utilization level that would be caused elsewhere in the network if a contained L3 node, L3 circuit, L1 node, or L1 link fails.

Example: [Figure 20: Example Site Borders in Failure Impact View, on page 32](#) is an example of how the site border of the sea site differs, depending on whether you are showing a Layer 3 view or a Layer 1 view. Notice that Layer 1 shows the higher failure impact utilization. Thus, when showing a multi-layer view, the border indicating the highest failure impact takes precedence.

The following columns in the L1 Links table show the impact of failing L1 links in Simulation Analysis:

- **Failure Impact**—Worst-case traffic utilization of L3 interfaces if this L1 link were to fail. For example, if the value is 70.13%, it means that if this L1 circuit failed, the resulting traffic utilization on one or more L3 interfaces would exceed 70.13%.
- **Failure Impact Interface**—The L3 interface that will experience the highest utilization as a result of the L1 link going down.

Format = if{Node|Interface}

Example: if{cr2.par|to_cr1.fra} means if the L1 link goes down, it will have the greatest traffic impact on the cr2.par to cr1.fra interface.

The following columns in the L1 Nodes table show the impact of failing L1 nodes in Simulation Analysis:

- **Failure Impact**—Worst-case traffic utilization of L3 interfaces if this L1 node were to fail. For example, if the value is 70.13%, it means that if this L1 node failed, the resulting traffic utilization on one or more L3 interfaces would exceed 70.13%.
- **Failure Impact Interface**—The L3 interface that will experience the highest utilization as a result of the L1 node going down.

Format = if{Node|Interface}

Example: if{cr1.chi|to_cr2.mia} means if the L1 node goes down, it will have the greatest traffic impact on the cr1.chir to cr2.mia interface.

Figure 20: Example Site Borders in Failure Impact View

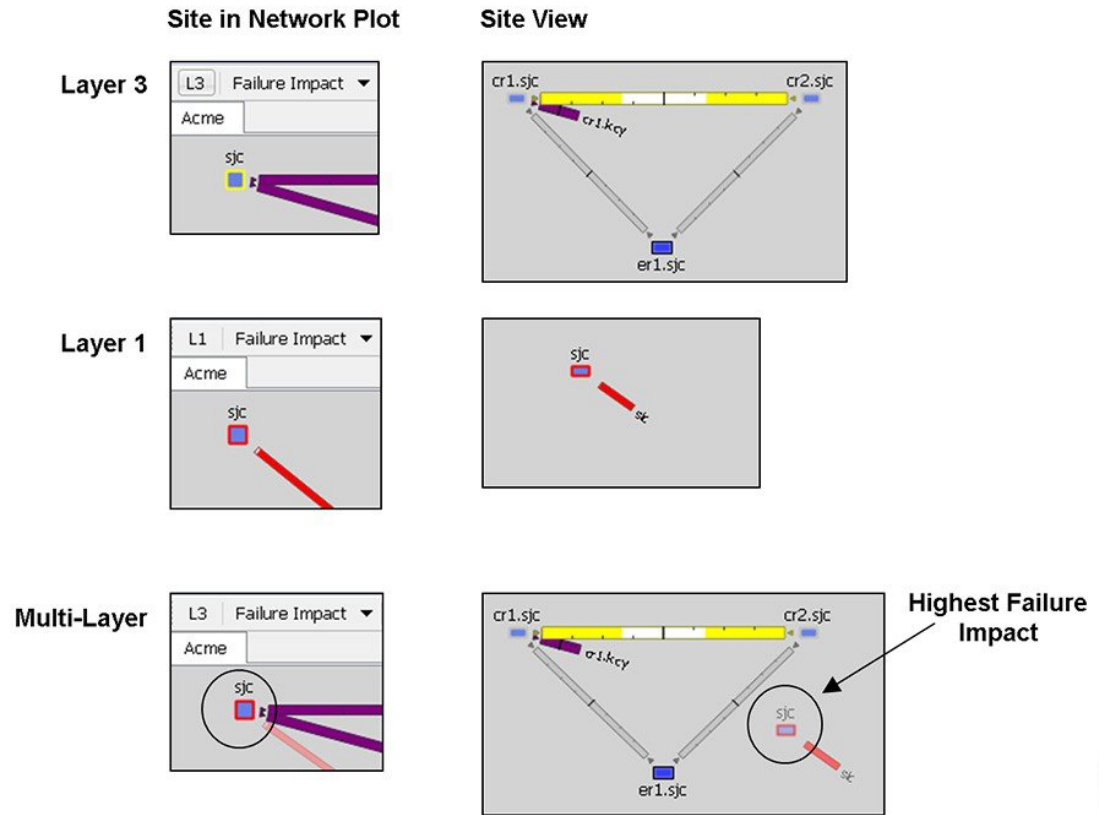

407054

Worst-Case Failures

After running a Simulation Analysis, you can view the L1 failure scenarios that caused the worst-case utilization for an L3 interface. Right-click an L3 interface or L3 circuit and choose **Fail to WC**. A dialog box opens from which you can choose a failure scenario to observe. Click **OK**; the network plot changes to show the failure scenario. If you are in the L3 view and the worst-case failure is an L1 object, switch views to see the failure in the L1 view.

For information on running Simulation Analysis, failing L1 objects to their worst-case utilization, and protecting L1 objects from inclusion in Simulation Analysis, see [Simulation Analysis](#).

Creating L1 Topology

Creating L1 Topology from L3 Topology

WAE Design provides a tool that constructs a complete L1 topology using an existing L3 topology as a model. You have an option to create the topology based on sites or L3 nodes. WAE Design then shows the same site in the L1 view and constructs the following L1 topology.

- Creates L1 nodes.

- Create L1 nodes from sites—WAE Design creates one L1 node within each selected site regardless of the number of L3 nodes within that site. The L1 nodes are assigned the same name as their sites. No L1 nodes are created for L3 nodes that are not residing in sites.
- Create L1 nodes from L3 nodes—WAE Design creates one L1 node for each L3 node selected. The L1 nodes are assigned the same name as the L3 nodes. If the L3 node resides within a site, the L1 node is placed there as well.
- Creates L1 links between all L1 nodes whose corresponding L3 nodes have connectivity between them. L1 link metrics are set to 1.
- Creates an L1 circuit and L1 circuit path between each pair of L1 nodes connected by L1 links. The L1 circuit Path Option value is set to 1.
- Creates a pair of L1 ports for each L1 circuit.
- Creates a list of blocked Central Frequency IDs.
- Creates the mapping between L1 circuits and L3 circuits. For more information on these mappings, see [Relationships Between L1 and L3](#), on page 18.
- Creates one standby L1 circuit path per each L1 circuit, and sets its Path Option to 1.

Follow these steps to create an L1 topology from an L3 topology. You can be in either an L1 or L3 view while performing these steps.

- Step 1** If you want to create an L1 topology based on only specific L3 objects, select those sites or L3 nodes from the L3 view. If you do not select sites or nodes, the topology is based on all sites or all L3 nodes, depending on your selection in Step 3.

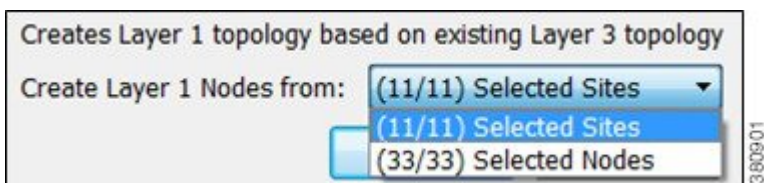

- Step 2** Choose **Insert > Layer 1 > L1 Topology from L3 Topology**, or right-click the plot and choose **New > Layer 1 > L1 Topology from L3 Topology**.
- Step 3** Select either sites or nodes, and click **OK**.

Creating L1 Nodes

- Step 1** Choose **Insert > Layer 1 > L1 Node**, or right-click the plot and choose **New > Layer 1 > L1 Node**.
- Step 2** Enter a unique L1 node name.
- Step 3** Choose the site to which you want this L1 node to belong, or choose **None** if you do not want the L1 node to reside in a site.
- Step 4** (Optional) Choose the node type from the drop-down list.

- Step 5** (Optional) Enter a description.
- Step 6** (Optional) Click the **Identification** tab to enter more descriptive information.
- Step 7** Click **OK**.

Creating L1 Links

Each L1 link name and L1 node combination must be unique.

- Step 1** Choose **Insert > Layer 1 > L1 Link**, or right-click the plot and choose **New > Layer 1 > L1 Link**.
- Step 2** Enter an L1 link name and description. If the L1 link has the same source and destination as another L1 link, it must have a unique name. Otherwise, it is not required.
- Step 3** Required: Choose the two nodes you want to connect with this L1 link by first choosing the site and then choosing the node.
- Step 4** Optional selections include:

Field	For Information...
Metric	L1 Link Metrics, on page 10
Distance, Delay	Delay and Distance, on page 22
Feasibility	L1 Circuit Wavelengths, on page 11
Frequency ID Blocked List	Central Frequency ID Exclude List, on page 17
Protected, Active, Failed	Simulation and Simulation Analysis

- Step 5** Check **SSON Enabled** to specify that the L1 Link is SSON enabled.
- Step 6** Click **OK**.

Creating L1 Circuits

You can manually create circuits by using the following method. Additionally, you can automatically create L1 circuits using their respective Properties dialog boxes.

Each L1 circuit name and L1 node combination must be unique.

- Step 1** Choose **Insert > Layer 1 > L1 Circuit**, or right-click the plot and choose **New > Layer 1 > L1 Circuit**.
- Step 2** Enter an L1 circuit name.
- Step 3** Choose the two L1 ports you want to connect with this L1 circuit by first choosing the sites (if applicable), the L1 nodes, and then L1 ports.

Name: (L1Circuit[*])	
L1 Port A	L1 Port B
Site: chi	Site: bos
L1 Node: chi	L1 Node: bos
L1 Port: chi-bos	L1 Port: bos-chi

Step 4 Optional selections are as follows:

Field	For Information...
Disjoint Group, Disjoint Priority	Explicit L1 Circuit Paths Initializer, on page 9
Bandwidth	Enter a value for the bandwidth that the L1 circuit requires. This value is not used for routing. It is copied to the BW Sim column in the L1 Circuits table. If no value is entered, the BW Sim column is set to the simulated capacity of the L3 circuit that is mapped to this L1 circuit. The total BW Sim for all L1 circuits routing over an L1 link is shown in the Circuit BW Sim column of the L1 Links table.
Active Path	Active L1 Path Selection, on page 6
Min Routed Paths	Minimum Routed Paths, on page 28

Step 5 Check the **Prefer Lower Frequency IDs** based on your requirements.

Step 6 Check **SSON Enabled** to specify that the L1 Circuit is SSON enabled.

Step 7 Click **OK**.

Plotting L1 Circuits

Step 1 In the L1 Circuits table, choose one or more L1 circuits.

Step 2 Right-click and choose **Plot L1 Circuits**.

To move the plot horizontally or vertically, use the left/right arrows and up/down arrows.

To select all L1 circuits within the plot, click **Select L1 Circuits**. To deselect all of these L1 circuits, click in an empty plot area.

Creating L1 Circuit Paths

Step 1 Choose one or more L1 circuits. If you do not choose any, L1 circuit paths are created for all of the L1 circuits.

- Step 2** Access an L1 circuit path in one of these ways:
- Choose **Insert > Layer 1 > L1 Circuit Paths**.
 - Right-click an L1 circuit in the L1 Circuits table and choose **Insert L1 Circuit paths**.
 - Right-click the plot and choose **New > Layer 1 > L1 Circuit Paths**.
- Step 3** Select or enter a path option.
- Step 4** If the L1 circuit path is a standby path, check **Standby**.
- Step 5** Click **OK**.

Plotting L1 Circuit Paths

- Step 1** In the L1 Circuit Paths table, choose one or more L1 circuit paths.
- Step 2** Right-click and choose **Plot L1 Circuit Paths**.
- To move the plot horizontally or vertically, use the left/right arrows and up/down arrows.
- To select all L1 circuit paths within the plot, click **Select L1 Circuit Paths**. To deselect all of these L1 circuit paths, click in an empty plot area.

Editing L1 Circuit Paths

If editing L1 circuit paths, you can change the L1 circuit to which the L1 circuit path is mapped, including the sites and L1 nodes. Other options include:

Field	For Information...
Path Options	Standby Paths and Path Options, on page 6
Delay, Distance	Delay and Distance, on page 22
Setup Priority	L1 Circuit Path Setup Priority, on page 11
Central Frequency ID, Auto Spectrum Assignment	L1 Circuit Wavelengths, on page 11
Feasibility Limit, Acceptance Threshold	L1 Circuit Wavelengths, on page 11
Standby	Standby Paths and Path Options, on page 6 , Resiliency Under L1 Failures, on page 26
Hops	Explicit L1 Circuit Paths Initializer, on page 9 , Creating Individual L1 Circuit Path Hops, on page 37

Creating Individual L1 Circuit Path Hops

To manually create L1 circuit path hops, the L1 nodes or L1 links must already exist. Alternatively, you can use the [Explicit L1 Circuit Paths Initializer, on page 9](#) to set explicit L1 circuit paths.

- Step 1** Right-click an L1 circuit path in the L1 Circuits Paths table and choose **Properties**, or double-click an L1 circuit path.
- Step 2** In the Starts From drop-down list, specify the first L1 node hop in the path as either A or B.
- Step 3** If you are editing an existing hop, double-click it from the Hops list.
If you are creating a hop on this path for the first time, click **Insert After** in the Hops area.
If you are creating a hop on this path and other hops already exist, select an existing hop and then click **Insert Before** or **Insert After**, depending on the required order of the hops.
- Step 4** Create or edit the node or link hop as follows:

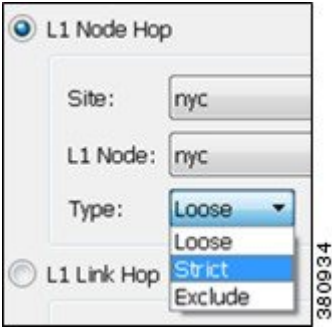
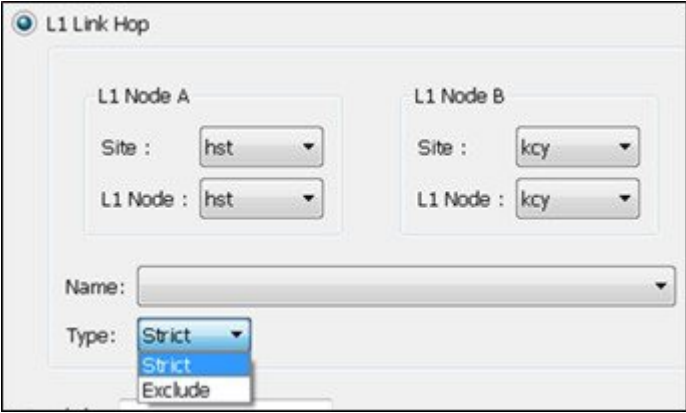
L1 Circuit Node Hops	L1 Circuit Link Hops
<p>In the Node Hop area, select the site and its L1 node that you want to set as the hop. Choose the type as loose, strict, or exclude.</p>  <p>Click OK.</p>	<p>Click Link Hop. Choose both endpoints (site and node) of the L1 link hop you are setting. Choose the L1 link name you are creating. Only those L1 links with the endpoints you selected are listed. Choose the type as strict or exclude.</p>  <p>Click OK.</p>

- Step 5** (Optional) Add a central frequency ID value for the L1 circuit path hop.
- Step 6** Repeat Step 3 to Step 5 as needed for each hop in the path. Because WAE Design always chooses the shortest path, you must enter enough hops to create an alternate, longer path.
- Step 7** Click **OK**.
- Step 8** In the L1 circuit path’s dialog box, verify that the list of finished hops is in the order of the desired path, and then click **OK**.

Creating L1 Waypoints

To create waypoints, we recommend that you set the plot options to be able to view them first.

- To view L1 waypoints in the network plot, you must be in the geographic view and the Layer 1 option to view them must be enabled in the Layer 1 tab of the Plot Options dialog box.
- To view waypoints within sites, the site must be viewed in a geographic layout or if using a schematic site view, the site must contain another site. This is set in the Site Canvas field in the General Options tab of the Plot Options dialog box.

The only method in which you can manually specify the Order value is through the L1 link context menu.



Note Once you enter the waypoint order value, you cannot edit it. To change its value, you must delete and recreate it, or insert another waypoint that would then alter the order value accordingly.

If no longitude and latitude coordinates are specified, the waypoint is inserted in the middle between L1 node B and the waypoint closest to L1 node B. If no other waypoints exist on the link, the new waypoint is inserted in the middle of the L1 link.

L1 Link Properties

Step 1 Right-click an L1 link and choose **Properties**, or double-click an L1 link.

Step 2 Click the **Waypoints** tab.

Step 3 If you are creating a waypoint for the first time, click **Insert After**.

If you are creating a waypoint on the L1 link and other waypoints already exist, select an existing waypoint and then click **Insert Before** or **Insert After**, depending on the required order of the waypoints.

Step 4 (Optional) Enter a description, longitude, and latitude.

Step 5 Click **OK**.

L1 Link Context Menu

Step 1 Right-click an L1 link and choose **Insert L1 Link Waypoint**.

Step 2 Enter the number representing the order in which you want the waypoint to appear in proximity to L1 node A.

Step 3 (Optional) Enter a description, longitude, and latitude.

Step 4 Click **OK**.

L1 Waypoint Context Menu

- Step 1** Right-click an L1 waypoint and choose **Insert L1 Link Waypoint > Before/After Selected Waypoint**.
- Step 2** (Optional) Enter a description, longitude, and latitude.
- Step 3** Click **OK**.
-

Duplicating L1 Objects

To duplicate an L1 link, L1 circuit, or L1 circuit path, right-click one and choose **Duplicate**.

- Duplicating an L1 circuit or L1 circuit path also duplicates its L1 circuit path hops.
- When duplicating L1 circuits, you can optionally choose to create as many duplicated L1 circuits as necessary. New L1 ports are created for each duplicated L1 circuit.

When duplicating an L3 circuit, you have the option to duplicate its associated L1 circuit if one exists and create an automatic mapping to it. If you select no, the newly duplicated L3 circuit maps to the existing L1 circuit.

Creating Central Frequency ID Exclude List

- Step 1** Choose **Insert > Layer 1 > Central Frequency ID Exclude List**, or right-click the plot and choose **New > Layer 1 > Central Frequency ID Exclude List**.
- Step 2** Enter a unique name for the central frequency ID exclude list.
- Step 3** Select from the list of frequency IDs using radio button. You can select multiple frequencies to be blocked. Use the **Filter** button to narrow the frequency IDs from the list.
- Step 4** (Optional) Enter the **Frequency ID Lower Bound** to specify the lower bound on available central frequency IDs.
- Step 5** (Optional) Enter the **Frequency ID Upper Bound** to specify the upper bound on available central frequency IDs.
- Step 6** Click **OK**.
-

Inserting L1 Diversity Constraint

- Step 1** Choose **Insert > Layer 1 > L1 Diversity Constraints**.
- Step 2** Enter a unique name for the L1 Diversity Constraint in **Name** field.
- Step 3** In the L1 Circuit A area, select the Site, L1 Node, L1 Port for L1 Port A and L1 Port B using the dropdown list. A list of L1 Circuits for the specified combination is displayed in the **Name** field. Select a L1 Circuit combination from the dropdown list.
- Step 4** Similarly, specify the L1 Port A and L1 Port B for L1 Circuit B and select from the list of matching combinations available.
- Step 5** Set the Constraints:
- **L1 Node Diversity**: Select this to set the respective paths of the L1 Circuits to be diverse in terms of L1 Nodes.

- **L1 Link Diversity:** Select this to set the respective paths of the L1 Circuits to be diverse in terms of L1 Links.
- **SRLG Diversity:** Select this to set the respective paths of the L1 Circuits to be diverse in terms of SRLGs.

Note WAE Design allows you to select multiple levels of diversity at the same time.

- **Active:** Set this property to Active for simulation to consider the L1 Diversity Constraint.

Step 6 Click **OK**.

Creating L1 and L3 Mappings

Creating L3-L1 Links Between Nodes

You can model the physical relationship between an L3 node and an L1 node to create an L3-L1 link, which is an object listed in the L3-L1 Links table. Creating these relationships can greatly expedite the process of creating L1 circuits from L3 circuits. For information on how these are used in that process, see [Mapping Multiple L1 Circuits to L3 Circuits, on page 41](#).



Note For L3-L1 links to be valid for creating L1 circuits, there must be a pair of them. That is, there must be one entry for each L3 end node of the L3 circuit. The L1 circuit that is created uses the L1 nodes to which those L3 nodes are mapped.

Example: This L3-L1 Links table shows an example of three L3-L1 links:

- L3 node cr1.hst is connected to (linked to) the L1 node hst.
- L3 node cr1.okc is connected to the L1 node okc.
- L3 node cr2.wdc is connected to the L1 node wdc.

Node	L1 Node
cr1.hst	hst
cr1.okc	okc
cr2.wdc	wdc

383004

-
- Step 1** Choose **Insert > Layer 1 > L3-L1 Link**, or right-click in an empty area and choose **New > Layer 1 > L3-L1 Link**. Note that preselecting an L3 node or L1 node has no effect on the selections opened in the dialog box.
- Step 2** Choose the L3 node and the site in which it is contained, if applicable.
- Step 3** Choose the L1 node and the site in which it is contained, if applicable.
- Step 4** Click **OK**.
-

Mapping Multiple L1 Circuits to L3 Circuits

The L1 Circuits for L3 Circuits tool creates L1 circuits based on L3 circuits and associates them with the L3 circuits using the following sequence of priorities. For each L1 circuit created, an associated L1 circuit path is also created. Nested objects are taken into account.

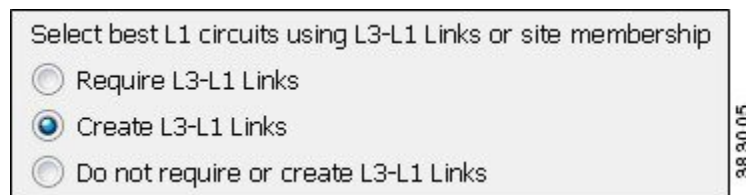

- If the L3 circuit already has an associated L1 circuit, one is not created.
- WAE Design checks the L3-L1 Links table for valid entries.
 - If multiple pairs of L3-L1 links exist that could create the L1 circuit, one is randomly used.
 - If no valid L3-L1 link entry exists and if “Require L3-L1 Links” is selected, no L1 circuit is created.
 - If no valid L3-L1 link entry exists and if “Do not require or create L3-L1 Links” is selected, for each L3 circuit WAE Design checks for sites that contain both the L3 end node and at least one L1 node.
 - If multiple L1 nodes are collocated within the same sites as the L3 nodes, one is randomly selected.
 - If this collocation is not found, WAE Design checks for L1 nodes within the parent sites of the sites containing the L3 end nodes. If none are found, an L1 circuit is not created.
- If “Create L3-L1 Links” is selected, the L3-L1 links are created that map the respective L3 and L1 nodes.
 - If needed, you can make changes to the L1 circuit’s endpoints and the L3-L1 links that are created by editing their respective Properties dialog boxes.
 - Creating L1 circuits in this manner automatically creates and assigns L1 ports for the newly created L1 circuits.

-
- Step 1** In this process, you can optionally use L3-L1 links. If you are using them, verify you have the set of L3-L1 links you need, and if not, create them. See [Creating L3-L1 Links Between Nodes, on page 40](#).
- Step 2** If you want to create L1 circuits for only selected L3 circuits, first select those L3 circuits. Otherwise, L1 circuits are created for as many L3 circuits as possible.

Step 3 Right-click in an empty area and choose **Layer 1 > L1 Circuits for L3 Circuits**, or choose **Insert > Layer 1 > L1 Circuits for L3 Circuits**.

Step 4 Choose either to require the use of existing L3-L1 links, to create them, or neither. Then click **OK**.

Examples

Figure 21: [Topology and Existing L3-L1 Links](#), on page 42 shows a plan file containing six L3 circuits and four L3-L1 links. All sites except sea contain one L3 node and one L1 node. The sea site contains two L3 nodes and one L1 node. Refer to the diagram for details of the objects' relationships and to see the objects in the L3-L1 Links table. There are no L1 circuits.

Figure 21: Topology and Existing L3-L1 Links

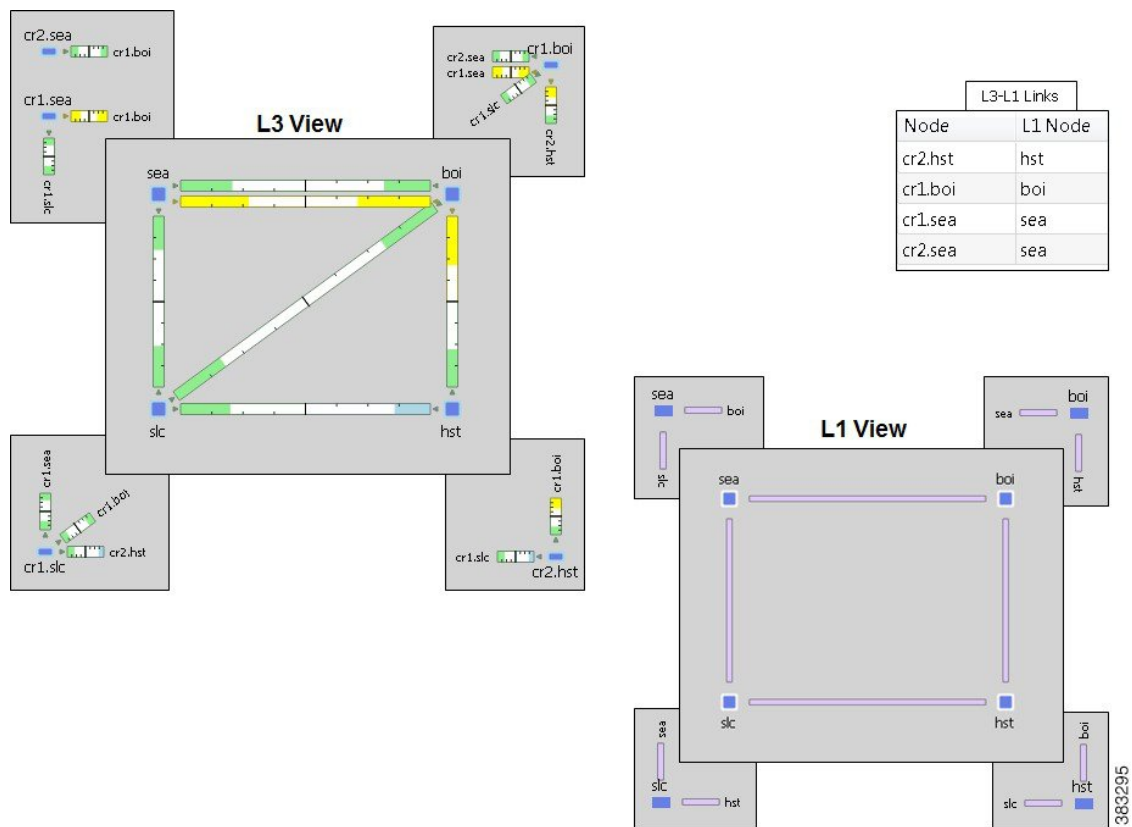

If you click **Require L3-L1 Links**, WAE Design creates three L1 circuits: one between hst and boi, and two between sea and boi.

Require L3-L1 Links

L1 Circuits		
Name	L1 Node A	L1 Node B
L1Circuit[1]	boi	hst
L1Circuit[2]	boi	sea
L1Circuit[1]	boi	sea

38 32 98

If you click **Do not to require or create L3-L1 Links**, WAE Design creates six L1 circuits: three using the L3-L1 Links table and the remaining three by determining that the source and destination sites both contain L3 and L1 nodes.

Do not require or create L3-L1 Links

L1 Circuits		
Name	L1 Node A	L1 Node B
L1Circuit[1]	boi	sea
L1Circuit[1]	boi	hst
L1Circuit[1]	boi	slc
L1Circuit[1]	hst	slc
L1Circuit[1]	sea	slc
L1Circuit[2]	boi	sea

38 32 96

Using the same topology as in [Figure 21: Topology and Existing L3-L1 Links, on page 42](#) but with no pre-existing L3-L1 links, if you click **Create L3-L1 Links**, WAE Design creates the same six L1 circuits as if you had selected no options. However, it also creates five L3-L1 links: one for each L3 node having an L1 circuit for which an L1 circuit was created.



Created L3-L1 Links

L3-L1 Links	
Node	L1 Node
cr1.boi	boi
cr2.hst	hst
cr1.sea	sea
cr2.sea	sea
cr1.slc	slc

Created L1 Circuits

L1 Circuits		
Name	L1 Node A	L1 Node B
L1Circuit[1]	boi	sea
L1Circuit[1]	boi	hst
L1Circuit[1]	boi	slc
L1Circuit[1]	hst	slc
L1Circuit[1]	sea	slc
L1Circuit[2]	boi	sea

383297

Mapping an L1 Circuit to an L3 Circuit

- Step 1** Right-click an L3 circuit in the Circuits table and choose **Properties**, or double-click an L3 circuit.
- Step 2** Click the **Advanced** tab.
- Step 3** In the L1 Circuit area, choose the applicable site, L1 nodes, and L1 ports for ports A and B.

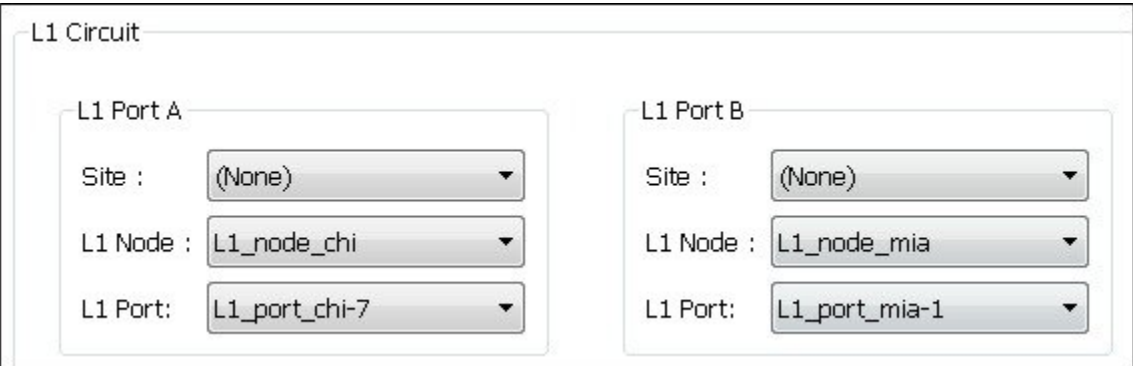

- Step 4** Create and map a new L1 circuit to the L3 circuit, or map an existing one to the L3 circuit.
 - Map existing L1 circuit—Click **Select** and then choose the L1 circuit from the drop-down list of all the available circuits.
 - Create L1 circuit—Click **Create** and enter a new name for the L1 circuit.

Then click **OK**. Creating L1 circuits in this manner automatically creates and assigns L1 ports for the newly created L1 circuits.

Mapping an L1 Circuit to an L3 Port Circuit

Each port circuit can be indirectly associated with an L1 circuit via direct mappings of L1 ports to L3 ports.

- Step 1** Right-click an L3 port circuit in the Port Circuits table and choose **Properties**, or double-click an L3 port circuit.
- Step 2** In the L1 Circuit area, select the sites (if applicable), L1 nodes, and optionally L1 ports for both ends of the L1 circuit. Note that if specifying L1 ports and mapping an L1 circuit, the pair must be already associated with an L1 circuit.
- Step 3** Map an existing L1 circuit or create a new one, and then click **OK**.
- To map an existing L1 circuit, click **Select** and then choose the L1 circuit from the drop-down list of all the available circuits. Note that this list is populated only if the L1 ports selected are connected via an L1 circuit.
 - To create an L1 circuit, click **Create**. Enter a new L1 circuit name or use the default name. After you click **OK**, you can create L3-L1 links. If you are creating an L1 circuit and if you did not choose L1 ports, L1 ports are created for the new L1 circuit.
-

Mapping L1 Ports to L3 Ports

If an L3 port circuit exists whose L3 ports are associated with L1 ports, that L3 port circuit is automatically associated with the L1 circuit that also contains those same L1 ports.

Mapping L1 ports to L3 ports automatically associates the L1 circuit to the port circuit if a port circuit exists.

- Step 1** Right-click a port in the Ports table and choose **Properties**, or double-click a port.
- Step 2** Click the **Layer 1** tab.
- Step 3** If applicable, choose the L1 node's site.
- Step 4** Choose the L1 node and L1 port, and then click **OK**.
-

Visualizing the L1 Network

Many of the visualization tools available for the L3 view are also available for L1. These tools are described in the *Cisco WAE Network Visualization Guide*.

- **Assign Sites to Nodes**—Automatically create sites based on L1 node names and a set of parameters that define which part of the node name to use.
- **Arrange Sites and Nodes**—Arrange sites and nodes using tools that offer a variety of alignment options or arrange sites to specific geographic locations. You can also show and hide sites, and change where their site name is displayed in the plot.

- Set Plot Backgrounds—Set the background for the network plot, including schematic view, outline of a geographic background, and detailed geographic background.
- Create or Edit Layouts—Create multiple layouts for a single plan file, each containing its own set of visual properties.

Editing L1 Plot Options

The Plot Options dialog box has a Layer 1 tab that lets you change how L1 links appear, whether to view another layer in the background, and whether to show or hide sites from another layer. Because these are plot options, they apply to the current layout and are saved on a per-layout basis when you save the plan file. You can also save them as user defaults. For information on user and system defaults, see the *Cisco WAE Network Visualization Guide*.

-
- Step 1** Click the **Plot Options** icon in the top right of the Visualization toolbar, or choose **Edit > Plot > Plot Options > Edit Options**.
- Step 2** Click the **Layer 1** tab.
- Step 3** Edit Layer 1 fields as described in the following sections, and then click **OK**.
-

L1 Link Appearance

- L1 Link Width—The L1 link width is only for visualization purposes and is not related to any property.
- L1 Link Text—By default, there is no text on L1 links. Use this option to display the link name, distance, delay, or the number of L1 circuit paths using the link.
- Show L1 Link Waypoints—If checked, L1 waypoints are shown in the network plot.
- Visualize L1 Link Utilization—If checked, L1 link utilization is shown in the network plot.

Multi-Layer Visualization

The first two background options let you show or hide Layer 1 in the Layer 3 view, and vice versa.

You can also set the degree of opacity of the background objects. The higher the value, the denser (darker) the background objects appear.



Note In the Visualization toolbar, there is a Set to Foreground icon that brings selected objects to the foreground and sends unselected objects to the background. This, too, has an opacity value for specifying the transparency of background objects. This feature has precedence over the layer opacity set in the Plot Options dialog box.

By default, sites containing only L1 nodes are hidden in the L3 view, and sites containing only L3 nodes are hidden in the L1 view. Use these selections to toggle whether to hide sites containing only L1 or L3 nodes. If you are showing a layer in the background, you cannot hide per-layer sites within that view. You can show and hide individual sites by right-clicking one and choosing **Layout > Hide/Show Site**.

Background Layer

- Show Layer 1 in the Background of the L3 View
- Show Layer 3 in the Background of the L1 View

Opacity of Background Layer

- Hide L1 Sites in L3 View
- Hide L3 Sites in L1 View

5/15/15

