



Cisco Ultra Cloud Serving Gateway Control Plane Function, Release 2023.01 - Configuration and Administration Guide

First Published: 2023-01-24

Last Modified: 2023-01-23

Americas Headquarters

Cisco Systems, Inc.
170 West Tasman Drive
San Jose, CA 95134-1706
USA
<http://www.cisco.com>
Tel: 408 526-4000
800 553-NETS (6387)
Fax: 408 527-0883

THE SPECIFICATIONS AND INFORMATION REGARDING THE PRODUCTS IN THIS MANUAL ARE SUBJECT TO CHANGE WITHOUT NOTICE. ALL STATEMENTS, INFORMATION, AND RECOMMENDATIONS IN THIS MANUAL ARE BELIEVED TO BE ACCURATE BUT ARE PRESENTED WITHOUT WARRANTY OF ANY KIND, EXPRESS OR IMPLIED. USERS MUST TAKE FULL RESPONSIBILITY FOR THEIR APPLICATION OF ANY PRODUCTS.

THE SOFTWARE LICENSE AND LIMITED WARRANTY FOR THE ACCOMPANYING PRODUCT ARE SET FORTH IN THE INFORMATION PACKET THAT SHIPPED WITH THE PRODUCT AND ARE INCORPORATED HEREIN BY THIS REFERENCE. IF YOU ARE UNABLE TO LOCATE THE SOFTWARE LICENSE OR LIMITED WARRANTY, CONTACT YOUR CISCO REPRESENTATIVE FOR A COPY.

The Cisco implementation of TCP header compression is an adaptation of a program developed by the University of California, Berkeley (UCB) as part of UCB's public domain version of the UNIX operating system. All rights reserved. Copyright © 1981, Regents of the University of California.

NOTWITHSTANDING ANY OTHER WARRANTY HEREIN, ALL DOCUMENT FILES AND SOFTWARE OF THESE SUPPLIERS ARE PROVIDED "AS IS" WITH ALL FAULTS. CISCO AND THE ABOVE-NAMED SUPPLIERS DISCLAIM ALL WARRANTIES, EXPRESSED OR IMPLIED, INCLUDING, WITHOUT LIMITATION, THOSE OF MERCHANTABILITY, FITNESS FOR A PARTICULAR PURPOSE AND NON-INFRINGEMENT OR ARISING FROM A COURSE OF DEALING, USAGE, OR TRADE PRACTICE.

IN NO EVENT SHALL CISCO OR ITS SUPPLIERS BE LIABLE FOR ANY INDIRECT, SPECIAL, CONSEQUENTIAL, OR INCIDENTAL DAMAGES, INCLUDING, WITHOUT LIMITATION, LOST PROFITS OR LOSS OR DAMAGE TO DATA ARISING OUT OF THE USE OR INABILITY TO USE THIS MANUAL, EVEN IF CISCO OR ITS SUPPLIERS HAVE BEEN ADVISED OF THE POSSIBILITY OF SUCH DAMAGES.

Any Internet Protocol (IP) addresses and phone numbers used in this document are not intended to be actual addresses and phone numbers. Any examples, command display output, network topology diagrams, and other figures included in the document are shown for illustrative purposes only. Any use of actual IP addresses or phone numbers in illustrative content is unintentional and coincidental.

All printed copies and duplicate soft copies of this document are considered uncontrolled. See the current online version for the latest version.

Cisco has more than 200 offices worldwide. Addresses and phone numbers are listed on the Cisco website at www.cisco.com/go/offices.

The documentation set for this product strives to use bias-free language. For purposes of this documentation set, bias-free is defined as language that does not imply discrimination based on age, disability, gender, racial identity, ethnic identity, sexual orientation, socioeconomic status, and intersectionality. Exceptions may be present in the documentation due to language that is hardcoded in the user interfaces of the product software, language used based on standards documentation, or language that is used by a referenced third-party product.

Cisco and the Cisco logo are trademarks or registered trademarks of Cisco and/or its affiliates in the U.S. and other countries. To view a list of Cisco trademarks, go to this URL: <https://www.cisco.com/c/en/us/about/legal/trademarks.html>. Third-party trademarks mentioned are the property of their respective owners. The use of the word partner does not imply a partnership relationship between Cisco and any other company. (1721R)

© 2023 Cisco Systems, Inc. All rights reserved.



CONTENTS

PREFACE

About this Guide	xxxiii
Conventions Used	xxxiii
Contacting Customer Support	xxxiv

CHAPTER 1

5G Architecture	1
Overview	1
Control Plane Network Functions	1
User Plane Network Function	2
Subscriber Microservices Infrastructure Architecture	2
Control Plane Network Function Architecture	4

CHAPTER 2

cnSGW-C Overview	7
Product Description	7
Converged Core Overview	7
Use Cases	8
Deployment Architecture and Interfaces	12
cnSGW-C Architecture	12
cnSGW-C Deployment	13
Converged Core Architecture	14
Converged Core Deployment	15
Supported Interfaces	16
Life Cycle of Data Packet	16
License Information	17
Standards Compliance	17

CHAPTER 3

Deploying and Configuring cnSGW-C through Operations Center	19
--	-----------

Feature Summary and Revision History	19
Summary Data	19
Revision History	19
Feature Description	20
cnSGW-C Ops Center	20
Prerequisites	20
cnSGW-C Service Configuration	21
Mapping Pods with Node Labels	21
Deploying and Accessing cnSGW-C	22
Deploying cnSGW-C	22
Accessing the cnSGW-C Ops Center	22
Day 0 Configuration	22
Loading Day 1 Configuration	25
Day1config.cli	25
<hr/>	
CHAPTER 4	Smart Licensing Support 43
Feature Summary and Revision History	43
Summary Data	43
Revision History	43
Smart Software Licensing	44
Cisco Software Central	44
Smart Accounts and Virtual Accounts	44
Requesting a Cisco Smart Account	44
cnSGW-C Smart Licensing	45
Software Tags and Entitlement Tags	45
Multiple Entitlement Tags	46
Feature Description	46
How it Works	46
Sample Configuration	47
Configuration Checks	48
Troubleshooting	49
Configuring Smart Licensing	49
Users with Access to Cisco Software Central	49
Users without Access to Cisco Software Central	53

Viewing the Smart Licensing information 57

CHAPTER 5

cnSGW-C Rolling Software Update 59

Feature Summary and Revision History 59

Summary Data 59

Revision History 59

Introduction 59

Updating cnSGW-C 60

Rolling Software Update Using the SMI Cluster Manager 61

Prerequisites 62

Triggering the Rolling Software Upgrade 66

Monitoring the Update Procedure 67

Viewing the Pod Details 68

Rolling Software Update on Non-SMI Cluster 70

CHAPTER 6

Pods and Services Reference 73

Feature Summary and Revision History 73

Summary Data 73

Revision History 73

Feature Description 73

Pods 74

UDP Proxy Pod 76

Feature Description 76

Services 78

Open Ports and Services 80

Associating Pods to the Nodes 82

Viewing the Pod Details and Status 82

Pod Details 83

States 83

CHAPTER 7

3GPP RAN/NAS Cause Codes Support 85

Feature Summary and Revision History 85

Summary Data 85

Revision History 85

- Feature Description 85
- How it Works 87
 - Call Flows 87
 - Create Bearer Procedure Call Flow 87
 - Update Bearer Procedure Call Flow 88
 - Delete Bearer Command Procedure Call Flow 89
 - Delete Session Procedure Call Flow 90

CHAPTER 8

Access Bearer Release Support 93

- Feature Summary and Revision History 93
 - Summary Data 93
 - Revision History 93
- Feature Description 93
- How it Works 94
 - Call Flows 94
 - Release Access Bearer (Active to IDLE Transaction) Call Flow 94

CHAPTER 9

APN Profile Support 97

- Feature Summary and Revision History 97
 - Summary Data 97
 - Revision History 97
- Feature Description 98
- Feature Configuration 98
 - Configuring DNN Profile 98
 - Configuring Network Element Profile 98
 - Configuration Modification Impact 99
- Troubleshooting Information 100
 - Configuration Errors 100

CHAPTER 10

Change Notification Request Handling 101

- Feature Summary and Revision History 101
 - Summary Data 101
 - Revision History 101
- Feature Description 101

Standards Compliance	102
How it Works	102
Call Flows	102
Change Notification Request Call Flow	102
OAM Support	104
Bulk Statistics Support	104

CHAPTER 11

Clear Subscriber Request	107
Feature Summary and Revision History	107
Summary Data	107
Revision History	107
Feature Description	107
Standards Compliance	108
How it Works	108
Supported Clear Command	109
Call Flows	109
Clear PDN Call Flow	109

CHAPTER 12

Context Replacement Support	113
Feature Summary and Revision History	113
Summary Data	113
Revision History	113
Feature Description	114
How it Works	114
Call Flows	114
Full Context Replacement Call Flow	114
Partial Context Replacement Call Flow	115
OAM Support	119
Bulk Statistics	119

CHAPTER 13

Dedicated Bearer Support	121
Feature Summary and Revision History	121
Summary Data	121
Revision History	121

Feature Description	121
Setup and Update Dedicated Bearers	122
Feature Description	122
How it Works	122
Call Flows	122
Delete Dedicated Bearers	129
Feature Description	129
How it Works	129
Call Flows	129

CHAPTER 14	Delete Bearer and Delete Session Request	133
	Feature Summary and Revision History	133
	Summary Data	133
	Revision History	133
	Feature Description	133
	Delete from MME	134
	Delete from PGW	134
	Standard Compliance	134
	How it Works	134
	Call Flows	134

CHAPTER 15	Downlink Data Notification	139
	Feature Summary and Revision History	139
	Summary Data	139
	Revision History	139
	Feature Description	140
	DDN Message Handling	140
	Feature Description	140
	How it Works	140
	Call Flows	140
	Feature Configuration	146
	Configuring the DDN Failure Timer	147
	Configuring DDN No User Connect Retry Timer	147
	Configuration Example	148

Configuration Verification	148
Control Messages Triggered DDN Support	148
Feature Description	148
How it Works	148
Call Flows	148
Feature Configuration	150
Configuration Example	150
Configuration Verification	150
Disabling the DDN Control Procedure	150
DDN Advance Features	150
Feature Description	150
How it Works	151
Call Flows	151
Standards Compliance	157
Feature Configuration	157
Configuration Example	158
OAM Support	158
Bulk Statistics	158
<hr/>	
CHAPTER 16	DSCP Marking Support 161
Feature Summary and Revision History	161
Summary Data	161
Revision History	161
Feature Description	162
DSCP Marking for Data Packets	162
Feature Description	162
How it Works	162
Feature Configuration	162
Configuration Example	164
Configuration Verification	164
DSCP Marking for CP Signaling Messages	164
Feature Description	164
Feature Configuration	164
Configuring DSCP under S11 Interface for GTP Endpoint	165

Configuring DSCP under S5e Interface for GTP Endpoint 165
 Configuring DSCP under Sxa Interface for Protocol Endpoint 166
 Removing DSCP Configuration 166

CHAPTER 17

Dynamic Routing by Using BGP 169

Feature Summary and Revision History 169
 Summary Data 169
 Revision History 169
 Feature Description 170
 How it Works 170
 External Network Failure 172
 Geo Switchover 172
 Internal Network Failure 173
 Local Switchover 173
 Recovery and Failback 173
 Call Flows 174
 Publish Route for Incoming Traffic in an Active-Standby Mode 174
 Single Protocol Pod Failure Call Flow 175
 Learn Route for Outgoing Traffic Call Flow 176
 Configuring Dynamic Routing by Using BGP 177
 Monitoring and Troubleshooting 180

CHAPTER 18

Emergency Call Support 185

Feature Summary and Revision History 185
 Summary Data 185
 Revision History 185
 Feature Description 185
 Limitations 186
 How it Works 186
 Call Flows 186
 Create Emergency Session Call Flow 186
 OAM Support 188
 Bulk Statistics Support 188

CHAPTER 19	Extended and Non-Standard QCI Values Support and Validation	189
	Feature Summary and Revision History	189
	Summary Data	189
	Revision History	189
	Feature Description	189
	Validation for Extended and Non-Standard QCI Values	190
	Support and Validation for Extended and Non-Standard QCI Values for VoLTE Marking	190

CHAPTER 20	eMPS/WPS Support	191
	Feature Summary and Revision History	191
	Summary Data	191
	Revision History	191
	Feature Description	191
	eMPS/WPS Support	192
	Feature Description	192
	Feature Configuration	192
	Configuring WPS Profile	192
	Configuring WPS-Profile and SGW-Profile Association	193
	Configuring WPS-Profile and DNN-Profile Association	193
	OAM Support	194
	Bulk Statistics Support	194
	eMPS GTPv2 Load/Overload Self Protection Exclusion Support	195
	Feature Description	195
	Feature Configuration	195
	Configuring Overload Exclude Profile	195
	Configuring the Overload-Profile and the SGW-Profile Association	196

CHAPTER 21	Failure and Error Handling Support	199
	Feature Summary and Revision History	199
	Summary Data	199
	Revision History	199
	Overview	200
	Attach and Detach Failure and Error Handling	200

Create Session Request Failure Handling	200
Delete Default Bearer Procedure Failure Handling	201
Delete Session Procedure Failure Handling	202
Session Setup Timer during Attach Procedure	202
Create-Update-Delete Bearer Request and Response Failure and Error Handling	203
Create Bearer Procedure Failure Handling	203
Delete Dedicated Bearer Procedure Failure Handling	204
Update Bearer Procedure Failure Handling	205
Radio Access Bearer/Modify Bearer Request Failure and Error Handling	208
Support for Failure Cause Code, Cause Source, and Bearer Context Error	210
Failure Cause Code	210
Cause Source	210
Bearer Context Error	210

CHAPTER 22
GTPC and Sx Path Management 211

Feature Summary and Revision History	211
Summary Data	211
Revision History	212
Feature Description	212
GTPC and Sx Path Management	212
Feature Description	212
Feature Configuration	212
Configuring the Echo Parameters	213
Configuring Heartbeat	213
Viewing the Peer Configuration	214
Configuration Example	215
OAM Support	215
Alerts	215
Bulk Statistics Support	215
GTPC Path Failure	217
Feature Description	217
How it Works	218
GTPC Path Failure Detection	218
Path Failure Handling	218

Feature Configuration	219
Configuring Action on Path Failure Detection	219
Configuring Notification to Update the Peer Node	219
Configuration Example	219
OAM Support	219
Bulk Statistics Support	219
Sx Path Failure	220
Feature Description	220
How it Works	220
Sx Path Failure Detection	221
Path Failure Handling	221
Heartbeat Handling	221
OAM Support	221
Bulk Statistics Support	221
Customization of Path Failure Detection	222
Feature Description	222
Feature Configuration	222
Configuring Sx Path Failure Customization	223
Configuring GTPC Path Failure Customization	223
OAM Support	224
Bulk Statistics Support	224
CHAPTER 23	
GTPU Error Indication	227
Feature Summary and Revision History	227
Summary Data	227
Revision History	227
Feature Description	228
How it Works	228
Error Indication Support	228
Default Bearer with s1u as local-purge Call Flow	229
Dedicated Bearer with s1u as local-purge Call Flow	231
Dedicated Bearer (IDFT) with s1u as local-purge Call Flow	232
Default/Dedicated Bearer with s1u as page-ue Call Flow	234
Default Bearer with s5u as local-purge/signal-peer Call Flow	235

- Dedicated Bearer with s5u as local-purge/signal-peer Call Flow 237
- Graceful Termination 239
 - Graceful Termination Call Flow 239
- Session Replacement 241
 - Session Replacement for Default Bearer Call Flow 241
 - Session Replacement for Dedicated Bearer Call Flow 243
- Feature Configuration 245
 - Configuration Example 245
 - Configuration Verification 246
- OAM Support 246
 - Bulk Statistics 246

CHAPTER 24

- GTPU Path Failure 249**
 - Feature Summary and Revision History 249
 - Summary Data 249
 - Revision History 249
 - Feature Description 250
 - How it Works 250
 - Call Flows 251
 - Path Failure for Default Bearer Call Flow 251
 - Path Failure for Dedicated Bearer Call Flow 252
 - Feature Configuration 254
 - Configuration Example 254
 - Configuration Verification 255
 - GTPU Path Failure OAM Support 255
 - Bulk Statistics 255

CHAPTER 25

- GTPv2 and Sx Messages Retransmission and Timeout Handling 257**
 - Feature Summary and Revision History 257
 - Summary Data 257
 - Revision History 257
 - Feature Description 257
 - How it Works 258
 - Inbound Message Retransmission 258

Call Flows	258
GTPCv2 (GTPC-EP or Service) Call Flow	258
Sxa (smf-proto or Service) Call Flow	260
Configuring the Dispatcher	261
Configuration Example	262
Configuration Verification	262

CHAPTER 26

GTPv2 Load/Overload Support	265
Feature Summary and Revision History	265
Summary Data	265
Revision History	265
Feature Description	265
Configuring the GTPv2 Load and Overload Feature	267
Configuring the Load Profile	267
Configuration Example	268
Configuring the Exclude Profile	268
Configuration Example	269
Configuring the Overload Condition Profile	269
Configuring the Maximum Session Count	270
Configuration Example	270
Configuring the Overload-Profile and the SGW-Profile Association	271
Configuration Example	272
Configuration Verification	273
GTPv2 Load and Overload OAM Support	273
Bulk Statistics	273

CHAPTER 27

GTPv2 Message Validation	275
Feature Summary and Revision History	275
Summary Data	275
Revision History	275
Feature Description	275
How it Works	276
Call Flows	276
Basic and Advance Validation on SGW-Ingress (S11) Call Flow	276

Basic and Advance Validation on SGW-Egress (S5) Call Flow 278

CHAPTER 28

IDFT Support 281

- Feature Summary and Revision History 281
 - Summary Data 281
 - Revision History 281
- Feature Description 281
 - Standards Compliance 282
- How it Works 282
 - Call Flows 282
 - IDFT Support without SGW Relocation Call Flow 282
 - IDFT Support with SGW Relocation Call Flow 284
 - 5G to 4G Handover Flow for Pure-S Call Flow 285
 - 4G to 5G Handover Flow for Pure-S Call Flow 287
 - Create IDFT (System-level) Call Flow 289
 - Delete IDFT (System-level) Call Flow 291
- OAM Support 292
 - Viewing IDFT Configuration 292
 - Failure Handling 294
 - Bulk Statistics Support 296

CHAPTER 29

Idle Session Timeout Settings 297

- Feature Summary and Revision History 297
 - Summary Data 297
 - Revision History 297
- Feature Description 297
- How it Works 298
 - Call Flows 298
 - Inactivity Report Call Flow 298
 - Idle Timer Handling on UPF Call Flow 300
 - Reactivity Report Call Flow 302
 - Clear Call Handling Call Flow 303
- Feature Configuration 304
 - Configuration Example 304

Configuration Verification 304

CHAPTER 30**Initial Attach Support 305**

Feature Summary and Revision History 305

Summary Data 305

Revision History 305

Feature Description 306

How it Works 306

Call Flows 306

Initial Attach Call Flow 306

Standards Compliance 309

Support for Backoff Timer, Origination TimeStamp, and MaxWait Time 309

Backoff Timer 309

Origination Time Stamp 309

MaxWaitTime 310

CHAPTER 31**Inter System RAT Handover 311**

Feature Summary and Revision History 311

Summary Data 311

Revision History 311

Feature Description 311

How it Works 312

Call Flows 312

Wi-Fi to LTE Success Call Flow 312

GnGp to LTE Handover with OI Indicator Set Call Flow 314

GnGp to LTE Handover with OI Indicator Unset Call Flow 315

Standards Compliance 317

CHAPTER 32**Intra-MME and Inter-MME Handover Procedures 319**

Feature Summary and Revision History 319

Summary Data 319

Revision History 319

Feature Description 319

How it Works 320

- Call Flows **320**
 - Inter-MME Handover Active-Active Transition Call Flow **320**
 - Intra-MME Handover Active-Active Transition Call Flow **321**
 - Inter/Intra-MME Handover Idle-Idle Transition Call Flow **322**
 - Inter/Intra-MME Handover Active-Idle Transition Call Flow **323**
 - Inter-MME Handover and Multi-PDN Handling Active-Idle Transition with ULI Change Call Flow **324**
 - Inter-MME Handover with Bearer Context Marked for Removal Call Flow **325**
- Intra-MME and Inter-MME Handover Procedures OAM Support **327**
- Bulk Statistics **327**

CHAPTER 33 **MCC/MNC Configuration in the SGW Service** **329**

- Feature Summary and Revision History **329**
 - Summary Data **329**
 - Revision History **329**
- Feature Description **329**
- How it Works **330**
 - Call Flows **330**
 - PLMN-type Detection Call Flow **330**
- Configuring the MCC or the MNC in the SGW Service **331**
 - Configuration Example **331**
- OAM Support **332**
 - Bulk Statistics Support **332**

CHAPTER 34 **Message Interactions Support** **335**

- Feature Summary and Revision History **335**
 - Summary Data **335**
 - Revision History **335**
- Feature Description **336**
- How it Works **337**
 - Call Flows **337**
 - CBR Multi-PDN Call Flow **337**
 - Graceful Stop the Existing PDN Procedure Call Flow **340**
 - Inter MME Handover with Multi-PDN Handling (With PGW Interaction) Call Flow **343**

Multi PDN Call X2 Handover SGW Relocation to cnSGW-C Call Flow	344
Multi-PDN S1 Handover SGW Relocation to Service-Pod (SGW) Call Fow	346
Multiple CBR for Same PDN Call Flow	349
Collision Resolver Discard Handling Call Flow	352
Suspend Handling Call Flow	353
Abort Handling of Low-Priority Procedure Call Flow	356
Double Delete Optimization Call Flow	357

CHAPTER 35 **Modify and Delete Bearer Command Support** 361

Feature Summary and Revision History	361
Summary Data	361
Revision History	361
Feature Description	361
How it Works	362
Call Flows	362
MBC Failure Handling Call Flow	362
MBC Success Handling Call Flow	363
DBC Failure Handling Call Flow	365
DBC Success Handling Call Flow	366

CHAPTER 36 **Modify Bearer Request Support** 369

Feature Summary and Revision History	369
Summary Data	369
Revision History	369
Feature Description	369
How it Works	370
Call Flows	370
UE-Triggered Service Request without PGW Interaction Call Flow	370
UE-Triggered Service Request with PGW Interaction Call Flow	371

CHAPTER 37 **Monitor Subscriber and Protocol Support** 375

Feature Summary and Revision History	375
Summary Data	375
Revision History	375

Feature Description	375
Feature Configuration	376
Configuring the Monitor Subscriber	376
Configuration Example	377
Configuring the Monitor Protocol	399
Configuration Example	400
Configuring the Transaction Messages	411
Configuration Example	411
Accessing the Logs	415

CHAPTER 38**Multiple PDN Attach or Detach Procedures 417**

Feature Summary and Revision History	417
Summary Data	417
Revision History	417
Feature Description	417
How it Works	418
Call Flows	418
UE-requested PDN Connection Call Flow	418
UE-requested or the MME-requested PDN Disconnection Call Flow	421
PGW-requested Disconnection Call Flow	423

CHAPTER 39**Performance Optimization Support 427**

Feature Summary and Revision History	427
Summary Data	427
Revision History	429
Feature Description	430
Async BG-IPC from GTPC-EP towards SGW-Service	431
Feature Description	431
Batch ID Allocation, Release, and Reconciliation Support	431
Feature Description	431
How it Works	431
Feature Configuration	432
OAM Support	432
Bulk Statistics	432

Cache Pod Optimization	434
Feature Description	434
CDL Flush Interval and Session Expiration Tuning Configuration	434
Feature Description	434
Feature Configuration	434
Configuration Example	435
DDN Call Flow Optimization	435
Feature Description	435
How it Works	435
Call Flows	435
Feature Configuration	439
Configuration Example	440
OAM Support	440
Bulk Statistics	440
DDN Timeout Configuration	440
Feature Description	440
Feature Configuration	440
Domain-based User Authorization Using Ops Center	441
Feature Description	441
How it Works	441
Feature Configuration	442
Configuration Example	443
Configuration Verification	443
Edge Echo Implementation	443
Feature Description	443
How it Works	444
OAM Support	444
Bulk Statistics Support	444
ETCD Peer Optimization Support	445
Feature Description	445
How it Works	445
Optimized GTPv2 Encoder and Decoder	446
Feature Description	446
Feature Configuration	446

Configuration Example	447
OAM Support	447
Bulk Statistics Support	448
GTPC Endpoint with GR Split	448
Feature Description	448
How it Works	448
GTPC Endpoint Interface Split with S11 and S5	449
Feature Description	449
How it Works	449
Feature Configuration	450
Configuration Example	451
GTPC IPC Cross-rack Support	451
Feature Description	451
How it Works	453
Call Flows	454
Feature Configuration	457
Configuration Example	458
OAM Support	458
KPI Support	458
Interservice Pod Communication	459
Feature Description	459
How it Works	460
Call Flows	460
OAM Support	462
Statistics Support	462
MBR Call Flow Optimization	462
Feature Description	462
How it Works	462
Call Flows	463
Feature Configuration	470
Configuration Example	471
Configuration Verification	471
OAM Support	471
Bulk Statistics Support	471

Maintenance Mode	472
Feature Description	472
How it Works	472
Limitations	473
Enabling or Disabling Maintenance Mode	473
Enabling or Disabling Maintenance Mode Example	473
Verifying the Maintenance Mode State	473
Partial CDL Update for Idle-Active Call Flow	473
Feature Description	473
How it Works	474
Limitations	475
Feature Configuration	475
Configuration Example	475
OAM Support	475
Bulk Statistics Support	475
PFCP Session Report with DLDR Throttling Support	476
Feature Description	476
How it Works	476
Feature Configuration	476
Configuration Example	477
Configuration Verification	477
OAM Support	478
Bulk Statistics Support	478
Resiliency Handling	478
Feature Description	478
How it Works	479
Feature Configuration	479
Configuration Example	481
Configuration Verification	481
OAM Support	481
Bulk Statistics Support	482
Roaming Peer Path Management Optimization	482
Feature Description	482
How it Works	482

- Feature Configuration 483
 - Configuring the Operator Policy and Subscriber Policy 483
 - Configuration Example 484
 - Configuring the Default Gateway 485
 - Configuration Example 485
 - Configuration Verification 485
- OAM Support 486
 - Bulk Statistics Support 486
- Flag DB Database Updates 486
 - Feature Description 486
 - OAM Support 487
 - Bulk Statistics Support 487
- UDP Proxy Functionality Merged into Protocol Microservices 487
 - Feature Description 487
 - PFCP Protocol Endpoint with UDP Proxy Bypass 488
 - GTPC Protocol Endpoint with UDP Proxy Bypass 488

CHAPTER 40

- Presence Reporting Area 493**
 - Feature Summary and Revision History 493
 - Summary Data 493
 - Revision History 493
 - Feature Description 493
 - How it Works 494

CHAPTER 41

- Redundancy Support 497**
 - Feature Summary and Revision History 497
 - Summary Data 497
 - Revision History 497
 - High Availability Support 498
 - Feature Description 498
 - High Availability of UDP Proxy 498
 - Architecture 498
 - cnSGW-C Pod and VM Deployment Layout 498
 - How it Works 499

Configuring Pod-level Labelling and Replicas	500
Configuration Example	500
Configuration Verification	500
Geographic Redundancy Support	501
Feature Description	501
How it Works	501
Overview	501
GR Triggers	502
Site Roles	503
General Guidelines	503
Instance Awareness	504
Configuring GR Instance	504
Configuring Endpoint Instance Awareness	505
Configuring Profile cnSGW-CSMF Instance Awareness	507
Configuring cnSGW-C Endpoint	507
Dynamic Routing	509
Configuring Dynamic Routing by Using BGP	511
Configuring BGP Speaker	514
IPAM	515
Configuring IPAM	516
Geo Replication	517
Configuring ETCD/Cachepod Replication	518
Geo Monitoring	519
POD Monitoring	519
Remote Cluster Monitoring	519
Traffic Monitoring	520
BFD Monitoring	521
CDL GR Deployment	523
Prerequisites for CDL GR	523
CDL Instance Awareness and Replication	524
Lawful Intercept	528
RADIUS Configuration	529
Software Upgrade on GR Pairs	530
Manual CLI Switchover	534

Geo Switch Role	534
Geo Reset Role	534
Troubleshooting	534
show/clear Commands	534
Monitor Subscriber	545
Monitor Protocol	547
Geographic Redundancy OAM Support	547
Prerequisites for RMA Process	547
Health Check	548
Recovery Procedure	552
Key Performance Indicators (KPIs)	554
Bulk Statistics	560
Alerts	562
Maintenance Mode	569

CHAPTER 42

Service Configuration Enhancements	571
Feature Summary and Revision History	571
Summary Data	571
Revision History	571
Feature Description	571
Feature Configuration	572
Configuring the SGW Profile	572
Configuration Example	572
Configuration Verification	572
Configuring the Subscriber Policy	573
Configuration Example	574
Configuring the Operator Policy	574
Configuration Example	574
Configuring the Policy DNN	574
Configuration Example	575
Configuration Modification Impact	576
Troubleshooting Information	577
Configuration Errors	577

CHAPTER 43**SGW Charging Support 579**

Feature Summary and Revision History 579

Summary Data 579

Revision History 579

Feature Description 579

Architecture 580

Roaming Support 581

How it Works 581

Call Flows 581

URR Installation on Initial Attach Call Flow 581

SGW CDR Call Flow 583

URR Removal and CDR Reporting on Detach Call Flow 585

Usage Report on Hitting Threshold Call Flow 587

URR Installation for Dedicated Bearer Call Flow 589

URR Removal and CDR Generation on Deletion of Dedicated Bearer Call Flow 590

Volume Reporting on S11 Trigger Call Flow 592

Volume Reporting on S5 Trigger Call Flow 594

Standards Compliance 596

Limitations 596

Feature Configuration 597

CLI Configuration 597

Configuring the cnSGW-C Charging Profile or GTP Prime 598

Configuring the Charging Mode 603

Configuring the cnSGW-C Charging Threshold 603

Configuring cnSGW-C Charging Threshold and cnSGW-C Charging Profile Association 605

Configuring Call Control Profile 606

Configuring Charging Characteristics Under Call Control Profile 607

Show CLI 608

GTPP-EP SFTP Push CLI 608

CDR Fields Supported in cnSGW-CDRs 608

custom24 Dictionary 608

ASN.1 Definition for Fields in custom24 632

SGW Charging OAM Support 640

Bulk Statistics 640

CHAPTER 44

SGW Relocation Support 645

Feature Summary and Revision History 645

Summary Data 645

Revision History 645

Feature Description 645

How it Works 646

Call Flows 646

X2 Handover SGW Relocation to cnSGW-C Call Flow 646

S1 Handover SGW Relocation to cnSGW-C Call Flow 648

TAU X2 Handover SGW Relocation to cnSGW-C Call Flow 649

X2 Handover SGW Relocation to CN-SGW (Multi PDN) Call Flow 651

S1 Handover SGW Relocation to CN-SGW (Multi PDN) Call Flow 653

X2 Handover SGW Relocation with Bearer Context Marked for Removal Call Flow 655

S1 Handover SGW Relocation with Bearer Context Marked for Removal Call Flow 658

Inter and Intra MME Handover and S1 SGW Relocation with Less Number of Bearer Context
Call Flow 661

SGW Relocation OAM Support 662

CHAPTER 45

Sx Load/Overload Control Handling 663

Feature Summary and Revision History 663

Summary Data 663

Revision History 663

Feature Description 664

How it Works 664

Node Feature Support 664

UP Selection 664

Throttling Support for Sx Establishment 665

Session Termination Trigger From User-Plane in Self-Protection 665

Failure-handling Profile Support for Congestion Cause 665

Configuring the Sx Load/Overload Feature 665

Configuring Failure Handling Profile 666

Sx Load/Overload Control OAM Support 668

Bulk Statistics 668

CHAPTER 46**Stale Session Handling and Clearing 669**

Feature Summary and Revision History 669

Summary Data 669

Revision History 669

Feature Description 670

How it Works 670

Call Flows 670

Timer Expiry Handling Call Flow 670

Feature Configuration 672

Configuration Example 673

Configuration Verification 673

OAM Support 673

Bulk Statistics 673

CHAPTER 47**Support for CSFB Procedures Suspend and Resume 675**

Feature Summary and Revision History 675

Summary Data 675

Revision History 675

Feature Description 675

How it Works 676

Call Flows 676

Suspend Notification Call Flow 676

Resume Notification Call Flow 678

Empty Modify Bearer Request for Resume Call Flow 679

CHAPTER 48**Update Bearer Request and Response 683**

Feature Summary and Revision History 683

Summary Data 683

Revision History 683

Feature Description 683

Standards Compliance 684

How it Works 684

Call Flows 684

CHAPTER 49

UPF Selection Support 689

Feature Summary and Revision History 689

Summary Data 689

Revision History 690

Feature Description 690

UPF Selection using DNN and DCNR Support 690

Feature Description 690

How it Works 690

UPF Selection Methods 691

Configuring UPF Selection Methods 692

Configuring UPF Group Profile-based UPF Selection 692

Configuring Network-based UPF Selection 692

Configuring Policy based UPF Selection 693

Troubleshooting Information 694

Configuration Errors 694

UPF Selection using Location Support 694

Feature Description 694

Configuring the UPF Selection Feature 694

Configuring ECGI for EPS 694

Configuring TAI-Group 696

Configuring Location-area-group 697

Configuring UPF Group and UPF Selection Policy Enhancement 697

Combined UPF Selection for cnSGW-C and SMF 698

Feature Description 698

Standards Compliance 698

How it Works 699

System Architecture 700

Call Flows 701

Configuring the Combined UPF Selection for cnSGW-C and SMF 708

Configuring Converged-Core Profile 708

Configuring Node-ID 709

UPF Selection OAM Support 710

Bulk Statistics 710

CHAPTER 50

VoLTE Call Prioritization 713

Feature Summary and Revision History 713

Summary Data 713

Revision History 713

Feature Description 714

How it Works 714

Feature Configuration 714

Configuring the Priority 714

Configuration Example 715

Configuration Verification 715

Sx Message Priority 717

OAM Support 717

Bulk Statistics 717

CHAPTER 51

cnSGW-C Troubleshooting 719

show subscriber and cdl show Commands 719

CHAPTER 52

Sample cnSGW-C Configuration 723

Sample Configuration 723



About this Guide



Note The documentation set for this product strives to use bias-free language. For purposes of this documentation set, bias-free is defined as language that does not imply discrimination based on age, disability, gender, racial identity, ethnic identity, sexual orientation, socioeconomic status, and intersectionality. While any existing biased terms are being substituted, exceptions may be present in the documentation due to language that is hardcoded in the user interfaces of the product software, language used based on RFP documentation, or language that is used by a referenced third-party product.

This preface describes the *Ultra Cloud Core Serving Gateway Control Plane Function - Configuration and Administration Guide*, the document conventions, and the customer support details.

- [Conventions Used, on page xxxiii](#)
- [Contacting Customer Support, on page xxxiv](#)

Conventions Used

The following tables describe the conventions used throughout this documentation.

Notice Type	Description
Information Note	Provides information about important features or instructions.
Caution	Alerts you of potential damage to a program, device, or system.
Warning	Alerts you of potential personal injury or fatality. May also alert you of potential electrical hazards.

Typeface Conventions	Description
Text represented as a screen display	This typeface represents displays that appear on your terminal screen, for example: Login:

Typeface Conventions	Description
Text represented as commands	<p>This typeface represents commands that you enter, for example:</p> <p>show ip access-list</p> <p>This document always gives the full form of a command in lowercase letters. Commands are not case sensitive.</p>
Text represented as a command <i>variable</i>	<p>This typeface represents a variable that is part of a command, for example:</p> <p>show card <i>slot_number</i></p> <p><i>slot_number</i> is a variable representing the applicable chassis slot number.</p>
Text represented as menu or sub-menu names	<p>This typeface represents menus and sub-menus that you access within a software application, for example:</p> <p>Click the File menu, then click New</p>

Contacting Customer Support

Use the information in this section to contact customer support.

Refer to the support area of <http://www.cisco.com> for up-to-date product documentation or to submit a service request. A valid username and password are required to access this site. Please contact your Cisco sales or service representative for additional information.



CHAPTER 1

5G Architecture

- [Overview, on page 1](#)
- [Subscriber Microservices Infrastructure Architecture, on page 2](#)
- [Control Plane Network Function Architecture, on page 4](#)

Overview

The Ultra Cloud Core is Cisco's solution supporting 3GPP's standards for 5G new radio (NR) standalone (SA) mode. These standards define various network functions (NFs) based on the separation of control plane (CP) and user plane (UP) (for example CUPS) functionality for increased network performance and capabilities.

Control Plane Network Functions

The CP-related NFs that comprise the Ultra Cloud Core are based on a common architecture that is designed around the following tenants:

- Cloud-scale—Fully virtualized for simplicity, speed, and flexibility.
- Automation and orchestration—Optimized operations, service creation, and infrastructure.
- Security—Multiple layers of security across the deployment stack from the infrastructure through the NF applications.
- API exposure—Open and extensive for greater visibility, control, and service enablement.
- Access agnostic—Support for heterogeneous network types (for example 5G, 4G, 3G, Wi-Fi, and so on).

These control plane NFs are each designed as containerized applications (for example microservices) for deployment through the Subscriber Microservices Infrastructure (SMI).

The SMI defines the common application layers for functional aspects of the NF such as life-cycle management (LCM), operations and management (OAM), and packaging.

Figure 1: Ultra Cloud Core CP Architectural Components

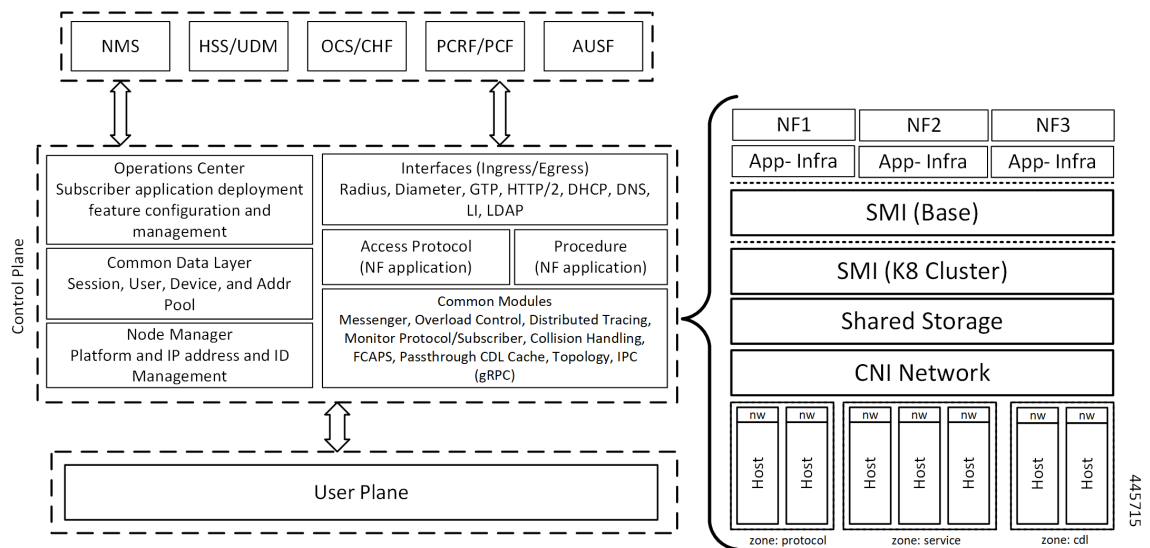

User Plane Network Function

The 5G UP NF within the Ultra Cloud Core is the User Plane Function (UPF). Unlike the CP-related NFs, the 5G UPF leverages the same Vector Packet Processing (VPP) technology currently in use by the user plane component within Cisco 4G CUPS architecture. This commonality ensures the delivery of a consistent set of capabilities between 4G and 5G such as:

- Ultrafast packet forwarding.
- Extensive integrated IP Services such as Subscriber Firewall, Tethering, Deep-Packet Inspection (DPI), Internet Content Adaption Protocol (ICAP), Application Detection and Control (ADC), and header enrichment (HE).
- Integrated third-party applications for traffic and TCP optimization.

Subscriber Microservices Infrastructure Architecture

The Ultra Cloud Core (UCC) Subscriber Microservices Infrastructure (SMI) is a layered stack of cloud technologies that enable the rapid deployment of, and seamless life-cycle operations for microservices-based applications.

The SMI stack consists of the following:

- SMI Cluster Manager—Creates the Kubernetes (K8s) cluster, creates the software repository, and provides ongoing LCM for the cluster including deployment, upgrades, and expansion.
- Kubernetes Management—Includes the K8s primary and etcd functions, which provide LCM for the NF applications that are deployed in the cluster. This component also provides cluster health monitoring and resources scheduling.
- Common Execution Environment (CEE)—Provides common utilities and OAM functionalities for Cisco Cloud native NFs and applications, including licensing and entitlement functions, configuration

management, telemetry and alarm visualization, logging management, and troubleshooting utilities. Also, it provides consistent interaction and experience for all customer touch points and integration points in relation to these tools and deployed applications.

- Common Data Layer (CDL)—Provides a high performance, low latency, stateful data store, designed specifically for 5G and subscriber applications. This next generation data store offers high availability in local or geo-redundant deployments.
- Service Mesh—Provides sophisticated message routing between application containers, enabling managed interconnectivity, extra security, and the ability to deploy new code and new configurations in low risk manner.
- NB Streaming—Provides Northbound Data Streaming service for billing and charging systems.
- NF or Application Worker Nodes—The containers that comprise an NF application pod.
- NF or Application Endpoints (EPs)—The NFs or applications and their interfaces to other entities on the network
- Application Programming Interfaces (APIs)—Provides various APIs for deployment, configuration, and management automation.

The following figure depicts how these components interconnect to comprise a microservice-based NF or application.

Figure 2: SMI Components

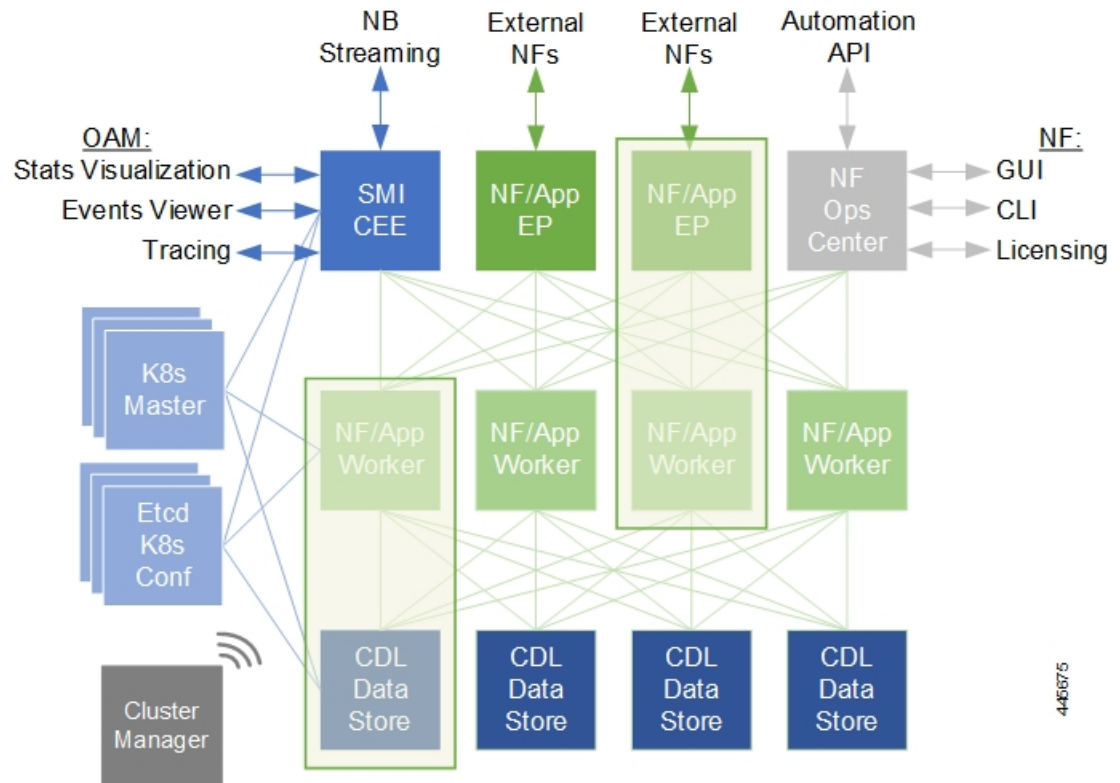

For more information on SMI components, see [Ultra Cloud Core Subscriber Microservices Infrastructure](#) and the related documentation at *Deployment Guide > Overview* chapter.

Control Plane Network Function Architecture

Control plane (CP) NFs are designed around a three-tiered architecture that take advantage of the stateful or stateless capabilities that are afforded within cloud native environments.

The architectural tiers are as follows:

- **Protocol Load Balancer Services**—These are stateless microservices that are primarily responsible for dynamic discovery of application containers as well as for protocol proxy and termination. These include traditional 3GPP protocols and new protocols that are introduced with 5G.
- **Applications Services**—Responsible for implementing the core application or business logic, these are the stateless services that render the actual application based on the received information. This layer may contain varying degrees of microservice granularity. Application services are stateless.
- **State management services**—Enable stateless application services by providing a common data layer (CDL) to store or cache state information (for example session and subscriber data). This layer supports various data storage technologies from in-memory caches to full-fledged databases.

Figure 3: Control Plan Network Function Tiered Architecture

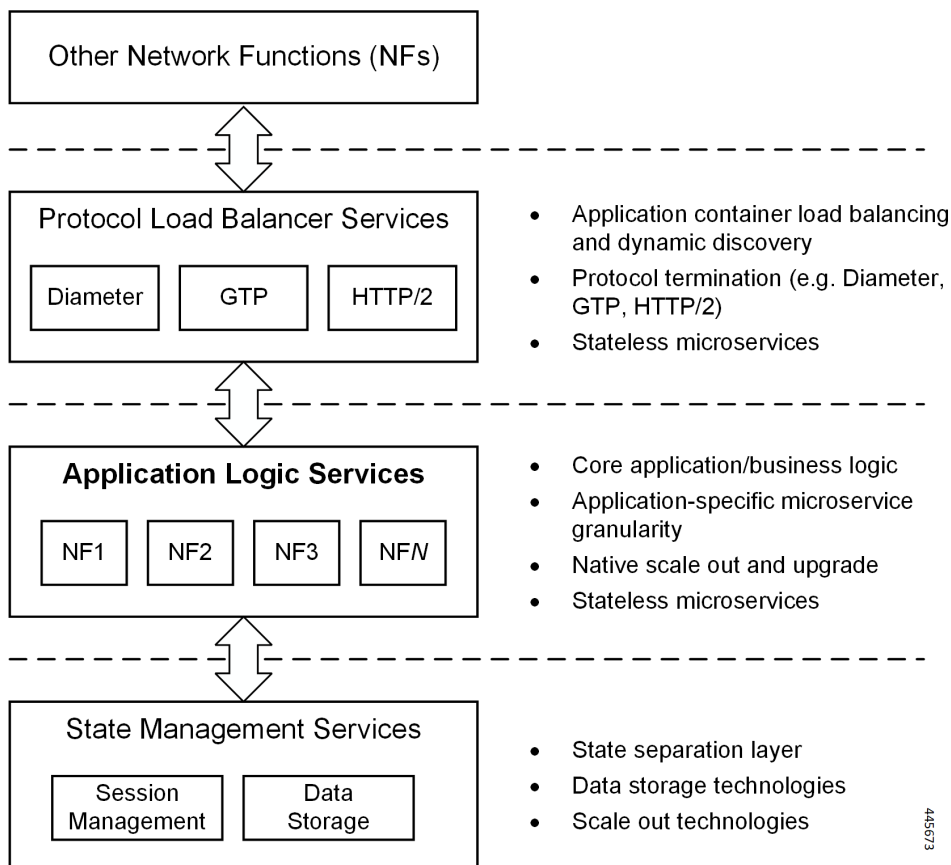

The three-tiered architecture on which Cisco CP NFs are designed fully support the 5G core (5GC) Service-based Architecture (SBA) defined by 3GPP. These NFs communicate with each other and with third-party NFs over the Service-based Interface (SBI) using HTTP/2 over TCP as defined by 3GPP.

Figure 4: Cisco CP NF Service-based Architecture Support

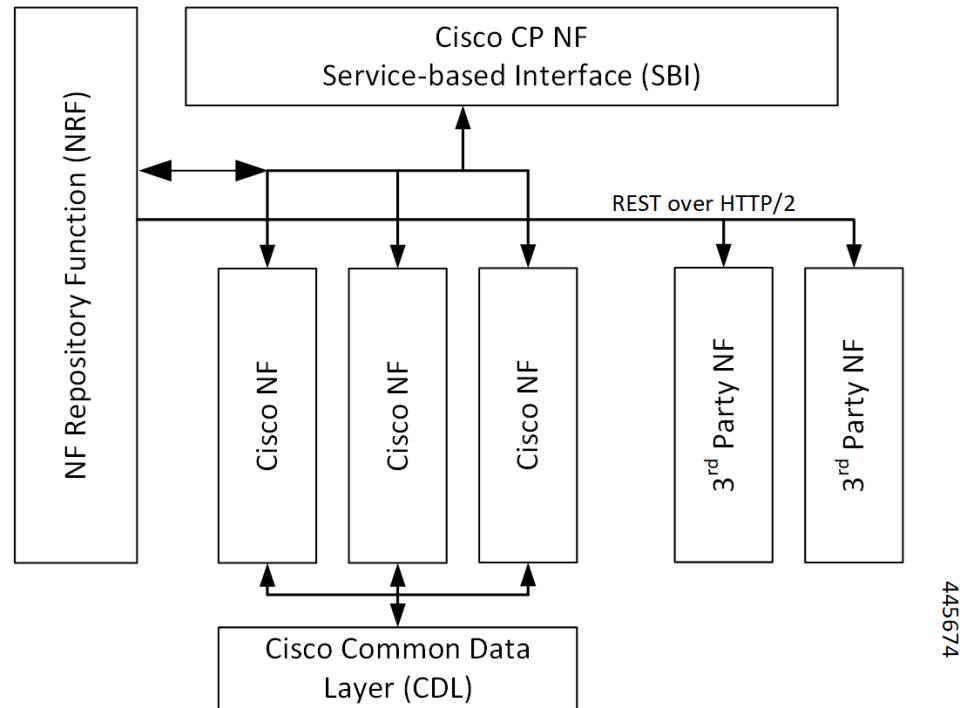

For more information on the Cisco network functions, see their corresponding network function documentation.



CHAPTER 2

cnSGW-C Overview

- [Product Description, on page 7](#)
- [Converged Core Overview, on page 7](#)
- [Use Cases, on page 8](#)
- [Deployment Architecture and Interfaces, on page 12](#)
- [Life Cycle of Data Packet, on page 16](#)
- [License Information, on page 17](#)
- [Standards Compliance, on page 17](#)

Product Description

cnSGW-C is a Control Plane Network Function (NF) of the converged core network (4G-5GC). The Serving Gateway Control Plane Function (cnSGW-C) is built on top of the SMI architecture. cnSGW-C acts as a UE anchor and supports mobility procedures, along with session setup and termination procedures, as specified in *3GPP TS 23.401* and *3GPP TS 23.214*.

The Serving Gateway Control Plane Function (cnSGW-C) provides the functionality of the S-GW as defined by *TS 23.401 [2]*, except for the functions that are performed by the SGW-U, as described in *3GPP Spec 23.214 Table 4.3.2-1*. In addition, the cnSGW-C is responsible for selecting the SGW-U (as described in *3GPP Spec 23.214 clause 4.3.3*) and for controlling the SGW-U with respect to the functions described in *TS 23.214 Table 4.3.2-1*.

With SMF (IWF) support based on Cisco Cloud Native Platform, it is recommended to support cnSGW-C functionality on Cloud Native Platform for better hardware utilization and O&M activities.

Converged Core Overview

The converged core solution provides an advanced, cloud-native, converged control plane with the capability to support 4G and 5G devices, and use cases.



Important

This release supports only the cloud-native integrated S-GW and SMF instance with S5C and cnSGW-C functionalities.

The converged core solution removes the operational complexity by providing a unified core network to handle all types of subscribers and use cases.

The operator has the following benefits:

- Improves the overall network efficiency by reducing signaling between cnSGW-C and SMF while handling a 4G subscriber or handoff from 5G to 4G coverage area.
- Reduces latency introduced due to the extra hop SGW-U for a subscriber in 4G coverage area, by collapsing the data path in the Converged UPF, thus improving the overall user experience.
- Provides ability to use a unified subscriber policy and billing infrastructure using SBA interfaces for 4G and 5G devices.

The solution supports the following converged control plane and user plane functions:

- Converged Control Plane Functions
 - Integrates S-GW and SMF network functions as a single deployment, under a single Kubernetes namespace, to support 4G and 5G devices from E-UTRAN/NR (converged core gateway)
 - Supports logical network functions (data)
- Converged User Plane Functions
 - Integrates UPF and SGW-U functionalities as a single network function
 - Provides simultaneous support for N4 and Sxa interfaces
 - Terminates multiple control planes in a single deployment

Use Cases

This section describes the use cases that cnSGW-C supports:

- **cnSGW-C Configuration**

The cnSGW-C base configuration provides a detailed view of configurations required for the cnSGW-C to be operational. The configuration includes setting up the infrastructure to deploy the cnSGW-C, deploying the cnSGW-C through SMI, and configuring the Ops Center for exploiting the cnSGW-C capabilities over time. For more information on SMI, see the *Ultra Cloud Core SMI Cluster Deployer Operations Guide*.

The following features are related to this use case:

- [APN Profile Support, on page 97](#)
- [Service Configuration Enhancements, on page 571](#)
- [UPF Selection Support, on page 689](#)

For Converged Core deployment, cnSGW-C is deployed using Converged Ops Center.

- **Session Management**

Every UE accessing the EPC is associated with a single S-GW. cnSGW-C supports multiple PDN for given UE. As a part of Session Management, cnSGW-C supports the following:

- Default and dedicated bearer establishment
- Bearer modification
- Bearer deactivation

The following features are related to this use case:

- [3GPP RAN/NAS Cause Codes Support, on page 85](#)
- [Change Notification Request Handling, on page 101](#)
- [Context Replacement Support, on page 113](#)
- [Dedicated Bearer Support, on page 121](#)
- [Delete Bearer and Delete Session Request, on page 133](#)
- [DSCP Marking for CP Signaling Messages, on page 164](#)
- [eMPS/WPS Support, on page 191](#)
- [Emergency Call Support, on page 185](#)
- [Idle Session Timeout Settings, on page 297](#)
- [Initial Attach Support, on page 305](#)
- [Multiple PDN Attach or Detach Procedures, on page 417](#)
- [Presence Reporting Area, on page 493](#)
- [Update Bearer Request and Response, on page 683](#)
- [VoLTE Call Prioritization, on page 713](#)

• **Support for UE Mobility**

cnSGW-C is a mobility anchor point for UE. In LTE Network, there can be mobility between eNodeB to eNodeB, with or without MME change. UE can also move from one cnSGW-C to another cnSGW-C with different modes, S1-based Relocation, X2-based Relocation, and 5G-4G interworking.

The following features are related to this use case:

- [IDFT Support, on page 281](#)
- [Intra-MME and Inter-MME Handover Procedures, on page 319](#)
- [Modify Bearer Request Support, on page 369](#)
- [Presence Reporting Area, on page 493](#)
- [SGW Relocation Support, on page 645](#)

• **S1-Release/Buffering/Downlink Data Notification**

cnSGW-C handles releasing S1-U bearer between eNodeB and SGW-U. When cnSGW-C receives Radio Access Bearers (RAB) message indicating that S1-U bearers are released, it updates User Plane and moves UE to IDLE state. When in IDLE state, if UE receives downlink data packet, cnSGW-C generates DDN message towards MME to page UE.

cnSGW-C also supports DDN Throttling, DDN Delay, and High Priority feature for DDN.

The following features are related to this use case:

- [Access Bearer Release Support, on page 93](#)
- [Downlink Data Notification, on page 139](#)
- [DDN Advance Features, on page 150](#)

• Retransmission and Timeout

For all procedures, as per *3GPP TS 23.401/29.274*, cnSGW-C supports N3-Retransmission, and T3-Timeout Support. These are supported for S11, S5, and Sx interfaces.

The following feature is related to this use case:

- [GTPv2 and Sx Messages Retransmission and Timeout Handling, on page 257](#)

• Failure and Error Handling

cnSGW-C supports handling of:

- Failure response for Create Session Request as part of initial attach procedure and additional PDN setup procedure
- PGW-initiated Dedicated Bearer Creation (DBC) procedure failure scenario
- Radio Access Bearers (RAB), Modify Bearer Request and Response (MBR) from PGW and User Plane

The following feature is related to this use case:

- [Failure and Error Handling Support, on page 199](#)

• Load/overload Control Functions

cnSGW-C supports:

- Exchange of load/overload control information and actions during peer node overload over Sx interface.
- Handling load/overload information on GTPv2 interface.

The following features are related to this use case:

- [GTPv2 Load/Overload Support, on page 265](#)
- [Sx Load/Overload Control Handling, on page 663](#)

• cnSGW-C Charging Support

cnSGW-C supports:

- Offline Charging (Gz).
- Writing CDR to local disk storage. The CDR files are pushed to SFTP server periodically.
- CDR generation for selected subscribers. This is achieved by enabling CDR generation per Operator Policy through call control profile.

The following feature is related to this use case:

- [SGW Charging Support, on page 579](#)

• Peer and Path Management for GTPC and Sx

cnSGW-C supports:

- Peer management for MME (S11 peers), PGW (S5 Peers), and User Plane.
- Peer monitoring through ECHO Request/Response and Heartbeat Request/Response.
- Handling of path failure events for S11 and S5 peers.

The following features are related to this use case:

- [GTPC and Sx Path Management, on page 212](#)
- [GTPC Path Failure, on page 217](#)
- [Customization of Path Failure Detection, on page 222](#)
- [Sx Path Failure, on page 220](#)

• Redundancy Support

The cnSGW-C deployment in K8 cluster plays a vital role to support High Availability (HA) and Geographic Redundancy (GR).

The Redundancy Support ensures stateful session continuity among the clusters during the rack or cluster failures.

The cnSGW-C achieves the HA through redundant set-up of each cluster component such that any single point of failure is avoided.

The GR provides rack-level redundancy to replicate data between two separate K8 Clusters across rack. On RACK/Cluster failure, traffic switches to a remote RACK to process the traffic. The failure can be due to power failure, multi-compute failures, network failure, multi-POD failure, BFD link failure, and so on.

The following features are related to this use case:

- [Redundancy Support, on page 497](#)
- [High Availability Support, on page 498](#)

• Dynamic Routing

Dynamic routing enables L3 peering with Leafs, in addition to L2 Static routing.

The following feature is related to this use case:

- [Dynamic Routing by Using BGP, on page 169](#)

• GTPU Path Management and Session Management

The UPF notifies an Error Indication message for a GTP-U peer to the sender when a GTP-PDU is received with a TEID that does not exist. This ensures that there are no stale sessions or bearers, and maintains consistency in the network.

Error Indication and GTP-U Path Failure Indication communication between S-GW and UPF nodes is supported over the N4 interface. For the neighbor nodes, the communication is supported over the S1u/S5u interfaces. Behavior variations of local-purge or signal-peer for Error Indication and GTP-U Path Failure are considered in this implementation.

The following features are related to this use case:

- [GTPU Error Indication, on page 227](#)
- [GTPU Path Failure, on page 249](#)

Deployment Architecture and Interfaces

cnSGW-C is a part of the converged core network functions portfolio with a common mobile core platform architecture. The core network functions include Access and Mobility Management Function (AMF), Policy Control Function (PCF), Session Management Function (SMF), and User Plane Function (UPF).

cnSGW-C Architecture

cnSGW-C network function consists of loosely coupled microservices. The microservice decomposition is based on a three-layered architecture, as illustrated in the following figure:

Figure 5: cnSGW-C Architecture

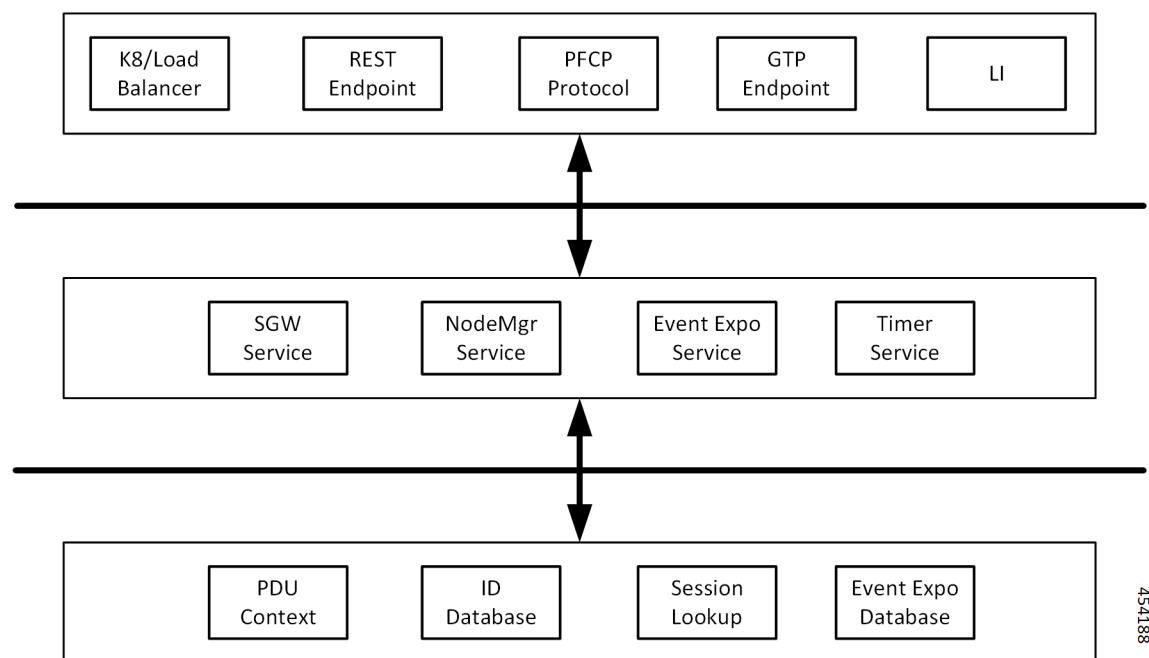

The following are the three layers of the cnSGW-C architecture:

- Layer 1 - Protocol and Load Balancer services (Stateless)
- Layer 2 - Application services (Stateless)

454188

- Layer 3 - Database services (Stateful)

cnSGW-C Deployment

cnSGW-C NF is deployed in a separate namespace as an independent NF.

Figure 6: cnSGW-C Deployment

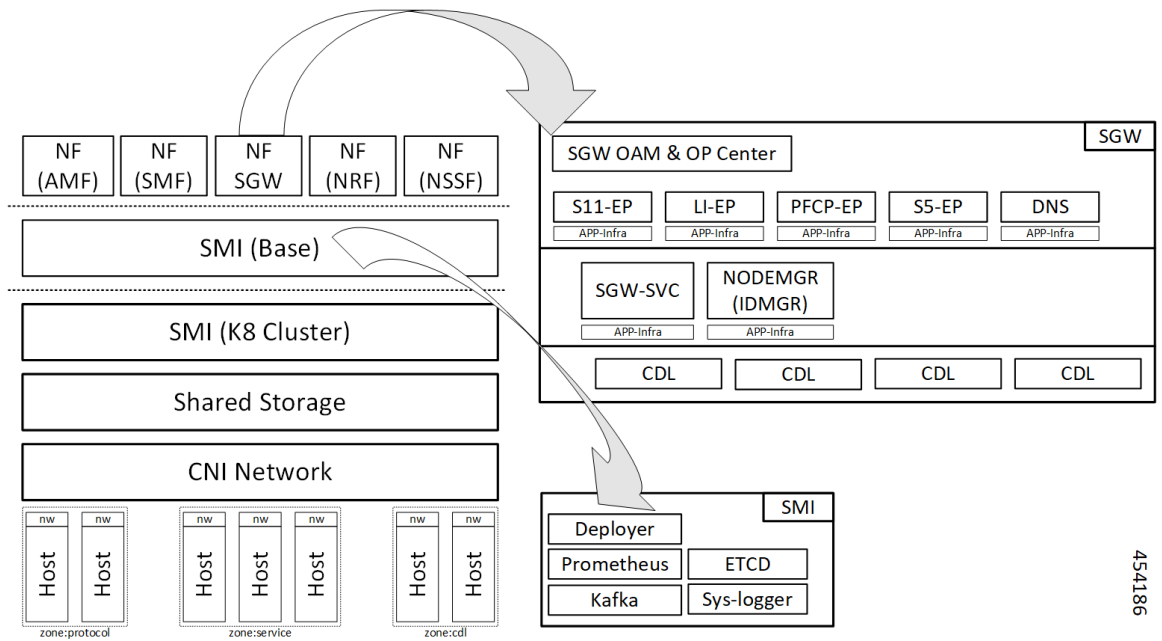

454186

Figure 7: cnSGW-C HELM Chart

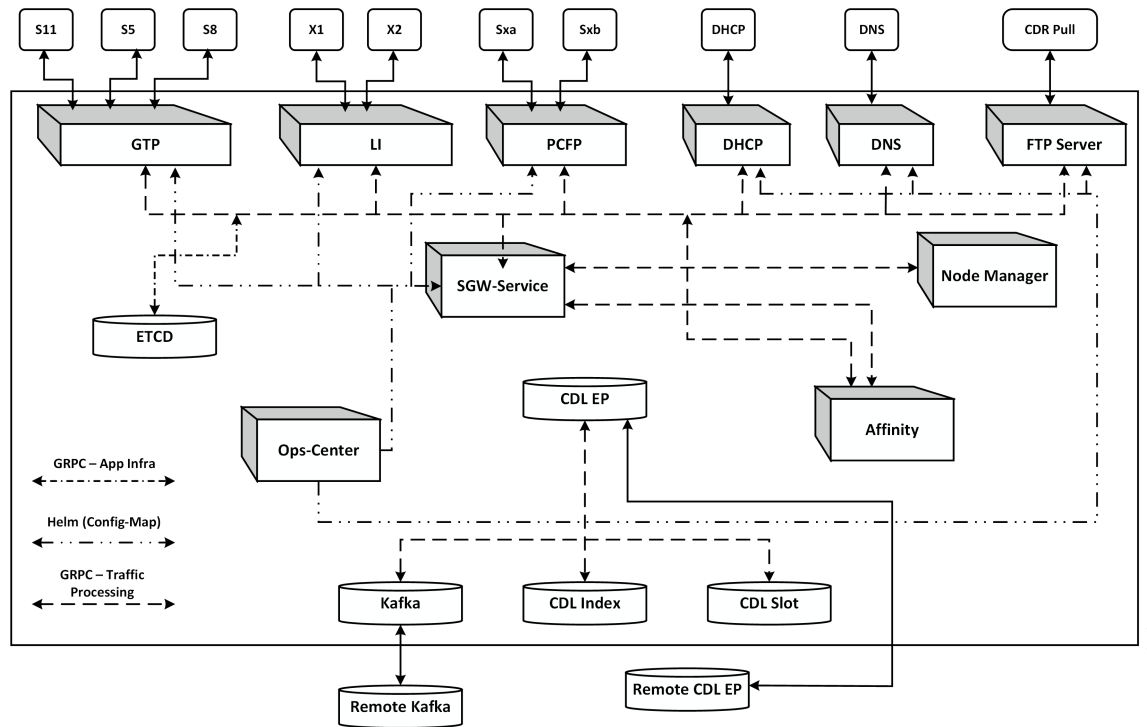

Converged Core Architecture

The converged core solution provides a single unified platform which is based on SMI architecture. The supporting architecture integrates the cloud-native S-GW and SMF deployment with 5GC and cnSGW-C functionalities. The solution uses 3GPP-defined SBA interfaces for policy and charging functions.

In the converged core architecture, the 4G and 5G capable UEs are anchored on the same control plane instance. The control plane instance provides the SMF, 5GC, and cnSGW-C functionalities.

The handoffs between 4G and 5G access types are seamless for 5G capable devices. The handoffs from LTE to UTRAN (bi-directional communication between 4G/5G and 3G/2G) are not seamless for 4G capable devices.

The following figure illustrates the supported network architecture.

Figure 8: Converged Core Architecture

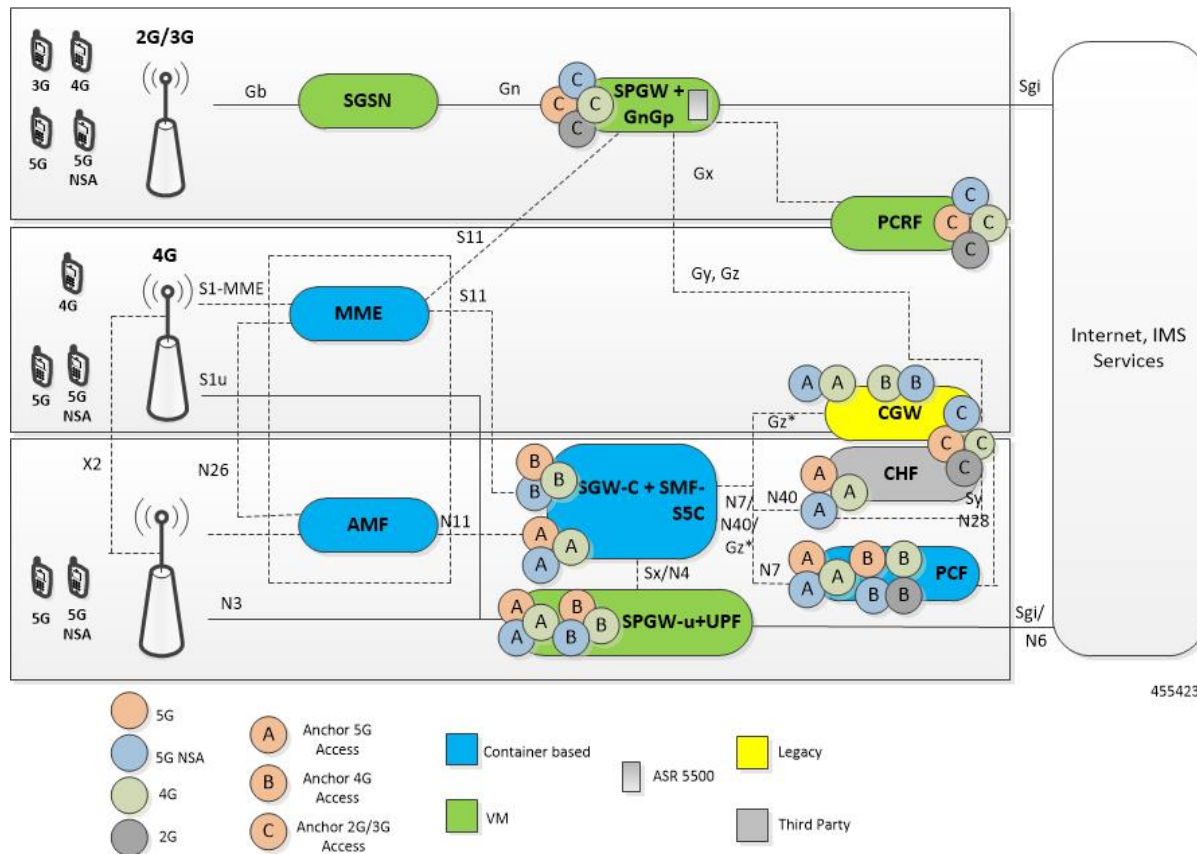

455423

The UPF deployed as a part of this solution is a VPC-SI VM. The UPF deployment is VM-based, and supports:

- SGW-U, PGW-U, and UPF functionalities in the same instance, and exposes the Sxa, Sxb, Sxab, or N4 interface towards the control plane.
- Multiple CP instances (up to 4) simultaneously.

Converged Core Deployment

The converged core deployment is based on the converged control plane and unified user plane infrastructure for all use cases.

In the converged core deployment, all 4G and 5G-capable UEs are anchored on the 5G core (SMF) with SBA interfaces towards PCF.

The converged core deployment has a converged Ops Center that allows the configuration of cnSGW-C and SMF services along with other microservices. A single product helm chart is used to install components.

The following figure illustrates the Kubernetes deployment for the converged S-GW and SMF network function.

Figure 9: Kubernetes Deployment

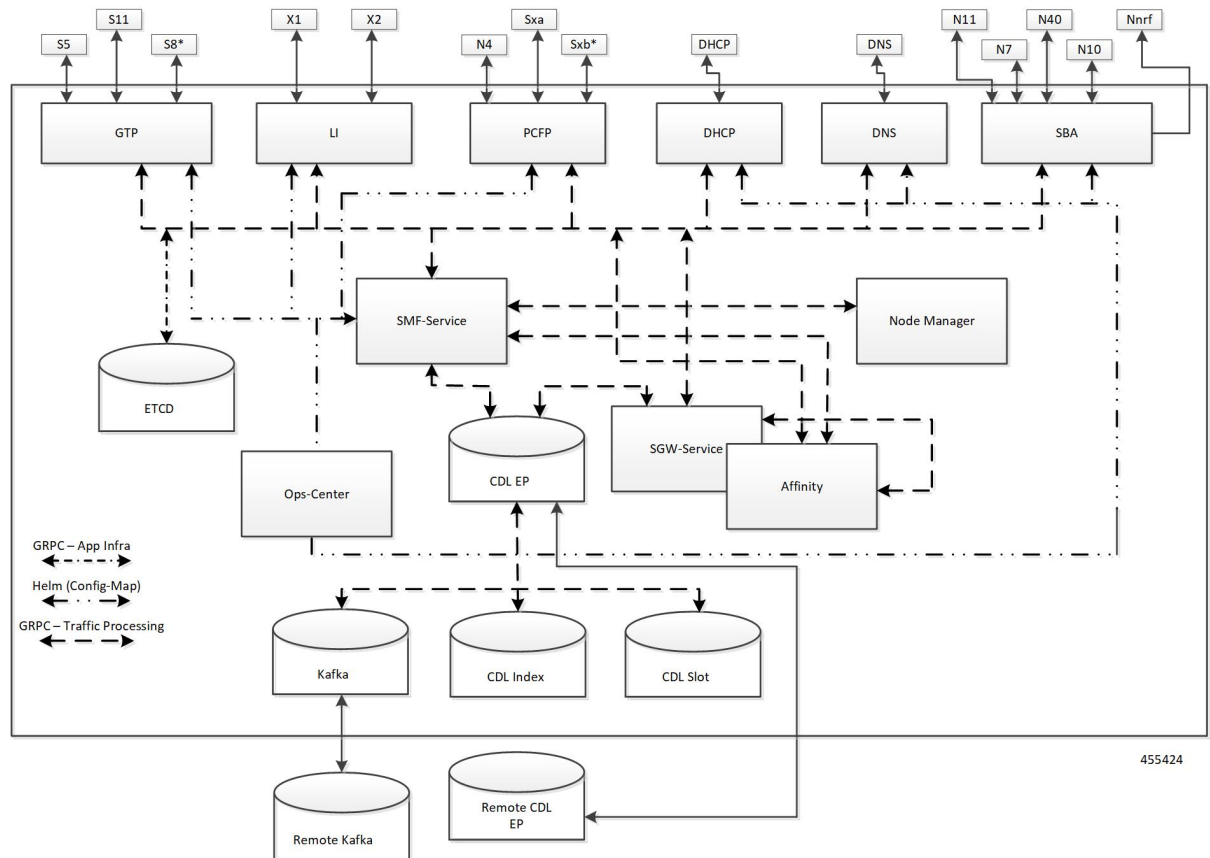

The protocol layer services are shared across SMF and S-GW. The GTP endpoint terminates the S11 interface and S5/S8 interface. Similarly, the PCFP (protocol) endpoint terminates the N4 and Sxa interfaces.

The SMF and S-GW services are deployed as distinct pods and the session processing is segregated. Both the service pods use CDL for storing subscriber sessions.

Supported Interfaces

This section describes the interfaces supported between cnSGW-C and other network functions in the 5GC.

- S11—Reference point between the SGW and the MME
- S5/S8—Reference point between the SGW and the PGW/SMF
- Sxa—Reference point between the SGW-C and the SGW-U
- Gz—Reference point between the SGW-C and the Charging Server

Life Cycle of Data Packet

For information on life cycle of a data packet, see [Initial Attach Support, on page 305](#).

License Information

cnSGW-C supports Cisco Smart Licensing. For more information, see [Smart Licensing Support](#), on page 43.

Standards Compliance

cnSGW-C complies with the following 3GPP standards:

- *3GPP TS 23.401 "General Packet Radio Service (GPRS) enhancements for Evolved Universal Terrestrial Radio Access Network (E-UTRAN) access"*
- *3GPP TS 23.402 "Architecture enhancements for non-3GPP accesses"*
- *3GPP TS 29.274 "Evolved General Packet Radio Service (GPRS) Tunnelling Protocol for Control plane (GTPv2-C);"*
- *3GPP TS 23.214 "Architecture enhancements for control and user plane separation of EPC nodes"*
- *3GPP TS 29.244 "Interface between the Control Plane and the User Plane nodes"*
- *3GPP TS 24.008 "Mobile radio interface Layer 3 specification; Core network protocols; Stage 3"*
- *3GPP TS 23.007 "Restoration procedures"*
- *3GPP TS 22.153 "Multimedia priority service"*
- *3GPP TS 33.107 "3G security; Lawful interception architecture and functions"*



CHAPTER 3

Deploying and Configuring cnSGW-C through Operations Center

- [Feature Summary and Revision History](#), on page 19
- [Feature Description](#), on page 20
- [cnSGW-C Service Configuration](#), on page 21
- [Deploying and Accessing cnSGW-C](#), on page 22
- [Loading Day 1 Configuration](#), on page 25

Feature Summary and Revision History

Summary Data

Table 1: Summary Data

Applicable Product(s) or Functional Area	cnSGW-C
Applicable Platform(s)	SMI
Feature Default Setting	Enabled - Always-on
Related Documentation	Not Applicable

Revision History

Table 2: Revision History

Revision Details	Release
The following enhancements were introduced: <ul style="list-style-type: none">• Multiple entitlement tags• cnSGW-C deployment on bare metal server	2021.02.0

Revision Details	Release
First introduced.	2020.07.0

Feature Description

cnSGW-C deployment process involves deploying cnSGW-C through Subscriber Microservices Infrastructure (SMI) Cluster Deployer. You can perform configurations or customizations through the cnSGW-C Ops Center which is based on the Confd CLI.

cnSGW-C Ops Center

The Ops Center is a system-level infrastructure that provides the following user interface to:

- Trigger the deployment of microservices by providing variable helm chart parameters. These chart parameters control the scale and properties of Kubernetes objects (deployment, pod, services, and so on) associated with the deployment.
- Push application specific configuration to one or more micro-services through Kubernetes configuration maps.
- Issue application-specific execution commands (such as show commands and clear). These commands:
 - Invoke APIs in application-specific pods
 - Display the information returned by the application on the user interface

The following screenshot is a sample of the web-based CLI.

Figure 10: Web-based Ops Center

```
[unknown] sgw# show running-config
system mode running
helm default-repository sgw-smi
helm repository sgw-smi
  access-token dev-deployer.gen:AKCp5ekcXA77knM9DbLASNbw4jwVEsx9Z9WpQwEvCvCQ2mJhLymcz6BfbH38YJiWC6fn1cKmw
  url          http://engci-maven-master.cisco.com/artifactory/smi-fuse-internal-snapshot/mobile-cn-at-sgw/sgw-products/dev-sgw-clear23
exit
k8s name      cn-sgw
k8s namespace sgw
k8s nf-name   sgw
k8s registry  dockerhub.cisco.com/smi-fuse-docker-internal
k8s single-node true
k8s use-volume-claims false
k8s ingress-host-name 209.165.201.0.nip.io
```

The cnSGW-C Ops Center allows you to configure the features, such as licensing, cnSGW-C engine, EGPT and PFCP endpoint, and CDL.

Prerequisites

Before deploying cnSGW-C on the SMI layer:

- Ensure that all the virtual network functions (VNFs) are deployed.
- Run the SMI synchronization operation for the cnSGW-C Ops Center and Cloud Native Common Execution Environment (CN-CEE).

cnSGW-C Service Configuration

The cnSGW-C service requires the basic configuration to process Call Setup, Modify, and Delete Request.

Mapping Pods with Node Labels

Prerequisites

- Ensure that the node labels are according to the pod deployment layout.
- Ensure that the external VIPs are according to the requirement of NF.
- Enable Istio for pod to pod traffic load balancing.

Node Labels are key and value pairs that are attached to nodes at cluster synchronization. Each node can have a set of key and value labels defined. Each key must be unique for a node. With labels, users can map their NF pods onto nodes in a loosely coupled manner.



Important

- The pod-level labeling configuration is applicable only when the cnSGW-C is deployed on a bare metal server.
- Ensure to configure the node label on the SMI cluster deployer before mapping the pods. Following is the sample command for master-1 labeling:

```
[cndp-clpnc-cm-cm-primary] SMI Cluster Deployer (config-nodes-master-1)# k8s
node-labels smi.cisco.com/svc-type smf-node
```

To map the pods with node labels, use the following sample configuration:

config

```
k8 label protocol-layer key label_key value label_value
k8 label service-layer key label_key value label_value
k8 label cdl-layer key label_key value label_value
k8 label oam-layer key label_key value label_value
end
```

Following is an example configuration of pod to node-label mapping:

```
k8 label protocol-layer key smi.cisco.com/node-type value smf-proto
exit
k8 label service-layer key vm-type value smf-svc
exit
k8 label cdl-layer key smi.cisco.com/node-type value smf-cdl
exit
k8 label oam-layer key smi.cisco.com/node-type value oam
exit
```

Deploying and Accessing cnSGW-C

This section describes how to deploy cnSGW-C and access the cnSGW-C Ops Center.

Deploying cnSGW-C

The Subscriber Microservices Infrastructure (SMI) platform is responsible for deploying and managing the cnSGW-C application and other network functions.

For information on how to deploy cnSGW-C Ops Center on bare metal servers (currently Cisco UCS-C servers) environment, see *Operating the SMI Cluster Manager on Bare Metal* section in the *Ultra Cloud Core Subscriber Microservices Infrastructure — Operations Guide*.

Accessing the cnSGW-C Ops Center

You can connect to the cnSGW-C Ops Center through SSH or the web-based CLI console.

- SSH:

```
ssh admin@ops_center_pod_ip -p 2024
```

- Web-based console:

1. Log in to the Kubernetes master node.

2. Run the following command:

```
kubectl get ingress <namespace>
```

The available ingress connections get listed.

3. Select the appropriate ingress and access the Ops Center.

4. Access the following URL from your web browser:

```
cli.<namespace>-ops-center.<ip_address>.nip.io
```

By default, the Day 0 configuration is loaded into the cnSGW-C.

Day 0 Configuration

To view the Day 0 configuration, run the following command.

```
show running-config
```

The following is a sample Day 0 configuration:

```
system mode shutdown
helm default-repository base-repos
helm repository base-repos
  url https://charts.209.165.201.1.nip.io/ccg.2021.01.0.i60
exit
k8s name          2nd-a18-kub-cluster
k8s namespace     cn-cn3
k8s nf-name       smf
k8s registry      docker.209.165.201.1.nip.io/ccg.2021.01.0.i60
```

```
k8s single-node false
k8s use-volume-claims false
k8s ingress-host-name 209.165.201.2.nip.io
k8s nodes 2nd-a18-kub-cluster-master-11
  node-type master
  worker-type master
exit
k8s nodes 2nd-a18-kub-cluster-master-22
  node-type master
  worker-type master
exit
k8s nodes 2nd-a18-kub-cluster-master-33
  node-type master
  worker-type master
exit
aaa authentication users user admin
  uid 1117
  gid 1117
  password $1$XNGJOr.C$iZZvQbNfmPN15qG4GpQa8/
  ssh_keydir /tmp/admin/.ssh
  homedir /tmp/admin
exit
aaa ios level 0
  prompt "\h> "
exit
aaa ios level 15
  prompt "\h# "
exit
aaa ios privilege exec
  level 0
    command action
    exit
    command autowizard
    exit
    command enable
    exit
    command exit
    exit
    command help
    exit
    command startup
    exit
  level 15
    command configure
    exit
  exit
exit
nacm write-default deny
nacm groups group LI
  user-name [ liadmin ]
exit
nacm groups group admin
  user-name [ admin ]
exit
nacm rule-list admin
  group [ admin ]
  rule li-deny-tap
    module-name lawful-intercept
    path /lawful-intercept
    access-operations *
    action deny
  exit
  rule li-deny-clear
```

```

    module-name      tailf-mobile-smf
    path              /clear/lawful-intercept
    access-operations *
    action            deny
  exit
rule any-access
  action permit
exit
exit
nacm rule-list confd-api-manager
  group [ confd-api-manager ]
  rule any-access
    action permit
  exit
exit
nacm rule-list ops-center-security
  group [ * ]
  rule change-self-password
    module-name      ops-center-security
    path              /smiuser/change-self-password
    access-operations exec
    action            permit
  exit
  rule smiuser
    module-name      ops-center-security
    path              /smiuser
    access-operations exec
    action            deny
  exit
exit
nacm rule-list lawful-intercept
  group [ LI ]
  rule li-accept-tap
    module-name      lawful-intercept
    path              /lawful-intercept
    access-operations *
    action            permit
  exit
  rule li-accept-clear
    module-name      tailf-mobile-smf
    path              /clear/lawful-intercept
    access-operations *
    action            permit
  exit
exit
nacm rule-list any-group
  group [ * ]
  rule li-deny-tap
    module-name      lawful-intercept
    path              /lawful-intercept
    access-operations *
    action            deny
  exit
  rule li-deny-clear
    module-name      tailf-mobile-smf
    path              /clear/lawful-intercept
    access-operations *
    action            deny
  exit
exit

```

Loading Day 1 Configuration

The cnSGW-C configuration is provided using the Ops Center infrastructure. To load the Day 1 configuration, run the following command:

```
ssh admin@ops_center_pod_ip -p 2024 Day1config.cli
```



Note The [Day1config.cli](#), on page 25 file contains the necessary parameters required for the Day 1 configuration.

Alternatively, you can copy the configuration and paste it in the cnSGW-C Ops Center CLI to load the Day 1 configuration.

```
config
<Paste the Day 1 configuration here>
commit
end
```

Day1config.cli

The following is a sample `Day1config.cli` file, which contains the Day 1 configuration for the cnSGW-C.

```
ipam
instance 1
source local
address-pool poolv4
vrf-name ISP
tags
dnn intershat
dnn starent.com
exit
ipv4
split-size
per-cache 1024
per-dp 256
exit
address-range 209.165.200 209.165.200.224
exit
exit
address-pool poolv4DNN2
vrf-name ISP
tags
dnn intershat1
exit
ipv4
split-size
per-cache 1024
per-dp 256
exit
address-range 209.165.100 209.165.201.0
exit
exit
address-pool poolv4DNN3
static
vrf-name ISP
tags
```

```
dnn intershat2
exit
ipv4
split-size
per-cache 512
per-dp 512
exit
address-range 209.165.202 209.165.202.128
exit
ipv6
prefix-ranges
split-size
per-cache 8192
per-dp 8192
exit
prefix-range 2002:db0:: length 48
exit
exit
exit
address-pool poolv4vDNN
vrf-name ISP
tags
dnn intershat1
exit
ipv4
split-size
per-cache 1024
per-dp 256
exit
address-range 209.165.200 209.165.202.128
exit
exit
address-pool poolv6
vrf-name ISP
tags
dnn intershat
exit
ipv6
prefix-ranges
split-size
per-cache 8192
per-dp 1024
exit
prefix-range 2001:db0:: length 48
exit
exit
exit
address-pool poolv6DNN2
vrf-name ISP
tags
dnn intershat1
exit
ipv6
prefix-ranges
split-size
per-cache 8192
per-dp 1024
exit
prefix-range 2001:ef0:: length 48
exit
exit
exit
address-pool poolv6vDNN
vrf-name ISP
```

```
tags
dnn intershat1
exit
ipv6
prefix-ranges
split-size
per-cache 8192
per-dp 1024
exit
prefix-range 2001:ab0:: length 48
exit
exit
exit
exit
cdl deployment-model small
cdl zookeeper replica 1
cdl datastore session
  slice-names 1
index map 1
index write-factor 1
slot replica 1
slot map 1
slot write-factor 1
exit
cdl kafka replica 1
etcd replicas 1
instances instance 1
  slice-name 1
  system-id DCNAME001
  cluster-id CLUSTER0001
exit
local-instance instance 1
instance instance-id 1
endpoint sbi
replicas 1
vip-ip 209.165.201.3 vip-port 1234

interface nrf
  loopbackPort 9001
  sla response 1000
  sla procedure 1000
  vip-ip 209.165.201.3 vip-port 9002 offline
exit
interface n11
  loopbackPort 9011
  sla response 1000
  sla procedure 1000
  vip-ip 209.165.201.3 vip-port 8090
exit
interface n7
  loopbackPort 9007
  sla response 1000
  sla procedure 1000
  vip-ip 209.165.201.3 vip-port 8090
exit
interface n10
  loopbackPort 9010
  sla response 1000
  sla procedure 1000
  vip-ip 209.165.201.3 vip-port 8090
exit
interface n40
  loopbackPort 9040
  sla response 1000
```

```

    sla procedure 1000
    vip-ip 209.165.201.3 vip-port 8090
    exit

exit
endpoint li
replicas 1
vip-ip 209.165.201.3
exit
endpoint nodemgr
replicas 1
nodes 1
exit
endpoint gtp
replicas 1
interface s5
vip-ip 209.165.200.225
exit
interface s2b
vip-ip 209.165.200.225
exit
interface s5e
vip-ip 209.165.201.3
exit
interface s11
vip-ip 209.165.200.226
exit
exit
endpoint pfcpl
replicas 1
enable-cpu-optimization true
interface sxa
heartbeat
interval 5
retransmission-timeout 3
max-retransmissions 5
exit
interface n4
heartbeat
interval 0
retransmission-timeout 3
max-retransmissions 5
exit
exit
exit
#endpoint radius-dns
#replicas 1
#vip-ip 209.165.201.3
#interface radius-client
#vip-ip 209.165.201.3
#exit
#exit
endpoint service
replicas 1
nodes 1
exit
endpoint protocol
vip-ip 209.165.201.3
replicas 1
interface n4
vip-ip 209.165.200.225
exit
interface sxa

```

```

vip-ip 209.165.201.3
exit
exit
endpoint sgw-service
replicas 1
node 1
exit
exit
logging level application debug
logging level transaction debug
logging level tracing debug
logging name infra.config.core level application trace
logging name infra.config.core level transaction trace
logging name infra.config.core level tracing off
logging name infra.message_log.core level transaction trace
deployment
  model small
  app-name SMF
  cluster-name Local
  dc-name DC
exit
k8 label protocol-layer key disktype value ssd
#k8 label service-layer key radnaik_key value mine
#k8 label service-layer key smi.cisco.com/node-type value oam
exit
system mode running
helm default-repository cn
helm repository cn
#access-token smf-deployer.gen:Mitg_123
#access-token dev-deployer.gen:Mitg_123
#access-token
dev-deployer.gen:AKCp5ekcXA7TknM9DbLASNBw4jwVEsx9Z9WpQwEvCvCQ2mJhLymcz6BfbH38YJiWC6fn1cKmw
access-token
smf-deployer.gen:AKCp5ekcX7DcBhuAmMZYfGLaHvH3E4Syr9TQDp1gjzcsjYrqsrgbXSYs5X2XYij3d9n9VfWQe
#url
https://engci-maven-master.cisco.com/artifactory/smi-fuse-internal-snapshot/mobile-cnat-cn/cn-products/dev-cn-stage
url
https://engci-maven-master.cisco.com/artifactory/smi-fuse-internal-snapshot/mobile-cnat-cn/cn-products/dev-cn-stage
exit
profile nf-client nf-type udm
udm-profile UP1
locality LOCl
priority 30
service name type nudm-sdm
endpoint-profile EP1
capacity 30
uri-scheme http
version
uri-version v2
exit
exit
endpoint-name EP1
primary ip-address ipv4 209.165.201.3
primary ip-address port 8001
exit
exit
exit
service name type nudm-uecm
endpoint-profile EP1
capacity 30
uri-scheme http
endpoint-name EP1
primary ip-address ipv4 209.165.201.3
primary ip-address port 8001

```

```

exit
exit
exit
service name type nudm-ee
endpoint-profile EP1
capacity      30
api-uri-prefix PREFIX
api-root      ROOT
uri-scheme    http
endpoint-name EP1
priority 56
primary ip-address ipv4 209.165.201.3
primary ip-address port 8001
exit
exit
exit
exit
exit
exit
profile nf-client nf-type pcf
pcf-profile PP1
locality LOC1
priority 30
service name type npcf-am-policy-control
endpoint-profile EP1
capacity      30
uri-scheme    http
endpoint-name EP1
priority 56
primary ip-address ipv4 209.165.201.3
primary ip-address port 8003
exit
exit
exit
service name type npcf-smpolicycontrol
endpoint-profile EP1
capacity      30
uri-scheme    http
endpoint-name EP1
priority 56
primary ip-address ipv4 209.165.201.3
primary ip-address port 8003
exit
exit
exit
exit
exit
exit
profile nf-client nf-type amf
amf-profile AP1
locality LOC1
priority 30
service name type namf-comm
endpoint-profile EP2
capacity      30
uri-scheme    http
endpoint-name EP1
priority 56
primary ip-address ipv4 209.165.201.3
primary ip-address port 8002
exit
exit
exit
exit

```

```
exit
exit
profile nf-client nf-type chf
chf-profile CP1
locality LOC1
priority 30
service name type nchf-convergedcharging
endpoint-profile EP1
capacity 30
uri-scheme http
version
uri-version v2
exit
exit
endpoint-name EP1
priority 56
primary ip-address ipv4 209.165.201.3
primary ip-address port 8004
exit
exit
exit
exit
chf-profile CP2
locality LOC1
priority 31
service name type nchf-convergedcharging
endpoint-profile EP1
capacity 30
uri-scheme http
version
uri-version v2
exit
exit
endpoint-name EP1
priority 56
primary ip-address ipv4 209.165.201.3
primary ip-address port 9040
exit
exit
exit
exit
profile nf-pair nf-type UDM
nrf-discovery-group udmdiscovery
locality client LOC1
locality preferred-server LOC1
locality geo-server GEO
exit
profile nf-pair nf-type AMF
nrf-discovery-group udmdiscovery
locality client LOC1
locality preferred-server LOC1
locality geo-server GEO
exit
profile nf-pair nf-type PCF
nrf-discovery-group udmdiscovery
locality client LOC1
locality preferred-server LOC1
locality geo-server GEO
exit
profile nf-pair nf-type UPF
nrf-discovery-group udmdiscovery
```

```

locality client LOC1
locality preferred-server LOC1
locality geo-server GEO
exit
profile nf-pair nf-type CHF
nrf-discovery-group udmdiscovery
locality client LOC1
locality preferred-server LOC1
locality geo-server GEO
exit
profile nf-client-failure nf-type udm
profile failure-handling FH4
service name type nudm-sdm
message type UdmSdmGetUESMSSubscriptionData
status-code httpv2 403
retry 3
action retry-and-ignore
exit
status-code httpv2 404
action continue
exit
status-code httpv2 413
retry 3
action retry-and-continue
exit
status-code httpv2 501
retry 3
action retry-and-terminate
exit
status-code httpv2 503
action terminate
exit
status-code httpv2 504
retry 3
action retry-and-terminate
exit
exit
message type UdmSdmSubscribeToNotification
status-code httpv2 403
retry 3
action retry-and-ignore
exit
status-code httpv2 404
action continue
exit
status-code httpv2 413
retry 3
action retry-and-continue
exit
status-code httpv2 501
retry 3
action retry-and-terminate
exit
status-code httpv2 503
action terminate
exit
status-code httpv2 504
retry 3
action retry-and-terminate
exit
exit
exit
service name type nudm-uecm
message type UdmUecmRegisterSMF

```



```
status-code httpv2 403
retry 3
action retry-and-ignore
exit
status-code httpv2 404
action continue
exit
status-code httpv2 413
retry 3
action retry-and-continue
exit
status-code httpv2 501
retry 3
action retry-and-terminate
exit
status-code httpv2 503
action terminate
exit
status-code httpv2 504
retry 3
action retry-and-terminate
exit
exit
exit
exit
exit
profile nf-client-failure nf-type pcf
profile failure-handling FH1
service name type npcfsmpolicycontrol
message type PcfSmpolicycontrolCreate
status-code httpv2 0
action retry-and-ignore
exit
status-code httpv2 400
action continue
exit
status-code httpv2 403
action retry-and-ignore
exit
status-code httpv2 404
action terminate
exit
status-code httpv2 500
retry 2
action retry-and-ignore
exit
status-code httpv2 503
retry 2
action retry-and-continue
exit
exit
message type PcfSmpolicycontrolUpdate
status-code httpv2 0
action retry-and-ignore
exit
status-code httpv2 400
action continue
exit
status-code httpv2 403
action retry-and-ignore
exit
status-code httpv2 404
action terminate
exit
```

```

status-code httpv2 500
retry 2
action retry-and-ignore
exit
status-code httpv2 503
retry 2
action retry-and-continue
exit
exit
message type PcfSmpolicycontrolDelete
status-code httpv2 0
action retry-and-ignore
exit
status-code httpv2 400
action continue
exit
status-code httpv2 403
action retry-and-ignore
exit
status-code httpv2 404
action terminate
exit
status-code httpv2 500
retry 2
action retry-and-ignore
exit
status-code httpv2 503
retry 2
action retry-and-continue
exit
exit
exit
exit
exit
profile nf-client-failure nf-type chf
profile failure-handling FH2
service name type nchf-convergedcharging
message type ChfConvergedchargingCreate
status-code httpv2 0
action continue
exit
status-code httpv2 400
retry 3
action retry-and-terminate
exit
status-code httpv2 403
retry 3
action retry-and-ignore
exit
status-code httpv2 404
retry 3
action retry-and-terminate
exit
status-code httpv2 500
action continue
exit
status-code httpv2 503
action terminate
exit
status-code httpv2 504
action continue
exit
exit
message type ChfConvergedchargingUpdate

```

```
status-code httpv2 0
action continue
exit
status-code httpv2 400
retry 3
action retry-and-terminate
exit
status-code httpv2 403
retry 3
action retry-and-ignore
exit
status-code httpv2 404
retry 3
action retry-and-terminate
exit
status-code httpv2 500
action continue
exit
status-code httpv2 503
action terminate
exit
status-code httpv2 504
action continue
exit
exit
message type ChfConvergedchargingDelete
status-code httpv2 0
action continue
exit
status-code httpv2 400
retry 3
action retry-and-terminate
exit
status-code httpv2 403
retry 3
action retry-and-ignore
exit
status-code httpv2 404
retry 3
action retry-and-terminate
exit
status-code httpv2 500
action continue
exit
status-code httpv2 503
action terminate
exit
status-code httpv2 504
action continue
exit
exit
exit
exit
exit
profile sgw sgw1
  locality          LOC2
  fqdn              cisco.com.apn.epc.mnc456.mcc123
  #subscriber-policy polSub
exit
profile smf smf1
node-id            abcdef
locality          LOC1
fqdn              cisco.com.apn.epc.mnc456.mcc123
allowed-nssai [ slice1 ]
```

```

plmn-id mcc 123
plmn-id mnc 456
service name nsmf-pdu
type pdu-session
schema http
service-id 1
version 1.Rn.0.0
http-endpoint base-url http://smf-service
icmpv6-profile icmpprf1
compliance-profile compl
access-profile access1
subscriber-policy polSub
exit
exit
profile sgw sgw1
locality LOC2
fqdn cisco.com.apn.epc.mnc456.mcc123
plmn-id mcc 123
plmn-id mnc 456
#subscriber-policy polSub
exit
profile dnn starent.com
network-element-profiles chf chf1
network-element-profiles amf amf1
network-element-profiles pcf pcf1
network-element-profiles udm udml
charging-profile chgprf1
virtual-mac b6:6d:47:47:47:47
ssc-mode 2 allowed [ 3 ]
session type IPV4 allowed [ IPV6 IPV4V6 ]
upf apn starent.com
#dcnr true
exit

profile dnn default-profile
network-element-profiles chf chf1
network-element-profiles amf amf1
network-element-profiles pcf pcf1
network-element-profiles udm udml
charging-profile chgprf1
virtual-mac b6:6d:47:47:47:47
ssc-mode 2 allowed [ 3 ]
session type IPV4 allowed [ IPV6 IPV4V6 ]
upf apn starent.com
#dcnr true
exit

profile dnn intershat
network-element-profiles chf chf1
network-element-profiles amf amf1
network-element-profiles pcf pcf1
network-element-profiles udm udml
charging-profile chgprf1
virtual-mac b6:6d:47:47:47:47
ssc-mode 2 allowed [ 3 ]
session type IPV4 allowed [ IPV6 IPV4V6 ]
upf apn intershat
dcnr true
exit
profile dnn intershat1
network-element-profiles chf chf1
network-element-profiles amf amf1
network-element-profiles pcf pcf1
network-element-profiles udm udml

```

```
charging-profile chgprf1
virtual-mac      b6:6d:47:47:48
pcscf-profile    PCSCF_Prof_2
ssc-mode 1
session type IPV4
exit
profile dnn intershat2
network-element-profiles chf chf
network-element-profiles amf amf
network-element-profiles pcf pcf
network-element-profiles udm udm
charging-profile chgprf1
virtual-mac      b6:6d:47:47:49
ssc-mode 2 allowed [ 3 ]
session type IPV4 allowed [ IPV6 IPV4V6 ]
upf apn intershat2
exit
profile qos abc
ambr ul "250 Kbps"
ambr dl "500 Kbps"
qi5      7
arp priority-level 14
arp preempt-cap NOT_PREEMPT
arp preempt-vuln PREEMPTABLE
priority 120
max data-burst 2000
exit
profile failure-handling FH1
interface pfcpc message N4SessionEstablishmentReq
cause-code pfcpc-entity-in-congestion action retry-terminate max-retry 2
cause-code system-failure action terminate
cause-code service-not-supported action terminate
cause-code no-resource-available action retry-terminate max-retry 3
cause-code no-response-received action retry-terminate max-retry 1
cause-code reject action terminate
exit
interface pfcpc message N4SessionModificationReq
cause-code mandatory-ie-incorrect action terminate
cause-code session-ctx-not-found action terminate
cause-code reject action terminate
exit
exit
profile failure-handling gtp1
interface gtpc message S5S8CreateBearerReq
cause-code temp-fail
action retry timeout 1000 max-retry 2
exit
exit
interface gtpc message S5S8UpdateBearerReq
cause-code temp-fail
action retry timeout 1000 max-retry 2
exit
exit
interface gtpc message S5S8DeleteBearerReq
cause-code temp-fail
action retry timeout 1000 max-retry 2
exit
exit
exit
profile network-element amf amf1
nf-client-profile      AP1
failure-handling-profile FH3
query-params [ dnn ]
exit
```

```

profile network-element pcf pcf1
nf-client-profile      PP1
failure-handling-profile FH1
query-params [ dnn ]
rulebase-prefix       cbn#
predefined-rule-prefix crn#
exit
profile network-element udm udm1
nf-client-profile      UP1
failure-handling-profile FH4
query-params [ dnn ]
exit
profile network-element upf upf226
node-id upf226@sgw.com
n4-peer-address ipv4 209.165.201.4
n4-peer-port 8805
dnn-list [ intershat intershat1 intershat2 cisco.com starent.com ]
capacity 2000
priority 10
exit
profile network-element upf upf1
node-id upf1@sgw.com
n4-peer-address ipv4 209.165.201.5
n4-peer-port 8805
dnn-list [ intershat intershat1 intershat2 cisco.com starent.com ]
capacity 2000
priority 10
exit
profile network-element upf upf2
node-id upf2@sgw.com
n4-peer-address ipv4 209.165.201.6
n4-peer-port 8805
dnn-list [ intershat1 intershat2 cisco.com starent.com ]
capacity 2000
priority 1
exit
profile network-element upf upf76
node-id upf3@sgw.com
n4-peer-address ipv4 209.165.201.7
n4-peer-port 8805
dnn-list [ intershat1 intershat2 starent.com cisco.com ]
capacity 1000
priority 10
exit
profile network-element upf upf70
node-id upf4@sgw.com
n4-peer-address ipv4 209.165.201.8
n4-peer-port 8805
dnn-list [ intershat1 intershat2 starent.com cisco.com ]
capacity 1000
priority 10
exit
profile network-element upf upf71
node-id upf5@sgw.com
n4-peer-address ipv4 209.165.201.9
n4-peer-port 8805
dnn-list [ intershat1 intershat2 starent.com cisco.com ]
capacity 1000
priority 10
exit
profile network-element upf upf72
n4-peer-address ipv4 209.165.201.10
n4-peer-port 8805
dnn-list [ intershat1 intershat2 starent.com cisco.com ]

```

```
capacity      2000
priority      10
exit
profile network-element upf upf79
n4-peer-address ipv4 209.165.201.11
n4-peer-port 8805
dnn-list      [ intershat1 intershat2 starent.com cisco.com ]
capacity      2000
priority      10
exit
profile network-element upf upf131
n4-peer-address ipv4 209.165.201.12
n4-peer-port 8805
dnn-list      [ intershat1 intershat2 starent.com cisco.com ]
capacity      2000
priority      10
exit
profile network-element upf upf132
n4-peer-address ipv4 209.165.201.13
n4-peer-port 8805
dnn-list      [ intershat1 intershat2 starent.com cisco.com ]
capacity      2000
priority      10
exit
profile network-element upf upf133
n4-peer-address ipv4 209.165.201.14
n4-peer-port 8805
dnn-list      [ intershat1 intershat2 starent.com cisco.com ]
capacity      2000
priority      10
exit
profile network-element upf upf134
n4-peer-address ipv4 209.165.201.15
n4-peer-port 8805
dnn-list      [ intershat1 intershat2 starent.com cisco.com ]
capacity      2000
priority      10
exit
profile network-element upf upf135
n4-peer-address ipv4 209.165.201.16
n4-peer-port 8805
dnn-list      [ intershat1 intershat2 starent.com cisco.com ]
capacity      2000
priority      10
exit
profile network-element upf upf136
n4-peer-address ipv4 209.165.201.17
n4-peer-port 8805
dnn-list      [ intershat1 intershat2 starent.com cisco.com ]
capacity      2000
priority      10
exit
profile network-element chf chf1
nf-client-profile      CP1
failure-handling-profile FH2
query-params [ dnn ]
nf-client-profile-offline CP2
exit
profile network-element chf chgser1
exit
profile compliance compl
service nsmf-pdusession
version uri v1
version full 1.0.0
```

```
version spec 15.4.0
exit
service namf-comm
version uri v1
version full 1.0.0
version spec 15.4.0
exit
service n1
version uri v1
version full 1.0.0
version spec 15.4.0
exit
service n2
version uri v1
version full 1.0.0
version spec 15.4.0
exit
service nudm-sdm
version uri v1
version full 1.0.0
version spec 15.4.0
exit
service nudm-uecm
version uri v1
version full 1.0.0
version spec 15.4.0
exit
service nnrf-disc
version uri v1
version full 1.0.0
version spec 15.4.0
exit
service nnrf-nfm
version uri v1
version full 1.0.0
version spec 15.4.0
exit
service npcfsmpolicycontrol
version uri v1
version full 1.0.0
version spec 15.4.0
exit
service nchf-convergedcharging
version uri v1
version full 1.0.0
version spec 15.3.0
exit
exit
profile upf-group group1
failure-profile FH1
exit
profile access access1
n26 idft enable timeout 15
n2 idft enable timeout 15
gtpc gtpc-failure-profile gtp1
exit
profile icmpv6 icmpprf1
options virtual-mac b6:6d:57:45:45:45
exit
profile charging chgprf1
method [ offline ]
exit
profile charging-characteristics 1
charging-profile chgprf1
```



```
exit
nssai name slicel
sst 2
sdt Abf123
dnn [ dnn1 intershat intershat1 intershat2 ]
exit
policy subscriber polSub
precedence 1
sst          02
sdt          Abf123
serving-plmn mcc 123
serving-plmn mnc 456
supi-start-range 100000000000001
supi-stop-range 999999999999999
gpsi-start-range 1000000000
gpsi-stop-range 9999999999
operator-policy opPol1
exit
precedence 511
operator-policy defOprPol1
exit
exit
policy operator defOprPol1
policy dnn          defPolDnn
policy network-capability ncl
exit
policy operator opPol1
policy dnn          polDnn
policy network-capability ncl
exit
policy dnn defPolDnn
profile default-profile
dnn dnn2 profile profile2
dnn intershat profile intershat
dnn intershat1 profile intershat1
dnn starent.com profile starent.com
exit
policy dnn polDnn
profile default-profile
dnn dnn2 profile profile2
dnn intershat profile intershat
dnn intershat1 profile intershat1
dnn intershat2 profile intershat2
dnn starent.com profile starent.com
exit
policy network-capability ncl
nw-support-local-address-tft true
exit
nacm groups group LI2
user-name [ liadmin2 ]
exit
nacm groups group LI3
user-name [ liadmin3 ]
exit
nacm groups group admin
user-name [ admin ]
exit
commit
end
```



CHAPTER 4

Smart Licensing Support

- [Feature Summary and Revision History, on page 43](#)
- [Smart Software Licensing, on page 44](#)
- [Configuring Smart Licensing, on page 49](#)
- [Viewing the Smart Licensing information, on page 57](#)

Feature Summary and Revision History

Summary Data

Table 3: Summary Data

Applicable Product(s) or Functional Area	cnSGW-C
Applicable Platform(s)	SMI
Feature Default Setting	Disabled - Configuration required
Related Documentation	Not Applicable

Revision History

Table 4: Revision History

Revision Details	Release
Enhancement introduced. Multiple Entitlement Tags - cnSGW-C supports a REST service that returns Software License entitlements information based on the installed service profile.	2021.02.0
First introduced.	2020.03.0

Smart Software Licensing

Cisco employs two types of license models - Legacy Licensing and Smart Software Licensing. Legacy Licensing consists of software activation by installing Product Activation Keys (PAK) on to the Cisco product. A Product Activation Key is a purchasable item, ordered in the same manner as other Cisco equipment and used to obtain license files for feature set on Cisco Products. This traditional licensing does not need any online communication with the Cisco licensing server.

Smart Software Licensing is a cloud-based licensing of the end-to-end platform through the use of a few tools that authorize and deliver license reporting. Smart Software Licensing functionality incorporated into the NFs complete the product registration and authorization. cnSGW-C supports the Smart Software Licensing model.

Smart Licensing simplifies the purchase, deployment, and management of Cisco software assets. Entitlements are purchased through your Cisco account through Cisco Commerce Workspace (CCW) and immediately available in your Virtual Account for usage. This approach eliminates the need to install license files on every device. Smart-enabled products communicate directly to Cisco to report consumption. A single location—Cisco Software Central—is available for customers to manage Cisco software licenses. License ownership and consumption are readily available to help make a better purchase decision that is based on consumption or business need.

For more information on Cisco Smart Licensing, see <https://www.cisco.com/c/en/us/buy/smart-accounts/software-licensing.html>.

Cisco Software Central

Cisco Software Central (CSC) enables the management of software licenses and the smart account from a single portal. The CSC interface allows you to enable your product, manage entitlements, renew, and upgrade software. You need a functioning smart account to complete the registration process.

To access Cisco Software Central, see <https://software.cisco.com>.

Smart Accounts and Virtual Accounts

A Smart Account provides a single location for all smart-enabled products and entitlements. It helps in procurement, deployment, and maintenance of Cisco Software. When creating a smart account, you must have the authority to represent the requesting organization. After submission, the request goes through approval process.

A Virtual Account exists as a sub-account within the smart account. Virtual Accounts are customer-defined based on the organizational layout, business function, geography, or any defined hierarchy. Smart account administrator creates and maintains the virtual accounts.

For information on setting up or managing the Smart Accounts, see <https://software.cisco.com>.

Requesting a Cisco Smart Account

A Cisco Smart Account is an account where smart licensing-enabled products are available. A Cisco smart account allows you to manage and activate your licenses to devices, monitor license use, and track Cisco license purchases. Through transparent access, you have a real-time view into your smart licensing products. IT administrators can manage licenses and account users within the organization's smart account through Cisco Software Central. To create a Cisco Smart Account, perform the following steps:

-
- Step 1** Visit the following URL:
- `https://software.cisco.com`
- Step 2** Log in using your credentials, and click **Request a Smart Account** in the **Administration** area. The **Smart Account Request** window appears.
- Step 3** Under **Create Account**, select one of the following options:
- **Yes, I have authority to represent my company and want to create the Smart Account.** If you select this option, you agree to authorize to create and manage product and service entitlements, users, and roles, on behalf of the organization.
 - **No, the person specified below will create the account.** If you select this option, you must enter the email address of the person who creates the smart account.
- Step 4** Under **Account Information**,
- a) Click **Edit** beside **Account Domain Identifier**.
 - b) In the **Edit Account Identifier** dialog box, enter the domain, and click **OK**. By default, the domain is based on the email address of the person creating the account, and must belong to the company that will own this account.
 - c) Enter the **Account Name** (typically, the company name).
- Step 5** Click **Continue**.
The Smart Account request will be in pending status until it is approved by the Account Domain Identifier. After the approval, you will receive an email confirmation with instructions for completing the setup process.
-

cnSGW-C Smart Licensing

The Smart Licensing feature supports application entitlement for online and offline licensing for all 5G applications. The application usage is unrestricted during all stages of licensing, including Out of Compliance (OOC) and expired stages.



Note A 90 day evaluation period is granted for all licenses in use. Currently, the functionality and operation of the 5G applications is unrestricted even after the end of the evaluation period.

Software Tags and Entitlement Tags

The following sections provide information on software and entitlement tags that are created to identify, report, and enforce licenses.

Software Tags

A Software tag or a Product tag is a unique identifier that helps Smart Licensing system identify the software product family. During the addition of Smart product instance in Cisco Smart Software Manager, the Smart client uses the software/product tag for identification.

The following software tags exist for the cnSGW-C.

Product Type / Description	Software Tag
Ultra Cloud Core - Serving Gateway Function (cnSGWc), Base Minimum	regid.2020-07.com.cisco.cnSGWc,1.0_ff0b64f1-f54d-46d3-afc7-052d41870b59

Entitlement Tags

An Entitlement tag is a part of the software that identifies the features that are being used in a software image. These tags underlay the communication on usage and entitlements of the software products that are installed on the devices. The entitlement tags map to both the PID license and the Software image. Every Smart-enabled PID may contain one or more entitlement tags.

The following entitlement tags identify licenses in use:

Product Type / Description	Entitlement Tag
Ultra Cloud Core - Serving Gateway Function (cnSGWc), 1K Sessions	regid.2020-07.com.cisco.cnSGWc_1K,1.0_6ce36c73-26dd-4607-ab9b-077fbb2e0f54



Note The license information is retained during software upgrades and rollback.

Multiple Entitlement Tags

Feature Description

cnSGW-C supports configuring REST endpoint. This REST endpoint supports a REST service that returns Software License entitlements information based on the installed service profile. For example:

- Standalone SMF
- Standalone cnSGW-C
- A combination of SMF and cnSGW-C



Note This feature is applicable only for Converged Core products.

How it Works

This section describes how this feature works.

To configure multiple entitlement tags, use the GET service added in NF's (cnSGW-C/SMF) rest-ep pod on the internal port 8000. The REST service name is 'entitlements'.



Note As `localhost:8000` is already occupied by entitlements service, it's recommended not to create a new service on port 8000 and localhost inside REST-EP.

Ops Center's `values.yaml` registers this service as a part of product configuration.

The following is a sample configuration:

```
ops-center:
  product:
    id: <product_id>, e.g. SMF
    softwareID: <s/w id>, e.g.
    regid.2020-04.com.cisco.SMF,1.0_37ffdc21-3e95-4192-bcda-d3225b6590ce
    entitlementsURL: http://entitlements:8000/entitlements.json
```

After `values.yaml` is populated with `entitlementsURL`, Ops Center installs all the available licenses received from entitlements service.

The entitlements service looks up for entitlements in `rest-ep-entitlements-cm` configmap and returns all the available entitlements back as a JSON response.

Entitlements in `rest-ep-entitlements-cm` are registered based on the following flags:

- `restep.smfProfile`
- `restep.sgwProfile`



Note The flags are configured in `cn-ops-center > confd_init > render > rest-ep > pod.yaml`.

If entitlements service has no entitlement information, Ops Center doesn't send any request to the smart license server or doesn't install any license.

SNMP Traps

If the product is not in compliance with the contract (the product has used too many licenses/entitlements or not authorized to use a particular entitlement tag), a notification is sent to all the applications using the entitlement tag. An SNMP trap is sent indicating the entitlements that are not in compliance. This SNMP trap is seen in smart agent syslogs, with the trap name as `SMART_LIC-3-OUT_OF_COMPLIANCE`.

Limitations

Converged Core has two service profiles—SMF and `cnSGW-C`, with each service having a specific product ID. When registering with Software License server, the SMF and the `cnSGW-C` send respective product ID with their entitlements.

Smart agent doesn't support processing multiple product IDs. It is recommended to use SMF product ID for processing by the smart agent.

Sample Configuration

The following is an example configuration of `rest-ep-entitlements-cm` configmap.

```
Name:          rest-ep-entitlements-cm
Namespace:    smf
Labels:       app=rest-ep
```

```

    app.kubernetes.io/managed-by=Helm
    chart=rest-ep-0.5.2-dev-multi-entitlement-7600-210225084534-a5b5b67
    component=rest-ep
    heritage=Helm
    release=smf-rest-ep
Annotations:  meta.helm.sh/release-name: smf-rest-ep
              meta.helm.sh/release-namespace: smf

Data
====
nf-profiles:
----
configuredProfiles:
- name: "smf"
  entitlement:
    displayName: "UCC 5G SMF BASE"
    entitlementTag: regid.2020-04.com.cisco.SMF_BASE,1.0_b49f5997-21aa-4d15-9606-0cff88729f69

    entitlementVersion: "1.0"
- name: "sgw"
  entitlement:
    displayName: "UCC cnSGWc 1K"
    entitlementTag: regid.2020-07.com.cisco.cnSGWc_1K,1.0_6ce36c73-26dd-4607-ab9b-077fbb2e0f54

    entitlementVersion: "1.0"
Events:  <none>

JSON response format from REST API http://entitlements:8000/entitlementens.json

[
{
  "displayName" : "SMF_BASE",
  "entitlementTag" : "
regid.2020-04.com.cisco.SMF_BASE,1.0_b49f5997-21aa-4d15-9606-0cff88729f69",
  "entitlementVersion" : "1.0"
},
{
  "displayName" : "cnSGW_BASE",
  "entitlementTag" :
"regid.2020-02.com.cisco.cnSGW_BASE,1.0_a61f0740-ef15-4ac2-916f-77257902b22",
  "entitlementVersion" : "1.0"
}
]

```

Configuration Checks

This section describes the configuration checks.

- The following checks must be done after you configure multiple entitlement tags:
 - Make sure that NF's Ops Center is deployed successfully.
 - Post new deployment and configuration, make sure that all pods are up and in ready state (primarily, the service, nodemgr, cachepod, udp-proxy, rest-ep, and protocol pods).
 - If SMF service is configured with profile, then `rest-ep-entitlements-cm` must be populated with SMF entitlement.
 - If the cnSGW-C service is configured with profile, then `rest-ep-entitlements-cm` must be populated with cnSGW-C entitlement.

- If both—the SMF and the cnSGW-C services—are configured with the profile, then `rest-ep-entitlements-cm` must be populated with SMF and cnSGW-C entitlements.
- The following checks must be done after you remove multiple entitlement tag configurations:
 - Make sure all pods are terminated and removed (and SMF deregisters with NRF).
 - Make sure all security-related items (except for security items used by Ops Center) are removed.

Troubleshooting

This section describes troubleshooting information.

- To troubleshoot entitlements service, check rest-ep pod logs.

```
kubectl logs rest-ep-n0-0 -n <namespace> -f
```
- To debug the issue with the entitlement service, you can also check the output data from the following commands.
 - `show license tech-support`
 - `show license status`
 - `show license summary`
- To troubleshoot smart-agent and Ops Center pods, you can use the following commands.
 - `kubectl logs <smart_agent_pod> -n namespace`
 - `kubectl logs <ops_center_pod> -n namespace`

Configuring Smart Licensing

You can configure Smart Licensing after a new cnSGW-C deployment.

Users with Access to Cisco Software Central

This section describes how to configure Smart Licensing if you have access to Cisco Software Central (CSC) portal from your environment.

Setting Up the Product and Entitlement in CSC

To set up your product and entitlement in CSC:

1. Log in to your CSC account.
2. Click **Add Product** and enter the following details.
 - **Product name**—Specify the name of the deployed product. Example: SGW.
 - **Primary PM CEC ID**—Specify the primary Project Manager's CEC ID for the deployed product.
 - **Dev Manager CEC ID**—Specify the Development Manager's CEC ID for the deployed product.

- **Description**—(Optional) Specify a brief description of the deployed product.
 - **Product Type**—Specify the product type.
 - **Software ID Tag**—Specify the software ID Tag provided by the Cisco Accounts team.
3. Click **Create**.
 4. Select your product from the **Product/Entitlement Setup** grid.
 5. Click **Entitlement** drop-down and select **Create New Entitlement**.
 6. Select **New Entitlement** in **Add Entitlement** and enter the following details:
 - **Entitlement Name**—Specify the license entitlement name. Example: SGW_BASE.
 - **Description**—(Optional) Specify a brief description about the license entitlement.
 - **Entitlement Tag**—Specify the entitlement tag provided by the Cisco Accounts team.
 - **Entitlement Type**—Specify the type of license entitlement.
 - **Vendor String**—Specify the vendor name.
 7. Click **Entitlement Allocation**.
 8. Click **Add Entitlement Allocation**.
 9. In **New License Allocation**, provide the following details:
 - **Product**—Select your product from the drop-down list.
 - **Entitlement**—Select your entitlement from the drop-down list.
 10. Click **Continue**.
 11. In **New License Allocation**, enter the following details:
 - **Quantity**—Specify the number of licenses.
 - **License Type**—Specify the type of license.
 - **Expiring Date**—Specify the date of expiry for the license purchased.
 12. Click **Create**.

Registering Smart Licensing

You must register the product entitled to the license with the CSC. To register the product, you must generate an ID token from the CSC.

1. Log in to your CSC account.
2. Click **General > New Token** and enter the following details:
 - **Description**—Specify a brief description for the ID token.
 - **Expires After**—Specify the number of days for the token to expire.
 - **Max. Number Users**—Specify the maximum number of users.

3. Click **Create Token**.
4. Select **new ID token** in **Product Instance Registration Token**.
5. Click **Actions > Copy**.
6. Log in to cnSGW-C Ops Center CLI and paste the **ID token** using the following command:

```
license smart register idtoken
```

NOTES:

- **license smart register** —Registers Smart Licensing with the CSC.
- *idtoken* —Specify the ID token generated from CSC.

Example:

```
license smart register
Value for 'idtoken' (<string>): MTI2Y2FlNTAtOThkMi00YTaxLWE4M2QtOTNhNzNjNjY4ZmFiLTE2MTc4N
Tky%0AMTA5MDh8ck1jUHNwc3k1ZC9nWFFCSnVEcUp4QU1jTFoxOGxDTU5kQ3lpa25E%0Ab04wST0%3D%0A
```

7. Verify the Smart Licensing status using the following command:

```
show license all
```

Example:

```
show license all

Smart Licensing Status
=====
Smart Licensing is ENABLED

Registration:
  Status: REGISTERED
  Smart Account: CN-5G-NF
  Virtual Account: Default
  Export-Controlled Functionality: Allowed
  Initial Registration: SUCCEEDED on Jul 12 19:46:04 2020 GMT
  Last Renewal Attempt: SUCCEEDED on Jul 12 19:46:04 2020 GMT
  Next Renewal Attempt: Jan 8 19:46:04 2021 GMT
  Registration Expires: Jul 12 19:39:10 2021 GMT

License Authorization:
  Status: AUTHORIZED on Jul 12 19:46:06 2020 GMT
  Last Communication Attempt: SUCCEEDED on Jul 12 19:46:06 2020 GMT
  Next Communication Attempt: Aug 11 19:46:06 2020 GMT
  Communication Deadline: Oct 10 19:43:32 2020 GMT

License Conversion:
  Automatic Conversion Enabled: true
  Status: NOT STARTED

Utility:
  Status: DISABLED

Transport:
  Type: CALLHOME

Evaluation Period:
  Evaluation Mode: Not In Use
  Evaluation Period Remaining: 89 days, 1 hr, 20 min, 55 sec

License Usage
```

```

=====
License Authorization Status: AUTHORIZED as of Jul 12 19:46:06 2020 GMT

cnSGWc_1K (cnSGWc_1K)
  Description: Ultra Cloud Core - Serving Gateway Function (cnSGWc), 1K Sessions
  Count: 1
  Version: 1.0
  Status: AUTHORIZED
  Export status: NOT RESTRICTED
  Feature Name: <empty>
  Feature Description: <empty>

Product Information
=====
UDI: PID:cnSGWc,SN:JC5LXHI-2KVPPIQ

Agent Version
=====
Smart Agent for Licensing: 3.0.13

```

Deregistering Smart Licensing

To deregister Smart Licensing:

1. Log in to cnSGW-C Ops Center CLI and use the following command:

```
license smart deregister
```

NOTES:

- **license smart deregister** —Deregisters Smart Licensing from CSC.
2. Verify the Smart Licensing status using the following command:

```
show license all
```

Example:

```

show license all

Smart Licensing Status
=====
Smart Licensing is ENABLED

Registration:
  Status: UNREGISTERED
  Export-Controlled Functionality: Not Allowed

License Authorization:
  Status: EVAL MODE
  Evaluation Period Remaining: 89 days, 1 hr, 18 min, 55 sec
  Last Communication Attempt: NONE

License Conversion:
  Automatic Conversion Enabled: true
  Status: NOT STARTED

Utility:
  Status: DISABLED

Transport:
  Type: CALLHOME

```

```

Evaluation Period:
  Evaluation Mode: In Use
  Evaluation Period Remaining: 89 days, 1 hr, 18 min, 55 sec

License Usage
=====
License Authorization Status: EVALUATION MODE
  Evaluation Period Remaining: 89 days, 1 hr, 18 min, 55 sec

cnSGWc_1K (cnSGWc_1K)
  Description: Ultra Cloud Core - Serving Gateway Function (cnSGWc), 1K Sessions
  Count: 1
  Version: 1.0
  Status: EVAL MODE
  Export status: NOT RESTRICTED
  Feature Name: <empty>
  Feature Description: <empty>

Product Information
=====
UDI: PID:cnSGWc,SN:JC5LXHI-2KVPPIQ

Agent Version
=====
Smart Agent for Licensing: 3.0.13

```

Users without Access to Cisco Software Central

The Smart License Reservation feature—Perpetual Reservation—is reserved for customers without access to CSC from their internal environments. Cisco allows customers to reserve licenses from their virtual account and tie them to their devices' Unique Device Identifier (UDI). This enables customers to use their devices with reserved licenses in a disconnected mode.

The subsequent section describes the procedure involved in reserving Smart License for users without access to CSC from their internal environment.

Enabling and Generating Smart License Reservation Request Code

To enable and generate the Smart License reservation request code:

1. Log in to cnSGW-C Ops Center CLI.
2. To enable reservation, use the following configuration:

```

config terminal
license smart reservation
end

```

NOTES:

- **license smart reservation** —Enables license reservation.

3. To request for a reservation code, use the following command:

```

license smart reservation request

```

NOTES:

- **license smart reservation request** —Generates the license reservation request code.



Important Copy the generated license request code from the SGW Ops Center CLI to your local machine for further use.

Example:

```
license smart reservation request
reservation-request-code CE-ZcnSGWc:JC5LXHI-2KVPPIQ-AwjEHYoEo-F8
Message from confd-api-manager at 2020-07-13 08:27:27...
Global license change NotifyReservationInProgress reason code Success - Successful.
```

Generating an Authorization Code from CSC

To generate an authorization code from CSC using the license reservation request code:

1. Log in to your CSC account.
2. Click **License Reservation**.
3. Enter the Request Code: Paste the license reservation request code copied from the SGW Ops Center CLI in the **Reservation Request Code** text-box.
4. Select the Licenses: Click **Reserve a Specific License** radio button and select *UCC 5G SGW BASE*.



Note In the **Reserve** text box, enter the value *l*.

5. Review your selection.
6. Click **Generate Authorization Code**.
7. Download the response file: The authorization code is generated and displayed on-screen. Click **Download as File** to download the authorization code.
8. Click **Close**.

Reserving Smart Licensing

To reserve Smart License for the deployed product using the authorization code generated in CSC:

1. Log in to cnSGW-C Ops Center CLI and use the following command:

```
license smart reservation install authorization_code
```

NOTES:

- **license smart reservation install *authorization_code*** —Installs a Smart License Authorization code.

Example:

```
license smart reservation install
Value for 'key' (<string>): CAAAsJ-iwTYvW-puASse-nLGbcj-NJwnCo-EpxZ
Message from confd-api-manager at 2020-07-13 08:30:00...
Global license change NotifyReservationInstalled reason code Success - Successful.
Message from confd-api-manager at 2020-07-13 08:30:01...
Global license change NotifyRegisterSuccess reason code Success - Successful
```

2. Verify the smart licensing status using the following command:

```
show license all
```

Example:

```
show license all

Smart Licensing Status
=====
Smart Licensing is ENABLED
License Reservation is ENABLED

Registration:
  Status: REGISTERED - UNIVERSAL LICENSE RESERVATION
  Export-Controlled Functionality: Allowed
  Initial Registration: SUCCEEDED on Mon Jul 13 08:29:59 GMT 2020
  Last Renewal Attempt: None

License Authorization:
  Status: AUTHORIZED - RESERVED on Mon Jul 13 08:29:59 GMT 2020

Utility:
  Status: DISABLED

Transport:
  Type: CALLHOME

Evaluation Period:
  Evaluation Mode: Not In Use
  Evaluation Period Remaining: 88 days, 23 hr, 28 min, 54 sec

License Usage
=====
License Authorization Status:
  Status: AUTHORIZED - RESERVED on Mon Jul 13 08:29:59 GMT 2020
  Last Communication Attempt: SUCCEEDED on Jul 13 08:29:59 2020 GMT
  Next Communication Attempt: NONE
  Communication Deadline: NONE

cnSGWc_1K (cnSGWc_1K)
  Description: Ultra Cloud Core - Serving Gateway Function (cnSGWc), 1K Sessions
  Count: 1
  Version: 1.0
  Status: AUTHORIZED
  Export status: RESTRICTED_ALLOWED
  Feature Name: <empty>
  Feature Description: <empty>

Product Information
=====
UDI: PID:cnSGWc,SN:JC5LXHI-2KVPPIQ

Agent Version
=====
Smart Agent for Licensing: 3.0.13
```

Returning the Reserved License

To return the reserved license, use the following procedure:

1. When the license reservation authorization code is installed in the SGW Ops Center:
 - a. Log in to the cnSGW-C Ops Center CLI and use the following command:

license smart reservation return**NOTES:**

- **license smart reservation return**—Returns a reserved Smart License.

Example:

```
license smart reservation return
reservation-return-code CAAsJA-vNGQbQ-YmwMTz-ZnN4Kb-eekEy7-jeo
Message from confd-api-manager at 2020-07-13 08:32:37...
Global license change NotifyReservationReturned reason code Success - Successful.
```

- Copy the license reservation return code generated in SGW Ops Center CLI to your local machine for further use.
 - Log in to your CSC account.
 - Select your product instance from the list.
 - Click **Actions > Remove**.
 - Paste the license reservation return code in the **Return Code** text box.
- When the license reservation authorization code is not installed in the SGW Ops Center:
 - Log in to the cnSGW-C Ops Center CLI and use the following command to generate the return code:

```
license smart reservation return
authorization_code
```



Important Paste the license reservation authorization code generated in CSC to generate the return code.

- Log in to your CSC account.
 - Select your product instance from the list.
 - Click **Actions > Remove**.
 - Paste the license reservation return code in the **Return Code** text box.
- Verify the smart licensing status using the following command:

```
show license all
```

Example:

```
show license all

Smart Licensing Status
=====
Smart Licensing is ENABLED
License Reservation is ENABLED

Registration:
  Status: UNREGISTERED
  Export-Controlled Functionality: Not Allowed

License Authorization:
  Status: EVAL MODE
```



```

Evaluation Period Remaining: 88 days, 23 hr, 23 min, 54 sec
Last Communication Attempt: SUCCEEDED on Jul 13 08:29:59 2020 GMT
Next Communication Attempt: NONE
Communication Deadline: NONE

License Conversion:
Automatic Conversion Enabled: true
Status: NOT STARTED

Utility:
Status: DISABLED

Transport:
Type: CALLHOME

Evaluation Period:
Evaluation Mode: In Use
Evaluation Period Remaining: 88 days, 23 hr, 23 min, 54 sec

License Usage
=====
License Authorization Status: EVALUATION MODE
Evaluation Period Remaining: 88 days, 23 hr, 23 min, 54 sec

cnSGWc_1K (cnSGWc_1K)
Description: Ultra Cloud Core - Serving Gateway Function (cnSGWc), 1K Sessions
Count: 1
Version: 1.0
Status: EVAL MODE
Export status: RESTRICTED_NOTALLOWED
Feature Name: <empty>
Feature Description: <empty>

Product Information
=====
UDI: PID:cnSGWc,SN:JC5LXHI-2KVPPIQ

Agent Version
=====
Smart Agent for Licensing: 3.0.13

```

Viewing the Smart Licensing information

Use the following **show license** command to view the Smart Licensing information in the cnSGW-C Ops Center:

```
show license [ all | UDI | displaylevel | reservation | smart | status |
summary | tech-support | usage ]
```

NOTES:

- **all**—Displays an overview of Smart Licensing information that includes license status, usage, product information, and Smart Agent version.
- **UDI**—Displays Unique Device Identifiers (UDI) details.
- **displaylevel**—Depth to display information.
- **reservation**—Displays Smart Licensing reservation information.

- **smart**—Displays Smart Licensing information.
- **status**—Displays the overall status of Smart Licensing.
- **summary**—Displays a summary of Smart Licensing.
- **tech-support**—Displays Smart Licensing debugging information.
- **usage**—Displays the license usage information for all the entitlements that are currently in use.



CHAPTER 5

cnSGW-C Rolling Software Update

- [Feature Summary and Revision History, on page 59](#)
- [Introduction, on page 59](#)
- [Updating cnSGW-C, on page 60](#)

Feature Summary and Revision History

Summary Data

Table 5: Summary Data

Applicable Product(s) or Functional Area	cnSGW-C
Applicable Platform(s)	SMI
Feature Default Setting	Not Applicable
Related Documentation	Not Applicable

Revision History

Table 6: Revision History

Revision Details	Release
First introduced.	2021.02.0

Introduction

The cnSGW-C has a three-tier architecture consisting of Protocol, Service, and Session. Each tier includes a set of microservices (pods) for a specific functionality. Within these tiers, there exists a Kubernetes Cluster comprising of Kubernetes (K8s) master, and worker nodes (including Operation and Management (OAM) nodes).

For high availability and fault tolerance, a minimum of two K8s worker nodes are configured for each tier. You can have multiple replicas for each worker node. Kubernetes orchestrates the pods using the StatefulSets controller. The pods require a minimum of two replicas for fault tolerance.

The following figure depicts cnSGW-C K8s cluster with 12 nodes.

- Three master nodes
- Three OAM worker nodes
- Two Protocol worker nodes
- Two Service worker nodes
- Two Session (data store) worker nodes

Figure 11: cnSGW-C Kubernetes Cluster

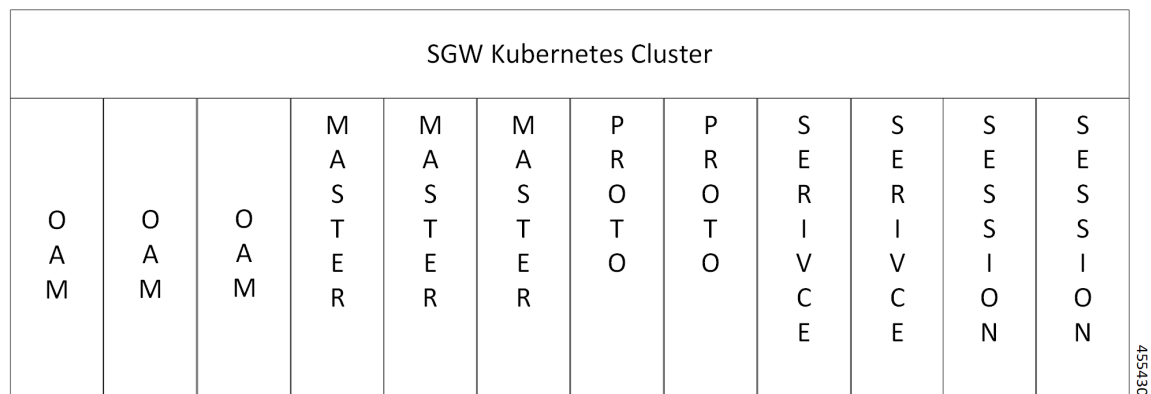

The cnSGW-C Kubernetes cluster comprises of the following nodes:

- The OAM worker nodes host the Ops Center pods for configuration management and metrics pods for statistics and Key Performance Indicators (KPIs).
- The Protocol worker nodes host the cnSGW-C protocol-related pods for service-based interfaces (N11, N7, N10, N40) and UDP-based protocol interfaces (N4, S5/S8).
- The Service worker nodes host the cnSGW-C application-related pods that perform session management processing.
- The Session worker nodes host the database-related pods that store subscriber session data.

Updating cnSGW-C

The rolling software update is a process of updating or migrating the build from an older to a newer version or updating the patch for the prescribed deployment set of application pods.

Rolling update takes place with zero downtime by incrementally updating the pod instances with the new ones.



Note The applications must be available when new versions are expected to be deployed with the new build versions or patches.

Update Scope

The rolling update feature is supported from an older to the newer versions within the same major release.

- **Assumptions:** When updating, it is assumed that the following has not been changed between the versions:
 - Features supported in the old and the new versions.
 - Configuration addition, deletion, or modification of the existing CLI behavior.
 - Interface change within the peer or across the pods.
- **Recommendations:**
 - Configuration changes are not recommended during the update process.
 - All configuration changes should be done after the update process is complete.
- **Failure Handling:** The system should be downgraded manually to an older healthy build following the downgrade process for:
 - Failure during the process such as crash, and pods deployment failures.
 - Failure after the successful update such as new events or procedures.

Rolling Software Update Using the SMI Cluster Manager

The cnSGW-C software update or in-service update procedure utilizes the K8s rolling strategy to update the pod images. In this strategy, the pods of a StatefulSet are updated sequentially to ensure that the ongoing process remains unaffected. Initially, a rolling update on a StatefulSet causes a single pod instance to terminate. A pod with an updated image replaces the terminated pod. This process continues until all the replicas of the StatefulSet are updated. The terminating pods exit gracefully after completing all the ongoing processes. Other in-service pods continue to receive and process the traffic to provide a seamless software update. You can control the software update process through the Ops Center CLI.



Note Each pod needs a minimum of two pods for high availability. In a worst-case scenario, the processing capacity of the pod may briefly reduce to 50% while the software update is in-progress.

The following figure illustrates a cnSGW-C rolling update for cnSGW-C REST endpoint pods (two replicas) on Protocol worker nodes along with cnSGW-C Service pods (three replicas) on Service worker nodes.

Figure 12: cnSGW-C Rolling Update

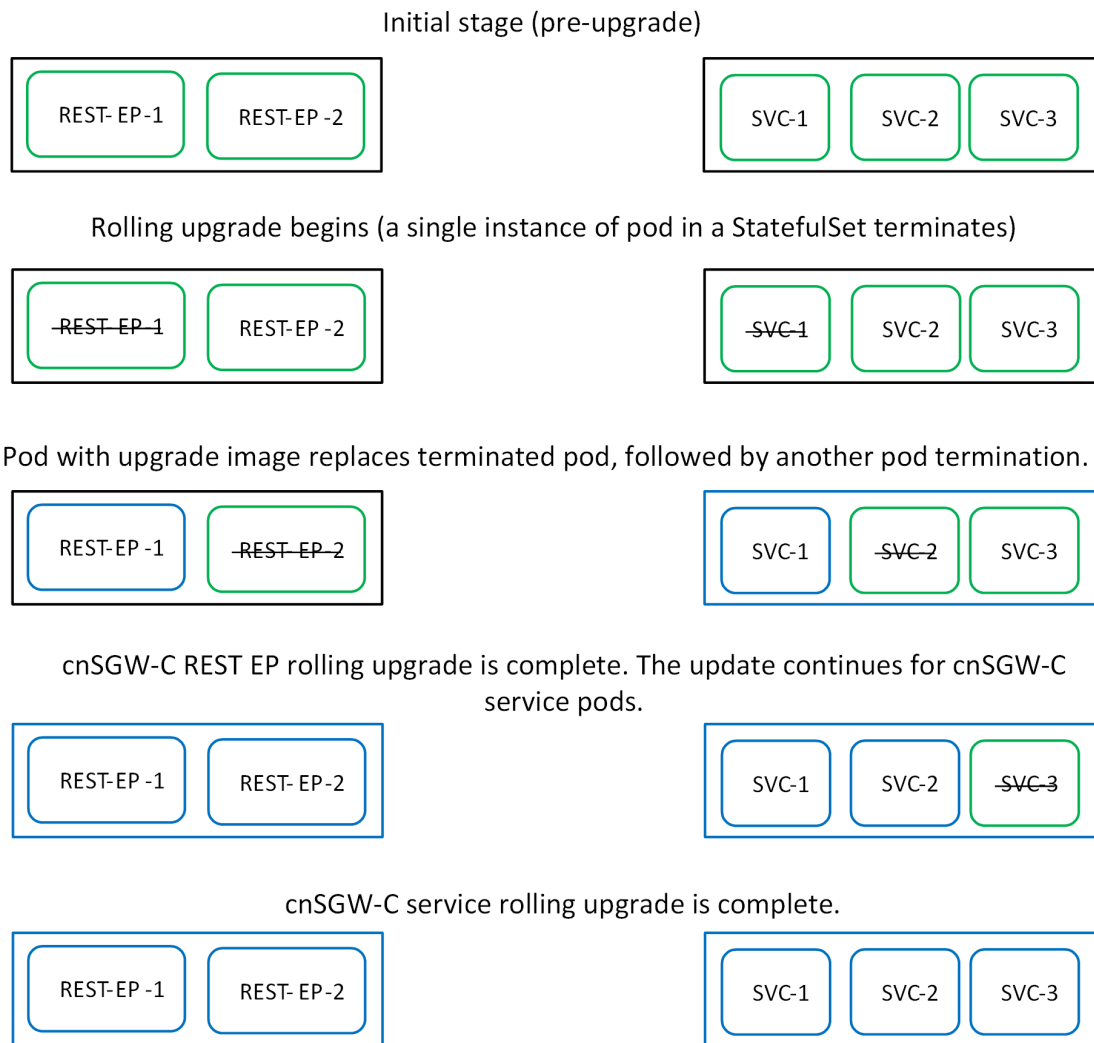

455431

Prerequisites

The prerequisites for upgrading cnSGW-C are:

- All the nodes that include all the pods in the node that are up and running.
- A patch version of the cnSGW-C software.



Note Major versions do not support rolling update.



Important Trigger rolling update only when the CPU usage of the nodes is less than 50%.

- Intra-site HA support.

cnSGW-C Health Check

Perform a health check to ensure that all the services are running and the nodes are in the ready state.

To perform health check, use the following configuration:

- Log in to the master node and use the following configuration:

```
kubectl get pods -n smi
kubectl get nodes
kubectl get pod --all-namespaces -o wide
kubectl get pods -n cnsgw-wsp -o wide
kubectl get pods -n cee-wsp -o wide
kubectl get pods -n smi-vips -o wide
helm list
kubectl get pods -A | wc -l
```



Important Make sure that all the services are running and nodes are in the ready state before you proceed.

Backing Up the Deployment File

To create a backup configuration, logs, and deployment files, use the following configuration:

1. Log in to the SMI Cluster Manager Node as an Ubuntu user.
2. Create a new directory for deployment.

Example:

```
test@smicnsgw-cm01:~$ mkdir -p "temp_$(date +%m%d%Y_T%H%M)" && cd "$_"
```

3. Back up the working files into the newly created deployment directory.
4. Untar the cnsgw deployment file.

Example:

```
test@smilcnsgw01-cm01:~/temp_08072019_T1651$ tar -xzvf cnsgw.2020.01.0-1.SPA.tgz
./
./cnsgw_REL_KEY-CCO_RELEASE.cer
./cisco_x509_verify_release.py
./cnsgw.2020.01.0-1.tar
./cnsgw.2020.01.0-1.tar.signature.SPA
./cnsgw.2020.01.0-1.tar.SPA.README
```

5. Verify the downloaded image.

Example:

```
test@smilcnsgw01-cm01:~/temp_08072019_T1651$ cat cnsgw.2020.01.0-1.tar.SPA.README
```



Important Follow the procedure mentioned in the *SPA.README* file to verify the build before proceeding to the next step.

Backing Up the Ops Center Configuration

To back up the Ops Center configurations, use the following configuration:

1. Log in to the SMI Cluster Manager node as an Ubuntu user.
2. Back up the SMI Ops Center configuration to the `/home/ubuntu/smiops.backup` file, using the following configuration:

```
ssh -p <port_number> admin@$(kubectl get svc -n smi | grep
'.*netconf.*<port_number>' | awk '{ print $4 }') "show run | nomore"
> smiops.backup_$(date +%m%d%Y_T%H%M')
```

3. Back up the CEE Ops Center configuration to the `/home/ubuntu/ceeops.backup` file, using the following configuration:

```
ssh admin@<cee-vip> "show run | nomore" > ceeops.backup_$(date
+%m%d%Y_T%H%M')
```

4. Back up the cnSGW-C Ops Center configuration to the `/home/ubuntu/cnSGWops.backup` file, using the following configuration:

```
ssh admin@<cnSGW-vip> "show run | nomore" > cnSGWops.backup_$(date
+%m%d%Y_T%H%M')
```

Back Up CEE and cnSGW-C Ops Center Configuration

To back up the CEE and Ops Center configuration from the master node, use the following configuration:

1. Log in to the master node as an Ubuntu user.
2. Create a directory to backup the configuration files, using the following configuration:

```
mkdir backups_$(date +%m%d%Y_T%H%M') && cd "$_"
```

3. Back up the cnSGW-C Ops Center configuration and verify the line count of the backup files, using the following configuration:

```
ssh -p <port_number> admin@$(kubectl get svc -n $(kubectl get namespaces
| grep -oP 'cnSGW-(\d+|\w+)') | grep <port_number> | awk '{ print $3
}') "show run | nomore" > cnSGWops.backup_$(date +%m%d%Y_T%H%M') &&
wc -l cnSGWops.backup_$(date +%m%d%Y_T%H%M')
```

Example:

```
ubuntu@pocnsgw-mas01:~/backups_09182019_T2141$ ssh -p 2024 admin@$(kubectl get svc -n
$(kubectl get namespaces | grep -oP 'cnSGW-(\d+|\w+)') | grep <port_number> | awk '{
print $3 }') "show run | nomore" > cnSGWops.backup_$(date +%m%d%Y_T%H%M') && wc -l
cnSGWops.backup_$(date +%m%d%Y_T%H%M')
admin@<ipv4address>'s password: cnSGW-OPS-PASSWORD
334 cnSGWops.backup
```

4. Back up the CEE Ops Center configuration and verify the line count of the backup files, using the following configuration:

```
ssh -p <port_number> admin@$(kubectl get svc -n $(kubectl get namespaces
| grep -oP 'cee-(\d+|\w+)') | grep <port_number> | awk '{ print $3
}') "show run | nomore" > ceeops.backup_$(date +%m%d%Y_T%H%M') && wc
-l ceeops.backup_$(date +%m%d%Y_T%H%M')
```

Example:

```
ubuntu@pocnSGW-mas01:~/backups_09182019_T2141$ ssh -p <port_number> admin@$(kubectl get
svc -n $(kubectl get namespaces | grep -oP 'cee-(\d+|\w+)') | grep <port_number> | awk
'{ print $3 }') "show run | nomore" > ceeops.backup_$(date +%m%d%Y_T%H%M') && wc -l
ceeops.backup_$(date +%m%d%Y_T%H%M')
admin@<ipv4address>'s password: CEE-OPS-PASSWORD
233 ceeops.backup
```

5. Move the SMI Ops Center backup file (from the SMI Cluster Manager) to the backup directory, using the following configuration:

```
scp $(grep cm01 /etc/hosts | awk '{ print $1
}') :/home/ubuntu/smiops.backup_$(date +%m%d%Y_T%H%M') .
```

Example:

```
ubuntu@pocnSGW-mas01:~/backups_09182019_T2141$ scp $(grep cm01 /etc/hosts | awk '{ print
$1 }') :/home/ubuntu/smiops.backup_$(date +%m%d%Y_T%H%M') .
ubuntu@<ipv4address>'s password: SMI-CM-PASSWORD
smiops.backup                                100% 9346      22.3MB/s
00:00
```

6. Verify the line count of the backup files.

Example:

```
ubuntu@pocnSGW-mas01:~/backups_09182019_T2141$ wc -l *
233 ceeops.backup
334 cnSGWops.backup
361 smiops.backup
928 total
```

Staging a New cnSGW-C Image

To stage a new cnSGW-C image before initiating the update, use the following configuration:

1. Download and verify the new cnSGW-C image.
2. Log in to the SMI Cluster Manager node as an Ubuntu user.
3. Copy the image to the **uploads** directory.

```
sudo mv <cnSGW_new_image.tar> /data/software/uploads
```



Note The SMI uses the new image present in the **uploads** directory to update.

4. Verify whether the image is picked up by the SMI for processing from the **uploads** directory.

```
sleep 30; ls /data/software/uploads
```

Example:

```
ubuntu@pocnSGW-cm01:~/temp_08072019_T1651$ sleep 30; ls /data/software/uploads
ubuntu@pocnSGW-cm01:~/temp_08072019_T1651$
```

5. Verify whether the images were successfully picked up and processed.

Example:

```
auser@unknown:$ sudo du -sh /data/software/packages/*
1.6G /data/software/packages/cee.2019.07
5.3G /data/software/packages/cnSGW.2019.08-04
16K /data/software/packages/sample
```



Note The SMI must unpack the images into the **packages** directory successfully to complete the staging.

Triggering the Rolling Software Upgrade

cnSGW-C utilizes the SMI Cluster Manager to perform a rolling software update.

To update cnSGW-C using SMI Cluster Manager, use the following configurations:



Important Before you begin, ensure that cnSGW-C is up and running with the current version of the software.

1. Log in to the SMI Cluster Manager Ops Center.
2. Download the latest tarall from the URL.

```
software-packages download url
```

NOTES:

- **software-packages download url**—Specifies the software packages to be downloaded through HTTP/HTTPS.

Example:

```
SMI Cluster Manager# software-packages download <url>
```

3. Verify whether the tarall is loaded.

```
software-packages list
```

NOTES:

- **software-packages list** —Specifies the list of available software packages.

Example:

```
SMI Cluster Manager# software-packages list
[ cnSGW-2019-08-21 ]
[ sample ]
```

4. Update the product repository URL with the latest version of the product chart.



Note If the repository URL contains multiple versions, the Ops Center automatically selects the latest version.

```
configure
cluster cluster_name
ops-centers app_name cnSGW_instance_name
repository url
exit
exit
```

Example:

```

SMI Cluster Manager# config
SMI Cluster Manager(config)# clusters test2
SMI Cluster Manager(config-clusters-test2)# ops-centers cnSGW data
SMI Cluster Manager(config-ops-centers-cnSGW/data)# repository <url>
SMI Cluster Manager(config-ops-centers-cnSGW/data)# exit
SMI Cluster Manager(config-clusters-test2)# exit

```

5. To update to the latest version of the product chart, run the **cluster sync** command using the following command:

```
clusters cluster_name actions sync run
```

Example:

```
SMI Cluster Manager# clusters test2 actions sync run
```

NOTES:

- **cluster** —Specifies the K8s cluster.
- *cluster_name* —Specifies the name of the cluster.
- **ops-centers** *app_name instance_name* —Specifies the product Ops Center and instance. *app_name* is the application name. *instance_name* is the name of the instance.
- **repository** *url*—Specifies the local registry URL for downloading the charts.
- **actions** —Specifies the actions performed on the cluster.
- **sync run** —Triggers the cluster synchronization.



Important

- The cluster synchronization updates the cnSGW-C Ops Center, which in turn updates the application pods (through **helm sync** command) one at a time automatically.
- When you trigger rolling upgrade on a specific pod, the cnSGW-C avoids routing new calls to that pod.
- The cnSGW-C honors in-progress call by waiting for 30 seconds before restarting the pod where rolling upgrade is initiated. Also, the cnSGW-C establishes all the in-progress calls completely within 30 seconds during the upgrade period (maximum call-setup time is 10 seconds).

Monitoring the Update Procedure

To monitor the status update through SMI Cluster Manager Ops Center, use the following configurations:

```

config
  clusters cluster_name actions sync run debug true
  clusters cluster_name actions sync logs
monitor sync-logs cluster_name
clusters cluster_name actions sync status
exit

```

Example:

```

SMI Cluster Manager# clusters test1 actions sync run
SMI Cluster Manager# clusters test1 actions sync run debug true
SMI Cluster Manager# clusters test1 actions sync logs

```

```
SMI Cluster Manager# monitor sync-logs test1
SMI Cluster Manager# clusters test1 actions sync status
```

NOTES:

- **clusters** *cluster_name*—Specifies the information about the nodes to be deployed. *cluster_name* is the name of the cluster.
- **actions**—Specifies the actions performed on the cluster.
- **sync run**—Triggers the cluster synchronization.
- **sync logs**—Shows the current cluster synchronization logs.
- **sync status** —Shows the current status of the cluster synchronization.
- **debug true**—Enters the debug mode.
- **monitor sync logs**—Monitors the cluster synchronization process.

**Important**

You can view the pod details after the upgrade through the CEE Ops Center. For more information on pod details, see [Viewing the Pod Details, on page 68](#) section.

Viewing the Pod Details

To view the details of the current pods through CEE Ops Center, use the following command in the CEE Ops Center CLI:

```
cluster pods instance_name pod_name detail
```

NOTES:

- **cluster pods**—Specifies the current pods in the cluster.
- *instance_name*—Specifies the name of the instance.
- *pod_name*—Specifies the name of the pod.
- **detail**—Displays the details of the specified pod.

The following example displays the details of the pod named *alertmanager-0* in the *cnSGW-data* instance.

Example:

```
cee# cluster pods cnSGW-data alertmanager-0 detail
details apiVersion: "v1"
kind: "Pod"
metadata:
  annotations:
    alertmanager.io/scrape: "true"
    cni.projectcalico.org/podIP: "<ipv4address/subnet>"
    config-hash: "5532425ef5fd02add051cb759730047390b1bce51da862d13597dbb38dfbde86"
    creationTimestamp: "2020-02-26T06:09:13Z"
    generateName: "alertmanager-"
  labels:
    component: "alertmanager"
    controller-revision-hash: "alertmanager-67cdb95f8b"
    statefulset.kubernetes.io/pod-name: "alertmanager-0"
name: "alertmanager-0"
```

```

namespace: "cnSGW"
ownerReferences:
- apiVersion: "apps/v1"
  kind: "StatefulSet"
  blockOwnerDeletion: true
  controller: true
  name: "alertmanager"
  uid: "82a11da4-585e-11ea-bc06-0050569ca70e"
resourceVersion: "1654031"
selfLink: "/api/v1/namespaces/cnSGW/pods/alertmanager-0"
uid: "82aee5d0-585e-11ea-bc06-0050569ca70e"
spec:
  containers:
  - args:
    - "/alertmanager/alertmanager"
    - "--config.file=/etc/alertmanager/alertmanager.yml"
    - "--storage.path=/alertmanager/data"
    - "--cluster.advertise-address=$(POD_IP):6783"
    env:
    - name: "POD_IP"
      valueFrom:
        fieldRef:
          apiVersion: "v1"
          fieldPath: "status.podIP"
    image: "<path_to_docker_image>"
    imagePullPolicy: "IfNotPresent"
    name: "alertmanager"
    ports:
    - containerPort: 9093
      name: "web"
      protocol: "TCP"
    resources: {}
    terminationMessagePath: "/dev/termination-log"
    terminationMessagePolicy: "File"
    volumeMounts:
    - mountPath: "/etc/alertmanager/"
      name: "alertmanager-config"
    - mountPath: "/alertmanager/data/"
      name: "alertmanager-store"
    - mountPath: "/var/run/secrets/kubernetes.io/serviceaccount"
      name: "default-token-kbjnx"
      readOnly: true
    dnsPolicy: "ClusterFirst"
    enableServiceLinks: true
    hostname: "alertmanager-0"
    nodeName: "for-smi-cdl-1b-worker94d84de255"
    priority: 0
    restartPolicy: "Always"
    schedulerName: "default-scheduler"
    securityContext:
      fsGroup: 0
      runAsUser: 0
    serviceAccount: "default"
    serviceAccountName: "default"
    subdomain: "alertmanager-service"
    terminationGracePeriodSeconds: 30
    tolerations:
    - effect: "NoExecute"
      key: "node-role.kubernetes.io/oam"
      operator: "Equal"
      value: "true"
    - effect: "NoExecute"
      key: "node.kubernetes.io/not-ready"
      operator: "Exists"

```

```

    tolerationSeconds: 300
  - effect: "NoExecute"
    key: "node.kubernetes.io/unreachable"
    operator: "Exists"
    tolerationSeconds: 300
volumes:
- configMap:
  defaultMode: 420
  name: "alertmanager"
  name: "alertmanager-config"
- emptyDir: {}
  name: "alertmanager-store"
- name: "default-token-kbjnx"
  secret:
    defaultMode: 420
    secretName: "default-token-kbjnx"
status:
  conditions:
  - lastTransitionTime: "2020-02-26T06:09:02Z"
    status: "True"
    type: "Initialized"
  - lastTransitionTime: "2020-02-26T06:09:06Z"
    status: "True"
    type: "Ready"
  - lastTransitionTime: "2020-02-26T06:09:06Z"
    status: "True"
    type: "ContainersReady"
  - lastTransitionTime: "2020-02-26T06:09:13Z"
    status: "True"
    type: "PodScheduled"
  containerStatuses:
  - containerID: "docker://821ed1a272d37e3b4c4c9c1ec69b671a3c3fe6eb4b42108edf44709b9c698ccd"

    image: "<path_to_docker_image>"
    imageID: "docker-pullable://<path_to_docker_image>"
    lastState: {}
    name: "alertmanager"
    ready: true
    restartCount: 0
    state:
      running:
        startedAt: "2020-02-26T06:09:05Z"
    hostIP: "<host_ipv4address>"
    phase: "Running"
    podIP: "<pod_ipv4address>"
    qosClass: "BestEffort"
    startTime: "2020-02-26T06:09:02Z"
cee#

```

Rolling Software Update on Non-SMI Cluster

To configure the helm repository, use the following configuration:

- Log in to cnSGW-C Ops Center and use the following configuration:

```

config
  helm default-repository cn
  helm repository cn
  access-token
  smf-deployer.gen:AKCp5ekcX7DcBhuAmMZyfgLaHvH3E4Syr9TQDp1gjzcSjYrqsrgbXSYs5X2XYij3d9n9vFwQe

  url <old-build/new-build>
exit

```

Validating the Update

The health check, current helm charts, and subscriber/peer/session information help in understanding whether the rolling update process is successful.

To validate the update, use the following steps:

1. All pods that are deployed should be in the running state before and after an update.

```
kubectl get pods -n cn
```

2. Helm charts should reflect charts from the appropriate build.

To check the helm charts currently deployed, use the following command in the cnSGW-C Ops Center.

```
show helm charts  
show running-config helm repository
```

3. Check subscriber, session, or peer information for retention validation, using the following configuration:

```
show subscriber namespace sgw count all  
show peers all
```



CHAPTER 6

Pods and Services Reference

- [Feature Summary and Revision History, on page 73](#)
- [Feature Description, on page 73](#)
- [Associating Pods to the Nodes, on page 82](#)
- [Viewing the Pod Details and Status, on page 82](#)

Feature Summary and Revision History

Summary Data

Table 7: Summary Data

Applicable Product(s) or Functional Area	cnSGW-C
Applicable Platform(s)	SMI
Feature Default Setting	Enabled - Always-on
Related Documentation	Not Applicable

Revision History

Revision Details	Release
First introduced	2020.07

Feature Description

cnSGW-C is built on the Kubernetes cluster strategy, adopting the native concepts of containerization, high availability, scalability, modularity, and ease of deployment. cnSGW-C uses the components, such as pods and services offered by Kubernetes.

Depending on your deployment environment, the cnSGW-C deploys the pods on the configured virtual machines (VM) that you have configured. Pods operate through the services that are responsible for the intrapod communications. If the machine hosting the pods fails or experiences network disruption, the pods are terminated or deleted. However, this situation is transient and k8s creates new pods to replace the invalid pods.

The following workflow provides high-level information about:

- Host machines
- Associated pods and services
- Interaction among pods

The representation might defer based on your deployment infrastructure.

Figure 13: Communication Workflow of Pods

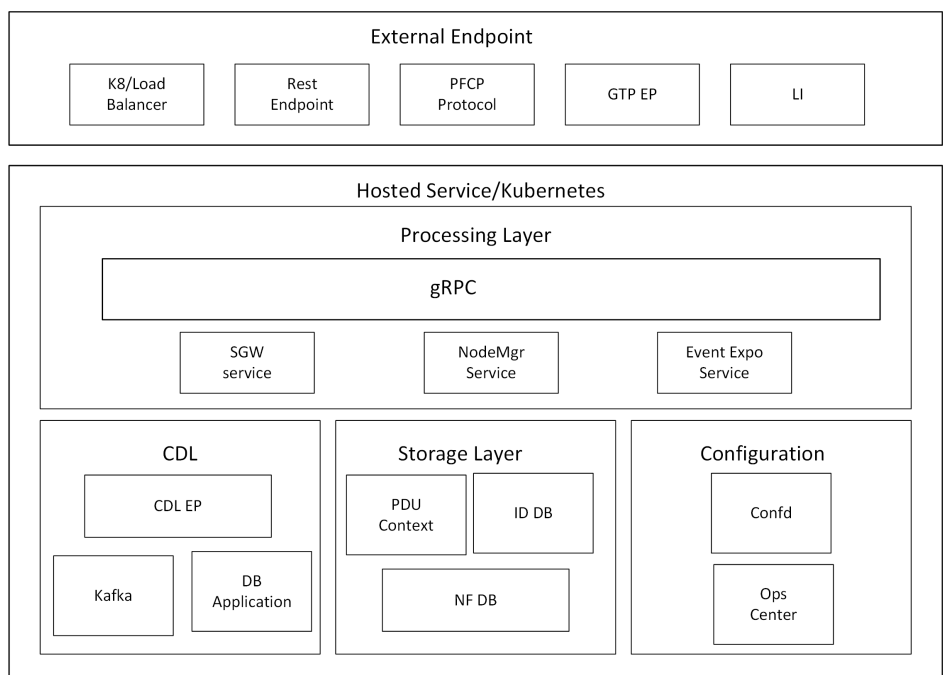

Kubernetes deployment includes the `kubectl` command-line tool to manage the Kubernetes resources in the cluster. You can manage the pods, nodes, and services.

For generic information on the Kubernetes concepts, see the Kubernetes documentation.

Pods

A pod is a process that runs on a Kubernetes cluster. A pod encapsulates a granular unit known as a container. A pod can contain one or more containers.

Kubernetes deploys one or multiple pods on a single node, which can be a physical or a virtual machine. Each pod has a discrete identity with an internal IP address and port number. The containers within the pod share the storage and network resources.

The following tables list the cnSGW-C and Common Execution Environment (CEE) pod names and the hosts on which they are deployed depending on the labels that you assign. See the following table for information on how to assign the labels.

Table 8: cnSGW-C Pods

Pod Name	Description	Host Name
api-sgw-ops-center	Functions as <i>confD</i> API pod for the cnSGW-C Ops Center.	OAM
base-entitlement-sgw	Operates to support smart licensing feature.	OAM Note Currently not supported.
bgpspeaker	Operates to support dynamic routing for L3 route management and BFD monitoring.	Protocol
cache-pod	Operates to support cache system information that is used by other pods as applicable.	Protocol
cdl-ep-session-c1	Provides an interface to the CDL.	Session
cdl-index-session-c1	Preserves the mapping of keys to the session pods.	Session
cdl-slot-session-c1	Operates as the CDL session pod to store the session data.	Session
documentation	Contains the documentation.	OAM
etcd-sgw-etcd-cluster	Hosts the etcd for the cnSGW-C OAM application to store information such as pod instances, leader information, endpoints.	OAM
georeplication	Operates to support cache, ETCD replication across sites, and site role management.	Protocol
grafana-dashboard-app-infra	Contains the default dashboard of app-infra metrics in Grafana.	OAM
grafana-dashboard-cdl	Contains the default dashboard of CDL metrics in Grafana.	OAM
grafana-dashboard-sgw	Contains the default dashboard of cnSGW-C service metrics in Grafana.	OAM
gtpc-ep-n0	Operates as GTPC endpoint of cnSGW-C.	Protocol
kafka	Hosts the Kafka details for the CDL replication.	Protocol

Pod Name	Description	Host Name
li-ep-n0	Operates as Lawful Intercept endpoint of cnSGW-C.	Protocol
oam-pod	Operates as the pod to facilitate Ops Center actions, such as show commands, configuration commands, monitor protocol monitor subscriber.	OAM
ops-center-sgw-ops-center	Acts as the cnSGW-C Ops Center.	OAM
smart-agent-sgw-ops-center	Operates as the utility pod for the cnSGW-C Ops Center.	OAM
nodemgr-n0	Performs node level interactions, such as Sxa link establishment and management (heartbeat). It generates unique identifiers, such as UE IP address and SEID.	Service
protocol-n0	Operates as encoder and decoder of application protocols (PCFP, whose underlying transport protocol is UDP).	Protocol
rest-ep-n0	cnSGW-C uses REST-EP as Notification client.	Protocol
service-n0	Contains main business logic of cnSGW-C.	Service
udp-proxy	Operates as proxy for all UDP messages. Owns UDP client and server functionalities.	Protocol
swift-sgw-ops-center	Operates as the utility pod for the cnSGW-C Ops Center.	OAM
zookeeper	Assists Kafka for topology management.	OAM

CEE Pods

For details, see the “CEE pods” topic from the [UCC Common Execution Environment - Configuration and Administration Guide](#).

UDP Proxy Pod

Feature Description

The cnSGW-C has UDP interfaces towards the UP (Sxa), MME (S11), and PGW (S5 or S8). With the help of the protocol layer pods, the messages are encoded, decoded, and exchanged on these UDP interfaces.

For achieving the functionalities mentioned on the 3GPP specifications:

- It is mandatory for the protocol layer pods to receive the original source and destination IP address and port number. But the original IP and UDP header is not preserved when the incoming packets arrive at the UDP service in the Kubernetes (K8s) cluster.
- Similarly, for the outgoing messages, the source IP set to the external IP address of the UDP service (published to the peer node) is mandatory. But the source IP is selected as per the egress interface when different instances of protocol layer pods send outgoing messages from different nodes of the K8s cluster.

The protocol layer pod spawns on the node, which has the physical interface configured with the external IP address to achieve the conditions mentioned earlier. However, spawning the protocol layer pods has the following consequences:

- It is not possible to achieve the node level HA (High Availability) as the protocol pods are spawned on the same node of the K8s cluster. Any failure to that node may result in loss of service.
- The protocol pods must include their own UDP client and server functionalities. In addition, each protocol layer pod may require labeling of the K8s nodes with the affinity rules. This restricts the scaling requirements of the protocol layer pods.

The cnSGW-C addresses these issues with the introduction of a new K8s pod called udp-proxy. The primary objectives of this pod are:

- The udp-proxy pod acts as a proxy for all kinds of UDP messages. It also owns the UDP client and server functionalities.
- The protocol pods perform the individual protocol (PFCP, GTP, Radius) encoding and decoding, and provide the UDP payload to the udp-proxy pod. The udp-proxy pod sends the UDP payload out after it receives the payload from the protocol pods.
- The udp-proxy pod opens the UDP sockets on a virtual IP (VIP) instead of a physical IP. This ensures that the udp-proxy pod does not have any strict affinity to a specific K8s node (VM), thus enabling node level HA for the UDP proxy.



Note One instance of the udp-proxy pod is spawned by default in all the worker nodes in the K8s cluster. The UDP proxy for cnSGW-C feature has functional relationship with the Virtual IP Address feature.

Architecture

The udp-proxy pod is placed in the worker nodes in the K8s cluster.

1. Each of the K8s worker node contains one instance of the udp-proxy pod. However, only one of the K8s worker node owns the virtual IP at any time. The worker node that owns the virtual IP remains in the active mode while all the other worker nodes remain in the standby mode.
2. The active udp-proxy pod binds to the virtual IP and the designated ports for listening to the UDP messages from the peer nodes (UPF and SGW).
3. The UDP payload received from the peer nodes are forwarded to one instance of the protocol, gtp-ep, or radius-ep pods. The payload is forwarded either on the same node or different node for further processing.

4. The response message from the protocol, gtp-ep, or radius-ep pods is forwarded back to the active instance of the udp-proxy pod. The udp-proxy pod sends the response message back to the corresponding peer nodes.
5. The cnSGW-C-initiated messages are encoded at the protocol, gtp-ep, or radius-ep pods. In addition, the UDP payload is sent to the udp-proxy pod. Eventually, the udp-proxy pod comprises of the complete IP payload and sends the message to the peer. When the response from the peer is received, the UDP payload is sent back to the same protocol pod from which the message originated.

Protocol Pod Selection for Peer-Initiated Messages

When the udp-proxy pod receives the peer node (for instance UPF) initiated messages, it is load-balanced across the protocol instances to select any instance of the protocol pod. An entry of this instance number is stored along with the source IP and source port number of the peer node. This ensures that the messages from the same source IP and source port are sent to the same instance that was selected earlier.

High Availability for the UDP Proxy

The UDP proxy's HA model is based on the keepalived virtual IP concepts. A VIP is designated to the N4 interface during the deployment. Also, a keepalived instance manages the VIP and ensures that the IP address of the VIP is created as the secondary address of an interface in one of the worker nodes of the K8s cluster.

The udp-proxy instance on this worker node binds to the VIP and assumes the role of the active udp-proxy pod. All udp-proxy instances in the other worker nodes remain in the standby mode.

Services

The cnSGW-C configuration is composed of several microservices that run on a set of discrete pods. These Microservices are deployed during the cnSGW-C deployment. cnSGW-C uses these services to enable communication between the pods. When interacting with another pod, the service identifies the pod's IP address to initiate the transaction and acts as an endpoint for the pod.

The following table describes the cnSGW-C services and the pod on which they run.

Table 9: cnSGW-C Services and Pods

Service Name	Pod Name	Description
base-entitlement-sgw	base-entitlement-sgw	Operates to support smart licensing feature.
bgpspeaker-pod	bgpspeaker	Operates to support dynamic routing for L3 route management and BFD monitoring.
datastore-ep-session	cdl-ep-session-cl	Responsible for the CDL session.
datastore-notification-ep	smf-rest-ep	Responsible for sending the notifications from the CDL to the <i>sgw-service</i> through <i>smf-rest-ep</i> . Note cnSGW-C uses REST-EP pod as notification client.

Service Name	Pod Name	Description
datastore-tls-ep-session	cdl-ep-session-c1	Responsible for the secure CDL connection.
documentation	documentation	Responsible for the cnSGW-C documents.
etcd	etcd-sgw-etcd-cluster-0, etcd-sgw-etcd-cluster-1, etcd-sgw-etcd-cluster-2	Responsible for pod discovery within the namespace.
etcd-sgw-etcd-cluster-0	etcd-sgw-etcd-cluster-0	Responsible for synchronization of data among the <i>etcd</i> cluster.
etcd-sgw-etcd-cluster-1	etcd-sgw-etcd-cluster-1	Responsible for synchronization of data among the <i>etcd</i> cluster.
etcd-sgw-etcd-cluster-2	etcd-sgw-etcd-cluster-2	Responsible for synchronization of data among the <i>etcd</i> cluster.
grafana-dashboard-app-infra	grafana-dashboard-app-infra	Responsible for the default dashboard of app-infra metrics in Grafana.
grafana-dashboard-cdl	grafana-dashboard-cdl	Responsible for the default dashboard of CDL metrics in Grafana.
grafana-dashboard-sgw	grafana-dashboard-sgw	Responsible for the default dashboard of cnSGW-C service metrics in Grafana.
gtpc-ep	gtpc-ep-n0	Responsible for inter-pod communication with GTP-C pod.
helm-api-sgw-ops-center	api-sgw-ops-center	Manages the Ops Center API.
kafka	kafka	Processes the Kafka messages.
li-ep	li-ep-n0	Responsible for lawful-intercept interactions.
local-ldap-proxy-sgw-ops-center	ops-center-sgw-ops-center	Responsible for leveraging Ops Center credentials by other applications like Grafana.
oam-pod	oam-pod	Responsible to facilitate Exec commands on the Ops Center.
ops-center-sgw-ops-center	ops-center-sgw-ops-center	Manages the cnSGW-C Ops Center.
ops-center-sgw-ops-center-expose-cli	ops-center-sgw-ops-center	To access cnSGW-C Ops Center with external IP address.
smart-agent-sgw-ops-center	smart-agent-sgw-ops-center	Responsible for the cnSGW-C Ops Center API.

Service Name	Pod Name	Description
smf-nodemgr	smf-nodemgr	Responsible for inter-pod communication with <i>smf-nodemgr</i> pod.
smf-protocol	smf-protocol	Responsible for inter-pod communication with smf-protocol pod.
sgw-service	sgw-service	Responsible for inter-pod communication with cnSGW-C service pod.
swift-sgw-ops-center	swift	Operates as the utility pod for the cnSGW-C Ops Center.
zookeeper	zookeeper	Assists Kafka for topology management.
zookeeper-service	zookeeper	Assists Kafka for topology management.

Open Ports and Services

The cnSGW-C uses different ports for communication. The following table describes the default open ports and the associated services.

Table 10: Open Ports and Services

Port	Type	Service	Usage
22	tcp	SSH	SMI uses TCP port to communicate with the virtual machines.
53	tcp	domain	DNS port.
80	tcp	HTTP	SMI uses TCP port for providing Web access to CLI, Documentation, and TAC.
111	tcp	rpcbind	Open Network Computing Remote Procedure Call.
179	tcp	bgp	Border Gateway Protocol (BGP)
443	tcp	SSL/HTTP	SMI uses TCP port for providing Web access to CLI, Documentation, and TAC.
2379	tcp	etcd-client	CoreOS etcd client communication.
6443	tcp	http	SMI uses port to communicate with the Kubernetes API server.
7472	tcp	unknown	speaker, used by Grafana.
8083	tcp	us-srv	Kafka connects REST interface.
8850	tcp	unknown	udp-proxy

Port	Type	Service	Usage
8879	tcp	unknown	udp-proxy
9100	tcp	jetdirect	<p>SMI uses TCP port to communicate with the Node Exporter.</p> <p>Node Exporter is a Prometheus exporter for hardware and OS metrics with pluggable metric collectors.</p> <p>It allows you to measure various machine resources, such as memory, disk, and CPU utilization.</p>
10250	tcp	SSL/HTTP	<p>SMI uses TCP port to communicate with Kubelet.</p> <p>Kubelet is the lowest level component in Kubernetes. It is responsible for what is running on an individual machine.</p> <p>It is a process watcher or supervisor focused on active container. It ensures the specified containers are up and running.</p>
10251	tcp	-	<p>SMI uses TCP port to interact with the Kube scheduler.</p> <p>Kube scheduler is the default scheduler for Kubernetes and runs as part of the control plane. A scheduler watches for newly created pods that have no node assigned.</p> <p>For every pod that the scheduler discovers, the scheduler becomes responsible for finding the best node for that pod to run on.</p>
10252	tcp	apollo-relay	<p>SMI uses this TCP port to interact with the Kube controller.</p> <p>The Kubernetes controller manager is a daemon that embeds the core control loops shipped with Kubernetes. The controller is a control loop that watches the shared state of the cluster through the API server and makes changes to move the current state to the desired state.</p>
10256	-	HTTP	<p>SMI uses TCP port to interact with the Kube proxy.</p> <p>Kube proxy is a network proxy that runs on each node in your cluster. Kube proxy maintains network rules on nodes. These network rules allow network communication to your pods from network sessions inside or outside of your cluster.</p>
50051	tcp	unknown	gRPC service listen port.
53	udp	domain ISC BIND (Fake version: 9.11.3-1ubuntu1.9-Ubuntu)	DNS port
111	udp	rpcbin	Open Network Computing Remote Procedure Call
2123	udp	gtpc	GTP control

Port	Type	Service	Usage
8805	udp	pfcp	Packet Forwarding Control Protocol (PFCP)

Associating Pods to the Nodes

This section describes how to associate a pod to the node.

After configuring a cluster, you can associate the pods to the nodes through labels. This association enables the pods to get deployed on the appropriate node, based on the key-value pair.

Labels are required for the pods to identify the nodes where they must be deployed and to run the services. For example, when you configure the protocol-layer label with the required key-value pair, the pods are deployed on the nodes that match the key-value pair.

- To associate pods to the nodes through the labels, use the following configuration:

```

config
  k8
    label
      cdl-layer
        key key_value
        value value
      oam-layer
        key key_value
        value value
      protocol-layer
        key key_value
        value value
      service-layer
        key key_value
        value value
    end

```

NOTES:

- If you don't configure the labels, cnSGW-C assumes the labels with the default key-value pair.
 - label { cdl-layer { key key_value | value value }**—Configures the key value pair for CDL.
 - oam-layer { key key_value | value value }**—Configures the key value pair for OAM layer.
 - protocol-layer { key key_value | value value }**—Configures the key value pair for protocol layer.
 - service-layer { key key_value | value value }**—Configures the key value pair for the service layer.

Viewing the Pod Details and Status

If the service requires additional pods, cnSGW-C creates and deploys the pods. You can view the list of available pods in your deployment through the cnSGW-C Ops Center.

You can run the `kubectl` command from the master node to manage the Kubernetes resources.

Pod Details

1. To view the comprehensive pod details, use the following command.

```
kubectl get pods -n sgw pod_name -o yaml
```

The output of this command provides the pod details in YAML format with the following information:

- The IP address of the host where the pod is deployed.
- The service and the application that is running on the pod.
- The ID and the name of the container within the pod.
- The IP address of the pod.
- The present state and phase of the pod.
- The start time from which pod is in the present state.

Use the following command to view the summary of the pod details.

```
kubectl get pods -n sgw_namespace -o wide
```

States

The following table describes the state of a pod.

Table 11: Pod States

State	Description
Running	The pod is healthy and deployed on a node. It contains one or more containers.
Pending	The application is in the process of creating the container images for the pod.
Succeeded	Indicates that all the containers in the pod are successfully terminated. These pods can't be restarted.
Failed	One or more containers in the pod have failed the termination process. The failure occurred as the container either exited with non-zero status or the system terminated the container.



CHAPTER 7

3GPP RAN/NAS Cause Codes Support

- [Feature Summary and Revision History, on page 85](#)
- [Feature Description, on page 85](#)
- [How it Works, on page 87](#)

Feature Summary and Revision History

Summary Data

Table 12: Summary Data

Applicable Product(s) or Functional Area	cnSGW-C
Applicable Platform(s)	SMI
Feature Default Setting	Enabled - Always-on
Related Documentation	Not Applicable

Revision History

Table 13: Revision History

Revision Details	Release
First introduced.	2021.02.0

Feature Description

cnSGW-C supports RAN/NAS cause codes as defined in *3GPP TS 29.274, version 15.4.0, section 8.103, RAN/NAS Cause*.

cnSGW-C transparently transmits the RAN/NAS Release Cause IE provided by the MME to the PGW for further propagation towards the PCRF.



Note GTP-based S5/S8 and S11 are supported.

The following table lists the RAN/NAS Cause codes.

Table 14: RAN/NAS Cause Codes

Octets	Bits							
	8	7	6	5	4	3	2	1
1	Type = 172 (decimal)							
2–3	Length = n							
4	Spare				Instance			
5	Protocol Type				Cause Type			
6 to m	Cause Value							
(m+1) to (n+4)	One or more octets from these octets are present, only if explicitly specified							

The Protocol Type field is encoded with the specified values for the RAN/NAS Cause as follows:

Table 15: Protocol Type

Protocol Type	Values (Decimal)
S1AP Cause	1
EMM Cause	2
ESM Cause	3
<spare>	4–15

The Cause Value field (and the associated RAN cause subcategory) is transferred over the S1-AP interface. The field is encoded in one octet as a binary integer.

Table 16: Cause Type

Cause Type	Values (Decimal)
Radio Network Layer	0
Transport Layer	1
NAS	2
Protocol	3
Miscellaneous	4

Cause Type	Values (Decimal)
<spare>	5–15

For EMM and ESM Causes, the Cause Value field contains the cause value as specified in *3GPP TS 24.301*. If the Protocol is S1AP, the cause value contains the specified value as in *3GPP TS 36.413*.

How it Works

This section describes how this feature works.

Call Flows

This section describes the key call flows for the RAN/NAS Cause Codes feature.

Create Bearer Procedure Call Flow

This section describes the create bearer procedure call flow.

Figure 14: Create Bearer Procedure Call Flow

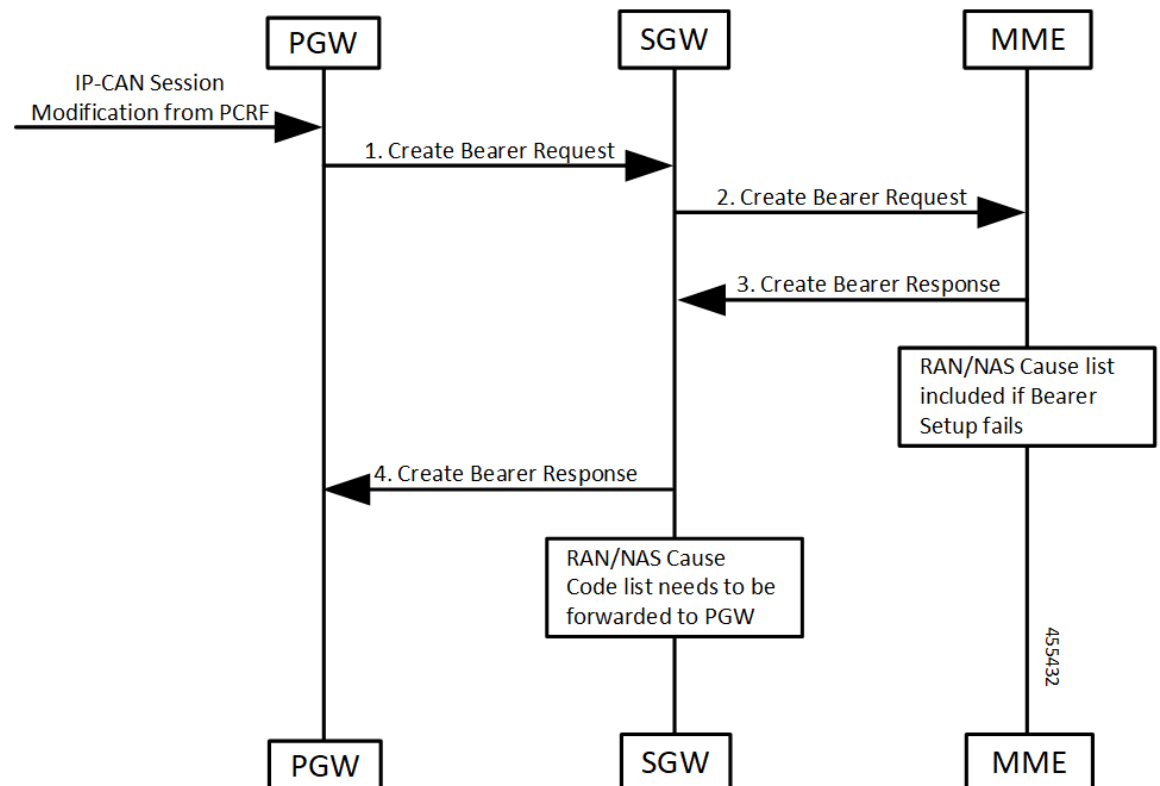

Table 17: Create Bearer Procedure Call Flow Description

Step	Description
1	PGW receives IP-CAN session modification request from PCRF. PGW creates the Create Bearer Request message and sends it to SGW (cnSGW-C).
2	SGW (cnSGW-C) forwards the Create Bearer Request message request to MME.
3	MME generates a Create Bearer Response message towards SGW (cnSGW-C). If bearer setup fails, then the RAN/Cause list included in the response.
4	SGW (cnSGW-C) forwards the Create Bearer Response message to PGW. It includes RAN/NAS Cause Code list.

Update Bearer Procedure Call Flow

This section describes the update bearer procedure call flow.

Figure 15: Update Bearer Procedure Call Flow

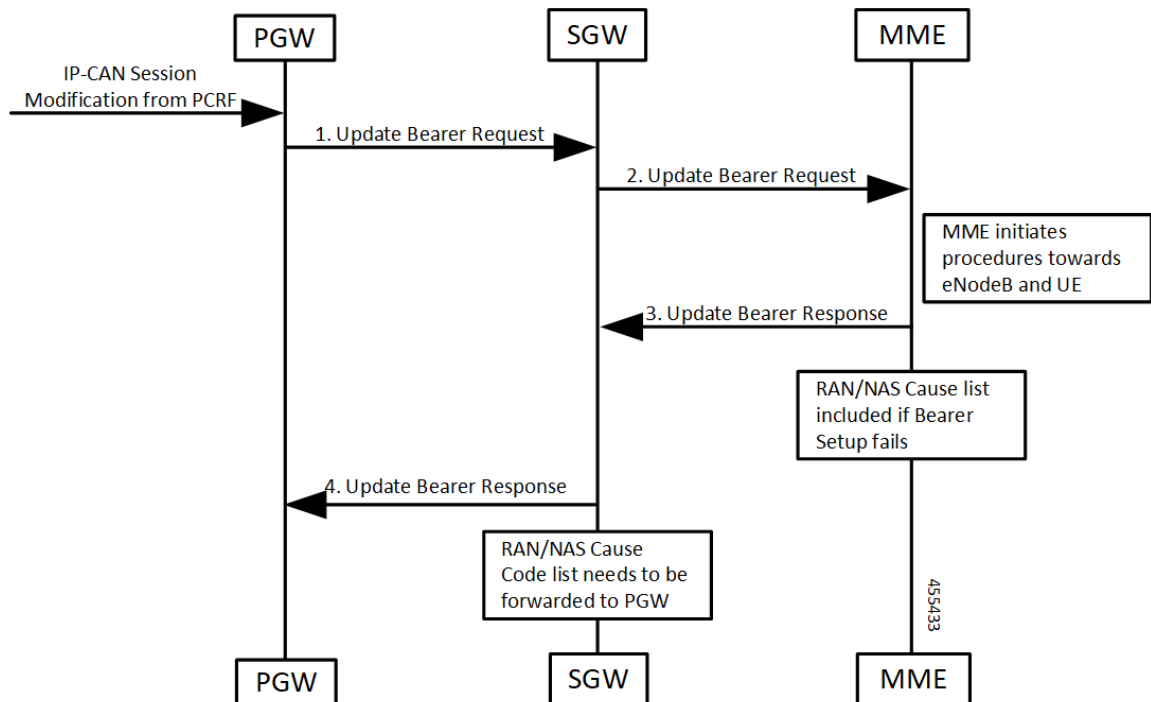

Table 18: Update Bearer Procedure Call Flow Description

Step	Description
1	PGW receives IP-CAN session modification request from PCRF. PGW creates the Update Bearer Request message to SGW (cnSGW-C).

Step	Description
2	SGW (cnSGW-C) forwards the Update Bearer Request message to MME.
3	MME generates an Update Bearer Response message towards SGW (cnSGW-C). If this bearer modification fails, then the RAN/NAS list included in the response.
4	SGW (cnSGW-C) forwards the Update Bearer Response message to PGW.

Delete Bearer Command Procedure Call Flow

This section describes the delete bearer command procedure call flow.

Figure 16: Delete Bearer Command Procedure Call Flow

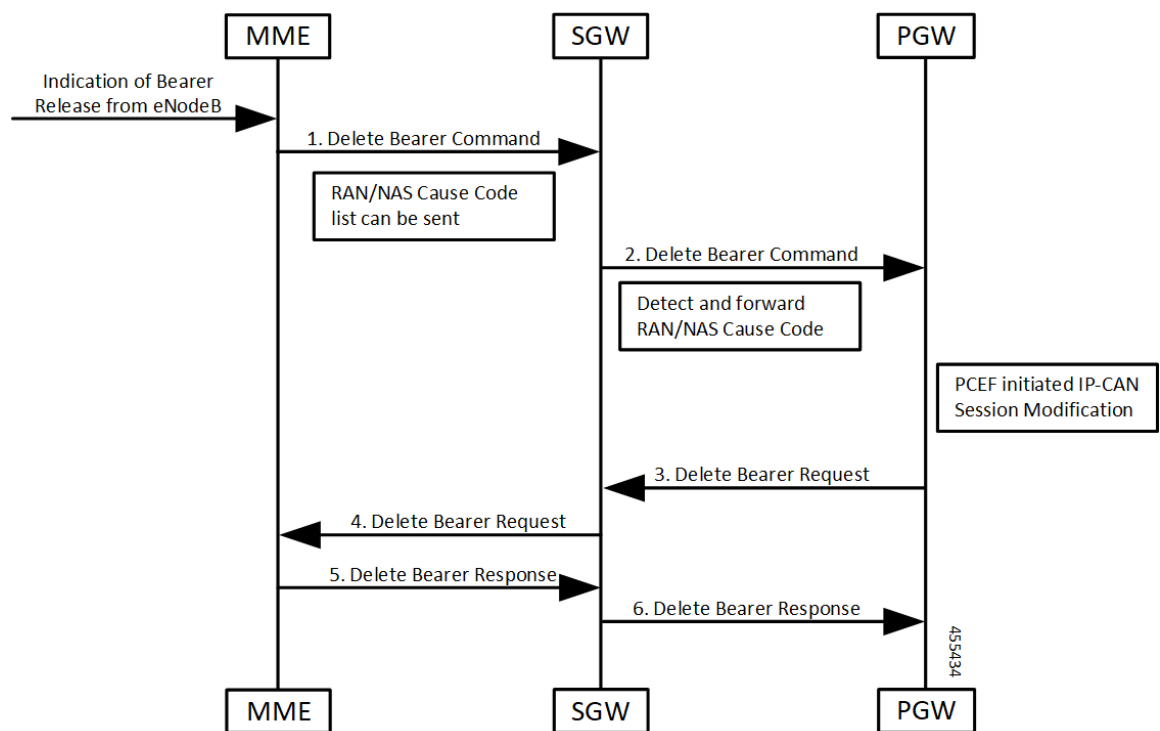

Table 19: Delete Bearer Command Procedure Call Flow Description

Step	Description
1	MME receives an indication of Bearer Release from eNodeB request. MME creates Delete Bearer Command message to SGW (cnSGW-C). It includes RAN/NAS cause code list.
2	SGW (cnSGW-C) forwards the Delete Bearer Command message request to PGW. It detects and forwards RAN/NAS cause code list.

Step	Description
3	PGW sends the Delete Bearer Request message to SGW (cnSGW-C). PGW receives IP-CAN session modification request from PCEF.
4	SGW (cnSGW-C) generates a Delete Bearer Request message towards MME.
5	MME generates a Delete Bearer Response message towards SGW (cnSGW-C).
6	SGW (cnSGW-C) further sends the Delete Bearer Response message to PGW.

Delete Session Procedure Call Flow

This section describes the delete session procedure call flow.

Figure 17: Delete Session Procedure Call Flow

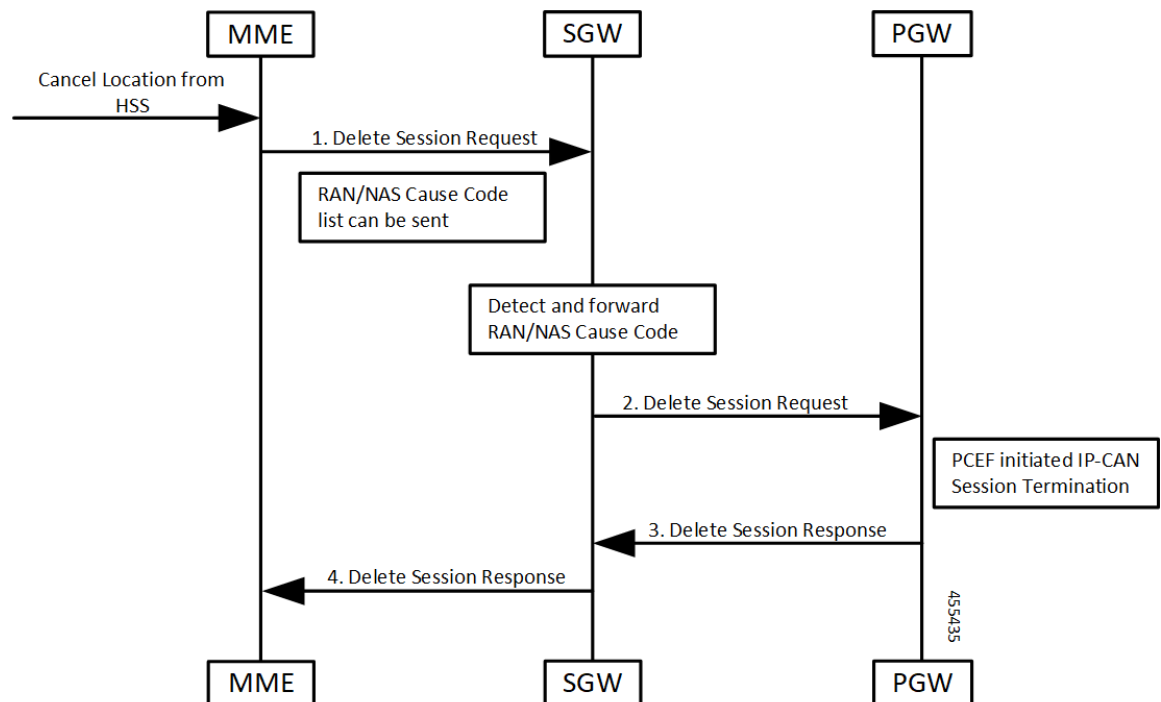

Table 20: Delete Session Procedure Call Flow Description

Step	Description
1	MME receives an indication of Cancel Location from HSS. MME creates Delete Session Request message to SGW (cnSGW-C). It includes RAN/NAS cause code list.
2	SGW (cnSGW-C) forwards the Delete Session Request message request to PGW. It detects and forwards RAN/NAS cause code list.

Step	Description
3	PGW sends the Delete Session Response message to SGW (cnSGW-C). PGW receives IP-CAN session modification request from PCEF.
4	SGW (cnSGW-C) generates a Delete Session Response message towards MME.



CHAPTER 8

Access Bearer Release Support

- [Feature Summary and Revision History, on page 93](#)
- [Feature Description, on page 93](#)
- [How it Works, on page 94](#)

Feature Summary and Revision History

Summary Data

Table 21: Summary Data

Applicable Product(s) or Functional Area	cnSGW-C
Applicable Platform(s)	SMI
Feature Default Setting	Enabled - Always-on
Related Documentation	Not Applicable

Revision History

Table 22: Revision History

Revision Details	Release
First introduced.	2020.03.0

Feature Description

cnSGW-C supports the handling of the Release Access Bearer (RAB) request procedure. It's a UE-level message. In multiple PDN scenarios, the MME sends only one RAB message, which applies to all the PDNs. cnSGW-C brings all the bearers of all the PDNs to the IDLE state.

How it Works

This section describes how this feature works.

cnSGW-C sends the Sx Modification Request message per PDN to the corresponding User Plane. After receiving the Sx Modification response message from all user planes (for all PDNs), cnSGW-C sends the response message to MME.

cnSGW-C updates the state as IDLE for all the bearers in CDL.

Call Flows

This section describes the key call flow for the Access Bearer Release Support feature.

Release Access Bearer (Active to IDLE Transaction) Call Flow

This section describes the Release Access Bearer call flow.

Figure 18: Release Access Bearer (Active to IDLE Transaction) Call Flow

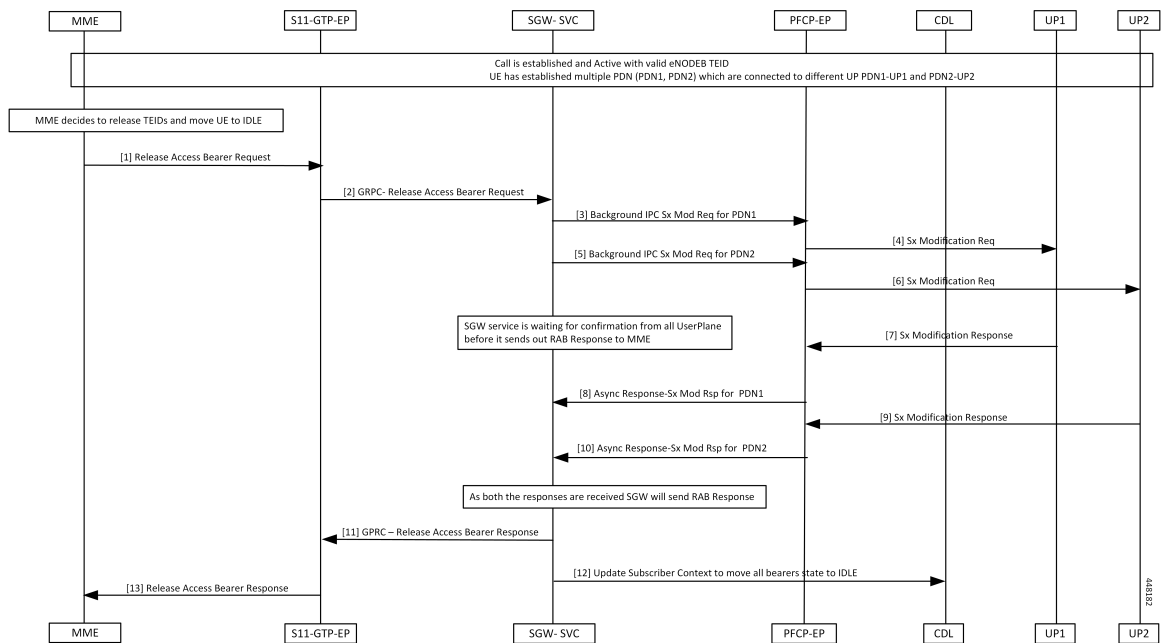

Table 23: Release Access Bearer (Active to IDLE Transaction) Call Flow Description

Step	Description
1	MME sends Release Access Bearer (RAB) request to S11-GTP-EP to release all S1-U bearers for the UE.

Step	Description
2	<p>S11-GTP EP decodes the received UDP message and converts it into gRPC. The converted gRPC message then sent to the SGW-Service pod, using the TEID value, which can handle this UE session.</p> <p>SGW-Service pod performs the following activities:</p> <ul style="list-style-type: none"> • Finds out Subscriber Context using local ingress TEID • Validates the RAB request content • Moves UE to the IDLE state • Builds the Sx Modify request message with the downlink apply action as DROP, to drop all downlink packets at SGW-U
3	SGW-Service pod sends the Sx Mod request message using the background IPC async call for PDN1 to PFCP-EP.
4	PFCP-EP forwards the Sx Modify Request (PDN1) message to UPF1 through the UDP proxy. UPF1 processes the Sx Modify Request (PDN1) message.
5	<p>SGW-Service pod sends the Sx Modify Request message using the background IPC async call for PDN2.</p> <p>PFCP-EP forwards the Sx Modify Request (PDN2) message to UPF2 through the UDP proxy.</p>
6	UPF2 processes the Sx Modify Request (PDN2) message.
7	UPF1 sends the Sx Modify response (PDN1) message to PFCP-EP.
8	<p>PFCP-EP sends the Async Sx Modify response message to cnSGW-C service for PDN1.</p> <p>SGW-Service pod waits for the PDN2 Sx Modify response message.</p>
9	UPF2 sends the Sx Modify response (PDN2) message to PFCP-EP.
10	PFCP-EP sends the Async Sx Modify response message to cnSGW-C service for PDN2.
11	<p>The SGW-Service pod sends the following, after receiving the PDN (PDN1, PDN2) responses:</p> <ul style="list-style-type: none"> • RAB response message to S11-GTP-EP using the gRPC protocol. • Updates to the CDL module
12	<p>SGW-Service pod sends Update Subscriber Context state to CDL, which moves all the bearers to the IDLE state.</p> <p>CDL module updates the information in the database.</p>
13	<p>S11-GTP-EP forwards the RAB response message to MME.</p> <p>MME process the RAB response message.</p>



CHAPTER 9

APN Profile Support

- [Feature Summary and Revision History, on page 97](#)
- [Feature Description, on page 98](#)
- [Feature Configuration, on page 98](#)
- [Troubleshooting Information, on page 100](#)

Feature Summary and Revision History

Summary Data

Table 24: Summary Data

Applicable Product(s) or Functional Area	cnSGW-C
Applicable Platform(s)	SMI
Feature Default Setting	Enabled - Configuration Required
Related Documentation	Not Applicable

Revision History

Table 25: Revision History

Revision Details	Release
Introduced support for IPv6.	2022.04.0
First introduced.	2021.01.0

Feature Description

This feature supports Access Point Name (APN) or Data Network Name (DNN) profile for the SGW (cnSGW-C) service. DNN is equivalent to APN in Evolved Packet System (EPS).

Using the Operator Policy and the Subscriber map, you can determine the DNN Profile for the cnSGW-C service.

Feature Configuration

Configuring this feature involves the following steps:

- Configure DNN Profile. For more information, refer to [Configuring DNN Profile, on page 98](#).
- Configure Network Element Profile. For more information, refer to [Configuring Network Element Profile, on page 98](#).

Configuring DNN Profile

To configure this feature, use the following configuration:

```

config
  profile dnn dnn_name
    upf-selection-policy upf_select_name
      dnn dnn_name network-function-list network_function_list
    end

```

NOTES:

- **dnn** *dnn_name*—Specify the DNN profile name. Must be a string.
- **upf-selection-policy** *upf_select_name*—Specify the UPF selection policy name. Must be a string.
- **network-function-list** *network_function_list*—Specify the list of network functions to which the selected DNN profile is sent. Must be a string.

Configuring Network Element Profile

Network element profile represents peer IP (UPF) profile and has the following configurations:

- Peer address and Port configuration
- Peer-supported DNNs or APNs. This configuration helps in UPF selection.

UPF selection considers priority and capacity parameters.

upf-group-profile indicates the UPF group to which it belongs.

To configure this feature, use the following configuration:

```

config
  profile network-element upf upf_name
    node-id node_id_value

```

```

n4-peer-address ipv6 ipv6_address
n4-peer-address ipv4 ipv4_address
n4-peer-port port_number
dual-stack-transport { true | false }
dnn-list dnn_list
capacity capacity_value
priority priority_value
upf-group-profile upf_group_name
end

```

NOTES:

- **network-element**—Specify the peer network element.
- **upf upf_name**—Specify the UPF peer name.
- **node-id node_id_value**—Specify the Node ID of the UPF node.
- **n4-peer-address ipv4 ipv4_address**—Specify the IPv4 address.
- **n4-peer-address ipv6 ipv6_address**—Specify the IPv6 address.
- **n4-peer-port port_number**—Specify the N4 peer port number. Must be an integer in the range of 0-65535.
- **dual-stack-transport { true | false }**—Enable the dual stack feature that allows you to specify IPv6 or IPv4 address. Specify true to enable this feature.
- **dnn-list dnn_list**—Specify the DNN list supported by UPF node.
- **capacity capacity_value**—Specify the capacity relative to other UPFs. This is used for load balancing. Must be an integer in the range of 0-65535. Default value is 10.
- **priority priority_value**—Specify the static priority relative to other UPFs. This is used for load balancing. Must be an integer in the range of 0-65535. Default value is 1.
- **upf-group-profile upf_group_name**—Specify the UPF group profile name. Must be a string.

Configuration Modification Impact

The following table indicates the impact or the configuration change behavior on an existing call, a new PDN, or a new subscriber.

Modification	cnSGW-C Existing Call	cnSGW-C New PDN or New subscriber
Delete the apn-profile	No impact	Applied new configuration based on the changes for the following: <ul style="list-style-type: none"> • subscriber policy • operator policy • dnn policy • dnn profile

Modification	cnSGW-C Existing Call	cnSGW-C New PDN or New subscriber
Modify the apn profile name in the operator policy	No impact	Applied new configuration based on the changes for the following: <ul style="list-style-type: none"> • subscriber policy • operator policy • dnn policy • dnn profile

Troubleshooting Information

This section describes troubleshooting information for this feature.

Configuration Errors

This section describes the errors that cnSGW-C might report during the APN profile configuration.

```
show config-error | tab
ERROR COMPONENT      ERROR DESCRIPTION
-----
SGWProfile            Subscriber policy name : sub_policy in profile sgw1 is not configured
SubscriberPolicy      Operator policy : op_policy1 under subscriber policy sub_policy2 is not
configured
OperatorPolicy        Dnn policy name : dnn_policy1 in operator policy op_policy2 is not
configured
DnnPolicy             Dnn profile name : dnn_profile1 in dnn policy dnn_policy2 is not configured
DnnProfile            UPF selection policy name : upf_sel_policy1 in dnn profile dnn_profile2
is not configured
```



CHAPTER 10

Change Notification Request Handling

- [Feature Summary and Revision History, on page 101](#)
- [Feature Description, on page 101](#)
- [How it Works, on page 102](#)
- [OAM Support, on page 104](#)

Feature Summary and Revision History

Summary Data

Table 26: Summary Data

Applicable Product(s) or Functional Area	cnSGW-C
Applicable Platform(s)	SMI
Feature Default Setting	Enabled - Always-on
Related Documentation	Not Applicable

Revision History

Table 27: Revision History

Revision Details	Release
First introduced.	2021.02.0

Feature Description

A change notification message is initiated in cnSGW-C to indicate modifications for the User Location Information (ULI) and User CSG Information (UCI) updates. If these updates are valid, the cnSGW-C CDR is initiated. The change notifications may contain the secondary RAT usage IE which is specific to the

cnSGW-C and the ISGW. The cnSGW-C saves the RAT usage information and transmits the usage information in the subsequent CDR message.

Standards Compliance

This feature complies with the following standards specifications:

- *3GPP TS 29.274 "3GPP Evolved Packet System (EPS); Evolved General Packet Radio Service (GPRS) Tunnelling Protocol for Control plane (GTPv2-C); Stage 3"*

How it Works

This section describes how this feature works.

The cnSGW-C network function handles the change notification request using the following approach:

- If the ULI or the UCI changes are valid in the connection request (CNREQ), the associated packet data network (PDN) is updated.
- cnSGW-C initiates a Query URR to get the latest usage information and generates cnSGW-C CDR when:
 - ULI is modified.
 - Charging and ULI trigger is enabled.

For information on configuring charging, see [SGW Charging Support](#) chapter.

Call Flows

This section describes the key call flow for this feature.

Change Notification Request Call Flow

This section describes the change notification request and the response call flow.

Figure 19: Change Notification Request Call Flow

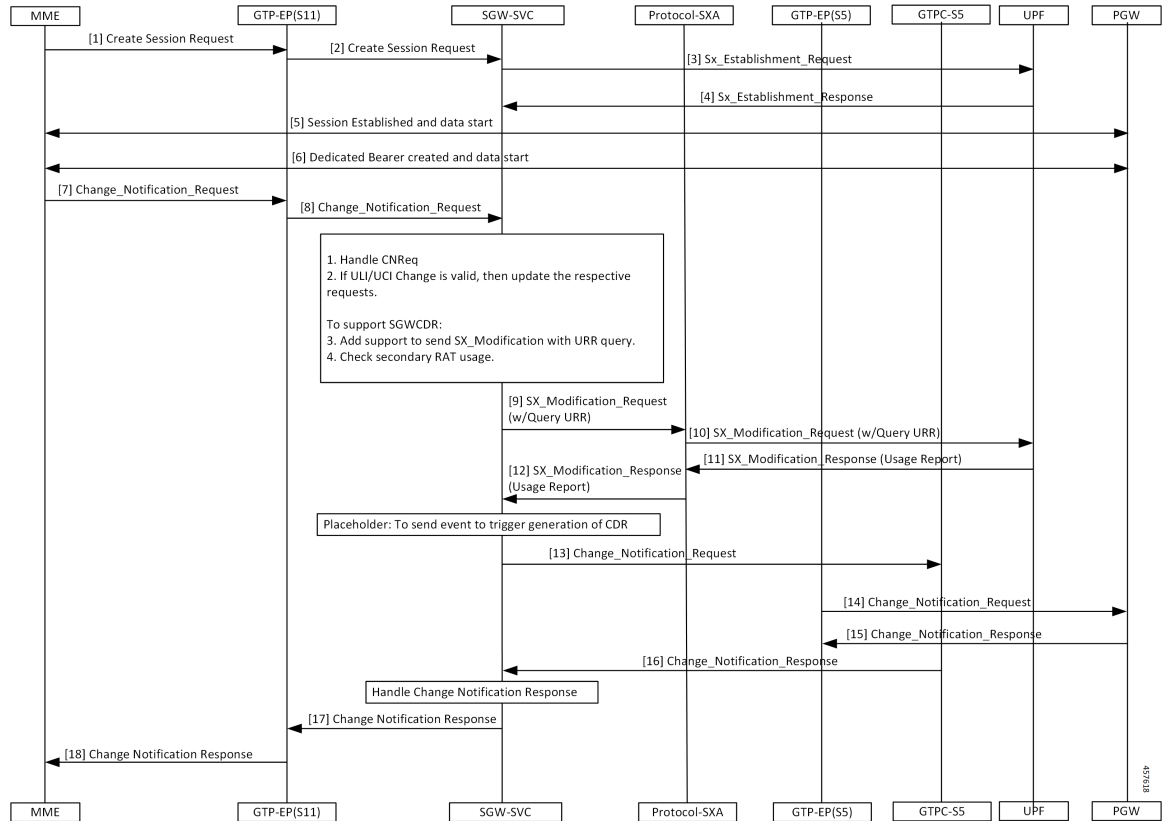

Table 28: Change Notification Request Call Flow Description

Step	Description
1	The MME sends a Create Session Request towards GTP-EP(S11).
2	The GTP-EP(S11) forwards the Create Session Request to the SGW-SVC.
3	The SGW-SVC sends the Sx Establishment Request to the UPF.
4	The UPF responds to the request with the SX Establishment Response directed towards the SGW-SVC.
5	The MME and the PGW establish the sessions and start exchanging data.
6	The MME and the PGW create the dedicated bearer and start exchanging data.
7	The MME sends the Change Notification Request to the GTP-EP.
8	The GTP-EP forwards the Change Notification Request to the SGW-SVC. If ULI or UCI changes are valid in the connection request (CNREQ), the PDN is updated. The GTP-EP sends the Sx Modification Request with the URR query after checking the secondary RAT usage.

Step	Description
9	The SGW-SVC sends the Sx Modification Request with the URR query to the Proto-SXA.
10	The Proto-SXA forwards the Sx Modification Request with the URR query to the UPF.
11	The UPF responds to the request with the Sx Modification Response, with the usage report to the Proto-SXA.
12	The Proto-SXA forwards the Sx Modification Response with the usage report to the SGW-SVC.
13	The SGW-SVC sends the Change Notification Request to the GTPC-S5.
14	The GTPC-S5 forwards the Change Notification Request to the PGW.
15	The PGW responds with the Change Notification Response to the GTPC-S5.
16	The GTPC-S5 forwards the Change Notification Response to the SGW-SVC.
17	The SGW-SVC sends the Change Notification Response to the GTP-EP(S11).
18	The GTP-EP(S11) forwards the Change Notification Response to the MME.

OAM Support

This section describes operations, administration, and maintenance information for this feature.

Bulk Statistics Support

The change notification filter displays the status of the change requests for which the notification is invoked. The following are the sample statistics and are provided for reference purposes only.

```
sgw_service_stats{app_name="smf",cluster="Local",data_center="DC",fail_reason="",instance_id="0",interface="interface_sgw_egress",reject_cause="",service_name="sgw-service",sgw_procedure_type="change_notification",status="attempted",sub_fail_reason=""} 1
```

```
sgw_service_stats{app_name="smf",cluster="Local",data_center="DC",fail_reason="",instance_id="0",interface="interface_sgw_egress",reject_cause="",service_name="sgw-service",sgw_procedure_type="change_notification",status="success",sub_fail_reason=""} 1
```

```
sgw_service_stats{app_name="smf",cluster="Local",data_center="DC",fail_reason="",instance_id="0",interface="interface_sgw_egress",reject_cause="",service_name="sgw-service",sgw_procedure_type="initial_attach",status="attempted",sub_fail_reason=""} 1
```

```
sgw_service_stats{app_name="smf",cluster="Local",data_center="DC",fail_reason="",instance_id="0",interface="interface_sgw_egress",reject_cause="",service_name="sgw-service",sgw_procedure_type="initial_attach",status="success",sub_fail_reason=""} 1
```



```
sgw_service_stats{app_name="smf",cluster="Local",data_center="DC",fail_reason="",
instance_id="0",interface="interface_sgw_ingress",reject_cause="",service_name="sgw-service",
sgw_procedure_type="change_notification",status="attempted",sub_fail_reason=""} 1
```

```
sgw_service_stats{app_name="smf",cluster="Local",data_center="DC",fail_reason="",
instance_id="0",interface="interface_sgw_ingress",reject_cause="",service_name="sgw-service",
sgw_procedure_type="change_notification",status="success",sub_fail_reason=""} 1
```

```
sgw_service_stats{app_name="smf",cluster="Local",data_center="DC",fail_reason="",
instance_id="0",interface="interface_sgw_ingress",reject_cause="",service_name="sgw-service",
sgw_procedure_type="initial_attach",status="attempted",sub_fail_reason=""} 1
```

```
sgw_service_stats{app_name="smf",cluster="Local",data_center="DC",fail_reason="",
instance_id="0",interface="interface_sgw_ingress",reject_cause="",service_name="sgw-service",
sgw_procedure_type="initial_attach",status="success",sub_fail_reason=""} 1
```

```
sgw_service_stats{app_name="smf",cluster="Local",data_center="DC",fail_reason="",
instance_id="0",interface="interface_sgw_ingress",reject_cause="",service_name="sgw-service",
sgw_procedure_type="modify_bearer_req_initial_attach",status="attempted",sub_fail_reason=""}
1
```

```
sgw_service_stats{app_name="smf",cluster="Local",data_center="DC",fail_reason="",
instance_id="0",interface="interface_sgw_ingress",reject_cause="",service_name="sgw-service",
sgw_procedure_type="modify_bearer_req_initial_attach",status="success",sub_fail_reason=""}
1
```



CHAPTER 11

Clear Subscriber Request

- [Feature Summary and Revision History, on page 107](#)
- [Feature Description, on page 107](#)
- [How it Works, on page 108](#)

Feature Summary and Revision History

Summary Data

Table 29: Summary Data

Applicable Product(s) or Functional Area	cnSGW-C
Applicable Platform(s)	SMI
Feature Default Setting	Enabled - Always-on
Related Documentation	Not Applicable

Revision History

Table 30: Revision History

Revision Details	Release
First introduced.	2020.04

Feature Description

cnSGW-C handles the Clear Subscriber or the PDN Request from the Ops Center.

The Clear Subscriber Request initiates the administrative clearing of subscribers for a specific IMSI or all IMSIs using the local purge and remote signaling procedures.

Based on the OAM query, the cnSGW-C receives the Subscriber Notification message at REST-EP and triggers the Clear Subscriber Request message towards the SGW-Service.

Standards Compliance

This feature complies with the following standards specifications:

- *3GPP TS 23.401 "General Packet Radio Service (GPRS) enhancements for Evolved Universal Terrestrial Radio Access Network (E-UTRAN) access"*
- *3GPP TS 23.214 "Architecture enhancements for control and user plane separation of EPC nodes"*
- *3GPP TS 29.274 "3GPP Evolved Packet System (EPS); Evolved General Packet Radio Service (GPRS) Tunnelling Protocol for Control plane (GTPv2-C); Stage 3"*
- *3GPP TS 29.244 "Interface between the Control Plane and the User Plane nodes"*

How it Works

This section describes how this feature works.

When the cnSGW-C receives the admin-initiated Deletion Request with the purge option as “true”, it initiates Sx signaling towards User Plane and exchanges following messages:

1. SGW sends a Sx Session Deletion Request to User Plane.
2. User Plane sends a Sx Session Deletion Response SGW.

When cnSGW-C receives the Deletion Request with the purge option as “false”, it performs the Sx signaling towards User Plane and GTP-C signaling towards MME and PGW. The cnSGW-C exchanges the following messages with User Plane, MME, and PGW:

1. SGW sends the Sx Session Modification Request to the User Plane.
2. User Plane sends the Sx Session Modification Response to SGW.
3. SGW sends the Delete Bearer Request to MME.
4. SGW sends the Delete Session Request to PGW.
5. MME sends the Delete Bearer Response to SGW.
6. PGW sends the Delete Session Response to SGW.
7. SGW sends the Sx Session Deletion Request to User Plane.
8. User Plane sends the Sx Session Deletion Response to SGW.

cnSGW-C sends the Delete Session Request towards PGW and Delete Bearer Request towards MME. After receiving the response from both remote peers, the cnSGW-C sends Sx Session Deletion Request towards User Plane to clear the sessions.

Supported Clear Command

cnSGW-C supports the following clear commands:

Table 31: Supported Clear Commands

Supported Clear Command Options	GTP-C Signalling (Towards MME/PGW)	Sx Signalling (Towards UP)	Impact (Subscriber/PDN)
clear sub all clear sub all purge false	Yes	Yes	All subscribers
clear sub all purge true	No	Yes	All subscribers
<ul style="list-style-type: none"> • clear sub namespace sgw imsi <i>imsi_val</i> • clear sub namespace sgw imsiimsi_valpurge false 	Yes	Yes	Subscriber with IMSI as <i>imsi_val</i>
clear sub namespace sgw imsiimsi_valpurge true	No	Yes	Subscriber with IMSI as <i>imsi_val</i>
clear sub namespace sgw imsiimsi_valebi_value	Yes	Yes	PDN with IMSI as <i>imsi_val</i> and default ebi as <i>ebi_value</i>

Call Flows

This section describes the key call flows for this feature.

Clear PDN Call Flow

This section describes the Clear PDN call flow.

Figure 20: Clear PDN Call Flow

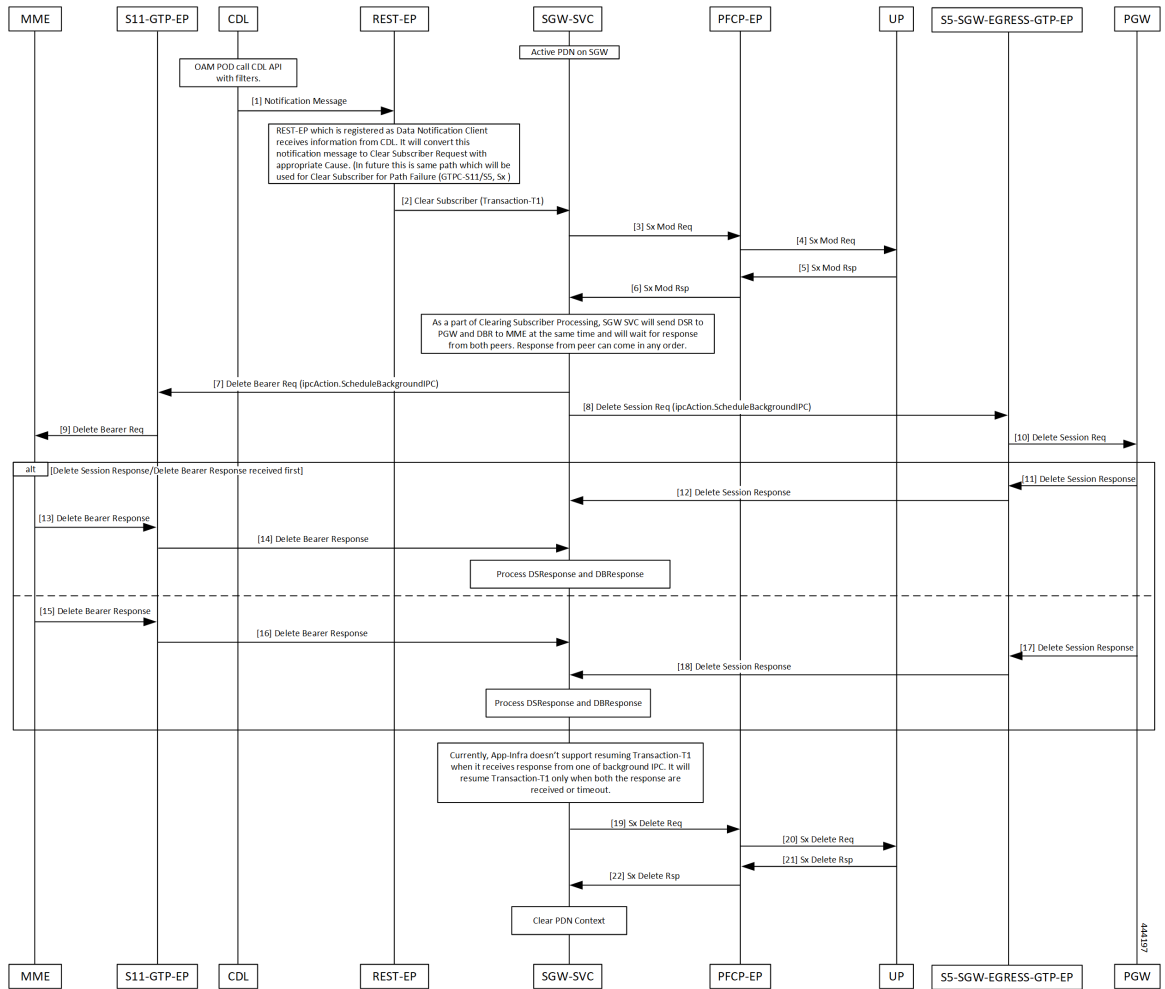

Table 32: Clear PDN Call Flow Description

Step	Description
1	The OAM pod calls the CDL API with the filters. CDL sends the notification message to REST EP.
2	The REST-EP converts this message to Clear Subscriber Request with a cause and sends Clear Subscriber to the SGW-Service pod. Transaction-T1 started.
3-6	The SGW-Service pod sends Sx Modification Request to UPF through PFCP-EP. The SGW-Service pod receives Sx Modification Response from UPF through PFCP-EP.
7	The SGW-Service pod sends the Delete Bearer Request to the S11-GTP-EP.
8	The SGW-Service pod sends the Delete Session Request to the S5-SGW-EGRESS-GTP-EP.

Step	Description
9	The S11-GTP-EP sends the Delete Bearer Request to MME.
10-12	The S5-SGW-EGRESS-GTP-EP sends the Delete Session Request to PGW. The PGW sends the Delete Session Response to S5-SGW-EGRESS-GTP-EP. The S5-SGW-EGRESS-GTP-EP forwards this request to the SGW-Service pod.
13-16	MME sends the Delete Bearer Response to S11-GTP-EP. S11-GTP-EP forwards to the SGW-Service pod.
17, 18	PGW sends the Delete Session Response to S5-SGW-EGRESS-GTP-EP. S5-SGW-EGRESS-GTP-EP forwards this request to the SGW-Service pod.
19-22	The SGW-Service pod sends the Sx Delete Request to PFCP-EP. The PFCP-EP forwards the request to UPF. UPF sends the Sx Delete Response to PFCP-EP, which it forwards it to the SGW-Service pod.



CHAPTER 12

Context Replacement Support

- [Feature Summary and Revision History, on page 113](#)
- [Feature Description, on page 114](#)
- [How it Works, on page 114](#)
- [OAM Support, on page 119](#)

Feature Summary and Revision History

Summary Data

Table 33: Summary Data

Applicable Product(s) or Functional Area	cnSGW-C
Applicable Platform(s)	SMI
Feature Default Setting	Enabled - Always-on
Related Documentation	Not Applicable

Revision History

Table 34: Revision History

Revision Details	Release
Introduced support for partial context replacement.	2021.02.0
First introduced.	2020.01.0

Feature Description

The cnSGW-C supports context replacement when it receives Create Session Request (CSReq) with the existing EBI. When the MME node and cnSGW-C are not synchronized, the session gets locally terminated on the MME. The MME sends a CSReq with the EBI that is already present in the cnSGW-C. If the CSReq contains a TEID with value as non-ZERO, then cnSGW-C partially replaces the context. When TEID is zero, cnSGW-C performs full context replacement.

How it Works

This section describes how this feature works.

Call Flows

This section describes the key call flows for this feature.

Full Context Replacement Call Flow

This section describes the full context replacement call flow.

Create Session Request Call Flow

This section describes the Create Session Request call flow.

Figure 21: Create Session Request (Context Replacement – Single or Multi-PDN subscriber) Call Flow

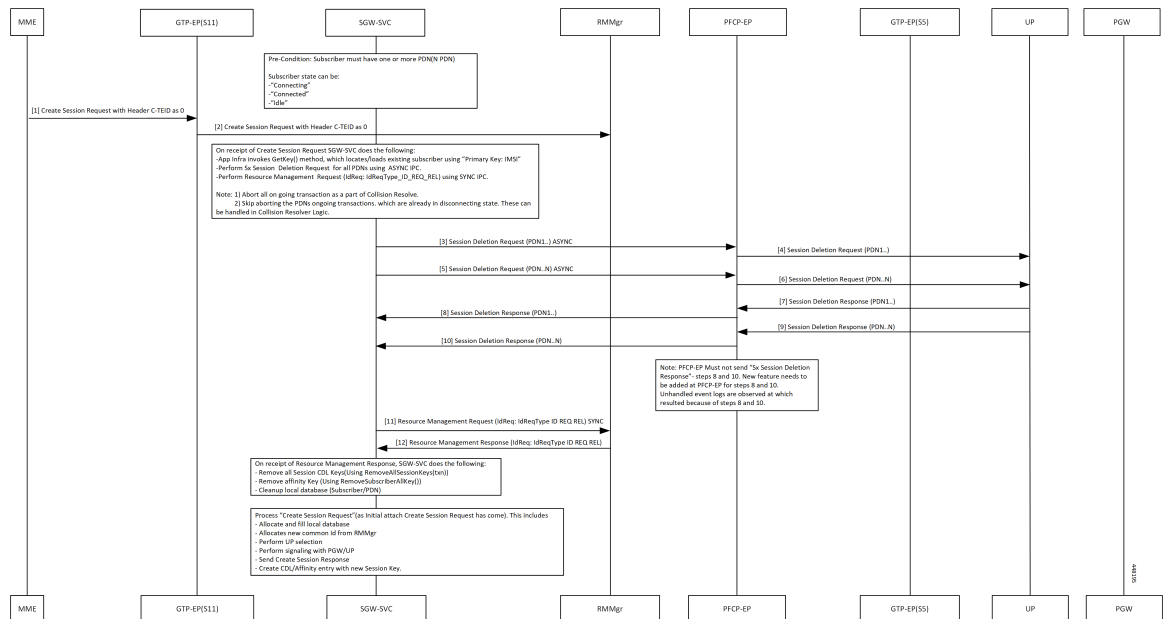

Table 35: Create Session Request (Context Replacement – Single or Multi-PDN subscriber) Call Flow Description

Step	Description
1	MME sends Create Session Request with C-TEID as zero to GTPC-EP ingress.
2	GTPC-EP ingress forwards the Create Session Request to SGW-SVC. Following actions takes place: <ul style="list-style-type: none"> • App Infra invokes the GetKey() method, which locates and loads the existing subscribers using Primary Key: IMSI. • Performs Sx Session Deletion Request for all PDNs using ASYNC IPC • Performs Resource Management Request (IdReq: IdReqType_ID_REQ_REL) using SYNC IPC
3, 5	The SGW service pod sends the Delete Session Request for PDN 1 - N to PFCP-EP.
4, 6	PFCP-EP forwards Delete Session Request for PDN 1 - N to UPF.
7, 9	PFCP-EP receives Delete Session Response for PDN 1 to N from UPF.
8, 10	PFCP-EP forwards Delete Session Response for PDN 1 - N to SGW service pod.
11	SGW service pod sends Resource Management Request to RMMgr with request ID-type as Request REL.
12	SGW service pod receives Resource Management Response from RMMgr with Req ID-type as REQ REL. The SGW service pod performs following: <ul style="list-style-type: none"> • Removes all session CDL keys (Using RemoveAllSessionKeys(txn)) • Removes affinity Key (Using RemoveSubscriberAllKey()) • Cleans up the local database (Subscriber/PDN)



Note You can ignore unhandled events for the Deletion Response from UPF.

Partial Context Replacement Call Flow

This section describes the partial context replacement call flow.

When cnSGW-C receives a CSReq with the existing EBI and TEID as non-ZERO, then cnSGW-C performs a partial context replacement by invoking the following call flows:

- EBI received in CSReq is for the existing default bearer.
- EBI received in CSReq is for the existing dedicated bearer.

Create Session Request with Default Bearer EBI Call Flow

This section describes the Create Session Request with Default Bearer EBI call flow.

Figure 22: CSReq with Default Bearer EBI Call Flow

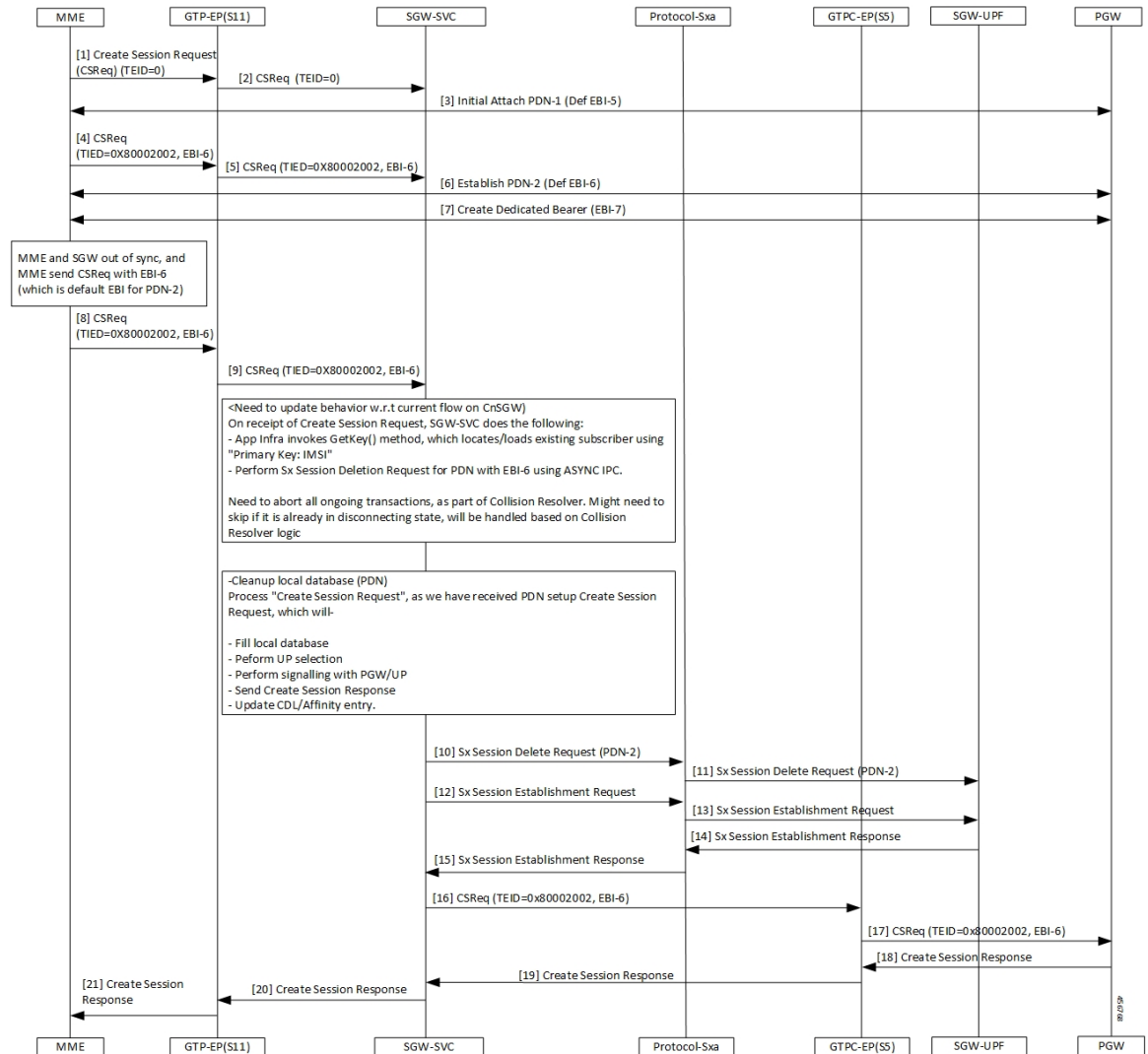

Table 36: CSReq with Default Bearer EBI Call Flow Description

Step	Description
1	The MME sends a Create Session Request with TIED value as 0 to the GTPC-EP(S11).
2	The GTPC-EP(S11) forwards the Create Session Request with TIED value as 0 to the SGW-SVC.
3	The MME and the PGW process the Initial Attach PDN-1 with the default EBI-5 process.
4	The MME sends a Create Session Request TIED=0x80002002 with EBI-6 to the GTPC-EP.

Step	Description
5	The GTPC-EP forwards the Create Session Request TIED=0x80002002 with EBI-6 to the SGW-SVC.
6	The MME and the PGW establish the PDN-2 with default EBI-6 connection.
7	The MME and PGW complete the Create Dedicated Bearer with EBI-7 process.
8	If the SGW and MME are not in sync, the MME sends a Create Session Request with EBI-6 present in the SGW.
9	The GTPC-EP sends a CSReq TIED= 0x80002002 with EBI-6 to SGW.
10	After receiving the Create Session Request, the SGW-SVC performs the following- <ul style="list-style-type: none"> • Cleans up the PDN with default EBI=6. • Sends the Sx signalling to UPF to clear the session. • Performs the Create Session Request as a new PDN-Setup. The SGW sends an Sx Session Delete Request on PDN-2 to Protocol-SXA.
11	The Protocol-SXA forwards a Sx Session Delete Request to SGW-UPF.
12	The SGW sends a Session Establishment Request to the Protocol-SXA.
13	The Protocol-SXA forwards a Sx Session Establishment Request to SGW-UPF.
14	The SGW-UPF responds to the Protocol-SXA with the Sx Session Establishment Response.
15	The Protocol-SXA sends the Sx Session Establishment Response to the SGW-SVC.
16	The SGW-SVC sends the Create Session Request TIED= 0x80002002 with EBI-6 to the GTPC-EP.
17	The GTPC-EP sends the Create Session Request TIED= 0x80002002 with EBI-6 to the PGW.
18	The PGW sends a Create Session Response to the GTPC-EP.
19	The GTPC-EP responds to the SGW-SVC with the Create Session Response.
20	The SGW-SVC forwards the response to the GTPC-EP.
21	The GTPC-EP sends the Create Session Response to the MME.

Create Session Request with Dedicated Bearer EBI Call Flow

This section describes the Create Session Request with the Dedicated EBI call flow.

Figure 23: CSReq with Dedicated Bearer EBI Call Flow

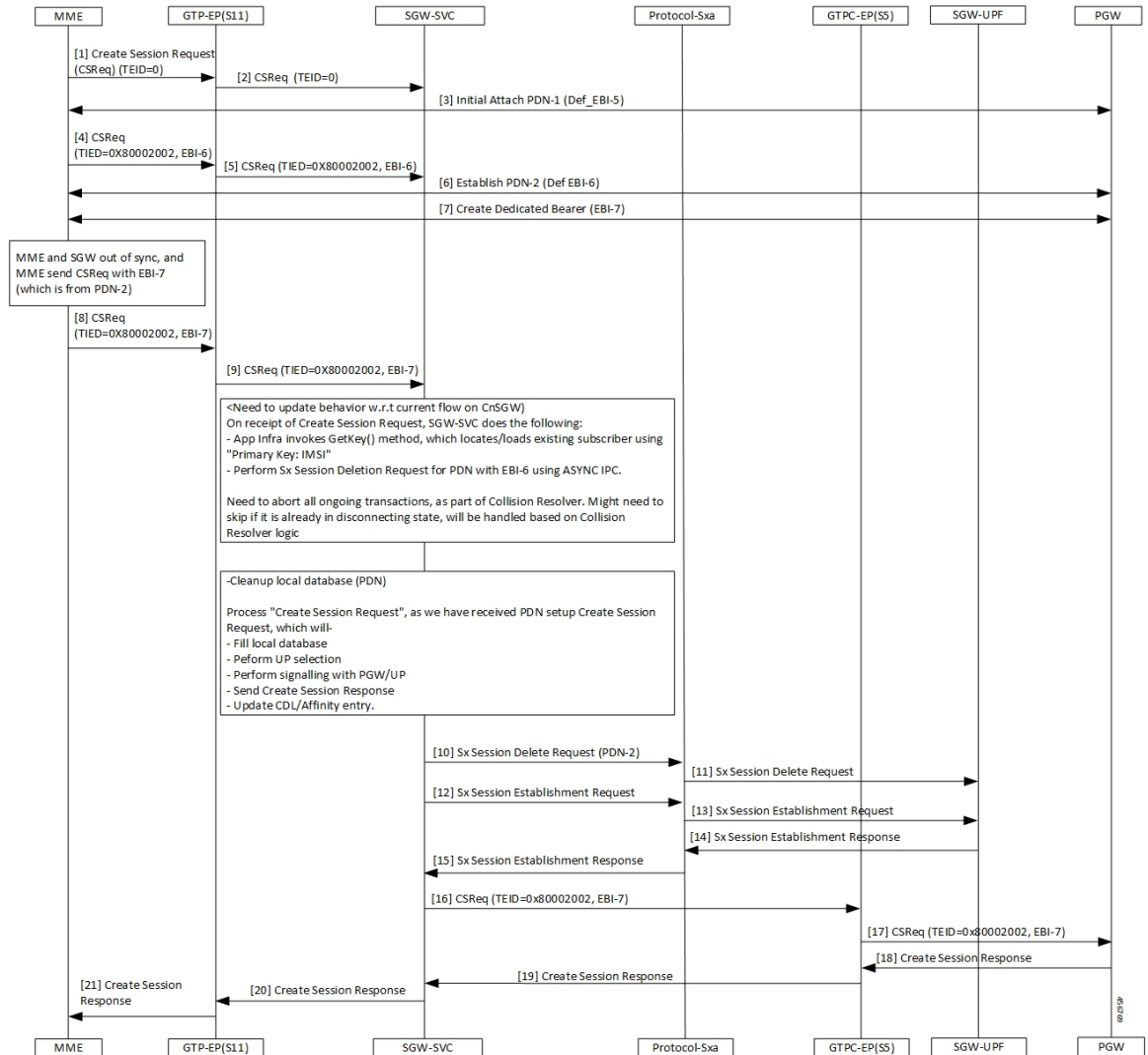

Table 37: CSReq with Dedicated Bearer EBI Call Flow Description

Step	Description
1	The MME sends a Create Session Request with the TIED value as zero to the GTPC-EP(S11).
2	The GTPC-EP(S11) forwards the Create Session Request with TIED value as zero to the SGW-SVC.
3	The MME and the PGW process the Initial Attach PDN with the EBI-5 process.
4	The MME sends the Create Session Request with EBI-6 to the GTPC-EP.
5	The GTPC-EP forwards the Create Session Request with EBI-6 to the SGW-SVC.
6	The MME and PGW establish the PDN with the EBI-6 connection.

Step	Description
7	The MME and PGW complete the Create Dedicated Bearer with EBI-7 process.
8	If the SGW and MME are not in sync, then MME sends a Create Session Request with EBI-6 present in SGW.
9	The GTPC-EP sends a CSReq with EBI-7 to SGW.
10	After receiving the Create Session Request, the SGW-SVC: <ul style="list-style-type: none"> • Cleans up the PDN with default EBI=6. • Sends the Sx signalling to UPF to clear the session. • Performs the Create Session Request as new PDN-Setup. The SGW sends a Sx Session Delete Request on PDN-2 to Protocol-SXA.
11	The Protocol-SXA forwards the Sx Session Delete Request to SGW-UPF.
12	The SGW sends a Session Establishment Request to the Protocol-SXA.
13	The Protocol-SXA forwards a Sx Session Establishment Request to SGW-UPF.
14	The SGW-UPF responds to the Protocol-SXA with the Sx Session Establishment Response.
15	The Protocol-SXA sends the Sx Session Establishment Response to the SGW-SVC.
16	The SGW-SVC sends the Create Session Request containing TIED=0x80002002, EBI-7 to the GTPC-EP.
17	The GTPC-EP sends the Create Session Request containing TIED=0x80002002, EBI-7 to the PGW.
18	The PGW sends a Create Session Response to the GTPC-EP.
19	The GTPC-EP responds to the SGW-SVC with the Create Session Response.
20	The SGW-SVC forwards the response to the GTPC-EP.
21	The GTPC-EP sends the Create Session Response to the MME.

OAM Support

This section describes operations, administration, and maintenance support for this feature.

Bulk Statistics

The following statistics are supported for the partial context replacement feature.

- `sgw_pdn_disconnect_stats`: Captures the total number of SGW PDN in the disconnected status.

An example of the Prometheus query:

```
sgw_pdn_disconnect_stats{app_name="smf",cluster="cn",data_center=\  
"cn",instance_id="0",pdn_type="ipv4",rat_type="EUTRAN",reason="context_replacement",\  
service_name="sgw-service"} 1
```



CHAPTER 13

Dedicated Bearer Support

- [Feature Summary and Revision History, on page 121](#)
- [Feature Description, on page 121](#)
- [Setup and Update Dedicated Bearers, on page 122](#)
- [Delete Dedicated Bearers, on page 129](#)

Feature Summary and Revision History

Summary Data

Table 38: Summary Data

Applicable Product(s) or Functional Area	cnSGW-C
Applicable Platform(s)	SMI
Feature Default Setting	Enabled - Always-on
Related Documentation	Not Applicable

Revision History

Table 39: Revision History

Revision Details	Release
First introduced.	2021.01.0

Feature Description

Setup and Update Dedicated Bearers

cnSGW-C supports creating and updating single/multiple dedicated bearers.

Delete Dedicated Bearers

cnSGW-C supports deletion of single/multiple dedicated bearers.

Setup and Update Dedicated Bearers

Feature Description

cnSGW-C supports creating and updating dedicated bearers for both single and multiple PDN subscribers. It also supports multiple bearer contexts as part of single create bearer procedure.

How it Works

This section describes how this feature works.

Call Flows

This section describes the key call flows for this feature.

Dedicated Bearer Setup – Request Accepted Call Flow

This section describes the Dedicated Bearer Setup – Request Accepted call flow.

Figure 24: Dedicated Bearer Setup – Request Accepted Call Flow

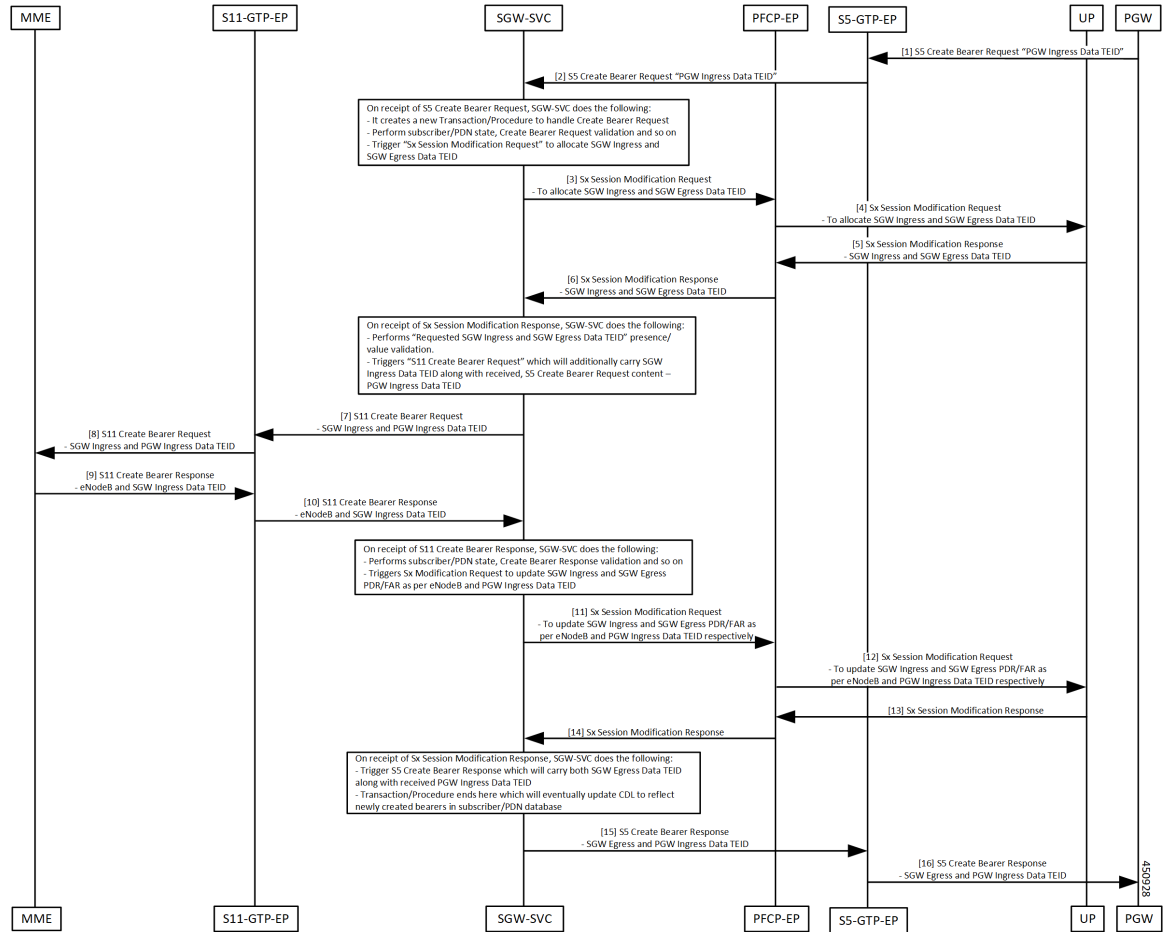

Table 40: Dedicated Bearer Setup – Request Accepted Call Flow Description

Step	Description
1	The PGW sends the S5 Create Bearer Request to the S5-GTP-EP pod.
2	The S5-GTP-EP pod forwards the S5 Create Bearer Request to the SGW-SVC pod.
3	The SGW-SVC receives the S5 Create Bearer request and performs the following: <ul style="list-style-type: none"> • Creates a new transaction • Performs GTP validations • Triggers the Sx Modification Request to the PFCP-EP pod
4	The PFCP-EP pod forwards the Sx Modification Request to the UP for allocating SGW Ingress and SGW Egress TEIDs.
5	The PFCP-EP pod receives the Sx Modification Response with SGW Ingress and SGW Egress TEIDs, from the UP.

Step	Description
6	The PFCP-EP pod forwards the Sx Modification Response with SGW Ingress and SGW Egress TEIDs, to the SGW-SVC.
7	The SGW-SVC receives the Sx Modification response and performs the following: <ul style="list-style-type: none"> • Validates the received SGW Ingress and SGW Egress TEIDs • Triggers the S11 Create Bearer Request with the SGW Ingress TEID to the S11-GTPC-EP pod
8	The S11-GTPC-EP pod forwards the S11 Create Bearer Request with the SGW Ingress TEID, to the MME.
9	The MME sends the S11 Create Bearer Response to the S11-GTPC-EP pod.
10	The S11-GTPC-EP pod forwards the S11 Create Bearer Response to the SGW-SVC.
11	The SGW-SVC receives the S11 Create Bearer response and performs the following: <ul style="list-style-type: none"> • GTP validations • Triggers the Sx Modification Request to the PFCP-EP pod to update SGW Ingress and SGW Egress PDR/FAR, with the MME and the PGW GTPU-TEID
12	The PFCP-EP pod forwards the Sx Modification Request to the UP.
13	The UP sends the Sx Modification Response to the PFCP-EP pod.
14	The PFCP-EP pod forwards the Sx Modification Response to the SGW-SVC pod.
15, 16	The SGW-SVC pod receives the Sx Modification Response and performs the following: <ul style="list-style-type: none"> • Ends the transaction/procedure • Updates the CDL • Sends the S5 Create Bearer Response with SGW Egress TEIDs with matching PGW GTPU TEIDs, and with the cause as Accepted.

Dedicated Bearer Setup – Request Accepted Partially Call Flow

This section describes the Dedicated Bearer set up call flow. In this procedure, the MME sends the Create Bearer Response with the GTP cause as Request Accepted Partially.

Prerequisite: Create Bearer Procedure with two bearer contexts.

Figure 25: Dedicated Bearer Setup – Request Accepted Partially Call Flow

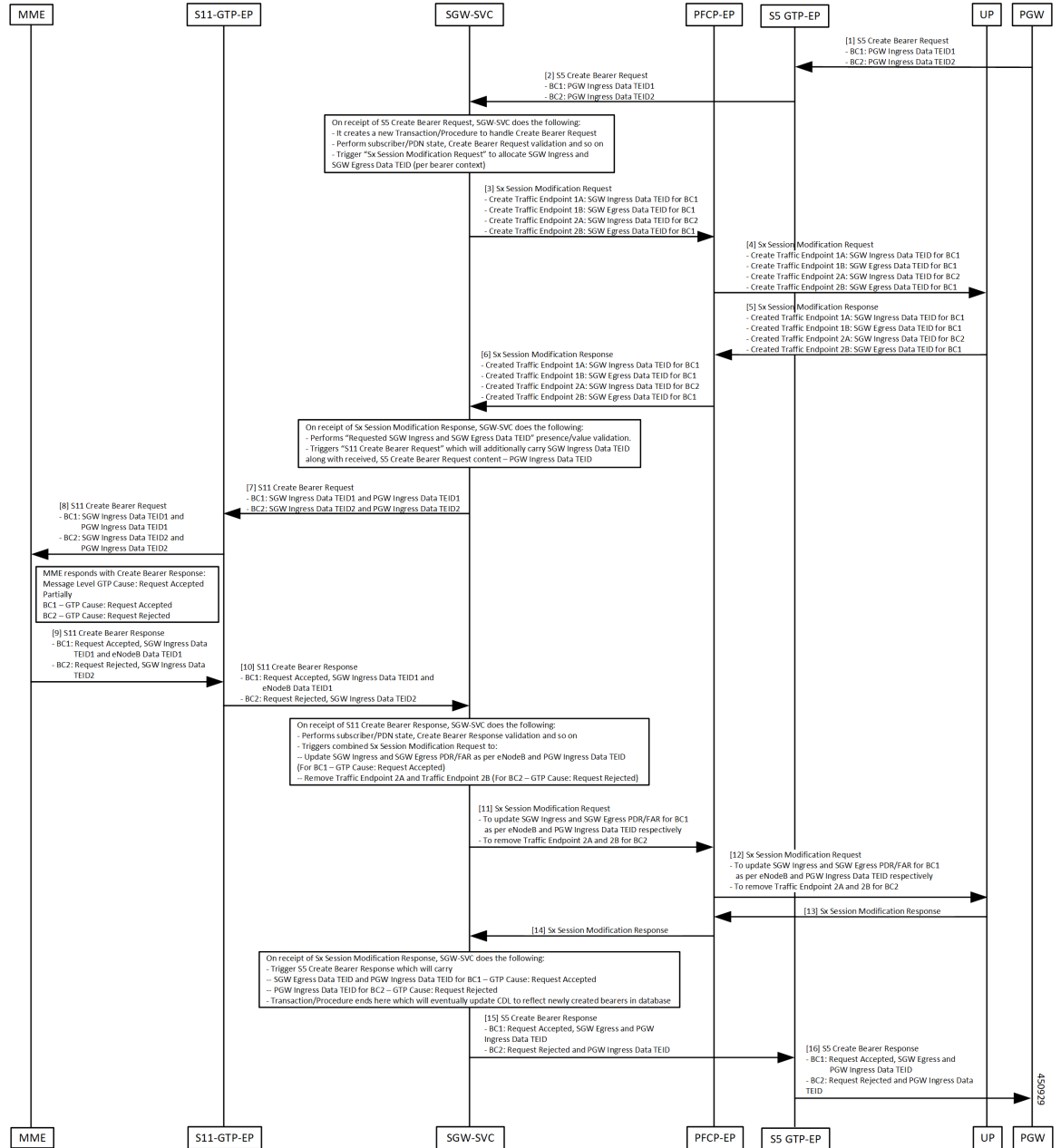

Table 41: Dedicated Bearer Setup – Request Accepted Partially Call Flow Description

Step	Description
1	The PGW sends the S5 Create Bearer Request with multiple bearer contexts to the S5-GTP-EP pod.
2	The S5-GTP-EP pod forwards the S5 Create Bearer Request to the SGW-SVC pod.

Step	Description
3	The SGW-SVC pod receives the S5 Create Bearer request and performs the following: <ul style="list-style-type: none"> • Creates a new transaction • Performs GTP validations • Triggers the Sx Modification Request to allocate SGW Ingress and SGW Egress TEIDs to the PFCP-EP pod.
4	The PFCP-EP pod forwards the Sx Modification Request to the UP.
5	The UP sends the Sx Modification Response to the PFCP-EP pod.
6	The PFCP-EP pod forwards the Sx Modification Response to the SGW-SVC pod.
7	The SGW-SVC receives the Sx Modification Response and performs the following: <ul style="list-style-type: none"> • Validates the received SGW Ingress and SGW Egress TEIDs • Triggers an S11 Create Bearer Request with the SGW Ingress TEID to the S11-GTPC-EP pod
8	The S11-GTPC-EP pod forwards the S11 Create Bearer Request to the MME.
9	The S11-GTPC-EP receives the S11 Create Bearer Response from the MME, with the Message Level GTP cause as Request Accepted Partially: <ul style="list-style-type: none"> • For some Bearer Contexts, GTP cause is Request Accepted • For some Bearer Contexts, GTP cause is Request Rejected
10	The S11-GTPC-EP pod forwards the S11 Create Bearer Response to the SGW-SVC pod.
11	The SGW-SVC pod receives the S11 Create Bearer response and performs the following: <ul style="list-style-type: none"> • GTP validations • For successful bearers: Triggers the Sx Modification Request to the PFCP-EP pod for updating SGW Ingress and SGW Egress PDR/FAR with the MME and the PGW GTPU-TEID • For failed bearers: Removes the traffic endpoints
12	The PFCP-EP pod forwards the Sx Modification Request to the UP.
13	The UP sends the Sx Modification Response to the PFCP-EP pod.
14	The PFCP-EP pod forwards the Sx Modification Response to the SGW-SVC pod.

Step	Description
15, 16	The SGW-SVC pod receives the Sx Modification Response and performs the following: <ul style="list-style-type: none">• Ends the transaction/procedure• Updates the CDL• For successful bearers: Sends the S5 Create Bearer Response with SGW Egress TEIDs with matching PGW GTPU TEIDs.• For failed bearers: Sends the bearer contexts as is with the message level cause as Partially Accepted.

Dedicated Bearer Update – Request Accepted Call Flow

This section describes the Default/Dedicated Bearer Update Procedure call flow.

Single Update Bearer Procedure supports:

- Default bearer QoS/TFT change
- Single/Multiple dedicated bearer QoS/TFT change
- APN-AMBR change



Note The call flow doesn't contain Sx Communication Messages related to the Default/Dedicated Bearer Update procedure.

Figure 26: Default/Dedicated Bearer Update (Single/Multiple Bearers) Support Call Flow

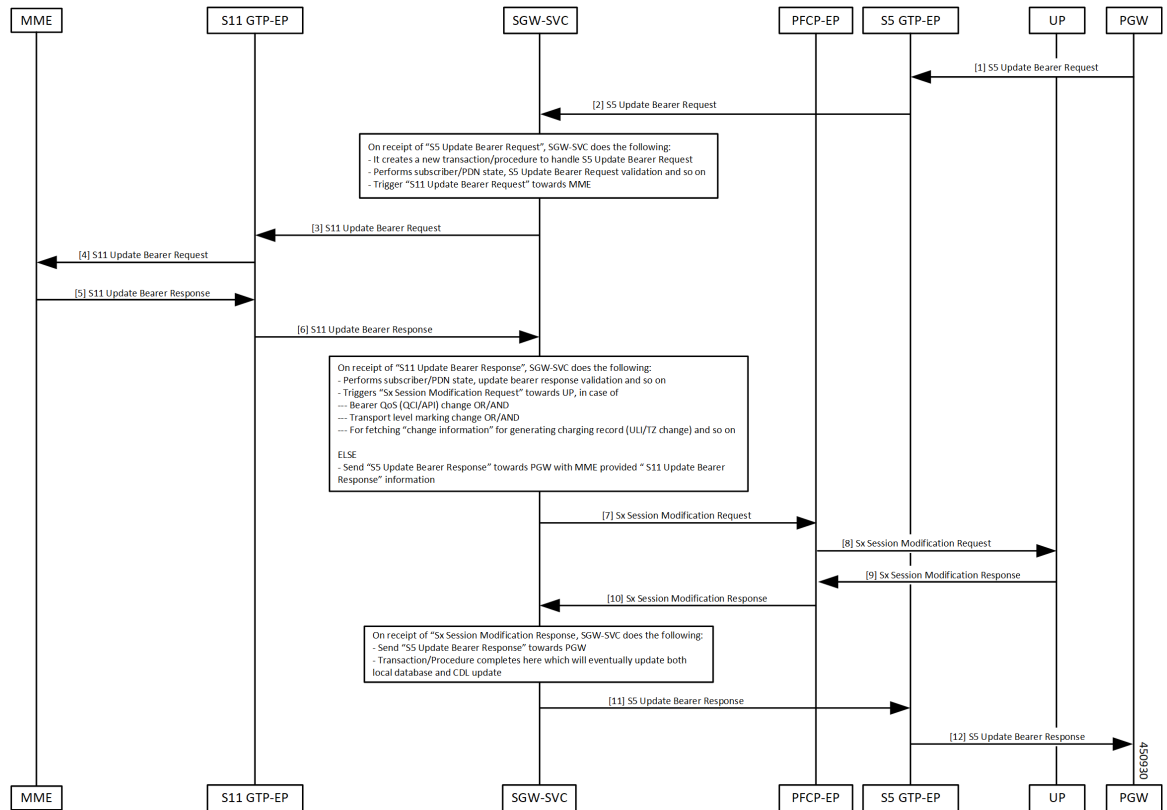

Table 42: Default/Dedicated Bearer Update (Single/Multiple Bearers) Support Call Flow Description

Step	Description
1	The PGW sends the S5 Update Bearer Request with multiple bearer contexts to the GTPC-EP pod.
2	The GTPC-EP pod forwards the S5 Update Bearer request to the SGW-SVC pod.
3	SGW-SVC receives the S5 Update Bearer request and performs the following: <ul style="list-style-type: none"> • Creates a new transaction • Performs GTP validations • Triggers the S11 Update Bearer Request to the GTPC-EP pod
4	The GTPC-EP pod forwards the S11 Update Bearer Request to the MME.
5	The MME sends the S11 Update Bearer Response to the GTPC-EP pod.
6	The GTPC-EP pod forwards the S11 Update Bearer Response to the SGW-SVC pod.

Step	Description
7	<p>SGW-SVC receives the S11 Update Bearer Response and performs GTP validations.</p> <ul style="list-style-type: none"> • If: Any of the following is true, the SGW-SVC triggers Sx Modification Request to the PFCP-EP pod: <ul style="list-style-type: none"> • Bearer QoS (QCI/ARP) change • Transport Level Marking change • Fetch charging information for generating charging record ULI/TZ change • Else: The SGW-SVC sends the S11 Update Bearer Response to the PGW with the MME-provided S11 Update Bearer Response information.
8	The PFCP-EP pod forwards the Sx Session Modification Request to the UP.
9	The UP sends the Sx Session Modification Response to the PFCP-EP pod.
10	<p>The PFCP-EP pod forwards the Sx Session Modification Response to the SGW-SVC. The SGW-SVC receives the Sx Modification Response and performs the following:</p> <ul style="list-style-type: none"> • Ends the transaction/procedure • Updates the CDL • Sends the S5 Update Bearer Response with cause as Accepted
11	<p>The SGW-SVC sends the S5 Update Bearer Response to the PFCP-EP pod.</p> <p>The PFCP-EP pod forwards the S5 Update Bearer Response to the GTP-EP pod.</p>
12	<p>The GTP-EP pod forwards the S5 Update Bearer Response to the UP.</p> <p>The UP forwards the S5 Update Bearer Response to the PGW.</p>

Delete Dedicated Bearers

Feature Description

cnSGW-C supports single/multiple dedicated bearer deletion as part of single delete bearer procedure.

How it Works

This section describes how this feature works.

Call Flows

This section describes the key call flows for this feature.

Dedicated Bearer Deletion Procedure Call Flow

This section describes the Dedicated Bearer Delete Procedure call flow.

Figure 27: Dedicated Bearer Deletion Procedure (Single/Multiple Bearer) Call Flow

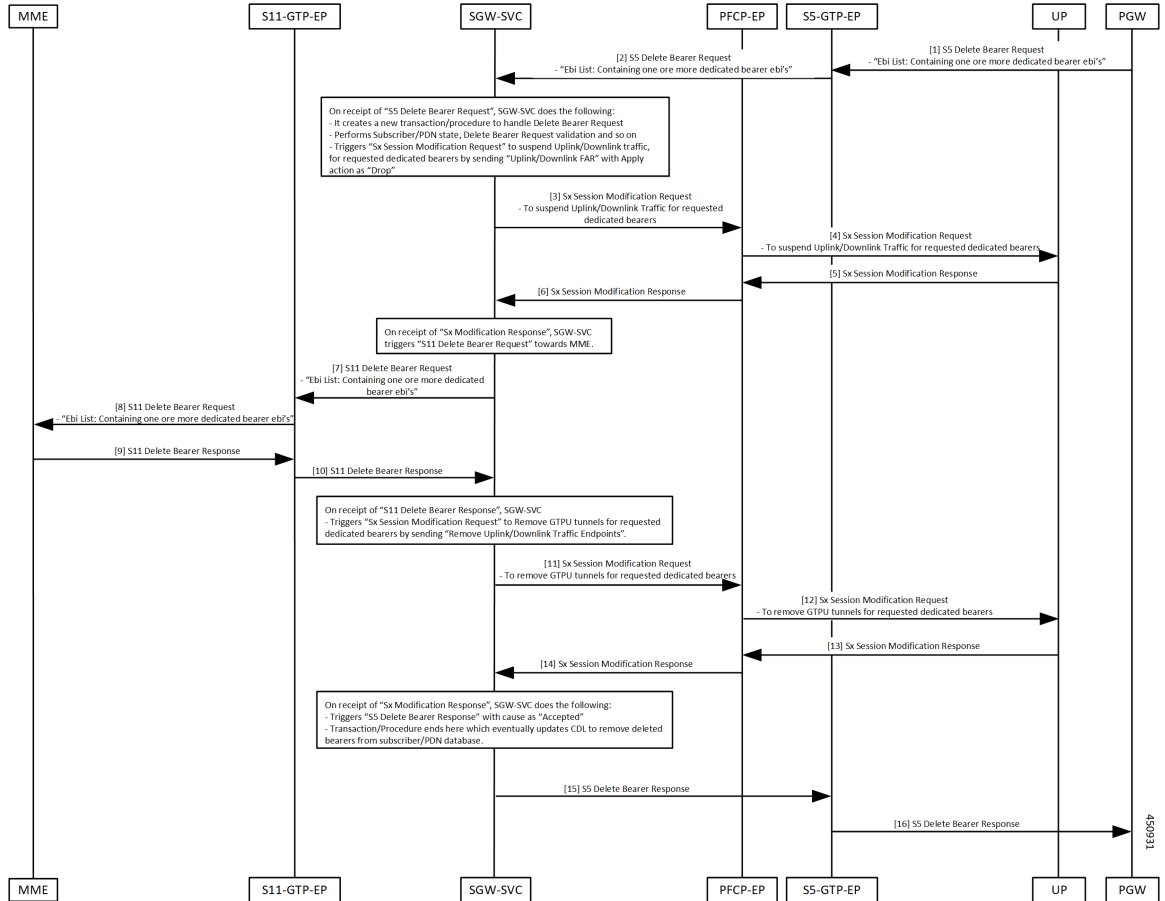

Table 43: Dedicated Bearer Deletion Procedure (Single/Multiple Bearer) Call Flow Description

Step	Description
1	The PGW sends the S5 Delete Bearer Request with EBI list containing one or more dedicated bearer EBIs, to the GTPC-EP pod.
2	The GTPC-EP pod forwards the S5 Delete Bearer Request to the SGW-SVC pod.
3	The SGW-SVC pod receives the S5 Delete Bearer request and performs the following: <ul style="list-style-type: none"> • Creates a new transaction • Performs GTP validations • Triggers the Sx Modification Request to the PCFCP-EP pod to suspend uplink/downlink traffic for the requested bearers
4	The PCFCP-EP pod forwards the Sx Modification Request to the UP.

Step	Description
5	The UP sends the Sx Modification Response to the PFCP-EP pod.
6	The PFCP-EP pod forwards the Sx Modification Response to the SGW-SVC pod.
7	The SGW-SVC pod receives the Sx Modification Response and triggers the S11 Delete Bearer Request to the GTPC-EP pod.
8	The GTPC-EP pod forwards the S11 Delete Bearer Request to the MME.
9	The MME sends the S11 Delete Bearer Response to the GTPC-EP pod.
10	The GTPC-EP pod forwards the S11 Delete Bearer Response to the SGW-SVC pod.
11	The SGW-SVC receives the S11 Delete Bearer Response and triggers the Sx Modification Request to the PFCP-EP pod, to remove traffic endpoints for removal of the GTPU tunnels for the requested dedicated bearers.
12	The PFCP-EP pod forwards the Sx Modification Request to the UP to remove GTP tunnels for the requested dedicated bearers.
13	The UP sends the Sx Modification Response to the PFCP-EP pod.
14	The PFCP-EP forwards the Sx Modification Response to the SGW-SVC pod.
15	The SGW-SVC receives the Sx Modification Response and performs the following: <ul style="list-style-type: none"> • Ends the transaction/procedure • Updates the CDL • Sends the S5 Delete Bearer Response with cause as Accepted, to the GTP-EP pod
16	The GTP-EP pod forwards the S5 Delete Bearer Response to the PGW.



CHAPTER 14

Delete Bearer and Delete Session Request

- [Feature Summary and Revision History, on page 133](#)
- [Feature Description, on page 133](#)
- [How it Works, on page 134](#)

Feature Summary and Revision History

Summary Data

Table 44: Summary Data

Applicable Product(s) or Functional Area	cnSGW-C
Applicable Platform(s)	SMI
Feature Default Setting	Enabled - Always-on
Related Documentation	Not Applicable

Revision History

Table 45: Revision History

Revision Details	Release
First introduced.	2020.04

Feature Description

This feature supports the following:

- Deletion of Session Request from the MME
- Deletion of Bearer Request from the PGW

This deletion helps in clearing the PDN connection at the SGW, which in turn clears resources at the cnSGW-C, and releases all the relevant TEIDs.

Delete from MME

1. cnSGW-C sends the Sx Modification Request to the User Plane (UP) to mark the forwarding action as DROP so that all uplink or downlink packets are dropped at the SGW-U.
2. cnSGW-C sends the Delete Session Request to the PGW/SMF.
3. After SGW receives the Delete Session Response from the PGW/SMF, cnSGW-C sends the Sx Terminate Request to the UP to clear the session.
4. After UP confirms the deletion of the SGW-U session, cnSGW-C releases the allocated ID by sending request to the Node Manager, and the Delete Session Response to the MME.

Delete from PGW

1. cnSGW-C sends the Sx Modification Request to the UP to mark the forwarding action as DROP so that all the uplink and downlink packets are dropped at the SGW-U.
2. cnSGW-C sends the Delete Bearer Request to the MME.
3. After SGW receives the Delete Bearer Response from the MME, the cnSGW-C sends the Sx Terminate Request to the UP to clear the session.
4. After UP confirms the deletion of the SGW-U session, cnSGW-C releases the allocated ID by sending request to the Node Manager, and the Delete Bearer Response to the PGW.

Standard Compliance

The Delete Bearer and Delete Session Request Support feature complies with the following standards:

- 3GPP TS 23.401 "General Packet Radio Service (GPRS) enhancements for Evolved Universal Terrestrial Radio Access Network (E-UTRAN) access"
- 3GPP TS 23.214 "Architecture enhancements for control and user plane separation of EPC nodes"
- 3GPP TS 29.274 "3GPP Evolved Packet System (EPS); Evolved General Packet Radio Service (GPRS) Tunnelling Protocol for Control plane (GTPv2-C); Stage 3"
- 3GPP TS 29.244 "Interface between the Control Plane and the User Plane nodes"

How it Works

This section describes how this feature works.

Call Flows

This section describes the key call flows for this feature.

Figure 28: Delete from MME Call Flow

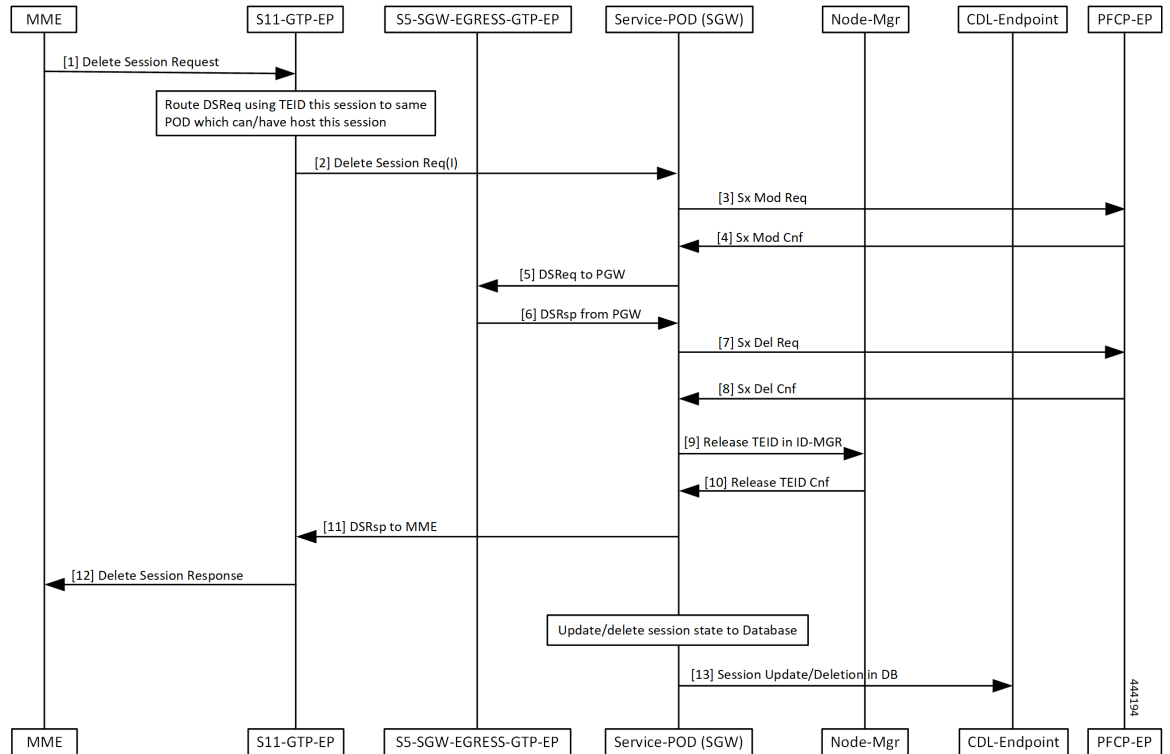

Table 46: Delete from MME Call Flow Description

Step	Description
1	The MME sends the Delete Session Request to the S11-GTP-EP.
2	The S11-GTP-EP routes this message with TEID value to the Service-POD (SGW) which handles this session.
3	The Service-POD (SGW) sends the Sx Modification Request to PFCP-EP.
4	The PFCP-EP sends the Sx Modification Confirmation to the Service-POD (SGW).
5	The Service-POD (SGW) sends the Delete Session Request to the PGW through the S5-SGW-EGRESS-GTP-EP.
6	The Service-POD (SGW) receives the Delete Session Request from the PGW through the S5-SGW-EGRESS-GTP-EP.
7	The Service-POD (SGW) sends the Sx Delete Request to PFCP-EP.
8	The Service-POD (SGW) receives the Sx Delete Confirmation from PFCP-EP.
9	The Service-POD (SGW) sends Release TEID in ID-MGR to Node-Mgr.
10	The Service-POD (SGW) receives the Release TEID Confirmation from the Node-Mgr.

Step	Description
11	The Service-POD (SGW) sends the Delete Session Response to S11-GTP-EP.
12	The S11-GTP-EP sends the Delete Session Response to the MME.
13	The Service-POD (SGW) sends the Session Update or Delete in database message to the CDL.

Figure 29: Delete from PGW Call Flow

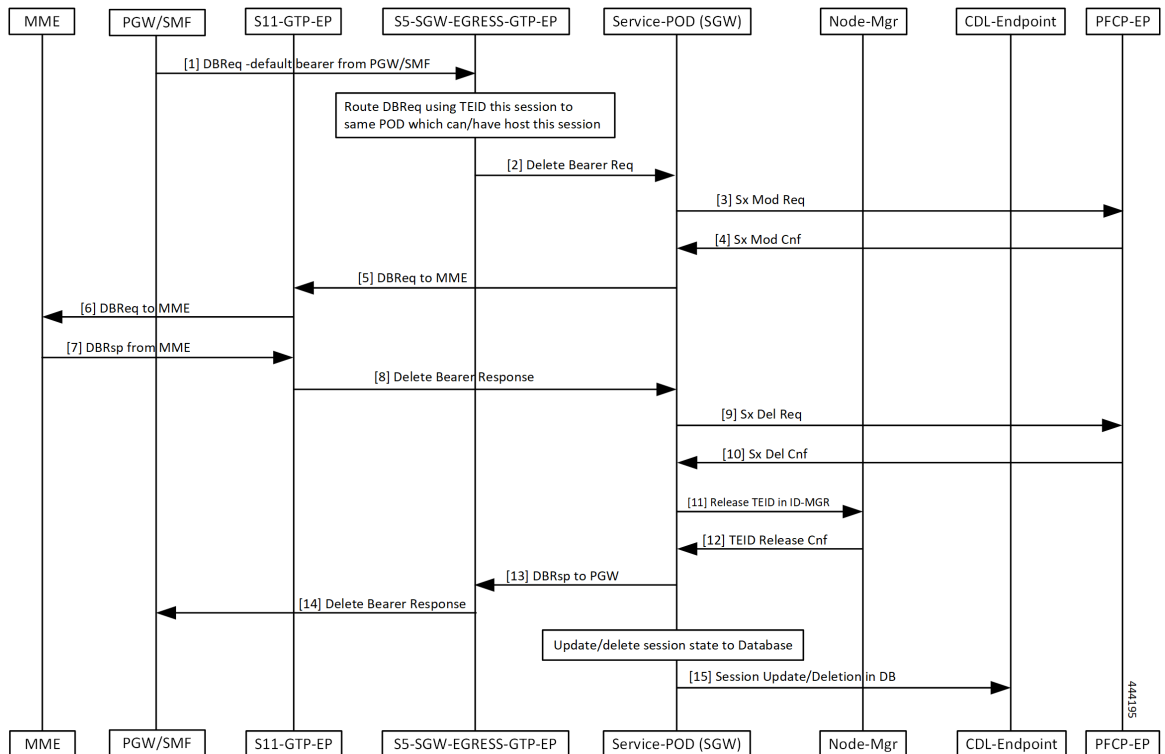

Table 47: Delete from PGW Call Flow Description

Step	Description
1	The PGW/SMF sends the Delete Bearer Request to the S5-SGW-EGRESS-GTP-EP.
2	The S5-SGW-EGRESS-GTP-EP performs routing of this message with TEID value to the same pod that has hosted this session. The S5-SGW-EGRESS-GTP-EP sends the Delete Bearer Request to the Service-POD (SGW).
3	The Service-POD (SGW) sends the Sx Modification Request to PFCP-EP and receives Sx Mod Cnf from it.
4	The PFCP-EP sends the Sx Modification Confirmation to the Service-POD (SGW).
5	The Service-POD (SGW) sends the Delete Bearer Request to the MME through the S11-GTP-EP.
6	The S11-GTP-EP forwards the Delete Bearer Request to the MME.

Step	Description
7	The MME sends the Delete Bearer Response to the S11-GTP-EP.
8	The S11-GTP-EP forwards the Delete Bearer Response to the Service-POD (SGW).
9	The Service-POD (SGW) sends the Sx Delete Request to the PFCP-EP.
10	The Service-POD (SGW) receives the Sx Delete Confirmation from the PFCP-EP.
11	The Service-POD (SGW) sends the Release TEID in ID-MGR to the Node-Mgr.
12	The Service-POD (SGW) receives the Release TEID Confirmation from the Node-Mgr.
13	The S11-GTP-EP sends the Delete Bearer Response to the PGW through S5-SGW-EGRESS-GTP-EP.
14	The S5-SGW-EGRESS-GTP-EP sends the Delete Bearer Response to the PGW/SMF.
15	The Service-POD (SGW) sends the Session Update or Delete in database message to the CDL.



CHAPTER 15

Downlink Data Notification

- [Feature Summary and Revision History, on page 139](#)
- [Feature Description, on page 140](#)
- [DDN Message Handling, on page 140](#)
- [Control Messages Triggered DDN Support, on page 148](#)
- [DDN Advance Features, on page 150](#)

Feature Summary and Revision History

Summary Data

Table 48: Summary Data

Applicable Product(s) or Functional Area	cnSGW-C
Applicable Platform(s)	SMI
Feature Default Setting	DDN Message Handling Support: Enabled - Always-on Control Messages Triggered DDN Support: Disabled - Configuration required to enable DDN Advance Features: Enabled - Always-on
Related Documentation	Not Applicable

Revision History

Table 49: Revision History

Revision Details	Release
Enhancement introduced. Added support for DDN Advance Features.	2021.02.0

Revision Details	Release
First introduced.	2021.01.0

Feature Description

The following sub-features are associated with this feature:

- DDN Message Handling
- Control Messages Triggered DDN
- Downlink Data Notification Delay
- High Priority Downlink Data Notification
- DDN Throttling

DDN Message Handling

Feature Description

cnSGW-C supports handling of the Downlink Data Notification (DDN) functionality that includes:

- Generating a DDN message towards the MME to page the UE on arrival of downlink data when UE is in IDLE state.
- Handling DDN ACK/DDN failure indication.

How it Works

This section describes how this feature works.

Call Flows

This section describes the key call flows for this feature.

Downlink Data Notification Success Call Flow

This section describes the Downlink Data Notification Success call flow.

Figure 30: Downlink Data Notification Success Procedure Call Flow

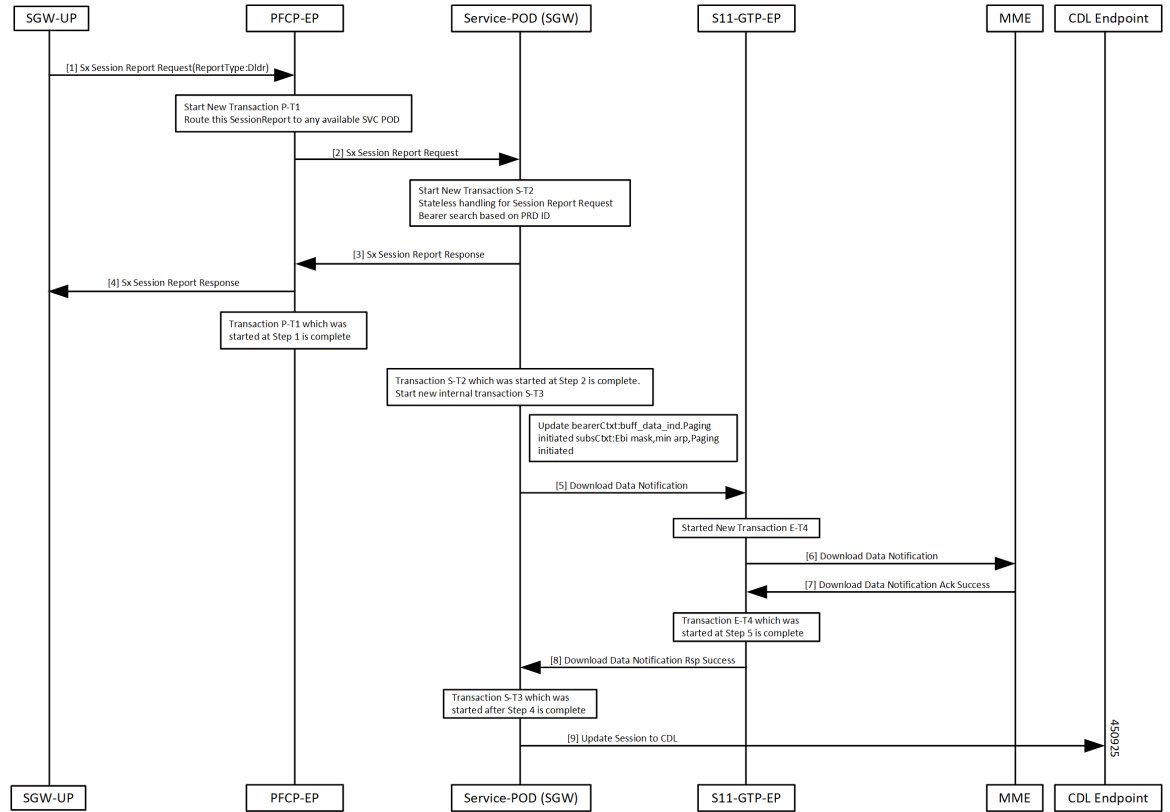

Table 50: Downlink Data Notification Success Procedure Call Flow Description

Step	Description
1	SGW-UP sends the Session Report Request to the PFCP-EP pod.
2	After receiving the Session Report Request, the PFCP-EP performs the following: <ul style="list-style-type: none"> Starts a new P-T1 transaction. Checks for the interface type. If its Sxa interface, it finds the available SGW-service pod and routes the request accordingly. Sends the Sx Session Report Request to the SGW-service pod.

Step	Description
3	<p>Upon reception of the Sx Session Report Request, SGW-service pod:</p> <ul style="list-style-type: none"> • Creates a new S-T2 transaction. • Based on the message type received, updates the state processing not required for this message. • Handles the non-state processing transaction. (High priority is given to handle such messages). • Searches for the bearer based on PDR ID. If the bearer isn't found, the SGW-service pod fills the cause as request rejected in the Session Report Response. • If the received report type in the request isn't valid/supported, SGW-service pod fills the cause as request rejected and sends the Sx Session Report Response.
4	<p>PFCP-EP forwards the Sx Session Report Response to the SGW-UP.</p>
5	<p>P-T1 transaction which is started at step one is completed.</p> <p>At SGW-service pod:</p> <ul style="list-style-type: none"> • S-T2 transaction which is started at step two is completed. • If the Sx Session Report Response is success, a new internal transaction S-T3 is started with the same buffer as of the Session Report Request. • A DDN procedure for DLDR report type is initiated. • Bearer information is extracted from the received PDR ID. • Bearer context is updated with buffer-data_ind. • Initiated the DDN with EBI of bearers, which has downlink data, and minimum ARP among these bearers. • Sends the DDN to the S11-GTP-EP pod.
6	<p>After receiving the DDN, S11-GTP-EP:</p> <ul style="list-style-type: none"> • Creates a new E-T4 transaction. • Sends the DDN to the MME.
7	<p>MME sends the DDN ACK Success to the S11-GTP-EP.</p>
8	<p>The transaction S-T3 which is started after step four is complete.</p> <p>S11-GTP-EP sends the DDN Response success to SGW-service pod.</p>
9	<p>SGW-service pod updates the CDL.</p>

Downlink Data Notification Failure Call Flow

This section describes the Downlink Data Notification Failure call flow.

Figure 31: Downlink Data Notification Failure Call Flow

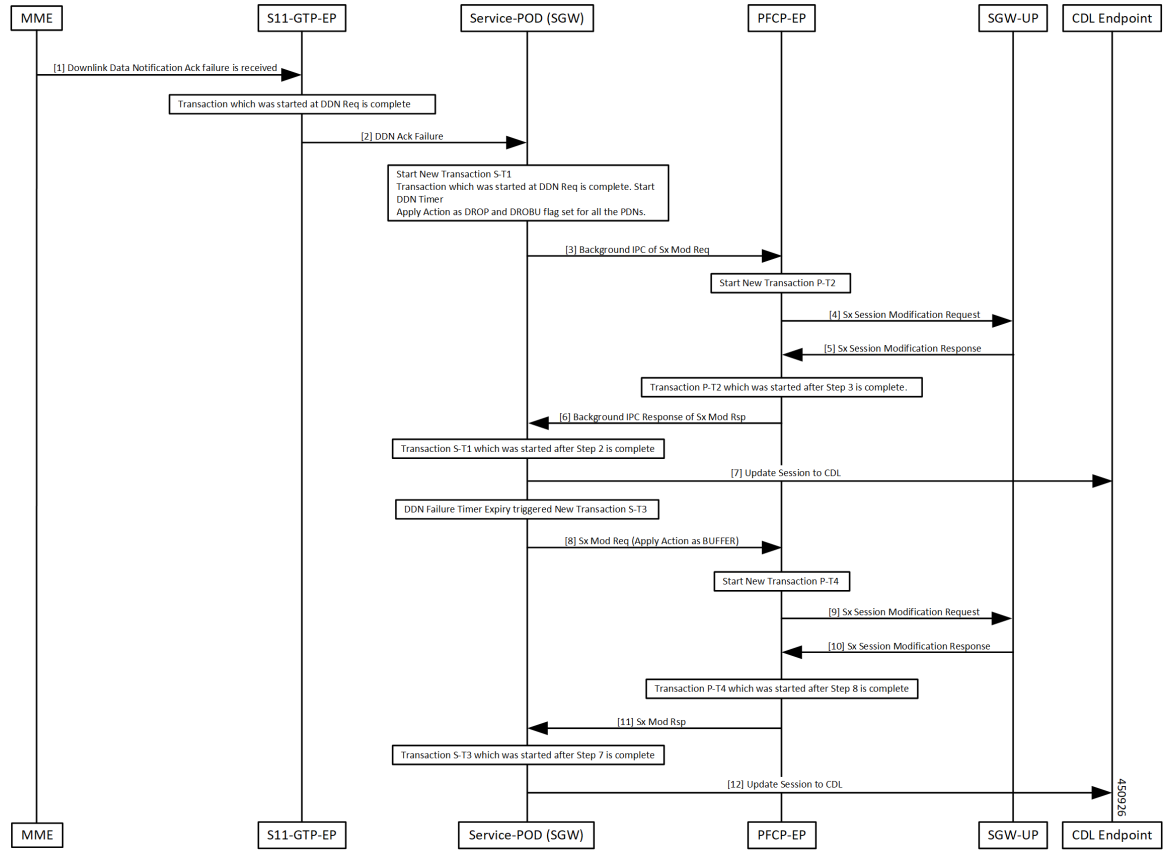

Table 51: Downlink Data Notification Failure Procedure Call Flow Description

Step	Description
1	S11-GTP-EP pod receives DDN ACK Failure.
2	The transaction started while sending the DDN Request ends. S11-GTP-EP forwards the DDN ACK Failure to the SGW-service pod.

Step	Description
3	<p>After receiving the DDN ACK Failure at the SGW-service pod:</p> <ul style="list-style-type: none"> • Decides the paging state based on the cause received: <ul style="list-style-type: none"> • EGTP_CAUSE_CONTEXT_NOT_FOUND: Submit internal transaction for call deletion. • EGTP_CAUSE_UNABLE_TO_PAGE_UE • EGTP_CAUSE_UNABLE_TO_PAGE_UE_DUE_TO_SUSPENSION • EGTP_CAUSE_UE_ALREADY_REATTACHED • EGTP_CAUSE_TEMP_REJECTED_DUE_TO_HANOVER_IN_PROGRESS • Checks if the PDNs are in connected state to initiate the Sx Modify Request. Minimum one one PDN should be in the CONNECTED state. • Submits internal transactions to handle these paging failure causes. • Ends the current procedure and transaction. • In the new transaction of handling paging failures, derives all the PDNs for which you want to send Sx Modify request. • Based on the paging state, derives paging action and send Sx Modify Request based on the action required. <p>Sends background IPC request for Sx Modification Request to PFCP-EP pod. Create a new transaction P-T2.</p>
4	<p>After receiving background IPC request for Sx Modification request, PFCP-EP:</p> <ul style="list-style-type: none"> • Starts a new P-12 transaction. • Sends the o the SGW-UP.
5	PFCP-EP receives the Sx Modification Response from the SGW-UP.
6	<p>The transaction P-T2 started at step three is complete.</p> <p>PFCP-EP pod sends background IPC response to the SGW-service pod.</p>
7	<p>The transaction S-T1 started at step two is complete.</p> <p>SGW-service pod updated the CDL with buff_data_ind at bearer level flag.</p>
8	<p>On DDN Failure timer expiry, a new transaction S-T3 is started.</p> <p>SGW-service pod sends background IPC request for the Sx Modification Request to the PFCP-EP pod with Apply Action as BUFFER.</p>
9	<p>A new P-T4 transaction is created.</p> <p>PFCP-EP pod sends the Sx Modification Request to the SGW-UP.</p>
10	SGW-UP sends the Sx Modification Response to the PFCP-EP pod.

Step	Description
11	The transaction P-T4 started at step eight is complete. PFCP-EP pod forwards the Sx Modification Response to the SGW-service pod.
12	The transaction S-T3 started at step seven is complete. SGW-service pod updates the CDL.

No User Connect Retry Timer Call Flow

This section describes the No User Connect Retry Timer call flow.

Figure 32: No User Connect Retry Timer Call Flow

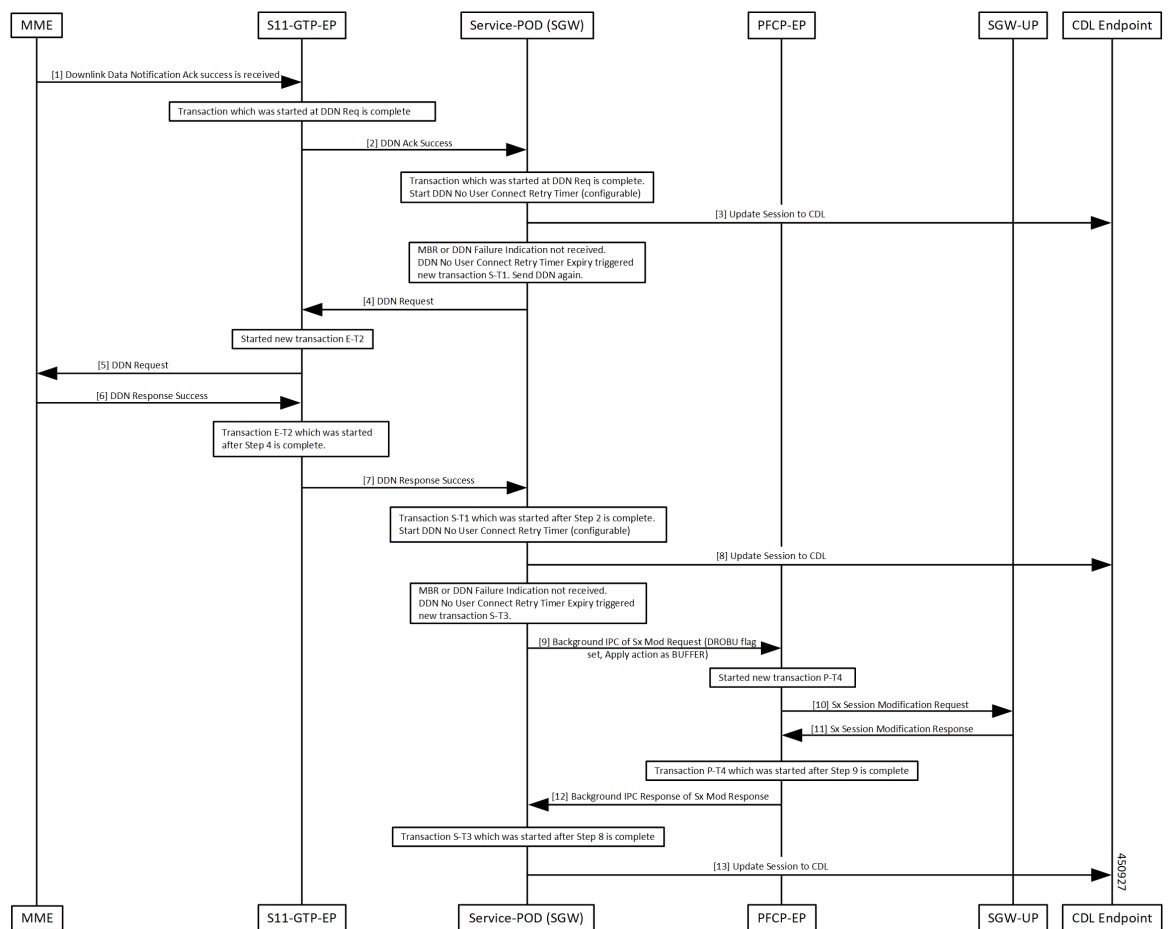

Table 52: No User Connect Retry Timer Call Flow Description

Step	Description
1	Received DDN ACK success at the S11-GTP-EP pod.

Step	Description
2	The transaction started while sending the DDN ends here. S11-GTP-EP sends the DDN ACK success to the SGW-service pod.
3	No User Connect Retry timer is started at the SGW-C pod. This timer is configurable. SGW-service pod updates the CDL.
4	SGW-service pod sends the DDN Request to the S11-GTP-EP pod, when: <ul style="list-style-type: none"> • The DDN Failure Indication/MBR is not received • No User Connect Retry timer expires. A new transaction S-T1 is created.
5	A new E-T2 transaction is created. S11-GTP-EP pod forwards the DDN Request to MME.
6	MME sends the DDN Response to the S11-GTP-EP.
7	The transaction E-T2 started at step four is complete. S11-GTP-EP forwards the DDN Response Success to the SGW-service pod.
8	S-T1 transaction started at step two is completed. No User Connect Retry timer is started at the SGW-C pod. This timer is configurable. SGW-service pod updates the CDL.
9	If DDN Failure Indication/MBR is not received, No User Connect Retry expiry triggered. A new transaction S-T3 is created. SGW-service pod sends the background IPC request for Sx Modification request to the PFCP-EP pod (DROBU flag and Apply Action as BUFFER).
10	A new transaction P-T4 is created. PFCP-EP pod sends the Sx Modification Request to the SGW-U pod.
11	PFCP-PE pod receives the Sx Modification Response.
12	The transaction P-T4 started at step nine is complete. PFCP-EP pod sends the background IPC response to the SGW-service pod.
13	The transaction S-T3 started at step eight is complete. CDL is updated.

Feature Configuration

Configuring this feature involves the following steps:

Configuring the DDN Failure Timer

DDN Failure Timer is configured under the `sgw-profile`.

To configure this feature, use the following configuration:

```
config
  profile sgw sgw_name
    ddn failure-action-drop-timer timer_value
    ddn timeout-purge-session { true | false }
  end
```

NOTES:

- **ddn failure-action-drop-timer *timer_value***—Specify the duration of the DDN packet drop timer. During this specified timeframe, the DDN is not sent to the UE. This timer is used, when a notification of DDN ACK Failure or DDN Failure Indication is received. The default value is 300 seconds.



Note To disable the timer, set the timer value to zero.

- **ddn timeout-purge-session { true | false }**—Specify the option to enable or disable the DDN timeout purge session. The default value is false.

Configuration Example

The following is an example configuration.

```
config
profile sgw sgw1
ddn failure-action-drop-timer 60
ddn timeout-purge-session false
end
```

Configuration Verification

To verify the configuration:

```
show running-config profile sgw
profile sgw sgw1
locality LOC1
fqdn 209.165.201.1
ddn failure-action-drop-timer 60
ddn timeout-purge-session false
end
```

Configuring DDN No User Connect Retry Timer

This section describes how to configure the DDN No User Connect Retry Timer.

DDN No User Connect Retry Timer can be configured under `sgw-profile`.

To configure this feature, use the following configuration:

```
config
  profile sgw sgw_name
    ddn no-user-connect-retry-timer timer_value
  end
```

NOTES:

- **ddn no-user-connect-retry-timer** *timer_value* - Specify the DDN retry timer used when DDN Ack is received with Success and MBR is not received. Default value is 60 seconds.

To disable the timer, set the value to 0.

Configuration Example

The following is the sample configuration.

```
config
profile sgw sgw1
  ddn no-user-connect-retry-timer 120
end
```

Configuration Verification

To verify the configuration:

```
show running-config profile sgw
profile sgw sgw1
locality LOC1
fqdn cisco.com.apn.epc.mnc456.mcc123
ddn failure-action-drop-timer 60
ddn no-user-connect-retry-timer 120
```

Control Messages Triggered DDN Support**Feature Description**

This feature supports paging the UE for the PGW-initiated control procedures when the UE is in IDLE mode.



Note This feature is CLI controlled.

How it Works

This section describes how this feature works.

Call Flows

This section describes the key call flows for this feature.

Downlink Data Notification for PGW-initiated procedure with Cloud Native Call Flow

This section describes the DDN for the PGW-initiated procedure with Cloud Native call flow.

Figure 33: Downlink Data Notification for PGW initiated Procedure with Cloud Native Call Flow

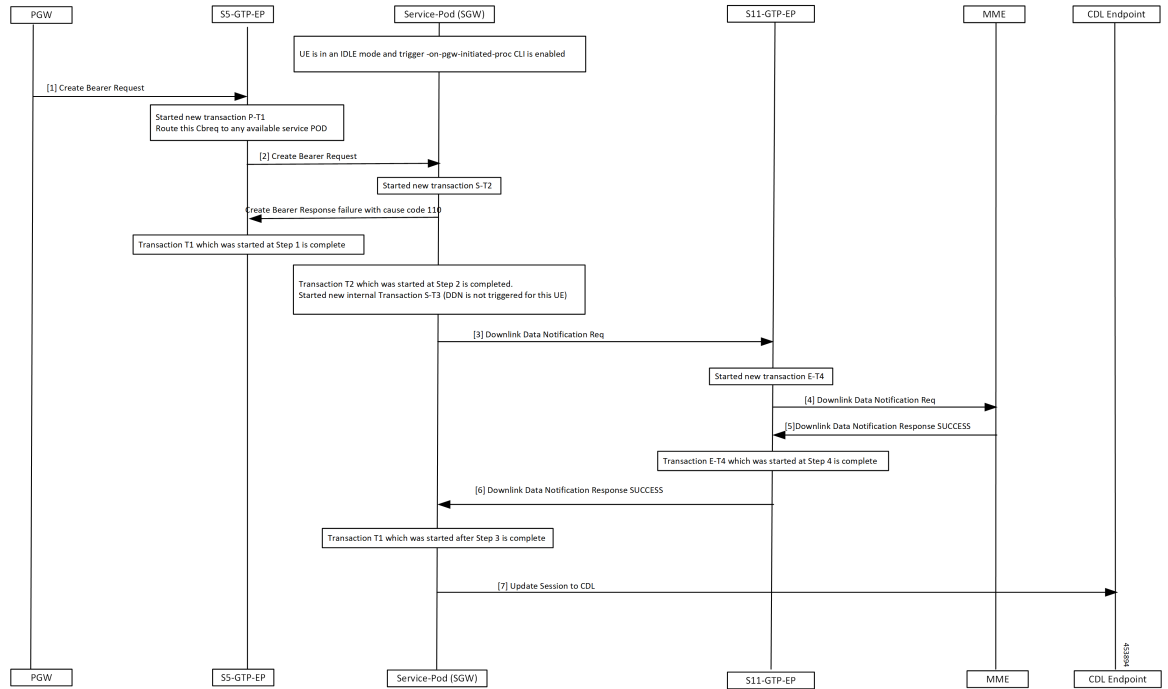

Table 53: Downlink Data Notification for PGW initiated procedure (CBR) with Cloud Native Call Flow Description

Step	Description
1, 2	Enabled trigger-on-pgw-initiated-proc CLI and state of the UE is in IDLE mode. S5-GTP-EP receives the CBR from the PGW and forwards it to the SGW-service pod. SGW-service pod starts a new S-T2 transaction. SGW-service pod sends failure response to the S5-GTP-EP with cause code 110.
3	The T2 transaction which started in step two is completed. A new S-T3 transaction is started for the UE for which DDN is not triggered. SGW-service pod initiates the DDN Request to the theS11-GTP-EP.
4	A new E-T4 transaction is started. S11-GTP-EP forwards the DDN Request to the MME.
5	S11-GTP-EP receives the DDN Response success from the MME.
6	Transaction E-T4 which started in step four is completed. S11-GTP-EP sends the DDN Response success to the SGW-service pod.
7	Transaction T1 which is started in step three is completed. SGW-service pod updates the session to CDL.

Feature Configuration

To configure this feature, use the following configuration:

```
config
profile sgw sgw_name
  ddn trigger-on-pgw-initiated-proc
end
```

NOTES:

- **ddn trigger-on-pgw-initiated-proc**—When UE is in IDLE mode, the DDN triggers paging for PGW-initiated procedures. SGW sends failure response to the PGW with cause code 110.

Configuration Example

The following is an example configuration.

```
config
profile sgw sgw1
  ddn trigger-on-pgw-initiated-proc
end
```

Configuration Verification

To verify the configuration:

```
show running-config profile sgw
profile sgw sgw1
locality LOC1
fqdn 209.165.201.1
ddn failure-action-drop-timer 60
ddn no-user-connect-retry-timer 120
ddn trigger-on-pgw-initiated-proc
exit
```

Disabling the DDN Control Procedure

Use `no ddn trigger-on-pgw-initiated-proc` to disable DDN Control Procedure feature.

DDN Advance Features

Feature Description

This feature supports the following:

- Downlink Data Notification Delay
- High Priority Downlink Data Notification
- DDN Throttling

How it Works

This section describes how this feature works.

Call Flows

This section describes the key call flows for this feature.

DDN Delay Call Flow

This section describes DDN Delay call flow.

Figure 34: DDN Delay Call Flow

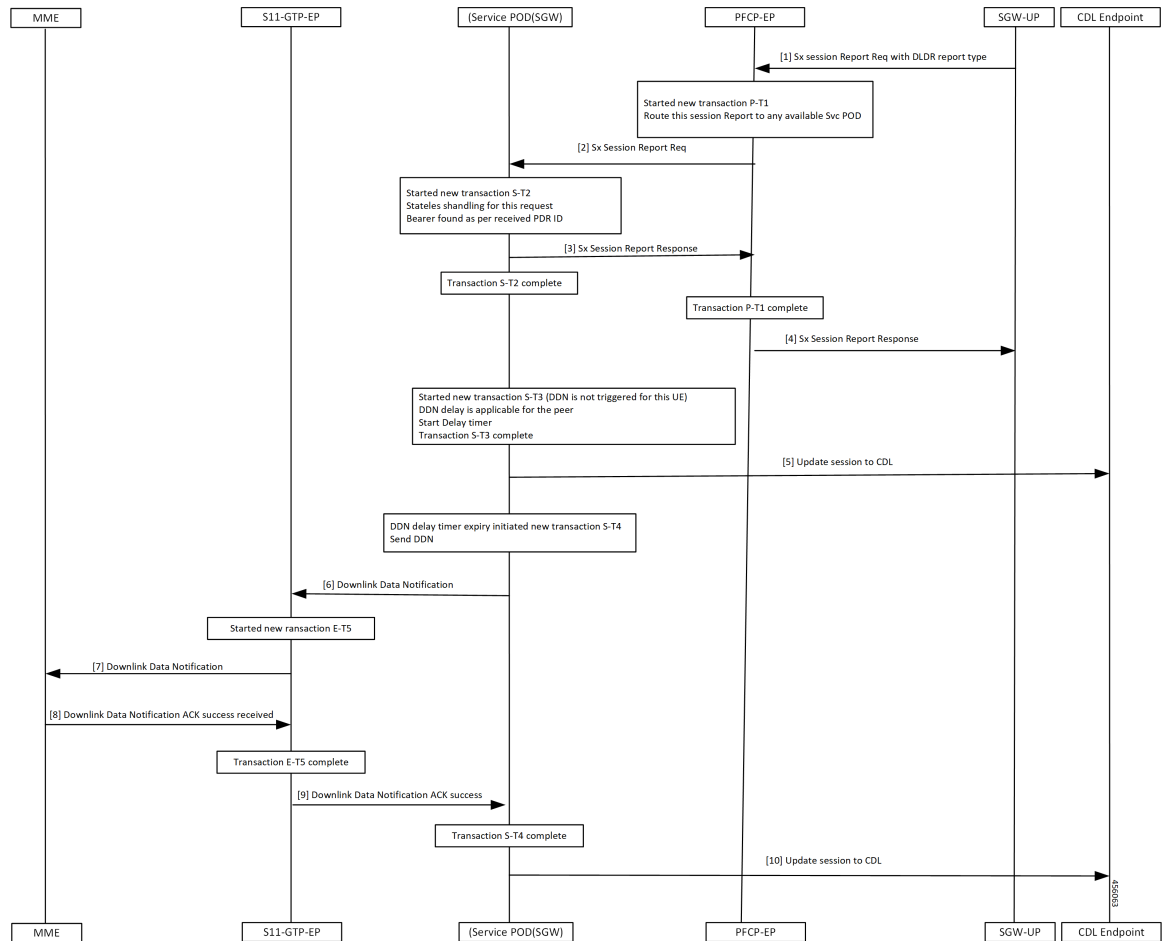

Table 54: DDN Delay Call Flow Description

Step	Description
1	Received downlink data when UE is in IDLE state. SGW-UP sends the Sx Report Request with report type as DLDR with corresponding PDR ID to the PFCP-EP.

Step	Description
2	Started a new P-T1 transaction. PFCP-EP pod: <ul style="list-style-type: none"> • Checks the available service pod. • Sends the Sx Session Report to the the SGW-service pod.
3	A new transaction S-T2 is started. SGW-CP sends success response to the SGW-UP, when a bearer found at CP for this PDR-ID.
4	The S-T2, P-T1 transactions are completed. PFCP-EP sends the Sx Session Report Response to the SGW-UP.
5	A new transaction S-T3 is started when DDN is not triggered for this UE. Sgw-service pod gets the peer information to check if the peer configured with the DDN delay value. DDN delay timer is triggered, if DDN delay configured. S-T3 transaction is completed. SGW-service pod sends the CDL update.
6, 7	A new S-T4 transaction started. SGW-service pod sends the DDN to the S11-GTP-EP. A new E-T5 transaction is started. S11-GTP-EP forwards the DDN to the MME.
8, 9	MME sends the DDN ACK success to the S11-GTP-EP. Transaction E-T5 started in step seven is completed. S11-GTP-EP forwards the DDN ACK success towards the SGW-service pod.
10	Transaction S-T4 started in step six is completed. SGW-service pod updates session information to CDL.

High Priority DDN Call Flow

This section describes High Priority DDN call flow.

Figure 35: High Priority DDN Call Flow

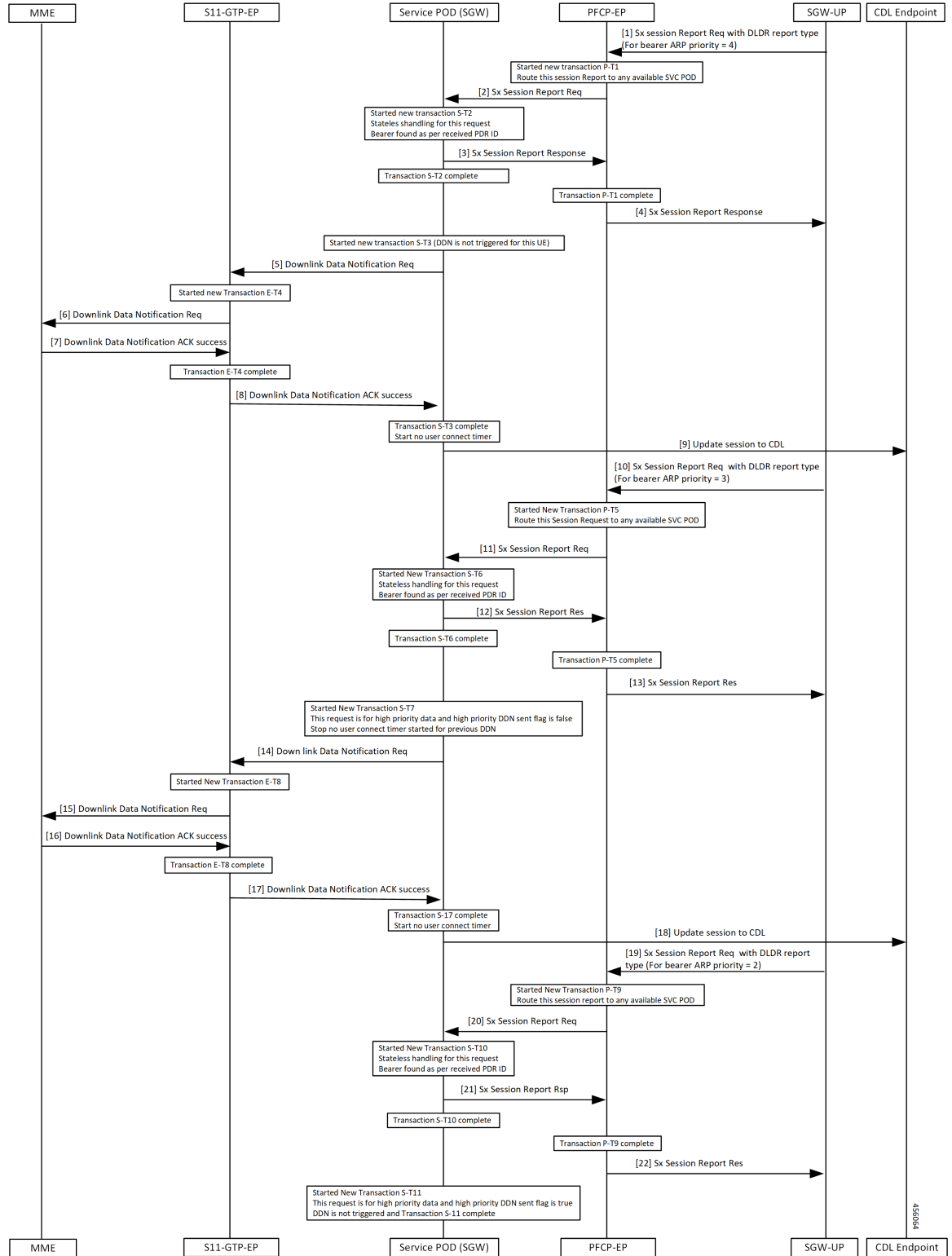

Table 55: High Priority DDN Call Flow Description

Step	Description
1	Bearer received downlink data with ARP priority value as four, when UE is in IDLE state. SGW-UP sends the Sx Report Request to the PFCP-EP with report type as DLDR with corresponding PDR ID.
2	New P-T1 transaction is started and routed the session report to all available service pods. PFCP-EP sends the Sx Session Report Request to the SGW-service pod.
3	New S-T2 transaction is started and the SGW-service pod sends Sx Session Report Response to the PFCP-EP.
4	Transaction P-T1 and S-T2 completed and the PFCP-EP forwards the Sx Session Report Response to the SGW-UP.
5	New S-T3 transaction is started for which the DDN isn't triggered. SGW-service pod sends the DDN Request to the S11-GTP-EP.
6	New E-T4 transaction is started and the S11-GTP-EP forwards the DDN Request to the MME.
7	MME sends the DDN ACK success to the S11-GTP-EP.
8	Transaction E-T4 is completed. S11-GTP-EP forwards the DDN ACK success to the SGW-service pod.
9	Transaction S-T3 completed. SGW-service pod triggers No User Connect timer and updates session to CDL.
10	SGW-UP sends the Sx Session Report Request to the PFCP-EP with report type as DLDR for bearer whose ARP priority value is three.
11	New P-T5 transaction is started and routed the session report to all the available service pods. PFCP-EP sends the Sx Session Report Request to the SGW-service pod.
12	New transaction S-T6 started SGW-service pod sends the Sx Session Report Response to the PFCP-EP when bearer found as per the received PDR ID.
13	Transaction S-T6 and P-T5 completed and PFCP-EP forwards the Sx Session Report Response to the SGW-UP.
14	New transaction S-T7 started and data, high priority DDN sent with the flag value as False. No User Connect timer is topped. SGW-service pod sends the DDN Request to the S11-GTP-EP.
15	New E-T8 transaction is started and the S11-GTP-EP forwards the DDN Request to the MME.
16	MME sends the DDN ACK success to the S11-GTP-EP.

Step	Description
17	S11-GTP-EP forwards the DDN ACK success to the SGW-service pod for this PDR ID.
18	Transaction S-17 completed. SGW-service pod triggers the No User Connect timer when received DDN ACK success and updated the session to CDL.
19	Bearer received the downlink data with ARP priority value as two. SGW-UP sends the Sx Report Request to the PFCP-EP with report type as DLDR with corresponding PDR ID.
20	New transaction P-T9 started and routed the session report to all the available service pods. PFCP-EP sends the Sx Session Report Request to the SGW-service pod.
21	New transaction S-T10 started and the SGW-service pod sends the Sx Session Report Response to the PFCP-EP when the bearer found as per the received PDR ID.
22	Transaction S-T10 and P-T9 completed and the PFCP-EP forwards the Sx Session Report Response to the SGW-UP. At SGW-service pod: <ul style="list-style-type: none"> • New transaction S-T11 started and data, high priority DDN sent with the flag value as True. SGW-service pod stops No User Connect timer. • SGW-service pod doesn't trigger DDN when high priority DDN already initiated. Transaction S-11 is completed.

DDN Throttling Call Flow

This section describes DDN Throttling call flow.

Figure 36: DDN Throttling Call Flow

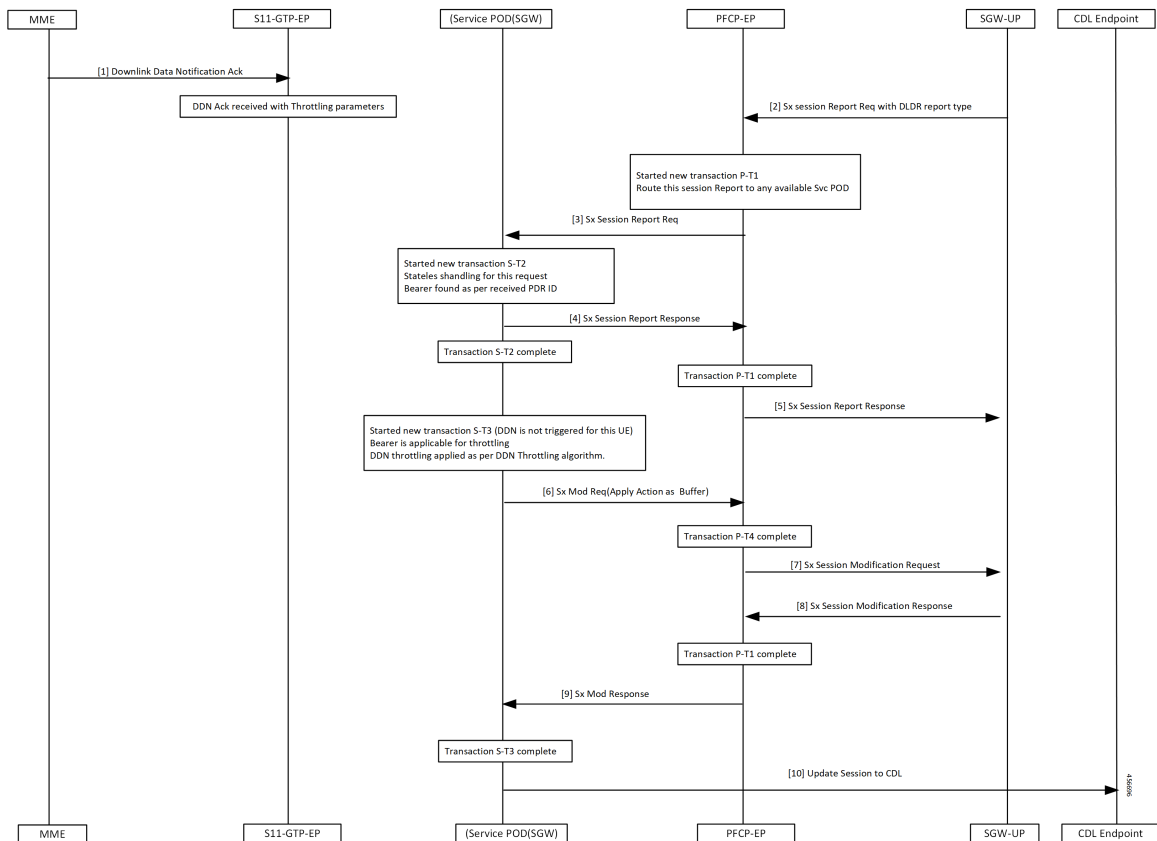

Table 56: DDN Throttling Call Flow Description

Step	Description
1	Received DDN with throttling parameters when UE is in IDLE state. MME sends the DDN ACK to the S11-GTP-EP.
2	SGW-UP sends the Sx Report Request with report type as DLDR with corresponding PDR ID to PFCP-EP.
3	PFCP-EP triggers a new P-T1 transaction and routes the Sx Report Request to available service pod. PFCP-EP sends the Sx Session Report Request to the SGW-service pod.
4	Started a new S-T2 transaction. Get peer information to check if DDN Throttle is active for this peer. Check if priority of this bearer is more than the configured ARP watermark SGW-service pod sends the Sx session Report Response to the PFCP-EP.

Step	Description
5	S-T2 transaction started in step four is completed. P-T1 transaction started in step three is completed. When a bearer found at CP for this PDR ID, the PFCP-EP sends success response to the SGW-UP.
6	A new S-T3 transaction is started for the UE for which DDN is not triggered. Apply DDN algorithm to check if the DDN must be throttled. If DDN throttled, SGW-service pod sends the Sx Modification Request with Apply Action as BUFFER towards PFCP-EP.
7, 8	P-T4 transaction is completed. PFCP-EP sends the Sx Session Modification Request to the SGW-UP and receives the Sx Session Modification Response from the SGW-UP.
9	P-T1 transaction started in step five is completed. PFCP-EP sends Sx Modification Response to the SGW-service pod.
10	S-T3 transaction started in step six is completed. SGW-service pod updates the session to CDL.

Standards Compliance

The Downlink Data Notification Support feature complies with the following standards:

- 3GPP TS 23.401, "General Packet Radio Service (GPRS) enhancements for Evolved Universal Terrestrial Radio Access Network (E-UTRAN) access"
- 3GPP TS 23.402, "Architecture enhancements for non-3GPP accesses"
- 3GPP TS 29.274, "3GPP Evolved Packet System (EPS); Evolved General Packet Radio Service (GPRS) Tunnelling Protocol for Control plane (GTPv2-C); Stage 3"
- 3GPP TS 23.214, "Architecture enhancements for control and user plane separation of EPC nodes"
- 3GPP TS 29.244, "Interface between the Control Plane and the User Plane nodes"
- 3GPP TS 24.008, "Mobile radio interface Layer 3 specification; Core network protocols; Stage 3"

Feature Configuration

By default, the DDN throttling is always enabled.



Note cnSGW-C handles DDN throttling parameters sent from the MME.

To configure this feature, use the following configuration:

```

config
profile sgw sgw_name
  ddn throttle-arp-watermark arp_value
end

```

NOTES:

- **ddn throttle-arp-watermark** *arp_value*—Specify the lowest priority ARP for DDN throttle.

Throttling is applicable only for bearer having ARP PL value greater than the configured *value*. Must be an integer in the range of 0-15.

By default, throttling is applicable for all bearers.

Configuration Example

The following is an example configuration.

```

config
profile sgw sgw1
  ddn throttle-arp-watermark 3
end

```

OAM Support

This section describes operations, administration, and maintenance information for this feature.

Bulk Statistics

The following statistics are supported for the DDN Advance feature.

```
sgw_ddn_stats{app_name="smf",cluster="cn",data_center="cn",
ddn_stats_type="control_proc_triggered",instance_id="0",service_name="sgw-service"} 2
```

```
sgw_ddn_stats{app_name="smf",cluster="cn",data_center="cn",ddn_stats_type="data_triggered",
instance_id="0",service_name="sgw-service"} 18
```

```
sgw_ddn_stats{app_name="smf",cluster="cn",data_center="cn",ddn_stats_type="delayed",
instance_id="0",service_name="sgw-service"} 7
```

```
sgw_ddn_stats{app_name="smf",cluster="cn",data_center="cn",ddn_stats_type="high_priority_initiated",
instance_id="0",service_name="sgw-service"} 3
```

```
sgw_ddn_stats{app_name="smf",cluster="cn",data_center="cn",ddn_stats_type="high_priority_suppressed",
instance_id="0",service_name="sgw-service"} 1
```

```
sgw_ddn_stats{app_name="smf",cluster="cn",data_center="cn",ddn_stats_type="throttled",
instance_id="0",service_name="sgw-service"} 6
```

- **high_priority_initiated** - DDN initiated count, due to high priority paging trigger.

- `high_priority_suppressed` - DDN high priority count which is suppressed. When a UE is already working on the high priority DDN-initiated paging request. It suppresses the incoming high priority paging request.
- `throttled` - DDN throttled count.
- `delayed` - DDN initiated count after the DDN delay timer.
- `control_proc_triggered` - The received count of paging triggers from control procedure when UE is in IDLE state.
- `data_triggered` - The received count of paging triggers from UPF for downlink data when UE is in IDLE state.



CHAPTER 16

DSCP Marking Support

- [Feature Summary and Revision History, on page 161](#)
- [Feature Description, on page 162](#)
- [DSCP Marking for Data Packets, on page 162](#)
- [DSCP Marking for CP Signaling Messages, on page 164](#)

Feature Summary and Revision History

Summary Data

Table 57: Summary Data

Applicable Product(s) or Functional Area	cnSGW-C
Applicable Platform(s)	SMI
Feature Default Setting	DSCP Marking for Data packets: Disabled – Configuration required to enable DSCP Marking for CP Signaling Messages: Enabled – Always-on
Related Documentation	Not Applicable

Revision History

Table 58: Revision History

Revision Details	Release
Validated support for Extended and Non-Standard (Operator-defined) QCI Values.	2021.02.3
Added support for DSCP Marking for CP Signaling Messages.	2021.02.0

Revision Details	Release
First introduced.	2021.01.0

Feature Description

Differentiated Services Code Point (DSCP) is a means of classifying and managing network traffic. It provides quality of service (QoS) in modern Layer 3 IP networks.

This feature supports the following:

- DSCP Marking for Data Packets
- DSCP Marking for CP Signaling Messages

DSCP Marking for Data Packets

Feature Description

This feature supports marking of DSCP with the combination of QCI and ARP.

It also supports the programming of the DSCP marking value to the User Plane (UP) for data packets.

How it Works

This section describes how this feature works.

DSCP Marking IEs

DSCP marking IEs are sent in the Sx Establishment Request or the Sx Modification Request message. These IEs are a part of Forwarding Action Rule (FAR) IE. The following are the supported IEs and their functions:

- Inner Packet Marking (Private Extension IE): Sends the user-datagram DSCP marking values to the UP.
- Transport Packet Marking (3GPP Spec-defined IE): Sends the encaps-header DSCP values to the UP.
- Transport Packet Marking Options (Private Extension IE): Sends copy-inner and copy-outer options of encaps-header marking to the UP.

Feature Configuration

To configure this feature, use the following configuration:

```
config
  profile
    sgw-qos-profile qos_profile_name
    dscp-map
      operator-defined-qci non_standard_qos_class_id
```

```

qci qci_value
  downlink downlink_value
    user-datagram
      dscp-marking dscp_marking_value
    encaps-header
      dscp-marking dscp_marking_value
    encsp-header encsp_header_value
      dscp-marking dscp_marking_value
  uplink uplink_value
    user-datagram
      dscp-marking dscp_marking_value
    encaps-header
      dscp-marking dscp_marking_value
    encsp-header encsp_header_value
  arp-priority-level arp_priority_level_value
  uplink
    user-datagram
      dscp-marking dscp_marking_value
    encaps-header
      dscp-marking dscp_marking_value
  downlink
    user-datagram
      dscp-marking dscp_marking_value
    encaps-header
      dscp-marking dscp_marking_value
end

```

NOTES:

- **sgw-qos-profile** *qos_profile_name*—Specify the QoS profile configuration name for SGW.
- **dscp-map**—Configures QCI to DSCP-Marking mapping.
- **operator-defined-qci** *non_standard_qos_class_id*—Specify the non-standard QoS class identifier. Must be an integer in the range of 128-254.
- **qci** *qci_value*—Specify the standard QCI value. Must be an integer from the following options: 1-9, 65, 66, 69, 70, 80, 82, 83.
- **arp-priority-level** *arp_priority_value*—Specify the ARP Priority Level. Must be an integer in the range of 1-15.
- **uplink** *uplink_value*—Specify the uplink QCI value.
- **downlink** *downlink_value*—Specify the downlink QCI value.
- **gbr**—Specify the type of the QCI to GBR.
- **non-gbr**—Specify the type of the QCI to non-GBR.
- **encaps-header**—Specify the DSCP value to be applied to the encaps header.
- **user-datagram**—Specify the DSCP value to be applied to the user datagram.
- **copy-inner**—Starts copying the inner DSCP to outer value.
- **copy-outer**—Starts copying the outer DSCP to inner value.

- **dscp-marking** *dscp_marking_value*—Specify the DSCP value to be applied to packets. (A hexadecimal string value, starting with 0x. For example: 0x3F)
- **qci**—The QCI uplink and downlink options are the same. Similarly, the commands for **operator-defined-qci** and standard QCI are the same, the only difference is the mandatory selection of *bearer-type* in **operator-defined-qci**. You can also specify ARP along with the type of the bearer.

Configuration Example

The following is an example configuration.

```
config
  profile sgw-qos-profile q
    dscp-map qci 1 uplink encaps-header copy-inner user-datagram dscp-marking 0x1
    dscp-map qci 1 downlink user-datagram dscp-marking 0x2 encaps-header dscp-marking 0x3
    dscp-map qci 2 gbr uplink user-datagram dscp-marking 0x5 encaps-header dscp-marking 0x6

    dscp-map operator-defined-qci 128 gbr arp-priority-level 1 uplink user-datagram
dscp-marking 0x7
  end
```

Configuration Verification

To verify the configuration:

```
show running-config profile sgw-qos-profile q
  profile sgw-qos-profile q
    dscp-map qci 1 uplink encaps-header copy-inner user-datagram dscp-marking 0x1
    dscp-map qci 1 downlink user-datagram dscp-marking 0x2 encaps-header dscp-marking 0x3
    dscp-map qci 2 gbr uplink user-datagram dscp-marking 0x5 encaps-header dscp-marking 0x6

    dscp-map operator-defined-qci 128 gbr arp-priority-level 1 uplink user-datagram
dscp-marking 0x7
  end
```

DSCP Marking for CP Signaling Messages

Feature Description

This feature supports the marking of DSCP values to control packets as per the configuration at the following interfaces:

- GTPC: S11, S5
- PFCP: Sxa

Feature Configuration

Configuring this feature involves the following steps:

- Configuring DSCP under the S11 Interface for the GTP Endpoint. For more information, refer to [Configuring DSCP under S11 Interface for GTP Endpoint, on page 165](#).

- Configuring DSCP under the S5e Interface for the GTP Endpoint. For more information, refer to [Configuring DSCP under S5e Interface for GTP Endpoint, on page 165](#).
- Configuring DSCP under the Sxa Interface for the Protocol Endpoint. For more information, refer to [Configuring DSCP under Sxa Interface for Protocol Endpoint, on page 166](#).

Configuring DSCP under S11 Interface for GTP Endpoint

To configure this feature, use the following configuration:

```
config
  instance instance-id instance_id
  endpoint endpoint_name
  interface interface_name
  dscp dscp_value
end
```

NOTES:

- **endpoint** *endpoint_name*—Specify the endpoint name.
- **interface** *interface_name*—Specify the endpoint interface name.
- **dscp** *dscp_value*—Specify the DSCP value. Must be a hexadecimal string starting with 0x (for example, 0x3F), or a decimal value (for example, 12). The decimal value must be in the range of 0-63.

Configuration Example

The following is an example configuration.

```
config
  instance instance-id 1
  endpoint gtp
  interface s11
  dscp 0x2
end
```

Configuration Verification

To verify the configuration:

```
show running-config instance instance-id 1 endpoint
  endpoint gtp
  interface s11
  dscp 0x2
end
```

Configuring DSCP under S5e Interface for GTP Endpoint

To configure this feature, use the following configuration:

```
config
  instance instance-id instance_id
  endpoint endpoint_name
  interface interface_name
  dscp dscp_value
end
```

Configuration Example

The following is an example configuration.

```
config
  instance instance-id 1
    endpoint gtp
    interface s5e
    dscp 0x2
  end
```

Configuration Verification

To verify the configuration:

```
show running-config instance instance-id 1 endpoint
  endpoint gtp
  interface s5e
  dscp 0x2
end
```

Configuring DSCP under Sxa Interface for Protocol Endpoint

To configure this feature, use the following configuration:

```
config
  instance instance-id instance_id
    endpoint endpoint_name
    interface interface_name
    dscp dscp_value
  end
```

Configuration Example

The following is an example configuration.

```
config
  instance instance-id 1
    endpoint gtp
    interface sxa
    dscp 0x2
  end
```

Configuration Verification

To verify the configuration:

```
show running-config instance instance-id 1 endpoint
  endpoint gtp
  interface sxa
  dscp 0x2
end
```

Removing DSCP Configuration

When you remove the DSCP signaling configuration from the interface or endpoint, it uses the default marking. The default value is 10 or 0xa (in Hexadecimal).

To clear the DSCP configuration:

```
config
  instance instance-id instance_id
```

```
endpoint endpoint_name
interface interface_name
no dscp
end
```

Configuration Example

The following is an example configuration for the removal of the DSCP configuration.

```
config
instance instance-id 1
endpoint gtp
interface s11
no dscp
end
```

Configuration Verification

To verify the DSCP configuration removal:

```
show running-config instance instance-id 1 endpoint
instance instance-id 1
endpoint gtp
interface s5e
dscp 0x4
exit
interface s11
exit
exit
endpoint protocol
interface sxa
dscp 8
end
```



CHAPTER 17

Dynamic Routing by Using BGP

- [Feature Summary and Revision History, on page 169](#)
- [Feature Description, on page 170](#)
- [How it Works, on page 170](#)
- [Configuring Dynamic Routing by Using BGP, on page 177](#)
- [Monitoring and Troubleshooting, on page 180](#)

Feature Summary and Revision History

Summary Data

Table 59: Summary Data

Applicable Product(s) or Functional Area	cnSGW-C SMF
Applicable Platform(s)	SMI
Default Setting	Disabled – Configuration required to enable
Related Changes in this Release	Not Applicable
Related Documentation	Not Applicable

Revision History

Table 60: Revision History

Revision Details	Release
First introduced.	2021.02.0

Feature Description

Border Gateway Protocol (BGP) allows you to create loop-free inter-domain routing between autonomous systems (AS). An AS is a set of routers under a single technical administration. The routers can use an Exterior Gateway Protocol to route packets outside the AS. The Dynamic Routing by Using BGP feature enables you to configure the next-hop attribute of a BGP router with alternate local addresses to service IP addresses with priority and routes. The SMF BGP speaker pods enable dynamic routing of traffic by using BGP to advertise pod routes to the service VIP.

This feature supports the following functionality:

- Dynamic routing by using BGP to advertise service IP addresses for the incoming traffic.
- Learn route for outgoing traffic.
- Handling a BGP pod failover.
- Handling a protocol pod failover.
- Statistics and KPIs for the BGP speakers.
- Log messages for debugging the BGP speakers.
- Enable or disable the BGP speaker pods.
- New CLI commands to configure BGP.

How it Works

This section describes the operation of the Dynamic Routing feature.

Incoming Traffic

BGP uses TCP as the transport protocol, on port 179. Two BGP routers form a TCP connection between one another. These routers are peer routers. The peer routers exchange messages to open and confirm the connection parameters.

The BGP speaker publishes routing information of the protocol pod for incoming traffic in the active/standby mode. Use the following image as an example to understand the dynamic routing functionality. There are two protocol pods, pod1 and pod2. Pod1 is active and pod2 is in the standby mode. The service IP address, 209.165.201.10 is configured on both the nodes, 209.165.200.226 and 209.165.200.227. Pod1 is running on host 209.165.200.226 and pod2 on host 209.165.200.227. The host IP address exposes the pod services. BGP speaker publishes the route 209.165.201.10 through 209.165.200.226 and 209.165.200.227. It also publishes the preference values, 110 and 100 to determine the priority of pods.

Figure 37: Dynamic Routing for Incoming Traffic in the Active-standby Topology

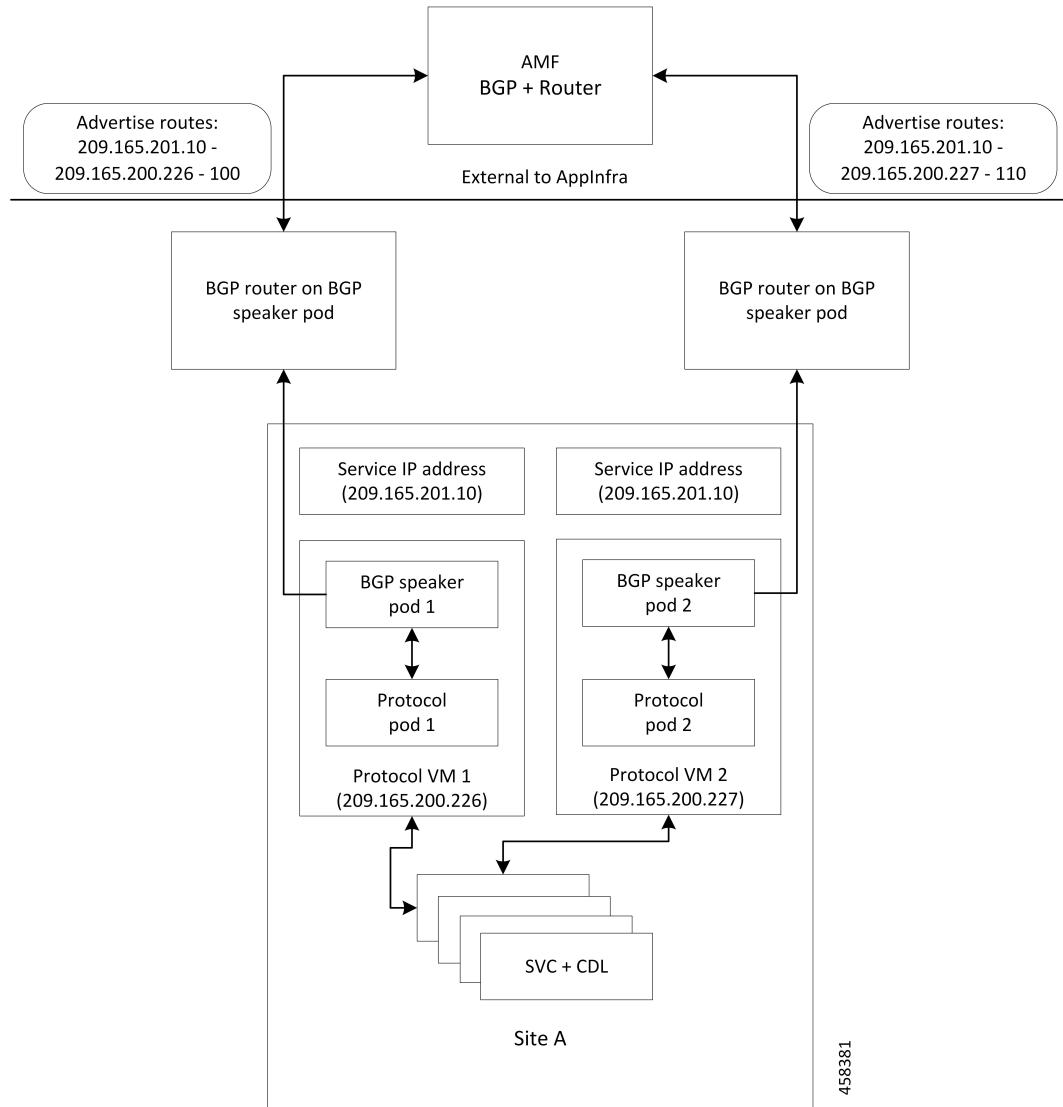

For high availability, each cluster has two BGP speaker pods with active/standby topology. Kernel route modification is done at host/network level where the protocol pod runs.

MED Value

The Local Preference is used only for IGP neighbors, whereas the MED Attribute is used only for EGP neighbors. A lower MED value is the preferred choice for BGP.

Table 61: MED Value

Bonding Interface Active	VIP Present	MED Value	Local Preference
Yes	Yes	1210	2220
Yes	No	1220	2210

Bonding Interface Active	VIP Present	MED Value	Local Preference
No	Yes	1215	2215
No	No	1225	2205

Bootstrap of BGP Speaker Pods

The following sequence of steps set up the BGP speaker pods:

1. The BGP speaker pods use TCP as the transport protocol, on port 179. These pods use the AS number that is configured in the Ops Center CLI.
2. Register the Topology manager.
3. Select the Leader pod. The active speaker pod is the default choice.
4. Establish connection to all the BGP peers provided by the Ops Center CLI.
5. Publish all existing routes from ETCD.
6. Configure import policies for routing by using CLI configuration.
7. Start gRPC stream server on both the speaker pods.
8. Similar to the cache pod, two BGP speaker pods must run on each Namespace.

External Network Failure

The NF instance start-up causes the BGP Speaker K8s pod to configure the next-hop attribute of the BGP router with alternate local addresses to service IP addresses with priority and routes.

After the Geo HA is triggered, the path selection is based on the destination service IP address, path connectivity and the priority value.



Note The subscriber sessions are not impacted because of the transparent migration between pods.

Geo Switchover

The SMF achieves geo switchover by transparently migrating service IP address to mated peer K8s cluster, rack collocated, or geo-located. During the NF start-up, all the K8s cluster Namespaces register with the next-hop BGP router to advertise its service IP address and local IP address along with the priority and route modifier values.

Each logical NF exposes separate NF instance toward NRF or DNS, separate configuration, and separate LCM for a Namespace.

Internal Network Failure

If a functioning K8s cluster has an internal network failure due to a disrupted server communication with the master node, BFD failure, or a K8s pod networking issue, Geo HA is triggered due to K8s dependency checks that are based on the K8s liveness failure.

In the example shown in the following figure, the AMF or MME transparently starts using the alternate rack server. The N11/S11/S5 and N4/Sxa service addresses are migrated to site B rack B. The system continues signalling from rack B for rack A. At rack B, the session continues without any impact to existing subscriber sessions.



Note Few in-transit calls might fail depending on the state where it is terminated before the UE re-attaches.

Figure 38: Geo HA for Internal Network Failure

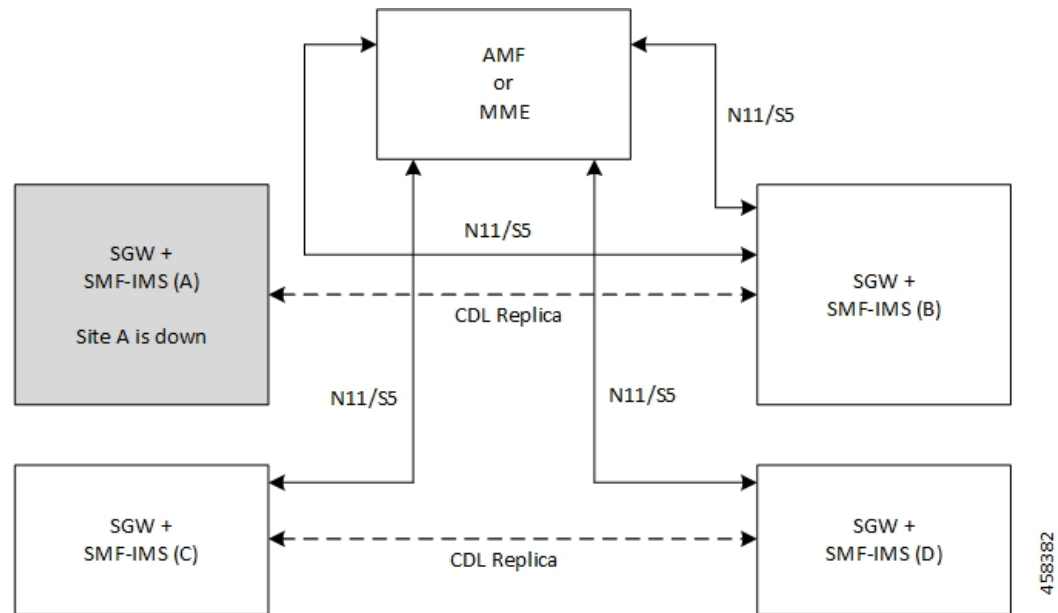

Local Switchover

The SMF achieves geo switchover by transparently migrating service IP address to mated peer K8s cluster or rack collocated within the same data center. During the NF start-up, all the K8s cluster Namespaces register with the next-hop BGP router to advertise its service IP address and local IP address along with the priority and route modifier values. Each logical NF exposes separate NF instance toward NRF or DNS, separate configuration, and separate LCM for a Namespace.

Recovery and Failback

For a seamless failover and failback, the UE sessions and the corresponding service IP addresses are grouped together.

The following scenarios describe the seamless failover and failback mechanism for the UE sessions:

- **Normal** - The UE sessions set is created, updated, or deleted from first rack and replicated to second rack.
- **Failure** - The UE sessions set is created, updated, or deleted from second rack and is not replicated to first rack due to its unavailability.
- **Recovery** - The CDL for first rack performs an auto-sync with the CDL for second rack to recover all the UE session data. During the recovery, the second rack continues to handle traffic from the sessions set.

Call Flows

This section describes the key call flows for Dynamic Routing by Using BGP.

Publish Route for Incoming Traffic in an Active-Standby Mode

The following sections describe the Control Plane and Data Plane call flows in an active/standby mode.

Control Plane Call Flow

This section describes the Control Plane call flow.

Figure 39: Control Plane Call Flow

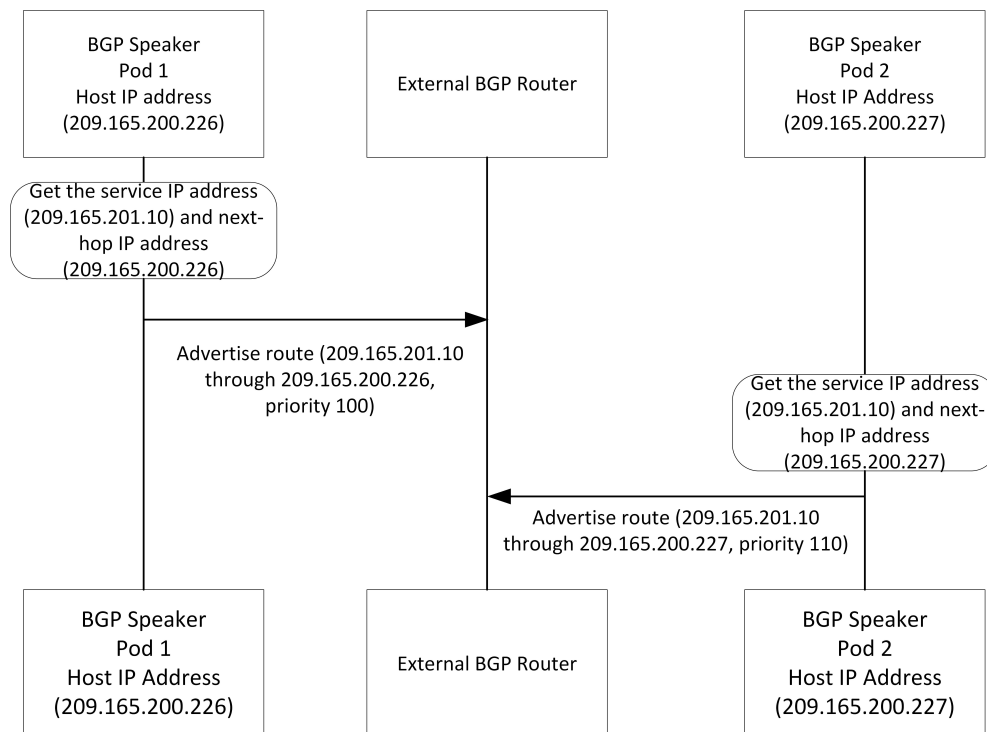

458377

Table 62: Control Plane Call Flow Description

Step	Description
1	The BGP speaker pod starts and fetches the service IP address, next-hop IP address (host IP or loopbackEth), and the Instance ID for the BGP speaker pod. The pod service is exposed through host IP or configured loopbackEth. The NF Instance ID is used to find the route priority or preference.
2	The BGP speaker pod advertises routes by fetching vip-ip (service IP addresses) from the Ops Center.

Data Plane Call Flow

This section describes the data plane call flow.

Figure 40: Data Plane Call Flow

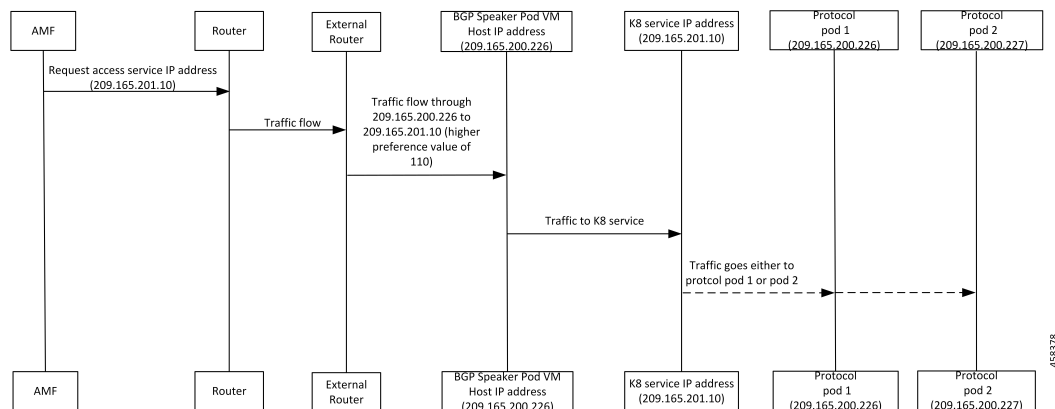

Table 63: Data Plane Call Flow Description

Step	Description
1	AMF requests for service IP address. The request is sent to the nearest connected router through multiple external routers. Then, the router sends the request to the BGP speaker pod with highest priority.
2	The BGP router sets the data plane flow based on the preference value. In the preceding call flow example, the router routes the service request through the host, 209.165.200.226 to pod 1 due to its higher preference value. From host 209.165.200.226, traffic is forwarded to the K8 service IP address, 209.165.201.10, which is then sent to either protocol pod 1 (209.165.200.226) or pod 2 (209.165.200.227).

Single Protocol Pod Failure Call Flow

The following section describes the Single Protocol Pod Failure call flow.

Figure 41: Single Protocol Pod Failure Call Flow

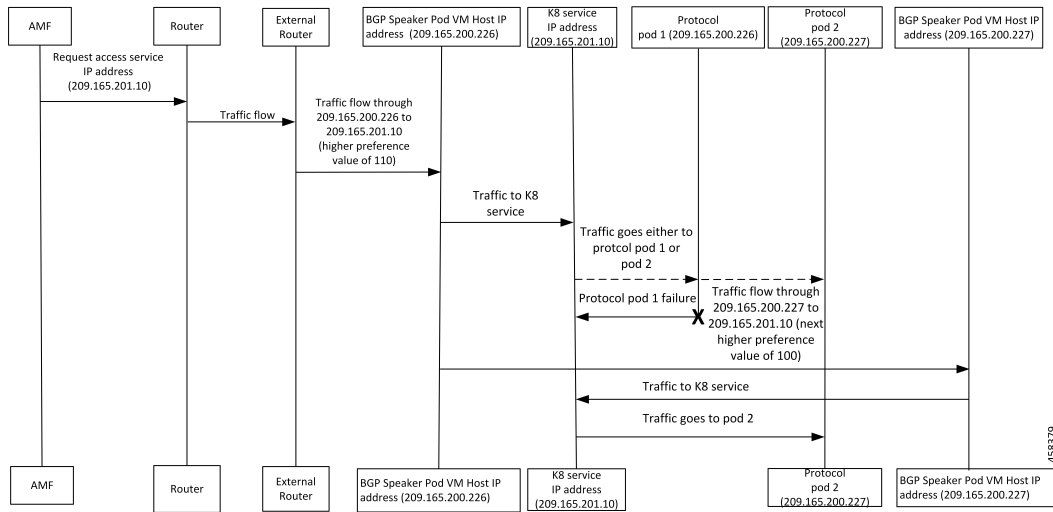

Table 64: Single Protocol Pod Failure Call Flow Description

Step	Description
1	AMF requests for service IP address. The request is sent to the nearest connected BGP router through multiple external routers based on the next highest preference value.
2	The BGP router sets the data plane flow based on the preference value. If the pod with the highest preference value is not available, then the request is routed to the pod with the next highest preference value through the K8 service pod. In the example shown in the preceding call flow figure, pod 2 with the IP address, 209.165.200.227 serves the request due to its higher preference value.

Learn Route for Outgoing Traffic Call Flow

This section describes the Learn route for outgoing traffic call flow.

Figure 42: Learn Route for Outgoing Traffic Call Flow

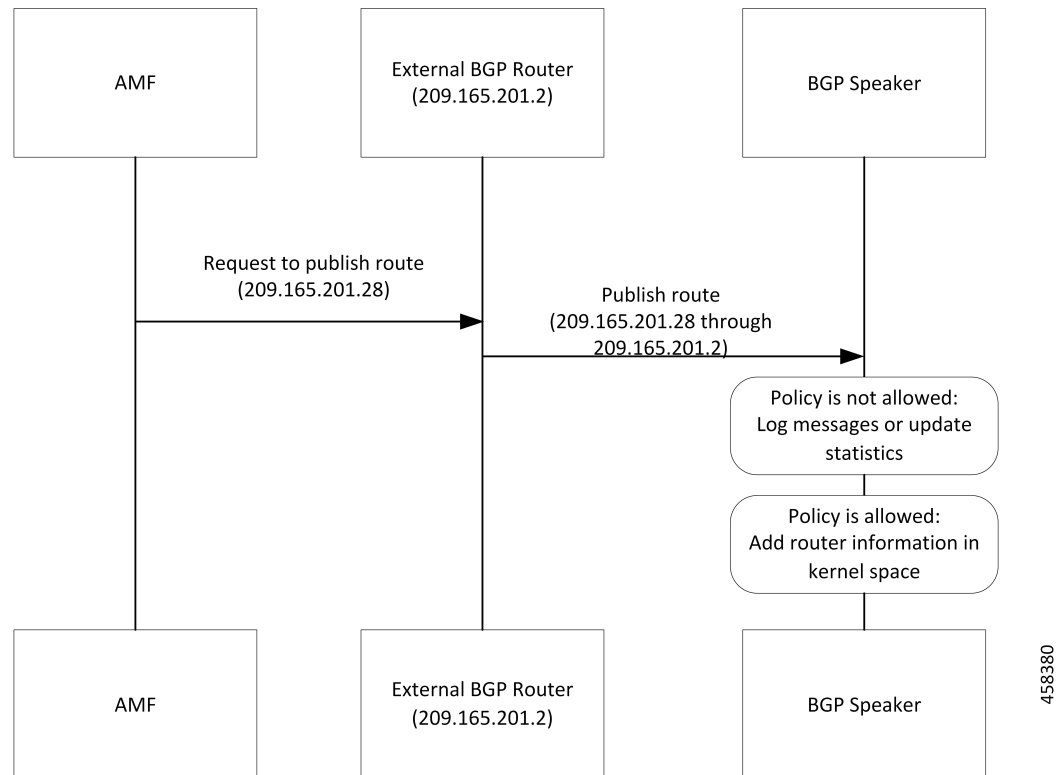

AMF or other systems advertise route to the external BGP route. In turn, the external BGP router advertises routes for its service through BGP.

Table 65: Learn Route for Outgoing Traffic Call Flow Description

Step	Description
1	The BGP speakers receive the routing information.
2	Learn the route by using the BGP protocol.
3	Based on the configure policy, the system either checks the routing information or ignores it.
4	If the policy is not allowed, then the system logs the messages and updates the statistics.
5	The protocol pods configures the route in Kernel space on host through the netlink go APIs.

Configuring Dynamic Routing by Using BGP

This section describes how to configure the Dynamic Routing by Using BGP feature.

Configuring AS and BGP Router IP Address

To configure the AS and IP address for the BGP router, use the following commands:

```

config
  router bgp local_as_number
  exit
exit

```

NOTES:

- **router bgp** *local_as_number*—Specify the identification number for the AS for the BGP router. In a GR deployment, you need to configure two Autonomous Systems (AS).
 - One AS for leaf and spine.
 - Second AS for both racks: Rack-1/Site-1 and Rack-2/Site-2

Configuring BGP Service Listening IP Address

To configure the BGP service listening IP address, use the following commands:

```

config
  router bgp local_as_number
    interface interface_name
  exit
exit

```

NOTES:

- **router bgp** *local_as_number*—Specify the identification number for the AS for the BGP router.
- **interface** *interface_name*—Specify the name of the interface.

Configuring BGP Neighbors

To configure the BGP neighbors, use the following commands:

```

config
  router bgp local_as_number
    interface interface_name
      neighbor neighbor_ip_address remote-as as_number
    exit
exit

```

NOTES:

- **router bgp** *local_as_number*—Specify the identification number for the AS for the BGP router.
- **interface** *interface_name*—Specify the name of the interface.
- **neighbor** *neighbor_ip_address*—Specify the IP address of the neighbor BGP router.
- **remote-as** *as_number*—Specify the identification number for the AS.

Configuring Bonding Interface

To configure the bonding interface related to the interfaces, use the following commands:

```

config
  router bgp local_as_number
    interface interface_name
      bondingInterface interface_name
    exit
  exit

```

NOTES:

- **router bgp** *local_as_number*—Specify the identification number for the AS for the BGP router.
- **interface** *interface_name*—Specify the name of the interface.
- **bondingInterface** *interface_name*—Specify the related bonding interface for an interface. If the bonding interface is active, then the BGP gives a higher preference to the interface-service by providing a lower MED value.

Configuring Learn Default Route

If the user configures specific routes on their system and they need to support all routes, then they must set the **learnDefaultRoute** as **true**.



Note This configuration is optional.

To configure the Learn Default Route, use the following commands:

```

config
  router bgp local_as_number
    learnDefaultRoute true/false
  exit
  exit

```

NOTES:

- **router bgp** *local_as_number*—Specify the identification number for the AS for the BGP router.
- **learnDefaultRoute** *true/false*—Specify the option to enable or disable the **learnDefaultRoute** parameter. When set to true, BGP learns default route and adds it in the kernel space. By default, it is false.

Configuring BGP Port

To configure the Port number for a BGP service, use the following commands:

```

config
  router bgp local_as_number
    loopbackPort port_number
  exit
  exit

```

NOTES:

- **router bgp** *local_as_number*—Specify the identification number for the AS for the BGP router.
- **loopbackPort** *port_number*—Specify the port number for the BGP service. The default value is 179.

Policy Addition

The BGP speaker pods learns many route information from its neighbors. However, only a few of them are used for supporting the outgoing traffic. This is required for egress traffic handling only, when cnSGW-CSMF is sending information outside to AMF/PCF. Routes are filtered by configuring import policies on the BGP speakers and is used to send learned routes to the protocol pods.

A sample CLI code for policy addition and the corresponding descriptions for the parameters are shown below.

```
$bgp policy <policy_Name> ip-prefix 209.165.200.225 subnet 16 masklength-range 21..24
as-path-set "^65100"
```

Table 66: Import Policies Parameters

Element	Description	Example	Optional
as-path-set	AS path value	"^65100"	Yes
ip-prefix	Prefix value	"209.165.200.225/16"	Yes
masklength-range	Range of length	"21..24"	Yes
interface	Interface to set as source IP (default is VM IP)	eth0	Yes
gateWay	Change gateway of incoming route	209.165.201.30	Yes
modifySourceIp	Modify source ip of incoming route Default value is False.	true	Yes
isStaticRoute	Flag to add static IP address into kernel route Default value is False.	true	Yes

Monitoring and Troubleshooting

This section describes the show commands that are supported by the Dynamic Routing by Using BGP feature.

show bgp-kernel-route

Use the **show bgp-kernel-route** command to view all the kernel level routes for a BGP router.

The following configuration is a sample output of the **show bgp-kernel-route** command:

```
kernel-route
-----bgpspeaker-pod-1 -----
DestinationIP      SourceIP           Gateway
209.165.200.235    209.165.200.239   209.165.200.239
-----bgpspeaker-pod-2 -----
DestinationIP      SourceIP           Gateway
```

```
209.165.200.235      209.165.200.229    209.165.200.244
```

show bgp-global

Use the **show bgp-global** command to view all BGP global configurations.

The following configuration is a sample output of the **show bgp-global** command:

```
global-details

-----bgpspeaker-pod-1 -----
AS:          65000
Router-ID: 209.165.200.239
Listening Port: 179, Addresses: 209.165.200.239
AS:          65000
Router-ID: 209.165.200.232
Listening Port: 179, Addresses: 209.165.200.232

-----bgpspeaker-pod-2 -----
AS:          65000
Router-ID: 209.165.200.235
Listening Port: 179, Addresses: 209.165.200.235
AS:          65000
Router-ID: 209.165.200.246
Listening Port: 179, Addresses: 209.165.200.246
```

show bgp-neighbors

Use the **show bgp-neighbors** command to view all BGP neighbors for a BGP router.

The following configuration is a sample output of the **show bgp-neighbors** command:

```
neighbor-details

-----bgpspeaker-pod-2 -----
Peer          AS Up/Down State     |#Received Accepted
209.165.200.244 60000 00:34:20 Establ  |      10      10
Peer          AS Up/Down State     |#Received Accepted
209.165.200.250 60000 00:34:16 Establ  |       3       3

-----bgpspeaker-pod-1 -----
Peer          AS Up/Down State     |#Received Accepted
209.165.200.244 60000 00:33:53 Establ  |      10      10
Peer          AS Up/Down State     |#Received Accepted
209.165.200.250 60000 00:33:53 Establ  |       3       3
```

show bgp-neighbors ip

Use the **show bgp-neighbors ip** command to view details of a neighbor for a BGP router.

The following configuration is a sample output of the **show bgp-neighbors ip** command:

```
neighbor-details

-----bgpspeaker-pod-1 -----
BGP neighbor is 209.165.200.244, remote AS 60000
  BGP version 4, remote router ID 209.165.200.244
  BGP state = ESTABLISHED, up for 00:34:50
  BGP OutQ = 0, Flops = 0
  Hold time is 90, keepalive interval is 30 seconds
  Configured hold time is 90, keepalive interval is 30 seconds

Neighbor capabilities:
```

```

multiprotocol:
  ipv4-unicast:  advertised and received
  route-refresh: advertised and received
  extended-nextthop: advertised
    Local: nlri: ipv4-unicast, nextthop: ipv6
  4-octet-as: advertised and received
Message statistics:
      Sent      Rcvd
Opens:          1          1
Notifications:  0          0
Updates:        1          2
Keepalives:     70         70
Route Refresh:  0          0
Discarded:      0          0
Total:          72         73
Route statistics:
  Advertised:    0
  Received:     10
  Accepted:     10

-----bgpspeaker-pod-2 -----
BGP neighbor is 209.165.200.244, remote AS 60000
BGP version 4, remote router ID 209.165.200.244
BGP state = ESTABLISHED, up for 00:35:17
BGP OutQ = 0, Flops = 0
Hold time is 90, keepalive interval is 30 seconds
Configured hold time is 90, keepalive interval is 30 seconds

Neighbor capabilities:
multiprotocol:
  ipv4-unicast:  advertised and received
  route-refresh: advertised and received
  extended-nextthop: advertised
    Local: nlri: ipv4-unicast, nextthop: ipv6
  4-octet-as: advertised and received
Message statistics:
      Sent      Rcvd
Opens:          1          1
Notifications:  0          0
Updates:        1          2
Keepalives:     71         71
Route Refresh:  0          0
Discarded:      0          0
Total:          73         74
Route statistics:
  Advertised:    0
  Received:     10
  Accepted:     10

```

show bgp-route-summary

Use the **show bgp-route-summary** command to view all the route details of a BGP router.

The following configuration is a sample output of the **show bgp-route-summary** command:

```

route-details

-----bgpspeaker-pod-1 -----
Table afi:AFI_IP safi:SAFI_UNICAST
Destination: 5, Path: 5

-----bgpspeaker-pod-2 -----
Table afi:AFI_IP safi:SAFI_UNICAST
Destination: 5, Path: 5

```

show bgp-routes

Use the **show bgp-routes** command to view all the routes for a BGP router.

The following configuration is a sample output of the **show bgp-routes** command:

```
bgp-route
```

```
-----bgpspeaker-pod-1 -----
  Network          Next Hop          AS_PATH          Age              Attrs
*> 209.165.200.235/24 209.165.200.250 60000            00:36:39        [{Origin: i} {Med:
0}]
*> 209.165.200.227/32 209.165.200.232 00:36:44        [{Origin: e} {LocalPref:
220} {Med: 3220}]
*> 209.165.200.247/24 209.165.200.250 60000            00:36:39        [{Origin: i} {Med:
0}]
*> 209.165.200.251/24 209.165.200.250 60000            00:36:39        [{Origin: i} {Med:
0}]
*> 209.165.200.252/32 209.165.200.232 00:36:44        [{Origin: e} {LocalPref:
220} {Med: 3220}]

-----bgpspeaker-pod-2 -----
  Network          Next Hop          AS_PATH          Age              Attrs
*> 209.165.200.235/24 209.165.200.250 60000            00:37:02        [{Origin: i} {Med:
0}]
*> 209.165.200.227/32 209.165.200.246 00:37:11        [{Origin: e}
{LocalPref: 220} {Med: 3220}]
*> 209.165.200.228/24 209.165.200.234 60000            00:37:02        [{Origin: i} {Med:
0}]
*> 209.165.200.229/24 209.165.200.234 60000            00:37:02        [{Origin: i} {Med:
0}]
*> 209.165.200.230/32 209.165.200.246 00:37:11        [{Origin: e}
{LocalPref: 220} {Med: 3220}]
```

KPIs

The following KPIs are supported for this feature:

Table 67: Statistics for Dynamic Routing by Using BGP

KPI Name	Type	Description/Formula	Label
bgp_outgoing_route request_total	Counter	Total number of outgoing routes.	local_pref, med, next_hop, service_IP
bgp_outgoing_failedroute request_total	Counter	Total number of failed outgoing routes.	local_pref, med, next_hop, service_IP
bgp_incoming_route request_total	Counter	Total number of incoming routes.	interface, next_hop, service_IP
bgp_incoming_failedroute request_total	Counter	Total number of failed incoming routes.	interface, next_hop, service_IP
bgp_peers_total	Counter	Total number of peers added.	peer_ip, as_path

KPI Name	Type	Description/Formula	Label
bgp_failed_peerstotal	Counter	Total number of failed peers.	peer_ip, as_path, error



CHAPTER 18

Emergency Call Support

- [Feature Summary and Revision History, on page 185](#)
- [Feature Description, on page 185](#)
- [How it Works, on page 186](#)
- [OAM Support, on page 188](#)

Feature Summary and Revision History

Summary Data

Table 68: Summary Data

Applicable Product(s) or Functional Area	cnSGW-C
Applicable Platform(s)	SMI
Feature Default Setting	Enabled - Always-on
Related Documentation	Not Applicable

Revision History

Table 69: Revision History

Revision Details	Release
First introduced.	2021.02.0

Feature Description

Emergency services refer to the functionalities provided by the serving network when the network is configured to support emergency services. These are provided to support IMS emergency sessions.

The MME Emergency Configuration Data contains the Emergency APN which is used for deriving a PDN GW. The MME Emergency Configuration Data can also contain the statically configured PDN GW for the Emergency APN.

cnSGW-C considers calls as emergency when:

- Create Session request has IMEI only.
- The Indication flag indicates unauthenticated IMSI and there's a valid IMSI and IMEI in the Create Session Request.



Note With an emergency session setup, cnSGW-C rejects any additional PDN request (Create Session Request) sent by the MME.

Limitations

This feature has the following limitations in 2021.02.0 and later releases:

- IMEI with 15 digits or 16 digits is supported only for the following procedures—show subscriber, clear subscriber, and monitor subscriber.

How it Works

This section describes how this feature works.

Call Flows

This section describes the key call flows for the feature.

Create Emergency Session Call Flow

This section describes the create emergency session (IMEI, Unauthenticated IMSI) call flow.

Figure 43: Create Emergency Session Call Flow

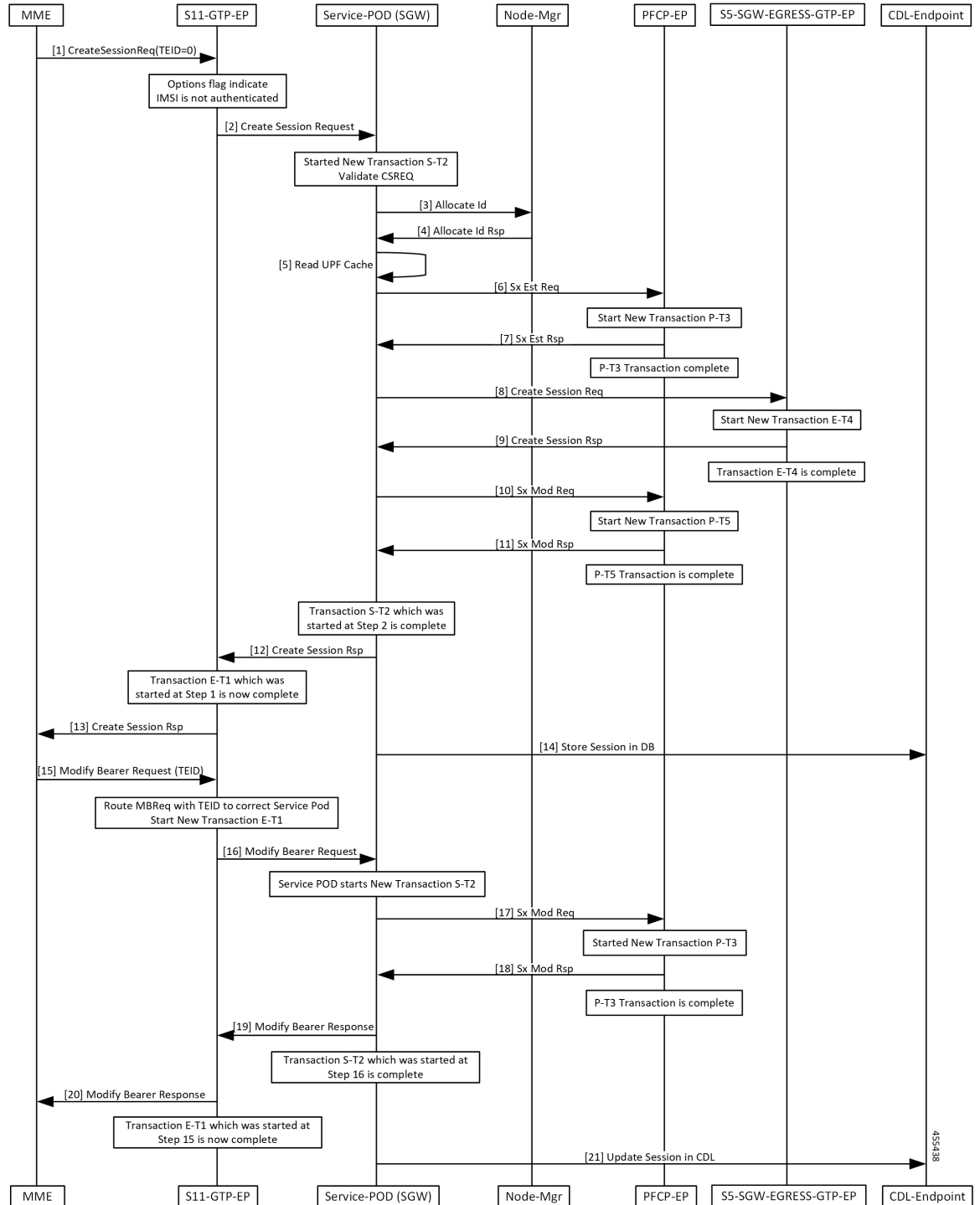

For an Emergency call, cnSGW-C receives an Initial Attach Request in CSR with an UnAuthenticated IMSI, or with an IMEI only. cnSGW-C allocates TEID and SEID from the Node Manager and sends the Sx Establishment Request with local SEID to the UP to establish the session.

Once cnSGW-C receives the Sx Establishment Response from the UP with the UP SEID and the local GTPU TEID for S5 and S1 GTPU FTEID, cnSGW-C sends the Create Session Request to the PGW using EGTP EP. After receiving response from the PGW for Create Session Response, cnSGW-C sends the Sx Modification Request to connect S5-GTPU tunnel between PGW-U and SGW-U. On successful reception of Sx Modification Response, cnSGW-C sends the Create Session Response to the MME and the session is created in CDL.

With Initial attach procedure, cnSGW-C supports handling of Modify Bearer Request which connects S1 GTPU tunnel between eNodeB and SGW-U. When cnSGW-C receives MBR, it sends Sx Modification Request to connect S1 GTPU tunnel between eNodeB and SGW-U. After receiving Sx Modification Response, cnSGW-C sends Modify Bearer Response to the MME. Session is updated in CDL as the end of transaction.

OAM Support

This section describes operations, administration, and maintenance information for this feature.

Bulk Statistics Support

Emergency Counters

```
sgw_ue_stats{app_name="SMF",cluster="Local",data_center="DC",gr_instance_id="1",
instance_id="0",rat_type="EUTRAN",service_name="sgw-service",status="emergency_release"}
9
```

```
sgw_ue_stats{app_name="SMF",cluster="Local",data_center="DC",gr_instance_id="1",
instance_id="0",rat_type="EUTRAN",service_name="sgw-service",status="emergency_setup"}
9
```

Emergency Statistics

```
db_records_total{app_name="datastore-ep",cluster="session",data_center="test",db=
"session",instance_id="3232257055",service_name="datastore-ep",session_type="SGW:
emergency_call:true",sliceName="1",systemId=""} 1
```

```
db_records_total{app_name="datastore-ep",cluster="session",data_center="test",db=
"session",instance_id="3232257055",service_name="datastore-ep",session_type="SGW:
rat_type:EUTRAN",sliceName="1",systemId=""} 3
```

```
db_records_total{app_name="datastore-ep",cluster="session",data_center="test",db=
"session",instance_id="3232257055",service_name="datastore-ep",session_type="SGW:
state:active",sliceName="1",systemId=""} 3
```

```
db_records_total{app_name="datastore-ep",cluster="session",data_center="test",db=
"session",instance_id="3232257055",service_name="datastore-ep",session_type="total",
sliceName="1",systemId="1"} 3
```



CHAPTER 19

Extended and Non-Standard QCI Values Support and Validation

- [Feature Summary and Revision History, on page 189](#)
- [Feature Description, on page 189](#)

Feature Summary and Revision History

Summary Data

Table 70: Summary Data

Applicable Product(s) or Functional Area	cnSGW-C
Applicable Platform(s)	SMI
Feature Default Setting	Enabled - Always-on
Related Documentation	Not Applicable

Revision History

Table 71: Revision History

Revision Details	Release
First introduced.	2021.02.3

Feature Description

This feature supports the following:

- Extended and Non-Standard QCI values as part of CSR | CBR | UBR | MBC call flows

- Extended and Non-Standard QCI values for DSCP marking
- Extended and Non-Standard QCI values for VoLTE marking

For more information, see the following:

- [DSCP Marking Support, on page 161](#)
- [Extended and Non-Standard QCI Values Support and Validation, on page 189](#)
- [VoLTE Call Prioritization, on page 713](#)

Validation for Extended and Non-Standard QCI Values

The following Extended QoS Class Identifier (QCI) and Non-Standard QCI (Operator-defined) values are validated for:

- **CSR | CBR | UBR | MBC Call Flows:** Validation is done for the following QCI values:

Extended QCI: 65, 66, 69, 70, 80, 82, 83

Non-Standard (Operator-defined) QCI: 128-154



Note As part of CSR | CBR | UBR | MBC call flows, values other than Standard / Extended / Operator-defined QCI range are also accepted. However, those values aren't supported as part of DSCP marking or VoLTE marking CLIs.

- **DSCP Marking:** Validation is done for the following QCI values:

Extended QCI: 65, 66, 69, 70, 80, 82, 83

Non-Standard (Operator-defined) QCI: 128-154

For more information on DSCP Marking, see *DSCP Marking Support* chapter in the *UCC Serving Gateway Control Plane Function - Configuration and Administration Guide*.

Support and Validation for Extended and Non-Standard QCI Values for VoLTE Marking

In release prior to 2021.02.2, only Standard QCI values 1-9 were supported for VoLTE Marking.

In 2021.02.2 and later releases, support is added and validated for the following Extended and Non-Standard QCI values:

Extended QCI: 65, 66, 69, 70, 80, 82, 83

Non-Standard (Operator-defined) QCI: 128-154

For more information on VoLTE Marking, see *VoLTE Call Prioritization* chapter in the *UCC Serving Gateway Control Plane Function - Configuration and Administration Guide*.



CHAPTER 20

eMPS/WPS Support

- [Feature Summary and Revision History, on page 191](#)
- [Feature Description, on page 191](#)
- [eMPS/WPS Support, on page 192](#)
- [eMPS GTPv2 Load/Overload Self Protection Exclusion Support, on page 195](#)

Feature Summary and Revision History

Summary Data

Table 72: Summary Data

Applicable Product(s) or Functional Area	cnSGW-C
Applicable Platform(s)	SMI
Feature Default Setting	Disabled – Configuration required to enable
Related Documentation	Not Applicable

Revision History

Table 73: Revision History

Revision Details	Release
First introduced.	2021.02.0

Feature Description

This feature supports the following:

- Enhanced Multimedia Priority Service (eMPS) or Wireless Priority Service (WPS)

- eMPS GTPv2 Load/Overload Self Protection Exclusion

eMPS/WPS Support

Feature Description

This feature supports identifying the eMPS subscriber. The feature sets the message priority bit for:

- PFCP interface towards the UP.
- GTPC interface towards the MME and PGW.

This feature includes DSCP marking for request messages in control messages as per the configured value in the profile for eMPS subscriber.

Feature Configuration

Configuring this feature involves the following steps:

- Configure WPS-Profile. For more information, refer to [Configuring WPS Profile, on page 192](#).
- Configure SGW-Profile, and enable WPS-Profile and SGW-Profile association. For more information, refer to [Configuring WPS-Profile and SGW-Profile Association, on page 193](#).
- Configure DNN-Profile, and enable WPS-Profile and DNN-Profile association. For more information, refer to [Configuring WPS-Profile and DNN-Profile Association, on page 193](#).

Configuring WPS Profile

To configure this feature, use the following configuration:

```
config
  profile wps wps_name
    arp arp_value
    dscp dscp_value
    message-priority [ pfcpc | gtpc ]
  end
```

NOTES:

- **wps** *wps_name*—Specify the WPS service name. Must be a string.
- **arp** *arp_value*—Specify the range of ARP levels (separated by , or -). Must be an integer or a string.
- **dscp** *dscp_value*—Specify the DSCP marking value in the decimal range 0-63 or hex range 0x0-0x3F. Must be a string.
- **message-priority**—Specify the message priority for GTP-C and UP. Must be one of the following:
 - gtpc
 - pfcpc

Configuration Example

The following is an example configuration.

```
config
  profile wps wpl
    arp 2
    message-priority gtpc
    message-priority pfcpc
  end
```

Configuration Verification

To verify the configuration:

```
show running-config profile wps
profile wps wpl
arp 2
message-priority [ pfcpc gtpc ]
```

Configuring WPS-Profile and SGW-Profile Association

To configure WPS-Profile and SGW-Profile association, use the following configuration:

```
config
  profile sgw sgw_name
  wps-profile wps_name
end
```

NOTES:

- **wps-profile** *wps_name*—Specify the Wireless Priority Service (WPS) name. Must be a string.

Configuration Example

The following is an example configuration.

```
config
  profile sgw sgw1
  wps-profile wpl
end
```

Configuration Verification

To verify the configuration:

```
show running-config profile sgw
profile sgw sgw1
wps-profile wpl
```

Configuring WPS-Profile and DNN-Profile Association

This section describes how to configure WPS-Profile and DNN-Profile association.



Note If WPS profile is associated with SGW profile and DNN profile, DNN profile takes the priority.

To configure WPS-Profile and DNN-Profile association, use the following configuration:

```

config
  profile dnn dnn_name
    wps-profile wps_name
  end

```

Configuration Example

The following is an example configuration.

```

config
  profile dnn dnn1
  wps-profile wps1
end

```

Configuration Verification

To verify the configuration:

```

show running-config profile dnn
profile dnn dnn1
wps-profile wps1

```

OAM Support

This section describes operations, administration, and maintenance information for this feature

Bulk Statistics Support

The following are the examples for eMPS messages:

```

sgw_pdn_emps_counters{app_name="smf",cluster="cn",data_center="cn",instance_id="0",
service_name="sgw-service",status="active"} 1

```

```

sgw_pdn_emps_stats{app_name="smf",cluster="cn",data_center="cn",instance_id="0",
service_name="sgw-service",status="release"} 7

```

```

sgw_pdn_emps_stats{app_name="smf",cluster="cn",data_center="cn",instance_id="0",
service_name="sgw-service",status="setup"} 8

```

```

gtpc_app_priority_events{app_name="smf",cluster="smf",data_center="smf",event_type=
"NumRxModifyBearerResFrmSerSuccess",instance_id="0",
interface_type="S11",priority_msg="true",service_name="gtpc-ep"} 3

```

```

gtpc_app_priority_events{app_name="smf",cluster="smf",data_center="smf",event_type=
"RxCreateSessionRes",instance_id="0",interface_type="S5E",
priority_msg="true",service_name="gtpc-ep"} 2

```

```

proto_pfcf_msg_total{app_name="smf",cluster="smf",data_center="smf",instance_id="0",
interface_type="SXA",message_direction="outbound",
message_name="N4_MSG_SESSION_ESTABLISHMENT_REQUEST",msgpriority="True",service_name=
"protocol",status="accepted",transport_type="origin"} 2

```

```
proto_pfcmsg_total{app_name="smf",cluster="smf",data_center="smf",instance_id="0",
interface_type="SXA",message_direction="outbound",
message_name="N4_MSG_SESSION_MODIFICATION_REQUEST",msgpriority="True",service_name="protocol",
status="accepted",transport_type="origin"} 6
```

eMPS GTPv2 Load/Overload Self Protection Exclusion Support

Feature Description

cnSGW-C supports interaction of eMPS with GTPv2 load or overload feature. It supports excluding eARPs /APNs/Emergency call during self-protection mode in GTPv2 load or overload feature.

cnSGW-C can exclude the dnn-list and the arp-list from the rejection for incoming request messages in self-protection mode. cnSGW-C excludes this rejection in the following manner:

- Excludes the dnn-list from rejection for any call level procedure when subscriber APN name (NI+OI) matches with *overload-exclude-profile*
- Excludes bearer modification or creation from rejection for any new or existing ARP (Priority-Level) value
- Excludes the delete bearer or the session operations, such as Delete Bearer Request, Delete Session Request, Delete Bearer command from rejection irrespective of the overload-exclude-profile configuration



Note cnSGW-C does not support message throttling.

Feature Configuration

Configuring this feature involves the following steps:

- Configure Overload Exclude Profile. For more information, refer to [Configuring Overload Exclude Profile, on page 195](#).
- Configure Overload-Profile, and enable Overload Exclude Profile and SGW-Profile Association. For more information, refer to [Configuring the Overload-Profile and the SGW-Profile Association, on page 196](#).

Configuring Overload Exclude Profile

To configure the Overload Exclude profile, use the following configuration:

```
config
  profile overload-exclude overload_exclude_profile_name
    dnn-list list_of_dnn
    arp-list list_of_arp
  end
```

NOTES:

- **overload-exclude** *overload_exclude_profile_name*— Specify the exclude overload profile name.

- **dnn-list** *list_of_dnn*—Specify the list of DNNs that needs to be excluded from throttling decision. Maximum three entries are allowed.
- **arp-list** *list_of_arp*—Specify the ARP list that needs to be excluded from throttling decisions. Must be an integer in the range of 1-15. Maximum eight entries are allowed.

Configuration Example

The following is an example configuration.

```
config
  profile overload-exclude oel
    dnn-list [ starent.com ]
    arp-list [ 1 2 ]
  end
```

Configuration Verification

To verify the configuration:

```
show running-config profile overload-exclude
profile overload-exclude oel
dnn-list [ starent.com ]
arp-list [ 1 2 ]
end
```

Configuring the Overload-Profile and the SGW-Profile Association

The association of the Overload-Profile and the SGW-Profile, can be configured.

To configure this feature use the following configuration:

```
config
  profile overload overload_profile_name
    overload-exclude-profile self-protection self_protection_profile_name
  node-level
    tolerance
      minimum min_percentage
      maximum max_percentage
    reduction-metric
      minimum min_percentage
      maximum max_percentage
    advertise
      interval interval_value
      change-factor
    exit
  interface gtpc
    overloaded-action [ advertise ]
  exit
exit
profile load load_name
load-calc-frequency load_calc_frequency_value
load-fetch-frequency load_fetch_frequency_value
advertise
interval interval_value
```

```

change-factor change_factor_value
exit
interface gtpc
action advertise
exit
exit
profile sgw sgw_name
load-profile profile_name
overload-profile overload_profile_name
end

```

NOTES:

- **overload** *overload_name*—Specify the overload protection profile name. Must be a string.
- **overload-exclude-profile**—Excludes profiles for overload scenarios.
- **self-protection** *overload_value*—Specify the profile to be excluded for self-protection. Must be a string.
- **tolerance minimum** *min_percentage*—Specify the minimum tolerance level below which the system is in a normal state. Must be an integer in the range of 1-100. The default value is 80.
- **tolerance maximum** *max_percentage*—Specify the maximum tolerance level above which the system is in a self-protection state. Must be an integer in the range of 1-100. The default value is 95.
- **reduction-metric minimum** *min_percentage*—Specify the percentage of reduction along with minimum tolerance-level for configuration. Must be an integer in the range of 1-100. The default value is 10.
- **reduction-metric maximum** *max_percentage*—Specify the percentage of reduction along with maximum tolerance-level for configuration. Must be an integer in the range of 1-100. The default value is 100.
- **interval** *interval_value*—Specify the advertising interval in seconds. Must be an integer in the range of 0-3600. The default value is 300 seconds.
- **validity** *validity_value*—Specify the validity period of the advertised OCI value in seconds. Must be an integer in the range of 1-3600. The default value is 600 seconds.
- **change-factor** *change_factor_value*—Specify the minimum change between current OCI and last indicated OCI, after which the advertising should happen. Must be an integer in the range of 1-20. The default value is five.
- **profile load** *load_name*—Specify the name of the load profile. Must be a string.
- **load-calc-frequency** *load_calc_frequency_value*—Specify the system load calculation interval in seconds. Must be an integer in the range of 5-3600. The default value is 10 seconds.
- **load-fetch-frequency** *load_fetch_frequency_value*—Specify the time interval in seconds at which the service pods fetch load from the cache pod. Must be an integer in the range of 5-3600. The default value is 10 seconds.
- **load-profile** *profile_name*—Specify the name of the load profile.
- **overload-profile** *overload_profile_name*—Specify the name of the overload profile.

Configuration Example

The following is an example configuration.

```
config
profile overload op
overload-exclude-profile self-protection <overload-exclude-profile-name>
node-level
tolerance minimum 5
tolerance maximum 50
reduction-metric minimum 50
reduction-metric maximum 100
advertise
interval 0
change-factor 1
exit
interface gtpc
overloaded-action [ advertise ]
exit
exit
exit
profile load lp
load-calc-frequency 120
load-fetch-frequency 15
advertise
interval 0
change-factor 1
exit
interface gtpc
action advertise
exit
exit
profile sgw <sgw_name>
load-profile <profile_name>
overload-profile <overload_profile_name>
end
```

Configuration Verification

To verify the configuration:

```
show running-config profile
profile sgw sgw1
load lp1
overload opl
end
```



CHAPTER 21

Failure and Error Handling Support

- [Feature Summary and Revision History, on page 199](#)
- [Overview, on page 200](#)
- [Attach and Detach Failure and Error Handling, on page 200](#)
- [Create-Update-Delete Bearer Request and Response Failure and Error Handling, on page 203](#)
- [Radio Access Bearer/Modify Bearer Request Failure and Error Handling, on page 208](#)
- [Support for Failure Cause Code, Cause Source, and Bearer Context Error, on page 210](#)

Feature Summary and Revision History

Summary Data

Table 74: Summary Data

Applicable Product(s) or Functional Area	cnSGW-C
Applicable Platform(s)	SMI
Feature Default Setting	Enabled - Always-on
Related Documentation	Not Applicable

Revision History

Table 75: Revision History

Revision Details	Release
Added support for the Information Elements (IE): <ul style="list-style-type: none">• Failure Cause Code• Cause Source (Bit 1 – CS)• Bearer Context IE error (Bit 2 – BCE)	2021.02.3

Revision Details	Release
First introduced.	2021.01.0

Overview

cnSGW-C supports:

- Attach and Detach failure and error handling.
- Create, Update, Delete Bearer Request and Response failure and error handling.
- Radio Access Bearer or Modify Beare Request failure and error handling.

The different types of failures that can occur during the call processing are as follows, except for Session Setup timer:

- Advance validation failure on request and response.
- Retransmission timeout.
- Transaction service level agreement (SLA).
- Failure reported from peer (UP, PGW, or MME depending on the stage of message process).

For Session Setup timer during attach procedure, following failures can happen:

- Ongoing PDN establishment and Modify Bearer Request from MME isn't received for Initial Attach and multi-PDN.

Attach and Detach Failure and Error Handling

cnSGW-C supports the following:

- Setup timeout functionlaity
- Failure response handling for:
 - Clear Session Request as a part of the Initial Attach and additional PDN setup procedures
 - Delete Beare Request and Delete Session Request processing for the PGW and UPF

Create Session Request Failure Handling

This section covers the Create Session Request procedure failure scenarios.

When failure occurs during Initial Attach procedure, subscriber context isn't created,

When another PDN setup fails, PDN isn't created in subscriber context.

The following table summarizes cnSGW-C behavior during different stages in the call processing for various failure types:

Table 76: cnSGW-C Behavior for Create Session Request Procedure Failure Scenarios

Scenarios	Sx Signaling (Revert)	S11 Signaling (Revert)	S5 Signaling
<ul style="list-style-type: none"> • Create Session Request advance validation failure • Sx Session Establishment Response failure from User Plane (UP) 	No	Negative - Create Session Response	No
<ul style="list-style-type: none"> • Create Session Response failure 	Yes Delete traffic endpoint for newly created bearers	Negative - Create Session Response	No
<ul style="list-style-type: none"> • Sx Modify Response process failure 	Yes Delete traffic endpoint for newly created bearers	Negative - Create Session Response	Delete Session Request to delete newly created session

Delete Default Bearer Procedure Failure Handling

This section covers the PGW-initiated default bearer deletion procedure failure scenarios.

The following table summarizes cnSGW-C behavior during different stages of call processing for various failure types:

Table 77: cnSGW-C Behavior for Delete Default Bearer Procedure Failure Scenarios

Scenarios	SGW-service Behavior	Signaling	Output
Delete Bearer Request advance validation failure	Send failure/No signaling over Sx/PGW	Negative - S5 Delete Bearer Response	Session/PDN is not deleted
Sx Session Modify failure	Skip failure and continue	Send S11 Delete Bearer Request towards MME S5 Delete Bearer Response (Cause = Accepted) Sx Delete Request (to Delete traffic endpoint) depends upon Sx Session Modify Response	Session/PDN is deleted
S11 Delete Bearer Request failure	Skip failure and continue	Send Delete Bearer Response (Cause = Accepted) to PGW Sx Delete Request (to Delete traffic endpoint)	Session/PDN is deleted

Scenarios	SGW-service Behavior	Signaling	Output
Sx Session Delete Request failure	Skip failure and continue	Send Delete Bearer Response (Cause = Accepted) to PGW	Session/PDN is deleted

Delete Session Procedure Failure Handling

This section covers the MME-initiated Deletion Session procedure failure scenarios.

The following table represents cnSGW-C behavior for the failure scenarios:

Table 78: cnSGW-C Behavior for Delete Session Procedure Failure Scenarios

Scenarios	SGW-service Behavior	Signaling	Output
Delete Session Request advance validation failure	Send failure/No signaling over Sx/MME	Negative - S11 Delete Session Response	Session/PDN is not deleted
Sx Session Modify Request failure	Skip failure and continue	Send Delete Session Request towards PGW Send Delete Session Response (Cause = Accepted) to MME Sx Delete Request (to Delete traffic endpoint) depends upon Sx Session Modify Response	Session/PDN is deleted
S5 Delete Session Request failure	Skip failure and continue	Send Delete Session Response (Cause = Accepted) to MME Sx Delete Request (to Delete traffic endpoint)	Session/PDN is deleted
Sx Session Delete Request failure	Skip failure and continue	Send Delete Session Response (Cause = Accepted) to MME	Session/PDN is deleted

Session Setup Timer during Attach Procedure

This section covers the session setup timer during attach procedure.

The following table represents cnSGW-C behavior for the session timeout scenarios:

Table 79: cnSGW-C Behavior for Session Timeout Failure Scenarios

Scenarios	Sx Signaling (Revert)	S11 Signaling (Revert)	S5 Signaling	Output
Session setup timeout expired after SGW sends Create Session Response to MME and waits for the Modify Bearer Request from MME.	Sx Delete Request (To delete traffic endpoint for newly created bearers)	Delete Session Request	Delete Bearer Request	Session/PDN is deleted

Create-Update-Delete Bearer Request and Response Failure and Error Handling

This section describes create, update, and delete bearer request and response failure and error handling scenarios.

Create Bearer Procedure Failure Handling

This section covers the PGW-initiated dedicated bearer creation procedure failure scenarios.

The following table summarizes cnSGW-C behavior during different stages of call processing for various failure types:



Note During processing of create dedicated Bearer Request and Response, if SGW receives Context Not Found from peer (MME/UP) it deletes the PDN without performing any signaling towards the peer which sent this cause.

Table 80: cnSGW-C Behavior for Create Bearer Procedure Failure Scenarios

Scenarios	Sx Signaling (Revert)	S11 Signaling (Revert)	S5 Signaling	Output
<ul style="list-style-type: none"> • Create Bearer Request advance validation failure • Sx Session Modify Request failure (request sent to UP to allocate tunnel endpoint and GTPU TEIDs). 	No	No	Negative - Create Bearer Response to PGW	New Bearer Context is not created.

Scenarios	Sx Signaling (Revert)	S11 Signaling (Revert)	S5 Signaling	Output
Create Bearer Request is sent to MME and SGW is waiting for the Response.	Yes To remove traffic endpoint for newly created bearers.	No	Negative - Create Bearer Response to PGW	New Bearer Context is not created. Optional parameters of Create Bearer Response are ignored.
SGW receives Create Bearer Resposne from MME and sends Sx Modify to UP to connect GTPU tunnel between eNodeB and SGW-U.	Yes To remove traffic endpoint for newly created bearers.	Yes To delete newly created bearers.	Negative - Create Bearer Response to PGW	New Bearer Context is not created. Optional parameters of Create Bearer Response are ignored.
Failure in Revert handling for the Delete Bearer Request or Sx Modify Request.	No	No	Negative - Create Bearer Response	Bearer Context is not created. Optional parameters of Create Bearer Response are ignored.

Delete Dedicated Bearer Procedure Failure Handling

This section covers the PGW-initiated dedicated bearer deletion procedure failure scenarios.

The following table summarizes cnSGW-C behavior during different stages of the call processing for various failure types:



Note During processing of delete dedicated Bearer Request and Response if SGW receives Context Not Found from peer (MME/UP), it deletes the PDN without performing any signaling towards the peer which sent this cause.

Table 81: cnSGW-C Behavior for Delete Dedicated Bearer Procedure Failure Scenarios

Scenarios	SGW-Service Behavior	Signaling	Output
Delete Bearer Request advance validation failure	Send failure/No Signaling over Sx/MME	Negative - Delete Bearer Response to PGW	Dedicated Bearer is not deleted.

Scenarios	SGW-Service Behavior	Signaling	Output
Partial Accepted: Delete Bearer Request received with multiple EBI's, where: <ul style="list-style-type: none"> • Some EBIs belong to PDN • Some EBIs don't belong to PDN/Invalid EBIs 	Continue DBR Procedure and delete all existing bearers for which Delete Bearer Request is received. S11 Delete Bearer Request should carry only existing EBIs information Sx Session Modification Request should carry existing EBIs information (Remove Traffic Endpoint)	S5 Delete Bearer Response (Cause = Partially Accepted)	S5 Delete Bearer Response where message level cause is Partially Accepted and bearer level cause is: <ul style="list-style-type: none"> • Some EBIs belong to PDN: S11 Delete Bearer Response • Some EBIs does not belong to PDN/Invalid EBIs: Context Not Found CDL is updated (Remove all existing bearers)
Sx Session Modify to set action as DROP	Skip failure and continue	S5 Delete Bearer Response (Cause = Accepted)	Skip failure and continue with DBR Procedure Call Flow: Yes S5 Delete Bearer Response (Cause = Accepted) CDL is updated
S11 Delete Bearer Request Failure	Skip failure and continue	S5 Delete Bearer Response (Cause) = Accepted	Skip failure and continue with DBR Procedure Call Flow: Yes CDL is updated
Sx Session Modify Request failure (Request to remove traffic endpoint on UP)	Skip failure and continue	S5 Delete Bearer Response (Cause = Accepted)	Skip failure and continue with DBR Procedure Call Flow: Yes CDL is updated

Update Bearer Procedure Failure Handling

This section covers the PGW-initiated update bearer procedure failure scenarios.

The following table summarizes cnSGW-C behavior during different stages in call processing for various failure types:

Table 82: cnSGW-C Behavior for Update Bearer Procedure Failure Scenarios

Scenarios	S5/Sx Signaling	Output
Update Bearer Request advance validation failure	Negative - Update Bearer Response	No change in Bearer/PDN context.

Scenarios	S5/Sx Signaling	Output
Update Bearer Request with non-existing EBIs	Update Bearer Response with message level cause as REQ_PARTIALLY_ACCEPTED. Bearer level cause for non-existing EBIs as Context Not Found. (Normal handling for existing EBIs)	Update Bearer Response with message level cause as REQ_PARTIALLY_ACCEPTED. Bearer level cause for non-existing EBIs as CONTEXT_NOT_FOUND. Normal handling for existing EBIs. CDL is updated for existing EBIs only.
Update Bearer Request is sent to MME and waiting for the response	Negative - Update Bearer Response	Negative - Update Bearer Response CDL is not updated.
S11 Update Bearer Response (Message level Cause == CONTEXT_NOT_FOUND) and S5 Update Bearer Req/Rsp had default bearer in the bearer context list	Sx Delete Req/Rsp Negative - Update Bearer Response	Negative - Update Bearer Response CDL is not updated. Statistics/Transactional Logs PDN Key Release + PDN deallocation If this is the last PDN, then resource manager is released, all subscriber keys are released and subscriber deallocation is done.
S11 Update Bearer Response (Message level Cause == CONTEXT_NOT_FOUND) and S5 Update Bearer Req/Rsp didn't have default bearer in the bearer context list	Sx Modify Req/Rsp Negative - Update Bearer Response	CDL is not updated.
S11 Update Bearer Response (Message level Cause == REQ_PARTIALLY_ACCEPTED, Bearer Context Cause == Any failure for dedicated bearer)	Sx Modify Req/Rsp Update Bearer Response with message level cause as REQ_PARTIALLY_ACCEPTED	Update Bearer Response with message level cause as REQ_PARTIALLY_ACCEPTED CDL is updated for successful bearers.

Scenarios	S5/Sx Signaling	Output
S11 Update Bearer Response (Message level Cause == REQ_PARTIALLY_ACCEPTED, Bearer Context Cause == CONTEXT_NOT_FOUND for default bearer)	Sx Delete Req/Rsp Negative - Update Bearer Response	Negative - Update Bearer Response CDL is not updated. PDN Key Release and PDN deallocation If this is the last PDN, then resource manager is released, all subscriber keys are released and subscriber deallocation is done.
If Sx modify is triggered after Update Bearer Response: <ul style="list-style-type: none"> • Sx Session Modify Request (IPC/Retransmission Timeout/Internal Failure and so on) • Sx Session Modify Response (Cause != ACCEPTED except CONTEXT_NOT_FOUND) 	Ignore failure and continue	Ignore failure and continue
If Sx Modify is triggered after Update Bearer Response: <ul style="list-style-type: none"> • Sx Session Modify Response (Cause == CONTEXT_NOT_FOUND) 	¹	²
If Sx Delete is triggered after Update Bearer Response: <ul style="list-style-type: none"> • Sx Session Delete Request (IPC/Retransmission Timeout/Internal Failure and so on) • Sx Session Delete Response (Cause != ACCEPTED) • Resource manager release (Internal Error) 	Ignore failure and continue	Ignore failure and continue

¹ As part of Update Bearer Procedure handling, SGW-service triggers new transaction for PDN deletion:

- Sx Failure Cause received as part of Sx Session Modification Response
 - Context Not Found

SGW Behavior (New Transaction):

- SGW triggers S11 Delete Bearer Request and S5 Delete Session Request to delete that PDN
- No Sx Signaling

SGW Behavior (Update Bearer Transaction): SGW sends S5 Update Bearer Response with Cause as No Resource Available, as part of Update Bearer Procedure Transaction. Also, SGW doesn't initiate any signaling towards UP as soon as it receives Sx Session Modification Response with cause as Context Not Found.

² As part of Update Bearer Procedure handling, SGW-SVC additionally triggers new transaction for PDN deletion:

- Sx Failure Cause received as part of Sx Session Modification Response
 - Context Not Found

SGW Behavior (New Transaction):

- SGW triggers S11 Delete Bearer Request and S5 Delete Session Request to delete that PDN
- No Sx Signaling

SGW Behavior (Update Bearer Transaction): SGW sends S5 Update Bearer Response with Cause as No Resource Available, as part of Update Bearer Procedure Transaction. Also, SGW doesn't initiate any signaling towards UP as soon as it receives Sx Session Modification Response with cause as Context Not Found.

Radio Access Bearer/Modify Bearer Request Failure and Error Handling

This section covers the Radio Access Bearers (RAB), Modify Bearer Request and Response (MBR) from PGW and User Plane (UP) failure scenarios.

The following table summarizes cnSGW-C behavior during different stages of call processing for various failure types:

Table 83: cnSGW-C Behavior for Radio access Bearer and Modify Bearer Response Procedure Failure Scenarios

Message Type	Failure Interface	Failure Response Received	Failure Response to be sent	Handling
MBR initial attach	Sx	CONTEXT_NOT_FOUND	EGTP_CAUSE_ NO_RESOURCES_ AVAILABLE	Cleanup PDN with DSR towards PGW and DBR towards MME
		Other Failure Response	EGTP_CAUSE_ NO_RESOURCES_ AVAILABLE	Cleanup PDN with DSR towards PGW and DBR towards MME. Sx_Modification_Req/ Sx_Session_Delete to cleanup resource on UP
	Timeout	Timeout on PFCP	EGTP_CAUSE_ NO_RESOURCES_ AVAILABLE	Cleanup PDN with DSR towards PGW and DBR towards MME. Sx_Modification_Req/ Sx_Session_Delete to cleanup resource on UP
MBR Service Request	Sx	CONTEXT_NOT_FOUND	EGTP_CAUSE_ NO_RESOURCES_ AVAILABLE	Cleanup PDN with DSR towards PGW and DBR towards MME
		Other Failure Responses	EGTP_CAUSE_ NO_RESOURCES_ AVAILABLE	Do not update anything in PDN, Ignore S5 Signaling
		Timeout	EGTP_CAUSE_ NO_RESOURCES_ AVAILABLE	Do not update anything in PDN, Ignore S5 Signaling
	S5	EGTP_CAUSE_ CONTEXT_NOT_FOUND	EGTP_CAUSE_ CONTEXT_NOT_FOUND	Sx_Session_Delete send to UP MBRsp failure to MME (No DBR/DSR)
		Other Failure Responses	Failure Response received from PGW	Do not update PDN/DB
	Timeout	Timeout from PGW	EGTP_CAUSE_ PEER_NOT_RESPONDING	Do not update PDN/DB

Message Type	Failure Interface	Failure Response Received	Failure Response to be sent	Handling
RAB	Sx	CONTEXT_ NOT_FOUND (Single PDN call)	EGTP_CAUSE_ REQ_ACCEPTED	Cleanup PDN with DSR towards PGW and DBR towards MME
		CONTEXT_ NOT_FOUND (Multi PDN call and context not found for one PDN)	Send RAB Resp (EGTP_CAUSE_ REQ_ACCEPTED)	Cleanup the PDN for which context not found received with DSR towards PGW and DBR towards MME Move other PDN/UE to IDLE
		Other Failure Response	EGTP_CAUSE_ REQ_ACCEPTED	Move PDN/UE to IDLE
		Timeout	EGTP_CAUSE_ REQ_ACCEPTED	Move PDN/UE to IDLE

Support for Failure Cause Code, Cause Source, and Bearer Context Error

This section describes the support for the Information Elements (IE) – Failure cause code, Cause Source (CS), and Bearer Context Error (BCE).

For more information on the technical specifications for the IEs, see *3GPP TS 29.274*.

Failure Cause Code

cnSGW-C supports handling any failure cause code received from SMF on S5 interface.

Cause Source

Bit 1 – CS (Cause Source) value ‘0’ indicates that the error is originated by the node sending the message.

Bit 1 – CS (Cause Source) value ‘1’ indicates that the error is originated by the remote node (MME/SGSN to a PGW, or PGW to an MME/SGN).

Bearer Context Error

The default value of Bit 2-BCE (Bearer Context IE Error) is ‘0’. If the BCE Bit is 1, it indicates that the corresponding rejection clause is due to the error in the Bearer Context IE. This bit is discarded if the cause value is one of Acceptance cause value.



CHAPTER 22

GTPC and Sx Path Management

- [Feature Summary and Revision History, on page 211](#)
- [Feature Description, on page 212](#)
- [GTPC and Sx Path Management, on page 212](#)
- [GTPC Path Failure, on page 217](#)
- [Sx Path Failure, on page 220](#)
- [Customization of Path Failure Detection, on page 222](#)

Feature Summary and Revision History

Summary Data

Table 84: Summary Data

Applicable Product(s) or Functional Area	cnSGW-C
Applicable Platform(s)	SMI
Feature Default Setting	GTPC and Sx Path Management: Disabled – Configuration required to enable GTPC Path Failure: Enabled – Always-on Sx Path Failure: Enabled – Always-on Path Failure Detection Customization: Disabled – Configuration required to enable
Related Documentation	Not Applicable

Revision History

Table 85: Revision History

Revision Details	Release
Introduced support for IPv6.	2022.04.0
First introduced.	2021.02.0

Feature Description

The GTPC and Sx Path Management feature supports the following:

- GTPC path management using Echo Request and Echo Response messages.
- Sx path management using PFCP Heartbeat Request and Heartbeat Response. Node-level heartbeat procedures between the SGW-C and UPF.
- Detection of the GTPC path failure on S11 and S5 interface.
- Detection of the Sx path failure on the Sx interface.
- Configuration of the path failure detection policy to configure the path failure detection capability.

GTPC and Sx Path Management

Feature Description

GTPC and Sx Path Management supports the following:

- GTPC path management using Echo Request and Echo Response exchange over S5 and S11 interface to check peer aliveness.
- Sx path management using Packet Forwarding Control Protocol (PFCP) Heartbeat Request and Heartbeat Response exchange over Sx interface to check peer aliveness.

Feature Configuration

Configuring this feature involves the following steps:

- Configure the echo parameters. For more information, refer to [Configuring the Echo Parameters, on page 213](#).
- Configure the heartbeat parameters. For more information, refer to [Configuring Heartbeat, on page 213](#).
- Verify the peer configuration. For more information, refer to [Viewing the Peer Configuration, on page 214](#).

Configuring the Echo Parameters

To configure the Echo parameters, use the following configuration:

Enabling the Echo Request

To enable the Echo Request, use the following configuration:

```

config
  instance instance-id instance_id
    endpoint endpoint_name
      interface [ s11 | s5e ]
        echo interval interval_value
        echo max-retransmissions max_retransmissions_count
        echo retransmission-timeout retransmission_timeout_count
      end

```

NOTES:

- **interval** *interval_value*—Specify the echo interval in seconds. Must be an integer in the range of 60-3600. Default value is 60 seconds.
- **max-retransmissions** *max_retransmissions_count*—Specify the maximum number of retries for GTP Echo Request. Must be an integer in the range of 0-15. Default value is 3.
- **retransmission-timeout** *retransmission_timeout_count*—Specify the Echo Request retransmission timeout period in seconds. Must be an integer in the range of 1-20. Default value is 5.

Disabling the Echo Request

To disable the Echo Request, use the following configuration:

```

config
  instance instance-id instance_id
    endpoint endpoint_name
      replicas replicas_count
      interface interface_name
        no echo
      end

```

Configuring Heartbeat

To configure the heartbeat parameters, use the following configuration:

Enabling Heartbeat

To enable a heartbeat, use the following configuration:

```

config
  instance instance-id instance_id
    endpoint pfcp
      interface sxa
        heartbeat
        interval interval
        retransmission-timeout timeout

```

```
max-retransmissions retransmission_count
end
```

NOTES:

- **interval** *heartbeat_interval*—Specify the heartbeat interval in seconds. Must be an integer in the range of 0-3600. To disable, set to 0.
- **max-retransmissions** *max_retransmissions*—Specify the maximum number of retries for the PFCP Heartbeat Request. Must be an integer in the range of 0-15. Default value is 4.
- **retransmission-timeout** *retransmission_timeout*—Specify the heartbeat retransmission timeout period in seconds. Must be an integer in the range of 1-20. Default value is 5.

Disabling Heartbeat

To disable a heartbeat, use the following configuration:

```
config
instance instance-id instance_id
  endpoint pfc
    interface sxa
      heartbeat
      interval interval
    end
```

NOTES:

- **interval** *heartbeat_interval*—Specify the heartbeat interval as 0 to disable the heartbeat.

Viewing the Peer Configuration

To view the peer restart counter, use the following configuration:

The following command displays the peer configuration:

```
show peers all [ endpoint ] [ local addr ] [ peer addr ]

show peers all SXA 209.165.201.12:8805 209.165.201.18:8805 POD CONNECTED
ENDPOINT LOCAL ADDRESS PEER ADDRESS DIRECTION INSTANCE TYPE TIME RPC ADDITIONAL DETAILS
-----
SXA 209.165.201.12:8805 209.165.201.18:8805 Inbound nodemgr-0 Udp 4 hours SGW-U Capacity:
65535,
LoadMetric: 0,LoadSeqNo: 0,Mode: Online,OverloadMetric: 0,OverloadSeqNo: 0,Priority: 65535

show peers all S11 209.165.201.4:2123 209.165.201.7:2123 LOCAL POD CONNECTED
ADDITIONAL ENDPOINT ADDRESS PEER ADDRESS DIRECTION INSTANCE TYPE TIME RPC DETAILS
-----
S11 209.165.201.4:2123 209.165.201.7:2123 Inbound nodemgr-0 Udp 25 seconds MME Recovery:
10

show peers all S5E 209.165.201.4:2123 209.165.201.21:2123 LOCAL POD CONNECTED
ADDITIONAL ENDPOINT ADDRESS PEER ADDRESS DIRECTION INSTANCE TYPE TIME RPC DETAILS
-----
S5E 209.165.201.4:2123 209.165.201.21:2123 Inbound nodemgr-0 Udp 25 seconds PGW Recovery:
10
```

```

show peers all POD CONNECTED
ENDPOINT LOCAL ADDRESS PEER ADDRESS DIRECTION INSTANCE TYPE TIME RPC ADDITIONAL DETAILS
-----
<none> 209.165.201.29 209.165.201.18:8001 Outbound rest-ep-0 Rest 17 hours UDM <none>
<none> 209.165.201.29 209.165.201.18:8002 Outbound rest-ep-0 Rest 17 hours AMF <none>
<none> 209.165.201.29 209.165.201.18:8003 Outbound rest-ep-0 Rest 17 hours PCF <none>
<none> 209.165.201.29 209.165.201.18:8004 Outbound rest-ep-0 Rest 17 hours CHF <none>
<none> 209.165.201.29 209.165.201.18:9040 Outbound rest-ep-0 Rest 17 hours CHF <none>
S11 209.165.201.4:2123 209.165.201.6:2123 Inbound nodemgr-1 Udp 18 minutes MME Recovery:
10
S5E 209.165.201.12:2123 209.165.201.24:2123 Inbound nodemgr-1 Udp 5 hours PGW Recovery:
65535
SXA 209.165.201.12:8805 209.165.201.18:8805 Inbound nodemgr-0 Udp 22 minutes SGW-U Capacity:
65535,LoadMetric: 0,LoadSeqNo: 0,Mode: Online,OverloadMetric: 0,OverloadSeqNo: 0,Priority:
65535

```

Configuration Example

The following is an example configuration to enable the echo.

```

config
  instance instance-id 1
    endpoint gtp
      interface s11
        echo interval 60
        echo max-retransmissions 5
        echo retransmission-timeout 4
      end

```

The following is an example configuration to disable the echo.

```

config
  instance instance-id 1
    endpoint gtp
      replicas 1
      interface s5e
        no echo
      exit
      interface s11
        no echo
      end

```

OAM Support

This section describes operations, administration, and maintenance support for this feature.

Alerts

To configure Alerts for Peer Up and Peer Down, see *Key Performance Indicators* chapter in *Cisco Ultra Cloud Serving Gateway Control Plane Function - Metrics Reference*.

Bulk Statistics Support

Node Manager

The following are examples of Echo Transmitted and Echo Retransmitted messages:

```
nodemgr_gtpc_msg_stats{app_name="smf",cluster="cn",data_center="cn",gtpc_msg_type="gtpc_echo_req_retX",
gtpc_peer_ip="209.165.201.11",instance_id="1",interface_type="S5E",service_name="nodemgr"}
3
```

```
nodemgr_gtpc_msg_stats{app_name="smf",cluster="cn",data_center="cn",gtpc_msg_type="gtpc_echo_req_tx",
gtpc_peer_ip="209.165.200.230",instance_id="1",interface_type="S11",service_name="nodemgr"}
2
```

```
nodemgr_gtpc_msg_stats{app_name="smf",cluster="cn",data_center="cn",gtpc_msg_type="gtpc_echo_req_tx",
gtpc_peer_ip="209.165.201.11",instance_id="1",interface_type="S5E",service_name="nodemgr"}
4
```

```
nodemgr_gtpc_msg_stats{app_name="smf",cluster="cn",data_center="cn",gtpc_msg_type="gtpc_echo_req_tx_initial",
gtpc_peer_ip="209.165.200.230",instance_id="1",interface_type="S11",service_name="nodemgr"}
2
```

```
nodemgr_gtpc_msg_stats{app_name="smf",cluster="cn",data_center="cn",gtpc_msg_type="gtpc_echo_req_tx_initial",
gtpc_peer_ip="209.165.201.11",instance_id="1",interface_type="S5E",service_name="nodemgr"}
1
```

```
nodemgr_gtpc_msg_stats{app_name="smf",cluster="cn",data_center="cn",gtpc_msg_type="gtpc_echo_res_rx",
gtpc_peer_ip="209.165.200.230",instance_id="1",interface_type="S11",service_name="nodemgr"}
2
```

GTPC-EP Pod

The following are examples of Echo Request received and Echo Response sent messages:

```
gtpc_echo_msg_stats{app_name="smf",cluster="cn",data_center="cn",gtpc_msg_type="gtpc_echo_req_rx",
gtpc_peer_ip="209.165.200.230",instance_id="0",service_name="gtpc-ep"} 1
```

```
gtpc_echo_msg_stats{app_name="smf",cluster="cn",data_center="cn",gtpc_msg_type="gtpc_echo_req_rx",
gtpc_peer_ip="209.165.200.231",instance_id="0",service_name="gtpc-ep"} 1
```

```
gtpc_echo_msg_stats{app_name="smf",cluster="cn",data_center="cn",gtpc_msg_type="gtpc_echo_req_rx",
gtpc_peer_ip="209.165.201.11",instance_id="0",service_name="gtpc-ep"} 1
```

```
gtpc_echo_msg_stats{app_name="smf",cluster="cn",data_center="cn",gtpc_msg_type="gtpc_echo_res_tx",
gtpc_peer_ip="209.165.200.230",instance_id="0",service_name="gtpc-ep"} 1
```

```
gtpc_echo_msg_stats{app_name="smf",cluster="cn",data_center="cn",gtpc_msg_type="gtpc_echo_res_tx",
gtpc_peer_ip="209.165.200.231",instance_id="0",service_name="gtpc-ep"} 1
```

```
gtpc_echo_msg_stats{app_name="smf",cluster="cn",data_center="cn",gtpc_msg_type="gtpc_echo_res_tx",
gtpc_peer_ip="209.165.201.11",instance_id="0",service_name="gtpc-ep"} 1
```

Procedure-Level

The following are examples of how to check the incremented values of Heartbeat Request, Heartbeat Response, and Heartbeat Request retry.

```
nodemgr_up_hb_msg_stats{app_name="smf",cluster="Local",current_nodemgr_id="0",data_center="DC",instance_id="0",interface_type="SXA",primary_nodemgr_id="0",service_name="nodemgr",up_ep_key="209.165.201.1:209.165.201.21",up_msg_type="up_heartbeat_req_retx"} 3
```

```
nodemgr_up_hb_msg_stats{app_name="smf",cluster="Local",current_nodemgr_id="0",data_center="DC",instance_id="0",interface_type="SXA",primary_nodemgr_id="0",service_name="nodemgr",up_ep_key="209.165.201.1:209.165.201.21",up_msg_type="up_heartbeat_req_tx"} 5
```

```
nodemgr_up_hb_msg_stats{app_name="smf",cluster="Local",current_nodemgr_id="0",data_center="DC",instance_id="0",interface_type="SXA",primary_nodemgr_id="0",service_name="nodemgr",up_ep_key="209.165.201.1:209.165.201.21",up_msg_type="up_heartbeat_rsp_rx"} 5
```

GTPC Path Failure

Feature Description

GTPC path failure detects peer-level GTPC path failure on the S11 and the S5 interface when:

- Echo Response contains a new restart counter value.
- Echo Request contains a new restart counter value.
- Echo Response is not received.
- Create Session Request or Modify Bearer Request contains a new restart counter value.
- Create Session Response or Modify Bearer Response contains a new restart counter value.

The connections may get disconnected due to different path failure is as follows:

- s11_path_failure
- s5e_path-failure
- s11_path_failure_local_purge
- s5e_path_failure_local_purge
- s5e_recovery
- s11_recovery
- s5e_recovery_local_purge
- s11_recovery_local_purge

How it Works

This section describes how this feature works.

GTPC Path Failure Detection

Path failure is detected in the following conditions:

- **Echo Failure:** Echo failure occurs when the peer doesn't respond to the Echo Request or the retries.
- **Restart Counter in Echo Response or Control Messages:** The GTPC entity receives Recovery IE either in an Echo Response or from the peer GTPC message. GTPC entity compares the received the restart counter value with the previously stored restart counter value for that peer entity and performs the following:
 - Stores the received restart counter value for the peer when previously stored value isn't available.
 - When the max-remote-rc-change parameter is not configured, GTPC detects the change in the restart counter.
 - When max-remote-rc-change is configured, calculate the difference in the restart counter value considering restart counter rollover. Detects path failure when the difference between new and old restart counter is less than the value of max-remote-rc-change.



Note For more information on max-remote-rc-change, refer to [Customization of Path Failure Detection, on page 222](#).

Path Failure Handling

Upon detecting a path failure, the network node notifies the failure through the Operation and Maintenance system and performs the following:

- Deletes the PDN connections (EPS bearer contexts) or the associated PDP contexts with peer IP address.
- Specifies the following actions for the selected interface:
 - **Local Purge:** The cnSGW-C clears the affected bearer (or PDN if the default bearer receives the path failure) locally without informing the peer. This action is default for all interfaces.



Note cnSGW-C sends the Sx Session Delete Request to UPF to clear session on path failure detection.

- **Signal-Peer:** The cnSGW-C sends control signal towards the peer MME and P-GW.

When signaling:

- For PDN deletion, the SGW sends a Delete Session Request message to the PGW and a Delete Bearer Request (with LBI) message to the MME.
- SGW sends a Delete Request on the S11 or the S5 interface to notify the peer.



Note Echo Request exchange is stopped when the peer is deleted.

Feature Configuration

Configuring this feature involves the following steps:

- Configure the action that must be taken on path failure detection. For more information, refer to [Configuring Action on Path Failure Detection, on page 219](#).
- Configure the notification to update the peer node. For more information, refer to [Configuring Notification to Update the Peer Node, on page 219](#).
- Verify the configuration. For more information, refer to [Configuration Example, on page 219](#).

Configuring Action on Path Failure Detection

To configure the action for path failure detection, use the following configuration:

```
config
  profile sgw sgw_name
    path-failure [ s11 | s5e ] [ local-purge | signal-peer ]
  end
```

Configuring Notification to Update the Peer Node

Whenever cnSGW-C is restarted, the restart counter needs to be updated. For implementing this functionality, verify the Kubernetes use-volume-claims parameter value is set as true in Ops Center.

This configuration updates the restart counter when cnSGW-C restarts with the CLI system mode shutdown and system mode running.

Configuration Example

The following is an example configuration of path failure detection:

```
config
profile sgw sgw1
  path-failure s11 local-purge
  path-failure s5e local-purge
exit
```

OAM Support

This section describes operations, administration, and maintenance information for this feature.

Bulk Statistics Support

The following are examples of the GTPC path failure:

```
nodemgr_gtpc_pathfail_reasons{app_name="smf",cluster="cn",
data_center="cn",instance_id="1",pathfail_reason="pathfail_no_echo_rcv",
service_name="nodemgr"} 2
```

```
nodemgr_gtpc_pathfail_reasons{app_name="smf",cluster="cn",data_center="cn",
instance_id="0",pathfail_reason="pathfail_echo_res_rc_change",
service_name="nodemgr"} 1
```

Sx Path Failure

Feature Description

Sx path failure detects the path failure on the Sx interface when:

- Heartbeat Request contains a higher value of recovery timestamp.
- Heartbeat Response contains a higher value of recovery timestamp.
- Heartbeat Response is not received.
- Sx Association Request is received.
- cnSGW-C receives the Sx Association Update Request to release the peer.

How it Works

This section describes how this feature works.

Heartbeat Request

The cnSGW-C or UPF sends the Heartbeat Request on a path to the peer node to find out if the node is alive. The Heartbeat Request messages are sent for each peer with which a PFCP control association is established. cnSGW-C or UPF is prepared to receive the Heartbeat Request and it responds with a Heartbeat Response. The Heartbeat Request starts with the peer when a new session is established with the peer and it's stopped when the last session is released from the peer.

cnSGW-C and UPF send the Heartbeat Request based on the configured interval. If the peer doesn't respond, the message is retried for the configured number of times within the retry interval. After the response is received the defined action is taken for the calls associated with the corresponding peer.

Recovery Time Stamp is the IE which contains the start time of the peer node. The Heartbeat Request contains the selfrecovery timestamp value sent to the peer.



Note The heartbeat request is stopped only when the peer is deleted.

Heartbeat Response

The Heartbeat Response message is sent as a response to a received Heartbeat Request.

Recovery Timestamp is the IE which contains the start time of the node. Heartbeat Response contains the peer's Recovery Timestamp value.

Sx Path Failure Detection

Sx path failure is detected in the following conditions:

- **Heartbeat Failure:** When the peer doesn't respond to the heartbeat sent and also to the retries.
- **Recovery Timestamp Change in Heartbeat:** When the Heartbeat Response has a new Recovery Timestamp value then the previously received value. If the Recovery Timestamp value received is lower than the previously received value, the path failure isn't detected.
- **Sx Association Message:** When the Sx Association message is received again from the peer. In this case, all the calls are cleared and a notification is sent to eGTP peer.
- **Sx Association Release Message:** When the Sx Association release message is received. In this case, all the calls are cleared and a notification is sent to eGTP peer.

Path Failure Handling

When the recovery timestamp value received is more than the previously received value, the peer restart is detected. If the timestamp is lower than the previously received value, the value is ignored and peer restart isn't detected.

When the peer restart is detected to indicate the path failure for the peer, all the calls connected to that peer are cleared. The disconnection reason used for such calls is Sx path failure.

Sx association is also removed on detecting Sx path failure.

Heartbeat Handling

Whenever a PFCP entity receives a Heartbeat Request message (even from unknown peers), it responds with a Heartbeat Response message.

After a path failure is detected due to **No response to peer** error, no further Heartbeat Request is sent to that peer until the association is reestablished. Calls are cleared based on the path failure detection policy configuration.



Note After the Sx associations are removed, the heartbeat is stopped when Sx path failure is detected.

OAM Support

This section describes operations, administration, and maintenance support for this feature.

Bulk Statistics Support

The following are examples of the procedure-level statistics incremented for Heartbeat Request, Heartbeat Response, and Heartbeat Request retry:

```
nodemgr_up_hb_msg_stats{app_name="smf",cluster="Local",current_nodemgr_id="0",
data_center="DC",instance_id="0",interface_type="SXA",primary_nodemgr_id="0",service_name=
"nodemgr",up_ep_key="209.165.201.5:209.165.201.28",up_msg_type="up_heartbeat_req_ret"}
3
```

```
nodemgr_up_hb_msg_stats{app_name="smf",cluster="Local",current_nodemgr_id="0",
data_center="DC",instance_id="0",interface_type="SXA",primary_nodemgr_id="0",service_name=
"nodemgr",up_ep_key="209.165.201.5:209.165.201.28",up_msg_type="up_heartbeat_req_tx"}
5
```

```
nodemgr_up_hb_msg_stats{app_name="smf",cluster="Local",current_nodemgr_id="0",
data_center="DC",instance_id="0",interface_type="SXA",primary_nodemgr_id="0",service_name=
"nodemgr",up_ep_key="209.165.201.5:209.165.201.28",up_msg_type="up_heartbeat_rsp_rx"}
5
```

Customization of Path Failure Detection

Feature Description

cnSGW-C lets you configure the path failure detection policy. By default, the path failure detection policy is enabled.

- **GTPC Path Failure Detection Customization:** GTPC path failure is detected when:
 - The Echo Request retries are exhausted.
 - The Echo Request or Response Restart counter is modified.
 - The control message Response Restart counter is modified.
 - If the absolute difference between the new and old restart counters is less than the value configured for max-remote-rc-change.



Note GTPC Path Failure Detection Customization allows user to ignore false peer restart with max remote restart counter (max-remote-rc-change) change functionality.

- **Sx Path Failure Detection Customization:** PFCP path failure is detected when:
 - The Heartbeat Request retries are exhausted.
 - The Heartbeat Request or Response recovery timestamps have modified.

Feature Configuration

Configuring this feature involves the following steps:

- Configure the GTPC path failure customization. For more information, refer to [Configuring GTPC Path Failure Customization, on page 223](#).
- Configure the Sx path failure customization. For more information, refer to [Configuring Sx Path Failure Customization, on page 223](#).

Configuring Sx Path Failure Customization

To configure the Sx path failure customization, use the following configuration:

```

config
  policy sx-path-failure-detection policy
    ignore heartbeat-retry-failure
    ignore heartbeat-recovery-timestamp-change
exit
  instance instance-id instance_id
    endpoint pfc
      replicas replica_count
      sx-path-failure sx-detection-policy policy
      interface sxa
        sx-path-failure sx-detection-policy policy
      end

```

Configuring GTPC Path Failure Customization

To configure the GTPC path failure customization, use the following configuration:

```

config
  policy path-failure-detection policy_name
    max-remote-rc-change maximum_remote
    ignore echo-rc-change
    ignore control-rc-change
    ignore echo-failure
  exit
exit
  instance instance-id instance_id
    endpoint gtp
      replicas replica_count
      vip-ip ipv4_address vip-port ipv4_port_number
      vip-ipv6 ipv6_address vip-ipv6-port ipv6_port_number
      dual-stack-transport { true | false }
      path-failure detection-policy policy
      interface [ s11 | s5e ]
    end

```

NOTES:

- When GTPC path failure detection policy isn't configured at interface-level, endpoint-level path failure detection policy is applicable.
- The max-remote-rc-change configuration specifies the counter change after which the S11 or S5 detects a peer restart. A peer restart is detected only if the absolute difference between the new and old restart counter is less than the value configured. For example, if the max-remote-rc-change is 10 and current peer restart counter is 251, then eGTP detects a peer restart only if the new restart counter is 252 through

255 or 0 through 5. Similarly, if the stored restart counter is 1, eGTP detects a peer restart only if the new restart counter is 2 through 11.

- Valid settings are from 1 to 255. The recommended setting is 32.

OAM Support

This section describes operations, administration, and maintenance support for this feature.

Bulk Statistics Support

GTPC Path Failure

Maintain statistics indicating number of times path failure was detected due to restart counter change in echo request or response message or control request or response message.

```
nodemgr_gtpc_msg_stats{app_name="smf",cluster="Local",data_center="DC",
gtpc_msg_type="gtpc_false_peer_restart_cfg_ctrl_rc_change",gtpc_peer_ip=
"209.165.201.17",instance_id="0",interface_type="S11",service_name="nodemgr"} 1
```

```
nodemgr_gtpc_msg_stats{app_name="smf",cluster="Local",data_center="DC",
gtpc_msg_type="gtpc_false_peer_restart_cfg_echo_rc_change",gtpc_peer_ip=
"209.165.201.17",instance_id="0",interface_type="S11",service_name="nodemgr"} 1
```

```
nodemgr_gtpc_msg_stats{app_name="smf",cluster="Local",data_center="DC",
gtpc_msg_type="gtpc_false_peer_restart_cfg_echo_rc_change",gtpc_peer_ip=
"209.165.201.27",instance_id="0",interface_type="S5E",service_name="nodemgr"} 1
```

```
nodemgr_gtpc_msg_stats{app_name="smf",cluster="Local",data_center="DC",
gtpc_msg_type="gtpc_ignore_echo_timeout",gtpc_peer_ip="209.165.201.27",
instance_id="0",interface_type="S5E",service_name="nodemgr"} 1
```

```
nodemgr_gtpc_msg_stats{app_name="smf",cluster="Local",data_center="DC",
gtpc_msg_type="gtpc_false_peer_restart_ignore_echo_rc_cfg",gtpc_peer_ip=
"209.165.201.27",instance_id="0",interface_type="S5E",service_name="nodemgr"} 1
```

```
nodemgr_gtpc_msg_stats{app_name="smf",cluster="Local",data_center="DC",
gtpc_msg_type="gtpc_false_peer_restart_ignore_ctrl_rc_cfg",gtpc_peer_ip=
"209.165.201.27",instance_id="0",interface_type="S5E",service_name="nodemgr"} 1
```

Table 86: GTPC Path Failure Statistics Descriptions

Statistics	Description
gtpc_false_peer_restart_cfg_echo_rc_change	The number of GTPC path failures ignored because Echo Restart Counter Change isn't within max-remote-rc-change configured.

Statistics	Description
gtpc_false_peer_restart_ignore_echo_rc_cfg	The number of GTPC path failures ignored because of Echo Restart Counter Change.
gtpc_false_peer_restart_cfg_ctrl_rc_change	The number of GTPC path failures ignored because Control Message Restart Counter Change isn't within max-remote-rc-change configured.
gtpc_false_peer_restart_ignore_ctrl_rc_cfg	The number of GTPC path failures ignored because of Control message Restart Counter Change.
gtpc_ignore_echo_timeout	The number of GTPC path failures ignored because of Echo Request timeout.

Sx Path Failure

Maintain statistics indicating number of times path failure was detected due to recovery timestamp change in the following messages.

```
nodemgr_up_pathfail_reasons{app_name="smf",cluster="cn",data_center="cn",
instance_id="0",service_name="nodemgr",up_pathfail_reason="up_pathfail_ignored_hb_retry"}
1
```

```
nodemgr_up_pathfail_reasons{app_name="smf",cluster="cn",data_center="cn",
instance_id="1",service_name="nodemgr",up_pathfail_reason="up_pathfail_ignored_hb_rt_change"}
1
```

```
nodemgr_up_pathfail_reasons{app_name="smf",cluster="cn",data_center="cn",
instance_id="1",service_name="nodemgr",up_pathfail_reason="up_pathfail_reason_association_release"}
1
```

```
nodemgr_up_pathfail_reasons{app_name="smf",cluster="cn",data_center="cn",
instance_id="1",service_name="nodemgr",up_pathfail_reason="up_pathfail_reason_hb_retry"}
8
```

```
nodemgr_up_pathfail_reasons{app_name="smf",cluster="cn",data_center="cn",
instance_id="1",service_name="nodemgr",up_pathfail_reason="up_pathfail_reason_hb_rt_change"}
1
```

Table 87: Sx Path Failure Statistics Descriptions

Statistics	Description
up_pathfail_ignored_hb_retry	The number of Sx path failures ignored because of Heartbeat Request timeout.
up_pathfail_reason_hb_retry	The number of Sx path failures detected because of Heartbeat Request timeout.

Statistics	Description
up_pathfail_ignored_hb_rt_change	The number of Sx path failures ignored because of Heartbeat Request Recovery Timestamp Change Ignored.
up_pathfail_reason_hb_rt_change	The number of Sx path failures detected because of Heartbeat Request Recovery Timestamp Change.
up_pathfail_reason_association_release	The number of Sx path failures detected because of Sx Association Release.



CHAPTER 23

GTPU Error Indication

- [Feature Summary and Revision History, on page 227](#)
- [Feature Description, on page 228](#)
- [How it Works, on page 228](#)
- [Feature Configuration, on page 245](#)
- [OAM Support, on page 246](#)

Feature Summary and Revision History

Summary Data

Table 88: Summary Data

Applicable Product(s) or Functional Area	cnSGW-C
Applicable Platform(s)	SMI
Feature Default Setting	Enabled - Always-on
Related Documentation	Not Applicable

Revision History

Table 89: Revision History

Revision Details	Release
Support added for signal peer (error indication and configuration is signal peer)	2021.02.3
First introduced.	2021.02.1

Feature Description

cnSGW-C supports the UPF reported GTPU errors in Session Report Request. UPF reports different GTPU errors to CP (cnSGW-C) in PFCP Session Report Request message.

cnSGW-C supports the following report requests.

- Error Indication Support (ERIR)
- Graceful Termination (GTER)
- Session Replacement (SRIR)

For more information, see the [GTPU Error Indication, on page 227](#) chapter.

How it Works

This section describes how this feature works.

Error Indication Support

When cnSGW-C receives Error Indication with PFCP Session Report Request from UPF, it responds with PFCP Session Report Response and performs as per the configuration.

For cnSGW-C, signaling is based on configuration.

- S1U - local purge or page-ue
- S5U - local purge or peer signaling

Table 90: Error Indication Support (ERIR) Report Type

Interface	Configuration	TEID	Action
S1U	Local Purge	Default	Send SxSessionDeleteRequest to clean up on UPF Purge locally
		Dedicated	Send SxModReq (Remove Traffic Endpoint) Purge locally
		IDFT	Send SxMod (Remove IDFT Traffic Endpoint) - async Purge Bearer locally
	Page-UE	Default / Dedicated	Move UE to Idle state Send Sx_Modification_Request (Set FAR Action=BUFFER)
S5U	Local Purge	Default	Send SxDeleteSession Purge locally
		Dedicated	Send SxMod (Remove Traffic Endpoint) Purge Bearer locally
	Signal Peer	Default	Send SxMod (Drop) DBR/DSR, SxDelete
		Dedicated	Send DBR/DBC (Async), SxMod (Remove Traffic Endpoint)

Default Bearer with s1u as local-purge Call Flow

This section describes Default Bearer with s1u as local-purge call flow.

Figure 44: Default Bearer with s1u as local-purge Call Flow

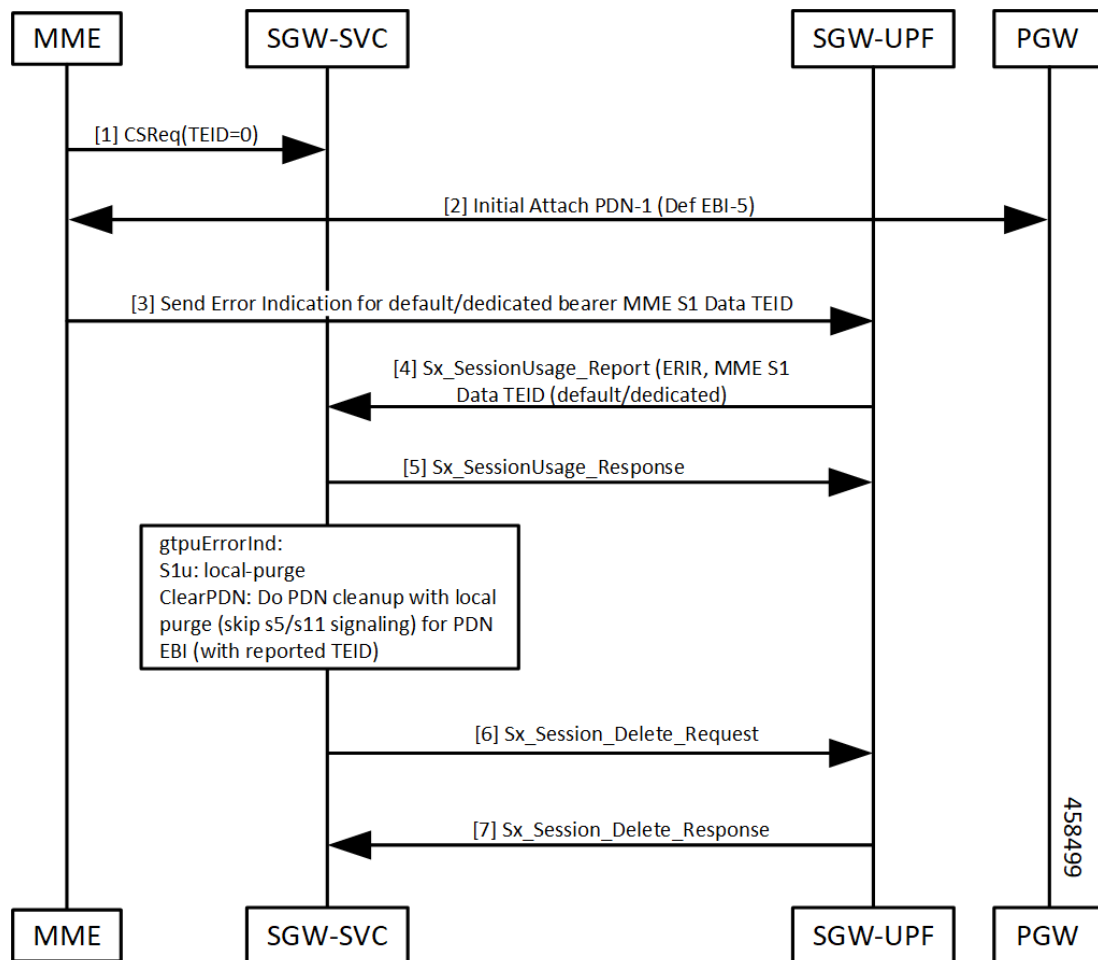

Table 91: Default Bearer with s1u as local-purge Call Flow Description

Step	Description
1, 2	Initial attach complete.
3, 4, 5	<ul style="list-style-type: none"> UPF sends Sx_Session_Report_Request with report type as ERIR and s1u TEID. cnSGW-C responds with Sx_Session_Report_Response.

Step	Description
6, 7	<p>cnSGW-C processes Sx_Session_Report_Request.</p> <p>gtpuErrorInd: s1u: local-purge</p> <p>If TEID received is for default bearer, submit internal transaction (T2) to clean up bearer (No peer signaling).</p> <ul style="list-style-type: none"> • Send Sx_Session_Deletion_Request. • UPF responds with Sx_Session_Deletion_Response.

Dedicated Bearer with s1u as local-purge Call Flow

This section describes Dedicated Bearer with s1u as local-purge call flow.

Figure 45: Dedicated Bearer with s1u as local-purge Call Flow

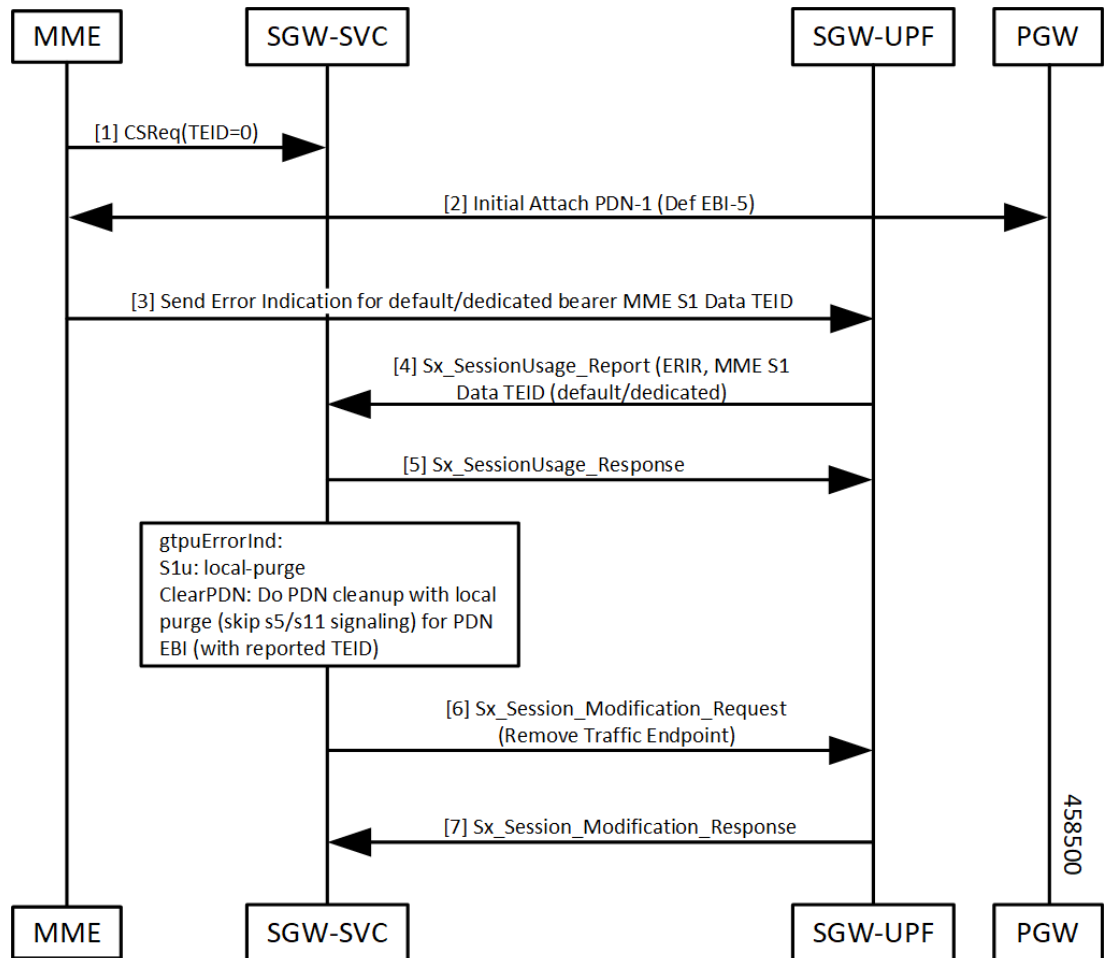

Table 92: Dedicated Bearer with s1u as local-purge Call Flow Description

Step	Description
1, 2	Initial attach complete.
3, 4, 5	<ul style="list-style-type: none"> • UPF sends Sx_Session_Report_Request with report type as ERIR and s1u TEID. • cnSGW-C responds with Sx_Session_Report_Response.
6, 7	<p>cnSGW-C processes Sx_Session_Report_Request.</p> <p>gtpuErrorInd: s1u: local-purge</p> <p>If TEID received is for dedicated bearer, submit internal transaction (T2) to clean up bearer (No peer signaling).</p> <ul style="list-style-type: none"> • Send Sx_Session_Modification_Request (Remove Traffic Endpoint). • UPF responds with Sx_Session_Modification_Response.

Dedicated Bearer (IDFT) with s1u as local-purge Call Flow

This section describes Dedicated Bearer (IDFT) with s1u as local-purge call flow.

Figure 46: Dedicated Bearer (IDFT) with s1u as local-purge Call Flow

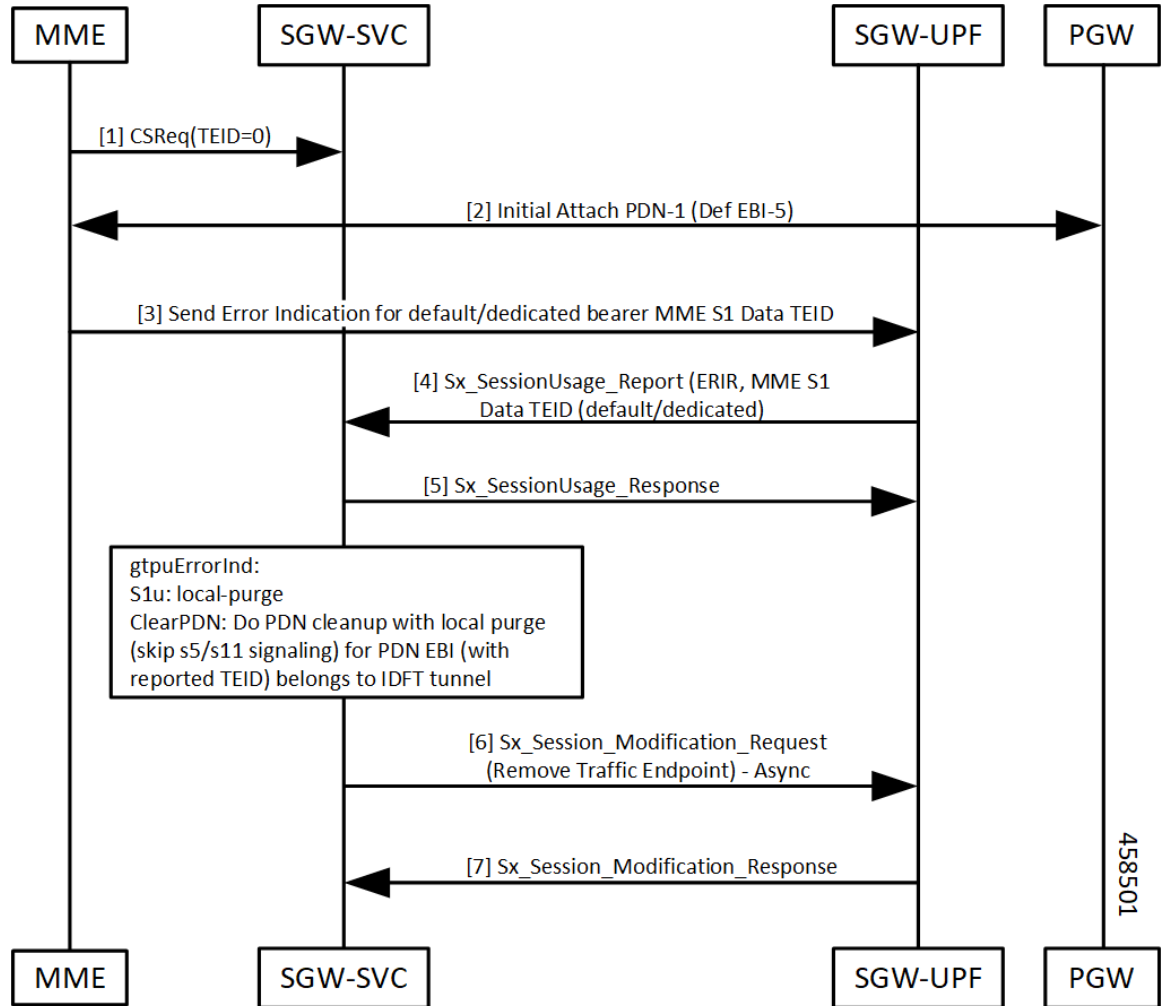

Table 93: Dedicated Bearer (IDFT) with s1u as local-purge Call Flow Description

Step	Description
1, 2	Initial attach complete.
3, 4, 5	<ul style="list-style-type: none"> UPF sends Sx_Session_Report_Request with report type as ERIR and s1u TEID. cnSGW-C responds with Sx_Session_Report_Response.

Step	Description
6, 7	<p>cnSGW-C processes Sx_Session_Report_Request.</p> <p>gtpuErrorInd: s1u: local-purge</p> <p>If TEID received is for dedicated bearer (IDFT), submit internal transaction (T2) to clean up bearer (No peer signaling).</p> <ul style="list-style-type: none"> • Send Sx_Session_Modification_Request (Remove Traffic Endpoint). • UPF responds with Sx_Session_Modification_Response.

Default/Dedicated Bearer with s1u as page-ue Call Flow

This section describes Default/Dedicated Bearer with s1u as page-ue call flow.

Figure 47: Default/Dedicated Bearer with s1u as page-ue Call Flow

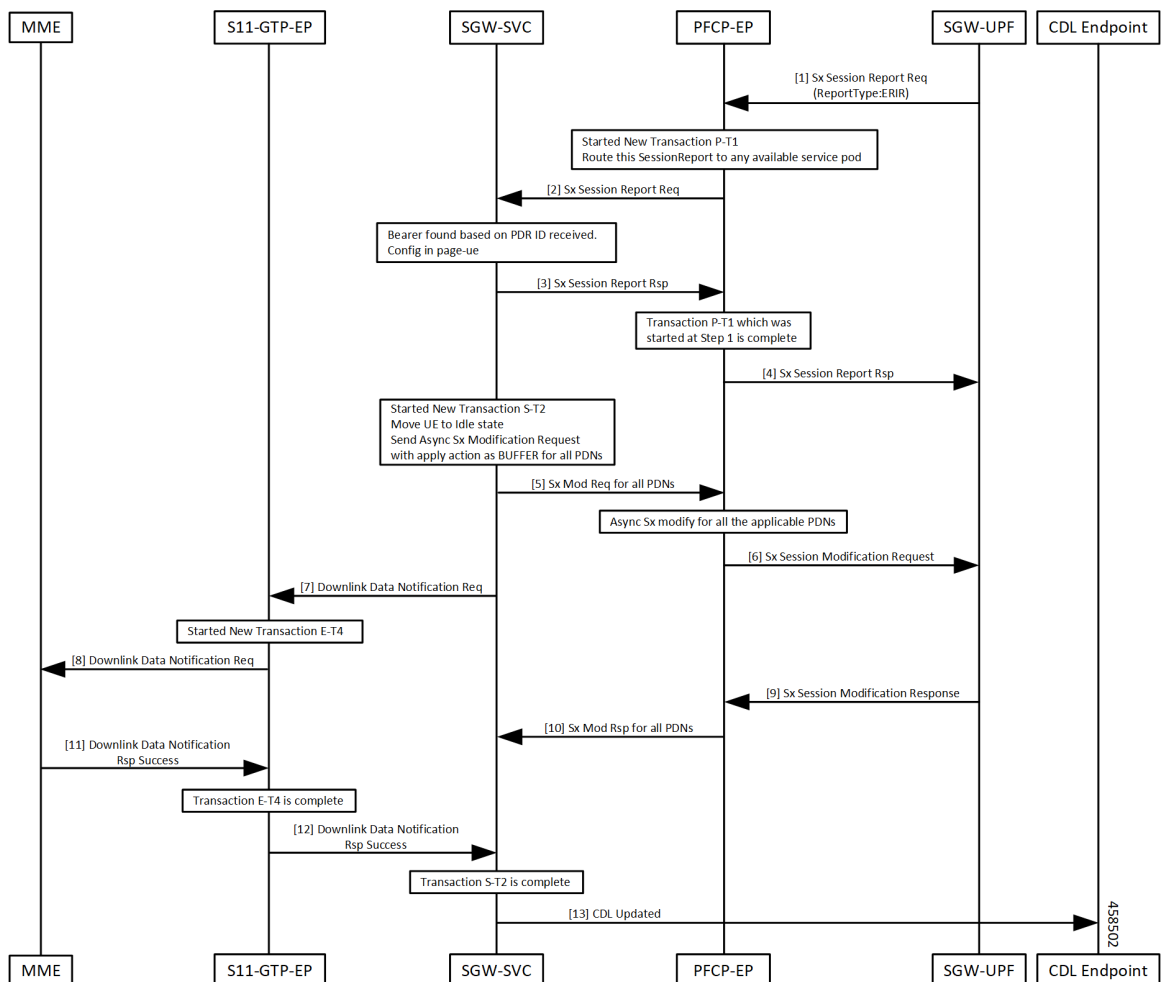

Table 94: Default/Dedicated Bearer with s1u as page-ue Call Flow Description

Step	Description
1, 2	SGW-UP sends Sx Session Report Req with type as ERIR to SGW service POD.
3, 4	SGW service POD sends Sx Session Report Res to SGW-UPF.
5, 6	PFCP-EP sends Sx Mod Req for all PDNs to SGW service POD. PFCP-EP sends Sx Session Modification Req to SGW-UP.
7, 8	SGW service POD sends Downlink Data Notification Req to S11-GTP-EP. S11-GTP-EP forwards Downlink Data Notification to MME.
9, 10	SGW-UP sends Sx session Modification Rsp to SGW service POD.
11, 12, 13	MME sends Downlink Data Notification Rsp Success to S11-GTP-EP. S11-GTP-EP forwards Downlink Data Notification Rsp Success to SGW service POD. SGW service POD sends CDL update to CDL endpoint when S-T2 transaction gets completed.

Default Bearer with s5u as local-purge/signal-peer Call Flow

This section describes Default Bearer with s5u as local-purge/signal-peer call flow.

Figure 48: Default Bearer with s5u as local-purge/signal-peer Call Flow

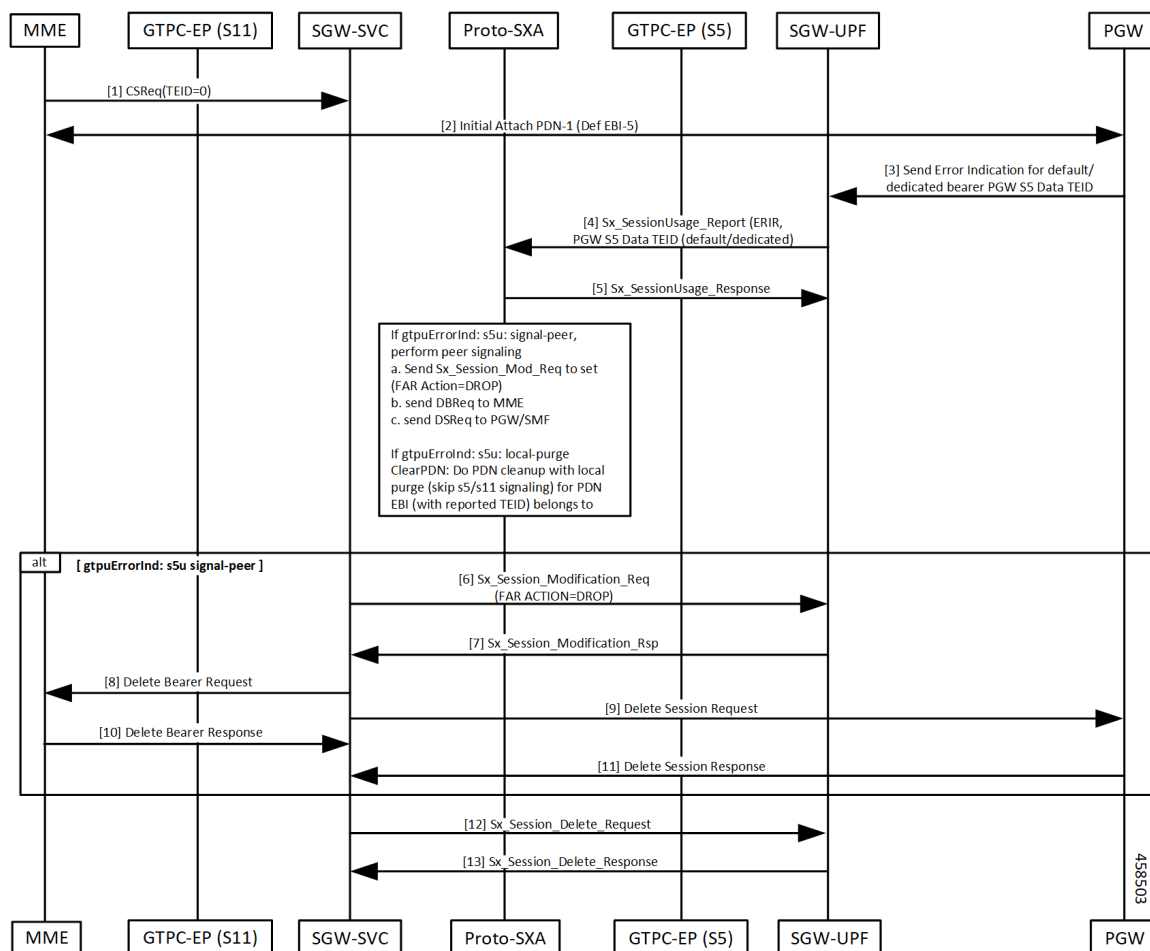

Table 95: Default Bearer with s5u as local-purge/signal-peer Call Flow Description

Step	Description
1, 2	Initial attach complete.
3, 4, 5	GTPU Error detected on UPF. <ul style="list-style-type: none"> • Sx_Session_Report_Request sent to cnSGW-C. • cnSGW-C responds with Sx_Session_Resport_Response.

Step	Description
6-11	<p>cnSGW-C processes Session Report Request (ERIR).</p> <p>If TEID is received for default bearer, submit internal transaction to clean up PDN (behavior depends on CLI configured).</p> <p>CLI: sgw-profile config</p> <p>If gtpuErrorInd:</p> <p>s5u: signal-peer</p> <ul style="list-style-type: none"> • Send Sx_Session_Report_Request to UPF to set (FAR ACTION=DROP). • Send Delete Bearer Req to MME. • Send Delete Session Request to PGW.
12	Send Sx_Session_Delete_Request to UPF.
13	UPF responds with Sx_Session_Delete_Response.

Dedicated Bearer with s5u as local-purge/signal-peer Call Flow

This section describes Dedicated Bearer with s5u as local-purge/signal-peer call flow.

Figure 49: Dedicated Bearer with s5u as local-purge/signal-peer Call Flow

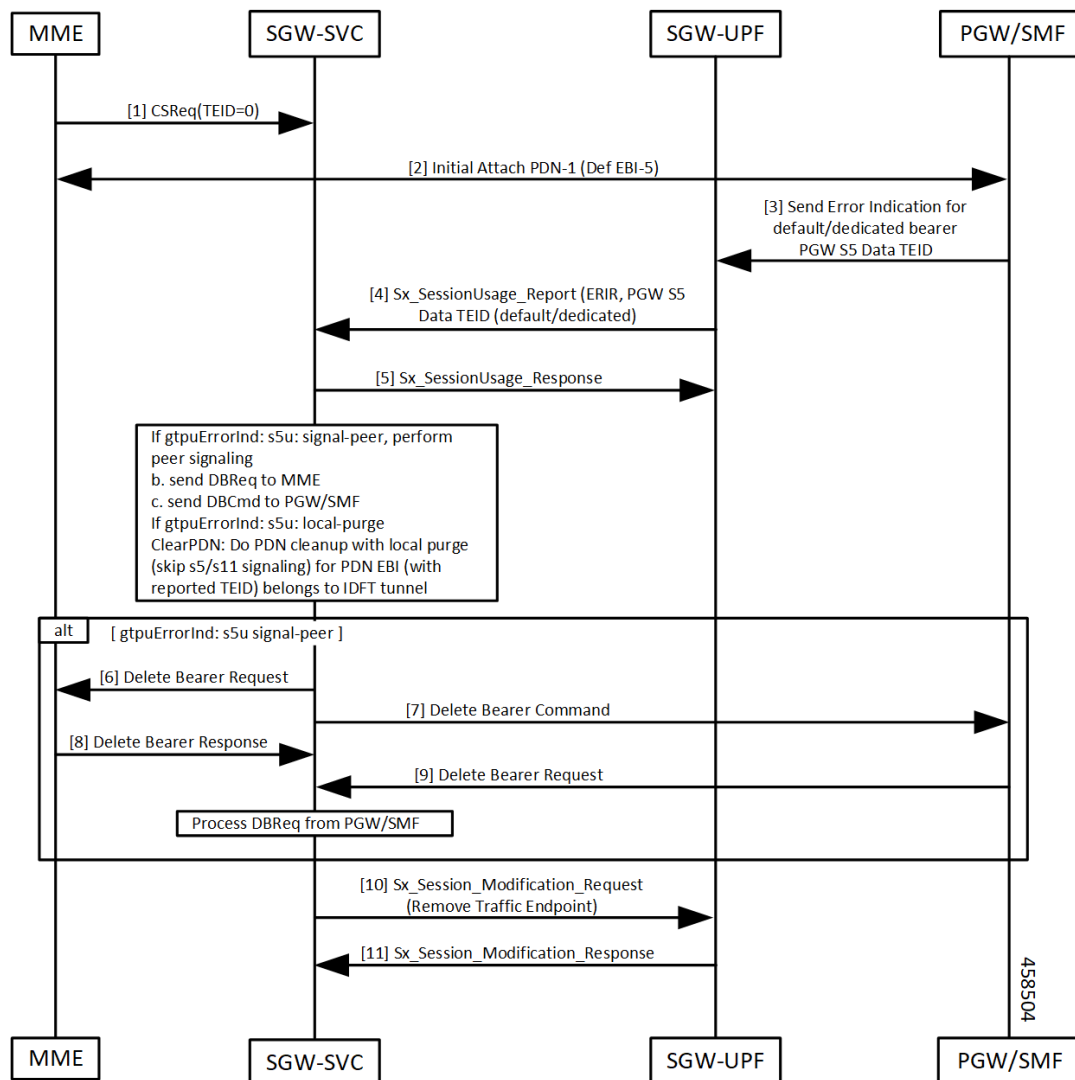

Table 96: Dedicated Bearer with s5u as local-purge/signal-peer Call Flow Description

Step	Description
1, 2	Initial attach complete.
3, 4, 5	GTPU Error detected on UPF. <ul style="list-style-type: none"> Sx_Session_Report_Request sent to cnSGW-C. cnSGW-C responds with Sx_Session_Report_Response.

Step	Description
6, 7, 8, 9	<p>cnSGW-C processes Session Report Request (ERIR). If TEID is received for dedicated bearer (s5u), submit internal transaction to clean up bearer.</p> <p>CLI: sgw-profile config</p> <p>If gtpuErrorInd:</p> <p>s5u: signal-peer</p> <ul style="list-style-type: none"> • Send Delete Bearer Req to MME. • Send Delete Bearer Command to PGW.
10	Send Sx_Session_Modification_Request (Remove Traffic Endpoint) to UPF.
11	UPF responds with Sx_Session_Modification_Response.

Graceful Termination

When UPF can't recover PDU session during SR/ICSR recovery, it sends PFCP session Report Request to cnSGW with type as Graceful Termination Report (GTER).

When UPF can't load session during session recovery, it sends a GTER indicating to clear up all the interfaces for this reported session.

Graceful Termination Call Flow

This section describes Graceful Termination call flow.

Figure 50: Graceful Termination Call Flow

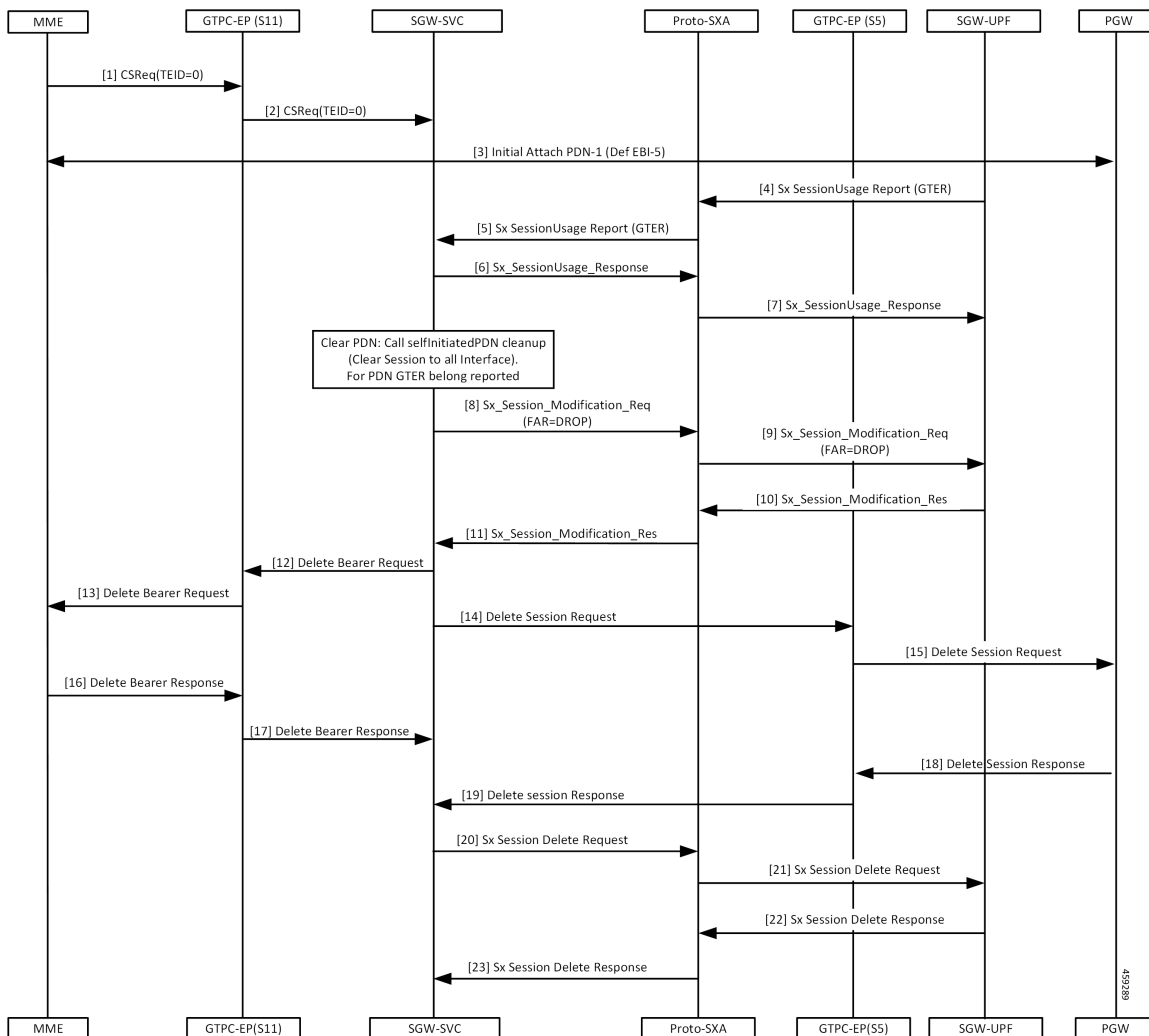

Table 97: Graceful Termination Call Flow Description

Step	Description
1, 2, 3	Initial attach complete.
4-7	<ul style="list-style-type: none"> UPF sends Sx_Session_Report_Request with report type as GTER and TEID. cnSGW-C responds with Sx_Session_Report_Response.
8-11	cnSGW-C processes Sx_Session_Report_Request and submits internal transaction (T2) to clean up PDN. <ul style="list-style-type: none"> cnSGW-C sends Sx_Session_Modification_Request to set FAR Action=Drop. UPF responds with Sx_Session_Modification_Response.

Step	Description
12-19	<ul style="list-style-type: none"> • Send Delete Bearer Req to MME. • Send Delete Session Request to PGW.
20-23	<ul style="list-style-type: none"> • Send Sx_Session_Delete_Request. • UPF responds with Sx_Session_Delete_Response.

Session Replacement

A Session Replacement (SRIR) is required when peer allocates same GTP-U TEID.

UPF sends SRIR report indicating to delete old session with same TEID. cnSGW-C uses GTPU path failure configuration for SRIR request processing.

Table 98: Session Replacement

Interface	Configuration	TEID	Action
S1U/S5U	Local Purge	Default	Send SxDeleteSession Purge locally
		Dedicated	Send SxMod (Remove Traffic Endpoint) Purge Bearer locally
	Signal Peer	Default	Send SxMod (Drop) DBR/DSR SxDelete
		Dedicated	Send DBR/DBC (Async) SxMod (Remove Traffic Endpoint)
IDFT	NA	NA	Send SxMod (Remove IDFT Traffic Endpoint)- async Purge Bearer locally

Session Replacement for Default Bearer Call Flow

This section describes the Session Replacement (SRIR) for Default Bearer call flow.

Figure 51: Session Replacement for Default Bearer Call Flow

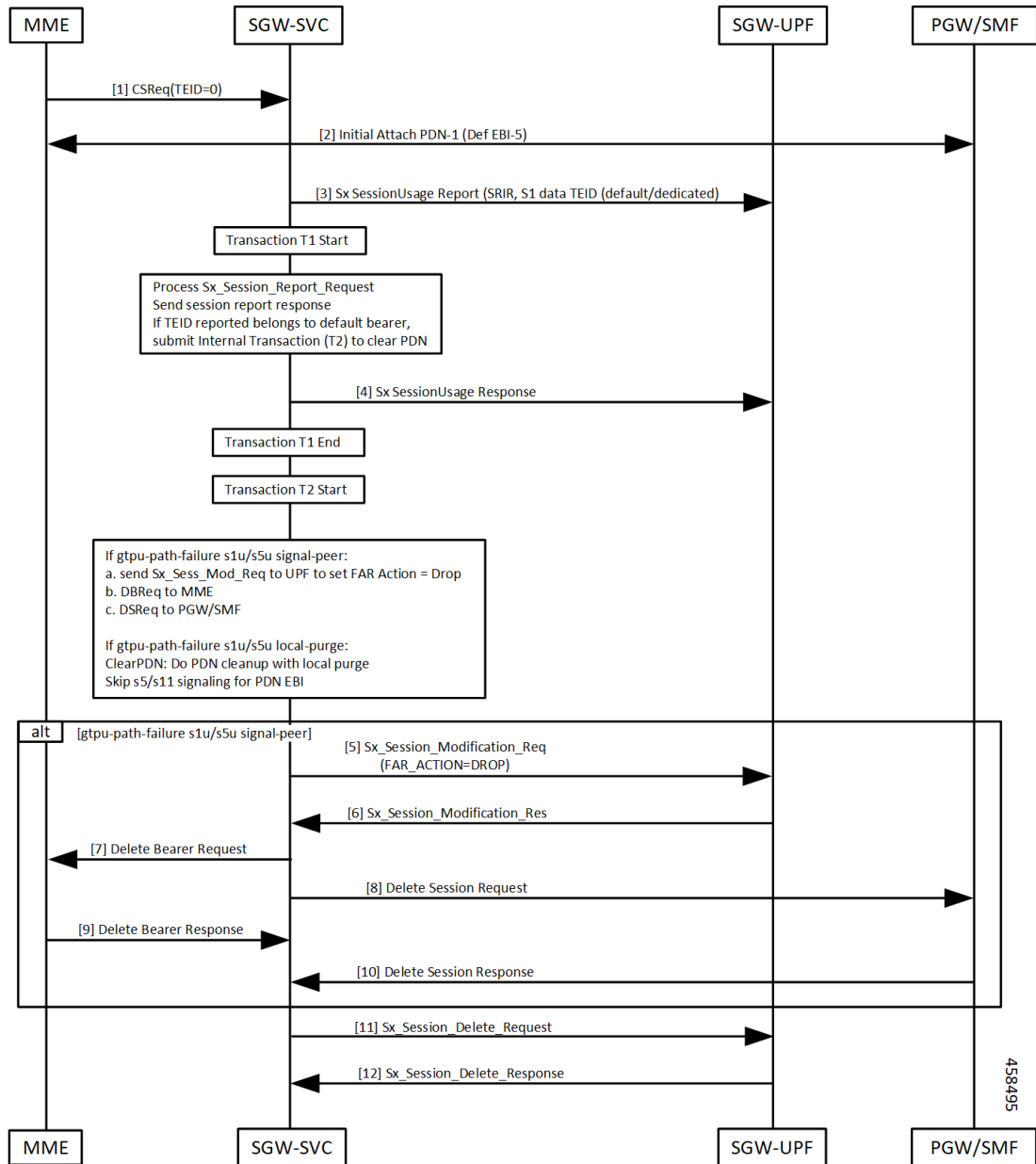

Table 99: Session Replacement for Default Bearer Call Flow Description

Step	Description
1, 2	Initial attach complete.
3, 4	<ul style="list-style-type: none"> UPF sends Sx_Session_Report_Request with report type as SRIR and TEID. cnSGW-C responds with Sx_Session_Report_Response.

Step	Description
5–10	<p>cnSGW-C processes Sx_Session_Report_Request, wrong Session Replacement uses GTPU path failure CLI for peer-signaling or local purge.</p> <p>If TEID is received for default bearer, submit internal transaction (T2) to clean up PDN.</p> <p>If CLI, <code>gtpu-path-failure s1u/s5u signal-peer</code></p> <ul style="list-style-type: none"> • Send Sx_Session_Report_Request to UPF to set FAR ACTION=DROP. • Send Delete Bearer Req to MME. • Send Delete Session Request to PGW.
11, 12	<ul style="list-style-type: none"> • Send Sx_Session_Delete_Request • UPF responds with Sx_Session_Delete_Response.

Session Replacement for Dedicated Bearer Call Flow

This section describes the Session Replacement (SRIR) for Dedicated Bearer call flow.

Figure 52: Session Replacement for Dedicated Bearer Call Flow

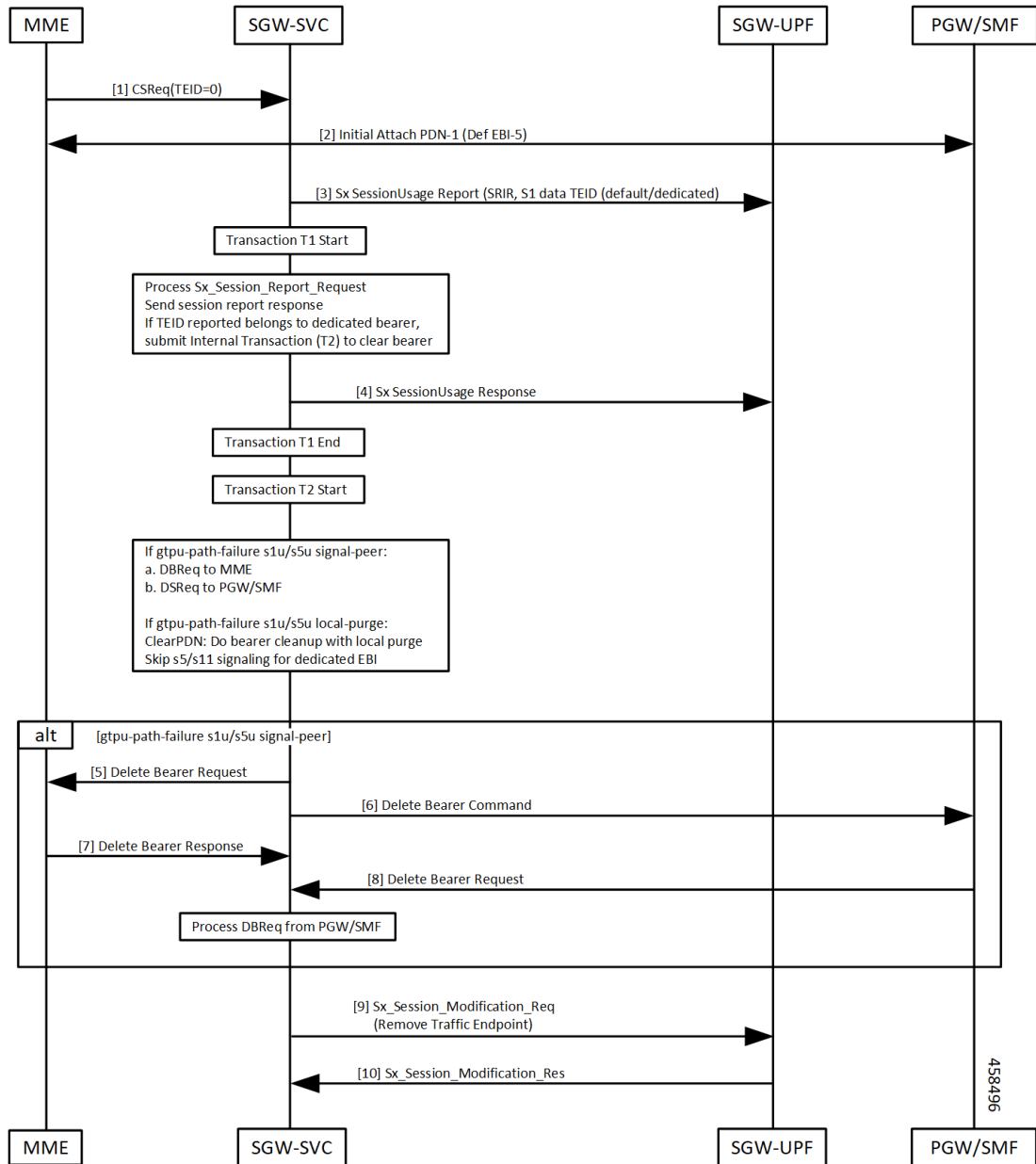

Table 100: Session Replacement for Dedicated Bearer Call Flow Description

Step	Description
1, 2	Initial attach complete.
3, 4	<ul style="list-style-type: none"> • UPF sends Sx_Session_Report_Request with report type as SRIR and TEID. • cnSGW-C responds with Sx_Session_Report_Response.

Step	Description
5–10	<p>cnSGW-C processes Sx_Session_Report_Request, wrong Session Replacement uses GTPU path failure CLI for peer-signaling or local purge.</p> <p>If TEID is received for dedicated bearer, submit internal transaction (T2) to clean up bearer.</p> <p>If CLI, <code>gtpu-path-failure s1u/s5u signal-peer</code></p> <ul style="list-style-type: none"> • Send Sx_Session_Report_Request to UPF to set FAR ACTION=DROP. • Send Delete Bearer Req to MME. • Send Delete Session Request to PGW.
11, 12	<ul style="list-style-type: none"> • Send Sx_Session_Modification_Request (Remove Traffic Endpoint) • UPF responds with Sx_Session_Modification_Response.

Feature Configuration

This section describes how to configure the GTPU Error Indication feature.

To configure this feature, use the following configuration:

```

config
profile sgw sgw_profile_name
  gtpu-error-ind
    s1u [ local-purge | page-ue ]
    s5u [ local-purge | signal-peer ]
  end

```

NOTES:

- **s1u**—S1-U interface.
- **s5u**—S5-U interface.
- **local-purge**—Locally purge the affected bearers or PDNs without informing peer.
- **page-ue**—Reset to S1-Idle state and initiate paging for this UE.
- **signal-peer**—Clear the affected bearers or PDNs with signaling towards peer.

Configuration Example

The following is an example configuration.

```

config
profile sgw sgw1
gtpu-error-ind s1u local-purge
gtpu-error-ind s5u signal-peer s1u local-purge
end

```

Configuration Verification

To verify the configuration:

```
show running-config profile sgw gtpu-error-ind slu local-purge
profile sgw sgw1
gtpu-error-ind slu local-purge
```

OAM Support

This section describes operations, administration, and maintenance information for this feature.

Bulk Statistics

The following are statistics for PDN cleanup due to Error Report.

```
sgw_pdn_disconnect_stats{app_name="smf",cluster="Local",data_center="DC",instance_id="0",
pdn_type="ipv4",rat_type="EUTRAN",reason="slu_gtpu_error",service_name="sgw-service"}
1
```

```
sgw_pdn_disconnect_stats{app_name="smf",cluster="Local",data_center="DC",instance_id="0",
pdn_type="ipv4",rat_type="EUTRAN",reason="s5u_gtpu_error",service_name="sgw-service"}
1
```

```
sgw_pdn_disconnect_stats{app_name="smf",cluster="Local",data_center="DC",instance_id="0",
pdn_type="ipv4",rat_type="EUTRAN",reason="slu_gtpu_session_replacement",service_name="sgw-service"}
1
```

```
sgw_pdn_disconnect_stats{app_name="smf",cluster="Local",data_center="DC",instance_id="0",
pdn_type="ipv4",rat_type="EUTRAN",reason="userplane_requested_graceful_termination",service_name="sgw-service"}
1
```

```
sgw_service_stats{app_name="smf",cluster="Local",data_center="DC",fail_reason="",gr_instance_id="1",
instance_id="0",interface="interface_sgw_egress",reject_cause="",service_name="sgw-service",
sgw_procedure_type="s5u_gtpu_error_initiated_bearer_deletion",status="attempted",sub_fail_reason=""}
1
```

```
sgw_service_stats{app_name="smf",cluster="Local",data_center="DC",fail_reason="",gr_instance_id="1",
instance_id="0",interface="interface_sgw_egress",reject_cause="",service_name="sgw-service",
sgw_procedure_type="s5u_gtpu_error_initiated_bearer_deletion",status="success",sub_fail_reason=""}
1
```

```
sgw_service_stats{app_name="smf",cluster="Local",data_center="DC",fail_reason="",gr_instance_id="1",
instance_id="0",interface="interface_sgw_egress",reject_cause="",service_name="sgw-service",
sgw_procedure_type="s5u_gtpu_session_replacement_initiated_bearer_deletion",status="attempted",sub_fail_reason=""}
1
```

```
sgw_service_stats{app_name="smf",cluster="Local",data_center="DC",fail_reason="",gr_instance_id="1",
instance_id="0",interface="interface_sgw_egress",reject_cause="",service_name="sgw-service",sgw_procedure_type=
"s5u_gtpu_session_replacement_initiated_bearer_deletion",status="success",sub_fail_reason=""}
1
```

```
sgw_service_stats{app_name="smf",cluster="Local",data_center="DC",fail_reason="",gr_instance_id="1",
instance_id="0",interface="interface_sgw_ingress",reject_cause="",service_name="sgw-service",sgw_procedure_type=
"s5u_gtpu_error_initiated_bearer_deletion",status="attempted",sub_fail_reason=""}
1
```

```
sgw_service_stats{app_name="smf",cluster="Local",data_center="DC",fail_reason="",gr_instance_id="1",
instance_id="0",interface="interface_sgw_ingress",reject_cause="",service_name="sgw-service",sgw_procedure_type=
"s5u_gtpu_error_initiated_bearer_deletion",status="success",sub_fail_reason=""}
1
```

```
sgw_service_stats{app_name="smf",cluster="Local",data_center="DC",fail_reason="",gr_instance_id="1",
instance_id="0",interface="interface_sgw_ingress",reject_cause="",service_name="sgw-service",sgw_procedure_type=
"s5u_gtpu_session_replacement_initiated_bearer_deletion",status="attempted",sub_fail_reason=""}
1
```

```
sgw_service_stats{app_name="smf",cluster="Local",data_center="DC",fail_reason="",gr_instance_id="1",
instance_id="0",interface="interface_sgw_ingress",reject_cause="",service_name="sgw-service",sgw_procedure_type=
"s5u_gtpu_session_replacement_initiated_bearer_deletion",status="success",sub_fail_reason=""}
1
```

The following SGW `ddn_stats_type` is added for DDN initiated due to GTPU Error indication on S1u tunnel.

```
sgw_ddn_stats{app_name="smf",cluster="cn",data_center="cn",ddn_stats_type="gtpu_err_ind_triggered",
instance_id="0",service_name="sgw-service"} 2
```



CHAPTER 24

GTPU Path Failure

- [Feature Summary and Revision History, on page 249](#)
- [Feature Description, on page 250](#)
- [How it Works, on page 250](#)
- [Feature Configuration, on page 254](#)
- [GTPU Path Failure OAM Support, on page 255](#)

Feature Summary and Revision History

Summary Data

Table 101: Summary Data

Applicable Product(s) or Functional Area	cnSGW-C
Applicable Platform(s)	SMI
Feature Default Setting	Enabled - Always-on
Related Documentation	Not Applicable

Revision History

Table 102: Revision History

Revision Details	Release
Support to clean session or bearer based on reported value in node-report (Node-ID and Peer Information)	2021.02.3
First introduced.	2021.02.1

Feature Description

When UPF detects a GTP-U path failure, it sends Node Report Request (with NodeID and GTPU Peer Information) to cnSGW-C. cnSGW-C clears the PDU sessions belonging to the GTP-U peer and UPF node ID.

This feature supports the following:

- Sending Node Report Success
- Cleaning session or bearer based on the reported value in node-report (Node-ID and Peer Information)
- Incrementing the relevant statistics

For more information, see the [GTPU Path Failure, on page 249](#) chapter.

How it Works

This section describes how this feature works.

The following table describes various actions on detecting GTPU path failure.

Table 103: GTPU Path Failure for Node Report

Interface	Configuration	TEID	Action
s1u/s5u	Local Purge	Default	Send SxSessionDeletion to clean up on UPF Purge PDN locally
		Dedicated	Send SxSessionModification (Remove TrafficEndpoint) Purge Bearer locally
	Signal Peer	Default	Send SxSessionModificationRequest (FAR Action=DROP) Send DBReq to MME and DSReq to PGW Send SxSessionDeletionRequest
		Dedicated	Send DBReq to MME and DBCmd to PGW (Async) Send SxSessionModificationRequest (Remove Traffic Endpoint)

Call Flows

This section describes key call flows of GTPU Path Failure.

Path Failure for Default Bearer Call Flow

This section describes the Path Failure for Default Bearer call flow.

Figure 53: Path Failure for Default Bearer Call Flow

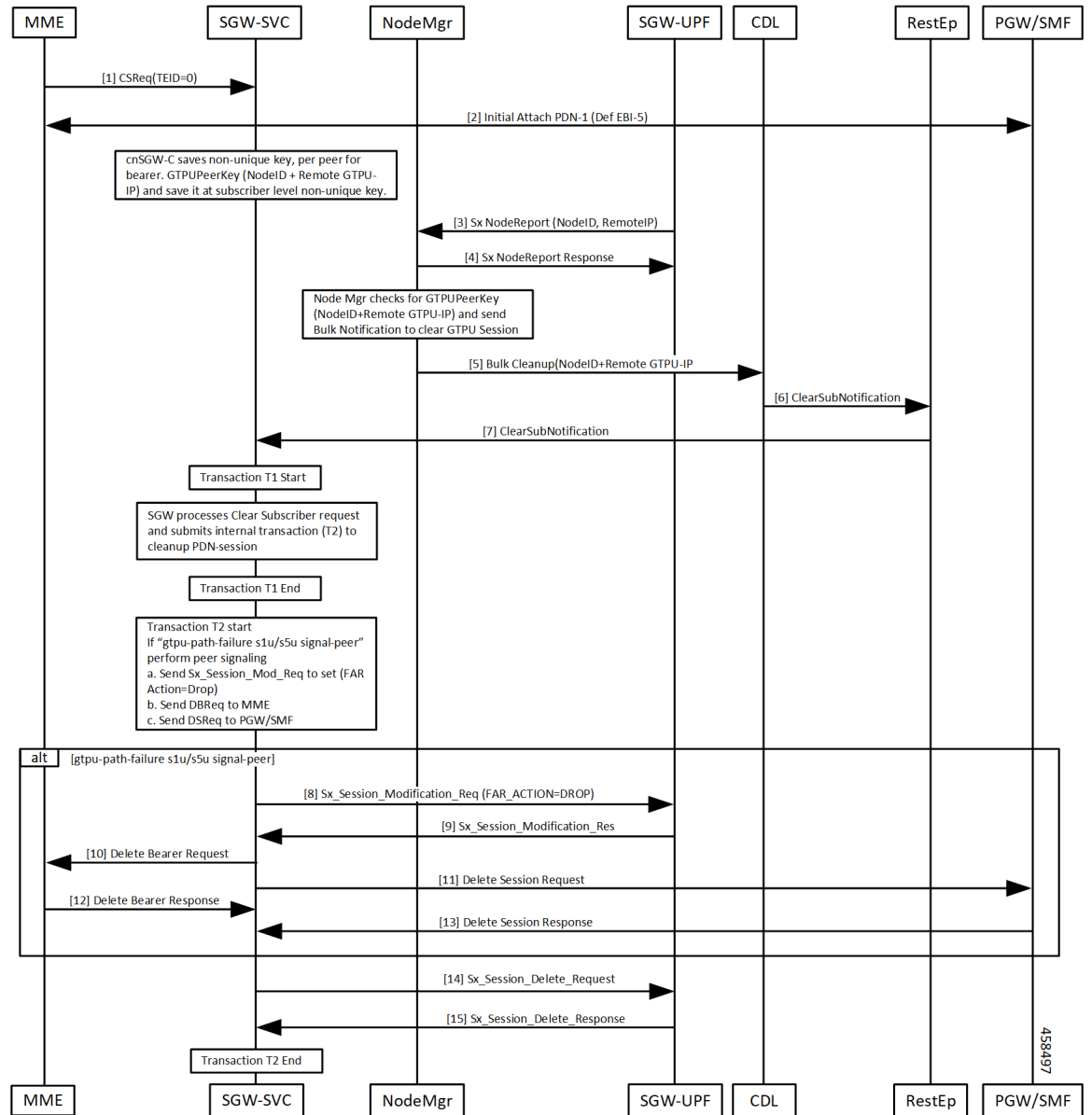

Table 104: Path Failure for Default Bearer Call Flow Description

Step	Description
1, 2	Initial attach complete. cnSGW-C saves non-unique GTPUPeerKey (NodeID:Remote GTPU-peer-IP) per bearer.
3, 4	<ul style="list-style-type: none"> • Path failure detected on UPF. UPF sends NodeReportRequest to Node Manager. • Node Manager responds with NodeReportResponse. • Initiate Bulk Cleanup request to CDL.
6, 7	<ul style="list-style-type: none"> • CDL sends ClearSubNotification to RestEp. • RestEP forwards it to cnSGW-C.
8–13	<p>cnSGW-C processes Clear Subscriber Request.</p> <p>If GTPU peer IP received is for default bearer, submit internal transaction (T2) to clean up PDN.</p> <p>If CLI <code>gtpu-path-failure slu/s5u signal-peer</code></p> <ul style="list-style-type: none"> • Send Sx_Session_Report_Request to UPF to set FAR ACTION=DROP. • Send Delete Bearer Req to MME. • Send Delete Session Request to PGW.
14, 15	<ul style="list-style-type: none"> • Send Sx_Session_Delete_Request. • UPF responds with Sx_Session_Delete_Response.

Path Failure for Dedicated Bearer Call Flow

This section describes the Path Failure for Dedicated Bearer call flow.

Figure 54: Path Failure for Dedicated Bearer Call Flow

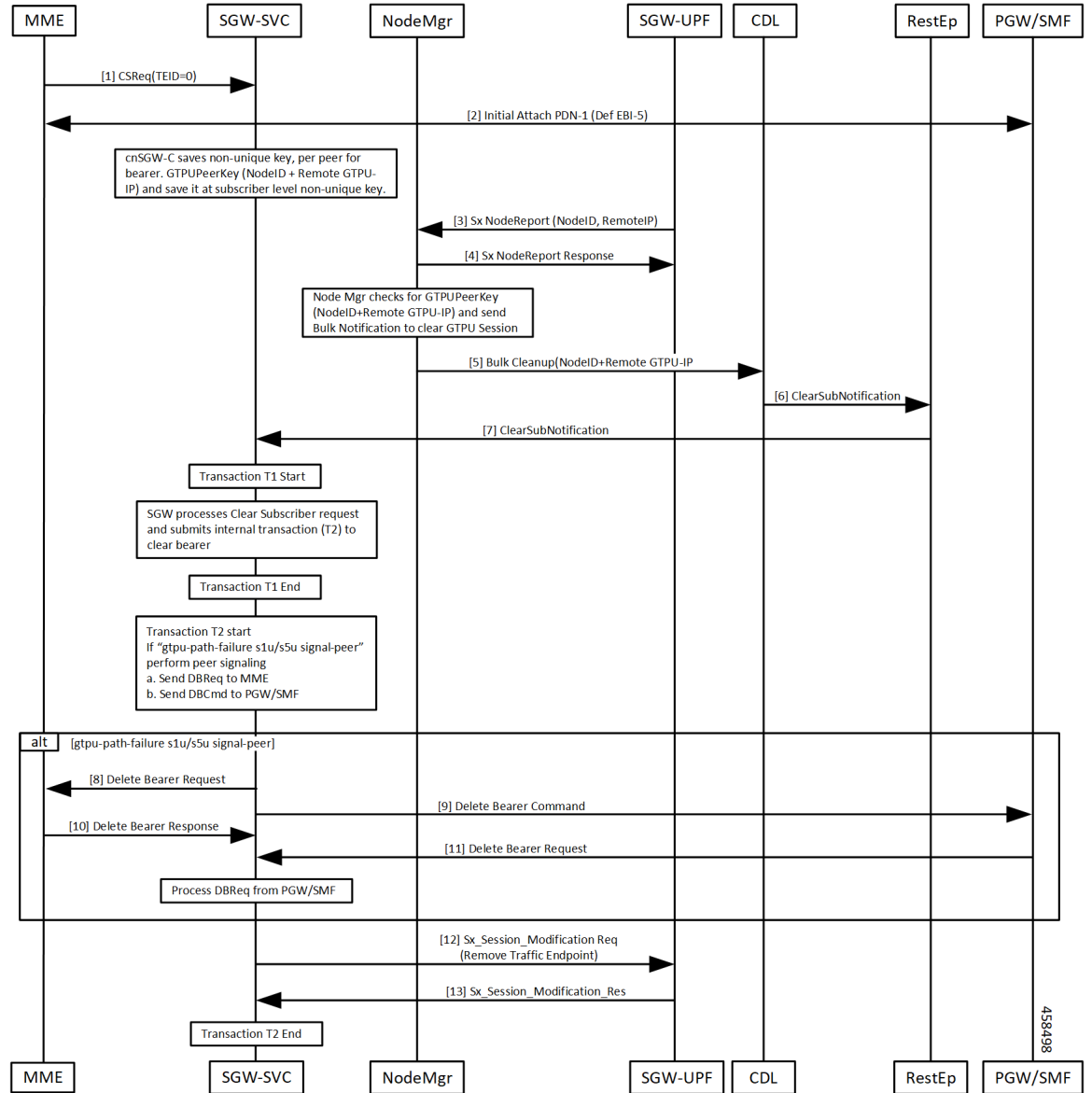

Table 105: Path Failure for Dedicated Bearer Call Flow Description

Step	Description
1, 2	Initial attach complete. cnSGW-C saves non-unique GTPUPeerKey (NodeID:Remote GTPU-peer-IP) per bearer.
3, 4	<ul style="list-style-type: none"> Path failure detected on UPF. UPF sends NodeReportRequest to Node Manager. Node Manager responds with NodeReportResponse. Initiate Bulk Cleanup request to CDL.

Step	Description
6, 7	<ul style="list-style-type: none"> • CDL sends ClearSubNotification to RestEp. • RestEP forwards it to cnSGW-C.
8–13	<p>cnSGW-C processes Clear Subscriber Request.</p> <p>If GTPU peer IP received is for dedicated bearer, submit internal transaction (T2) to clean up PDN.</p> <p>If CLI <code>gtpu-path-failure s1u/s5u signal-peer</code></p> <ul style="list-style-type: none"> • Send Delete Bearer Req to MME. • Send Delete Bearer Command to PGW.
14, 15	<ul style="list-style-type: none"> • Send Sx_Session_Modification_Request (Remove Traffic Endpoint). • UPF responds with Sx_Session_Delete_Response.

Feature Configuration

This section describes how to configure the GTPU Path Failure feature.

To configure this feature, use the following configuration.

```

config
  profile sgw sgw_profile_name
    gtpu-path-failure
      s1u [ local-purge | signal-peer ]
      s5u [ local-purge | signal-peer ]
    end

```

NOTES:

- **s1u**—S1-U interface. Default is local-purge.
- **s5u**—S5-U interface. Default is local-purge.
- **local-purge**—Locally purge the affected bearers or PDNs without informing peer.
- **signal-peer**—Clear the affected bearers or PDNs with signaling towards peer.

Configuration Example

The following is an example configuration.

```

config
  profile sgw sgw1
    gtpu-path-failure s1u local-purge
    gtpu-path-failure s5u local-purge
  end

```

Configuration Verification

To verify the configuration:

```
show running-config profile sgw sgw1
profile sgw sgw1
sgw-charging-threshold threl
sgw-charging-profile chl
locality LOCl
fqdn cisco.com.apn.epc.mnc456.mcc123
charging-mode gtp
subscriber-policy subl
session-idle-timer 86000
ddn failure-action-drop-timer 60
ddn no-user-connect-retry-timer 60
path-failure s11 signal-peer
path-failure s5e signal-peer
gtpu-error-ind s5u signal-peer
gtpu-path-failure slu local-purge
gtpu-path-failure s5u local-purge
```

GTPU Path Failure OAM Support

This section describes operations, administration, and maintenance information for this feature.

Bulk Statistics

- Node Manager Statistics

```
nodemgr_node_report_stats{app_name="smf",backlog_tmr="0",cluster="Local",data_center="DC",
instance_id="0",node_report_no_of_sess="0",node_report_peer_gtpu="209.165.201.20:209.165.201.30",
node_report_type="",service_name="nodemgr",session_tmr="0",status="attempted",
up_ep_key="209.165.201.20:209.165.201.10"} 1
```

```
nodemgr_node_report_stats{app_name="smf",backlog_tmr="1617268831815934340",cluster="Local",
data_center="DC",instance_id="0",node_report_no_of_sess="0",
node_report_peer_gtpu="209.165.201.20:209.165.201.30",node_report_type="origin",
service_name="nodemgr",session_tmr="600",status="success",
up_ep_key="209.165.201.20:209.165.201.10"} 1
```

- SGW Service Statistics

```
sgw_service_stats{app_name="smf",cluster="Local",data_center="DC",fail_reason="",
gr_instance_id="1",instance_id="0",interface="interface_sgw_egress",reject_cause="",
service_name="sgw-service",sgw_procedure_type="s5u_gtpu_path_failure_initiated",
status="attempted",sub_fail_reason=""} 1
```

```
sgw_service_stats{app_name="smf",cluster="Local",data_center="DC",fail_reason="",
gr_instance_id="1",instance_id="0",interface="interface_sgw_egress",reject_cause="",
service_name="sgw-service",sgw_procedure_type="s5u_gtpu_path_failure_initiated",
status="success",sub_fail_reason=""} 1
```

```
sgw_service_stats{app_name="smf",cluster="Local",data_center="DC",fail_reason="",gr_instance_id="1",instance_id="0",interface="interface_sgw_ingress",reject_cause="",service_name="sgw-service",sgw_procedure_type="s5u_gtpu_path_failure_initiated",status="attempted",sub_fail_reason=""} 1
```

```
sgw_service_stats{app_name="smf",cluster="Local",data_center="DC",fail_reason="",gr_instance_id="1",instance_id="0",interface="interface_sgw_ingress",reject_cause="",service_name="sgw-service",sgw_procedure_type="s5u_gtpu_path_failure_initiated",status="success",sub_fail_reason=""} 1
```



CHAPTER 25

GTPv2 and Sx Messages Retransmission and Timeout Handling

- [Feature Summary and Revision History, on page 257](#)
- [Feature Description, on page 257](#)
- [How it Works, on page 258](#)
- [Configuring the Dispatcher, on page 261](#)

Feature Summary and Revision History

Summary Data

Table 106: Summary Data

Applicable Product(s) or Functional Area	cnSGW-C
Applicable Platform(s)	SMI
Feature Default Setting	Enabled - Always-on
Related Documentation	Not Applicable

Revision History

Table 107: Revision History

Revision Details	Release
First introduced.	2021.01.0

Feature Description

cnSGW-C supports the handling of retransmission and timeout messages. It sends the following:

- Messages over a GTPC interface towards MME and PGW
- Sx messages are also sent towards the User Plane (UP).



Note For handling the retransmission and timeout functionalities, you must add the retransmission configuration (N3/T3) for the interface (S5e, S11, and Sxa).

How it Works

This section describes how this feature works.

Inbound Message Retransmission

At each N4 and GTP endpoint, there's a set of queues for incoming and outgoing traffic. Each queue has a dispatcher thread running that pulls the message from the queue. It dispatches the message to the application for further processing.

Each dispatcher references a retransmission cache to check if the incoming request is already in service. It further performs the following actions:

- If it's a retry request, the dispatcher drops the incoming request.
- If the retransmission cache reaches the threshold for outstanding requests, the incoming request is dropped.

Each dispatcher has a separate retransmission cache. This cache is also updated with the response of the request sent. It's for the retransmission request received after the response is sent.

Call Flows

This section describes the key call flows for this feature.

The following are the outbound message retransmission call flows.

GTPCv2 (GTPC-EP or Service) Call Flow

This section describes the GTPCv2 (GTPC-EP or Service) call flow.

Figure 55: GTPCv2 (GTPC-EP or Service) Call Flow

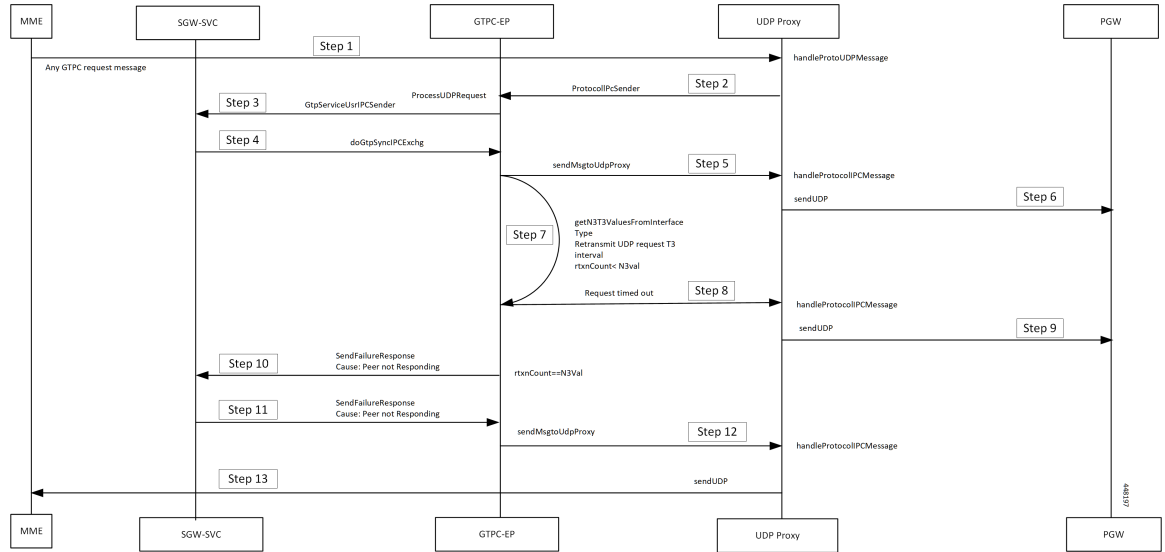

Table 108: GTPCv2 (GTPC-EP or Service) Call Flow Description

Step	Description
1	The MME sends the GTPC-EP message request to the UDP Proxy.
2	The UDP Proxy processes handleProtoUDPMessage and send ProtocolIPCSender to the GTPC-EP.
3	The GTPC-EP processes ProcessUDPRequest and sends GtpServiceUsrIPCSender to the SGW-SVC.
4	The SGW-SVC processes and sends doGtpSyncIPCExchg to the GTPC-EP.
5	The GTPC-EP sends sendMsgtoUdpProxy to the UDP Proxy.
6	The UDP Proxy processes handleProtocolIPCMMessage and sendUDP messages to the PGW.
7	The GTPC-EP processes the following requests: <ul style="list-style-type: none"> • It gets the N3T3 value from the interface (S5e for the S5 interface). • It retransmits the UDP request when the T3 interval expires and the retransmit_count value is less than the N3 value.
8	The GTPC-EP sends the request timed out message to the UDP Proxy.
9	The UDP Proxy processes handleProtocolIPCMMessage and sendUDP messages to the PGW.
10	The SGW-SVC receives the Timeout failure response when the retransmit_count is equal to the N3, and no response is received.
11	The SGW-SVC sends SendFailureResponse to the GTPC-EP, with the cause as Peer not Responding.

Step	Description
12	The GTPC-EP sends sendMsgtoUdpProxy to the UDP Proxy.
13	The UDP Proxy processes handleProtocolIPCMessage and sendUDP messages to the MME.

Sxa (smf-proto or Service) Call Flow

This section describes the call flow for the Sxa (smf-proto or service).

Figure 56: Sxa (smf-proto or Service) Call Flow

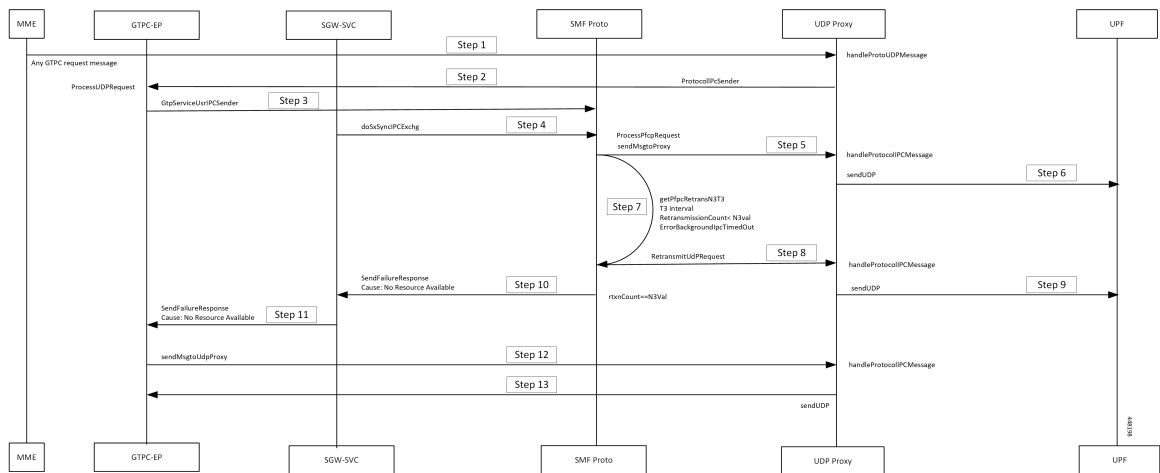

Table 109: Sxa (smf-proto or Service) Call Flow Description

Step	Description
1	The MME sends the GTPC-EP message request to the UDP Proxy.
2	The UDP Proxy processes handleProtoUDPMessage and sends ProtocolIPCSender to the GTPC-EP.
3	The GTPC-EP processes ProcessUDPRequest and sends GtpServiceUsrIPCSender to the SGW-SVC.
4	The SGW-SVC processes and sends doGtpSyncIPCExchg to the GTPC-EP.
5	The GTPC-EP sends sendMsgtoUdpProxy to the UDP Proxy.
6	The UDP Proxy processes handleProtocolIPCMessage and sendUDP messages to the PGW.
7	The GTPC-EP processes the following requests: <ul style="list-style-type: none"> It gets the N3T3 values from the interface (S5e for the S5 interface). It retransmits the UDP request, when the T3 interval expires, and the retransmit_count value is less than the value of N3.
8	The GTPC-EP sends the request timed out message to the UDP Proxy.

Step	Description
9	The UDP Proxy processes handleProtocolIPCMess and sendUDP messages to the PGW.
10	The SGW-SVC receives the Timeout failure response when the retransmit_count is equal to the value of N3, and no response is received.
11	The SGW-SVC sends SendFailureResponse to the GTPC-EP, with the cause as Peer not Responding.
12	The GTPC-EP sends sendMsgtoUdpProxy to the UDP Proxy.
13	The UDP Proxy processes handleProtocolIPCMess and sendUDP messages to the MME

Configuring the Dispatcher

This section describes the dispatcher configuration for GTPC-EP (GTP) and SMF_PROTO (PCF) endpoint.

config

```

instance instance-id instance_id
  endpoint endpoint_name
  interface interface_name
    dispatcher dispatcher_values
  end

```

NOTES:

- **instance** **instance-id** *instance_id*—Specify the instance ID.
- **endpoint** *endpoint_name*—Specify the endpoint name.
- **interface** *interface_name*—Specify the interface name.
- **dispatcher** *dispatcher_values*—Configure the dispatcher values.
 - **cache** *true* / *false*—Disable the retransmission cache support for dispatcher queue. The default value is *false*.
Must be one of the following:
 - *true*—Disable the retransmission cache support for dispatcher queue, set the **cache** to *true*.
 - *false*—Enable the retransmission cache support for dispatcher queue, set the **cache** to *false*.
 - **capacity** *capacity_value*—Specify the queue size for each dispatcher queue. The default value is 5000.
 - **count** *value*—Specify the number of supported dispatcher queues for the interface or the endpoint.
 - **expiry** *expiry_duration*—Specify the duration for which the cache entry with response is held in the cache. The default value is 60 seconds.
 - **nonresponsive** *nonresponsive_duration*—Specify the duration for which the cache entry without response is held in the cache.

- **outbound** *true / false*—Disable dispatcher queue support for outgoing messages. The default value is true. When set to false, the queue support is enabled for outgoing messages.

It means by default, the queue support is enabled for the outgoing messages. Must be one of the following:

- *true*—Disable dispatcher queue support for outgoing messages, set the **outbound** to true.
- *false*—Enable dispatcher queue support for outgoing messages, set the **outbound** to false.
- **rate-limit** *rate_limit*—Specify the rate limit for each queue.
- **threshold** *threshold*—Specify the outstanding limit for non-responsive cache entries. When the threshold is reached, the incoming requests are dropped. It must be an integer. The default value is 30000 milliseconds.

Configuration Example

The following is an example configuration.

```

config
  instance instance-id 1
  endpoint protocol
  interface n4
    dispatcher
      count 5
      outbound true
      threshold 5000
    end

```

Configuration Verification

To verify the configuration:

```

show running-config instance instance-id 1 endpoint gtp
instance instance-id 1
endpoint gtp
replicas 1
interface s5e
sla response 7000
dispatcher
count 1
capacity 1000
outbound true
threshold 10000
expiry 40000
nonresponsive 20000
exit
vip-ip 209.165.201.25
exit
interface s11
sla response 7000
dispatcher
count 1
capacity 1000
outbound true

```

```
threshold 10000
expiry 40000
nonresponsive 20000
exit
vip-ip 209.165.201.2
exit
exit

show running-config instance instance-id 1 endpoint pfcf
instance instance-id 1
endpoint pfcf
replicas 1
interface sxa
dispatcher
count 1
capacity 1000
outbound true
threshold 10000
expiry 40000
nonresponsive 20000
exit
heartbeat
interval 0
retransmission-timeout 3
max-retransmissions 5
exit
retransmission timeout 5 max-retry 1
exit
interface n4
heartbeat
interval 0
retransmission-timeout 3
max-retransmissions 5
```



CHAPTER 26

GTPv2 Load/Overload Support

- [Feature Summary and Revision History, on page 265](#)
- [Feature Description, on page 265](#)
- [Configuring the GTPv2 Load and Overload Feature, on page 267](#)
- [GTPv2 Load and Overload OAM Support, on page 273](#)

Feature Summary and Revision History

Summary Data

Table 110: Summary Data

Applicable Product(s) or Functional Area	cnSGW-C
Applicable Platform(s)	SMI
Feature Default Setting	Disabled – Configuration required to enable
Related Documentation	Not Applicable

Revision History

Table 111: Revision History

Revision Details	Release
First introduced.	2021.02.0

Feature Description

The following are the details for the load control and the overload control features.

Load Control

The load control enables a GTPC entity, such as SGW or PGW, to send its load information to a GTPC peer, such as MME, ePDG, and TWAN. This information is used to balance the session load across all the nodes supporting the same function, such as SGW cluster, as per their effective loads. The load information reflects the operational status of the GTPC entity resources.

cnSGW-C load control behavior is as follows:

- Activate or deactivate the load control support in cnSGW-C, using the CLI.
- When the load control feature is activated, cnSGW-C signals its load control information to the MME for the following reasons:
 - Optimum GW selection procedures
 - Enhanced load balancing across cnSGW-C in the network
- The calculation of the load control information is based on the deployment scenarios.
- The applicable GTPC request or the response message contains piggybacked load control information.
- cnSGW-C includes only the single instance of LCI (Load Control Information) IE as per the SGW load control information. cnSGW-C sends the LCI IE received from the PGW to the MME, along with its LCI information.
- The frequency of load control information inclusion at SGW is based on the deployment scenario. The SGW ensures the propagation of the new or the updated load control information to the target receivers is within the acceptable delay. This acceptable delay helps in achieving the effective load balancing act in the network.

Overload Control

The overload control enables a GTPC entity to reduce gracefully its own incoming signaling load by instructing its GTPC peers to send the reduced traffic. The GTPC entity reaches overload, when it operates above the signaling capacity. This overload results in a diminished performance, resulting in to impacts on the incoming and the outgoing traffic handling. The GTPC node uses the load information to reduce, or throttle, or reduce and throttle, the amount of GTPC signaling traffic between these nodes.

cnSGW-C overload control behavior is as follows:

- Activate or deactivate overload control support in cnSGW-C using the CLI.
- When the overload control feature is activated, cnSGW-C signals its overload control information to the MME or the PGW. This helps in controlling the GTPC signaling traffic towards itself.
- SGW supports the handling of the overload control information in all the applicable messages.
- The applicable GTPC request or the response message contains piggybacked overload control information.
- cnSGW-C includes only the single instance of OCI (Overload Control Information) IE as per the SGW overload control information. cnSGW-C sends the OCI IE received from the PGW to the MME, along with its OCI information.
- The calculation of the overload control information is based on the deployment scenario.
- cnSGW-C rejects with the cause as GTPC entity congestion, when the SGW is in self-protection mode.

- SGW doesn't store the MME or the PGW overload control information.
- SGW doesn't perform throttling towards the MME and the PGW.



Note The load control and the overload control are optional features.

Configuring the GTPv2 Load and Overload Feature

This section describes how to configure the GTPv2 load or overload conditions.

Configuring this feature involves the following steps:

- [Configuring the Load Profile](#): This section describes how to configure the load profile and the parameters required to calculate the load of cnSGW-C.
- [Configuring the Exclude Profile, on page 268](#): This section describes how to make an exclusion and configure the exclude profile in overload conditions.
 - This profile determines the session-related messages to exclude from the throttling decisions.
 - Both self-protection and peer overload control, use this configuration.
- [Configuring the Overload Condition Profile, on page 269](#): This section describes how to configure the profile in overload conditions.
 - The profile determines the various conditions for overload control and the resulting throttling decisions.
 - It supports only one overload profile.
 - The load profile supports overload profile functionality.
- [Configuring the Maximum Session Count, on page 270](#): This section describes how to configure the maximum session count that contributes to the session percent load factor in LCI/OCI calculation.
- [Configuring the Overload-Profile and the SGW-Profile Association, on page 196](#): The association of the Overload-Profile and the SGW-Profile, can be configured.

Configuring the Load Profile

To configure this feature use the following configuration:

```
config
  profile load profile_name
    load-calc-frequency load_calc_frequency_value
    load-fetch-frequency load_fetch_frequency_value
    advertise
    interval interval_value
    change-factor change_factor_value
  exit
```

```

interface gtpc
  action advertise
end

```

NOTES:

- **profile load** *profile_name*—Specify the load profile name.
- **load-calc-frequency** *load_calc_frequency_value*—Specify the system load calculation time in seconds. Must be an integer in the range of 5-3600. The default value is 10 seconds.
- **load-fetch-frequency** *load_fetch_frequency_value*—Specify the time interval in seconds at which protocol pods fetch load from the cache POD. Must be an integer in the range of 5-3600. The default value is 10 seconds.
- **advertise interval** *interval_value*—Specify the time interval of sending LCI to the peers in seconds. Must be an integer in the range of 0-3600. The default value is 300 seconds.
- **advertise change-factor** *change_factor_value*—Specify the LCI value to corresponding peers, if the difference between the current load value and the last indicated load value is greater than the change-factor. Must be an integer in the range of 1-20. The default value is five.
- **interface gtpc action advertise**—Enables LCI publishing on the GTPC interface.

Configuration Example

The following is an example configuration.

```

config
profile load pl
load-calc-frequency 30
load-fetch-frequency 60
advertise
interval 300
change-factor 1
exit
interface gtpc
action advertise
end

```

Configuring the Exclude Profile

To configure this feature use the following configuration:

```

config
  profile overload-exclude overload_exclude_profile_name
    dnn-list dnn_list
    arp-list arp_list
  end

```

NOTES:

- **profile overload-exclude** *overload_exclude_profile_name*—Specify the name of the exclude profile. You can configure multiple exclude profiles.
- **dnn-list** *dnn_list*—Specify the list of DNNs that needs to be excluded from throttling decisions. The maximum limit is three.

- **arp-list** *arp_list*—Specify the list of 5G allocation and retention priorities and exclusion of throttling decision messages. Must be an integer in the range of 1-15. The maximum limit is eight.

Configuration Example

The following is an example configuration.

```
config
profile overload-exclude ol-excl-profl
dnn-list emergency-dnn1 wps-dnn2
arp-list 1 2 3
end
```

Configuring the Overload Condition Profile

To configure this feature use the following configuration:

```
config
  profile overload overload_profile_name
    overload-exclude-profile self-protection self_protection_profile_name
      node-level
      tolerance
        minimum min_percentage
        maximum max_percentage
      reduction-metric
        minimum min_percentage
        maximum max_percentage
    interface gtpc
      overloaded-action advertise
      advertise
        interval interval_value
        change-factor change_factor_value
        validity-period validity_period_value
    end
```

NOTES:

- **profile overload** *overload_profile_name*—Specify the overload profile name.
- **overload-exclude-profile self-protection** *self_protection_profile_name*—(This is an optional configuration) Exclude messages from throttling decisions in self-protection condition.
- **tolerance minimum** *min_percentage* **maximum** *max_percentage*—Specify the system overload limits. Refer the following scenarios:
 - When the system load is less than *min_percentage*, the system is in a normal state.
 - When the system load is in between *min_percentage* and *max_percentage*, the system is in an overloaded state. In this scenario, the node overload control action is triggered.
 - When the system load is greater than *max_percentage*, the system is in a self-protection state. In this scenario, the self-protection action is triggered.
 - *max_percentage* must be an integer in the range of 1-100. The default value is 95.
 - *min_percentage* must be an integer in the range of 1-100. The default value is 80.

- **reduction-metric minimum** *min_percentage* **maximum** *max_percentage*—Specify the reduction metric limits. Refer the following scenarios:
 - Both percentage values, *min_percentage* and *max_percentage* work along with the **tolerance** configuration.
 - The percentage value *max_percentage* must be an integer in the range of 1-100. The default value is 100.
 - The percentage value *min_percentage* must be an integer in the range of 1-100. The default value is 10.

Example: Send 10 percent OCI to peer nodes, when the load is 80 percent, and 30 percent, when the load is 95 percent, during the following conditions:

- **tolerance** *min_percentage* is 80 and *max_percentage* is 95.
- **reduction-metric** *min_percentage* is 10 and *max_percentage* is 30.
- **interface gtpc overloaded-action advertise**—Configures the action on GTPC interface when a node gets overloaded. GTPC includes S5/S8/S11/S2b interfaces. Certain actions apply only to specific interfaces.
- **advertise interval** *interval_value*—Specify the periodicity of sending LCI to the peers in seconds. Must be an integer in the range of 0-3600. The default value is 300 seconds.
- **advertise change-factor** *change_factor_value*—Specify the change-factor value. GTPC sends the LCI to corresponding peers, if the difference between the current load value and the lastly indicated load value is greater than the change-factor value. Must be an integer in the range of 1-20. The default value is five.
- **advertise validity-period** *validity_period_value*— Specify the validity period of the advertised OCI value in seconds. Must be an integer in the range of 1-3600. The default value is 600 seconds.

Configuring the Maximum Session Count

To configure this feature use the following configuration:

```
config
  profile converged-core profile_name
    max-session-count max_session_count_value
  end
```

NOTES:

- **profile converged-core** *profile_name*—Specify the name of the converged core profile.
- **max-session-count** *max_session_count_value*—Specify the maximum number of sessions supported. Must be an integer in the range of 1-12000000.

Configuration Example

The following is an example configuration.

```
config
profile converged-core convergedCoreProfile
```

```
max-session-count 12000000
exit
```

Configuring the Overload-Profile and the SGW-Profile Association

The association of the Overload-Profile and the SGW-Profile, can be configured.

To configure this feature use the following configuration:

```
config
  profile overload overload_profile_name
    overload-exclude-profile self-protection self_protection_profile_name
  node-level
    tolerance
      minimum min_percentage
      maximum max_percentage
    reduction-metric
      minimum min_percentage
      maximum max_percentage
      advertise
      interval interval_value
      change-factor
    exit
  interface gtpc
    overloaded-action [ advertise ]
  exit
  exit
  profile load load_name
  load-calc-frequency load_calc_frequency_value
  load-fetch-frequency load_fetch_frequency_value
  advertise
  interval interval_value
  change-factor change_factor_value
  exit
  interface gtpc
  action advertise
  exit
exit
profile sgw sgw_name
load-profile profile_name
overload-profile overload_profile_name
end
```

NOTES:

- **overload** *overload_name*—Specify the overload protection profile name. Must be a string.
- **overload-exclude-profile**—Excludes profiles for overload scenarios.
- **self-protection** *overload_value*—Specify the profile to be excluded for self-protection. Must be a string.
- **tolerance minimum** *min_percentage*—Specify the minimum tolerance level below which the system is in a normal state. Must be an integer in the range of 1-100. The default value is 80.

- **tolerance maximum** *max_percentage*—Specify the maximum tolerance level above which the system is in a self-protection state. Must be an integer in the range of 1-100. The default value is 95.
- **reduction-metric minimum** *min_percentage*—Specify the percentage of reduction along with minimum tolerance-level for configuration. Must be an integer in the range of 1-100. The default value is 10.
- **reduction-metric maximum** *max_percentage*—Specify the percentage of reduction along with maximum tolerance-level for configuration. Must be an integer in the range of 1-100. The default value is 100.
- **interval** *interval_value*—Specify the advertising interval in seconds. Must be an integer in the range of 0-3600. The default value is 300 seconds.
- **validity** *validity_value*—Specify the validity period of the advertised OCI value in seconds. Must be an integer in the range of 1-3600. The default value is 600 seconds.
- **change-factor** *change_factor_value*—Specify the minimum change between current OCI and last indicated OCI, after which the advertising should happen. Must be an integer in the range of 1-20. The default value is five.
- **profile load** *load_name*—Specify the name of the load profile. Must be a string.
- **load-calc-frequency** *load_calc_frequency_value*—Specify the system load calculation interval in seconds. Must be an integer in the range of 5-3600. The default value is 10 seconds.
- **load-fetch-frequency** *load_fetch_frequency_value*—Specify the time interval in seconds at which the service pods fetch load from the cache pod. Must be an integer in the range of 5-3600. The default value is 10 seconds.
- **load-profile** *profile_name*—Specify the name of the load profile.
- **overload-profile** *overload_profile_name*—Specify the name of the overload profile.

Configuration Example

The following is an example configuration.

```

config
profile overload op
overload-exclude-profile self-protection <overload-exclude-profile-name>
node-level
tolerance minimum 5
tolerance maximum 50
reduction-metric minimum 50
reduction-metric maximum 100
advertise
interval 0
change-factor 1
exit
interface gtpc
overloaded-action [ advertise ]
exit
exit
exit
profile load lp
load-calc-frequency 120
load-fetch-frequency 15
advertise
interval 0
change-factor 1
exit

```



```
interface gtpc
action advertise
exit
exit
profile sgw <sgw_name>
load-profile <profile_name>
overload-profile <overload_profile_name>
end
```

Configuration Verification

To verify the configuration:

```
show running-config profile
profile sgw sgw1
load lpl
overload opl
end
```

GTPv2 Load and Overload OAM Support

This section describes operations, administration, and maintenance information for this feature.

Bulk Statistics

Normal

```
node_overload_status{app_name="smf", cluster="cn", data_center="cn",
instance_id="0", service_name="oam-pod"} 0
```

Overload

```
node_overload_status{app_name="smf", cluster="cn", data_center="cn",
instance_id="0", service_name="oam-pod"} 1
```

Self-Protection

```
node_overload_status{app_name="smf", cluster="cn", data_center="cn",
instance_id="0", service_name="oam-pod"} 2
```

SGW Service Statistics

```
sgw_service_stats{app_name="smf", cluster="cn", data_center="cn",
fail_reason="gtp_entity_in_congestion", instance_id="0",
interface="interface_sgw_ingress", reject_cause="entity_in_congestion",
service_name="sgw-service", sgw_procedure_type="initial_attach",
status="rejected", sub_fail_reason=""}
```

LCI/OCI Metric Values

```
node_lci_metric{app_name="SGW", cluster="cn", component="oam-pod",  
data_center="DC", namespace="cn", instance_id="0", service_name="oam-pod"}
```

```
node_oci_metric{app_name="SGW", cluster="cn", component="oam-pod",  
data_center="DC", namespace="cn", instance_id="0", service_name="oam-pod"}
```



CHAPTER 27

GTPv2 Message Validation

- [Feature Summary and Revision History, on page 275](#)
- [Feature Description, on page 275](#)
- [How it Works, on page 276](#)

Feature Summary and Revision History

Summary Data

Table 112: Summary Data

Applicable Product(s) or Functional Area	cnSGW-C
Applicable Platform(s)	SMI
Feature Default Setting	Enabled - Always-on
Related Documentation	Not Applicable

Revision History

Table 113: Revision History

Revision Details	Release
First introduced.	2021.01.0

Feature Description

cnSGW-C supports basic GTPv2 message validation of IEs (values, mandatory IE, and service-dependent IE), and sends responses from the SGW-Service/GTPC-EP pod.

How it Works

This section describes how this feature works.

Call Flows

This section describes the key call flows for this feature.

Basic and Advance Validation on SGW-Ingress (S11) Call Flow

The following section describes the Basic and Advance Validation on SGW-Ingress (S11) call flow.

Figure 57: Basic and Advance Validation - S11 Call Flow

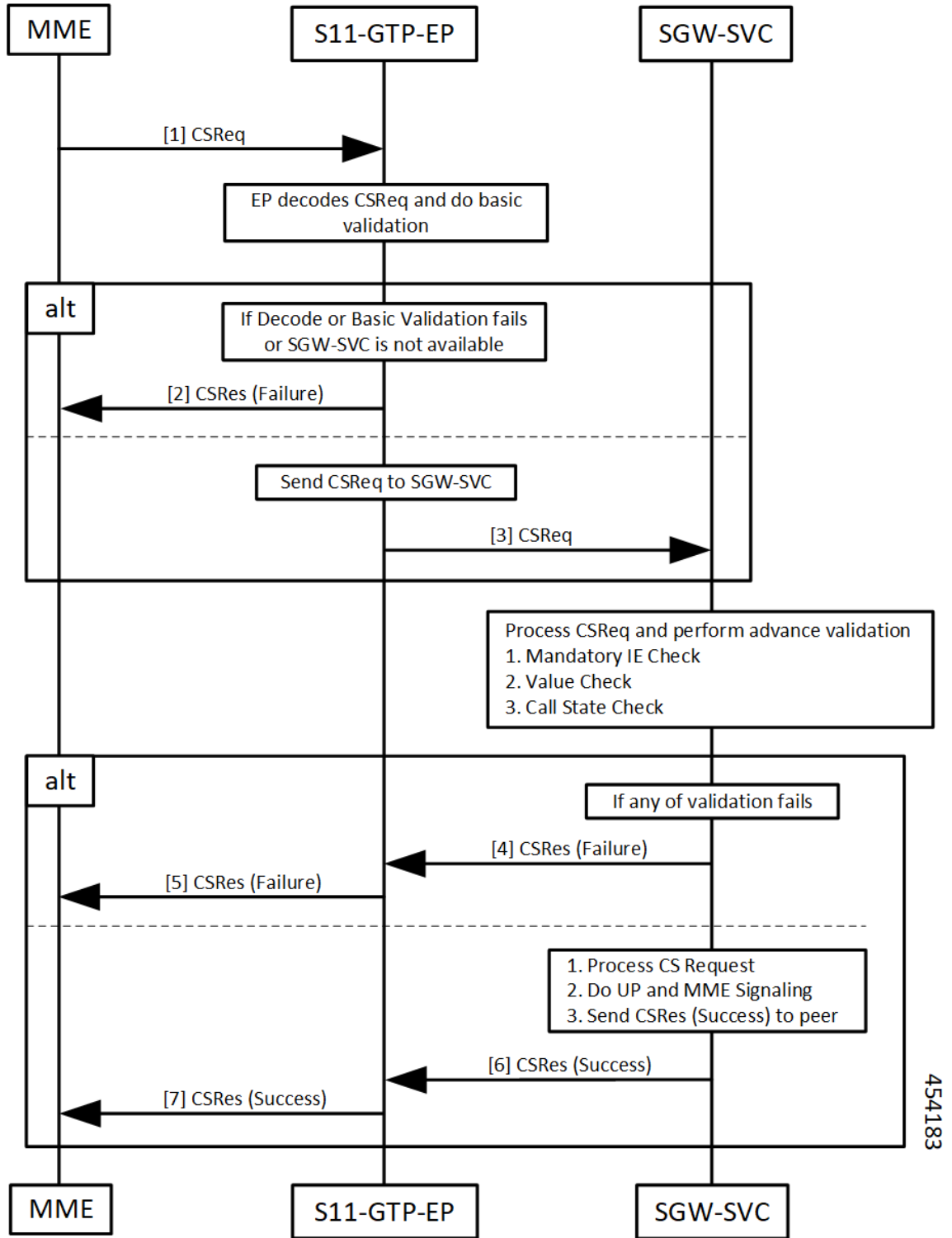

Table 114: Basic and Advance Validation - S11 Call Flow Description

Step	Description
1	The MME sends the Create Session Request to the S11-GTP-EP pod. The S11-GTP-EP pod decodes the Create Session Request and performs basic validation.
2	If decoding or basic validation fails, or if SGW-SVC is not available, the S11-GTP-EP pod sends Create Session Response failure message to the MME.
3	If Create Session Request basic validation is successful, the S11-GTP-EP pod forwards the Create Session Request to the SGW-SVC pod. SGW-SVC processes the Create Session Request and performs the following: <ul style="list-style-type: none"> • Mandatory IE check • Value check • Call State check
4, 5	If validation from Step 3 fails: <ul style="list-style-type: none"> • The SGW-SVC sends the Create Session Response failure message to the S11-GTP-EP pod. • The S11-GTP-EP pod forwards the Create Session Response failure message to the MME.
6, 7	If validation from Step 3 is successful, the SGW-SVC performs the following: <ul style="list-style-type: none"> • Processes Create Session Request • Performs UP and MME signaling • Sends Create Session Response success message to the S11-GTP-EP pod The S11-GTP-EP pod forwards the Create Session Response success message to the MME.

Basic and Advance Validation on SGW-Egress (S5) Call Flow

The following section describes the Basic and Advance Validation on SGW-Egress (S5) call flow.

Figure 58: Basic and Advance Validation - S5 Call Flow

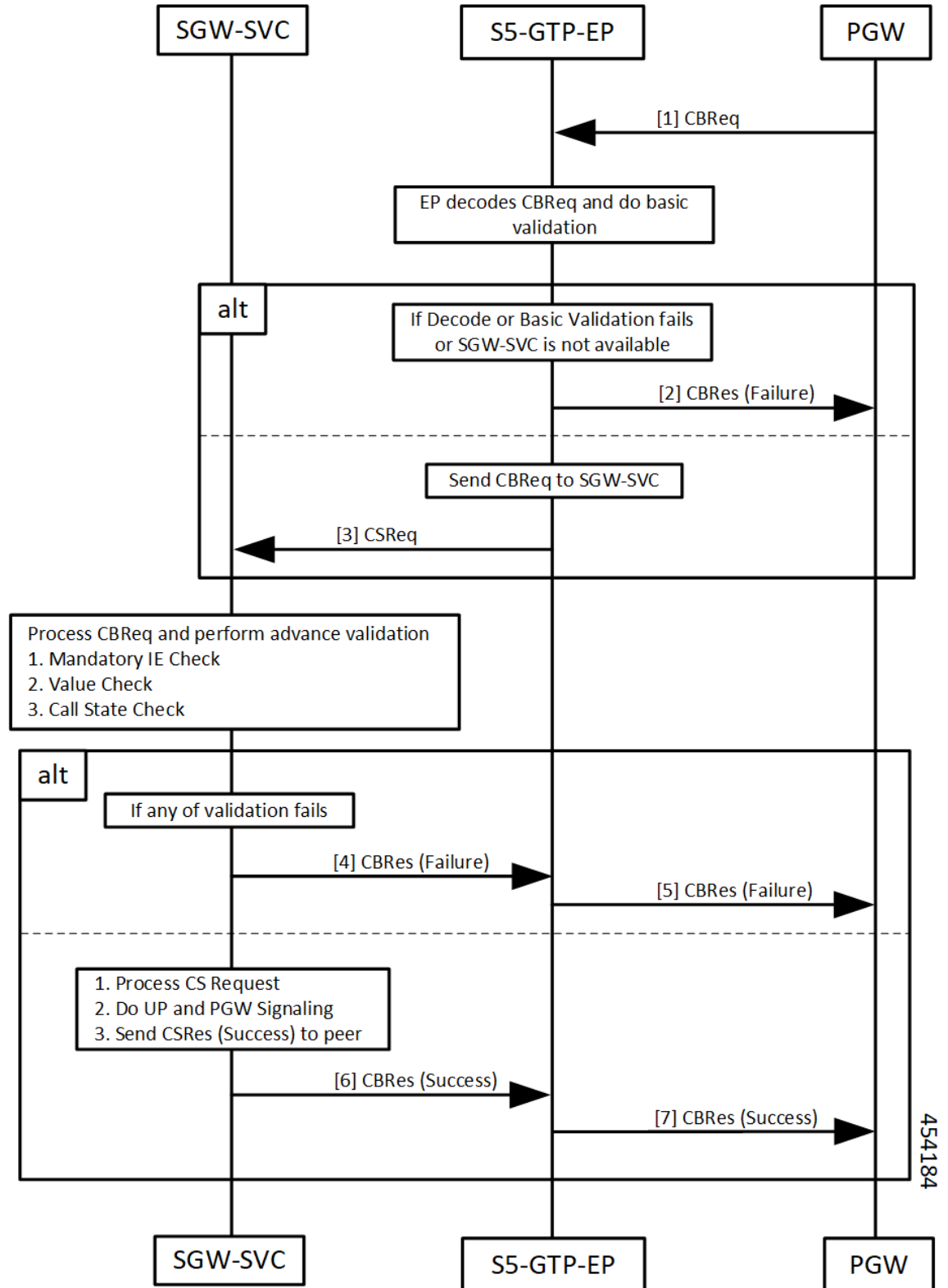

Table 115: Basic and Advance Validation - S5 Call Flow Description

Step	Description
1	The PGW sends the Create Bearer Request to the S5-GTPC-EP pod. The S5-GTPC-EP pod decodes the Create Bearer Request and performs basic validation.
2	If decoding or basic validation fails, or if SGW-SVC is not available, the S5-GTP-EP pod sends the Create Bearer Response failure message to the PGW.
3	If Create Bearer Request basic validation is successful, the S5-GTP-EP pod forwards the Create Bearer Request to the SGW-SVC pod. SGW-SVC processes the Create Bearer Request and performs the following: <ul style="list-style-type: none"> • Mandatory IE check • Value check • Call State check
4, 5	If validation from Step 3 fails: <ul style="list-style-type: none"> • The SGW-SVC sends the Create Bearer Response failure message to the S5-GTP-EP pod. • The S5-GTP-EP pod forwards the Create Bearer Response failure message to the PGW.
6, 7	If validation from Step 3 is successful, the SGW-SVC performs the following: <ul style="list-style-type: none"> • Processes Create Bearer Request • Performs UP and PGW signaling • Sends Create Bearer Response success message to the S5-GTP-EP pod The S5-GTP-EP pod forwards the Create Bearer Response success message to the PGW.



CHAPTER 28

IDFT Support

- [Feature Summary and Revision History, on page 281](#)
- [Feature Description, on page 281](#)
- [How it Works, on page 282](#)
- [OAM Support, on page 292](#)

Feature Summary and Revision History

Summary Data

Table 116: Summary Data

Applicable Product(s) or Functional Area	cnSGW-C
Applicable Platform(s)	SMI
Feature Default Setting	Enabled - Always-on
Related Documentation	Not Applicable

Revision History

Table 117: Revision History

Revision Details	Release
First introduced.	2021.02.0

Feature Description

cnSGW-C supports Indirect Forwarding Tunnel (IDFT) Creation and Deletion for Pure-S call with dedicated bearers, with and without SGW relocation.

Standards Compliance

This feature complies with the following standards specifications:

- *3GPP TS 23.401 "General Packet Radio Service (GPRS) enhancements for Evolved Universal Terrestrial Radio Access Network (E-UTRAN) access"*
- *3GPP TS 23.402 "Architecture enhancements for non-3GPP accesses"*
- *3GPP TS 29.274 "Evolved General Packet Radio Service (GPRS) Tunnelling Protocol for Control plane (GTPv2-C)"*
- *3GPP TS 23.214 "Architecture enhancements for control and user plane separation of EPC nodes"*
- *3GPP TS 29.244 "Interface between the Control Plane and the User Plane nodes"*
- *3GPP TS 24.008 "Mobile radio interface Layer 3 specification; Core network protocols; Stage 3"*

How it Works

This section describes how this feature works.

Call Flows

This section describes the key call flows for this feature.

IDFT Support without SGW Relocation Call Flow

This section describes the IDFT Support without SGW Relocation call flow.

Figure 59: IDFT Support without SGW Relocation Call Flow

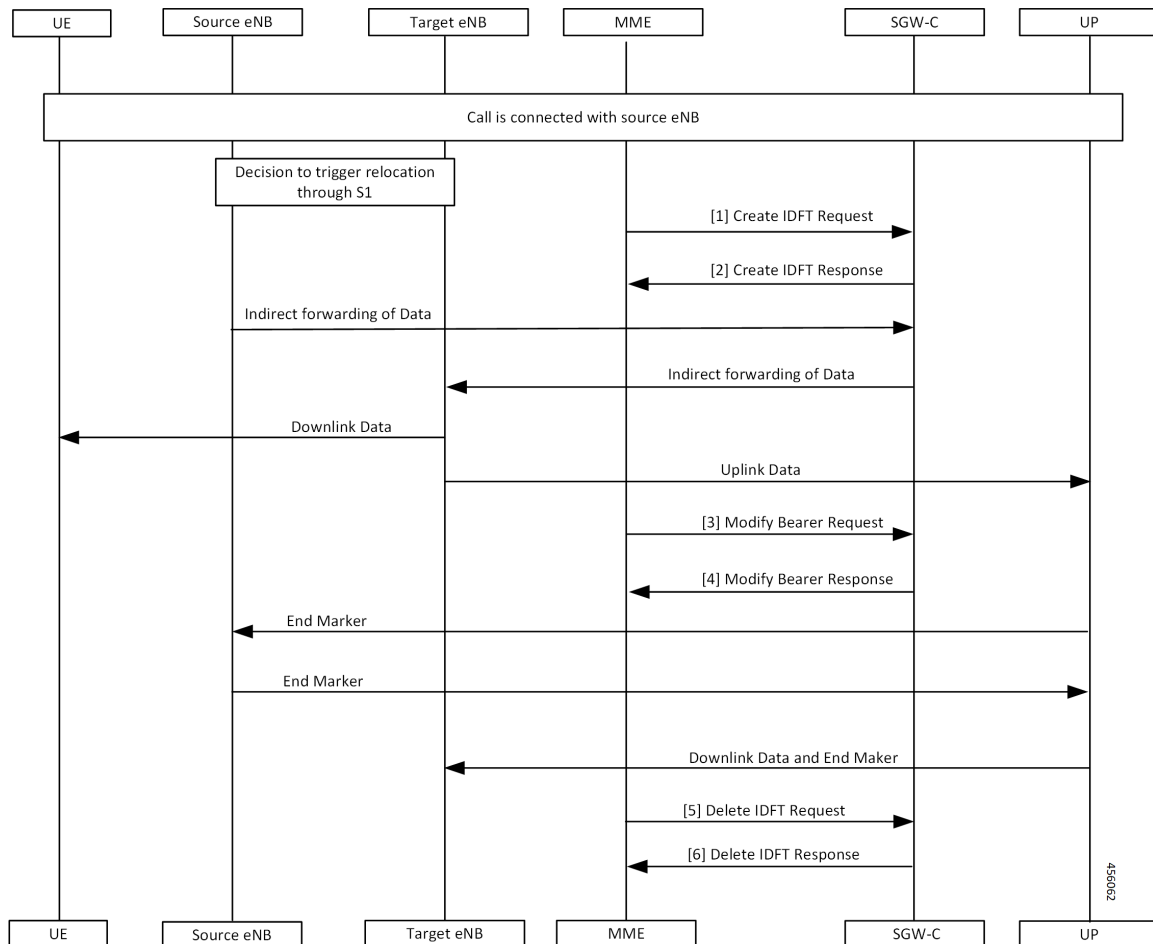

Table 118: IDFT Support without SGW Relocation Call Flow Description

Step	Description
1	Call is connected with the Source eNodeB and there’s a decision to trigger relocation via S1. The MME sends the Create IDFT Request to the SGW-C.
2	The MME receives the Create IDFT Response from the SGW-C.
3	The indirect forwarding of the data starts from the Source eNodeB to the SGW-C. The indirect forwarding of the data starts from the SGW-C to the eNodeB. The Target eNodeB sends the Downlink Data to the UE. The Target eNodeB sends the Uplink Data to the UP. The MME sends the Modify Bearer Request to the SGW-C.

Step	Description
4	The SGW-C sends the Modify Bearer Response to the MME. The UP sends the End Marker to the Source eNodeB, and the Source eNodeB forwards the End Marker to the UP. The UP sends the Downlink Data and the End Marker to the Target eNodeB.
5	The MME sends the Delete IDFT Request to the SGW-C.
6	The MME receives the Delete IDFT Response from the SGW-C.

IDFT Support with SGW Relocation Call Flow

This section describes the IDFT Support with SGW Relocation call flow.

Figure 60: IDFT Support with SGW Relocation Call Flow

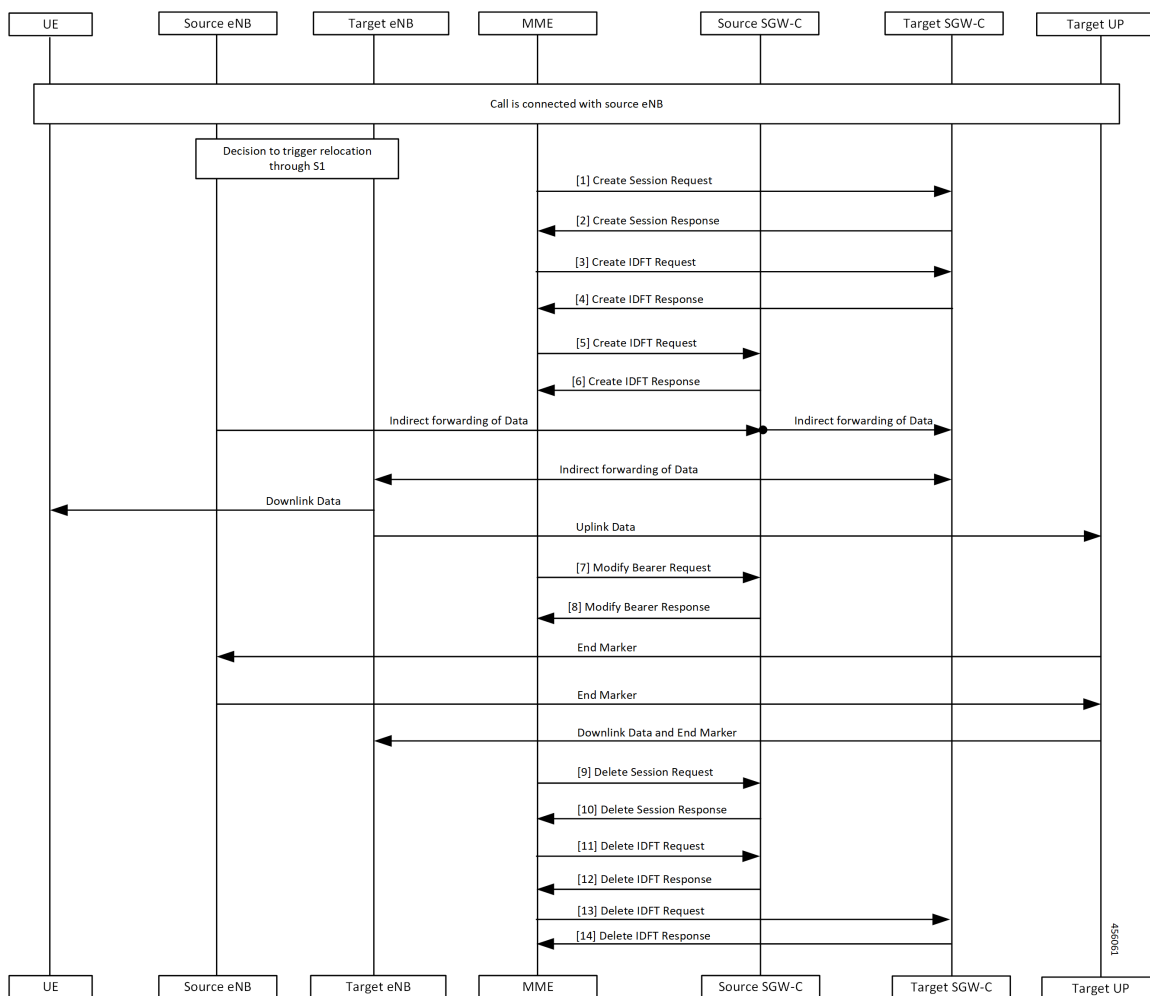

Table 119: IDFT Support with SGW Relocation Call Flow Description

Step	Description
1	Call is connected with the Source eNodeB and there's a decision to trigger relocation via S1. The MME sends the Create Session Request to the Target SGW-C.
2	The MME receives the Create Session Response from the Target SGW-C.
3	The MME sends the Create IDFT Request to the Target SGW-C.
4	The MME receives the Create IDFT Response from the Target SGW-C.
5	The MME sends the Create IDFT Request to the Source SGW-C.
6	The MME receives the Create IDFT Response from the Source SGW-C. The indirect forwarding of the data starts from the Source eNodeB to the Source SGW-C. The indirect forwarding of the data starts from the Source SGW-C to the Target SGW-C. The indirect forwarding of the data starts from the Target SGW-C to the Target eNodeB. The Target eNodeB sends the Downlink Data to the UE. The Target eNodeB sends the Uplink Data to the Target UP.
7	The MME sends the Modify Bearer Request to the Target SGW-C.
8	The Source SGW-C sends the Modify Bearer Response to the MME. The Target UP sends the End Marker to the Source eNodeB, and the Source eNodeB forwards the End Marker to the Target UP. The Target UP sends the Downlink Data and the End Marker to the Target eNodeB.
9	The MME sends the Delete Session Request to the Source SGW-C.
10	The MME receives the Delete Session Response from the Source SGW-C.
11	The MME sends the Delete IDFT Request to the Source SGW-C.
12	The MME receives the Delete IDFT Response from the Target SGW-C.
13	The MME sends the Delete IDFT Request to the Target SGW-C.
14	The MME receives the Delete IDFT Response from the Target SGW-C.

5G to 4G Handover Flow for Pure-S Call Flow

This section describes the 5G to 4G Handover flow for Pure-S call flow.

Figure 61: 5G to 4G Handover Flow for Pure-S Call Flow

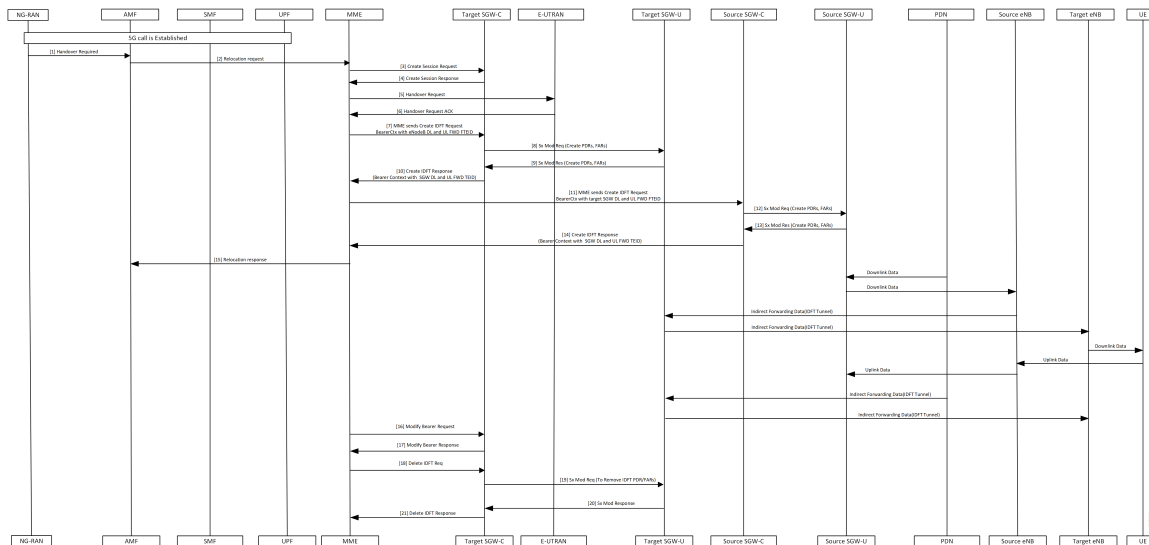

Table 120: 5G to 4G Handover Flow for Pure-S Call Flow Description

Step	Description
1	5G call is established. The NG-RAN sends the Handover Required message to the AMF.
2	The AMF sends the Relocation Request to the MME.
3	The MME sends the Create Session Request to the Target SGW-C.
4	The MME receives the Create Session Response from the Target SGW-C.
5	The MME sends the Handover Request to the E-UTRAN.
6	The MME receives the Handover Request ACK from the E-UTRAN.
7	The MME sends the Create IDFT Request with the Bearer Context with the eNodeB DL and UL FWD FTEID, to the Target SGW-C.
8	The Target SGW-C sends the Sx Modification Request with the Create PDRs and FARs to the Target SGW-U.
9	The Target SGW-U sends the Sx Modification Response with the Create PDRs and FARs to the Target SGW-C.
10	The Target SGW-C sends the Create IDFT Response with the Bearer Context with the SGW DL and UL FWD TEID, to the MME.
11	The MME sends Create IDFT Request with the Bearer Context, along with SGW DL and UL FWD FTEID, to the Source SGW-C.
12	The Source SGW-C sends the Sx Modification Request with Create PDRs and FARs, to the Source SGW-U.

Step	Description
13	The Source SGW-C receives the Sx Modification Response with Create PDRs and FARs, from the Source SGW-U.
14	The MME receives the Create IDFT Response with the Bearer Context, with the SGW DL and UL FWD TEID, from the Source SGW-C.
15	<p>The MME sends the Relocation Response to the AMF.</p> <p>The PDN sends the Downlink Data to the Source SGW-U, and the Source SGW-U sends the Downlink Data to the Source eNodeB.</p> <p>The indirect forwarding data (IDFT Tunnel) starts from the Source eNodeB to the Target SGW-U, and from the Target SGW-U to the Target eNodeB.</p> <p>The Target eNodeB sends the Downlink Data to the UE.</p> <p>The UE sends the Uplink Data to the Source eNodeB, and the Source eNodeB sends the Uplink Data to the Source SGW-U.</p> <p>The PDN sends the indirect forwarding data to the Target SGW-U, and the Target SGW-U sends the indirect forwarding data to the Target eNodeB.</p>
16	The MME sends the Modify Bearer Request to the Target SGW-C.
17	The MME receives the Modify Bearer Response from the Target SGW-C.
18	The MME sends the Delete IDFT Request to the Target SGW-C.
19	The Target SGW-C sends the Sx Modification Request with PDRs and FARs (to remove), to the Target SGW-U.
20	The Target SGW-C receives the Sx Modification Response from the Target SGW-U.
21	The MME receives the Delete IDFT Response from the Target SGW-C.

4G to 5G Handover Flow for Pure-S Call Flow

This section describes the 4G to 5G Handover flow for Pure-S call flow.

Figure 62: 4G to 5G Handover Flow for Pure-S Call Flow

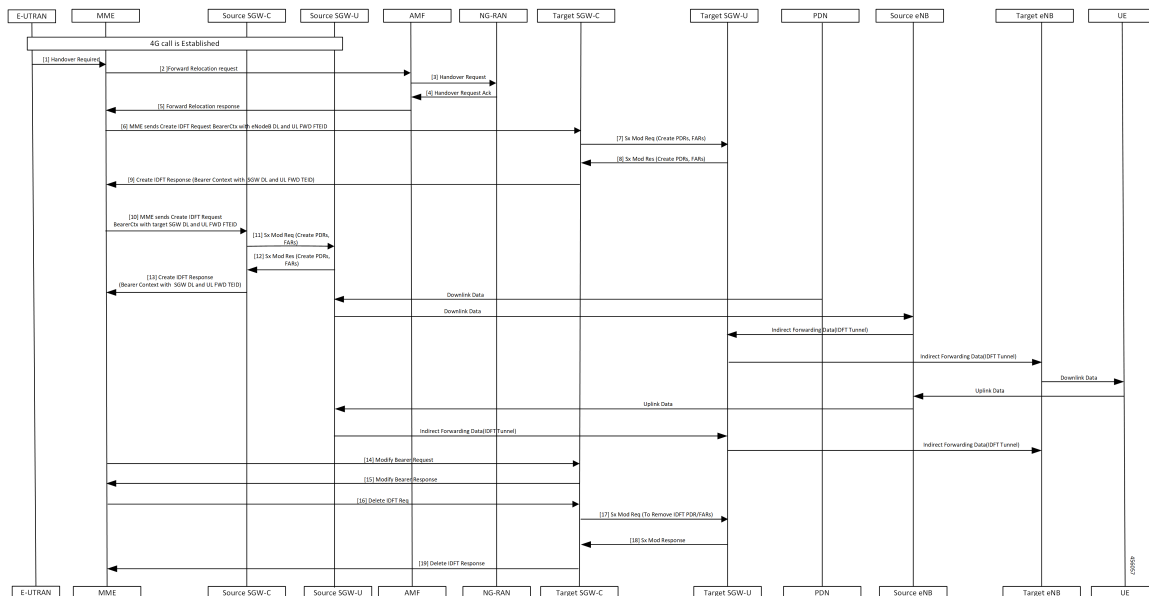

Table 121: 4G to 5G Handover Flow for Pure-S Call Flow Description

Step	Description
1	4G call is established. The E-UTRAN sends the Handover Required message to the MME.
2	The MME sends the Forward Relocation Request to the AMF.
3	The AMF sends the Handover Request message to the NG-RAN.
4	The AMF receives Handover Request ACK message.
5	The MME receives the Forward Relocation Response from the AMF.
6	The MME sends the Create IDFT Request with the Bearer Context with the eNodeB DL and UL FWD FTEID, to the Target SGW-C.
7	The Target SGW-C sends the Sx Modification Request with Create PDRs and FARs to the Target SGW-U.
8	The Target SGW-U sends the Sx Modification Response with Create PDRs and FARs to the Target SGW-C.
9	The Target SGW-C sends the Create IDFT Request with the Bearer Context along with eNodeB DL and UL FWD FTEID to the MME.
10	The MME sends the Create IDFT Request with the Bearer Context along with target SGW DL and UL FWD FTEID to the Source SGW-C.
11	The Source SGW-C sends the Sx Modification Request with Create PDRs and FARs to the Source SGW-U.

Step	Description
12	The Source SGW-C receives the Sx Modification Response with Create PDRs and FARs from the Source SGW-U.
13	<p>The MME receives the Create IDFT Response with the Bearer Context along with SGW DL and UL FWD FTEID, from the Source SGW-C.</p> <p>The PDN sends the Downlink Data to the Source SGW-U, and the Source SGW-U sends the Downlink Data to the Source eNodeB.</p> <p>The indirect forwarding data (IDFT Tunnel) starts from the Source eNodeB to the Target SGW-U, and from the Target SGW-U to the Target eNodeB.</p> <p>The Target eNodeB sends the Downlink Data to the UE.</p> <p>The UE sends Uplink Data to the Source eNodeB, and the Source eNodeB sends the Uplink Data to the Source SGW-U.</p> <p>The Source SGW-U sends the indirect forwarding data to the Target SGW-U, and the Target SGW-U sends the indirect forwarding data to the Target eNodeB.</p>
14	The MME sends the Modify Bearer Request to the Target SGW-C.
15	The MME receives the Modify Bearer Response from the Target SGW-C.
16	The MME sends the Delete IDFT Request to the Target SGW-C.
17	The Target SGW-C sends the Sx Modification Request to the Target SGW-U, to remove the PDRs and FARs.
18	The Target SGW-C receives the Sx Modification Response from the Target SGW-U.
19	The MME receives the Delete IDFT Response from the Target SGW-C.

Create IDFT (System-level) Call Flow

This section describes the Create IDFT (System-level) call flow.

Figure 63: Create IDFT (System-level) Call Flow

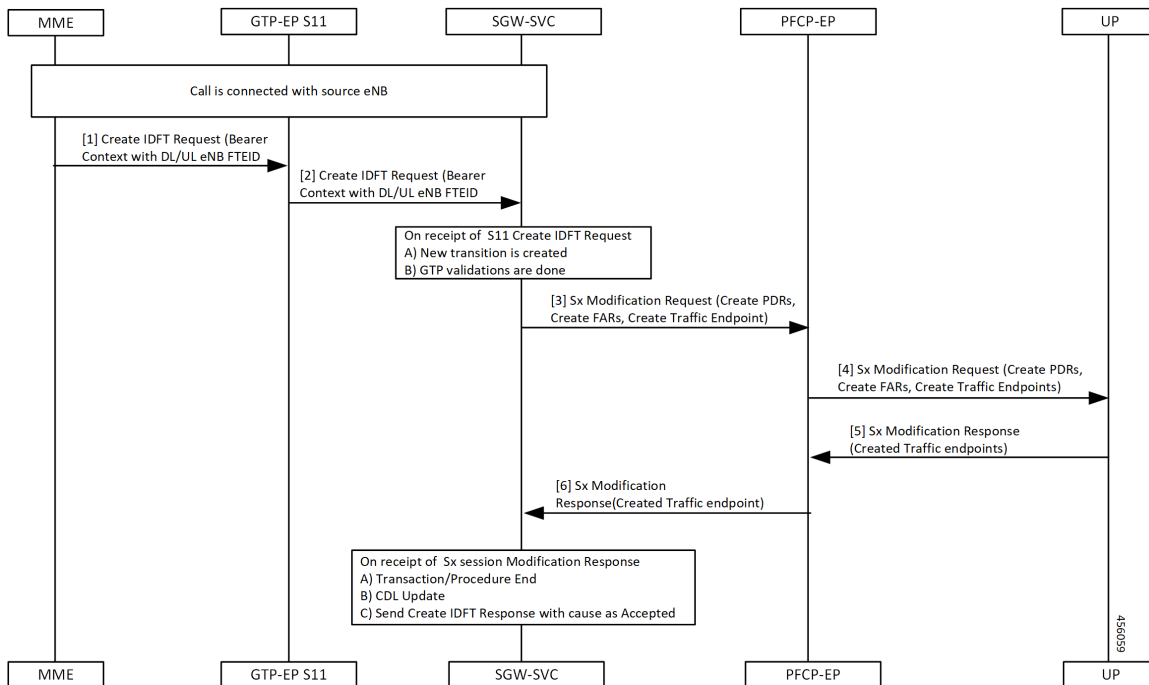

Table 122: Create IDFT (System-level) Call Flow Description

Step	Description
1	Call is connected with the Source eNodeB. The MME sends the S11 Create IDFT Request with the Bearer Context with a DL/UL enB FTEID, to the GTP-EP S11.
2	The GTP-EP S11 sends the S11 Create IDFT Request with the Bearer Context with a DL/UL enB FTEID, to the SGW-SVC. The SGW-SVC receives the S11 Create IDFT Request and performs the following: <ul style="list-style-type: none"> • Creates a new transaction • Completes GTP validations
3	The SGW-SVC sends the Sx Modification Request with Create PDRs, Create FARs, and Create Traffic Endpoints, to the PFCP-EP.
4	The PFCP-EP sends the Sx Modification Request with Create PDRs, Create FARs, and Create Traffic Endpoints, to the UP.
5	The UPF sends the Sx Session Modification Response with Created Traffic endpoints, to the PFCP-EP.

Step	Description
6	The SGW-SVC receives the Sx Session Modification Response from the PCF-PF and performs the following: <ul style="list-style-type: none"> • Ends the transaction/procedure • Updates the CDL • Sends the Create IDFT Response with cause as Accepted

Delete IDFT (System-level) Call Flow

This section describes the Delete IDFT (system-level) call flow.

Figure 64: Delete IDFT (System-level) Call Flow

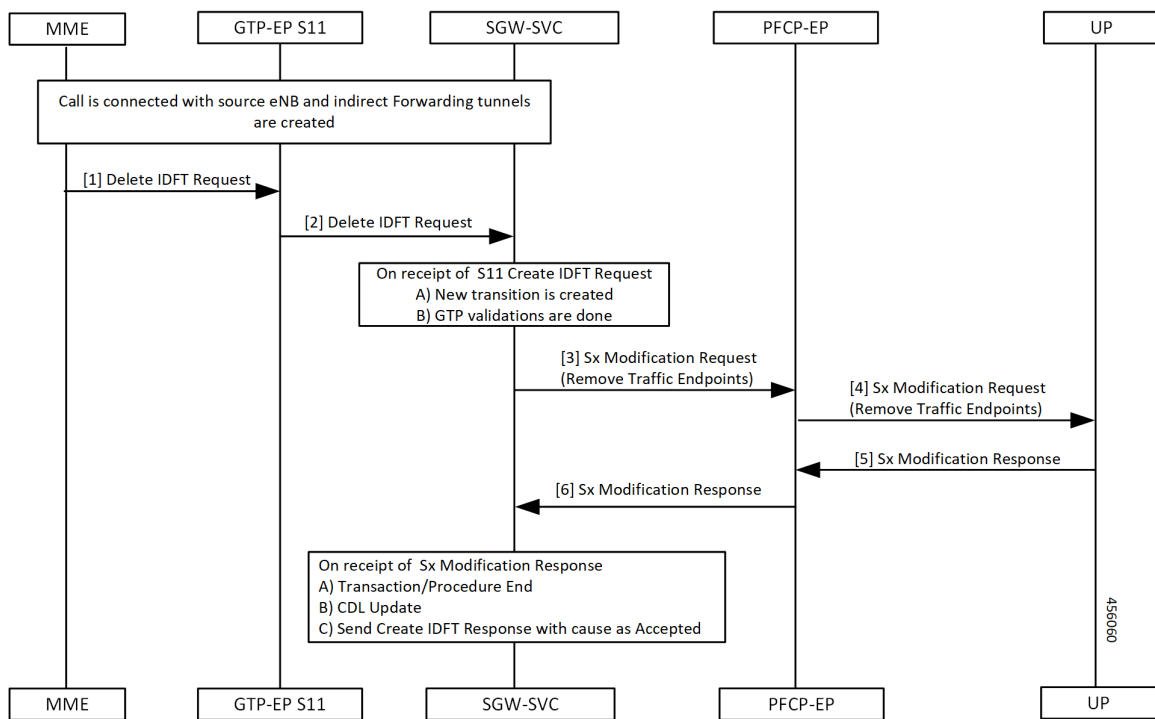

Table 123: Delete IDFT (System Level Flow) Call Flow Description

Step	Description
1	Call is connected with the Source eNodeB and indirect forwarding tunnels are created. MME sends the S11 Delete IDFT Request with Bearer Context with a DL/UL enB FTEID, to the GTP-EP S11.

Step	Description
2	The GTP-EP S11 forwards the S11 Delete IDFT Request with Bearer Context with a DL/UL enB FTEID, to the SGW-SVC. The SGW-SVC receives the S11 Delete IDFT Request and performs the following: <ul style="list-style-type: none"> • Creates a new transaction • Completes the GTP validations
3	The SGW-SVC sends the Sx Modification Request with Remove Traffic Endpoints, to the PFCP-EP.
4	The PFCP-EP sends the Sx Modification Request with Remove Traffic Endpoints, to the UP.
5	The UP sends the Sx Session Modification Response to the PFCP-EP.
6	The SGW-SVC receives the Sx Session Modification Response from the PFCP-EP and performs the following: <ul style="list-style-type: none"> • Ends the transaction/procedure • Updates the CDL • Sends the Delete IDFT Response with cause as Accepted

OAM Support

This section describes operations, administration, and maintenance information for this feature.

Viewing IDFT Configuration

This section describes the command to view IDFT configurations.

Non- active IDFT for the UE

Command: **show subscriber namespace sgw imsi 123456789012345**

Output:

```
{ "subResponses": [ { "status": true,
...
...
"pdnInfoList": { "totalPdn": 1,
"bearerInfoList": {
"totalBearer": 1, "bearerInfo": [ { "bearerId": "Bearer-1", "state": "Connected",
...
...
} }
]
}
```

Active IDFT for the UE with one PDN having one bearer

Command: **show subscriber namespace sgw imsi 123456789012345**

Output:

```

{ "subResponses": [ { "status": true,
...
...
"pdnInfoList": { "totalPdn": 1,
"bearerInfoList": {
"totalBearer": 1, "bearerInfo": [ { "bearerId": "Bearer-1", "state": "Connected",
...
...
"IndirectForwardingInfo": {
"UplinkInfo":{
"localTeid": "[0x1100000e] 285212686", "localIPv4Address": "209.165.201.8", "remoteTeid":
"[0x1100000f] 285212687", "remoteIPv4Address": "209.165.201.8",
}
"DownlinkInfo":{
"localTeid": "[0x1100000e] 285212686", "localIPv4Address": "209.165.201.8", "remoteTeid":
"[0x1100000f] 285212687", "remoteIPv4Address": "209.165.201.8",
}
}
}
}
}
}

```

Active IDFT for the UE with one PDN having one bearer in downlink direction

Command: **show subscriber namespace sgw imsi 123456789012345**

Output:

```

{ "subResponses": [ { "status": true,
...
...
"pdnInfoList": { "totalPdn": 1,
"bearerInfoList": {
"totalBearer": 1, "bearerInfo": [ { "bearerId": "Bearer-1", "state": "Connected",
...
...
"IndirectForwardingInfo": {
"DownlinkInfo":{
"localTeid": "[0x1100000e] 285212686",
"localIPv4Address": "209.165.201.8",
"remoteTeid": "[0x1100000f] 285212687",
"remoteIPv4Address": "209.165.201.8",
}
}
}
}
}
}

```

Active IDFT for one bearer for the UE with one PDN having two bearers

Command: **show subscriber namespace sgw imsi 123456789012345**

Output:

```

"subResponses": [ { "status": true,
...
...
"pdnInfoList": { "totalPdn": 1,
"bearerInfoList": {
"totalBearer": 2, "bearerInfo": [ { "bearerId": "Bearer-1", "state": "Connected",
...
...

```

```

"IndirectForwardingInfo": {
  "UplinkInfo":{
    "localTeid": "[0x1100000e] 285212686", "localIPv4Address": "209.165.201.8", "remoteTeid":
    "[0x1100000f] 285212687", "remoteIPv4Address": "209.165.201.8",
  }
  "DownlinkInfo":{
    "localTeid": "[0x1100000e] 285212686", "localIPv4Address": "209.165.201.8", "remoteTeid":
    "[0x1100000f] 285212687", "remoteIPv4Address": "209.165.201.8",
  }
}
"bearerInfo": [ { "bearerId": "Bearer-2", "state": "Connected",
...
}
}
]
}

```



Note The displayed IndirectForwardingInfo block is only for bearers having indirect forwarding tunnels.

Failure Handling

cnSGW-C supports failure handling for creating or deleting IDFT request procedure.

Following are the failure types that can occur during message processing:

- Advance validation failure on request and response
- Retransmissions timeout
- Transaction SLA
- Failure reported from peer (UP/PGW/MME), depending on the stage of message processing.

The following table depicts the behavior of cnSGW-C during different failure scenarios in call processing.

Failure Scenario	SGW-SVC behavior	Signaling (S11)
1. Create IDFT Request advance validation failure.	Sends failure or No signaling over Sx.	Negative Create IDFT response.
2. cnSGW doesn't have a bearer context for any of the EBIs received in Create IDFT.		

Failure Scenario	SGW-SVC behavior	Signaling (S11)
<p>Single PDN</p> <ol style="list-style-type: none"> 1. Sx Session Modify Request (for example, IPC, Retransmission, Internal Failure) with single PDN 2. Sx Session Modify Response (Cause!= ACCEPTED) with single PDN 3. Sx Modification Response validation failure 	<p>Sends failure.</p> <p>Sends Context not found of nonexisting EBI.</p> <p>Clear the PDN if sxCause = Context Not Found.</p>	<p>Negative Create IDFT response.</p> <p>DBR and DSR over S11 and S5 when <i>sxCause = Context Not Found</i>.</p>
<p>Multi PDN (Partial Failure)</p> <ol style="list-style-type: none"> 1. Partial Existing PDN: Continue with existing PDN 2. Sx Session Modify Request (for example, IPC, Retransmission Timeout, Internal Failure) for some PDNs 3. Sx Session Modify Response (Cause!= ACCEPTED) for some PDN 4. Sx Modification Response validation failure 	<p>Send Context Not Found for nonexisting PDNs.</p> <p>Send failure in Bearer Context for PDNs for which Sx Modification Request fails.</p>	<p>Partially Accepted Create IDFT Response.</p> <p>DBR and DSR over S11 and S5 for the PDN for which <i>sxCause = Context Not Found</i>.</p>
<p>Multi PDN (Complete Failure):</p> <ol style="list-style-type: none"> 1. Partial Existing PDN: Continue with existing PDN. 2. Sx Session Modify Request (for example, IPC, Retransmission Timeout, Internal Failure) 3. Sx Session Modify Response (Cause!= ACCEPTED) 4. Sx Modification Response validation failure 	<p>Send Context Not Found for nonexisting PDNs.</p> <p>Send failure in Bearer Context for PDNs which has Sx Modification Request fails.</p>	<p>Negative Create IDFT Response.</p> <p>DBR and DSR over S11 and S5 for the PDN for which <i>sxCause = Context Not Found</i>.</p>
<p>Delete IDFT Request Advance validation failure.</p>	<p>Send failure or No signaling over Sx.</p>	<p>Negative Delete IDFT response.</p>

Failure Scenario	SGW-SVC behavior	Signaling (S11)
<ol style="list-style-type: none"> 1. Single and Multi-PDN 2. Sx Session Modify Request (for example, IPC, Retransmission Timeout, Internal Failure) 3. Sx Session Modify Response (Cause!= ACCEPTED) 	Ignore Failure.	Positive Delete IDFT Response. DBR and DSR over S11 and S5 for the PDN for which <i>sxCause = Context Not Found</i> .

Bulk Statistics Support

The following statistics are supported for the IDFT Support feature.

```
sgw_service_stats{app_name="smf",cluster="cn",data_center="cn",fail_reason="",instance_id="0",interface="interface_sgw_ingress",reject_cause="",service_name="sgw-service",sgw_procedure_type="create_indirect_data_forwarding_tunnel",status="attempted",sub_fail_reason=""}
3
```

```
sgw_service_stats{app_name="smf",cluster="cn",data_center="cn",fail_reason="",instance_id="0",interface="interface_sgw_ingress",reject_cause="",service_name="sgw-service",sgw_procedure_type="create_indirect_data_forwarding_tunnel",status="success",sub_fail_reason=""} 2
```

```
sgw_service_stats{app_name="smf",cluster="cn",data_center="cn",fail_reason="",instance_id="0",interface="interface_sgw_ingress",reject_cause="",service_name="sgw-service",sgw_procedure_type="delete_indirect_data_forwarding_tunnel",status="attempted",sub_fail_reason=""}
1
```

```
sgw_service_stats{app_name="smf",cluster="cn",data_center="cn",fail_reason="",instance_id="0",interface="interface_sgw_ingress",reject_cause="",service_name="sgw-service",sgw_procedure_type="delete_indirect_data_forwarding_tunnel",status="success",sub_fail_reason=""}
1
```

```
sgw_service_stats{app_name="smf",cluster="cn",data_center="cn",fail_reason="",instance_id="0",interface="interface_sgw_ingress",reject_cause="",service_name="sgw-service",sgw_procedure_type="indirect_data_forwarding_tunnel_guard_timer_expiry",status="attempted",sub_fail_reason=""}
1
```

```
sgw_service_stats{app_name="smf",cluster="cn",data_center="cn",fail_reason="",instance_id="0",interface="interface_sgw_ingress",reject_cause="",service_name="sgw-service",sgw_procedure_type="indirect_data_forwarding_tunnel_guard_timer_expiry",status="success",sub_fail_reason=""}
1
```



CHAPTER 29

Idle Session Timeout Settings

- [Feature Summary and Revision History, on page 297](#)
- [Feature Description, on page 297](#)
- [How it Works, on page 298](#)
- [Feature Configuration, on page 304](#)

Feature Summary and Revision History

Summary Data

Table 124: Summary Data

Applicable Product(s) or Functional Area	cnSGW-C
Applicable Platform(s)	SMI
Feature Default Setting	Disabled – Configuration required to enable
Related Documentation	Not Applicable

Revision History

Table 125: Revision History

Revision Details	Release
First introduced.	2021.02.0

Feature Description

The stale session timeout determines the duration for which the SGW-U sessions can remain inactive before they are terminated. On the cnSGW-C platform, the SubscribeCtx represents the subscriber session. The SGW-U establishes a connection with peers, such as:

- MME and PGW using the S11 or S4 interface
- PGW on the S5 or S8 interface

When the peers delete the peer session, the SGW-U doesn't receive the deletion message or inadvertently misses them. In such situations, the SGW-U sessions remain idle and continue to receive the calls but do not process or respond to the request. To prevent the stale sessions from using the resources, the idle timeout feature enables the SGW-U to receive new subscriber session requests after deleting the old or stale sessions.

How it Works

This section describes how this feature works.

A subscriber session is idle when data traffic activity is not steered towards it as it is inactive for a stipulated time.

The session manager on the user plane tracks the state of the call line. Sessions for which the session manager does not record the call line data traffic are determined as idle. Using the idle session timeout configuration, you can set the time interval for which the session can remain idle before it times out. The idle timeout configuration is set when the session is established. The SGW-U sends the timeout configuration to the user plane in the Sx Session Establishment Request. In case of multi-PDN calls, the calls directed towards a stale session are cleared after the inactivity report is generated for all PDNs.

Every second, the SGW-U monitors the data traffic activity to determine the session's idleness status. On identifying a stale session, the user plane updates the User Plane Inactivity Report in the Sx Session Usage Report and sends it to cnSGW-C to convey that the session is idle. Further, the cnSGW-C initiates a session deletion request towards its peers.

Based on the network environment, configure the idle timeout configuration in seconds. The accepted range of the timeout value is 1–4294967295 seconds. The timeout configuration is applicable at the SGW-U service profile level enabling the idle timeout handling for the set of subscribers handled by the SGW-U service.

Call Flows

This section describes the key call flows for this feature.

Inactivity Report Call Flow

This section describes the Inactivity Report call flow.

Figure 65: Inactivity Report Call Flow

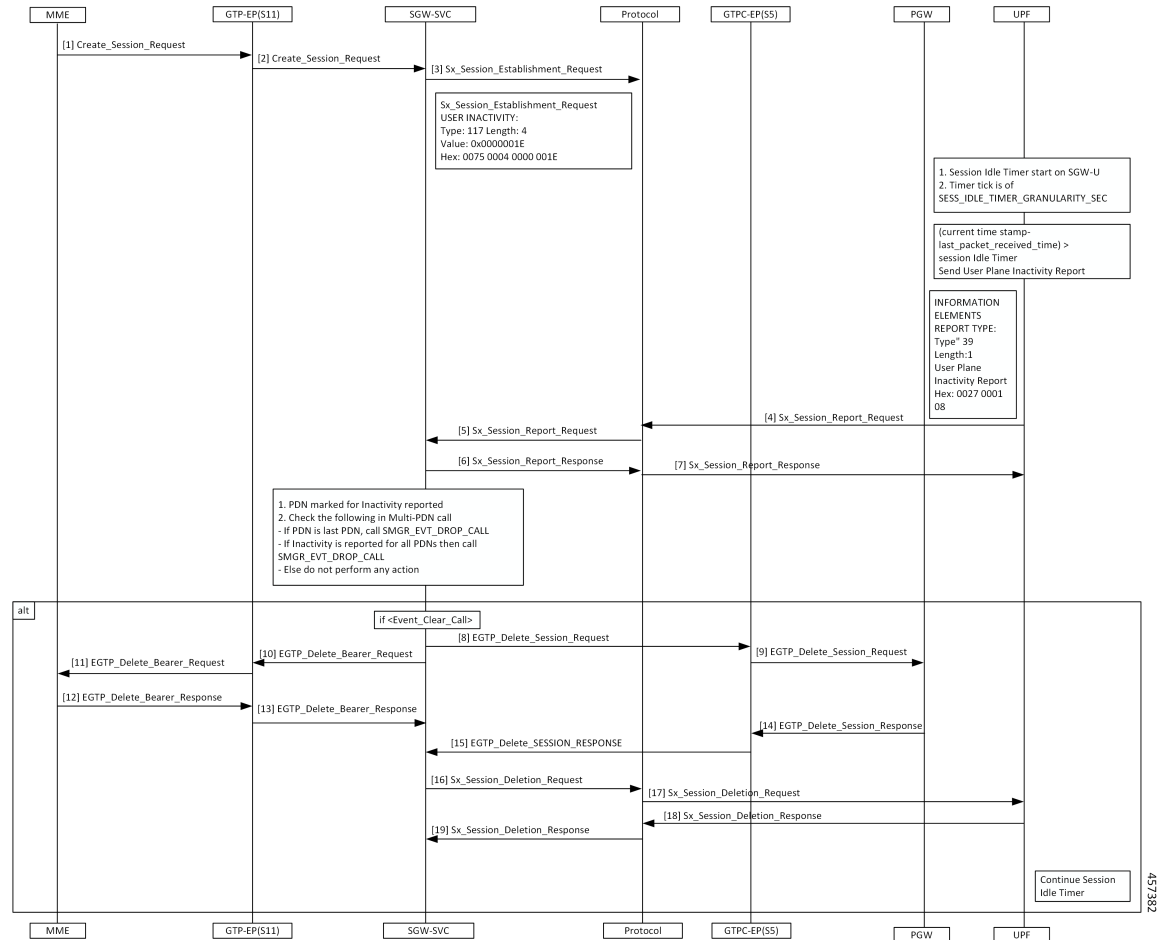

Table 126: Inactivity Report Call Flow Description

Step	Description
1	The MME sends the Create Session Request to the GTP-EP (S11).
2	The GTP-EP (S11) forwards the Create Session Request to the SGW.
3	The SGW-SVC sends the Session Idle Timer in IE = USER INACTIVITY as part of Sx Session Establishment Request to the Protocol.
4	The SGW-U reads the Session Idle Timer from USER INACTIVITY and stores it at the CLP level. The UPF sends the Sx Session Report Request to the Protocol.
5	The Protocol sends the Sx Session Report Request to the SGW-SVC.
6	The SGW-SVC sends the Sx Session Report Response to the Protocol.
7	The Protocol sends the Sx Session Report Response to the UPF.

Step	Description
8	The SGW-SVC sends the Delete Session Request to the GTPC-EP.
9	The GTPC-EP sends the Delete Session Request to the PGW.
10	The SGW-SVC sends the Delete Bearer Request to the GTP-EP.
11	The GTP-EP sends the Delete Bearer Request to the MME.
12	The MME sends the Delete Bearer Response to the GTP-EP.
13	The GTP-EP sends the Delete Bearer Response to the SGW-SVC.
14	The PGW sends the Delete Session Response to the GTPC-EP.
15	The GTPC-EP sends the EGTP Delete Session Response to the SGW-SVC.
16	The SGW-SVC sends the Sx Session Deletion Request to the Protocol.
17	The Protocol sends the Sx Session Deletion Request to the UPF.
18	The UPF sends the Sx Session Deletion Response to the Protocol.
19	The Protocol sends the Sx Session Deletion Response to the SGW-SVC.

Idle Timer Handling on UPF Call Flow

This section describes the call flow when the idle timer is received in the Create Session Request on the UPF.

Figure 66: Idle Timer Handling on UPF Call Flow

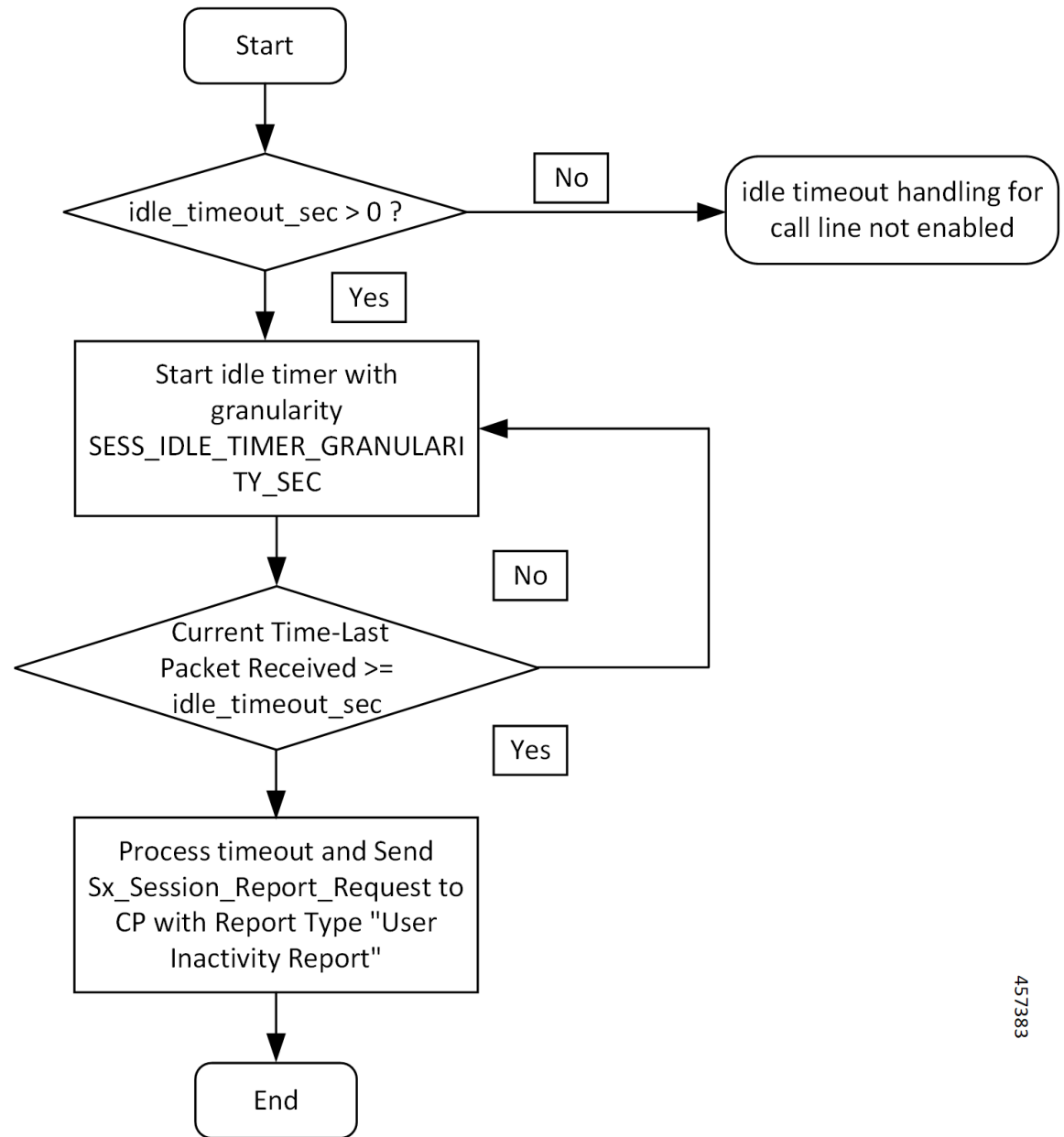

457383

Table 127: Idle Timer Handling on UPF Call Flow Description

Step	Description
1	If the value of idle_timeout_sec is greater than zero, the timer is started on UPF with granularity of one second. Else, idle timeout is disabled.

Step	Description
2	The timer timeouts every second. Checks if the difference in current time and last packet received is greater than <code>idle_timeout_sec</code> or not. If the time difference is greater than <code>idle_timeout_sec</code> , then UP sends the Sx Session Report Request with Report Type = UPIR (Inactivity Report) to CP (cnSGW-C).

Reactivity Report Call Flow

This section describes the Reactivity Report call flow.

Figure 67: Reactivity Report Call Flow

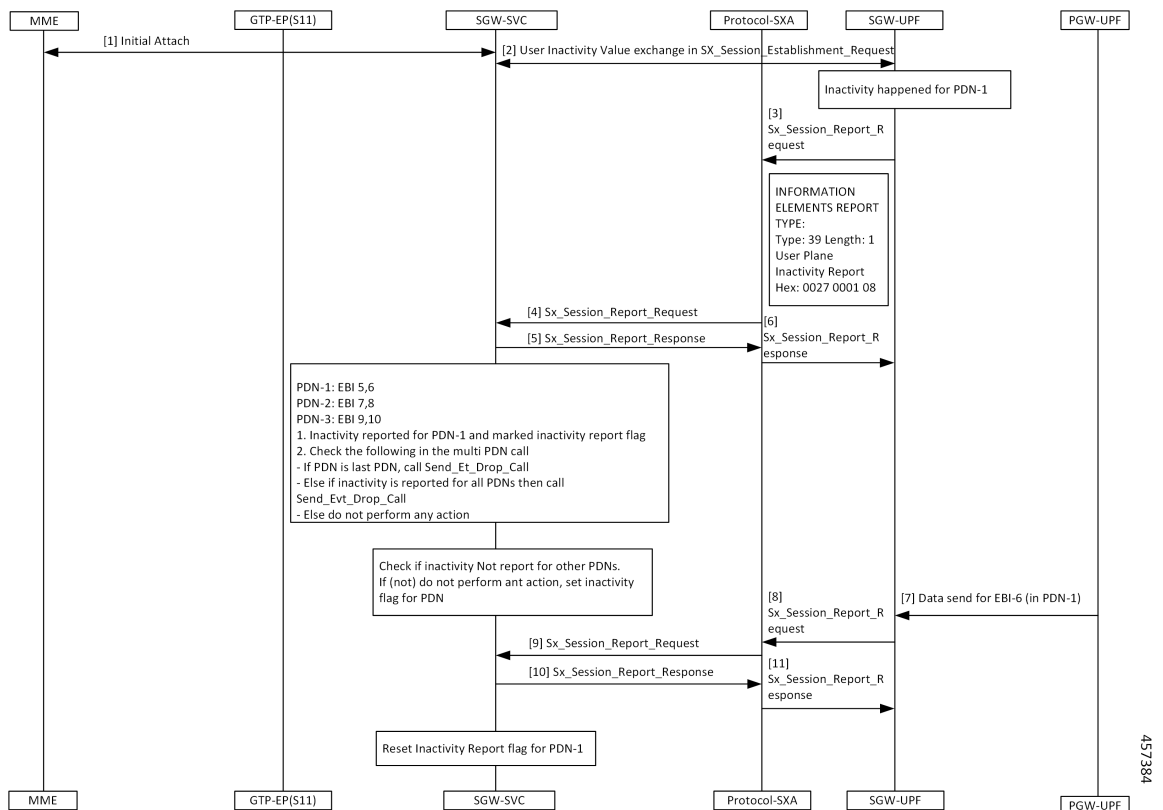

Table 128: Reactivity Report Call Flow Description

Step	Description
1	The MME and the SGW-SVC process the initial attach request.
2	The Protocol-SXA and the SGW-UPF perform the user inactivity exchange in the Sx Session Establishment Request.
3	If the inactivity is observed in PDN-1, the SGW-UPF sends the Sx_Session_Report_Request with type User Plane Inactivity Report to the Protocol-SXA.

Step	Description
4	The Protocol-SXA sends the Sx_Session_Report_Request to the SGW-SVC.
5	The SGW-SVC sends the Sx_Session_Report_Response to the Protocol-SXA.
6	The Protocol-SXA forwards the Sx_Session_Report_Response to the SGW-UPF.
7	The PGW-UPF sends the data for the EBI-6 (in PDN-1) to the SGW-UPF.
8	The SGW-UPF sends the Sx_Session_Report_Request with IE Report-Type = User Plane Re-Activity Report to the Protocol-SXA.
9	The Protocol-SXA sends the Sx_Session_Report_Request with IE Report-Type = User Plane Re-Activity Report to the SGW-SVC.
10	The SGW-SVC responds with the Sx_Session_Report_Response to the Protocol-SXA.
11	The Protocol-SXA sends the Sx_Session_Report_Response to the SGW-UPF. After receiving the Sx_Session_Report_Response on the control plane, SGW-SVC clears the Inactivity Report Flag for the PDN.

Clear Call Handling Call Flow

This section describes the Clear Call Handling call flow.

Figure 68: Clear Call Handling Call Flow

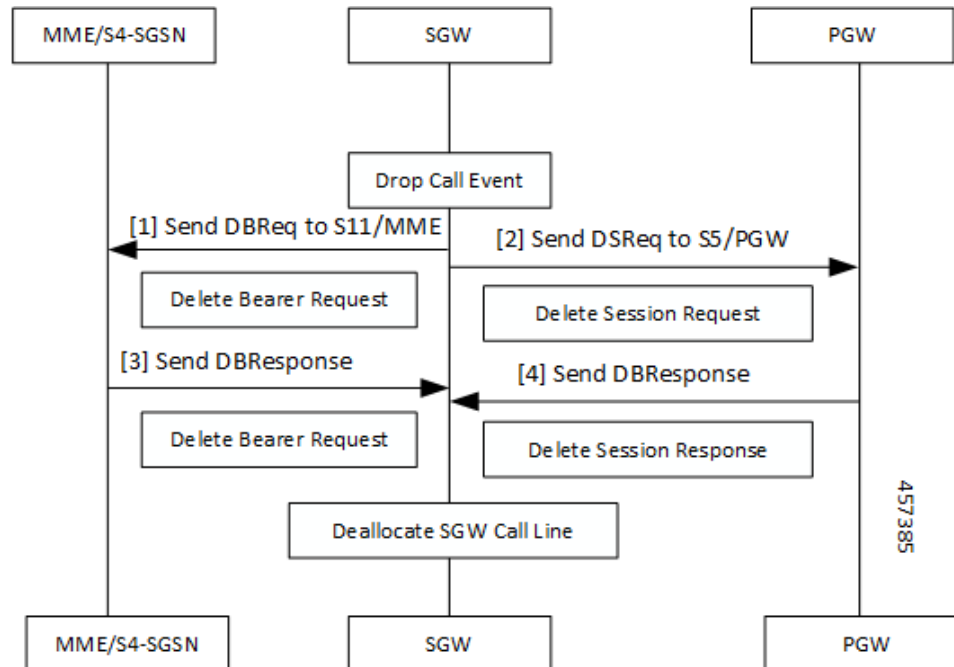

Table 129: Clear Call Handling Call Flow Description

Step	Description
1	On the SGW, the control plane receives the User Plane Inactivity Report in Sx Session Report Request. The control plane evaluates if PDN in the request is the latest PDN, or the inactivity report has already reported other PDNs. The control plane initiates the ClearCall procedure.
2	After receiving the ClearCall message, the cnSGW-C triggers a Session Deletion Request to its peers.
3	The SGW sends the Delete Bearer Request to the S11/MME.
4	The SGW sends the Delete Session Request to the S5/PGW.
5	On receiving the Delete Session Request, SGW clears resources on the UPF by sending a Sx Session Delete Request.

Feature Configuration

To configure this feature, use the following configuration:

```
config
  profile sgw sgw_group_name
    session-idle-timer session_idle_timer
  end
```

NOTES:

- **session-idle-timer** *session_idle_timer*—Specify the maximum duration in seconds for which a session remains idle. After the configured time is reached, the system automatically terminates the session. The accepted range contains integers in the range of 1–4294967295. The default value is zero indicating that the idle session is disabled.

Configuration Example

The following is an example configuration.

```
config
  profile sgw sgw1
    session-idle-timer 1000
  end
```

Configuration Verification

To verify the configuration:

```
show running-config profile sgw sgw1 session-idle-timer
profile sgw sgw1
session-idle-timer 1000
```



CHAPTER 30

Initial Attach Support

- [Feature Summary and Revision History, on page 305](#)
- [Feature Description, on page 306](#)
- [How it Works, on page 306](#)
- [Support for Backoff Timer, Origination TimeStamp, and MaxWait Time, on page 309](#)

Feature Summary and Revision History

Summary Data

Table 130: Summary Data

Applicable Product(s) or Functional Area	cnSGW-C
Applicable Platform(s)	SMI
Feature Default Setting	Enabled - Always-on
Related Documentation	Not Applicable

Revision History

Table 131: Revision History

Revision Details	Release
Added support for the Information Elements (IE): <ul style="list-style-type: none">• Backoff Timer• Origination Time Stamp• Maximum Wait Time	2021.02.3
First introduced.	2020.04

Feature Description

cnSGW-C supports handling of Initial Attach Create Session Request. As a part of this feature, cnSGW-C supports receiving Create Session Request from the MME through the EGTP endpoint. Further, cnSGW-C decodes the UDP message and converts the message into gRPC message for internal message processing.

How it Works

This section describes how this feature works.

Call Flows

This section describes the key call flow for this feature.

Initial Attach Call Flow

This section describes the Initial Attach call flow.

Figure 69: Initial Attach Call Flow

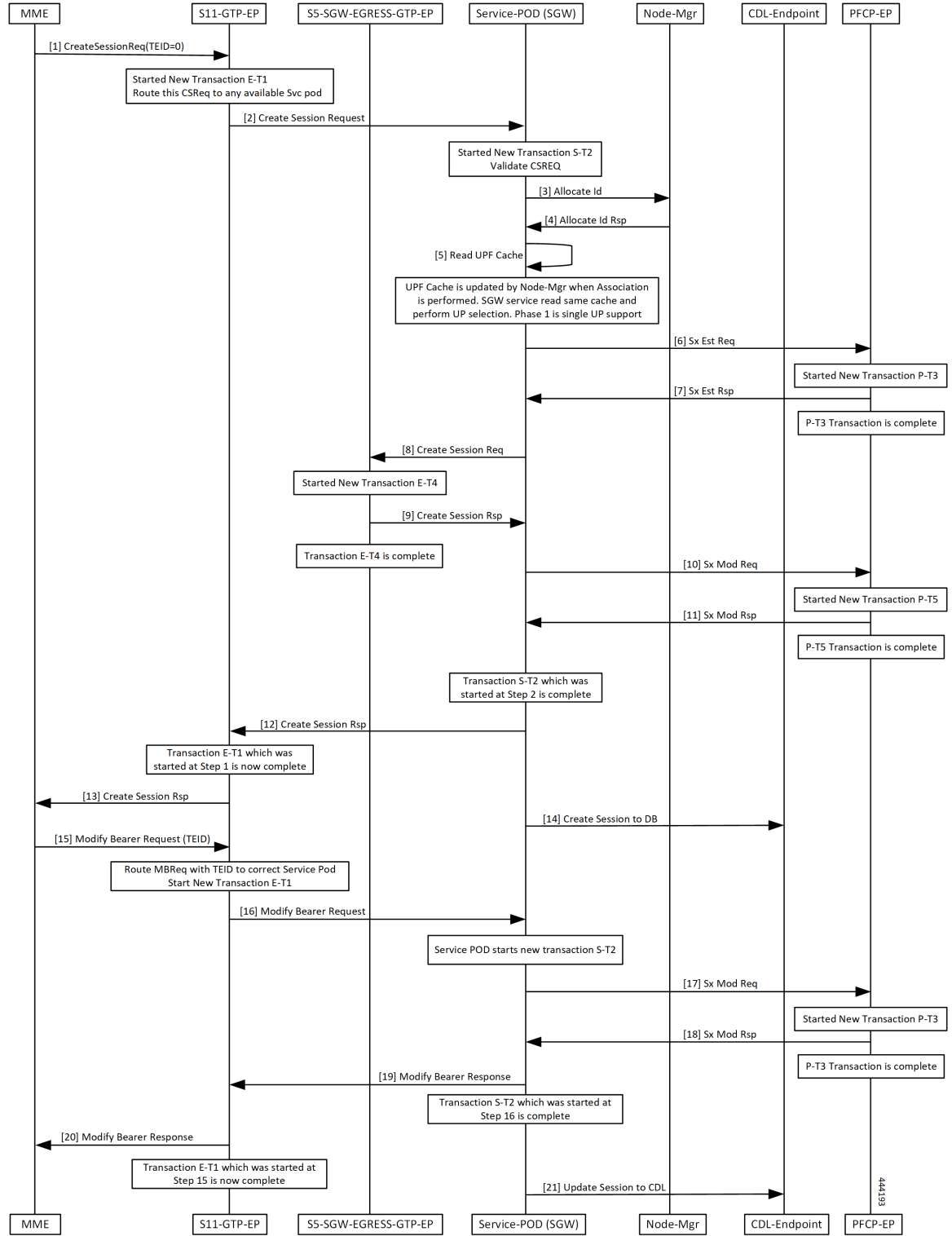

Table 132: Initial Attach Call flow Description

Step	Description
1	The MME sends the Create Session Request with TEID value zero to the S11-GTP-EP.
2	Transaction E-T1 is started. The S11-GTP-EP forwards the Create Session Request to the Service-POD (SGW).
3	Transaction S-T2 is started to validate the Create Session Request. The Service-POD (SGW) sends the Allocate Id Request to the Node-Mgr.
4	The Node-Mgr sends the Allocate Id Response to the Service-POD (SGW).
5	The Service-POD (SGW) reads the cache to perform the UPF selection.
6	The Service-POD (SGW) sends the Sx Establishment Request to the PFCP-EP.
7	Transaction P-T3 is started. The PFCP-EP sends the Sx Establishment Response to the Service-POD (SGW).
8	Transaction P-T3 is completed. The Service-POD (SGW) sends the Create Session Request to the S5-SGW-EGRESS-GTP-EP.
9	Transaction E-T4 is started. The S5-SGW-EGRESS-GTP-EP sends the Create Session Response to the Service-POD (SGW).
10	Transaction E-T4 is completed. The Service-POD (SGW) sends the Sx Modification Request to the PFCP-EP.
11	Transaction P-T5 is started. The PFCP-EP sends the Sx Modification Response to the Service-POD (SGW).
12	Transactions P-T5 and S-T2 are completed. The Service-POD (SGW) sends the Create Session Response to the S11-GPT-EP.
13	Transaction E-T1 is completed. The S11-GPT-EP forwards the Create Session Response to the MME.
14	The Service-POD (SGW) sends the Create Session to DB message to the CDL-Endpoint.
15	The MME sends the Modify Bearer Request with TEID to the S11-GTP-EP.
16	Transaction E-T1 is started. The S11-GTP-EP sends the Modify Bearer Request to the Service-POD (SGW).
17	Transaction S-T2 is started. The Service-POD (SGW) sends the Sx Modification Request to the PFCP-EP.

Step	Description
18	Transaction P-T3 is started. The PFCP-EP sends the Sx Modification Response to the Service-POD (SGW).
19	Transaction P-T3 is completed. The Service-POD (SGW) sends the Modify Bearer Response to the S11-GTP-EP.
20	Transaction S-T2 is completed. The S11-GTP-EP forwards the Modify Bearer Response to the MME.
21	Transaction E-T1 is completed. The Service-POD (SGW) sends the Update Session to CDL message to the CDL-Endpoint. The session is updated in CDL.

Standards Compliance

This feature complies with the following standards specifications:

- *3GPP TS 29.274 "3GPP Evolved Packet System (EPS); Evolved General Packet Radio Service (GPRS) Tunnelling Protocol for Control plane (GTPv2-C); Stage 3"*

Support for Backoff Timer, Origination TimeStamp, and MaxWait Time

This section describes the support for the Information Elements (IE)—Backoff Timer, Origination Time Stamp, and MaxWait Time.

For more information on technical specifications for the IEs, see *3GPP TS 29.274*.

Backoff Timer

Backoff time indicates the time during which the MME or S4-SGSN refrains from sending the subsequent PDN connection establishment requests to the PGW for the congested APN, for services other than service users or emergency services.

The backoff timer feature enables rejecting new attaches for the failure condition when IP addresses are exhausted.

When IP addresses are exhausted, the PGW-C/SMF detects the status as failure and adds backoff timer in Create Session Response. SGW forwards the backoff timer value to the MME in the Create Session Response.

Origination Time Stamp

Origination Time Stamp is the time at which the originating entity initiated the request. The time stamp is in UTC format.

MME/SGSN and TWAN/ePDG contain the Origination Time Stamp IE on S11/S4 and S2a/S2b interfaces, respectively.

SGW receives the Origination Time Stamp IE from MME/SGSN and includes the IE on the S5/S8 interface.

MaxWaitTime

MaxWaitTime indicates the duration (number of milliseconds since the Origination Time Stamp has lapsed) during which the originator of the request waits for the response.

MME/SGSN and TWAN/ePDG contain the MaxWaitTime IE on S11/S4 and S2a/S2b interfaces, respectively.

SGW contains the MaxWaitTime IE on the S5/S8 interface.



CHAPTER 31

Inter System RAT Handover

- [Feature Summary and Revision History, on page 311](#)
- [Feature Description, on page 311](#)
- [How it Works, on page 312](#)

Feature Summary and Revision History

Summary Data

Table 133: Summary Data

Applicable Product(s) or Functional Area	cnSGW-C
Applicable Platform(s)	SMI
Feature Default Setting	Enabled - Always-on
Related Documentation	Not Applicable

Revision History

Table 134: Revision History

Revision Details	Release
First introduced.	2021.01.0

Feature Description

cnSGW-C is the Control Plane Network Functions (NF) of the Converged Core Network (4G-5GC).

cnSGW-C NF is built on top of SMI architecture. cnSGW-C acts as the UE anchor and supports mobility procedures along with session setup and termination procedures as specified in 3GPP TS 23.401, 23.214.

cnSGW-C User Plane (UP) is used to create UP sessions and bearers to carry data traffic.

This feature supports the following procedures in cnSGW-C:

- Wi-Fi to LTE
- GnGp to LTE Hand Over

How it Works

This section describes how this feature works.

Call Flows

This section describes the key call flows of this feature.

Wi-Fi to LTE Success Call Flow

This section describes the Wi-Fi to LTE success call flow.

Figure 70: Wi-Fi to LTE Success Call Flow

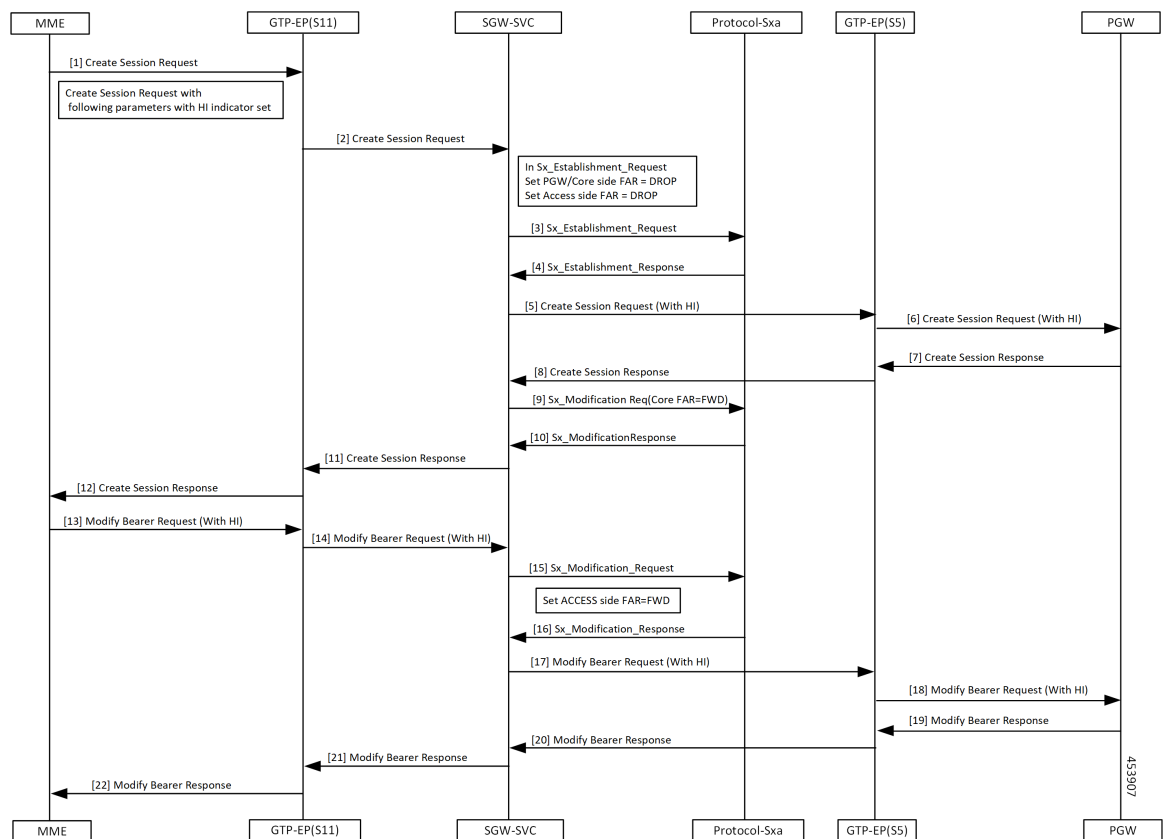

Table 135: Wi-Fi to LTE Success Call Flow Description

Step	Description
1	The MME sends the Create Session Request to the GTP-EP(S11) with: <ul style="list-style-type: none"> • RAT as EUTRAN • The handoff indicator set to TRUE.
2	The GTP-EP(S11) forwards the Create Session Request to the SGW-SVC.
3	The SGW-SVC sends the Sx Establishment Request to the Protocol-Sxa.
4	The Protocol-Sxa sends the Sx Establishment Response to the SGW-SVC.
5	The SGW-SVC sends the Create Session Request (with HI) to the GTP-EP(S5).
6	The GTP-EP(S5) forwards the Create Session Request (with HI) to the PGW.
7	The PGW sends the Create Session Response to the GTP-EP(S5). The PGW provides IPv6 Prefix.
8	The GTP-EP(S5) forwards the Create Session Response to the SGW-SVC.
9	The SGW-SVC sends the Sx Modification Request to the Protocol-Sxa.
10	The Protocol-Sxa sends the Sx Modification Response to the SGW-SVC.
11	The SGW-SVC sends the Create Session Response to the GTP-EP(S11).
12	The GTP-EP(S11) sends the Create Session Response to the MME.
13	The MME sends the Modify Bearer Request (with HI) to the GTP-EP(S11).
14	The GTP-EP forwards the Modify Bearer Request (with HI) to the SGW-SVC.
15	The SGW-SVC sends the Sx Modification Request to the Protocol-Sxa.
16	The Protocol-Sxa sends the Sx Modification Response to the SGW-SVC.
17	The SGW-SVC forwards the Modify Bearer Request (with HI) to the GTP-EP(S5).
18	The GTP-EP(S5) forwards the Modify Bearer Request (with HI) to the PGW.
19	The PGW sends the Modify Bearer Response to the GTP-EP(S5).
20	The GTP-EP(S5) forwards the Modify Bearer Response to the SGW-SVC.
21	The SGW-SVC forwards the Modify Bearer Response to the GTP-EP(S11).

Step	Description
22	<p>The GTP-EP(S11) forwards the Modify Bearer Response to the MME.</p> <p>The S1 SGW FTEID is the same as the S1-U SGW FTEID sent in Create Session Response from the SGW-SVC to the MME.</p> <p>The SGW-SVC can now send the downlink packets to the eNodeB, and the switching of the data path from Wi-Fi to LTE occurs after the Modify Bearer Response.</p>

GnGp to LTE Handover with OI Indicator Set Call Flow

This section describes the GnGp to LTE Handover with Operation Indication (OI) Indicator Set call flow.

Figure 71: GnGp to LTE Handover with OI Indicator Set Call Flow

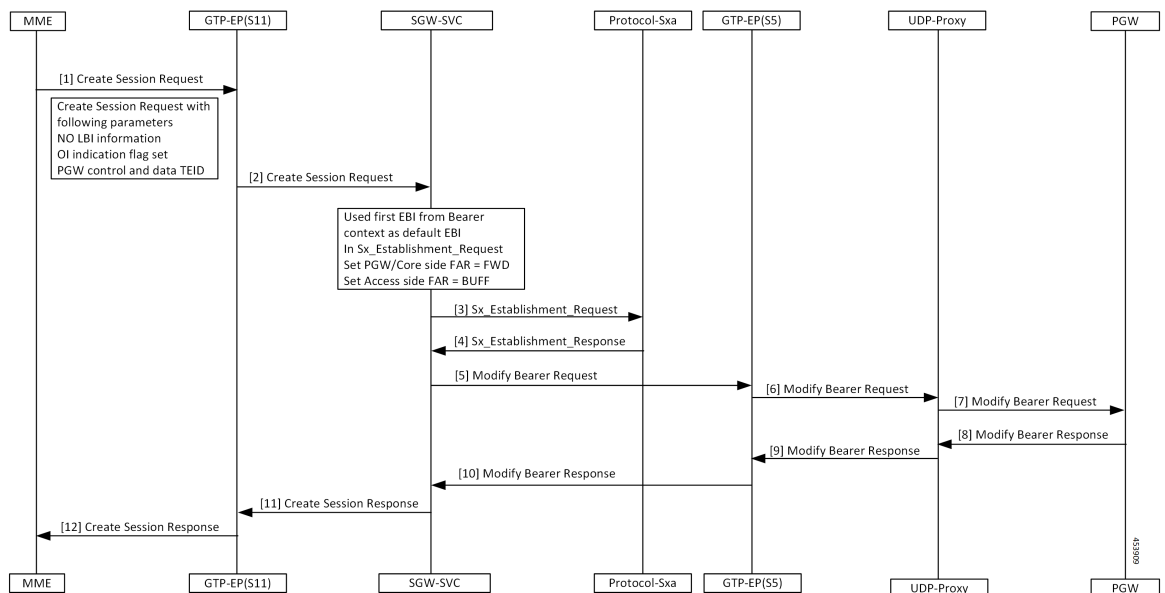

Table 136: GnGp to LTE Handover with OI Indicator Set Call Flow Description

Step	Description
1	<p>The MME sends the Create Session Request to the GTP-EP(S11) with the following information:</p> <ul style="list-style-type: none"> • EBI List (No LBI Information) • PGW control and data TEID • OI Indicator flag set
2	The GTP-EP(S11) forwards the Create Session Request to the SGW-SVC.
3	The SGW-SVC sends the Sx Session Establishment Request to the Protocol-Sxa.
4	The Protocol-Sxa sends the Sx Establishment Response to the SGW-SVC.
5	The SGW-SVC sends the Modify Bearer Request to GTP-EP(S5).

Step	Description
6	The GTP-EP(S5) forwards the Modify Bearer Request to the UDP-proxy.
7	The UDP-proxy forwards the Modify Bearer Request to the PGW.
8	The PGW sends the Modify Bearer Response with the default EBI information to the UDP-Proxy.
9	The UDP-proxy forwards the Modify Bearer Response to the GTP-EP(S5).
10	The GTP-EP(S5) forwards the Modify Bearer Response to the SGW-SVC.
11	The SGW-SVC sends the Create Session Response with the default EBI information to the GTP-EP(S11).
12	The GTP-EP(S11) forwards the Create Session Response to the MME.

GnGp to LTE Handover with OI Indicator Unset Call Flow

This section describes the GnGp to LTE Handover with Operation Indication (OI) Indicator Unset call flow.

Figure 72: GnGp to LTE Handover with OI Indicator Unset Call Flow

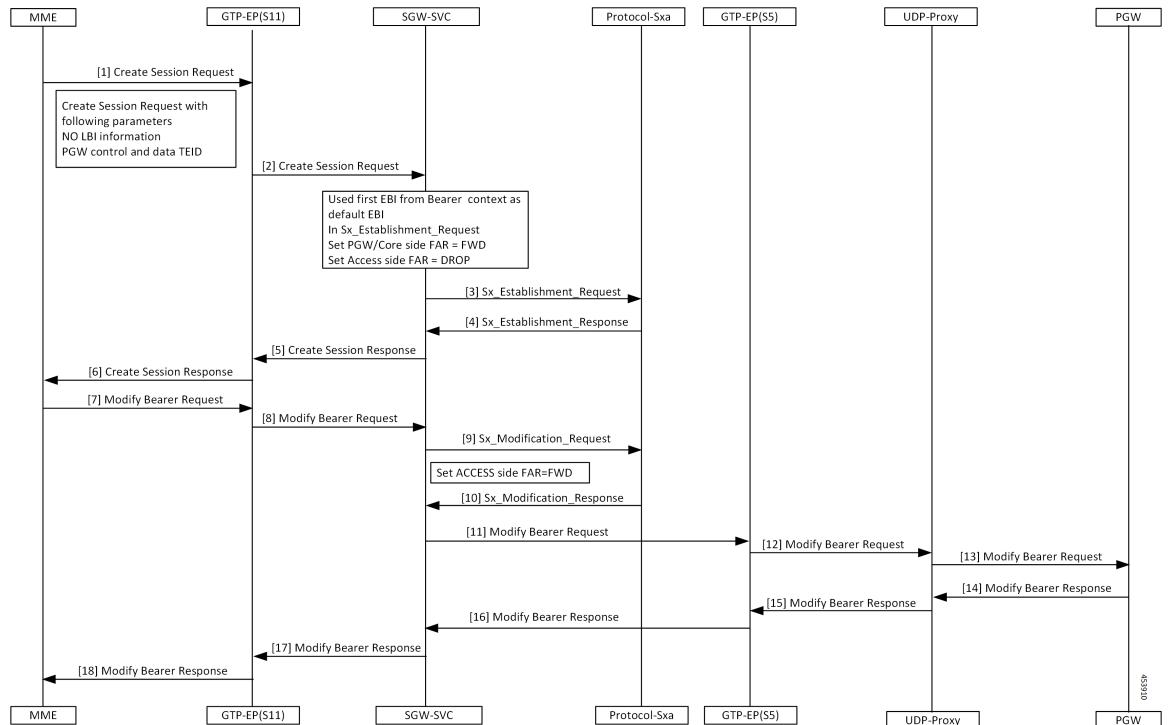

Table 137: GnGp to LTE HO with OI Indicator Unset Call Flow Description

Step	Description
1	The MME sends the Create Session Request to the GTP-EP(S11) with the following information: <ul style="list-style-type: none"> • EBI List (No LBI Information) • PGW control and data TEID • OI Indicator flag unset
2	The GTP-EP(S11) forwards the Create Session Request to the SGW-SVC.
3	The SGW-SVC sends the Sx Session Establishment Request to the Protocol-Sxa.
4	The Protocol-Sxa sends the Sx Establishment Response to the SGW-SVC.
5	The SGW-SVC sends the Create Session Response to the GTP-EP(S11).
6	The GTP-EP(S11) forwards the Create Session Response to the MME.
7	The MME sends the Modify Bearer Request to the GTP-EP(S11).
8	The GTP-EP(S11) forwards the Modify Bearer Request to the SGW-SVC.
9	The SGW-SVC sends the Sx Modification Request to the Protocol-Sxa.
10	The Protocol-Sxa sends the Sx Modification Response to the SGW-SVC.
11	The SGW-SVC sends the Modify Bearer Request to the GTP-EP(S5).
12	The GTP-EP(S5) forwards the Modify Bearer Request to the UDP-Proxy.
13	The UDP-proxy forwards the Modify Bearer Request to the PGW.
14	The PGW sends the Modify Bearer Response with the default EBI information to the UDP-Proxy.
15	The UDP-Proxy forwards the Modify Bearer Response to the GTP-EP(S5).
16	The GTP-EP(S5) forwards the Modify Bearer Response to the SGW-SVC.
17	The SGW-SVC forwards the Modify Bearer Response to the GTP-EP(S11).
18	The GTP-EP(S11) forwards the Modify Bearer Response to the MME. The S1 SGW FTEID is the same as the S1-U SGW FTEID sent in Create Session Response from the SGW-SVC to the MME. The SGW-SVC can now send the downlink packets to the eNodeB, and the switching of the data path from Wi-Fi to LTE occurs after the Modify Bearer Response.



Note cnSGW-C clears the call when the received default EBI in the Modify Bearer Response differs with the first EBI in the following scenarios:

- GnGp to LTE HO with OI Indicator Set
 - GnGp to LTE HO with OI Indicator Unset
-

Standards Compliance

This feature complies with the following standards specifications:

- *3GPP TS 23.401 "General Packet Radio Service (GPRS) enhancements for Evolved Universal Terrestrial Radio Access Network (E-UTRAN) access"*
- *3GPP TS 23.214 "Architecture enhancements for control and user plane separation of EPC nodes"*



CHAPTER 32

Intra-MME and Inter-MME Handover Procedures

- [Feature Summary and Revision History, on page 319](#)
- [Feature Description, on page 319](#)
- [How it Works, on page 320](#)
- [Intra-MME and Inter-MME Handover Procedures OAM Support, on page 327](#)

Feature Summary and Revision History

Summary Data

Table 138: Summary Data

Applicable Product(s) or Functional Area	cnSGW-C
Applicable Platform(s)	SMI
Feature Default Setting	Enabled - Always-on
Related Documentation	Not Applicable

Revision History

Table 139: Revision History

Revision Details	Release
First introduced.	2021.01.0

Feature Description

cnSGW-C supports Intra-MME Intra-SGW, and Inter-MME Intra-SGW handover.

How it Works

This section describes how this feature works.

Call Flows

This section describes the key call flows for this feature.

Inter-MME Handover Active-Active Transition Call Flow

This section describes the Inter-MME Handover Active-Active Transition call flow.

Figure 73: Inter-MME Handover Active-Active Transition Call Flow

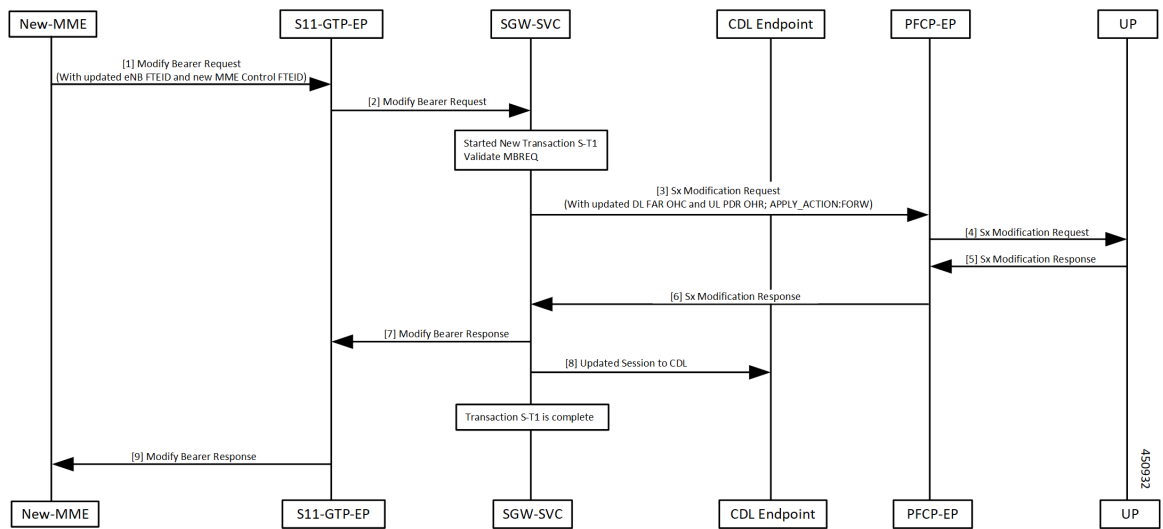

Table 140: Inter-MME Handover Active-Active Transition Call Flow Description

Step	Description
1	New-MME sends the Modify Bearer Request to the S11-GTP-EP pod, with updated eNodeB F-TEID and new MME control F-TEID.
2	S11-GTP-EP pod forwards the Modify Bearer Request to the SGW-SVC. SGW-SVC performs the following: <ul style="list-style-type: none"> • Creates a new transaction S-T1 • Validates the Modify Bearer Request
3	SGW-SVC sends the the Sx Modification Request with downlink FAR OHC, uplink PDR OHR, and APPLY ACTION as FORWARD, to the PFCP-EP pod.
4	PFCP-EP pod sends the Sx Modification Request to the UP.
5	UP sends the Sx Modification Response to the PFCP-EP pod.

Step	Description
6	PFCP-EP pod sends the Sx Modification Response to the SGW-SVC.
7	SGW-Service pod sends the Modify Bearer response to the S11-GTP-EP pod.
8	SGW-SVC sends the Updated Session to the CDL Endpoint. Transaction S-T1 is complete.
9	S11-GTP-EP pod sends the Modify Bearer Response to the New-MME.

Intra-MME Handover Active-Active Transition Call Flow

This section describes the Intra-MME Handover Active-Active Transition call flow.

Figure 74: Intra-MME Handover Active-Active Transition Call Flow

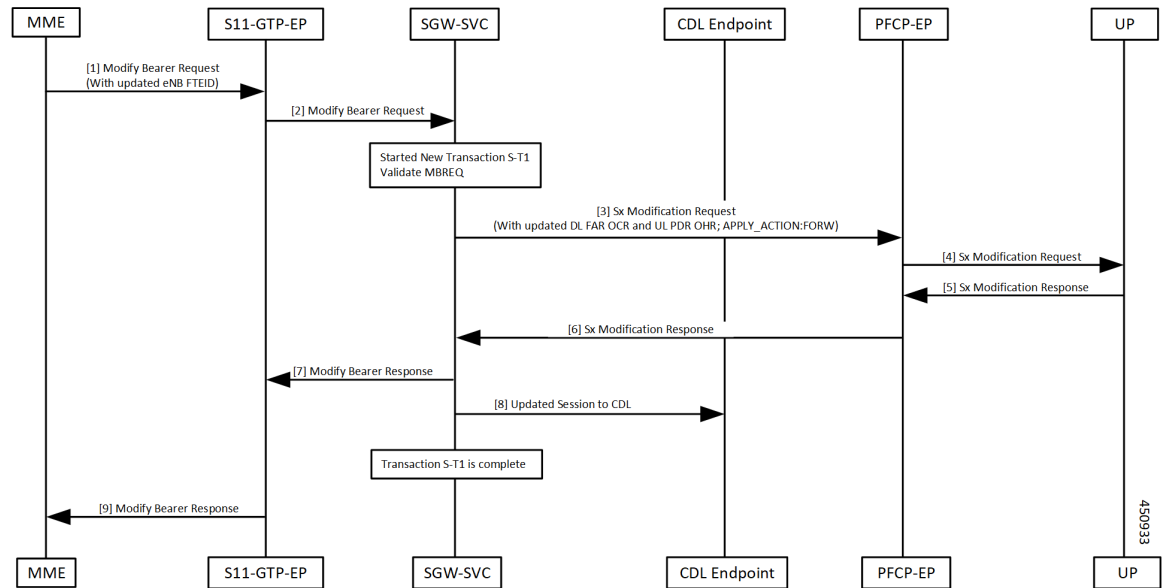

Table 141: Intra-MME Handover Active-Active Transition Call Flow Description

Step	Description
1	MME sends the Modify Bearer Request to the S11-GTP-EP pod, with the updated eNodeB F-TEID.
2	S11-GTP-EP pod sends the Modify Bearer Request to the SGW-SVC. SGW-SVC performs the following: <ul style="list-style-type: none"> • Creates a new transaction S-T1 • Validates Modify Bearer Request
3	SGW-SVC sends the the Sx Modification Request with downlink FAR OCR, uplink PDR OHR, and APPLY ACTION as FORWARD, to the PFCP-EP pod.

Step	Description
4	PFCP-EP pod forwards the Sx Modification Request to the UP.
5	UP sends the Sx Modification Response to the PFCP-EP pod.
6	PFCP-EP pod sends the Sx Modification Response to the SGW-SVC.
7	SGW-SVC sends the Modify Bearer Response to the S11-GTP-EP pod.
8	SGW-SVC sends the Updated Session to the CDL Endpoint. Transaction S-T1 is complete.
9	S11-GTP-EP pod sends the Modify Bearer Response to the MME.

Inter/Intra-MME Handover Idle-Idle Transition Call Flow

This section describes the Inter/Intra-MME Handover Idle-Idle Transition call flow.

Figure 75: Inter/Intra-MME Handover Idle-Idle Transition Call Flow

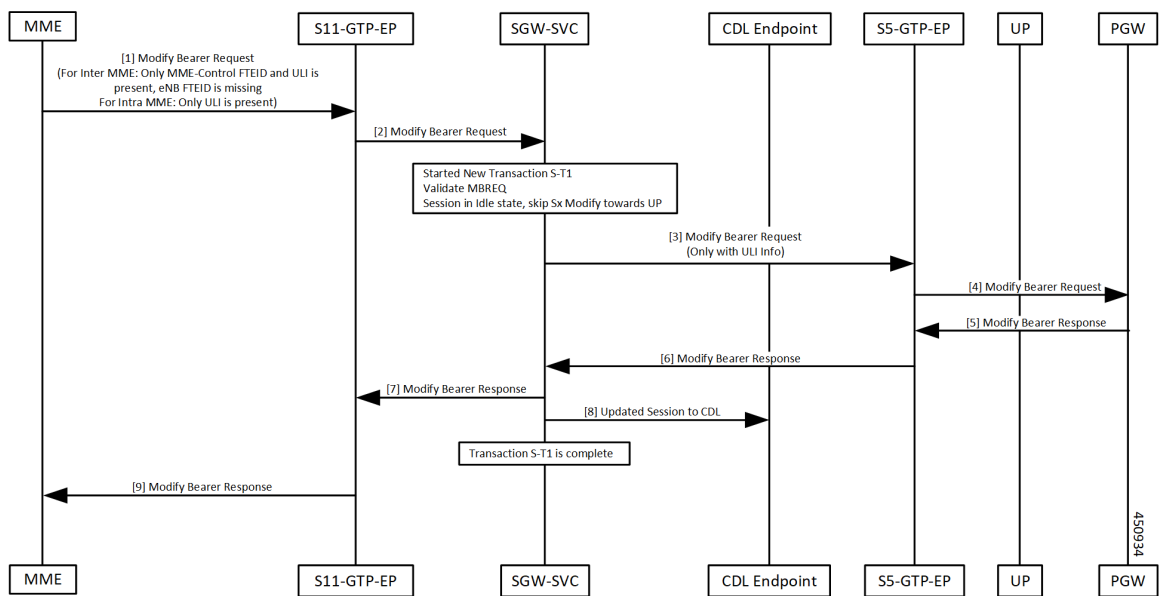

Table 142: Inter/Intra-MME Handover Idle-Idle Transition Call Flow Description

Step	Description
1, 2	<p>For inter-MME, received Modify Bearer request at SGW-Service POD via S11-GTPC-EP POD with MME control F-TEID and ULI. There is no eNodeB F-TEID.</p> <p>For intra-MME, received Modify Bearer request at SGW-Service POD with only ULI present:</p> <ul style="list-style-type: none"> • Create a new transaction S-T1. • Validate Modify Bearer request. • Skip Sx modification as session is in idle state.

Step	Description
3, 4	Received Modify Bearer request at S5 GTPC-EP POD from SGW-Service POD with ULI. Modify Bearer request is forwarded to PGW.
5, 6	Received Modify Bearer response at S5 GTPC-EP POD from PGW. Modify Bearer response received at SGW-Service POD.
7	SGW-Service POD forwards Modify Bearer response to S11 GTPC-EP POD ingress.
8, 9	Session updated at CDL. Transaction S-T1 is complete. S11 GTPC-EP POD forwards Modify Bearer response to MME.

Inter/Intra-MME Handover Active-Idle Transition Call Flow

This section describes the Inter/Intra-MME Handover Active-Idle transition call flow.

Figure 76: Inter/Intra-MME Handover Active-Idle Transition Call Flow

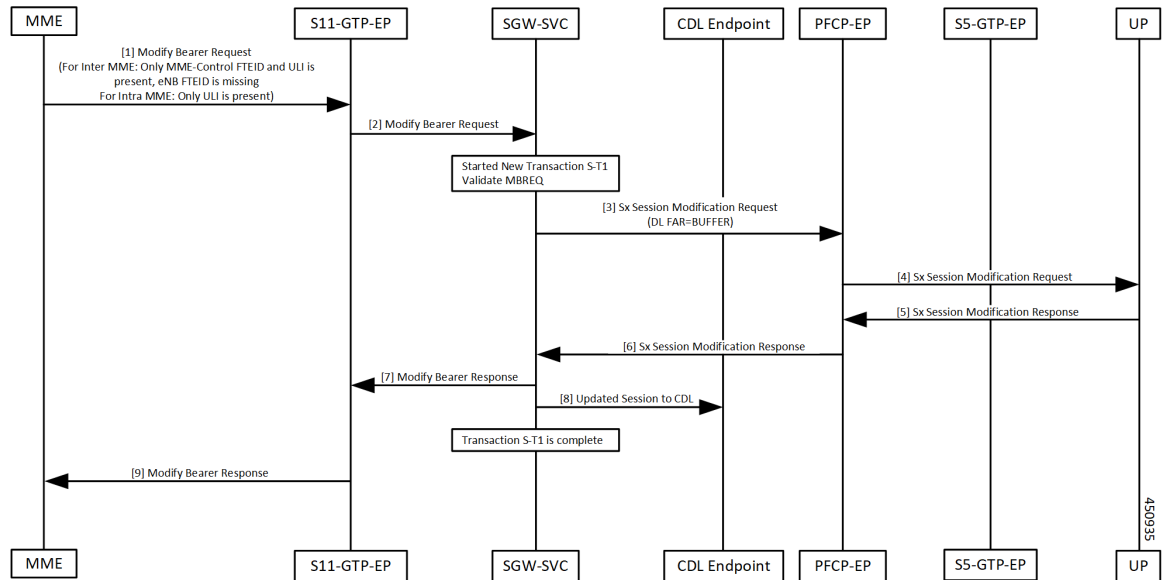

Table 143: Inter/Intra-MME Handover Active-Idle Transition Call Flow Description

Step	Description
1, 2	For inter-MME, received Modify Bearer request at SGW-Service POD via S11-GTPC-EP POD with MME control F-TEID and ULI. There is no eNodeB F-TEID. For intra-MME, received Modify Bearer request at SGW-Service POD with only ULI present: <ul style="list-style-type: none"> • Create a new transaction S-T1. • Validate Modify Bearer request.
3, 4	Received Sx Modification request at PFCP-EP POD from SGW-Service POD with downlink FAR as BUFFER. Sx Modification request is forwarded to UP.

Step	Description
5, 6	Received Sx Modification response at at PFCP-EP POD from UP. Sx Modification response received at SGW-Service POD.
7	SGW-Service POD forwards Modify Bearer response to GTPC-EP POD ingress.
8, 9	Session updated at CDL. Transaction S-T1 is complete. GTPC-EP POD forwards Modify Bearer response to MME.

Inter-MME Handover and Multi-PDN Handling Active-Idle Transition with ULI Change Call Flow

This section describes the Inter-MME Handover and Multi-PDN Handling Active-Idle transition with ULI change call flow.

Figure 77: Inter-MME Handover and Multi-PDN Handling Active-Idle Transition with ULI Change Call Flow

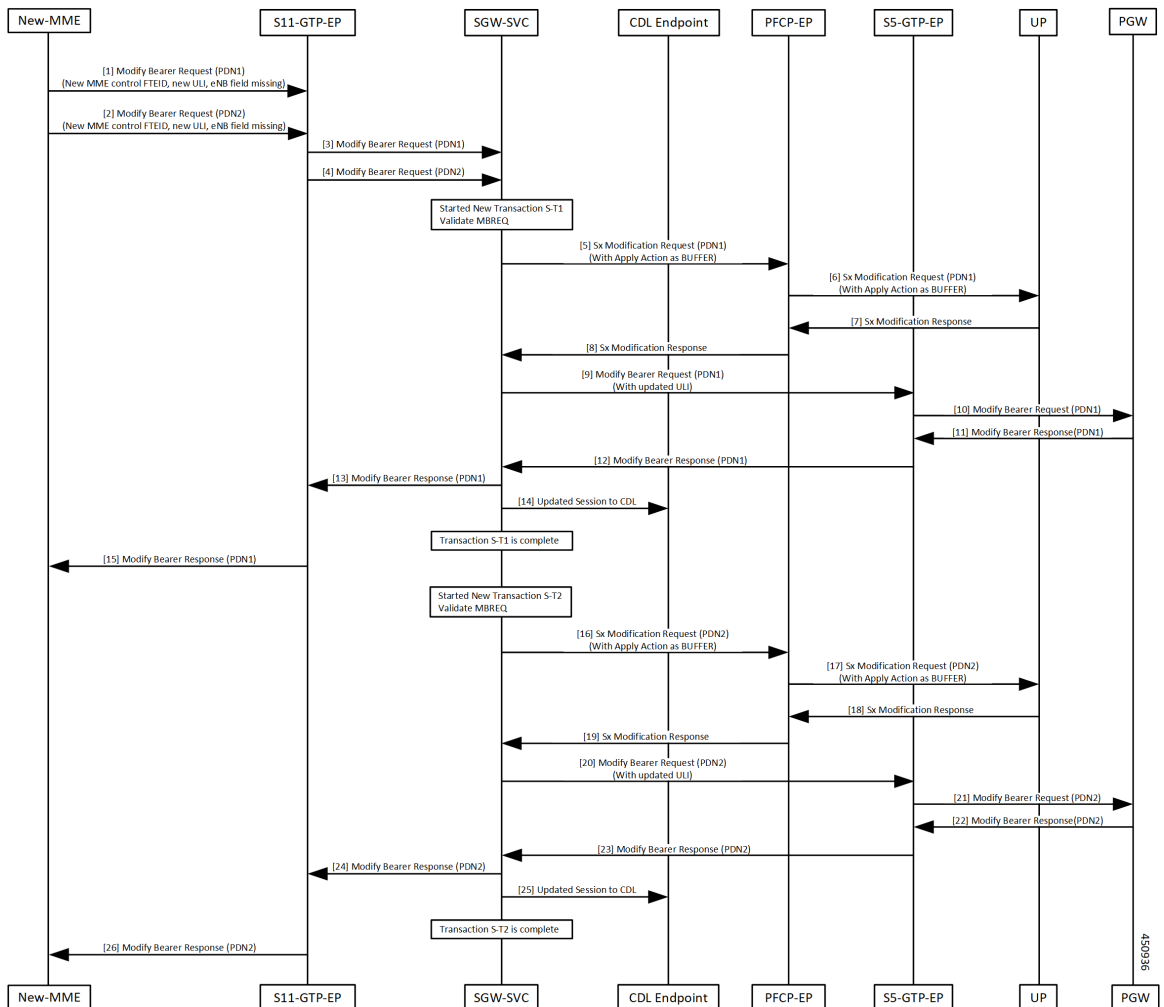

Repeat the steps provided in the [Table 144: Inter-MME Handover and Multi-PDN Handling Active-Idle Transition with ULI Change Call Flow Description](#), on page 325 for PDN1 and PDN2 with respective transaction S-T1 and S-T2.

Table 144: Inter-MME Handover and Multi-PDN Handling Active-Idle Transition with ULI Change Call Flow Description

Step	Description
1, 2, 3, 4	Received Modify Bearer request for both the PDNs (PDN1 and PDN2) at SGW-Service POD with new MME control F-TEID and new ULI. There is no eNodeB F-TEID present in Modify Bearer request. <ul style="list-style-type: none"> • Create a new transaction S-T1. • Validate Modify Bearer request.
5, 6	Received Sx Modification request from SGW-Service POD > PFCP-EP POD with APPLY ACTION as BUFFER. Sx Modification request is forwarded to UP.
7, 8	Received Sx Modification response from UP > PFCP-EP POD. Sx Modification response received at SGW-Service POD.
9, 10	Received Modify Bearer request from SGW-Service POD > S5 GTPC-EP POD with updated ULI. Modify Bearer request is received at PGW.
11, 12	Received Modify Bearer response from PGW > S5 GTPC-EP POD. Modify Bearer response received from S5 GTPC-EP POD > SGW-Service POD.
13	SGW-Service POD forwards Modify Bearer response to GTPC-EP POD ingress.
14, 15	Session updated at CDL. Transaction S-T1 is complete. GTPC-EP POD forwards Modify Bearer response to MME.

Inter-MME Handover with Bearer Context Marked for Removal Call Flow

This section describes the Inter-MME Handover with Bearer Context Marked for Removal call flow.

Inter-MME Handover with Bearer Context Marked for Removal Call Flow

Figure 78: Inter-MME Handover with Bearer Context Marked for Removal Call Flow

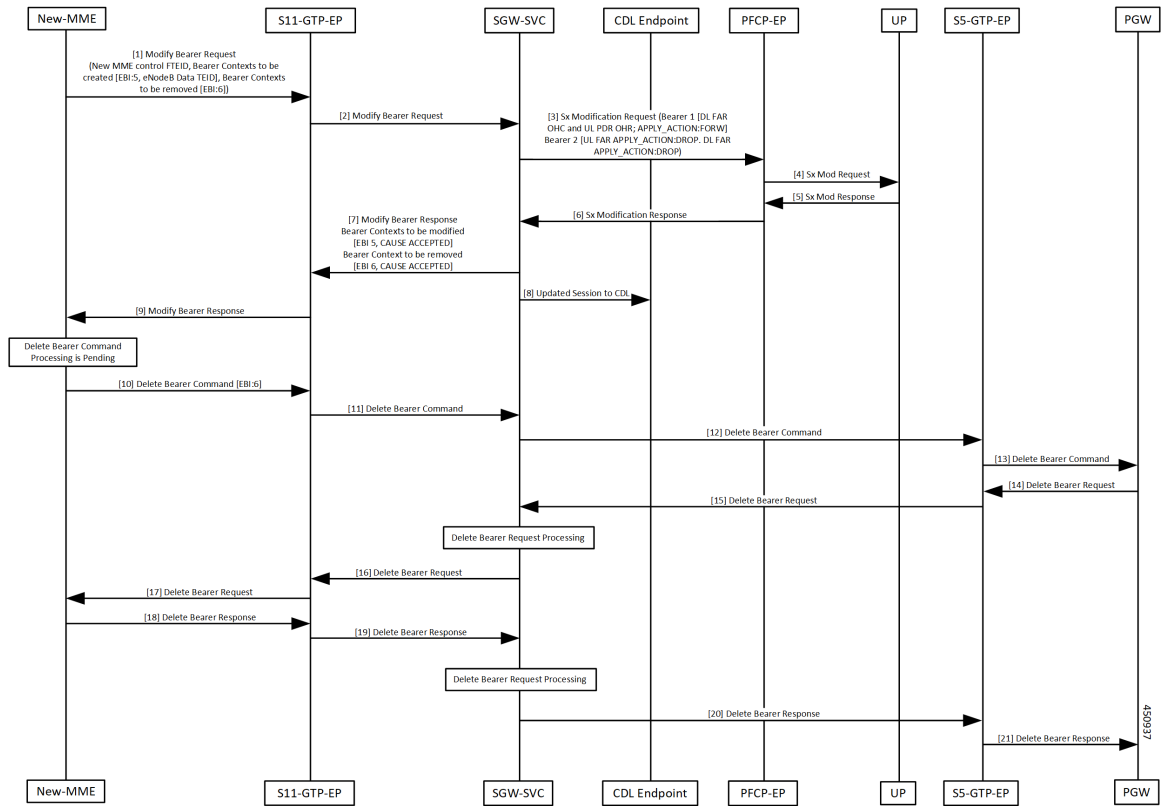

Table 145: Inter-MME Handover with Bearer Context Marked for Removal Call Flow Description

Step	Description
1, 2	Received Modify Bearer request at SGW-Service POD with new MME control F-TEID, bearer-context-1 to be created with EBI:5, eNodeB data TEID, bearer-context-2 to be removed with EBI:6. <ul style="list-style-type: none"> • Create a new transaction S-T1. • Validate Modify Bearer request.
3, 4	Received Sx Modification request from SGW-Service POD to PFCP-EP POD for: <ul style="list-style-type: none"> • bearer-context-1: downlink FAR OHC, uplink PDR OHR and APPLY ACTION as FORWARD • bearer-context-2: uplink FAR APPLY ACTION as DROP and downlink FAR APPLY ACTION as DROP Sx Modification request is forwarded to UP.
5, 6	Received Sx Modification response from UP > PFCP-EP POD. Sx Modification response is received at SGW-Service POD.

Step	Description
7	SGW-Service POD forwards Modify Bearer response to GTPC-EP POD ingress with bearer context to be modified (EBI:5, cause as ACCEPTED) and bearer context to be removed (EBI:6, cause as ACCEPTED).
8, 9	Session updated at CDL. GTPC-EP POD forwards Modify Bearer response to MME.
10, 11	Received delete bearer command at SGW-Service POD with EBI:6.
12, 13	SGW-Service POD forwards delete bearer command to S5 GTPC-EP POD. Delete bearer command received at PGW.
14, 15	Received Delete Bearer request from PGW > S5 GTPC-EP POD. Delete Bearer request received at SGW-Service POD.
16, 17	SGW-Service POD processes Delete Bearer request and forwards it to GTPC-EP POD ingress.
18, 19	Delete Bearer response received at SGW-Service POD and processed.
20, 21	Delete Bearer response received at S5 GTPC-EP POD. Delete Bearer response is received at PGW.

Intra-MME and Inter-MME Handover Procedures OAM Support

This section describes operations, administration, and maintenance information for this feature.

Bulk Statistics

The following statistics are supported for the Intra-MME and Inter-MME Handover Procedures feature.

Intra-MME Handover

```
sgw_service_stats{app_name="smf",cluster="cn",data_center="cn",fail_reason="",instance_id="0",interface="interface_sgw_ingress",reject_cause="",service_name="sgw-service",sgw_procedure_type="intra_mme_handover",status="attempted",sub_fail_reason=""} 2
```

```
sgw_service_stats{app_name="smf",cluster="cn",data_center="cn",fail_reason="",instance_id="0",interface="interface_sgw_ingress",reject_cause="",service_name="sgw-service",sgw_procedure_type="intra_mme_handover",status="success",sub_fail_reason=""} 2
```

Inter-MME Handover

```
sgw_service_stats{app_name="smf",cluster="cn",data_center="cn",fail_reason="",instance_id="0",interface="interface_sgw_ingress",reject_cause="",service_name="sgw-service",sgw_procedure_type="inter_mme_handover",status="attempted",sub_fail_reason=""} 2
```

```
sgw_service_stats{app_name="smf",cluster="cn",data_center="cn",fail_reason="",
instance_id="0",interface="interface_sgw_ingress",reject_cause="",service_name="sgw-service",
sgw_procedure_type="inter_mme_handover",status="success",sub_fail_reason=""} 2
Perform S1 Based SGW handover (with OI=0)
```



CHAPTER 33

MCC/MNC Configuration in the SGW Service

- [Feature Summary and Revision History, on page 329](#)
- [Feature Description, on page 329](#)
- [How it Works, on page 330](#)
- [Configuring the MCC or the MNC in the SGW Service , on page 331](#)
- [OAM Support, on page 332](#)

Feature Summary and Revision History

Summary Data

Table 146: Summary Data

Applicable Product(s) or Functional Area	cnSGW-C
Applicable Platform(s)	SMI
Feature Default Setting	Disabled – Configuration required to enable
Related Documentation	Not Applicable

Revision History

Table 147: Revision History

Revision Details	Release
First introduced.	2021.01.0

Feature Description

This feature supports the list of MCC and MNC configuration as a PLMN-list in the SGW profile.

As per the PLMN-list configuration in the SGW profile, the PLMN-type is identified as one of the following:

- Homer
- Roamer
- Visitor



Note If this feature is not enabled, the PLMN-type subscriber is marked as a Visitor, by default.

How it Works

This section describes how the feature works.

Call Flows

This section describes the key call flows for this feature.

PLMN-type Detection Call Flow

This section describes the PLMN-type Detection call flow.

Figure 79: PLMN-type Detection Call Flow

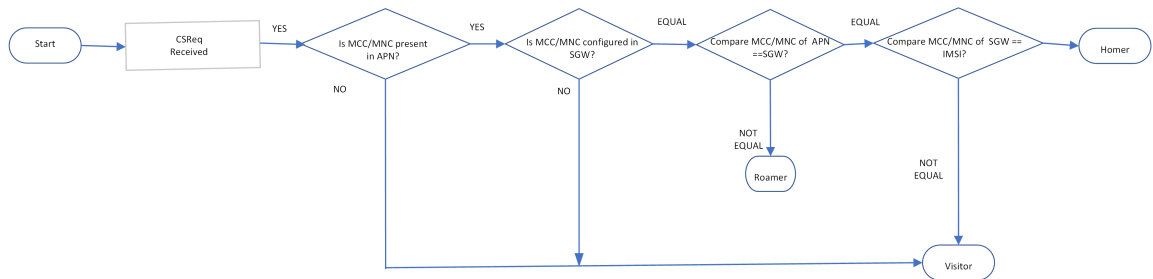

Table 148: PLMN-type Detection Call Flow Description

Step	Description
1	The PLMN-type detection process begins.
2	The Create Session Request is received.
3	The MCC or the MNC presence in the APN is verified: <ul style="list-style-type: none"> • If YES, the next step is executed. • If NO, the PLMN-type subscriber is concluded as Visitor.

Step	Description
4	The MCC or the MNC presence in the SGW is verified: <ul style="list-style-type: none"> • If YES, the next step is executed. • If NO, the PLMN-type subscriber is concluded as Visitor.
5	The values of the MCC or the MNC in the APN and the SGW are compared: <ul style="list-style-type: none"> • If EQUAL, it proceeds to the next step. • If NOT EQUAL, the PLMN-type subscriber is concluded as Roamer.
6	The values of the MCC or the MNC in the SGW and the IMSI are compared: <ul style="list-style-type: none"> • If EQUAL, the PLMN-type subscriber is concluded as Homer. • If NOT EQUAL, the PLMN-type subscriber is concluded as Visitor.

Configuring the MCC or the MNC in the SGW Service

This section describes how to configure the MCC or the MNC in the SGW service.

Use the following commands to configure the MCC or the MNC in the SGW service.

```

config
  profile sgw sgw_name
    plmn-list
      mcc mcc_value
      mnc mnc_value
    end

```

NOTES:

- **plmn-list**—List of MCC and MNC values.
- **mcc** *mcc_value*—Specify the MCC value. Must be a three-digit number. Example: 123
- **mnc** *mnc_value*—Specify the MNC value. Must be a two or three-digit number. Example: 23 or 456

Configuration Example

The following is an example configuration.

```

config
  profile sgw sgw_1
    plmn-list
      mcc 123
      mnc 456
    end

```

OAM Support

This section describes operations, administration, and maintenance support for this feature.

Bulk Statistics Support

The following statistics are supported for the MCC and MNC Configuration in the SGW Service feature.

Active PDN Counters

```
sgw_pdn_counters{app_name="smf",cluster="cn",data_center="cn",
instance_id="0",pdn_plmn_type="homer",pdn_type="ipv6",rat_type="EUTRAN",
service_name="sgw-service"} 12
```

```
sgw_pdn_counters{app_name="smf",cluster="cn",data_center="cn",
instance_id="0",pdn_plmn_type="roamer",pdn_type="ipv4v6",rat_type="EUTRAN",
service_name="sgw-service"} 3
```

```
sgw_pdn_counters{app_name="smf",cluster="cn",data_center="cn",
instance_id="0",pdn_plmn_type="visitor",pdn_type="ipv4",rat_type="EUTRAN",
service_name="sgw-service"} 2
```

Setup or Released PDN Statistics

```
sgw_pdn_stats{app_name="smf",cluster="cn",data_center="cn",
instance_id="0",pdn_plmn_type="homer",pdn_type="ipv6",rat_type="EUTRAN",
service_name="sgw-service",status="release"} 1
```

```
sgw_pdn_stats{app_name="smf",cluster="cn",data_center="cn",
instance_id="0",pdn_plmn_type="homer",pdn_type="ipv6",rat_type="EUTRAN",
service_name="sgw-service",status="setup"} 13
```

```
sgw_pdn_stats{app_name="smf",cluster="cn",data_center="cn",
instance_id="0",pdn_plmn_type="roamer",pdn_type="ipv4v6",rat_type="EUTRAN",
service_name="sgw-service",status="release"} 1
```

```
sgw_pdn_stats{app_name="smf",cluster="cn",data_center="cn",
instance_id="0",pdn_plmn_type="roamer",pdn_type="ipv4v6",rat_type="EUTRAN",
service_name="sgw-service",status="setup"} 4
```

```
sgw_pdn_stats{app_name="smf",cluster="cn",data_center="cn",
instance_id="0",pdn_plmn_type="visitor",pdn_type="ipv4",rat_type="EUTRAN",
service_name="sgw-service",status="release"} 1
```

```
sgw_pdn_stats{app_name="smf",cluster="cn",data_center="cn",  
instance_id="0",pdn_plmn_type="visitor"pdn_type="ipv4",rat_type="EUTRAN",  
service_name="sgw-service",status="setup"} 3
```



CHAPTER 34

Message Interactions Support

- [Feature Summary and Revision History, on page 335](#)
- [Feature Description, on page 336](#)
- [How it Works, on page 337](#)

Feature Summary and Revision History

Summary Data

Table 149: Summary Data

Applicable Product(s) or Functional Area	cnSGW-C
Applicable Platform(s)	SMI
Feature Default Setting	Enabled – Always-on
Related Documentation	Not Applicable

Revision History

Table 150: Revision History

Revision Details	Release
Procedures added for: <ul style="list-style-type: none">• Collision Resolver• Multiple CBR• Double Delete Optimized• Abort Handling of Low priority and Handling Suspension	2021.02.0

Revision Details	Release
First introduced.	2021.01.0

Feature Description

The Message Interactions feature provides the capability to receive and process the messages from different peers (UPF, MME, and PGW), and performs the priority resolution.

The following are the examples of message interaction scenarios and priorities:

- The Modify Bearer Request (MBR) and Update Bearer Request (UBR) received for the same PDN1 waits for the Sx Modify Response from UPF. The UBR is processed after the MBR is completed. In this scenario, the UBR process is suspended until the MBR is processed.
- The UBR1 received for the PDN1 while processing a Release Access Bearer (RAB) for the same PDN1. The UBR is processed after the RAB is completed. In this scenario, the UBR1 process is suspended when the RAB procedure is in progress.
- The existing PDN procedure is stopped when the disconnect procedure (Delete Session Request (DSR), Delete Bearer Request (DBR), or Clear Sub) is sent for the same PDN. For example, cnSGW-C receives the DSR for the PDN when the CBR1 and UBR1 procedures are in progress for the same PDN1. The DSR processing is started, and CBR1 and UBR1 processing is stalled. For more information, see the [Graceful Stop the Existing PDN Procedure Call Flow, on page 340](#) call flow.
- The existing UE procedure (RAB or DDN) is stopped when the disconnect procedure (DSR, DBR, or Clear Sub) for the PDN is received. For example, cnSGW-C receives the DBR for the PDN while processing the RAB or DDN. The DBR procedure is started, and the RAB or DDN procedure is stopped.
- The incoming procedure for the PDN is stopped when the disconnect procedure (DSR, DBR, or Clear Sub) for the same PDN is in progress. For example, the UBR receives the PDN when sending the DSR for the same PDN. The UBR procedure is stopped, and the DSR procedure continues.
- The new incoming UE procedure is stopped when processing the disconnect procedure (DSR, DBR, or Clear Sub) for the same PDN. For example, the RAB received for the PDN1 when processing the multi-PDN call DSR for the same PDN1. The RAB procedure is stopped and rescheduled after the DSR for PDN1 gets completed.
- The CBR and the UBR message handling are stopped when the initial attach procedure is in progress.
- Optimization of the double delete handling. For example, the cnSGW-C receives the DSR from MME and DBR in the PGW, for which the DBR Sx modify step is pending toward the UPF. The DBR signaling is not initiated toward the S11 interface.
- The processing of the low priority procedures is stopped when the high priority procedure is received on the same bearer. For example, cnSGW-C receives the DBR for the PDN on a dedicated bearer while processing UBR on the same bearer. The DBR handling procedure is started, and the processing of the existing UBR procedure on the same bearer is stopped.

How it Works

This section describes how this feature works.

Call Flows

This section describes the key call flows for this feature.

CBR Multi-PDN Call Flow

This section describes the CBR Multi-PDN call flow.

Figure 80: CBR Multi-PDN Call Flow

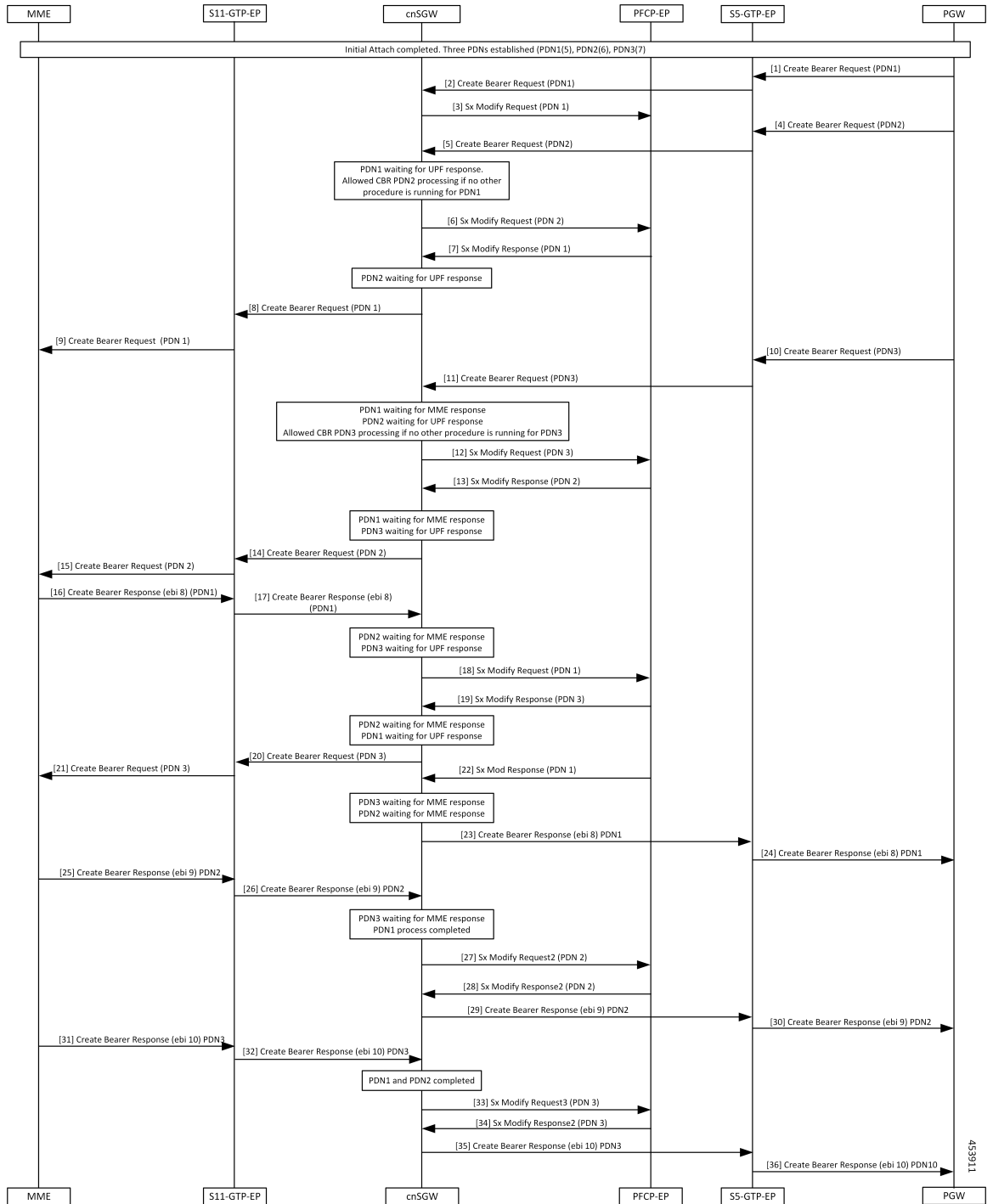

453911

Table 151: CBR Multi-PDN Call Flow Description

Step	Description
1	The Initial Attach process is completed with the three established PDNs. The PGW sends a Create Bearer Request for PDN1 to the S5-GTP-EP.
2	The S5-GTP-EP sends the Create Bearer Request for PDN1 to the cnSGW.
3	The cnSGW sends a Sx Modify Request for PDN1 to the PFCP-EP.
4	The PGW sends a Create Bearer Request for PDN2 to the S5-GTP-EP.
5	The S5-GTP-EP sends the Create Bearer Request PDN2 to the cnSGW.
6	The cnSGW sends a Sx Modify Request to PFCP-EP for PDN2.
7	The PFCP-EP sends the Sx Modify Response for PDN1 to the cnSGW.
8	The cnSGW sends the Create Bearer Request for PDN1 to the S11-GTP-EP.
9	The S11-GTP-EP sends the Create Bearer Request for PDN1 to the MME.
10	The PGW sends the Create Bearer Request (PDN3) to the S5-GTP-EP.
11	The S5-GTP-EP sends the Create Bearer Request (PDN3) to the cnSGW.
12	The cnSGW sends the Sx Modify Request (PDN3) to the PFCP-EP.
13	The PFCP-EP sends the Sx Modify Response for PDN2 to the cnSGW.
14	The cnSGW sends the Create Bearer Request for PDN2 to the S11-GTP-EP.
15	The S11-GTP-EP sends the Create Bearer Request for PDN1 to the MME.
16	The MME sends the Create Bearer Response for PDN1 to the S11-GTP-EP.
17	The S11-GTP-EP sends the Create Bearer Response for PDN1 to the cnSGW.
18	The cnSGW sends the Sx Modify Request for PDN1 to the PFCP-EP.
19	The PFCP-EP sends the Sx Modify Response for PDN3 to the cnSGW.
20	The cnSGW sends the Create Bearer Request for PDN3 to the S11-GTPC-EP.
21	The S11-GTPC-EP sends the Create Bearer Request for PDN3 to the MME.
22	The PFCP-EP sends the Sx Modify Response2 for PDN1 to the cnSGW.
23	The cnSGW sends the Create Bearer Response for PDN1 to the S5-GTP-EP.
24	The S5-GTP-EP sends the Create Bearer Response for PDN1 to the PGW.
25	The MME sends the Create Bearer Response for PDN2 to the S11-GTPC-EP.
26	The S11-GTPC-EP sends the Create Bearer Response for PDN1 to the cnSGW.

Step	Description
27	The cnSGW sends the Sx Modify Request to the PFCP-EP for PDN2.
28	The PFCP-EP sends the Sx Modify Response for PDN2 to the cnSGW.
29	The cnSGW sends the Create Bearer Response for PDN2 to the S5-GTP-EP.
30	The S5-GTP-EP sends the Create Bearer Response for PDN2 to the PGW.
31	The MME sends the Create Bearer Response for PDN3 to the S11-GTPC-EP.
32	The S11-GTPC-EP sends the Create Bearer Response for PDN3 to the cnSGW.
33	The cnSGW sends the Sx Modify Request for PDN2 to the PFCP-EP.
34	The PFCP-EP sends the Sx Modify Response for PDN3 to the cnSGW.
35	The cnSGW sends the Create Bearer Response for PDN3 to the S5-GTP-EP.
36	The S5-GTP-EP sends the Create Bearer Response for PDN3 to the PGW.

Graceful Stop the Existing PDN Procedure Call Flow

This section describes the Graceful Stop the Existing PDN Procedure call flow.

Figure 81: Graceful Stop the Existing PDN Procedure Call Flow

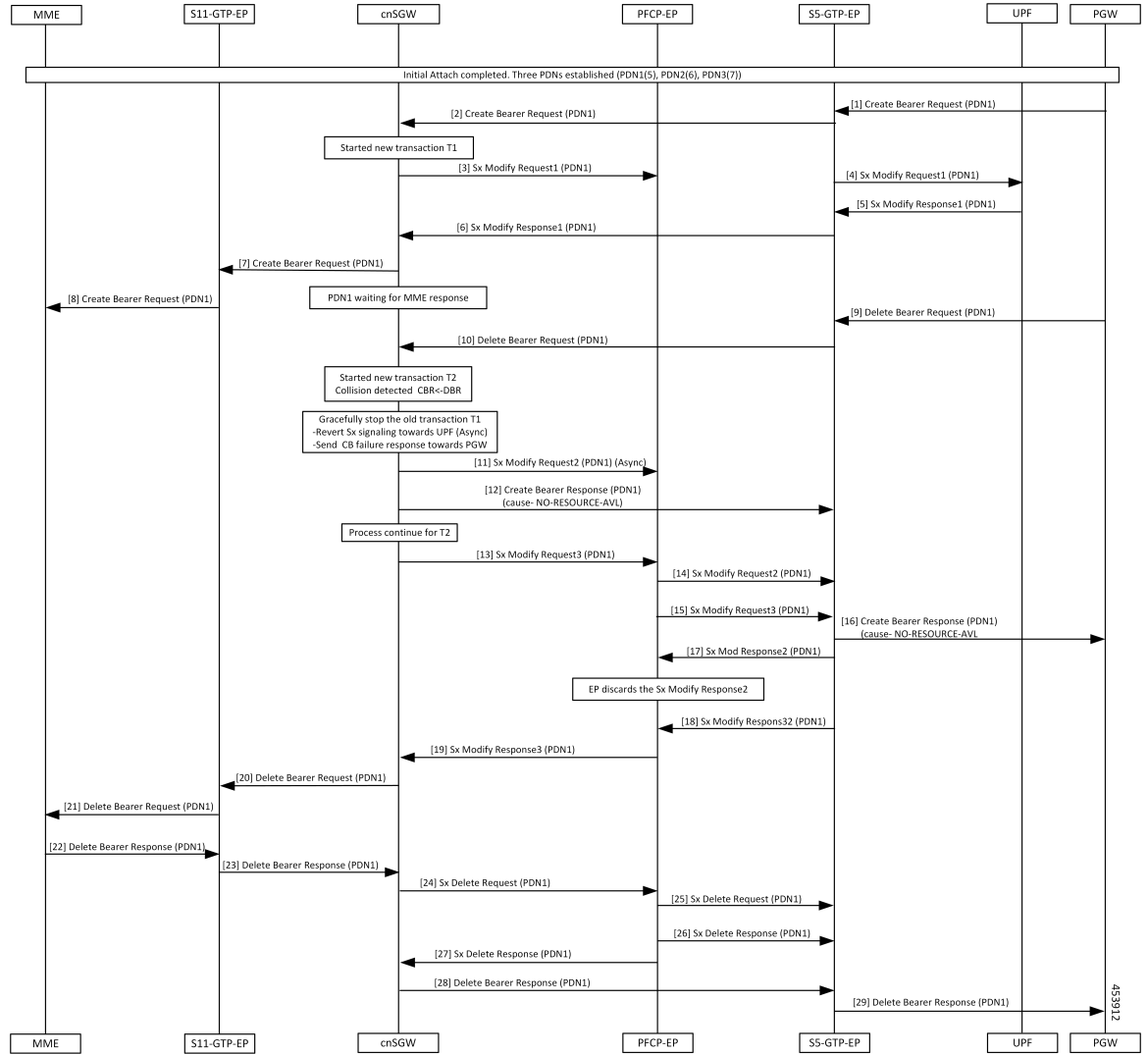

Table 152: Graceful Stop the Existing PDN Procedure Call Flow Description

Step	Description
1	The Initial Attach process is completed with the already established three PDNs. The PGW sends the Create Bearer Request to the S5-GTTPC-EP.
2	The S5-GTTPC-EP forwards the Create Bearer Request for PDN1 to the cnSGW.
3	The cnSGW forwards the Sx Modify Request for PDN1 to the PFCP-EP. The cnSGW waits for the Sx Modify Response for PDN1.
4	The PFCP-EP sends the Sx Modify Request for PDN1 to the UPF.
5	The UPF sends the Sx Modify Response for PDN1 to the PFCP-EP.

Step	Description
6	The PFCP-EP sends the Sx Modify Response for PDN1 to the cnSGW.
7	The cnSGW sends the Create Bearer Request for PDN1 to the S11-GTPC-EP.
8	The S11-GTPC-EP forwards the Create Bearer Request for PDN1 to the MME.
9	The PGW sends the Delete Bearer Request for PDN1 to the S5-GTPC-EP.
10	The S5-GTPC-EP forwards the Delete Bearer Request for PDN1 to the cnSGW. The cnSGW waits for the MME response and the cnSGW receives the Delete Bearer Request for PDN1. When collision is detected for PDN1, stop the old transaction T1 for PDN1.
11	The cnSGW sends the Sx Modify Request (async) to the PFCP-EP.
12	The cnSGWcnSGW sends the Create Bearer Response with cause No-Resource-Available for PDN1 to the S5-GTPC-EP.
13	The cnSGW sends the Sx Modify Request for DBR to the PFCP-EP.
14	The PFCP-EP forwards the Sx Modify Request for CBR to the UPF.
15	The PFCP-EP forwards the Sx Modify Request for DBR to the UPF.
16	The S5-GTPC-EP sends the Create Bearer Response with cause No.
17	The UPF sends the Sx Modify Response for CBR to the PFCP-EP. The PFCP-EP discards this response.
18	The UPF sends the Sx Modify Response for DBR to the PFCP-EP.
19	The PFCP-EP forwards the Sx Modify Response for DBR to the cnSGW.
20	The cnSGW sends the Delete Bearer Request for PDN1 to the S11-GTPC-EP.
21	The S11-GTPC-EP forwards the Delete Bearer Request for PDN1 to the MME.
22	The MME sends the Delete Bearer Response for PDN1 to the S11-GTPC-EP.
23	The S11-GTCP-EP forwards the Delete Bearer Response for PDN1 to the cnSGW.
24	The cnSGW sends the Sx Delete Request for PDN1 to the PFCP-EP.
25	The PFCP-EP forwards the Sx Delete Request for PDN1 to the UPF.
26	The UPF sends the Sx Delete Response for PDN1 to the PFCP-EP.
27	The PFCP-EP forwards the Sx Delete Response for PDN1 to the cnSGW.
28	The cnSGW sends the Delete Bearer Response for PDN1 to the S5-GTPC-EP.
29	The S5-GTPC-EP forwards the Delete Bearer Response for PDN1 to the PGW.

Inter MME Handover with Multi-PDN Handling (With PGW Interaction) Call Flow

This section describes the Inter MME Handover with Multi-PDN Handling (With PGW Interaction) call flow.

Figure 82: Inter MME Handover with Multi-PDN Handling (With PGW Interaction) Call Flow

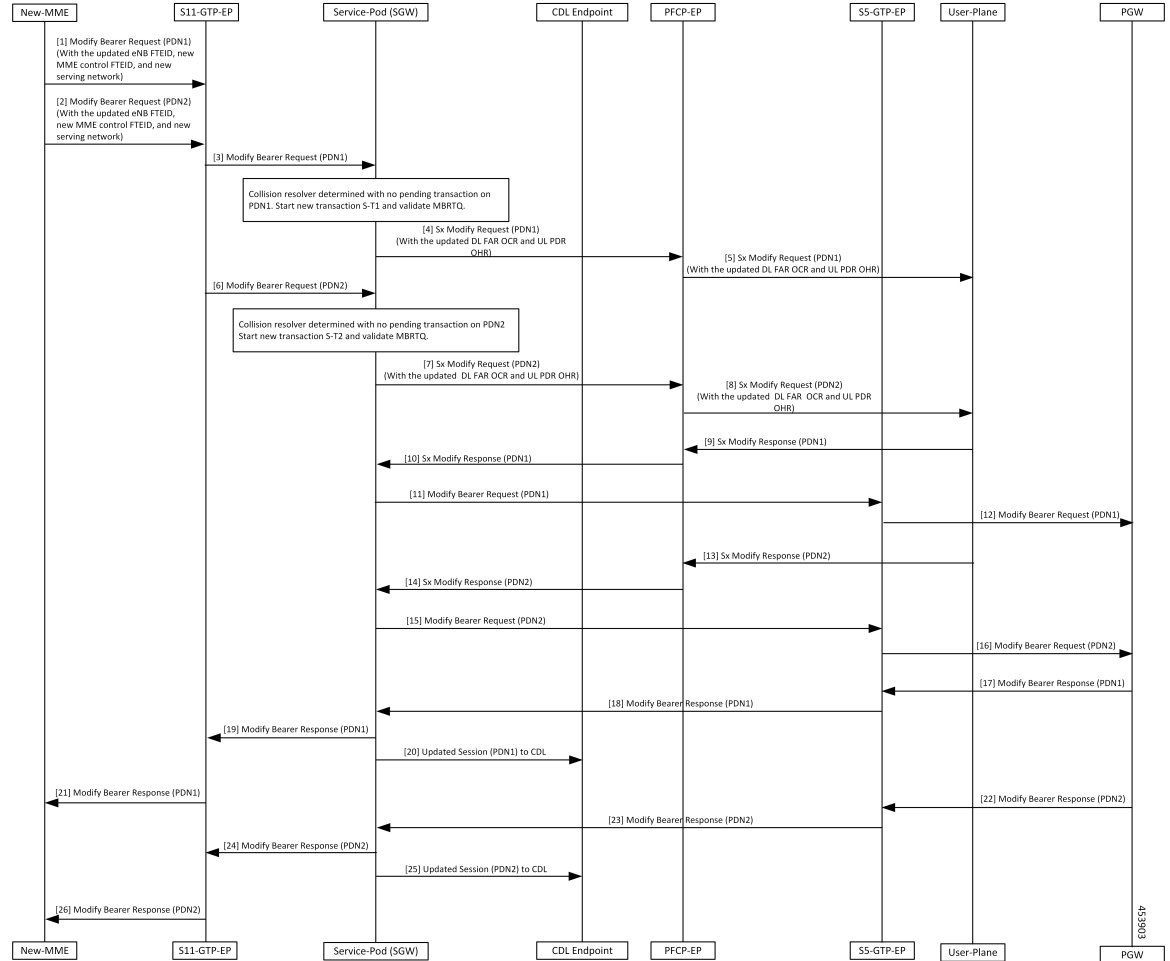

Table 153: Inter MME Handover with Multi-PDN Handling (With PGW Interaction) Call Flow Description

Step	Description
1	The New-MME sends the Modify Bearer Request for (PDN1) with the updated eNodeB FTEID, new MME control FTEID, and new serving network to the S11-GTP-EP.
2	The New-MME sends the Modify Bearer Request for (PDN2) with the updated eNodeB FTEID, new MME control FTEID, and new serving network to the S11-GTP-EP.
3	The S11-GTP-EP sends the Modify Bearer Request (PDN1) to the cnSGW-C.
4	The cnSGW-C sends the Sx Modify Request (PDN1) with the updated DL FAR OCR and UL PDR OHR to the PFCP-EP.
5	The PFCP-EP forwards the Sx Modify Request for (PDN1) to the User-Plane.

Step	Description
6	The S11-GTP-EP sends the Modify Bearer Request (PDN2).
7	The Service-Pod (SGW) sends Sx Modify Request (PDN2) with updated DL FAR OCR and UL PDR OHR to the PFCP-EP.
8	The PFCP-EP forwards the Sx Modify Request (PDN2) to User-Plane.
9	The User-Plane sends the Sx Modify Response (PDN1) to the PFCP-EP.
10	The PFCP-EP forwards the Sx Modify Response (PDN1) to the Service-Pod (SGW).
11	The Service-Pod (SGW) sends the Modify Bearer Request (PDN1) with updated serving network information to the S5-GTP-EP.
12	The S5-GTP-EP forwards the Modify Bearer Request (PDN1) to the PGW.
13	The User-Plane sends the Sx Modify Response (PDN2) to the PFCP-EP.
14	The PFCP-EP forwards the Sx Modify Response (PDN2) to the Service-Pod (SGW).
15	The Service-Pod (SGW) sends the Modify Bearer Request (PDN2) with the updated serving network information to S5-GTP-EP.
16	The S5-GTP-EP sends the Modify Bearer Request (PDN2) to the PGW.
17	The PGW sends the Modify Bearer Response (PDN1) to the S5-GTP-EP.
18	The S5-GTP-EP forwards the Modify Bearer Response (PDN1) to the Service-Pod (SGW).
19	The Service-Pod (SGW) forwards the Modify Bearer Response (PDN1) to the S11-GTP-EP.
20	The Service-Pod (SGW) updates the PDN1 session sent to the CDL Endpoint.
21	The S11-GTP-EP sends the Modify Bearer Response (PDN1) to the New-MME.
22	The PGW sends the Modify Bearer Response for (PDN2) to the S5-GTP-EP.
23	The S5-GTP-EP forwards the Modify Bearer Response (PDN2) to the Service-Pod (SGW).
24	The Service-Pod (SGW) forwards the Modify Bearer Response (PDN2) to the S11-GTP-EP.
25	The Service-Pod (SGW) marks Inter-MME as completed (PDN2) and updates PDN2 session sent to the CDL Endpoint.
26	The S11-GTP-EP sends the Modify Bearer Response (PDN2) to New-MME.

Multi PDN Call X2 Handover SGW Relocation to cnSGW-C Call Flow

This section describes the Multi PDN Call X2 Handover SGW Relocation to cnSGW-C call flow.

Figure 83: Multi PDN Call X2 Handover SGW Relocation to cnSGW-C Call Flow

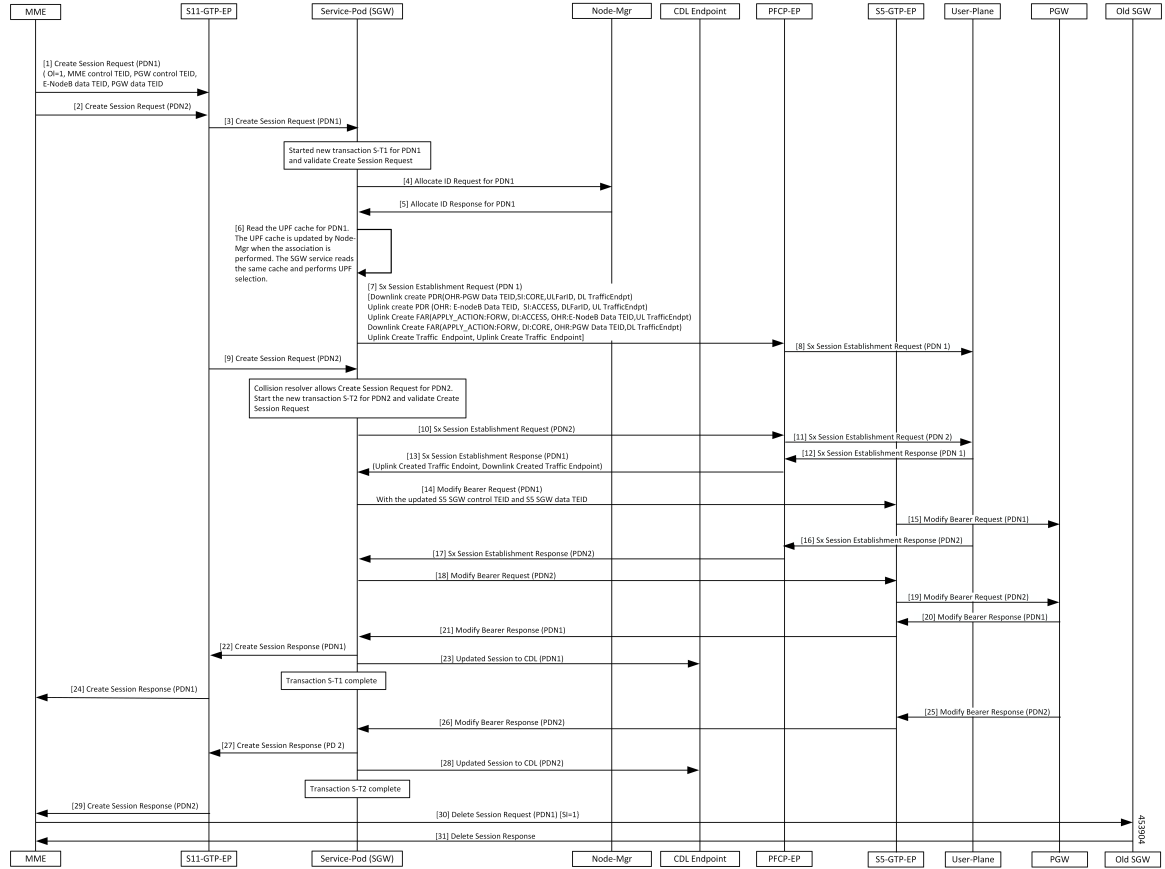

Table 154: Multi PDN call X2 Handover SGW Relocation to cnSGW-C Call Flow Description

Step	Description
1	The MME sends the Create Session Request for (PDN1) with (OI = 1, MME Control TEID, PGW Control TEID, eNodeB Data TEID, PGW Data TEID) to the S11-GTP-EP.
2	The MME sends the Create Session Request (PDN2) to the S11-GTP-EP.
3	The S11-GTP-EP forwards the Create Session Request (PDN1) to the Service-Pod (SGW).
4	The Service-Pod (SGW) requests for ID allocation (PDN1) to the Node-Mgr.
5	The Node-Mgr responds with the Allocate Id Response (PDN1).
6	The Service-Pod (SGW) performs the UPF selection.
7	The Service-Pod (SGW) sends the Sx Session Establishment Request (PDN1) to the PFCP-EP.
8	The PFCP-EP forwards the Sx Session Establishment Request (PDN1) to the User-Plane.
9	The S11-GTP-EP sends the Create Session Request (PDN2) to the Service-Pod (SGW).

Step	Description
10	The Service-Pod (SGW) sends the Sx Session Establishment Request (PDN2) to PFCP-EP.
11	The PFCP-EP forwards the Sx Session Establishment Request (PDN2) to the User-Plane.
12	The User-Plane sends the Sx Session Establishment Response (PDN1) to the PFCP-EP.
13	The PFCP-EP sends the Sx Session Establishment Response (PDN1) to the Service-Pod (SGW).
14	The Service-Pod (SGW) sends the Modify Bearer Request (PDN1) with the updated S5 SGW Control TEID and S5 SGW Data TEID to S5-GTP-EP.
15	The S5-GTP-EP forwards the Modify Bearer Request (PDN1) to the PGW.
16	The User-Plane sends the Sx Session Establishment Response (PDN2) to the PFCP-EP.
17	The PFCP-EP forwards the Sx Session Establishment Response (PDN2) to the Service-Pod (SGW).
18	The Service-Pod (SGW) sends the Modify Bearer Request (PDN2) with the updated S5 SGW Control TEID and S5 SGW Data TEID to the S5-GTP-EP.
19	The S5-GTP-EP forwards the Modify Bearer Request (PDN2) to the PGW.
20	The PGW sends the Modify Bearer Response (PDN1) to the S5-GTP-EP.
21	The S5-GTP-EP forwards the Modify Bearer Response (PDN1) to the Service-Pod (SGW).
22	The Service-Pod (SGW) sends the Create Session Response (PDN1) to the S11-GTP-EP.
23	The Service-Pod (SGW) updates the PDN1 session to the CDL Endpoint.
24	The S11-GTP-EP forwards the Create Session Response (PDN1) to the MME.
25	The PGW sends the Modify Bearer Response (PDN2) to the S5-GTP-EP.
26	The S5-GTP-EP forwards the Modify Bearer Response (PDN2) to the Service-Pod (SGW).
27	The Service-Pod (SGW) sends the Create Session Response (PDN2) to the S11-GTP-EP.
28	The Service-Pod (SGW) updates the PDN2 session to the CDL Endpoint.
29	The S11-GTP-EP forwards the Create Session Response (PDN2) to the MME.
30	The MME sends the Delete Session Request (PDN1) [SI=1] to the Old SGW.
31	The Old SGW responds with the Delete Session Response to the MME.

Multi-PDN S1 Handover SGW Relocation to Service-Pod (SGW) Call Flow

This section describes the Multi-PDN S1 Handover SGW Relocation to Service-Pod (SGW) call flow.

Figure 84: Multi-PDN S1 Handover SGW Relocation to Service-Pod (SGW) Call Flow

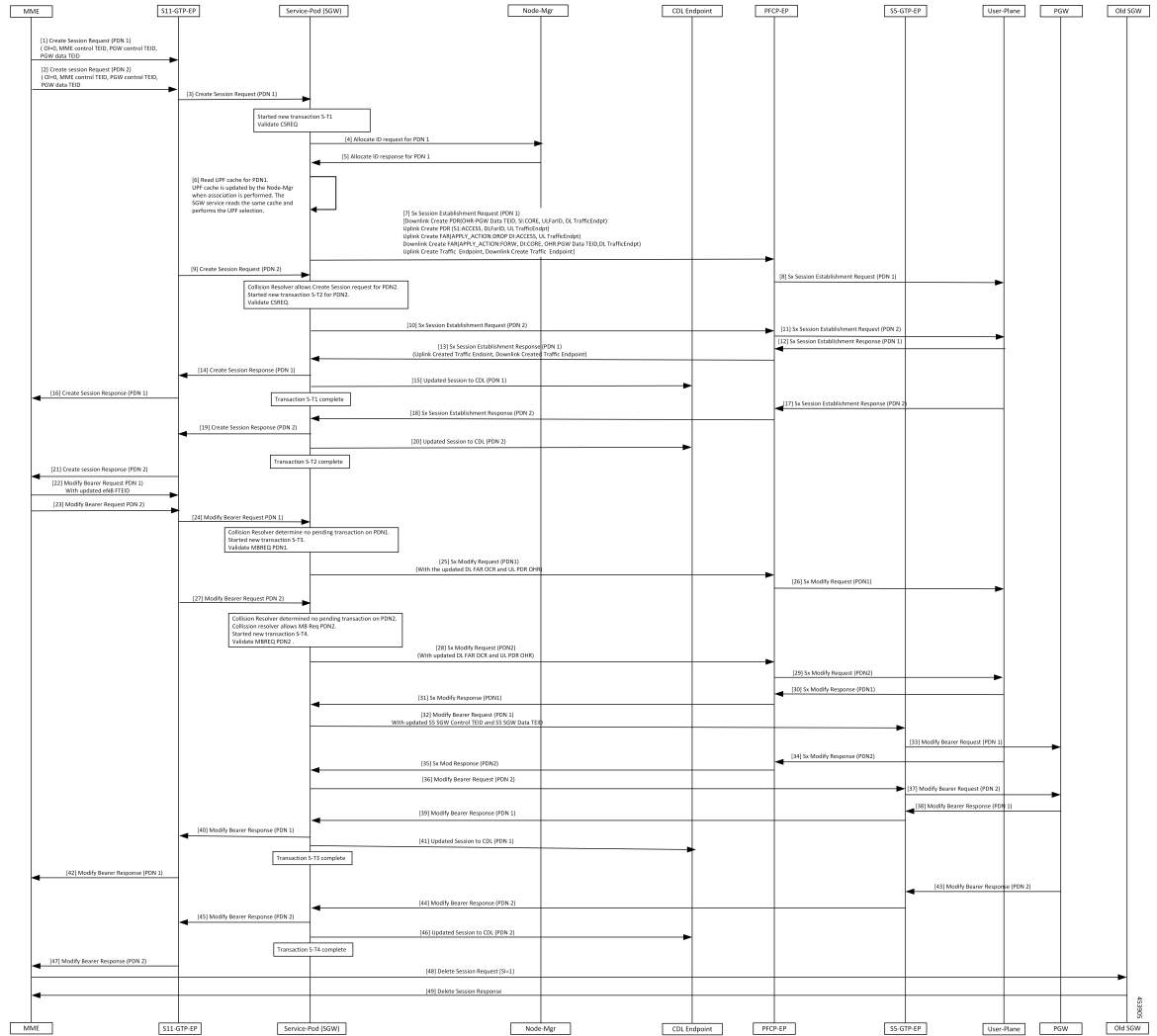

Table 155: Multi-PDN S1 Handover SGW Relocation to Service-Pod (SGW) Call Flow Description

Step	Description
1	The MME sends a Create Session Request (PDN1) with (OI = 0, MME Control TEID, PGW Control TEID, and PGW Data TEID) to the S11-GTP-EP.
2	The MME sends the Create Session Request (PDN2) with (OI = 0, MME Control TEID, PGW Control TEID, and PGW Data TEID) to the S11-GTP-EP.
3	The S11-GTP-EP sends the Create Session Request (PDN1) to the Service-Pod (SGW).
4	The Service-Pod (SGW) requests ID allocation (PDN1) to the Node-Mgr.
5	The Node-Mgr responds with the Allocate ID Response (PDN1) to the Service-Pod (SGW).
6	The Service-Pod (SGW) performs the UPF selection.

Step	Description
7	The Service-Pod (SGW) triggers the Sx Session Establishment Request (PDN1) to the PFCP-EP.
8	The PFCP-EP forwards a Sx Session Establishment Request (PDN1) to the User-Plane.
9	The Service-Pod (SGW) receives the Create Session Request (PDN2) from the S11-GTP-EP.
10	The Service-Pod (SGW) sends a Sx Session Establishment Request (PDN2) to the PFCP-EP.
11	The PFCP-EP forwards the Sx Session Establishment Request (PDN2) to the User-Plane.
12	The User-Plane responds with the Sx Session Establishment Response (PDN1) to the PFCP-EP.
13	The PFCP-EP forwards the Sx Session Establishment Response (PDN1) to the Service-Pod (SGW).
14	The Service-Pod (SGW) sends the Create Session Response (PDN1) to the S11-GTP-EP.
15	The Service-Pod (SGW) updates the PDN1 session to the CDL Endpoint.
16	The S11-GTP-EP forwards the Create Session Response (PDN1) to the MME.
17	The User-Plane responds with the Sx Session Establishment Response (PDN2) to the PFCP-EP.
18	The PFCP-EP forwards the Sx Session Establishment Response (PDN2) to the Service-Pod (SGW).
19	The Service-Pod (SGW) sends the Create Session Response (PDN2) to the S11-GTP-EP.
20	The Service-Pod (SGW) updates the PDN2 session to the CDL Endpoint.
21	The S11-GTP-EP forwards the Create Session Response (PDN2) to the MME.
22	The MME sends a Modify Bearer Request (PDN1) to the S11-GTP-EP.
23	The MME sends the Modify Bearer Request (PDN2) to the S11-GTP-EP.
24	The S11-GTP-EP forwards the Modify Bearer Request (PDN1) to the Service-Pod (SGW).
25	The Service-Pod (SGW) sends a Sx Modify Request (PDN1) to the PFCP-EP.
26	The PFCP-EP forwards the Sx Modify Request (PDN1) to the User-Plane.
27	The S11-GTP-EP sends the Modify Bearer Request (PDN2) to the Service-Pod (SGW).
28	The Service-Pod (SGW) sends a Sx Modify Request (PDN2) with the updated DL FAR OCR and UL PDR OHR to the PFCP-EP.
29	The PFCP-EP forwards the Sx Modify Request (PDN2) to the User-Plane.
30	The User-Plane responds with the Sx Modify Response (PDN1) to the PFCP-EP.
31	The PFCP-EP forwards the Sx Modify Response (PDN1) to the Service-Pod (SGW).
32	The Service-Pod (SGW) sends the Modify Bearer Request (PDN1) with the updated S5 SGW Control TEID and S5 SGW Data TEID to the S5-GTP-EP.
33	The S5-GTP-EP forwards the Modify Bearer Request (PDN1) to the PGW.

Step	Description
34	The User-Plane sends the Sx Modify Response (PDN2) to the PFCP-EP.
35	The PFCP-EP forwards the Sx Modify Response (PDN2) to the Service-Pod (SGW).
36	The Service-Pod (SGW) sends the Modify Bearer Request (PDN2) to the S5-GTP-EP.
37	The S5-GTP-EP forwards the Modify Bearer Request (PDN2) to the PGW.
38	The PGW responds with the Modify Bearer Response (PDN1) to the S5-GTP-EP.
39	The S5-GTP-EP forwards the Modify Bearer Response (PDN1) to the Service-Pod (SGW).
40	The Service-Pod (SGW) sends the Modify Bearer Response (PDN1) to the S11-GTP-EP.
41	The Service-Pod (SGW) updates the PDN1 session to the CDL Endpoint.
42	The S11-GTP-EP forwards the Modify Bearer Response (PDN1) to the MME.
43	The PGW responds with the Modify Bearer Response (PDN2) to the S11-GTP-EP.
44	The S5-GTP-EP forwards the Modify Bearer Response (PDN2) to the Service-Pod (SGW).
45	The Service-Pod (SGW) sends the Modify Bearer Response (PDN2) to the S11-GTP-EP.
46	The Service-Pod (SGW) updates the PDN2 session to the CDL Endpoint.
47	The S11-GTP-EP forwards the Modify Bearer Response (PDN2) to the MME.
48	The MME triggers the Delete Session Request [SI=1] to Old SGW.
49	The Old SGW deletes the session and responds with the Delete Session Response.

Multiple CBR for Same PDN Call Flow

This section describes the Multiple CBR for Same PDN call flow.

Figure 85: Multiple CBR for Same PDN Call Flow

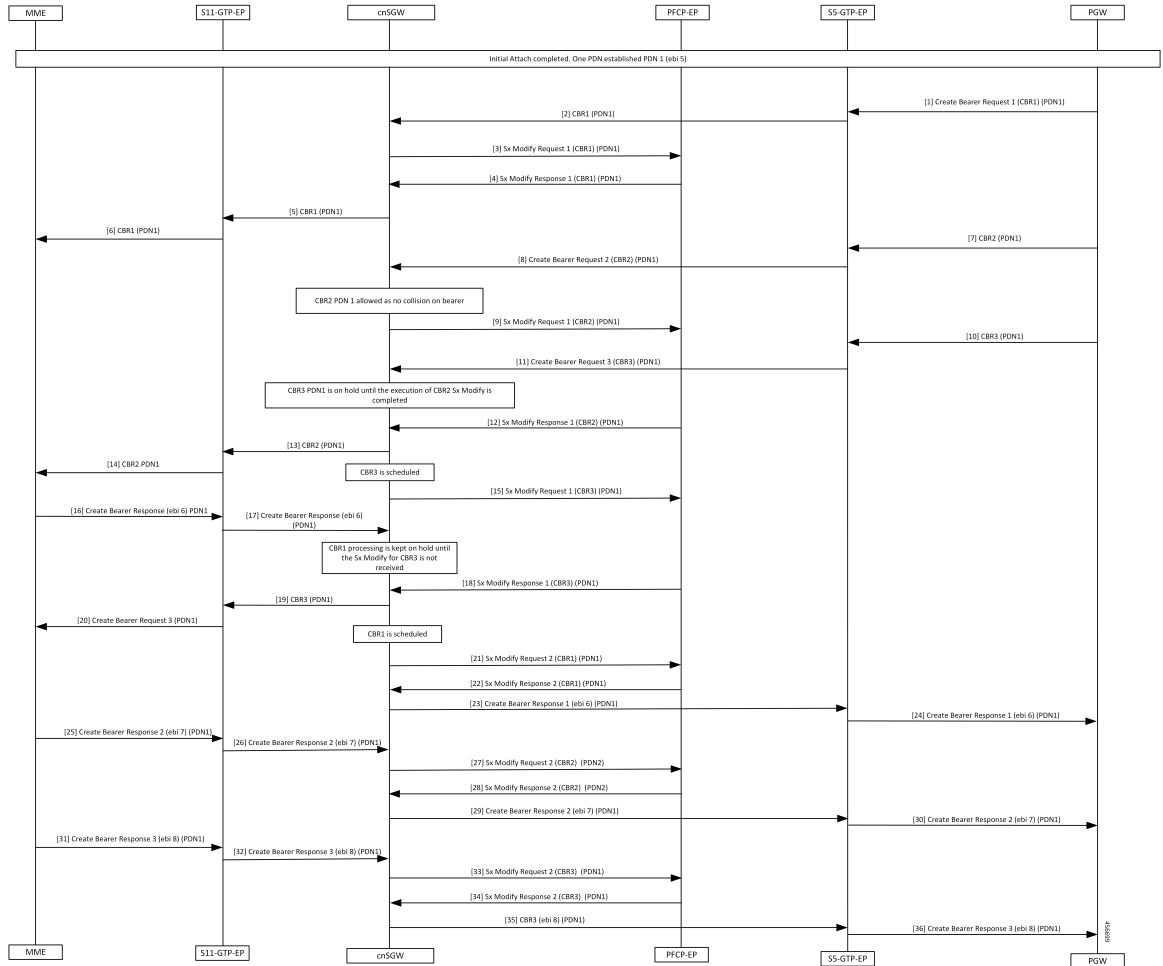

Table 156: Multiple CBR for Same PDN Call Flow Description

Step	Description
1	Initial Attach completed. One PDN has established PDN1 (ebi 5). The PGW sends the Create Bearer Request 1 for PDN1 to the S5-GTP-EP.
2	The S5-GTP-EP forwards the Create Bearer Request 1 for PDN1 to the cnSGW.
3	The cnSGW sends the Sx Modify Request 1 for PDN1 to the PFCP-EP.
4	The cnSGW receives the Sx Modify Response 1 for PDN1 from the PFCP-EP.
5	The cnSGW sends the Create Bearer Request 1 for PDN1 to the S11-GTP-EP.
6	The S11-GTP-EP sends the Create Bearer Request 1 for PDN1 to the MME.
7	The PGW sends the Create Bearer Request 2 to the S5-GTP-EP.

Step	Description
8	The S5-GTP-EP sends the Create Bearer Request 2 to the cnSGW.
9	The cnSGW sends the Sx Modify Request 1 (Create Bearer Request 2) for PDN1 to the PFCP-EP.
10	The PGW sends the Create Bearer Request 3 for PDN1 to the S5-GTP-EP.
11	The S5-GTP-EP sends the Create Bearer Request 3 for PDN1 to the cnSGW
12	The PFCP-EP sends the Sx Modify Response 1 (CBR2) for PDN1 to the cnSGW.
13	The cnSGW sends the Create Bearer Request 2 for PDN1 to the S11-GTP-EP.
14	The S11-GTP-EP sends the Create Bearer Request 2 for PDN1 to the MME.
15	The cnSGW sends the Sx Modify Request 1(CBR3) for PDN1 to the PFPC-EP.
16	The MME sends the Create Bearer Response 1 (ebi6) for PDN1 to the S11-GTP-EP.
17	The S11-GTP-EP sends the Create Bearer Response 1 (ebi6) for PDN1 to the cnSGW.
18	The cnSGW receives the Sx Modify Response 1 (CBR3) for PDN1 to the PFPC-EP.
19, 20	The cnSGW sends the Create Bearer Request 3 to the S11-GTP-EP.
20	The S11-GTP-EP sends the Create Bearer Request 3 to the MME.
21	The cnSGW sends the Sx Modify Request 2(CBR1) for PDN1 to the PFPC-EP.
22	The cnSGW receives the Sx Modify Response 2 (CBR1) for PDN1 to the PFPC-EP.
23	The cnSGW sends the Create Bearer Response 1 (ebi 6) for PDN1 to the S5-GTP-EP.
24	The S5-GTP-EP sends the Create Bearer Response 1 (ebi 6) for PDN1 to the PGW.
25	The MME sends the Create Bearer Response 2 (ebi 7) for PDN1 sent from MME to cnSGW.
26	The S11-GTP-EP sends the Create Bearer Response 2 (ebi 7) for PDN1 sent from MME to the cnSGW.
27	The cnSGW sends the Sx Modify Request 2 (CBR2) for PDN1 to PFCP-EP.
28	The PFCP-EP sends the Sx Modify Response 2 (CBR2) for PDN1 to the cnSGW.
29	The cnSGW sends the Create Bearer Response 2 (ebi 7) for PDN1 to the S5-GTP-EP.
30	The S5-GTP-EP sends the Create Bearer Response 2 (ebi 7) for PDN1 to the PGW.
31	The MME sends the Create Bearer Response 3 (ebi 8) for PDN1 to the S11-GTP-EP.
32	The S11-GTP-EP sends the Create Bearer Response 3 (ebi 8) for PDN1 to the cnSGW.
33	The cnSGW sends the Sx Modify Request 2 (CBR3) for PDN1 to the PFPC-EP.
34	The PFCP-EP send the Sx Modify Response 2 (CBR3) for PDN1 to the cnSGW.

Step	Description
35	The cnSGW sends the Create Bearer Response 3 (ebi 8) for PDN1 to the S5-GTP-EP.
36	The S5-GTP-EP sends the Create Bearer Response 3 (ebi 8) for PDN1 to the PGW.

Collision Resolver Discard Handling Call Flow

This section describes the Collision Resolver Discard Handling call flow.

Figure 86: Collision Resolver Discard Handling Call Flow

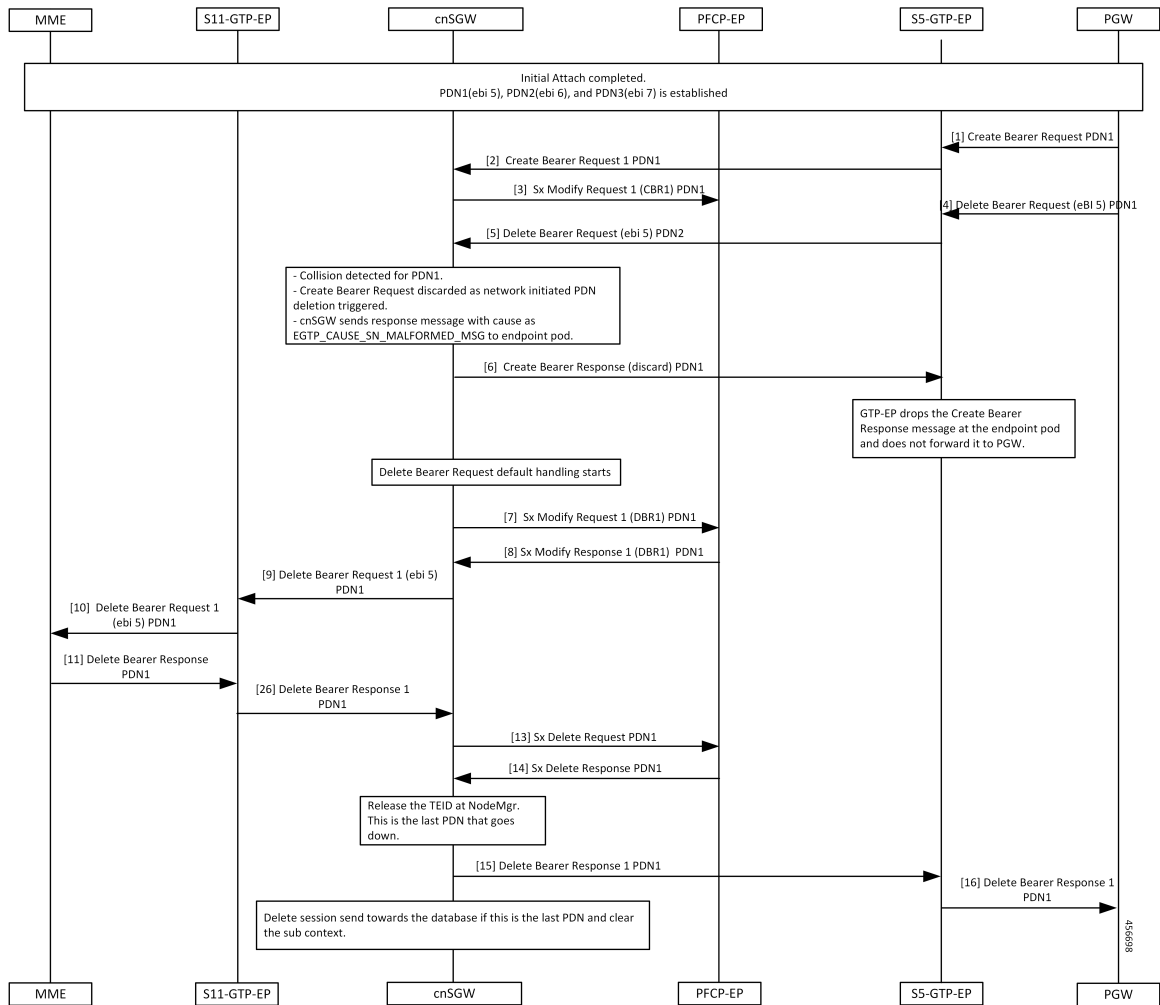

Table 157: Collision Resolver Discard Handling Call Flow Description

Step	Description
1	Initial Attach procedure is completed. The PDN1(ebi 5), PDN2(ebi 6), and PDN3(ebi 7) is established. The PGW sends the Create Bearer Request for PDN1 to the S5-GTP-EP.

Step	Description
2	The PFCP-EP sends the Create Bearer Request 1 for PDN1 to the cnSGW.
3	The cnSGW sends the Sx Modify Request 1 for PDN1 to the PFCP-EP.
4, 5	The PGW sends the Delete Bearer Request (ebi5) for PDN1 to the cnSGW.
6	Collision detected for PDN1. The Create Bearer Request is discarded as network initiated PDN deletion request is triggered. The cnSGW sends a response message with the cause as EGTP_CAUSE_SN_MALFORMED_MSG to the endpoint pod. The cnSGW sends Create Bearer Response (discard 1) for PDN1 to the S5-GTP-EP.
7	The cnSGW sends the Sx Modify Request 1 (DBR1) for PDN1 to the PFCP-EP.
8	The cnSGW receives the Sx Modify Response 1 (DBR1) for PDN1 from the PFCP-EP.
9	The cnSGW sends the Delete Bearer Request 1 to the S11-GTP-EP.
10	The S11-GTP-EP sends the Delete Bearer Request 1 to the MME.
11	The MME sends the Delete Bearer Response 1 to the S11-GTP-EP.
12	The S11-GTP-EP sends the Delete Bearer Response 1 to the cnSGW.
13	The cnSGW sends the Sx Delete Request for PDN1 to the PFCP-EP.
14	The PFCP-EP sends the Sx Delete Response for PDN1 to the cnSGW.
15	The cnSGW sends the Delete Bearer Response 1 for PDN1 to the PGW.
16	The S5-GTP-EP sends the Delete Bearer Response for PDN1 to the PGW.

Suspend Handling Call Flow

This section describes the Suspend Handling call flow.

Figure 87: Suspend Handling Call Flow

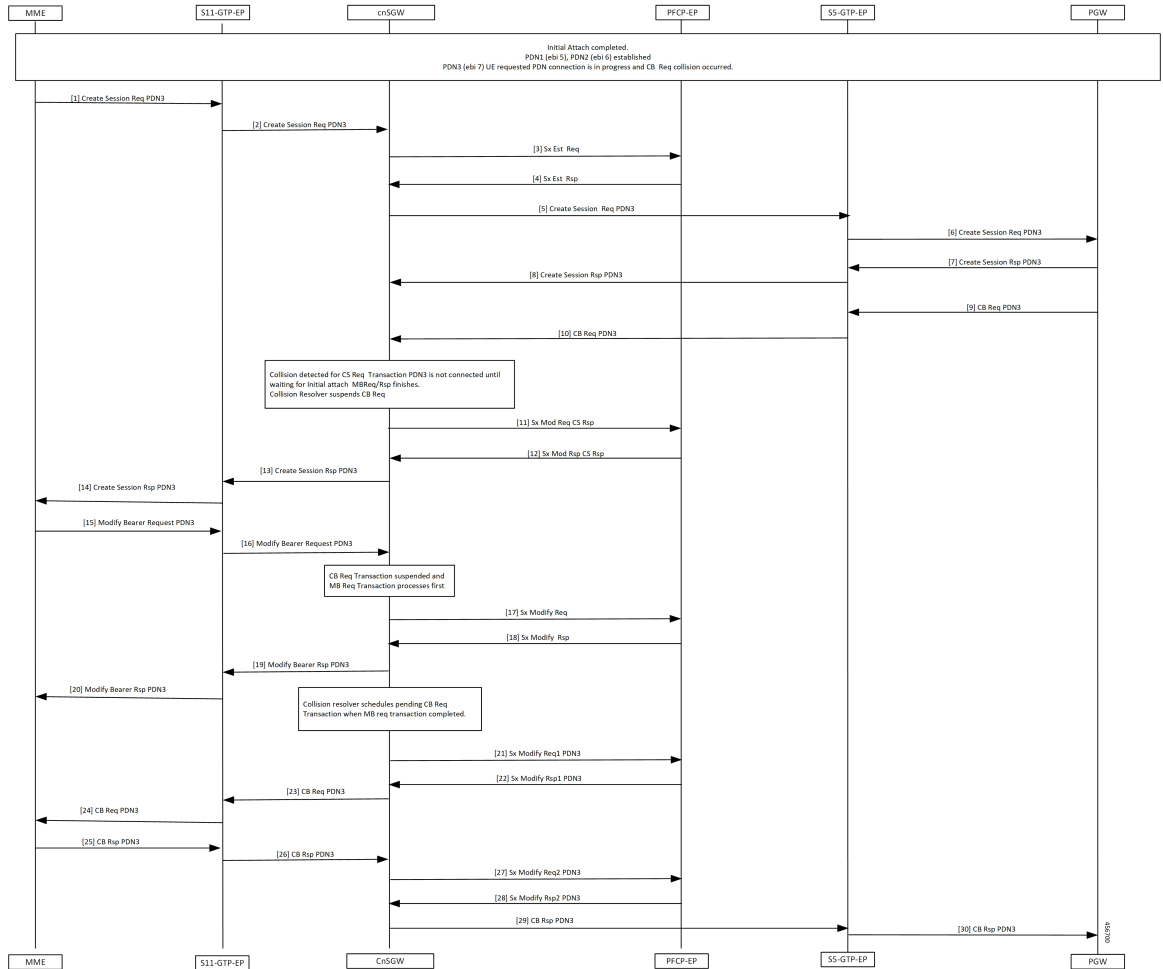

Table 158: Suspend Handling Call Flow Description

Step	Description
1	Initial Attach process is completed. The PDN1 (ebi 5) and PDN2 (ebi 6) is established. PDN3 (ebi 7) UE requested that PDN connection is in progress. The Create Bearer Request collision occurred. The MME sends Create Session Req for PDN3 to S11-GTP-EP.
2	The S11-GTP-EP sends the Create Session Request for PDN3 to the cnSGW.
3	The cnSGW sends the Sx Establishment Request to the PFCP-EP.
4	The PFCP-EP sends the Sx Establishment Response to the cnSGW.
5	The cnSGW sends the Create Session Request for PDN3 to the PGW.

Step	Description
6	The S5-GTP-EP sends the Create Session Request for PDN3 to the PGW.
7	The PGW sends the Create Session Rspnse for PDN3 to the S5-GTP-EP.
8	The S5-GTP-EP sends the Create Session Response for PDN3 to the cnSGW.
9	The PGW sends the Create Bearer Request for PDN3 to the S5-GTP-EP.
10	The S5-GTP-EP sends the Create Bearer Request for PDN3 to the cnSGW.
11	Collision that is detected for Create Session Request transaction for PDN3 gets connected when waiting for the initial attach Modify Bearer Request or Response is complete. Collision Resolver suspends Create Bearer Request. The cnSGW sends Sx Modify Request and Create Session Request to the PFCP-EP.
12	The PFCP-EP sends the Sx Modify Response and Create Session Response to cnSGW.
13	The cnSGW sends the Create Session Response for PDN3 sent to the S11-GTP-EP.
14	The S11-GTP-EP sends the Create Session Response for PDN3 sent to the MME.
15	The MME sends the Modify Bearer Request for PDN3 to the S11-GTP-EP.
16	The S11-GTP-EP sends the Modify Bearer Request for PDN3 to the cnSGW.
17	The cnSGW sends the Modify Bearer Request for PDN3 to the PFCP-EP.
18	The PFCP-EP sends the Sx Modify Response to the cnSGW.
19	The cnSGW sends the Modify Bearer Response for PDN3 to the S11-GTP-EP.
20	The S11-GTP-EP sends the Modify Bearer Response for PDN3 to the MME.
21	The cnSGW sends Sx Modify Request 1 for PDN3 to the PFCP-EP.
22	The PFPC-EP sends the Sx Modify Response 1 for PDN3 to the PFPC-EP.
23	The cnSGW sends the Create Bearer Request for PDN3 sent to the S11-GTP-EP.
24	The S11-GTP-EP sends the Create Bearer Request for PDN3 sent to the MME.
25	The MME sends the Create Bearer Response for PDN3 to the S11-GTP-EP.
26	The S11-GTP-EP sends the Create Bearer Response for PDN3 to the cnSGW.
27	The cnSGW sends Sx Modify Request 2 for PDN3 to the PFCP-EP.
28	The PFCP-EP sends the Sx Modify Response 2 for PDN3 to the cnSGW.
29	The cnSGW sends the Create Bearer Response for PDN3 to the PGW.
30	The S5-GTP-EP sends the Create Bearer Response for PDN3 to the PGW.

Step	Description
5	The MME sends an Update Bearer Response to the S11-GTP-EP.
6	The S11-GTP-EP sends a Update Bearer Response to the cnSGW.
7	The cnSGW sends Sx Modify Request to the PFCP-EP.
8	The PGW sends the Delete Bearer Request (eBi 7) for PDN2 to the S5-GTP-EP.
9	The S5-GTP-EP forwards Delete Bearer Request (eBi 7) for PDN2 to the cnSGW.
10	Collision is detected for PDN2. The Update Bearer Request is discarded as high priority-dedicated bearer delete received for the same bearer. The cnSGW sends a response message with cause as EGTP_CAUSE_SN_MALFORMED_MSG to endpoint POD. The cnSGW sends Update Bearer Response (Discard) for PDN2 to the S5-GTP-EP.
11	The GTP-EP drops the Update Bearer Response message at endpoint pod and not forwarded to the PGW. The cnSGW sends the Sx Modify Request 1 for PDN2 to the PFCP-EP.
12	The PFCP-EP sends the Sx Modify Response 1 for PDN2 to the cnSGW.
13	The cnSGW sends the Delete Bearer Request for PDN2 to the S11-GTP-EP.
14	The S11-GTP-EP sends the Delete Bearer Request (ebi 7) for PDN2 to the MME.
15	The MME sends the Delete Bearer Response for PDN2 to the S11-GTP-EP.
16	The S11-GTP-EP sends the Delete Bearer Response for PDN2 to the cnSGW.
17	The cnSGW sends the Sx Modify Request for PDN2 to the PFCP-EP.
18	The PFCP-EP sends Sx Modify Response for PDN2 to the cnSGW.
19	The cnSGW sends the Delete Bearer Response for PDN2 to the S5-GTP-EP.
20	The S5-GTP-EP sends the Delete Bearer Response for PDN2 to the PGW.

Double Delete Optimization Call Flow

This section describes the Double Delete Optimization call flow.

Figure 89: Double Delete Optimization Call Flow

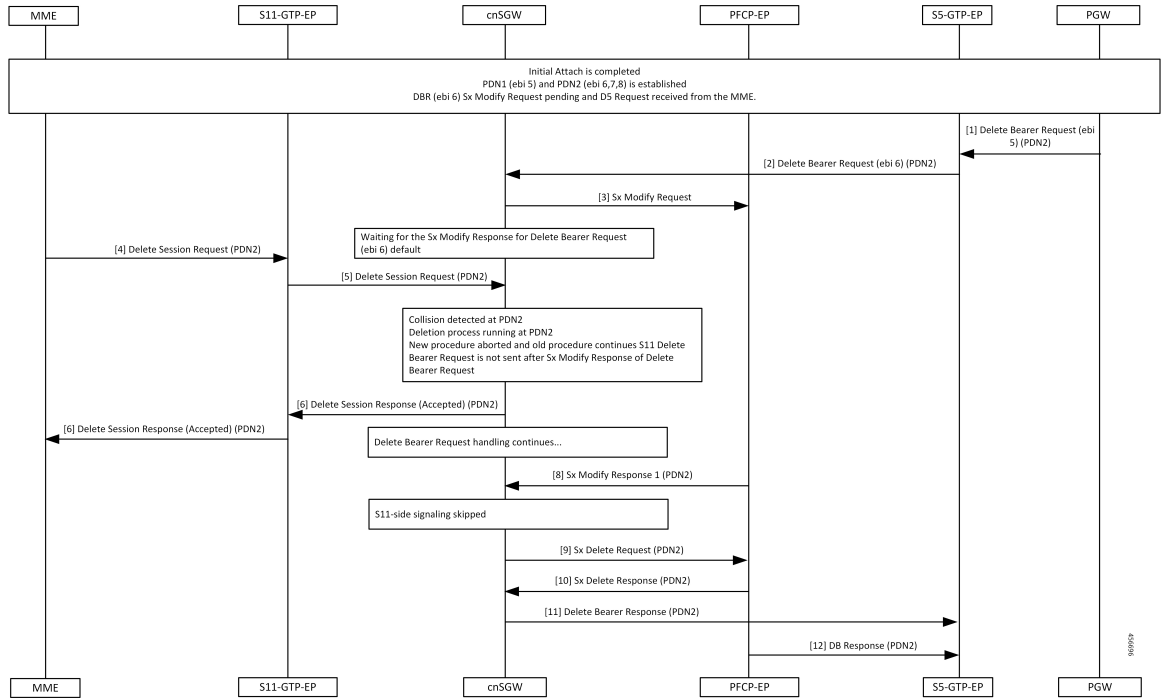

Table 160: Double Delete Optimization Call Flow Description

Step	Description
1	Initial Attach procedure is completed. The PDN1(ebi 5) and PDN2(ebi 6,7,8) is established. The Delete Bearer Request (ebi 6) and Sx Modify Request is pending and the Delete Session Request is received from the MME. The PGW sends the Delete Bearer Request (ebi 6) for PDN2 to the S5-GTP-EP.
2	The S5-GTP-EP forwards the Delete Bearer Request (ebi 6) for PDN2 to the cnSGW.
3	The cnSGW sends the Sx Modify Request to the PFCP-EP.
4	Waits for the Sx Modify Response for the Delete Bearer Request (ebi 6) default. The MME sends the Delete Session Request for PDN2 to the S11-GTP-EP.
5	The S11-GTP-EP forwards the Delete Session Request for PDN2 to the cnSGW.

Step	Description
6	<p>Collision detected at PDN2.</p> <p>Deletion process running at PDN2.</p> <p>New procedure aborted and old procedure continue.</p> <p>The S11 Delete Bearer Request isn't send after an Sx Modify Response of the Delete Bearer Request.</p> <p>The cnSGW sends Delete Session Response (Accepted) for PDN2 to the S11-GTP-EP.</p>
7	<p>The S11-GTP-EP forwards the Delete Session Response (Accepted) for PDN2 to the MME.</p>
8	<p>While the Delete Bearer Request handling continues, the PFCP-EP sends Sx Modify Response 1 for PDN2 to the cnSGW.</p>
9	<p>The cnSGW sends the Sx Delete Request for PDN2 to the PFCP-EP.</p>
10	<p>The PFCP-EP sends the Sx Delete Response for PDN2 to the cnSGW.</p>
11	<p>The cnSGW sends Delete Bearer Response for PDN2 to the S5-GTP-EP.</p>
12	<p>The S5-GTP-EP forwards the Delete Bearer Response for PDN2 to the PGW.</p>



CHAPTER 35

Modify and Delete Bearer Command Support

- [Feature Summary and Revision History, on page 361](#)
- [Feature Description, on page 361](#)
- [How it Works, on page 362](#)

Feature Summary and Revision History

Summary Data

Table 161: Summary Data

Applicable Product(s) or Functional Area	cnSGW-C
Applicable Platform(s)	SMI
Feature Default Setting	Enabled – Always-on
Related Documentation	Not Applicable

Revision History

Table 162: Revision History

Revision Details	Release
First introduced.	2021.01.0

Feature Description

cnSGW-C supports Modify Bearer Command (MBC) and Delete Bearer Command (DBC). This feature is supported on the following pods—SGW-service, GTP-EP, and UDP-Proxy. The SGW-service pod is responsible for handling the following:

- The MBC and DBC
- The MBC triggered Update Bearer Request
- The DBC triggered Delete Bearer Response

The GTPC-EP pod is responsible for sending the following:

- Modify Bearer Command Failure Indication (MBCFI) and Delete Bearer Command Failure Indication (DBCFI) if no response is received.
- MBCFI and DBCFI (success) on receiving Update Bearer Request and Delete Bearer Request respectively.
- Update Bearer Response and Delete Bearer Response back to PGW on receiving the respective message from the SGW-service pod.

How it Works

This section describes how this feature works.

Call Flows

This section describes the key call flows for this feature.

MBC Failure Handling Call Flow

This section describes the MBC Failure Handling call flow.

Figure 90: MBC Failure Handling Call Flow

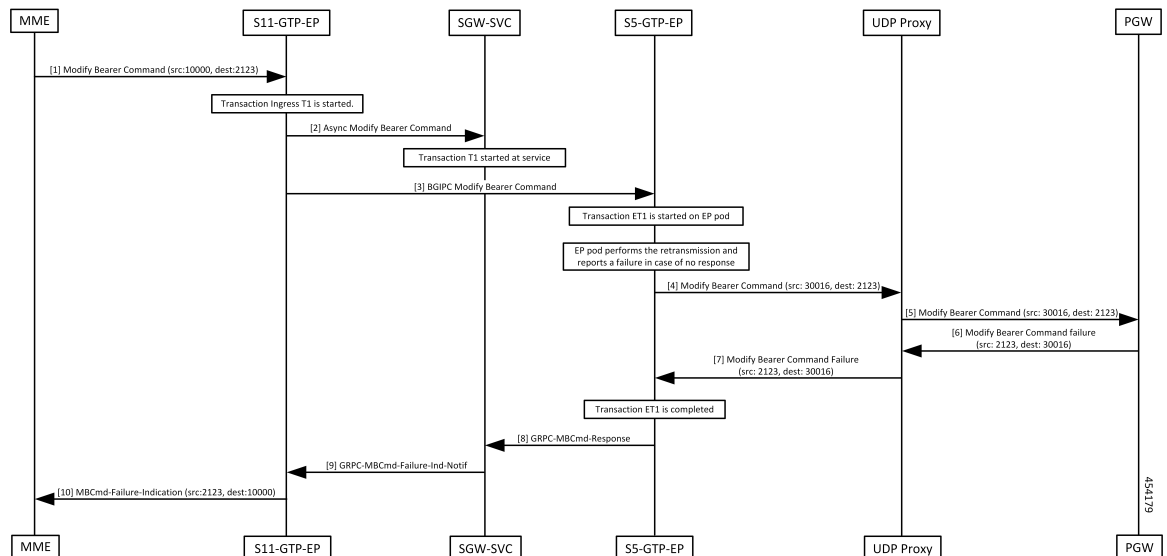

Table 163: MBC Failure Handling Call Flow Description

Step	Description
1	The MME sends the Modify Bearer Command to the S11 GTPC-EP pod.
2	The GTPC-EP pod sends the ASYNC Modify Bearer Command to the SGW-SVC pod.
3	The SGW-SVC pod forwards Modify Bearer Command to PGW. Save MBC_info in PDN for the response.
4	The GTPC-EP pod performs retransmission. If there is no response, the pod sends Modify Bearer Command Failure Indication (MBCFI) to SGW-SVC pod.
5	The UDP Proxy sends the Modify Bearer Command request to PGW.
6	The MBCFI is received on the S5 GTPC-EP pod and is forwarded to SGW-SVC pod.
7	The UDP Proxy sends the Modify Bearer Command failure details to the S5-GTP-EP.
8	The S5-GTP-EP sends the GRPC Modify Bearer Command Response to the SGW-SVC.
9	The SGW-SVC sends the GRPC Modify Bearer Command failure notification to the S11-GTP-EP.
10	The SGW-SVC pod processes MBCFI and forwards the response to MME with saved MBC_Info.

MBC Success Handling Call Flow

This section describes the MBC Success Handling call flow.

Figure 91: MBC Success Handling Call Flow

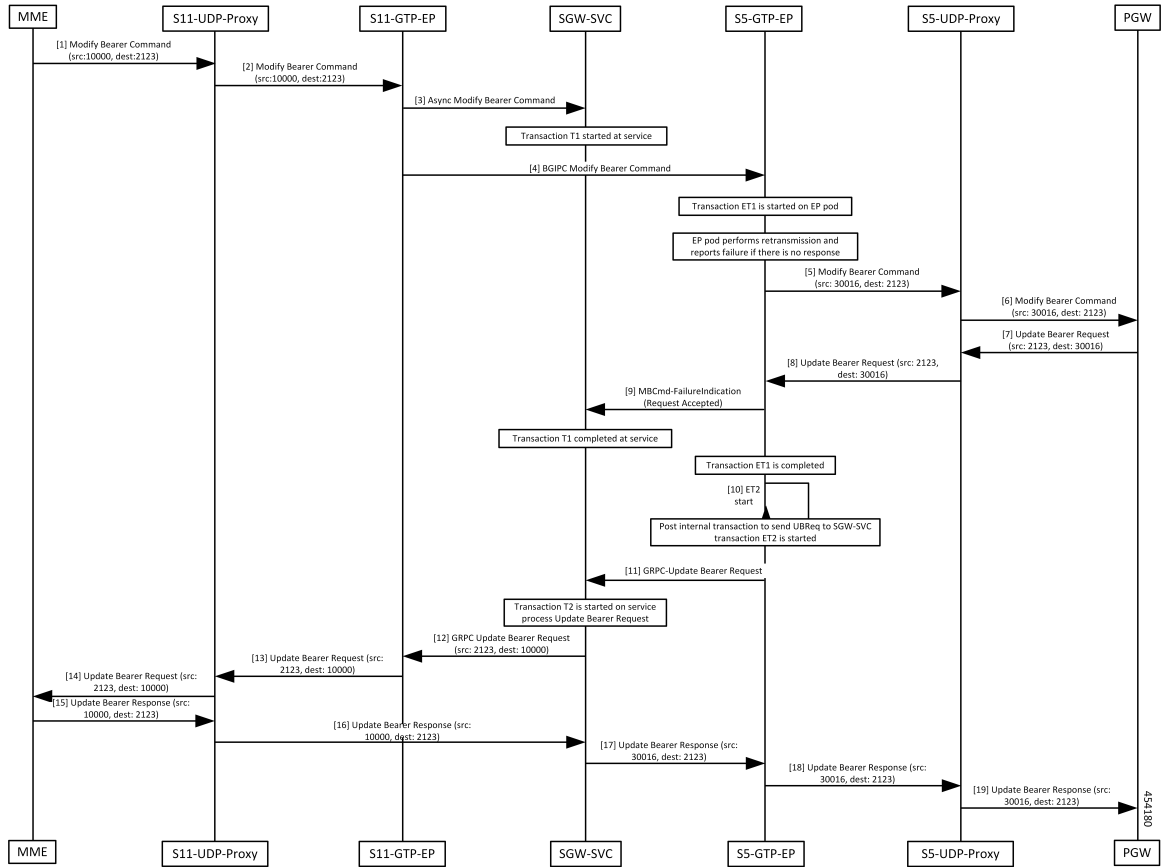

Table 164: MBC Success Handling Call Flow Description

Step	Description
1	The MME sends the Modify Bearer Command to the S11-UDP-Proxy.
2	The S11-UDP-Proxy forwards the Modify Bearer Command to the S11-GTP-EP pod.
3	The S11-GTP-EP pod sends the ASYNC Modify Bearer Command to the SGW-SVC pod. The SGW-SVC pod forwards the Modify Bearer Command to the PGW. Save MBC_info in PDN for response.
4	The S11-GTP-EP pod performs the retransmission. If there is no response, the pod sends the Modify Bearer Command Failure Indication (MBCFI) to the S5-GTP-EP pod.
5	The S5-GTP-EP sends the Modify Bearer Command to the S5-UDP-Proxy.
6	The S5-UDP-Proxy forwards the Modify Bearer Command to the PGW.
7	The PGW sends the Update Bearer Request to the S5-UDP-Proxy.
8	The S5-UDP-Proxy sends the Update Bearer Request (src: 2123, dest: 30016) to the S5-GTP-EP.

Step	Description
9	The S5-GTP-EP pod sends MBCmd-FailureIndication to SGW-SVC pod to end the transaction. Post internal transaction, the GRPC Update Bearer Request is sent to the SGW-SVC pod.
10	The S5-GTP-EP starts the ET2.
11	The S5-GTP-EP sends the GRPC Update Bearer Request to SGW-SVC pod.
12	The SGW-SVC pod processes the Update Bearer Request and consumes the saved MBC_Info to send Update Bearer Request to the S11-GTP-EP.
13	The S11-GTP-EP sends the Update Bearer Request to the S11-UDP-Proxy.
14	The S11-UDP-Proxy forwards the Update Bearer Request to the MME.
15	The MME sends Update Bearer Response to the SGW-SVC pod.
16	The S11-UDP-Proxy processes and sends the Update Bearer Response to the SGW-SVC pod.
17	The SGW-SVC pods forward the Update Bearer Response to the S5-GTP-EP pod.
18	The S5-GTP-EP pod sends the Update Bearer Response to the S5-UDP-Proxy.
19	The S5-UDP-Proxy sends the Update Bearer Response to the PGW.

DBC Failure Handling Call Flow

This section describes the DBC Failure Handling call flow.

Figure 92: DBC Failure Handling Call Flow

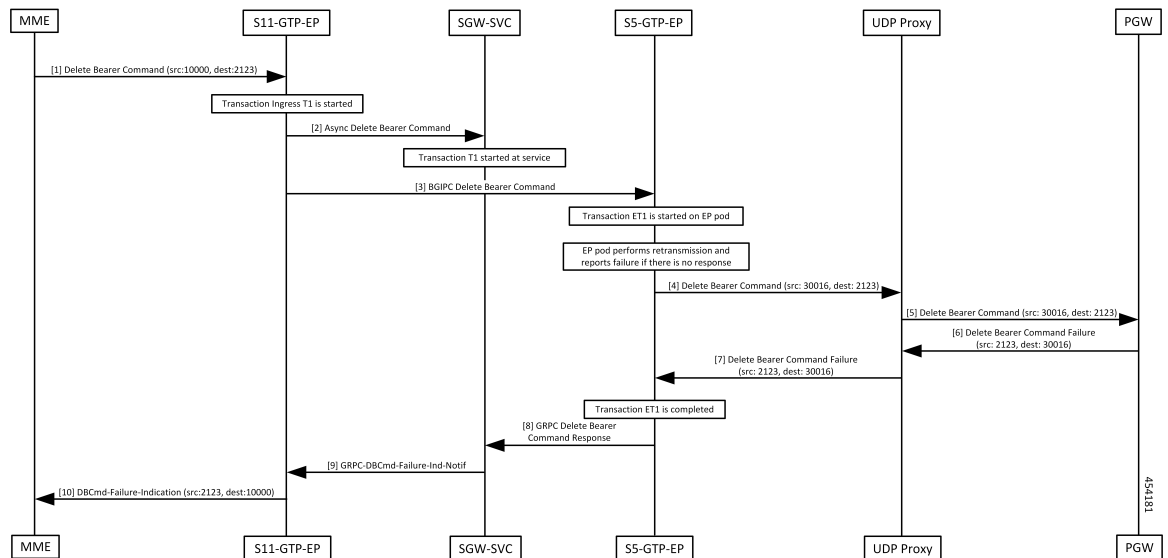

Table 165: DBC Failure Handling Call Flow Description

Step	Description
1	The MME sends the Delete Bearer Command to the S11-GTP-EP pod.
2	The S11-GTP-EP pod sends the ASYNC Delete Bearer Command to the SGW-SVC pod.
3	The SGW-SVC pod forwards Delete Bearer Command to the PGW. Save DBC_info in PDN for response. The EP pod performs retransmission. If there is no response, the pod sends the Delete Bearer Command Failure Indication (DBCFI) to the SGW-SVC pod.
4	The S5-GTP-EP sends the Delete Bearer Command to the UDP Proxy.
5	The UDP Proxy forwards the Delete Bearer Command to the PGW.
6	The PGW sends the Delete Bearer Command Failure to the UDP Proxy. DBCFI is received on S5 GTPC-EP pod and is forwarded to the SGW-SVC pod.
7	The UDP Proxy forwards the Delete Bearer Command Failure to the S5-GTP-EP.
8	The S5-GTP-EP sends the GRPC Delete Bearer Command Response to the SGW-SVC.
9	The SGW-SVC pod sends the GRPC-DBCcmd-Failure-Ind-Notif to the S11-GTP-EP.
10	The S11-GTP-EP pod processes the DBCFI and forwards the response to MME with the saved DBC_Info.

DBC Success Handling Call Flow

This section describes the DBC Success Handling call flow.

Figure 93: DBC Success Handling Call Flow

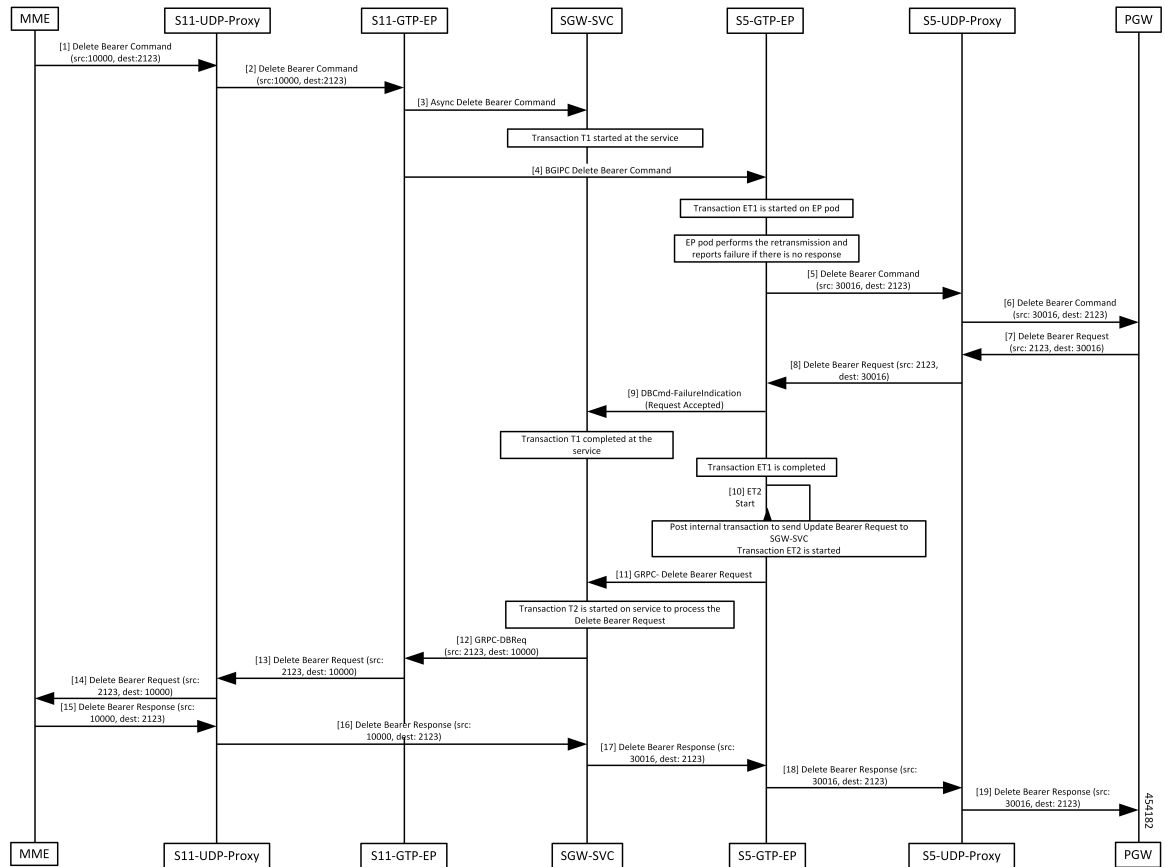

Table 166: DBC Success Handling Call Flow Description

Step	Description
1	The MME sends a Delete Bearer Command to the S11-UDP-Proxy.
2	The S11-UDP-Proxy forwards the Delete Bearer Command to the S11-GTP-EP.
3	The S11-UDP-Proxy sends the ASYNC Delete Bearer Command to the SGW-SVC pod.
4	The SGW-SVC pod sends the BGIPC Delete Bearer Command to the S5-GTP-EP. Save DBC_info in the PDN for response.
5	The EP pod performs the retransmission and reports a failure if there is no response. The pod sends the Delete Bearer Command Failure Indication (DBCFI) to the SGW-SVC pod. The S5-GTP-EP sends the Delete Bearer Command to the S5-UDP-Proxy.
6	The S5-UDP-Proxy send the Delete Bearer Command to the PGW.
7	The PGW sends the Delete Bearer Request to the S5-UDP-Proxy pod.
8	The S5-UDP-Proxy pod forwards the Delete Bearer Request to the S5-GTP-EP.

Step	Description
9	The S5-GTP-EP pod sends the DBCFI (with Request as ACCEPTED) to the SGW-SVC pod to end the transaction. The SGW-SVC pod ends the transaction and consumes this DBCFI. The post internal transaction sends the GRPCE_DBReq to SGW-SVC pod.
10	After the ET1 transaction is completed, the S5-GTP-EP starts.
11	The S5-GTP-EP pod sends the GRPC-DBRequest to the SGW-SVC.
12	The SGW-SVC pod processes the Delete Bearer Request and used saved DBC_Info to send the Updated Bearer Request to the MME.
13	The S11-GTP-EP pod sends the Delete Bearer Request to the S11-UDP-Proxy pod.
14	The S11-UDP-Proxy forwards the Delete Bearer Request to the MME.
15	The MME sends the Delete Bearer Response to the S11-UDP-Proxy pod.
16	The S11-UDP-Proxy processes the Delete Bearer Response to the SGW-SVC.
17	The SGW-SVC forwards the Delete Bearer Response to the S5-GTP-EP.
18	The S5-GTP-EP pod sends the Delete Bearer Response to the S5-UDP-Proxy.
19	The S5-UDP-Proxy sends the Delete Bearer Response to the PGW.



CHAPTER 36

Modify Bearer Request Support

- [Feature Summary and Revision History, on page 369](#)
- [Feature Description, on page 369](#)
- [How it Works, on page 370](#)

Feature Summary and Revision History

Summary Data

Table 167: Summary Data

Applicable Product(s) or Functional Area	cnSGW-C
Applicable Platform(s)	SMI
Feature Default Setting	Enabled - Always-on
Related Documentation	Not Applicable

Revision History

Revision Details	Release
First introduced.	2020.03.0

Feature Description

cnSGW-C supports the MBR service request from MME to change the UE state from IDLE to ACTIVE. cnSGW-C supports the following service requests:

- UE-triggered service request without PGW interaction
- UE-triggered service request with PGW interaction

How it Works

This section describes how this feature works.

The cnSGW-C performs the following actions while processing the UE-triggered service request:

- Sends the Sx Modification Request message to the UPF to:
 - Mark downlink Forwarding Action Rule (FAR) as forward.
 - Update the S1 eNodeB-F TEID information to UPF sends the downlink packets to eNodeB.
- After receiving the Sx Modify Response message from the UPF, cnSGW-C:
 - Sends the Modify Bearer Response message to MME.
 - Checks User Location Information (ULI) or UE time zone. For any change in the time zone, it sends Modify Bearer Request to PGW to update the TAI. The UE-triggered service request with PGW interaction request only considers ULI or UE time zone check.

Call Flows

This section describes the key call flows for this feature.

UE-Triggered Service Request without PGW Interaction Call Flow

This section describes the UE-Triggered Service Request without PGW Interaction call flow.

Figure 94: UE Triggered Service Request without PGW Interaction Call Flow

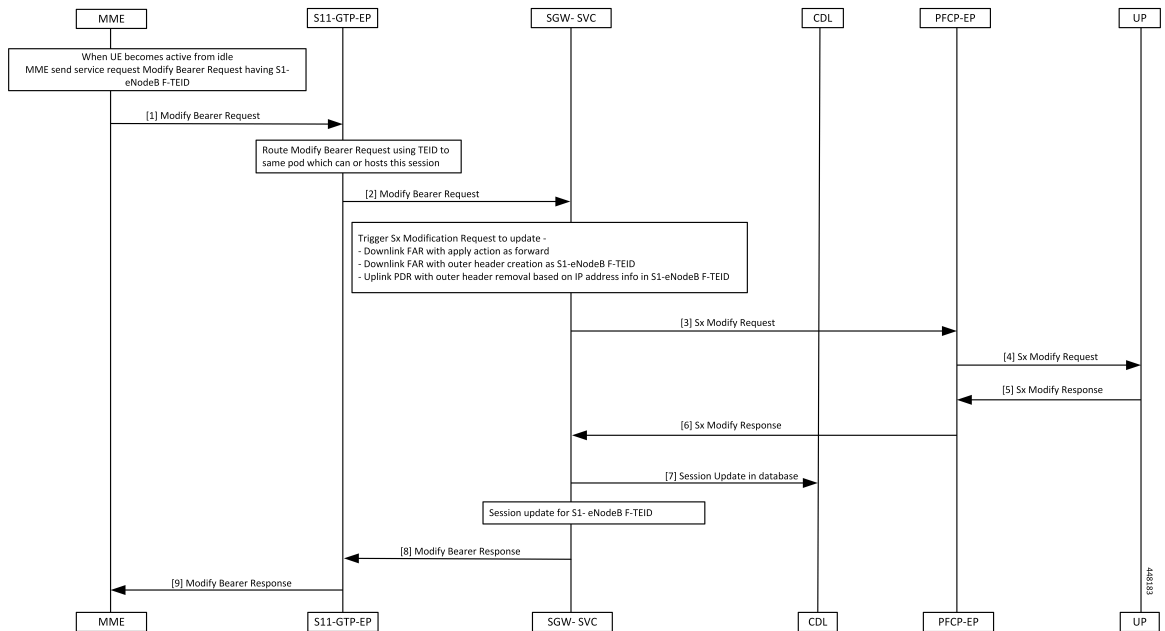

Table 168: UE Triggered Service Request without PGW Interaction Call Flow Description

Step	Description
1	The MME sends the Modify Bearer Request message with s1-eNodeB F-TEID to cnSGW-C when the UE changes from IDLE to ACTIVE state.
2	The S11-GTP-EP decodes the UDP message and converts it into gRPC message. This gRPC message is sent to the SGW-SVC pod (which can handle this UE session) using TEID.
3	The SGW-SVC pod finds the subscriber context using the local ingress TEID. The SGW-SVC pod sends the Modify Bearer Request content and sends Sx Modify Request to PFCP-EP.
4	The PFCP-EP sends Sx Modify Request message to UPF through the UDP proxy.
5	The UPF process the Sx Modify Request message and sends Sx Modify Response message to PFCP-EP.
6	The PFCP-EP sends the Sx Modify Response message to SGW-SVC pod.
7	The SGW-SVC pod changes PDN into CONNECTED state and sends session update to CDL. The CDL module updates the information in the database.
8	The SGW-SVC pod sends the Modify Bearer Response message to the S11-GTP-EP.
9	The S11-GTP-EP sends the Modify Bearer Response message to MME. The MME processes the Modify Bearer Response message.

UE-Triggered Service Request with PGW Interaction Call Flow

This section describes the UE-Triggered Service Request with PGW Interaction call flow.

Figure 95: UE-Triggered Service Request with PGW Interaction Call Flow

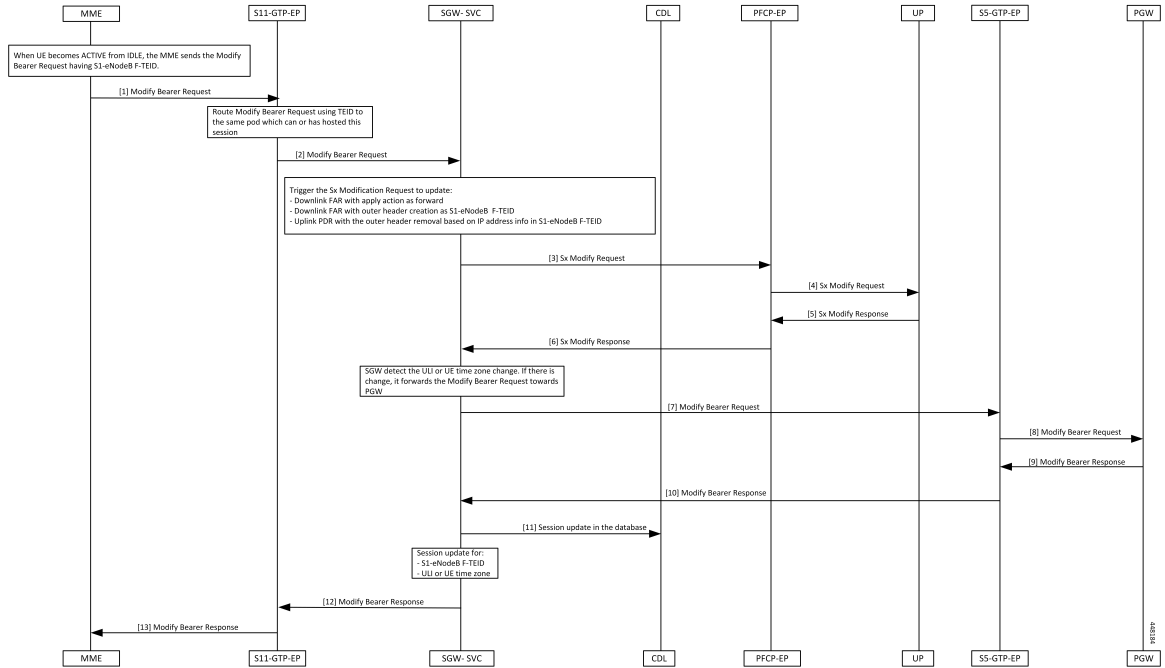

Table 169: UE-Triggered Service Request with PGW Interaction Call Flow description

Step	Description
1	The MME sends the Modify Bearer Request with s1-eNodeB F-TEID to cnSGW-C when the UE changes from the IDLE to ACTIVE state.
2	The S11-GTP-EP decodes the UDP message and converts it into the gRPC message. This gRPC message is sent to the SGW-Service pod, which handles the UE session using TEID.
3	The SGW-Service pod finds the subscriber context using the local ingress TEID. It validates the Modify Bearer Request content and sends the Sx Modify Request to PFCP-EP.
4	The PFCP-EP sends the Sx Modify Request to the UPF through the UDP proxy.
5	The UPF1 processes the Sx Modify Request and sends the Sx Modify Response message.
6	The PFCP-EP sends the Sx Modify Response message to the SGW-Service pod.
7	The SGW-Service pod detects ULI or UE time zone change and sends the Modify Bearer Request message to S5-GTP-EP.
8	The S5-GTP-EP sends the Modify Bearer Request message to the PGW.
9	The PGW processes the Modify Bearer Request message and sends the Modify Bearer Response message.
10	The S5-GTP-EP sends the Modify Bearer Response message to the SGW-Service pod.

Step	Description
11	The SGW-Service pod moves PDN into the CONNECTED state and sends the update to CDL. The CDL module updates the information in the database.
12	The SGW-Service pod sends the Modify Bearer Response message to the S11-GTP-EP.
13	The S11-GTP-EP sends the Modify Bearer Response message to the MME. The MME processes the Modify Bearer Response message.



CHAPTER 37

Monitor Subscriber and Protocol Support

- [Feature Summary and Revision History, on page 375](#)
- [Feature Description, on page 375](#)
- [Feature Configuration, on page 376](#)

Feature Summary and Revision History

Summary Data

Table 170: Summary Data

Applicable Product(s) or Functional Area	cnSGW-C
Applicable Platform(s)	SMI
Feature Default Setting	Enabled – Configuration required to disable
Related Documentation	Not Applicable

Revision History

Table 171: Revision History

Revision Details	Release
First introduced.	2021.01.0

Feature Description

The cnSGW-C service supports the subscriber map and the operator policy configurations for the SGW service parameters.

Feature Configuration

Configuring this feature involves the following steps:

- Configure the monitor subscriber utility to trace messages related to a specified subscriber. For more information, refer to [Configuring the Monitor Subscriber, on page 376](#).
- An example of the monitor subscriber utility. For more information, refer to [Configuration Example, on page 377](#).
- Configure the monitor protocol utility to capture packets on a specified interface. For more information, refer to [Configuring the Monitor Protocol, on page 399](#).
- An example of the monitor protocol utility. For more information, refer to [Configuration Example, on page 400](#).
- Configure the Request Response messages in the transaction logs. For more information, refer to [Configuring the Transaction Messages, on page 411](#).
- An example of the transaction logs. For more information, refer to [Configuration Example, on page 411](#).
- Access the monitor subscriber and protocol logs. For more information, refer to [Accessing the Logs, on page 415](#).

Configuring the Monitor Subscriber

To configure this feature use the following configuration:

```
exec
  monitor subscriber
    capture-duration capture_duration
    dump filename filename_value
    gr-instance gr_instance
    imei imei_value
    imsi imsi_value
    supi supi_value
    list subscriber_list
    internal-messages [ Yes | No ]
    transaction-logs [ Yes | No ]
    nf-service nf_service
  end
```



Note In 2021.02 and later releases, the namespace keyword is deprecated and replaced with nf-service.

NOTES:

- **capture-duration** *capture_duration*—Specify the duration in seconds during which the monitor subscriber feature is enabled. The default value is 300 seconds.
- **supi** *supi_value*—Specify the subscriber identifier. For example, imsi-123456789 and imsi-123*

- **imsi** *imsi_value*—Specify the IMSI value. For example, 123456789 and *
- **imei** *imei_value*—Specify the IMEI value. For example, 123456789012345 and *
- **internal-messages** [Yes | No]—Configures internal messaging. When set to yes, the internal messaging is enabled. By default, the configuration is disabled.
- **transaction-logs** [Yes | No]—Configures transaction logging. By default, the configuration is disabled.



Note At any point, either the internal messages or the transaction logs are displayed.

- **nf-service** *nf_service*—Specify the NF service. The accepted services are sgw and smf. The default value is none.
- **gr-instance** *gr_instance*—Specify the GR instance that the cnSGW-C monitors the subscriber for.

Configuration Example

The following is an example configuration.

```
monitor subscriber imsi 123456789 capture-duration 100 internal-messages yes
monitor subscriber imsi 123456789 capture-duration 100 transaction-logs yes
```

Sample Output

The following is a sample output.

```
monitor subscriber imsi * namespace sgw
supi: imsi-*
captureDuration: 300
enableInternalMsg: false
enableTxnLog: false
namespace(deprecated. Use nf-service instead.): sgw
nf-service: none
gr-instance: 0
  % Total      % Received % Xferd  Average Speed   Time    Time       Time  Current
   100    277  100     89  100    188    5235  11058  --:--:--  --:--:--  --:--:--  16294
Command: --header Content-type:application/json --request POST --data
{"commandname":"mon_sub","parameters":{"supi":"imsi-*","duration":300,
"enableTxnLog":false,
"enableInternalMsg":false,"action":"start","namespace":"sgw","nf-service":"none",
"grInstance":0}}
http://oam-pod:8879/commands
Result start mon_sub, fileName ->
logs/monsublogs/sgw.imsi-*_TS_2021-08-15T12:36:17.569800845.txt
Starting to tail the monsub messages from file:
logs/monsublogs/sgw.imsi-*_TS_2021-08-15T12:36:17.569800845.txt
Defaulting container name to oam-pod.
Use 'kubectl describe pod/oam-pod-0 -n cn' to see all of the containers in this pod.
  Subscriber Id: imsi-123456789012348
  Timestamp: 2021/08/15 12:39:25.288997
  Message: Sx Session Establishment Request
  Description: Sx Session Establishment Request Message from SGWC to SGWU
  Source: 209.165.201.19 (SGW.protocol.DC.Local.1)
  Destination: 209.165.201.20 (SGW.udp-proxy.DC.Local.0)
  PAYLOAD:
```

```

Sx Session Establishment Request:
  Sx Session Establishment Request:
    FSeid:
      Seid: 1297038098512740679
      IPv4Address: 209.165.201.19
    CreatePdr:
      CreatePdr[0]:
        PdrId: 1
        Precedence: 0
        Pdi:
          SrcIf: CORE
          UeIp:
            Src: false
            Dst: false
            IPv4Addr: 209.165.201.30
          TEndpointId: 1
          Valid: true
        OuterHdrRem: 0
        FarId:
          FarId[0]: 1
        Qfi: 0
        OuterHdrRemValid: false
      CreatePdr[1]:
        PdrId: 2
        Precedence: 0
        Pdi:
          SrcIf: ACCESS
          UeIp:
            Src: false
            Dst: false
            IPv4Addr: 209.165.201.30
          TEndpointId: 2
          Valid: true
        OuterHdrRem: 0
        FarId:
          FarId[0]: 2
        Qfi: 0
        OuterHdrRemValid: false
    CreateFar:
      CreateFar[0]:
        FarId: 1
        ApplyAction:
          Drop: true
          Frwd: false
          Buff: false
          Nocp: false
          Dupl: false
          Valid: true
        FwdParams:
          DestIf: ACCESS
          RedirectInfo:
            AddrType: 0
            Valid: false
          OuterHdr:
            OuterHdrDesc: 0
            Teid: 0
            IPv4Address: 209.165.201.30
            Port: 0
            Valid: false
          TEndptId: 2
          OuterPktTos: 255
          InnerPktTos: 255
          TosOpt:
            CopyInner: false

```

```
        CopyOuter: false
SendTos: 0
PfcpsmFlags:
    Drobu: false
    Qaurr: false
    Sndem: false
    Valid: false
Valid: true
NextHopId: 0
DuplParams:
    DestIf: ACCESS
    OuterHdr:
        OuterHdrDesc: 0
        Teid: 0
        IPv4Address: 209.165.201.30
        Port: 0
        Valid: false
    InterceptInfo:
        InterceptId: 0
        ChargingId: 0
        SmfLiNodeId:
            IpDesc: 0
            IPv4Address: 209.165.201.30
            Valid: false
        PduSessionId: 0
        Valid: false
    Valid: false
BarId: 0
CreateFar[1]:
    FarId: 2
    ApplyAction:
        Drop: true
        Frwd: false
        Buff: false
        Nocp: false
        Dupl: false
        Valid: true
    FwdParams:
        DestIf: CORE
        RedirectInfo:
            AddrType: 0
            Valid: false
        OuterHdr:
            OuterHdrDesc: 0
            Teid: 0
            IPv4Address: 209.165.201.30
            Port: 0
            Valid: false
        TEndptId: 1
        OuterPktTos: 255
        InnerPktTos: 255
        TosOpt:
            CopyInner: false
            CopyOuter: false
        SendTos: 0
        PfcpsmFlags:
            Drobu: false
            Qaurr: false
            Sndem: false
            Valid: false
        Valid: true
        NextHopId: 0
    DuplParams:
        DestIf: ACCESS
```

```

        OuterHdr:
            OuterHdrDesc: 0
            Teid: 0
            IPv4Address: 209.165.201.30
            Port: 0
            Valid: false
        InterceptInfo:
            InterceptId: 0
            ChargingId: 0
            SmfLiNodeId:
                IpDesc: 0
                IPv4Address: 209.165.201.30
                Valid: false
            PduSessionId: 0
            Valid: false
        Valid: false
    BarId: 0
CreateTEndpt:
    CreateTEndpt[0]:
        EndpointId: 1
        FTeid:
            Teid: 0
            IPv4Address: 209.165.201.30
            ChooseId: 0
        BearerLvlInfo:
            Valid: 1
            Qci: 6
    CreateTEndpt[1]:
        EndpointId: 2
        FTeid:
            Teid: 0
            IPv4Address: 209.165.201.30
            ChooseId: 0
        BearerLvlInfo:
            Valid: 1
            Qci: 6
PdnType: 0
UplaneInacTimer: 0
MetaData: From:209.165.201.19:10665->To:209.165.201.20:8805
Supi:
Seid: 1297038098512740679
Seqno: 4252
Version: 0
MsgPriority: false
MsgPriorityVal: 0
Cmnid: 0
Rseid: 0
IntfType: 0
HdrLen: 0
MsgLen: 0
UserIDInfo:
    Imsi: 123456789012348
    Imei: 123456786666660
    Msisdn: 223310101010101
    Valid: true
XHeaderInfo:
    RatType:
        Valid: false
CfPolicyId:
    PolicyId: 0
    Valid: false
ChargingDisabled:
    Valid: false
    Value: false

```

```

ChargingParams:
  Valid: 0
  GyOfflineChargingEnabled: 0
  NextHopIPv4: 0

```

```

-----
Subscriber Id: imsi-123456789012348
Timestamp: 2021/08/15 12:39:25.371114
Message: Sx Session Establishment Response
Description: Sx Session Establishment Response Message from SGWU to SGWC
Source: 209.165.201.20 (SGW.udp-proxy.DC.Local.0)
Destination: 209.165.201.19 (SGW.protocol.DC.Local.1)
PAYLOAD:

```

```

  Sx Session Establishment Response:
    Sx Session Establishment Response:
      Cause: 1
      OffendingIe: 0
      FSeid:
        Seid: 10002
        IPv4Address: 209.165.201.20
      CreatedTEndpt:
        CreatedTEndpt[0]:
          EndpointId: 1
          FTeid:
            Teid: 25270
            IPv4Address: 209.165.201.1
            ChooseId: 0
          CreatedTEndpt[1]:
            EndpointId: 2
            FTeid:
              Teid: 25271
              IPv4Address: 209.165.200.226
              ChooseId: 0
        MetaData: From:209.165.201.20:8805->To:209.165.201.19:10665
      Supi:
      Seid: 1297038098512740679
      Seqno: 4252
      Version: 0
      MsgPriority: false
      MsgPriorityVal: 0
      Cmnid: 0
      Rseid: 0
      IntfType: 0
      HdrLen: 0
      MsgLen: 0
      LoadControlInfo:
        SeqNum: 0
        Metric: 0
        Valid: false
      OverloadControlInfo:
        SeqNum: 0
        Metric: 0
        Ociflag: 0
        Valid: false

```

```

-----
Subscriber Id: imsi-123456789012348
Timestamp: 2021/08/15 12:39:25.377609
Message: GtpEpDecodeRPCResponse
Description: 2071
Source:
Destination:

```

PAYLOAD:

```

-----
Subscriber Id: imsi-123456789012348
Timestamp: 2021/08/15 12:39:25.379043
Message: S5 S8 Create Session Request
Description: S5 S8 Create Session Request Message
Source: 209.165.201.19
Destination: 209.165.201.18
PAYLOAD:
  S5 S8 Create Session Request:
    S5 S8 Create Session Request:
      Version: 2
      Pflag: false
      TEIDflag: true
      MsgPriority: false
      MsgLength: 221
      TIED: 0
      Seq: 66683
      MsgTypeId: 32
      MsgPriorityValue: 0
      Peer_IPv4_Flag: false
      Peer_IPv6_Flag: false
      MetaData: From:209.165.201.19:15001->To:209.165.201.18:2123
      Seid: 0
      Rseid: 0
      Cmnid: 0
      MsgType:
        Create_Session_Request:
          IMSI: 123456789012348
          Recovery:
            Value: 0
          APN: intershat
          AMBR: UL: 232323 kbps, DL: 232323 kbps
          MEI: 1234567866666660
          MSISDN: 223310101010101
          Indication:
            DAF: false
            DTF: false
            HI: false
            DFI: false
            OI: false
            ISRSI: false
            ISRAI: false
            SGWCI: false
            SQCI: false
            UIMSI: false
            CFSI: false
            CRSI: false
            P: false
            PT: false
            SI: false
            MSV: false
            RetLoc: false
            PBIC: false
            SRNI: false
            S6AF: false
            S4AF: false
            MBMDT: false
            ISRAU: false
            CCRSI: false
            CPRAI: false
            ARRL: false

```

```

PPOF: false
PPON_PPEI: false
PPSI: false
CSFBI: false
CLII: false
CPSR: false
NSI: false
UASI: false
DTCI: false
BDWI: false
PSCI: false
PCRI: false
AOSI: false
AOPI: false
ROAAI: false
EPCOSI: false
CPOPCI: false
PMTSMI: false
S11TF: false
PNSI: false
UNACCSI: false
WPMSI: false
5GSIWK: false
EEVRSI: false
LTEMUI: false
LTEMPI: false
ENBCRSI: false
TSPCMI: false
PGBK: false
PCPSI: false
PCP: false
PCPU: false
N26_5GS: false
RI_5GCN: false
RS_5GCN: false
PAA:
  PDN_Type: 1
  IPv4: 209.165.201.30
  IPv6_Prefix: 0
RAT_Type:
  Value: 6
Serving_Network:
  MCC: 123
  MNC: 456
ULI:
  UliTai: Mcc: 123, Mnc: 456, TAC: 2346
  UliEcgi:
    Mcc: 123
    Mnc: 456
    Eci: 1234567
FQ_TEID:
  SgwCntrl:
    IFace: 6
    TEID: 1375732039
    IPv4: 209.165.201.19
Bearer_Context_List:
  NumBearerCtxt: 1
  PbBearerCxt:
    PbBearerCxt[0]:
      BearerCtxType: 0
      EBI: 5
      Fqteid:
        SgwData:
          IFace: 0
```

```

TEID: 25270
IPv4: 209.165.201.1
BearerQos:
  PCI: true
  PL: 12
  PVI: true
  QCI: 6
  UL_MBR: 0 kbps
  DL_MBR: 0 kbps
  UL_GBR: 0 kbps
  DL_GBR: 0 kbps
  Arp: 113
  QciType: 0
Charging_Characteristics:
  Value:
    Value[0]: 210
    Value[1]: 4
    Value[2]: 0
    Value[3]: 0
PDN_Type:
  Value: 1
UE_Time_Zone:
  Time_Zone: 16
  Daylight_Saving_Time: 1
APN_Restriction:
  Value: 0
Selection_Mode:
  Value: 0
EPCO:
  Len: 5
  Value:
    Value[0]: 128
    Value[1]: 0
    Value[2]: 26
    Value[3]: 1
    Value[4]: 5

```

```

-----
Subscriber Id: imsi-123456789012348
Timestamp: 2021/06/08 04:37:51.487884
Message: GtpEpDecodeRPCResponse
Description: 2071
Source:
Destination:
PAYLOAD:

```

```

-----
Subscriber Id: imsi-123456789012348
Timestamp: 2021/06/08 04:37:51.487884
Message: GtpEpDecodeRPCIPResponse
Description: 2071
Source:
Destination:
PAYLOAD:

```

```

-----
Subscriber Id: imsi-123456789012348
Timestamp: 2021/08/15 12:39:25.475859
Message: GtpEpDecodeRPCResponse
Description: 2071
Source:

```

Destination:
PAYLOAD:

```

-----
Subscriber Id: imsi-123456789012348
Timestamp: 2021/08/15 12:39:25.476252
Message: S5 S8 Create Session Response
Description: S5 S8 Create Session Response Message
Source: 209.165.201.18
Destination: 209.165.201.19
PAYLOAD:
  S5 S8 Create Session Response:
    S5 S8 Create Session Response:
      Version: 2
      Pflag: false
      TEIDflag: true
      MsgPriority: false
      MsgLength: 107
      TIED: 1375732039
      Seq: 66683
      MsgTypeId: 33
      MsgPriorityValue: 0
      Peer_IPv4_Flag: false
      Peer_IPv6_Flag: false
      MetaData: From:209.165.201.18:0->To:209.165.201.19:0
      Seid: 0
      Rseid: 0
      Cmnid: 0
      MsgType:
        Create_Session_Response:
          Cause:
            Cause_Value: 16
            PCE: false
            BCE: false
            OrigInd: false
          Recovery:
            Value: 100
          AMBR: UL: 10 kbps, DL: 20 kbps
          PAA:
            PDN_Type: 1
            IPv4: 209.165.201.26
            IPv6_Prefix: 0
          FQ_TEID:
            PgwCntrl:
              IFace: 7
              TEID: 13210
              IPv4: 209.165.201.18
          Bearer_Context_List:
            NumBearerCtxt: 1
            PbBearerCxt:
              PbBearerCxt[0]:
                BearerCtxType: 0
                EBI: 5
                Cause:
                  Cause_Value: 16
                  PCE: false
                  BCE: false
                  OrigInd: false
                Fqteid:
                  PgwData:
                    IFace: 5
                    TEID: 13211
                    IPv4: 209.165.201.18

```

```

ChrgId:
  Value: 303174163
APN_Restriction:
  Value: 1

```

```

-----
Subscriber Id: imsi-123456789012348
Timestamp: 2021/08/15 12:39:25.483195
Message: Sx Session Modification Request
Description: Sx Session Modification Request Message from SGWC to SGWU
Source: 209.165.201.19 (SGW.protocol.DC.Local.2)
Destination: 209.165.201.20 (SGW.udp-proxy.DC.Local.0)
PAYLOAD:
  Sx Session Modification Request:
    Sx Session Modification Request:
      UpdatePdr:
        UpdatePdr[0]:
          PdrId: 1
          OuterHdrRem: 0
          Precedence: 0
          Pdi:
            SrcIf: ACCESS
            UeIp:
              Src: false
              Dst: false
              IPv4Addr: 209.165.201.30
            TEndpointId: 0
            Valid: false
          Qfi: 0
        UpdateFar:
          UpdateFar[0]:
            FarId: 2
            ApplyAction:
              Drop: false
              Frwd: true
              Buff: false
              Nocp: false
              Dupl: false
              Valid: true
            UpdateFwdParams:
              DestIf: ACCESS
              RedirectInfo:
                AddrType: 0
                Valid: false
            OuterHdr:
              OuterHdrDesc: 256
              Teid: 13211
              IPv4Address: 209.165.201.18
              Port: 0
              Valid: true
            TEndPointId: 0
            OuterPktTos: 0
            InnerPktTos: 0
            TosOpt:
              CopyInner: false
              CopyOuter: false
            SendTos: 0
            PfcpsmFlags:
              Drobu: false
              Qaurr: false
              Sndem: false
              Valid: false
            Valid: true

```

```
NextHopId: 0
UpdateDuplParams:
  DestIf: ACCESS
  OuterHdr:
    OuterHdrDesc: 0
    Teid: 0
    IPv4Address: 209.165.201.30
    Port: 0
    Valid: false
  InterceptInfo:
    InterceptId: 0
    ChargingId: 0
    SmfLiNodeId:
      IpDesc: 0
      IPv4Address: 209.165.201.30
      Valid: false
    PduSessionId: 0
    Valid: false
  Valid: false
BarId: 0
UplaneInacTimer: 0
MetaData: From:209.165.201.19:10002->To:209.165.201.20:8805
Supi:
Seid: 1297038098512740679
Seqno: 4248
Version: 0
MsgPriority: false
MsgPriorityVal: 0
Cmnid: 0
Rseid: 10002
IntfType: 0
HdrLen: 0
MsgLen: 0
PfcpsmFlags:
  Drobu: false
  Qaurr: false
  Sndem: false
  Valid: false
UserIDInfo:
  Valid: false
XHeaderInfo:
  RatType:
  Valid: false
CfPolicyId:
  PolicyId: 0
  Valid: false
GyStatus:
  Valid: false
  Value: false
ChargingDisabled:
  Valid: false
  Value: false
QueryInterface:
  Valid: false
  OfflineUrr: false
  OnlineUrr: false
  RadiusUrr: false
  BearerUrr: false
  SessUrr: false
```

```
-----
Subscriber Id: imsi-123456789012348
Timestamp: 2021/08/15 12:39:25.549171
```

```

Message: Sx Session Modification Response
Description: Sx Session Modification Response Message from SGWU to SGWC
Source: 209.165.201.20 (SGW.udp-proxy.DC.Local.0)
Destination: 209.165.201.19 (SGW.protocol.DC.Local.2)
PAYLOAD:
  Sx Session Modification Response:
    Sx Session Modification Response:
      Cause: 1
      OffendingIe: 0
      LoadControlInfo:
        SeqNum: 0
        Metric: 0
        Valid: false
      OverloadControlInfo:
        SeqNum: 0
        Metric: 0
        Ociflag: 0
        Valid: false
      MetaData: From:209.165.201.20:8805->To:209.165.201.19:10002
      Supi:
      Seid: 1297038098512740679
      Seqno: 4248
      Version: 1
      MsgPriority: false
      MsgPriorityVal: 0
      Cmnid: 0
      Rseid: 0
      IntfType: 0
      HdrLen: 17
      MsgLen: 0

```

```

-----
Subscriber Id: imsi-123456789012348
Timestamp: 2021/08/15 12:39:25.262224
Message: S11 Create Session Request
Description: S11 Create Session Request Message
Source: 209.165.201.20
Destination: 209.165.201.19
PAYLOAD:
  S11 Create Session Request:
    S11 Create Session Request:
      Version: 2
      Pflag: false
      TEIDflag: true
      MsgPriority: false
      MsgLength: 223
      TIED: 0
      Seq: 5842
      MsgTypeId: 32
      MsgPriorityValue: 0
      Peer_IPv4_Flag: false
      Peer_IPv6_Flag: false
      MetaData: From:209.165.201.20:2123->To:209.165.201.19:2123
      Seid: 0
      Rseid: 0
      Cmnid: 0
      MsgType:
        Create_Session_Request:
          IMSI: 123456789012348
          Recovery:
            Value: 100
          APN: intershat
          AMBR: UL: 232323 kbps, DL: 232323 kbps

```

```
MEI: 123456786666660
MSISDN: 223310101010101
Indication:
  DAF: false
  DTF: false
  HI: false
  DFI: false
  OI: false
  ISRSI: false
  ISRAI: false
  SGWCI: false
  SQCI: false
  UIMSI: false
  CFSI: false
  CRSI: false
  P: false
  PT: false
  SI: false
  MSV: false
  RetLoc: false
  PBIC: false
  SRNI: false
  S6AF: false
  S4AF: false
  MBMDT: false
  ISRAU: false
  CCRSI: false
  CPRAI: false
  ARRL: false
  PPOF: false
  PPON_PPEI: false
  PPSI: false
  CSFBI: false
  CLII: false
  CPSR: false
  NSI: false
  UASI: false
  DTCI: false
  BDWI: false
  PSCI: false
  PCRI: false
  AOSI: false
  AOPi: false
  ROAAI: false
  EPCOSI: false
  CPOPCI: false
  PMTSMI: false
  S11TF: false
  PNSI: false
  UNACCSI: false
  WPMSI: false
  5GSIWK: false
  EEVRSI: false
  LTEMUI: false
  LTEMPI: false
  ENBCRSI: false
  TSPCMI: false
  PGBK: false
  PCPSI: false
  PCP: false
  PCPU: false
  N26_5GS: false
  RI_5GCN: false
  RS_5GCN: false
```

```

PAA:
  PDN_Type: 1
  IPv4: 209.165.201.30
  IPv6_Prefix: 0
RAT_Type:
  Value: 6
Serving_Network:
  MCC: 123
  MNC: 456
ULI:
  UliTai: Mcc: 123, Mnc: 456, TAC: 2346
  UliEcgi:
    Mcc: 123
    Mnc: 456
    Eci: 1234567
FQ_TEID:
  MmcCntrl:
    IFace: 10
    TEID: 25269
    IPv4: 209.165.201.20
  PgwCntrl:
    IFace: 7
    TEID: 0
    IPv4: 209.165.201.18
Bearer_Context_List:
  NumBearerCtxt: 1
  PbBearerCxt:
    PbBearerCxt[0]:
      BearerCtxType: 0
      EBI: 5
      Fqteid:
      BearerQos:
        PCI: true
        PL: 12
        PVI: true
        QCI: 6
        UL_MBR: 0 kbps
        DL_MBR: 0 kbps
        UL_GBR: 0 kbps
        DL_GBR: 0 kbps
        Arp: 113
        QciType: 0
Charging_Characteristics:
  Value:
    Value[0]: 210
    Value[1]: 4
    Value[2]: 0
    Value[3]: 0
PDN_Type:
  Value: 1
UE_Time_Zone:
  Time_Zone: 16
  Daylight_Saving_Time: 1
APN_Restriction:
  Value: 0
Selection_Mode:
  Value: 0
EPCO:
  Len: 5
  Value:
    Value[0]: 128
    Value[1]: 0
    Value[2]: 26
    Value[3]: 1

```

Value[4]: 5

```
-----
Subscriber Id: imsi-123456789012348
Timestamp: 2021/08/15 12:39:25.568954
Message: GtpEpDecodeRPCResponse
Description: 258
Source:
Destination:
PAYLOAD:
```

```
-----
Subscriber Id: imsi-123456789012348
Timestamp: 2021/08/15 12:39:25.569939
Message: S11 Create Session Response
Description: S11 Create Session Response Message
Source: 209.165.201.19
Destination: 209.165.201.20
PAYLOAD:
  S11 Create Session Response:
    S11 Create Session Response:
      Version: 2
      Pflag: false
      TEIDflag: true
      MsgPriority: false
      MsgLength: 120
      TIED: 25269
      Seq: 5842
      MsgTypeId: 33
      MsgPriorityValue: 0
      Peer_IPv4_Flag: false
      Peer_IPv6_Flag: false
      MetaData: From:209.165.201.19:2123->To:209.165.201.20:2123
      Seid: 0
      Rseid: 0
      Cmnid: 0
      MsgType:
        Create_Session_Response:
          Cause:
            Cause_Value: 16
            PCE: false
            BCE: false
            OrigInd: false
          Recovery:
            Value: 0
          AMBR: UL: 10 kbps, DL: 20 kbps
          PAA:
            PDN_Type: 1
            IPv4: 209.165.201.26
            IPv6_Prefix: 0
          FQ_TEID:
            PgwCntrl:
              IFace: 7
              TEID: 13210
              IPv4: 209.165.201.18
            SgwCntrl:
              IFace: 11
              TEID: 301990215
              IPv4: 209.165.201.19
          Bearer_Context_List:
            NumBearerCtxt: 1
            PbBearerCxt:
```

```

PbBearerCxt[0]:
  BearerCtxType: 0
  EBI: 5
  Cause:
    Cause_Value: 16
    PCE: false
    BCE: false
    OrigInd: false
  Fqteid:
    PgwData:
      IFace: 5
      TEID: 13211
      IPv4: 209.165.201.18
    SgwData:
      IFace: 1
      TEID: 25271
      IPv4: 209.165.200.226
  ChrgId:
    Value: 303174163
APN_Restriction:
  Value: 1

```

```

-----
Subscriber Id: imsi-123456789012348
Timestamp: 2021/08/15 12:39:25.570132
Message: S11 Create Session Response
Description: S11 Create Session Response Message
Source: 209.165.201.19
Destination: 209.165.201.20
PAYLOAD:
  S11 Create Session Response:
    S11 Create Session Response:
      Version: 2
      Pflag: false
      TEIDflag: true
      MsgPriority: false
      MsgLength: 120
      TIED: 25269
      Seq: 5842
      MsgTypeId: 33
      MsgPriorityValue: 0
      Peer_IPv4_Flag: false
      Peer_IPv6_Flag: false
      MetaData: From:209.165.201.19:2123->To:209.165.201.20:2123
      Seid: 0
      Rseid: 0
      Cmnid: 0
      MsgType:
        Create_Session_Response:
          Cause:
            Cause_Value: 16
            PCE: false
            BCE: false
            OrigInd: false
          Recovery:
            Value: 0
          AMBR: UL: 10 kbps, DL: 20 kbps
          PAA:
            PDN_Type: 1
            IPv4: 209.165.201.26
            IPv6_Prefix: 0
          FQ_TEID:
            PgwCntrl:

```



```

        IFace: 7
        TEID: 13210
        IPv4: 209.165.201.18
    SgwCntrl:
        IFace: 11
        TEID: 301990215
        IPv4: 209.165.201.19
    Bearer_Context_List:
        NumBearerCtxt: 1
        PbBearerCxt:
            PbBearerCxt[0]:
                BearerCtxType: 0
                EBI: 5
                Cause:
                    Cause_Value: 16
                    PCE: false
                    BCE: false
                    OrigInd: false
                Fqteid:
                    PgwData:
                        IFace: 5
                        TEID: 13211
                        IPv4: 209.165.201.18
                    SgwData:
                        IFace: 1
                        TEID: 25271
                        IPv4: 209.165.200.226
                ChrgId:
                    Value: 303174163
    APN_Restriction:
        Value: 1

```

```

-----
Subscriber Id: imsi-123456789012348
Timestamp: 2021/08/15 12:39:25.652708
Message: Sx Session Modification Request
Description: Sx Session Modification Request Message from SGWC to SGWU
Source: 209.165.201.19 (SGW.protocol.DC.Local.0)
Destination: 209.165.201.20 (SGW.udp-proxy.DC.Local.0)
PAYLOAD:
    Sx Session Modification Request:
        Sx Session Modification Request:
            UpdatePdr:
                UpdatePdr[0]:
                    PdrId: 2
                    OuterHdrRem: 0
                    Precedence: 0
                    Pdi:
                        SrcIf: ACCESS
                        UeIp:
                            Src: false
                            Dst: false
                            IPv4Addr: 209.165.201.30
                        TEndpointId: 0
                        Valid: false
                    Qfi: 0
            UpdateFar:
                UpdateFar[0]:
                    FarId: 1
                    ApplyAction:
                        Drop: false
                        Frwd: true
                        Buff: false

```

```

    Nocp: false
    Dupl: false
    Valid: true
  UpdateFwdParams:
    DestIf: ACCESS
    RedirectInfo:
      AddrType: 0
      Valid: false
    OuterHdr:
      OuterHdrDesc: 256
      Teid: 25272
      IPv4Address: 209.165.201.20
      Port: 0
      Valid: true
    TEndptId: 0
    OuterPktTos: 0
    InnerPktTos: 0
    TosOpt:
      CopyInner: false
      CopyOuter: false
    SendTos: 0
    PfcpsmFlags:
      Drobu: false
      Qaurr: false
      Sndem: false
      Valid: false
    Valid: true
    NextHopId: 0
  UpdateDuplParams:
    DestIf: ACCESS
    OuterHdr:
      OuterHdrDesc: 0
      Teid: 0
      IPv4Address: 209.165.201.30
      Port: 0
      Valid: false
    InterceptInfo:
      InterceptId: 0
      ChargingId: 0
      SmfLiNodeId:
        IpDesc: 0
        IPv4Address: 209.165.201.30
        Valid: false
      PduSessionId: 0
      Valid: false
    Valid: false
  BarId: 0
  UplaneInacTimer: 0
  MetaData: From:209.165.201.19:13486->To:209.165.201.20:8805
  Supi:
  Seid: 1297038098512740679
  Seqno: 4245
  Version: 0
  MsgPriority: false
  MsgPriorityVal: 0
  Cmnid: 0
  Rseid: 10002
  IntfType: 0
  HdrLen: 0
  MsgLen: 0
  PfcpsmFlags:
    Drobu: false
    Qaurr: false
    Sndem: false

```

```

Valid: false
UserIDInfo:
Valid: false
XHeaderInfo:
RatType:
Valid: false
CfPolicyId:
PolicyId: 0
Valid: false
GyStatus:
Valid: false
Value: false
ChargingDisabled:
Valid: false
Value: false
QueryInterface:
Valid: false
OfflineUrr: false
OnlineUrr: false
RadiusUrr: false
BearerUrr: false
SessUrr: false

```

```

-----
Subscriber Id: imsi-123456789012348
Timestamp: 2021/08/15 12:39:25.713891
Message: Sx Session Modification Response
Description: Sx Session Modification Response Message from SGWU to SGWC
Source: 209.165.201.20 (SGW.udp-proxy.DC.Local.0)
Destination: 209.165.201.19 (SGW.protocol.DC.Local.0)
PAYLOAD:
  Sx Session Modification Response:
    Sx Session Modification Response:
      Cause: 1
      OffendingIe: 0
      LoadControlInfo:
        SeqNum: 0
        Metric: 0
        Valid: false
      OverloadControlInfo:
        SeqNum: 0
        Metric: 0
        Ociflag: 0
        Valid: false
      MetaData: From:209.165.201.20:8805->To:209.165.201.19:13486
      Supi:
      Seid: 1297038098512740679
      Seqno: 4245
      Version: 1
      MsgPriority: false
      MsgPriorityVal: 0
      Cmnid: 0
      Rseid: 0
      IntfType: 0
      HdrLen: 17
      MsgLen: 0

```

```

-----
Subscriber Id: imsi-123456789012348
Timestamp: 2021/08/15 12:39:25.640179
Message: S11 Modify Bearer Request
Description: S11 Modify Bearer Request Message

```

```

Source: 209.165.201.20
Destination: 209.165.201.19
PAYLOAD:
  S11 Modify Bearer Request:
    S11 Modify Bearer Request:
      Version: 2
      Pflag: false
      TEIDflag: true
      MsgPriority: false
      MsgLength: 58
      TIED: 301990215
      Seq: 5843
      MsgTypeId: 34
      MsgPriorityValue: 0
      Peer_IPv4_Flag: false
      Peer_IPv6_Flag: false
      MetaData: From:209.165.201.20:2123->To:209.165.201.19:2123
      Seid: 0
      Rseid: 0
      Cmnid: 0
      MsgType:
        Modify_Bearer_Request:
          RAT_Type:
            Value: 6
          Indication:
            DAF: false
            DTF: false
            HI: false
            DFI: false
            OI: false
            ISRSI: false
            ISRAI: false
            SGWCI: false
            SQCI: false
            UIMSI: false
            CFSI: false
            CRSI: false
            P: false
            PT: false
            SI: false
            MSV: false
            RetLoc: false
            PBIC: false
            SRNI: false
            S6AF: false
            S4AF: false
            MBMDT: false
            ISRAU: false
            CCRSI: false
            CPRAI: false
            ARRL: false
            PPOF: false
            PPON_PPEI: false
            PPSI: false
            CSFBI: false
            CLII: false
            CPSR: false
            NSI: false
            UASI: false
            DTCTI: false
            BDWI: false
            PSCI: false
            PCRI: false
            AOSI: false

```

```

AOPI: false
ROAAI: false
EPCOSI: false
CPOPCI: false
PMTSMI: false
S11TF: false
PNSI: false
UNACCSI: false
WPMSI: false
5GSIWK: false
EEVRSI: false
LTEMUI: false
LTEMP: false
ENBCRSI: false
TSPCMI: false
PGBK: false
PCPSI: false
PCP: false
PCPU: false
N26_5GS: false
RI_5GCN: false
RS_5GCN: false
FQ_TEID:
DelayValue:
  Value: 0
Recovery:
  Value: 100
Bearer_Context_List:
  NumBearerCtxt: 1
  PbBearerCxt:
    PbBearerCxt[0]:
      BearerCtxType: 0
      EBI: 5
      Fqteid:
        ENbData:
          IFace: 0
          TEID: 25272
          IPv4: 209.165.201.20

```

```

-----
Subscriber Id: imsi-123456789012348
Timestamp: 2021/08/15 12:39:25.729811
Message: S11 Modify Bearer Response
Description: S11 Modify Bearer Response Message
Source: 209.165.201.19
Destination: 209.165.201.20
PAYLOAD:
  S11 Modify Bearer Response:
    S11 Modify Bearer Response:
      Version: 2
      Pflag: false
      TEIDflag: true
      MsgPriority: false
      MsgLength: 42
      TIED: 25269
      Seq: 5843
      MsgTypeId: 35
      MsgPriorityValue: 0
      Peer_IPv4_Flag: false
      Peer_IPv6_Flag: false
      MetaData: From:209.165.201.19:2123->To:209.165.201.20:2123
      Seid: 0
      Rseid: 0

```

```

Cmnid: 0
MsgType:
  Modify_Bearer_Response:
    Cause:
      Cause_Value: 16
      PCE: false
      BCE: false
      OrigInd: false
    Bearer_Context_List:
      NumBearerCtxt: 1
      PbBearerCxt:
        PbBearerCxt[0]:
          BearerCtxType: 0
          EBI: 5
          Cause:
            Cause_Value: 16
            PCE: false
            BCE: false
            OrigInd: false
          Fqteid:
            SgwData:
              IFace: 1
              TEID: 25271
              IPv4: 209.165.200.226

```

```

-----
Subscriber Id: imsi-123456789012348
Timestamp: 2021/08/15 12:39:25.730371
Message: S11 Modify Bearer Response
Description: S11 Modify Bearer Response Message
Source: 209.165.201.19
Destination: 209.165.201.20
PAYLOAD:
  S11 Modify Bearer Response:
    S11 Modify Bearer Response:
      Version: 2
      Pflag: false
      TEIDflag: true
      MsgPriority: false
      MsgLength: 42
      TIED: 25269
      Seq: 5843
      MsgTypeId: 35
      MsgPriorityValue: 0
      Peer_IPv4_Flag: false
      Peer_IPv6_Flag: false
      MetaData: From:209.165.201.19:2123->To:209.165.201.20:2123
      Seid: 0
      Rseid: 0
      Cmnid: 0
      MsgType:
        Modify_Bearer_Response:
          Cause:
            Cause_Value: 16
            PCE: false
            BCE: false
            OrigInd: false
          Bearer_Context_List:
            NumBearerCtxt: 1
            PbBearerCxt:
              PbBearerCxt[0]:
                BearerCtxType: 0
                EBI: 5

```

```

Cause:
Cause_Value: 16
PCE: false
BCE: false
OrigInd: false
Fqteid:
SgwData:
IFace: 1
TEID: 25271
IPv4: 209.165.200.226

-----

command terminated with exit code 124
  % Total      % Received % Xferd  Average Speed   Time
Time         Time    Current                Dload  Upload   Total
Spent       Left  Speed
100  222  100    35  100   187   4375  23375
--:--:-- --:--:-- --:--:--  27750
Stop Response Disabled mon_sub as part of timeout for
Cmd: --header Content-type:application/json --request
POST --data
{"commandname":"mon_sub","parameters":{"supi":"imsi-*","duration":300,
"enableTxnLog":false,"enableInternalMsg":false,"action":"stop","namespace":
"sgw","nf-service":"none","grInstance":0}}
http://oam-pod:8879/commands

```

Configuring the Monitor Protocol

To configure this feature, use the following configuration:

```

exec
  monitor protocol interface interface
    capture-duration capture_duration
    pcap [ Yes | No ]
    gr-instance gr_instance
  end

```

NOTES:

- **monitor protocol interface *interface***—Specify the interface on which PCAP is captured. For example, *sbi*, *pfcp*, *gtpu*, *gtpc*, *gtp*, and *radius*.
- **capture-duration *capture_duration***—Specify the duration in seconds during which PCAP is captured. The default value is 300 seconds.
- **pcap [Yes | No]**—Configures the PCAP file generation. By default, the pcap feature is disabled.
- **gr-instance *gr_instance***—Specify the GR instance that the cnSGW-C monitors the subscriber for.



Note If the GTP endpoint IPs are the same on S5e and S11 interfaces, the protocol output is inconsistent and displays S11 for the S5 interface on which the message is received. The following is a sample of an endpoint configuration:

```

instance instance-id 1 endpoint gtp replicas 3 interface s5e vip-ip 209.165.201.22
instance instance-id 1 endpoint gtp replicas 3 interface s11 vip-ip 209.165.201.22

```

Configuration Example

The following is an example configuration.

```
monitor protocol interface pfcfp,gtpc capture-duration 100 pcap yes
```

Sample Output

The following is a sample output.

```
monitor protocol interface pfcfp,gtpc capture-duration 100 pcap yes
% Total    % Received % Xferd  Average Speed   Time    Time     Time  Current
           Dload  Upload   Total     Spent    Left  Speed
100    231    100    101    100    130    6733    8666  --:--:--  --:--:--  --:--:-- 15400
Command: --header Content-type:application/json --request POST --data
{"commandname":"mon_pro","parameters":{"interface":"pfcfp, gtpc","duration":
:100,"action":"start","enable_pcap": true,"grInstance":0}} http://oam-pod:8879/commands
Result start mon_pro, fileName -> logs/monprologs/sessintfname_pfcfp,
gtpc_at_2021-06-06T06:15:39.005414271.txt
Starting to tail the monpro messages from file: logs/monprologs/sessintfname_pfcfp,
gtpc_at_2021-06-06T06:15:39.005414271.txt
Defaulting container name to oam-pod.
Use 'kubectl describe pod/oam-pod-0 -n cn' to see all of the containers in this pod.
InterfaceName = gtpc | InterfaceIP = 209.165.200.229 | Filter = (tcp or udp or sctp)
and (port 2123 or (host 209.165.200.227 and port 2123)
or (host 209.165.201.11 and port 2123) or (host 209.165.200.228 and port 2123))
<<<<OUTBOUND
from 209.165.200.229:15002 to 209.165.200.228:2123
Protocol: UDP | Sequence Number: 0
Packet Metadata: {Timestamp:2021-06-06 06:16:00.373101 +0000 UTC CaptureLength:59
Length:59 InterfaceIndex:0 AncillaryData:[]}
```

```
Packet Raw Bytes:
0004000100060050569c095908004528002dcc0e4000401
155510a01029c0a01029b3a9a084b001919634863000d000008d0
020175004900010005
```

```
Packet Dump:
-- FULL PACKET DATA (59 bytes) -----
00000000  00 04 00 01 00 06 00 50  56 9c 09 59 08 00 45 28  |.....PV..Y..E(|
00000010  00 2d cc 0e 40 00 40 11  55 51 0a 01 02 9c 0a 01  |...@.@.UQ.....|
00000020  02 9b 3a 9a 08 4b 00 19  19 63 48 63 00 0d 00 00  |...K...cHc....|
00000030  08 d0 02 01 75 00 49 00  01 00 05                    |...u.I....|
--- Layer 1 ---
Ethernet      {Contents=[..14..] Payload=[..45..] SrcMAC=00:50:56:9c:09:59
DstMAC=00:04:00:01:00:06 EthernetType=IPv4 Length=0}
00000000  00 04 00 01 00 06 00 50  56 9c 09 59 08 00         |.....PV..Y..|
--- Layer 2 ---
IPv4          {Contents=[..20..] Payload=[..25..] Version=4 IHL=5 TOS=40 Length=45
Id=52238 Flags=DF FragOffset=0 TTL=64 Protocol=UDP
Checksum=21841 SrcIP=209.165.200.229 DstIP=209.165.200.228 Options=[] Padding=[]}
00000000  45 28 00 2d cc 0e 40 00  40 11 55 51 0a 01 02 9c  |E(-..@.@.UQ....|
00000010  0a 01 02 9b                    |....|
--- Layer 3 ---
UDP           {Contents=[..8..] Payload=[..17..] SrcPort=15002 DstPort=2123(gtp-control)
Length=25 Checksum=6499}
00000000  3a 9a 08 4b 00 19 19 63          |...K...c|
--- Layer 4 ---
Payload 17 byte(s)
00000000  48 63 00 0d 00 00 08 d0  02 01 75 00 49 00 01 00  |Hc.....u.I...|
00000010  05                               |.|
```



```

InterfaceName = gtpc | InterfaceIP = 209.165.200.229 | Filter = (tcp or udp or sctp)
and (port 2123 or (host 209.165.200.227 and port 2123)
or (host 209.165.201.11 and port 2123) or (host 209.165.200.228 and port 2123))
<<<<OUTBOUND
from 209.165.200.229:15000 to 209.165.200.227:2123
Protocol: UDP | Sequence Number: 0
Packet Metadata: {Timestamp:2021-06-06 06:16:00.373236 +0000 UTC CaptureLength:72
Length:72 InterfaceIndex:0 AncillaryData:[]}

Packet Raw Bytes:
0004000100060050569c095908004528003a9af
c4000401186570a01029c0a01029a3a98084b0026196f 4824001a0000074a
00014f0049000100055700090086510000970a01029c

Packet Dump:
-- FULL PACKET DATA (72 bytes) -----
00000000 00 04 00 01 00 06 00 50 56 9c 09 59 08 00 45 28 |.....PV..Y..E(|
00000010 00 3a 9a fc 40 00 40 11 86 57 0a 01 02 9c 0a 01 ||...@.e..w.....|
00000020 02 9a 3a 98 08 4b 00 26 19 6f 48 24 00 1a 00 00 ||...K.&.oH$....|
00000030 07 4a 00 01 4f 00 49 00 01 00 05 57 00 09 00 86 |.J..O.I....W....|
00000040 51 00 00 97 0a 01 02 9c |Q.....|
--- Layer 1 ---
Ethernet {Contents=[..14..] Payload=[..58..] SrcMAC=00:50:56:9c:09:59
DstMAC=00:04:00:01:00:06 EthernetType=IPv4 Length=0}
00000000 00 04 00 01 00 06 00 50 56 9c 09 59 08 00 |.....PV..Y..|
--- Layer 2 ---
IPv4 {Contents=[..20..] Payload=[..38..] Version=4 IHL=5 TOS=40 Length=58
Id=39676 Flags=DF FragOffset=0 TTL=64 Protocol=UDP
Checksum=34391 SrcIP=209.165.200.229 DstIP=209.165.200.227 Options=[] Padding=[]}
00000000 45 28 00 3a 9a fc 40 00 40 11 86 57 0a 01 02 9c |E(...@.e..w....|
00000010 0a 01 02 9a |....|
--- Layer 3 ---
UDP {Contents=[..8..] Payload=[..30..] SrcPort=15000(hydap) DstPort=2123(gtp-control)
Length=38 Checksum=6511}
00000000 3a 98 08 4b 00 26 19 6f |...K.&.o|
--- Layer 4 ---
Payload 30 byte(s)
00000000 48 24 00 1a 00 00 07 4a 00 01 4f 00 49 00 01 00 |H$.....J..O.I...|
00000010 05 57 00 09 00 86 51 00 00 97 0a 01 02 9c |.W....Q.....|

-----
InterfaceName = gtpc | InterfaceIP = 209.165.200.229 | Filter = (tcp or udp or sctp)
and (port 2123 or (host 209.165.200.227 and port 2123)
or (host 209.165.201.11 and port 2123) or (host 209.165.200.228 and port 2123))
<<<<OUTBOUND
from 209.165.200.229:15000 to 209.165.200.227:2123
Protocol: UDP | Sequence Number: 0
Packet Metadata: {Timestamp:2021-06-06 06:16:02.462216 +0000 UTC CaptureLength:72
Length:72 InterfaceIndex:0 AncillaryData:[]}

Packet Raw Bytes:
0004000100060050569c095908004528003a9cdc4000401184770a01029c0a
01029a3a98084b0026196f4824001a0000074a00014f0049000100055700090086510000970a01029c

Packet Dump:
-- FULL PACKET DATA (72 bytes) -----
00000000 00 04 00 01 00 06 00 50 56 9c 09 59 08 00 45 28 |.....PV..Y..E(|
00000010 00 3a 9c dc 40 00 40 11 84 77 0a 01 02 9c 0a 01 ||...@.e..w.....|
00000020 02 9a 3a 98 08 4b 00 26 19 6f 48 24 00 1a 00 00 ||...K.&.oH$....|
00000030 07 4a 00 01 4f 00 49 00 01 00 05 57 00 09 00 86 |.J..O.I....W....|
00000040 51 00 00 97 0a 01 02 9c |Q.....|
--- Layer 1 ---
Ethernet {Contents=[..14..] Payload=[..58..] SrcMAC=00:50:56:9c:09:59

```

Configuration Example

```

DstMAC=00:04:00:01:00:06 EthernetType=IPv4 Length=0}
00000000 00 04 00 01 00 06 00 50 56 9c 09 59 08 00 |.....PV..Y..|
--- Layer 2 ---
IPv4 {Contents=[..20..] Payload=[..38..] Version=4 IHL=5 TOS=40 Length=58
Id=40156 Flags=DF FragOffset=0 TTL=64 Protocol=UDP
Checksum=33911 SrcIP=209.165.200.229 DstIP=209.165.200.227 Options=[] Padding=[]}
00000000 45 28 00 3a 9c dc 40 00 40 11 84 77 0a 01 02 9c |E(...@.@..w....|
00000010 0a 01 02 9a |....|
--- Layer 3 ---
UDP {Contents=[..8..] Payload=[..30..] SrcPort=15000(hydap) DstPort=2123(gtp-control)
Length=38 Checksum=6511}
00000000 3a 98 08 4b 00 26 19 6f |:..K.&.o|
--- Layer 4 ---
Payload 30 byte(s)
00000000 48 24 00 1a 00 00 07 4a 00 01 4f 00 49 00 01 00 |H$.....J..O.I...|
00000010 05 57 00 09 00 86 51 00 00 97 0a 01 02 9c |.W....Q.....|

-----
InterfaceName = gtpc | InterfaceIP = 209.165.200.229 | Filter = (tcp or udp or sctp)
and (port 2123 or (host 209.165.200.227 and port 2123)
or (host 209.165.201.11 and port 2123) or (host 209.165.200.228 and port 2123))
<<<<OUTBOUND
from 209.165.200.229:15000 to 209.165.200.227:2123
Protocol: UDP | Sequence Number: 0
Packet Metadata: {Timestamp:2021-06-06 06:16:04.563024 +0000 UTC CaptureLength:72
Length:72 InterfaceIndex:0 AncillaryData:[]}

Packet Raw Bytes:
0004000100060050569c095908004528003a9e4740004011830c0a01029c0a01029a3a98084b
0026196f4824001a0000074a00014f0049000100055700090086510000970a01029c

Packet Dump:
-- FULL PACKET DATA (72 bytes) -----
00000000 00 04 00 01 00 06 00 50 56 9c 09 59 08 00 45 28 |.....PV..Y..E(|
00000010 00 3a 9e 47 40 00 40 11 83 0c 0a 01 02 9c 0a 01 |:..G@.@.....|
00000020 02 9a 3a 98 08 4b 00 26 19 6f 48 24 00 1a 00 00 |:..:..K.&.oH$.....|
00000030 07 4a 00 01 4f 00 49 00 01 00 05 57 00 09 00 86 |.J..O.I....W....|
00000040 51 00 00 97 0a 01 02 9c |Q.....|
--- Layer 1 ---
Ethernet {Contents=[..14..] Payload=[..58..] SrcMAC=00:50:56:9c:09:59
DstMAC=00:04:00:01:00:06 EthernetType=IPv4 Length=0}
00000000 00 04 00 01 00 06 00 50 56 9c 09 59 08 00 |.....PV..Y..|
--- Layer 2 ---
IPv4 {Contents=[..20..] Payload=[..38..] Version=4 IHL=5 TOS=40 Length=58
Id=40519 Flags=DF FragOffset=0 TTL=64 Protocol=UDP
Checksum=33548 SrcIP=209.165.200.229 DstIP=209.165.200.227 Options=[] Padding=[]}
00000000 45 28 00 3a 9e 47 40 00 40 11 83 0c 0a 01 02 9c |E(...G@.@.....|
00000010 0a 01 02 9a |....|
--- Layer 3 ---
UDP {Contents=[..8..] Payload=[..30..] SrcPort=15000(hydap)
DstPort=2123(gtp-control) Length=38 Checksum=6511}
00000000 3a 98 08 4b 00 26 19 6f |:..K.&.o|
--- Layer 4 ---
Payload 30 byte(s)
00000000 48 24 00 1a 00 00 07 4a 00 01 4f 00 49 00 01 00 |H$.....J..O.I...|
00000010 05 57 00 09 00 86 51 00 00 97 0a 01 02 9c |.W....Q.....|

-----
InterfaceName = gtpc | InterfaceIP = 209.165.200.229 | Filter = (tcp or udp or sctp)
and (port 2123 or (host 209.165.200.227 and port 2123)
or (host 209.165.201.11 and port 2123) or (host 209.165.200.228 and port 2123))
<<<<OUTBOUND

```

```

from 209.165.200.229:15000 to 209.165.200.227:2123
Protocol: UDP | Sequence Number: 0
Packet Metadata: {Timestamp:2021-06-06 06:16:06.662105 +0000 UTC CaptureLength:72
Length:72 InterfaceIndex:0 AncillaryData:[]}
```

```

Packet Raw Bytes:
0004000100060050569c095908004528003a9eb440004011829f0a01029c0a01029a3a
98084b0026196f4824001a0000074a00014f0049000100055700090086510000970a01029c
```

Packet Dump:

```

-- FULL PACKET DATA (72 bytes) -----
00000000 00 04 00 01 00 06 00 50 56 9c 09 59 08 00 45 28 |.....PV..Y..E(|
00000010 00 3a 9e b4 40 00 40 11 82 9f 0a 01 02 9c 0a 01 ||...@.@.....|
00000020 02 9a 3a 98 08 4b 00 26 19 6f 48 24 00 1a 00 00 ||...K.&.oH$....|
00000030 07 4a 00 01 4f 00 49 00 01 00 05 57 00 09 00 86 ||.J..O.I....W...|
00000040 51 00 00 97 0a 01 02 9c |Q.....|
--- Layer 1 ---
Ethernet {Contents=[..14..] Payload=[..58..] SrcMAC=00:50:56:9c:09:59
DstMAC=00:04:00:01:00:06 EthernetType=IPv4 Length=0}
00000000 00 04 00 01 00 06 00 50 56 9c 09 59 08 00 |.....PV..Y..|
--- Layer 2 ---
IPv4 {Contents=[..20..] Payload=[..38..] Version=4 IHL=5 TOS=40 Length=58
Id=40628 Flags=DF FragOffset=0 TTL=64 Protocol=UDP
Checksum=33439 SrcIP=209.165.200.229 DstIP=209.165.200.227 Options=[] Padding=[]}
00000000 45 28 00 3a 9e b4 40 00 40 11 82 9f 0a 01 02 9c |E(...@.@.....|
00000010 0a 01 02 9a |....|
--- Layer 3 ---
UDP {Contents=[..8..] Payload=[..30..] SrcPort=15000(hydap)
DstPort=2123(gtp-control) Length=38 Checksum=6511}
00000000 3a 98 08 4b 00 26 19 6f |...K.&.o|
--- Layer 4 ---
Payload 30 byte(s)
00000000 48 24 00 1a 00 00 07 4a 00 01 4f 00 49 00 01 00 |H$.....J..O.I...|
00000010 05 57 00 09 00 86 51 00 00 97 0a 01 02 9c |.W....Q.....|
```

```

-----
InterfaceName = gtpc | InterfaceIP = 209.165.200.229 | Filter = (tcp or udp or sctp)
and (port 2123 or (host 209.165.200.227 and port 2123)
or (host 209.165.201.11 and port 2123) or (host 209.165.200.228 and port 2123))
<<<<OUTBOUND
from 209.165.200.229:15002 to 209.165.200.228:2123
Protocol: UDP | Sequence Number: 0
Packet Metadata: {Timestamp:2021-06-06 06:16:07.385688 +0000 UTC CaptureLength:59
Length:59 InterfaceIndex:0 AncillaryData:[]}
```

```

Packet Raw Bytes:
0004000100060050569c095908004528002dd2dd400040114e820a0102
9c0a01029b3a9a084b001919634863000d000000 8d0020175004900010005
```

Packet Dump:

```

-- FULL PACKET DATA (59 bytes) -----
00000000 00 04 00 01 00 06 00 50 56 9c 09 59 08 00 45 28 |.....PV..Y..E(|
00000010 00 2d d2 dd 40 00 40 11 4e 82 0a 01 02 9c 0a 01 ||...@.@.N.....|
00000020 02 9b 3a 9a 08 4b 00 19 19 63 48 63 00 0d 00 00 ||...K...cHC....|
00000030 08 d0 02 01 75 00 49 00 01 00 05 |.....u.I....|
--- Layer 1 ---
Ethernet {Contents=[..14..] Payload=[..45..] SrcMAC=00:50:56:9c:09:59
DstMAC=00:04:00:01:00:06 EthernetType=IPv4 Length=0}
00000000 00 04 00 01 00 06 00 50 56 9c 09 59 08 00 |.....PV..Y..|
--- Layer 2 ---
IPv4 {Contents=[..20..] Payload=[..25..] Version=4 IHL=5 TOS=40 Length=45
Id=53981 Flags=DF FragOffset=0 TTL=64 Protocol=UDP
Checksum=20098 SrcIP=209.165.200.229 DstIP=209.165.200.228 Options=[] Padding=[]}
```

Configuration Example

```

00000000 45 28 00 2d d2 dd 40 00 40 11 4e 82 0a 01 02 9c |E(.-..@.@.N.....|
00000010 0a 01 02 9b                                     |....|
--- Layer 3 ---
UDP      {Contents=[..8..] Payload=[..17..] SrcPort=15002 DstPort=2123(gtp-control)
Length=25 Checksum=6499}
00000000 3a 9a 08 4b 00 19 19 63                         |:..K...c|
--- Layer 4 ---
Payload 17 byte(s)
00000000 48 63 00 0d 00 00 08 d0 02 01 75 00 49 00 01 00 |Hc.....u.I...|
00000010 05                                           |.|

```

```

-----
InterfaceName = gtpc | InterfaceIP = 209.165.200.229 | Filter = (tcp or udp or sctp)
and (port 2123 or (host 209.165.200.227 and port 2123)
or (host 209.165.201.11 and port 2123) or (host 209.165.200.228 and port 2123))
<<<<OUTBOUND
from 209.165.200.229:15001 to 209.165.200.227:2123
Protocol: UDP | Sequence Number: 0
Packet Metadata: {Timestamp:2021-06-06 06:16:13.078691 +0000 UTC CaptureLength:55
Length:55 InterfaceIndex:0 AncillaryData:[]}

```

Packet Raw Bytes:

```

0004000100060050569c0959080045280029a11540004011804f0a01029c0
a01029a3a99084b0015195e400100090101ab000300010000

```

Packet Dump:

```

-- FULL PACKET DATA (55 bytes) -----
00000000 00 04 00 01 00 06 00 50 56 9c 09 59 08 00 45 28 |.....PV..Y..E(|
00000010 00 29 a1 15 40 00 40 11 80 4f 0a 01 02 9c 0a 01 |.)..@.@..O.....|
00000020 02 9a 3a 99 08 4b 00 15 19 5e 40 01 00 09 01 01 |...:K...^@.....|
00000030 ab 00 03 00 01 00 00                         |.....|
--- Layer 1 ---
Ethernet {Contents=[..14..] Payload=[..41..] SrcMAC=00:50:56:9c:09:59
DstMAC=00:04:00:01:00:06 EthernetType=IPv4 Length=0}
00000000 00 04 00 01 00 06 00 50 56 9c 09 59 08 00       |.....PV..Y..|
--- Layer 2 ---
IPv4     {Contents=[..20..] Payload=[..21..] Version=4 IHL=5 TOS=40 Length=41
Id=41237 Flags=DF FragOffset=0 TTL=64 Protocol=UDP
Checksum=32847 SrcIP=209.165.200.229 DstIP=209.165.200.227 Options=[] Padding=[]}
00000000 45 28 00 29 a1 15 40 00 40 11 80 4f 0a 01 02 9c |E(..)..@.@..O....|
00000010 0a 01 02 9a                                     |....|
--- Layer 3 ---
UDP      {Contents=[..8..] Payload=[..13..] SrcPort=15001 DstPort=2123(gtp-control)
Length=21 Checksum=6494}
00000000 3a 99 08 4b 00 15 19 5e                         |:..K...^|
--- Layer 4 ---
Payload 13 byte(s)
00000000 40 01 00 09 01 01 ab 00 03 00 01 00 00           |@.....|

```

```

-----
InterfaceName = gtpc | InterfaceIP = 209.165.200.229 | Filter = (tcp or udp or sctp)
and (port 2123 or (host 209.165.200.227 and port 2123)
or (host 209.165.201.11 and port 2123) or (host 209.165.200.228 and port 2123))
<<<<OUTBOUND
from 209.165.200.229:15000 to 209.165.200.228:2123
Protocol: UDP | Sequence Number: 0
Packet Metadata: {Timestamp:2021-06-06 06:16:13.084971 +0000 UTC CaptureLength:55
Length:55 InterfaceIndex:0 AncillaryData:[]}

```

Packet Raw Bytes:

```

0004000100060050569c0959080045280029d5a7400040114bbc0a01029c0a01029b3
a98084b0015195f400100090000df000300010000

```

```

Packet Dump:
-- FULL PACKET DATA (55 bytes) -----
00000000 00 04 00 01 00 06 00 50 56 9c 09 59 08 00 45 28 |.....PV..Y..E(|
00000010 00 29 d5 a7 40 00 40 11 4b bc 0a 01 02 9c 0a 01 |..)..@.K.....|
00000020 02 9b 3a 98 08 4b 00 15 19 5f 40 01 00 09 00 00 |...:K..._@.....|
00000030 df 00 03 00 01 00 00 |.....|
--- Layer 1 ---
Ethernet {Contents=[..14..] Payload=[..41..] SrcMAC=00:50:56:9c:09:59
DstMAC=00:04:00:01:00:06 EthernetType=IPv4 Length=0}
00000000 00 04 00 01 00 06 00 50 56 9c 09 59 08 00 |.....PV..Y..|
--- Layer 2 ---
IPv4 {Contents=[..20..] Payload=[..21..] Version=4 IHL=5 TOS=40 Length=41
Id=54695 Flags=DF FragOffset=0 TTL=64 Protocol=UDP
Checksum=19388 SrcIP=209.165.200.229 DstIP=209.165.200.228 Options=[] Padding=[]}
00000000 45 28 00 29 d5 a7 40 00 40 11 4b bc 0a 01 02 9c |E(..)..@.K.....|
00000010 0a 01 02 9b |....|
--- Layer 3 ---
UDP {Contents=[..8..] Payload=[..13..] SrcPort=15000(hydap) DstPort=2123(gtp-control)
Length=21 Checksum=6495}
00000000 3a 98 08 4b 00 15 19 5f |:..K..._|
--- Layer 4 ---
Payload 13 byte(s)
00000000 40 01 00 09 00 00 df 00 03 00 01 00 00 |@.....|

-----
InterfaceName = gtpc | InterfaceIP = 209.165.200.229 | Filter = (tcp or udp or sctp)
and (port 2123 or (host 209.165.200.227 and port 2123)
or (host 209.165.201.11 and port 2123) or (host 209.165.200.228 and port 2123))
<<<<OUTBOUND
from 209.165.200.229:15002 to 209.165.200.228:2123
Protocol: UDP | Sequence Number: 0
Packet Metadata: {Timestamp:2021-06-06 06:16:14.485021 +0000 UTC CaptureLength:59
Length:59 InterfaceIndex:0 AncillaryData:[]}

Packet Raw Bytes:
0004000100060050569c095908004528002dd679400040114ae60a01029c0a01029b3
a9a084b001919634863000d000008d0020175004900010005

Packet Dump:
-- FULL PACKET DATA (59 bytes) -----
00000000 00 04 00 01 00 06 00 50 56 9c 09 59 08 00 45 28 |.....PV..Y..E(|
00000010 00 2d d6 79 40 00 40 11 4a e6 0a 01 02 9c 0a 01 |.-.y@.i.J.....|
00000020 02 9b 3a 9a 08 4b 00 19 19 63 48 63 00 0d 00 00 |...:K...cHc....|
00000030 08 d0 02 01 75 00 49 00 01 00 05 |.....u.I....|
--- Layer 1 ---
Ethernet {Contents=[..14..] Payload=[..45..] SrcMAC=00:50:56:9c:09:59
DstMAC=00:04:00:01:00:06 EthernetType=IPv4 Length=0}
00000000 00 04 00 01 00 06 00 50 56 9c 09 59 08 00 |.....PV..Y..|
--- Layer 2 ---
IPv4 {Contents=[..20..] Payload=[..25..] Version=4 IHL=5 TOS=40 Length=45
Id=54905 Flags=DF FragOffset=0 TTL=64 Protocol=UDP
Checksum=19174 SrcIP=209.165.200.229 DstIP=209.165.200.228 Options=[] Padding=[]}
00000000 45 28 00 2d d6 79 40 00 40 11 4a e6 0a 01 02 9c |E(..)..y@.i.J.....|
00000010 0a 01 02 9b |....|
--- Layer 3 ---
UDP {Contents=[..8..] Payload=[..17..] SrcPort=15002 DstPort=2123(gtp-control)
Length=25 Checksum=6499}
00000000 3a 9a 08 4b 00 19 19 63 |:..K...c|
--- Layer 4 ---
Payload 17 byte(s)
00000000 48 63 00 0d 00 00 08 d0 02 01 75 00 49 00 01 00 |Hc.....u.I...|
00000010 05 |.|

```

```

-----
InterfaceName = gtpc | InterfaceIP = 209.165.200.229 | Filter = (tcp or udp or sctp)
and (port 2123 or (host 209.165.200.227 and port 2123)
or (host 209.165.201.11 and port 2123) or (host 209.165.200.228 and port 2123))
<<<<OUTBOUND
from 209.165.200.229:15002 to 209.165.200.227:2123
Protocol: UDP | Sequence Number: 0
Packet Metadata: {Timestamp:2021-06-06 06:16:18.078521 +0000 UTC CaptureLength:55
Length:55 InterfaceIndex:0 AncillaryData:[]}

```

Packet Raw Bytes:

```

0004000100060050569c0959080045280029a1bb400040117fa90a01029c0a01029a3
a9a084b0015195e400100090201c9000300010000

```

Packet Dump:

```

-- FULL PACKET DATA (55 bytes) -----
00000000 00 04 00 01 00 06 00 50 56 9c 09 59 08 00 45 28 |.....PV..Y..E(|
00000010 00 29 a1 bb 40 00 40 11 7f a9 0a 01 02 9c 0a 01 |.)..@.@.....|
00000020 02 9a 3a 9a 08 4b 00 15 19 5e 40 01 00 09 02 01 |...:K...^@.....|
00000030 c9 00 03 00 01 00 00 |.....|
--- Layer 1 ---
Ethernet {Contents=[..14..] Payload=[..41..] SrcMAC=00:50:56:9c:09:59
DstMAC=00:04:00:01:00:06 EthernetType=IPv4 Length=0}
00000000 00 04 00 01 00 06 00 50 56 9c 09 59 08 00 |.....PV..Y..|
--- Layer 2 ---
IPv4 {Contents=[..20..] Payload=[..21..] Version=4 IHL=5 TOS=40 Length=41
Id=41403 Flags=DF FragOffset=0 TTL=64 Protocol=UDP
Checksum=32681 SrcIP=209.165.200.229 DstIP=209.165.200.227 Options=[] Padding=[]}
00000000 45 28 00 29 a1 bb 40 00 40 11 7f a9 0a 01 02 9c |E(.)..@.@.....|
00000010 0a 01 02 9a |....|
--- Layer 3 ---
UDP {Contents=[..8..] Payload=[..13..] SrcPort=15002 DstPort=2123(gtp-control)
Length=21 Checksum=6494}
00000000 3a 9a 08 4b 00 15 19 5e |:...K...^|
--- Layer 4 ---
Payload 13 byte(s)
00000000 40 01 00 09 02 01 c9 00 03 00 01 00 00 |@.....|

```

```

-----
InterfaceName = gtpc | InterfaceIP = 209.165.200.229 | Filter = (tcp or udp or sctp)
and (port 2123 or (host 209.165.200.227 and port 2123)
or (host 209.165.201.11 and port 2123) or (host 209.165.200.228 and port 2123))
<<<<OUTBOUND
from 209.165.200.229:15000 to 209.165.200.228:2123
Protocol: UDP | Sequence Number: 0
Packet Metadata: {Timestamp:2021-06-06 06:16:18.089434 +0000 UTC CaptureLength:55
Length:55 InterfaceIndex:0 AncillaryData:[]}

```

Packet Raw Bytes:

```

0004000100060050569c0959080045280029d8cf4000401148940a0102
9c0a01029b3a98084b0015195f400100090000e0000300010000

```

Packet Dump:

```

-- FULL PACKET DATA (55 bytes) -----
00000000 00 04 00 01 00 06 00 50 56 9c 09 59 08 00 45 28 |.....PV..Y..E(|
00000010 00 29 d8 cf 40 00 40 11 48 94 0a 01 02 9c 0a 01 |.)..@.@.H.....|
00000020 02 9b 3a 98 08 4b 00 15 19 5f 40 01 00 09 00 00 |...:K..._@.....|
00000030 e0 00 03 00 01 00 00 |.....|
--- Layer 1 ---
Ethernet {Contents=[..14..] Payload=[..41..] SrcMAC=00:50:56:9c:09:59
DstMAC=00:04:00:01:00:06 EthernetType=IPv4 Length=0}

```

```

00000000 00 04 00 01 00 06 00 50 56 9c 09 59 08 00 |.....PV..Y..|
--- Layer 2 ---
IPv4      {Contents=[..20..] Payload=[..21..] Version=4 IHL=5 TOS=40 Length=41
Id=55503  Flags=DF FragOffset=0 TTL=64 Protocol=UDP
Checksum=18580 SrcIP=209.165.200.229 DstIP=209.165.200.228 Options=[] Padding=[]}
00000000 45 28 00 29 d8 cf 40 00 40 11 48 94 0a 01 02 9c |E(..)..@.@.H....|
00000010 0a 01 02 9b                                     |....|
--- Layer 3 ---
UDP       {Contents=[..8..] Payload=[..13..] SrcPort=15000(hydap) DstPort=2123(gtp-control)
Length=21 Checksum=6495}
00000000 3a 98 08 4b 00 15 19 5f                             |:...K..._|
--- Layer 4 ---
Payload 13 byte(s)
00000000 40 01 00 09 00 00 e0 00 03 00 01 00 00             |@.....|

```

```

-----
InterfaceName = gtpc | InterfaceIP = 209.165.200.229 | Filter = (tcp or udp or sctp)
and (port 2123 or (host 209.165.200.227 and port 2123)
or (host 209.165.201.11 and port 2123) or (host 209.165.200.228 and port 2123))
<<<<OUTBOUND
from 209.165.200.229:15002 to 209.165.200.228:2123
Protocol: UDP | Sequence Number: 0
Packet Metadata: {Timestamp:2021-06-06 06:16:21.584999 +0000 UTC CaptureLength:59
Length:59 InterfaceIndex:0 AncillaryData:[]}
```

```

Packet Raw Bytes:
0004000100060050569c095908004528002ddb124000401146
4d0a01029c0a01029b3a9a084b001919634863000d00 0008d0020175004900010005
```

```

Packet Dump:
-- FULL PACKET DATA (59 bytes) -----
00000000 00 04 00 01 00 06 00 50 56 9c 09 59 08 00 45 28 |.....PV..Y..E(|
00000010 00 2d db 12 40 00 40 11 46 4d 0a 01 02 9c 0a 01 |.-..@.@.FM.....|
00000020 02 9b 3a 9a 08 4b 00 19 19 63 48 63 00 0d 00 00 |:...K...cHc....|
00000030 08 d0 02 01 75 00 49 00 01 00 05                 |.....u.I....|
--- Layer 1 ---
Ethernet  {Contents=[..14..] Payload=[..45..] SrcMAC=00:50:56:9c:09:59
DstMAC=00:04:00:01:00:06 EthernetType=IPv4 Length=0}
00000000 00 04 00 01 00 06 00 50 56 9c 09 59 08 00 |.....PV..Y..|
--- Layer 2 ---
IPv4      {Contents=[..20..] Payload=[..25..] Version=4 IHL=5 TOS=40 Length=45
Id=56082  Flags=DF FragOffset=0 TTL=64 Protocol=UDP
Checksum=17997 SrcIP=209.165.200.229 DstIP=209.165.200.228 Options=[] Padding=[]}
00000000 45 28 00 2d db 12 40 00 40 11 46 4d 0a 01 02 9c |E(..)..@.@.FM....|
00000010 0a 01 02 9b                                     |....|
--- Layer 3 ---
UDP       {Contents=[..8..] Payload=[..17..] SrcPort=15002 DstPort=2123(gtp-control)
Length=25 Checksum=6499}
00000000 3a 9a 08 4b 00 19 19 63                             |:...K...c|
--- Layer 4 ---
Payload 17 byte(s)
00000000 48 63 00 0d 00 00 08 d0 02 01 75 00 49 00 01 00 |Hc.....u.I...|
00000010 05                                     |.|

```

```

-----
InterfaceName = gtpc | InterfaceIP = 209.165.200.229 | Filter = (tcp or udp or sctp)
and (port 2123 or (host 209.165.200.227 and port 2123)
or (host 209.165.201.11 and port 2123) or (host 209.165.200.228 and port 2123))
<<<<OUTBOUND
from 209.165.200.229:15001 to 209.165.200.227:2123
Protocol: UDP | Sequence Number: 0
Packet Metadata: {Timestamp:2021-06-06 06:16:23.07887 +0000 UTC CaptureLength:55
```

Configuration Example

```
Length:55 InterfaceIndex:0 AncillaryData:[]
```

Packet Raw Bytes:

```
0004000100060050569c0959080045280029a2c0400040117
ea40a01029c0a01029a3a99084b0015195e400100090101ac000300010000
```

Packet Dump:

```
-- FULL PACKET DATA (55 bytes) -----
00000000 00 04 00 01 00 06 00 50 56 9c 09 59 08 00 45 28 |.....PV..Y..E(|
00000010 00 29 a2 c0 40 00 40 11 7e a4 0a 01 02 9c 0a 01 |.)..@.@~.....|
00000020 02 9a 3a 99 08 4b 00 15 19 5e 40 01 00 09 01 01 |...:K...^@.....|
00000030 ac 00 03 00 01 00 00 |.....|
--- Layer 1 ---
Ethernet {Contents=[..14..] Payload=[..41..] SrcMAC=00:50:56:9c:09:59
DstMAC=00:04:00:01:00:06 EthernetType=IPv4 Length=0}
00000000 00 04 00 01 00 06 00 50 56 9c 09 59 08 00 |.....PV..Y..|
--- Layer 2 ---
IPv4 {Contents=[..20..] Payload=[..21..] Version=4 IHL=5 TOS=40 Length=41
Id=41664 Flags=DF FragOffset=0 TTL=64 Protocol=UDP
Checksum=32420 SrcIP=209.165.200.229 DstIP=209.165.200.227 Options=[] Padding=[]}
00000000 45 28 00 29 a2 c0 40 00 40 11 7e a4 0a 01 02 9c |E(.)..@.@~.....|
00000010 0a 01 02 9a |....|
--- Layer 3 ---
UDP {Contents=[..8..] Payload=[..13..] SrcPort=15001 DstPort=2123(gtp-control)
Length=21 Checksum=6494}
00000000 3a 99 08 4b 00 15 19 5e |:..K...^|
--- Layer 4 ---
Payload 13 byte(s)
00000000 40 01 00 09 01 01 ac 00 03 00 01 00 00 |@.....|
```

```
-----
InterfaceName = gtpc | InterfaceIP = 209.165.200.229 | Filter = (tcp or udp or sctp)
and (port 2123 or (host 209.165.200.227 and port 2123)
or (host 209.165.201.11 and port 2123) or (host 209.165.200.228 and port 2123))
<<<<OUTBOUND
from 209.165.200.229:15002 to 209.165.200.228:2123
Protocol: UDP | Sequence Number: 0
Packet Metadata: {Timestamp:2021-06-06 06:16:23.086144 +0000 UTC CaptureLength:55
Length:55 InterfaceIndex:0 AncillaryData:[]}
```

Packet Raw Bytes:

```
0004000100060050569c0959080045280029dbe740004011457c0a01029c0a01029b3
a9a084b0015195f40010009020176000300010000
```

Packet Dump:

```
-- FULL PACKET DATA (55 bytes) -----
00000000 00 04 00 01 00 06 00 50 56 9c 09 59 08 00 45 28 |.....PV..Y..E(|
00000010 00 29 db e7 40 00 40 11 45 7c 0a 01 02 9c 0a 01 |.)..@.@E|.....|
00000020 02 9b 3a 9a 08 4b 00 15 19 5f 40 01 00 09 02 01 |...:K..._@.....|
00000030 76 00 03 00 01 00 00 |v.....|
--- Layer 1 ---
Ethernet {Contents=[..14..] Payload=[..41..] SrcMAC=00:50:56:9c:09:59
DstMAC=00:04:00:01:00:06 EthernetType=IPv4 Length=0}
00000000 00 04 00 01 00 06 00 50 56 9c 09 59 08 00 |.....PV..Y..|
--- Layer 2 ---
IPv4 {Contents=[..20..] Payload=[..21..] Version=4 IHL=5 TOS=40 Length=41
Id=56295 Flags=DF FragOffset=0 TTL=64 Protocol=UDP
Checksum=17788 SrcIP=209.165.200.229 DstIP=209.165.200.228 Options=[] Padding=[]}
00000000 45 28 00 29 db e7 40 00 40 11 45 7c 0a 01 02 9c |E(.)..@.@E|....|
00000010 0a 01 02 9b |....|
--- Layer 3 ---
UDP {Contents=[..8..] Payload=[..13..] SrcPort=15002 DstPort=2123(gtp-control)
Length=21 Checksum=6495}
```



```

00000000  3a 9a 08 4b 00 15 19 5f          |:...K..._|
--- Layer 4 ---
Payload 13 byte(s)
00000000  40 01 00 09 02 01 76 00 03 00 01 00 00          |@.....v.....|

-----
InterfaceName = gtpc | InterfaceIP = 209.165.200.229 | Filter = (tcp or udp or sctp)
and (port 2123 or (host 209.165.200.227 and port 2123)
or (host 209.165.201.11 and port 2123) or (host 209.165.200.228 and port 2123))
<<<<OUTBOUND
from 209.165.200.229:15002 to 209.165.200.227:2123
Protocol: UDP | Sequence Number: 0
Packet Metadata: {Timestamp:2021-06-06 06:16:28.079013 +0000 UTC CaptureLength:55
Length:55 InterfaceIndex:0 AncillaryData:[]}

Packet Raw Bytes:
0004000100060050569c0959080045280029a336400040117e2e0a01029c0
a01029a3a9a084b0015195e400100090201ca000300010000

Packet Dump:
-- FULL PACKET DATA (55 bytes) -----
00000000  00 04 00 01 00 06 00 50 56 9c 09 59 08 00 45 28 |.....PV..Y..E(|
00000010  00 29 a3 36 40 00 40 11 7e 2e 0a 01 02 9c 0a 01 |.)..6@.@.~.....|
00000020  02 9a 3a 9a 08 4b 00 15 19 5e 40 01 00 09 02 01 |:...K...^@.....|
00000030  ca 00 03 00 01 00 00          |.....|
--- Layer 1 ---
Ethernet {Contents=[..14..] Payload=[..41..] SrcMAC=00:50:56:9c:09:59
DstMAC=00:04:00:01:00:06 EthernetType=IPv4 Length=0}
00000000  00 04 00 01 00 06 00 50 56 9c 09 59 08 00          |.....PV..Y..|
--- Layer 2 ---
IPv4 {Contents=[..20..] Payload=[..21..] Version=4 IHL=5 TOS=40 Length=41
Id=41782 Flags=DF FragOffset=0 TTL=64 Protocol=UDP
Checksum=32302 SrcIP=209.165.200.229 DstIP=209.165.200.227 Options=[] Padding=[]}
00000000  45 28 00 29 a3 36 40 00 40 11 7e 2e 0a 01 02 9c |E(.)..6@.@.~.....|
00000010  0a 01 02 9a          |.....|
--- Layer 3 ---
UDP {Contents=[..8..] Payload=[..13..] SrcPort=15002 DstPort=2123(gtp-control)
Length=21 Checksum=6494}
00000000  3a 9a 08 4b 00 15 19 5e          |:...K...^|
--- Layer 4 ---
Payload 13 byte(s)
00000000  40 01 00 09 02 01 ca 00 03 00 01 00 00          |@.....|

-----
InterfaceName = gtpc | InterfaceIP = 209.165.200.229 | Filter = (tcp or udp or sctp)
and (port 2123 or (host 209.165.200.227 and port 2123)
or (host 209.165.201.11 and port 2123) or (host 209.165.200.228 and port 2123))
<<<<OUTBOUND
from 209.165.200.229:15002 to 209.165.200.228:2123
Protocol: UDP | Sequence Number: 0
Packet Metadata: {Timestamp:2021-06-06 06:16:28.086562 +0000 UTC CaptureLength:55
Length:55 InterfaceIndex:0 AncillaryData:[]}

Packet Raw Bytes:
0004000100060050569c0959080045280029dfb14000401141b20a01029
c0a01029b3a9a084b0015195f40010009020177000300010000

Packet Dump:
-- FULL PACKET DATA (55 bytes) -----
00000000  00 04 00 01 00 06 00 50 56 9c 09 59 08 00 45 28 |.....PV..Y..E(|
00000010  00 29 df b1 40 00 40 11 41 b2 0a 01 02 9c 0a 01 |.)...@.A.....|
00000020  02 9b 3a 9a 08 4b 00 15 19 5f 40 01 00 09 02 01 |:...K..._@.....|

```

Configuration Example

```

00000030 77 00 03 00 01 00 00          |w.....|
--- Layer 1 ---
Ethernet      {Contents=[..14..] Payload=[..41..] SrcMAC=00:50:56:9c:09:59
DstMAC=00:04:00:01:00:06 EthernetType=IPv4 Length=0}
00000000 00 04 00 01 00 06 00 50 56 9c 09 59 08 00          |.....PV..Y..|
--- Layer 2 ---
IPv4          {Contents=[..20..] Payload=[..21..] Version=4 IHL=5 TOS=40 Length=41
Id=57265 Flags=DF FragOffset=0 TTL=64 Protocol=UDP
Checksum=16818 SrcIP=209.165.200.229 DstIP=209.165.200.228 Options=[] Padding=[]}
00000000 45 28 00 29 df b1 40 00 40 11 41 b2 0a 01 02 9c |E(..).@.A.....|
00000010 0a 01 02 9b          |....|
--- Layer 3 ---
UDP           {Contents=[..8..] Payload=[..13..] SrcPort=15002 DstPort=2123(gtp-control)
Length=21 Checksum=6495}
00000000 3a 9a 08 4b 00 15 19 5f          |:..K..._|
--- Layer 4 ---
Payload 13 byte(s)
00000000 40 01 00 09 02 01 77 00 03 00 01 00 00          |@.....w.....|

```

```

-----
InterfaceName = gtpc | InterfaceIP = 209.165.200.229 | Filter = (tcp or udp or sctp)
and (port 2123 or (host 209.165.200.227 and port 2123)
or (host 209.165.201.11 and port 2123) or (host 209.165.200.228 and port 2123))
<<<<OUTBOUND
from 209.165.200.229:15002 to 209.165.200.228:2123
Protocol: UDP | Sequence Number: 0
Packet Metadata: {Timestamp:2021-06-06 06:16:28.685112 +0000 UTC CaptureLength:59
Length:59 InterfaceIndex:0 AncillaryData:[]}

```

```

Packet Raw Bytes:
0004000100060050569c095908004528002de03240004011412d0a01029c0a01029b3a9a
084b001919634863000d000008d0020175004900010005

```

```

Packet Dump:
-- FULL PACKET DATA (59 bytes) -----
00000000 00 04 00 01 00 06 00 50 56 9c 09 59 08 00 45 28 |.....PV..Y..E(|
00000010 00 2d e0 32 40 00 40 11 41 2d 0a 01 02 9c 0a 01 |.-.2@.@.A-.....|
00000020 02 9b 3a 9a 08 4b 00 19 19 63 48 63 00 0d 00 00 |.....K...cHc....|
00000030 08 d0 02 01 75 00 49 00 01 00 05          |.....u.I....|
--- Layer 1 ---
Ethernet      {Contents=[..14..] Payload=[..45..] SrcMAC=00:50:56:9c:09:59
DstMAC=00:04:00:01:00:06 EthernetType=IPv4 Length=0}
00000000 00 04 00 01 00 06 00 50 56 9c 09 59 08 00          |.....PV..Y..|
--- Layer 2 ---
IPv4          {Contents=[..20..] Payload=[..25..] Version=4 IHL=5 TOS=40 Length=45
Id=57394 Flags=DF FragOffset=0 TTL=64 Protocol=UDP
Checksum=16685 SrcIP=209.165.200.229 DstIP=209.165.200.228 Options=[] Padding=[]}
00000000 45 28 00 2d e0 32 40 00 40 11 41 2d 0a 01 02 9c |E(..).2@.@.A-....|
00000010 0a 01 02 9b          |....|
--- Layer 3 ---
UDP           {Contents=[..8..] Payload=[..17..] SrcPort=15002 DstPort=2123(gtp-control)
Length=25 Checksum=6499}
00000000 3a 9a 08 4b 00 19 19 63          |:..K...c|
--- Layer 4 ---
Payload 17 byte(s)
00000000 48 63 00 0d 00 00 08 d0 02 01 75 00 49 00 01 00 |Hc.....u.I...|
00000010 05          |.|

```

```

-----
command terminated with exit code 124

```

% Total	% Received	% Xferd	Average Speed	Time	Time	Time	Current
			Dload	Upload	Total	Spent	Left
							Speed

```

100 172 100 43 100 129 8600 25800 --:--:-- --:--:-- --:--:-- 34400
Stop Response Already disabled mon_pro as part of timeout for Cmd: --header
Content-type:application/json --request POST --data
{"commandname":"mon_pro","parameters":{"interface":"pcfp,gtpc","duration":100,"action":
"stop","enable_pcap":true,"grInstance":0}} http://oam-pod:8879/commands

```

Configuring the Transaction Messages

To configure the transaction logs, use the following configuration:

```

config
  logging transaction message [ disable | enable ]
end

```

NOTES:

- **logging transaction message [disable | enable]**—Configure the messages in transaction logging. When set to enable, the transactional and internal logs are combined. By default, the logs are disabled.

Configuration Example

The following is an example configuration.

```
logging transaction message enable
```

Sample Output

The following is a sample output.

```
/opt/workspace/monsublogs# cat 'sgw.imsi-*_WithTxnLogs_TS_2020-12-22T15:16:58.158964842.txt'
```

```

Transaction Log received from Instance: smf.nodemgr.cn.cn.0
***** TRANSACTION: 00088 *****
TRANSACTION SUCCESS:
  Txn Type           : NmgrRersourceMgmtRequest(1025)
  Priority            : 1
  Session Namespace  : sgw(2)
LOG MESSAGES:
  2020/12/22 15:20:07.093 [TRACE] [infra.message_log.core] >>>>>>>
IPC message
Name: NmgrRersourceMgmtRequest
MessageType: NmgrRersourceMgmtRequest
Key:
--body--
{"supi":"imsi-123456789012348","idReqType":1,"serviceUsertype":2}
  2020/12/22 15:20:07.093 [DEBUG] [nodemgr0.app.Int]
    GetSessionNamespace for txn id: 88, Type: 1025
  2020/12/22 15:20:07.093 [DEBUG] [nodemgr0.app.Int]
    GetSessionNamespace returned namespace : 2
  2020/12/22 15:20:07.093 [INFO] [nodemgr0.app.Int]
    RECEIVED REQUEST <-- NmgrRersourceMgmtRequest
  2020/12/22 15:20:07.093 [TRACE] [infra.message_log.core] <<<<<<<

*****
Transaction Log received from Instance: smf.protocol.cn.cn.0
***** TRANSACTION: 00050 *****
TRANSACTION SUCCESS:
  Txn Type           : 524(524)
  Priority            : 1
  Session Namespace  : sgw(2)

```

```

INCOMING REQUEST:
  Message: Sx Session Establishment Request
  Description: Sx Session Establishment Request Message from SGWC to SGWU
  Source: 209.165.200.229
  Destination: 209.165.200.228
  PAYLOAD:
    Sx Session Establishment Request:
      Sx Session Establishment Request:
        CreatePdr:
          CreatePdr[0]:
            PdrId: 1
            Precedence: 0
            Pdi:
              SrcIf: CORE
              UeIp:
                Src: false
                Dst: false
                IPv4Addr: 209.165.201.30
              TEndpointId: 1
              Valid: true
            OuterHdrRem: 0
            FarId:
              FarId[0]: 1
            Qfi: 0
            OuterHdrRemValid: false
          CreatePdr[1]:
            PdrId: 2
            Precedence: 0
            Pdi:
              SrcIf: ACCESS
              UeIp:
                Src: false
                Dst: false
                IPv4Addr: 209.165.201.30
              TEndpointId: 2
              Valid: true
            OuterHdrRem: 0
            FarId:
              FarId[0]: 2
            Qfi: 0
            OuterHdrRemValid: false
        CreateFar:
          CreateFar[0]:
            FarId: 1
            ApplyAction:
              Drop: true
              Frwd: false
              Buff: false
              Nocp: false
              Dupl: false
              Valid: true
            FwdParams:
              DestIf: ACCESS
              RedirectInfo:
                AddrType: 0
                Valid: false
              OuterHdr:
                OuterHdrDesc: 0
                Teid: 0
                IPv4Address: 209.165.201.30
                Port: 0
                Valid: false
              TEndptId: 2
              OuterPktTos: 255

```

```
InnerPktTos: 255
TosOpt:
  CopyInner: false
  CopyOuter: false
SendTos: 0
PfcPsmFlags:
  Drobu: false
  Qaurr: false
  Sndem: false
  Valid: false
Valid: true
DuplParams:
  DestIf: ACCESS
  OuterHdr:
    OuterHdrDesc: 0
    Teid: 0
    IPv4Address: 209.165.201.30
    Port: 0
    Valid: false
  InterceptInfo:
    InterceptId: 0
    ChargingId: 0
    SmfLiNodeId:
      IpDesc: 0
      IPv4Address: 209.165.201.30
      Valid: false
    PduSessionId: 0
    Valid: false
  Valid: false
BarId: 0
CreateFar[1]:
  FarId: 2
  ApplyAction:
    Drop: true
    Frwd: false
    Buff: false
    Nocp: false
    Dupl: false
    Valid: true
  FwdParams:
    DestIf: CORE
    RedirectInfo:
      AddrType: 0
      Valid: false
    OuterHdr:
      OuterHdrDesc: 0
      Teid: 0
      IPv4Address: 209.165.201.30
      Port: 0
      Valid: false
    TEndptId: 1
    OuterPktTos: 255
    InnerPktTos: 255
    TosOpt:
      CopyInner: false
      CopyOuter: false
    SendTos: 0
    PfcPsmFlags:
      Drobu: false
      Qaurr: false
      Sndem: false
      Valid: false
    Valid: true
  DuplParams:
```

```

        DestIf: ACCESS
        OuterHdr:
            OuterHdrDesc: 0
            Teid: 0
            IPv4Address: 209.165.201.30
            Port: 0
            Valid: false
        InterceptInfo:
            InterceptId: 0
            ChargingId: 0
            SmfLiNodeId:
                IpDesc: 0
                IPv4Address: 209.165.201.30
                Valid: false
            PduSessionId: 0
            Valid: false
        Valid: false
    BarId: 0
CreateTEndpt:
    CreateTEndpt[0]:
        EndpointId: 1
        FTeid:
            Teid: 0
            IPv4Address: 209.165.201.30
            ChooseId: 0
        BearerLvlInfo:
            Valid: 1
            Qci: 6
    CreateTEndpt[1]:
        EndpointId: 2
        FTeid:
            Teid: 0
            IPv4Address: 209.165.201.30
            ChooseId: 0
        BearerLvlInfo:
            Valid: 1
            Qci: 6
PdnType: 0
UplaneInacTimer: 0
MetaData: From:209.165.200.229:11000->To:209.165.200.228:8805 Seqno:37
        Supi: Seid:1224979349111832634 Cmnid:0 Rseid:0 IntfType:0
UserIDInfo:
    Valid: false
XHeaderInfo:
    RatType:
        Valid: false
CfPolicyId:
    PolicyId: 0
    Valid: false
ChargingDisabled:
    Valid: false
    Value: false
ChargingParams:
    Valid: 0
    GyOfflineChargingEnabled: 0

```

OUTGOING RESPONSE:

```

Message: Sx Session Establishment Response
Description: Sx Session Establishment Response Message from SGWU to SGWC
Source: 209.165.200.228
Destination: 209.165.200.229
PAYLOAD:
    Sx Session Establishment Response:
        Sx Session Establishment Response:

```

```

Cause: 1
OffendingIe: 0
FSeid:
  Seid: 10002
  IPv4Address: 209.165.200.228
CreatedTEndpt:
  CreatedTEndpt[0]:
    EndpointId: 1
    FTeid:
      Teid: 2086
      IPv4Address: 209.165.201.1
      ChooseId: 0
  CreatedTEndpt[1]:
    EndpointId: 2
    FTeid:
      Teid: 2087
      IPv4Address: 209.165.200.226
      ChooseId: 0
MetaData: From:209.165.200.228:8805->To:209.165.200.229:11000 Seqno:37
  Supi: Seid:1224979349111832634 Cmnd:0 Rseid:0 IntfType:0
LoadControlInfo:
  SeqNum: 0
  Metric: 0
  Valid: false
OverloadControlInfo:
  SeqNum: 0
  Metric: 0
  Ociflag: 0
  Valid: false

```

LOG MESSAGES:

```

2020/12/22 15:20:10.934 [TRACE] [infra.message_log.core] >>>>>>>

2020/12/22 15:20:10.934 [DEBUG] [proto_ep.app.Int]
  GetSessionNamespace for txn id: 50, Type: 524
2020/12/22 15:20:10.934 [DEBUG]
  [proto_ep.app.Int] GetSessionNamespace returned namespace : 2
2020/12/22 15:20:10.934 [DEBUG]
  [infra.ipc_action.core] BG IPC will be executed after process
continue.
2020/12/22 15:20:10.934 [DEBUG]
  [infra.ipc_action.core] BG IPC is executing after process
continue.
2020/12/22 15:20:10.967 [DEBUG]
  [infra.transaction.core] Response received for correlation ID
app_protocol-0_37
2020/12/22 15:20:10.967 [DEBUG]
  [infra.transaction.core]
  (1) All pending ipc action finished, hence waking up transaction

2020/12/22 15:20:10.967 [TRACE]
  [infra.message_log.core] <<<<<<<<

```

Accessing the Logs

To access the monitor subscriber logs, navigate to the oam-pod at /opt/workspace/logs/monsublogs

Sample Logs

```

root@oam-pod-0:/opt/workspace/logs/monsublogs# ls
none.imsi-123456789_TS_2021-06-05T06:19:12.682444275.txt
sgw.imei-352099001761480_TS_2021-06-05T13:07:41.774214146.txt.sorted

```

```

none.imsi-123456789_TS_2021-06-05T06:20:39.751939118.txt
sgw.imei-352099001761480_TS_2021-06-05T13:48:51.868279985.txt
none.imsi-123456789_TS_2021-06-06T06:22:16.015635407.txt
sgw.imei-352099001761480_TS_2021-06-05T13:48:51.868279985.txt.sorted
sgw.imei-352099001761480_TS_2021-06-04T19:09:24.863985017.txt
sgw.imei-352099001761480_TS_2021-06-05T14:50:09.330635953.txt
sgw.imei-352099001761480_TS_2021-06-04T19:09:24.863985017.txt.sorted
sgw.imei-352099001761480_TS_2021-06-05T14:50:09.330635953.txt.sorted
sgw.imei-352099001761480_TS_2021-06-05T08:44:25.889632126.txt
sgw.imei-352099001761480_TS_2021-06-05T17:36:17.238331396.txt
sgw.imei-352099001761480_TS_2021-06-05T08:44:25.889632126.txt.sorted
sgw.imei-352099001761480_TS_2021-06-05T17:36:17.238331396.txt.sorted
sgw.imei-352099001761480_TS_2021-06-05T10:26:23.529652777.txt
'sgw.imsi-*_TS_2021-06-05T06:23:19.865508390.txt'
sgw.imei-352099001761480_TS_2021-06-05T10:26:23.529652777.txt.sorted
'sgw.imsi-*_TS_2021-06-05T06:25:18.219875282.txt'
sgw.imei-352099001761480_TS_2021-06-05T13:07:41.774214146.txt

```

To access the monitor protocol logs, navigate to the oam-pod at `/opt/workspace/logs/monprologs`.

Sample Logs

```

root@oam-pod-0:/opt/workspace/logs/monprologs# ls
sessintfname_gtpc_at_2021-06-05T06:28:18.310397784.pcap
sessintfname_pcfp,gtpc_at_2021-06-06T06:15:39.005414271.pcap
sessintfname_gtpc_at_2021-06-05T06:28:18.310397784.txt
sessintfname_pcfp,gtpc_at_2021-06-06T06:15:39.005414271.txt

```



CHAPTER 38

Multiple PDN Attach or Detach Procedures

- [Feature Summary and Revision History, on page 417](#)
- [Feature Description, on page 417](#)
- [How it Works, on page 418](#)

Feature Summary and Revision History

Summary Data

Table 172: Summary Data

Applicable Product(s) or Functional Area	cnSGW-C
Applicable Platform(s)	SMI
Feature Default Setting	Enabled - Always-on
Related Documentation	Not Applicable

Revision History

Table 173: Revision History

Revision Details	Release
First introduced.	2020.03.0

Feature Description

cnSGW-C handles the following functionalities:

- UE-requested PDN connection
- UE-requested PDN disconnection

- PGW-initiated PDN disconnection
- Admin-initiated disconnection.

How it Works

This section describes how this feature works.

Call Flows

This section describes the key call flows for this feature.

UE-requested PDN Connection Call Flow

This section describes the UE-requested PDN connection call flow.

Figure 96: UE-requested PDN Connection Call Flow

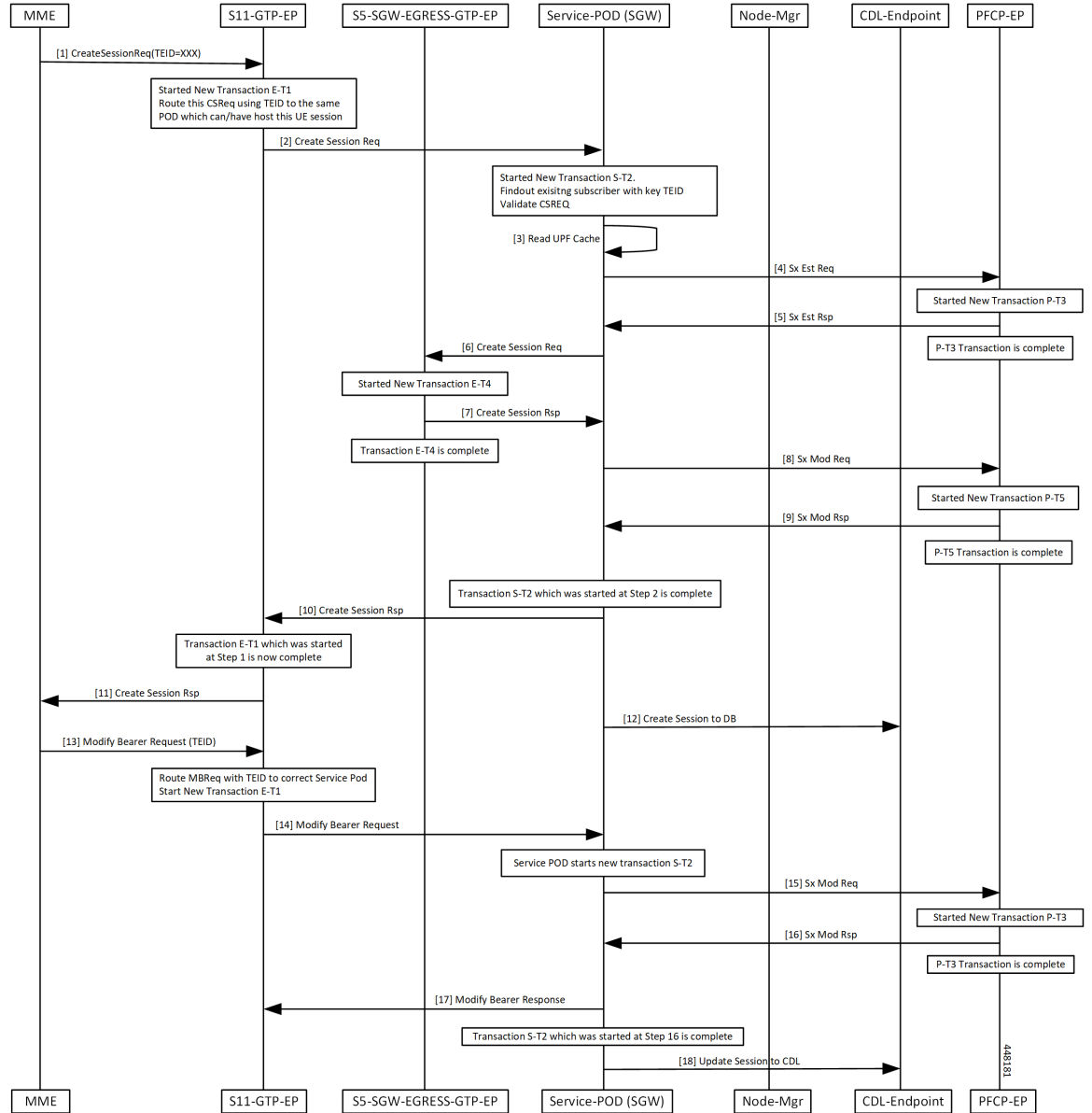

Table 174: UE-requested PDN Connection Call Flow Description

Step	Description
1	The MME sends the Create Session Request for a new PDN connection to the S11-GTP-EP with a nonzero TEID.

Step	Description
2	<p>The E-T1 transaction is started.</p> <p>The S11-GTP-EP decodes the received UDP message and converts the message into the gRPC message. Based on the IMSI value, the message is forwarded to the respective SGW-service pod which handles the UE session.</p> <p>The SGW-service pod receives the Create Session Request from the S11-GTP-EP.</p>
3	<p>The S-T2 transaction is started.</p> <p>The SGW-service pod finds the subscriber context based on the local ingress TEID, and validates the Create Session Request content and updates the PDN and subscriber information.</p> <p>The SGW-service pod reads the UPF cache to provide the selected UPF.</p>
4	The SGW-service pod sends the Sx Establishment Request to the PFCP-EP.
5	<p>The P-T3 transaction is started.</p> <p>The PFCP-EP sends the Sx Establishment Response to the SGW-service pod.</p>
6	<p>The P-T3 transaction is completed.</p> <p>The SGW-service pod sends the Create Session Request to the S5-SGW-EGRESS-GTP-EP with S11-U and S5-U TEID details.</p>
7	<p>The E-T4 transaction is started.</p> <p>The Create Session Response is validated and the S5-U remote TEID is updated in the PDN.</p> <p>The S5-SGW-EGRESS-GTP-EP sends the Create Session response to the SGW-service pod.</p>
8	<p>The E-T4 transaction is completed.</p> <p>The SGW-service pod sends the Sx Modify Request to the PFCP-EP.</p>
9	<p>The P-T5 transaction is started.</p> <p>The PFCP-EP sends the Sx Modify Response to the SGW-service pod on expiry of the timer T5.</p>
10	<p>The P-T5 and S-T2 transaction is completed.</p> <p>The GTP-EP receives the Create Session Response from the SGW-service pod.</p>
11	<p>The E-T1 transaction is completed.</p> <p>The MME receives the Create Session Response from the S11-GTP-EP.</p>
12	The SGW-service pod updates the created session in CDL endpoint (database) with new PDN information.
13	The MME sends the Modify Bearer Request with TEID to the S11-GTP-EP.
14	<p>The E-T1 transaction is started.</p> <p>The S11-GTP-EP routes the Modify Bearer Request to the SGW-service pod.</p> <p>The S11-GTP-EP sends the Modify Bearer Request to the SGW-service pod.</p>

Step	Description
15	The S-T2 transaction is started. The SGW-service pod sends the Sx Modify Request to the PFCP-EP pod on expiry of the timer S-T2.
16	The P-T3 transaction is started. The PFCP-EP sends the Sx Modify Response to the SGW-service pod on expiry of the timer T3.
17	R-T3 transaction is completed. The SGW-service pod sends the Modify Bearer Response to the MME.
18	S-T2 transaction is completed The SGW-service pod sends the update session to the CDL endpoint.

UE-requested or the MME-requested PDN Disconnection Call Flow

This section describes the UE or the MME-requested PDN disconnection call flow.

Figure 97: UE-requested or the MME-requested PDN Disconnection Call Flow

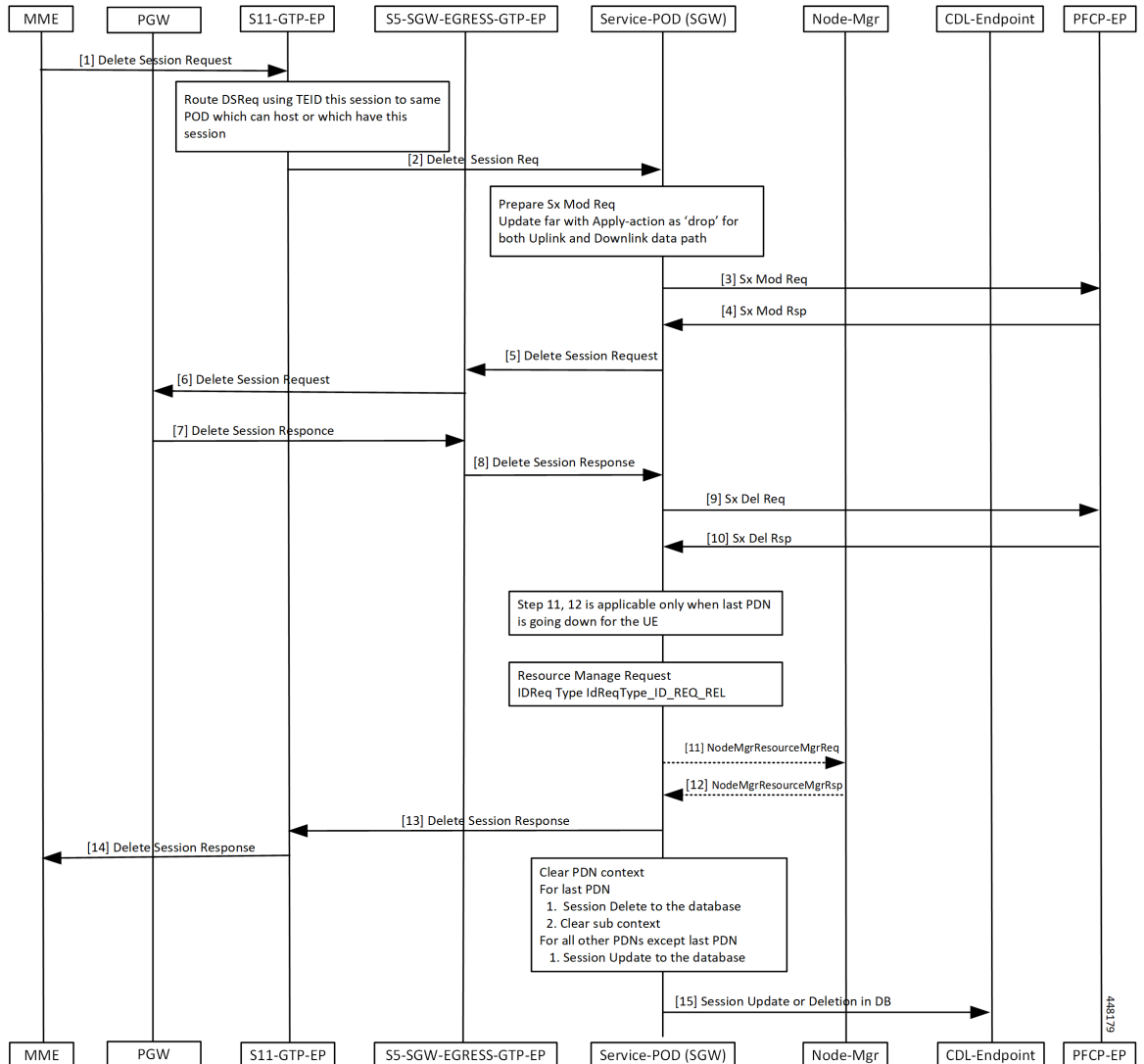

Table 175: UE-requested or the MME-requested PDN Disconnection Call Flow Description

Step	Description
1	The MME sends the Delete Session Request to the S11-GTP-EP for other PDN disconnection.
2	The GTP-EP decodes the received UDP message and converts the message into the gRPC message. Based on the TEID value, the gRPC message is forwarded to the SGW-service pod which can handle the UE session.
3	The SGW-service pod finds the subscriber context information as per the local ingress TEID. The SGW-service pod validates the Delete Session Request content. The SGW-service pod sends the Sx Modify Request to the PFCP-EP with apply action as DROP to drop the uplink or downlink packets at the SGW-U.

Step	Description
4	The PFCP-EP sends the Sx Modify Response to the SGW-service pod.
5	The SGW-service pod forwards the Delete Session Request to the S5-SGW-EGRESS-GTP-EP.
6	The S5-SGW-EGRESS-GTP-EP forwards the Delete Session Request to the PGW through the UDP proxy.
7	The PGW sends the Delete Session Response to the S5-SGW-EGRESS-GTP-EP.
8	The S5-SGW-EGRESS-GTP-EP forwards the Delete Session Response to the SGW-service pod.
9	The SGW-service pod validates the Delete Session Response, and sends the Sx Delete Request to the PFCP-EP.
10	The SGW-service pod receives the Sx Delete Session Response from the PFCP-EP.
11	For the last PDN, the SGW-service pod sends the NodeMgrResourceManager Request for the ID release to the NodeManager.
12	The Node Manager releases the ID and sends the acknowledgment to the SGW-service pod.
13	The SGW-service pod sends the Delete Session Response to the S11-GTP-EP.
14	The S11-GTP-EP forwards the Delete Session Response to the MME.
15	The SGW-service pod <ul style="list-style-type: none"> • Updates the session in database for the delete PDN information for other than the last PDN • Sends the delete session message to the database for the last PDN

PGW-requested Disconnection Call Flow

This section describes the PGW-requested disconnection call flow.

Figure 98: PGW-requested Disconnection Call Flow

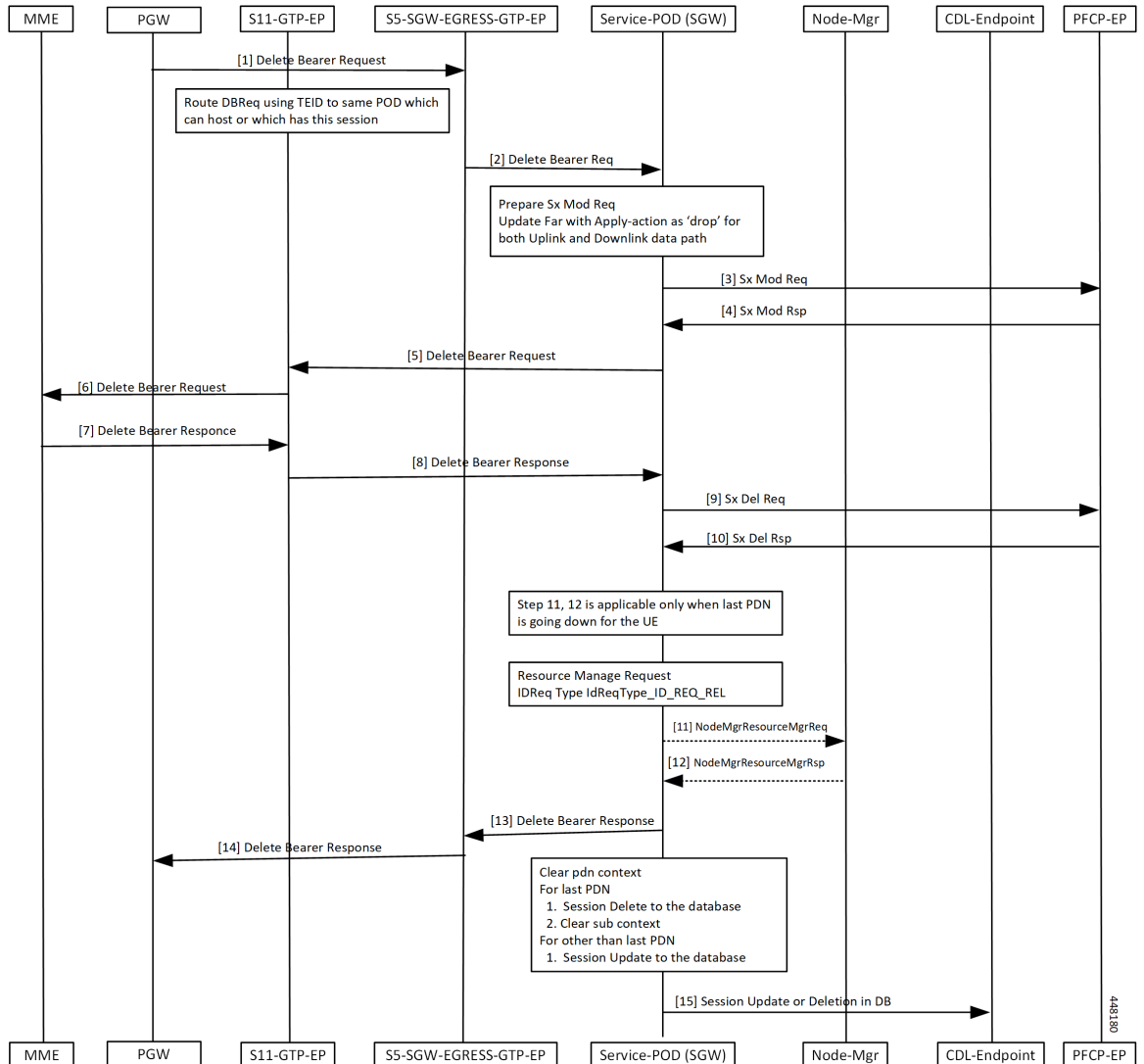

Table 176: PGW-requested Disconnection Call Flow Description

Step	Description
1	The PGW sends the Delete Bearer Request to the S11-GTP-EP for other PDN disconnection.
2	The GTP-EP decodes the received UDP message and converts the message into the gRPC message. Based on the TEID value, the gRPC message is forwarded to the SGW-service pod which can handle the UE session.
3	The SGW-service pod finds the subscriber context information as per the local ingress TEID. The SGW-service pod validates the Delete Bearer Request content. The SGW-service pod sends the Sx Modify Request to the PFCP-EP with apply action as DROP to drop the uplink or downlink packets at the SGW-U.

Step	Description
4	The PFCP-EP sends the Sx Modify Response to the SGW-service pod.
5	The SGW-service pod forwards the Delete Bearer Request to the S5-SGW-EGRESS-GTP-EP.
6	The S5-SGW-EGRESS-GTP-EP forwards the Delete Bearer Request to the PGW through the UDP proxy.
7	The PGW sends the Delete Bearer Response to the S5-SGW-EGRESS-GTP-EP.
8	The S5-SGW-EGRESS-GTP-EP forwards the Delete Bearer Response to the SGW-service pod.
9	The SGW-service pod validates the Delete Bearer Response, and sends the Sx Delete Request to the PFCP-EP.
10	The SGW-service pod receives the Sx Delete Bearer Response from the PFCP-EP.
11	For the last PDN, the SGW-service pod sends the NodeMgrResourceManager Request for the ID release to the NodeManager.
12	The Node Manager releases the ID and sends the acknowledgment to the SGW-service pod.
13	The SGW-service pod sends the Delete Bearer Response to the S11-GTP-EP.
14	The S11-GTP-EP forwards the Delete Bearer Response to the MME.
15	The SGW-service pod <ul style="list-style-type: none"> • Updates the Bearer in database for the delete PDN information for other than the last PDN • Sends the delete Bearer message to the database for the last PDN



CHAPTER 39

Performance Optimization Support

- Feature Summary and Revision History, on page 427
- Feature Description, on page 430
- Async BG-IPC from GTPC-EP towards SGW-Service, on page 431
- Batch ID Allocation, Release, and Reconciliation Support, on page 431
- Cache Pod Optimization, on page 434
- CDL Flush Interval and Session Expiration Tuning Configuration, on page 434
- DDN Call Flow Optimization, on page 435
- DDN Timeout Configuration, on page 440
- Domain-based User Authorization Using Ops Center, on page 441
- Edge Echo Implementation, on page 443
- ETCN Peer Optimization Support, on page 445
- Optimized GTPv2 Encoder and Decoder, on page 446
- GTPC Endpoint with GR Split, on page 448
- GTPC Endpoint Interface Split with S11 and S5 , on page 449
- GTPC IPC Cross-rack Support, on page 451
- Interservice Pod Communication, on page 459
- MBR Call Flow Optimization, on page 462
- Maintenance Mode, on page 472
- Partial CDL Update for Idle-Active Call Flow, on page 473
- PFCP Session Report with DLDR Throttling Support, on page 476
- Resiliency Handling, on page 478
- Roaming Peer Path Management Optimization, on page 482
- Flag DB Database Updates, on page 486
- UDP Proxy Functionality Merged into Protocol Microservices, on page 487

Feature Summary and Revision History

Summary Data

Table 177: Summary Data

Applicable Products or Functional Area	cnSGW-C
--	---------

Applicable Platforms	SMI
Feature Default Setting	<p>Async BG IPC from GTPC-EP towards SGW-Service: Enabled – Always-on</p> <p>Batch ID Allocation, Release, Reconciliation Support: Disabled – Configuration required to enable</p> <p>Cache Pod Optimization</p> <p>CDL Flush Interval and Session Expiration Tuning Configuration: Enabled – Configuration required to disable</p> <p>DDN Call Flow Optimization: Disabled – Configuration required to enable</p> <p>DDN Timeout Configuration: Disabled – Configuration required to enable</p> <p>Edge Echo Implementation: Enabled – Always-on</p> <p>ETCD Peer Optimization Support: Enabled - Always-on</p> <p>Flag the DB Database Updates: Enabled – Always-on</p> <p>GTPC Interface Split: Disabled – Configuration required to enable</p> <p>GTPC IPC Cross-rack Support: Disabled – Configuration required to enable</p> <p>Interservice Pod Communication: Disabled – Configuration required to enable</p> <p>Maintenance Mode: Disabled – Configuration required to enable</p> <p>MBR Call Flow Optimization: Disabled – Configuration required to enable</p> <p>Optimized GTPv2 Encoder and Decoder: Enabled – Always-on</p> <p>Partial CDL Update for Idle Active Call Flow: Enabled – Always-on</p> <p>PFCP Session Report with DLDR Throttling Support: Disabled – Configuration required to enable</p> <p>Resiliency Handling: Disabled – Configuration required to enable</p> <p>Roaming Peer Path Management Optimization: Disabled – Configuration required to enable</p> <p>UDP Proxy functionality merge into Protocol microservices: Enabled – Configuration required to disable</p>

Related Documentation	Not Applicable
-----------------------	----------------

Revision History

Table 178: Revision History

Revision Details	Release
Support for the following sub-features were introduced: <ul style="list-style-type: none">• Added support for cache pod optimization.• PFCP Session Report with DLDR Throttling Support• Resiliency Handling	2023.01.0

Revision Details	Release
Support for the following sub-features were introduced: <ul style="list-style-type: none"> • Batch ID Allocation, Release, and Reconciliation • CDL Flush Interval and Session Expiration Tuning Configuration • DDN Call Flow Optimization • DDN Timeout Configuration • Edge Echo Implementation • ETCD Peer Optimization Support • Flag the DB Database Updates • GR Split • GTPC Interface Split • GTPC IPC Cross-rack Support • Interservice Pod Communication • Introduced support for IPv6. • Maintenance Mode • Optimization of Modify Bearer Request and Response (MBR) call flows • Optimized GTPv2 Encoder and Decoder is provided for additional Request and Response messages. • UDP Proxy and GTPC-EP Merge • UDP Proxy and PFCP-EP Merge 	2022.04.0
First introduced.	2021.02.3

Feature Description

This chapter describes about the performance optimization features.

Some of the performance optimization features are common across cnSGW-C and SMF.

For complete information on SMF features, see the *UCC 5G SMF Configuration and Administration Guide*.

Async BG-IPC from GTPC-EP towards SGW-Service

Feature Description

cnSGW-C supports Asynchronous BG-IPC call from GTPC-EP to cnSGW-C, by consuming less resources of the GTPC-EP pod.

For Async BG-IPC call, the GTPC-EP pod uses:

- `SendRequestWithCallbackAsResponseWithRequestId` API of app-infra to send request messages to the SGW-service.
- `GetIPCRequestCallbackResponseWithRequestId` API to receive response from the SGW-service.

Batch ID Allocation, Release, and Reconciliation Support

Feature Description

The nodemgr allocates a unique ID to the subscriber that is in the attached state. When the subscriber detaches, the unique ID is released to the nodemgr. If the allocation and deallocation procedures increase, the nodemgr performance is impacted and the sgw-service continues to wait longer to complete these procedures.

The Batch ID Allocation, Release, and Reconciliation Support feature provide a mechanism to reduce the interaction between the sgw-service and nodemgr, which in turn optimizes the nodemgr's performance.

How it Works

This section describes how this feature works.

Batch ID Allocation:

Allocation of batch ID involves the following steps:

- The sgw-service manages the ID store by allocating the free IDs to the subscriber. When the IDs are unavailable in the store, the sgw-service sends the Batch ID Allocation Request to nodemgr.
- In response, nodemgr returns a batch of 128 IDs with the ID Reserve Report Interval. The sgw-service updates the ID store with the IDs received from the nodemgr and starts a timer for the ID Reserve Report Interval.
- If all the IDs are used before the duration configured in the ID Reserve Report Interval, sgw-service sends a Batch of ID Allocation Request to the nodemgr with a notification to reserve all IDs from the previous request.
- If the ID Reserve Report Interval timer expires before the sgw-service allocates all the IDs, sgw-service sends the unused IDs back to nodemgr through the Reserve Report Batch operation.

Batch ID Release:

Releasing of the batch ID involves the following steps:

- The `sgw-service` manages the IDs that the ID store releases for each `nodemgr`.
- The `sgw-service` returns the ID to the ID store whenever an ID is deallocated. If the ID store is full, the `sgw-service` sends a Batch ID Release Request and the released IDs to the respective `nodemgr`.
- When `sgw-service` starts adding IDs to the ID store, the ID release timer starts.
- If the ID release timer expires before the batch IDs are released or the batch is full, `sgw-service` sends the released IDs to `nodemgr`.

Batch ID Reconciliation

Batch ID reconciliation occurs when the service pod and the `nodemgr` pod restarts.

On service pod restart:

1. When the service pod receives the batch IDs and becomes unresponsive before allocating the IDs, the `nodemgr` does not get the Batch ID Reserve Request causing the ID reserve procedure to time out. In such a scenario, the `nodemgr` reconciles the unreserved or unallocated IDs with CDL. The IDs that are not allocated to the subscribers are released to the ID store.
2. The service pod collects the IDs that are released and if it becomes unresponsive before releasing them to the `nodemgr`. In this scenario, the IDs are dropped.

On `nodemgr` pod restart:

1. The IDs existing in the in-flight Batch ID Reserve Request and Batch ID Release Request are dropped.
2. The `nodemgr` notifies `cachemgr` about the allocated IDs in a batch. If `nodemgr` becomes unresponsive before notifying the IDs to `cachemgr`, after a restart, `nodemgr` starts allocating the new IDs. The `nodemgr` allocated the IDs based on the last allocated ID and the batch size.

Feature Configuration

To configure this feature, use the following configuration:

```
config
  sgw sgw_name
    resmgr-batch-operation [ disable | enable ]
  end
```

NOTES:

resmgr-batch-operation [disable | enable]—Configures the batch operation. By default, **resmgr-batch-operation** is disabled.

OAM Support

This section describes operations, administration, and maintenance support for this feature.

Bulk Statistics

The following statistics are supported for the Batch ID Allocation and Release Support feature:

- `sgw_resource_mgmt_stats`—Captures the total number of the `cnSGW-C` resource management statistics.

Sample queries:

```
sgw_resource_mgmt_stats{app_name="smf",cluster="Local",data_center="DC",gr_instance_id="1",
id_req_type="id_batch_alloc",instance_id="0",service_name="sgw-service",status="attempted"}
3
:sgw_resource_mgmt_stats{app_name="smf",cluster="Local",data_center="DC",gr_instance_id="1",
id_req_type="id_batch_alloc",instance_id="0",service_name="sgw-service",status="success"}
3
```

```
sgw_resource_mgmt_stats{app_name="smf",cluster="Local",data_center="DC",gr_instance_id="1",
,id_req_type="id_batch_dealloc",instance_id="0",service_name="sgw-service",status="attempted"}
2
sgw_resource_mgmt_stats{app_name="smf",cluster="Local",data_center="DC",gr_instance_id="1",id_req_type=
"id_batch_dealloc",instance_id="0",service_name="sgw-service",status="success"}
2
```

```
sgw_resource_mgmt_stats{app_name="smf",cluster="Local",data_center="DC",gr_instance_id="1",
id_req_type="id_batch_dealloc_timeout",instance_id="0",service_name="sgw-service",status="attempted"}
1
:sgw_resource_mgmt_stats{app_name="smf",cluster="Local",data_center="DC",gr_instance_id="1",id_req_type
="id_batch_dealloc_timeout",instance_id="0",service_name="sgw-service",status="success"}
1
```

```
sgw_resource_mgmt_stats{app_name="smf",cluster="Local",data_center="DC",gr_instance_id="1",
id_req_type="id_batch_release_timeout",instance_id="0",service_name="sgw-service",status="attempted"}
1
-:sgw_resource_mgmt_stats{app_name="smf",cluster="Local",data_center="DC",gr_instance_id="1",id_req_type
="id_batch_release_timeout",instance_id="0",service_name="sgw-service",status="success"}
1
```

- `nodemgr_rmgr_batch_reconcile_stats`—Captures the total count of batches that are sent for reconciliation.

Sample queries:

```
nodemgr_rmgr_batch_reconcile_stats{app_name="smf",cluster="Local",data_center="DC",instance_id="0",
service_name="nodemgr",status="success"} 1
```

- `nodemgr_resource_mgmt_resp_stats`—Captures the total number of IDs released due to reconciliation.

Sample queries:

```
nodemgr_resource_mgmt_resp_stats{app_name="smf",cluster="Local",data_center="DC",error="",
gr_instance_id="0",instance_id="0",ip_ver_type="IP_TYPE_NONE",req_type="ID_REQ_REL_RECONCILE",
service_name="nodemgr",status="success"} 16
```

For more information on bulk statistics support, see *UCC Serving Gateway Control Plane Function Metrics Reference*.

Cache Pod Optimization

Feature Description

The cnSGW-C supports the cache pod optimization to reduce the cache pod query at the GTPC endpoint.

The get affinity query is used to receive the affinity information in an outgoing request or response message toward the GTPC endpoint. With this optimization, the GTPC endpoint pod doesn't send the query to the cache pod for the upcoming request messages.

To receive this affinity information, an affinity query is used in an outgoing request or response message toward the GTPC endpoint. With this optimization, the GTPC endpoint pod doesn't send the query to the cache pod for the upcoming request messages.

In the previous releases, after the cnSGW-C sent out the DDN and received the MBR from the MME, the GTPC endpoint had to send the query to the cache pod to get affinity information. Later, the cnSGW-C used the affinity information so that an MBR can be forwarded to the correct service pod.

With this optimization, you can prevent the extra cache pod query.

CDL Flush Interval and Session Expiration Tuning Configuration

Feature Description

You can modify the default service-pod parameters to fine-tune the throughput performance and optimize the load performance.

Feature Configuration

To configure this feature, use the following configuration:

```

config
  profile sgw sgw_name
    timers [ session-expiration-in-secs session_expiration |
affinity-expiration-in-secs affinity_expiration | session-dbsync-interval-in-ms
database_sync ]
  end

```

NOTES:

- **session-expiration-in-secs** *session_expiration* —Specify the duration for which the session is cached on service pod. *session_expiration* accepts value in the range of 1-600 milliseconds. The default value is 30 milliseconds.
- **affinity-expiration-in-secs** *affinity_expiration* —Specify the duration for which the session affinity keys are valid on the service pod and other pods. *affinity_expiration* accepts value in the range of 1-1200 seconds. The default value is 80 seconds.

- **session-dbsync-interval-in-ms** *database_sync* —Specify the duration after which the session is synchronized in the database. *database_sync* accepts value in the range of 1-10000 milliseconds. The default value is 500 milliseconds.

Configuration Example

The following is an example configuration.

```
config
  profile sgw sgw1 [ timers session-expiration-in-secs 30 | affinity-expiration-in-secs
    80 | timers session-dbsync-interval-in-ms 500 ]
end
```

DDN Call Flow Optimization

Feature Description

The Downlink Data Notification (DDN) Call Flow Optimization feature lets you suspend the invoking of the DDN procedure for a specified period. With this feature, the network-initiated service request procedure is scheduled before the DDN is received and the UE is moved to the active state. In case of the timer expiry, if the UE ID is active, or the Modify Bearer Request is in progress, the cnSGW ignores the DDN procedure.

How it Works

This section describes how this feature works.

cnSGW-C invokes the DDN procedure in the following scenarios:

- A session rapidly moves to the idle state causing the Uplink and Downlink data to trigger simultaneously.
- When a subscriber is in the idle state and the Downlink data is received, cnSGW-C sends a DDN to MME. The DDN notifies MME to page the UE and change the UE state to active.
- When a subscriber is in the idle state and the Uplink data is received, the MME sends a Modify Bearer Request to SGW to change the UE state to active.
- If the SGW service has initiated DNN and it receives the Modify Bearer Request, the service aborts the DDN procedure and processes the Modify Bearer Request to change the UE state to active.

Call Flows

This section describes the key call flows for this feature.

Current Downlink Data Notification Handling Call Flow

This section describes the Current Downlink Data Notification Handling call flow.

Figure 99: Current Downlink Data Notification Handling Call Flow

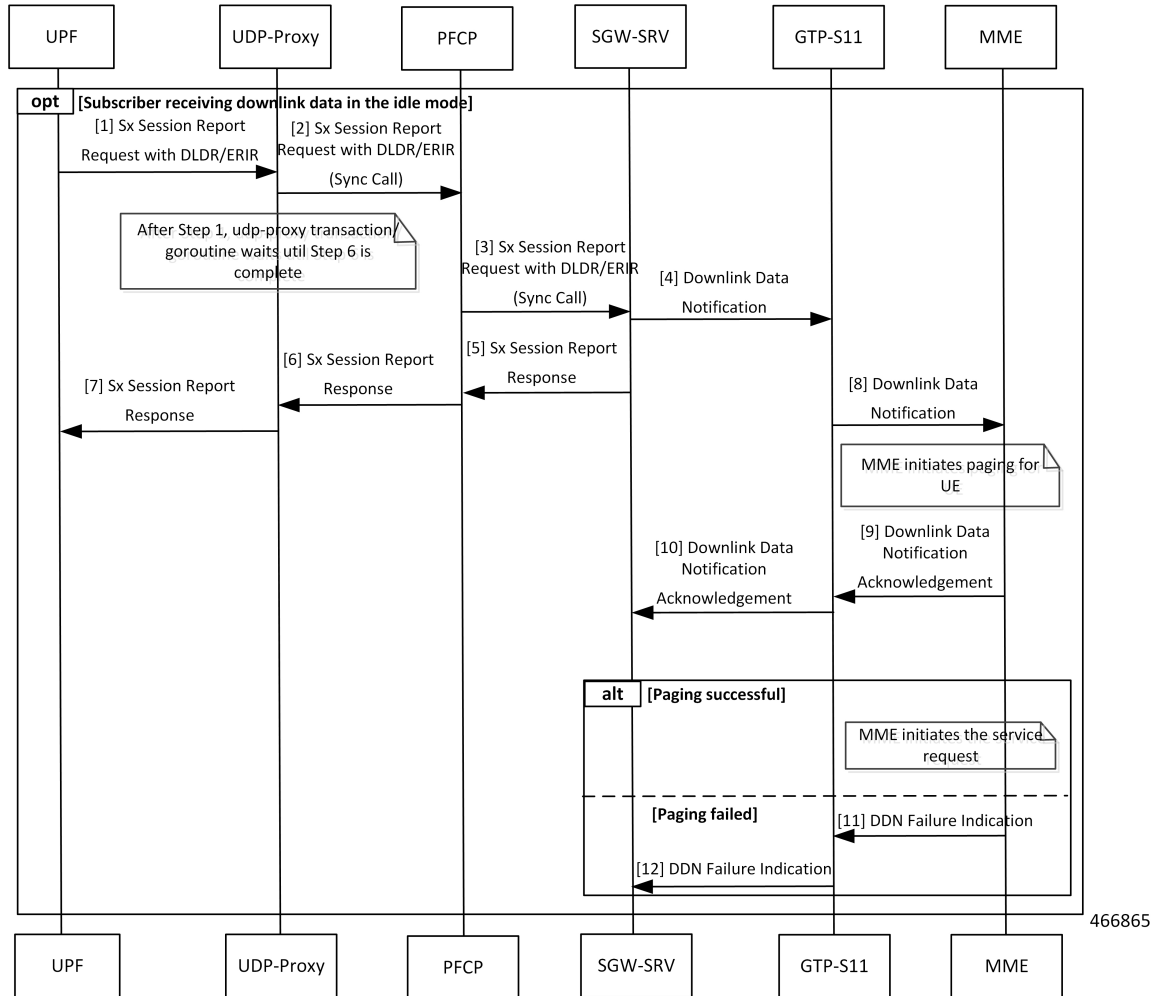

Table 179: Current Downlink Data Notification Handling Call Flow Description

Step	Description
1	UPF sends a Sx Session Report Request with DLDR or ERIR to UDP-Proxy.
2	UDP-Proxy sends the Sx Session Report Request with DLDR or ERIR to PFCP.
3	PFCP sends the Sx Session Report Request with DLDR or ERIR to SGW-SRV.
4	The SGW-SRV sends the Downlink Data Notification (DDN) to GTP-S11.
5	SGW-SRV sends Sx Session Report Response to PFCP.
6	PFCP sends the Sx Session Report Response to UDP-Proxy.
7	UDP-Proxy sends the Sx Session Report Response to UPF.
8	GTP-S11 sends the DDN Notification to MME.

Step	Description
9	MME initiates a paging for UE and sends the DDN Acknowledgment to GTP-S11.
10	GTP-S11 sends the DDN Acknowledgment to SGW-SRV.
11	When the paging fails, MME sends the DDN Failure Indication to GTP-S11.
12	GTP-S11 sends the DDN Failure Indication to SGW-SRV.

DDN Handling with Internal DDN Delay Timer Call Flow

This section describes the DDN Handling with Internal DDN Delay Timer call flow.

Figure 100: DDN Handling with Internal DDN Delay Timer Call Flow

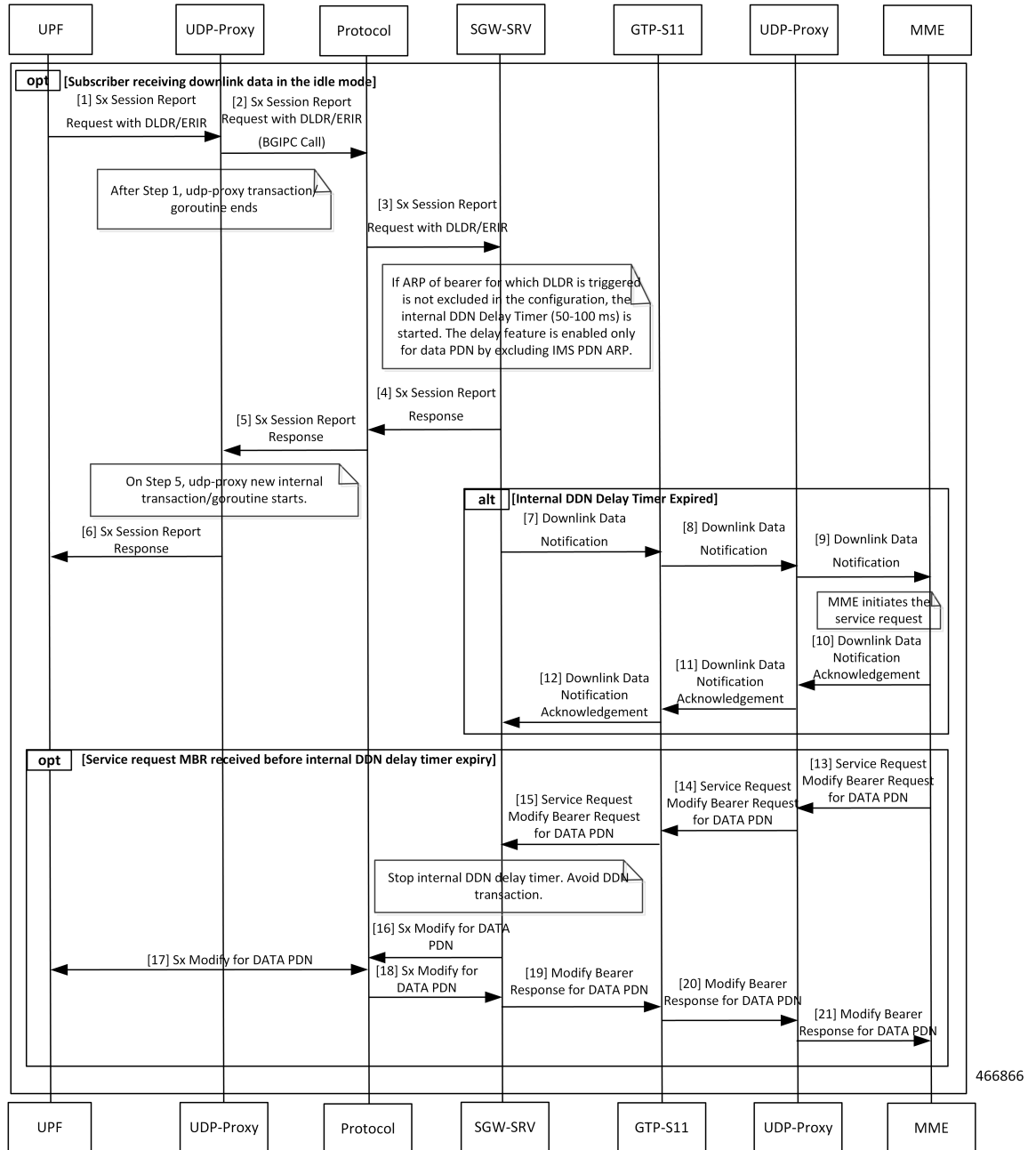

Table 180: DDN Handling with Internal DDN Delay Timer Call Flow Description

Step	Description
1	UPF sends a Sx Session Report Request with DLDR/ERIR to UDP-Proxy.
2	UDP-Proxy sends the Sx Session Report Request with DLDR/ERIR (BGIPC Call) to Protocol.
3	Protocol sends the Sx Session Report Request with DLDR/ERIR to SGW-SRV.

Step	Description
4	SGW-SRV sends a Sx Session Report Response to Protocol.
5	Protocol sends the Sx Session Report Request to UDP-Proxy.
6	UDP-Proxy sends the Sx Session Report Request to UPF.
7	SGW-SRV sends the Downlink Data Notification to GTP-S11.
8	GTP-S11 sends the Downlink Data Notification to UDP-Proxy.
9	UDP-Proxy sends the Downlink Data Notification to MME.
10	After MME initiates paging for UE, MME sends the Downlink Data Notification Acknowledgement to UDP-Proxy.
11	UDP-Proxy sends the Downlink Data Notification Acknowledgement to GTP-S11.
12	GTP-S11 sends the Downlink Data Notification Acknowledgement to SGW-SRV.
13	MME sends the Modify Bearer Request for DATA PDN to UDP-Proxy.
14	UDP-Proxy sends the Modify Bearer Request for DATA PDN to GTP-S11.
15	GTP-S11 sends the Modify Bearer Request for DATA PDN to SGW-SRV.
16	SGW-SRV sends the Modify Bearer Request for DATA PDN to Protocol.
17	Protocol and UPF processes the Sx Modify Bearer Request for DATA PDN.
18	Protocol sends Sx Modify Response for DATA PDN to SGW-SRV.
19	SGW-SRV sends Sx Modify Response for DATA PDN to GTP-S11.
20	GTP-S11 sends Sx Modify Response for DATA PDN to UDP-Proxy.
21	UDP-Proxy sends Sx Modify Response for DATA PDN to MME.

Feature Configuration

To configure this feature, use the following configuration:

```

config
  profile sgw sgw_name
    ddn { delay-exclude-arplist number_priorities | delay-timer delay_duration
    }
  end

```

NOTES:

- **delay-exclude-arplist** *number_priorities*—Specify the priority-level for allocation and retention priorities [1-15] that must be excluded from delaying the DDN. *number_priorities* can accept a maximum of eight entries.

- **delay-timer** *delay_duration*—Specify the duration for which the DDN procedure is delayed. *delay_duration* accepts duration in milliseconds 0–5000. The default duration is 0 which indicates that the timer is disabled.

Configuration Example

The following is an example configuration.

```
config
  profile sgw sgw1
    ddn delay-timer 100 delay-exclude-arplist [ 3 4 ]
  end
```

OAM Support

This section describes operations, administration, and maintenance support for this feature.

Bulk Statistics

The following statistics are supported for the DDN Call Flow Optimization feature:

sgw_tmr_stats—The internal DDN delay timer for stop, start, and expired states.

Query:

```
sgw_tmr_stats{app_name="smf",cluster="Local",data_center="DC",gr_instance_id="1",
instance_id="0",service_name="sgw-service",status="expired",timer_type="internal_ddn_delay"}
1

sgw_tmr_stats{app_name="smf",cluster="Local",data_center="DC",gr_instance_id="1",instance_id="0",
service_name="sgw-service",status="start",timer_type="internal_ddn_delay"}
2

sgw_tmr_stats{app_name="smf",cluster="Local",data_center="DC",gr_instance_id="1",instance_id="0",
service_name="sgw-service",status="stop",timer_type="internal_ddn_delay"}
1
```

DDN Timeout Configuration

Feature Description

cnSGW-C lets you configure the DDN Timeout and Peer Not Responding configuration through the cnSGW-C Ops Center.

Feature Configuration

To configure this feature, use the following configuration:

```
config
  profile sgw sgw_name
    ddn timeout-purge-session { true | false }
  end
```

NOTES:

ddn timeout-purge-session { true | false }—Configures the session when the MME does not send the DDN acknowledgment. The default value is false.

Domain-based User Authorization Using Ops Center

Feature Description

SMF and cnSGW-C support domain-based user authorization using the Ops Center. To control the access on a per-user basis, use the TACACS protocol in Ops Center AAA. This protocol provides centralized validation of users who attempt to gain access to a router or NAS.

Configure the NETCONF Access Control (NACM) rules in the rule list. Then, map these rules in the Ops center configuration to map the group to appropriate operational authorization. Use the configurations that are based on the following criteria and products:

- With the NACM rules and SMF domain-based group, configure the Ops center to allow only access or update SMF-based configuration.
- With the NACM rules and cSGW-C domain-based group, configure the Ops center to allow only access or update cSGW-C-based configuration.
- With the NACM rules and cSGW-C domain-based group, configure the Ops center to allow only access or update CCG-based configuration.



Note The NSO service account can access the entire configuration.

How it Works

To support this feature configuration in Ops Center, the domain-based-services configuration is added in the TACACS security configuration. The TACACS flow change works in the following way:

- If you have configured the **domain-based-services** parameter, then the configured user name that is sent to the TACACS process, splits user ID into user ID and domain. The split character, which is a domain delimiter, is configured in domain-based-services. These split characters can be "@", "/", or "\" and are used in the following format to get the domain and user ID information.
 - @ — <user id>@<domain>
 - / — <domain>/<user id>
 - \ — <domain>\<user id>
- The TACACS authenticates and authorizes as per the existing flow. However, if the domain-based-services feature is enabled and TACACS authenticates and authorizes the user, following steps are added to the TACACS flow procedure.
 - If Network Services Orchestrator (NSO) logs in as the NSO service account, then that session receives a specific NACM group that you configured in **domain-based-services nso-service-account group group-name**. This functionally is the same as the way NSO works.

- If the specified domain exists in the group mapping, then the NACM group that you configured in **domain-based-services domain-service domain group group-name** is applied.
- If the user does not have a domain or the domain does not exist in the domain to group mapping, then **no-domain** NACM group that you configured in **domain-based-services no-domain group group-name** is applied. If the **no-domain** configuration does not exist, then the user value is rejected.

To enable this feature, you must configure the **domain-based-services** CLI command with the following options:

- NSO service account
- Domain service
- Domain delimiter
- No domain

Feature Configuration

To enable domain-based user authorization using Ops Center, use the following sample configuration:

```
config
  tacacs-security domain-based-services [ domain-delimiter delimiter_option
    | domain-service domain_service_name [ group service_group_name ] | no-domain
group service_group_name | nso-service-account [ group service_group_name | id
service_account_id ] ]
end
```

NOTES:

- **domain-based-services [domain-delimiter delimiter_option | domain-service domain_service_name [group service_group_name] | no-domain group service_group_name | nso-service-account [group service_group_name | id service_account_id]]**: Configure the required domain-based-services value. The **domain-based-services** includes the following options:
 - **domain-delimiter**: Specify the delimiter to use to determine domain. This option is mandatory and allows the following values:
 - **@**—If domain-delimiter is "@", the user value is in the format: <user>@<domain>.
 - **/**—If domain-delimiter is "/", the user value is in the format: <domain>/<user>.
 - ****—If domain-delimiter is "\", the user value is in the format: <domain>\<user>.
 - **domain-service**: Specify the list of domains and their group mapping. The key is the name of the domain and group is the group that is assigned to the domain. You must configure at least one option in this list.
 - **no-domain**: Specify the group that has no domain or if the domain is unavailable in the domain-service mapping, then this group is sent in the accept response.
 - **nso-service-account**: Specify the NSO service account that has the ID and group. If you configure this parameter, then you must configure the ID and group fields. The ID and group must have string values.

Configuration Example

The following is an example of the domain-based user authorization in the tacacs-security mode:

```
config
 tacacs-security domain-based-services nso-service-account id nsid
   tacacs-security domain-based-services nso-service-account group nso-group
 tacacs-security domain-based-services no-domain group read-operational
 tacacs-security domain-based-services domain-delimiter @
 tacacs-security domain-based-services domain-service etcd
   group etcd
exit
tacacs-security domain-based-services domain-service sgw
   group sgw_1
exit
tacacs-security domain-based-services domain-service smf
   group smf
exit
```

Configuration Verification

To verify the configuration, use the following show command:

show running-config tacacs-security

The output of this show command displays all the configurations of the domain-based services within the TACACS security.

```
[smf] smf# show running-config tacacs-security
tacacs-security service smf
tacacs-security server 1
address 209.165.200.234
key $8$+twbdL2ZCgmjVswgp7kFJp8+SMXDjQRTZgoPVa3oEwY=
exit
tacacs-security domain-based-services nso-service-account id nsid
tacacs-security domain-based-services nso-service-account group nso-group
tacacs-security domain-based-services no-domain group read-operational
tacacs-security domain-based-services domain-delimiter @
tacacs-security domain-based-services domain-service etcd
group etcd
exit
tacacs-security domain-based-services domain-service sgw
group sgw_1
exit
tacacs-security domain-based-services domain-service smf
group smf
exit
```

Edge Echo Implementation

Feature Description

In a nonmerged mode, the udp-proxy pod acts as an endpoint, and the gtpc-ep responds to the Echo Requests from the peer node.

The gtpc-ep experiences traffic when the system receives a high number of inputs CEPS leading to a discrepancy between the rate at which gtpc-ep picks up the messages from udp-proxy and the rate at which udp-proxy gets the messages.

If the gtpc-ep is loaded, the queue between the udp-proxy and gtpc-ep gets full, and some of the messages at udp-proxy might get dropped. The peer detects path failure if these are Echo Request messages because an Echo Response is not received. Further, the peer clears all the sessions sent to the sgw-service.

How it Works

This section describes how this feature works.

Nodemgr processes the Echo Request in the following steps:

- The nodemgr preserves a self-restart counter cache for each GR instance ID and the GTPC peer.
- When the udp-proxy pod receives an Echo Request from a peer and the self-restart counter value is not available in the self-restart counter cache, the udp-proxy pod forwards the Echo Request to gtpc-ep.
- The gtpc-ep sends the self-restart counter as part of the UDP proxy message metadata in the Echo Response. The udp-proxy stores the self-restart counter in the self-restart counter cache. When the udp-proxy receives an Echo Request from a peer, and a self-restart counter value is available in the self-restart counter cache, the udp-proxy sends an Echo Response with the restart counter.
- The udp-proxy forwards the Echo Request message to the gtpc-ep. The gtpc-ep processes the Echo Request and forwards it to nodemgr, if necessary.
- If the peer restart counter value is modified, the nodemgr detects a path failure.
- In the Echo Response, the gtpc-ep sends the self-restart counter in the UDP Proxy Message metadata to the udp-proxy. If the self-restart counter differs from the counter that is stored in the self-restart counter cache, the udp-proxy updates the self-restart counter in the cache and drops the Echo Response received from the gtpc-ep.



Note The Edge Echo feature is not supported when the gtpc-ep is started in the merged mode.

Heartbeat

To handle the Echo Request and Echo Response messages for the GTPV2 interface, a heartbeat queue is implemented between the gtpc-ep and the udp-proxy pod. The heartbeat queue is responsible for handling the HeartBeat Request and HeartBeat Response Messages between the protocol and udp-proxy pod for the PFCP interface.

OAM Support

This section describes operations, administration, and maintenance support for this feature.

Bulk Statistics Support

The following statistics are supported for the Edge Echo Implementation feature:

- Heartbeat queue status:

```
sum(irate(ipc_response_total{rpc_name~".ipc_stream_hb."}[10s])) by
(service_name,
instance_id, status, status_code, rpc_name, dest_host)
```

- Check the EdgeEcho messages:

```
sum(irate(udp_proxy_msg_total{ message_name = "edge_echo" }[30s])) by
(message_name,
message_direction, status)
```

To enable the Heartbeat queue and EdgeEcho messages statistics, configure the trace-level statistics for `udp_proxy_msg_total` using the following:

```
infra metrics verbose application
metrics udp_proxy_msg_total level trace
exit
```



Note Enabling the heartbeat and EdgeEcho messages statistics may lead to a performance degradation on the `udp-proxy` pod.

ETCD Peer Optimization Support

Feature Description

When large numbers of GTPC peers are connected with SMF or cnSGW-C, the performance of ETCD is impacted. Each peer is considered as a record in the ETCD, and the timestamp is updated every 30 seconds for each peer. This causes continuous updates on ETCD and generates huge traffic that impacts the overall system performance.

The ETCD Peer Optimization feature facilitates optimization in peer management and enables reduced performance impact on ETCD.

How it Works

This section describes how this feature works.

Instead of considering each peer as an ETCD record entry, several peers are grouped as a peer group based on the hash value of the IP address of each peer. This reduces the number of entries in ETCD. By default, a maximum of 200 peer groups can be created. For any changes related to a peer in a peer group:

- For a new peer, the peer group is persisted immediately in ETCD.
- For the change in timestamp for existing peers, the peer group is updated once every 3 seconds. This update:
 - Results in a cumulative group update for many peers that have undergone timestamp change within each peer group.
 - Reduces frequent updates to ETCD.

Optimized GTPv2 Encoder and Decoder

Feature Description

cnSGW-C provides an optimized GTPv2 encoder and decoder for:

- Modify Bearer Request and Response messages when the subscriber is moving to ACTIVE state after receiving the Modify Bearer Request message.
- Release Access Bearer Request and Response messages when the subscriber is moving to IDLE state on receiving the Release Access Bearer Request message.

The optimized GTPv2 encoder and decoder is provided for the following messages:

- Bearer Resource Command
- Change Notification Request and Response
- Create Bearer Request and Response
- Create IDFT Request and Response
- Create Session Request and Response
- Delete Bearer Command
- Delete Bearer Failure Indication
- Delete Bearer Request and Response
- Delete IDFT Request and Response
- Delete Session Request and Response
- Downlink Data Notification Acknowledgment
- Downlink Data Notification Failure Indication
- Download Datalink Notification Request
- Echo Request and Response
- Modify Bearer Request and Response
- Modify Bearer Command
- Modify Bearer Failure Indication
- Update Bearer Request and Response

Feature Configuration

To configure this feature on S11, S5, and S5e interfaces, use the following configuration:

```
config
  instance instance-id instance_id
```

```

endpoint gtp
  replicas replica_count
  vip-ip ipv4_address vip-port ipv4_port_number
  vip-ipv6 ipv6_address vip-ipv6-port ipv6_port_number
  dual-stack-transport { true | false }
  enable-go-encdec { true | false }
  interface interface_name
    enable-go-encdec { true | false }
  end

```

NOTES:

- **enable-go-encdec { true | false }**—Enable the Go language-based GTPv2 encoder and decoder for the interface.
- **dual-stack-transport { true | false }**—Enable the dual stack feature that allows you to specify IPv6 or IPv4 address. Specify true to enable this feature.

Configuration Example

The following is an example configuration.

```

config
  instance instance-id 1
    endpoint gtp
      replica 2
      vip-ip 209.165.200.224 vip-port 2022
      vip-ipv6 ipv6_address 2001:db8:1::2 22
      dual-stack-transport true
      enable-go-encdec false
    exit
    interface s5e
      replica 3
      vip-ip 209.165.200.225 vip-port 2022
      vip-ipv6 ipv6_address 2001:db8:1::3 22
      dual-stack-transport true
      enable-go-encdec true
    exit
    interface s11
      replica 3
      vip-ip 209.165.200.226 vip-port 2022
      vip-ipv6 ipv6_address 2001:db8:1::4 22
      dual-stack-transport true
      enable-go-encdec true
    exit
    interface s5
      replica 3
      vip-ip 209.165.200.227 vip-port 2022
      vip-ipv6 ipv6_address 2001:db8:1::5 22
      dual-stack-transport true
      enable-go-encdec true
    end

```

OAM Support

This section describes operations, administration, and maintenance support for this feature.

Bulk Statistics Support

The following statistics are supported for the Optimized GTPv2 Encoder and Decoder feature:

Grafana Query for Go based encoder decoder:

Query:

```
sum(irate(gtpc_golang_enc_dec_stats{namespace="$namespace"}[60s]))  
by (gtpc_msg_type, gtpc_msg_operation, gtpc_msg_status)
```

Legend:

```
{{gtpc_msg_type}}-{{gtpc_msg_operation}}-{{gtpc_msg_status}}
```

GTPC Endpoint with GR Split

Feature Description

The GR Split feature enables handling the scaled GTP traffic and facilitates the optimal use of the CPU. The GR Split feature starts multiple active instances of GTPC-EP and performs traffic split which is based on GR instances. This helps in aiding the UDP proxy bypass feature.

How it Works

This section describes how this feature works.

The UDP Proxy merge mode is a prerequisite for this feature.

- For a sunny-day scenario, RACK1 (GTPC-EP Active Instance-1) and RACK2 (GTPC-EP Active Instance-2) handle the traffic from GR-Instance-1 and GR Instance-2, respectively.
- For a rainy-day scenario, the GR Instance-1 (S11, S5E, S5) and GR Instance-2 (S11, S5E, S5) traffic splits between two GTPC-EP instances.

In the rainy-day scenario, assuming RACK2 is down, RACK1 handles all the traffic for GR Instance-1 and GR Instance-2. With the GR Split implementation, the GTPC-EP Active Instance-1 handles GTP traffic for all the interfaces for GR Instance-1, and GTPC-EP Active Instance-2 handles all the GTP traffic for GR Instance-2.

Figure 101: GTPC-EP with Merged Mode and GR Split

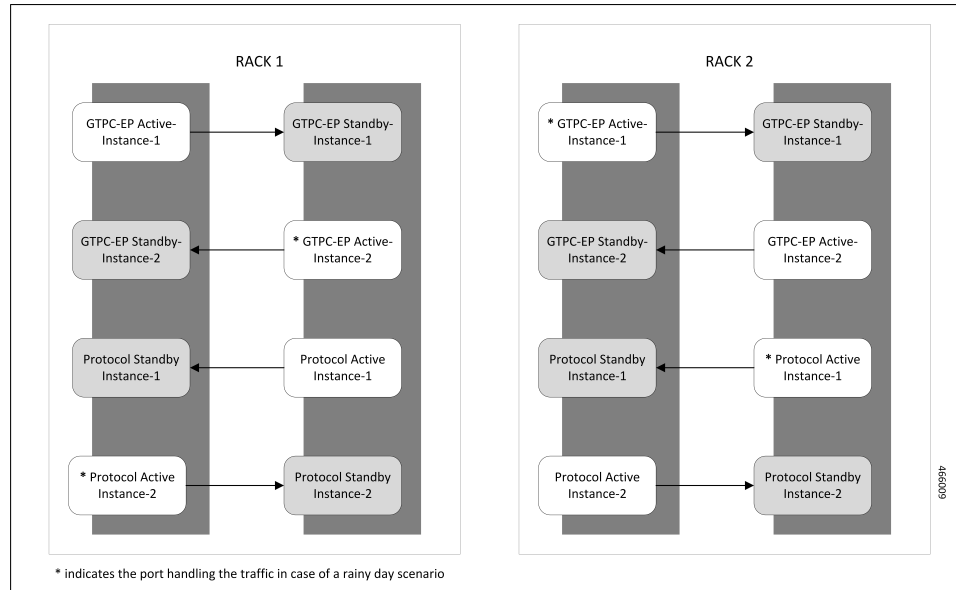

GTPC Endpoint Interface Split with S11 and S5

Feature Description

The GTPC Interface Split feature enables splitting the GTPC endpoint based on the interface. cnSGW-C splits the GTPC pod into two interfaces, S11 and S5 which enables handling all GTPC incoming and outgoing traffic for S11 (SGW-Ingress), S5E (SGW-Egress), and S5 (SMF-Ingress).

How it Works

This section describes how this feature works.

The GR Instance Split or UDP Proxy merge mode is a prerequisite for this feature.

This feature is disabled by default. While configuring this feature, provide separate internal and external VIP addresses for S11 and S5 GTPC endpoints, and deploy two GTPC-EP pods.

On configuring the feature, cnSGW-C sends the IPC call from SMF-service, SGW-service, and the Node Manager to the GTPC pod based on the GTPC interface and the GR instance ID.

The following are the recommendations for the GTPC interface split feature:

- CPU Core:
 - S5 Interface: 6
 - S11 Interface: 18
 - UDP Proxy: 2

- VIP Configuration: Separate internal and external VIP for S5 and S11 interfaces
- The Dispatcher configuration must be the same configuration as existing before upgrade.

The following diagram indicates the GTPC Interface Split pod layout.

Figure 102: GTPC Interface Split pod layout

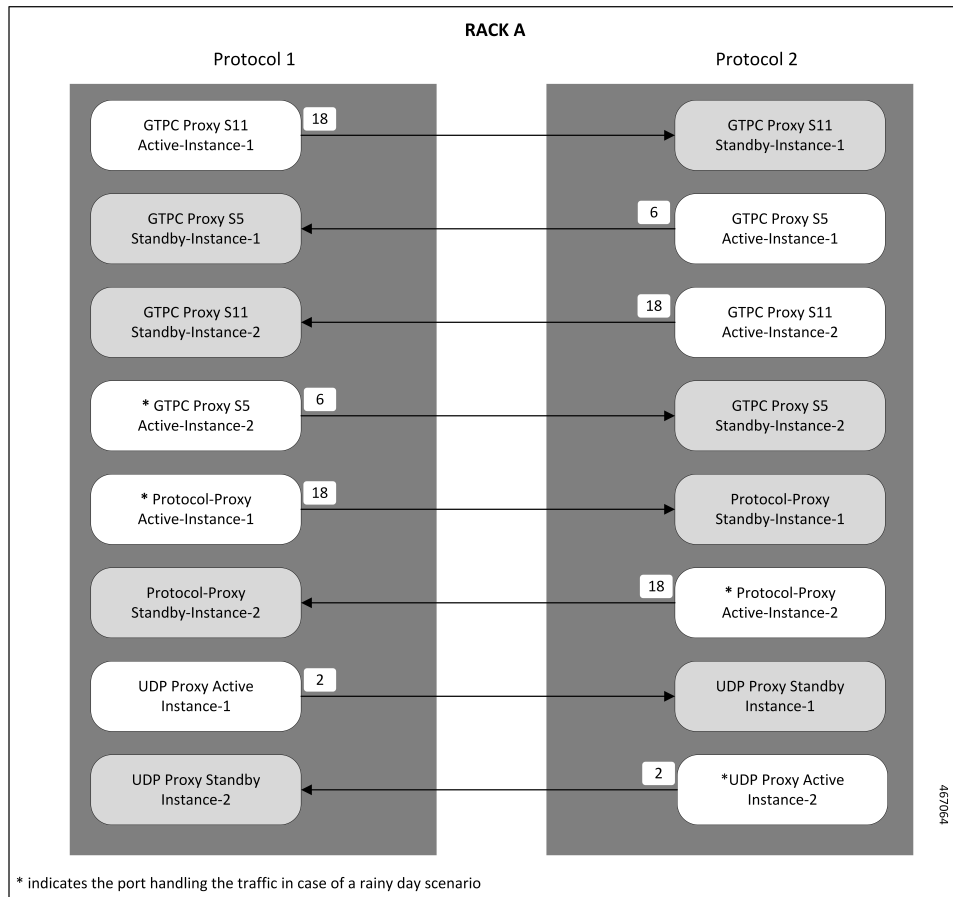

Feature Configuration

To configure this feature, use the following configuration:

```

config
  instance instance-id instance_id
    endpoint gtp
    interface s11
      standalone true
      cpu max-process cpu_core_value
      internal-vip internal_vip_address
      vip-ip ipv4_address vip-port ipv4_port_number
      vip-ipv6 ipv6_address vip-ipv6-port ipv6_port_number
      dual-stack-transport { true | false }
      vip-interface vip_interface_value

```

```

    exit
  exit
  interface s5
    vip-ip ipv4_address vip-port ipv4_port_number
    vip-ipv6 ipv6_address vip-ipv6-port ipv6_port_number
    dual-stack-transport { true | false }
    vip-interface vip_interface_value
  end

```

NOTES:

- **standalone true:** Configures the interface to run in standalone mode with a separate pod for the interface.
- **cpu max-process *cpu_core_value*:** Specify the CPU core value for the CPU for the interface. This sets the GO_MAX_PROCS parameter value for the pod.
- **dual-stack-transport { true | false }**—Enable the dual stack feature that allows you to specify IPv6 or IPv4 address. Specify true to enable this feature.

Configuration Example

The following is an example configuration.

```

config
  instance instance-id 1
    endpoint gtp
    interface s11
      standalone true
      cpu max-process 18
      internal-vip 209.165.200.225
      vip-ip 209.165.200.226 vip-interface bd1.gtp.2131
    exit
  exit
  interface s5
    vip-ip 209.165.200.228 vip-interface bd1.gtp.2131
  end

```

GTPC IPC Cross-rack Support

Feature Description

When you perform GR-setup activities with cnSGW-C and SMF, the GTPC message handling can be optimized between these two racks, as in the following scenarios:

- The set of IPC messages from cnSGW-C to SMF service pods flow over `gtpc-ep` pods twice leading to message encoding and decoding overheads.
- Within a GR pair, these IPC messages can avoid one more processing step, if service pods such as cnSGW-C and SMF can route messages to the corresponding peer GTPC nodes directly.



Note Before applying the configuration for enabling GTPC IPC on cnSGW or SMF interfaces, it is required to apply inter-rack routing networks using cluster sync. More configuration is required to add BGP routes for supporting new routable networks across rack servers.

The following figure represents a design of the new network layout that is required for supporting the feature, the core setup activities, and their interconnections.

Figure 103: SGW-GTPC Inter-rack IPC

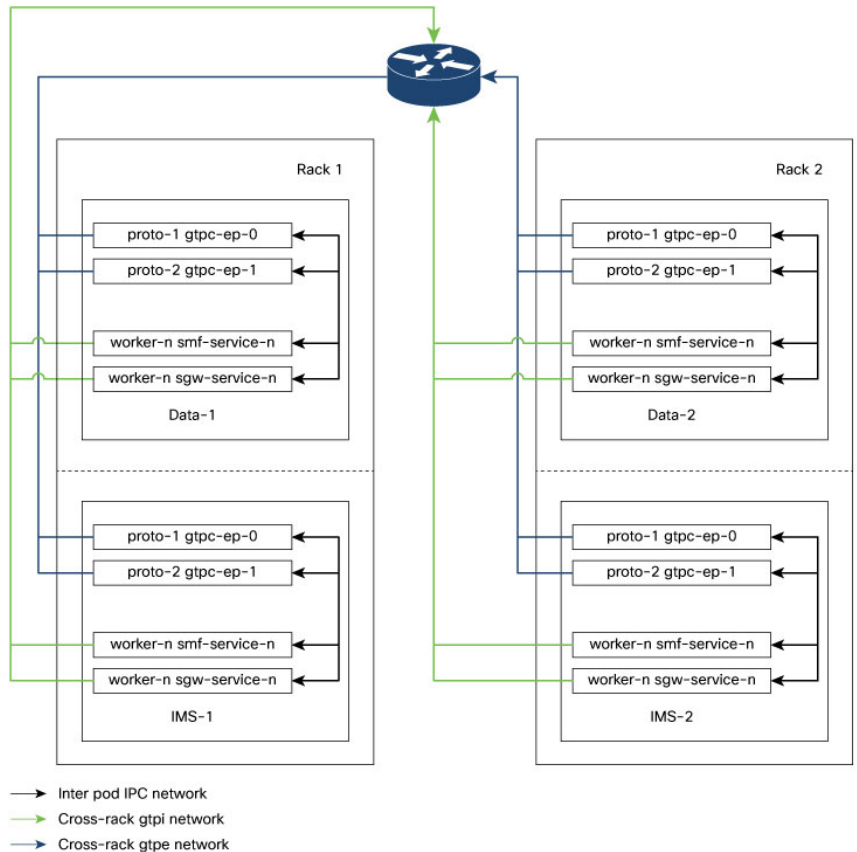

The following steps are performed for the GTPC message handling optimization between two racks and deploying the cross-rack endpoints:

- The cnSGW-C in IMS-1 Rack-1 routes the IPC request internally to PGW GTPC-EP in DATA-2 Rack-2 passing through the cross-rack GTPI network to the router.
- The router will then use the GTPE network as the next-hop for forwarding requests to the `gtpc-ep` pod.
- The GTPI and GTPE network are new networks added to the Racks during the process of deployment.
- Also, the feature requires internal GTPC IPC messages, which are received on the active `gtpc-ep` pod.
- In this process, the IPC messages from cnSGW-C to SMF service pods flow over the GTPC-EP pods, leading twice to message encoding and decoding outlays.

- Within a GR pair, such IPC messages can avoid one extra hop of processing, if these service pods (cnSGW-C and SMF) can route messages to the corresponding peer GTPC nodes directly.



Note The configured protocol nodes must be in the same VIP group as S5 and S5e VIP groups are deployed.

How it Works

This section describes how this feature works:

- In `SMF-Ops-Center`, you can configure `GTPC-EP Geo` endpoints for each rack in IMS and data racks.
- In `SMF-Ops-Center` CLI, you can configure `GTPC-EP Geo` endpoints for each rack in IMS and DATA racks.



Note The optimization of GTPC messages can be applied to all four instances or a subset of instances of GTPC endpoints within these racks. A new element is added under the GTPC endpoints to configure a list of IP addresses where SMF and cnSGW-C service pods can route the GTPv2 messages over the IPC interface.

Upgrading and Enabling Inter-rack GTPC IPC

This section describes how to upgrade and enable the inter-rack GTPC IPC.

Before you configure, upgrade, and enable the GTPC IPC optimization on cnSGW-C and SMF interfaces, you must perform the following:

- The inter-rack routing must be applied to the branched core network.
- More configuration parameters such as GTPC, cnSGW-C, and SMF are enabled, when extra routes are added for supporting a new routable network across rack servers.



Note The following are configuration-related points:

- The SGW service pods for the S5 egress MBR request are used for IPC messages toward PGWc and SMF IP in the list.
- The SMF service pods for S5 CBR, UBR, and DBR requests are used for IPC messages toward the cnSGW-C in the list.
- IPC messages reuse the N3 or the T3 configuration for the respective interfaces to retry messages, whenever the timeout in the peer node occurs.

Call Flows

This section describes the key call flows for this feature.

cnSGW-C GTPC Optimization with Inter-rack IPC Call Flow

This section describes the cnSGW-C GTPC Optimization with Inter-rack IPC call flow.

Figure 104: cnSGW-C GTPC Optimization with Inter-rack IPC Call Flow

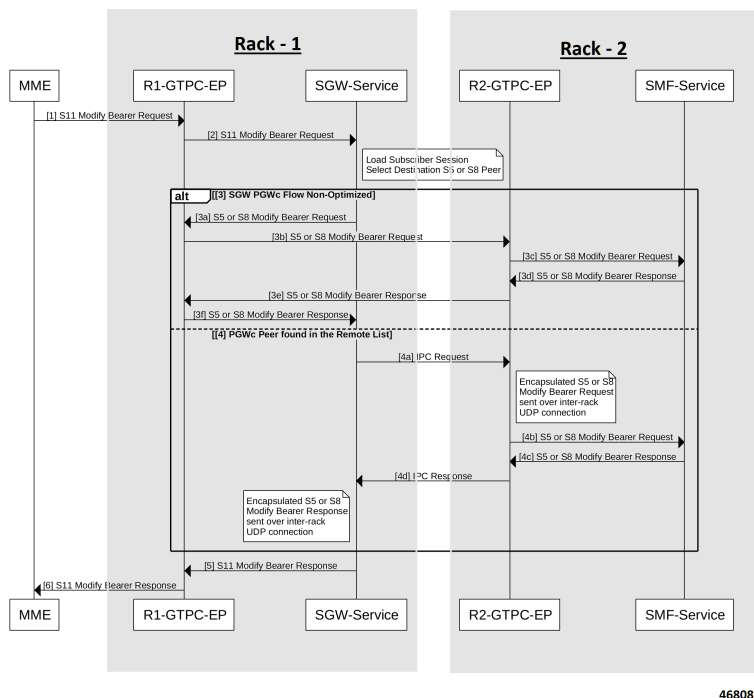

468085

Table 181: cnSGW-C GTPC Optimization with Inter-rack IPC Call Flow Description

Step	Description
1	MME sends the S11 Modify Bearer Request to R1-GTPC-EP.
2	R1-GTPC-EP sends the S11 Modify Bearer Request to SGW-service. Note The SGW-service section performs the following: <ul style="list-style-type: none"> • Loads the subscriber session. • Selects the destination as the S5 or the S8 peer.
3	The following are sub-steps in the Alt SGW PGWc flow non-optimized scenario.
3a	SGW-service sends the S5 or the S8 Modify Bearer Request to R1-GTPC-EP.
3b	R1-GTPC-EP sends the S5 or the S8 Modify Bearer Request to R2-GTPC-EP.

Step	Description
3c	R2-GTPC-EP sends the S5 or the S8 Modify Bearer Request to SMF-service.
3d	SMF-service processes and sends the S5 or the S8 Modify Bearer Response to R2-GTPC-EP.
3e	R2-GTPC-EP sends the Modify Bearer Response to R1-GTPC-EP.
3f	R1-GTPC-EP sends the Modify Bearer Response to SGW-service.
4	Alternatively, the PGWc peer scenario is available in the remote list. The following are sub-steps in this scenario.
4a	SGW-service sends the IPC Request to R2-GTPC-EP. Note The R2-GTPC-EP section performs the following: <ul style="list-style-type: none"> • Encapsulates the S5 or the S8 Modify Bearer Request. • Sends it over the inter-rack UDP connection.
4b	R2-GTPC-EP sends the S5 or the S8 Modify Bearer Request to SMF-service.
4c	SMF-service processes and sends the S5 or the S8 Modify Bearer Response to R2-GTPC-EP.
4d	R2-GTPC-EP sends the IPC Response to SGW-service. Note The SGW-service section performs the following: <ul style="list-style-type: none"> • Encapsulates the S5 or the S8 Modify Bearer Response. • Sends it over the inter-rack UDP connection.
5	SGW-service sends the Modify Bearer Response to R1-GTPC-EP.
6	R1-GTPC-EP sends the Modify Bearer Response to MME.

SMF and PGWc GTPC Optimization with Inter-rack IPC Call Flow

This section describes the SMF and PGWc GTPC Optimization with Inter-rack IPC call flow.

Figure 105: SMF and PGWc GTPC Optimization with Inter-rack IPC Call Flow

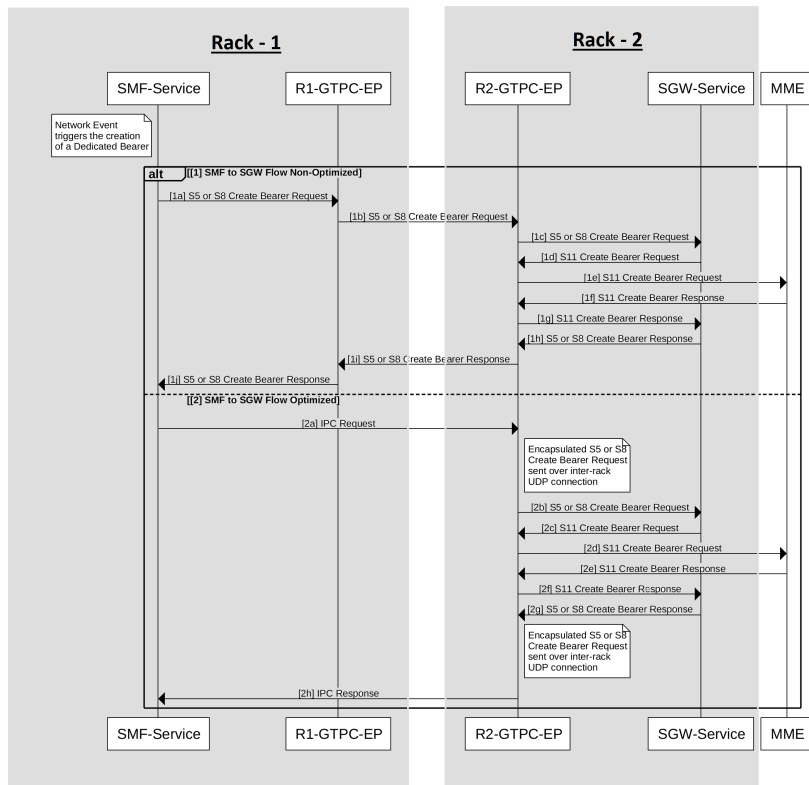

468086

Table 182: SMF and PGWc GTPC Optimization with Inter-rack IPC Call Flow Description

Step	Description
1	The following are sub-steps in the Alt SMF to SGW flow non-optimized scenario. Note The SMF-service section performs the following: <ul style="list-style-type: none"> • Triggers the networking event. • Creates the resolute bearer.
1a	SMF-service sends the S5 or the S8 Create Bearer Request to R1-GTPC-EP.
1b	R1-GTPC-EP sends the S5 or the S8 Create Bearer Request to R2-GTPC-EP.
1c	R2-GTPC-EP sends the S5 or the S8 Create Bearer Request to SGW-service.
1d	SGW-service processes and sends the S11 Create Bearer Request to R2-GTPC-EP.
1e	R2-GTPC-EP sends the S11 Create Bearer Request to MME.
1f	MME processes and sends the S11 Create Bearer Response to R2-GTPC-EP.

Step	Description
1g	R2-GTPC-EP sends the S11 Create Bearer Response to SGW-service.
1h	SGW-service processes and sends the S5 or the S8 Create Bearer Response to R2-GTPC-EP.
1i	R2-GTPC-EP sends the S5 or the S8 Create Bearer Response to R1-GTPC-EP.
1j	R1-GTPC-EP sends the S5 or the S8 Create Bearer Response to SMF-service.
2	The following are sub-steps in the SMF to SGW flow-optimized scenario.
2a	SMF-service sends the IPC request to R2-GTPC-EP. Note The R2-GTPC-EP section performs the following: <ul style="list-style-type: none"> • Encapsulates the S5 or the S8 Create Bearer Request. • Sends it over the inter-rack UDP connection.
2b	R2-GTPC-EP sends the S5 or the S8 Create Bearer Request to SGW-service.
2c	SGW-service processes and sends the S11 Create Bearer Request to R2-GTPC-EP.
2d	R2-GTPC-EP sends the S11 Create Bearer Request to MME.
2e	MME processes and sends the S11 Create Bearer Response to R2-GTPC-EP.
2f	R2-GTPC-EP sends the S11 Create Bearer Response to SGW-service.
2g	SGW-service processes and sends the S5 or the S8 Create Bearer Response to R2-GTPC-EP. Note The R2-GTPC-EP section performs the following: <ul style="list-style-type: none"> • Encapsulates the S5 or the S8 Create Bearer Request. • Sends it over the inter-rack UDP connection.
2h	R2-GTPC-EP processes and sends the IPC Response to SMF-service.

Feature Configuration

To configure this feature, use the following configuration:

```

config
instance instance_id 1
  endpoint endpoint_name
    interface gtp-inter-rack gtp_inter_rack_name
      vip-ip vip_ip_address vip-port vip_port_address vip-interface
vip_interface_address
      gtpc-ipc gtpc_ipc_name
      gtp-peer-entry gtp_peer_entry_address port port_address
    remote-gtp-peer-list remote_gtp_peer_list_addresses
  end

```



- Note** In the preceding new configuration example, the following are the enhanced scenarios:
- The cnSGW-C service pod for the S5 egress MBR request will be using IPC messages toward the PGWc or the SMF IP in the preceding list.
 - Similarly, the SMF service pod for S5 CBR, UBR, and DBR requests are using IPC messages toward cnSGW in the preceding list.
 - IPC messages reuse the N3 or T3 configuration for the respective interface to retry messages, when there is a timeout in the peer node.

NOTES:

- **instance** *instance_id 1*—Specify the instance ID.
- **endpoint** *endpoint_name*—Specify the endpoint name.
- **gtp-inter-rack** *gtp_inter_rack_name*—Specify the interface name. Specify the **gtp-inter-rack** name, you want to select. It is a new interface, added for cross-rack routing.
- **vip-ip** *vip_ip_address* **vip-port** *vip_port_address* **vip-interface** *vip_interface_address*—Specify the addresses for **vip-ip**, which is a GTP IPC endpoint server IP, **vip-port**, which is a GTP IPC endpoint server listening port, and **vip-interface**, which is a GTP IPC endpoint server interface VLAN.
- **gtpc-ipc** *gtpc_ipc_name*—Specify the interface name. Specify the **gtpc-ipc** name, you want to select.
- **gtp-peer-entry** *gtp_peer_entry_address* **port** *port_address* **remote-gtp-peer-list** *remote_gtp_peer_list_addresses*—Specify the addresses for the list of **gtp-peer-entry**, which is a remote GTP IPC peer IP configured on other racks or instances (multiple rows), **port**, which is a remote GTP IPC peer port, and **remote-gtp-peer-list**, which is a list of S5 and S5e remote GTP peers endpoints on a rack or instances corresponding to the **gtp-peer-entry**.

Configuration Example

The following is an example configuration.

```

config
instance instance-id 1
  endpoint GTP
  interface gtp-inter-rack
    vip-ip 209.165.202.130 vip-port 9084 vip-interface bd2.gtpe.2101
    gtpc-ipc
    gtp-peer-entry 209.165.202.131 port 9084 remote-gtp-peer-list [ 209.165.202.140
209.165.202.141 ]
  end

```

OAM Support

This section describes operations, administration, and maintenance support for this feature.

KPI Support

The following statistics are supported for the GTPC IPC Cross-rack Support feature.

1. KPI Name: **udp_rpc_request_total**

The following table lists **udp_rpc_request_total** KPI details.

Description	Functionality	Label Names	Possible Values
This KPI displays the total number of UDP client endpoint request messages.	The functionality output is inter-rack RPC requests total.	MessageName	gptv2 message types like CBR, UBR, MBR
		retry	Is attempt a retry
		status	Status of the request message, which is a success or a failure
		status_code	0/1/2

2. KPI Name: **udp_rpc_response_total**

The following table lists **udp_rpc_response_total** KPI details.

Description	Functionality	Label Names	Possible Values
This KPI displays the total number of UDP client endpoint response messages.	The functionality output is inter-rack RPC response total.	MessageName	gptv2 message types like CBR, UBR, MBR
		status	Status of the response message, which is a success or a failure
		status_code	0/1/2



Note The current implementation supports KPIs only on the client-side, as they reside on service pods, where KPIs can be enabled without impacting performance.

Interservice Pod Communication

Feature Description

When the IMS PDN sgw-service and smf-service selected for a subscriber are on the same cluster and same RACK, the following message flow occurs when sgw-service sends a message to smf-service:

- The message is sent from S5e gtpc-ep interface to network interface.
- The message returns to the S5 interface from gtpc-ep to smf-service.

For the subscribers that are collocated, the communication happens between the sgw-service and the smf-service. This approach reduces the processing load on the gtpc-ep.



Note A direct communication between sgw-service and smf-service is not supported to transfer messages on monitor protocol and monitor subscriber.

How it Works

This section describes how this feature works.

The sgw-service communicates with smf-service for processing the following requests:

- Create Session Request
- Modify Bearer Request
- Delete Session Request

The smf-service communicates with sgw-service for processing the following requests:

- Create Bearer Request
- Update Bearer Request
- Delete Bearer Request

The sgw-service sends the Modify Bearer Command and Delete Bearer Command messages to SMF through gtpc-ep. If the Update Bearer Request and Delete Bearer Request is triggered, the command messages are sent to sgw-service through gtpc-ep.

Call Flows

This section describes the key call flows for this feature.

Collapsed Call Attach with SGW-Service to SMF-Service Configuration Call Flow

This section describes the Collapsed Call Attach with SGW-Service to SMF-Service Configuration call flow.

Figure 106: Collapsed Call Attach with SGW-Service to SMF-Service Configuration Call Flow

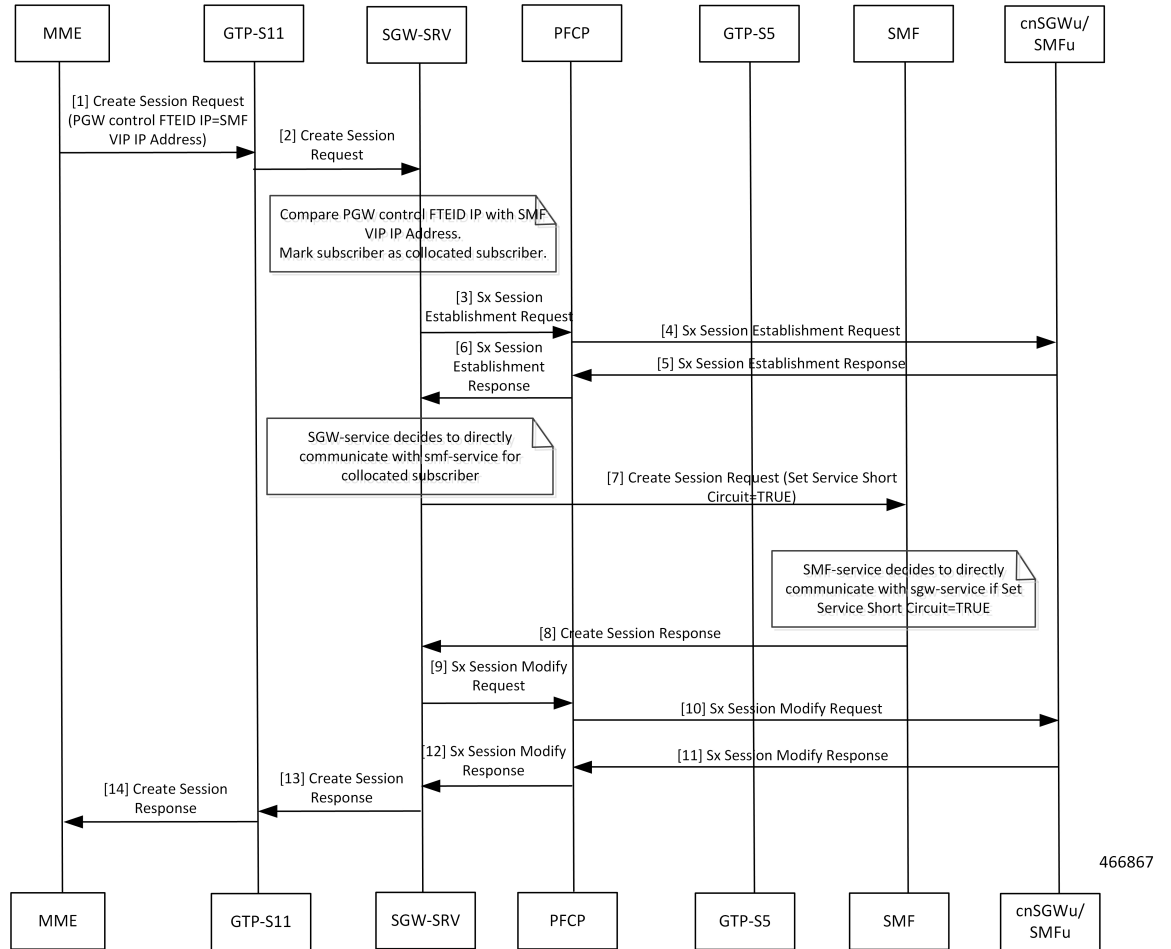

Table 183: Collapsed Call Attach with SGW-Service to SMF-Service Configuration Call Flow Description

Step	Description
1	MME sends the Create Session Request to GTP-S11.
2	GTP-S11 sends the Create Session Request to SGW-SRV.
3	SGW-SRV sends the Sx Session Establishment Request to PCFP.
4	PCFP sends the Sx Session Establishment Request to cnSGWu/SMFu.
5	cnSGWu/SMFu sends the Sx Session Establishment Response to PCFP.
6	PCFP sends the Sx Session Establishment Response to SGW-SRV.
7	SGW-SRV sends the Create Session Request to SMF. The Service Short Circuit is set to TRUE.
8	SMF sends the Create Session Response to SGW-SRV.
9	SGW-SRV sends the Sx Session Modify Request to PCFP.

Step	Description
10	PFCP sends the Sx Session Modify Request to cnSGWu/SMFu.
11	cnSGWu/SMFu sends the Sx Session Modify Response to PFCP.
12	PFCP sends the Sx Session Modify Response to SGW-SRV.
13	SGW-SRV sends the Create Session Response to GTP-S11.
14	GTP-S11 sends the Create Session Response to MME. For a collocated subscriber, when SGW-SRV receives: <ul style="list-style-type: none"> • Modify Bearer Request and Delete Session Request from the MME, the SGW-SRV communicates these messages to the SMF service. • Create Bearer Request, Update Bearer Request, and Delete Bearer Request from the SMF, the SGW-SRV communicates the response messages for these request messages to the SMF service.

OAM Support

This section describes operations, administration, and maintenance support for this feature.

Statistics Support

To check for messages that are directly communicated to SMF service, add `svc_to_svc` field in `sgw_service_stats` query as shown below:

Query: `sum(irate(sgw_service_stats{status=~"attempted"}[30s])) by (sgw_procedure_type,status, interface, svc_to_svc)`

Legend: `{{interface}}` -> `{{sgw_procedure_type}}` | `{{svc_to_svc}}` | `{{status}}`

MBR Call Flow Optimization

Feature Description

cnSGW-C supports optimization of Modify Bearer Request and Modify Bearer Response (MBR) call flows to reduce I/O operation, reduce transaction wait time, and improve performance in multi-PDN scenarios.

How it Works

This section describes how this feature works.

The following functions explain the optimization of MBR call flows:

- To reduce I/O operations, cnSGW-C combines all Modify Bearer Requests towards SGW-service into a single GRPC call, and Sx Modify Requests from SGW-service pod to protocol pod in a single GRPC call.

- To reduce transaction wait time in GTPC-EP, cnSGW-C sends Modify Bearer Response immediately from GTPC-EP (except last MBR) after receiving Modify Bearer Request.

GTPC-EP combines all Modify Bearer Requests in a single Modify Bearer Request List message and sends to SGW-service.

- SGW-service combines all Modify Bearer Responses into a single Modify Bearer Response List message and sends to GTPC-EP.

SGW-service combines all Sx Modify Requests towards UPF into a single Sx Modify Request List message and sends to protocol pod. The protocol pod sends individual Sx Modify Requests to UPF.

- The protocol pod waits for all Sx Modify Responses from UPF and combines them into a single Sx Modify Response List and sends it to SGW-service.

- In non-merged mode, UDP proxy maintains the local TEID and remote TEID cache information. In merged mode, GTPC-EP maintains the local TEID and remote TEID cache information.

- If GTPC-EP does not find the TEID cache entry for the received Modify Bearer Request, the Modify Bearer Request will be forwarded to the SGW-service immediately.

If all expected Modify Bearer Requests are not received within the MBR cache expiry, only the Modify Bearer Requests that are received will be sent to the SGW-service.

Call Flows

This section describes the key call flows for this feature.

Idle-Active Transition with Intra MME HO Call Flow

This section describes the current call flow with intra MME handover (NSA MBR) for moving from eNodeB to gNodeB.

Figure 107: Idle-Active Transition with Intra MME HO Call Flow

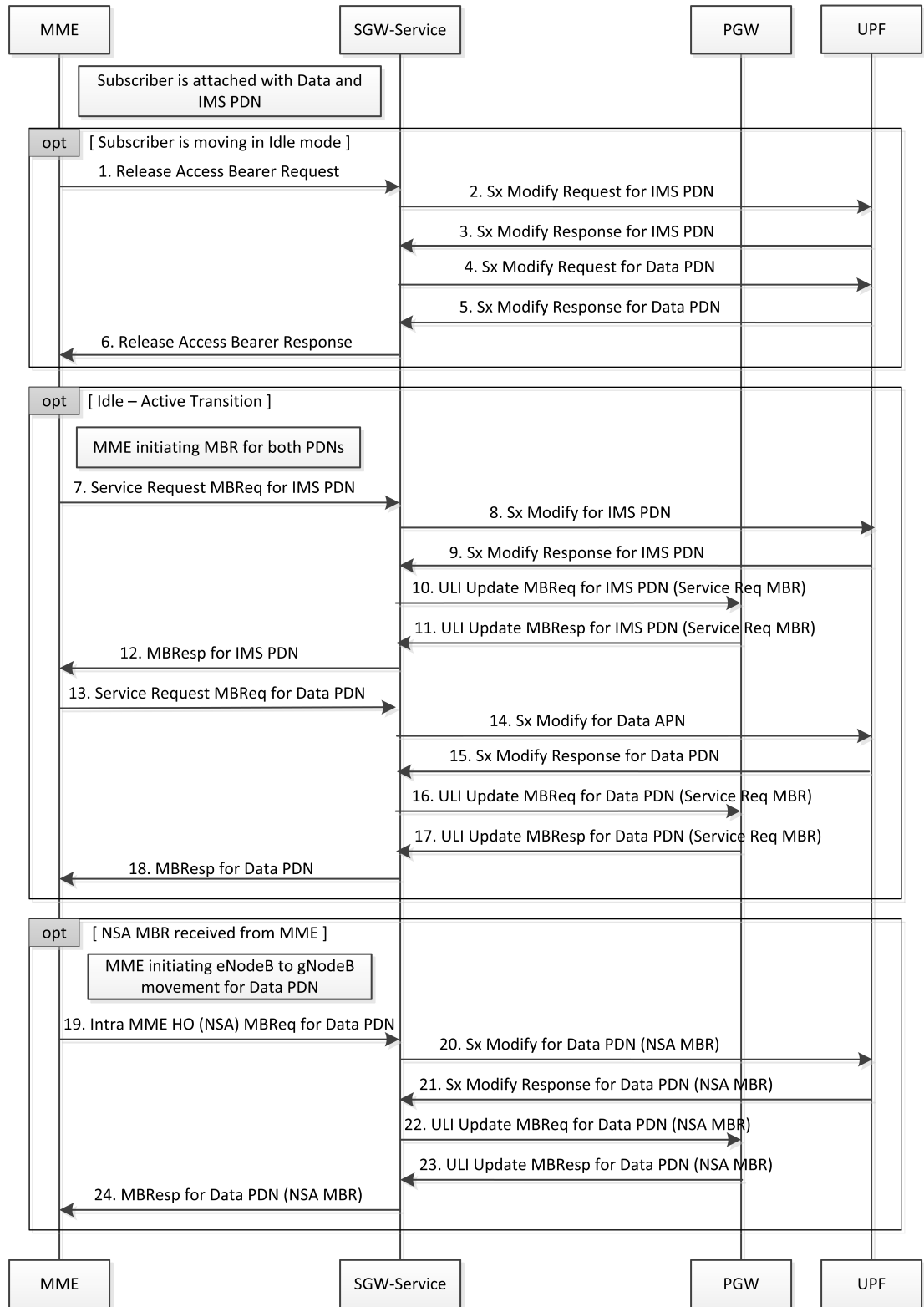

466863

Table 184: Idle-Active Transition with Intra MME HO Call Flow Description

Step	Description
1	MME sends Release Access Bearer (RAB) request to SGW-service.
2	SGW-service sends Sx Modify Request for IMS PDN to UPF.
3	UPF sends Sx Modify Response for IMS PDN to SGW-service.
4	SGW-service sends Sx Modify Request for Data PDN to UPF.
5	UPF sends Sx Modify Response for Data PDN to SGW-service.
6	SGW-service sends the Release Access Bearer Response message to MME.
7	MME sends Service Request MBRequest for IMS PDN to SGW-service.
8	SGW-service sends Sx Modify Request for IMS PDN to UPF.
9	UPF sends Sx Modify Response for IMS PDN to SGW-service.
10	SGW-service sends ULI Update MBRequest for IMS PDN (Service Request MBR) to PGW.
11	PGW sends ULI Update MBResponse for IMS PDN (Service Request MBR) to SGW-service.
12	SGW-service sends MBResponse for IMS PDN to MME.
13	MME sends Service Request MBRequest for Data PDN to SGW-service.
14	SGW-service sends Sx Modify Request for Data PDN to UPF.
15	UPF sends Sx Modify Response for Data PDN to SGW-service.
16	SGW-service sends ULI Update MBRequest for Data PDN (Service Request MBR) to PGW.
17	PGW sends ULI Update MBResponse for Data PDN (Service Request MBR) to SGW-service.
18	SGW-service sends MBResponse for Data PDN to MME.
19	MME sends intra MME HO (NSA) MBRequest for Data PDN to SGW-service.
20	SGW-service sends Sx Modify Request for Data PDN (NSA MBR) to UPF.
21	UPF sends Sx Modify Response for Data PDN (NSA MBR) to SGW-service.
22	SGW-service sends ULI Update MBRequest for Data PDN (NSA MBR) to UPF.
23	UPF sends ULI Update MBResponse for Data PDN to SGW-service.
24	SGW-service sends MBResponse for Data PDN (NSA MBR) to MME.

MBR Optimization Call Flow

This section describes the high-level MBR Optimization call flow for idle↔active transition.

Figure 108: MBR Optimization Call Flow

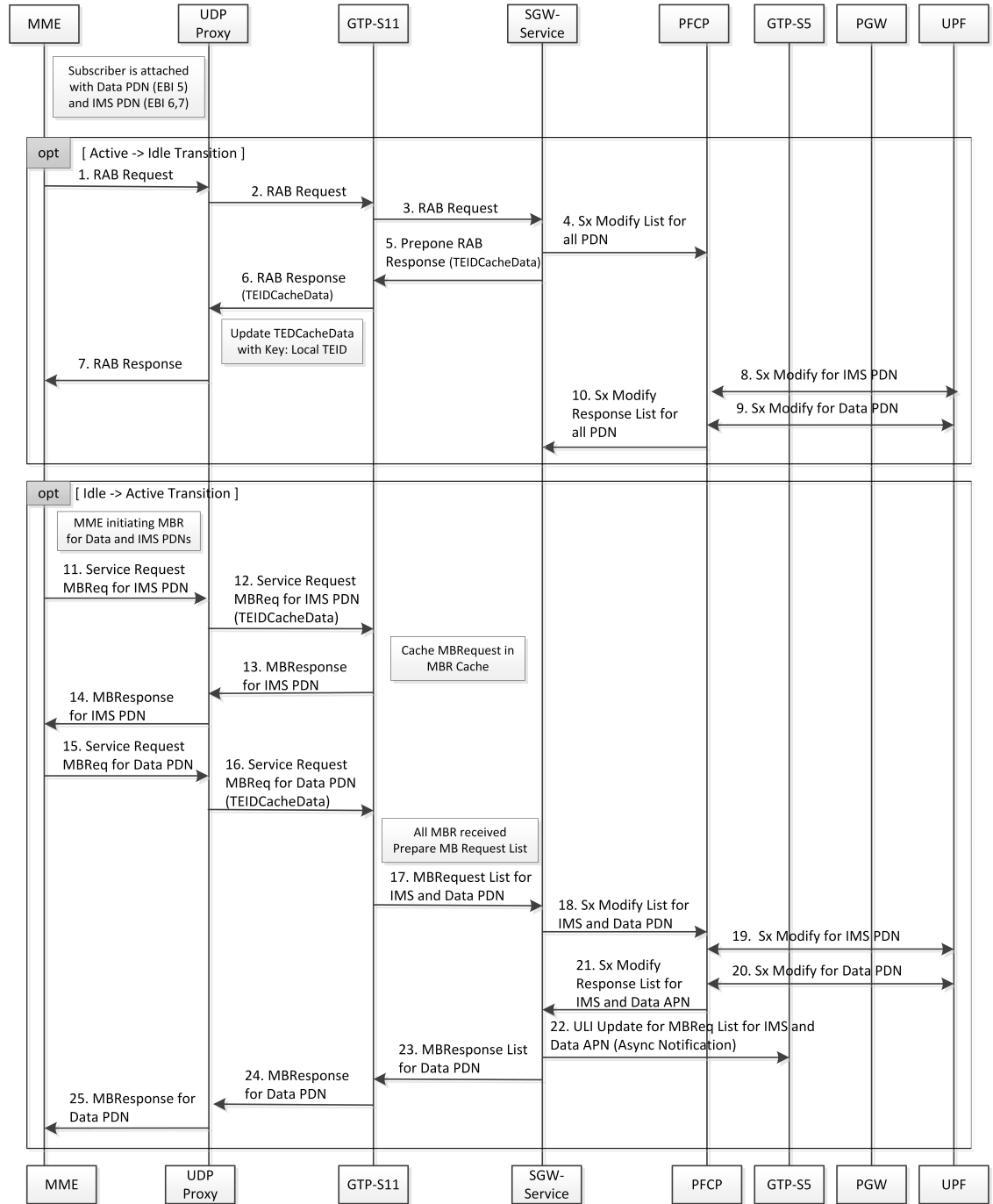

CONT... 466864

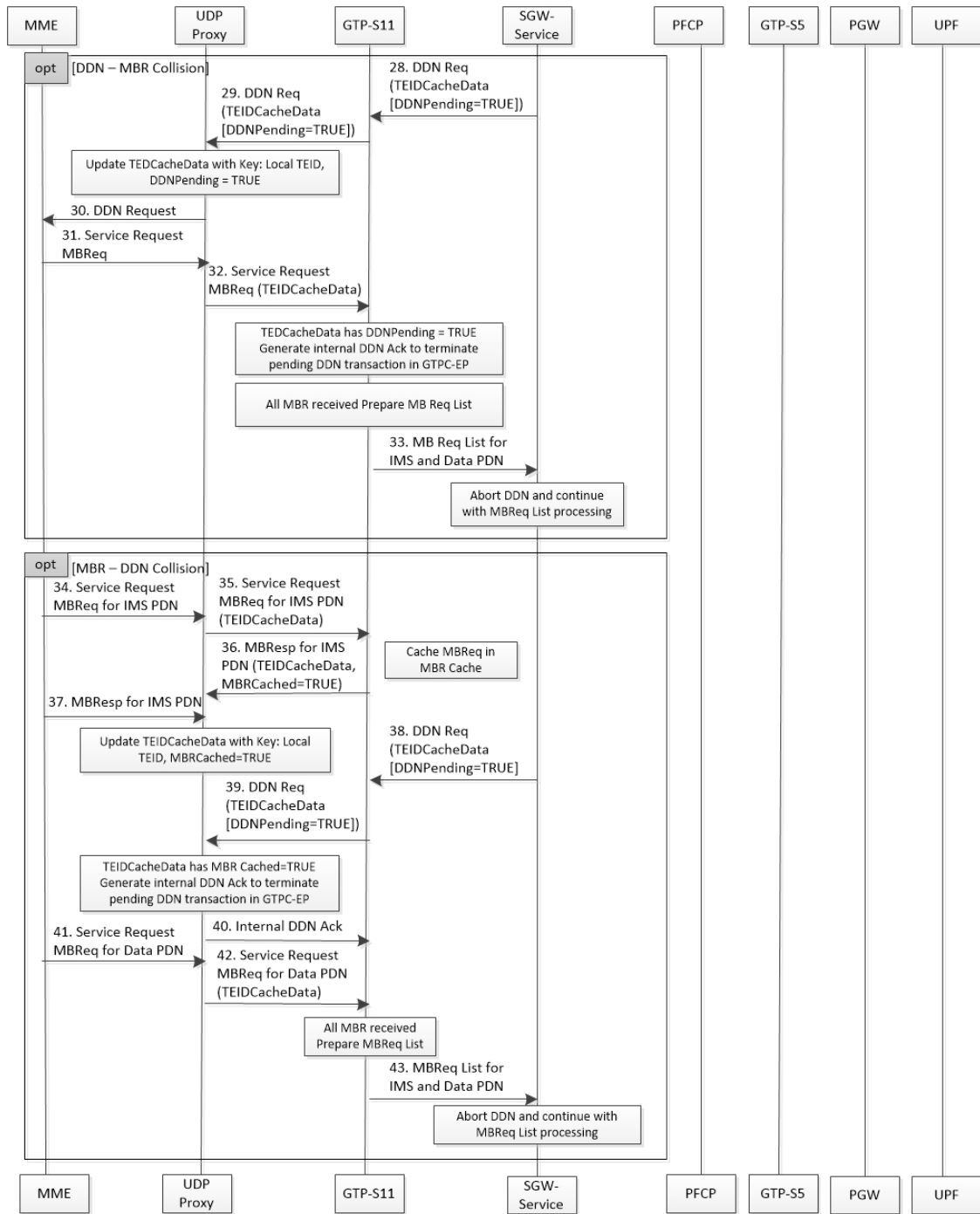

466864

Table 185: MBR Optimization Call Flow Description

Step	Description
1	MME sends Release Access Bearer (RAB) request to UDP proxy.

Step	Description
2	UDP Proxy forwards RAB Request to GTP-S11.
3	GTP-S11 forwards RAB Request to SGW-service.
4	SGW-service sends Sx Modify List for all PDNs to PFCP.
5	SGW-service prepones RAB Response.
6	GTP-S11 sends RAB Response to UDP Proxy.
7	UDP Proxy sends RAB Response to MME.
8	PFCP sends and receives Sx Modify for IMS APN to and from UPF.
9	PFCP sends and receives Sx Modify for Data APN to and from UPF.
10	PFCP sends Sx Modify Response List for all PDNs to SGW-service.
11	MME sends Service Request MBRequest for IMS PDN to UDP Proxy.
12	UDP Proxy forwards Service Request MBRequest for IMS PDN with TEID cache data to GTP-S11.
13	GTP-S11 sends MBResponse for IMS PDN to UDP Proxy.
14	UDP Proxy forwards MBResponse for IMS PDN to MME.
15	MME sends Service Request MBRequest for Data PDN to UDP Proxy.
16	UDP Proxy sends Service Request MBRequest for Data PDN with TEID cache data to GTP-S11.
17	GTP-S11 sends MBRequest List for IMS and Data PDNs to SGW-service.
18	SGW-service sends Sx Modify List for IMS and Data PDN to PFCP.
19	PFCP sends and receives Sx Modify for IMS PDN to and from UPF.
20	PFCP sends and receives Sx Modify for Data PDN to and from UPF.
21	PFCP sends Sx Modify Response List for IMS and Data PDN to SGW-service.
22	SGW-service sends ULI Update MBRequest List for IMS and Data PDN (Async Notification) to GTP-S5.
23	SGW-service sends MBResponse List for Data PDN to GTP-S11.
24	GTP-S11 sends MBResponse for Data PDN to UDP Proxy.
25	UDP Proxy forwards MBResponse for Data PDN to MME.
26	GTP-S5 sends and receives ULI Update MBRequest for IMS PDN to and from PGW.
27	GTP-S5 sends and receives ULI Update MBRequest for Data PDN to and from PGW.
28	SGW-service sends DDN Request to GTP-S11.

Step	Description
29	S-11 forwards DDN Request to UDP Proxy.
30	UDP Proxy forwards DDN Request to MME.
31	MME sends Service Request MBRequest to UDP Proxy.
32	UDP Proxy sends Service Request MBRequest with TEIDCacheData to GTP-S11.
33	GTP-S11 sends MBResponse List for IMS and Data PDNs to SGW-service.
34	MME sends Service Request MBRequest for IMS PDN to UDP Proxy.
35	UDP Proxy Service Request MBRequest for IMS PDN with TEID cache data to GTP-S11.
36	GTP-S11 sends MBResponse for IMS PDN to UDP Proxy.
37	UDP Proxy sends MBResponse for IMS PDN to MME.
38	SGW-service sends DDN Request to GTP-S11.
39	GTP-S11 forwards DDN Request to UDP Proxy.
40	UDP Proxy sends internal DDN acknowledgement to GTP-S11.
41	MME sends Service Request MBRequest for Data PDN to UDP Proxy.
42	MME sends Service Request MBRequest for Data PDN with TEID cache data to GTP-S11.
43	GTP-S11 sends MBRequest List for IMS and Data PDNs to SGW-service.

Feature Configuration

To configure this feature, use the following sample configuration:

```

config
  instance instance-id instance_id
    endpoint endpoint_name
      mbr-optimization [ enable { false | true } | mbr-cache-expiry
mbr_cache | teid-cache-expiry teid_cache ]
    exit
  exit
exit

```

NOTES:

- **mbr-optimization** [**enable** { **false** | **true** } | **mbr-cache-expiry** *mbr_cache* | **teid-cache-expiry** *teid_cache*]: Specify the MBR optimization configuration.
 - **enable** { **false** | **true** }: Enable or disable MBR optimization. Default: Disabled.
 - **mbr-cache-expiry** *mbr_cache* : Specify the MBR cache expiry time interval in milliseconds, as an integer from 1 millisecond to 6 seconds. Default: 50 milliseconds.

Note that the value of **mbr-cache-expiry** can be changed during the runtime.

- **teid-cache-expiry** *teid_cache* : Specify the TEID cache expiry time interval in milliseconds, as an integer from 1000 milliseconds to 1 hour. Default: 120000 milliseconds.

Configuration Example

The following is an example configuration.

```
config
  instance instance-id 1
    endpoint gtp
      mbr-optimization enable true mbr-cache-expiry 60 teid-cache-expiry 180000
    end
```

Configuration Verification

To verify the configuration:

```
show running-config instance instance-id 1 endpoint gtp
instance instance-id 1
endpoint gtp
  replicas          1
  nodes            1
  mbr-optimization
  enable           true
  teid-cache-expiry 180000
  mbr-cache-expiry 60
exit
enable-cpu-optimization true
.....
```

OAM Support

This section describes operations, administration, and maintenance support for the MBR Optimization feature.

Bulk Statistics Support

The following statistics are supported for the MBR Optimization feature.

The SGW-service supports the *service_request_list* procedure type to handle Modify Bearer Request list from GTPC-EP.

Query: `sum(rate(sgw_service_stats{namespace=~"$namespace", interface="interface_sgw_ingress",sgw_procedure_type="service_request_list", status="attempted"}[1m]))`

Legend: IDLE -> ACTIVE (List)

The MBR short circuit statistics are enhanced to capture statistics for Modify Bearer Request list sent to SGW-service.

Query: `sum(irate(gtpc_msg_short_circuit_stats{namespace=~"$namespace"}[60s])) by (gtpc_msg_type, gtpc_short_circuit_category)`

Legend: {{gtpc_msg_type}}, {{gtpc_short_circuit_category}}

This feature supports the following statistics:

- RxModifyBearerReq, SendSCMBResp—The number of early MB responses sent from GTPC-EP.

- RxModifyBearerReq, SendMBReqListToSrv—The number of MB request lists sent to SGW-service.
- RxModifyBearerReq, SendMBReqToSrv—The number of MB requests sent to SGW-service.
- RxModifyBearerReq, MBREventExpired—The number of MB requests expired in MBR cache.

Maintenance Mode

Feature Description

The maintenance mode feature allows a cluster in the GR setup to undergo an in-service upgrade (rolling upgrade) without any service disruption. Maintenance mode works with routing the traffic to the mated cluster to perform the responsibility of the source cluster.

How it Works

When the maintenance mode flag is set to true, the cluster role changes and GR is triggered for the rack. The standby cluster takes over the responsibility of the cluster that is in the maintenance mode. During this period, the monitoring threads check the runtime value of the flag and pause the execution when the maintenance mode flag is set to true. By default, for fresh installation, the flag is set to false.

Both, the source and standby clusters (racks) can be under the maintenance mode at the same time. You can enable the maintenance mode for the rack server regardless of its state.

You can push the system to the maintenance mode when the maintenance procedure is in-progress for the mated cluster. Before you start the maintenance activity, set the `geo maintenance mode` flag value to true. When the maintenance is complete, reset the flag to false after confirming the health of the system.

For information on how to configure the maintenance mode flag, see [Enabling or Disabling Maintenance Mode, on page 473](#).

When the maintenance mode is enabled:

- Automated GR-switchover such as pod monitoring, BFD link monitoring from the rack server is not supported.
- Only CLI-based GR-switchover is supported from the rack (with maintenance mode enabled) to the partner rack.
- GR-switchover, including CLI-based, is not supported from the partner rack to the rack where the maintenance mode is enabled.
- If both partner racks are in the maintenance mode, GR-switchover is not supported.
- All the monitoring activities are paused.
- The mated cluster cannot trigger the failover when it detects the local failure.
- Replication activities continue on the cluster.
- Maintenance mode doesn't implicitly change the instance roles of the site. However, role change is possible using the **geo switch-role role** CLI command.

GR trigger is not supported towards and from the cluster that is under maintenance. Only CLI-based failover is supported from the cluster under the maintenance.

Limitations

This feature has the following limitation in this release:

The maintenance mode feature does not overwrite the multicompute failure switchover case. However, the multicompute failure switchover scenario is supported when the partner rack is also in maintenance mode.



Note The multicompute failure is a switchover case that occurs when multiple servers in a rack fail causing the partner rack to handle the traffic.

Enabling or Disabling Maintenance Mode

To enable or disable this feature, use the following command:

```
geo maintenance mode { true | false }
```

NOTES:

geo maintenance mode { true | false }—Specify to enable or disable the maintenance mode. To enable the maintenance mode, specify true. If the maintenance mode flag is set to true, the cluster role changes and GR is triggered for the rack.

The value for the maintenance mode is stored in the `.etcd` file.

Enabling or Disabling Maintenance Mode Example

The following is an example of the command:

```
geo maintenance mode true
geo maintenance mode false
```

Verifying the Maintenance Mode State

To verify the maintenance mode state:

```
show geo maintenance mode
result "geo maintenance mode is disabled"
```

Partial CDL Update for Idle-Active Call Flow

Feature Description

cnSGW-C supports partial CDL update of the subscriber data. Partial CDL update helps in saving the CPU requirement in the CDL pod for processing the subscriber data.

With each transition of the subscriber from Idle-to-Active state and Active-to-Idle state, cnSGW-C updates only the following fields:

- eNodeB FTEID
- Subscriber state
- Bearer state

How it Works

This section describes how this feature works.

cnSGW-C stores the update bearer information in the Flags database in the CDL.

cnSGW-C uses partial CDL update when the subscriber moves from:

- Active state to Idle state on receiving Release Access Bearer Request
- Idle state to Active state on receiving Modify Bearer Request

With partial CDL update, the session-state-flag displays the following value in the **cdl show sessions summary slice-name <n>** CLI output:

- **sgw_active**: when the session is Active
- **sgw_inactive**: when the session is Idle

The following is a sample output for an Active session:

```
cdl show sessions summary slice-name 1
message params: {session-summary cli session {0 100 0 [] 0 0 false 4096 [] []} 1}
session {
  primary-key 2#/#imsi-123456789012348
  unique-keys [ "2#/#16777229" ]
  non-unique-keys [ "2#/#id-index:1:0:32768" "2#/#id-value:16777229"
    "2#/#imsi:imsi-123456789012348" "2#/#msisdn:msisdn-223310101010101"
    "2#/#imei:imei-123456786666660" "2#/#upf:209.165.201.1"
    "2#/#upfEpKey:209.165.201.1:209.165.201.30" "2#/#s5s8Ipv4:209.165.202.129"
  "2#/#s11Ipv4:209.165.201.1"
  "2#/#namespace:sgw" ]
  flags [ byte-flag1:00:13:03:53:00:00:06:85:0A:01:01:1B session-state-flag:sgw_active ]
  map-id 1
  instance-id 1
  app-instance-id 1
  version 1
  create-time 2022-01-20 11:37:15.181259564 +0000 UTC
  last-updated-time 2022-01-20 11:37:15.703032336 +0000 UTC
  purge-on-eval false
  next-eval-time 2022-01-27 11:37:26 +0000 UTC
  session-types [ SGW:rat_type:EUTRAN ]
  data-size 925
}
```

The following is a sample output for an Idle session:

```
cdl show sessions summary slice-name 1
message params: {session-summary cli session {0 100 0 [] 0 0 false 4096 [] []} 1}
session {
  primary-key 2#/#imsi-123456789012348
  unique-keys [ "2#/#16777229" ]
  non-unique-keys [ "2#/#id-index:1:0:32768" "2#/#id-value:16777229"
    "2#/#imsi:imsi-123456789012348" "2#/#msisdn:msisdn-223310101010101"
    "2#/#imei:imei-123456786666660" "2#/#upf:209.165.201.1"
    "2#/#upfEpKey:209.165.201.1:209.165.201.30"
    "2#/#s5s8Ipv4:209.165.202.129" "2#/#s11Ipv4:209.165.201.1" "2#/#namespace:sgw" ]
}
```

```

flags [ byte-flag1:00:25:00:55:00:65 session-state-flag:sgw_inactive ]
map-id 1
instance-id 1
app-instance-id 1
version 3
create-time 2022-01-20 11:37:15.181259564 +0000 UTC
last-updated-time 2022-01-20 11:37:18.102852792 +0000 UTC
purge-on-eval false
next-eval-time 2022-01-27 11:37:28 +0000 UTC
session-types [ SGW:rat_type:EUTRAN ]
data-size 1644

```

Limitations

cnSGW-C doesn't support partial CDL update for IPv6 TEID.

Feature Configuration

To configure this feature, use the following configuration:

```

config
  cdl
    datastore datastore_session_name
      slot metrics report-idle-session-type { true | false }
    end

```

NOTES:

- **slot metrics report-idle-session-type** { true | false }—Enable or disable Idle or Active session count in CDL db_records_total.

Configuration Example

The following is an example configuration.

```

config
  cdl
    datastore session
      slot metrics report-idle-session-type true
    end

```

OAM Support

This section describes operations, administration, and maintenance support for this feature.

Bulk Statistics Support

The following statistics are supported for the Partial CDL Update Idle-Active Call Flow feature.

Grafana Query to find cnSGW-C Idle and Active Session count:

```

SGW_ACTIVE_COUNT :-
(db_records_total{namespace=~"$namespace",session_type=~"sgw_active"})
SGW_IDLE_COUNT :
(db_records_total{namespace=~"$namespace",session_type=~"sgw_inactive"})

```

PFCP Session Report with DLDR Throttling Support

Feature Description

In a live network deployment, due to some external events, all or most of the idle sessions become active at the same time. When idle sessions become active, the UPF sends the session report request with the report type DLDR to the cnSGW-C.

When the cnSGW-C receives the session report with the report type as DLDR, the cnSGW-C sends the DDN message to page UE. To turn the UE active, the MME initiates the paging procedure for the UE. If paging is successful, the MME initiates the service request Modify Bearer Request. On delivering data to the UE, the UE initiates the Release Access Bearer Request and turns idle. This call flow increases an overall load on the system. When the entire call flow occurs for all subscribers in a short time, there's a huge process overhead on the system.

The PFCP Session Report with the DLDR Throttling Support feature enables the cnSGW-C to limit the number of session report requests that enter the system to prevent the process overload on the system.

How it Works

This section describes how this feature works.

The cnSGW-C uses the app-infra feature for SBA overload control to throttle the incoming messages.

The system takes appropriate action for the incoming messages that are based on the interface-level threshold configuration. The incoming messages get added to different queues and they are processed based on the message-level priority configuration.

For more information on Overload Support, see the *SMF Overload Support* chapter, in the *UCC 5G Session Management Function Configuration and Administration Guide*.

You can exclude session reports for emergency call, voice calls, and empty calls from throttling.

To exclude these session reports, configure the `ddn delay-exclude-arplist` configuration in profile `sgw`. If the session report is received for one of the configured ARPs, the cnSGW-C omits that session report from the session report throttling.

Feature Configuration

To configure this feature, use the following configuration:

```

config
  instance instance-id instance_id
    endpoint pfc
      interface sxa
        overload-control msg-type session-report
        rate-limit rate_limit
        queue-size queue_size
        reject-threshold reject_threshold
        pending-request pending_request
      exit
    
```

```

config
  profile sgw sgw_name
    ddn delay-exclude-arplist number_priorities
  end

```

NOTES:

- **overload-control msg-type session-report**—Configure the virtual message specifications for interface overload.
- **rate-limit *rate_limit***—Specify the rate limit for the virtual queue.
- **queue-size *queue_size***—Specify the packet count or capacity of each virtual queue.
- **reject-threshold *reject_threshold***—Specify the limit to reject incoming messages when this threshold percentage of pending requests is reached.
- **pending-request *pending_request***—Specify the pending requests count in the virtual queue.
- **ddn delay-exclude-arplist *number_priorities***—Specify the priority-level for allocation and retention priorities [1-15] that must be excluded from delaying the DDN/Session report throttling.

Configuration Example

The following is an example configuration.

```

config
  instance instance-id 1
    endpoint pfc
      interface sxa
        overload-control msg-type session-report
        rate-limit 4500 queue-size 2500 reject-threshold 80 pending-request 2400
      exit
    profile sgw sgw1
      ddn delay-exclude-arplist [ 9 ]
    end

```

Configuration Verification

To verify the configuration:

```

#show running-config instance instance-id 1 endpoint pfc
instance instance-id 1
endpoint pfc
.
.
.
interface sxa
.
.
.
overload-control msg-type session-report
msg-priority high rate-limit 5 priority 1 queue-size 11 reject-threshold 80 pending-request
10
discard-behavior reject
discard-behavior reject-code 1
exit
.
.
.

```

OAM Support

This section describes operations, administration, and maintenance support for this feature.

Bulk Statistics Support

The following statistics are supported for the PFCP Session Report with DLDR Throttling Support feature.

Protocol Pod-level SXa Statistics

```
Query: sum(irate(proto_udp_req_msg_total{interface_type="SXA",
message_name=~"session_report_.*"}[1m])) by (message_name, status)
```

```
Legend: {{message_name}} | {{status}}
```

- **accepted**: Session reports accepted because of ARP configured in exclude-arp list
- **throttle_allow**: Session reports allowed by rate limit framework
- **throttled_pending_req_limit**: Session reports throttled by rate limit framework.

SGW Service-level Session Report Statistics

```
Query: sum(irate(sgw_sx_session_report_stats{}[30s])) by (sx_session_report_type,
status)
```

```
Legend: {{sx_session_report_type}} -> {{status}}
```



Timesaver

For more information on bulk statistics support for SMF, see the *UCC 5G SMF Metrics Reference* document.

For more information on bulk statistics support for cnSGW-C, see the *UCC 5G cnSGW-C Metrics Reference* document.

Resiliency Handling

Feature Description

The Resiliency Handling feature introduces a CLI-controlled framework to support the service pod recovery, when you observe a system fault or a reported crash. It helps in recovering one of the following service pods:

- sgw-service pod
- smf-service pod
- gtpc-ep pod

- protocol pod

These service pods are software modules containing the logic to handle several session messages. The service pods are fault-prone due to any one of the following or a combination of multiple scenarios:

- Complex call flow and collision handling
- Inconsistent session state
- Incorrect processing of inbound messages against the session state
- Unexpected and unhandled content in the inbound messages

Whenever you observe the system fault or a crash, the fault behavior results into a forced restart of the service pod. It impacts the ongoing transaction processing of other sessions. The crash reoccurs even after the pod restart.

To mitigate this risk, use the CLI-based framework with actions defined to clean up subscriber sessions or terminate the current processing.

How it Works

This section describes how you can use the fault recovery framework to define actions for the crash. The framework allows you to define any of the following actions:

- Terminate—When a fault occurs, this action terminates the faulty transactions, and clears the subscriber session cache. It's applicable for smf-service and sgw-service pods.



Note The pod doesn't get restarted. The database doesn't get cleared during this action.

- Cleanup—When a fault occurs, this action clears the faulty subscriber session and releases the call. It's applicable for smf-service and sgw-service pods.
- Graceful reload—When a fault occurs, this action restarts the pod. It's applicable for gtpc-ep and protocol pods. It handles the fault signals to clean up resources, such as the keepalive port and closes it early. It also allows the checkport script to detect the protocol pod state and initiates the PFCP VIP switch processing.
- Reload—When the pod crashes, it initiates the reloading activity. It's a default setting or value applicable for all the pods.

Feature Configuration

To configure this feature and to enable the system fault recovery, use the following sample configuration:

```
config
  system-diagnostics { gtp | pfc | service | sgw-service }
  fault
    action { abort | cleanup { file-detail | interval | num | skip
```

```
{ ims | emergency | wps } } | graceful-Reload | reload }
end
```

NOTES:

- **system-diagnostics { gtp | pfcf | service | sgw-service }**—Specify the required type of service pods for system diagnostics. The available pod options are gtp, pfcf, smf-service, and sgw-service.
- **fault**—Enables fault recovery while processing sessions.
- **action { abort | cleanup | graceful-Reload | reload }**—Specify one of the following actions to take on fault occurrence. The default action is reload.
 - **abort**—Deletes the faulty transaction and clears its session cache. The database doesn't get cleared.



Note It's an exclusive option to the smf-service pod.

- **cleanup { file-detail | interval | num | skip }**—Enable the cleanup activity. It has the following selections to mitigate the fault action:
 - **file-detail**—Lists the file names with line numbers. It excludes the file name details from the recovery.
 - **interval**—Specifies the duration of the interval in minutes. This duration specifies the permissible interval within which it allows the maximum number of faults. Must be an integer in the range 1–3600.
 - **num**—Specifies the maximum number of tolerable faults in an interval. Must be an integer in the range 0–50.
 - **skip { ims | emergency | wps }**—Enable the skip cleanup of a subscriber session for an active voice call, or the WPS, or an emergency call.
 - To detect the active voice calls, use the following command:

```
profile dnn dnn_name ims mark qci qos_class_id
```
 - When you enable the skip cleanup configuration, the SMF deletes the faulty transaction, and clears its session cache.
 - When a fault occurs during the session setup or the release state, the SMF performs the following:
 - Deletes the transactions on the session end.
 - Overrides the configured fault action during these states.
 - Clears the session cache and database entries for the faulty transaction.
 - It allows the dynamic configuration change.



Note It's an exclusive option to smf-service and sgw-service pods.

- **graceful-Reload**—Specify the option to gracefully reload the pod. The protocol pod handles fault signals to clean up resources like the keepalive port and continues with crash processing (pod restart processing).



Note It's an exclusive option to gtpc-ep and protocol service pods.

- **reload**—Reloads the pod, when it crashes due to a faulty behavior. It's an option applicable to all the service pods. It's also the default option.

Configuration Example

The following example configuration allows three crashes of smf-service or sgw-service pods, within a duration of 10 minutes interval, and with the fault occurrence action as subscriber cleanup.

```
config
  system-diagnostics { service | sgw-service }
    fault
      num 3 interval 10
      action cleanup
    end
```

The following example configuration allows graceful fault handling for the gtpc-ep pod or the protocol pod to close the keepalive port on receiving a fault signal.

```
config
  system-diagnostics { gtp | pfcf }
    fault
      action graceful-Reload
    end
```

Configuration Verification

To verify the configuration:

```
smf# show running-config system-diagnostics service
  fault num 3
  fault interval 10
  fault action cleanup
exit
sgw# show running-config system-diagnostics sgw-service
  fault num 3
  fault interval 10
  fault action cleanup
exit
gtp# show running-config system-diagnostics gtp
  fault action graceful-Reload
exit
pfcf# show running-config system-diagnostics pfcf
  fault action graceful-Reload
exit
```

OAM Support

This section describes operations, administration, and maintenance support for this feature.

Bulk Statistics Support

The following bulk statistics are supported for the resiliency handling feature.

recover_request_total—This statistic includes the following new labels:

- **action**—Defines the fault action.
- **reason**—Defines the fault reason.
- **status**—Defines the fault status.

The following is an example of bulk statistics for the resiliency handling feature.

```
recover_request_total{action="panic_recovery_cleanup",
app_name="SMF",cluster="Local",data_center="DC",instance_id="0",
reason="creating_panic",service_name="sgw-service",status="success"} 1
```



Timesaver

For more information on bulk statistics support for SMF, see the *UCC 5G SMF Metrics Reference* document.

For more information on bulk statistics support for cnSGW-C, see the *UCC 5G cnSGW-C Metrics Reference* document.

Roaming Peer Path Management Optimization

Feature Description

cnSGW-C supports inbound roaming. When inbound roaming is enabled, cnSGW-C communicates with remote PGW which is located in the roamer home network.

cnSGW-C generates Echo Request messages towards the roaming peers and detects path failure, thereby handling echo request messages from the roaming peers.

How it Works

This section describes how this feature works.

cnSGW-C uses subscriber policy and operator policy to categorize peer as a roamer or a home peer. cnSGW-C applies the following functionalities to the roaming peer:

- cnSGW-C responds immediately to the echo request message received from the roaming peer. If the restart counter value changes in the echo request, cnSGW-C doesn't detect path failure towards the peer.
- cnSGW-C continues to generate echo request towards the roaming peer after reaching the configured echo interval. If the restart counter value changes in the echo response, cnSGW-C detects path failure towards the peer.
- If the restart counter value changes in the first Create Session Response message and the SGW Relocation Modify Bearer Response message, cnSGW-C detects path failure towards the peer.

- cnSGW-C doesn't update the last activity time of roaming when it receives echo request from the roaming peer.
- In the NodeMgr pod, the variable `ROAMING_PEER_ECHO_MODULATOR` controls the echo request generation towards the roaming peer. The default value for `ROAMING_PEER_ECHO_MODULATOR` is 3. cnSGW-C generates echo request towards the roaming peer after reaching `ROAMING_PEER_ECHO_MODULATOR * Echo Interval`.

For example, if the `ROAMING_PEER_ECHO_MODULATOR` is 3, and the Echo Interval is 60, the cnSGW-C generates the Echo Request after 180 seconds. Similarly, if the `ROAMING_PEER_ECHO_MODULATOR` is 0, cnSGW-C doesn't generate the echo request towards the roaming peer.

- In the GTPC-EP pod, the variable `GTPC_UPDATE_LAST_MSG_RECV_TIME_AFTER` controls the last activity time updates. The default value for this variable is 30 seconds. The cnSGW-C updates the last activity time for the peer after 30 seconds. You can increase this value to reduce the last activity time update notifications towards the NodeMgr.

Feature Configuration

Configuring this feature involves the following steps:

- Configure the operator policy with the roaming status as roamer, and associate the operator policy with the subscriber policy to identify the operator as roaming peer. For more information, see [Configuring the Operator Policy and Subscriber Policy, on page 483](#).
- Configure the default gateway to be used, while adding the BGP route dynamically. For more information, see [Configuring the Default Gateway, on page 485](#).

Configuring the Operator Policy and Subscriber Policy

To configure this feature, use the following configuration:

```

config
  policy
    subscriber subscriber_name
      precedence precedence_value
      imsi mcc mcc_value
      imsi mnc mnc_value
      operator-policy policy_name
    exit
  exit
  operator operator_policy
    roaming-status roamer
  exit
  profile sgw sgw_profile_name
    subscriber-policy policy_name
  end

```

NOTES:

- **precedence** *precedence_value*—Specify the precedence for entry. Must be an integer in the range of 1-2048.

- **mcc** *mcc_value*—Specify the Mobile Country Code (MCC). Must be a three-digit number.
- **mnc** *mnc_value*—Specify the Mobile Network code (MNC). Must be a two or three-digit number.
- **operator-policy** *policy_name*—Specify the operator policy name. Must be a string.
- **policy-operator** *operator_policy*—Specify the operator policy. Must be one of the following:
 - <any string>
 - defOprPoll
 - opPolHomer
 - opPolRoaming
 - opPolVisiting
 - opPolVisiting_hrt
 - opPolVisiting_hrt_overriden
- **roaming-status roamer**—Specify the roaming status of the peer. This is disabled by default.
- **subscriber-policy** *policy_name*—Specify the subscriber policy name. Must be a string.

Configuration Example

The following is an example configuration.

```

config
  policy subscriber polSubSgw
    precedence 1
      imsi mcc 310
      imsi mnc 260
      operator-policy Home_op1
    exit

    precedence 2
      imsi mcc 311
      imsi mnc 660
      operator-policy Home_op1
    exit

    precedence 3
      imsi mcc 310
      imsi mnc 240
      operator-policy Home_op1
    exit

    precedence 4
      operator-policy Roaming_SGW_op1
    exit
  exit

  policy operator Roaming_SGW_op1
    roaming-status roamer
  exit

  profile sgw sgw1
    subscriber-policy polSubSgw
  end

```

Configuring the Default Gateway

To configure this feature, use the following configuration:

```

config
  router bgp local_as_number
  policy-name policy_name
    source-prefix source_prefix_value
    mask-range mask_range
  interface interface_id
    gateWay gateway_address
  end

```

NOTES:

- **router bgp** *local_as_number*—Specify the identification number for the AS for the BGP router.
- **policy-name** *policy_name*—Specify the policy name.
- **source-prefix** *source_prefix_value*—Specify the source prefix value.
- **mask-range** *mask_range*—Specify the mask range.
- **gateWay** *gateway_address*—Specify the gateway address.

Configuration Example

The following is an example configuration.

```

config
  router bgp 6500
  policy-name sgw_bgp
    source-prefix 209.165.201.12/32
    mask-range 32..32
  interface ens224.2084
    gateWay 209.165.201.28
  end

```

Configuration Verification

To verify the configuration:

- **show subscriber namespace sgw imsi 123456789012345 full subscriber-details**

```

{
  "subResponses": [
    "pdnInfoList": {
      "pdnInfo": [
        {
          "plmnType": "VISITOR"
          "s5ePeerType": "ROAMER"
        }
      ]
    }
  ]
}

```

- **show peers | include S5**

```

1 S5E 209.165.201.12:212320.20.20.124:2123Inbound nodemgr-1 Udp 2 minutes PGW
MaxRemoteRcChange: N/A,Recovery: 10 S5

```

```
1 S5E 209.165.201.12:212320.20.20.127:2123Inbound nodemgr-0 Udp 35 seconds PGW
MaxRemoteRcChange: N/A,Recovery: 10,S5E PeerType: Roaming
```

OAM Support

This section describes operations, administration, and maintenance support for this feature.

Bulk Statistics Support

The following statistics are supported for the Roaming Peer Path Management Optimization feature.

gtpc-ep statistics indicating Echo Request Handling from Roaming Peer is Suppressed:

```
gtpc_roaming_peer_path_mgmt{app_name="SGW",cluster="Local",data_center="DC",
gtpc_peer_type="ROAMER",instance_id="1",interface_type="S5E",service_name="gtpc-ep",
status="suppressed"} 1
```

upd_proxy statistics indicating Total number of bgp add request:

```
# HELP upd_proxy_bgp_routes_count Total number of bgp add request
# TYPE upd_proxy_bgp_routes_count counter
upd_proxy_bgp_routes_count{app_name="SGW",cluster="Local",data_center="DC",
gr_instance_id="1",instance_id="0",service_name="udp-proxy",status="success"} 1
```

Flag DB Database Updates

Feature Description

cnSGW-CSMF updates the CDL whenever the subscriber state changes from idle to active, and the ULI, UeTz, UCI, or the serving network is modified.

When the transaction requests driven to CDL increases, cnSGW-CSMF incurs a higher CPU utilization. To prevent the needless CPU utilization, cnSGW-CSMF updates only a subset of the CDL with the changed attributes.

Flag DB Database for the DDN Procedure

When the DDN procedure completes, sgw-service updates the CDL which impacts the CPU utilization. To optimize the CPU usage, the CDL is notified about the DDN only with the partial updates.

DDN Internal Timer

cnSGW-C implements the DDN Retry Timer by applying the CDL's timer functionality. Every DDN transaction starts the DDN Retry Timer that requires the complete CDL instance to be updated, which results in an increase in the CPU usage of the CDL and sgw-service.

SMF implements the DDN Retry Timer by applying the CDL's timer functionality. Every DDN transaction starts the DDN Retry Timer that requires the complete CDL instance to be updated, which results in an increase in the CPU usage of the CDL and smf-service.

cnSGW-CSMF is modified to have an integrated DDN Retry Timer that is configurable from `sgw-profile`. With this approach, the performance is improved because the cnSGW-CSMF does not communicate with the CDL for starting the DDN Retry Timer as it is an internal timer. The DDN Retry Timer is started for a duration of 10 seconds.

OAM Support

This section describes operations, administration, and maintenance support for this feature.

Bulk Statistics Support

The following statistics are supported for the Flag DB Database Updates feature:

- `mbr_partial_cdl_update`: Captures the total number of partial CDL update procedures invoked by the Modify Bearer Request.

Sample query:

```
sgw_cdl_update_stats{app_name="smf",cdl_update_type="mbr_partial_cdl_update",cluster="Local",data_center="DC",gr_instance_id="1",instance_id="0",rat_type="EUTRAN",service_name="sgw-service"} 1
```

- `ddn_partial_cdl_update`: Captures the total number of partial CDL update procedures that DDN has invoked

Sample query:

```
sgw_cdl_update_stats{app_name="smf",cdl_update_type="ddn_partial_cdl_update",cluster="Local",data_center="DC",gr_instance_id="1",instance_id="0",rat_type="EUTRAN",service_name="sgw-service"} 1
```

For more information on bulk statistics support, see *UCC Serving Gateway Control Plane Function Metrics Reference*.

UDP Proxy Functionality Merged into Protocol Microservices

Feature Description

The UDP proxy microservices provide UDP transport termination for protocols (PFCP, GTPC, and RADIUS) that require UDP protocol as the transport layer protocol. The UDP proxy provides user space packet forwarding and IPC communication to protocol microservices. It uses host networking for source IP address observability and operates in Active-Standby mode.

Multiple protocol microservices depend on UDP proxy for UDP transport. Therefore, UDP proxy is a scaling bottleneck. A surge of messages can lead to packet drop.

The incoming and outgoing messages use the UDP proxy pod for forwarding messages. With minimal packet processing, the UDP proxy forwards the messages to the GTPC-EP pod. This requires the IPC communication for message forwarding, along with marshal or unmarshal of the packet.

The UDP proxy functionality merges into the respective protocol microservice to mitigate the scaling bottleneck. The protocol pod receives the messages directly, and avoids forwarding the messages and IPC communication.

The UDP proxy bypass improves the CPU usage by reducing one hop across microservices in the signaling path. cnSGW-C supports UDP proxy bypass for the PFCP and GTPC protocols.

PFCP Protocol Endpoint with UDP Proxy Bypass

With the UDP proxy mode, all message exchanges for the protocols, such as N4, Sxa, and GTP-U, occur through the UDP proxy. The UDP proxy is responsible for connecting or receiving connections from the UPF. The service or the UPF initiates all node-related or session-related messages, and the responses pass through the UDP proxy. The UDP proxy handles all node-related messages and forwards the messages to the protocol node.

With the outbound UDP proxy bypass mode, the session-related messages flow directly from the protocol to the UPF. The node-related messages continue to take the current path, which is through the UDP proxy to the protocol pod or the node manager.

With the inbound and outbound UDP proxy bypass mode, the service sends the session-related messages directly to UPF through the protocol pod, with UDP proxy bypassed. The protocol also establishes a connection with the UPF as and when the app service initiates a PFCP message toward the UPF.

For more information about UDP Proxy Bypass for PFCP, see *UCC 5G SMF Configuration and Administration Guide*.

GTPC Protocol Endpoint with UDP Proxy Bypass

With the UDP proxy mode, all message exchanges for the GTPv2 protocol occur through the UDP proxy. The UDP proxy is responsible for connecting or receiving connections on the S11 and S5e, S2b, and S5/S8 interface. The service or the GTP peer initiates the session-related or node-related messages, and the responses pass through the UDP proxy. The UDP proxy handles all node-related messages and forwards the messages to the protocol node.

With the inbound and outbound UDP proxy bypass mode, the service-initiated session-related messages are sent directly to the GTP peer through the GTPC-EP pod, with the UDP proxy bypassed. For node-related messages, the GTPC-EP starts a GTP endpoint for peers to connect with it on the S11, S5e, S2b, and S5/S8 interfaces. The GTPC-EP pod also establishes a connection with the GTP peer as and when the app service initiates a GTPv2 message toward the GTP peer.

The following features are integrated from UDP proxy:

- Transaction SLA
- DSCP marking for GTP packets
- Adding BGP routes for roamer subscribers on the fly
- Supporting Dispatcher feature and incoming retransmission
- SGW cache integration for DDN
- MBR cache integration

The following features are integrated from GTPC-EP:

- Retransmissions based on n3t3 configuration for outbound requests
- Monitor protocol and monitor subscriber

- Echo message handling

All existing features supporting the UDP proxy mode are supported with and without the UDP proxy bypass mode.

How it Works

This section describes how this feature works.

The GTPC-EP k8 service is disabled when the bypass feature is enabled.

The GTPC protocol endpoint with the UDP Proxy Bypass feature requires the GTPC-EP pod to run in the host environment in Active-Standby mode. When the GTPC-EP pod runs in the host environment in the Active-Standby mode, the k8-service is disabled. Further, if the pods (SGW-Service and the node manager) must communicate with the GTPC-EP pod, an extra endpoint is required at the GTPC-EP pod. This infra endpoint initializes at the GTPC-EP app start and the internal IP is used for the same.

When the internal IP is not configured, the available GTP VIPs are used for initializing the infra endpoint.

The S11, S5, S5e, and S2b interfaces are used to configure the GTP VIPs instead of the base GTP VIP IP address.

The UDP sockets are created at the GTPC-EP pod for handling GTP packets.

No new CLI or keyword is added to enable or disable bypass UDP proxy functionality. The existing endpoint configuration is used in the following manner to enable or disable bypass UDP proxy functionality:

- GTP VIPs must be configured under the endpoint protocol for using UDP proxy (no bypass).
- GTP VIPs must be configured under the GTPC endpoint to enable bypass UDP proxy.
- If the GTP VIPs are configured under both the protocol endpoint and the GTP endpoint, the UDP proxy is used by default.
- The GTPC feature-specific configurations, such as Retransmission n3t3-based, ECHO, SLA, Dispatcher, and the DSCP must be configured under endpoint GTP irrespective of the bypass feature.



Note Prior to this feature, if endpoint GTP was configured, the UDP proxy mode was the default behaviour. With this feature onwards, if the endpoint GTP is configured with the GTP interface VIP (s5, s11, s5e, or s2b), the UDP proxy bypass is enabled by default. For UDP proxy bypass to be disabled, the endpoint protocol must be configured with the GTP interface VIP (s5, s11, s5e, or s2b).

Call flows

This section describes the key call flows for this feature.

GTPC Protocol Endpoint with UDP Proxy Bypass Call Flow

This section describes the GTPC Protocol Endpoint with UDP Proxy Bypass call flow.

Figure 109: GTPC Protocol Endpoint with UDP Proxy Bypass Call Flow

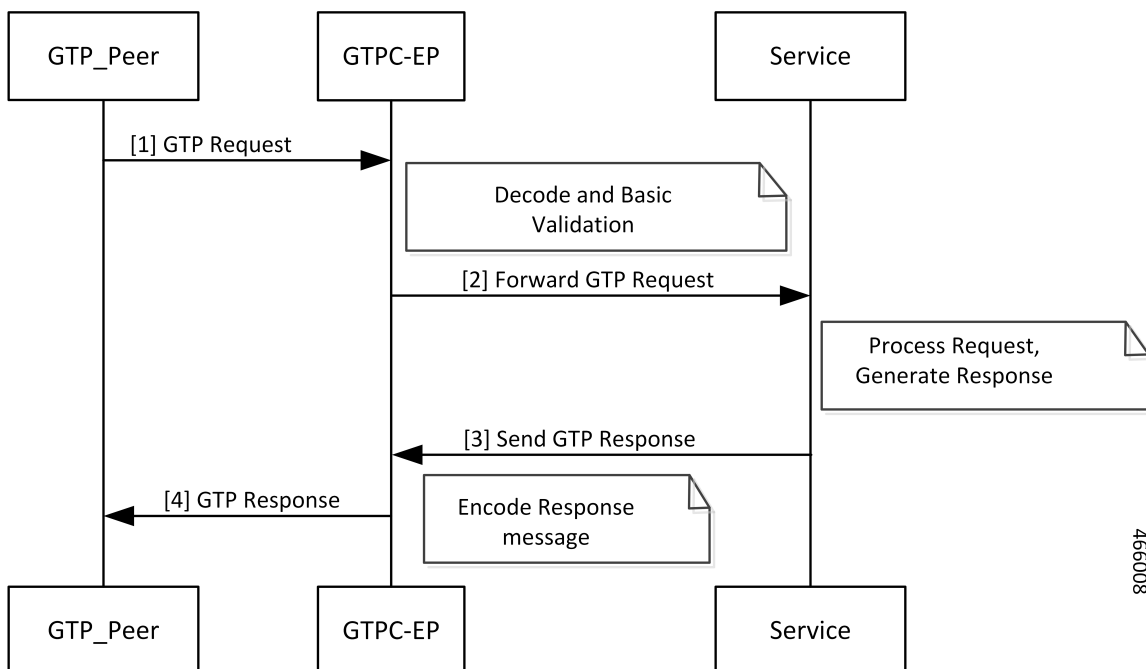

Table 186: GTPC Protocol Endpoint with UDP Proxy Bypass Call Flow Description

Step	Description
1	The GTP_Peer sends the GTP Request to the GTPC-EP pod.
2	The GTPC-EP pod decodes the message, performs the basic validation, and forwards the GTP Request to the Service.
3	The Service processes the GTP Request, generates the GTP Response, and sends the GTP Response to the GTPC-EP pod.
4	The GTPC-EP pod encodes the GTP Response message and forwards the GTP Response message to the GTP_Peer.

Feature Configuration

Configuring this feature involves the following steps:

- [Configuring Internal VIP](#)
- [Configuring GTP VIPs](#)

Configuring Internal VIP

To configure the internal VIP, use the following configuration:

```

config
  instance instance-id instance_id
  endpoint gtp
  
```

```

internal-vip vip_ip_address
vip-ip ipv4_address vip-port ipv4_port_number
vip-ipv6 ipv6_address vip-ipv6-port ipv6_port_number
dual-stack-transport { true | false }
end

```

NOTES:

- **internal-vip** vip_ip_address—Specify the internal VIP IP address of the additional endpoint of the GTPC-EP pod. The Service pod sends the messages directly to this IP address.
- **dual-stack-transport** { true | false }—Enable the dual stack feature that allows you to specify IPv6 or IPv4 address. Specify true to enable this feature.

Configuring GTP VIPs

To configure the GTP VIPs under the interface for initializing the infra-GTP endpoint, use the following configuration:

```

config
  instance instance-id instance_id
    endpoint gtp
      vip-ip ipv4_address vip-port ipv4_port_number
      vip-ipv6 ipv6_address vip-ipv6-port ipv6_port_number
      dual-stack-transport { true | false }
    interface interface_name
      vip-ip ipv4_address vip-port ipv4_port_number
      vip-ipv6 ipv6_address vip-ipv6-port ipv6_port_number
      dual-stack-transport { true | false }
    end
end

```

NOTES:

- **vip-ip** ipv4_address **vip-port** ipv4_port_number—Specify the IPv4 address of the interface.
- **vip-ipv6** ipv6_address **vip-ipv6-port** ipv6_port_number—Specify the IPv6 address of the interface.
- **dual-stack-transport** { true | false }—Enable the dual stack feature that allows you to specify IPv6 or IPv4 address. Specify true to enable this feature.

Configuration Example

The following are example configurations.

Example configuration with the internal VIP for GTPC-EP, with UDP Proxy bypass enabled:

```

config
  instance instance-id 1
    endpoint gtp
      internal-vip 209.165.201.15
    end
end

```

Example configuration with the bypass feature enabled (UDP Proxy bypassed):

```

config
  instance instance-id 1
    endpoint gtp
      vip-ip 209.165.201.20
      interface s5
    end
end

```

```
        vip-ip 209.165.201.20
    exit
interface s5e
    vip-ip 209.165.201.8
    exit
interface s2b
    vip-ip 209.165.201.20
    exit
interface s11
    vip-ip 209.165.201.8
end
```

Example configuration with bypass feature disabled (UDP Proxy used for GTP messages):

```
config
    instance instance-id 1
        endpoint protocol
            vip-ip 209.165.201.20
            interface s5
                vip-ip 209.165.201.20
                exit
            interface s5e
                vip-ip 209.165.201.8
                exit
            interface s2b
                vip-ip 209.165.201.20
                exit
            interface s11
                vip-ip 209.165.201.8
            end
```



CHAPTER 40

Presence Reporting Area

- [Feature Summary and Revision History, on page 493](#)
- [Feature Description, on page 493](#)
- [How it Works, on page 494](#)

Feature Summary and Revision History

Summary Data

Table 187: Summary Data

Applicable Product(s) or Functional Area	cnSGW-C
Applicable Platform(s)	SMI
Feature Default Setting	Enabled - Always-on
Related Documentation	Not Applicable

Revision History

Table 188: Revision History

Revision Details	Release
First introduced.	2021.02.1

Feature Description

Presence Reporting Area (PRA) is an area defined within 3GPP packet domain for reporting UE presence within that area for policy control and/or charging reasons.

A Presence Reporting Area consists of:

- TAs or eNBs and/or ECGI for E-UTRAN
- RAs or SAIs or CGIs for UTRAN
- RAs or CGIs for GERAN

The two types of Presence Reporting Areas that apply to an MME pool are UE-dedicated Presence Reporting Areas and Core Network pre-configured Presence Reporting Areas.



Note cnSGW-C supports Core Network pre-configured PRAs in this release.

The information for leveraging PRA for implementing differential charging and policy enforcement is provided in *3GPP TS 23.401*.

The cnSGW supports:

- Passing PRA action to MME as received from PGW in CSRsp, CBRsp, UBRsp, MBRsp, and CNRsp messages.
- Passing PRA information to PGW if received from MME in CSReq, CBRsp, UBRsp, CNotf Req, and MBReq messages.
- Always passing the message to PGW if PRA information is present in MBReq.

How it Works

This section describes how this feature works.

cnSGW-C relays the instructions received from PGW towards MME and the information thus reported by MME towards PGW.

To pass the information, two IEs are defined on GTPC interface as per *3GPP TS 29274 V15.4.0*. The following section shows the IE support implemented in cnSGW-C.

Presence Reporting Area Action

Table 189: Presence Reporting Area Action

Octets	Bits							
	8	7	6	5	4	3	2	1
1	Type = 177							
2–3	Length = n							
4	SPARE				Instance			
5	SPARE				INAPRA	Action		
6–8	Presence Reporting Area Identifier							

Table 190: Action Values

Action	Value (Decimal)
Start Reporting changes of UE presence in the Presence Reporting Area (PRA)	1
Stop Reporting changes of UE presence in the Presence Reporting Area (PRA)	2

- The Action value 1 (Start Reporting change) is used to request to start reporting changes of UE presence in the Presence Reporting Area identified by the Presence Reporting Area Identifier and, if present, the Presence Reporting Area elements composing the Presence Reporting Area.
- The Action value 2 (Stop Reporting change) is used to request to stop reporting changes of UE presence in a Presence Reporting Area.
- The Inactive PRA (INAPRA) flag in the Octet 5 is set to 1 on the S10/S16/S3 interface if the PRA is inactive in the source MME/SGSN during an inter MME/SGSN mobility procedure, i.e. the reporting change of UE presence in this Presence Reporting Area was requested by the PGW/PCRF/OCS but it was deactivated by the source MME/SGSN.
- The Presence Reporting Area Identifier shall be present if the Action value requests to start, stop, or modify reporting changes of UE presence in a Presence Reporting Area. If so, the Presence Reporting Area Identifier shall contain an identifier of the Presence Reporting Area and encoded using full hexadecimal representation.

Presence Reporting Area Information

Table 191: Presence Reporting Area Information

Octets	Bits							
	8	7	6	5	4	3	2	1
1	Type = 178							
2–3	Length = n							
4	SPARE				Instance			
5–7	PRA Identifier							
8	SPARE				INAPRA	SPARE	OPRA	IPRA

- The PRA Identifier in octets 5–7 is present and contains the identifier of the PRA the UE is entering or leaving. It's encoded using full hexadecimal representation (binary, not ASCII encoding). The PRA Identifier is defined in *3GPP TS 23.003 [2], Clause 19.10*.
- The Inside PRA (IPRA) flag is set to 1 if the UE is inside or enters the Presence Reporting Area identified by the PRA Identifier.
- The Outside PRA (OPRA) flag is set to 1 if the UE is outside or leaves the Presence Reporting Area identified by the PRA Identifier.

- The Inactive PRA (INAPRA) flag in octet 8 is set to 1 if the PRA is inactive in the MME/SGSN, i.e. the reporting of change of UE presence in this PRA is currently deactivated in the MME/SGSN, e.g. due to an overload situation.
- Either the IPRA or the OPRA flag or the INAPRA is set to 1, not several ones, for a given Presence Reporting Area Identifier.



CHAPTER 41

Redundancy Support

- [Feature Summary and Revision History](#), on page 497
- [High Availability Support](#), on page 498
- [Geographic Redundancy Support](#), on page 501

Feature Summary and Revision History

Summary Data

Table 192: Summary Data

Applicable Product(s) or Functional Area	cnSGW-C 5G-SMF
Applicable Platform(s)	SMI
Feature Default Setting	Enabled - Configuration Required
Related Documentation	Not Applicable

Revision History

Table 193: Revision History

Revision Details	Release
First introduced.	2021.02.0

High Availability Support

Feature Description

The cnSGW-C is built on the Kubernetes cluster strategy so that it inherits the high availability aspects of K8 cluster deployments. The cnSGW-C uses the construct that includes the components, such as pods and services.

Each pod has at least 2 instances to ensure high availability against:

- Pod instance restart or failure
- Pod lost due to node restart or failure

For details on the pods and services, see the [Pods and Services Reference, on page 73](#) chapter in this guide.

High Availability of UDP Proxy

The cnSGW-C supports High Availability (HA) of UDP proxy. The HA model of UDP proxy is based on the keepalived virtual IP concepts.

For more information on UDP proxy redundancy, see the [High Availability for the UDP Proxy, on page 78](#) section in the [Pods and Services Reference, on page 73](#) chapter.

Architecture

This section describes the recommended layout of cnSGW-C pods and VMs.

cnSGW-C Pod and VM Deployment Layout

This section describes the deployment of cnSGW-C pods and its microservices.

The following figure shows the deployment model of six VMs in cnSGW-C.

Figure 110: VM Deployment Model

Protocol VM1	Protocol-ep	Rest-ep	Gtp-ep	Rad-dns-ep	UDP proxy(act)
Protocol VM2	Protocol-ep	Rest-ep	Gtp-ep	Rad-dns-ep	UDP proxy(std)
Service VM1	Service- 7 replicas		Nodemgr		
Service VM2	Service- 7 replicas		Nodemgr		
Session VM1	cdl-ep-session	cdl-index-session- 2 replica		cdl-slot-session- 7 replica	
Session VM2	cdl-ep-session	cdl-index-session- 2 replica		cdl-slot-session- 7 replica	

461858

In this model, the pods are deployed on VM pairs. Two replicas are available for each protocol pod (for example, rest-ep, protocol-ep, and gtp-ep). One instance is deployed on each protocol VM.

Similarly, service pods and session pods are distributed equally on both the service and session VMs. Such a distribution is controlled by labelling the VMs as well as implementing the K8 affinity and anti-affinity rules during pod scheduling.

This model ensures that, during VM reboot scenarios, at least 50% of the replicas of each pod type are available to handle user signaling.

Graceful pod restart allows pod to complete ongoing processing within 30 seconds. Abrupt pod restart will affect ongoing transactions without impact to PDU sessions.

How it Works

This section provides information on how the resiliency and HA can be achieved.

The cnSGW-C enables inter-pod communication during the pod failure or restart.

During graceful pod restart:

- Ongoing processing is not impacted.
- New messages are not sent to the pod through Kubernetes service.
- Messages with session affinity continue to be received by the pod.
- Existing call flow expected to complete within 30 seconds.

After pod restart:

- All Prometheus metrics of the pod are reset.
- When internal diagnostics is green, the pod status changes to Ready.
- Pod is ready to process the new messages.

When the cnSGW-C VM reboots or the VM is unavailable:

- All pods on the VM are lost.
- Pods on the other available VM continue processing, thus providing high availability.
- VIP, if present, is switched to the other available node.
- It takes about 5 minutes of the node unreachability for Kubernetes to detect the node as down.
- Pods on the node are thereafter not discoverable through Kubernetes service.

After the pod restarts, pods on the VM are scheduled one after another. This operation is similar to the pod restart.

During the VIP and VM reboot, virtual IP is associated with a single VM. UDP proxy binds to N4 VIP address for communication with UPF. UDP proxy binds to S5 VIP address for communication with cnSGW-C.

Reboot of VM with active VIP causes VIP to switch to the other protocol VM. The active UDP proxy failure causes VIP to switch to other protocol VM.

Before the Subscriber Microservices Infrastructure (SMI) handles the VIP monitoring and switchover, make sure that appropriate VIP configuration is available in the SMI deployer. Also, check if the port is set to 28000 and the host priority is equal.

Configuring Pod-level Labelling and Replicas

The node label is configured on the SMI cluster deployer. For information on the configuration commands, see the [Mapping Pods with Node Labels, on page 21](#) section in the [Deploying and Configuring cnSGW-C through Operations Center, on page 19](#) chapter.

Configuration Example

The following is an example of VM labelling and replica configuration.

```
k8 label protocol-layer key smi.cisco.com/node-type value smf-proto
exit
k8 label service-layer key vm-type value smf-svc
exit
k8 label cdl-layer key smi.cisco.com/node-type value smf-cdl
exit
k8 label oam-layer key smi.cisco.com/node-type value oam
exit

endpoint pfcpl
  replicas 1
  nodes 2
exit
endpoint service
  replicas 1
  nodes 2
exit
endpoint protocol
  replicas 1
  nodes 2
  vip-ip 209.165.201.28
exit
endpoint sbi
  replicas 1
  nodes 2
```

Configuration Verification

To verify the configuration, use the following show command:

```
show running-config instance instance-id instance_id endpoint
```

The following is an example output of this show command.

```
show running-config instance instance-id 1 endpoint
instance instance-id 1
  endpoint nodemgr
    replicas 1
    nodes 2
  exit
  endpoint gtp
    replicas 1
    vip-ip 209.165.201.29
  exit
  endpoint pfcpl
    replicas 2
    enable-cpu-optimization true
  interface n4
    heartbeat
      interval 0
      retransmission-timeout 3
      max-retransmissions 5
```

```
    exit
  exit
endpoint service
  replicas 2
exit
endpoint protocol
  replicas 1
  vip-ip 209.165.201.29
end
```

This command output displays the configurations related to multiple endpoints, such as endpoint names, pod replicas, and nodes.

Geographic Redundancy Support

Feature Description

The cnSGW-CSMF supports Geographical Redundancy (GR) in active-active mode. The GR takes place through replication of sessions, configuration, and any other data required for seamless failover and failback of services to the remote site.

How it Works

cnSGW-CSMF (CNF) can be deployed in a geographic redundant manner to provide service across a catastrophic failure, such as data center failure of a rack hosting a cnSGW-CSMF cluster.

Each CNF instance service registers with NRF and S11/S5 for DNS entry for MME/SGW. Local HA redundancy allows instance to achieve rack level redundancy in addition to K8 cluster level failures within same data center or handle locally within same K8 cluster if failed containers are per Type-2 $< n$.

where, n is a value. For less than 50% of container failures, HA should handle the failures. For more than 50% of container failures, GR switchover is triggered.

Overview

In active-active mode,

- GR deployment is transparent to the adjacent NFs.
- GR deployment contains two instances of CCG function, each instance manifest itself with a set of interface IPs.
- Each instance support sets of sessions and continue to use the same IP for session consistency.
- At a specific time period, one CCG instance can be primary only on one site and standby on the other site.
- The set of interface IPs that are associated with the CCG instance, dynamically route to the primary site of the instance.

cnSGW-CSMF supports primary/standby redundancy in which data is replicated from the primary to standby instance. The primary instance provides services in normal operation. If the primary instance fails, the standby instance becomes the primary and takes over operation. To achieve a geographically distributed system, two

primary/standby pairs can be set up where each site is actively processing traffic and standby is acting as backup for the remote site.

In an Active/Active GR deployment, consider there are two racks: Rack-1/Site-1 and Rack-2/Site-2 located in the same geographic site. All the NFs are trying to reach instance-1 and instance-2.

Figure 111: Active-Active GR Deployment

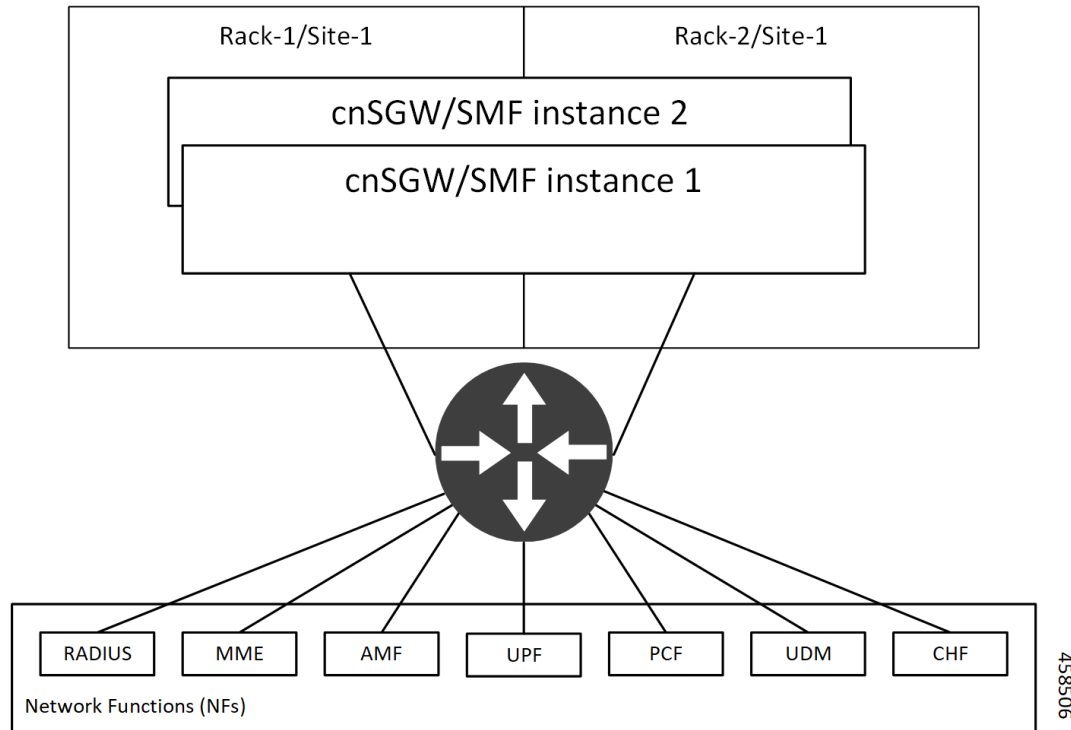

For NFs, both the instances are active. But in actual, instance-1 and instance-2 are divided across racks.

Rack-1/Site-1 has instance-1 and instance-2. In a pre-trigger scenario, instance-1 is local and acts as Primary and instance-2 is in Standby mode.

Rack-2/Site-2 also has instance-1 and instance-2. In a pre-trigger scenario, instance-2 is local and acts as Primary and instance-1 is in Standby mode.

In case, if Rack-1/Site-1 goes down, the traffic moves to Rack-2/Site-2. On Rack-2/Site-2 both the instances, instance-1 and instance-2 acts as Primary.

GR Triggers

Geographic Redundancy (GR) supports the following GR triggers:

- CLI-based switchover: Manual CLI commands are used to switch the roles and trigger GR failover.
- BFD link failover detection: When both the BFD links between the connected rack and the leafs are down, GR failover is triggered.
- Local Site POD failure detection: When threshold percentage of POD replica-sets failing is greater than the configured threshold value, GR failover is triggered.

- Remote Site POD failure detection: When the remote POD monitoring detects failure breaching threshold percentage, the POD becomes self-primary for that instance.
- Remote Site Role monitoring: When the remote role monitoring detects that the rack is in Standby_error state, it becomes self-primary.
- Multi-Compute Failure: When two or more servers are powered down, it triggers GR failover.

Site Roles



Note

- Cachepod/ETCD and CDL Replication happens during all the roles mentioned in the following section.
 - If GR links are down or periodic heartbeat fails, GR triggers are suspended.
-

- PRIMARY: Site is ready and actively taking traffic for the given instance.
- STANDBY: Site is standby, ready to take traffic but not taking traffic for the given instance.
- STANDBY_ERROR: Site is in problem, not active and not ready to take traffic for the given instance.
- FAILOVER_INIT: Site has started to failover and not in condition to take traffic. Buffer time is 2 sec for application to complete their activity.
- FAILOVER_COMPLETE: Site has completed the failover and attempted to inform the peer site about the failover for given instance. Buffer time is 2 seconds.
- FAILBACK_STARTED: Manual failover is triggered with delay from remote site for the given instance.

For fresh installation, site boots up with:

- Role PRIMARY for local instance (each site has local instance-id configured to identify local instance). It is recommended not to configure the pods for monitoring during fresh installation. Once the setup is ready, you can configure the pods for monitoring.
- Role STANDBY for other instances

For upgrades, site boots up with:

- STANDBY_ERROR role for all the instances as moving the traffic post upgrade needs manual intervention.
- ETCD stores instance roles.



Note

Rolling upgrade or in-service upgrade isn't supported.

General Guidelines

Before configuring Geographic Redundancy deployment, here are some general guidelines:

- Both GR sites should be on the same software version.
- Both GR sites should be configured with same configuration.
- Loopback port of Instance 1 and Instance 2 should be different. Else, REST-EP POD wouldn't come up due to K8 IP/Port conflict.
- Respective interface on both GR sites should be on the same VLAN. For example, N4 VLAN of Instance 1 and Instance 2 should be on the same VLAN. Else, there's a route conflict on Kernel while enforcing BGP policies.
- Consult your Cisco Technical Representative to perform the following procedures to make sure proper roles are assigned.

For more information, see [Software Upgrade on GR Pairs, on page 530](#).

- Post GR, perform the failback manually after ensuring the site is healthy. Autonomous failback isn't supported.

For more information, see [Recovery Procedure, on page 552](#).

- Use non-bonded interface in BGP speaker PODs for BGP peering.
- BGP peering per Proto node is supported with only two BGP routers/leafs. Considering two Proto nodes, there can be maximum of four BGP neighborships.
- Use bonded interfaces for Service traffic.
- Geo pod uses two VIPs:
 - Internal-VIP for Inter-POD communication (within the rack)
 - External-VIP for Inter-Rack Geo pod communication. Configure only on Proto Nodes on L2 Subnet. This is used to communicate across the racks. This node has external connectivity to other Rack
- Geo Internal IP to be reachable to all nodes within the rack.
- Geo External IP:
- CDL/Kafka VIPs: Configure on CDL Labeled Nodes on L2 Subnet.
- Enable LI tapping on both sites.
- MDF server should be reachable from both sites.

Instance Awareness

Instance awareness configuration in cnSGW-CSMF helps to distinguish local site instance and remote site instance.

Configuring GR Instance

This configuration is needed to provide a geo-redundancy configuration for multiple sites. With instance ID, endpoint configurations should be configured for each Geo-Redundancy site.

Sample Configuration 1

The following is a sample configuration for endpoint VIP configuration under one instance:

```
config
  instance instance-id gr_instanceId
    endpoint endpoint_name
    vip-ip vip_ip_address
  exit
exit
```

Example:

```
config
instance instance-id 1
  endpoint sbi
  vip-ip 209.165.201.21
exit
exit
```

Sample Configuration 2

The following is a sample configuration to provide information on system-id, cluster-id and slice-name under an instance:

```
config
  instances instance instance_id
    system-id system_id
    cluster-id cluster_id
    slice-name cdl_slice_name
  exit
exit
```

Example:

```
config
  instances instance 1
    system-id sgwsmf
    cluster-id sgwsmf
    slice-name 1
  exit
exit
```



Note It is recommended to have the same values for *system-id*, *cluster-id* in the instance, and *app-name*, *cluster-name* in deployment.

Configuring Endpoint Instance Awareness

Only two instances can be configured on each local and remote site, and corresponding endpoints can be instantiated.

A local instance-id is the identity of the local site irrespective of the site is in GR aware or not.

Local Instance ID Configuration

The local instance is configured using the local-instance command.

```
local-instance instance 1
```

Endpoint configuration must be under instance specified by each unique instance ID.

Endpoint Configuration Example

Following are a few configuration examples.



Note In the following example, *instance-id "1"* is a local instance-id, and endpoints configured under it belong to the local site.

Optionally, remote site *instance-id "2"* can be configured for endpoints belonging to the geo-site.

```
instance instance-id 1
  endpoint li
    replicas 1
    nodes 2
    vip-ip 209.165.201.6
    vip-ip 209.165.201.13
  exit
  endpoint gtp
    replicas 1
    nodes 2
    retransmission timeout 5 max-retry 4
    vip-ip 209.165.201.6
    vip-ip 209.165.201.4
    interface s5
      echo interval 60
      echo retransmission-timeout 5
      echo max-retransmissions 4
    exit
    interface s2b
      echo interval 60
      echo retransmission-timeout 5
      echo max-retransmissions 4
    exit
  exit
exit
instance instance-id 2
  endpoint li
    replicas 1
    nodes 2
    vip-ip 209.165.201.6
    vip-ip 209.165.201.13
  exit
exit
  endpoint gtp
    replicas 1
    nodes 2
    retransmission timeout 5 max-retry 4
    vip-ip 209.165.201.6
    vip-ip 209.165.201.5
    interface s5
      echo interval 60
      echo retransmission-timeout 5
      echo max-retransmissions 4
    exit
    interface s2b
      echo interval 60
      echo retransmission-timeout 5
      echo max-retransmissions 4
```

```

exit
exit
exit

```

Configuring Profile cnSGW-CSMF Instance Awareness

Add instance for PGW FQDN corresponding to local and remote instances.

Example

Following is a configuration example.



Note In the following example, *instance-id "1"* is a local instance-id, and the cnSGW-CSMF profile configured under it belongs to the local site.

Optionally, remote site *instance-id "2"* can be configured for FQDN belonging to the geo-site.

```

profile smf smf1
locality LOC1
allowed-nssai [ slice1 ]
instances 1 fqdn cisco.com.apn.epc.mnc456.mcc123
instances 2 fqdn cisco.com.apn.epc.mnc567.mcc123

profile sgw sgw1
locality LOC1
instances 1 fqdn cisco.com.apn.epc.mnc456.mcc123
instances 2 fqdn cisco.com.apn.epc.mnc567.mcc123

```

Configuring cnSGW-C Endpoint

Endpoint configuration is required only for cnSGW-C.

Example

The following is a configuration example.



Note In the following example, *instance-id "1"* is a local instance-id, and endpoints configured under it belong to the local site.

Optionally, remote site *instance-id "2"* can be configured for endpoints belonging to the geo-site.

```

instance instance-id 1
endpoint nodemgr
  replicas 1
  nodes 1
exit
endpoint gtp
  replicas 1
  vip-ip 209.165.201.10
  interface s5e
    vip-ip 209.165.201.29
  exit
  interface s11
    vip-ip 209.165.201.29
  exit

```

```
exit
endpoint pfc
  replicas 1
  interface sxa
    heartbeat
      interval 0
      retransmission-timeout 5
      max-retransmissions 3
    exit
  exit
exit
endpoint service
  replicas 1
exit
endpoint protocol
  replicas 1
  vip-ip 209.165.201.29
  interface sxa
    vip-ip 209.165.201.29
  exit
exit
endpoint sgw-service
  replicas 1
exit
exit
instance instance-id 2
  endpoint nodemgr
    replicas 1
    nodes 1
  exit
  endpoint gtp
    replicas 1
    vip-ip 209.165.202.150
    interface s5e
      vip-ip 209.165.201.27
    exit
  interface s11
    vip-ip 209.165.201.27
  exit
exit
endpoint pfc
  replicas 1
  interface sxa
    heartbeat
      interval 0
      retransmission-timeout 5
      max-retransmissions 3
    exit
  exit
exit
endpoint service
  replicas 1
exit
endpoint protocol
  replicas 1
  vip-ip 209.165.201.27
  interface sxa
    vip-ip 209.165.201.27
  exit
exit
endpoint sgw-service
  replicas 1
exit
exit
```

Dynamic Routing

Border Gateway Protocol (BGP) allows you to create loop-free inter-domain routing between autonomous systems (AS). An AS is a set of routers under a single technical administration. The routers can use an Exterior Gateway Protocol to route packets outside the AS. The Dynamic Routing by Using BGP feature enables you to configure the next-hop attribute of a BGP router with alternate local addresses to service IP addresses with priority and routes. The App-Infra BGP speaker pods enable dynamic routing of traffic by using BGP to advertise pod routes to the service VIP.

This feature supports the following functionality:

- Dynamic routing by using BGP to advertise service IP addresses for the incoming traffic.
- Learn route for outgoing traffic.
- Handling a BGP pod failover.
- Handling a protocol pod failover.
- Statistics and KPIs for the BGP speakers.
- Log messages for debugging the BGP speakers.
- Enable or disable the BGP speaker pods.
- New CLI commands to configure BGP.

Incoming Traffic

BGP uses TCP as the transport protocol, on port 179. Two BGP routers form a TCP connection between one another. These routers are peer routers. The peer routers exchange messages to open and confirm the connection parameters.

The BGP speaker publishes routing information of the protocol pod for incoming traffic in the active standby mode. Use the following image as an example to understand the dynamic routing functionality. There are two protocol pods, pod1 and pod2. Pod1 is active and pod2 is in the standby mode. The service IP address, 209.165.200.225 is configured on both the nodes, 209.165.200.226 and 209.165.200.227. pod1 is running on host 209.165.200.226 and pod2 on host 209.165.200.227. The host IP address exposes the pod services. BGP speaker publishes the route 209.165.200.225 through 209.165.200.226 and 209.165.200.227. It also publishes the preference values, 110 and 100 to determine the priority of pods.

Figure 112: Dynamic Routing for Incoming Traffic in the Active-standby Topology

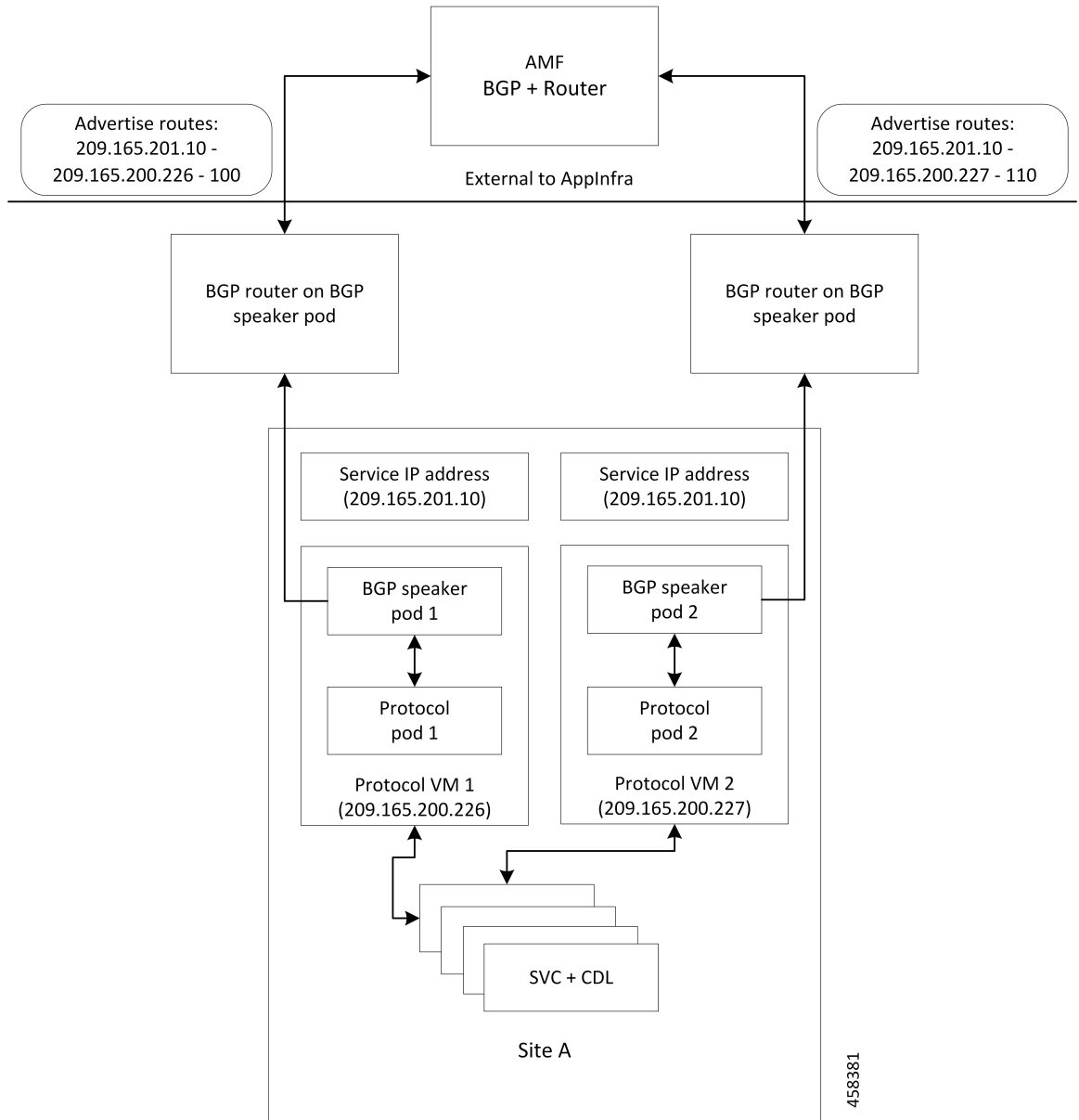

For high availability, each cluster has two BGP speaker pods with Active-standby topology. Kernel route modification is done at host network level where the protocol pod runs.

MED Value

The Local Preference is used only for IGP neighbours, whereas the MED Attribute is used only for EGP neighbours. A lower MED value is the preferred choice for BGP.

Table 194: MED Value

Bonding Interface Active	VIP Present	MED Value	Local Preference
Yes	Yes	1210	2220
Yes	No	1220	2210
No	Yes	1215	2215
No	No	1225	2205

Bootstrap of BGP Speaker Pods

The following sequence of steps set up the BGP speaker pods:

1. The BGP speaker pods use TCP as the transport protocol, on port 179. These pods use the AS number configured in the Ops Center CLI.
2. Register the Topology manager.
3. Select the Leader pod. The Active speaker pod is the default choice.
4. Establish connection to all the BGP peers provided by the Ops Center CLI.
5. Publish all existing routes from ETCD.
6. Configure import policies for routing by using CLI configuration.
7. Start gRPC stream server on both the speaker pods.
8. Similar to the cache pod, two BGP speaker pods must run on each Namespace.

For more information on Dynamic Routing, see the *Dynamic Routing by Using BGP* chapter in the *UCC Serving Gateway Control Plane Function - Configuration and Administration Guide*.

For more information on Dynamic Routing, see the *Dynamic Routing by Using BGP* chapter in the *UCC 5G Session Management Function - Configuration and Administration Guide*.

Configuring Dynamic Routing by Using BGP

This section describes how to configure the Dynamic Routing by Using BGP feature.

Configuring AS and BGP Router IP Address

To configure the AS and IP address for the BGP router, use the following commands:

```
config
  router bgp local_as_number
  exit
exit
```

NOTES:

- **router bgp local_as_number**—Specify the identification number for the AS for the BGP router.

In a GR deployment, you need to configure two Autonomous Systems (AS).

- One AS for leaf and spine.
- Second AS for both racks: Rack-1/Site-1 and Rack-2/Site-2

Configuring BGP Service Listening IP Address

To configure the BGP service listening IP address, use the following commands:

```
config
  router bgp local_as_number
    interface interface_name
  exit
exit
```

NOTES:

- **router bgp** *local_as_number*—Specify the identification number for the AS for the BGP router.
- **interface** *interface_name*—Specify the name of the interface.

Configuring BGP Neighbors

To configure the BGP neighbors, use the following commands:

```
config
  router bgp local_as_number
    interface interface_name
      neighbor neighbor_ip_address remote-as as_number
    exit
exit
```

NOTES:

- **router bgp** *local_as_number*—Specify the identification number for the AS for the BGP router.
- **interface** *interface_name*—Specify the name of the interface.
- **neighbor** *neighbor_ip_address*—Specify the IP address of the neighbor BGP router.
- **remote-as** *as_number*—Specify the identification number for the AS.

Configuring Bonding Interface

To configure the bonding interface related to the interfaces, use the following commands:

```
config
  router bgp local_as_number
    interface interface_name
      bondingInterface interface_name
    exit
exit
```

NOTES:

- **router bgp** *local_as_number*—Specify the identification number for the AS for the BGP router.
- **interface** *interface_name*—Specify the name of the interface.

- **bondingInterface** *interface_name*—Specify the related bonding interface for an interface. If the bonding interface is active, then the BGP gives a higher preference to the interface-service by providing a lower MED value.

Configuring Learn Default Route

If the user configures specific routes on their system and they need to support all routes, then they must set the **learnDefaultRoute** as **true**.



Note This configuration is optional.

To configure the Learn Default Route, use the following commands:

```
config
router bgp local_as_number
  learnDefaultRoute true/false
exit
exit
```

NOTES:

- **router bgp** *local_as_number*—Specify the identification number for the AS for the BGP router.
- **learnDefaultRoute** *true/false*—Specify the option to enable or disable the **learnDefaultRoute** parameter. When set to true, BGP learns default route and adds it in the kernel space. By default, it is false.

Configuring BGP Port

To configure the Port number for a BGP service, use the following commands:

```
config
router bgp local_as_number
  loopbackPort port_number
exit
exit
```

NOTES:

- **router bgp** *local_as_number*—Specify the identification number for the AS for the BGP router.
- **loopbackPort** *port_number*—Specify the port number for the BGP service. The default value is 179.

Policy Addition

The BGP speaker pods learns many route information from its neighbors. However, only a few of them are used for supporting the outgoing traffic. This is required for egress traffic handling only, when cnSGW-CSMF is sending information outside to AMF/PCF. Routes are filtered by configuring import policies on the BGP speakers and is used to send learned routes to the protocol pods.

A sample CLI code for policy addition and the corresponding descriptions for the parameters are shown below.

```
$bgp policy <policy_Name> ip-prefix 209.165.200.225 subnet 16 masklength-range 21..24
as-path-set "^65100"
```

Table 195: Import Policies Parameters

Element	Description	Example	Optional
as-path-set	AS path value	“^65100”	Yes
ip-prefix	Prefix value	“209.165.200.225/16”	Yes
masklength-range	Range of length	“21..24”	Yes
interface	Interface to set as source IP (default is VM IP)	eth0	Yes
gateWay	Change gateway of incoming route	209.165.201.30	Yes
modifySourceIp	Modify source ip of incoming route Default value is False.	true	Yes
isStaticRoute	Flag to add static IP address into kernel route Default value is False.	true	Yes

Configuring BGP Speaker

This configuration controls the number of BGP speaker pods in deployment. BGP speaker advertises service IP information for incoming traffic from both the sites.



Note

- Use non-bonded interface in BGP speaker pods for BGP peering.
- BGP peering per Proto node is supported with only two BGP routers/leafs. Considering two Proto nodes, there can be maximum of four BGP neighborships.

```
instance instance-id instance_id endpoint bgpspeaker interface { bgp | bfd
} internal base-port start base_port_number
```

```
config
instance instance-id instance_id
endpoint bgpspeaker
  replicas replica_id
  nodes node_id
  interface bgp
    internal base-port start base_port_number
  exit
  interface bfd
    internal base-port start base_port_number
  exit
exit
```

NOTES:

- **instance instance-id** *instance_id*—Specify the GR instance ID.
- **base_port_number**—Specify the port range only if logical NF is configured. This range depends on your deployment.

Example

The following is a configuration example:

```
instance instance-id 1
endpoint bgpspeaker
  replicas 1
  nodes 2
  interface bgp
    internal base-port start {24000}
  exit
  interface bfd
    internal base-port start {25000}
  exit
exit
```

IPAM

This section describes IP Address Management (IPAM) at the rack/site level.

Figure 113: IPAM

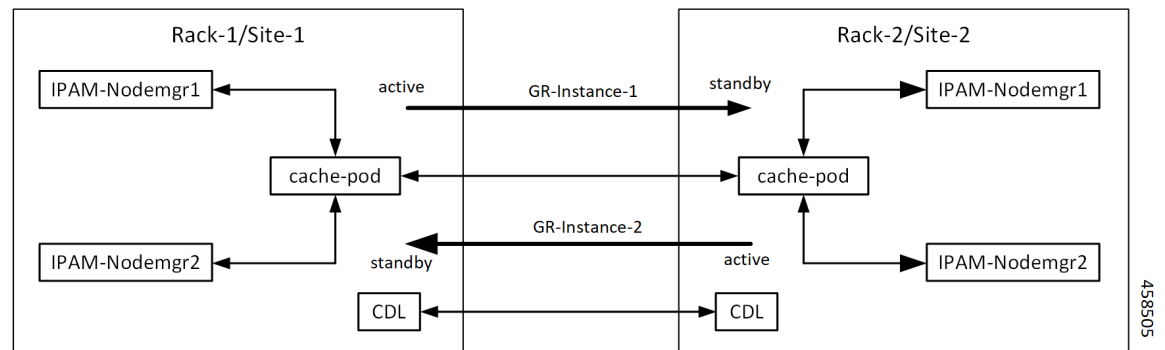

During UPF registration, active IPAM instance reserves four address-ranges per UPF per DNN.

- Range-1: Active cluster, nodemgr-1
- Range-2: Active cluster, nodemgr-2
- Range-3: Standby cluster, nodemgr-1
- Range-4: Standby cluster, nodemgr-2

During normal operation, Rack-1/Site-1 handles UPF-register/release, address-allocate/release for subscribers coming up in GR-instance-1.

If Rack-2/Site-2 goes down, Rack-1/Site-1 gets role-change trigger for GR-Instance-2.

- IPAM in Rack-1/Site-1, restores the content of GR-Instance-2 from local-cache-pod (which was already synced)

- IPAM in Rack-1/Site-1 handles UPF-Register/Release and address-allocate/release for subscribers coming up with GR-Instance-2 using the restored content in addition to handling GR-Instance-1.

Each IPAM pool is associated to a GR-Instance, with the following:

- Pool name is unique across all the instances.
- Address-ranges are unique within VRF and across all the instances.

The same pool configuration must be configured in both the active and standby cnSGW-CSMF clusters of a particular instance.

During address-allocation, active instance assign free-IP from reserved address-range for the UPF.

Incase new address-ranges is not available, change ownership of standby's address-range to current active instance and continue assigning address-ranges from it.

Configuring IPAM

The following section provides IPAM configuraton examples.

cnSGW-C-1SMF-1 Example

The following is a configuration example for cnSGW-C-1SMF-1:

```
ipam
instance 1
address-pool pool-1
vrf-name ISP
tags
dnn dnn-1
exit
ipv4
address-range 209.165.201.1 209.165.201.31
exit
instance 2
address-pool pool-2
vrf-name ISP
tags
dnn dnn-2
exit
ipv4
address-range 209.165.202.129 209.165.202.159
exit
exit
```

cnSGW-C-2SMF-2 Example

The following is a configuration example for cnSGW-C-2SMF-2:

```
ipam
instance 1
address-pool pool-1
vrf-name ISP
tags
dnn dnn-1
exit
ipv4
address-range 209.165.201.1 209.165.201.31
exit
instance 2
```

```

address-pool pool-2
 vrf-name ISP
  tags
  dnn dnn-2
  exit
 ipv4
  address-range 209.165.202.129 209.165.202.159
  exit
exit

```

Geo Replication

Geo replication is used for inter-rack/site communication and for POD/VIP/BFD monitoring within the rack. In Geographic Redundancy,

- Two instances of Geo pods are running for each rack/site.
- Two Geo pods functions in Active-Standby mode.
- Each Geo pod instance is spawned on different Proto node/VM.
- Geo pod running on the Proto node/VM having VIP is Active Geo pod.
- In the event of Active Geo pod restart, VIPs are switched to other Proto node/VM and Standby Geo pod running on the other Proto node/VM becomes active.
- Geo pod uses host networking mode (similar to UDP-Proxy).
- Geo pod uses two VIPs:
 - Internal-VIP for Inter-POD communication (within the rack)
 - External-VIP for Inter-Rack Geo pod communication. Configure only on Proto Nodes on L2 Subnet. This is used to communicate across the racks. This node has external connectivity to other Rack.
- Logical-NF-InstanceID should be configured same for both cnSGW-CsSMFs in GR-Pair
- For KeepAliveD monitoring,
 - Geo pod uses base port as: $15000 + (\text{Logical-NF-InstanceID} * 32) + 4$
Geo pod base port should be different than BGP speaker pod port.
 - Default port (without logical cnSGW-CSMF) would be: 15004
 - For Logical cnSGW-CSMF configured with logical-nf-instance-id as 1, the port would be: 15036
 - UDP-Proxy pod uses base port as : $28000 + \text{Logical-NF-InstanceID}$
 - Default port (without logical cnSGW-CSMF) would be: 28000
 - For Logical cnSGW-CSMF configured with logical-nf-instance-id as 1, the port would be: 28001
 - BGPSpeaker-pod uses default base port as: $20000 + (\text{Logical-NF-InstanceID} * 32) + 4$
 - Default port (without logical cnSGW-CSMF) would be: 20004

- For Logical cnSGW-CSMF configured with logical-nf-instance-id as 1, the port would be: 20036



Note Only ETCD and cachepod data is replicated to standby rack.

Configuring ETCD/CachePod Replication

Endpoints must be configured under an instance. Two Geo-Redundancy pods are needed on each GR site. You should also configure VIP for internal and external Geo interface for ETCD/CachePod replication.

```
instance instance-id instance_id endpoint geo interface { geo-internal |
geo-external } vip-ip { vip_ip_address } vip-port { vip_port_number }
```

```
config
instance instance-id instance_id
  endpoint geo
    replicas replica_id
    nodes node_id
    internal base-port start base_port_number
    interface geo-internal
      vip-ip vip_ip_address vip-port vip_port_number
    exit
    interface geo-external
      vip-ip vip_ip_address vip-port vip_port_number
    exit
  exit
exit
```

NOTES:

- **instance instance-id *instance_id***—Specify GR instance ID. One instance ID for local site and other for remote site.
- **vip-ip *vip_ip_address***—Specify VIP IP address for Internal/External Geo interface.
- **vip-port *vip_port_number***—Specify VIP port number.
- **internal base-port start *base_port_number***—Specify port range only if logical NF is configured.

Example

The following is a configuration example:

```
instance instance-id 1
endpoint geo
  replicas 1
  nodes 2
  internal base-port start 25000
  interface geo-internal
    vip-ip 209.165.201.8 vip-port 7001
  exit
  interface geo-external
    vip-ip 209.165.201.8 vip-port 7002
```

```
exit
exit
```

Geo Monitoring

This section describes Geo monitoring.

POD Monitoring

To configure POD monitoring and failover thresholds in the GR setup, use the following configuration. The GR pod monitors the configured POD name.

```
config
geomonitor
podmonitor pods pod_name
retryCount value
retryInterval interval_value
retryFailOverInterval failover_interval
failedReplicaPercent percent_value
exit
exit
```

NOTES:

- **pod** *pod_name*—Specify the name of the pod to be monitored. For example, Cache-pod, res-ep, and so on
- **retryCount** *value*—Specify the retry counter value to retry if pod fails to ping after which pod is marked as down. Must be an integer in the range of 1-10.
- **retryInterval** *interval_value*—Specify the retry interval in milliseconds if pod successfully pings. Must be an integer in the range of 200-10000.
- **retryFailOverInterval** *failover_interval*—Specify the retry interval in milliseconds if pod fails to ping. Must be an integer in the range of 200-10000.
- **failedReplicaPercent** *percent_value*—Specify the percent value of failed replica after which GR failover is triggered. Must be an integer in the range of 10-100.

Configuration Example

The following is an example configuration.

```
geomonitor podmonitor pods cache-pod
retryCount 3
retryInterval 5
retryFailOverInterval 1
failedReplicaPercent 40
exit
```

Remote Cluster Monitoring

Remote cluster monitoring auto corrects roles (it becomes self primary if the remote site is in STANDBY_ERROR state) for uninterrupted traffic flow of traffic. However, this auto role correction is done for specific roles only.

```

config
  geomonitor
    remoteclustermonitor
      retryCount value
      retryInterval interval_value
    exit
  exit

```

NOTES:

- **retryCount** *value*—Specify the retry count before making current site PRIMARY. Must be an integer in the range of 1-10. Default value is 3.
- **retryInterval** *interval_value*—Specify the retry interval in milliseconds after which remote site status is fetched. Must be an integer in the range of 200-50000. Default value is 3000.

Configuration Example

The following is an example configuration

```

geomonitor remoteclustermonitor
  retryCount 3
  retryInterval 3000

```

Traffic Monitoring

The following command is used to monitor the traffic.

```

config
  geomonitor
    trafficMonitor
      thresholdCount value
      thresholdInterval interval_value
    exit
  exit

```

NOTES:

- **thresholdCount** *value*—Specify the number of calls received for standby instance. Must be an integer in the range of 0-10000. Default value is 0.
Both UDP-proxy and REST-EP must be considered for the counter value.
- **thresholdInterval** *interval_value*—Specify the maximum duration to hit the threshold count value in ms. Must be an integer in the range of 100-10000. Default value is 3000.

Configuration Example

The following is an example configuration

```

geomonitor trafficmonitor
  thresholdCount 3
  thresholdInterval 3000

```

BFD Monitoring

Bidirectional Forwarding Detection (BFD) protocol is used for Faster Network Failure Detection along with BGP. Whenever connectivity between BGP peering fails with cluster (NF), failover is triggered to minimize traffic failure impact.

config

```

router bgp as
  bfd interval interval min_rx min_rx multiplier multiplier
  loopbackPort loopbackPort loopbackBFDPort loopbackBFDPort
interface interface_id (BGP on non-bonded interface <-- loopbackEth)
  bondingInterface bondingInterface (leaf6-nic)
  bondingInterface bondingInterface (leaf6-nic)
  neighbor neighbor_ip_address remote-as remote_as fail-over fail_over_type
exit
interface interface_id (BGP on non-bonded interface <-- loopbackEth)
  bondingInterface bondingInterface (leaf7-nic)
  bondingInterface bondingInterface (leaf7-nic)
  neighbor bondingInterface remote-as remote_as fail-over fail_over_type
exit
policy-name policy_name
  as-path-set as_path_set
  gateWay gateWay_address
  interface interface_id_source
  ip-prefix ip_prefix_value
  isStaticRoute false | true
  mask-range mask_range
  modifySourceIp false | true
exit
exit

```

NOTES:

- **bgp as**—Specify the Autonomous System (AS) path set.
- **bfd**—Specify BFD configuration.
 - **interval interval** —Specify BFD interval in milliseconds.
 - **min_rx min_rx**—Specify BFD minimum RX in milliseconds.
 - **multiplier multiplier**—Specify BFD interval multiplier.
- **interface interface_id**—Specify BGP local interface.
 - **bondingInterface bondingInterface**—Specify linked bonding interface.
 - **neighbor neighbor_ip_address**—Specify IP address of neighbor.
 - **fail-over fail_over_type**—Specify failover type.
 - **remote-as remote_as**—Specify Autonomous System (AS) number of BGP neighbor.
- **learnDefaultRoute**—Learn default route and add it in kernel space
- **loopbackBFDPort loopbackBFDPort**—Specify BFD local port.

- **loopbackPort** *loopbackPort*—Specify BGP local port.
- **policy-name** *policy_name*—Specify policy name.
 - **as-path-set** *as_path_set*—Specify Autonomous System (AS) path set.
 - **gateWay** *gateWay_address*—Specify gateway address.
 - **interface** *interface_id_source*—Specify interface to set as source IP.
 - **ip-prefix** *ip_prefix_value*—Specify IP prefix value.
 - **isStaticRoute** *false | true*—Specify whether to add static route in kernel space. Default value is false.
 - **mask-range** *mask_range*—Specify mask range.
 - **modifySourceIp** *false | true*—Modify source IP of the incoming route. Default value is false.
 - true:** This option is used for non-UDP related VIPs. Source IP of the given interface is used as Source IP while sending out packets from cnSGW-CSMF.
 - false:** This option is used for all UDP related VIPs. VIP is used as Source IP while sending out packets from cnSGW-CSMF.

Example

Following are configuration examples:

```
router bgp 65000
  bfd interval 250000 min_rx 250000 multiplier 3
  loopbackPort 179 loopbackBFDPort 3784
interface ens160 (BGP on non-bonded interface <-- loopbackEth)
  bondingInterface enp216s0f0 (leaf6-nic)
  bondingInterface enp216s0f1 (leaf6-nic)
  neighbor leaf6-ip remote-as 60000 fail-over bfd
exit
interface ens192 (BGP on non-bonded interface <-- loopbackEth)
  bondingInterface enp94s0f1 (leaf7-nic)
  bondingInterface enp94s0f0 (leaf7-nic)
  neighbor leaf7-ip remote-as 60000 fail-over bfd
exit
policy-name allow-all ip-prefix 209.165.201.30/0 mask-range 0...32
exit
```

BGP router configuration with BFD

```
show running-config router
router bgp 65142
  learnDefaultRoute false
  bfd interval 250000 min_rx 250000 multiplier 3
  interface enp94s0f0.3921
    bondingInterface enp216s0f0
    bondingInterface enp94s0f0
    neighbor 209.165.201.24 remote-as 65141 fail-over bfd
  exit
  interface enp94s0f1.3922
    bondingInterface enp216s0f1
    bondingInterface enp94s0f1
    neighbor 209.165.202.24 remote-as 65141 fail-over bfd
```

Show BFD status of neighbor

```

show bfd-neighbor
status-details

----- bgpspeaker-pod-1-----

Peer                Status

209.165.202.142    STATE_DOWN
----- bgpspeaker-pod-2-----

Peer                Status

209.165.202.142    STATE_UP

policy-name allow-n11 ip-prefix 209.165.200.225/54 mask-range 25..32 interface bd1.n11.2271
modifySourceIp true isStaticRoute true gateWay 209.165.201.14

```

In the above example, *modifySourceIp* is set to true.

- AMF subnet: 209.165.200.225/54
 - N11 Svc Bonded Physical Interface: bd1.n11.2271 (IP address - 209.165.201.23)
 - N11 Svc Bonded VxLAN Anycast GW: 209.165.201.14
 - N11 VIP Address: 209.165.201.7
- cnSGW-CSMF Outbound Packet (will have source IP as 209.165.201.23)
 - Inbound Packet to cnSGW-CSMF (will have destination IP as 209.165.201.7)

```

policy-name allow-n4-1 ip-prefix 209.165.201.17/41 mask-range 24..32 interface bd2.n4.2274
gateWay 209.165.201.17

```

In the above example, *modifySourceIp* is set to false (default).

- UPF N4 Interface IP: 209.165.201.17/41
 - N4 Svc Bonded Physical Interface: bd2.n4.2274 (IP address - 209.165.201.23)
 - N4 Svc Bonded VxLAN Anycast GW: 209.165.201.17
 - N4 VIP Address: 209.165.201.14
- cnSGW-CSMF Outbound Packet (will have source IP as 209.165.201.14)
 - Inbound Packet to cnSGW-CSMF (will have destination IP as 209.165.201.14)

CDL GR Deployment

By default, CDL is deployed with two replicas for db-ep, 1 slot map (2 replicas per map), and 1 index map (2 replicas per map).



Note It is recommended to configure the CDL container in YANG.

Prerequisites for CDL GR

Before deploying the CDL GR, user must configure the following:

- CDL Session Database and define the base configuration.
- Kafka for CDL.
- Zookeeper for CDL.

CDL Instance Awareness and Replication

In CDL, along with existing GR related parameters, GR instance awareness must be enabled using a feature flag on all sites. Also, the mapping of system-id to slice names should also be provided for this feature to work on all sites.

The CDL is also equipped with Geo Replication (GR) failover notifications, which can notify the timer expiry of session data and bulk notifications to the currently active site. The CDL uses Border Gateway Protocol (BGP) through App-Infra for the GR failover notifications.

The CDL subscribes to the key value on both the GR sites. The App-Infra sends notifications to the CDL when there is any change in these key values. A key value indicates the state of the CDL System ID or the GR instance. The GR instance is mapped to the CDL slices using the CDL system ID or the GR instance ID in the key.

The system ID is mandatory on both the sites. The GR instance ID in the NF configuration must match the CDL system ID.

CDL has instance-specific data slices. It also allows users to configure instance-specific slice information at the time of bringing up.

- CDL notifies the data on expiry or upon bulk notification request from the active slices.
- CDL determines the active instance based on the notification from app-infra memory-cache.
- CDL slice is a partition within a CDL instance to store a different kind of data. In this case, NF stores a different instance of data.



Note CDL slice name should match with the slice-name configured in GR.

Configuring CDL Instance Awareness

The following command is used to configure CDL instance awareness.

```
config
cdl
  datastore datastore_session_name
  features
    instance-aware-notification
      enable [ true | false ]
      system-id system_id
      slice-names slice_names
    end
```

NOTES:

- **datastore** *datastore_session_name*—Specify the datastore name.

- **enable** [**true** | **false**]—Enables the GR instance state check for slices.
- **system-id** *system_id*—Mapping of system ID to slice name.
- **slice-names** *slice_names*—Specify the list of slice names associated with the system ID. CDL slice name should match with the slice-name configured in GR.

Example

The following is a configuration example:

```
cdl datastore session
  features instance-aware-notification enable true
  features instance-aware-notification system-id 1
  slice-names [ sgw1 smf1 ]
exit
features instance-aware-notification system-id 2
  slice-names [ sgw2 smf2 ]
end
```

Configuring CDL Replication

This section describes CDL replication configuration.

1. Configure Site-1 CDL HA system without any Geo-HA-related configuration parameters.
 - a. Set the System ID as 1 in the configuration.
 - b. Set the slot map/replica and index map/replica and Kafka replica as per requirements.

The following is a sample configuration:

```
cdl system-id 1
cdl node-type session
cdl datastore session
endpoint replica replica_id
  slot map 4
  slot replica 2
  index map 1
  index replica 2
cdl kafka replica 2
```

1. Configure external IPs on Rack-1/Site-1 for Rack-2/Site-2 to Rack-1/Site-1 communication.
 - a. Enable geo-replication on Rack-1/Site-1 and configure the remote Rack as 2 for Rack-1/Site-1.

```
cdl enable-geo-replication true
```

- b. Configure the external IP for CDL endpoint to be accessed by Rack-2/Site-2.

```
cdl datastore session endpoint external-ip site-1_external_ip
```

- c. Configure the external IP and port for all Kafka replicas.

So, if two replicas (default) are configured for Kafka, user need to provide two different *<ip>+<port>* pairs.

```
cdl kafka external-ip site-1_external_ip port1 cdl kafka external-ip
site-1_external_ip port2
```

2. Add remote site (Site-1) information on Rack-2/Site-2.

- Remote site cdl-ep configuration on Rack-2/Site-2:

```
cdl remote-site 1 db-endpoint host site-1_cdl_ep_ip
cdl remote-site 1 db-endpoint port site-1_cdl_ep_port
```

(Port Example: 8882)

- Remote site Kafka configuration on Rack-2/Site-2:

```
cdl remote-site 1 kafka-server site-1_kafka1_ip site-1_kafka1_port
cdl remote-site 1 kafka-server site-1_kafka2_ip site-1_kafka2_port
```

- Direct the session datastore configuration to remote Rack-2/Site-2 configuration:

```
cdl datastore session geo-remote-site 1
```

- (Optional) Configure the SSL certificates to establish a secure connection with remote site on Rack-1/Site-1. All the certificates are in multi-line raw text format. If the certificates are not valid, the server continues with non-secure connection.

```
cdl ssl-config certs site-2_external_ip ssl-key <ssl_key>
cdl ssl-config certs site-2_external_ip ssl-crt <ssl_crt>
```

3. Commit GR configuration on Rack-2/Site-2:

- Commit the configuration and let the pods be deployed on Rack-2/Site-2.
- Verify all pods are in running state.
- Once both sites are deployed, verify that the mirror maker pods on both sites are running and in ready state.

Examples

HA:

```
cdl node-type db-ims

cdl datastore session
  endpoint replica 2
  index map 1
  index write-factor 1
  slot replica 2
  slot map 4
  slot write-factor 1
exit

k8 label cdl-layer key smi.cisco.com/node-type value smf-ims-session
```

Rack-1/Site-1:

```
cdl system-id 1
cdl node-type session
cdl enable-geo-replication true
cdl zookeeper replica 1

cdl remote-site 2
db-endpoint host 209.165.201.21 >> Rack-2 external CDL IP
db-endpoint port 8882
```

```

kafka-server 209.165.201.21 10092 >> Rack-2 external CDL IP
exit
exit

cdl label-config session
endpoint key smi.cisco.com/node-type1
endpoint value smf-cdl
slot map 1
  key smi.cisco.com/node-type1
  value smf-cdl
exit
index map 1
  key smi.cisco.com/node-type1
  value smf-cdl
exit
exit
cdl logging default-log-level debug

cdl datastore session
label-config session
geo-remote-site [ 2 ]
slice-names [ 1 2 ]
endpoint cpu-request 100
endpoint replica 2
endpoint external-ip 209.165.201.25 >> Rack-1 external CDL IP
endpoint external-port 8882
index cpu-request 100
index replica 2
index map 1
slot cpu-request 100
slot replica 2
slot map 1
exit

cdl kafka replica 1
cdl kafka label-config key smi.cisco.com/node-type1
cdl kafka label-config value smf-cdl
cdl kafka external-ip 209.165.201.25 10092 >> Rack-1 external CDL IP

```

Rack-2/Site-2:

```

cdl system-id 2
cdl node-type session
cdl enable-geo-replication true
cdl zookeeper replica 1

cdl remote-site 1
db-endpoint host 209.165.201.25 >> Rack-1 external CDL IP
db-endpoint port 8882
kafka-server 209.165.201.25 10092 >> Rack-1 external CDL IP
exit
exit

cdl label-config session
endpoint key smi.cisco.com/node-type12
endpoint value smf-cdl
slot map 1
  key smi.cisco.com/node-type12
  value smf-cdl
exit
index map 1
  key smi.cisco.com/node-type12
  value smf-cdl
exit
exit

```

```

cdl datastore session
  label-config session
  geo-remote-site [ 1 ]
  slice-names [ 1 2 ]
  endpoint cpu-request 100
  endpoint replica 2
  endpoint external-ip 209.165.201.21 >> Rack-2 external CDL IP
  endpoint external-port 8882
  index cpu-request 100
  index replica 2
  index map 1
  slot cpu-request 100
  slot replica 2
  slot map 1
exit

cdl kafka replica 1
cdl kafka label-config key smi.cisco.com/node-type12
cdl kafka label-config value smf-cdl
cdl kafka external-ip 209.165.201.21 10092 >> Rack-2 external CDL IP

```

Lawful Intercept

The Lawful Intercept (LI) feature enables law enforcement agencies (LEAs) to intercept subscriber communications. The LI functionality provides the network operator the capability to intercept control and data messages of the targeted mobile users. To invoke this support, the LEA requests the network operator to start the interception of a particular mobile user. Legal approvals support this request.

1. Lawful Intercept (LI) tap should be configured/enabled on all the sites. If LI configuration fails on one site, LEA should reconfigure it so that for a given subscriber tap is enabled on all the sites.



Note LI tap configuration is not synchronized across sites.

Hence, LI tap configuration is mandatory on all the sites.

For more information on LI tap configuration, contact your Cisco Technical Representative.

2. GR instance awareness is applicable for lawful-intercept src-address only.

Example:

```
lawful-intercept instance 1 src-addr 209.165.200.225
```

OR

```

lawful-intercept
  instance 1
    src-addr 209.165.200.225

```

3. `show` commands are not instance-aware. It shows all the taps configured in a given cluster.

For more information on LI `show` commands, contact your Cisco Technical Representative.

4. In case all GR instances are in Standby state in a cluster and active LI tap fails with CLI message `Rack is in standby mode, Active Tap is not allowed. Try camp on, configure camp-on tap for the same subscriber.`

RADIUS Configuration

NAS-IP and NAS-Identifier is instance-aware. You can configure different NAS-IP and NAS-Identifier per instance-id in profile-radius configuration. Existing non-instance based NAS-IP and NAS-Identifier configuration is used as default nas-ip and default nas-id for local-instance of the site.

Example

Following are a few configuration examples.

```

profile radius
  attribute
    instance 1
      nas-ip 209.165.200.225 --> Instance-1 specific NAS-IP, used for common AUTH & ACCT
      nas-identifier smf1 --> Instance-1 specific NAS-Identifier, used for common AUTH &
ACCT
    exit
    instance 2
      nas-ip 209.165.200.230 --> Instance-2 specific NAS-IP, used for common AUTH & ACCT
      nas-identifier smf2 --> Instance-2 specific NAS-Identifier, used for common AUTH &
ACCT
    exit
  exit
  accounting
    attribute
      instance 1
        nas-ip 209.165.200.225 --> Instance-1 specific NAS-IP, used for common ACCT
        nas-identifier smf1 --> Instance-1 specific NAS-Identifier , used for common ACCT
      exit
      instance 2
        nas-ip 209.165.200.230 --> Instance-2 specific NAS-IP, used for common ACCT
        nas-identifier smf2 --> Instance-2 specific NAS-Identifier , used for common ACCT
      exit
    exit
  exit
  server-group g1
    attribute
      instance 1
        nas-ip 209.165.200.225 --> Instance-1 specific NAS-IP, used for server-group <g1> AUTH
& ACCT
        nas-identifier smf1 --> Instance-1 specific NAS-ID, used for server-group <g1> Auth
&Acct
      exit
      instance 2
        nas-ip 209.165.200.230 --> Instance-2 specific NAS-IP, used for server-group <g1> AUTH
& ACCT
        nas-identifier smf2 --> Instance-2 specific NAS-ID,used for server-group <g1>AUTH&ACCT
      exit
    exit
  exit
  accounting
    attribute
      instance 1
        nas-ip 209.165.200.225 --> Instance-1 specific NAS-IP, used for server-group <g1> ACCT
        nas-identifier smf1 --> Instance-1 specific NAS-ID, used for server-group <g1> ACCT
      exit
      instance 2
        nas-ip 209.165.200.230 --> Instance-2 specific NAS-IP, used for server-group <g1> ACCT
        nas-identifier smf2 --> Instance-2 specific NAS-ID, used for server-group <g1> ACCT
    
```

```

    exit
  exit
  exit
  exit
  exit

```

Since **endpoint** *pod* configuration is moved under specific instance, Radius Disconnect-Request VIP is also instance-aware.

```

instance instance-id 1
  endpoint radius
    replicas 1
    interface coa-nas
      vip-ip 209.165.202.130 vip-port 3799 --> Instance-1 specific Radius-Disconnect-Msg-VIP
      & PORT
    exit
  exit
exit
instance instance-id 2
  endpoint radius
    replicas 1
    interface coa-nas
      vip-ip 209.165.202.129 vip-port 3799 --> Instance-2 specific Radius-Disconnect-Msg-VIP
      & PORT
    exit
  exit
exit

```

Software Upgrade on GR Pairs

Considering `config commit` as reference. The same checklist is also applicable for other upgrade scenarios.

Checklist



Note Don't perform `cluster sync` on both sites (Rack-1/Site-1 and Rack-2/Site-2) at the same time. Trigger manual switchover on Rack-1 before proceeding with Rack-1/Site-1 upgrade.

- Don't perform `config commits` on both sites at the same time. Perform `config commit` on each site separately.
- Prior to `config commit` on Rack-1/Site-1, initiate CLI based switchover on Rack-1/Site-1 and make sure that Rack-2/Site-2 is having Primary ownership for both the instances (instance-id 1 and instance-id 2).
- Perform `config commit` on Rack-1/Site-1. Wait till `config commit` is successful and PODs restart and are back in running state to fetch latest helm charts (if applicable).
- Revert the role of Rack-1/Site-1 to be Primary (Switch/Reset roles on both sites).
- Verify that roles of Rack-1/Site-2 (Primary) and Rack-2/Site-2 (Standby) are as expected.
- Repeat the above checklist for Rack-2/Site-2.

Software Upgrade

Rack-1/Site-1 Upgrade when GR is Enabled

1. Verify that roles of both instances on Rack-1//Site-1 are in PRIMARY/STANDBY.

```
show role instance-id 1
result "PRIMARY"

show role instance-id 2
result "STANDBY"
```
2. Initiate switch role for both instances on Rack-1/Site-1 to STANDBY with failback-interval of 30 seconds. This step transitions the roles from PRIMARY/STANDBY to STANDBY_ERROR/STANDBY_ERROR.



Note Heartbeat between both the sites should be successful.

```
geo switch-role instance-id 1 role standby failback-interval 30
geo switch-role instance-id 2 role standby failback-interval 30
```

3. Verify that roles of both instances has moved to STANDBY_ERROR on Rack-1/Site-1.

```
show role instance-id 1
result "STANDBY_ERROR"

show role instance-id 2
result "STANDBY_ERROR"
```
4. Verify that roles of both instances has moved to PRIMARY on Rack-2/Site-2.

```
show role instance-id 1
result "PRIMARY"

show role instance-id 2
result "PRIMARY"
```
5. Perform rolling upgrade (or) non-graceful upgrade using system mode shutdown/running as per the requirement on Rack-1/Site-1.
6. Perform the following steps post completion of upgrade procedure. Perform health check on Rack-1/Site-1 and ensure the PODs have come up and Rack-1/Site-1 is healthy.
7. Verify that roles of both instances remain in STANDBY_ERROR mode on Rack-1/Site-1.

```
show role instance-id 1
result "STANDBY_ERROR"

show role instance-id 2
result "STANDBY_ERROR"
```
8. Initiate reset role for both instances on Rack-1/Site-1 to STANDBY. This step transitions the roles from STANDBY_ERROR/STANDBY_ERROR to STANDBY/STANDBY.

```
geo reset-role instance-id 1 role standby
geo reset-role instance-id 2 role standby
```
9. Verify that the roles of both instances have moved to STANDBY on Rack-1/Site-1.

```
show role instance-id 1
result "STANDBY"

show role instance-id 2
result "STANDBY"
```

10. Initiate switch role for instance-id 1 on Rack-2/Site-2 to STANDBY. This step transitions roles of Rack-2/Site-2 from PRIMARY/PRIMARY to STANDBY_ERROR/PRIMARY and Rack-1/Site-1 from STANDBY/STANDBY to PRIMARY/STANDBY.

```
geo switch-role instance-id 1 role standby failback-interval 30
```

11. Verify that roles of the instances on Rack-2/Site-2 are in STANDBY_ERROR/PRIMARY.

```
show role instance-id 1
result "STANDBY_ERROR"
```

```
show role instance-id 2
result "PRIMARY"
```

12. Verify that the roles of both instances on Rack-1/Site-1 are in PRIMARY/STANDBY.

```
show role instance-id 1
result "PRIMARY"
```

```
show role instance-id 2
result "STANDBY"
```

13. Initiate reset role for instance-id 1 on Rack-2/Site-2 to STANDBY. This step transitions the roles of Rack-2/Site-2 from STANDBY_ERROR/PRIMARY to STANDBY/PRIMARY.

```
geo reset-role instance-id 1 role standby
```

14. Verify that roles of both instances on Rack-2/Site-2 are in STANDBY/PRIMARY.

```
show role instance-id 1
result "STANDBY"
```

```
show role instance-id 2
result "PRIMARY"
```

Rack-2/Site-2 Upgrade when GR is Enabled

1. Verify that roles of both instances on Rack-2/Site-2 are in STANDBY/PRIMARY.

```
show role instance-id 1
result "STANDBY"
```

```
show role instance-id 2
result "PRIMARY"
```

2. Initiate switch role for both instances on Rack-2/Site-2 to STANDBY with failback-interval of 30 seconds. This step transitions the roles from STANDBY/PRIMARY to STANDBY_ERROR/STANDBY_ERROR.

```
geo switch-role instance-id 1 role standby failback-interval 30
geo switch-role instance-id 2 role standby failback-interval 30
```

3. Verify that roles of both instances move to STANDBY_ERROR on Rack-2/Site-2.

```
show role instance-id 1
result "STANDBY_ERROR"
```

```
show role instance-id 2
result "STANDBY_ERROR"
```

4. Verify that roles of both instances move to PRIMARY on Rack-1/Site-1.

```
show role instance-id 1
result "PRIMARY"
```

```
show role instance-id 2
result "PRIMARY"
```

5. Perform rolling upgrade (or) non-graceful upgrade via system mode shutdown/running as per the requirement on Rack-2/Site-2.
6. Perform the subsequent steps post completion of upgrade procedure. Perform health check on Rack-2/Site-2 and ensure the PODs have come up and Rack-2/Site-2 is healthy
7. Verify that roles of both the instances remain in STANDBY_ERROR on Rack-2/Site-2.

```
show role instance-id 1
result "STANDBY_ERROR"

show role instance-id 2
result "STANDBY_ERROR"
```
8. Initiate reset role for both instances on Rack-2/Site-2 to STANDBY. This step transitions the roles from STANDBY_ERROR/STANDBY_ERROR to STANDBY/STANDBY.

```
geo reset-role instance-id 1 role standby
geo reset-role instance-id 2 role standby
```
9. Verify that the roles of both instances move to STANDBY on Rack-2/Site-2.

```
show role instance-id 1
result "STANDBY"

show role instance-id 2
result "STANDBY"
```
10. Initiate switch role for instance-id 2 on Rack-1/Site-1 to STANDBY. This step transitions roles of Rack-1/Site-2 from PRIMARY/PRIMARY to PRIMARY/STANDBY_ERROR and Rack-2/Site-2 from STANDBY/STANDBY to STANDBY/PRIMARY.

```
geo switch-role instance-id 2 role standby failback-interval 30
```
11. Verify that roles of both instances on Rack-1/Site-1 are in PRIMARY/STANDBY_ERROR.

```
show role instance-id 1
result "PRIMARY"

show role instance-id 2
result "STANDBY_ERROR"
```
12. Verify that roles of both instances on Rack-2/Site-2 are in STANDBY/PRIMARY.

```
show role instance-id 1
result "STANDBY"

show role instance-id 2
result "PRIMARY"
```
13. Initiate reset role for instance-id 2 on Rack-1/Site-1 to STANDBY. This step transitions the roles of Rack-1/Site-1 from PRIMARY/STANDBY_ERROR to PRIMARY/STANDBY.

```
geo reset-role instance-id 2 role standby
```
14. Verify that roles of both the instances on Rack-1/Site-1 are in PRIMARY/STANDBY.

```
show role instance-id 1
result "PRIMARY"

show role instance-id 2
result "STANDBY"
```

Manual CLI Switchover

The following section provides information on manual CLI based switchover commands.

Geo Switch Role

To switch GR role (for example, role Primary to Standby), use the following command.

```
geo switch-role role role instance-id gr_instanceId failback-interval interval_in_sec
```

NOTES:

- **role** *role*—Specify new role for the given site.
Role can be maintenance, primary, or standby.
- **instance-id** *gr_instanceId*—Specify GR Instance ID
- **failback-interval** *interval_in_sec*—Specify interval in seconds between notify failover and actual failover.

`geo switch-role` command triggers manual failover from one site to another site for specific instance ID. The site which triggers the failover is moved from PRIMARY role to STANDBY_ERROR role. In between, the site which triggers failover, sends a failover (trigger GR) message to another site. The other site which receives the failover message is moved from STANDBY role to PRIMARY role.

Geo Reset Role

To reset the GR instance role (for example, role from STANDBY to PRIMARY), use the following command:

```
geo reset-role role role instance-id gr_instanceId
```

NOTES:

- **role** *role*—Specify new role for the given site.
Role can be maintenance, primary, or standby (maintenance mode is not supported).
- **instance-id** *gr_instanceId*—Specify GR Instance ID.

`geo reset-role` command triggers change in the role for the given instance on local site. Remote site will not receive any message for the same command. It is only possible to change the role for the given instance ID from STANDBY_ERROR to STANDBY and STANDBY to PRIMARY. Another role change is not possible.

Troubleshooting

This section describes about various applicable troubleshooting scenarios.

show/clear Commands

This section describes show/clear commands that help in debugging issues.

clear subscriber

To clear gr-instance aware subscriber, use the following command:

```
clear subscriber all gr-instance gr_instanceId
```



Note `gr-instance` is optional parameter. If `gr-instance` is not specified, `show subscriber all` considers the local instance-id of that rack/site.

Example

The following is a configuration example.

```
clear subscriber all gr-instance 1
result
ClearSubscriber Request submitted
```

show BFD Status

To view the BFD status of neighbors, use the following command:

```
show bfd-neighbor
```

Example

The following is a list of few configuration examples:

```
show bfd-neighbor
status-details

-----example-bgp-ep-1 ----
Peer                Status

 209.165.202.142    STATE_DOWN
-----example-bgp-ep-2 ----

Peer                Status

 209.165.202.142    STATE_DOWN

show bfd-neighbor
status-details

-----bgpspeaker-pod-1 ----
Peer                Status

 209.165.202.131
-----bgpspeaker-pod-2 ----

Peer                Status

 209.165.202.131    STATE_UP
```

show BGP Global

To view BGP global configuration, use the following command:

```
show bgp-global
```

Example

The following is a list of few configuration examples:

```

show bgp-global
global-details
-----example-bgp-ep-2 ----
AS:          65000
Router-ID: 209.165.202.149
Listening Port: 179, Addresses: 209.165.202.149
-----example-bgp-ep-1 ----
AS:          65000
Router-ID: 209.165.202.148
Listening Port: 179, Addresses: 209.165.202.148

show bgp-global
global-details

-----bgpspeaker-pod-2 ----
AS:          65061
Router-ID: 209.165.202.132
Listening Port: 179, Addresses: 209.165.202.132

```

show bgp kernel route

To view BGP kernel configured routes, use the following command:

```
show bgp-kernel-route kernel-route
```

Example

The following is a list of few configuration examples:

```

show bgp-kernel-route
kernel-route

-----example-bgp-ep-2 ----

  DestinationIP  SourceIP          Gateway
-----example-bgp-ep-1 ----

  DestinationIP  SourceIP          Gateway
209.165.202.133  209.165.202.148  209.165.202.142
209.165.202.134  209.165.202.148  209.165.202.142

show bgp-kernel-route
kernel-route

-----bgpspeaker-pod-2 ----

  DestinationIP  SourceIP          Gateway
209.165.202.135  209.165.202.132  209.165.202.131

-----bgpspeaker-pod-1 ----

  DestinationIP  SourceIP          Gateway

```

show bgp neighbors

To view BGP neighbors status, use the following command

```
show bgp-neighbors neighbor-details
show bgp-neighbors ip ip_address neighbor-details
```

Example

The following is a list of few configuration examples:

```
show bgp-neighbors neighbor-details
-----example-bgp-ep-1 ----
Peer          AS Up/Down State      |#Received Accepted
209.165.202.142 60000 00:25:06 Establ    |      3      3
-----example-bgp-ep-2 ----
Peer          AS Up/Down State      |#Received Accepted
209.165.202.142 60000  never Idle       |      0      0

show bgp-neighbors ip 209.165.202.142 neighbor-details
-----example-bgp-ep-2 ----
BGP neighbor is 209.165.202.142, remote AS 60000
  BGP version 4, remote router ID unknown
  BGP state = ACTIVE
  BGP OutQ = 0, Flops = 0
  Hold time is 0, keepalive interval is 0 seconds
  Configured hold time is 90, keepalive interval is 30 seconds

Neighbor capabilities:
  multiprotocol:
    ipv4-unicast:  advertised
    route-refresh: advertised
    extended-nextthop: advertised
    Local:  nlri: ipv4-unicast, nexthop: ipv6
    4-octet-as: advertised
Message statistics:
      Sent      Rcvd
Opens:          130      0
Notifications:  0        0
Updates:        0        0
Keepalives:     0        0
Route Refresh:  0        0
Discarded:      0        0
Total:          130      0
Route statistics:
  Advertised:    0
  Received:      0
  Accepted:      0

-----example-bgp-ep-1 ----
BGP neighbor is 209.165.202.142, remote AS 60000
  BGP version 4, remote router ID 209.165.202.136
  BGP state = ESTABLISHED, up for 00:25:20
  BGP OutQ = 0, Flops = 0
  Hold time is 90, keepalive interval is 30 seconds
  Configured hold time is 90, keepalive interval is 30 seconds

Neighbor capabilities:
  multiprotocol:
    ipv4-unicast:  advertised and received
    route-refresh: advertised and received
    extended-nextthop: advertised
    Local:  nlri: ipv4-unicast, nexthop: ipv6
    4-octet-as: advertised and received
Message statistics:
      Sent      Rcvd
Opens:          1        1
Notifications:  0        0
```

show bgp route summary

```

Updates:                1          1
Keepalives:             51         51
Route Refresh:          0          0
Discarded:              0          0
Total:                  53         53
Route statistics:
  Advertised:           0
  Received:             3
  Accepted:             3

```

show bgp route summary

To view BGP route summary, use the following command:

```
show bgp-route-summary
```

Example

The following is a configuration example.

```

show bgp-route-summary
route-details
-----example-bgp-ep-1 -----
Table afi:AFI_IP safi:SAFI_UNICAST
Destination: 5, Path: 5
-----example-bgp-ep-2 -----
Table afi:AFI_IP safi:SAFI_UNICAST
Destination: 2, Path: 2

```

show BGP Routes

To view BGP routes information, use the following command:

```
show bgp-routes
```

Example

The following is a configuration example:

```

show bgp-routes
bgp-route

-----example-bgp-ep-1 -----
  Network                Next Hop                AS_PATH                Age                Attrs
*> 209.165.202.133/24    209.165.202.142        60000                 00:25:55          [{Origin: i} {Med: 0}]
*> 209.165.200.225/32    209.165.202.148        60000                 00:26:00          [{Origin: e} {LocalPref:
100} {Med: 600}]
*> 209.165.202.134/24    209.165.202.142        60000                 00:25:55          [{Origin: i} {Med: 0}]
*> 209.165.202.140/24    209.165.202.142        60000                 00:25:55          [{Origin: i} {Med: 0}]
*> 209.165.202.146/32    209.165.202.148        60000                 00:26:00          [{Origin: e} {LocalPref:
100} {Med: 600}]

-----example-bgp-ep-2 -----
  Network                Next Hop                AS_PATH                Age                Attrs
*> 209.165.200.225/32    209.165.202.149        60000                 00:26:24          [{Origin: e} {LocalPref:
100} {Med: 600}]
*> 209.165.202.146/32    209.165.202.149        60000                 00:26:24          [{Origin: e} {LocalPref:
100} {Med: 600}]

```

show endpoint

To view endpoints that are now gr-instance aware, use the following command:

```
show endpoint all grInstance gr_instanceId
```



Note `grInstance` is optional parameter. If `grInstance` is not specified, `show subscriber all` considers the local instance-id of that rack/site.

Example

The following is a configuration example:

```
show endpoint all grInstance 1
```

STOPPED GR ENDPOINT TIME	INSTANCE	ADDRESS	TYPE	STATUS	INTERFACE	INTERNAL	START TIME
209.165.202.137:2123 hours <none> 1	1	209.165.202.137:2123	Udp	Started		false	10
Gtpu:209.165.202.137:2152 hours <none> 1	1	209.165.202.137:2152	Udp	Started	GTPU	false	10
N4:209.165.202.137:8806 hours <none> 1	1	209.165.202.137:8806	Udp	Started	N4	false	10
S2B-GTP hours <none> 1	1	209.165.202.138:2124	Udp	Started	s2b	false	10
S5-GTP hours <none> 1	1	209.165.202.138:2125	Udp	Started	s5	false	10
S5S8S2B-GTP hours <none> 1	1	209.165.202.138:2123	Udp	Started	s5s8s2b	false	10
Sxa:209.165.202.137:8805 hours <none> 1	1	209.165.202.137:8805	Udp	Started	SXA	false	10
n10-1 hours <none> 1	1	209.165.202.139:9010	Rest	Started	N10-1	false	10
n11-1 hours <none> 1	1	209.165.202.139:9011	Rest	Started	N11-1	false	10
n40-1 hours <none> 1	1	209.165.202.139:9040	Rest	Started	N40-1	false	10
n7-1 hours <none> 1	1	209.165.202.139:9007	Rest	Started	N7-1	false	10
sbi-1 hours <none> 1	1	209.165.202.139:8090	Rest	Started	SBI-1	false	10

show ETCD/Cache Pod Replication

To view replication details for etcd and cache-pod data, use the following command:

```
show georeplication checksum instance-id gr_instanceId
```

Example

The following is a configuration example:

```
show georeplication checksum instance-id
Value for 'instance-id' (<string>): 1
checksum-details
--
ID          Type      Checksum
--
1           ETCD     1617984439
IPAM       CACHE    1617984439
NRFCache   CACHE    1617984439
```

```

NRFSubs      CACHE  1617984439
IDMGR        CACHE  1617984439
NRFMgmt      CACHE  1617984439

```

show geo role

To view the current role of GR instance, use the following command:

```
show role instance-id gr_instanceId
```



Note The following is a list of possible values for the role:

- PRIMARY
- STANDBY
- FAILOVER_INIT
- FAILOVER_COMPLETE
- STANDBY_ERROR
- FAILBACK_STARTED

Example

The following is a list of few configuration examples:

```

show role instance-id 1
result
"PRIMARY"

show role instance-id 2
result
"STANDBY"

```

show ipam dp with type and address

To view the instance ID and flag to indicate chunk for remote instance, use the following command:

```
show ipam dp { dp_type } { addr_type }
```

NOTES:

- **dp** *dp_type*—Specify DP type.
- *addr_type*—Specify IPv4/IPv6 address type.

Example

The following is a configuration example.

```

show ipam dp 209.165.202.145:209.165.202.144 ipv4-addr
=====
Flag Indication: S(Static) O(Offline) R(For Remote Instance)
G:N/P Indication: G(GR InstId) N(Native NM InstId) P(Peer NM InstId)
=====
StartAddress      EndAddress      AllocContext      Route      G:N/P
Utilization Flag

```

```

=====
209.165.200.240 209.165.200.243 209.165.202.145:209.165.202.144 209.165.200.240/24 1:0/1
0.00%          R
=====

```

show ipam dp

To view all the instances this DP has chunks from, use the following command:

```
show ipam dp dp_name
```

NOTES:

- **dp** *dp_name*—Specify data plane allocation name.

Example

The following is a configuration example.

```

show ipam dp 209.165.202.145:209.165.202.144
-----
Ipv4Addr [Total/Used/Utilization] = 257 / 1 / 0.39%
Ipv6Addr [Total/Used/Utilization] = 0 / 0 / 0.00%
Ipv6Prefix [Total/Used/Utilization] = 2048 / 0 / 0.00%
Instance ID = 1
-----

```

show ipam pool

To view instance ID information under which pool is configured, use the following command:

```
show ipam pool pool_name
```

NOTES:

- **pool** *pool_name*—Specify pool name.

Example

The following is a list of few configuration examples.

```

show ipam pool
-----
PoolName                               Ipv4Utilization  Ipv6AddrUtilization  Ipv6PrefixUtilization
-----
poolv6DNN2                             0.00%            0.00%                 0.00%
poolv6                                  0.00%            0.00%                 0.00%
poolv4vDNN                              0.00%            0.00%                 0.00%
poolv4DNN2                              0.00%            0.00%                 0.00%
poolv4                                   0.00%            0.00%                 0.00%
poolv6vDNN                              0.00%            0.00%                 0.00%
poolv4DNN3                              -                -                     -
-----

show ipam pool poolv4DNN3
-----
Ipv4Addr [Total/Used/Utilization] = 2814 / 0 / -
Ipv6Addr [Total/Used/Utilization] = 0 / 0 / -
Ipv6Prefix [Total/Used/Utilization] = 65536 / 0 / -
Instance ID = 1
isStatic = true
-----

```

show nrf discovery-info discovery-filter

```

show ipam pool poolv4
-----
Ipv4Addr   [Total/Used/Utilization] = 2814 / 0 / 0.00%
Ipv6Addr   [Total/Used/Utilization] = 0 / 0 / 0.00%
Ipv6Prefix [Total/Used/Utilization] = 0 / 0 / 0.00%
Instance ID                = 1
-----

```

show nrf discovery-info discovery-filter

To view GR Instance ID information to determine for which GR instance the discovery filter information belongs, use the following command:

```
show nrf discovery-info nf_type discovery-filter
```

Example

The following is a configuration example.

```

=====
-----
Discovery Filter: dnn=intershat;
Expiry Time: 1580146356
GR Instance ID: 1
-----
=====

```

show nrf discovery-info

To view GR Instance ID information to determine for which GR instance the discovery information belongs, use the following command:

```
show nrf discovery-info
```

Example

The following is a configuration example.

```

show nrf discovery-info
=====
-----Discovered NFs:-----
  NF Type: AMF
  Number of Discovery Filters: 15
  Number of NF Profiles: 15
  GR Instance ID: 1
-----Discovered NFs:-----
  NF Type: UDM
  Number of Discovery Filters: 1
  Number of NF Profiles: 3
  GR Instance ID: 2
=====

```

show nrf registration-info

To view GR Instance ID information to determine which GR instance the registration information belongs to, use the following command:

```
show nrf registration-info
```

Example

The following is a configuration example.

```
show nrf registration-info
=====
NF Status: Not Registered
Registration Time:
Active MgmtEP Name:
Heartbeat Duration: 0
GR Instance ID: 1
=====

show nrf registration-info

=====
Gr-instance:
NF Status: Not Registered
Registration Time:
Active MgmtEP Name:
Heartbeat Duration: 0
Uri:
Host Type:

=====
Gr-instance:
NF Status: Not Registered
Registration Time:
Active MgmtEP Name:
Heartbeat Duration: 0
Uri:
Host Type:

=====
```

show nrf subscription-info

To view GR Instance ID information to determine for which GR instance the subscription information belongs, use the following command:

```
show nrf subscription-info
```

Example

The following is a configuration example.

```
show nrf subscription-info
=====
NF Instance Id: f9882966-a253-32d1-8b82-c785b34a7cc9
SubscriptionID : subs123459
Actual Validity Time : 2020-01-21 12:39:45 +0000 UTC
Requested Validity Time : 2020-01-21 12:39:45 +0000 UTC
GR Instance ID: 1
=====
```

show peers

To view peers that are now gr-instance aware, use the following command:

```
show peers all grInstance gr_instanceId
```



Note `grInstance` is optional parameter. If `grInstance` is not specified, `show subscriber all` considers the local instance-id of that rack/site.

Example

The following is a configuration example.

```
show peers all grInstance 1
```

ADDITIONAL ENDPOINT NAME	INTERFACE LOCAL ADDRESS	GR PEER ADDRESS	DIRECTION	POD INSTANCE	TYPE	CONNECTED TIME	RPC	DETAILS
<none>n10	209.165.202.139	209.165.201.22:8001	Outbound	rest-ep-0	Rest	10 hours	UDM	<none>
<none>n11	209.165.202.139	209.165.201.22:8002	Outbound	rest-ep-0	Rest	10 hours	AMF	<none>
<none>n7	209.165.202.139	209.165.201.22:8003	Outbound	rest-ep-0	Rest	10 hours	PCF	<none>
<none>n40	209.165.202.139	209.165.201.22:8004	Outbound	rest-ep-0	Rest	10 hours	CHF	<none>
<none>n40	209.165.202.139	209.165.201.22:9040	Outbound	rest-ep-0	Rest	10 hours	CHF	<none>

show role

To view the instance role, use the following command:

```
show role
```

Example

The following is a list of few configuration examples:

```
show role instance-id 2
result "PRIMARY"

show role instance-id 1
result "PRIMARY"
```

show subscriber

To view subscriber details that are made gr-instance aware, use the following command:

```
show subscriber { all | gr-instance gr_instanceId }
```



Note `show subscriber all` displays only the local instance subscriber details.

`gr-instance` is optional parameter. If `gr-instance` is not specified, `show subscriber all` considers the local instance-id of that rack/site.

Example

The following is a configuration example.

```

show subscriber gr-instance 1 all
subscriber-details
{
  "subResponses": [
    [
      ""
    ],
    [
      ""
    ],
    [
      "roaming-status:homer",
      "supi:imsi-123456789300001",
      "gpsi:msisdn-22331010301010",
      "psid:1",
      "dn:intershat",
      "emergency:false",
      "rat:nr",
      "access:3gpp access",
      "connectivity:5g",
      "udm-uecm:209.165.202.150",
      "udm-sdm:209.165.202.150",
      "auth-status:unauthenticated",
      "pcfGroupId:PCF-*",
      "policy:2",
      "pcf:209.165.202.152",
      "upf:209.165.202.154",
      "upfEpKey:209.165.202.154:209.165.202.158",
      "ipv4-addr:v4pool1/209.165.200.250",
      "ipv4-pool:v4pool1",
      "ipv4-range:v4pool1/209.165.200.249",
      "ipv4-startrange:v4pool1/209.165.200.250",
      "id-index:1:0:0:32768",
      "id-value:8",
      "chfGroupId:CHF-*",
      "chf:209.165.202.151",
      "amf:209.165.202.153",
      "peerGtpuEpKey:209.165.202.154:209.165.202.155",
      "namespace:smf",
      "nf-service:smf"
    ]
  ]
}

```

Monitor Subscriber

To capture messages for subscriber (gr-instance aware), use the following command:

```

monitor subscriber [ supi ] [ imsi ] [ imei ] (capture-duration)
(internal-messages) (transaction-logs) (nf-service) (gr-instance)

```



Note In 2021.02 and later releases, the **namespace** keyword is deprecated and replaced with the **nf-service** keyword.

NOTES:

- **supi** —Specify the subscriber identifier.

Example: imsi-123456789, imsi-123*

- **imsi**—Specify the IMSI value.
Example: 123456789, *
- **imei**—Specify the IMEI value.
Example: 123456789012345, *
- **capture-duration**—(Optional) Used to specify the duration in seconds during which monitor subscriber is enabled. Default value is 300 secs.
- **internal-messages**—(Optional) When set to yes, it enables internal messaging. By default, it is disabled.
- **transaction-logs**—(Optional) When set to yes, it enables transaction logging. By default, it is disabled.



Note Messages and transaction logs are mutually exclusive.

- **namespace**—Deprecated option. Use nf-service instead.
- **nf-service**—(Optional) Specify the NF service. Possible values are sgw, smf. Default value is none.
- **gr-instance**—(Optional) Monitor subscriber for a given gr-instance only.

Example

The following is a configuration example.

```
monitor subscriber imsi 123456789 gr-instance 1
supi: imsi-123456789
captureDuration: 300
enableInternalMsg: false
enableTxnLog: false
namespace(deprecated. Use nf-service instead.): none
nf-service: none
gr-instance: 1
% Total      % Received % Xferd  Average Speed   Time    Time     Time  Current
   Dload  Upload   Total    Spent    Left  Speed
100  295  100    98  100    197  10888  21888  --:--:--  --:--:--  --:--:-- 29500
Command: --header Content-type:application/json --request POST --data
{"commandname":"mon_sub","parameters":{"supi":"imsi-123456789","duration":300,
"enableTxnLog":false,"enableInternalMsg":false,"action":"start","namespace":"none",
"nf-service":"none","grInstance":1}} http://oam-pod:8879/commands
Result start mon_sub, fileName
->logs/monsublogs/none.imsi-123456789_TS_2021-04-09T09:59:59.964148895.txt
Starting to tail the monsub messages from file:
logs/monsublogs/none.imsi-123456789_TS_2021-04-09T09:59:59.964148895.txt
Defaulting container name to oam-pod.
Use 'kubectl describe pod/oam-pod-0 -n smf' to see all the containers in this pod.
```

For more information on Monitor Protocol on cnSGW-C, see the *Monitor Subscriber and Monitor Protocol Support* chapter in the *UCC Serving Gateway Control Plane Function - Configuration and Administration Guide*.

For more information on Monitor Protocol on SMF, see the *Monitor Subscriber and Monitor Protocol* section in the *UCC 5G Session Management Function - Configuration and Administration Guide*.

Monitor Protocol

To capture packets on different interfaces (gr-instance aware), use the following command:

```
monitor protocol [ interface ] (capture-duration) (count) (level)
(gr-instance)
```

NOTES:

- **interface**—Interface on which PCAP is captured.
Example: sbi, pfcf, gtpu, gtpc, gtp, radius
- **list**—Monitor protocol list files.
- **capture-duration**—(Optional) Used to specify the duration in secs during which PCAP is captured. Default value is 300 secs.
- **pcap**—(Optional) When set to yes, it enables PCAP file generation. By default, the value is "no" (disabled).
- **gr-instance**—(Optional) Monitor subscriber for a given gr-instance only.

Example

The following is a configuration example.

```
monitor protocol interface sbi gr-instance 1
  % Total    % Received % Xferd  Average Speed   Time    Time       Time  Current
                               Dload  Upload  Total   Spent    Left     Speed
100  220  100    95  100    125    8636  11363  --:--:--  --:--:--  --:--:--  20000
Command: --header Content-type:application/json --request POST --data
{"commandname":"mon_pro","parameters":{"interface":"sbi","duration":300,"action":
"start","enable_pcap":false,"grInstance":1}} http://oam-pod:8879/commands
Result start mon_pro, fileName
->logs/monprologs/sessintfname_sbi_at_2021-04-30T05:26:22.712229347.txt
Starting to tail the monpro messages from file:
logs/monprologs/sessintfname_sbi_at_2021-04-30T05:26:22.712229347.txt
Defaulting container name to oam-pod.
Use 'kubectl describe pod/oam-pod-0 -n cn' to see all of the containers in this pod.
```

For more information on Monitor Protocol on cnSGW-C, see the *Monitor Subscriber and Monitor Protocol Support* chapter in the *UCC Serving Gateway Control Plane Function - Configuration and Administration Guide*.

For more information on Monitor Protocol on SMF, see the *Monitor Subscriber and Monitor Protocol* section in the *UCC 5G Session Management Function - Configuration and Administration Guide*.

Geographic Redundancy OAM Support

This section describes operations, administration, and maintenance information for this feature.

Prerequisites for RMA Process

For GR deployment, the node-monitor pods starts automatically. During RMA procedure, the node-monitor pod automatically shutdown the rack if multi-compute failure is detected when the node is drain and deleted.

For more information on RMA (Return Merchandise Authorization), see *SMI Cluster RMA* section in the *Ultra Cloud Core Subscriber Microservices Infrastructure - Operations Guide*.

Before starting RMA process, perform the following:

1. Switch the role for both the instance to other rack using `geo switch-role role` command and make sure the target rack for RMA is in STANDBY_ERROR role for both the instances.

2. Disable the node-monitor pod.

- a. Take the backup of daemonsets.

```
kubectl get daemonsets node-monitor -n cn -o yaml > node-monitor.yaml
```

- b. Delete node-monitor pods.

```
kubectl delete daemonsets node-monitor -n cn
```

3. Continue with RMA procedure. For more information, see the [link](#).

4. Once RMA procedure is complete, check if the node-monitor pods are already spawned.

```
kubectl get pods -n cn -o wide | grep node-monitor
```

If the node-monitor pods have not started, restart them.

```
kubectl create -f node-monitor.yaml
```



Note `node-monitor.yaml` file is same as in Step 2.a, on page 548.

5. Correct the role for the instances accordingly.



Note For both earlier and current SMI versions:

- If you are replacing hardware components during an RMA procedure that contain firmware, such as an mLOM card, before adding the repaired or replaced node back to the cluster, you must run the HUU (Host Upgrade Utility) to ensure that the component is compatible with the system before syncing the node back into service.
 - As part of RMA, if you remove a node from the cluster and before you return it to the manufacturer, you must purge all data on the device as per instructions provided by the hardware vendor.
-

Health Check

The following section provides information on GR setup health check.

- All critical pods are in good condition to serve user traffic.

Use the following command to check whether GR and CDL related pods are in Running state.

```
kubectl get pods -n cn-cn1 -o wide | grep georeplication-pod
kubectl get pods -n cn-cn1 -o wide | grep cdl
kubectl get pods -n cn-cn1 -o wide | grep mirror-maker
```

- Keepalived pods are in healthy state to monitor all VIPs which are configured for check-interface/check-port.

Use the following command to check whether keepalived pods in “smi-vips” namespace are in “Running” state.

```
kubectl get pods -n smi-vips
```

- Health-check of pods related to CDL: Check the status of CDL db-endpoint, slot and indexes. All should be in STARTED or ONLINE state for both System IDs 1 and 2.

```
cdl show status
message params: {cmd:status mode:cli dbName:session sessionIn:{mapId:0 limit:500 key:
purgeOnEval:0 filters:[] nextEvalTsStart:0 nextEvalTsEnd:0 allReplicas:false
maxDataSize:4096} sliceName:}
db-endpoint {
  endpoint-site {
    system-id 1
    state STARTED
    total-sessions 4
    site-session-count 2
    total-reconciliation 0
    remote-connection-time 66h37m31.36054781s
    remote-connection-last-failure-time 2021-07-13 11:24:10.233825924 +0000 UTC
    slot-geo-replication-delay 2.025396ms
  }
  endpoint-site {
    system-id 2
    state STARTED
    total-sessions 4
    site-session-count 2
    total-reconciliation 0
    remote-connection-time 66h58m49.83449066s
    remote-connection-last-failure-time 2021-07-13 11:02:51.759971655 +0000 UTC
    slot-geo-replication-delay 1.561816ms
  }
}
slot {
  map {
    map-id 1
    instance {
      system-id 1
      instance-id 1
      records 4
      capacity 2500000
      state ONLINE
      avg-record-size-bytes 1
      up-time 89h38m37.335813523s
      sync-duration 9.298061ms
    }
    instance {
      system-id 1
      instance-id 2
      records 4
      capacity 2500000
      state ONLINE
      avg-record-size-bytes 1
      up-time 89h39m11.1268024s
      sync-duration 8.852556ms
    }
  }
  instance {
    system-id 2
    instance-id 1
    records 4
    capacity 2500000
    state ONLINE
    avg-record-size-bytes 1
```

```

        up-time 89h28m38.274713022s
        sync-duration 8.37766ms
    }
    instance {
        system-id 2
        instance-id 2
        records 4
        capacity 2500000
        state ONLINE
        avg-record-size-bytes 1
        up-time 89h29m37.934345015s
        sync-duration 8.877442ms
    }
}
}
index {
    map {
        map-id 1
        instance {
            system-id 1
            instance-id 1
            records 4
            capacity 60000000
            state ONLINE
            up-time 89h38m16.119032086s
            sync-duration 2.012281769s
            leader false
            geo-replication-delay 10.529821ms
        }
        instance {
            system-id 1
            instance-id 2
            records 4
            capacity 60000000
            state ONLINE
            up-time 89h39m8.47664588s
            sync-duration 2.011171261s
            leader true
            leader-time 89h38m53.761213379s
            geo-replication-delay 10.252683ms
        }
        instance {
            system-id 2
            instance-id 1
            records 4
            capacity 60000000
            state ONLINE
            up-time 89h28m29.5479133s
            sync-duration 2.012101957s
            leader false
            geo-replication-delay 15.974538ms
        }
        instance {
            system-id 2
            instance-id 2
            records 4
            capacity 60000000
            state ONLINE
            up-time 89h29m11.633496562s
            sync-duration 2.011566639s
            leader true
            leader-time 89h28m51.29928233s
            geo-replication-delay 16.213323ms
        }
    }
}
}

```

```
}
}
```

- CDL replication status

Check whether four gRPC connections are established between the CDL EP session pods (of each namespace) across the racks in **GRPC_Connections_to_RemoteSite** panel of **CDL Replication Stats** Grafana dashboard. Check Grafana on both racks.



- Admin port status between the racks for geo-replication.

Check heartbeat messages between geo-replication pods across the racks in **Periodic_Heartbeat_to_Remote_Site** panel of **GR Statistics** Grafana dashboard.

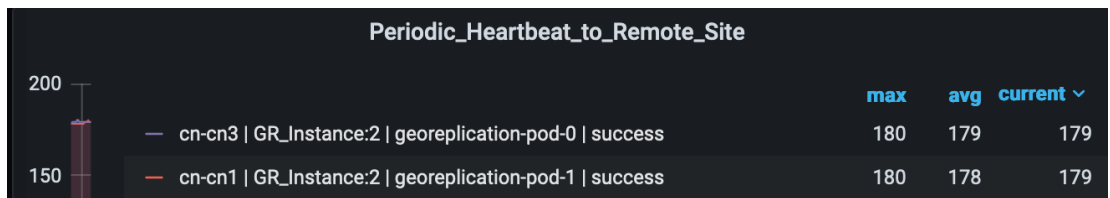

- BGP/BFD link status on rack

Check whether neighborhood with BGP peers is established in **BGP Peers** panel of **BGP, BFD Statistics** Grafana dashboard.

BGP Peers					
Time	as_path	namespace	peer_ip	pod	Value
2021-07-16 06:29:18	3333	cn-cn1	192.204.10.6	bgpspeaker-pod-0	1
2021-07-16 06:29:18	3333	cn-cn1	192.204.10.6	bgpspeaker-pod-1	1
2021-07-16 06:29:18	3333	cn-cn3	192.204.18.6	bgpspeaker-pod-0	1
2021-07-16 06:29:18	3333	cn-cn3	192.204.18.6	bgpspeaker-pod-1	1

Check whether BFD link is in connected state in **BFD Link Status** panel of **BGP, BFD Statistics** Grafana dashboard.

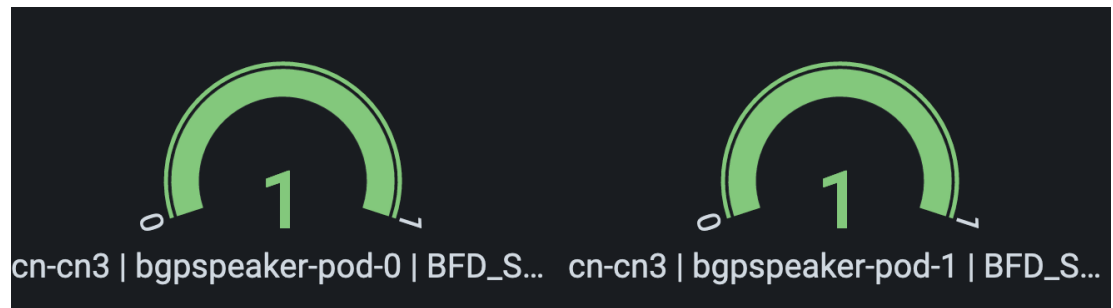

- Roles of each instances are in healthy state

Check that in each rack the roles are not in STANDBY_ERROR state at any point of time.

- Active/Standby model: Roles should be in the following states on each rack

Rack-1/Site-1:

```
show role instance-id 1
result "PRIMARY"
show role instance-id 2
result "PRIMARY"
```

Rack-2/Site-2:

```
show role instance-id 1
result "STANDBY"
show role instance-id 2
result "STANDBY"
```

- Active/Active model: Roles should be in the following states on each rack.

Rack-1/Site-1:

```
show role instance-id 1
result "PRIMARY"
show role instance-id 2
result "STANDBY"
```

Rack-2/Site-2:

```
show role instance-id 1
result "STANDBY"
show role instance-id 2
result "PRIMARY"
```

Recovery Procedure

On Rack-1/Site-1

1. Verify that roles of both instances on Rack-1/Site-1 are in STANDBY_ERROR.

```
show role instance-id 1
result "STANDBY_ERROR"

show role instance-id 2
result "STANDBY_ERROR"
```

2. Initiate reset role for both instances on Rack-1/Site-1 to STANDBY. This step transitions the roles from STANDBY_ERROR/STANDBY_ERROR to STANDBY/STANDBY.

```
geo reset-role instance-id 1 role standby
geo reset-role instance-id 2 role standby
```

3. Verify that roles of both instances have moved to STANDBY on Rack-1/Site-1.

```
show role instance-id 1
result "STANDBY"

show role instance-id 2
result "STANDBY"
```

4. Initiate switch role for instance-id 1 on Rack-2/Site-2 to STANDBY with failback-interval of 30 seconds. This step transitions the roles of Rack-2/Site-2 from PRIMARY/PRIMARY to STANDBY_ERROR/PRIMARY and Rack-1/Site-1 from STANDBY/STANDBY to PRIMARY/STANDBY.

```
geo switch-role instance-id 1 role standby failback-interval 30
```

5. Verify that roles of both instances on Rack-2/Site-2 are in STANDBY_ERROR/PRIMARY.

```
show role instance-id 1
result "STANDBY_ERROR"

show role instance-id 2
result "PRIMARY"
```

6. Verify that roles of both instances on Rack-1/Site-1 are in PRIMARY/STANDBY.

```
show role instance-id 1
result "PRIMARY"

show role instance-id 2
result "STANDBY"
```

7. Initiate reset role for instance-id 1 on Rack-2/Site-2 to STANDBY. This step transitions the roles of Rack-2/Site-2 from STANDBY_ERROR/PRIMARY to STANDBY/PRIMARY.

```
geo reset-role instance-id 1 role standby
```

8. Verify that the roles of Rack-2/Site-2 are in STANDBY/PRIMARY.

```
show role instance-id 1
result "STANDBY"

show role instance-id 2
result "PRIMARY"
```

On Rack-2/Site-2

1. Verify that roles of both the instances on Rack-2/Site-2 are in STANDBY_ERROR.

```
show role instance-id 1
result "STANDBY_ERROR"

show role instance-id 2
result "STANDBY_ERROR"
```

2. Initiate reset role for both instances on Rack-2/Site-2 to STANDBY. This step transitions the roles from STANDBY_ERROR/STANDBY_ERROR to STANDBY/STANDBY.

```
geo reset-role instance-id 1 role standby
geo reset-role instance-id 2 role standby
```

3. Verify that the roles of both the instances move to STANDBY on Rack-2/Site-2.

```
show role instance-id 1
result "STANDBY"
```

```
show role instance-id 2
result "STANDBY"
```

4. Initiate switch role for instance-id 2 on Rack-1/Site-1 to STANDBY. This step transitions roles of Rack-1/Site-1 from PRIMARY/PRIMARY to PRIMARY/STANDBY_ERROR and Rack-2/Site-2 from STANDBY/STANDBY to STANDBY/PRIMARY.

```
geo switch-role instance-id 2 role standby failback-interval 30
```

5. Verify that roles of instances on Rack-1/Site-1 are in PRIMARY/STANDBY_ERROR mode.

```
show role instance-id 1
result "PRIMARY"
```

```
show role instance-id 2
result "STANDBY_ERROR"
```

6. Verify that roles of instances on Rack-2/Site-2 are in STANDBY/PRIMARY mode.

```
show role instance-id 1
result "STANDBY"
```

```
show role instance-id 2
result "PRIMARY"
```

7. Initiate reset role for instance-id 2 on Rack-1/Site-1 to STANDBY. This step transitions the roles of Rack-1/Site-1 from PRIMARY/STANDBY_ERROR to PRIMARY/STANDBY.

```
geo reset-role instance-id 2 role standby
```

8. Verify that roles of instances on Rack-1/Site-1 are in PRIMARY/STANDBY.

```
show role instance-id 1
result "PRIMARY"
```

```
show role instance-id 2
result "STANDBY"
```

Key Performance Indicators (KPIs)

The following section describes KPIs.

ETCD/CachePod Replication KPIs

The following table lists ETCD/CachePod Replication KPIs.

Table 196: geo_replication_total KPIs

KPI Name	Description	Labels	Possible Values
geo_replication_total	This KPI displays total number of replication requests/responses for various Sync types and Replication types.	ReplicationRequest Type	Request / Response
		ReplicationSync Type	Immediate / Deferred / Pull
		ReplicationNode	ETCD / CACHE_POD / PEER
		ReplicationReceiver	Local / Remote
		status	True / False
		status_code	Error code/description

Geo Rejected Role Change KPIs

The following table lists Geo Rejected Role Change KPIs.

Table 197: Geo Rejected Role Change KPIs

KPI Name	Description	Labels	Possible Values
geo_RejectedRole Changed_total	This KPI displays the total number of rejected requests/calls received for STANDBY instance. After the count, the same instance is moved to PRIMARY.	RejectedCount	Number value indicating rejected calls/requests received for standby instance.
		GRInstance Number	1 / 2

Monitoring KPIs

The following table lists monitoring KPIs.

Table 198: geo_monitoring_total KPIs

KPI Name	Description	Labels	Possible Values
geo_monitoring_total	This KPI displays the total number of successful / failure messages of different kinds such as, heartbeat / remoteNotify / TriggerGR and so on.	ControlAction Type	AdminMonitoring ActionType / AdminRemote MessageAction Type / AdminRole ChangeActionType
		ControlAction NameType	MonitorPod / MonitorBfd / RemoteMsgHeartbeat / RemoteMsgNotifyFailover / RemoteMsgNotify PrepareFailover / RemoteMsgGetSiteStatus / RemoteClusterPodFailure / RemoteSiteRole Monitoring / TriggerGRApi / ResetRoleApi
		Admin Node	Any string value. For example, GR Instance ID or instance key / pod name
		Status Code	0 / 1001 / 1002 / 1003 / 1004 / 1005 / 1006 / 1007 / 1008 / received error code (1206, 1219, 2404, ...)
		Status Message	

KPI Name	Description	Labels	Possible Values
			Success (0) / STANDBY_ERROR => STANDBY/STANDBY => PRIMARY (0) / Pod Failure (0) / CLI (0) / BFD Failure (0) / Decode Failure (1001) / remote status unavailable (1002) / target role does not support (1002) / Pod Failure (1002) / CLI (1002) / BFD Failure (1002) / site is down (1003) / Pod Failure (1003) / CLI (1003) / BFD Failure (1003) / Traffic Hit (1004) / Pod Failure (1004) / CLI (1004) / BFD Failure (1004) / current role is not STANDBY_ERROR/ STANDBY to reset role (1005) / resetRole: Key not found in etcd (1006) / monitoring threshold per pod is breached (1007) / Retry on heartbeat failure (1008) / received error message (No remote host available for this request / Selected remote host <remotehostname> has no client connection / Sla is expired for transaction / ...)

BFD KPIs

The following table lists BFD KPIs.

Table 199: BFD KPIs - 1

KPI Name	Description	Labels	Possible Values
bgp_speaker_bfd_status	This KPI displays BFD link status on BGP Speaker.	status	STATE_UP / STATE_DOWN
geo_bfd_status	This KPI displays BFD link status on Geo POD.	status	STATE_UP / STATE_DOWN

Table 200: BFD KPIs - 2

KPI Name	Description	Gauge
bgp_speaker_bfd_status	This KPI displays BFD link status on BGP Speaker.	1 (UP) or 0 (DOWN)
geo_bfd_status	This KPI displays BFD link status on Geo POD.	1 (UP) or 0 (DOWN)

Cross-rack-routing BFD Interface Monitoring

Table 201: Cross-rack-routing BFD Interface Monitoring KPIs

KPI Name	Description	Labels	Possible Values
geo_monitoring_total	This KPI displays the total number of Gateway Down or LocalBFDInterface down messages when peer rack is down with the details of gateway IP or interface name.	ControlAction Type	AdminMonitoring ActionType
		ControlAction NameType	MonitorGateway / MonitorLocalBfdInterface
		AdminNode	gateway_ip / interface_name
		status	gateway ip is down from all proto node / local bfd interface is down from all proto node
		status_code	1012 / 1013
bgp_bfd_Monitor_Interface_status (Type - Gauge)	This KPI indicates each peer connection status. This connection is BFD interface configured and peers on the remote rack.	interface	<Local Rack Interface Name>
		peer_address	<Remote Rack neighbor Ip address>
		type	Bfd-Peer

KPI Name	Description	Labels	Possible Values
bgp_bfd_Monitor_ Remote_Rack_ status (Type - Gauge)	This KPI indicates the status of remote rack. Current rack interface and remote rack peers are configured in as a part of BFD peering. Rack status is up if any of the connection from both the proto node is up. If connection is down at both the proto nodes, then this KPI indicates the remote rack status is down.	status	BFD_Remote_ Rack_STATUS

Local Interface Monitoring

Table 202: Local Interface Monitoring KPI

KPI Name	Description	Labels	Possible Values
geo_monitoring_ total	This KPI displays the total number of local interface down cases with the details of interface name.	ControlAction Type	AdminMonitoring ActionType
		ControlAction NameType	MonitorInterface
		AdminNode	interface_name
		status	Local interface is down from all proto node
		status_code	1014

GR Instance Information

Table 203: GR Instance Information KPI

KPI Name	Description	Labels	Possible Values
gr_instance_ information (Type – Gauge)	This KPI displays the current role of the GR instance in the application.	gr_instance_id	Configured GR instances value (numerical value)

Geo Maintenance Mode

Table 204: Geo Maintenance Mode KPI

KPI Name	Description	Labels	Possible Values
geo_MaintenanceMode_info (Type – Guage)	This KPI displays the current state of maintenance mode for the rack.	MaintenanceMode	0: false 1: true

Bulk Statistics

The following section provides details on GR-specific bulkstats.

```

bulk-stats query GR-BGP-Incoming-Failed-Routes
  expression "sum(bgp_incoming_failedroutererequest_total) by (namespace, interface, service_IP,
  next_hop, instance_id)"
  labels    [ instance_id interface next_hop service_IP ]
  alias     gr-bgp-routes-in
exit
bulk-stats query GR-Geo-Monitoring-Failure
  expression "sum(geo_monitoring_total{ControlActionNameType=~'MonitorPod|RemoteMsgHeartbeat|
  RemoteMsgGetSiteStatus|RemoteSiteRoleMonitoring|RemoteClusterPodFailure|RemoteMsgNotifyFailover|
  RemoteMsgNotifyPrepareFailover|MonitorVip',status!~'success|monitoring.*'}) by (namespace,
  AdminNode, ControlActionType, ControlActionNameType, pod, status, status_code)"
  labels    [ pod AdminNode ControlActionNameType status status_code ]
  alias     gr-geo-monitoring-failure
exit
bulk-stats query GR-Geo-Monitoring-Success
  expression "sum(geo_monitoring_total{ControlActionNameType=~'MonitorPod|RemoteMsgHeartbeat|
  RemoteMsgGetSiteStatus|RemoteSiteRoleMonitoring|RemoteClusterPodFailure|RemoteMsgNotifyFailover|
  RemoteMsgNotifyPrepareFailover',status=~'success|monitoring.*'}) by (namespace, AdminNode,
  ControlActionType, ControlActionNameType, pod, status)"
  labels    [ pod AdminNode ControlActionNameType status ]
  alias     gr-geo-monitoring
exit
bulk-stats query GR-Geo-Monitoring-Total
  expression "sum(geo_monitoring_total{ControlActionNameType=~'MonitorPod|RemoteMsgHeartbeat|
  RemoteMsgGetSiteStatus|RemoteSiteRoleMonitoring|RemoteClusterPodFailure|RemoteMsgNotifyFailover|
  RemoteMsgNotifyPrepareFailover|MonitorVip'})
  by (namespace, AdminNode, ControlActionType, ControlActionNameType, pod, status)"
  labels    [ pod AdminNode ControlActionNameType status ]
  alias     gr-geo-monitoring
exit
bulk-stats query GR-Geo-Replication-Failure
  expression
  "sum(geo_replication_total{ReplicationNode=~'CACHE_POD|ETCD|PEER',status!='success',
  ReplicationRequestType='Response'}) by (namespace, ReplicationNode, ReplicationSyncType,
  ReplicationReceiver,ReplicationRequestType,status,status_code)"
  labels    [ pod ReplicationNode ReplicationReceiver ReplicationRequestType
  ReplicationSyncType status status_code ]
  alias     gr-geo-replication-failure
exit
bulk-stats query GR-Geo-Replication-Success
  expression "sum(geo_replication_total{ReplicationNode=~'CACHE_POD|ETCD|PEER',
  status='success',ReplicationRequestType='Response'}) by (namespace, ReplicationNode,
  ReplicationSyncType,ReplicationReceiver,ReplicationRequestType,status)"
  labels    [ pod ReplicationNode ReplicationReceiver ReplicationRequestType

```



```

ReplicationSyncType status ]
  alias      gr-geo-replication-success
exit
bulk-stats query GR-Geo-Replication-Total
  expression "sum(geo_replication_total{ReplicationNode=~'CACHE_POD|ETCD|PEER'})
by (namespace, ReplicationNode, ReplicationSyncType, ReplicationReceiver,
ReplicationRequestType, pod) "
  labels    [ pod ReplicationNode ReplicationReceiver ReplicationRequestType
ReplicationSyncType ]
  alias      gr-geo-replication-total
exit
bulk-stats query GR-Trigger-ResetRole-Api
  expression "sum(geo_monitoring_total{ControlActionNameType=~'TriggerGRApi|ResetRoleApi'})

by (namespace, AdminNode, ControlActionType, ControlActionNameType, pod, status,
status_code) "
  labels    [ pod AdminNode ControlActionNameType status status_code ]
  alias      gr-api
exit
bulk-stats query GR-CDL-Index-Replication
  expression "sum(consumer_kafka_records_total) by (pod, origin_instance_id)"
  labels    [ origin_instance_id pod ]
  alias      gr-cdl-index-replication
exit
bulk-stats query GR-CDL-Inter-Rack-Replications-Failures
  expression "sum(datastore_requests_total{local_request='0',errorCode!='0'}) by
(operation, sliceName, errorCode) "
  labels    [ sliceName operation errorCode ]
  alias      gr-cdl-inter-rack-replications
exit
bulk-stats query GR-CDL-Inter-Rack-Replications-Success
  expression "sum(datastore_requests_total{local_request='0',errorCode='0'}) by
(operation, sliceName, errorCode) "
  labels    [ sliceName operation errorCode ]
  alias      gr-cdl-inter-rack-replications
exit
bulk-stats query GR-CDL-Inter-Rack-Replications-Total
  expression "sum(datastore_requests_total{local_request='0'}) by
(operation, sliceName, errorCode) "
  labels    [ sliceName operation errorCode ]
  alias      gr-cdl-inter-rack-replications
exit
bulk-stats query GR-CDL-Intra-Rack-Operations-Failures
  expression "sum(datastore_requests_total{local_request='1',errorCode!='0'}) by
(operation, sliceName, errorCode) "
  labels    [ sliceName operation errorCode ]
  alias      gr-cdl-intra-rack-operations
exit
bulk-stats query GR-CDL-Intra-Rack-Operations-Success
  expression "sum(datastore_requests_total{local_request='1',errorCode='0'}) by
(operation, sliceName, errorCode) "
  labels    [ sliceName operation errorCode ]
  alias      gr-cdl-intra-rack-operations
exit
bulk-stats query GR-CDL-Intra-Rack-Operations-Total
  expression "sum(datastore_requests_total{local_request='1'}) by
(operation, sliceName, errorCode) "
  labels    [ errorCode operation sliceName ]
  alias      gr-cdl-intra-rack-operations
exit
bulk-stats query GR-CDL-Session-Count-Per-Slice
  expression
sum(avg(db_records_total{namespace=~'$namespace', session_type='total'})by(systemId, sliceName))by(sliceName)

```

```

labels      [ sliceName ]
alias       gr-cdl-session-count-per-slice
exit
bulk-stats query GR-CDL-Session-Count-Per-System-ID
  expression sum(avg(db_records_total{namespace=~'$namespace',session_type='total'})
by(systemId,sliceName))by(systemId)
  labels     [ systemId ]
  alias      gr-cdl-session-count-per-system-id
exit
bulk-stats query GR-CDL-Slot-Records-Per-Slice
  expression "sum(slot_records_total{pod=~'.*',systemId!=''}) by (pod, sliceName)"
  labels     [ pod sliceName ]
  alias      gr-cdl-slot-records-per-slice
exit
bulk-stats query GR-CDL-Slot-Records-Per-System-ID
  expression "sum(slot_records_total{pod=~'.*',systemId!=''}) by (pod, systemId)"
  labels     [ pod systemId ]
  alias      gr-cdl-slot-records-per-system-id
exit
bulk-stats query GR-CDL-Total-Session-Count
  expression "sum(db_records_total{namespace=~'$namespace',session_type='total'}) by
(systemId,sliceName)"
  labels     [ sliceName systemId ]
  alias      gr-cdl-total-session-count
exit

```

For more information on GR-related statistics, see the following:

- In cnSGW-C statistics, you can filter GR-specific statistics using `gr_instance_id` label.
For more information, see the *UCC Serving Gateway Control Plane Function - Metrics Reference*.
- In RADIUS statistics, you can filter GR-specific statistics using `grInstId` label.
For more information, see the *UCC 5G Session Management Function - Metrics Reference*.
- In GTP Endpoint statistics, you can filter GR-specific statistics using `gr_instance_id` label.
For more information, see the *UCC 5G Session Management Function - Metrics Reference*.
- In SMF statistics, you can filter GR-specific statistics using `gr_instance_id` label.
For more information, see the *UCC 5G Session Management Function - Metrics Reference*.
- In REST Endpoint statistics, you can filter GR-specific statistics using `gr_instance_id` label.
For more information, see the *UCC 5G Session Management Function - Metrics Reference*.
- In IPAM-related statistics, you can filter GR-specific statistics using `grInstId` label.
For more information, see the *UCC 5G Session Management Function - Metrics Reference*.

Alerts

The following section provides details on GR alerts.

BFD Alerts

The following table list alerts for rule group BFD with *interval-seconds* as 60.

Table 205: Alert Rule Group - BFD

Alert Rule	Severity	Duration (in mins)	Type
BFD-Link-Fail	critical	1	Communication Alarm
	<p>Expression: sum by (namespace,pod,status) (bgp_speaker_bfd_status{status='BFD_STATUS'}) == 0</p> <p>Description: This alert is generated when BFD link associated with BGP peering is down.</p>		

GR Alerts

The following table list alerts for rule group GR with *interval-seconds* as 60.

Table 206: Alert Rule Group - GR

Alert Rule	Severity	Duration (in mins)	Type
Cache-POD-Replication-Immediate-Local	critical	1	Communication Alarm
	<p>Expression: (sum by (namespace) (increase(geo_replication_total{ReplicationNode='CACHE_POD', ReplicationSyncType='Immediate',ReplicationReceiver='local', ReplicationRequestType='Response',status='success'}[1m]))/sum by (namespace) (increase(geo_replication_total{ReplicationNode='CACHE_POD', ReplicationSyncType='Immediate',ReplicationReceiver='local', ReplicationRequestType='Request'}[1m]))) * 100 < 90</p> <p>Description: This alert is generated when the success rate of CACHE_POD sync type:Immediate and replication receiver:Local is below threshold value.</p>		
Cache-POD-Replication-Immediate-Remote	critical	1	Communication Alarm
	<p>Expression: (sum by (namespace) (increase(geo_replication_total{ReplicationNode='CACHE_POD', ReplicationSyncType='Immediate',ReplicationReceiver='remote', ReplicationRequestType='Response',status='success'}[1m]))/sum by (namespace) (increase(geo_replication_total{ReplicationNode='CACHE_POD', ReplicationSyncType='Immediate',ReplicationReceiver='remote', ReplicationRequestType='Request'}[1m]))) * 100 < 90</p> <p>Description: This alert is generated when the success rate of CACHE_POD sync type:Immediate and replication receiver:Remote is below threshold value.</p>		

Alert Rule	Severity	Duration (in mins)	Type
Cache-POD- Replication-PULL -Remote	critical	1	Communication Alarm
	<p>Expression: (sum by (namespace) (increase(geo_replication_total{ReplicationNode='CACHE_POD', ReplicationSyncType='PULL',ReplicationReceiver='remote', ReplicationRequestType='Response',status='success'}[1m]))/sum by (namespace) (increase(geo_replication_total{ReplicationNode='CACHE_POD', ReplicationSyncType='PULL',ReplicationReceiver='remote', ReplicationRequestType='Request'}[1m]))) * 100 < 90</p> <p>Description: This alert is generated when the success rate of CACHE_POD sync type:PULL and replication receiver:Remote is below threshold value.</p>		
ETCD- Replication-Immediate -Local	critical	1	Communication Alarm
	<p>Expression: (sum by (namespace) (increase(geo_replication_total{ReplicationNode='ETCD', ReplicationSyncType='Immediate',ReplicationReceiver='local', ReplicationRequestType='Response',status='success'}[1m]))/sum by (namespace) (increase(geo_replication_total{ReplicationNode='ETCD', ReplicationSyncType='Immediate',ReplicationReceiver='local', ReplicationRequestType='Request'}[1m]))) * 100 < 90</p> <p>Description: This alert is generated when the success rate of ETCD sync type:Immediate and replication receiver:Local is below threshold value.</p>		
ETCD- Replication-Immediate -Remote	critical	1	Communication Alarm
	<p>Expression: (sum by (namespace) (increase(geo_replication_total{ReplicationNode='ETCD', ReplicationSyncType='Immediate',ReplicationReceiver='remote', ReplicationRequestType='Response',status='success'}[1m]))/sum by (namespace) (increase(geo_replication_total{ReplicationNode='ETCD', ReplicationSyncType='Immediate',ReplicationReceiver='remote', ReplicationRequestType='Request'}[1m]))) * 100 < 90</p> <p>Description: This alert is generated when the success rate of ETCD sync type:Immediate and replication receiver:Remote is below threshold value.</p>		

Alert Rule	Severity	Duration (in mins)	Type
ETCD- Replication-PULL -Remote	critical	1	Communication Alarm
	<p>Expression: (sum by (namespace) (increase(geo_replication_total {ReplicationNode='ETCD', ReplicationSyncType='PULL',ReplicationReceiver='remote', ReplicationRequestType='Response',status='success'}[1m]))/ sum by (namespace) (increase(geo_replication_total {ReplicationNode='ETCD',ReplicationSyncType='PULL', ReplicationReceiver='remote',ReplicationRequestType= 'Request'}[1m]))) * 100 < 90</p> <p>Description: This alert is generated when the success rate of ETCD sync type:PULL and replication receiver:Remote is below threshold value.</p>		
Heartbeat-Remote -Site	critical	-	Communication Alarm
	<p>Expression: sum by (namespace) (increase(geo_monitoring_total {ControlActionNameType= 'RemoteMsgHeartbeat',status!='success'}[1m])) > 0</p> <p>Description: This alert is triggered when periodic Heartbeat to remote site fails.</p>		
Local-Site- POD-Monitoring	critical	-	Communication Alarm
	<p>Expression: sum by (namespace,AdminNode) (increase(geo_monitoring_total {ControlActionNameType ='MonitorPod'}[1m])) > 0</p> <p>Description: This alert is triggered when local site pod monitoring failures breaches the configured threshold for the pod mentioned in Label: {{ \$labels.AdminNode }}.</p>		

Alert Rule	Severity	Duration (in mins)	Type
PEER-Replication-Immediate-Local	critical	1	Communication Alarm
	<p>Expression: (sum by (namespace) (increase(geo_replication_total{ReplicationNode='PEER', ReplicationSyncType='Immediate',ReplicationReceiver='local', ReplicationRequestType='Response',status='success'} [1m]))/sum by (namespace) (increase(geo_replication_total {ReplicationNode='PEER',ReplicationSyncType='Immediate',ReplicationReceiver='local', ReplicationRequestType='Request'}[1m]))) * 100 < 90</p> <p>Description: This alert is generated when the success rate of PEER sync type:Immediate and replication receiver:Local is below threshold value.</p>		
PEER-Replication-Immediate-Remote	critical	1	Communication Alarm
	<p>Expression: (sum by (namespace) (increase(geo_replication_total{ReplicationNode='PEER', ReplicationSyncType='Immediate',ReplicationReceiver='remote', ReplicationRequestType='Response',status='success'} [1m]))/sum by (namespace) (increase(geo_replication_total {ReplicationNode='PEER',ReplicationSyncType='Immediate', ReplicationReceiver='remote',ReplicationRequestType='Request'}[1m]))) * 100 < 90</p> <p>Description: This alert is generated when the success rate of PEER sync type:Immediate and replication receiver:Remote is below threshold value.</p>		
RemoteCluster-PODFailure	critical	-	Communication Alarm
	<p>Expression: sum by (namespace,AdminNode) (increase(geo_monitoring_total{ControlActionNameType='RemoteClusterPodFailure'}[1m])) > 0</p> <p>Description: This alert is generated when pod failure is detected on the Remote site for the pod mentioned in Label: {{ \$labels.AdminNode }}.</p>		

Alert Rule	Severity	Duration (in mins)	Type
RemoteMsg NotifyFailover	critical	1	Communication Alarm
	<p>Expression: sum by (namespace,status) (increase(geo_monitoring_total{ControlActionNameType ='RemoteMsgNotifyFailover',status!='success'}[1m])) > 0</p> <p>Description: This alert is generated when transient role RemoteMsgNotifyFailover has failed for the reason mentioned in Label: {{ \$labels.status }}.</p>		
RemoteMsg NotifyPrepare Failover	critical	1	Communication Alarm
	<p>Expression: sum by (namespace,status) (increase(geo_monitoring_total{ControlActionNameType ='RemoteMsgNotifyPrepareFailover',status!='success'}[1m])) > 0</p> <p>Description: This alert is generated when transient role RemoteMsgNotifyPrepareFailover has failed for the reason mentioned in Label: {{ \$labels.status }}.</p>		
RemoteSite- RoleMonitoring	critical	-	Communication Alarm
	<p>Expression: sum by (namespace,AdminNode) (increase(geo_monitoring_total{ControlActionNameType ='RemoteSiteRoleMonitoring'}[1m])) > 0</p> <p>Description: This alert is generated when RemoteSiteRoleMonitoring detects role inconsistency for an instance on the partner rack and accordingly changes the role of the respective instance on local rack to Primary. The impacted instance is in Label: {{ \$labels.AdminNode }}.</p>		
ResetRoleApi -Initiated	critical	-	Communication Alarm
	<p>Expression: sum by (namespace,status) (increase(geo_monitoring_total{ControlActionNameType ='ResetRoleApi'}[1m])) > 0</p> <p>Description: This alert is generated when ResetRoleApi is initiated with the state transition of roles mentioned in Label: {{ \$labels.status }}.</p>		
TriggerGRApi -Initiated	critical	-	Communication Alarm
	<p>Expression: sum by (namespace,status) (increase(geo_monitoring_total{ControlActionNameType ='TriggerGRApi'}[1m])) > 0</p> <p>Description: This alert is generated when TriggerGRApi is initiated for the reason mentioned in Label: {{ \$labels.status }}.</p>		

Alert Rule	Severity	Duration (in mins)	Type
VIP-Monitoring -Failures	critical	-	Communication Alarm
	<p>Expression: sum by (namespace,AdminNode) (increase(geo_monitoring_total{ControlActionNameType='MonitorVip'}[1m])) > 0</p> <p>Description: This alert is generated when GR is generated upon detecting VIP monitoring failures for the VIP and Instance mentioned in the Label: {{Labels.AdminNode}}.</p>		

CDL Alerts

The following table list alerts for rule group CDL with *interval-seconds* as 60.

Table 207: Alert Rule Group - CDL

Alert Rule	Severity	Duration (in mins)	Type
GRPC- Connections- Remote-Site	critical	1	Communication Alarm
	<p>Expression: sum by (namespace, pod, systemId) (remote_site_connection_status) !=4</p> <p>Description: This alert is generated when GRPC connections to remote site are not equal to 4.</p>		
Inter-Rack -CDL-Replication	critical	1	Communication Alarm
	<p>Expression: (sum by (namespace) (increase(datastore_requests_total{local_request="\0", errorCode="\0"}[1m]))/sum by (namespace) (increase(datastore_requests_total{local_request="\0"} [1m]))) * 100 < 90</p> <p>Description: This alert is generated when the Inter-rack CDL replication success rate is below threshold value.</p>		
Intra-Rack -CDL-Replication	critical	1	Communication Alarm
	<p>Expression: (sum by (namespace) (increase(datastore_requests_total{local_request="\1", errorCode="\0"}[1m]))/sum by (namespace) (increase(datastore_requests_total{local_request="\1"} [1m]))) * 100 < 90</p> <p>Description: This alert is generated when the Intra-rack CDL replication success rate is below threshold.</p>		

Maintenance Mode

cnSGW-CSMF supports the maintenance mode flag to disable the impact on a cluster if the cluster in GR setup is scheduled for in-service (rolling upgrade). This is useful so that the other mated cluster executes its responsibility and other activities on the targeted cluster without any issue.

If the maintenance mode flag is set to **true**, cluster role change and GR trigger for the rack is allowed only in case of CLI-based failover.

During the execution, all the monitoring threads check the runtime value for the flag and hold the execution if the maintenance mode flag is set to **true**. By default, for fresh installation, the flag is set to **false**. Based on your requirements, to configure the maintenance mode, use the following configuration.

```
config
  geo maintenance mode { true | false }
end
```

NOTES:

- **geo maintenance mode { true | false }** - Enable/disable the maintenance mode.

The value for the maintenance mode is stored in `etcd`

Both the clusters can be under maintenance at the same time. You can push the system in maintenance mode if the mated cluster is already under maintenance. Before you start the maintenance activity, set the `geo maintenance mode` flag value to **true**. When maintenance is complete, reset the flag to **false** after confirming the health of the system.

When the maintenance flag is set to `true`:

- All the monitoring activities are paused.
- The mated cluster cannot trigger the failover when it detects the local failure.
- Replication activities continue on the cluster.
- Maintenance mode doesn't change instance roles of the site implicitly. However, role change is possible using `geo switch-role role` CLI command.

GR trigger is not allowed towards and from the cluster under maintenance. Only CLI-based failover is supported from the cluster under the maintenance. After disabling maintenance mode, start with new data for pod and VIP monitoring. Remote cluster is informed about the maintenance mode value using the `NotifyMaintenanceActivity()` [Operation 24] message.

Example

The following is a configuration example:

```
geo maintenance mode true
result "success"

geo maintenance mode false
result "success"
```

Viewing the Maintenance Mode Status

To check the maintenance mode status, use the following `show` command.

```
show geo maintenance mode
result "geo maintenance mode is disabled"
```



CHAPTER 42

Service Configuration Enhancements

- [Feature Summary and Revision History, on page 571](#)
- [Feature Description, on page 571](#)
- [Feature Configuration, on page 572](#)
- [Troubleshooting Information, on page 577](#)

Feature Summary and Revision History

Summary Data

Table 208: Summary Data

Applicable Product(s) or Functional Area	cnSGW-C
Applicable Platform(s)	SMI
Feature Default Setting	Enabled - Always-on
Related Documentation	Not Applicable

Revision History

Table 209: Revision History

Revision Details	Release
Support added for DNN List	2021.02.3
First introduced	2020.01.0

Feature Description

cnSGW-C supports Subscriber Map and Operator Policy configurations.

SGW profile represents SGW-service or node. The operator policy is decided based on subscriber policy association.

Feature Configuration

Configuring this feature involves the following steps:

- SGW profile. For more information, see [Configuring the SGW Profile, on page 572](#).
- Subscriber policy. For more information, see [Configuring the Subscriber Policy, on page 573](#).
- Operator policy. For more information, see [Configuring the Operator Policy, on page 574](#).
- Policy DNN. For more information, see [Configuring the Policy DNN, on page 574](#).

Configuring the SGW Profile

To configure this feature, use the following configuration:

```
config
  profile sgw sgw_name
    locality locality_code
    fqdn dnn_name
    subscriber-policy policy_name
  end
```

NOTES:

- **locality** *locality_code*—Specify the locality code. Must be a string.
- **fqdn** *dnn_name*—Specify the cnSGW-C FQDN.
- **subscriber-policy** *policy_name*—Specify the subscriber policy name. Must be a string.

Configuration Example

The following is an example configuration.

```
config
  profile sgw sgw-data
    locality LOC1
    fqdn 209.165.200.254
    subscriber-policy subpoll
  end
```

Configuration Verification

To verify the configuration:

```
show running-config profile sgw
profile sgw sgw-data
locality LOC1
fqdn 209.165.200.254
subscriber-policy subpoll
```

Configuring the Subscriber Policy



Note The maximum number of supported subscriber map profiles is 64.

To configure this feature, use the following configuration:

```

config
  policy subscriber subscriber_name
    precedence precedence_value
    imsi
      mcc mcc_value
      mnc mnc_value
      msin first_value last_value
    serving-plmn
      mcc mcc_value
      mnc mnc_value
    imsi-start-range range_value
    imsi-stop-range range_value
    supi-start-range range_value
    supi-stop-range range_value
    operator-policy policy_name
  end

```



Note All parameters are optional.

NOTES:

- **precedence** *precedence_value*—Specify the precedence for entry. Must be an integer in the range of 1-2048.
- **mcc** *mcc_value*—Specify the Mobile Country Code (MCC). Must be a three digit integer.
- **mnc** *mnc_value*—Specify the Mobile Network code (MNC). Must be a two or three digit integer.
- **msin** *first_value last_value*—Specify the mobile subscriber identification number (MSIN) range.
first_value—Specify starting value of the MSIN range. Must be an integer in the range of 1-9999999999.
last_value—Specify the ending value of the MSIN range. Must be an integer in the range of 1-9999999999.
- **operator-policy** *policy_name*—Specify the operator policy name. Must be a string.
- **imsi-start-range** *range_value*—Specify the IMSI start range. Must be an integer in the range of 10000000000000-99999999999999.
- **imsi-stop-range** *range_value*—Specify the IMSI stop range. Must be an integer in the range of 10000000000000-99999999999999.
- **supi-start-range** *range_value*—Specify the SUPI start range. Must be an integer in the range of 10000000000000-99999999999999.

- **supi-stop-range** *range_value*—Specify the SUPI stop range. Must be an integer in the range of 10000000000000-99999999999999.

Configuration Example

The following is an example configuration.

```
config
  policy subscriber subl
    precedence 2
      imsi mcc 123 mnc 456
      imsi msin first 99 last 100
    serving-plmn mcc 404 mnc 678
    supi-start-range 100000000000001
    supi-stop-range 199999999999999
    imsi-start-range 200000000000001
    imsi-stop-range 299999999999999
    operator-policy opl
  end
```

Configuring the Operator Policy



Note The maximum number of supported operator policy profiles is 1000.

To configure this feature, use the following configuration:

```
config
  policy operator operator_name
  policy dnn dnn_policy_name
end
```

NOTES:

- **policy operator** *operator_name*—Specify the operator policy name. Must be a string.
- **policy dnn** *dnn_policy_name*—Specify the DNN policy name. Must be a string.

Configuration Example

The following is an example configuration.

```
config
  policy operator opl
  policy dnn poll
end
```

Configuring the Policy DNN

This section describes how to configure Policy DNN and adding it to cnSGW-C. The DNN support enables you to determine the exact APN profile as per the APN name, APN network-identifier and APN operator-identifier.



Note The maximum number of supported DNN policies is 1000.

To configure this feature, use the following configuration:

```

config
  policy dnn dnn_policy_name
    dnn dnn_name
      dnn-list dnn_list
      profile profile_name
      dnn network-identifier network_identifier_name operator-identifier
operator_identifier_name profile profile_name
      dnn operator-identifier operator_identifier_name profile profile_name
      dnn operator-identifier profile profile_name
    end

```

NOTES:

- **dnn** *dnn_name*—Specify the DNN name.
- **network-identifier** *network_identifier_name*—Specify the network identifier. Must be a string.
- **profile** *profile_name*—Specify the profile name. Must be a string.
- **operator-identifier** *operator_identifier_name*—Specify the operator identifier. Must be a string.
- **profile** *default_dnn_profile*—Specify the default DNN profile name.
- **dnn-list** *dnn_list*—Specify the DNN list for selecting a DNN profile. It helps in minimizing the entries needed for pointing multiple DNN to a single profile.



Note With present evaluation criteria, following is the matching order to select the associated profile:

- DNN/DNN List
- NI+OI
- NI
- OI
- Default

Don't configure overlapping criteria.

Configuration Example

The following is an example configuration.

```

config
  policy dnn polsub1
    dnn network-identifier ims profile ims1
    dnn network-identifier ims operator-identifier ims.com profile ims
    dnn network-identifier voice operator-identifier volte profile voiceprofile

```

```

    dnn operator-identifier data profile data-profile
    profile default-dnn-profile
    end

config
  policy dnn polsub1
    dnn intershat dnn-list [ intershat1 intershat2 intershat3 ]
    profile profile_name
      dnn network-identifier ims operator-identifier ims.com profile ims
      dnn operator-identifier volte profile voiceprofile
      dnn operator-identifier data profile profile_name
    end
  end

```

Configuration Modification Impact

This section describes the impact or behavior of configuration change on existing call, new PDN, or new subscriber.

Modification	cnSGW-C Existing Call	cnSGW-C New PDN or New subscriber
Define a new SGW-profile and delete the old profile (with or without the pod restart)	When the new transaction happens, the call gets loaded on cn-SGW-C from CDL. <i>Observation:</i> Change in the cnSGW-C profile configuration and termination of the call.	Rejects the new PDN and deletes the existing call. New subscriber uses new SGW profile.
Delete the subscriber map	No impact	Applies modified configuration for the following: <ul style="list-style-type: none"> • subscriber policy • operator policy • dnn policy • dnn profile
Modify the subscriber map in SGW-service	No impact	Applies modified configuration for the following: <ul style="list-style-type: none"> • subscriber policy • operator policy • dnn policy • dnn profile

Modification	cnSGW-C Existing Call	cnSGW-C New PDN or New subscriber
Delete the operator policy	No impact	Applies modified configuration for the following: <ul style="list-style-type: none"> • subscriber policy • operator policy • dnn policy • dnn profile
Add the deleted or new operator policy	No impact	Applies modified configuration for the following: <ul style="list-style-type: none"> • subscriber policy • operator policy • dnn policy • dnn profile
Modify the operator policy name in the subscriber map	No impact	Applies modified configuration for the following: <ul style="list-style-type: none"> • subscriber policy • operator policy • dnn policy • dnn profile

Troubleshooting Information

This section describes the troubleshooting information that enables you to resolve the service configuration issues.

Configuration Errors

This section describes the errors that cnSGW-C reports during the service configuration.

Subscriber Policy Configuration Errors

```
show config-error
ERROR
COMPONENT ERROR DESCRIPTION
-----
SGWProfile Subscriber policy name : polSubSgw in profile sgw1 is not configured
```

Operator Policy Configuration Errors

```
show config-error
ERROR COMPONENT ERROR DESCRIPTION
```

SubscriberPolicy Operator policy : op2 under subscriber policy polSubSgw is not configured

DNN Policy Configuration Errors

show config-error

ERROR COMPONENT ERROR DESCRIPTION

OperatorPolicy Dnn policy name : dnn_1 in operator policy opl is not configured



CHAPTER 43

SGW Charging Support

- [Feature Summary and Revision History, on page 579](#)
- [Feature Description, on page 579](#)
- [How it Works, on page 581](#)
- [Feature Configuration, on page 597](#)
- [CDR Fields Supported in cnSGW-CDRs, on page 608](#)
- [SGW Charging OAM Support, on page 640](#)

Feature Summary and Revision History

Summary Data

Table 210: Summary Data

Applicable Product(s) or Functional Area	cnSGW-C
Applicable Platform(s)	SMI
Feature Default Setting	Enabled - Always-on
Related Documentation	Not Applicable

Revision History

Table 211: Revision History

Revision Details	Release
First introduced.	2021.02.0

Feature Description

cnSGW-c supports the following:

- GTPP charging (Gz) interface
- Monitor subscriber for Charging Data Record (CDR)
- CDR dictionary: **custom24**
- Two custom file formats: **custom1** (default) and **custom5**
- One replica of GTPP-EP pod which is functional with active or standby mode (two pods get spawned when GTPP-EP pod configured with one instance)
- Writing CDR records to the local file system

Architecture

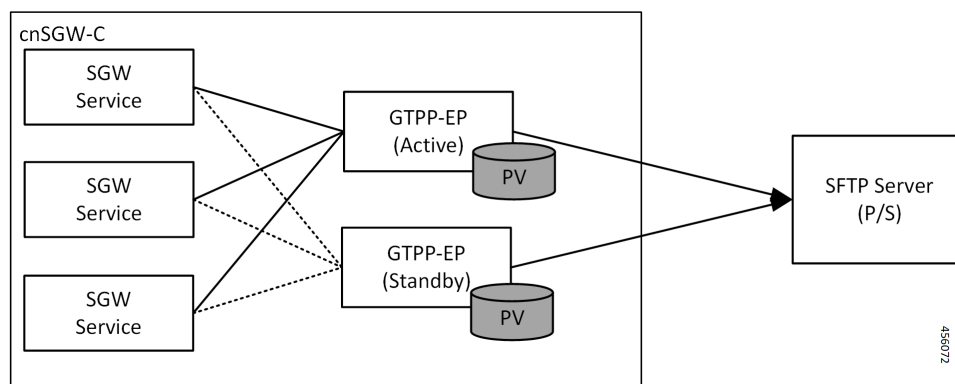

- GTP' (GTP Prime) or GTPP-EP is the new endpoint pod and interfaces with mediation or CGF server over SFTP
- GTP' attaches to the local disk (Persistent Volume). This attachment is with each server or virtual machine (VM)
- SGW-service generates CDRs and sends the records to the GTP' endpoint for the storage
- GTP' stores the CDRs in ASN.1 encoding in flat files in persistent storage
- GTP' pushes the flat files over SCTP towards the mediation server or CGF

The charging functionality is split into two parts.

- Accounting and CDR generation:
 - SGW-service generates usage reporting rule (URR) for each established bearer on the Sxa interface with SGW-U
 - SGW-service uses the reported usage information with the trigger event to generate accounting information
- CDR management and storage:
 - GTPP-EP microservice or K8 pod archives the CDRs and pushes the CDR files to the external storage server
 - GTPP-EP receives the proto-CDRs from SGW-service over the streaming GRPC IPC endpoint

- GTPP-EP encodes each received proto-CDR into ASN.1 format as specified in the dictionary (from CLI)
- The ASN.1 CDRs are written to flat files in the specified pattern as specified in the CLI configuration
- Transfers to the new CDR files to the configured external storage server using SFTP protocol periodically

Roaming Support

Roaming scenarios uses a Gz interface and offline accounting functions to match the CDR records with the foreign PGW.

The operator policy provides mechanisms to modify the behavior of subsets of subscribers described in the SGW profile. cnSGW-C supports call-control-profile under the operator-policy to control the accounting mode (enable or disable the charging) and define more charging configurations.

The default accounting mode is NONE which indicates charging is disabled.

The accounting mode value from the call control profile overrides the configured value in the SGW profile.

See the following configuration details:

- Call Control Profile Configuration
- Charging-Characteristics under Call-Control-Profile

How it Works

This section describes how this feature works.

Call Flows

This section describes the key call flows for this feature.

URR Installation on Initial Attach Call Flow

This section describes URR Installation on Initial Attach call flow.

Figure 114: URR Installation on Initial Attach Call Flow

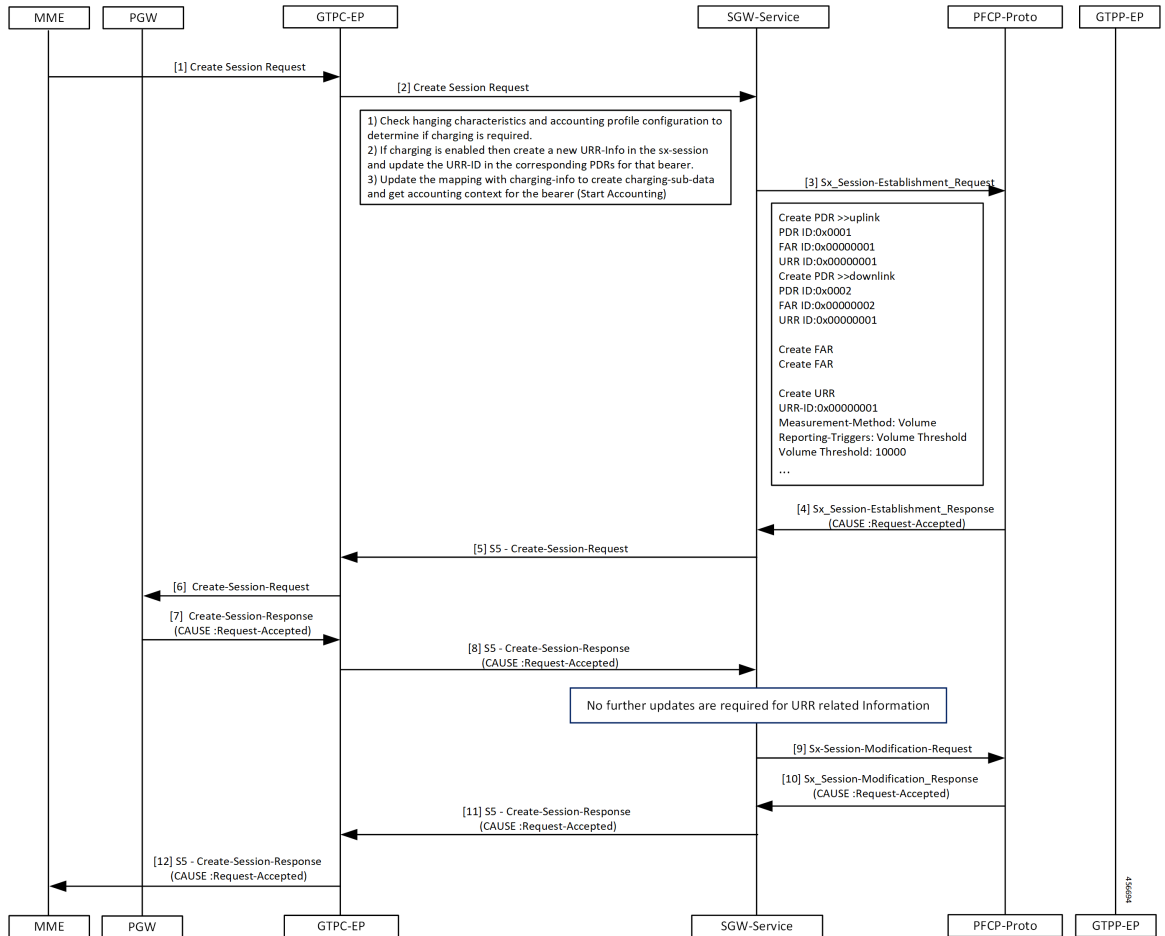

Table 212: URR Installation on Initial Attach Call Flow Description

Step	Description
1	The MME sends the Create Session Request to the GTPC-EP.
2	The GTPC-EP forwards the Create Session Request to the SGW-service pod.
3	The SGW-service pod sends the Sx Session Establishment Request to the PFCP proto
4	The PFCP proto sends the Sx Session Establishment Response to the SGW-service with the cause as Request-Accepted.
5	The SGW-service pod sends the S5 Create Session Request to the GTPC-EP.
6	The GTPC-EP sends the S5 Create Session Request to the PGW.
7	The PGW sends the Create Session Response to the GTPC-EP with the cause as Request-Accepted.
8	The GTPC-EP sends the S5 Create Session Response to the SGW-service with the cause as Request-Accepted.

Step	Description
9	The SGW-service pod sends the Sx Session Modification Request to the PFCP proto.
10	The SGW-service pod receives the Sx Session Modification Response from the PFCP proto with the cause as Request-Accepted.
11	The SGW-service pod sends the S5 Create Session Response to the GTPC-EP with the cause as Request-Accepted.
12	The GTPC-EP forwards the S5 Create Session Response to the MME with the cause as Request-Accepted.

SGW CDR Call Flow

This section describes the SGW CDR call flow.

Figure 115: SGW CDR Call Flow

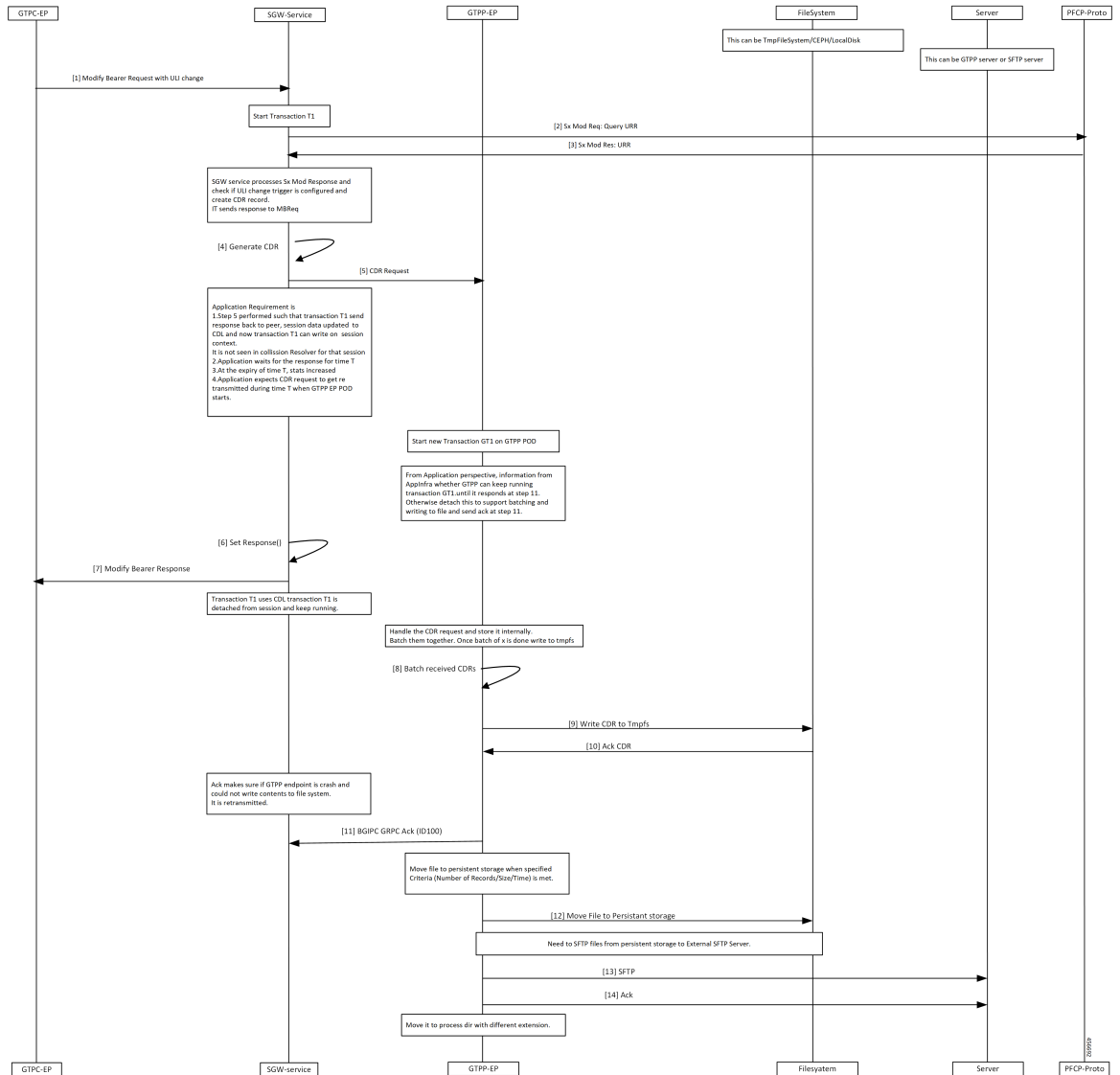

Table 213: SGW CDR Call Flow Description

Step	Description
1	The GTPC-EP sends the Modify Bearer Request with ULI to the SGW-service pod.
2	The SGW-service pod sends the Sx Mod Request with Query URR to the PFCP proto.
3	The SGW-service pod receives the Sx Mod Response with URR from the PFCP proto.
4	The SGW-service pod generate CDR.
5	The SGW-service pod sends the CDR request to the GTPP-EP.
6	The SGW-service pod triggers a set response () function.

Step	Description
7	The SGW-service pod sends the Modify Bearer Response to the GTPC-EP.
8	The GTPP-EP batches the received CDR requests .
9	The GTPP-EP sends the batched CDR requests to the TmpF5 file.
10	The GTPP-EP receives the CDR ACK from the file system.
11	The GTPP-EP sends GRPC ACK to the SGW-service.
12	The GTPP-EP moves the file to persistent storage when specified criteria (number of records or size or time) meets.
13	The GTPP-EP sends SFTP files from persistent storage to the server.
14	The GTPP-EP receives ACK from the server and moves it to the process directory with different extension.

URR Removal and CDR Reporting on Detach Call Flow

This section describes URR Removal and CDR Reporting on Detach call flow.

Figure 116: URR Removal and CDR Reporting on Detach Call Flow

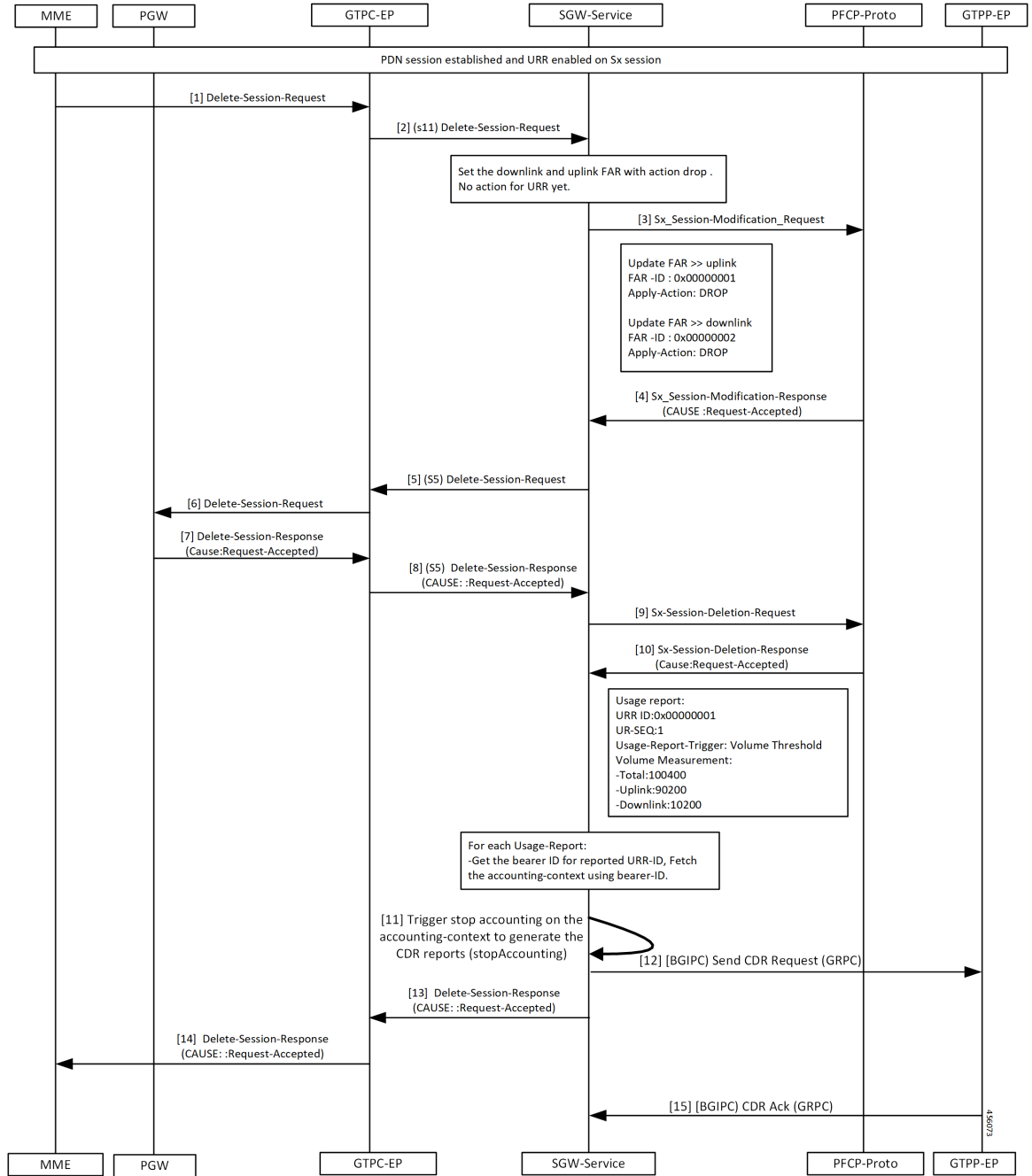

Table 214: URR Removal and CDR Reporting on Detach Call Flow Description

Step	Description
1	A PDN session is established and URR is enabled for Sx session. The MME sends the Delete Session Request to the GTPC-EP.

Step	Description
2	The GTPC-EP forwards the S11 Delete Bearer Request to the SGW-service pod.
3	The SGW-service pod sends the Sx Session Modification Request to the PFCP proto.
4	The PFCP proto sends the Sx Session Modification Response to the SGW-service pod with the cause as Request-Accepted.
5	The SGW-service pod sends the S5 Delete Session Request to the GTPC-EP.
6	The GTPC-EP sends the Delete Session Request to the PGW.
7	The PGW sends the Delete Session Response to the GTPC-EP with the cause as Request-Accepted.
8	The GTPC-EP sends the S5 Delete Session Response to the SGW-service pod with the cause as Request-Accepted.
9	The SGW-service pod sends the Sx Session Delete Request to the PFCP proto.
10	The SGW-service pod receives the Sx Session Delete Response from the PFCP proto with the cause as Request-Accepted.
11	The SGW-service pod triggers the CDR generation.
12	The SGW-service pod sends the CDR request to the GTPP-EP.
13	The SGW-service pod sends the Delete Session Response to the GTPC-EP with the cause as Request-Accepted.
14	The GTPC-EP pod forwards the Delete Session Response to the MME with the cause as Request-Accepted.
15	The GTPP-EP sends the CDR ACK to the SGW-service pod.

Usage Report on Hitting Threshold Call Flow

This section describes Usage Report on Hitting Threshold call flow.

Figure 117: Usage Report on Hitting Threshold Call Flow

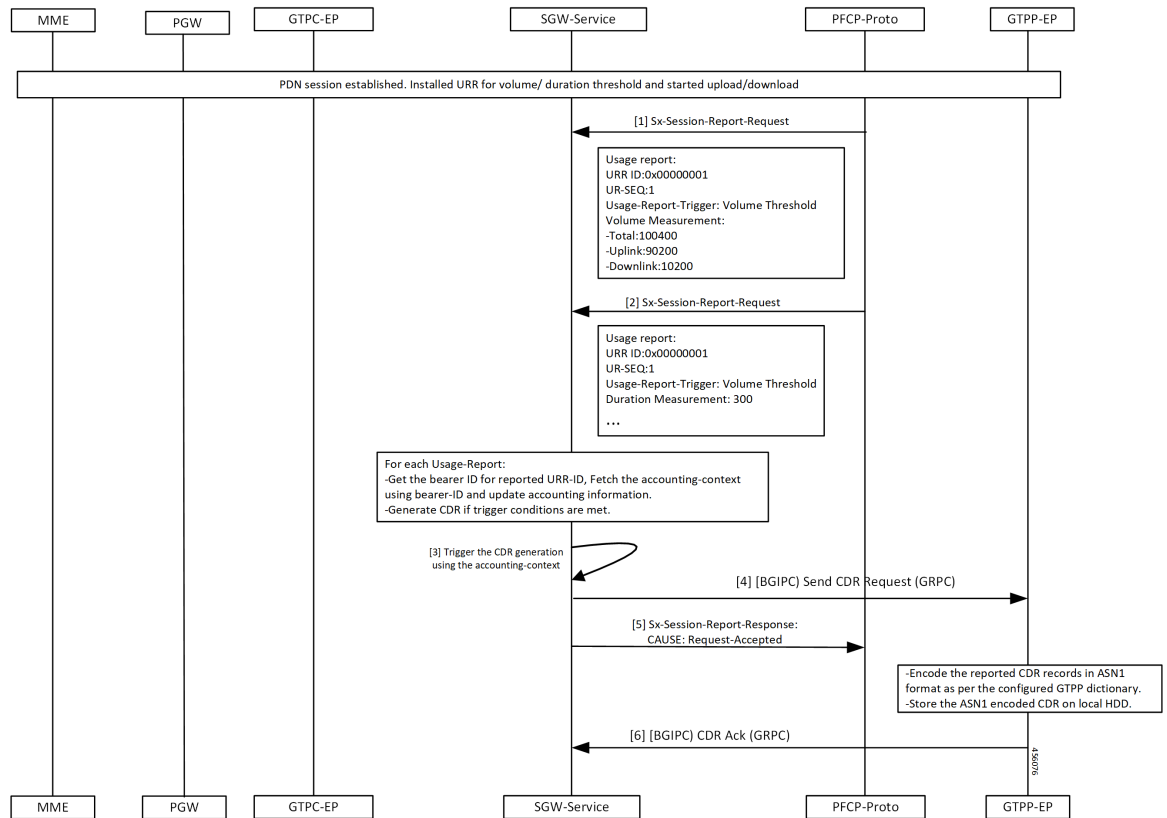

Table 215: Usage Report on Hitting Threshold Call Flow Description

Step	Description
1	Established a PDN session. Installed URR for the threshold duration. Trigger upload and download. The PFCP proto sends the Sx Session Report Request to the SGW-service pod.
2	The PFCP proto sends the Sx Session Report Request to the SGW-service pod until it reaches the threshold value of the User-plane.
3	The SGW-service pod triggers the CDR generation.
4	The SGW-service pod sends the CDR request to the GTPP-EP.
5	The SGW-service pod sends the Sx Session Report Response to the PFCP proto with the cause as Request-Accepted.
6	The GTPP-EP sends the CDR ACK to the SGW-service pod.

URR Installation for Dedicated Bearer Call Flow

This section describes the URR Installation for Dedicated Bearer call flow.

Figure 118: URR Installation for Dedicated Bearer Call Flow

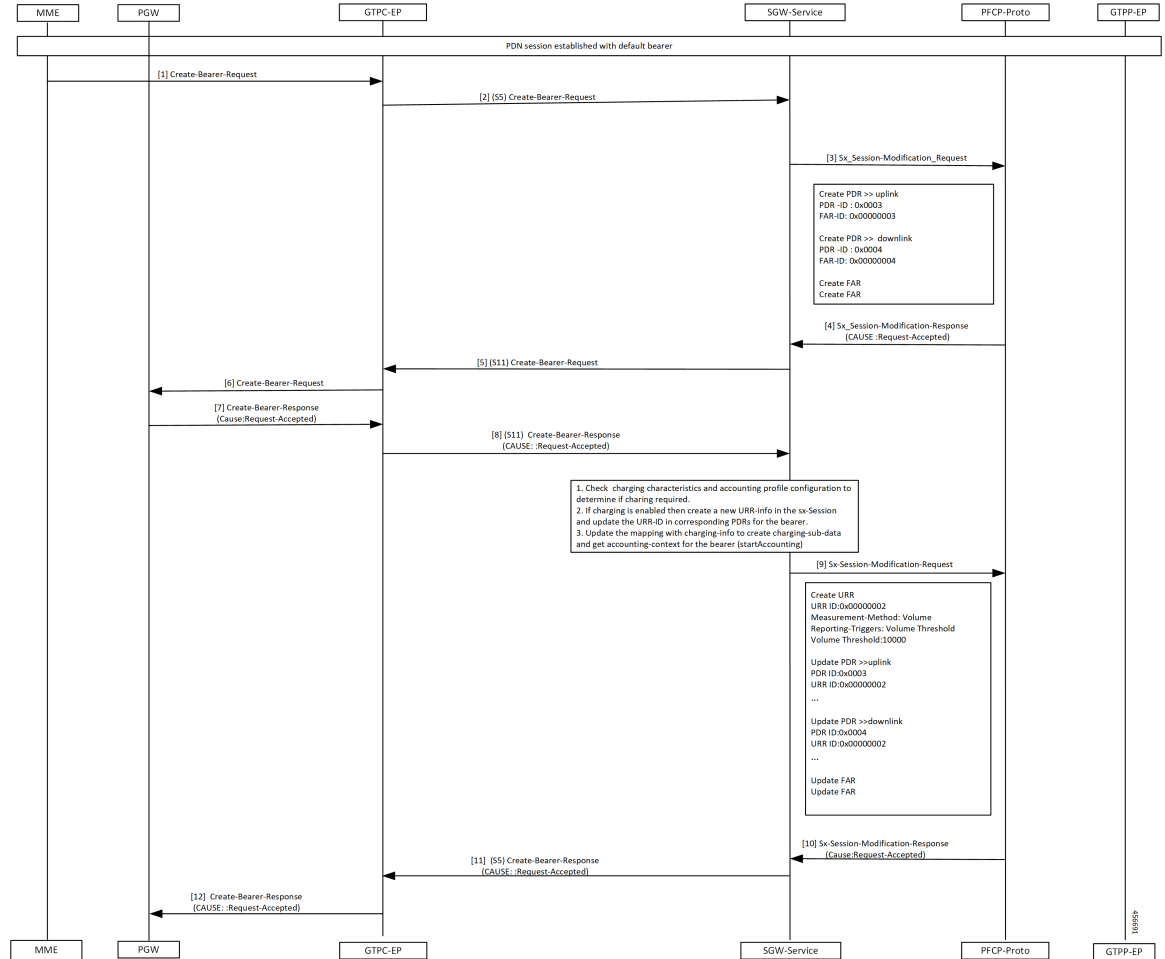

Table 216: URR Installation for Dedicated Bearer Call Flow Description

Step	Description
1	Established a PDN session with a default bearer. The PGW sends the Create Bearer Request to the GTPC-EP.
2	The GTPC-EP forwards the S5 Create Bearer Request to the SGW-service pod.
3	The SGW-service pod sends the Sx Session Modification Request to the PFCP proto.
4	The PFCP proto sends the Sx Session Modification Response to the SGW-service pod with the cause as Request-Accepted.
5	The SGW-service pod sends the S11 Create Bearer Request to the GTPC-EP.

Step	Description
6	The GTPC-EP forwards the S11 Create Bearer Request to the MME.
7	The GTPC-EP receives the Create Bearer Response to the GTPC-EP with the cause as Request-Accepted.
8	The GTPC-EP forwards the S11 Create Bearer Response to the SGW service with the cause as Request-Accepted.
9	The SGW-service pod sends the Sx Session Modification Request to the PFCP proto.
10,	The PFCP proto sends the Sx Session Modification Response to the SGW-service pod with the cause as Request-Accepted.
11	The SGW-service pod sends the S5 Create Bearer Response to the GTPC-EP with the cause as Request-Accepted.
12	The GTPC-EP sends the Create Bearer Response to the PGW with the cause as Request-Accepted.

URR Removal and CDR Generation on Deletion of Dedicated Bearer Call Flow

This section describes the URR Removal and CDR Generation on Deletion of Dedicated Bearer call flow.

Figure 119: URR Removal and CDR Generation on Deletion of Dedicated Bearer Call Flow

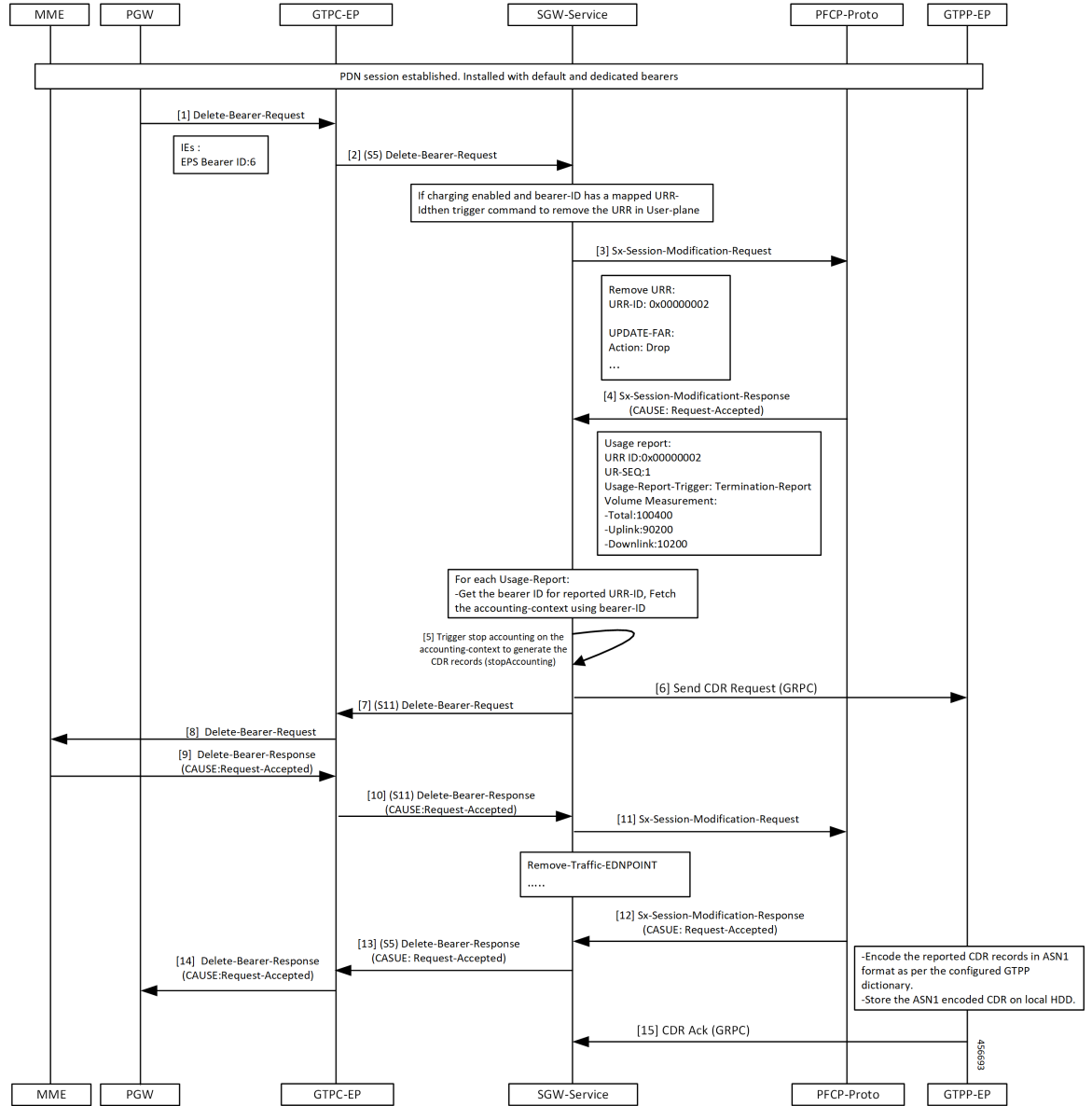

Table 217: URR Removal and CDR Generation on Deletion of Dedicated Bearer Call Flow Description

Step	Description
1	Established a PDN session with the default and dedicated bearer. The PGW sends the Delete Bearer Request to the GTPC-EP.
2	The GTPC-EP forwards the S5 Delete Bearer Request to the SGW-service pod.

Step	Description
3	The SGW-service pod requests a usage report query when charging enabled with QoS trigger and QoS change detected. The SGW-service pod sends the Sx Session Modification Request to the PFCP-Proto.
4	The PFCP proto sends the Sx Session Modification Response to the SGW-service pod with the cause as Request-Accepted.
5	The SGW-service pod triggers the CDR generation and sends CDR request to the GTPP-EP.
6	The SGW-service pod sends the S5 Sx Modify Bearer Request to the GTPP-EP.
7	The SGW-service pod sends the S11 Delete Bearer Request to the GTPC-EP.
8	The GTPC-EP forwards the Delete Bearer Request to the MME.
9	The GTPC-EP receives the Delete Bearer Response from the MME with the cause as Request-Accepted.
10	The GTPC-EP forwards the S11 Delete Bearer Response to the SGW-service pod with the cause as Request-Accepted.
11	The SGW-service pod sends the Sx Session Modification Request to the PFCP proto.
12	The SGW-service pod receives the Sx Session Modification Response from the PFCP proto with the cause as Request-Accepted.
13	The SGW-service pod sends the S5 Delete Bearer Response to the GTPC-EP with the cause as Request-Accepted.
14	The GTPC-EP sends the Delete Bearer Response to the PGW with the cause as Request-Accepted.
15	The PFCP proto sends the CDR ACK to the SGW-service pod.

Volume Reporting on S11 Trigger Call Flow

This section describes Volume Reporting on S11 Trigger call flow.

Figure 120: Volume Reporting on S11 Trigger Call Flow

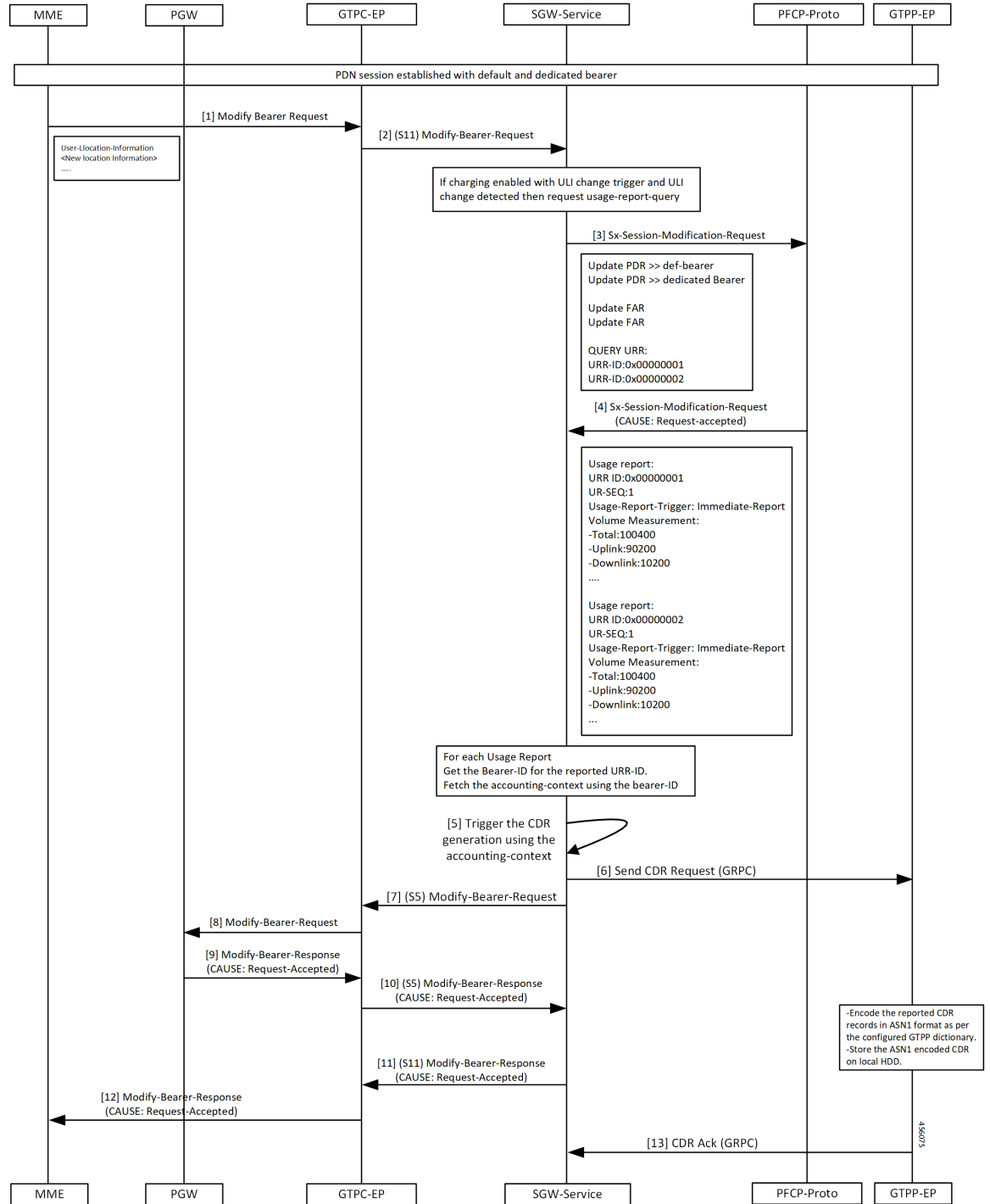

Table 218: Volume Reporting on S11 Trigger Call Flow Description

Step	Description
1	Established a PDN session with the default and dedicated bearers. The MME sends Modify Bearer Request to the GTPC-EP.
2	The GTPC-EP forwards the S11 Modify Bearer Request to the SGW-service pod.
3	The SGW-service pod requests the usage report query when charging enabled with QoS trigger and QoS change detected. The SGW-service pod sends the Sx session Modification Request to the PFCP proto.
4	The PFCP proto sends the Sx Session Modification Response to the SGW-service pod with the cause as Request-Accepted.
5	The SGW-service pod triggers the CDR generation.
6	The SGW-service pod sends the generated CDR request to the GTPP-EP.
7	The SGW-service pod sends the S5 Sx Modify Bearer Request to the GTPC-EP.
8	The GTPC-EP sends the Modify Bearer Request to the PGW.
9	The GTPC-EP receives the Modify Bearer Response from the PGW with the cause as Request-Accepted.
10	The GTPC-EP forwards the S5 Modify Bearer Response to the SGW-service pod with the cause as Request-Accepted.
11	The SGW-service pod sends the S11 Modify Bearer Response to the PGW with the cause as Request-Accepted.
12	The GTPC-EP sends the Modify Bearer Response to the MME with the cause as Request-Accepted.
13	The GTPP-EP sends the CDR ACK to the SGW-service pod.

Volume Reporting on S5 Trigger Call Flow

This section describes the Volume Reporting on S5 Trigger call flow.

Figure 121: Volume Reporting on S5 Trigger Call Flow

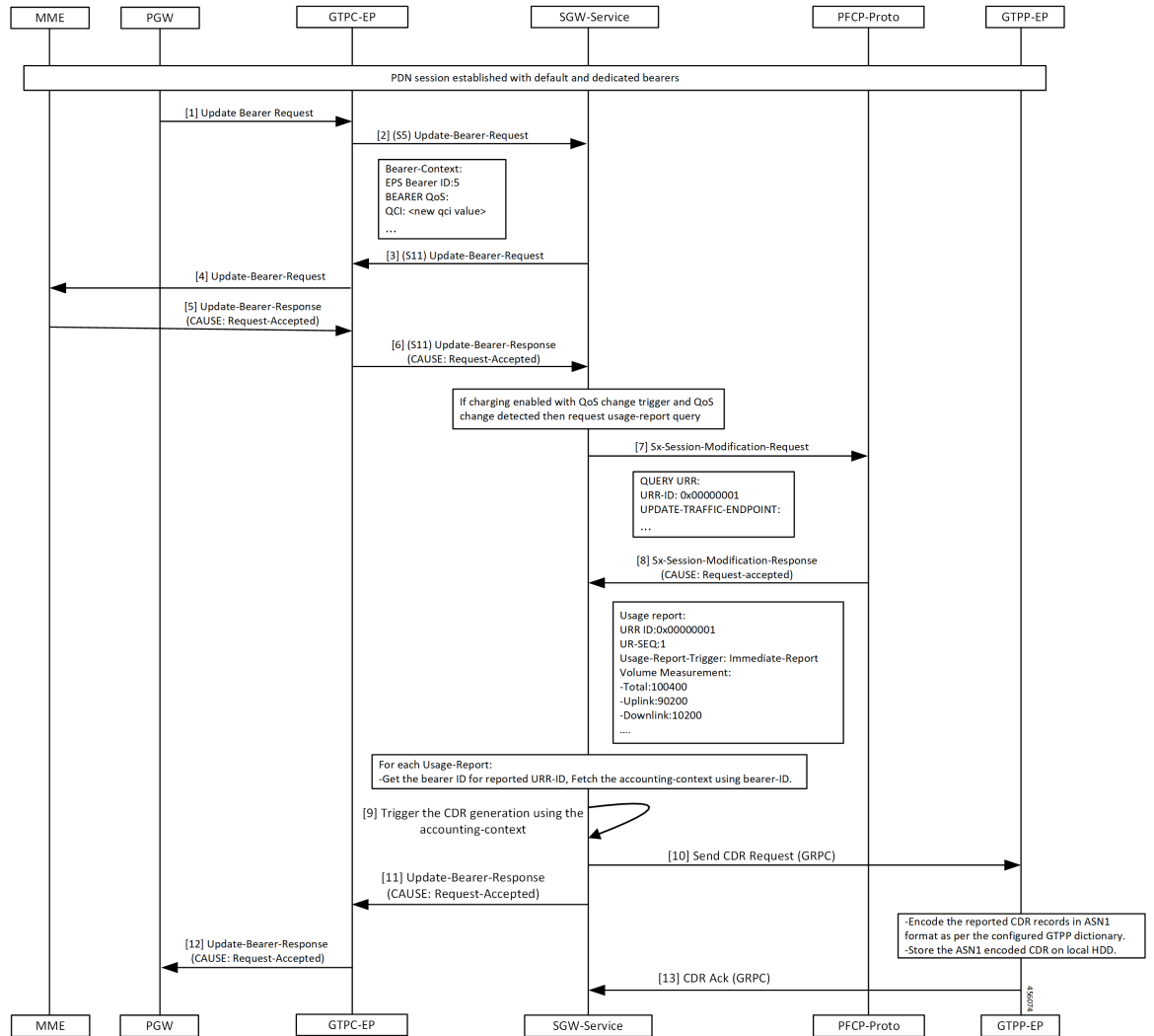

Table 219: Volume Reporting on S5 Trigger Call Flow Description

Step	Description
1	Established a PDN session with the default and dedicated bearers. The PGW sends the Update Bearer Request to the GTPC-EP.
2	The GTPC-EP forwards S5 Update Bearer Request to the SGW-service pod.
3	The SGW sends the Update Bearer request S11 to the GTPC-EP.
4	The GTPC-EP forwards the Update Bearer request to the MME.
5	The MME sends the Update Bearer Response to the GTPC-EP with the cause as Request-Accepted.

Step	Description
6	The GTPC-EP sends the S11 Update Bearer Response to the SGW-service pod with the cause as Request-Accepted.
7	The SGW-service pod requests the Usage report query when charging enabled with QoS trigger and QoS Change detected. The SGW-service pod sends the Sx Session Modification Request to the PFCP proto.
8	The SGW-service pod receives the Sx Session Modification Response from the PFCP proto with the cause as Request-Accepted.
9	The SGW-service pod triggers the CDR generation.
10	The SGW-service pod sends the CDR report to the GTPP-EP.
11	The GTPC-EP receives the Update Bearer response from the SGW-service pod with the cause as Request-Accepted.
12	The PGW forwards the S5 the Update Bearer response from the GTPC-EP with the cause as Request-Accepted.
13	The GTPP-EP sends the CDR ACK to the SGW-service pod.

Standards Compliance

The SGW Charging support complies with the following 3GPP standards:

- *3GPP TS 32.251 "Telecommunication management; Charging management; Packet Switched (PS) domain charging"*
- *3GPP TS 32.295 "Telecommunication management; Charging management; Charging Data Record (CDR) transfer"*
- *3GPP TS 32.297 "Telecommunication management; Charging management; Charging Data Record (CDR) file format and transfer"*
- *3GPP TS 32.298 "Telecommunication management; Charging management; Charging Data Record (CDR) parameter description"*

Limitations

This feature has the following limitations in this release:

- In 2021.02.0 release, cnSGW-C supports the following:
 - Charging with the converged UPF (UPF and SGW-U), after the UPF supports the collapsed-data path functionality
 - Enable or Disable of anp-mbr and node-id-prefix CDR attributes. Other cnSGW-C CDR attributes are enabled by default
 - Only encrypted-url configuration while performing push operation to a remote SFTP server

- In 2021.02.0 release, cnSGW-C does not support the following:
 - Monitor protocol doesn't support CDR
 - Served PDP or PDN Address Extension CDR attribute for the dual stack (IPv4v6) calls
 - Behavior bit. Default value is zero
 - Compression of CDR files
 - Purging of CDR files using user provided regex
- For cnSGW-C Charging Profile dynamic configuration:
 - You cannot remove the Charging Profile configuration dynamically. Before removing the Charging Profile configuration, the existing subscriber must be cleared.

Feature Configuration

Configuring this feature involves the following steps:

- CLI Configuration-This configuration provides commands to configure cnSGW-C charging profile, mode, threshold, and its characteristics. For more information, refer to [CLI Configuration, on page 597](#).
- Show CLI-This configuration provides the commands to display the SFTP push CLI. For more information, refer to [Show CLI, on page 608](#).

CLI Configuration

cnSGW-C charging CLI configuration involves the following steps:

- Charging Profile or GTP Prime-This configuration provides commands to configure cnSGW-C GTP profile. For more information, refer to [Configuring the cnSGW-C Charging Profile or GTP Prime, on page 598](#).
- Charging Mode-This configuration provides commands to configure the cnSGW-C charging mode. For more information, refer to [Configuring the Charging Mode, on page 603](#).
- Charging Threshold-This configuration provides commands to configure the cnSGW-C charging threshold. For more information, refer to [Configuring the cnSGW-C Charging Threshold, on page 603](#).
- Charging Threshold and Charging Profile Association-This configuration provides commands to configure cnSGW-C charging threshold and cnSGW-C charging profile association. For more information, refer to [Configuring cnSGW-C Charging Threshold and cnSGW-C Charging Profile Association, on page 605](#).
- Call Control Profile-This configuration provides commands to configure cnSGW-C call control profile. For more information, refer to [Configuring Call Control Profile, on page 606](#).
- Charging Characteristics Under Call Control Profile-This configuration provides commands to configure cnSGW-C charging characteristics under call control profile. For more information, refer to [Configuring Charging Characteristics Under Call Control Profile, on page 607](#).

Configuring the cnSGW-C Charging Profile or GTP Prime



Note

- cnSGW-C charging supports multiple replicas of GTP Prime.
- cnSGW-C switches from primary storage server to secondary storage server on four consecutive failures with the primary storage server. It switches back to primary storage server on four consecutive failures to secondary storage server or after 30 minutes of switchover from primary storage server to secondary storage server whichever is earlier.
- When CDR file storage reaches beyond 95% of its allocated size, then old CDR files are deleted.

Configuring cnSGW-C charging profile or GTP prime involves the following steps:

- GTPP profile-This configuration provides commands to configure cnSGW-C GTPP profile. For more information, refer to [Configuring the GTPP Profile, on page 598](#).
- Existing endpoint-related CLI-This configuration provides commands to configure cnSGW-C existing endpoint-related CLI. For more information, refer to [Configuring the GTPP Endpoint, on page 601](#).
- SGW charging profile--This configuration provides commands to configure cnSGW-C GTPP profile. For more information, refer to [Configuring SGW Charging Profile, on page 601](#).

Configuring the GTPP Profile

You can configure server details, dictionary, timeout, and so on, to use by the GTPP-EP pod.

To configure the GTPP profile, use the following configuration:

```

config
  profile gtp-profile profile_name gtp
    local-storage
      file
        rotation
          volume volume_value
          cdr-count cdrcount_value
          time-interval interval_value
        exit
      name
        prefix prefix_value
        format format
        max-file-seq-num max_sequence_number
        start-file-seq-num start_sequence_number
        recover-file-seq-num { true | false }
      exit
    purge-processed-files purge-interval purgeinterval_value
  exit
push
  encrypted-url url_name
  encrypted-secondary-url url_name
  exit
exit

```

```

dictionary custom_value
end

```

NOTES:

- **local-storage**—Local storage details.
- **file**—Specify the file details.
- **rotation**—Specify the file rotation details.
- **volume** *volume_value*—Specify the file volume in MiB for file rotation. Must be an integer in the range of 2-40. Default value is 4.
- **cdr-count** *cdrcount_value*—Specify the CDR count for file rotation. Must be an integer in the range of 1000-65000. Default value is 10000.
- **time-interval** *interval_value*—Specify the time interval in seconds for file rotation. Must be an integer in the range of 30-86400. Default value is 3600.
- **prefix** *prefix_value*—Specify the file name prefix to be used. If the prefix value isn't specified, the configuration takes default profile name.
- **format** *format*—Specify the file name format to be used to override the name format associated with the file format.
- **max-file-seq-num** *max_sequence_number*—Specify the maximum file sequence number to rollover. Default value is 4294967295.
- **start-file-seq-num** *start_sequence_number*—Specify the start sequence number during rollover. Default value is 1.
- **recover-file-seq-num** { **true** | **false** }—When set to true, file sequence number continues from the last sequence number on application restart. Default value is false.
- **purge-processed-files** —Enables periodic purging of processed files.
- **purge-processed-files** **purge-interval** *purgeinterval_value*—Specify the purging interval of processed files in minutes. Default value is 60.
- **encrypted-url**—Specify the primary SFTP URL to push CDR files to.
- **encrypted-secondary-url**—Specify the secondary SFTP URL to push when push fails on primary host.
- **dictionary** *custom_value*—Specify the dictionary to be used to ASN.1 encode a CDR.

**Note**

- The path in SFTP URL is by default a relative path to home directory of SFTP URL user specified in URL.

Example: encrypted-url sftp://user:pass@example.com:2020/upload/pf1. It pushes files to %USER_HOME/upload/pf1

Example: encrypted-url sftp://user:pass@example.com:2020. It pushes files to %USER_HOME

- To upload files to a folder outside the user's home directory, configure an absolute path by preceding the path with // at the beginning of the SFTP server path.

Example: encrypted-url sftp://user:pass@example.com:2020//var/opt. It pushes the files to absolute path /var/opt

SFTP user must have the write access to this path for the upload to be successful.

If password contains any special character outside the permissible URL character set, they must be percent coded as per the RFC 3986. For example, a URL with password `pass!word`, entered as `sftp://user:pass%21word@example.com/path/to/folder`

Configuration Example

The following is an example configuration.

```

config
  profile gtp-profile pf1 gtp
    local-storage
      file
        rotation
          volume 5
          cdr-count 1000
          time-interval 60
          exit
          name
            prefix NYPCF508
            format .%Y-%m-%d%H-%M-%S.%4Q
            max-file-seq-num 4
            start-file-seq-num 1
            recover-file-seq-num false
          exit
        purge-processed-files purge-interval 10
      exit
    push
      encrypted-url sample.com sftp://user:pass@example.com//var/opt
      encrypted-secondary-url sftp://user:pass@mirror.example.com//var/opt
    exit
  exit
  dictionary custom24
end

```

Configuring the GTPP Endpoint



- Note**
- GTPP-EP pod uses this configuration.
 - GTPP-EP pod always ignores nodes configuration.
 - When **k8s single-node** is set to **false**, it spawns two replicas of GTPP-EP pod in active or standby mode independent of replicas and nodes configuration.
 - When **k8s single-node** is set to **true**, the configured replicas have its impact.
 - When **k8s use-volume-claim** is set to **true**, endpoint GTP prime is used to set the storage size limit. Default value of storage size limit is one GB.
 - When system is up and running, we can't change the storage size.

To configure GTPP endpoint, use the following commands:

```
config
instance instance-id instance_id
  endpoint gtpprime
    replicas replicas_count
    nodes nodes_count
    storage storage_capacity
  end
```

NOTES:

- **replicas** *replicas_count*—Specify the number of replicas per node. Must be an integer.
- **nodes** *nodes_count*—This property is ignored. You may skip configuring it.
- **storage** *storage_capacity*—Specify the storage size of persistent volume in GB. Must be an integer in the range of 1-20.



- Note** CLI doesn't allow changing storage size while system is running. To change the storage size, bring the system down first.

Configuration Example

The following is an example configuration.

```
config
instance instance-id 1
  endpoint gtpprime
    replicas 1
    storage 2
  end
```

Configuring SGW Charging Profile

This section describes how to configure SGW Charging profile.

You can configure the SGW charging profile for the following:

- Attribute details and adding them to the CDRs
- Different triggers in generating CDR

SGW service pod uses this configuration in cnSGW-C charging.

Use following commands to configure cnSGW-C charging profile.

```

config
  profile sgw-charging-profile profile_name
    gtpv-triggers
      volume-limit { enable | disable }
      time-limit { enable | disable }
      serving-node-change-limit { enable | disable }
      serving-node-plmn-change { enable | disable }
      uli-change { enable | disable }
      qos-change { enable | disable }
      ms-timezone-change { enable | disable }
    gtpv-attributes
      apn-ambr
        include-for-all-bearers
        include-for-default-bearer
        include-for-non-gbr-bearers
      node-id-suffix suffix_value
      gtpv-profile association_profile_name
    exit

```



Note The value of `node-id-suffix` is implementation-specific. However, it's recommended to give same value as prefix configured as a part of GTPV Profile.

NOTES:

- **apn-ambr**—Includes APN-AMBR value in CDR.
- **node-id-suffix** *suffix_value*—Specify the node ID suffix to include in NodeId field of CDR.
- **ms-timezone-change** { **enable** | **disable** }—Specify enable or disable the MS time zone change as a trigger for CDR generation. Default value is enable.
- **qos-change** { **enable** | **disable** }—Specify enable or disable the QoS change as a trigger for container addition to CDR. Default value is enable.
- **serving-node-change-limit** { **enable** | **disable** }—Specify enable or disable the serving node change (address) as a trigger for CDR generation. Default value is enable.
- **serving-node-plmn-change** { **enable** | **disable** }—Specify enable or disable the serving node PLMN change as a trigger for CDR generation.
- **time-limit** { **enable** | **disable** }—Specify enable or disable the time limit breach as a trigger for CDR generation. Default value is enable.

- **uli-change { enable | disable }**—Specify enable or disable the ULI change as a trigger for container addition to CDR. Default value is enable.
- **volume-limit { enable | disable }**—Specify enable or disable the volume limit breach as a trigger for CDR generation. Default value is enable and that is included in NodeId field of CDR.

Configuration Example

The following is an example configuration.

```
config
  profile sgw-charging-profile chl
    gtp-headers volume-limit enable
    gtp-headers time-limit enable
    gtp-headers serving-node-change-limit disable
    gtp-headers uli-change enable
    gtp-headers qos-change disable
    gtp-headers ms-timezone-change disable
    gtp-headers apn-ambr include-for-all-bearers
    gtp-headers node-id-suffix test
    gtp-profile pfl
  end
```

Configuring the Charging Mode

Charging mode configures the cnSGW-C service mode for accounting GTPP or none (default).



Note Enable offline charging when charging mode is set to GTPP.

To configure charging mode, use the following configuration:

```
config
  profile sgw sgw_srv_name
    charging-mode { gtp | none }
    sgw-charging-threshold sgw_threshold_name
    sgw-charging-profile sgw_charging_profile_name
  end
```

NOTES:

- **charging-mode { gtp | none }**—Specify cnSGW-C charging mode.
- **sgw-charging-threshold *sgw_threshold_name***—Specify the name of associated cnSGW-C charging threshold
- **sgw-charging-profile *sgw_charging_profile_name***—Specify the name of associated cnSGW-C charging profile

Configuring the cnSGW-C Charging Threshold

cnSGW-C charging threshold configuration helps in configuring the thresholds or limits corresponding to volume or duration or buckets per CC (charging-characteristics).

Configuration of cnSGW-c charging threshold can be done in two ways.

Method - 1

```

config
  profile sgw-charging-threshold threshold_name
    cc profile value cc_profile_value
    volume total total_value
    buckets buckets_value
    duration duration_value
  end

```

Method - 2

```

config
  profile sgw-charging-threshold threshold_name
    cc profile value cc_profile_value
    volume
      total total_value
      uplink uplink_value
      downlink downlink_value
    volume total
    buckets buckets_value
    serving-node-changes node_changes_value
    duration duration_value
  end

```

NOTES:

- **buckets** *buckets_value*—Specify the number of traffic volume container changes due to QoS change or other triggers before an accounting record must be closed. It ranges 1–20 and the default value is 4.
- **duration** *duration_value*—Specify the normal time duration that must elapse before closing an accounting record.
- **volume total**—Specify the CC volume details.

Configuration Example

The following is an example configuration:

```

config
  profile sgw-charging-threshold thre1
    cc profile value 1
    volume total 100000
    buckets 1
    duration 60
  end

config
  profile sgw-charging-threshold thre1
    cc profile value 2
    volume uplink 100000
    volume downlink 100000
    buckets 1
    serving-node-changes 4
    duration 120
  end

```



Note When **gtp-*triggers-serving-node-change-limit*** is enabled and **servicing-node-changes** configured under SGW charging threshold, CDR gets generated after 4 times serving node changes (MME).

Configuring cnSGW-C Charging Threshold and cnSGW-C Charging Profile Association

This section describes how to configure the SGW Charging Threshold and SGW Charging profile association.

This configuration associate **sgw-charging-threshold** and **sgw-charging-profiles** to the SGW profile.

Configuration of cnSGW-c charging threshold and cnSGW-c charging profile association can be done in two ways.

Method - 1

To configure cnSGW-c charging threshold and cnSGW-c charging profile association, use the following commands.

```
config
  profile sgw sgw_srv_name
    locality location_code
    fqdn dnn_name
    plmn-id
      mcc mcc_value
      mnc mnc_value
    charging-mode { gtp | none }
    sgw-charging-profile value
    sgw-charging-threshold limit_name
  end
```

Method - 2

Use the following commands to configure SGW Charging Threshold and SGW Charging Profile association.

```
config
  profile sgw sgw_srv_name
    sgw-charging-threshold threshold_value
    locality location_code
    fqdn dnn_name
    charging-mode mode_name
    subscriber-policy policy_name
  end
```

Configuration Example

The following is an example configuration.

```
config
  profile sgw sgw1
    locality LOC1
    fqdn 209.165.200.254
    allowed-nssai [ slice1 ]
    plmn-id mcc 123
    plmn-id mnc 456
    charging-mode gtp
```

```

sgw-charging-profile chl
sgw-charging-threshold limit1
end

config
profile sgw sgw1
sgw-charging-threshold thre1
locality LOC1
fqdn 209.165.200.254
charging-mode none
subscriber-policy polSub
end

```

Configuring Call Control Profile

Call control profile configuration defines and applies the call handling rules through an operator policy.

The charging mode value from the call control profile overrides the configured value in cnSGW-C profile.



-
- Note**
- One call control profile is associated with one operator policy
 - It's a standalone configuration
-

Configuring cnSGW-C call control profile involves the following steps:

- Call Control Profile Creation-This configuration provides commands to configure cnSGW-C call control profile Creation. For more information, refer to [Configuring the Call Control Profile Creation, on page 606](#).
- Operator Policy Association-This configuration provides commands to configure cnSGW-operator policy association. For more information, refer to [Configuring the Operator Policy Association, on page 606](#).

Configuring the Call Control Profile Creation

To configure the call control profile creation, use the following configuration:

```

config
policy call-control-profile call_control_profile_name
charging-mode sgw_charging_mode
sgw-charging-profile assocaited_sgw_charging_profile
end

```

Configuration Example

The following is an example configuration.

```

config
policy call-control-profile ccp1
charging-mode gtp
sgw-charging-profile chl
end

```

Configuring the Operator Policy Association

To configure the operator policy association, use following configuration:

```

config
  policy operator operator_name
  policy dnn dnn_policy_name
  policy network-capability network_name
  call-control-profile value
end

```

Configuration Example

The following is an example configuration.

```

config
  policy operator opPoll
  policy dnn polDnn
  policy network-capability ncl
  call-control-profile ccpl
end

```

Configuring Charging Characteristics Under Call Control Profile

You can define local values and select the source of charging characteristics for charging decisions.

To configure charging characteristics under call control profile, use the following configuration:

```

config
  policy call-control-profile call_control_profile_name
    sgw-charging-profile charging_type
    charging-mode mode_type
    cc prefer preference_type
    cc local-value profile index_bit
  end

```

NOTES:

- **cc prefer local-value** and **cc prefer hlr-hss-value** are optional parameters.
- **cc prefer { hlr-hss-value | local-value }**—Specify a preference to use in charging characteristics from the following:
 - When received from HLR or HSS through MME and preference set to hlr-hss.
 - When preference set to local-value. See the following CLI:

```

cc prefer local-value
cc local-value profile index-bit

```
- **cc local-value profile** —Specify the local-value parameter information as follows:
 - *index_bit* default value is 8
 - Sets the local value of the profile index for the charging characteristics, when the charging characteristics(CC) prefer value is set to local-value

Configuration Example

The following is an example configuration.

```

config
  policy call-control-profile CCP

```

```

sgw-charging-profile test
charging-mode gtp
cc prefer local-value
cc local-value profile 4
end

config
policy call-control-profile CCP1
sgw-charging-profile test
charging-mode gtp
cc prefer hlr-hss-value
end

```



Note Use the system default configured value as 8 otherwise use the value which comes in CSR.

```

config
policy call-control-profile CCP2
sgw-charging-profile test
charging-mode gtp
cc prefer local-value
end

```



Note Default value for cc profile is 8.

Show CLI

GTPP-EP SFTP Push CLI

- **show gtp-ep endpoints:** Displays the list of running GTPP-EP pods and their corresponding IPs
- **show gtp-ep files endpoint *pod-name* profile *gtp-profile_name*:** Displays the archived files on specific GTPP-EP pod for the given gtp
- **cdr push endpoint *pod-name* profile *gtp-profile* filename *file-to-be-uploaded*:** Pushes the available file to archive folder on specific GTPP-EP pod for given GTPP profile.

CDR Fields Supported in cnSGW-CDRs

The tables in this section list the cnSGW-CDR fields present in the available dictionaries.

custom24 Dictionary

Table 220: custom24 Dictionary Description

Field Name	Tag Number	Category	Description	Format	Size (in bytes)	ASN1 code
Record Type	0	M	SGW IP-CAN bearer record.	Integer	1	0x80

Field Name	Tag Number	Category	Description	Format	Size (in bytes)	ASN1 code
Served IMSI	3	M	IMSI of the served party.	BCD encoded octet string	3-8	0x83
S-GW Address	4	M	The control plane IP address of the SGW used.	Choice	6 (IPv4) or 18 (IPv6)	0xa4
S-GW BINARY IPV4 ADDRESS	4-0	M	The octet string includes the Gn address of the GGSN service in binary coding.	Octet string	4	0x80
S-GW BINARY IPV6 ADDRESS	4-0	M	The octet string included in the field described includes the Gn address of the GGSN service in binary coding.	Octet string	16	0x81
Charging ID	5	M	IP-CAN bearer identifier. To identify IP-CAN bearers created by PCNs in different records	Integer	1-5	0x85
List of Serving Node Address	6	M	List of serving node control plane IP addresses (Example: SGSN, MME) used during this record.	Sequence	6 to 90	0xa6

Field Name	Tag Number	Category	Description	Format	Size (in bytes)	ASN1 code
Serving Node BINARY IPV4 ADDRESS	6-0	M	The octet string included in the field described above includes the IPv4 address of the MME.	Octet string	4	0x80
Serving Node BINARY IPV6 ADDRESS	6-0	M	The octet string included in the Serving node binary IPv4 address field includes the IPV6 address of the MME.	Octet string	16	0x81
Access point name network identifier	7	M	The logical name of the connected access point to the external packet data network (network identifier part of APN).	IA5 string	1-63	0x87
PDP/PDN Type	8	M	This field indicates PDN type (Example IPv4, IPv6 or IPv4v6).	Octet string (SIZE(2))	2	0x88

Field Name	Tag Number	Category	Description	Format	Size (in bytes)	ASN1 code
Served PDP/PDN Address	9	M	IP address allocated for the PDP context or PDN connection, if available. IPv4 when PDN type is IPv4 or IPv6 when PDN type is IPv6 or IPv4v6.	Choice	8 (IPv4) or 20 (IPv6)	0xa9
PDP IP Address	9-0	M	This field contains the IP address for the PDP context.	Choice	6 (IPv4) or 18 (IPv6)	0xa0
PDP IPv4 Address	9-0-0	M	The octet string included in the PDP IP address field includes the the SGW assigned IPv4 address to the subscriber in binary format.	Octet string	4	0x80
PDP IPv6 Address	9-0-0	M	The octet string included in the PDP IP address field includes the IPv6 address assigned to the subscriber by the SGW in binary coding.	Octet string	16	0x81

Field Name	Tag Number	Category	Description	Format	Size (in bytes)	ASN1 code
Dynamic Address Flag	11	O	Indicates whether served PDP/PDN address is dynamic, which is allocated during IP-CAN bearer activation, initial attach (E-UTRAN or over S2x) and UE requested PDN connectivity. This field is missing if address is static.	Boolean	1	0x8b
List of Traffic Data Volumes	12	M	A list of changes in charging conditions for QCI, ARP pair, each change is time stamped. Charging conditions categorize traffic volumes, such as per tariff period. Initial and subsequently changed QoS and corresponding data values are also listed.	Sequence	—	0xac

Field Name	Tag Number	Category	Description	Format	Size (in bytes)	ASN1 code
Change of charging condition	12-0	M	Each traffic volume container contains details of a charging condition. A new container is usually created for a QoS change and for tariff changes.	Sequence	—	0x30
Data Volume GPRS Uplink	12-0-3	M	This field is a part of the ChangeOfCharCondition element in the List of Traffic Volumes. It includes the number of octets received in the uplink direction during the timeframe specified by the container. For each new container, the counter is reset and does not accumulate.	Integer	1-5	0x83

Field Name	Tag Number	Category	Description	Format	Size (in bytes)	ASN1 code
Data Volume GPRS Downlink	12-0-4	M	This field is a part of the ChangeOf CharCondition element in the List of Traffic Volumes. It includes the number of octets transmitted in the downlink direction during the timeframe specified by the container. For each new container, the counter is reset and does not accumulate.	Integer	1-5	0x84
Change Condition	12-0-5	M	This field is part of the ChangeOf CharCondition element in the List of Traffic Volumes. It defines the change in user plane to UE.	Enumerated	1	85 01

Field Name	Tag Number	Category	Description	Format	Size (in bytes)	ASN1 code
Change Time	12-0-6	M	This field is part of the ChangeOfCharCondition element in the List of Traffic Volumes. It provides the local time when a change condition (example: record closure) occurred and the container is closed.	BCD encoded octet string	9	0x86
User Location Information	12-0-8	O	This field contains the User Location Information.	Octet string	8-33	0x88

Field Name	Tag Number	Category	Description	Format	Size (in bytes)	ASN1 code
EPC QoS Information	12-0-9	O	In case of IP-CAN bearer specific container, this field contains authorized QoS for the IP-CAN bearer. First container for each QCI/ARP pair includes this field. In the following containers this field is present if previous change condition is "QoS change". This field is applicable only in SGW-CDR.	Octet string	18-42	0xa9

Field Name	Tag Number	Category	Description	Format	Size (in bytes)	ASN1 code
CP ClIoT EPS Optimisation Indicator	12-0-19	O	The cPCIoTEPS Optimisation Indicator field indicates whether Control Plane ClIoT EPS optimisation is used for the transfer of the data volume captured by the container. This is included in the Traffic data container only if previous container's change condition is "change in user plane to UE". Note, the CP ClIoT EPS Optimisation indicator field in SGW-CDR main level contains the CP ClIoT EPS optimisation indicator value when SGW-CDR was opened.	Boolean	1	93 01
QCI	12-9-1	M	—	Integer	1-5	0x81
Uplink MBR	12-9-2	O	—	Integer	1-5	0x82
Down link MBR	12-9-3	O	—	Integer	1-5	0x83
Uplink GBR	12-9-4	O	—	Integer	1-5	0x84
Down link GBR	12-9-5	O	—	Integer	1-5	0x85

Field Name	Tag Number	Category	Description	Format	Size (in bytes)	ASN1 code
arp	12-9-6	O	—	Integer	1-5	0x86
APN AMBR Uplink	12-9-7	O	—	Integer	1-5	0x87
APN AMBR Downlink	12-9-8	O	—	Integer	1-5	0x88
Extended Maximum Requested BW UL	12-9-9	O	—	Integer	1-5	0x89
Extended Maximum Requested BW DL	12-9-10	O	—	Integer	1-5	0x8a
Extended GBR UL	12-9-11	O	—	Integer	1-5	0x8b
extended GBRDL	12-9-12	O	—	Integer	1-5	0x8c
Extended APN AMBR UL	12-9-13	O	—	Integer	1-5	0x8d
Extended APN AMBR DL	12-9-14	O	—	Integer	1-5	0x8e
Record Opening Time	13	M	Time stamp when IP-CAN bearer is activated in this S-GW or record opening time on subsequent partial records.	BCD encoded octet string	9	0x8d
Duration	14	M	This field contains the duration in seconds for the record.	Integer	1-5	0x8e

Field Name	Tag Number	Category	Description	Format	Size (in bytes)	ASN1 code
Cause for Record Closing	15	M	This field contains a reason for the closure of the CDR.	Integer	1	0x8f
Diagnostics	16	O	This field is included in the CDR when the bearer context is released and when the gtp attribute diagnostics is configured.	Choice	3	0xb0
gsm408cause	16-0	M	—	Integer	1	0x80
Record Sequence Number	17	O	Partial record sequence number, only present in case of partial records.	Integer	1-5	0x91
Node ID	18	O	Name of the recording entity.	IA5 string	5-20	0x92
Record Extensions	19	O	A set of network operator or manufacturer specific extensions to the record. Conditioned when the extension is available.	Sequence	NA	0xb3

Field Name	Tag Number	Category	Description	Format	Size (in bytes)	ASN1 code
Local Record Sequence Number	20	O	Consecutive record number created by this node. The number is allocated sequentially including all CDR types.	Integer	1-5	0x94
APN Selection Mode	21	M	An index indicating how the APN is selected.	Enumerated	1	0x95
Served MSISDN	22	M	The primary MSISDN of the subscriber.	Integer	1-9	0x96
Charging Characteristics	23	M	The charging characteristics that are applied to the IP-CAN bearer.	Hex Value Octet string	2	0x97
Charging Characteristics Selection Mode	24	O	Holds the information about how charging characteristics are selected.	Enumerated	1	0x98
IMS Signaling Context	25	O	Included if the IM-CN Subsystem Signalling Flag is set, see [201] IP-CAN bearer is used for IMS signalling.	Null	0	0x99

Field Name	Tag Number	Category	Description	Format	Size (in bytes)	ASN1 code
Serving Node PLMN Identifier	27	O	Serving node PLMN Identifier (MCC and MNC) used during this record, if available.	Octet string	3	0x9b
Served IMEISV	29	O	IMEISV of the ME, if available.	BCD encoded octet string	8	0x9d
RAT Type	30	O	This field indicates the Radio Access Technology (RAT) type currently used by the Mobile Station, when available.	Integer	1	9e
MS Time Zone	31	O	The Time Zone IE that the MME may provide to the SGW during the PDN context activation or modification procedure.	Octet string (SIZE (2))	2	9f1f

Field Name	Tag Number	Category	Description	Format	Size (in bytes)	ASN1 code
User Location Information	32	O	<p>This field contains the user location information as described in TS 29.274 for eGTP case (Example: CGI, SAI, RAI TAI and ECGI).</p> <p>This field is provided by the SGSN or MME and transferred to the SGW or PGW during the IP-CAN bearer activation or modification.</p>	Octet string	8-33	9f20
S-GW Change	34	O	<p>This field is present only in the SGW-CDR to indicate that this is the first record after an SGW change. In this case, it is set to TRUE (FF).</p>	Boolean	1	9f22

Field Name	Tag Number	Category	Description	Format	Size (in bytes)	ASN1 code
Serving Node Type	35	M	These fields contain one or several serving node types in control plane of SGW or PGW, which is connected during the record. The serving node types listed here map to the serving node addresses listed in the field Serving node Address in sequence.	Sequence	—	bf23
Serving Node Type enum	35-1	M	—	Sequence: Enumerated	—	0x0a
P-GW Address Used	36	M	This field is the PGW IP address for the control plane.	Choice	6 (IPv4) or 18 (IPv6)	bf24
P-GW Binary IPV4 Address	36-0	M	This field includes the PGW assigned IPv4 address to the subscriber in binary format.	Octet String	4	0x80
P-GW Binary IPV6 Address	36-0	M	This field includes the PGW assigned IPv6 address to the subscriber in binary format.	Octet String	16	0x81
P-GW PLMN Identifier	37	O	—	Octet string	3	9f25

Field Name	Tag Number	Category	Description	Format	Size (in bytes)	ASN1 code
Start Time	38	O	This field holds the time when User IP-CAN session starts. It's available in the CDR for the first bearer in an IP-CAN session.	BCD encoded octet string	9	9f26
Stop Time	39	O	This field holds the time when User IP-CAN session is terminated. It's available in the CDR for the last bearer in an IP-CAN session.	BCD encoded octet string	9	9f27
PDN Connection ID	40	O	This field holds the PDN connection (IP-CAN session) identifier to identify different records belonging to same PDN connection.	Integer	1-5	9f28
iMSI unauthenticated Flag	41	O	This field indicates the provided served IMSI is not authenticated (emergency bearer service situation).	Null	0	9f29

Field Name	Tag Number	Category	Description	Format	Size (in bytes)	ASN1 code
user CSG Information	42	O	This field contains the User CSG Information status of the user accessing a CSG cell. It comprises CSG ID within the PLMN, Access mode and indication on CSG membership for the user when hybrid access applies, as defined in <i>TS 29.060</i> for GPRS case, and in <i>TS 29.274</i> for EPC case.	Sequence	—	bf2a
cSGId	42-0	O	A CSG ID is a unique identifier within the scope of PLMN which identifies a Closed Subscriber Group (CSG) in the PLMN associated with a CSG cell or group of CSG cells.	Octet string	4	80
cSGAccess Mode	42-1	O	cSGAccessMode. It's either closed or hybrid.	Enumerated	1	81

Field Name	Tag Number	Category	Description	Format	Size (in bytes)	ASN1 code
cSG Membership Indication	42-2	O	This field provides an indication on CSG membership for the user.	Null	0	82
Served PDP PDN Address Extension	43	O	This field contains the IPv4 address for the PDN connection (PDP context, IP-CAN bearer) when dual-stack IPv4 IPv6 is used, and the IPv6 address is included in served PDP address or served PDP or PDN address.	Choice	8 (IPv4)	bf2b
PDP IP Address	43-0	M	This field contains the IP address for the PDP context.	Choice	6 (IPv4)	0xa0
PDP IPV4 Address	43-0-0	M	This field includes the IPv4 address assigned to the subscriber by SGW in binary coding.	Octet String	4 (IPv4)	0x80
lowAccess Priority Indicator	44	O	This field indicates if the PDN connection has a low priority, which is for machine type communication.	Null	0	9f2c

Field Name	Tag Number	Category	Description	Format	Size (in bytes)	ASN1 code
dynamic Address FlagExt	47	O	This field indicates whether served IPv4 PDP or PDN address is dynamic, which is allocated during IP-CAN bearer activation, initial attach (E-UTRAN or over S2x) and UE requested PDN connectivity with PDP or PDN type IPv4v6. This field is missing if IPv4 address is static.	Boolean	1	9f2f
s-GW IPv6 Address	48	O	The control plane IPv6 address, in case of IPv4v6 dual stack, of the S-GW.	Choice	18 (IPv6)	bf 30
SGW BINARY IPV6 ADDRESS	48-0	O	This field includes the Gn address of the GGSN service in binary format.	Octet string	16 (IPv6)	0x81

Field Name	Tag Number	Category	Description	Format	Size (in bytes)	ASN1 code
List of Serving Node IPv6Address	49	O	List of serving node control plane IPv6 addresses, in case of IPv4v6 dual stack, (Example: S4-SGSN, MME) used during this record.	Sequence	18 to 270	bf31
Serving Node BINARY IPV6 ADDRESS	49-0	M	The octet string in this field includes the IPV6 address of the MME.	Octet string	16 (IPv6)	0x81
p-GW IPv6 Address Used	50	O	This field is the PGW IPv6 Address, in case of IPv4v6 dual stack, for the control plane.	Choice	18 (IPv6)	bf32
PGW BINARY IPV6 ADDRESS	50-0	O	The octet string in this field includes the IPV6 address assigned to the subscriber by of the P-GW in binary coding.	Octet string	16 (IPv6)	0x81
last User Location Information	55	O	Indicates the UE's last user location information during bearer deactivation or session release.	Octet string	13	9f39

Field Name	Tag Number	Category	Description	Format	Size (in bytes)	ASN1 code
last MStime Zone	56	O	Indicates the Latest timezone of UE while bearer deactivation or session release.	Octet string	2	9f3a
CP ClOT EPS Optimisation Indicator	59	O	This field indicates whether Control Plane ClOT EPS optimisation is used by the PDN connection during data transfer with the UE (that is, Control Plane NAS PDU viaS11-U between S-GW and MME) or not (that is, User Plane via S1-U between S-GW and eNB).	Boolean	1	9f3b

Field Name	Tag Number	Category	Description	Format	Size (in bytes)	ASN1 code
UNI PDU CP Only Flag	60	O	The uNIPDU CP OnlyFlag field indicates whether this PDN connection is applied with "Control Plane Only flag", that is, transferred using Control Plane NAS PDUs only, when Control Plane CIoT EPS Optimisation is enabled. This field is not flagged when both user plane and control plane UNI for PDU transfer (that is, S1-U and S11-U from S-GW) are allowed, when Control Plane CIoT EPS Optimisation is enabled.	Boolean	1	9f3c
List of RAN Secondary RAT Usage Reports	64	OC	This field includes one or more containers reported from the RAN for a secondary RAT.	Sequence of RAN secondary RAT usage report	Variable	0xbf40

Field Name	Tag Number	Category	Description	Format	Size (in bytes)	ASN1 code
RAN Secondary RAT Usage Report	64-0	M	This field includes RAN reported containers for a secondary RAT.	Sequence	Variable	0x30
Data Volume Uplink	64-0-1	M	This field includes the number of octets transmitted during the usage of the packet data services in the uplink direction reported from RAN. The counting and reporting from RAN of uplink data volumes is optional.	Integer	9	0x81
Data Volume Downlink	64-0-2	M	This field includes the number of octets transmitted during the usage of the packet data services in the downlink direction reported from RAN. The counting and reporting from RAN of downlink data volumes is optional.	Integer	9	0x82

Field Name	Tag Number	Category	Description	Format	Size (in bytes)	ASN1 code
RAN Start Time	64-0-3	M	This field is a timestamp at which RAN opens the volume container.	Timestamp	9	0x83
RAN End Time	64-0-4	M	This field is a time stamp at which RAN closes the volume container.	Timestamp	9	0x84
Secondary RAT Type	64-0-5	OC	This field contains the RAT type for the secondary RAT.	Integer	1	0x85
UE Local IP Port Info	253	O	This field includes the S2b user local IP port information.	Sequence	34	0xbf817d
UE Local IP Address	253-0	O	This field includes the UWAN user IP address.	IP Address	32	0xa0
UDP Source Port	253-1	O	This field includes the UWAN user source port.	Integer	2	0x81



Note All IP addresses are encoded in binary format.

ASN.1 Definition for Fields in custom24

The following section provides the complete ASN.1 definition of all cnSGW-CDR related fields in the custom24 dictionary.

```
GPRS-SGW-Charging-DataTypes-REL8 DEFINITIONS IMPLICIT TAGS ::=
BEGIN

-----
--
--      GPRS RECORDS
```



```

--
-----
GPRSRecord ::= CHOICE
--
-- Record values 20, 22..27 are specific
-- Record values 76..77 are MBMS specific
-- Record values 78..79 are EPC specific
{
    sGWRecord[78] SGWRecord
}

SGWRecord ::= SET
{
    recordType [0] RecordType,
    servedIMSI [3] IMSI,
    s-GWAddress [4] GSNAddress,
    chargingID [5] ChargingID,
    servingNodeAddress [6] SEQUENCE OF GSNAddress,
    accessPointNameNI [7] AccessPointNameNI OPTIONAL,
    pdpPDNType [8] PDPTType OPTIONAL,
    servedPDPPDNAddress [9] PDPAddress OPTIONAL,
    dynamicAddressFlag [11] DynamicAddressFlag OPTIONAL,
    listOfTrafficVolumes [12] SEQUENCE OF ChangeOfCharCondition
OPTIONAL,
    recordOpeningTime [13] TimeStamp,
    duration [14] CallDuration,
    causeForRecClosing [15] CauseForRecClosing,
    diagnostics [16] Diagnostics OPTIONAL,
    recordSequenceNumber [17] INTEGER OPTIONAL,
    nodeID [18] NodeID OPTIONAL,
    recordExtensions [19] ManagementExtensions OPTIONAL,
    localSequenceNumber [20] LocalSequenceNumber OPTIONAL,
    apnSelectionMode [21] APNSelectionMode OPTIONAL,
    servedMSISDN [22] MSISDN OPTIONAL,
    chargingCharacteristics [23] ChargingCharacteristics,
    chChSelectionMode [24] ChChSelectionMode OPTIONAL,
    imssignalingContext [25] NULL OPTIONAL,
    servingNodePLMNIdentifier [27] PLMN-Id OPTIONAL,
    servedIMEISV [29] IMEI OPTIONAL,
    rATType [30] RATType OPTIONAL,
    mSTimeZone [31] MSTimeZone OPTIONAL,
    userLocationInformation [32] OCTET STRING OPTIONAL,
    sGWChange [34] SGWChange OPTIONAL,
    servingNodeType [35] SEQUENCE OF ServingNodeType,
    p-GWAddressUsed [36] GSNAddress OPTIONAL,
    p-GWPLMNIdentifier [37] PLMN-Id OPTIONAL,
    startTime [38] TimeStamp OPTIONAL,
    stopTime [39] TimeStamp OPTIONAL,
    pdnConnectionID [40] ChargingID OPTIONAL,
    servedPDPPDNAddressExt [43] PDPAddress OPTIONAL,
    lowAccessPriorityIndicator [44] NULL OPTIONAL,
    dynamicAddressFlagExt [47] DynamicAddressFlag OPTIONAL,
    s-GWiPv6Address [48] GSNAddress OPTIONAL,
    servingNodeiPv6Address [49] SEQUENCE OF GSNAddress OPTIONAL,
    p-GWiPv6AddressUsed [50] GSNAddress OPTIONAL,
    lastUserLocationInformation [55] OCTET STRING OPTIONAL,
    lastMSTimeZone [56] MSTimeZone OPTIONAL,
    cPCIoTEPSOptimisationIndicator [59] BOOLEAN OPTIONAL,
    uNIPDUCOnlyFlag [60] BOOLEAN OPTIONAL,
    listOfRANSecondaryRATUsageReports [64] SEQUENCE OF RANSecondaryRATUsageReport
OPTIONAL,
    uELocalIPAddressPort [253] SEQUENCE OF UELocalIPPortInfo OPTIONAL
}

```

```

}

AccessPointNameNI ::= IA5String (SIZE(1..63))
--
-- Network Identifier part of APN in dot representation.
-- For example, if the complete APN is 'apn1a.apn1b.apn1c.mnc022.mcc111.gprs'
-- NI is 'apn1a.apn1b.apn1c' and is presented in this form in the CDR.

APNSelectionMode ::= ENUMERATED
{
--
-- See Information Elements TS 29.060, TS 29.274 or TS 29.275
--
    mSorNetworkProvidedSubscriptionVerified (0),
    mSProvidedSubscriptionNotVerified (1),
    networkProvidedSubscriptionNotVerified (2)
}

CallDuration ::= INTEGER
--
-- The call duration is counted in seconds.
-- For successful calls /sessions / PDP contexts, this is the chargeable
duration.
-- For call attempts this is the call holding time.
--

CauseForRecClosing ::= INTEGER
{
--
-- In PGW-CDR and SGW-CDR the value servingNodeChange is used for partial record
-- generation due to Serving Node Address list Overflow
-- In SGSN servingNodeChange indicates the SGSN change
--
-- LCS related causes belong to the MAP error causes acc. TS 29.002
--
-- cause codes 0 to 15 are defined 'CauseForTerm' (cause for termination)
-- All cause values are not relevant to SGW. Refer the spec to find out the
-- cause values for SGW.
    normalRelease (0),
    abnormalRelease (4),
    CAMELInitCallRelease (5),
    volumeLimit (16),
    timeLimit (17),
    servingNodeChange (18),
    maxChangeCond (19),
    managementIntervention (20),
    intraSGSNIntersystemChange (21),
    rATChange (22),
    mSTimeZoneChange (23),
    SGSNPLMNIDChange (24),
    unauthorizedRequestingNetwork (52),
    unauthorizedLCSCClient (53),
    positionMethodFailure (54),
    unknownOrUnreachableLCSCClient (58),
    listOfDownstreamNodeChange (59)
}

ChangeCondition ::= ENUMERATED
{
    qcSChange (0),
    tariffTime (1),
    recordClosure (2),

```

```

        CGI-SAICChange          (6),    -- bearer modification. CGI-SAI Change
        rAICChange              (7),    -- bearer modification. RAI Change
        dT-Establishment        (8),
        dT-Removal              (9),
        eCGIChange              (10),   -- bearer modification. ECGI Change
        tAICChange              (11),   -- bearer modification. TAI Change
        apnAmbrChange           (50)    -- apn-ambr change
    }

ChangeOfCharCondition ::= SEQUENCE
{
    --
    -- qosRequested and qosNegotiated are used in S-CDR only
    -- ePCQoSInformation used in SGW-CDR,PGW-CDR, IPE-CDR, TWAG-CDR and ePDG-CDR only
    -- userLocationInformation is used only in S-CDR, SGW-CDR and PGW-CDR
    -- chargingID used in PGW-CDR only when Charging per IP-CAN session is active
    -- accessAvailabilityChangeReason and relatedChangeOfCharCondition applicable only
in PGW-CDR
    -- cPCIoTOptimisationIndicator is used in SGW-CDR only
    --
    qosRequested                [1] QoSInformation OPTIONAL,
    qosNegotiated               [2] QoSInformation OPTIONAL,
    dataVolumeGPRSUplink        [3] DataVolumeGPRS OPTIONAL,
    dataVolumeGPRSDownlink      [4] DataVolumeGPRS OPTIONAL,
    changeCondition             [5] ChangeCondition,
    changeTime                  [6] TimeStamp,
    userLocationInformation      [8] OCTET STRING OPTIONAL,
    ePCQoSInformation           [9] EPCQoSInformation OPTIONAL,
    chargingID                  [10] ChargingID OPTIONAL,
    userCSGInformation          [12] UserCSGInformation OPTIONAL,
    diagnostics                 [13] Diagnostics OPTIONAL,
    rATType                     [15] RATType OPTIONAL,
    uWANUserLocationInformation [17] UWANUserLocationInfo OPTIONAL,
    cPCIoTEPSOptimisationIndicator [19] CPCIoTEPSOptimisationIndicator OPTIONAL
}

ChargingCharacteristics ::= OCTET STRING (SIZE(2))

ChargingID ::= INTEGER (0..4294967295)
--
-- Generated in P-GW, part of IP CAN bearer
-- 0..4294967295 is equivalent to 0..2**32-1
--

ChChSelectionMode ::= ENUMERATED
{
    servingNodeSupplied        (0), -- For S-GW/P-GW
    subscriptionSpecific       (1), -- For SGSN only
    aPNSpecific                (2), -- For SGSN only
    homeDefault                 (3), -- For SGSN, S-GW and P-GW
    roamingDefault              (4), -- For SGSN, S-GW and P-GW
    visitingDefault            (5) -- For SGSN, S-GW and P-GW
}

DataVolumeGPRS ::= INTEGER
--
-- The volume of data transferred in octets.
--

```

```

DynamicAddressFlag ::= BOOLEAN

EPCQoSInformation ::= SEQUENCE
{
  --
  -- See TS 29.212 for more information
  --
  qCI [1] INTEGER,
  maxRequestedBandwithUL [2] INTEGER OPTIONAL,
  maxRequestedBandwithDL [3] INTEGER OPTIONAL,
  guaranteedBitrateUL [4] INTEGER OPTIONAL,
  guaranteedBitrateDL [5] INTEGER OPTIONAL,
  aRP [6] INTEGER OPTIONAL,
  apnAmbrUplink [7] INTEGER OPTIONAL,
  apnAmbrDownlink [8] INTEGER OPTIONAL,
  extendedMaxRequestedBWUL [9] INTEGER OPTIONAL,
  extendedMaxRequestedBWDL [10] INTEGER OPTIONAL,
  extendedGBRUL [11] INTEGER OPTIONAL,
  extendedGBRDL [12] INTEGER OPTIONAL,
  extendedAPNAMBRUL [13] INTEGER OPTIONAL,
  extendedAPNAMBRDL [14] INTEGER OPTIONAL
}

ETSIAddress ::= AddressString
--
-- First octet for nature of address, and numbering plan indicator (3 for X.121)
-- Other octets TBCD
-- See TS 29.002
--

GSNAddress ::= IPAddress

MSNetworkCapability ::= OCTET STRING (SIZE(1..8))
-- see TS 24.008

NetworkInitiatedPDPContext ::= BOOLEAN
--
-- Set to true if PDP context was initiated from network side
--

NodeID ::= IA5String (SIZE(1..20))

NumberOfDPENcountered ::= INTEGER

PDPAddress ::= CHOICE
{
  iPAddress [0] IPAddress,
  eTSIAddress [1] ETSIAddress
}

PDPTType ::= OCTET STRING (SIZE(2))
--
-- OCTET 1: PDP Type Organization
-- OCTET 2: PDP Type Number
-- See TS 29.060 for GTP, TS 29.274 for eGTP and TS 29.275 for PMIP
--

PLMN-Id ::= OCTET STRING (SIZE (3))
--
-- This is a 1:1 copy from the Routing Area Identity (RAI) IE specified in TS 29.060
-- as follows:

```

```

-- OCTET 1 of PLMN-Id = OCTET 2 of RAI
-- OCTET 2 of PLMN-Id = OCTET 3 of RAI
-- OCTET 3 of PLMN-Id = OCTET 4 of RAI
--

QoSInformation ::= OCTET STRING (SIZE (4..255))
--
-- This      octet string
-- is a 1:1 copy of the contents (i.e. starting with octet 5) of the "Bearer Quality of
-- Service" information element specified in TS 29.274
--

RANSecondaryRATUsageReport ::= SEQUENCE
-- ]
{
    dataVolumeUplink          [1] DataVolumeGPRS,
    dataVolumeDownlink        [2] DataVolumeGPRS,
    rANStartTime              [3] TimeStamp,
    rANEndTime                [4] TimeStamp,
    secondaryRATType          [5] SecondaryRATType OPTIONAL
}

SecondaryRATType ::= INTEGER
{
    reserved (0),
    nR (1) -- New Radio 5G
}

RATType ::= INTEGER (0..255)
--
-- This integer is 1:1 copy of the RAT type value as defined in TS 29.060 for GTP,
-- TS 29.274 for eGTP and TS 29.275 for PMIP.
--

UWANUserLocationInfo ::= SEQUENCE
{
    uELocalIPAddress          [0] IPAddress,
    uDPSourcePort             [1] OCTET STRING (SIZE(2)) OPTIONAL,
    sSSID                     [2] OCTET STRING OPTIONAL,      -- see format in IEEE Std 802.11-2012
[408]
    bSSID                     [3] OCTET STRING OPTIONAL      -- see format in IEEE Std 802.11-2012
[408]
}

RecordType ::= INTEGER
{
    -- Record values 0..17 are CS specific.
    -- The contents are defined in TS 32.250

    sGWRecord                 (84)
}

ResultCode ::= INTEGER
-- charging protocol return value, range of 4 byte (0...4294967259)
-- see Result-Code AVP as used in 3GPP 32.299
--

ServingNodeType ::= ENUMERATED
{
    sGSN                      (0),
    pMIPSGW                   (1),
    gTPSGW                    (2),
    ePDG                      (3),

```

```

        hSGW                (4),
        mME                  (5)
    }

SGWChange ::= BOOLEAN
--
-- present if first record after inter S-GW change
--

Diagnostics ::= CHOICE
{
    gsm0408Cause                [0] INTEGER,
    -- See TS 24.008
    gsm0902MapErrorValue        [1] INTEGER,
    -- Note: The value to be stored here corresponds to
    -- the local values defined in the MAP-Errors and
    -- MAP-DialogueInformation modules, for full details
    -- see TS 29.002
    itu-tQ767Cause              [2] INTEGER,
    -- See ITU-T Q.767
    networkSpecificCause        [3] ManagementExtension,
    -- To be defined by network operator
    manufacturerSpecificCause   [4] ManagementExtension,
    -- To be defined by manufacturer
    positionMethodFailureCause   [5] PositionMethodFailure-Diagnostic,
    -- see TS 29.002
    unauthorizedLCSCClientCause [6] UnauthorizedLCSCClient-Diagnostic
    -- see TS 29.002
}

IPAddress ::= CHOICE
{
    iPBinaryAddress             IPBinaryAddress,
    iPTextRepresentedAddress     IPTextRepresentedAddress
}

CPCIoTEPSOptimisationIndicator ::= BOOLEAN

IPBinaryAddress ::= CHOICE
{
    iPBinV4Address              [0] OCTET STRING (SIZE(4)),
    iPBinV6Address              [1] OCTET STRING (SIZE(16))
}

IPTextRepresentedAddress ::= CHOICE
{
    --
    -- IP address in the familiar "dot" notation
    --
    iPTextV4Address             [2] IA5String (SIZE(7..15)),
    iPTextV6Address             [3] IA5String (SIZE(15..45))
}

PositionMethodFailure-Diagnostic ::= ENUMERATED
{
    congestion                    (0),
    insufficientResources          (1),
    insufficientMeasurementData    (2),
    inconsistentMeasurementData    (3),
    locationProcedureNotCompleted   (4),
    locationProcedureNotSupportedByTargetMS (5),
    qoSNotAttainable               (6),
    positionMethodNotAvailableInNetwork (7),
    positionMethodNotAvailableInLocationArea (8)
}

```

```

}

LocalSequenceNumber ::= INTEGER (0..4294967295)
--
-- Sequence number of the record in this node
-- 0.. 4294967295 is equivalent to 0..2**32-1, unsigned integer in four octets

ManagementExtension ::= SEQUENCE
{
    identifier OBJECT IDENTIFIER,
    significance [1] BOOLEAN DEFAULT FALSE,
    information [2] ANY DEFINED BY identifier
}

ManagementExtensions ::= SET OF ManagementExtension

MSISDN ::= ISDN-AddressString
--
-- See TS 23.003

MSTimeZone ::= OCTET STRING (SIZE (2))
--
-- 1.Octet: Time Zone and 2. Octet: Daylight saving time, see TS 29.060

TimeStamp ::= OCTET STRING (SIZE(9))
--
-- The contents of this field are a compact form of the UTCTime format
-- containing local time plus an offset to universal time. Binary coded
-- decimal encoding is employed for the digits to reduce the storage and
-- transmission overhead
-- e.g. YYMMDDhhmmssShhmm
-- where
-- YY = Year 00 to 99 BCD encoded
-- MM = Month 01 to 12 BCD encoded
-- DD = Day 01 to 31 BCD encoded
-- hh = hour 00 to 23 BCD encoded
-- mm = minute 00 to 59 BCD encoded
-- ss = second 00 to 59 BCD encoded
-- S = Sign 0 = "+", "-" ASCII encoded
-- hh = hour 00 to 23 BCD encoded
-- mm = minute 00 to 59 BCD encoded
--

UELocalIPPortInfo ::= SEQUENCE
{
    --
    -- The S2b user Local IP Port Information
    --
    uELocalIPAddress [0] IPADDRESS OPTIONAL,
    uDPSourcePort [1] INTEGER OPTIONAL
}

UELocalIPAddress ::= IPADDRESS
UDPSourcePort ::= INTEGER

UnauthorizedLCSCClient-Diagnostic ::= ENUMERATED
{
    noAdditionalInformation (0),
    clientNotInMSPrivacyExceptionList (1),
    callToClientNotSetup (2),
    privacyOverrideNotApplicable (3),
}

```

```

        disallowedByLocalRegulatoryRequirements      (4),
        unauthorizedPrivacyClass                    (5),
        unauthorizedCallSessionUnrelatedExternalClient (6),
        unauthorizedCallSessionRelatedExternalClient (7)
    }

    CSGAccessMode ::= ENUMERATED
    {
        closedMode (0),
        hybridMode (1)
    }

    CSGId ::= OCTET STRING (SIZE(4))
    --
    -- Defined in 23.003. Coded according to TS 29.060 for GTP, and in TS
29.274
    -- for eGTP.
    -- 24.008
    --
    UserCSGInformation ::= SEQUENCE
    {
        CSGId [0] CSGId,
        CSGAccessMode [1] CSGAccessMode,
        CSGMembershipIndication [2] NULL OPTIONAL
    }

    TBCDSTRING ::= OCTET STRING
    ISDN-AddressString ::= OCTET STRING
    IMEI ::= TBCDSTRING (SIZE(8))
    IMSI ::= TBCDSTRING (SIZE(3..8))
    maxAddressLength INTEGER ::= 20
    AddressString ::= OCTET STRING (SIZE (1..maxAddressLength))
    END

```

SGW Charging OAM Support

This section describes operations, administration, and maintenance information for this feature.

Bulk Statistics

SGW Charging CDR Statistics

sgw_charging_cdr counter

```

sgw_charging_cdr{action="close_final",app_name="SMF",cause="abnormalRelease",
cluster="Local",data_center="DC",event="AbnormalRelease",gr_instance_id="1",instance_id="0",
pdn_plmn_type="visitor",pdn_type="ipv4v6",service_name="sgw-service"} 1
sgw_charging_cdr{action="close_final",app_name="SMF",cause="normalRelease",
cluster="Local",data_center="DC",event="NormalRelease",gr_instance_id="1",instance_id="0",
pdn_plmn_type="visitor",pdn_type="ipv4v6",service_name="sgw-service"} 22
sgw_charging_cdr{action="close_final",app_name="SMF",cause="sGWChange",
cluster="Local",data_center="DC",event="SGWChange",gr_instance_id="1",instance_id="0",
pdn_plmn_type="visitor",pdn_type="ipv4v6",service_name="sgw-service"} 3
sgw_charging_cdr{action="close_interim",app_name="SMF",cause="maxChangeCond",
cluster="Local",data_center="DC",event="QoSChange",gr_instance_id="1",instance_id="0",
pdn_plmn_type="visitor",pdn_type="ipv4v6",service_name="sgw-service"} 3
sgw_charging_cdr{action="close_interim",app_name="SMF",cause="maxChangeCond",
cluster="Local",data_center="DC",event="ServingNodeChange",gr_instance_id="1",instance_id="0",

```



```

pdn_plmn_type="visitor",pdn_type="ipv4v6",service_name="sgw-service"} 5
sgw_charging_cdr{action="close_interim",app_name="SMF",cause="timeLimit",
cluster="Local",data_center="DC",event="TimeLimit",gr_instance_id="1",instance_id="0",
pdn_plmn_type="visitor",pdn_type="ipv4v6",service_name="sgw-service"} 56
sgw_charging_cdr{action="close_interim",app_name="SMF",cause="volumeLimit",
cluster="Local",data_center="DC",event="VolumeLimit",gr_instance_id="1",instance_id="0",
pdn_plmn_type="visitor",pdn_type="ipv4v6",service_name="sgw-service"} 3
sgw_charging_cdr{action="open",app_name="SMF",cause="",cluster="Local",
data_center="DC",event="QoSChange",gr_instance_id="1",instance_id="0",pdn_plmn_type="visitor",
pdn_type="ipv4v6",service_name="sgw-service"} 3
sgw_charging_cdr{action="open",app_name="SMF",cause="",cluster="Local",
data_center="DC",event="SGWChange",gr_instance_id="1",instance_id="0",pdn_plmn_type="visitor",
pdn_type="ipv4v6",service_name="sgw-service"} 3
sgw_charging_cdr{action="open",app_name="SMF",cause="",cluster="Local",
data_center="DC",event="ServicingNodeChange",gr_instance_id="1",instance_id="0",pdn_plmn_type="visitor",
pdn_type="ipv4v6",service_name="sgw-service"} 5
sgw_charging_cdr{action="open",app_name="SMF",cause="",cluster="Local",
data_center="DC",event="StartAccounting",gr_instance_id="1",instance_id="0",pdn_plmn_type="visitor",
pdn_type="ipv4v6",service_name="sgw-service"} 26
sgw_charging_cdr{action="open",app_name="SMF",cause="",cluster="Local",
data_center="DC",event="TimeLimit",gr_instance_id="1",instance_id="0",pdn_plmn_type="visitor",
pdn_type="ipv4v6",service_name="sgw-service"} 56
sgw_charging_cdr{action="open",app_name="SMF",cause="",cluster="Local",
data_center="DC",event="VolumeLimit",gr_instance_id="1",instance_id="0",pdn_plmn_type="visitor",
pdn_type="ipv4v6",service_name="sgw-service"} 3

```

SGW Charging CDR Container Statistics

sgw_charging_cdr_container counter

```

sgw_charging_cdr_container{action="close",app_name="SMF",change_condition="qoSChange",
cluster="Local",data_center="DC",event="QoSChange",gr_instance_id="1",instance_id="0",
pdn_plmn_type="visitor",pdn_type="ipv4v6",service_name="sgw-service"} 6
sgw_charging_cdr_container{action="close",app_name="SMF",change_condition="recordClosure",
cluster="Local",data_center="DC",event="AbnormalRelease",gr_instance_id="1",instance_id="0",
pdn_plmn_type="visitor",pdn_type="ipv4v6",service_name="sgw-service"} 1
sgw_charging_cdr_container{action="close",app_name="SMF",change_condition="recordClosure",
cluster="Local",data_center="DC",event="NormalRelease",gr_instance_id="1",instance_id="0",
pdn_plmn_type="visitor",pdn_type="ipv4v6",service_name="sgw-service"} 22
sgw_charging_cdr_container{action="close",app_name="SMF",change_condition="recordClosure",
cluster="Local",data_center="DC",event="SGWChange",gr_instance_id="1",instance_id="0",
pdn_plmn_type="visitor",pdn_type="ipv4v6",service_name="sgw-service"} 3
sgw_charging_cdr_container{action="close",app_name="SMF",change_condition="recordClosure",
cluster="Local",data_center="DC",event="ServicingNodeChange",gr_instance_id="1",instance_id="0",
pdn_plmn_type="visitor",pdn_type="ipv4v6",service_name="sgw-service"} 5
sgw_charging_cdr_container{action="close",app_name="SMF",change_condition="recordClosure",
cluster="Local",data_center="DC",event="TimeLimit",gr_instance_id="1",instance_id="0",
pdn_plmn_type="visitor",pdn_type="ipv4v6",service_name="sgw-service"} 56
sgw_charging_cdr_container{action="close",app_name="SMF",change_condition="recordClosure",
cluster="Local",data_center="DC",event="VolumeLimit",gr_instance_id="1",instance_id="0",
pdn_plmn_type="visitor",pdn_type="ipv4v6",service_name="sgw-service"} 3
sgw_charging_cdr_container{action="open",app_name="SMF",change_condition="",cluster="Local",
data_center="DC",event="QoSChange",gr_instance_id="1",instance_id="0",pdn_plmn_type="visitor",
pdn_type="ipv4v6",service_name="sgw-service"} 6
sgw_charging_cdr_container{action="open",app_name="SMF",change_condition="",cluster="Local",

```

```

data_center="DC",event="SGWChange",gr_instance_id="1",instance_id="0",pdn_plmn_type="visitor",
pdn_type="ipv4v6",service_name="sgw-service"} 3
sgw_charging_cdr_container{action="open",app_name="SMF",change_condition="",cluster="Local",
data_center="DC",event="ServingNodeChange",gr_instance_id="1",instance_id="0",pdn_plmn_type="visitor",
pdn_type="ipv4v6",service_name="sgw-service"} 5
sgw_charging_cdr_container{action="open",app_name="SMF",change_condition="",cluster="Local",
data_center="DC",event="StartAccounting",gr_instance_id="1",instance_id="0",pdn_plmn_type="visitor",
pdn_type="ipv4v6",service_name="sgw-service"} 26
sgw_charging_cdr_container{action="open",app_name="SMF",change_condition="",cluster="Local",
data_center="DC",event="TimeLimit",gr_instance_id="1",instance_id="0",pdn_plmn_type="visitor",
pdn_type="ipv4v6",service_name="sgw-service"} 56
sgw_charging_cdr_container{action="open",app_name="SMF",change_condition="",cluster="Local",
data_center="DC",event="VolumeLimit",gr_instance_id="1",instance_id="0",pdn_plmn_type="visitor",
pdn_type="ipv4v6",service_name="sgw-service"}

```

SGW Sx Report Statistics

sgw_sx_session_report_stats counter

```

sgw_sx_session_report_stats{app_name="SMF",cluster="Local",data_center="DC",
gr_instance_id="1",instance_id="0",service_name="sgw-service",status="success",
sx_session_report_type="USAR"} 55

```

sgw_sx_usage_report_stats counter

```

sgw_sx_usage_report_stats{app_name="SMF",cluster="Local",data_center="DC",
gr_instance_id="1",instance_id="0",service_name="sgw-service",status="success"}
95

```

GTPP-EP Statistics

gtp_received_cdrs_total counter

```

gtp_received_cdrs_total{app_name="SMF",cluster="Local",data_center="DC",dictionary="custom24",
gtp_profile="pf1",instance_id="0",service_name="gtp-ep"} 7

```

gtp_processed_cdrs_total counter

```

gtp_processed_cdrs_total{app_name="SMF",cluster="Local",data_center="DC",dictionary="custom24",
gtp_profile="pf1",instance_id="0",service_name="gtp-ep",status="success"} 7

```

gtp_batched_cdrs_total gauge

```

gtp_batched_cdrs_total{app_name="SMF",cluster="Local",data_center="DC",dictionary="custom24",
gtp_profile="pf1",instance_id="0",service_name="gtp-ep",status="batch_success"}
2

```

gtp_batch_flush_millis_total counter

```

gtp_batch_flush_millis_total{app_name="SMF",cluster="Local",data_center="DC",dictionary="custom24",
gtp_profile="pf1",instance_id="0",service_name="gtp-ep",status="batch_success"}
1126.000588626

```

gtpb_batch_flush_duration_histogram_total counter

```
gtpb_batch_flush_duration_histogram_total{app_name="SMF",bin=">5000ms",cluster="Local",data_center="DC",dictionary="custom24",gtpb_profile="pf1",instance_id="0",service_name="gtpb-ep",status="batch_success"}  
6
```

gtpb_asn1field_encoding_failures_total

```
gtpb_asn1field_encoding_failures_total{app_name="SMF",cluster="Local",data_center="DC",gtpb_profile="pf1",dictionary="custom24",asn1_field="ServedIMSI",reason="Constraint Violation",gr_instance_id="1",service_name="gtpb-ep"}1
```



CHAPTER 44

SGW Relocation Support

- [Feature Summary and Revision History, on page 645](#)
- [Feature Description, on page 645](#)
- [How it Works, on page 646](#)
- [SGW Relocation OAM Support, on page 662](#)

Feature Summary and Revision History

Summary Data

Table 221: Summary Data

Applicable Product(s) or Functional Area	cnSGW-C
Applicable Platform(s)	SMI
Feature Default Setting	Enabled - Always-on
Related Documentation	Not Applicable

Revision History

Table 222: Revision History

Revision Details	Release
First introduced.	2021.01.0

Feature Description

This feature supports following procedures:

- S1 based SGW Relocation

- X2 based SGW Relocation
- TAU SGW Relocation
- 5G to 4G SGW Relocation

This feature also supports ePCO Indication flag at the PDN level, if it receives this indication in CS Request during Initial attach or PDN connection or SGW relocation.

SGW triggers a Modify Bearer Request to PGW in the following scenario:

- The source MME supports ePCO and the target MME does not support it.
- The target MME supports ePCO and the source MME does not support it.



Note When 4G SGW relocation Create Session Request message receives 5GS Interworking Indication (5GSIWKI), then set SGW relocation type as 5G.

How it Works

This section describes how this feature works.

Call Flows

This section describes the key call flows for SGW relocation feature.

X2 Handover SGW Relocation to cnSGW-C Call Flow

This section describes the X2 handover SGW relocation to cnSGW-C call flow.

Figure 122: X2 Handover SGW Relocation to cnSGW-C Call Flow

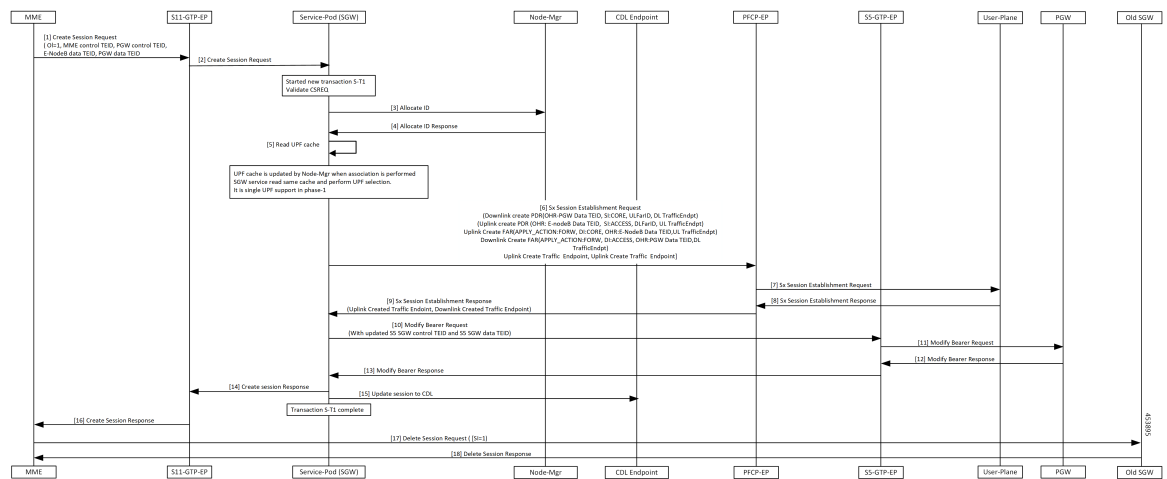

Table 223: X2 Handover SGW Relocation to cnSGW-C Call Flow Description

Step	Description
1	MME sends Create Session Request message to GTPC-EP ingress with the following: <ul style="list-style-type: none"> • OI flag set • MME Control TEID • PGW Control TEID • eNodeB Data TEID • PGW Data TEID Establishes new transaction at GTPC-EP ingress.
2	SGW service POD receives Create Session Request.
3	SGW service POD Create a new transaction S-T1.
4	Validate Create Session Req.
5	NodeMgr allocates TEID. SGW service POD reads the UPF cache and performs UPF selection.
6	PFCP-EP receives Sx Session Establishment Request from SGW service POD with the uplink and downlink Create PDRs/FARs (Apply Action as Forward)/CTEs.
7	PFCP-EP forwards Sx Session Establishment Request to UPF.
8	PFCP-EP receives Sx Session Establishment Response from UPF with Created CTEs.
9	SGW service POD receives Sx Session Establishment Response from PFCP-EP.
10	Modify Bearer Request with updated S5 SGW Control TEID and S5 SGW Data TEID sent from the SGW service POD to GTPC-EP.
11	PGW receives Modify Bearer Request message from GTPC-EP.
12	GTC-EP receives Modify Bearer Response from PGW.
13	SGW service POD receives Modify Bearer Response from GTPC-EP.
14	SGW service POD forwards Create Session Response to GTPC-EP ingress.
15	Updated session at CDL. Transaction S-T1 completed.
16	GTPC-EP ingress forwards Create Session Response to MME.
17	MME sends Delete Session Request with SI=1 to old SGW and receives Delete Session Response. Call cleared in old SGW.

S1 Handover SGW Relocation to cnSGW-C Call Flow

This section describes the S1 handover SGW Relocation to cnSGW-C call flow.

Figure 123: S1 Handover SGW Relocation to cnSGW-C Call Flow

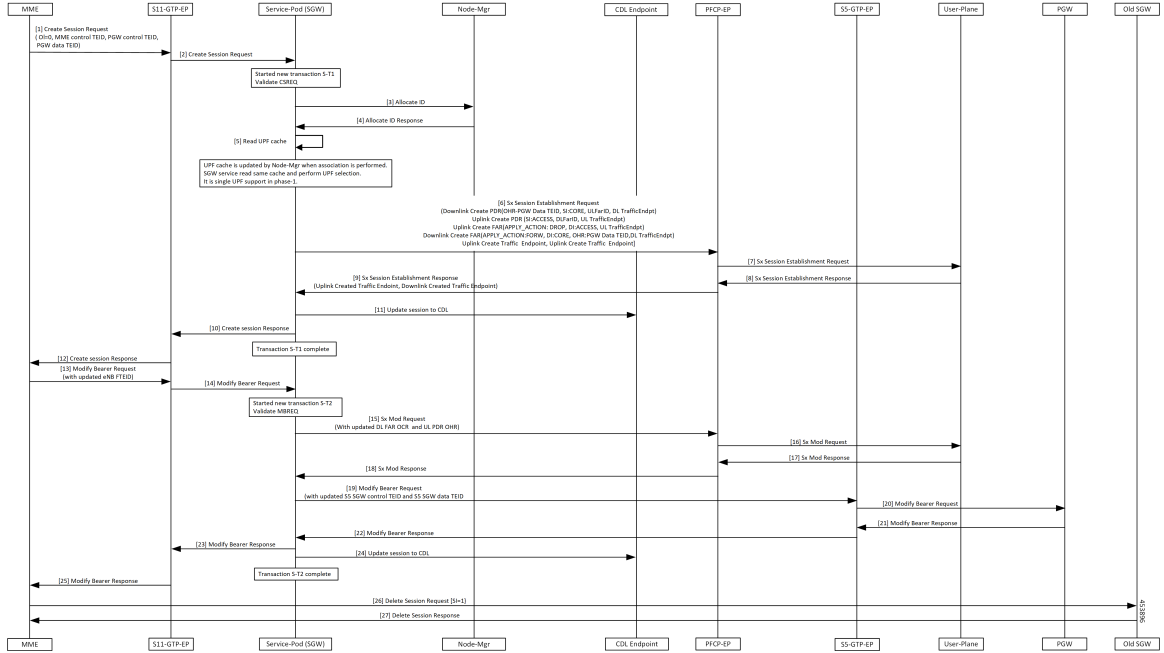

Table 224: S1 Handover SGW Relocation to cnSGW-C Call Flow Description

Step	Description
1	MME sends Create Session Request message to GTPC-EP ingress with the following: <ul style="list-style-type: none"> • OI flag unset • MME Control TEID • PGW Control TEID • PGW Data TEID Establishes new transaction at GTPC-EP ingress.
2	SGW service POD receives Create Session Request.
3	Create a new transaction S-T1.
4	Validate Create Session Req.
5	NodeMgr allocates TEID. SGW service reads the UPF cache and performs UPF selection.
6	PFCP-EP receives Sx Session Establishment Request from SGW service POD with the following: <ul style="list-style-type: none"> • Uplink and downlink Create PDRs/FARs (Apply Action as Forward)/CTEs

Step	Description
7	PFPCP-EP forwards Sx Session Establishment Request to UPF
8	PFPCP-EP receives Sx Session Establishment Response from UPF with Created CTEs.
9	SGW service POD receives Sx Session Establishment Response from PFPCP-EP.
10	SGW service POD forwards Create Session Response to GTPC-EP ingress.
11	Updated session at CDL. Transaction S-T1 completed.
12	GTPC-EP ingress forwards Create Session Response to MME.
13	GTPC-EP ingress receives Modify Bearer Req with updated eNodB FTEID from MME.
14	GTPC-EP ingress forwards Modify Bearer Req to SGW service POD. Creates new transaction-T2.
15	PFPCP-EP receives Sx Mod Req from SGW service POD with the updated downlink FAR and uplink PDR.
16	PFPCP-EP forwards Sx Mod Req to UPF.
17	PFPCP-EP receives Sx Mod Response from UPF.
18	SGW receives Sx Mod Response from PFPCP-EP.
19	SGW service POD sends Modify Bearer Request with updated S5 SGW Control TEID and S5 SGW Data TEID to GTPC-EP.
20	GTPC-EP forwards Modify Bearer Request to PGW.
21	GTPC-EP receives Modify Bearer Response from PGW.
22	SGW service POD receives Modify Bearer Response from GTPC-EP.
23	GTPC-EP ingress receives Modify Bearer Response from SGW service POD.
24	Session updated at CDL. Transaction S-T2 completed.
25	GTPC-EP ingress forwards Modify Bearer Response to MME.
26	MME sends Delete Session Request with SI=1 to old SGW and receives Delete Session Response. Call cleared in old SGW.

TAU X2 Handover SGW Relocation to cnSGW-C Call Flow

This section describes the TAU X2 handover SGW relocation to cnSGW-C call flow.

Figure 124: TAU X2 Handover SGW Relocation to cnSGW-C Call Flow

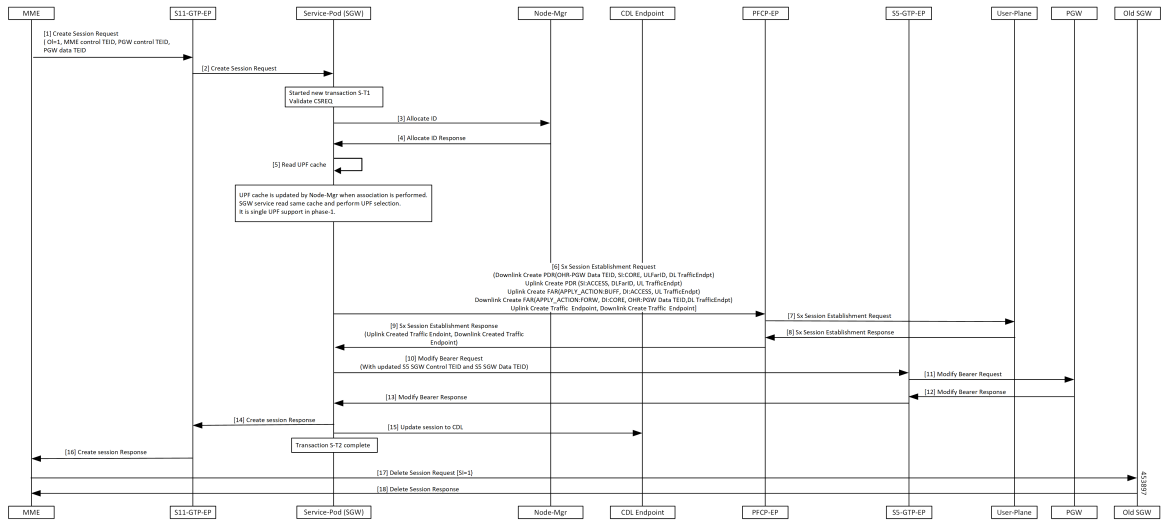

Table 225: TAU X2 Handover SGW Relocation to cnSGW-C Call Flow Description

Step	Description
1	MME sends Create session Req to GTPC-EP ingress with the following: <ul style="list-style-type: none"> • OI flag set • MME Control TEID • PGW Control TEID • PGW Data TEID Establishes new transaction at GTPC-EP ingress.
2	GTPC-EP ingress forwards Create Session req to SGW service POD.
3	SGW service POD receives Create Session Req. Create a new transaction S-T1.
4	Validate CSReq. NodeMgr performs TEID allocation.
5	SGW service reads UPF Cache and performs UPF selection.
6	PFCP-EP receives Sx Session Establishment Req from SGW service POD with the following: <ul style="list-style-type: none"> • Uplink and downlink Create PDRs/FARs(ApplyAction as Forward for the uplink FAR)/CTEs.
7	PFCP-EP forwards Sx Session Establishment Req to UPF.
8	PFCP-EP receives Sx Session Establishment Response from UPF.
9	SGW service POD receives Sx Session Establishment Response from PFCP-EP.

Step	Description
10	SGW service POD sends Modify Bearer Req with updated S5 SGW Control TEID and S5 SGW Data TEID to GTPC-EP.
11	GTPC-EP forwards Modify Bearer Request to PGW.
12	GTPC-EP receives Modify Bearer Response from PGW.
13	GTPC-EP forwards Modify Bearer Response to SGW service POD.
14	SGW service POD forwards Create Session Response to GTPC-EP ingress.
15	Session updated at CDL. Transaction S-T1 completed.
16	GTPC-EP ingress forwards Create Session Response to MME.
17	MME sends Delete Session Request with SI=1 sent to old SGW and receives Delete Session Response. Call cleared in old SGW.

X2 Handover SGW Relocation to CN-SGW (Multi PDN) Call Flow

This section describes the X2 handover SGW relocation to CN-SGW (Multi PDN) to cnSGW-C call flow.

Figure 125: X2 Handover SGW Relocation to CN-SGW (Multi PDN) Call Flow

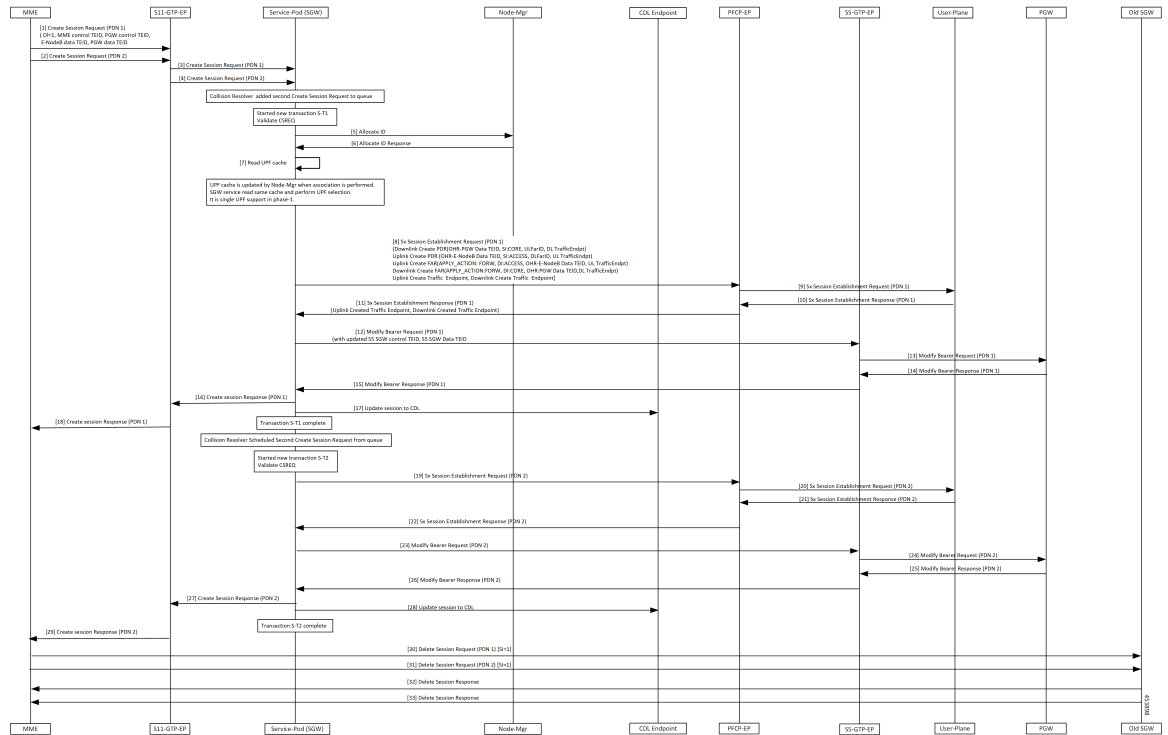

Table 226: X2 Handover SGW Relocation to CN-SGW (Multi PDN) Call Flow Description

Step	Description
1, 2	MME sends Create Session Req for both PDNs to GTPC-EP ingress with the following: <ul style="list-style-type: none"> • OI flag set • MME Control TEID • PGW Control TEID • eNodeB Data TEID • PGW Data TEID Establishes new transactions at GTPC-EP ingress.
3, 4	SGW service POD receives Create Session Req for both PDNs from PFCP-EP ingress. Collision resolver added Create Session Req for PDN 2 in queue.
5	Create a new transaction S-T1 for Create Session Req for PDN 1 Validate CSReq.
6	NodeMgr allocates TEID.
7	SGW service POD reads UPF Cache and performs UPF selection.
8	PFCP-EP receives Sx Session Establishment Req from SGW service POD for PDN 1 with the following: <ul style="list-style-type: none"> • Uplink and downlink Create PDRs/FARs(ApplyAction as Forward)/CTEs.
9	PFCP-EP forwards Sx Session Establishment Req for PDN 1 to UPF.
10	UPF sends Sx Session Establishment Response for PDN 1 to PFCP-EP with Created CTEs.
11	PFCP-EP forwards Sx Session Establishment Response for PDN 1 to SGW service POD.
12	SGW service POD sends Modify Bearer Req for PDN 1 to GTPC-EP with the following: <ul style="list-style-type: none"> • Updated S5 SGW Control TEID • S5 SGW Data TEID
13	GTPC-EP forwards Modify Bearer Req for PDN 1 to PGW.
14	PGW sends Modify Bearer Response for PDN 1 to GTPC-EP.
15	GTPC-EP forwards Modify Bearer Response for PDN 1 to SGW service POD.
16	SGW service forwards Create Session Response for PDN 1 to GTPC-EP ingress.
17	Session updated at CDL. Transaction S-T1 completed. Collision resolver schedules Create Session Req for PDN 2 from queue.

Step	Description
18	GTPC-EP ingress forwards Create Session Response for PDN 1 to MME.
19 - 27	Repeat steps from 8 to 16 for PDN2.
28	Session updated at CDL. Transaction S-T2 completed.
29	GTPC-EP ingress forwards Create Session Response for PDN 2 to MME.
30 - 33	MME sends Delete Session Request for both PDNs with SI=1 to old SGW and receives Delete Session Response. Call cleared in old SGW.

S1 Handover SGW Relocation to CN-SGW (Multi PDN) Call Flow

This section describes the S1 handover SGW relocation to CN-SGW (Multi PDN) to CN-SGW call flow.

Figure 126: S1 Handover SGW Relocation to CN-SGW (Multi PDN) Call Flow

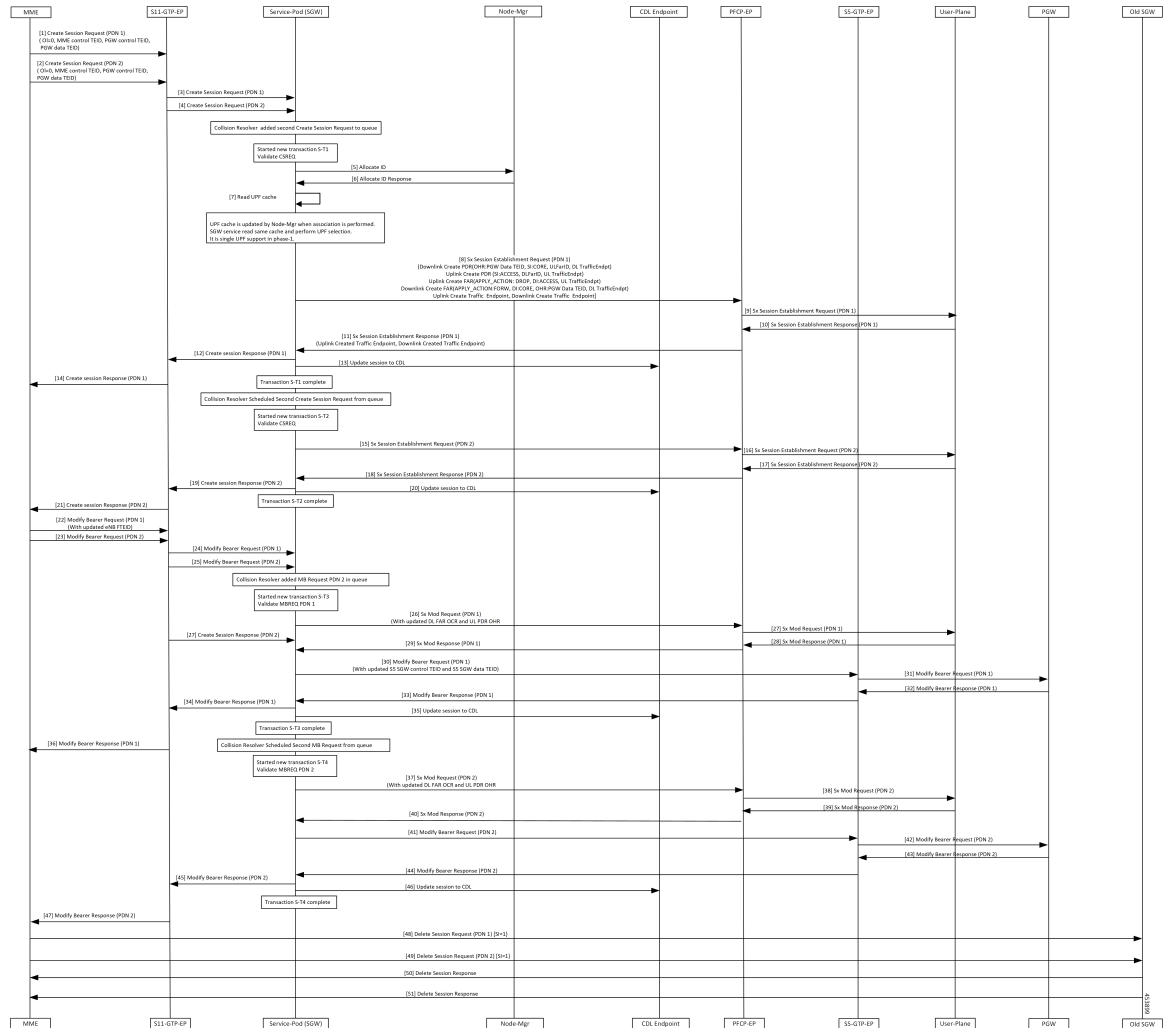

Table 227: S1 Handover SGW Relocation to CN-SGW (Multi PDN) Call Flow Description

Step	Description
1, 2	<p>GTPC-EP ingress receives Create Session Req for both the PDNs with the following:</p> <ul style="list-style-type: none"> • Ol flag unset • MME control TEID • PGW control TEID • PGW Data TEID <p>Establishes new transaction at GTPC-EP ingress.</p>
3, 4	<p>SGW service POD receives Create Session Req for both the PDNs from GTPC-EP ingress. Collision resolver added Create Session Req for PDN 2 in queue. Create a new transaction S-T1.</p>
5	Validate CSReq.
6	NodeMgr allocates TEID.
7	SGW service reads UPF Cache and performs UPF selection.
8	<p>PFCP-EP receives Sx Session Establishment Req from SGW service POD for PDN 1 with the following:</p> <ul style="list-style-type: none"> • Uplink and downlink Create PDRs/FARs/CTEs.
9	PFCP-EP forwards Sx Session Establishment Req for PDN 1 to UPF.
10	PFCP-PE receives Sx Session Establishment Response for PDN 1 from UPF with Created CTEs.
11	SGW service POD receives Sx Session Establishment Response for PDN 1 from PFCP-EP.
12	SGW service POD forwards Create Session Response for PDN 1 to GTPC-EP ingress.
13	<p>Session updated at CDL. Transaction S-T1 completed. Collision resolver scheduled Create Session Req for PDN 2 from queue.</p>
14	GTPC-EP ingress forwards Create Session Response for PDN 1 to MME.
15–21	Repeat steps 11–14 for PDN2(S-T2).
22, 23	GTPC-EP ingress receives Modify Bearer Req for both the PDNs with updated eNodB FTEID from MME.
24, 25	<p>GTPC-EP ingress forwards Modify Bearer Req to both PDNs to SGW service POD. Collision resolver added Modify Bearer Req for PDN 2 in the queue. Create a new transaction S-T3.</p>

Step	Description
26	PFCP-EP receives Sx Session Modification Req for PDN 1 from SGW service POD with the updated downlink FAR and uplink PDR.
27	PFCP-EP forwards Sx Session Modification Req for PDN 1 to UPF.
28	UPF sends Sx Session Modification Response for PDN 1 to PFCP-EP.
29	SGW service POD receives Sx Modify Response for PDN 1 from PFCP-EP.
30	GTPC-EP receives Modify Bearer Req for PDN 1 from SGW service POD with the following: <ul style="list-style-type: none"> • Updated S5 SGW Control TEID and S5 SGW Data TEID.
31	GTPC-EP forwards Modify Bearer Req for PDN 1 to PGW.
32	GTPC-EP receives Modify Bearer Response for PDN 1 from PGW.
33	GTPC-EP forwards Modify Bearer Response for PDN 1 to SGW service POD.
34	SGW service POD forwards Modify Bearer Response for PDN 1 to GTPC-EP ingress.
35	Session updated at CDL.
36	GTPC-EP ingress forwards Modify Bearer Response for PDN 1 to MME.
37	SGW service POD sends Modify Bearer Req for PDN 2 to PFCP-EP. Transaction S-T3 completed. Collision resolver schedules Modify Bearer Req to PDN 2.
38–40	Repeat steps 27,28, 29 for PDN 2.
41	SGW service POD sends Modify Bearer request for PDN 2 to GTPC-EP.
42–47	Repeat steps 31–36 for PDN 2.
48, 49	MME sends Delete Session Request for both the PDNs with SI=1 sent to old SGW.
50	MME receives Delete Session Response. Call cleared in old SGW.

X2 Handover SGW Relocation with Bearer Context Marked for Removal Call Flow

This section describes the X2 handover SGW relocation with bearer context marked for removal call flow.

Figure 127: X2 Handover SGW Relocation with Bearer Context Marked for Removal Call Flow

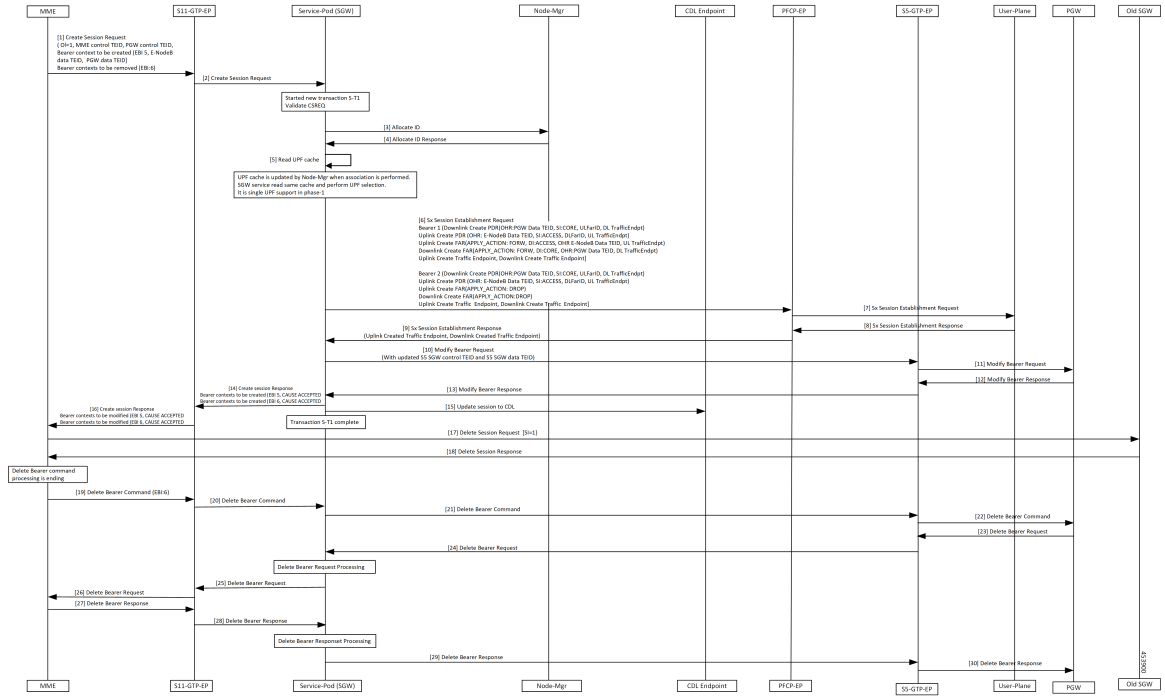

Table 228: X2 Handover SGW Relocation with Bearer Context Marked for Removal Call Flow Description

Step	Description
1	GTPC-EP ingress receives Create Session Req with the following: <ul style="list-style-type: none"> • OI flag set • MME Control TEID • PGW Control TEID • new Bearer Contexts to create (EBI:5, eNodeB Data TEID and PGW Data TEID) • Bearer context to delete (EBI: 6) Establishes new transaction at GTPC-EP.
2	GTPC-EP ingress forwards Create Session Req to SGW service POD.
3	SGW service POD receives Create Session Req. Create a new transaction S-T1.
4	Validate CSReq. NodeMgr allocates TEID.
5	SGW service POD reads UPF Cache and performs UPF selection.

Step	Description
6	PFPCP-EP receives Sx Session Establishment Req from SGW service POD with the following: <ul style="list-style-type: none"> • Uplink and downlink Create PDRs/FARs (ApplyAction as Forward for EBI 5 and as Drop EBI 6)/CTEs.
7	PFPCP-EP forwards Sx Session Establishment Req to UPF.
8	PFPCP-EP receives Sx Session Establishment Response from UPF with Created CTEs.
9	SGW service POD receives Sx Session Establishment Response from PFPCP-EP.
10	SGW service POD sends Modify Bearer Req with updated S5 SGW Control TEID and S5 SGW Data TEID to GTPC-EP.
11	GTPC-EP forwards Modify Bearer Request to PGW.
12	GTPC-EP receives Modify Bearer Response from PGW.
13	GTPC-EP forwards Modify Bearer Response to SGW service POD.
14	SGW service POD sends Create Session Response to GTPC-EP ingress with cause Accepted for both Bearer Contexts.
15	Session updated at CDL. Transaction S-T1 completed.
16	GTPC-EP ingress forwards Create Session Response to MME.
17	MME sends Delete Session Request with SI=1 sent to old SGW.
18	MME receives Delete Session Response. Call cleared in old SGW.
19	GTPC-EP ingress receives Delete Bearer Command for Bearer Context from MME to delete (EBI 6).
20	SGW service POD receives Delete Bearer Command from GTPC-EP ingress.
21	SGW service POD forwards Delete Bearer Command to GTPC-EP.
22	GTPC-EP forwards Delete Bearer Command to PGW.
23	PGW responds with Delete Bearer Request (EBI 6) to GTPC-EP.
24	GTPC-EP forwards Delete Bearer Request to SGW service POD.
25	SGW service POD processes Delete Bearer Request and sends to GTPC-EP.
26	GTPC-EP ingress forwards Delete Bearer request to MME.
27	MME responds with the Delete Bearer Response to GTPC-EP ingress.
28	GTPC-EP ingress forwards Delete Bearer Response to SGW service POD.
29	SGW service POD processes Delete Bearer Response and sends to GTPC-EP.

Step	Description
30	GTPC-EP forwards Delete Bearer Response to PGW.

S1 Handover SGW Relocation with Bearer Context Marked for Removal Call Flow

This section describes the S1 handover SGW relocation with bearer context marked for removal call flow.

Figure 128: S1 Handover SGW Relocation with Bearer Context Marked for Removal Call Flow

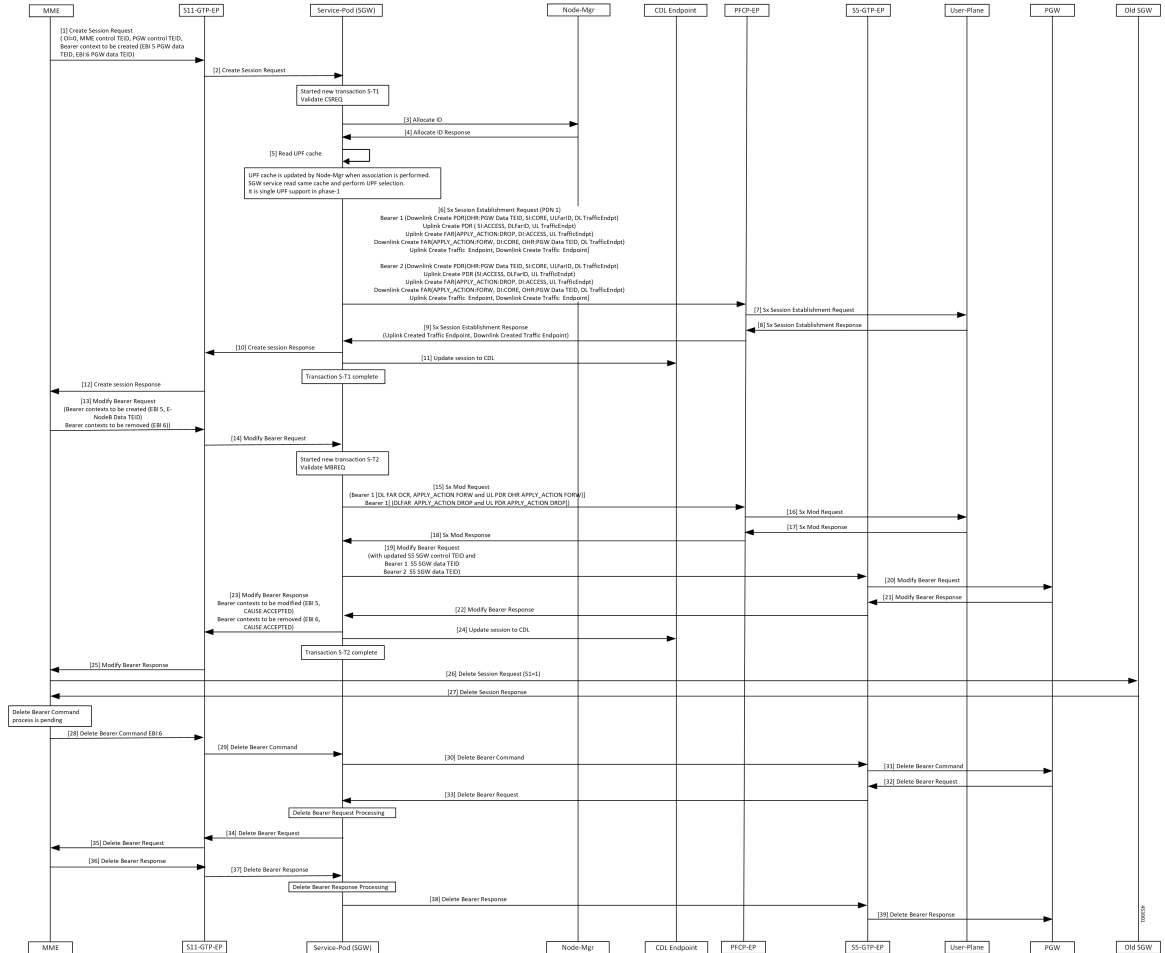

Table 229: S1 Handover SGW Relocation with Bearer Context Marked for Removal Call Flow Description

Step	Description
1	<p>GTPC-EP ingress receives Create Session Request from MME with the following:</p> <ul style="list-style-type: none"> • OI flag unset • MME Control TEID • PGW Control TEID • Bearer context to create (EBI:5, PGW Data TEID, EBI:6, PGW Data TEID) <p>Establishes new transaction at GTPC-EP ingress.</p>
2	GTPC-EP ingress forwards Create Session req to SGW service POD.
3	<p>SGW service POD receives Create Session Req.</p> <p>Create a new transaction S-T1.</p>
4	<p>Validate CSReq.</p> <p>NodeMgr allocates TEID.</p>
5	SGW service reads UPF cache and performs UPF selection.
6	<p>PFCP-EP receives Sx Session Establishment Req from SGW service with the following:</p> <ul style="list-style-type: none"> • Uplink and downlink Create PDRs/FARs(ApplyAction as Forward for EBI 5 and as Drop EBI 6)/CTEs.
7	PFCP-EP forwards Sx Session Establishment Req to UPF.
8	PFCP-EP receives Sx Session Establishment Response from UPF with Created CTEs.
9	SGW service receives Sx Session Establishment Response from PFCP-EP.
10	SGW forwards Sx Session Establishment Response to GTPC-EP ingress.
11	Session updated at CDL. Transaction S-T1 completed.
12	GTPC-EP ingress sends Create Session Response to MME.
13	<p>GTPC-EP ingress receives Modify Bearer Req with the following:</p> <ul style="list-style-type: none"> • Updated eNodeB FTEID with new Bearer Contexts (here EBI 5) and removed (here EBI 6).
14	GTPC-EP forwards Modify Bearer Req to SGW.
15	<p>Create a new transaction S-T2.</p> <p>PFCP-EP receives Sx Session Modification Req from SGW service POD with the following:</p> <ul style="list-style-type: none"> • Updated downlink FAR and uplink PDR (Apply Action as DROP for Bearer 2).
16	PFCP-EP forwards Sx Session Modification Req forwarded to UPF.

Step	Description
17	UPF sends Sx Modification Response to PFCP-EP
18	PFCP-EP forwards Sx Modification Response to SGW service POD.
19	SGW service POD sends Modify Bearer Req with updated S5 SGW Control TEID and S5 SGW Data TEID to GTPC-EP.
20	GTPC-EP forwards Modify Bearer Request to PGW.
21	GTPC-EP receives Modify Bearer Response from PGW.
22	GTPC-EP forwards Modify Bearer Response to SGW service POD.
23	SGW service POD forwards Create Session Response to GTPC-EP ingress with cause Accepted for both Bearer Contexts.
24	Session updated at CDL. Transaction S-T2 completed.
25	GTPC-EP ingress sends Modify Bearer Response to MME.
26	MME sends Delete Session Request with SI=1 to old SGW.
27	MME receives Delete Session Response. Call cleared in old SGW.
28	GTPC-EP ingress receives Delete Bearer Command from MME for BearerContext to delete (EBI 6).
29	SGW service POD receives Delete Bearer Command from GTPC-EP ingress.
30	SGW service POD forwards Delete Bearer Command to GTPC-EP.
31	GTPC-EP forwards Delete Bearer Command to PGW.
32	PGW responds with Delete Bearer Request (EBI 6) to GTPC-EP.
33	GTPC-EP sends Delete Bearer Request to SGW service POD.
34	SGW service POD processes Delete Bearer Request and sends to GTPC-EP ingress.
35	GTPC-EP ingress sends Delete Bearer request to MME.
36	MME responds with the Delete Bearer Response to GTPC-EP ingress.
37	GTPC-EP ingress receives Delete Bearer response and sends to SGW service POD.
38	SGW service POD processes Delete Bearer Response and forwards to GTPC-EP.
39	GTPC-EP forwards Delete Bearer Response to PGW.

Inter and Intra MME Handover and S1 SGW Relocation with Less Number of Bearer Context Call Flow

This section describes the inter and intra MME handover and S1 SGW relocation with less number of bearer context call flow.

Figure 129: Inter and Intra MME Handover and S1 SGW Relocation with Less Number of Bearer Context Call Flow

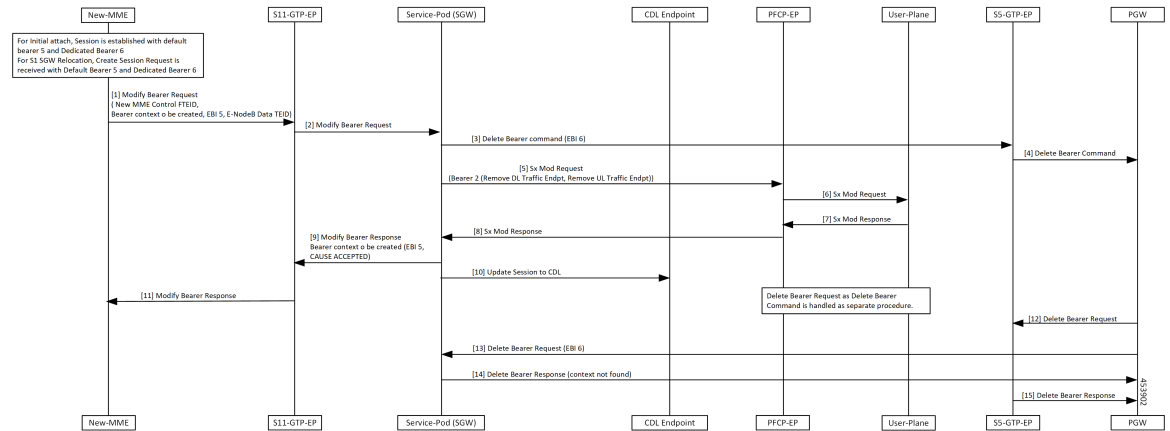

Table 230: Inter and Intra MME Handover and S1 SGW Relocation with Less Number of Bearer Context Call Flow Description

Step	Description
1	Established NEW MME session with the default bearer EBI 5 and dedicated bearer 6. New MME receives Create Session Request for S1 SGW Relocation with Default bearer EBI 5 and dedicated bearer 6. New MME sends Modify Bearer Request to GTPC-EP ingress with the following: <ul style="list-style-type: none"> • New MME Control TEID • New Bearer Contexts to create • EBI5 • eNodeB Data TEID
2	GTPC-EP ingress forwards Modify Bearer Request to SGW service POD.
3	SGW service POD sends Delete Bearer Command with EBI 6 to GTPC-EP.
4	GTPC-EP forwards Delete Bearer Command to PGW.
5	SGW service POD sends Sx Mod Req to PFCP-EP with Remove DL Traffic Endpoint and Remove UL Traffic Endpoint for Bearer 2.
6	PFCP-EP forwards Sx Mod Req to UPF.
7	UPF sends Sx Mod Response to PFCP-EP.
8	PFCP-EP forwards Sx Mod Response to SGW service POD.

Step	Description
9	SGW service POD sends Modify Bearer Response to GTPC-EP ingress with the following: <ul style="list-style-type: none"> • Bearer Contexts EBI 5 to modify with cause as <i>Accepted</i>
10	Updated session to CDL.
11	GTPC-EP ingress sends Modify Bearer Response to New MME.
12	PGW sends Delete Bearer Request to GTPC-EP.
13	SGW service POD receives Delete Bearer Request with EBI6 from PGW as Delete Bearer Command handled as separate procedure.
14	SGW service POD responds with Delete Bearer Response with cause as <i>Context Not Found</i> to GTPC-EP.
15	GTPC-EP forwards Delete Bearer Response to PGW.

**Note**

- Sx Modify Request message along with Remove DL traffic Endpoint and Remove UL traffic Endpoint is sent as don't confirm message in Legacy CUPS. Sx Modify for MBReq message follows Sx Modify Request and sent to UPF.
- UPF receives the following messages in cnSGW-C.
 - Single Sx Modify Request message for MB Request
 - Remove DL traffic Endpoint
 - Remove UL traffic Endpoint

SGW Relocation OAM Support

This section describes operations, administration, and maintenance information for this feature.



CHAPTER 45

Sx Load/Overload Control Handling

- [Feature Summary and Revision History, on page 663](#)
- [Feature Description, on page 664](#)
- [How it Works, on page 664](#)
- [Configuring the Sx Load/Overload Feature, on page 665](#)
- [Configuring Failure Handling Profile, on page 666](#)
- [Sx Load/Overload Control OAM Support, on page 668](#)

Feature Summary and Revision History

Summary Data

Table 231: Summary Data

Applicable Product(s) or Functional Area	cnSGW-C
Applicable Platform(s)	SMI
Feature Default Setting	Disabled – Configuration required to enable
Related Documentation	Not Applicable

Revision History

Table 232: Revision History

Revision Details	Release
First introduced.	2021.01.0

Feature Description

This feature supports enabling Sx load and overload for user-plane. UP selection takes place when the user-plane reports LCI (Load control information) and OCI (Overload Control Information).

Load control enables the user-plane function to send its load information to the control plane function. This load information is to balance the PFCP session load across the user-plane functions according to their effective loads.

Overload controls the information for throttling of new session requests towards specific user-plane.

How it Works

This section describes how this feature works.

Node Feature Support

As per 3GPP standard:

- CP informs load and overload feature to the user-plane.
- User-plane decides to send load or overload information towards the CP peer or not.

Configure load and overload feature at CP as a part of PFCP Sxa endpoint node feature. This configuration in turn communicates to UP during Sx Association Response message or Sx Association Update Request message when change in configuration occurs.

The CP Function Feature IE indicates the supported CP function features. This IE contains features which have (system-wide) UP function behavior impact.



Note If CP does not support load or overload feature through CLI then it ignores the user-plane reported load or overload information for the UP selection process.

UP Selection

UP selection occurs as per LCI value only whereas throttling occurs as per OCI value only (Specified in 3GPP standards).

Per Peer Level LCI and OCI display:

```
show peers | tab | exclude rest
```

ENDPOINT	LOCAL ADDRESS	PEER ADDRESS	DIRECTION	INSTANCE	POD TYPE	CONNECTED TIME	RPC
S5/S8	<nil>:2123	209.165.202.143:2123	Inbound	nodemgr-0	Udp	6 minutes	SGW Recovery: 10
SXA	209.165.200.226:8805	209.165.202.143:8805	Inbound	nodemgr-0	Udp	About a minute	SGW-U Capacity: 65535, LoadMetric: 20,LoadSeqNo: 1,OverloadMetric: 0,OverloadSeqNo: 0,Priority: 10
SXA	209.165.200.226:8805	209.165.202.147:8805	Inbound	nodemgr-0	Udp	2 minutes	SGW-U

```
Capacity: 10,
LoadMetric: 40,LoadSeqNo: 1,OverloadMetric: 100,OverloadSeqNo: 1,Priority: 20
SXA 209.165.200.226:8805 209.165.202.159:8805 Inbound nodemgr-0 Udp 2 minutes SGW-U
Capacity: 10,
LoadMetric: 100,LoadSeqNo: 1,OverloadMetric: 77,OverloadSeqNo: 1,Priority: 1
```

Throttling Support for Sx Establishment

When user-plane is in overload situation, cnSGW-C establishes throttling the Sx Establishment request message toward user-plane. This throttling avoids new calls (Low priority or non-emergency) towards the overloaded user-plane.

Throttling takes place as per the reported OCI values in percentage. Following actions takes place when throttling happens:

- Random drop of percentage in reported Sx Establishment Request messages towards that user-plane.
- Call drop occurs at cnSGW-C with `sx_no_resource_available` disconnect reason.
- Respective statistics get incremented.

Session Termination Trigger From User-Plane in Self-Protection

User-plane triggers the session termination request towards cnSGW-C in pacing manner through Sx Report Request message. User-plane triggers session termination request when it is in self-protection mode and there is no improvement in load. This trigger happens with setting of SPTER (Self Protection Termination Request) bit.

cnSGW-C initiates Sx Termination Request for those PDNs and releases the PDN session with disconnect reason as `userplane_requested_termination`.

Failure-handling Profile Support for Congestion Cause

When the user-plane is in self-protection mode and rejects the new sessions with the cause `PFCP_ENTITY_IN_CONGESTION (74)`, cnSGW-C selects different user-plane as per the failure template profile configuration.

Failure-handling profile is associated with UPF-Group.

Reselection of UPF follows the UPF selection process and considers the retries count to different UPF from profile configuration.



Note Currently, only `PFCP_ENTITY_IN_CONGESTION (74)` is supported as cause code for retry and reselection of user-plane as part of this feature.

Configuring the Sx Load/Overload Feature

This section describes how to configure Sx Load/Overload.

Use the following commands to configure Sx Load/Overload configuration.

```

config
  instance instance-id instance_id
    endpoint endpoint_name
      interface interface_name
        supported-features [ load-control | overload-control ]
      exit
    exit
  exit

```

NOTES:

- **endpoint** *endpoint_name* - Specify the endpoint name.
- **interface** *interface_name* - Specify the interface name.
- **supported-features** [**load-control** | **overload-control**] - Enable load/overload control.

Sample Configuration

Following is a sample configuration.

```

configure
  instance instance-id 1
  endpoint pfcf
  interface sxa
    supported-features load-control overload-control
  exit

```

Verifying Sx Load/Overload Configuration

Use the following `show` command to view the Sx load/overload configuration.

```

show running-config instance instance-id 1 endpoint
instance instance-id 1
endpoint pfcf
interface sxa
supported-features load-control overload-control
exit
exit

```

Configuring Failure Handling Profile

This section describes how to configure failure handling profile.

Use the following commands to configure failure handling profile.

```

config
  profile failure-handling failure-handling_profile_name
    interface interface_name
      message message_type
        cause-code cause_code
        action action_type
        max-retry max_retry_count
      exit
    exit
  exit
  profile upf-group upf-group_profile_name

```

```
failure-profile profile_name
exit
```

NOTES:

- **profile failure-handling** *failure-handling_profile_name* - Specify the failure-handling profile name.
- **interface** *interface_name* - Specify the interface name.
- **message** *message_type* - Specify the message type.
- **cause-code** *cause_code* - Specify the cause ID (range of 2-255) or range of cause IDs (range of 2-255) separated by either '-' or ',' or both.

-Or-

Must be one of the following:

- no-resource-available
 - no-response-received
 - pfc-p-entity-in-congestion
 - reject
 - service-not-supported
 - system-failure
- **action** *action_type* - Specify the action type for the cause. Must be one of the following:
 - retry-terminate
 - terminate
 - **max-retry** *max_retry_count* - Specify the maximum retry count for the retry-terminate action. Must be an integer in the range of 0-5. Default value is 1.
 - **profile upf-group** *upf-group_profile_name* - Specify the UPF group profile name.
 - **failure-profile** *profile_name* - Specify the UPF failure profile name.

Sample Configuration

Following is the sample configuration:

```
profile failure-handling fh1
  interface sxa
    message SessionEstablishmentReq
      cause-code pfc-p-entity-in-congestion action terminate
    exit
  exit
exit
profile failure-handling fh2
  interface sxa
    message SessionEstablishmentReq
      cause-code 74 action retry-terminate max-retry 3
    exit
  exit
exit
```

```

profile upf-group g1
  failure-profile fh1
exit
profile upf-group g2
  failure-profile fh2
exit

```

Sx Load/Overload Control OAM Support

This section describes operations, administration, and maintenance information for this feature.

Bulk Statistics

UE Disconnect Statistics

```

sgw_ue_disconnect_stats{app_name="smf",cluster="cn",data_center="cn",instance_id="0",reason="sx_no_resource_available",service_name="sgw-service"} 1

```

```

sgw_ue_disconnect_stats{app_name="smf",cluster="cn",data_center="cn",instance_id="0",reason="userplane_requested_termination",service_name="sgw-service"} 1

```

PDN Disconnect Statistics

```

sgw_pdn_disconnect_stats{app_name="smf",cluster="cn",data_center="cn",instance_id="0",pdn_type="ipv4",rat_type="EUTRAN",reason="sx_no_resource_available",service_name="sgw-service"} 1

```

```

sgw_pdn_disconnect_stats{app_name="smf",cluster="cn",data_center="cn",instance_id="0",pdn_type="ipv4v6",rat_type="EUTRAN",reason="userplane_requested_termination",service_name="sgw-service"} 1

```

SGW Service Statistics

```

sgw_service_stats{app_name="smf",cluster="cn",data_center="cn",fail_reason="sx_oci_throttling_reject",instance_id="0",interface="interface_sgw_ingress",reject_cause="no_resources_available",service_name="sgw-service",sgw_procedure_type="initial_attach",status="rejected",sub_fail_reason=""} 1

```

```

sgw_service_stats{app_name="smf",cluster="cn",data_center="cn",fail_reason="",instance_id="0",interface="interface_sgw_egress",reject_cause="",service_name="sgwservice",sgw_procedure_type="upf_initiated_deletion",status="attempted",sub_fail_reason=""} 1

```

```

sgw_service_stats{fail_reason="sx_cause_fail",interface="interface_sgw_ingress",reject_cause="service_denied",sub_fail_reason="pfcpc_entity_in_congestion",sgw_procedure_type="initial_attach",status="rejected"}

```



CHAPTER 46

Stale Session Handling and Clearing

- [Feature Summary and Revision History, on page 669](#)
- [Feature Description, on page 670](#)
- [How it Works, on page 670](#)
- [Feature Configuration, on page 672](#)
- [OAM Support, on page 673](#)

Feature Summary and Revision History

Summary Data

Table 233: Summary Data

Applicable Product or Functional Area	cnSGW-C
Applicable Platform	SMI
Feature Default Setting	Disabled - Configuration required to enable
Related Documentation	Not Applicable

Revision History

Table 234: Revision History

Revision Details	Release
First introduced	2021.02.3

Feature Description

The cnSGW-C supports identifying and clearing stale sessions using a *session-stale-timer* parameter in the SGW Profile configuration. An example of a stale session is one that is inactive and not read or modified for a specific period of time.

For more information, see the [Stale Session Handling and Clearing, on page 669](#) chapter.

How it Works

This section describes how this feature works.

Call Flows

This section describes the key call flows for this feature.

Timer Expiry Handling Call Flow

This section describes the Timer Expiry Handling call flow.

Figure 130: Timer Expiry Handling Call Flow

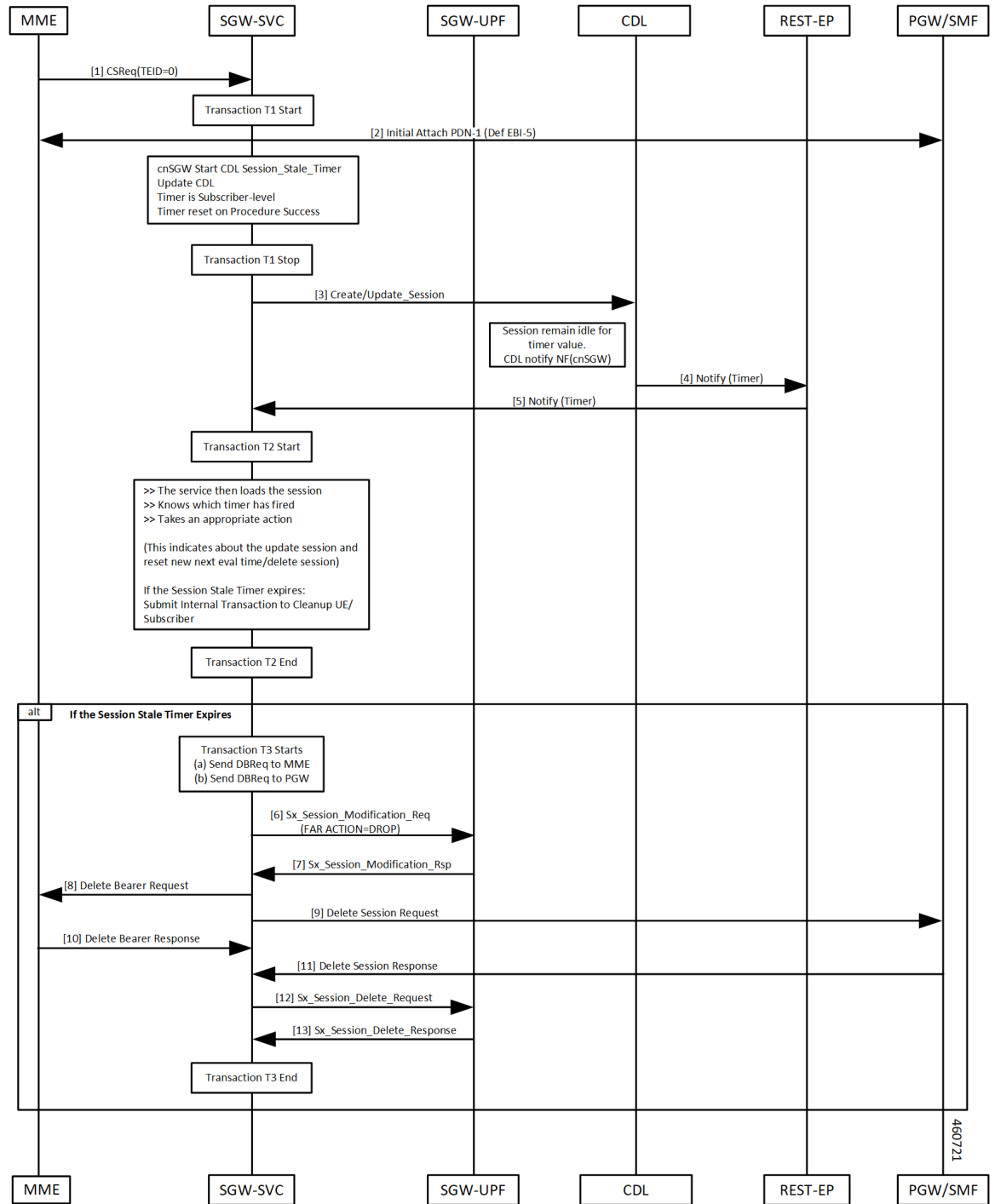

Table 235: Timer Expiry Handling Call Flow Description

Step	Description
1, 2, 3	<p>The initial attach and Session Stale Timer updates are sent to CDL and the timer starts. The sequence is as follows:</p> <ul style="list-style-type: none"> • Initial Attach Success • Session Stale Timer created • CDL updates done. • CDL starts Time (eval time) and waits for update session. <p>Note Session Stale Timer is Reset or Restart, when any of the activity or transaction happens on the Control Plane (cnSGW-C).</p>
4, 5	<p>The Timer expires on CDL pod, and the timer sends notification to cnSGW-C. The sequence is as follows:</p> <ul style="list-style-type: none"> • If no Session update received for eval timer duration • Timer Expiry on CDL pod • CDL sends Timer Notification to cnSGW-C
6–13	<p>The session cleanup is activated, when the Session Stale Timer expires, and the timer reset isn't required. The sequence is as follows:</p> <ul style="list-style-type: none"> • Receives Timer Notification on cnSGW-C • If the Timer Notification is for Session Stale Timer and if the timer reset isn't required, it starts UE session clean-up activities. • Sends Sx_Session_Modification_Req to UPF to set FAR Action=Drop, Sx_Session_Modification response received • Sends Delete Bearer Request towards MME • Sends Delete Session Request toward PGW • Sends Sx_Session_Delete_Request toward UPF to clean up User Plane data

Feature Configuration

To configure this feature, use the following configuration:

```

config
  profile sgw sgw_profile_name
  session-stale-timer session_stale_timer
end

```

NOTES:

- **session-stale-timer** *session_stale_timer*—Specify the maximum number of seconds for which a session can remain idle without any signaling or event, after which the session will be terminated.

The *session_stale_timer* value must be in the range of 0–4294967295, and must be greater than the **setup-timeout** and **session-idle-timeout** timer values.

To disable the session-stale-timer configuration, set it to 0.

Configuration Example

The following is an example configuration.

```
config
  profile sgw sgw1
    session-stale-timer 120
  end
```

Configuration Verification

To verify the configuration:

```
show running-config profile sgw sgw1
session-stale-timer 120
```

The output of the show command includes the following field:

session-stale-timer—Indicates the maximum number of seconds for which a session can remain idle without any signaling or event, after which the session is terminated.

OAM Support

This section describes operations, administration, and maintenance information for this feature.

Bulk Statistics

The following statistics are supported for this feature

```
sgw_service_stats{app_name="smf",cluster="Local",data_center="DC",
fail_reason="",gr_instance_id="1",instance_id="0",interface="interface_sgw_egress",reject_cause="",
service_name="sgw-service",sgw_procedure_type="stale_session_initiated_deletion",status="attempted",
sub_fail_reason=""} 1
```

```
sgw_service_stats{app_name="smf",cluster="Local",data_center="DC",fail_reason="",
gr_instance_id="1",instance_id="0",interface="interface_sgw_egress",reject_cause="",
service_name="sgw-service",sgw_procedure_type="stale_session_initiated_deletion",status="success",
sub_fail_reason=""} 1
```

```
sgw_service_stats{app_name="smf",cluster="Local",data_center="DC",fail_reason="",
gr_instance_id="1",instance_id="0",interface="interface_sgw_ingress",reject_cause="",
service_name="sgw-service",sgw_procedure_type="stale_session_initiated_deletion",status="attempted",
sub_fail_reason=""} 1
```

```
sgw_service_stats{app_name="smf",cluster="Local",data_center="DC",fail_reason="",  
gr_instance_id="1",instance_id="0",interface="interface_sgw_ingress",reject_cause="",  
service_name="sgw-service",sgw_procedure_type="stale_session_initiated_deletion",status="success",  
sub_fail_reason="" } 1
```

```
sgw_ue_disconnect_stats{app_name="smf",cluster="Local",data_center="DC",  
gr_instance_id="1",instance_id="0",reason="stale_session_init_disconnect",  
service_name="sgw-service"} 1
```

```
sgw_pdn_disconnect_stats{app_name="smf",cluster="Local",data_center="DC",  
gr_instance_id="1",instance_id="0",pdn_type="ipv4",rat_type="EUTRAN",  
reason="stale_session_init_disconnect",service_name="sgw-service"} 1
```



CHAPTER 47

Support for CSFB Procedures Suspend and Resume

- [Feature Summary and Revision History, on page 675](#)
- [Feature Description, on page 675](#)
- [How it Works, on page 676](#)

Feature Summary and Revision History

Summary Data

Table 236: Summary Data

Applicable Products or Functional Area	cnSGW-C
Applicable Platforms	SMI
Feature Default Setting	Enabled – Always-on
Related Documentation	Not Applicable

Revision History

Table 237: Revision History

Revision Details	Release
First introduced.	2022.04.0

Feature Description

Circuit Switched Fall Back (CSFB) enables the UE to camp on an EUTRAN cell and originate or terminate voice calls through a forced switchover to the circuit-switched (CS) domain or other CS-domain services,

such as Location Services (LCS) and supplementary services. Also, SMS delivery through the CS core network is realized without CSFB. As LTE EPC networks are not meant to directly anchor CS connections, when any CS voice services are initiated, any PS-based data activities on the EUTRAN network get suspended (that is, either the data transfer is suspended, or the packet switched connection is handed over to the 2G/3G network). The data activities can further be resumed to enable telephony and SMS services for LTE operators that do not plan to deploy IMS packet switched services at the initial service launch.

cnSGW-C supports the following CSFB Messaging services on an S11 interface over GTPC:

- Suspend Notification
- Suspend Acknowledgment
- Resume Notification
- Resume Acknowledgment

Along with the Resume procedure, it is possible that MME can send a nonempty Modify Bearer Request. In the suspended state, cnSGW-C supports handling the Modify Bearer Request by considering it as an implicit resume procedure.

How it Works

This section describes how this feature works.

cnSGW-C forwards Suspend Notification messages to the PGW to suspend downlink data for non-GBR traffic. Later, when the UE completes the CS services and moves back to E-UTRAN, the MME sends a Resume Notification message to cnSGW-C which forwards the message to the PGW. The downlink data traffic resumes thereafter.

Support for Empty Modify Bearer Request for Resume

In the suspended state, cnSGW-C handles the Modify Bearer Request by considering it as an implicit resume procedure. SGW resumes and forwards the empty Modify Bearer Request to PGW. If eNodeB teid exists in MBR, cnSGW-C sets the Downlink Far Action as Forward. If eNodeB teid does not exist in MBR, cnSGW-C sets the Downlink Far Action as Buffer.

Call Flows

This section describes the key call flow for this feature.

Suspend Notification Call Flow

This section describes the Suspend Notification call flow.

Figure 131: Change Notification Request Call Flow

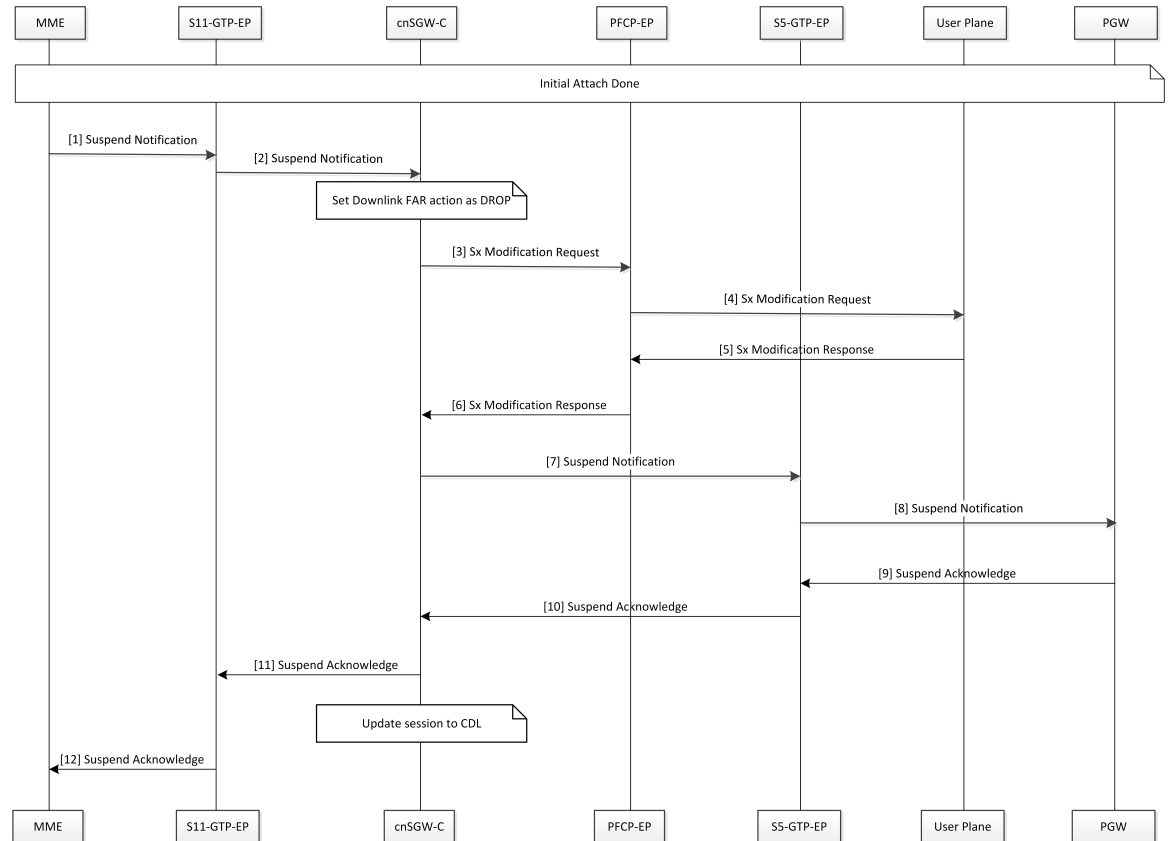

Table 238: Suspend Notification Call Flow Description

Step	Description
1	MME sends the Suspend Notification to the S11-GTP-EP pod.
2	The S11-GTP-EP pod sends the Suspend Notification to the cnSGW-c.
3	cnSGW-c updates the Download FAR action Drop by sending the Sx Session Modification Request to the SGW-U with the FAR action set as DROP. cnSGW-c sends the Sx Modification Request to the PFCP-EP.
4	PFCP-EP sends the Sx Modification Request to the User Plane.
5	The user plane sends the Sx Modification Response to the PFCP-EP.
6	PFCP-EP sends the Sx Modification Response to the cnSGW-C.
7	cnSGW-C sends the Suspend Notification to the S5-GTP-EP pod.
8	The S5-GTP-EP pod sends the Suspend Notification to the PGW.
9	PGW sends the Suspend Acknowledgment to the S5-GTP-EP pod.

Step	Description
10	The S5-GTP-EP pod sends the Suspend Acknowledgment to the cnSGW-C.
11	cnSGW-C sends the Suspend Acknowledgment to the S11-GTP-EP pod. cnSGW-C updates the session to CDL.
12	The S11-GTP-EP pod sends the Suspend Acknowledgment to the MME.

Resume Notification Call Flow

This section describes the resume notification call flow.

Figure 132: Resume Notification Call Flow

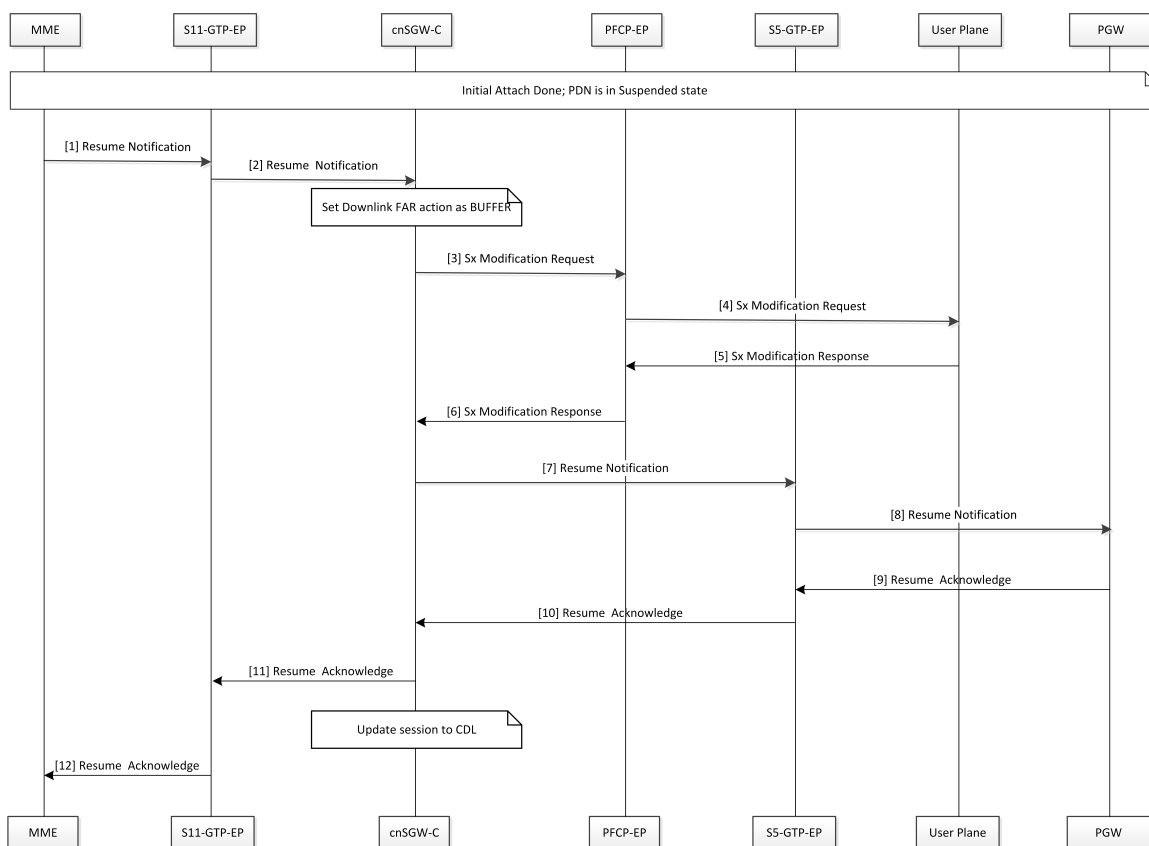

Table 239: Resume Notification Call Flow Description

Step	Description
1	MME sends the Resume Notification to the S11-GTP-EP pod.
2	The S11-GTP-EP pod sends the Resume Notification to cnSGW-c.

Step	Description
3	cnSGW-c updates the Download FAR action Buffer by sending the Sx Session Modification Request to the SGW-U with the FAR action set as BUFFER. cnSGW-c sends the Sx Modification Request to the PFCP-EP.
4	PFCP-EP sends the Sx Modification Request to the User Plane.
5	The User Plane sends the Sx Modification Response to the PFCP-EP.
6	PFCP-EP sends the Sx Modification Response to the cnSGW-C.
7	cnSGW-C sends the Resume Notification to the S5-GTP-EP pod.
8	The S5-GTP-EP pod sends the Resume Notification to the PGW.
9	PGW sends the Resume Acknowledgment to the S5-GTP-EP pod.
10	The S5-GTP-EP pod sends the Resume Acknowledgment to the cnSGW-C.
11	cnSGW-C sends the Resume Acknowledgment to the S11-GTP-EP pod. cnSGW-C updates the session to CDL.
12	The S11-GTP-EP pod sends the Resume Acknowledgment to the MME.

Empty Modify Bearer Request for Resume Call Flow

This section describes the Empty Modify Bearer Request for Resume call flow.

Figure 133: Empty Modify Bearer Request for Resume Call Flow

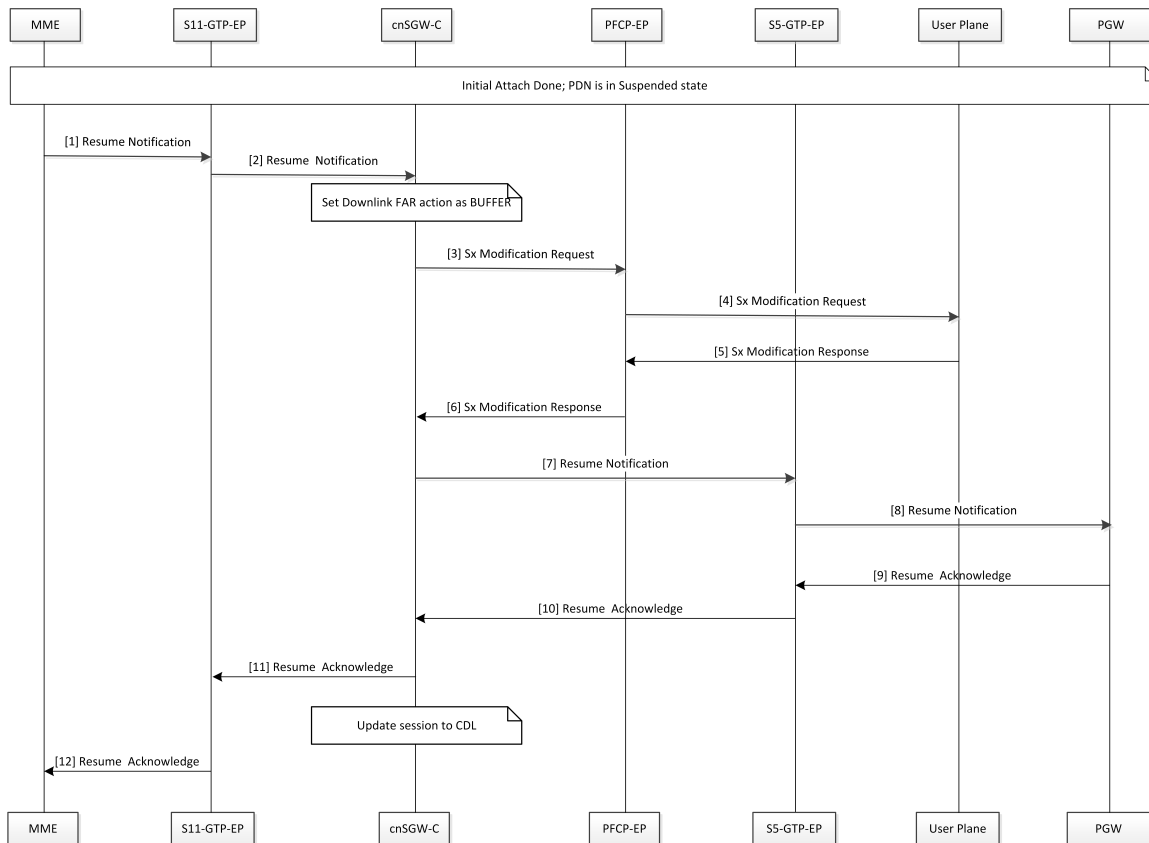

Table 240: Empty Modify Bearer Request for Resume Call Flow Description

Step	Description
1	MME sends the Modify Bearer Request to the S11-GTP-EP pod.
2	The S11-GTP-EP pod sends the Modify Bearer Request to the cnSGW-C. cnSGW-C considers the request as the implicit resume of the suspended bearers in the SGW.
3	If eNodeB exists, cnSGW-C updates Set Downlink Far action as Forward. Else cnSGW-C updates Set Downlink Far action as BUFFER. cnSGW-C sends the Sx Modify Request to the PFCP-EP pod.
4	PFCP-EP sends the Sx Modify Request to the User Plane.
5	The User Plane sends the Sx Modify Response to the PFCP-EP.
6	PFCP-EP sends the Sx Modify Response to the cnSGW-C.
7	cnSGW-C sends the Modify Bearer Request to the S5-GTP-EP pod. The implicit resume for PGW can contain zero or more IEs.

Step	Description
8	The S5-GTP-EP pod sends the Modify Bearer Request to the PGW.
9	PGW sends the Modify Bearer Response to the S5-GTP-EP pod.
10	The S5-GTP-EP pod sends the Modify Bearer Response to the cnSGW-C.
11	cnSGW-C sends the Modify Bearer Response to the S11-GTP-EP pod.
12	The S11-GTP-EP pod sends the Modify Bearer Response to the MME.



CHAPTER 48

Update Bearer Request and Response

- [Feature Summary and Revision History, on page 683](#)
- [Feature Description, on page 683](#)
- [How it Works, on page 684](#)

Feature Summary and Revision History

Summary Data

Table 241: Summary Data

Applicable Product(s) or Functional Area	cnSGW-C
Applicable Platform(s)	SMI
Feature Default Setting	Enabled - Always-on
Related Documentation	Not Applicable

Revision History

Table 242: Revision History

Revision Details	Release
First introduced.	2020.04

Feature Description

In this release, cnSGW-C supports only relay of update bearer request (which can contain TFT change, QCI change or APB – AMBR change) from PGW towards MME. When MME sends response to cnSGW-C, it relays update bearer response towards PGW.

This release doesn't support signaling towards User Plane.

Standards Compliance

The Update Bearer Request and Response Support feature complies with the following standards:

- *3GPP TS 23.401*
- *3GPP TS 23.214*
- *3GPP TS 29.274*
- *3GPP TS 29.244*

How it Works

This section describes how this feature works.

Call Flows

This section describes the key call flow of Update Bearer Request and Response feature.

Figure 134: Bearer Request/Response without UP Signaling Call Flow

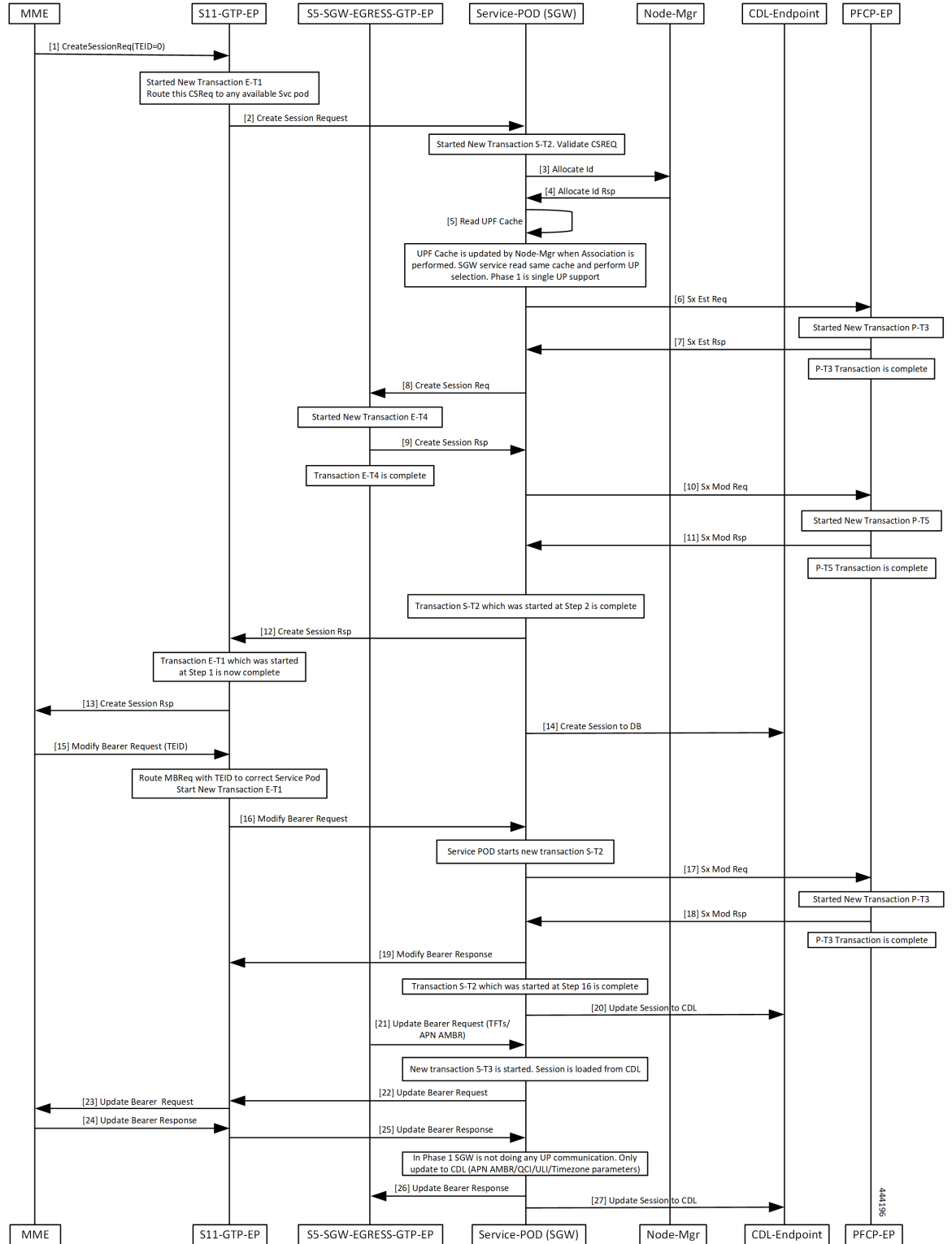

Table 243: Bearer Request/Response without UP Signaling Call Flow Description

Step	Description
1	MME sends Create Session Req to S11-GTP-EP with TEID value as zero.
2	Transaction E-T1 started. S11-GTP-EP sends Create Session Req to SGW-Service POD.
3, 4	Transaction S-T2 started. SGW-Service POD sends Allocate ID to Node-Mgr and receives response from it.
5, 6, 7	SGW-Service POD reads Node-Mgr updated UPF cache and performs UPF selection. SGW-Service POD sends Sx Est Req to PFCP-EP. Transaction P-T3 started. SGW-Service POD receives Sx Est Rsp from PFCP-EP.
8, 9	Transaction P-T3 completed. SGW-Service POD sends Create Session Req to S5-SGW-EGRESS-GTP-EP. Transaction E-T4 started. SGW-Service POD receives Create Session Rsp from S5-SGW-EGRESS-GTP-EP.
10, 11, 12	Transaction E-T4 completed. SGW-Service POD sends Sx Mod Req to PFCP-EP. Transaction P-T5 started. SGW-Service POD receives Sx Mod Rsp from PFCP-EP.
12	Transaction S-T2 ans P-T5 completed. SGW-Service POD sends Create Session Rsp to S11-GTP-EP.
13	Transaction E-T1 completed. S11-GTP-EP sends Create Session Rsp to MME.
14	SGW-Service POD sends Create Session to DB.
15	MME sends Modify Bearer Req with TEID value to S11-GTP-EP.
16	S11-GTP-EP routes MBReq with TEID to the exact SGW-Service POD. S11-GTP-EP sends Modify Bearer Request SGW-Service POD.
17	Transaction S-T2 completed. SGW-Service POD sends Sx Mod Req to PFCP-EP.
18	Transaction P-T3 started. SGW-Service POD receives Sx Mod Rsp from PFCP-EP.

Step	Description
19	Transaction P-T3 completed. SGW-Service POD sends Sx Mod Rsp to S11-GTP-EP.
20	Transaction S-T2 completed. SGW-Service POD sends Update Session to CDL.
21	S5-SGW-EGRESS-GTP-EP sends Update Bearer request with TFTs and APN AMBR to SGW-Service POD.
22, 23	Transaction S-T3 completed. SGW-Service POD sends Update Bearer Request to S11-GTP-EP. S11-GTP-EP forwards Update Bearer Request to MME.
24, 25	MME sends Update Bearer Rsp to S11-GTP-EP. S11-GTP-EP forwards Update Bearer Rsp to SGW-Service POD.
26	SGW-Service POD forwards Update Bearer Rsp to S5-SGW-EGRESS-GTP-EP.
27	SGW-Service POD sends Update Session to CDL.



CHAPTER 49

UPF Selection Support

- [Feature Summary and Revision History, on page 689](#)
- [Feature Description, on page 690](#)
- [UPF Selection using DNN and DCNR Support, on page 690](#)
- [UPF Selection using Location Support, on page 694](#)
- [Combined UPF Selection for cnSGW-C and SMF, on page 698](#)
- [UPF Selection OAM Support, on page 710](#)

Feature Summary and Revision History

Summary Data

Table 244: Summary Data

Applicable Product(s) or Functional Area	cnSGW-C
Applicable Platform(s)	SMI
Feature Default Setting	<p>UPF Selection using DCNR Support: Disabled – Configuration required to enable</p> <p>UPF Selection using DNN Support: Enabled – Always-on</p> <p>UPF Selection using Location Support: Disabled – Configuration required to enable</p> <p>Combined UPF Selection for cnSGW-C and SMF: Disabled – Configuration required to enable</p>
Related Documentation	Not Applicable

Revision History

Table 245: Revision History

Revision Details	Release
Added support for UPF selection using Location. Added support for Combined UPF selection for cnSGW-C and SMF.	2021.02.0
First introduced.	2021.01.0

Feature Description

This feature describes the following UPF selection methods.

- DNN and DCNR
- Location support
- cnSGW-C and SMF to select same UPF instance

UPF Selection using DNN and DCNR Support

Feature Description

The following are the three UPF selection methods:

- DNN or APN based
- Network based
- Policy based



Note DNN is enabled when UPF selection policy isn't associated.

How it Works

This section describes how the feature works.

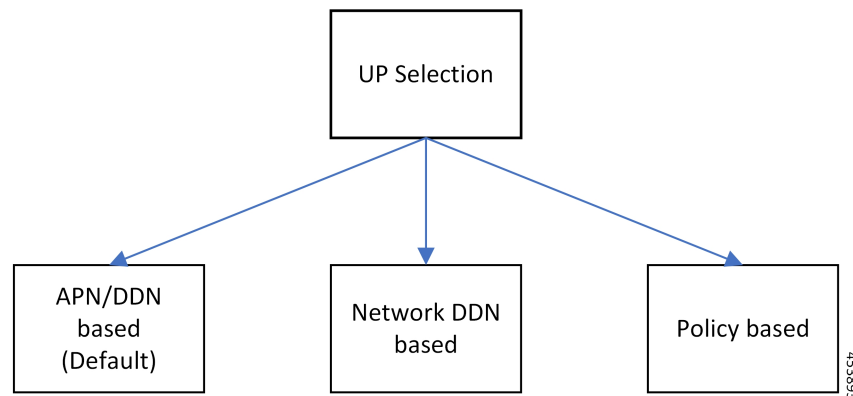

UPF Selection Methods

DNN or APN Based

- Create Session request message has APN information. This APN gets configured as part of DNN-list in the Network element profile for each user-plane.
- The PDN establishment considers these user-planes.
- UPF selection uses Capacity and Priority if many user-planes are available.

Network Based

- UPF selection considers DNN which got configured as part of the APN or DNN profile.
- This DNN is local SGW network specific DNN name.
- The same network DNN or APN name gets configured as part of DNN-list in the network element profile for each user-plane.
- Instead of using APN that comes in CSReq, local DNN is used for the UPF selection based on the DNN list.

For example, in case of roaming scenario where APN is not known, this configuration helps in UPF selection.

- PDN establishment considers these user-planes.
- UPF selection uses Capacity and Priority if many user-planes are available.

UPF Selection Policy Based

- UPF selection profile configuration with parameters determines UPF for each precedence. The supported max number of precedencies are four.
- Each precedence parameter is a *Logical AND* condition. If DNN and DCNR are configured as precedence 1, then it searches for the DNN supported user-plane and enables DCNR based support. If this search criteria fails, it moves to the next (mostly 2) precedence and tries to evaluate that condition.
- UPF selection policy is associated with a DNN profile.

- UPF group provides characteristics to the network element profile which belongs to the same UPF group profile.
- UPF selection uses Capacity and Priority if many user-planes available.

**Note**

- cnSGW-C rejects the call with Create Session Response specifying cause as NO_RESOURCE_AVAILABLE when no UPF matches the precedence criteria.

Configuring UPF Selection Methods

This section describes how to configure the UPF selection methods.

Configuring UPF Group Profile-based UPF Selection

This section describes how to configure UPF group profile-based UPF selection.

Use the following commands to configure the UPF group profile-based UPF selection.

```
config
  profile upf-group upf_group_name
    dcnr [true | false]
  end
```

NOTES:

- **profile upf-group upf_group_name**—Specify the UPF group name. Must be a string.
- **dcnr [true | false]**—Specify to enable or disable support for dual connectivity with new radio. Default value is false.

Sample Configuration

Following is a sample configuration.

```
config
  profile upf-group G1
    dcnr true
  end
```

Configuring Network-based UPF Selection

This section describes how to configure network-based UPF selection.

Use the following commands to configure the network-based UPF Selection.

```
config
  profile network-element upf_name
    node-id node_id_value
    n4-peer-address ipv4 ipv4_address
    n4-peer-address ipv6 ipv6_address
    n4-peer-port port_number
    dual-stack-transport { true | false }
```

```

upf-group-profile upf_group_profile_name
dnn-list dnn_list
priority priority_value
capacity capacity_value
end

```

NOTES:

- **network-element upf** *upf_name*—Specify the UPF profile name.
- **node-id** *node_id_value*—Specify the Node ID of the UPF node.
- **n4-peer-address ipv4** *ipv4_address*—Specify the IPv4 address.
- **n4-peer-address ipv6** *ipv6_address*—Specify the IPv6 address.
- **dual-stack-transport { true | false }**—Enable the dual stack feature that allows you to specify IPv6 or IPv4 address. Specify true to enable this feature.
- **upf-group-profile** *upf_group_profile_name*—Specify the UPF group profile name.
- **dnn-list** *dnn_list*—Specify the DNN list supported by UPF node.
- **priority** *priority_value*—Specify the static priority relative to other UPFs. This is used for load balancing. Must be an integer in the range of 0–65535. Default value is 1.
- **capacity** *capacity_value*—Specify the capacity relative to other UPFs. This is used for load balancing. Must be an integer in the range of 0–65535. Default value is 10.

Sample Configuration

Following is a sample configuration.

```

config
profile network-element upf UP1
  node-id      upf1@sgw.com
  upf-group-profile G1
  dnn-list [dnn1 dnn2]
  priority 20
  capacity 65535
end

```

Configuring Policy based UPF Selection

This section describes how to configure Policy based UPF selection.

Use the following commands to configure the Policy based UPF Selection.

```

config
policy upf-selection upf_selection_policyname
  precedence precedence_value location
exit
  precedence precedence_value dnn
exit
exit

```

NOTES:

- **upf-selection** *upf_selection_policyname* - Specify the UPF selection policy name.

- **precedence** *precedence_value* - Specify the precedence for entry. Must be an integer in the range of 1-4.

Sample Configuration

Following is a sample configuration.

```
config
policy upf-selection upf_poll
  precedence 1
    [ location ]
  exit
  precedence 2
    [ dnn ]
  exit
exit
```

Troubleshooting Information

This section describes the troubleshooting information that enables you to view the UPF selection using DNN and DCNR configuration issues.

Configuration Errors

```
show config-error | tab
ERROR COMPONENT      ERROR DESCRIPTION
-----
SGWProfile           Subscriber policy name : sub_policy in profile sgw1 is not configured
SubscriberPolicy     Operator policy : op_policy1 under subscriber policy sub_policy2 is not
configured
OperatorPolicy       Dnn policy name : dnn_policy1 in operator policy op_policy2 is not
configured
DnnPolicy            Dnn profile name : dnn_profile1 in dnn policy dnn_policy2 is not configured
DnnProfile           UPF selection policy name : upf_sel_policy1 in dnn profile dnn_profile2
is not configured
```

UPF Selection using Location Support

Feature Description

This feature supports Location-based UPF selection in Create Session Request message. It performs this selection as per the received TAI or ECGI or both TAI and ECGI values together.

Configuring the UPF Selection Feature

This section describes how to configure the UPF selection using location.

Configuring ECGI for EPS

This section describes how to configure ECGI for EPS.

New configuration and profile **ecgi-group** added to configure the list of individual ECGI values or the range of ECGI.

You can configure both ECGI list and ECGI range. ECGI range configuration is optional.

Use the following commands to configure the ECGI Configuration for EPS.

```
config
  profile ecgi-group ecgi_group_name
    mcc mcc_value
    mnc mnc_value
    ecgi list ecgi_list_name
    ecgi range start start_value end end_value
  exit
```

NOTES:

- **ecgi-group** *ecgi_group_name* - Specify the ECGI group name.
- **mcc** *mcc_value* - Specify the MCC value. Must be a three digit number. For example, 123
- **mnc** *mnc_value* - Specify the MNC value. Must be a two or three digit number. For example, 23 or 456
- **ecgi list** *ecgi_list* - Specify the list of ECGI values - 7 digit hex string Eutra Cell ID. For example, A12345f. Must be a string.
- **ecgi range start** *start_value* **end** *end_value* - Specify the ECGI range start and end values. Must be a string.



Note

- You can configure multiple ECGI range values.
- You can configure multiple [PLMN and ECGI values] under **ecgi-group** configuration.
- You can configure maximum of 16 PLMNs under **ecgi-group** configuration.
- You can configure maximum of 64 ECGI values in the ECGI list under a PLMN.
- Maximum defined number of ECGI ranges under a PLMN is 64.

Sample Configuration

Following is the sample configuration.

```
config
  profile ecgi-group e1 mcc 123 mnc 45
  ecgi list [ 1234567 abcdef0 ]
  ecgi range start 1111111 end ffffffff
  exit
```

Verifying ECGI for EPS Configuration

This section describes how to verify the ECGI Configuration for EPS.

Use the following `show` command to view the ECGI configuration for EPS.

```
show running-config profile ecgi-group
profile ecgi-group e1
mcc 123 mnc 45
ecgi list [ 1234567 abcdef0 ]
ecgi range start 1111111 end ffffffff
```

```
exit
exit
exit
```

Configuring TAI-Group

This section describes how to configure TAI-Group.

You can enhance the following TAI-Group configuration to support multiple TAI-Group configurations with different names.

Use the following commands to configure the TAI-Group.

```
config
  profile tai-group tai_group_name
    mcc mcc_value
    mnc mnc_value
    tac list tac_list
    tac range start start_value end end_value
  exit
```

NOTES:

- **tai-group** *tai_group_name* - Specify the TAI group name.
- **mcc** *mcc_value* - Specify the MCC value. Must be a three digit number. For example, 123
- **mnc** *mnc_value* - Specify the MNC value. Must be a two or three digit number. For example, 23 or 456
- **tac list** *tac_list* - Specify the list of TAC values - `[0-9a-fA-F]{4}|[0-9a-fA-F]{6}` - 4 digit or 6 digit hex string - Example A123, 1a2B3F. Must be a string.
- **tac range start** *start_value* **end** *end_value* - Specify the TAC range start and end values. Must be a string.



Note

- You can configure maximum of 16 PLMNs under a TAI-Group.
- You can configure maximum of 64 TAC values in a TAC list under a PLMN.
- Maximum defined number of TAC ranges under a PLMN is 64.

Sample Configuration

Following is the sample configuration.

```
config
profile tai-group TAI-GRP1
  mcc 123 mnc 234
  tac list [ 1a25 A123 ]
  tac range start B234 end b999
  exit
  tac range start C213 end c999
  exit
exit
mcc 231 mnc 45
  tac list [ 2a2B B123 ]
  tac range start d111 end d999
```



```

    exit
  exit
exit

```

Configuring Location-area-group

This section describes how to configure Location-area-group.

You can add new configuration and profile location-area-group. Configuration of **ecgi-group** and **tai-group** are optional.

Use the following commands to configure the Location-area-group.

```

config
  profile location-area-group location_area_group_name
    tai-group tai_group_name
    ecgi-group ecgi_group_name
  exit

```

NOTES:

- **location-area-group** *location_area_group_name* - Specify the location area group name.
- **tai-group** *tai_group_name* - Specify the TAI group name.
- **ecgi-group** *ecgi_group_name* - Specify the ECGI group name.

Sample Configuration

Following is the sample configuration.

```

config
profile location-area-group LOC_AREA_GRP_1
  tai-group TAI-AUTO-GRP1
  ecgi-group ECGI-AUTO-GRP1
exit
profile location-area-group LOC_AREA_GRP_2
  tai-group TAI-AUTO-GRP2
exit

```

Configuring UPF Group and UPF Selection Policy Enhancement

This section describes how to configure UPF Group and UPF Selection Policy Enhancement.

You can add new configuration under upf-group-profile to configure location-area-group-list.

Use the following commands to configure the UPF group and UPF selection policy enhancement.

```

config
  profile upf-group upf_group_name
    location-area-group-list [area_group_list]
  exit

config
  policy upf-selection selection_policy_name
    precedence value [ selection_parameter_list ]
  exit

```

NOTES:

- **upf-group** *upf_group_name* - Specify the UPF group name.
- **location-area-group-list** *area_group_list* - Specify the list of Location Area Group supported by UPF node.
- **upf-selection** *selection_policy_name* - Specify the UPF selection policy name.
- **precedence** *value* [*selection_parameter_list*] - Specify the precedence for entry. Must be an integer in the range of 1-4.



Note If pdn-type-subscription and pdn-type-session both are configured, pdn-type-subscription is considered.

Sample Configuration

Following is the sample configuration.

```

config
profile upf-group G1
  location-area-group-list [ LOC_AUTO_GRP_1 ]
exit
profile upf-group G2
  location-area-group-list [ LOC_AUTO_GRP_2 ]
exit
profile upf-group G3
  location-area-group-list [LOC_AUTO_GRP_1 LOC_AUTO_GRP_2 ]
exit

config
policy upf-selection upf_poll
  precedence 1
    [ location ]
  exit
  precedence 2
    [ dnn ]
  exit
exit

```

Combined UPF Selection for cnSGW-C and SMF

Feature Description

This feature supports cnSGW-C and SMF to select the same UPF instance when the UPF and SMF are deployed on same cluster and UPF instance is available. If the UPF instance is not available, the UPF selection is based on the existing configurations.

Standards Compliance

The Combined UPF Selection for cnSGW-C and SMF feature complies with the following standards:

- 3GPP TS 23.401
- 3GPP TS 23.402

- *3GPP TS 29.274*
- *3GPP TS 23.214*
- *3GPP TS 29.244*
- *3GPP TS 24.008*

How it Works

This section describes how this feature works.

System Architecture

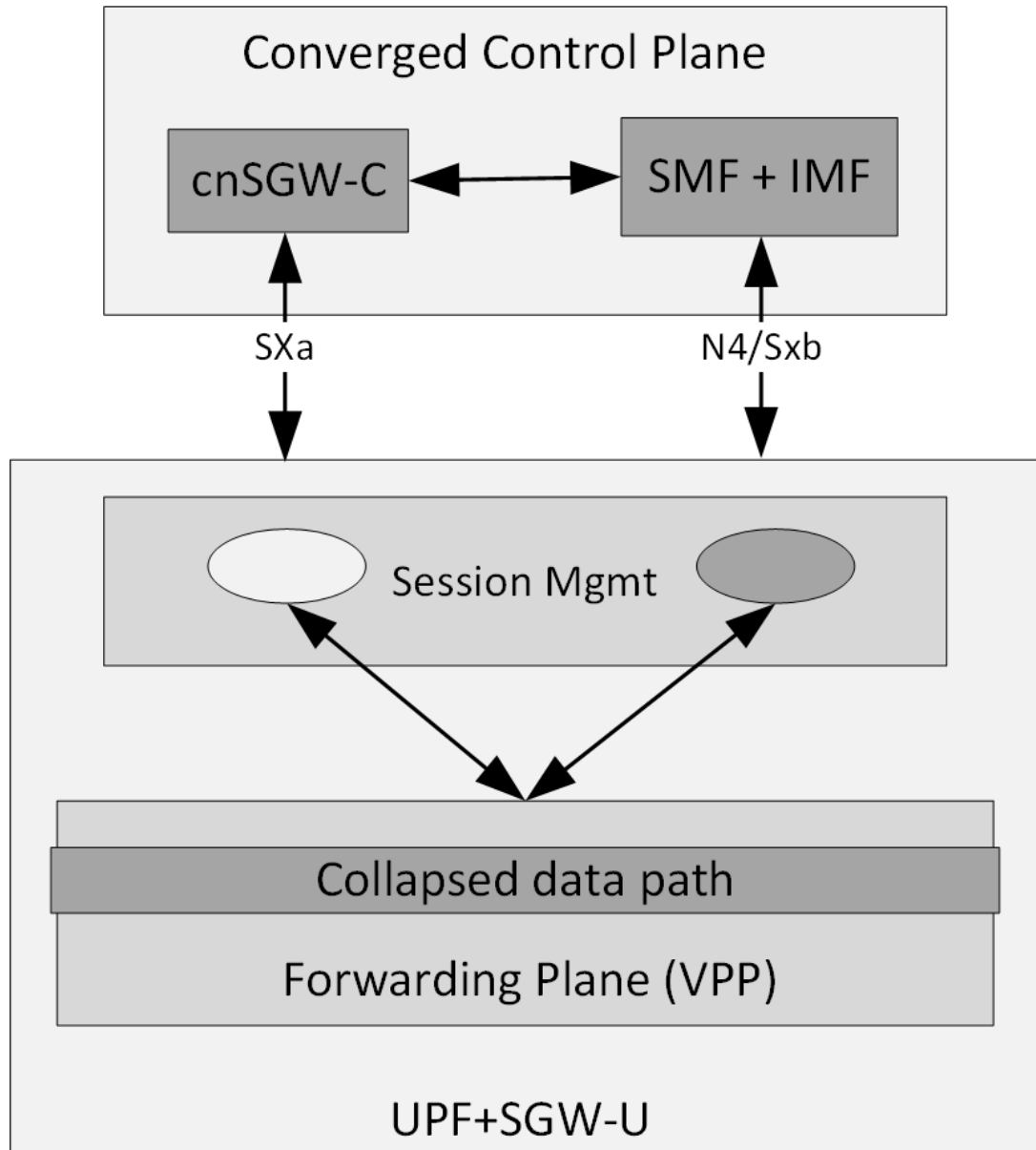

cnSGW-C and SMF/IWF uses the same UPF instance, so that UPF can use those sessions to the collapsed data path.

Control plane (cnSGW-C and SMF) selects the same User-plane in various scenarios (initial attach, handover, and so on).

Following actions takes place during Initial Attach:

- cnSGW-C passes the SGW-U FQDN information of selected UPF instance to SMF in Initial attach.
- SMF selects the UPF instance as per the received SGW-U FQDN.

- Same UPF FQDN is configured at cnSGW-C and at SMF to create a correlation as part of the network element profile.

Call Flows

This section describes the key call flows of Combined UPF Selection for cnSGW-C and SMF feature.

Initial Attach on 4G for 5G Capable Device Call Flow

This section describes the Initial Attach on 4G for 5G Capable Device call flow.

Figure 135: Initial Attach on 4G for 5G Capable Device Call Flow

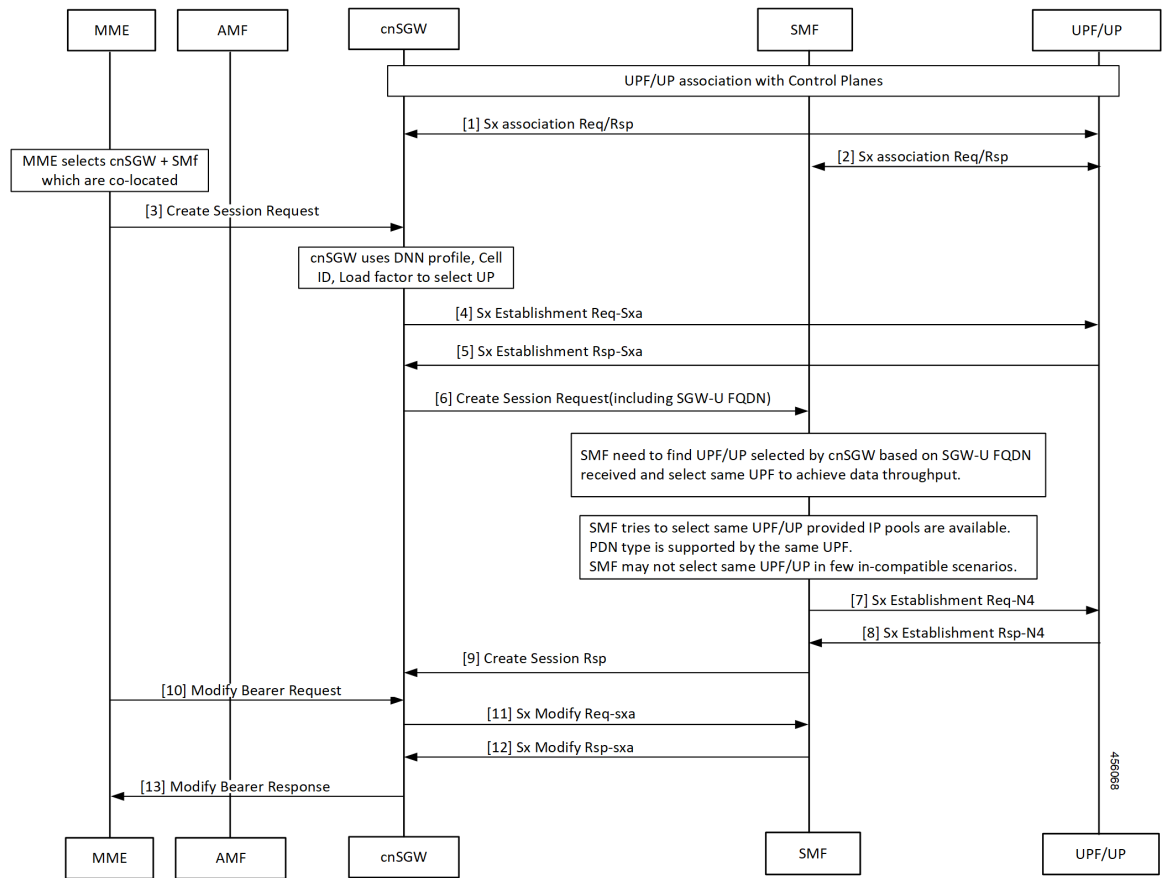

Table 246: Initial Attach on 4G for 5G Capable Device Call Flow Description

Step	Description
1	Established UPF association with control planes. cnSGW-C sends Sx Association Req/Rep to UPF.
2	SMF sends Sx Association Req/Rep to UPF.
3	MME sends Create Session Request to cnSGW-C after selecting co-located cnSGW-C and SMF.

Step	Description
4	cnSGW-C sends Sx Establishment Req (SXA) to UPF after selecting UPF using DNN profile, Cell ID, and local factors.
5	cnSGW-C receives Sx Establishment Res from UPF.
6	cnSGW-C sends Create Session Request to SMF including SGW-U FQDN.
7	SMF must find cnSGW-C selected UPF as per received SGW-U FQDN and select the same UPF to achieve data throughput. SMF tries to select same UPF when IP pools are available. Same UPF supports the PDN type. SMF may not select same UPF in few in-compatible scenarios. SMF send Sx Establishment Req N4 to UPF.
8	SMF receives Sx Establishment Res-N4 from UP.
9	cnSGW-C receives Create Session Response from SMF.
10	MME sends Modify Bearer Request to cnSGW-C.
11	cnSGW-C sends Sx Modify Req (SXA) to SMF.
12	cnSGW-C receives Sx Modify Res (SXA) to SMF.
13	cnSGW-C sends Modify Bearer Response to MME.

UPF Registration with User Plane ID Call Flow

This section describes the UPF Registration with User Plane ID call flow.

Figure 136: UPF Registration with User Plane ID Call Flow

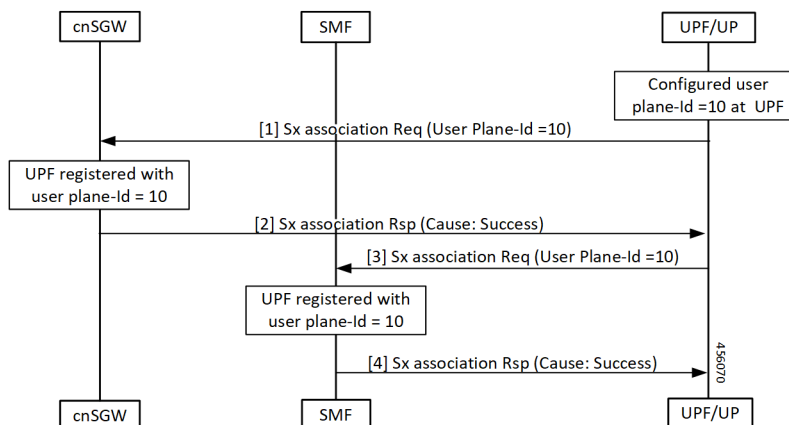

Table 247: UPF Registration with User Plane ID Call Flow Description

Step	Description
1	Configured User-plane ID at UPF cnSGW-C receives Sx association Request from UPF with configured User-plane ID.
2	UPF receives Sx association Response with Cause = SUCCESS from cnSGW-C.
3	SMF receives Sx association Request from UPF with configured User-plane ID.
4	UPF receives Sx association Response with Cause = SUCCESS from SMF.

Inter-SGW Handover on 4G RAT for 5G Capable Devices Call Flow

This section describes the Inter-SGW Handover on 4G RAT for 5G Capable Devices call flow.

Figure 137: Inter-SGW Handover on 4G RAT for 5G Capable Devices Call Flow

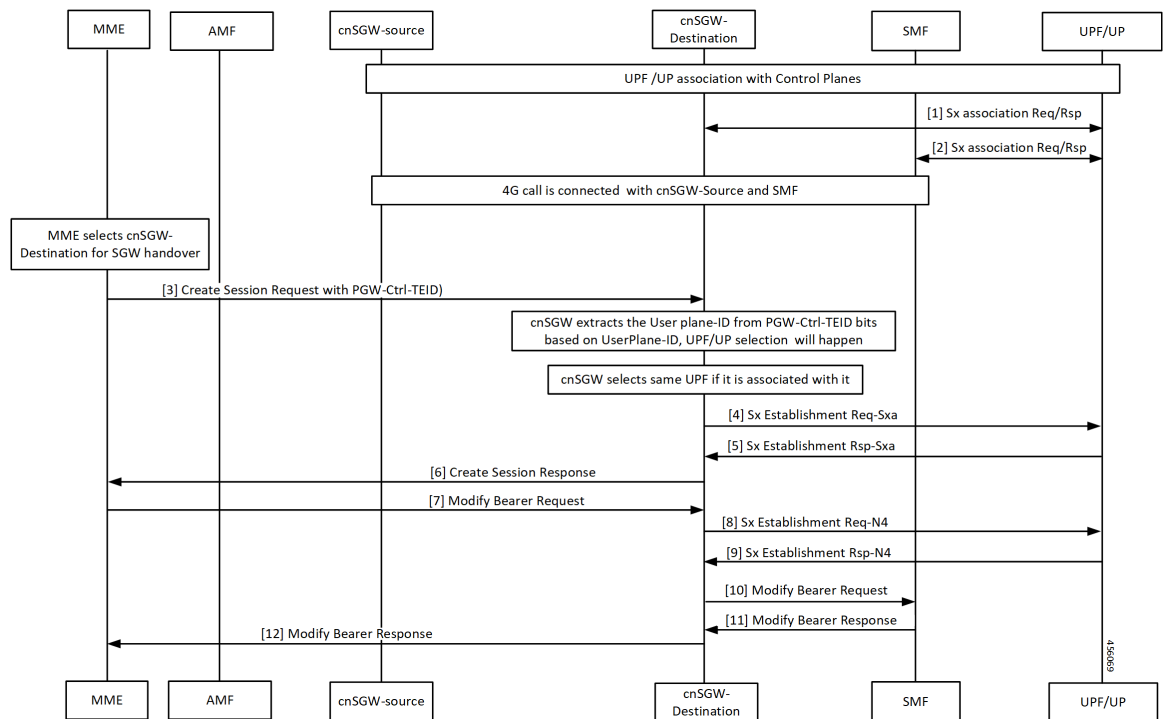

Table 248: Inter-SGW Handover on 4G RAT for 5G Capable Devices Call Flow Description

Step	Description
1	Established UPF association with control planes. UPF sends Sx Association Req/Rep to destination cnSGW-C.
2	UPF sends Sx Association Req/Rep to SMF.

Step	Description
3	4G call connected between cnSGW-C-source and SMF. MME selects cnSGW-C-Destination for the SGW handover. MME sends Create Session Req with PGW-Ctrl-TEID to cnSGW-C-Destination.
4	cnSGW-C extracts same associated UPF ID from PGW-Ctrl-TEID. cnSGW-C-Destination sends Sx Establishment Req (SXA) to UPF.
5	cnSGW-C-Destination receives Sx Establishment Rsp (SXA) from UPF.
6	cnSGW-C-Destination sends Create Session Response to MME.
7	cnSGW-C-Destination receives Modify Bearer Request from MME.
8	cnSGW-C-Destination sends Sx Establishment Req-N4 to UPF.
9	cnSGW-C-Destination receives Sx Establishment Rsp-N4 from UPF.
10	cnSGW-C-Destination sends Modify Bearer Request to SMF.
11	cnSGW-C-Destination receives Modify Bearer Response from SMF.
12	cnSGW-C-Destination forwards Modify Bearer Request to MME.

5G to EPS Handover Using N26 Interface – cnSGW-C and SMF Separate Node Call Flow

This section describes the 5G to EPS Handover Using N26 Interface – cnSGW-C and SMF Separate Node call flow.

Figure 138: 5G to EPS Handover Using N26 Interface – cnSGW-C and SMF Separate Node Call Flow

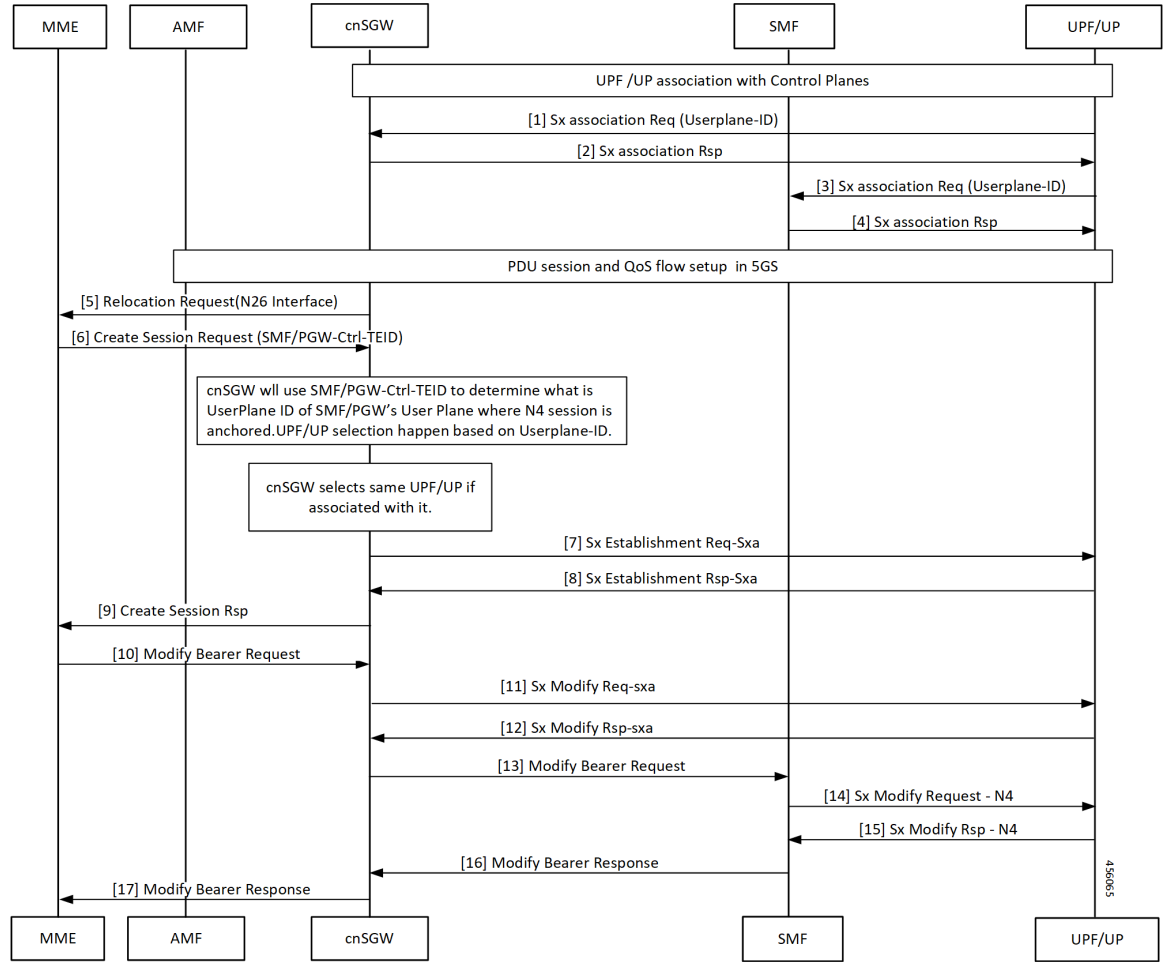

Table 249: 5G to EPS Handover Using N26 Interface – cnSGW-C and SMF Separate Node Call Flow Description

Step	Description
1	cnSGW-C selects associated same UPF. cnSGW-C receives Sx Establishment Request with User-plane ID from UPF/UP.
2	cnSGW-C sends Sx Establishment Response from UPF/UP.
3	UPF/UP sends Sx Association Request with User-plane ID to SMF.
4	SMF sends Sx Association Response to UPF/UP.
5	cnSGW-C sends Relocation Request to MME on interface N26.
6	MME sends Create Session Request to cnSGW-C with SMF and PGW-ctrl-TEID information.
7	cnSGW-C selects associated same UPF. cnSGW-C sends Sx Establishment Req (SXA) to UPF/UP.

Step	Description
8	cnSGW-C receives Sx Establishment Rsp (SXA) from UPF/UP.
9	cnSGW-C sends Create Session response to MME.
10	MME sends Modify Bearer Request to cnSGW-C.
11	cnSGW-C sends Sx Modify Req (SXA) to UPF/UP.
12	cnSGW-C receives Sx Modify Rsp (SXA) from UPF/UP.
13	cnSGW-C sends Modify Bearer Request to SMF.
14	SMF sends Sx Modify Request – N4 to UPF/UP.
15	SMF receives Sx Modify Response from UPF/UP.
16	cnSGW-C receives Modify Bearer Response to SMF.
17	cnSGW-C forwards Modify Bearer Response to MME.

Wi-Fi to LTE Handover Call Flow

This section describes the Wi-Fi to LTE Handover call flow.

Figure 139: Wi-Fi to LTE Handover Call Flow

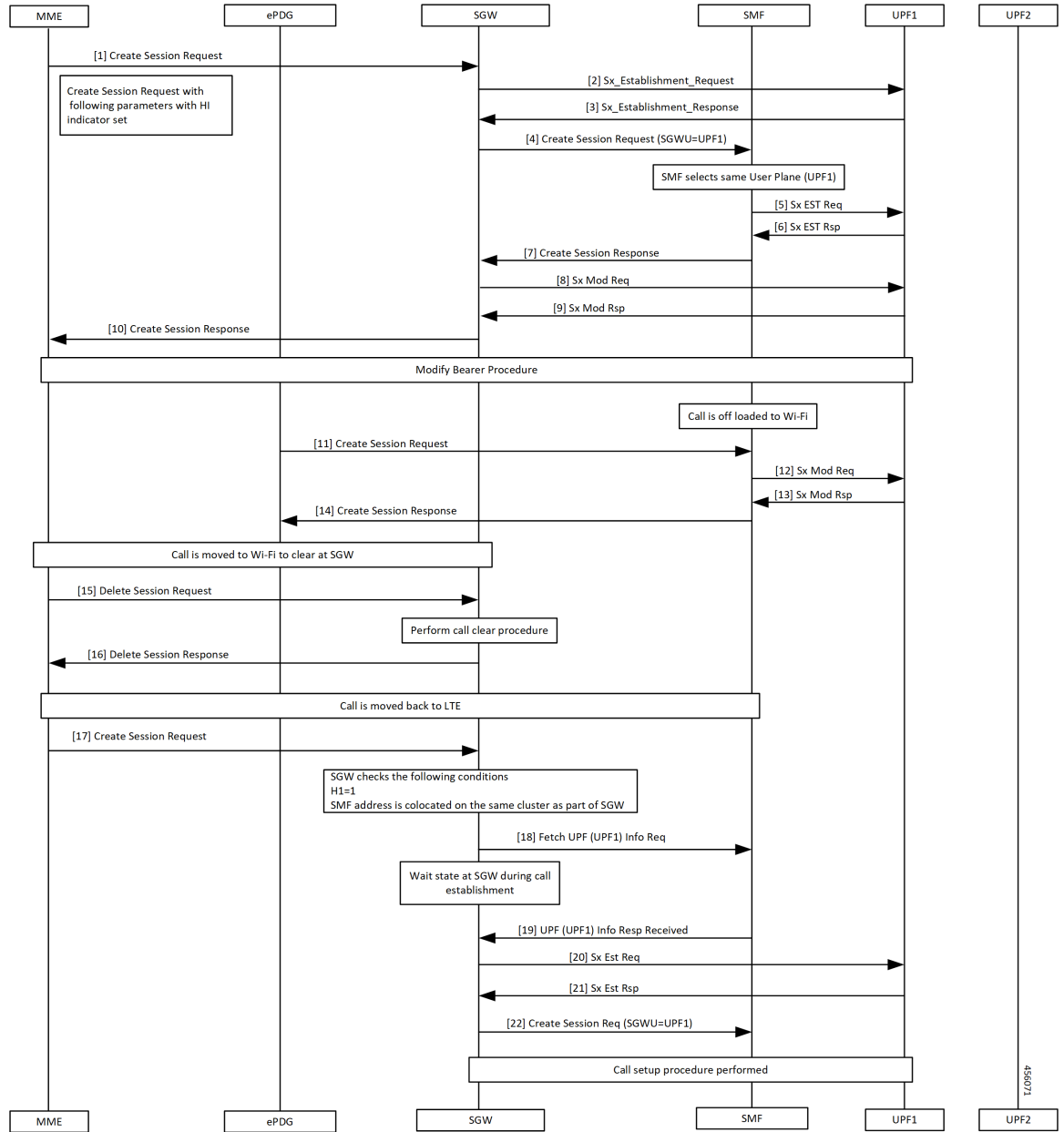

Table 250: Wi-Fi to LTE Handover Call Flow Description

Step	Description
1	MME sends create Session Request to SGW.
2	SGW sends Sx Establishment Request to UPF1.
3	SGW receives Sx Establishment Response from SMF.
4	SGW sends Create Session Request to SMF. SMF selects same UPF.

Step	Description
5	SMF sends Sx Establishment Request to UPF1.
6	SMF receives Sx Establishment Response from UPF1.
7	SMF sends Create Session Response to SGW.
8	SGW sends Sx Mod Request to UPF1.
9, 10	SGW receives Sx Mod Response from UPF1 and forwards to MME.
11	Modify Bearer procedure takes place and off-loaded call to Wi-Fi. ePDG sends Create Session Request to SGW.
12	SMF sends Sx Mod Request to UPF1.
13	SMF receives Sx Mod Response from UPF1.
14	ePDG receives Create Session Response from SGW.
15	Call moved to Wi-Fi to clear at SGW. MME sends Delete Session Request to SGW.
16	MME receives Delete Session Response from SGW after performing call clear procedure.
17	MME sends Create Session Request to SGW.
18	SGW sends fetch UPF (UPF1) info request to SMF after checking SMF as same cluster as cnSGW-C.
19	SGW receives UPF (UPF1) Info Response from SMF.
20	SGW sends Sx Establishment Request to UPF1.
21	SGW receives Sx Establishment Response from UPF1.
22	SGW sends Create Session Request with SGWU=UPF1 to UPF1 and performs call setup procedure.

Configuring the Combined UPF Selection for cnSGW-C and SMF

This section describes how to configure the Combined UPF Selection for cnSGW-C and SMF.

Configuring Converged-Core Profile

This section describes how to configure the Converged-Core Profile.

Use the following commands to configure the profile converged-core with UPF selection enabled.

```

config
  profile converged-core core_name
    max-upf-index value
    no upf-selection disable
  exit

```

Use the following commands to configure the profile converged-core with UPF selection disabled.

```
config
  profile converged-core core_name
    max-upf-index value
    upf-selection disable
  exit
```

NOTES:

- **converged-core** *core_name* - Specify the converged core profile name.
- **max-upf-index** *value* - Specify the UPF index value. Must be an integer in the range of 1-1023.
- **no upf-selection disable** - Enable colocated UPF selection.
- **upf-selection disable** - Disable colocated UPF selection.

Sample configuration

Following is a sample configuration with UPF selection enabled.

```
config
profile converged-core ccl
max-upf-index 1023
no upf-selection disable
exit
```

Following is a sample configuration with UPF selection disabled.

```
config
profile converged-core ccl
max-upf-index 1023
upf-selection disable
exit
```

Verifying the Profile Converged-core Configuration

This section describes how to verify the Profile Converged-core configuration.

Use the following show command to view the Profile Converged-Core configuration with UPF selection enabled.

```
show running-config profile converged-core ccl
profile converged-core ccl
max-upf-index 1023
no upf-selection disable
exit
```

Use the following show command to view the Profile Converged-Core configuration with UPF selection disabled.

```
show running-config profile converged-core ccl
profile converged-core ccl
max-upf-index 1023
upf-selection disable
exit
```

Configuring Node-ID

This section describes how to configure the Node-ID.

Use the following commands to configure the Node-ID.

```
config
  profile network-element upf upf_name
    node-id node_id_value
  exit
```

NOTES:

- **network-element upf upf_name** - Specify the UPF peer network element name.
- **node-id node_id_value** - Specify the Node ID of the UPF node. Must be a string

Sample Configuration

Following is a sample configuration.

```
config
profile network-element upf upf1
node-id upf1@cn.com
exit
```

UPF Selection OAM Support

This section describes operations, administration, and maintenance information for this feature.

Bulk Statistics

UE Disconnect Statistics

```
sgw_ue_disconnect_stats{app_name="smf",cluster="cn",data_center="cn",instance_id="0",
reason="userplane_info_not_available",service_name="sgw-service"} 24
```

PDN Disconnect Statistics

```
sgw_pdn_disconnect_stats{app_name="smf",cluster="cn",data_center="cn",instance_id="0",
pdn_type="ipv4",rat_type="EUTRAN",reason="userplane_info_not_available",service_name="sgw-service"}
8
```

```
sgw_pdn_disconnect_stats{app_name="smf",cluster="cn",data_center="cn",instance_id="0",
pdn_type="ipv4v6",rat_type="EUTRAN",reason="userplane_info_not_available",service_name="sgw-service"}
15
```

```
sgw_pdn_disconnect_stats{app_name="smf",cluster="cn",data_center="cn",instance_id="0",
pdn_type="ipv6",rat_type="EUTRAN",reason="userplane_info_not_available",service_name="sgw-service"}
1
```

SGW Service Statistics

```
sgw_service_stats{app_name="smf",cluster="cn",data_center="cn",fail_reason="userplane_selection_fail",
instance_id="0",interface="interface_sgw_ingress",reject_cause="no_resources_available",service_name=
```

```
"sgw-service",sgw_procedure_type="initial_attach",status="failure",sub_fail_reason=""}  
22
```

```
sgw_service_stats{app_name="smf",cluster="cn",data_center="cn",fail_reason="userplane_selection_fail",  
instance_id="0",interface="interface_sgw_ingress",reject_cause="no_resources_available",service_name="sgw-service",  
sgw_procedure_type="secondary_pdn_creation",status="failure",sub_fail_reason=""}  
2
```



CHAPTER 50

VoLTE Call Prioritization

- [Feature Summary and Revision History, on page 713](#)
- [Feature Description, on page 714](#)
- [How it Works, on page 714](#)
- [Feature Configuration, on page 714](#)
- [OAM Support, on page 717](#)

Feature Summary and Revision History

Summary Data

Table 251: Summary Data

Applicable Product(s) or Functional Area	cnSGW-C
Applicable Platform(s)	SMI
Feature Default Setting	Enabled - Always-on
Related Documentation	Not Applicable

Revision History

Table 252: Revision History

Revision Details	Release
Added support for Extended and Non-Standard (Operator-defined) QCI Values.	2021.02.3
First introduced.	2021.02.0

Feature Description

cnSGW-C provides:

- CLI support to mark QCI as IMS media.
- CLI support to display whether session/bearer is VoLTE or not in `show subscriber output`.
- Counter support to identify number of VoLTE subscribers in the system.
- Sx message priority configuration based on VoLTE marked session.

How it Works

This section describes how this feature works.

- SGW profile represents SGW service.
- SGW profile has associated subscriber policy, which helps to select the Operator Policy.
- Operator Policy has DNN policy associated with it.
- DNN policy has DNN profile associated with it which has the QCI mark for marking VoLTE subscriber for priority.

Based on the QCI marking as IMS, *volteBearer* and *volteSession* flags are set internally when you execute `show subscriber` command.

- *volteBearer* is a bearer level flag. If bearer QCI is present in marked QCI list, *volteBearer* flag is set as true and the bearer is considered as **volteBearer**.
- *volteSession* is a session level flag. This flag is set as **true** if there's a VoLTE bearer present in any PDN of that subscriber.

Feature Configuration

Configuring this feature involves the following steps:

- Configure the call priority. For more information, refer to [Configuring the Priority, on page 714](#).
- Configure the message priority. For more information, refer to [Sx Message Priority, on page 717](#).

Configuring the Priority

This section describes how to configure the priority.

CLI is used to mark the QCI level as VoLTE media under dnn profile. If requested QCI in the call matches with the marked QCI, SGW sets the *volteSession* and *volteBearer* flags. If a subscriber session has **volteSession**, then that subscriber has the highest priority compared to other subscribers.

```

config
  profile dnn profile_name ims mark qci qci_value

```

NOTES:

- **profile dnn** *profile_name*—Specify the DNN profile name.
- **mark**—For marking standard QCI value as IMS media.
- **qci** *qci_value*—Specify the QCI value. The following QoS Class Identifiers are supported:

Standard: 1-9

Extended: 65, 66, 69, 70, 80, 82, 83

Non-Standard (Operator-defined): 128-254

Configuration Example

The following is an example configuration.

```

config
  profile dnn dnn1 ims mark qci [ 2 3 4 ]
end

```

Configuration Verification

To verify the configuration

```

show full-configuration profile dnn dnn1
profile dnn dnn1
  ims mark qci [ 2 3 4 ]

```

Based on the QCI marking as IMS, *volteSession* and *volteBearer* flags are set internally when you execute **show subscriber** command.

This section provides sample output.

```

show subscriber namespace sgw imsi 123456789012348
subscriber-details
{
  "subResponses": [
    {
      "status": true,
      "genericInfo": {
        "imsi": "imsi-123456789012348",
        "imei": "imei-123456786666660",
        "msisdn": "msisdn-223310101010101",
        "accessType": "EUTRAN",
        "plmnId": {
          "mcc": "123",
          "mnc": "456"
        },
        "sgwProfileName": "sgw1",
        "unAuthenticatedImsi": "No"
      },
      "s11cInterfaceInfo": {
        "sgwTeid": "[0x12000147] 301990215",
        "sgwIPv4Address": "209.165.201.19",
        "mmeTeid": "[0x62b5] 25269",
        "mmeIPv4Address": "209.165.201.20"
      }
    }
  ],

```

```

"pdnInfoList": {
  "totalPdn": 1,
  "pdnInfo": [
    {
      "pdnId": "PDN-1",
      "apn": "intershat",
      "attachType": "Initial Attach",
      "sgwRelocState": "N/A",
      "operatorPolicyName": "N/A",
      "dnnProfileName": "N/A",
      "defaultEbi": 5,
      "pdnType": "IPv4",
      "allocatedIPv4": "209.165.201.26",
      "apnSelectionMode": "Subscribed",
      "ambrUplink": "10 Kbps",
      "ambrDownlink": "20 Kbps",
      "s5cInterfaceInfo": {
        "sgwTeid": "[0x52000147] 1375732039",
        "sgwIPv4Address": "209.165.201.19",
        "pgwTeid": "[0x339a] 13210",
        "pgwIPv4Address": "209.165.201.18"
      },
      "sxaInterfaceInfo": {
        "selectedUP": "209.165.201.20",
        "upEpKey": "209.165.201.20:209.165.201.19",
        "cpSeid": "[0x1200014752000147] 1297038098512740679",
        "upSeid": "[0x2712] 10002"
      },
      "bearerInfoList": {
        "totalBearer": 1,
        "bearerInfo": [
          {
            "bearerId": "Bearer-1",
            "state": "Connected",
            "ebi": 5,
            "isDefaultBearer": true,
            "qosInfo": {
              "qci": 6,
              "arp": 113
            },
            "sluInterfaceInfo": {
              "sgwTeid": "[0x62b7] 25271",
              "sgwIPv4Address": "209.165.200.226",
              "eNodeBTeid": "[0x62b8] 25272",
              "eNodeBIPv4Address": "209.165.201.20"
            },
            "s5uInterfaceInfo": {
              "sgwTeid": "[0x62b6] 25270",
              "sgwIPv4Address": "209.165.201.1",
              "pgwTeid": "[0x339b] 13211",
              "pgwIPv4Address": "209.165.201.18"
            },
            "chargingId": 303174163
          }
        ]
      },
      "uli": {
        "mcc": "123",
        "mnc": "456",
        "tac": "0x92a",
        "eci": "0x12d687"
      },
      "uetimeZone": {
        "timeZone": "+0:15",

```

```

        "dayLightSavingTime": "+1 hour"
    },
    "plmnType": "VISITOR"
  }
}
}
}
}
}
}
}
}
}
}

```

Sx Message Priority

This section describes the Sx message priority.

Based on the VoLTE flags (`volteSession` and `volteBearer`), SGW sets the message priority in Sx request messages (Sx-Est, Sx-Mod, and so on) while processing the received requests/responses (for example, S5-CBReq, S11CBResp, S11-UBRes, S5DBReq, and so on).

Sx Message Priority is set when the session is marked for `volteSession` (or it has VoLTE QCI).

In Sx Req (Establishment or Modification) Message Header:

```

"HEADERS": {
  "length": 30,
  "msg_type": 52,
  "priority": 2,          <<< VOLTE Session priority value
  "priority_flag": 1,    <<< Priority flag is true i.e 1
  "retransmit": 0,
  "seid": 10002,
  "seid_flag": 1,
  "seq_number": 22,
  "version": 1
},

```

OAM Support

This section describes operations, administration, and maintenance information for this feature.

Bulk Statistics

`sgw_voltesession_counter` is added based on the `volteSession` flag. This counter indicates how many VoLTE sessions are present in the system at a particular moment.

If `volteSession` flag is true, counter gets incremented.

If `volteSession` flag isn't present (no VoLTE bearer is present in any PDN), the counter gets decremented.

Counter Name: `sgw_voltesession_counter`

Description: Current active VoLTE sessions present in the system.

Label:

- LABEL_STAT: `VolteSession`

Sample Counter Output:

You can check the counter from the pod:

```

curl http://209.165.201.20:8080/metrics | grep "volte"
% Total    % Received % Xferd  Average Speed   Time    Time       Time  Current
           Dload  Upload   Total     Spent    Left     Speed
   0     0     0     0     0     0     0     0  ---:--:--  ---:--:--  ---:--:--    0#
HELP sgw_voltesession_counter Current Active Volte Session
# TYPE sgw_voltesession_counter gauge
sgw_voltesession_counter{app_name="smf",cluster="cn",data_center="cn",instance_id="0",
service_name="sgw-service",state="VolteSession"} 1
100 246k   0 246k   0   0 16.0M   0  ---:--:--  ---:--:--  ---:--:-- 17.1M
root@sgw-service-n0-0:/opt/workspace#

```



CHAPTER 51

cnSGW-C Troubleshooting

- [show subscriber and cdl show Commands, on page 719](#)

show subscriber and cdl show Commands

This section describes troubleshooting information.

- To display the SGW subscriber information, use the following commands:

```
show subscriber namespace sgw imsi imsi_value
```

```
show subscriber nf-service sgw imsi imsi_value
```

```
show subscriber count { all }
```

```
show subscriber namespace sgw imsi 123456789012348  
subscriber-details
```

```
{  
  "subResponses": [  
    {  
      "status": true,  
      "genericInfo": {  
        "imsi": "imsi-123456789012348",  
        "imei": "imei-123456786666660",  
        "msisdn": "msisdn-223310101010101",  
        "accessType": "EUTRAN",  
        "plmnId": {  
          "mcc": "123",  
          "mnc": "456"  
        },  
        "sgwProfileName": "sgw1",  
        "unAuthenticatedImsi": "No"  
      },  
      "s11cInterfaceInfo": {  
        "sgwTeid": "[0x12000147] 301990215",  
        "sgwIPv4Address": "209.165.201.19",  
        "mmeTeid": "[0x62b5] 25269",  
        "mmeIPv4Address": "209.165.201.20"  
      },  
      "pdnInfoList": {  
        "totalPdn": 1,  
        "pdnInfo": [  
          {  
            "pdnId": "PDN-1",  
            "apn": "intershat",  
            "attachType": "Initial Attach",
```

```

"sgwRelocState": "N/A",
"operatorPolicyName": "N/A",
"dnnProfileName": "N/A",
"defaultEbi": 5,
"pdnType": "IPv4",
"allocatedIPv4": "209.165.201.26",
"apnSelectionMode": "Subscribed",
"ambrUplink": "10 Kbps",
"ambrDownlink": "20 Kbps",
"s5cInterfaceInfo": {
  "sgwTeid": "[0x52000147] 1375732039",
  "sgwIPv4Address": "209.165.201.19",
  "pgwTeid": "[0x339a] 13210",
  "pgwIPv4Address": "209.165.201.18"
},
"sxaInterfaceInfo": {
  "selectedUP": "209.165.201.20",
  "upEpKey": "209.165.201.20:209.165.201.19",
  "cpSeid": "[0x1200014752000147] 1297038098512740679",
  "upSeid": "[0x2712] 10002"
},
"bearerInfoList": {
  "totalBearer": 1,
  "bearerInfo": [
    {
      "bearerId": "Bearer-1",
      "state": "Connected",
      "ebi": 5,
      "isDefaultBearer": true,
      "qosInfo": {
        "qci": 6,
        "arp": 113
      },
      "sluInterfaceInfo": {
        "sgwTeid": "[0x62b7] 25271",
        "sgwIPv4Address": "209.165.200.226",
        "eNodeBTeid": "[0x62b8] 25272",
        "eNodeBIPv4Address": "209.165.201.20"
      },
      "s5uInterfaceInfo": {
        "sgwTeid": "[0x62b6] 25270",
        "sgwIPv4Address": "209.165.201.1",
        "pgwTeid": "[0x339b] 13211",
        "pgwIPv4Address": "209.165.201.18"
      },
      "chargingId": 303174163
    }
  ]
},
"uli": {
  "mcc": "123",
  "mnc": "456",
  "tac": "0x92a",
  "eci": "0x12d687"
},
"uetimeZone": {
  "timeZone": "+0:15",
  "dayLightSavingTime": "+1 hour"
},
"plmnType": "VISITOR"
}
}
}
}

```



```
    ]
  }
  show subscriber count all
  subscriber-details
  {
    "sessionCount": 50
  }
}
```

- To display the session summary information, use the following command:

cdl show sessions summary

```
cdl show sessions summary
message params: {session-summary cli session {0 100 0 [] 0 0}}
session {
  primary-key imsi-146062234105885
  unique-key [ 16777218 ]
  map-id 1
  instance-id 1
  version 1
  create-time 2020-04-27 16:18:24.225646626 +0000 UTC
  last-updated-time 2020-04-27 16:18:24.87241245 +0000 UTC
  purge-on-eval false
  next-eval-time 2020-05-04 16:18:24 +0000 UTC
  data-size 406
}
```

- To clear subscriber information, use the following commands:

clear subscriber all

clear subscriber nf-service sgw all

```
clear subscriber all
result
ClearSubscriber Request submitted

clear subscriber nf-service sgw all
result
ClearSubscriber Request submitted
```



CHAPTER 52

Sample cnSGW-C Configuration

- [Sample Configuration, on page 723](#)

Sample Configuration

The following is a sample configuration.

```
show running-config
profile compliance compl
service nsmf-pdusession
  version uri v1
  version full 1.0.0
  version spec 15.4.0
exit
service namf-comm
  version uri v1
  version full 1.0.0
  version spec 15.4.0
exit
service n1
  version uri v1
  version full 1.0.0
  version spec 15.4.0
exit
service n2
  version uri v1
  version full 1.0.0
  version spec 15.4.0
exit
service nudm-sdm
  version uri v1
  version full 1.0.0
  version spec 15.4.0
exit
service nudm-uecm
  version uri v1
  version full 1.0.0
  version spec 15.4.0
exit
service nnrf-disc
  version uri v1
  version full 1.0.0
  version spec 15.4.0
exit
service nnrf-nfm
  version uri v1
```

```

    version full 1.0.0
    version spec 15.4.0
  exit
  service npcfc-smpolicycontrol
    version uri v1
    version full 1.0.0
    version spec 15.4.0
  exit
  service nchf-convergedcharging
    version uri v1
    version full 1.0.0
    version spec 15.3.0
  exit
exit
profile network-element amf amf1
  nf-client-profile      AP1
  failure-handling-profile FH3
  query-params [ dnn ]
exit
profile network-element udm udml
  nf-client-profile      UP1
  failure-handling-profile FH4
  query-params [ dnn ]
exit
profile network-element pcf pcf1
  nf-client-profile      PP1
  failure-handling-profile FH1
  query-params [ dnn ]
  rulebase-prefix      cbn#
  predefined-rule-prefix crn#
exit
profile network-element chf chf1
  nf-client-profile      CP1
  failure-handling-profile FH2
  query-params [ dnn ]
  nf-client-profile-offline CP2
exit
profile network-element chf chgser1
exit
profile network-element upf upf1
  node-id      upf1@sgw.com
  n4-peer-address ipv4 209.165.200.234
  n4-peer-port 8805
  dnn-list [ cisco.com intershat starent.com ]
  capacity 65535
  priority 65535
exit
profile upf-group group1
  failure-profile FH1
exit
profile icmpv6 icmpprf1
  options virtual-mac b6:6d:57:45:45:45
exit
profile charging chgprf1
  method [ offline ]
exit
profile charging-characteristics 1
  charging-profile chgprf1
exit
profile failure-handling FH1
  interface pfcpc
    message N4SessionEstablishmentReq
      cause-code pfcpc-entity-in-congestion action retry-terminate max-retry 2
      cause-code system-failure action terminate

```

```
cause-code service-not-supported action terminate
cause-code no-resource-available action retry-terminate max-retry 3
cause-code no-response-received action retry-terminate max-retry 1
cause-code reject action terminate
exit
message N4SessionModificationReq
cause-code mandatory-ie-incorrect action terminate
cause-code session-ctx-not-found action terminate
cause-code reject action terminate
exit
exit
profile failure-handling gtp1
interface gtpc message S5S8CreateBearerReq
cause-code temp-fail
action retry timeout 1000 max-retry 2
exit
interface gtpc message S5S8UpdateBearerReq
cause-code temp-fail
action retry timeout 1000 max-retry 2
exit
interface gtpc message S5S8DeleteBearerReq
cause-code temp-fail
action retry timeout 1000 max-retry 2
exit
exit
profile access access1
n26 idft enable timeout 15
n2 idft enable timeout 15
gtpc gtpc-failure-profile gtp1
exit
profile dnn default-profile
network-element-profiles chf chf1
network-element-profiles amf amf1
network-element-profiles pcf pcf1
network-element-profiles udm udm1
charging-profile chgprf1
virtual-mac b6:6d:47:47:47:47
ssc-mode 2 allowed [ 3 ]
session type IPV4 allowed [ IPV6 IPV4V6 ]
upf apn starent.com
exit
profile dnn intershat
network-element-profiles chf chf1
network-element-profiles amf amf1
network-element-profiles pcf pcf1
network-element-profiles udm udm1
charging-profile chgprf1
virtual-mac b6:6d:47:47:47:47
ssc-mode 2 allowed [ 3 ]
session type IPV4 allowed [ IPV6 IPV4V6 ]
upf apn intershat
dcsr true
exit
profile dnn intershat1
network-element-profiles chf chf1
network-element-profiles amf amf1
network-element-profiles pcf pcf1
network-element-profiles udm udm1
charging-profile chgprf1
virtual-mac b6:6d:47:47:47:48
```

```

pcscf-profile    PCSCF_Prof_2
ssc-mode 1
session type IPV4
exit
profile dnn intershat2
network-element-profiles chf chf
network-element-profiles amf amf
network-element-profiles pcf pcf
network-element-profiles udm udm
charging-profile chgprfl
virtual-mac      b6:6d:47:47:47:49
ssc-mode 2 allowed [ 3 ]
session type IPV4 allowed [ IPV6 IPV4V6 ]
upf apn intershat2
exit
profile dnn starent.com
network-element-profiles chf chf1
network-element-profiles amf amf1
network-element-profiles pcf pcf1
network-element-profiles udm udm1
charging-profile chgprfl
virtual-mac      b6:6d:47:47:47:47
ssc-mode 2 allowed [ 3 ]
session type IPV4 allowed [ IPV6 IPV4V6 ]
upf apn starent.com
exit
profile qos abc
ambr ul "250 Kbps"
ambr dl "500 Kbps"
qi5      7
arp priority-level 14
arp preempt-cap NOT_PREEMPT
arp preempt-vuln PREEMPTABLE
priority 120
max data-burst 2000
exit
profile nf-client nf-type udm
udm-profile UP1
locality LOC1
priority 30
service name type nudm-sdm
endpoint-profile EP1
capacity 30
uri-scheme http
version
uri-version v2
exit
exit
endpoint-name EP1
primary ip-address ipv4 209.165.201.21
primary ip-address port 8001
exit
exit
service name type nudm-uecm
endpoint-profile EP1
capacity 30
uri-scheme http
endpoint-name EP1
primary ip-address ipv4 209.165.201.21
primary ip-address port 8001
exit
exit
exit

```

```
service name type nudm-ee
endpoint-profile EP1
capacity 30
api-uri-prefix PREFIX
api-root ROOT
uri-scheme http
endpoint-name EP1
priority 56
primary ip-address ipv4 209.165.201.21
primary ip-address port 8001
exit
exit
exit
exit
exit
exit
profile nf-client nf-type pcf
pcf-profile PP1
locality LOC1
priority 30
service name type npcfc-am-policy-control
endpoint-profile EP1
capacity 30
uri-scheme http
endpoint-name EP1
priority 56
primary ip-address ipv4 209.165.201.21
primary ip-address port 8003
exit
exit
exit
service name type npcfc-smpolicycontrol
endpoint-profile EP1
capacity 30
uri-scheme http
endpoint-name EP1
priority 56
primary ip-address ipv4 209.165.201.21
primary ip-address port 8003
exit
exit
exit
exit
exit
exit
profile nf-client nf-type amf
amf-profile AP1
locality LOC1
priority 30
service name type namf-comm
endpoint-profile EP2
capacity 30
uri-scheme http
endpoint-name EP1
priority 56
primary ip-address ipv4 209.165.201.21
primary ip-address port 8002
exit
exit
exit
exit
exit
exit
profile nf-client nf-type chf
```

```

chf-profile CP1
locality LOC1
priority 30
service name type nchf-convergedcharging
endpoint-profile EP1
  capacity 30
  uri-scheme http
  version
  uri-version v2
  exit
exit
endpoint-name EP1
priority 56
primary ip-address ipv4 209.165.201.21
primary ip-address port 8004
exit
exit
exit
exit
chf-profile CP2
locality LOC1
priority 31
service name type nchf-convergedcharging
endpoint-profile EP1
  capacity 30
  uri-scheme http
  version
  uri-version v2
  exit
exit
endpoint-name EP1
priority 56
primary ip-address ipv4 209.165.201.21
primary ip-address port 9040
exit
exit
exit
exit
exit
profile nf-pair nf-type UDM
nrf-discovery-group udmdiscovery
locality client LOC1
locality preferred-server LOC1
locality geo-server GEO
exit
profile nf-pair nf-type AMF
nrf-discovery-group udmdiscovery
locality client LOC1
locality preferred-server LOC1
locality geo-server GEO
exit
profile nf-pair nf-type PCF
nrf-discovery-group udmdiscovery
locality client LOC1
locality preferred-server LOC1
locality geo-server GEO
exit
profile nf-pair nf-type UPF
nrf-discovery-group udmdiscovery
locality client LOC1
locality preferred-server LOC1
locality geo-server GEO

```



```
exit
profile nf-pair nf-type CHF
  nrf-discovery-group udmdiscovery
  locality client LOC1
  locality preferred-server LOC1
  locality geo-server GEO
exit
profile nf-client-failure nf-type udm
profile failure-handling FH4
  service name type nudm-sdm
  message type UdmSdmGetUESMSSubscriptionData
  status-code httpv2 403
  retry 3
  action retry-and-ignore
exit
  status-code httpv2 404
  action continue
exit
  status-code httpv2 413
  retry 3
  action retry-and-continue
exit
  status-code httpv2 501,504
  retry 3
  action retry-and-terminate
exit
  status-code httpv2 503
  action terminate
exit
message type UdmSdmSubscribeToNotification
  status-code httpv2 403
  retry 3
  action retry-and-ignore
exit
  status-code httpv2 404
  action continue
exit
  status-code httpv2 413
  retry 3
  action retry-and-continue
exit
  status-code httpv2 501,504
  retry 3
  action retry-and-terminate
exit
  status-code httpv2 503
  action terminate
exit
exit
service name type nudm-uecm
message type UdmUecmRegisterSMF
  status-code httpv2 403
  retry 3
  action retry-and-ignore
exit
  status-code httpv2 404
  action continue
exit
  status-code httpv2 413
  retry 3
  action retry-and-continue
exit
```

```

    status-code httpv2 501,504
      retry 3
      action retry-and-terminate
    exit
    status-code httpv2 503
      action terminate
    exit
  exit
exit
profile nf-client-failure nf-type pcf
profile failure-handling FH1
service name type npcfsmpolicycontrol
message type PcfSmpolicycontrolCreate
  status-code httpv2 0,403
    action retry-and-ignore
  exit
  status-code httpv2 400
    action continue
  exit
  status-code httpv2 404
    action terminate
  exit
  status-code httpv2 500
    retry 2
    action retry-and-ignore
  exit
  status-code httpv2 503
    retry 2
    action retry-and-continue
  exit
exit
message type PcfSmpolicycontrolUpdate
  status-code httpv2 0,403
    action retry-and-ignore
  exit
  status-code httpv2 400
    action continue
  exit
  status-code httpv2 404
    action terminate
  exit
  status-code httpv2 500
    retry 2
    action retry-and-ignore
  exit
  status-code httpv2 503
    retry 2
    action retry-and-continue
  exit
exit
message type PcfSmpolicycontrolDelete
  status-code httpv2 0,403
    action retry-and-ignore
  exit
  status-code httpv2 400
    action continue
  exit
  status-code httpv2 404
    action terminate
  exit
  status-code httpv2 500
    retry 2

```

```
        action retry-and-ignore
    exit
    status-code httpv2 503
        retry 2
        action retry-and-continue
    exit
    exit
    exit
    exit
    exit
profile nf-client-failure nf-type chf
profile failure-handling FH2
    service name type nchf-convergedcharging
    message type ChfConvergedchargingCreate
        status-code httpv2 0,500,504
            action continue
        exit
        status-code httpv2 400,404
            retry 3
            action retry-and-terminate
        exit
        status-code httpv2 403
            retry 3
            action retry-and-ignore
        exit
        status-code httpv2 503
            action terminate
        exit
    exit
    message type ChfConvergedchargingUpdate
        status-code httpv2 0,500,504
            action continue
        exit
        status-code httpv2 400,404
            retry 3
            action retry-and-terminate
        exit
        status-code httpv2 403
            retry 3
            action retry-and-ignore
        exit
        status-code httpv2 503
            action terminate
        exit
    exit
    message type ChfConvergedchargingDelete
        status-code httpv2 0,500,504
            action continue
        exit
        status-code httpv2 400,404
            retry 3
            action retry-and-terminate
        exit
        status-code httpv2 403
            retry 3
            action retry-and-ignore
        exit
        status-code httpv2 503
            action terminate
        exit
    exit
    exit
    exit
    exit
```

```

profile smf smf1
  locality      LOC1
  allowed-nssai [ slicel ]
  plmn-id mcc 123
  plmn-id mnc 456
  service name nsmf-pdu
    type          pdu-session
    schema        http
    service-id    1
    version       1.Rn.0.0
    http-endpoint base-url http://smf-service
    icmpv6-profile icmpprf1
    compliance-profile compl
    access-profile access1
    subscriber-policy polSub
  exit
exit
profile sgw sgw1
  sgw-charging-threshold threl
  sgw-charging-profile ch1
  locality          LOC2
  fqdn              cisco.com.apn.epc.mnc456.mcc123
  charging-mode     gtp
exit
profile sgw-charging-threshold threl
  cc profile value 1
  volume total 100000
  buckets 1
  duration 60
exit
  cc profile value 2
  volume uplink 100000
  volume downlink 100000
  buckets 1
  duration 120
exit
exit
profile sgw-charging-profile ch1
  gtp-triggers volume-limit enable
  gtp-triggers time-limit enable
  gtp-profile pf1
exit
profile gtp-profile pf1 gtp
  local-storage
  file
  rotation
  volume      5
  cdr-count   1000
  time-interval 60
  exit
  name
  prefix      NYPCF508
  format      .%Y-%m-%d%H-%M-%S.%4Q
  max-file-seq-num 4
  start-file-seq-num 1
  recover-file-seq-num false
  exit
  purge-processed-files purge-interval 10
  format custom5
  exit
  push
  encrypted-url
"$8$6vhjkoHt8RL2noFs/ON6ZJavTDzWGS2KUn/Yq1BzgzkeZFmx5SzvnaRYzAdVacCSyCirYovc\`nTFnHpBNim3QY3Q=="

```

```
    exit
  exit
  dictionary custom24
exit
policy subscriber polSub
  precedence 1
    sst          02
    sdt          Abf123
    serving-plmn mcc 123
    serving-plmn mnc 456
    supi-start-range 100000000000001
    supi-stop-range 999999999999999
    gpsi-start-range 1000000000
    gpsi-stop-range 9999999999
    operator-policy opPol1
  exit
  precedence 511
    operator-policy defOprPol1
  exit
exit
policy operator defOprPol1
  policy dnn          defPolDnn
  policy network-capability ncl
exit
policy operator opPol1
  policy dnn          polDnn
  policy network-capability ncl
exit
policy dnn defPolDnn
  profile default-profile
  dnn dnn2 profile profile2
  dnn intershat profile intershat
  dnn intershat1 profile intershat1
  dnn starent.com profile starent.com
exit
policy dnn polDnn
  profile default-profile
  dnn dnn2 profile profile2
  dnn intershat profile intershat
  dnn intershat1 profile intershat1
  dnn intershat2 profile intershat2
  dnn starent.com profile starent.com
exit
policy network-capability ncl
  nw-support-local-address-tft true
exit
nssai name slice1
  sst 2
  sdt Abf123
  dnn [ dnn1 intershat intershat1 intershat2 ]
exit
ipam
  instance 1
  source local
  address-pool poolv4
  vrf-name ISP
  tags
    dnn starent.com
  exit
  ipv4
  split-size
    per-cache 1024
    per-dp 256
  exit
```

```

        address-range 209.165.202.129 209.165.200.253
    exit
exit
address-pool poolv4DNN2
vrf-name ISP
tags
    dnn intershat1
exit
ipv4
    split-size
        per-cache 1024
        per-dp 256
    exit
    address-range 209.165.200.241 209.165.200.244
exit
exit
address-pool poolv4DNN3
vrf-name ISP
static
tags
    dnn intershat2
exit
ipv4
    split-size
        per-cache 512
        per-dp 512
    exit
    address-range 209.165.200.247 209.165.200.248
exit
ipv6
    prefix-ranges
        split-size
            per-cache 8192
            per-dp 8192
        exit
        prefix-range 2002:db0:: length 48
    exit
exit
exit
address-pool poolv4vDNN
vrf-name ISP
tags
    dnn intershat1
exit
ipv4
    split-size
        per-cache 1024
        per-dp 256
    exit
    address-range 209.165.200.245 209.165.200.244
exit
exit
address-pool poolv6
vrf-name ISP
tags
    dnn intershat
exit
ipv6
    prefix-ranges
        split-size
            per-cache 8192
            per-dp 1024
        exit
        prefix-range 2001:db0:: length 48

```

```
    exit
  exit
exit
address-pool poolv6DNN2
  vrf-name ISP
  tags
    dnn intershat1
  exit
  ipv6
    prefix-ranges
      split-size
        per-cache 8192
        per-dp 1024
      exit
      prefix-range 2001:ef0:: length 48
    exit
  exit
exit
address-pool poolv6vDNN
  vrf-name ISP
  tags
    dnn intershat1
  exit
  ipv6
    prefix-ranges
      split-size
        per-cache 8192
        per-dp 1024
      exit
      prefix-range 2001:ab0:: length 48
    exit
  exit
exit
exit
exit
cdl system-id 1
cdl enable-geo-replication true
cdl deployment-model small
cdl zookeeper replica 1
cdl remote-site 2
db-endpoint host 209.165.202.157
db-endpoint port 8882
kafka-server 209.165.202.157 10001
exit
exit
cdl datastore session
  geo-remote-site [ 2 ]
  slice-names [ cnSGW1 cnSGW2 ]
  endpoint replica 1
  endpoint external-ip 209.165.202.156
  endpoint external-port 8882
  index map 1
  index write-factor 1
  slot replica 1
  slot map 1
  slot write-factor 1
  features instance-aware-notification enable true
  features instance-aware-notification system-id 1
  slice-names [ cnSGW1 ]
  exit
  features instance-aware-notification system-id 2
  slice-names [ cnSGW2 ]
  exit
exit
```

```

cdl kafka replica 1
cdl kafka external-ip 209.165.202.156 10001
exit
etcd replicas 1
instance instance-id 1
  endpoint li
    replicas 1
    vip-ip 209.165.200.237
  exit
  endpoint nodemgr
    replicas 1
    nodes 1
  exit
  endpoint gtp
    replicas 1
    interface s5
      vip-ip 209.165.201.11
    exit
    interface s5e
      vip-ip 209.165.201.21
    exit
    interface s11
      vip-ip 209.165.200.237
    exit
  exit
  endpoint pfcf
    replicas 1
    interface sxa
      heartbeat
      interval 0
    exit
  exit
  interface n4
    heartbeat
    interval 0
    retransmission-timeout 3
    max-retransmissions 5
  exit
  exit
  endpoint radius-dns
    replicas 1
    vip-ip 209.165.201.21
  exit
  endpoint service
    replicas 1
  exit
  endpoint protocol
    replicas 1
    internal-vip 209.165.201.11
    vip-ip 209.165.201.21
    interface sxa
      vip-ip 209.165.201.21
    exit
    interface n4
      vip-ip 209.165.201.11
    exit
  exit
  endpoint gtpprime
    replicas 2
    nodes 1
  exit
  endpoint sgw-service
    replicas 1

```



```
exit
endpoint geo
  replicas 1
  nodes 2
  interface geo-internal
    vip-ip 209.165.200.233 vip-port 7001
  exit
  interface geo-external
    vip-ip 209.165.200.234 vip-port 7002
  exit
exit
endpoint sbi
  replicas 1
  vip-ip 209.165.201.21
exit
endpoint bgpspeaker
  replicas 1
  nodes 2
exit
exit
instance instance-id 2
  endpoint li
    replicas 1
    vip-ip 209.165.200.238
  exit
  endpoint nodemgr
    replicas 1
    nodes 1
  exit
  endpoint gtp
    replicas 1
    interface s5
      vip-ip 209.165.201.12
    exit
    interface s5e
      vip-ip 209.165.201.141
    exit
    interface s11
      vip-ip 209.165.200.238
    exit
  exit
  endpoint pfc
    replicas 1
    interface sxa
      heartbeat
        interval 0
    exit
  exit
  interface n4
    heartbeat
      interval 0
      retransmission-timeout 3
      max-retransmissions 5
    exit
  exit
  endpoint radius-dns
    replicas 1
    vip-ip 209.165.201.141
  exit
  endpoint service
    replicas 1
  exit
  endpoint protocol
```

```

replicas      1
internal-vip 209.165.201.11
vip-ip 209.165.201.141
interface sxa
  vip-ip 209.165.201.141
exit
interface n4
  vip-ip 209.165.201.12
exit
exit
endpoint gtpprime
  replicas 2
  nodes 1
exit
endpoint sgw-service
  replicas 1
exit
endpoint geo
  replicas 1
  nodes 2
  interface geo-internal
    vip-ip 209.165.200.235 vip-port 7001
  exit
  interface geo-external
    vip-ip 209.165.200.236 vip-port 7002
  exit
exit
endpoint sbi
  replicas 1
  vip-ip 209.165.201.141
exit
endpoint bgpspeaker
  replicas 1
  nodes 2
exit
exit
logging level application debug
logging level transaction debug
logging level tracing debug
logging name gtp-ep0.application.config level application debug
logging name gtp-ep0.application.gen level application trace
logging name gtp-ep1.application.config level application debug
logging name gtp-ep1.application.gen level application trace
logging name infra.cdr.core level application debug
logging name infra.cdr_sftp.core level application debug
logging name infra.config.core level application trace
logging name infra.config.core level transaction trace
logging name infra.config.core level tracing off
logging name infra.message_log.core level transaction trace
router bgp 65061
  bfd interval 250000 min_rx 250000 multiplier 3
  interface v4001
    neighbor 209.165.202.131 remote-as 65060 fail-over bfd
  exit
  policy-name allow-all ip-prefix 209.165.201.30/0 mask-range 0..32
exit
deployment
  app-name smf
  cluster-name Local
  dc-name DC
  model small
exit
k8 label protocol-layer key disktype value ssd
exit

```

```

geomonitor podmonitor pods bgpspeaker-pod
  retryCount 1
  retryInterval 200
  retryFailOverInterval 200
  failedReplicaPercent 40
exit
geomonitor podmonitor pods gtp-ep
  retryCount 1
  retryInterval 200
  retryFailOverInterval 200
  failedReplicaPercent 40
exit
geomonitor podmonitor pods li-ep
  retryCount 1
  retryInterval 200
  retryFailOverInterval 200
  failedReplicaPercent 40
exit
geomonitor podmonitor pods sgw-service
  retryCount 1
  retryInterval 200
  retryFailOverInterval 200
  failedReplicaPercent 40
exit
instances instance 1
  system-id DCNAME001
  cluster-id CLUSTER0001
  slice-name cnSGW1
exit
instances instance 2
  system-id DCNAME002
  cluster-id CLUSTER0002
  slice-name cnSGW2
exit
local-instance instance 1
system mode running
helm default-repository cn
helm repository cn
  access-token
sgw-deployer.gen:AKCp8ihVrCfvm9puwTSt8oKKG6HxPlFn8sLY5fzqWYr3NhrBmjjJrUHaxfZD3ziQpiLkAy1Q3
url
https://engci-maven-master.cisco.com/artifactory/smi-fuse-internal-snapshot/mobile-cn-at-cn/cn-products/rel-2021.02/
exit
k8s name cn
k8s namespace cn
k8s nf-name smf
k8s registry dockerhub.cisco.com/smi-fuse-docker-internal
k8s single-node true
k8s use-volume-claims true
k8s image-pull-secrets regcred
k8s ingress-host-name 209.165.200.235.nip.io
aaa authentication users user admin
  uid 117
  gid 117
  password $1$g8J36yTY$1g/tM5a9pdsGMnKcspnxD.
  ssh_keydir /tmp/admin/.ssh
  homedir /tmp/admin
exit
aaa ios level 0
  prompt "\h> "
exit
aaa ios level 15
  prompt "\h# "
exit

```

```

aaa ios privilege exec
level 0
  command action
  exit
  command autowizard
  exit
  command enable
  exit
  command exit
  exit
  command help
  exit
  command startup
  exit
exit
level 15
  command configure
  exit
exit
exit
nacm write-default deny
nacm groups group LI
  user-name [ liadmin ]
exit
nacm groups group LI2
  user-name [ liadmin2 ]
exit
nacm groups group LI3
  user-name [ liadmin3 ]
exit
nacm groups group admin
  user-name [ admin ]
exit
nacm rule-list admin
  group [ admin ]
  rule li-deny-tap
    module-name      lawful-intercept
    path              /lawful-intercept
    access-operations *
    action            deny
  exit
  rule li-deny-clear
    module-name      tailf-mobile-smf
    path              /clear/lawful-intercept
    access-operations *
    action            deny
  exit
  rule any-access
    action permit
  exit
exit
nacm rule-list confd-api-manager
  group [ confd-api-manager ]
  rule any-access
    action permit
  exit
exit
nacm rule-list ops-center-security
  group [ * ]
  rule change-self-password
    module-name      ops-center-security
    path              /smiuser/change-self-password
    access-operations exec
    action            permit

```

```
exit
rule smiuser
  module-name      ops-center-security
  path             /smiuser
  access-operations exec
  action           deny
exit
exit
nacm rule-list lawful-intercept
  group [ LI LI2 LI3 ]
  rule li-accept-tap
    module-name    lawful-intercept
    path           /lawful-intercept
    access-operations *
    action         permit
  exit
  rule li-accept-clear
    module-name    tailf-mobile-smf
    path           /clear/lawful-intercept
    access-operations *
    action         permit
  exit
  exit
  nacm rule-list any-group
    group [ * ]
    rule li-deny-tap
      module-name  lawful-intercept
      path         /lawful-intercept
      access-operations *
      action       deny
    exit
    rule li-deny-clear
      module-name  tailf-mobile-smf
      path         /clear/lawful-intercept
      access-operations *
      action       deny
    exit
  exit
exit
```

