



## **Cisco Catalyst 9800 Series Wireless Controller Software Configuration Guide, Cisco IOS XE Bengaluru 17.6.x**

**First Published:** 2021-07-31

**Last Modified:** 2022-08-12

### **Americas Headquarters**

Cisco Systems, Inc.  
170 West Tasman Drive  
San Jose, CA 95134-1706  
USA  
<http://www.cisco.com>  
Tel: 408 526-4000  
800 553-NETS (6387)  
Fax: 408 527-0883

THE SPECIFICATIONS AND INFORMATION REGARDING THE PRODUCTS IN THIS MANUAL ARE SUBJECT TO CHANGE WITHOUT NOTICE. ALL STATEMENTS, INFORMATION, AND RECOMMENDATIONS IN THIS MANUAL ARE BELIEVED TO BE ACCURATE BUT ARE PRESENTED WITHOUT WARRANTY OF ANY KIND, EXPRESS OR IMPLIED. USERS MUST TAKE FULL RESPONSIBILITY FOR THEIR APPLICATION OF ANY PRODUCTS.

THE SOFTWARE LICENSE AND LIMITED WARRANTY FOR THE ACCOMPANYING PRODUCT ARE SET FORTH IN THE INFORMATION PACKET THAT SHIPPED WITH THE PRODUCT AND ARE INCORPORATED HEREIN BY THIS REFERENCE. IF YOU ARE UNABLE TO LOCATE THE SOFTWARE LICENSE OR LIMITED WARRANTY, CONTACT YOUR CISCO REPRESENTATIVE FOR A COPY.

The Cisco implementation of TCP header compression is an adaptation of a program developed by the University of California, Berkeley (UCB) as part of UCB's public domain version of the UNIX operating system. All rights reserved. Copyright © 1981, Regents of the University of California.

NOTWITHSTANDING ANY OTHER WARRANTY HEREIN, ALL DOCUMENT FILES AND SOFTWARE OF THESE SUPPLIERS ARE PROVIDED "AS IS" WITH ALL FAULTS. CISCO AND THE ABOVE-NAMED SUPPLIERS DISCLAIM ALL WARRANTIES, EXPRESSED OR IMPLIED, INCLUDING, WITHOUT LIMITATION, THOSE OF MERCHANTABILITY, FITNESS FOR A PARTICULAR PURPOSE AND NON-INFRINGEMENT OR ARISING FROM A COURSE OF DEALING, USAGE, OR TRADE PRACTICE.

IN NO EVENT SHALL CISCO OR ITS SUPPLIERS BE LIABLE FOR ANY INDIRECT, SPECIAL, CONSEQUENTIAL, OR INCIDENTAL DAMAGES, INCLUDING, WITHOUT LIMITATION, LOST PROFITS OR LOSS OR DAMAGE TO DATA ARISING OUT OF THE USE OR INABILITY TO USE THIS MANUAL, EVEN IF CISCO OR ITS SUPPLIERS HAVE BEEN ADVISED OF THE POSSIBILITY OF SUCH DAMAGES.

Any Internet Protocol (IP) addresses and phone numbers used in this document are not intended to be actual addresses and phone numbers. Any examples, command display output, network topology diagrams, and other figures included in the document are shown for illustrative purposes only. Any use of actual IP addresses or phone numbers in illustrative content is unintentional and coincidental.

All printed copies and duplicate soft copies of this document are considered uncontrolled. See the current online version for the latest version.

Cisco has more than 200 offices worldwide. Addresses and phone numbers are listed on the Cisco website at [www.cisco.com/go/offices](http://www.cisco.com/go/offices).

Cisco and the Cisco logo are trademarks or registered trademarks of Cisco and/or its affiliates in the U.S. and other countries. To view a list of Cisco trademarks, go to this URL: <https://www.cisco.com/c/en/us/about/legal/trademarks.html>. Third-party trademarks mentioned are the property of their respective owners. The use of the word partner does not imply a partnership relationship between Cisco and any other company. (1721R)

© 2021 Cisco Systems, Inc. All rights reserved.



## CONTENTS

---

### PREFACE

<b>Preface</b>	<b>lxxxvii</b>
Document Conventions	<b>lxxxvii</b>
Related Documentation	<b>lxxxix</b>
Communications, Services, and Additional Information	<b>lxxxix</b>
Cisco Bug Search Tool	<b>lxxxix</b>
Documentation Feedback	<b>lxxxix</b>

---

### CHAPTER 1

<b>Overview of Cisco 9800 Series Wireless Controllers</b>	<b>1</b>
Elements of the New Configuration Model	<b>1</b>
Configuration Workflow	<b>2</b>
Initial Setup	<b>3</b>
Interactive Help	<b>4</b>

---

### PART I

<b>System Configuration</b>	<b>7</b>
-----------------------------	----------

---

### CHAPTER 2

<b>New Configuration Model</b>	<b>9</b>
Information About New Configuration Model	<b>9</b>
Configuring a Wireless Profile Policy (GUI)	<b>12</b>
Configuring a Wireless Profile Policy (CLI)	<b>12</b>
Configuring a Flex Profile (GUI)	<b>13</b>
Configuring a Flex Profile	<b>14</b>
Configuring an AP Profile (GUI)	<b>15</b>
Configuring an AP Profile (CLI)	<b>19</b>
Configuring User for AP Management (CLI)	<b>21</b>
Setting a Private Configuration Key for Password Encryption	<b>21</b>
Configuring an RF Profile (GUI)	<b>22</b>

Configuring an RF Profile (CLI)	22
Configuring a Site Tag (GUI)	23
Configuring a Site Tag (CLI)	24
Configuring Policy Tag (GUI)	25
Configuring a Policy Tag (CLI)	25
Configuring Wireless RF Tag (GUI)	26
Configuring Wireless RF Tag (CLI)	27
Attaching a Policy Tag and Site Tag to an AP (GUI)	28
Attaching Policy Tag and Site Tag to an AP (CLI)	28
Configuring a Radio Profile	29
Information About Wireless Radio Profile	29
Configuring a Wireless Radio Profile (GUI)	30
Configuring a Radio Profile and Beam Selection	30
Configuring the Antenna Count in a Wireless Radio Profile	31
Configuring a Slot Per Radio in the RF Tag Profile	31
Verifying a Radio Profile	32
AP Filter	33
Introduction to AP Filter	33
Set Tag Priority (GUI)	34
Set Tag Priority	34
Create an AP Filter (GUI)	35
Create an AP Filter (CLI)	35
Set Up and Update Filter Priority (GUI)	36
Set Up and Update Filter Priority	36
Verify AP Filter Configuration	36
Configuring Access Point for Location Configuration	37
Information About Location Configuration	37
Prerequisite for Location Configuration	38
Configuring a Location for an Access Point (GUI)	38
Configuring a Location for an Access Point (CLI)	38
Adding an Access Point to the Location (GUI)	39
Adding an Access Point to the Location (CLI)	40
Configuring SNMP in Location Configuration	40
SNMP MIB	40

Verifying Location Configuration 41

Verifying Location Statistics 41

---

**CHAPTER 3****Wireless Management Interface 43**

Information About Wireless Management Interface 43

Recommendations for Wireless Management Interface 44

Configuring your Controller with Wireless Management Interface (CLI) 45

Verifying Wireless Management Interface Settings 47

Information About Network Address Translation (NAT) 48

Information About CAPWAP Discovery 48

Configuring Wireless Management Interface with a NAT Public IP (CLI) 49

Configuring CAPWAP Discovery to Respond Only with Public or Private IP (CLI) 50

    Configuring the Controller to Respond only with a Public IP (CLI) 50

    Configuring the Controller to Respond only with a Private IP (CLI) 50

Verifying NAT Settings 51

---

**CHAPTER 4****BIOS Protection 53**

BIOS Protection on the Controller 53

BIOS or ROMMON Upgrade with BIOS Protection 53

Upgrading BIOS 54

---

**CHAPTER 5****Smart Licensing Using Policy 55**

Introduction to Smart Licensing Using Policy 55

Information About Smart Licensing Using Policy 56

    Overview 56

    Supported Products 56

    Architecture 57

        Product Instance 57

        CSLU 57

        CSSM 58

        Controller 58

        SSM On-Prem 59

    Concepts 60

        License Enforcement Types 60

License Duration	61
Authorization Code	61
Policy	61
RUM Report and Report Acknowledgement	63
Trust Code	63
Supported Topologies	64
Connected to CSSM Through CSLU	64
Connected Directly to CSSM	65
CSLU Disconnected from CSSM	67
Connected to CSSM Through a Controller	68
No Connectivity to CSSM and No CSLU	70
SSM On-Prem Deployment	70
Interactions with Other Features	73
High Availability	73
Upgrades	75
Downgrades	76
How to Configure Smart Licensing Using Policy: Workflows by Topology	79
Workflow for Topology: Connected to CSSM Through CSLU	79
Workflow for Topology: Connected Directly to CSSM	81
Workflow for Topology: CSLU Disconnected from CSSM	83
Workflow for Topology: Connected to CSSM Through a Controller	85
Workflow for Topology: No Connectivity to CSSM and No CSLU	86
Workflow for Topology: SSM On-Prem Deployment	87
Tasks for Product Instance-Initiated Communication	87
Tasks for SSM On-Prem Instance-Initiated Communication	90
Migrating to Smart Licensing Using Policy	92
Example: Smart Licensing to Smart Licensing Using Policy	93
Example: SLR to Smart Licensing Using Policy	100
Example: Evaluation or Expired to Smart Licensing Using Policy	108
Migrating to a Version of SSM On-Prem That Supports Smart Licensing Using Policy	111
Task Library for Smart Licensing Using Policy	113
Logging into Cisco (CSLU Interface)	113
Configuring a Smart Account and a Virtual Account (CSLU Interface)	113
Adding a Product-Initiated Product Instance in CSLU (CSLU Interface)	114

Ensuring Network Reachability for Product Instance-Initiated Communication	114
Adding a CSLU-Initiated Product Instance in CSLU (CSLU Interface)	116
Collecting Usage Reports: CSLU Initiated (CSLU Interface)	116
Export to CSSM (CSLU Interface)	117
Import from CSSM (CSLU Interface)	118
Ensuring Network Reachability for CSLU-Initiated Communication	118
Assigning a Smart Account and Virtual Account (SSM On-Prem UI)	122
Validating Devices (SSM On-Prem UI)	123
Ensuring Network Reachability for Product Instance-Initiated Communication	123
Retrieving the Transport URL (SSM On-Prem UI)	125
Exporting and Importing Usage Data (SSM On-Prem UI)	126
Adding One or More Product Instances (SSM On-Prem UI)	127
Ensuring Network Reachability for SSM On-Prem-Initiated Communication	128
Setting Up a Connection to CSSM	133
Configuring Smart Transport Through an HTTPs Proxy	135
Configuring the Call Home Service for Direct Cloud Access	136
Configuring the Call Home Service for Direct Cloud Access through an HTTPs Proxy Server	139
Removing and Returning an Authorization Code	140
Removing the Product Instance from CSSM	142
Generating a New Token for a Trust Code from CSSM	143
Installing a Trust Code	144
Downloading a Policy File from CSSM	145
Uploading Data or Requests to CSSM and Downloading a File	145
Installing a File on the Product Instance	146
Setting the Transport Type, URL, and Reporting Interval	147
Configuring an AIR License	150
Sample Resource Utilization Measurement Report	152
Troubleshooting Smart Licensing Using Policy	153
System Message Overview	153
System Messages	154
Additional References for Smart Licensing Using Policy	163
Feature History for Smart Licensing Using Policy	163

Overview of Boot Integrity Visibility	165
Verifying Software Image and Hardware	165
Verifying Platform Identity and Software Integrity	166

**CHAPTER 7****Management over Wireless 169**

Information About Management over Wireless	169
Restrictions on Management over Wireless	169
Enabling Management over Wireless on Controller (GUI)	169
Enabling Management over Wireless on Controller (CLI)	170

**CHAPTER 8****Link Aggregation Group 171**

Information About Link Aggregation Group	171
Link Aggregation Control Protocol	171
Configuring LAG Using LACP	172
Port Aggregation Protocol	172
Configuring LAG Using PAgP	172
Information About Port Channel Interface Number	172
Configuring LAG in ON Mode	173
Multichassis Link Aggregation Group	173
Prerequisites for Multi-LAG	173
Restrictions for Multi-LAG	174
Supported Topologies	174
Configuring a Port Channel Interface (GUI)	175
Create a Port-Channel Interface	176
Configuring LAG in ON Mode	176
Add an Interface to a Port Channel (LACP)	177
Add an Interface to a Port Channel (PAgP)	178
Add a VLAN to a Port Channel	178
Remove a Port Channel Group from a Physical Interface	179
Verify the LAG Configuration	179

**CHAPTER 9****Best Practices 181**

Introduction	181
--------------	-----



---

**PART II****System Upgrade 183**

---

**CHAPTER 10****Upgrading the Cisco Catalyst 9800 Wireless Controller Software 185**

- Overview of Upgrading the Controller Software 185
- Upgrading the Controller Software (GUI) 186
- Upgrade the Controller Software (CLI) 187
- Converting From Bundle-Mode to Install-Mode 188
- Copying a WebAuth Tar Bundle to the Standby Controller 191

---

**CHAPTER 11****In-Service Software Upgrade 193**

- Information About In-Service Software Upgrade 193
- Prerequisites for Performing In-Service Software Upgrade 194
- Guidelines and Restrictions for In-Service Software Upgrade 194
- Upgrading Software Using In-Service Software Upgrade 195
- Upgrading Software Using ISSU (GUI) 196
- Upgrading Software Using In-Service Software Upgrade with Delayed Commit 197
- Monitoring In-Service Software Upgrade 198
- Troubleshooting ISSU 200

---

**CHAPTER 12****Software Maintenance Upgrade 203**

- Introduction to Software Maintenance Upgrade 203
  - Installing a SMU (GUI) 205
  - Installing SMU 206
  - Roll Back an Image (GUI) 207
  - Rollback SMU 207
  - Deactivate SMU 207
  - Configuration Examples for SMU 208
- Information About AP Device Package 208
  - Installing AP Device Package (GUI) 209
  - Installing AP Device Package (CLI) 210
  - Verifying APDP on the Controller 210
- Information About Per Site or Per AP Model Service Pack (APSP) 211
  - Rolling AP Upgrade 212

Rolling AP Upgrade Process	212
Installing AP Service Package (GUI)	213
Installing AP Service Package (CLI)	214
Adding a Site to a Filter	215
Deactivating an Image	215
Roll Back APSP	215
Canceling the Upgrade	216
Verifying the Upgrade	216
Verifying of AP Upgrade on the Controller	219

---

**CHAPTER 13****Efficient Image Upgrade 221**

Efficient Image Upgrade	221
Enable Pre-Download (GUI)	221
Enable Pre-Download (CLI)	222
Configuring a Site Tag (CLI)	222
Attaching Policy Tag and Site Tag to an AP (CLI)	223
Trigger Predownload to a Site Tag	224

---

**CHAPTER 14****Predownloading an Image to an Access Point 227**

Information About Predownloading an Image to an Access Point	227
Restrictions for Predownloading an Image to an Access Point	227
Predownloading an Image to Access Points (CLI)	228
Predownloading an Image to Access Points (GUI)	230
Predownloading an Image to Access Points (YANG)	230
Monitoring the Access Point Predownload Process	231
Information About AP Image Download Time Enhancement (OEAP or Teleworker Only)	232
Configuring AP Image Download Time Enhancement (GUI)	233
Configuring AP Image Download Time Enhancement (CLI)	233
Verifying AP Image Download Time Enhancement Configuration	234

---

**CHAPTER 15****N+1 Hitless Rolling AP Upgrade 235**

N+1 Hitless Rolling AP Upgrade	235
Configuring Hitless Upgrade	236
Verifying Hitless Upgrade	237

---

<b>CHAPTER 16</b>	<b>NBAR Dynamic Protocol Pack Upgrade</b>	<b>239</b>
	NBAR Dynamic Protocol Pack Upgrade	239
	Upgrading the NBAR2 Protocol Pack	240

---

<b>CHAPTER 17</b>	<b>Wireless Sub-Package for Switch</b>	<b>241</b>
	Introduction to Wireless Sub-package	241
	Booting in Install Mode	242
	Installing Sub-Package in a Single Step (GUI)	243
	Installing Sub-Package in a Single Step	243
	Multi-step Installation of Sub-Package	244
	Installing on a Stack	244
	Upgrading to a Newer Version of Wireless Package	245
	Deactivating the Wireless Package	245
	Enabling or Disabling Auto-Upgrade	245

---

<b>PART III</b>	<b>Lightweight Access Points</b>	<b>247</b>
-----------------	----------------------------------	------------

---

<b>CHAPTER 18</b>	<b>Country Codes</b>	<b>249</b>
	Information About Country Codes	249
	Prerequisites for Configuring Country Codes	249
	Configuring Country Codes (GUI)	250
	Configuring Country Codes (CLI)	250
	Configuration Examples for Configuring Country Codes	252
	Viewing Channel List for Country Codes	252

---

<b>CHAPTER 19</b>	<b>Regulatory Compliance (Rest of the World) for Domain Reduction</b>	<b>255</b>
	Information About Regulatory Compliance Domain	255
	Global Country-Level Domains	256
	Restrictions on Regulatory Compliance Domain	258
	Rest of World Domain	259
	Configuring Country Code for Rest of the World (CLI)	264

---

<b>CHAPTER 20</b>	<b>Sniffer Mode</b>	<b>267</b>
-------------------	---------------------	------------

Information about Sniffer	267
Prerequisites for Sniffer	267
Restrictions on Sniffer	268
How to Configure Sniffer	268
Configuring an Access Point as Sniffer (GUI)	268
Configuring an Access Point as Sniffer (CLI)	269
Enabling or Disabling Sniffing on the Access Point (GUI)	269
Enabling or Disabling Sniffing on the Access Point (CLI)	270
Verifying Sniffer Configurations	270
Examples for Sniffer Configurations and Monitoring	271

---

**CHAPTER 21**      **Monitor Mode**    273

Introduction to Monitor Mode	273
Enable Monitor Mode (GUI)	273
Enable Monitor Mode (CLI)	274

---

**CHAPTER 22**      **AP Priority**      275

Failover Priority for Access Points	275
Setting AP Priority (GUI)	275
Setting AP Priority	276

---

**CHAPTER 23**      **FlexConnect**    277

Information About FlexConnect	277
FlexConnect Authentication	279
Guidelines and Restrictions for FlexConnect	281
Configuring a Site Tag	285
Configuring a Policy Tag (CLI)	286
Attaching a Policy Tag and a Site Tag to an Access Point (GUI)	287
Attaching Policy Tag and Site Tag to an AP (CLI)	287
Linking an ACL Policy to the Defined ACL (GUI)	288
Applying ACLs on FlexConnect	289
Configuring FlexConnect	290
Configuring a Switch at a Remote Site	290
Configuring the Controller for FlexConnect	291

Configuring Local Switching in FlexConnect Mode (GUI)	291
Configuring Local Switching in FlexConnect Mode (CLI)	292
Configuring Central Switching in FlexConnect Mode (GUI)	292
Configuring Central Switching in FlexConnect Mode	293
Configuring an Access Point for FlexConnect	293
Configuring an Access Point for Local Authentication on a WLAN (GUI)	293
Configuring an Access Point for Local Authentication on a WLAN (CLI)	294
Connecting Client Devices to WLANs	294
Configuring FlexConnect Ethernet Fallback	295
Information About FlexConnect Ethernet Fallback	295
Configuring FlexConnect Ethernet Fallback	295
Flex AP Local Authentication (GUI)	296
Flex AP Local Authentication (CLI)	297
Flex AP Local Authentication with External Radius Server	299
Configuration Example: FlexConnect with Central and Local Authentication	302
NAT-PAT for FlexConnect	302
Configuring NAT-PAT for a WLAN or a Remote LAN	302
Creating a WLAN	302
Configuring a Wireless Profile Policy and NAT-PAT (GUI)	303
Configuring a Wireless Profile Policy and NAT-PAT	303
Mapping a WLAN to a Policy Profile	304
Configuring a Site Tag	305
Attaching a Policy Tag and a Site Tag to an Access Point (GUI)	305
Attaching a Policy Tag and a Site Tag to an Access Point	306
Split Tunneling for FlexConnect	306
Configuring Split Tunneling for a WLAN or Remote LAN	307
Defining an Access Control List for Split Tunneling (GUI)	307
Defining an Access Control List for Split Tunneling	307
Linking an ACL Policy to the Defined ACL	308
Creating a WLAN	309
Configuring a Wireless Profile Policy and a Split MAC ACL Name (GUI)	309
Configuring a Wireless Profile Policy and a Split MAC ACL Name	310
Mapping a WLAN to a Policy Profile (GUI)	311
Mapping WLAN to a Policy Profile	311

Configuring a Site Tag	312
Attaching a Policy Tag and Site Tag to an Access Point	312
VLAN-based Central Switching for FlexConnect	313
Configuring VLAN-based Central Switching (GUI)	313
Configuring VLAN-based Central Switching (CLI)	314
OfficeExtend Access Points for FlexConnect	315
Configuring OfficeExtend Access Points	316
Disabling OfficeExtend Access Point	316
Support for OEAP Personal SSID	317
Information About OEAP Personal SSID Support	317
Configuring OEAP Personal SSID (GUI)	317
Configuring OEAP Personal SSID (CLI)	318
Viewing OEAP Personal SSID Configuration	318
Clearing Personal SSID from an OfficeExtend Access Point	319
Example: Viewing OfficeExtend Configuration	319
Proxy ARP	320
Enabling Proxy ARP for FlexConnect APs (GUI)	320
Enabling Proxy ARP for FlexConnect APs	320
Overlapping Client IP Address in Flex Deployment	321
Overview of Overlapping Client IP Address in Flex Deployment	321
Enabling Overlapping Client IP Address in Flex Deployment (GUI)	321
Enabling Overlapping Client IP Address in Flex Deployment	322
Verifying Overlapping Client IP Address in Flex Deployment (GUI)	322
Verifying Overlapping Client IP Address in Flex Deployment	323
Flex Resilient with Flex and Bridge Mode Access Points	324
Information About Flex Resilient with Flex and Bridge Mode Access Points	324
Configuring a Flex Profile (GUI)	324
Configuring a Flex Profile (CLI)	325
Configuring a Site Tag (CLI)	326
Configuring a Mesh Profile (CLI)	326
Associating Wireless Mesh to an AP Profile (CLI)	327
Attaching Site Tag to an Access Point (CLI)	328
Configuring Switch Interface for APs (CLI)	328
Verifying Flex Resilient with Flex and Bridge Mode Access Points Configuration	329

---

<b>CHAPTER 24</b>	<b>OEAP Link Test</b>	<b>331</b>
	Feature History for OEAP Link Test	331
	Information About OEAP Link Test	331
	Configuring OEAP Link Test (CLI)	332
	Performing OEAP Link Test (GUI)	332
	Verifying OEAP Link Test	332

---

<b>CHAPTER 25</b>	<b>Data DTLS</b>	<b>335</b>
	Information About Data Datagram Transport Layer Security	335
	Configuring Data DTLS (GUI)	336
	Configuring Data DTLS (CLI)	336

---

<b>CHAPTER 26</b>	<b>AP Crash File Upload</b>	<b>339</b>
	AP Crash File Upload	339
	Configuring AP Crash File Upload (CLI)	340

---

<b>CHAPTER 27</b>	<b>Access Point Plug-n-Play</b>	<b>341</b>
	Overview of Access Point Plug-n-Play	341
	Provisioning AP from PnP Server	341
	Verifying AP Tag Configuration	342

---

<b>CHAPTER 28</b>	<b>802.11 Parameters for Cisco Access Points</b>	<b>343</b>
	2.4-GHz Radio Support	343
	Configuring 2.4-GHz Radio Support for the Specified Slot Number	343
	5-GHz Radio Support	345
	Configuring 5-GHz Radio Support for the Specified Slot Number	345
	Information About Dual-Band Radio Support	348
	Configuring Default XOR Radio Support	349
	Configuring XOR Radio Support for the Specified Slot Number (GUI)	351
	Configuring XOR Radio Support for the Specified Slot Number	351
	Receiver Only Dual-Band Radio Support	353
	Information About Receiver Only Dual-Band Radio Support	353

Configuring Receiver Only Dual-Band Parameters for Access Points	353
Enabling CleanAir with Receiver Only Dual-Band Radio on a Cisco Access Point (GUI)	353
Enabling CleanAir with Receiver Only Dual-Band Radio on a Cisco Access Point	354
Disabling Receiver Only Dual-Band Radio on a Cisco Access Point (GUI)	354
Disabling Receiver Only Dual-Band Radio on a Cisco Access Point	354
Configuring Client Steering (CLI)	355
Verifying Cisco Access Points with Dual-Band Radios	356

**CHAPTER 29****802.1X Support 359**

Introduction to the 802.1X Authentication	359
EAP-FAST Protocol	359
EAP-TLS/EAP-PEAP Protocol	360
Limitations of the 802.1X Authentication	360
Topology - Overview	361
Configuring 802.1X Authentication Type and LSC AP Authentication Type (GUI)	361
Configuring 802.1X Authentication Type and LSC AP Authentication Type	362
Configuring the 802.1X Username and Password (GUI)	363
Configuring the 802.1X Username and Password (CLI)	363
Enabling 802.1X on the Switch Port	364
Verifying 802.1X on the Switch Port	366
Verifying the Authentication Type	366

**CHAPTER 30****CAPWAP Link Aggregation Support 367**

Information About CAPWAP LAG Support	367
Restrictions for CAPWAP LAG Support	368
Enabling CAPWAP LAG Support on Controller (GUI)	368
Enabling CAPWAP LAG Support on Controller	368
Enabling CAPWAP LAG Globally on Controller	369
Disabling CAPWAP LAG Globally on Controller	369
Enabling CAPWAP LAG for an AP Profile (GUI)	369
Enabling CAPWAP LAG for an AP Profile	370
Disabling CAPWAP LAG for an AP Profile	370
Disabling CAPWAP LAG Support on Controller	371
Verifying CAPWAP LAG Support Configurations	371



---

<b>CHAPTER 31</b>	<b>DHCP and NAT Functionality on Root Access Point</b>	<b>373</b>
	Information About DHCP and NAT Functionality on Root AP (RAP)	373
	Configuring DHCP Server on Root Access Point (RAP)	374
	Verifying DHCP Server for Root AP Configuration	374

---

<b>CHAPTER 32</b>	<b>OFDMA Support for 11ax Access Points</b>	<b>375</b>
	Information About OFDMA Support for 11ax Access Points	375
	Supported Modes on 11ax Access Points	375
	Configuring 11AX (GUI)	376
	Configuring Channel Width	376
	Configuring 802.11ax Radio Parameters (GUI)	377
	Configuring 802.11ax Radio Parameters (CLI)	377
	Setting up the 802.11ax Radio Parameters	378
	Configuring OFDMA on a WLAN	379
	Verifying Channel Width	380
	Verifying Client Details	381
	Verifying Radio Configuration	382

---

<b>CHAPTER 33</b>	<b>AP Audit Configuration</b>	<b>385</b>
	Information About AP Audit Configuration	385
	Restrictions for AP Audit Configuration	385
	Configure AP Audit Parameters (CLI)	386
	Verifying AP Audit Report Summary	386
	Verifying AP Audit Report Detail	386

---

<b>CHAPTER 34</b>	<b>AP Support Bundle</b>	<b>389</b>
	Access Point Support Bundle	389
	Exporting an AP Support Bundle (GUI)	389
	Exporting an AP Support Bundle (CLI)	390
	Monitoring the Status of Support Bundle Export	390

---

<b>CHAPTER 35</b>	<b>Cisco Flexible Antenna Port</b>	<b>391</b>
-------------------	------------------------------------	------------

Information About Cisco Flexible Antenna Port	391
Configuring a Cisco Flexible Antenna Port (GUI)	391
Configuring a Cisco Flexible Antenna Port (CLI)	392
Verifying Flexible Antenna Port Configuration	392

---

**CHAPTER 36****LED States for Access Points 393**

Information About LED States for Access Points	393
Configuring LED State in Access Points (GUI)	393
Configuring LED State for Access Points in the Global Configuration Mode (CLI)	394
Configuring LED State in the AP Profile	394
Verifying LED State for Access Points	395

---

**CHAPTER 37****Access Points Memory Information 397**

Information About Access Point Memory Information	397
Verifying Access Point Memory Information	397

---

**CHAPTER 38****Real-Time Access Points Statistics 399**

Information About Access Point Real-Time Statistics	399
Configuring Access Point Real-Time Statistics (GUI)	399
Configuring Access Point Real-Time Statistics (CLI)	400
Monitoring Access Point Real-Time Statistics (GUI)	401
Verifying Access Point Real-Time Statistics	402

---

**CHAPTER 39****Access Point Tag Persistency 405**

Information About Access Point Tag Persistency	405
Configuring AP Tag Persistency (GUI)	405
Saving Tags on an Access Point (GUI)	406
Deleting Saved Tags on the Access Point	406
Configuring AP Tag Persistency (CLI)	406
Verifying AP Tag Persistency	407

---

**CHAPTER 40****Configuring the AP Console 409**

Feature History for Configuring the Access Point Console	409
--	-----

Information About Configuring the Access Point Console 409

Configuring the AP Console (GUI) 410

Configuring the AP Console (CLI) 410

Verifying the AP Console Status 410

---

**PART IV**

**Radio Resource Management 413**

---

**CHAPTER 41**

**Radio Resource Management 415**

Information About Radio Resource Management 415

Radio Resource Monitoring 416

Information About RF Groups 416

RF Group Leader 417

RF Group Name 419

Rogue Access Point Detection in RF Groups 420

Secure RF Groups 420

Transmit Power Control 420

Overriding the TPC Algorithm with Minimum and Maximum Transmit Power Settings 420

Dynamic Channel Assignment 421

Dynamic Bandwidth Selection 423

Coverage Hole Detection and Correction 423

Restrictions for Radio Resource Management 424

How to Configure RRM 424

Configuring Neighbor Discovery Type (GUI) 424

Configuring Neighbor Discovery Type (CLI) 425

Configuring RF Groups 426

Configuring RF Group Selection Mode (GUI) 426

Configuring RF Group Selection Mode (CLI) 426

Configuring an RF Group Name (CLI) 427

Configuring a Secure RF Group (CLI) 427

Configuring Members in an 802.11 Static RF Group (GUI) 428

Configuring Members in an 802.11 Static RF Group (CLI) 428

Configuring Transmit Power Control 429

Configuring Transmit Power (GUI) 429

Configuring the Tx-Power Control Threshold (CLI) 430

Configuring the Tx-Power Level (CLI)	430
Configuring 802.11 RRM Parameters	431
Configuring Advanced 802.11 Channel Assignment Parameters (GUI)	431
Configuring Advanced 802.11 Channel Assignment Parameters (CLI)	432
Configuring 802.11 Coverage Hole Detection (GUI)	434
Configuring 802.11 Coverage Hole Detection (CLI)	435
Configuring 802.11 Event Logging (CLI)	436
Configuring 802.11 Statistics Monitoring (GUI)	437
Configuring 802.11 Statistics Monitoring (CLI)	437
Configuring the 802.11 Performance Profile (GUI)	438
Configuring the 802.11 Performance Profile (CLI)	439
Configuring Advanced 802.11 RRM	440
Enabling Channel Assignment (GUI)	440
Enabling Channel Assignment (CLI)	440
Restarting DCA Operation	441
Updating Power Assignment Parameters (GUI)	441
Updating Power Assignment Parameters (CLI)	441
Configuring Rogue Access Point Detection in RF Groups	442
Configuring Rogue Access Point Detection in RF Groups (CLI)	442
Monitoring RRM Parameters and RF Group Status	443
Monitoring RRM Parameters	443
Verifying RF Group Status (CLI)	444
Examples: RF Group Configuration	444
Information About ED-RRM	445
Configuring ED-RRM on the Cisco Wireless Controller (CLI)	445

---

**CHAPTER 42**
**Coverage Hole Detection 447**

Coverage Hole Detection and Correction	447
Configuring Coverage Hole Detection (GUI)	447
Configuring Coverage Hole Detection (CLI)	448
Configuring CHD for RF Tag Profile (GUI)	450
Configuring CHD for RF Profile (CLI)	450

---

**CHAPTER 43**
**Optimized Roaming 453**

Optimized Roaming	453
Restrictions for Optimized Roaming	453
Configuring Optimized Roaming (GUI)	454
Configuring Optimized Roaming (CLI)	454

---

**CHAPTER 44****Cisco Flexible Radio Assignment** 455

Information About Flexible Radio Assignment	455
Benefits of the FRA	456
Configuring an FRA Radio (CLI)	456
Configuring an FRA Radio (GUI)	458

---

**CHAPTER 45****XOR Radio Support** 461

Information About Dual-Band Radio Support	461
Configuring Default XOR Radio Support	462
Configuring XOR Radio Support for the Specified Slot Number (GUI)	464
Configuring XOR Radio Support for the Specified Slot Number	464

---

**CHAPTER 46****Cisco Receiver Start of Packet** 467

Information About Receiver Start of Packet Detection Threshold	467
Restrictions for Rx SOP	467
Configuring Rx SOP (CLI)	468
Customizing RF Profile (CLI)	468

---

**CHAPTER 47****Client Limit** 471

Information About Client Limit	471
Configuring Client Limit Per WLAN (GUI)	471
Configuring Client Limit Per WLAN (CLI)	471

---

**CHAPTER 48****IP Theft** 473

Introduction to IP Theft	473
Configuring IP Theft (GUI)	474
Configuring IP Theft	474
Configuring the IP Theft Exclusion Timer	474

Adding Static Entries for Wired Hosts 475

Verifying IP Theft Configuration 476

---

**CHAPTER 49****Unscheduled Automatic Power Save Delivery 479**

Information About Unscheduled Automatic Power Save Delivery 479

Viewing Unscheduled Automatic Power Save Delivery (CLI) 479

---

**CHAPTER 50****Target Wake Time 481**

Target Wake Time 481

Extended Power-Savings Using Target Wake Time 481

Configuring Target Wake Time at the Radio Level (CLI) 482

Configuring Target Wake Time on WLAN 483

Enabling Target Wake Time on WLAN (CLI) 483

Disabling Target Wakeup Time on WLAN (CLI) 484

Configuring Target Wake Time (GUI) 485

Verifying Target Wakeup Time 485

---

**CHAPTER 51****Enabling USB Port on Access Points 487**

USB Port as Power Source for Access Points 487

Configuring an AP Profile (CLI) 488

Configuring USB Settings for an Access Point (CLI) 489

Configuring USB Settings for an Access Point (GUI) 489

Monitoring USB Configurations for Access Points (CLI) 490

---

**CHAPTER 52****Dynamic Frequency Selection 491**

Feature History for Channel Availability Check (CAC) 491

Information About Dynamic Frequency Selection 491

Information About Channel Availability Check (CAC) 492

Verifying DFS 492

---

**CHAPTER 53****Cisco Access Points with Tri-Radio 493**

Cisco Access Points with Tri-Radio 493

Guidelines and Restrictions for Tri-Radio Access Points 495

Configuring Tri-Radio	495
Configuring Tri-Radio for AP (GUI)	495
Configuring the Tri-Radio (CLI)	495
Configuring 5-GHz Dual Radio Mode for AP (GUI)	496
Configuring the Dual Radio Mode and Enabling Slots (CLI)	496
Setting Radio Roles for Slots	497
Configuring the Tri-Radio Dual Radio Role (CLI)	498
Verifying Tri-Radio Configuration on the Controller	498

**CHAPTER 54**

<b>Cisco Catalyst Center Assurance Wi-Fi 6 Dashboard</b>	<b>501</b>
Cisco Catalyst Center Assurance Wi-Fi 6 Dashboard	501
Configuring Cisco Catalyst Center Assurance Wi-Fi 6 Dashboard Parameters (CLI)	502
Verifying AP DFS Counters (CLI)	503
Verifying Wi-Fi 6 Access Point Parameters	504

**CHAPTER 55**

<b>Antenna Disconnection Detection</b>	<b>505</b>
Feature History for Antenna Disconnection Detection	505
Information About Antenna Disconnection Detection	505
Recommendations and Limitations	506
Configuring Antenna Disconnection Detection (CLI)	506
Configuring Antenna Disconnection Detection (GUI)	507
Detecting Broken Antenna Using SNMP Trap (CLI)	508
Detecting Broken Antenna Using SNMP Trap (GUI)	508
Verifying Antenna Disconnection Detection	509
Verifying Antenna Disconnection Detection (GUI)	510

**CHAPTER 56**

<b>Neighbor Discovery Protocol Mode on Access Points</b>	<b>511</b>
Information About Neighbor Discovery Protocol Mode	511
Configuring RRM Neighbor Discovery Mode (GUI)	512
Configuring the Neighbor Discovery Protocol Mode (CLI)	512
Configuring Neighbor Discovery Protocol Mode in the RF Profile (GUI)	513
Configuring Neighbor Discovery Protocol Mode in the RF Profile (CLI)	513
Monitoring Radio Statistics-NDP Capability and NDP Mode (GUI)	514
Verifying Neighbor Discovery Protocol Mode	515

---

**PART V****Network Management 517**

---

**CHAPTER 57****AP Packet Capture 519**

- Introduction to AP Client Packet Capture 519
- Enabling Packet Capture (GUI) 519
- Enabling Packet Capture (CLI) 520
- Create AP Packet Capture Profile and Map to an AP Join Profile (GUI) 520
- Create AP Packet Capture Profile and Map to an AP Join Profile 521
- Start or Stop Packet Capture 521

---

**CHAPTER 58****DHCP Option82 523**

- Information About DHCP Option 82 523
- Configuring DHCP Option 82 Global Interface 525
  - Configuring DHCP Option 82 Globally Through Server Override (CLI) 525
  - Configuring DHCP Option 82 Through Server Override (CLI) 525
  - Configuring DHCP Option 82 Globally Through Different SVIs (GUI) 526
  - Configuring DHCP Option 82 Globally Through Different SVIs (CLI) 526
- Configuring DHCP Option 82 Format 527
- Configuring DHCP Option82 Through a VLAN Interface 528
  - Configuring DHCP Option 82 Through Option-Insert Command (CLI) 528
  - Configuring DHCP Option 82 Through the server-ID-override Command (CLI) 529
  - Configuring DHCP Option 82 Through a Subscriber-ID (CLI) 530
  - Configuring DHCP Option 82 Through server-ID-override and subscriber-ID Commands (CLI) 531
  - Configuring DHCP Option 82 Through Different SVIs (CLI) 532

---

**CHAPTER 59****RADIUS Realm 535**

- Information About RADIUS Realm 535
- Enabling RADIUS Realm 536
- Configuring Realm to Match the RADIUS Server for Authentication and Accounting 536
- Configuring the AAA Policy for a WLAN 537
- Verifying the RADIUS-Realm Configuration 539

---

**CHAPTER 60****RADIUS Accounting 541**



Information About RADIUS Accounting of AP Events	541
Configuring Accounting Method-List for an AP Profile	541
Verifying the AP Accounting Information	542

---

<b>CHAPTER 61</b>	<b>RADIUS Call Station Identifier</b>	<b>543</b>
	RADIUS Call Station Identifier	543
	Configuring a RADIUS Call Station Identifier	544

---

<b>CHAPTER 62</b>	<b>RADIUS VSA</b>	<b>545</b>
	Information About RADIUS VSA	545
	Create an Attribute List	546
	Create a AAA Policy and Map it to Attribute List	547
	Map a AAA Policy to the WLAN Policy Profile	548
	Map the WLAN Policy Profile to a WLAN	549

---

<b>CHAPTER 63</b>	<b>Cisco StadiumVision</b>	<b>551</b>
	Cisco StadiumVision Overview	551
	Configure Parameters for Cisco StadiumVision (GUI)	552
	Configure Parameters for Cisco StadiumVision (CLI)	552
	Verify StadiumVision Configurations	553

---

<b>CHAPTER 64</b>	<b>Persistent SSID Broadcast</b>	<b>555</b>
	Persistent SSID Broadcast	555
	Configuring Persistent SSID Broadcast	555
	Verifying Persistent SSID Broadcast	556

---

<b>CHAPTER 65</b>	<b>Network Monitoring</b>	<b>557</b>
	Network Monitoring	557
	Status Information Received Synchronously - Configuration Examples	557
	Alarm and Event Information Received Asynchronously - Configuration Examples	559

---

<b>CHAPTER 66</b>	<b>Creating a Lobby Ambassador Account</b>	<b>561</b>
	Information About Lobby Ambassador Account	561

Creating a Lobby Ambassador User Account (GUI)	561
Creating a User Account	562
Logging In Using the Lobby Account	563
Creating a Lobby Ambassador Account (CLI)	563

**CHAPTER 67****Lobby Ambassador Account 565**

Information About Lobby Ambassador Account	565
Creating a Lobby Ambassador User Account (GUI)	566
Creating a User Account	566
Logging In Using the Lobby Account	567
Creating a Lobby Ambassador Account (CLI)	567
Configuring WLAN (GUI)	568
Client Allowed List	569
Restrictions for Client Allowed List	569
Creating a Client Allowed List (GUI)	569
Adding Single MAC Address to Allowed List	569
Adding Bulk MAC Address to Allowed List	570
Managing Guest Users	570
Viewing a Client Allowed List	571

**CHAPTER 68****Guest User Accounts 573**

Information About Creating Guest User Accounts	573
Creating a Guest User Account (GUI)	573
Creating a Guest User Account (CLI)	574
Verifying Guest User Account	575
Assigning Username to Guest Users in a WLAN (CLI)	576

**CHAPTER 69****Link Local Bridging 577**

Feature History for Link Local Bridging	577
Information About Link Local Bridging	577
Use Case for Link Local Bridging	578
Guidelines and Restrictions for Link Local Bridging	578
Enabling Link Local Bridging Per Policy Profile (GUI)	578
Enabling Link Local Bridging Per Policy Profile (CLI)	579

Verifying Link Local Bridging 579

---

**PART VI**

**System Management 581**

---

**CHAPTER 70**

**Network Mobility Services Protocol 583**

Information About Network Mobility Services Protocol 583

Radioactive Tracing for NMSP 584

Enabling NMSP on Premises Services 584

Modifying the NMSP Notification Interval for Clients, RFID Tags, and Rogues 585

Modifying the NMSP Notification Threshold for Clients, RFID Tags, and Rogues 585

Configuring NMSP Strong Cipher 586

Verifying NMSP Settings 586

Examples: NMSP Settings Configuration 589

NMSP by AP Groups with Subscription List from CMX 589

Verifying NMSP by AP Groups with Subscription List from CMX 589

Probe RSSI Location 591

Configuring Probe RSSI 591

RFID Tag Support 593

Configuring RFID Tag Support 593

Verifying RFID Tag Support 594

---

**CHAPTER 71**

**Application Visibility and Control 597**

Information About Application Visibility and Control 597

Prerequisites for Application Visibility and Control 599

Restrictions for Application Visibility and Control 599

AVC Configuration Overview 599

Create a Flow Monitor 600

Configuring a Flow Monitor (GUI) 601

Create a Flow Record 602

Create a Flow Exporter 604

Configuring a Policy Tag 605

Attaching a Policy Profile to a WLAN Interface (GUI) 605

Attaching a Policy Profile to a WLAN Interface (CLI) 606

Attaching a Policy Profile to an AP 607

Verify the AVC Configuration	607
Default DSCP on AVC	608
Configuring Default DSCP for AVC Profile (GUI)	608
Configuring Default DSCP for AVC Profile	609
Creating Class Map	609
Creating Policy Map	610
AVC-Based Selective Reanchoring	611
Restrictions for AVC-Based Selective Reanchoring	611
Configuring the Flow Exporter	611
Configuring the Flow Monitor	612
Configuring the AVC Reanchoring Profile	613
Configuring the Wireless WLAN Profile Policy	613
Verifying AVC Reanchoring	615

**CHAPTER 72****Cisco Hyperlocation 619**

Information About Cisco Hyperlocation	619
Restrictions on Cisco Hyperlocation	621
Support for IPv6 in Cisco Hyperlocation or BLE Configuration	622
Configuring Cisco Hyperlocation (GUI)	622
Configuring Cisco Hyperlocation (CLI)	623
Configuring Hyperlocation BLE Beacon Parameters for AP (GUI)	624
Configuring Hyperlocation BLE Beacon Parameters for AP (CLI)	624
Configuring Hyperlocation BLE Beacon Parameters (CLI)	625
Information About AP Group NTP Server	626
Configuring an AP Group NTP Server	626
Configuring AP Timezone	627
Verifying Cisco Hyperlocation	627
Verifying Hyperlocation BLE Beacon Configuration	631
Verifying Hyperlocation BLE Beacon Configuration for AP	631

**CHAPTER 73****FastLocate for Cisco Catalyst Series Access Points 633**

Information About FastLocate	633
Restrictions on FastLocate	633
Supported Access Points	634

FastLocate Network Components	634
Configuring FastLocate (GUI)	635
Verifying FastLocate on Cisco Catalyst APs	635

---

<b>CHAPTER 74</b>	<b>IoT Services Management</b>	<b>637</b>
	Information About IoT Services Management	637
	Enabling the Dot15 Radio	638
	Configuring the gRPC Token	638
	Enabling gRPC in an AP Profile	639
	Verifying BLE State and Mode	639
	Verifying BLE Details	640
	Verifying gRPC Summary, Status, and Statistics	641

---

<b>CHAPTER 75</b>	<b>IoT Module Management in the Controller</b>	<b>643</b>
	Information About IoT Module Management in the Controller	643
	Enabling a USB on the Controller	643
	Verifying the USB Modules	644

---

<b>CHAPTER 76</b>	<b>Cisco Spaces</b>	<b>645</b>
	Cisco Spaces	645
	Configuring Cisco Spaces	645
	Verifying Cisco Spaces Configuration	646

---

<b>CHAPTER 77</b>	<b>EDCA Parameters</b>	<b>649</b>
	Enhanced Distributed Channel Access Parameters	649
	Configuring EDCA Parameters (GUI)	649
	Configuring EDCA Parameters (CLI)	650

---

<b>CHAPTER 78</b>	<b>Adaptive Client Load-Based EDCA</b>	<b>653</b>
	Feature History for Adaptive Client Load-Based EDCA	653
	Information About Adaptive Client Load-Based EDCA	653
	Restrictions for Adaptive Client Load-Based EDCA	654
	Configuration Workflow	654

Configuring Adaptive Client Load-Based EDCA (GUI)	654
Configuring Adaptive Client Load-Based EDCA (CLI)	655
Verifying Adaptive Client Load-Based EDCA Configuration	655

**CHAPTER 79****802.11 parameters and Band Selection 657**

Information About Configuring Band Selection, 802.11 Bands, and Parameters	657
Band Select	657
802.11 Bands	658
802.11n Parameters	658
802.11h Parameters	658
Restrictions for Band Selection, 802.11 Bands, and Parameters	659
How to Configure 802.11 Bands and Parameters	659
Configuring Band Selection (GUI)	659
Configuring Band Selection (CLI)	660
Configuring the 802.11 Bands (GUI)	661
Configuring the 802.11 Bands (CLI)	662
Configuring a Band-Select RF Profile (GUI)	664
Configuring a Band-Select RF Profile (CLI)	664
Configuring 802.11n Parameters (GUI)	665
Configuring 802.11n Parameters (CLI)	666
Configuring 802.11h Parameters (CLI)	668
Monitoring Configuration Settings for Band Selection, 802.11 Bands, and Parameters	669
Verifying Configuration Settings Using Band Selection and 802.11 Bands Commands	669
Example: Viewing the Configuration Settings for the 5-GHz Band	669
Example: Viewing the Configuration Settings for the 2.4-GHz Band	671
Example: Viewing the status of 802.11h Parameters	672
Example: Verifying the Band-Selection Settings	673
Configuration Examples for Band Selection, 802.11 Bands, and Parameters	674
Examples: Band Selection Configuration	674
Examples: 802.11 Bands Configuration	675
Examples: 802.11n Configuration	675
Examples: 802.11h Configuration	676

**CHAPTER 80****NBAR Protocol Discovery 677**

Introduction to NBAR Protocol Discovery 677

Configuring NBAR Protocol Discovery 677

Verifying Protocol Discovery Statistics 678

---

**CHAPTER 81**

**Conditional Debug, Radioactive Tracing, and Packet Tracing 679**

Introduction to Conditional Debugging 679

Introduction to Radioactive Tracing 680

Conditional Debugging and Radioactive Tracing 680

Location of Tracefiles 681

Configuring Conditional Debugging (GUI) 681

Configuring Conditional Debugging 682

Radioactive Tracing for L2 Multicast 683

Recommended Workflow for Trace files 683

Copying Tracefiles Off the Box 684

Configuration Examples for Conditional Debugging 684

Verifying Conditional Debugging 685

Example: Verifying Radioactive Tracing Log for SISF 685

Information About Packet Tracing 686

Configuring Conditional Debugging Packet Tracing 687

Configuring Conditional Debugging Packet Tracing per AP 688

Configuring Conditional Debugging Packet Tracing per Client (GUI) 689

Configuring Conditional Debugging Packet Tracing per Client 689

Verifying Conditional Debugging Packet Tracing Configuration 689

---

**CHAPTER 82**

**Aggressive Client Load Balancing 691**

Information About Aggressive Client Load Balancing 691

Enabling Aggressive Client Load Balancing (GUI) 692

Configuring Aggressive Client Load Balancing (GUI) 692

Configuring Aggressive Client Load Balancing (CLI) 693

---

**CHAPTER 83**

**Accounting Identity List 695**

Configuring Accounting Identity List (GUI) 695

Configuring Accounting Identity List (CLI) 695

Configuring Client Accounting (GUI) 696

Configuring Client Accounting (CLI) 696

---

**CHAPTER 84**

**Support for Accounting Session ID 699**

Information About Accounting Session ID 699

Configuring an Accounting Session ID (CLI) 699

Verifying an Account Session ID 700

---

**CHAPTER 85**

**Interim Accounting 703**

Information About Interim Accounting 703

Disabling Interim Accounting (CLI) 704

Verifying Interim Accounting 704

---

**CHAPTER 86**

**Wireless Multicast 705**

Information About Wireless Multicast 705

Multicast Optimization 706

IPv6 Global Policies 706

Information About IPv6 Snooping 706

IPv6 Neighbor Discovery Inspection 706

Prerequisites for Configuring Wireless Multicast 708

Restrictions on Configuring Wireless Multicast 709

Restrictions for IPv6 Snooping 709

Configuring Wireless Multicast 709

Configuring Wireless Multicast-MCMC Mode (CLI) 709

Configuring Wireless Multicast-MCUC Mode 710

Configuring Multicast Listener Discovery Snooping (GUI) 710

Configuring IPv6 MLD Snooping 711

Verifying the Multicast VLAN Configuration 711

IPv6 Multicast-over-Multicast 711

Configuring IPv6 Multicast-over-Multicast (GUI) 712

Configuring IPv6 Multicast-over-Multicast 713

Verifying IPv6 Multicast-over-Multicast 713

Verifying the Multicast Connection Between the Controller and the AP 713

Directed Multicast Service 714

Configuring Directed Multicast Service(GUI) 714



Configuring Directed Multicast Service	714
Verifying the Directed Multicast Service Configuration	715
Wireless Broadcast, Non-IP Multicast and Multicast VLAN	716
Configuring Non-IP Wireless Multicast (CLI)	717
Configuring Wireless Broadcast (GUI)	717
Configuring Wireless Broadcast (CLI)	718
Configuring Multicast-over-Multicast for AP Multicast Groups (CLI)	718
Verifying Wireless Multicast	719
Multicast Optimization	719
Configuring IP Multicast VLAN for WLAN (GUI)	720
Configuring IP Multicast VLAN for WLAN	720
Verifying the Multicast VLAN Configuration	721
Multicast Filtering	722
Information About Multicast Filtering	722
Configuring Multicast Filtering	723
Verifying Multicast Filtering	723

**CHAPTER 87****Map-Server Per-Site Support 725**

Information About Map Server Per Site Support	725
Configuring the Default Map Server (GUI)	726
Configuring the Default Map Server (CLI)	726
Configuring a Map Server Per Site (GUI)	727
Configuring a Map Server Per Site (CLI)	727
Creating a Map Server for Each VNID (GUI)	728
Creating a Map Server for Each VNID	728
Creating a Fabric Profile and Associating a Tag and VNID (GUI)	729
Creating a Fabric Profile and Associating a Tag and VNID (CLI)	729
Verifying the Map Server Configuration	730

**CHAPTER 88****Volume Metering 733**

Volume Metering	733
Configuring Volume Metering	733

**CHAPTER 89****Enabling Syslog Messages in Access Points and Controller for Syslog Server 735**

Information About Enabling Syslog Messages in Access Points and Controller for Syslog Server	735
Configuring Syslog Server for an AP Profile	737
Configuring Syslog Server for the Controller (GUI)	738
Configuring Syslog Server for the Controller	739
Information About Syslog Support for Client State Change	740
Configuring Syslog Support for Client State Change (CLI)	741
Sample Syslogs	741
Verifying Syslog Server Configurations	742

---

**CHAPTER 90****Login Banner 747**

Information About Login Banner	747
Configuring a Login Banner (GUI)	747
Configuring a Login Banner	748

---

**CHAPTER 91****Wi-Fi Alliance Agile Multiband 749**

Introduction to Wi-Fi Alliance Agile Multiband	749
Limitations of MBO	751
Configuring MBO on a WLAN	751
Verifying MBO Configuration	752

---

**CHAPTER 92****SNMP Traps 755**

Information About Configuring SNMP Traps	755
Configuring SNMP Traps (GUI)	756
Enabling Access Points Traps (CLI)	756
Enabling Wireless Client Traps (CLI)	757
Enabling Mesh Traps (CLI)	757
Enabling RF Traps (CLI)	758
Enabling Rogue, Mobility, RRM, and General Traps (CLI)	758
Verifying SNMP Wireless Traps	759

---

**CHAPTER 93****Disabling Clients with Random MAC Address 761**

Information About Disabling Clients with Random MAC Addresses	761
Configuring Random MAC Address Deny (CLI)	761
Verifying Denial of Clients with a Random MAC Address	762

---

<b>CHAPTER 94</b>	<b>Dataplane Packet Logging</b>	<b>765</b>
	Information About Dataplane Packet Logging	765
	Enabling or Disabling Debug Level (CLI)	766
	Enabling Packet Logging in Global and Filtered Buffer in Ingress Path (CLI)	766
	Enabling Packet Logging in Global and Filtered Buffer in Punt-Inject Path (CLI)	767
	Verifying Dataplane Packet Logging	768
	Clearing Logs and Conditions in Global and Filtered Trace Buffers	769
<hr/>		
<b>CHAPTER 95</b>	<b>Streaming Telemetry</b>	<b>771</b>
	Information About Streaming Telemetry	771
	Gather Points	771
	Subscription	772
	Transport	773
	Scale Considerations	773
	Session	773
	gNMI Dial-In-Mode	773
	gRPC- Dial-Out-Mode	774
	Configuring Telemetry on a Cisco Catalyst 9800 Series Wireless Controller	774
	Enabling gNXI in Insecure Mode (CLI)	774
	Enabling gNXI in Secure Mode (CLI)	775
	Verifying the Status of a Telemetry Subscription on a Cisco Catalyst 9800 Series Wireless Controller	777
	Managing Configured Subscriptions on a Cisco Catalyst 9800 Series Wireless Controller	777
	Zero Trust Telemetry	778
	Define a Protocol	779
	Define a Named Receiver	779
	Configure Telemetry Subscription	780
	Troubleshooting Telemetry Support	781
<hr/>		
<b>CHAPTER 96</b>	<b>Wireless Clients Threshold Warning</b>	<b>785</b>
	Information About Wireless Clients Threshold Warning	785
	Configuring a Warning Period	785
	Configuring Client Threshold	786

---

**PART VII****Security 787**

---

**CHAPTER 97****MAC Filtering 789**

MAC Filtering 789

MAC Filtering Configuration Guidelines 789

Configuring MAC Filtering for Local Authentication (CLI) 791

Configuring MAC Filtering (GUI) 792

Configuring MAB for External Authentication (CLI) 792

---

**CHAPTER 98****Web-Based Authentication 795**

Local Web Authentication Overview 795

Device Roles 797

Authentication Process 798

Local Web Authentication Banner 799

Customized Local Web Authentication 801

Guidelines 801

Redirection URL for Successful Login Guidelines 803

How to Configure Local Web Authentication 803

Configuring Default Local Web Authentication 803

Information About the AAA Wizard 803

Configuring AAA Authentication (GUI) 807

Configuring AAA Authentication (CLI) 808

Configuring the HTTP/HTTPS Server (GUI) 809

Configuring the HTTP Server (CLI) 809

Configuring HTTP and HTTPS Requests for Web Authentication 810

Information About Configuring HTTP and HTTPS Requests for Web Authentication 810

Guidelines and Limitations 812

Configuring HTTP and HTTPS Requests for Web Authentication (CLI) 812

Creating a Parameter Map (GUI) 813

Creating Parameter Maps 814

Configuring Local Web Authentication (GUI) 814

Configuring the Internal Local Web Authentication (CLI) 815

Configuring the Customized Local Web Authentication (CLI) 815

Configuring the External Local Web Authentication (CLI)	817
Configuring the Web Authentication WLANs	818
Configuring Pre-Auth Web Authentication ACL (GUI)	819
Configuring Pre-Auth Web Authentication ACL (CLI)	819
Configuring the Maximum Web Authentication Request Retries	821
Configuring a Local Banner in Web Authentication Page (GUI)	821
Configuring a Local Banner in Web Authentication Page (CLI)	822
Configuring Type WebAuth, Consent, or Both	822
Configuring Preauthentication ACL	823
Configuring TrustPoint for Local Web Authentication	824
Configuration Examples for Local Web Authentication	825
Example: Obtaining Web Authentication Certificate	825
Example: Displaying a Web Authentication Certificate	826
Example: Choosing the Default Web Authentication Login Page	827
Example: Choosing a Customized Web Authentication Login Page from an IPv4 External Web Server	827
Example: Choosing a Customized Web Authentication Login Page from an IPv6 External Web Server	828
Example: Assigning Login, Login Failure, and Logout Pages per WLAN	828
Example: Configuring Preauthentication ACL	828
Example: Configuring Webpassthrough	829
Verifying Web Authentication Type	829
External Web Authentication (EWA)	830
Configuring EWA with Single WebAuth Server Address and Default Ports (80/443) (CLI)	830
Configuring EWA with Multiple Web Servers and/or Ports Different than Default (80/443)	832
Configuring Wired Guest EWA with Multiple Web Servers and/or Ports Different than Default (80/443)	834
Authentication for Sleeping Clients	835
Information About Authenticating Sleeping Clients	835
Restrictions on Authenticating Sleeping Clients	835
Configuring Authentication for Sleeping Clients (GUI)	836
Configuring Authentication for Sleeping Clients (CLI)	836
Sleeping Clients with Multiple Authentications	837
Mobility Support for Sleeping Clients	837
Supported Combinations of Multiple Authentications	837

Configuring Sleeping Clients with Multiple Authentications	837
Configuring WLAN for Dot1x and Local Web Authentication	837
Configuring a WLAN for MAC Authentication Bypass and Local Web Authentication	839
Configuring a WLAN for Local Web Authentication and MAC Filtering	840
Configuring a PSK + LWA in a WLAN	841
Configuring a Sleeping Client	842
Verifying a Sleeping Client Configuration	842

**CHAPTER 99****Central Web Authentication 845**

Information About Central Web Authentication	845
Prerequisites for Central Web Authentication	846
How to Configure ISE	846
Creating an Authorization Profile	846
Creating an Authentication Rule	847
Creating an Authorization Rule	847
How to Configure Central Web Authentication on the Controller	848
Configuring WLAN (GUI)	848
Configuring WLAN (CLI)	849
Configuring Policy Profile (CLI)	851
Configuring a Policy Profile (GUI)	852
Creating Redirect ACL	853
Configuring AAA for Central Web Authentication	854
Configuring Redirect ACL in Flex Profile (GUI)	854
Configuring Redirect ACL in Flex Profile (CLI)	855
Troubleshooting Central Web Authentication	856
Authentication for Sleeping Clients	856
Information About Authenticating Sleeping Clients	856
Restrictions on Authenticating Sleeping Clients	857
Configuring Authentication for Sleeping Clients (GUI)	857
Configuring Authentication for Sleeping Clients (CLI)	858
Sleeping Clients with Multiple Authentications	858
Mobility Support for Sleeping Clients	858
Supported Combinations of Multiple Authentications	858
Configuring Sleeping Clients with Multiple Authentications	859

Configuring WLAN for Dot1x and Local Web Authentication	859
Configuring a WLAN for MAC Authentication Bypass and Local Web Authentication	860
Configuring a WLAN for Local Web Authentication and MAC Filtering	861
Configuring a PSK + LWA in a WLAN	862
Configuring a Sleeping Client	863
Verifying a Sleeping Client Configuration	864

**CHAPTER 100****Private Shared Key 865**

Information About Private Preshared Key	865
Configuring a PSK in a WLAN (CLI)	866
Configuring a PSK in a WLAN (GUI)	867
Applying a Policy Profile to a WLAN (GUI)	868
Applying a Policy Profile to a WLAN (CLI)	868
Verifying a Private PSK	869

**CHAPTER 101****Multi-Preshared Key 873**

Information About Multi-Preshared Key	873
Restrictions on Multi-PSK	874
Configuring Multi-Preshared Key (GUI)	874
Configuring Multi-Preshared Key (CLI)	877
Verifying Multi-PSK Configurations	878

**CHAPTER 102****Multiple Authentications for a Client 881**

Information About Multiple Authentications for a Client	881
Information About Supported Combination of Authentications for a Client	881
Combination of Authentications on MAC Failure Not Supported on a Client	882
Configuring Multiple Authentications for a Client	883
Configuring WLAN for 802.1X and Local Web Authentication (GUI)	883
Configuring WLAN for 802.1X and Local Web Authentication (CLI)	883
Configuring WLAN for Preshared Key (PSK) and Local Web Authentication (GUI)	885
Configuring WLAN for Preshared Key (PSK) and Local Web Authentication	885
Configuring WLAN for PSK or Identity Preshared Key (iPSK) and Central Web Authentication (GUI)	887
Configuring WLAN for PSK or Identity Preshared Key (iPSK) and Central Web Authentication	887

Configuring WLAN	887
Applying Policy Profile to a WLAN	888
Configure WLAN for Web Authentication on MAC Authentication Bypass Failure with Pre-Shared Key (CLI)	889
Configure WLAN for Web Authentication on MAC Authentication Bypass Failure with OWE (CLI)	891
Configure WLAN for Web Authentication on MAC Authentication Bypass Failure with Secure Agile Exchange (CLI)	893
Configuring 802.1x and Central Web Authentication on Controller (CLIs)	894
Creating AAA Authentication	894
Configuring AAA Server for External Authentication	895
Configuring AAA for Authentication	896
Configuring Accounting Identity List	897
Configuring AAA for Central Web Authentication	897
Defining an Access Control List for Radius Server	898
Configuration Example to Define an Access Control List for Radius Server	898
Configuring WLAN	899
Configuring Policy Profile	899
Mapping WLAN and Policy Profile to Policy Tag	900
Configuring ISE for Central Web Authentication with Dot1x (GUI)	901
Defining Guest Portal	901
Defining Authorization Profile for a Client	901
Defining Authentication Rule	901
Defining Authorization Rule	902
Creating Rules to Match Guest Flow Condition	902
Verifying Multiple Authentication Configurations	903

---

**CHAPTER 103**
**Wi-Fi Protected Access 3 907**

Simultaneous Authentication of Equals	907
Opportunistic Wireless Encryption	908
Configuring SAE (WPA3+WPA2 Mixed Mode)	908
Configuring WPA3 Enterprise (GUI)	909
Configuring WPA3 Enterprise	910
Configuring the WPA3 OWE	911
Configuring WPA3 OWE Transition Mode (GUI)	912



Configuring WPA3 OWE Transition Mode	912
Configuring WPA3 SAE (GUI)	914
Configuring WPA3 SAE	915
Configuring Anti-Clogging and SAE Retransmission (GUI)	916
Configuring Anti-Clogging and SAE Retransmission	917
Verifying WPA3 SAE and OWE	918

---

<b>CHAPTER 104</b>	<b>IP Source Guard</b>	<b>923</b>
	Information About IP Source Guard	923
	Configuring IP Source Guard (GUI)	923
	Configuring IP Source Guard	924

---

<b>CHAPTER 105</b>	<b>802.11w</b>	<b>925</b>
	Information About 802.11w	925
	Prerequisites for 802.11w	928
	Restrictions for 802.11w	928
	How to Configure 802.11w	929
	Configuring 802.11w (GUI)	929
	Configuring 802.11w (CLI)	929
	Disabling 802.11w	930
	Monitoring 802.11w	931

---

<b>CHAPTER 106</b>	<b>Management Frame Protection</b>	<b>933</b>
	Information About Management Frame Protection	933
	Restrictions for Management Frame Protection	934
	Configuring Management Frame Protection (CLI)	935
	Verifying Management Frame Protection Settings	935

---

<b>CHAPTER 107</b>	<b>IPv4 ACLs</b>	<b>937</b>
	Information about Network Security with ACLs	937
	ACL Overview	937
	Access Control Entries	937
	ACL Supported Types	938
	Supported ACLs	938

ACL Precedence	938
Port ACLs	938
Router ACLs	939
ACEs and Fragmented and Unfragmented Traffic	940
ACEs and Fragmented and Unfragmented Traffic Examples	940
Standard and Extended IPv4 ACLs	941
IPv4 ACL Switch Unsupported Features	941
Access List Numbers	941
Numbered Standard IPv4 ACLs	942
Numbered Extended IPv4 ACLs	943
Named IPv4 ACLs	943
ACL Logging	944
Hardware and Software Treatment of IP ACLs	944
IPv4 ACL Interface Considerations	945
Restrictions for Configuring IPv4 Access Control Lists	945
How to Configure ACLs	946
Configuring IPv4 ACLs (GUI)	946
Configuring IPv4 ACLs	946
Creating a Numbered Standard ACL (GUI)	947
Creating a Numbered Standard ACL (CLI)	947
Creating a Numbered Extended ACL (GUI)	948
Creating a Numbered Extended ACL (CLI)	949
Creating Named Standard ACLs (GUI)	953
Creating Named Standard ACLs	953
Creating Extended Named ACLs (GUI)	954
Creating Extended Named ACLs	955
Applying an IPv4 ACL to an Interface (GUI)	957
Applying an IPv4 ACL to an Interface (CLI)	957
Applying ACL to Policy Profile (GUI)	958
Applying ACL to Policy Profile	958
Configuration Examples for ACLs	959
Examples: Including Comments in ACLs	959
Examples: Applying an IPv4 ACL to a Policy Profile in a Wireless Environment	959
IPv4 ACL Configuration Examples	960

ACLs in a Small Networked Office	960
Examples: ACLs in a Small Networked Office	961
Example: Numbered ACLs	961
Examples: Extended ACLs	961
Examples: Named ACLs	962
Monitoring IPv4 ACLs	963
<hr/>	
<b>CHAPTER 108</b>	<b>DNS-Based Access Control Lists 965</b>
Information About DNS-Based Access Control Lists	965
Defining ACLs	966
Applying ACLs	967
Types of URL Filters	967
Restrictions on DNS-Based Access Control Lists	968
Flex Mode	969
Defining URL Filter List	969
Applying URL Filter List to Flex Profile	970
Configuring ISE for Central Web Authentication (GUI)	970
Local Mode	971
Defining URL Filter List	971
Applying URL Filter List to Policy Profile (GUI)	972
Applying URL Filter List to Policy Profile	973
Configuring ISE for Central Web Authentication	973
Creating Authorization Profiles	973
Mapping Authorization Profiles to Authentication Rule	974
Mapping Authorization Profiles to Authorization Rule	974
Viewing DNS-Based Access Control Lists	975
Configuration Examples for DNS-Based Access Control Lists	975
Verifying DNS Snoop Agent (DSA)	976
Information About Flex Client IPv6 Support with WebAuth Pre and Post ACL	977
Enabling Pre-Authentication ACL for LWA and EWA (GUI)	978
Enabling Pre-Authentication ACL for LWA and EWA	979
Enabling Post-Authentication ACL for LWA and EWA (GUI)	980
Enabling Post-Authentication ACL for LWA and EWA	981
Enabling DNS ACL for LWA and EWA (GUI)	981

Enabling DNS ACL for LWA and EWA	981
Verifying Flex Client IPv6 Support with WebAuth Pre and Post ACL	982

**CHAPTER 109**

<b>Allowed List of Specific URLs</b>	<b>983</b>
Allowed List of Specific URLs	983
Adding URL to Allowed List	983
Verifying URLs on the Allowed List	985

**CHAPTER 110**

<b>Cisco Umbrella WLAN</b>	<b>987</b>
Information About Cisco Umbrella WLAN	987
Registering Controller to Cisco Umbrella Account	988
Configuring Cisco Umbrella WLAN	989
Importing CA Certificate to the Trust Pool	989
Creating a Local Domain RegEx Parameter Map	991
Configuring Parameter Map Name in WLAN (GUI)	991
Configuring the Umbrella Parameter Map	992
Enabling or Disabling DNSCrypt (GUI)	992
Enabling or Disabling DNSCrypt	993
Configuring Timeout for UDP Sessions	993
Configuring Parameter Map Name in WLAN (GUI)	994
Configuring Parameter Map Name in WLAN	994
Configuring the Umbrella Flex Profile	995
Configuring the Umbrella Flex Profile (GUI)	995
Configuring Umbrella Flex Parameters	996
Configuring the Umbrella Flex Policy Profile (GUI)	996
Verifying the Cisco Umbrella Configuration	997

**CHAPTER 111**

<b>RADIUS Server Load Balancing</b>	<b>999</b>
Information About RADIUS Server Load Balancing	999
Prerequisites for RADIUS Server Load Balancing	1001
Restrictions for RADIUS Server Load Balancing	1001
Enabling Load Balancing for a Named RADIUS Server Group (CLI)	1001

**CHAPTER 112**

<b>AAA Dead-Server Detection</b>	<b>1003</b>
----------------------------------	-------------

Information About AAA Dead-Server Detection	1003
Prerequisites for AAA Dead-Server Detection	1004
Restrictions for AAA Dead-Server Detection	1004
Configuring AAA Dead-Server Detection (CLI)	1004
Verifying AAA Dead-Server Detection	1005

**CHAPTER 113****ISE Simplification and Enhancements 1007**

Utilities for Configuring Security	1007
Configuring Multiple Radius Servers	1008
Verifying AAA and Radius Server Configurations	1009
Configuring Captive Portal Bypassing for Local and Central Web Authentication	1009
Information About Captive Bypassing	1009
Configuring Captive Bypassing for WLAN in LWA and CWA (GUI)	1010
Configuring Captive Bypassing for WLAN in LWA and CWA (CLI)	1011
Sending DHCP Options 55 and 77 to ISE	1012
Information about DHCP Option 55 and 77	1012
Configuration to Send DHCP Options 55 and 77 to ISE (GUI)	1012
Configuration to Send DHCP Options 55 and 77 to ISE (CLI)	1012
Configuring EAP Request Timeout (GUI)	1013
Configuring EAP Request Timeout	1014
Configuring EAP Request Timeout in Wireless Security (CLI)	1014
Captive Portal	1015
Captive Portal Configuration	1015
Configuring Captive Portal (GUI)	1015
Configuring Captive Portal	1016
Captive Portal Configuration - Example	1018

**CHAPTER 114****RADIUS DTLS 1021**

Information About RADIUS DTLS	1021
Prerequisites	1023
Configuring RADIUS DTLS Server	1023
Configuring RADIUS DTLS Connection Timeout	1024
Configuring RADIUS DTLS Idle Timeout	1024
Configuring Source Interface for RADIUS DTLS Server	1025

Configuring RADIUS DTLS Port Number	1026
Configuring RADIUS DTLS Connection Retries	1026
Configuring RADIUS DTLS Trustpoint	1027
Configuring RADIUS DTLS Match-Server-Identity	1028
Configuring DTLS Dynamic Author	1028
Enabling DTLS for Client	1029
Configuring Client Trustpoint for DTLS	1029
Configuring DTLS Idle Timeout	1030
Configuring Server Trustpoint for DTLS	1031
Verifying the RADIUS DTLS Server Configuration	1031
Clearing RADIUS DTLS Specific Statistics	1031

---

<b>CHAPTER 115</b>	<b>Policy Enforcement and Usage Monitoring</b>	<b>1033</b>
	Policy Enforcement and Usage Monitoring	1033
	Configuring Policy Enforcement and Enabling Change-of-Authorization (CLI)	1033
	Example: Configuring Policy Enforcement and Usage Monitoring	1034
	Verifying Policy Usage and Enforcement	1035

---

<b>CHAPTER 116</b>	<b>Local Extensible Authentication Protocol</b>	<b>1037</b>
	Information About Local EAP	1037
	Restrictions for Local EAP	1038
	Configuring Local EAP Profile (CLI)	1038
	Configuring Local EAP profile (GUI)	1039
	Configuring AAA Authentication (GUI)	1039
	Configuring AAA Authorization Method (GUI)	1039
	Configuring AAA Authorization Method (CLI)	1040
	Configuring Local Advanced Methods (GUI)	1041
	Configuring WLAN (GUI)	1041
	Configuring WLAN (CLI)	1042
	Creating a User Account (CLI)	1042
	Attaching a Policy Profile to a WLAN Interface (GUI)	1043
	Deploy Policy Tag to Access Points (GUI)	1044

---

<b>CHAPTER 117</b>	<b>Authentication and Authorization Between Multiple RADIUS Servers</b>	<b>1045</b>
--------------------	---	-------------

Information About Authentication and Authorization Between Multiple RADIUS Servers	1045
Configuring 802.1X Security for WLAN with Split Authentication and Authorization Servers	1046
Configuring Explicit Authentication and Authorization Server List (GUI)	1046
Configuring Explicit Authentication Server List (GUI)	1047
Configuring Explicit Authentication Server List (CLI)	1047
Configuring Explicit Authorization Server List (GUI)	1048
Configuring Explicit Authorization Server List (CLI)	1049
Configuring Authentication and Authorization List for 802.1X Security (GUI)	1050
Configuring Authentication and Authorization List for 802.1X Security	1050
Configuring Web Authentication for WLAN with Split Authentication and Authorization Servers	1051
Configuring Authentication and Authorization List for Web Authentication (GUI)	1051
Configuring Authentication and Authorization List for Web Authentication	1052
Verifying Split Authentication and Authorization Configuration	1053
Configuration Examples	1054

**CHAPTER 118****Secure LDAP 1055**

Information About SLDAP	1055
Prerequisite for Configuring SLDAP	1057
Restrictions for Configuring SLDAP	1057
Configuring SLDAP	1057
Configuring an AAA Server Group (GUI)	1058
Configuring a AAA Server Group	1059
Configuring Search and Bind Operations for an Authentication Request	1060
Configuring a Dynamic Attribute Map on an SLDAP Server	1061
Verifying the SLDAP Configuration	1061

**CHAPTER 119****Network Access Server Identifier 1063**

Information About Network Access Server Identifier	1063
Creating a NAS ID Policy(GUI)	1064
Creating a NAS ID Policy	1064
Attaching a Policy to a Tag (GUI)	1065
Attaching a Policy to a Tag (CLI)	1065
Verifying the NAS ID Configuration	1066

## CHAPTER 120

**Locally Significant Certificates 1069**

Information About Locally Significant Certificates	1069
Certificate Provisioning in Controllers	1070
Device Certificate Enrollment Operation	1070
Certificate Provisioning on Lightweight Access Point	1070
Restrictions for Locally Significant Certificates	1071
Provisioning Locally Significant Certificates	1071
Configuring RSA Key for PKI Trustpoint	1071
Configuring PKI Trustpoint Parameters	1072
Authenticating and Enrolling a PKI Trustpoint (GUI)	1073
Authenticating and Enrolling the PKI Trustpoint with CA Server (CLI)	1073
Configuring AP Join Attempts with LSC Certificate (GUI)	1075
Configuring AP Join Attempts with LSC Certificate (CLI)	1075
Configuring Subject-Name Parameters in LSC Certificate	1075
Configuring Key Size for LSC Certificate	1076
Configuring Trustpoint for LSC Provisioning on an Access Point	1076
Configuring an AP LSC Provision List (GUI)	1077
Configuring an AP LSC Provision List (CLI)	1078
Configuring LSC Provisioning for all the APs (GUI)	1078
Configuring LSC Provisioning for All APs (CLI)	1079
Configuring LSC Provisioning for the APs in the Provision List	1079
Importing a CA Certificate to the Trustpool (GUI)	1080
Importing a CA Certificate to the Trustpool (CLI)	1080
Cleaning the CA Certificates Imported in Trustpool (GUI)	1081
Cleaning CA Certificates Imported in Trustpool (CLI)	1081
Creating a New Trustpoint Dedicated to a Single CA Certificate	1082
Verifying LSC Configuration	1083
Configuring Management Trustpoint to LSC (GUI)	1083
Configuring Management Trustpoint to LSC (CLI)	1084
Information About MIC and LSC Access Points Joining the Controller	1084
Overview of Support for MIC and LSC Access Points Joining the Controller	1084
Recommendations and Limitations	1084
Configuration Workflow	1085



Configuring LSC on the Controller (CLI)	1085
Enabling the AP Certificate Policy on the APs (CLI)	1086
Configuring the AP Policy Certificate (GUI)	1087
Configuring the Allowed List of APs to Join the Controller (CLI)	1087
Verifying the Configuration Status	1088
LSC Fallback Access Points	1089
Information About LSC Fallback APs	1089
Troubleshooting LSC Fallback State	1089
Recovery Steps	1089
Configuring Controller Self-Signed Certificate for Wireless AP Join	1090
Use Cases	1090
Prerequisites	1091
Configuring Clock Calendar (CLI)	1091
Enabling HTTP Server (CLI)	1092
Configuring CA Server (CLI)	1092
Configuring Trustpoint (CLI)	1094
Authenticating and Enrolling the PKI TrustPoint with CA Server (CLI)	1095
Tagging Wireless Management TrustPoint Name (CLI)	1096
Verifying Controller Certificates for Wireless AP Join	1096

---

**CHAPTER 121 Certificate Management 1099**

About Public Key Infrastructure Management (GUI)	1099
Authenticating and Enrolling a PKI Trustpoint (GUI)	1099
Generating an AP Self-Signed Certificate (GUI)	1100
Adding the Certificate Authority Server (GUI)	1100
Adding an RSA or EC Key for PKI Trustpoint (GUI)	1101
Adding and Managing Certificates	1101
	1102

---

**CHAPTER 122 Controller Self-Signed Certificate for Wireless AP Join 1103**

Use Cases	1103
Prerequisites	1104
Configuring Clock Calendar (CLI)	1104
Enabling HTTP Server (CLI)	1105

Configuring CA Server (CLI) 1105  
 Configuring Trustpoint (CLI) 1107  
 Authenticating and Enrolling the PKI TrustPoint with CA Server (CLI) 1108  
 Tagging Wireless Management TrustPoint Name (CLI) 1109  
 Verifying Controller Certificates for Wireless AP Join 1109

---

**CHAPTER 123**

**Managing Rogue Devices 1111**

Rogue Detection 1111  
     Rogue Devices 1111  
         Information About Rogue Containment (Protected Management Frames (PMF) Enabled) 1113  
         AP Impersonation Detection 1113  
         Configuring Rogue Detection (GUI) 1114  
         Configuring Rogue Detection (CLI) 1115  
         Configuring RSSI Deviation Notification Threshold for Rogue APs (CLI) 1116  
         Configuring Management Frame Protection (GUI) 1116  
         Configuring Management Frame Protection (CLI) 1116  
         Enabling Access Point Authentication 1117  
         Verifying Management Frame Protection 1118  
         Verifying Rogue Events 1118  
         Verifying Rogue Detection 1119  
         Examples: Rogue Detection Configuration 1121  
         Configuring Rogue Policies (GUI) 1121  
         Configuring Rogue Policies (CLI) 1122  
     Rogue Detection Security Level 1123  
     Setting Rogue Detection Security-level 1124  
     Wireless Service Assurance Rogue Events 1125  
         Monitoring Wireless Service Assurance Rogue Events 1126

---

**CHAPTER 124**

**Classifying Rogue Access Points 1127**

Information About Classifying Rogue Access Points 1127  
 Guidelines and Restrictions for Classifying Rogue Access Points 1129  
 How to Classify Rogue Access Points 1129  
     Classifying Rogue Access Points and Clients Manually (GUI) 1129  
     Classifying Rogue Access Points and Clients Manually (CLI) 1130

Configuring Rogue Classification Rules (GUI)	1131
Configuring Rogue Classification Rules (CLI)	1132
Monitoring Rogue Classification Rules	1135
Examples: Classifying Rogue Access Points	1135

**CHAPTER 125****Advanced WIPS 1137**

Feature History for Advanced WIPS	1137
Information About Advanced WIPS	1138
Guidelines and Restrictions	1140
Enabling Advanced WIPS	1141
Syslog Support for Advanced WIPS	1141
Advanced WIPS Solution Components	1142
Supported Modes and Platforms	1142
Enabling Advanced WIPS(GUI)	1143
Enabling Advanced WIPS (CLI)	1143
Configuring Syslog Threshold for Advanced WIPS (CLI)	1144
Viewing Advanced WIPS Alarms (GUI)	1144
Verifying Advanced WIPS	1145
Verifying Syslog Configuration for Advanced WIPS	1146

**CHAPTER 126****Cisco TrustSec 1147**

Information about Cisco TrustSec	1147
Cisco TrustSec Features	1148
Security Group Access Control List	1149
Inline Tagging	1151
Policy Enforcement	1151
SGACL Support for Wireless Guest Access	1152
Enabling SGACL on the AP (GUI)	1153
Enabling SGACL on the AP	1153
Enabling SGACL Policy Enforcement Globally (CLI)	1155
Enabling SGACL Policy Enforcement Per Interface (CLI)	1155
Manually Configure a Device SGT (CLI)	1156
Configuring SGACL, Inline Tagging, and SGT in Local Mode (GUI)	1156
Configuring SGACL, Inline Tagging, and SGT in Local Mode	1157

Configuring ISE for TrustSec 1157  
 Verifying Cisco TrustSec Configuration 1159

---

**CHAPTER 127 SGT Inline Tagging and SXPv4 1161**  
 Introduction to SGT Inline Tagging on AP and SXPv4 1161  
 Creating an SXP Profile 1161  
 Configuring SGT Inline Tagging on Access Points 1162  
 Configuring an SXP Connection (GUI) 1162  
 Configuring an SXP Connection 1163  
 Verifying SGT Push to Access Points 1164

---

**CHAPTER 128 Multiple Cipher Support 1167**  
 Default Ciphersuites Supported for CAPWAP-DTLS 1167  
 Configuring Multiple Ciphersuites 1168  
 Setting Server Preference 1169  
 Verifying Operational Ciphersuites and Priority 1169

---

**CHAPTER 129 Configuring Secure Shell 1171**  
 Information About Configuring Secure Shell 1171  
     SSH and Device Access 1171  
     SSH Servers, Integrated Clients, and Supported Versions 1171  
     SSH Configuration Guidelines 1172  
     Secure Copy Protocol Overview 1172  
     Secure Copy Protocol 1173  
     SFTP Support 1173  
 Prerequisites for Configuring Secure Shell 1173  
 Restrictions for Configuring Secure Shell 1174  
 How to Configure SSH 1175  
     Setting Up the Device to Run SSH 1175  
     Configuring the SSH Server 1176  
 Monitoring the SSH Configuration and Status 1177

---

**CHAPTER 130 Encrypted Traffic Analytics 1179**  
 Information About Encrypted Traffic Analytics 1179

Exporting Records to IPv4 Flow Export Destination	1180
Exporting Records to IPv6 Flow Export Destination	1181
Exporting Records to IPv4 and IPv6 Destination over IPFIX	1181
Allowed List of Traffic	1182
Configuring Source Interface for Record Export	1183
Configuring Source Interface for Record Export Without IPFIX	1184
Configuring ETA Flow Export Destination (GUI)	1185
Enabling In-Active Timer	1185
Enabling ETA on WLAN Policy Profile	1186
Attaching Policy Profile to VLAN (GUI)	1187
Attaching Policy Profile to VLAN	1187
Verifying ETA Configuration	1188

---

## CHAPTER 131 FIPS 1193

FIPS	1193
Guidelines and Restrictions for FIPS	1194
FIPS Self-Tests	1194
Configuring FIPS	1195
Configuring FIPS in HA Setup	1196
Verifying FIPS Configuration	1197

---

## CHAPTER 132 Internet Protocol Security 1199

Information about Internet Protocol Security	1199
Internet Key Exchange Version 1 Transform Sets	1200
Configure IPsec Using Internet Key Exchange Version 1	1201
Internet Key Exchange Version 2 Transform Sets	1203
Configure IPsec Using Internet Key Exchange Version 2	1204
IPsec Transforms and Lifetimes	1206
Use of X.509 With Internet Key Exchange Version	1207
For IKEv2 Commands	1208
IPsec Session Interruption and Recovery	1208
Example: Configure IPsec Using ISAKMP	1208
Verifying IPsec Traffic	1209
Example: Configure IPsec Using Internet Key Exchange Version 2	1210

Verifying IPsec With Internet Key Exchange Version 2 Traffic 1211

---

CHAPTER 133

**Transport Layer Security Tunnel Support 1215**

Information About Transport Layer Security Tunnel Support 1215

Configuring a Transport Layer Security Tunnel 1216

Verifying a Transport Layer Security Tunnel 1217

---

CHAPTER 134

**Disabling IP Learning in FlexConnect Mode 1221**

Information About Disabling IP Learning in FlexConnect Mode 1221

Restrictions for Disabling IP Learning in FlexConnect Mode 1221

Disabling IP Learning in FlexConnect Mode (CLI) 1222

Verifying MAC Entries from Database 1222

---

PART VIII

**Mobility 1223**

---

CHAPTER 135

**Mobility 1225**

Introduction to Mobility 1225

SDA Roaming 1228

Definitions of Mobility-related Terms 1229

Mobility Groups 1229

Guidelines and Restrictions 1230

Configuring Mobility (GUI) 1232

Configuring Mobility (CLI) 1233

Configuring Inter-Release Controller Mobility (GUI) 1235

Configuring Inter-Release Controller Mobility 1235

Verifying Mobility 1239

---

CHAPTER 136

**NAT Support on Mobility Groups 1245**

Information About NAT Support on Mobility Groups 1245

Restrictions for NAT Support on Mobility Groups 1246

Functionalities Supported on Mobility NAT 1246

Configuring a Mobility Peer 1247

Verifying NAT Support on Mobility Groups 1247

<b>CHAPTER 137</b>	<b>Static IP Client Mobility</b>	<b>1249</b>
	Information About Static IP Client Mobility	1249
	Restrictions	1249
	Configuring Static IP Client Mobility (GUI)	1250
	Configuring Static IP Client Mobility (CLI)	1250
	Verifying Static IP Client Mobility	1251
<b>CHAPTER 138</b>	<b>Mobility Domain ID - Dot11i Roaming</b>	<b>1253</b>
	Information about Mobility Domain ID - 802.11i Roaming	1253
	Verifying Mobility Domain ID - 802.11i Roaming	1254
<b>CHAPTER 139</b>	<b>802.11r Support for Flex Local Authentication</b>	<b>1255</b>
	Information About 802.11r Support for FlexConnect Local Authentication	1255
	Support Guidelines	1255
	Verifying 802.11r Support for Flex Local Authentication	1256
<b>CHAPTER 140</b>	<b>Opportunistic Key Caching</b>	<b>1257</b>
	Information about Opportunistic Key Caching	1257
	Enabling Opportunistic Key Caching	1258
	Enabling Opportunistic Key Caching (GUI)	1258
	Verifying Opportunistic Key Caching	1258
<b>PART IX</b>	<b>High Availability</b>	<b>1261</b>
<b>CHAPTER 141</b>	<b>High Availability</b>	<b>1263</b>
	Feature History for High Availability	1264
	Information About High Availability	1264
	Prerequisites for High Availability	1265
	Restrictions on High Availability	1266
	Configuring High Availability (CLI)	1268
	Disabling High Availability	1269
	Copying a WebAuth Tar Bundle to the Standby Controller	1270
	System and Network Fault Handling	1271

Handling Recovery Mechanism	1277
Verifying High Availability Configurations	1278
Verifying AP or Client SSO Statistics	1278
Verifying High Availability	1280
Configuring a Switchover	1283
Information About Redundancy Management Interface	1284
Configuring Redundancy Management Interface (GUI)	1288
Configuring Redundancy Management Interface (CLI)	1289
Configuring Gateway Monitoring (CLI)	1291
Configuring Gateway Monitoring Interval (CLI)	1291
Gateway Reachability Detection	1292
Information About Gateway Reachability Detection	1292
Configuration Workflow	1292
Migrating to RMI IPv6	1293
Monitoring the Health of the Standby Controller	1293
Monitoring the Health of Standby Parameters Using SNMP	1294
Standby Monitoring Using Standby RMI IP	1294
Standby Monitoring Using the Active Controller	1295
Standby IOS Linux Syslogs	1295
Standby Interface Status Using Active SNMP	1296
Monitoring the Health of Standby Controller Using Programmatic Interfaces	1296
Monitoring the Health of Standby Controller Using CLI	1297
Verifying the Gateway-Monitoring Configuration	1300
Verifying the RMI IPv4 Configuration	1301
Verifying the RMI IPv6 Configuration	1302
Verifying Redundancy Port Interface Configuration	1302
Information About Auto-Upgrade	1305
Use Cases	1305
Configuration Workflow	1306
Configuring Auto-Upgrade (CLI)	1306

---

**PART X**

<b>Quality of Service</b>	<b>1307</b>
---------------------------	-------------

---

**CHAPTER 142**

<b>Quality of Service</b>	<b>1309</b>
---------------------------	-------------



Wireless QoS Overview	1309
Wireless QoS Targets	1310
SSID Policies	1310
Client Policies	1310
Supported QoS Features on Wireless Targets	1310
Wireless QoS Mobility	1311
Precious Metal Policies for Wireless QoS	1311
Prerequisites for Wireless QoS	1312
Restrictions for QoS on Wireless Targets	1312
Metal Policy Format	1313
Metal Policy Format	1313
Auto QoS Policy Format	1317
Architecture for Voice, Video and Integrated Data (AVVID)	1319
How to apply Bi-Directional Rate Limiting	1320
Information about Bi-Directional Rate Limiting	1320
Prerequisites for Bi-Directional Rate Limiting	1321
Configure Metal Policy on SSID	1321
Configure Metal Policy on Client	1322
Configure Bi-Directional Rate Limiting for All Traffic	1323
Configure Bi-Directional Rate Limiting Based on Traffic Classification	1323
Apply Bi-Directional Rate Limiting Policy Map to Policy Profile	1325
Apply Metal Policy with Bi-Directional Rate Limiting	1326
How to apply Per Client Bi-Directional Rate Limiting	1327
Information About Per Client Bi-Directional Rate Limiting	1327
Prerequisites for Per Client Bi-Directional Rate Limiting	1328
Restrictions on Per Client Bi-Directional Rate Limiting	1328
Configuring Per Client Bi-Directional Rate Limiting (GUI)	1328
Verifying Per Client Bi-Directional Rate Limiting	1329
Configuring BDRL Using AAA Override	1329
Verifying Bi-Directional Rate-Limit	1330
How to Configure Wireless QoS	1331
Configuring a Policy Map with Class Map (GUI)	1331
Configuring a Class Map (CLI)	1332
Configuring Policy Profile to Apply QoS Policy (GUI)	1333

Configuring Policy Profile to Apply QoS Policy (CLI)	1333
Applying Policy Profile to Policy Tag (GUI)	1334
Applying Policy Profile to Policy Tag (CLI)	1335
Attaching Policy Tag to an AP	1335
Configuring Custom QoS Mapping	1336
Configuring DSCP-to-User Priority Mapping Exception	1337
Configuring Trust Upstream DSCP Value	1338

**CHAPTER 143****Wireless Auto-QoS 1341**

Information About Auto QoS	1341
How to Configure Wireless AutoQoS	1342
Configuring Wireless AutoQoS on Profile Policy	1342
Disabling Wireless AutoQoS	1343
Rollback AutoQoS Configuration (GUI)	1343
Rollback AutoQoS Configuration	1343
Clearing Wireless AutoQoS Policy Profile (GUI)	1344
Clearing Wireless AutoQoS Policy Profile	1344
Viewing AutoQoS on policy profile	1345

**CHAPTER 144****Native Profiling 1347**

Information About Native Profiling	1347
Creating a Class Map (GUI)	1348
Creating a Class Map (CLI)	1349
Creating a Service Template (GUI)	1351
Creating a Service Template (CLI)	1352
Creating a Parameter Map	1353
Creating a Policy Map (GUI)	1353
Creating a Policy Map (CLI)	1354
Configuring Native Profiling in Local Mode	1356
Verifying Native Profile Configuration	1356

**CHAPTER 145****Air Time Fairness 1359**

Information About Air Time Fairness	1359
Restrictions on Cisco Air Time Fairness	1361

Cisco Air Time Fairness (ATF) Use Cases	1362
Configuring Cisco Air Time Fairness (ATF)	1362
Configuring Cisco Air Time Fairness	1362
Creating a Cisco ATF Profile (GUI)	1362
Creating Cisco ATF Profile (CLI)	1363
Attaching Cisco ATF Profile to a Policy Profile (GUI)	1364
Attaching Cisco ATF Profile to a Policy Profile (CLI)	1364
Enabling ATF in the RF Profile (GUI)	1365
Enabling ATF in the RF Profile (CLI)	1365
Verifying Cisco ATF Configurations	1366
Verifying Cisco ATF Statistics	1366

---

<b>CHAPTER 146</b>	<b>IPv6 Non-AVC QoS Support</b>	<b>1369</b>
	Information About IPv6 Non-AVC QoS Support	1369
	Configuring IPv6 Non-AVC QoS	1369
	Marking DSCP Values for an IPv6 Packet	1370
	Dropping an IPv6 Packet with DSCP Values	1370
	Policing IPv6 Traffic	1371
	Verifying IPv6 Non-AVC QoS	1372

---

<b>CHAPTER 147</b>	<b>QoS Basic Service Set Load</b>	<b>1373</b>
	Information About QoS Basic Set Service Load	1373
	Configuring QBSS Load	1374
	Configuring Wi-Fi Multimedia	1374
	Enabling QoS Basic Set Service Load	1375
	Verifying QoS Basic Set Service Load	1375

---

<b>PART XI</b>	<b>IPv6</b>	<b>1377</b>
----------------	-------------	-------------

---

<b>CHAPTER 148</b>	<b>IPv6 Client IP Address Learning</b>	<b>1379</b>
	Information About IPv6 Client Address Learning	1379
	Address Assignment Using SLAAC	1379
	Stateful DHCPv6 Address Assignment	1380
	Router Solicitation	1381

Router Advertisement	1381
Neighbor Discovery	1381
Neighbor Discovery Suppression	1382
Router Advertisement Guard	1382
Router Advertisement Throttling	1383
Prerequisites for IPv6 Client Address Learning	1383
Configuring RA Throttle Policy (CLI)	1383
Applying RA Throttle Policy on VLAN (GUI)	1384
Applying RA Throttle Policy on a VLAN (CLI)	1385
Configuring IPv6 Interface on a Switch (GUI)	1385
Configuring IPv6 on Interface (CLI)	1386
Configuring DHCP Pool on Switch (GUI)	1387
Configuring DHCP Pool on Switch (CLI)	1387
Configuring Stateless Auto Address Configuration Without DHCP on Switch (CLI)	1388
Configuring Stateless Auto Address Configuration With DHCP on Switch	1389
Configuring Stateless Address Auto Configuration Without DHCP on Switch (CLI)	1391
Native IPv6	1392
Information About IPv6	1392
Configuring IPv6 Addressing	1393
Creating an AP Join Profile (GUI)	1394
Creating an AP Join Profile (CLI)	1394
Configuring the Primary and Backup Controller (GUI)	1395
Configuring Primary and Backup Controller (CLI)	1395
Verifying IPv6 Configuration	1396

---

**CHAPTER 149**
**IPv6 ACL 1397**

Information About IPv6 ACL	1397
Understanding IPv6 ACLs	1397
Types of ACL	1397
Per User IPv6 ACL	1397
Filter ID IPv6 ACL	1398
Prerequisites for Configuring IPv6 ACL	1398
Restrictions for Configuring IPv6 ACL	1398
Configuring IPv6 ACLs	1398

Default IPv6 ACL Configuration	1399
Interaction with Other Features and Switches	1399
How To Configure an IPv6 ACL	1399
Creating an IPv6 ACL (GUI)	1399
Creating an IPv6 ACL	1400
Creating WLAN IPv6 ACL (GUI)	1404
Creating WLAN IPv6 ACL	1404
Verifying IPv6 ACL	1404
Displaying IPv6 ACLs	1404
Configuration Examples for IPv6 ACL	1405
Example: Creating an IPv6 ACL	1405
Example: Applying an IPv6 ACL to a Policy Profile in a Wireless Environment	1405
Displaying IPv6 ACLs	1406
Example: Displaying IPv6 ACLs	1406
Example: Configuring RA Throttling	1407

**CHAPTER 150****IPv6 Client Mobility 1409**

Information About IPv6 Client Mobility	1409
Using Router Advertisement	1410
Router Advertisement Throttling	1410
IPv6 Address Learning	1411
Handling Multiple IP Addresses	1411
IPv6 Configuration	1411
Prerequisites for IPv6 Client Mobility	1411
Monitoring IPv6 Client Mobility	1412

**CHAPTER 151****IPv6 Support on Flex and Mesh 1413**

IPv6 Support on Flex + Mesh Deployment	1413
Configuring IPv6 Support for Flex + Mesh	1413
Configuring Preferred IP Address as IPv6 (GUI)	1414
Configuring Preferred IP Address as IPv6	1415
Verifying IPv6 on Flex+Mesh	1415

**CHAPTER 152****IPv6 CAPWAP UDP Lite Support 1417**

Information About UDP Lite 1417  
 Enabling UDP Lite Support 1417  
 Verifying UDP Lite Support Configuration 1418

---

**CHAPTER 153 Neighbor Discovery Proxy 1419**  
 Information About Neighbor Discovery 1419  
 Configure Neighbor Discovery Proxy (CLI) 1419  
 Configure Duplicate Address Detection Proxy (CLI) 1420

---

**CHAPTER 154 Address Resolution Protocol Proxy 1423**  
 Information About Address Resolution Protocol 1423  
 Configure Address Resolution Protocol Proxy (CLI) 1423

---

**CHAPTER 155 IPv6 Ready Certification 1425**  
 Feature History for IPv6-Ready Certification 1425  
 IPv6 Ready Certification 1425  
 Configuring IPv6 Route Information 1426  
 Verifying IPv6 Route Information 1426

---

**PART XII CleanAir 1427**

---

**CHAPTER 156 Cisco CleanAir 1429**  
 Information About Cisco CleanAir 1429  
 Cisco CleanAir-Related Terms 1430  
 Cisco CleanAir Components 1430  
 Interference Types that Cisco CleanAir can Detect 1431  
 EDRRM and AQR Update Mode 1432  
 Prerequisites for CleanAir 1432  
 Restrictions for CleanAir 1433  
 How to Configure CleanAir 1433  
 Enabling CleanAir for the 2.4-GHz Band (GUI) 1433  
 Enabling CleanAir for the 2.4-GHz Band (CLI) 1434  
 Configuring Interference Reporting for a 2.4-GHz Device (GUI) 1434  
 Configuring Interference Reporting for a 2.4-GHz Device (CLI) 1435

Enabling CleanAir for the 5-GHz Band (GUI)	1436
Enabling CleanAir for the 5-GHz Band (CLI)	1437
Configuring Interference Reporting for a 5-GHz Device (GUI)	1437
Configuring Interference Reporting for a 5-GHz Device (CLI)	1438
Configuring Event Driven RRM for a CleanAir Event (GUI)	1439
Configuring EDRRM for a CleanAir Event (CLI)	1440
Verifying CleanAir Parameters	1441
Monitoring Interference Devices	1442
Configuration Examples for CleanAir	1442
CleanAir FAQs	1443

---

<b>CHAPTER 157</b>	<b>Bluetooth Low Energy</b>	<b>1445</b>
	Information About Bluetooth Low Energy	1445
	Enabling Bluetooth Low Energy Beacon (GUI)	1446
	Enabling Bluetooth Low Energy Beacon	1446

---

<b>CHAPTER 158</b>	<b>Persistent Device Avoidance</b>	<b>1449</b>
	Information about Cisco Persistent Device Avoidance	1449
	Configuring Persistent Device Avoidance (GUI)	1450
	Configuring Persistent Device Avoidance (CLI)	1450
	Verifying Persistent Device Avoidance	1450

---

<b>CHAPTER 159</b>	<b>Spectrum Intelligence</b>	<b>1453</b>
	Spectrum Intelligence	1453
	Configuring Spectrum Intelligence	1454
	Verifying Spectrum Intelligence Information	1454
	Debugging Spectrum Intelligence on Supported APs (CLI)	1455

---

<b>CHAPTER 160</b>	<b>Spectrum Analysis</b>	<b>1457</b>
	Information About Spectrum Analysis	1457
	Live Spectrum Analysis	1458
	Performing AP Spectrum Analysis (GUI)	1458
	Configuring Spectrum Analysis	1459
	Verifying Spectrum Analysis	1459

---

**PART XIII****Mesh Access Points 1461**

---

**CHAPTER 161****Mesh Access Points 1463**

- Introduction to the Mesh Network 1465
- Restrictions for Mesh Access Points 1466
- MAC Authorization 1467
- Preshared Key Provisioning 1468
- EAP Authentication 1468
- Bridge Group Names 1469
- Background Scanning 1470
- Mesh Backhaul at 2.4 GHz and 5 GHz 1470
- Information About Mesh Backhaul 1470
- Dynamic Frequency Selection 1471
- Country Codes 1471
- Intrusion Detection System 1472
- Mesh Interoperability Between Controllers 1472
- Information About DHCP and NAT Functionality on Root AP (RAP) 1472
- Mesh Convergence 1473
  - Noise-Tolerant Fast 1473
- Ethernet Bridging 1473
- Multicast Over Mesh Ethernet Bridging Network 1474
- Radio Resource Management on Mesh 1475
- Air Time Fairness on Mesh 1475
- Spectrum Intelligence for Mesh 1476
- Indoor Mesh Interoperability with Outdoor Mesh 1476
- Workgroup Bridge 1476
- Link Test 1477
- Mesh Daisy Chaining 1477
- Mesh Leaf Node 1478
- Flex+Bridge Mode 1478
- Backhaul Client Access 1478
- Mesh CAC 1478
- Prerequisites for Mesh Ethernet Daisy Chaining 1479



Restrictions for Mesh Ethernet Daisy Chaining	1479
Speeding up Mesh Network Recovery Through Fast Detection of Uplink Gateway Reachability Failure	1480
Configuring MAC Authorization (GUI)	1480
Configuring MAC Authorization (CLI)	1481
Configuring MAP Authorization - EAP (GUI)	1482
Configuring MAP Authorization (CLI)	1483
Configuring PSK Provisioning (CLI)	1483
Configuring a Bridge Group Name (GUI)	1485
Configuring a Bridge Group Name (CLI)	1485
Configuring Background Scanning (GUI)	1486
Configuring Background Scanning	1486
Configuring Backhaul Client Access (GUI)	1486
Configuring Backhaul Client Access (CLI)	1487
Configuring Dot11ax Rates on Mesh Backhaul Per Access Point (GUI)	1487
Configuring Dot11ax Rates on Mesh Backhaul in Mesh Profile (GUI)	1488
Configuring Wireless Backhaul Data Rate (CLI)	1488
Configuring Data Rate Per AP (CLI)	1489
Configuring Data Rate Using Mesh Profile (CLI)	1490
Configuring Mesh Backhaul (CLI)	1490
Configuring Dynamic Frequency Selection (CLI)	1491
Configuring the Intrusion Detection System (CLI)	1491
Configuring Ethernet Bridging (GUI)	1492
Configuring Ethernet Bridging (CLI)	1492
Configuring Multicast Modes over Mesh	1494
Configuring RRM on Mesh Backhaul (CLI)	1494
Selecting a Preferred Parent (GUI)	1495
Selecting a Preferred Parent (CLI)	1495
Changing the Role of an AP (GUI)	1496
Changing the Role of an AP (CLI)	1497
Configuring the Mesh Leaf Node (CLI)	1497
Configuring the Mesh Leaf Node (GUI)	1497
Configuring Subset Channel Synchronization	1498
Provisioning LSC for Bridge-Mode and Mesh APs (GUI)	1498

Provisioning LSC for Bridge-Mode and Mesh APs	1499
Specifying the Backhaul Slot for the Root AP (GUI)	1500
Specifying the Backhaul Slot for the Root AP (CLI)	1500
Using a Link Test on Mesh Backhaul (GUI)	1501
Using a Link Test on Mesh Backhaul	1501
Configuring Battery State for Mesh AP (GUI)	1502
Configuring Battery State for Mesh AP	1502
Configuring Mesh Convergence (CLI)	1502
Configuring DHCP Server on Root Access Point (RAP)	1503
Configuring Mesh Ethernet Daisy Chaining (CLI)	1504
Enabling Mesh Ethernet Daisy Chaining	1504
Configuring Mesh CAC (CLI)	1505
Configuring ATF on Mesh (GUI)	1505
Configuring ATF on Mesh	1506
Create an ATF Policy for a MAP	1506
Creating an ATF Policy (GUI)	1507
Adding an ATF to a Policy Profile (GUI)	1507
Enabling ATF Mode in an RF Profile (GUI)	1507
Configuring Fast Teardown for a Mesh AP Profile (CLI)	1508
Flex Resilient with Flex and Bridge Mode Access Points	1509
Information About Flex Resilient with Flex and Bridge Mode Access Points	1509
Configuring a Flex Profile (GUI)	1509
Configuring a Flex Profile (CLI)	1510
Configuring a Site Tag (CLI)	1511
Configuring a Mesh Profile (CLI)	1512
Associating Wireless Mesh to an AP Profile (CLI)	1512
Attaching Site Tag to an Access Point (CLI)	1513
Configuring Switch Interface for APs (CLI)	1514
Verifying Flex Resilient with Flex and Bridge Mode Access Points Configuration	1514
Verifying ATF Configuration on Mesh	1515
Verifying Mesh Ethernet Daisy Chaining	1516
Verifying Mesh Convergence	1516
Verifying DHCP Server for Root AP Configuration	1517
Verifying Mesh Backhaul	1517

Verifying Mesh Configuration	1518
Verifying Dot11ax Rates on Mesh Backhaul	1526

---

<b>CHAPTER 162</b>	<b>Redundant Root Access Point (RAP) Ethernet Daisy Chaining</b>	<b>1527</b>
	Overview of Redundant RAP Ethernet Daisy Chaining	1527
	Prerequisites for Redundant RAP Ethernet Daisy Chaining Support	1528
	Configuring Redundant RAP Ethernet Daisy Chaining Support (CLI)	1528
	Verifying Daisy Chain Redundancy (CLI)	1528

---

<b>PART XIV</b>	<b>VideoStream</b>	<b>1531</b>
-----------------	--------------------	-------------

---

<b>CHAPTER 163</b>	<b>VideoStream</b>	<b>1533</b>
	Information about Media Stream	1533
	Prerequisites for Media Stream	1534
	How to Configure Media Stream	1534
	Configuring Multicast-Direct Globally for Media Stream (CLI)	1534
	Configuring Media Stream for 802.11 Bands (CLI)	1535
	Configuring a WLAN to Stream Video(GUI)	1537
	Configuring a WLAN to Stream Video (CLI)	1537
	Deleting a Media Stream (GUI)	1538
	Deleting a Media Stream (CLI)	1538
	Monitoring Media Streams	1539
	Configuring the General Parameters for a Media Stream (GUI)	1539
	Adding Media Stream (CLI)	1540
	Enabling a Media Stream per WLAN (GUI)	1541
	Enabling a Media Stream per WLAN (CLI)	1541
	Configuring the General Parameters for a Media Stream (GUI)	1542
	Configuring the General Parameters for a Media Stream (CLI)	1542
	Configuring Multicast Direct Admission Control (GUI)	1543
	Configuring Multicast Direct Admission Control (CLI)	1543
	Create and Attach Policy-based QoS Profile	1545
	Create a QoS Profile (GUI)	1545
	Create a QoS Profile (CLI)	1546
	Create a Service Template (GUI)	1547

Create a Service Template (CLI)	1547
Map the Service Template to the Policy Map (GUI)	1548
Map the Service Template to the Policy Map (CLI)	1548
Map the Policy Map (GUI)	1550
Map the Policy Map (CLI)	1550
Viewing Media Stream Information	1550

---

**PART XV**

**Software-Defined Access Wireless 1553**

---

**CHAPTER 164**

**Software-Defined Access Wireless 1555**

Information to Software-Defined Access Wireless	1555
Configuring SD-Access Wireless	1558
Configuring Default Map Server (GUI)	1558
Configuring Default Map Server (CLI)	1559
Configuring SD-Access Wireless Profile (GUI)	1559
Configuring SD-Access Wireless Profile (CLI)	1560
Configuring Map Server in Site Tag (GUI)	1560
Configuring Map Server in Site Tag (CLI)	1561
Configuring Map Server per L2-VNID (GUI)	1561
Configuring Map Server per L2-VNID (CLI)	1562
Verifying SD-Access Wireless	1562

---

**CHAPTER 165**

**Passive Client 1563**

Information About Passive Clients	1563
Enabling Passive Client on WLAN Policy Profile (GUI)	1564
Enabling Passive Client on WLAN Policy Profile (CLI)	1564
Enabling ARP Broadcast on VLAN (GUI)	1565
Enabling ARP Broadcast on VLAN (CLI)	1565
Configuring Passive Client in Fabric Deployment	1566
Enabling Broadcast Underlay on VLAN	1566
Enabling ARP Flooding	1568
Verifying Passive Client Configuration	1569

---

**CHAPTER 166**

**Fabric in a Box with External Fabric Edge 1571**

Introduction to Fabric in a Box with External Fabric Edge	1571
Configuring a Fabric Profile (CLI)	1571
Configuring a Policy Profile (CLI)	1572
Configuring a Site Tag (CLI)	1573
Configuring a WLAN (CLI)	1574
Configuring a Policy Tag (CLI)	1574
Configuring an AP Profile	1575
Configuring Map Server and AP Subnet (CLI)	1575
Configuring Fabric on FiaB Node	1576
Configuring a Fabric Edge Node	1582
Verifying Fabric Configuration	1589

---

**PART XVI**
**VLAN 1595**

---

**CHAPTER 167**
**VLANs 1597**

Information About VLANs	1597
Logical Networks	1597
Supported VLANs	1597
VLAN Port Membership Modes	1597
VLAN Configuration Files	1598
Normal-Range VLAN Configuration Guidelines	1599
Extended-Range VLAN Configuration Guidelines	1599
Prerequisites for VLANs	1599
Restrictions for VLANs	1600
How to Configure VLANs	1601
How to Configure Normal-Range VLANs	1601
Creating or Modifying an Ethernet VLAN	1601
Assigning Static-Access Ports to a VLAN (GUI)	1602
Assigning Static-Access Ports to a VLAN	1602
How to Configure Extended-Range VLANs	1603
Creating an Extended-Range VLAN (GUI)	1604
Creating an Extended-Range VLAN	1604
Monitoring VLANs	1604

---

<b>CHAPTER 168</b>	<b>VLAN Groups</b>	<b>1607</b>
	Information About VLAN Groups	1607
	Prerequisites for VLAN Groups	1608
	Restrictions for VLAN Groups	1608
	Creating a VLAN Group (GUI)	1608
	Creating a VLAN Group (CLI)	1609
	Adding a VLAN Group to Policy Profile (GUI)	1609
	Adding a VLAN Group to a Policy Profile	1610
	Viewing the VLANs in a VLAN Group	1610

---

<b>PART XVII</b>	<b>WLAN</b>	<b>1611</b>
------------------	-------------	-------------

---

<b>CHAPTER 169</b>	<b>WLANs</b>	<b>1613</b>
	Information About WLANs	1613
	Band Selection	1614
	Off-Channel Scanning Deferral	1614
	DTIM Period	1614
	WLAN Radio Policy	1615
	Restrictions for WLAN Radio Policy	1615
	Prerequisites for Configuring Cisco Client Extensions	1615
	Peer-to-Peer Blocking	1615
	Diagnostic Channel	1616
	Prerequisites for WLANs	1616
	Restrictions for WLANs	1616
	How to Configure WLANs	1618
	WLAN Wizard	1618
	Local Mode	1618
	FlexConnect Mode	1622
	Guest CWA Mode	1626
	Creating WLANs (GUI)	1629
	Creating WLANs (CLI)	1629
	Deleting WLANs (GUI)	1630
	Deleting WLANs	1630

Searching WLANs (CLI)	1631
Enabling WLANs (GUI)	1631
Enabling WLANs (CLI)	1632
Disabling WLANs (GUI)	1632
Disabling WLANs (CLI)	1632
Configuring General WLAN Properties (CLI)	1633
Configuring Advanced WLAN Properties (CLI)	1634
Configuring Advanced WLAN Properties (GUI)	1636
Configuring WLAN Radio Policy (GUI)	1638
Configuring a WLAN Radio Policy (CLI)	1639
Verifying WLAN Properties (CLI)	1640
Verifying WLAN-VLAN Information for an AP	1640
Verifying a WLAN Radio Policy	1641

**CHAPTER 170****WLAN Security 1643**

Information About WPA1 and WPA2	1643
Information About AAA Override	1644
Configuring AAA Override	1644
Information About VLAN Override	1645
Configuring Override VLAN for Central Switching	1645
Configuring Override VLAN for Local Switching	1646
VLAN Override on Layer 3 Web Authentication	1647
Verifying VLAN Override on Layer 3 Web Authentication	1647
Prerequisites for Layer 2 Security	1647
Restrictions for WPA2 and WP3	1648
Feature History for Fallback for AAA-Overridden VLAN	1648
Information About Fallback for AAA- Overridden VLAN	1649
Central Switching and FlexConnect Mode Scenarios	1649
Configuring Fallback for AAA-Overridden VLAN (CLI)	1650
Verifying Fallback for AAA-Overridden VLAN	1650
How to Configure WLAN Security	1651
Configuring Static WEP Layer 2 Security Parameters (GUI)	1651
Configuring Static WEP Layer 2 Security Parameters (CLI)	1651
Configuring WPA + WPA2 Layer 2 Security Parameters (GUI)	1653

Configuring WPA + WPA2 Layer 2 Security Parameters (CLI) 1653

---

**CHAPTER 171**

**Remote LANs 1657**

- Information About Remote LANs 1657
- Configuring Remote LANs (RLANs) 1659
  - Enabling or Disabling all RLANs 1659
  - Creating RLAN Profile (GUI) 1659
  - Creating RLAN Profile (CLI) 1659
  - Configuring RLAN Profile Parameters (GUI) 1660
  - Configuring RLAN Profile Parameters (CLI) 1661
  - Creating RLAN Policy Profile (GUI) 1662
  - Creating RLAN Policy Profile (CLI) 1662
  - Configuring RLAN Policy Profile Parameters (GUI) 1663
  - Configuring RLAN Policy Profile Parameters (CLI) 1664
  - Configuring Policy Tag and Mapping an RLAN Policy Profile to an RLAN Profile (CLI) 1666
  - Configuring LAN Port (CLI) 1667
  - Attaching Policy Tag to an Access Point (GUI) 1667
  - Attaching Policy Tag to an Access Point (CLI) 1668
  - Verifying RLAN Configuration 1668

---

**CHAPTER 172**

**RLAN External Module 1673**

- Information About External Module 1673
- Prerequisites for Configuring External Module 1673
- Configuring External Module (GUI) 1673
- Configuring External Module (CLI) 1674
- Verifying External Module 1674

---

**CHAPTER 173**

**802.11ax Mode Per WLAN 1675**

- Information About 802.11ax Mode Per WLAN 1675
- Configuring 802.11ax Mode Per WLAN (GUI) 1675
- Configuring 802.11ax Mode Per WLAN (CLI) 1676
- Verifying 802.11ax Mode Per WLAN 1676

---

**CHAPTER 174**

**BSS Coloring 1679**



Information About BSS Coloring	1679
BSS Coloring	1680
OBSS-PD and Spatial Reuse	1680
Configuring BSS Color on AP (GUI)	1680
Configuring BSS Color in the Privileged EXEC Mode	1681
Configuring BSS Color Globally (GUI)	1681
Configuring BSS Color in the Configuration Mode	1682
Configuring Overlapping BSS Packet Detect (GUI)	1682
Configuring OBSS-PD Spatial Reuse Globally (CLI)	1683
Configuring OBSS PD in an RF Profile (GUI)	1683
Configuring OBSS-PD Spatial Reuse in the RF Profile Mode (CLI)	1684
Verifying BSS Color and OBSS-PD	1684

**CHAPTER 175****DHCP for WLANs 1687**

Information About Dynamic Host Configuration Protocol	1687
Internal DHCP Servers	1687
External DHCP Servers	1688
DHCP Assignments	1688
DHCP Option 82	1689
Restrictions for Configuring DHCP for WLANs	1690
Guidelines for DHCP Relay Configuration	1690
How to Configure DHCP for WLANs	1691
Configuring DHCP Scopes (GUI)	1691
Configuring DHCP Scopes (CLI)	1692
Configuring the Internal DHCP Server	1693
Configuring the Internal DHCP Server Under Client VLAN SVI (GUI)	1693
Configuring the Internal DHCP Server Under Client VLAN SVI (CLI)	1693
Configuring the Internal DHCP Server Under a Wireless Policy Profile (GUI)	1696
Configuring the Internal DHCP Server Under a Wireless Policy Profile	1696
Configuring the Internal DHCP Server Globally (GUI)	1699
Configuring the Internal DHCP Server Globally (CLI)	1699
Verifying Internal DHCP Configuration	1701
Configuring DHCP-Required for FlexConnect	1703
Information About FlexConnect DHCP-Required	1703

Restrictions and Limitations for FlexConnect DHCP-Required	1703
Configuring FlexConnect DHCP-Required (GUI)	1703
Configuring FlexConnect DHCP-Required (CLI)	1704
Verifying FlexConnect DHCP-Required	1704

**CHAPTER 176****Aironet Extensions IE (CCX IE) 1707**

Information About Aironet Extensions Information Element	1707
Configuring Aironet Extensions IE (GUI)	1707
Configuring Aironet Extensions IE (CLI)	1707
Verifying the Addition of AP Name	1708

**CHAPTER 177****Device Analytics 1711**

Device Analytics	1711
Information About Device Analytics	1711
Restrictions for Device Analytics	1711
Configuring Device Analytics (GUI)	1712
Configuring Device Analytics (CLI)	1712
Verifying Device Analytics	1713
Verifying Device Analytics Configuration	1713
Adaptive 802.11r	1715
Information About Adaptive 802.11r	1715
Configuring Adaptive 802.11r (GUI)	1715
Verifying Adaptive 802.11r	1716

**CHAPTER 178****BSSID Counters 1717**

BSSID Counters	1717
Enabling BSSID Statistics and BSSID Neighbor Statistics	1717
Verifying BSSID Statistics on the Controller	1718

**CHAPTER 179****Fastlane+ 1721**

Information About Fastlane+	1721
Configuring an Fastlane+ on a WLAN (CLI)	1721
Configuring an Fastlane+ on a WLAN (GUI)	1722
Monitoring Fastlane+	1722

Verifying Fastlane+ 1723

---

**CHAPTER 180**

**Workgroup Bridges 1725**

Cisco Workgroup Bridges 1725

Configuring Workgroup Bridge on a WLAN 1727

Verifying the Status of a Workgroup Bridge on the Controller 1729

Configuring Access Points as Workgroup Bridge 1729

Turning Cisco Aironet 2700/3700/1572 Series AP into Autonomous Mode 1729

Configuring Cisco Wave 2 APs in Workgroup Bridge or CAPWAP AP Mode (CLI) 1730

Configure an SSID Profile for Cisco Wave 2 APs (CLI) 1731

Configuring a Dot1X Credential (CLI) 1732

Configuring an EAP Profile (CLI) 1732

Configuring Manual-Enrollment of a Trustpoint for Workgroup Bridge (CLI) 1733

Configuring Auto-Enrollment of a Trustpoint for Workgroup Bridge (CLI) 1735

Configuring Manual Certificate Enrolment Using TFTP Server (CLI) 1736

Importing the PKCS12 Format Certificates from the TFTP Server (CLI) 1738

Configuring Radio Interface for Workgroup Bridges (CLI) 1738

Configuring Workgroup Bridge Timeouts (CLI) 1741

Configuring Bridge Forwarding for Workgroup Bridge (CLI) 1742

---

**CHAPTER 181**

**Peer-to-Peer Client Support 1743**

Information About Peer-to-Peer Client Support 1743

Configure Peer-to-Peer Client Support 1743

---

**CHAPTER 182**

**Deny Wireless Client Session Establishment Using Calendar Profiles 1745**

Information About Denial of Wireless Client Session Establishment 1745

Configuring Daily Calendar Profile 1746

Configuring Weekly Calendar Profile 1747

Configuring Monthly Calendar Profile 1748

Mapping a Daily Calendar Profile to a Policy Profile 1749

Mapping a Weekly Calendar Profile to a Policy Profile 1750

Mapping a Monthly Calendar Profile to a Policy Profile 1751

Verifying Calendar Profile Configuration 1752

Verifying Policy Profile Configuration 1752

---

**CHAPTER 183****Ethernet over GRE 1755**

- Introduction to EoGRE 1755
  - EoGRE Configuration Overview 1756
- Create a Tunnel Gateway 1757
- Configuring the Tunnel Gateway (GUI) 1758
- Configuring a Tunnel Domain 1758
- Configuring Tunnel Domain (GUI) 1759
- Configuring EoGRE Global Parameters 1760
- Configuring EoGRE Global Parameters (GUI) 1760
- Configuring a Tunnel Profile 1761
- Configuring the Tunnel Profile (GUI) 1762
- Associating WLAN to a Wireless Policy Profile 1763
- Attaching a Policy Tag and a Site Tag to an AP 1764
- Verifying the EoGRE Tunnel Configuration 1764

---

**CHAPTER 184****Wireless Guest Access 1773**

- Wireless Guest Access 1773
  - Foreign Map Overview 1776
  - Wireless Guest Access: Use Cases 1776
- Load Balancing Among Multiple Guest Controllers 1777
- Guidelines and Limitations for Wireless Guest Access 1777
  - Troubleshooting IPv6 1777
- Configure Mobility Tunnel for Guest Access (GUI) 1778
- Configure Mobility Tunnel for Guest Access (CLI) 1778
- Configuring Guest Access Policy (GUI) 1778
- Configuring Guest Access Policy (CLI) 1779
- Viewing Guest Access Debug Information (CLI) 1781
- Verifying Wireless Guest Access Enablement 1781
- Configure Guest Access Using Different Security Methods 1781
  - Open Authentication 1781
    - Configure a WLAN Profile for Guest Access with Open Authentication (GUI) 1782
    - Configure a WLAN Profile For Guest Access with Open Authentication (CLI) 1782
  - Configuring a Policy Profile 1783

Local Web Authentication	1784
Configure a Parameter Map (GUI)	1784
Configure a Parameter Map (CLI)	1784
Configure a WLAN Profile for Guest Access with Local Web Authentication (GUI)	1785
Configure a WLAN Profile for Guest Access with Local Web Authentication (CLI)	1785
Configure an AAA Server for Local Web Authentication (GUI)	1786
Configure an AAA Server for Local Web Authentication (CLI)	1786
Global Configuration	1787
Central Web Authentication	1787
Configure a WLAN Profile for Guest Access with Central Web Authentication (GUI)	1788
Configure a WLAN Profile for Guest Access with Central Web Authentication (CLI)	1788
AAA Server Configuration (GUI)	1789
AAA Server Configuration (CLI)	1790
Configuring 802.1x with Local Web Authentication	1791
Configuring Local Web Authentication with PSK Protocol	1792
Central Web Authentication with PSK Protocol	1793
Configure WLAN Profile for Central Web Authentication with PSK Protocol	1793
Central Web Authentication with iPSK Protocol	1794
Configure WLAN Profile for Central Web Authentication with iPSK Protocol	1794
Configure Web Authentication on MAC Address Bypass failure (GUI)	1795
Configure Web Authentication on MAC Address Bypass Failure (CLI)	1795
Configure WLAN for Web Authentication on MAC Authentication Bypass Failure with Pre-Shared Key (CLI)	1797
Configure WLAN for Web Authentication on MAC Authentication Bypass Failure with OWE (CLI)	1798
Configure WLAN for Web Authentication on MAC Authentication Bypass Failure with Secure Agile Exchange (CLI)	1800
Configuring WLAN for Web Authentication on MAC Authentication Failure with Dot1x (CLI)	1801

**CHAPTER 185****Wired Guest Access 1803**

Information About Wired Guest Access	1803
Restrictions for Wired Guest Access	1806
Configuring Access Switch for Wired Guest Client	1806
Configuring Access Switch for Foreign Controller	1807

Configuring Foreign Controller with Open Authentication (GUI) 1808

Configuring Foreign Controller with Open Authentication 1808

Configuring Foreign Controller with Local Web Authentication (GUI) 1810

Configuring Foreign Controller with Local WEB Authentication 1811

Configuring Anchor Controller with Open Authentication (GUI) 1812

Configuring Anchor Controller with Open Authentication 1813

Configuring Anchor Controller with Local Web Authentication (GUI) 1814

Configuring Anchor Controller with Local Web Authentication 1815

Configuring Session Timeout for a Profile Policy 1816

Global Configuration (GUI) 1817

Verifying Wired Guest Configurations 1817

Wired Guest Access—Use Cases 1821

---

**CHAPTER 186**

**Express Wi-Fi by Facebook 1823**

Information About Express Wi-Fi by Facebook 1823

Restrictions for Express Wi-Fi by Facebook 1824

Enabling Express Wi-Fi by Facebook NAC for Policy Profile (GUI) 1824

Enabling Accounting RADIUS Server for Flex Profile (GUI) 1825

Configuring Captive Portal for Express Wi-Fi by Facebook (GUI) 1825

Configuring Captive Portal for Express Wi-Fi by Facebook (CLI) 1825

Configuring Express Wi-Fi by Facebook Policy on Controller (CLI) 1826

Configuring RADIUS Server for Accounting and Authentication in FlexConnect Profile (CLI) 1828

Verifying Express Wi-Fi by Facebook Configurations on Controller 1829

Verifying Express Wi-Fi by Facebook Configurations on the AP 1829

---

**CHAPTER 187**

**User Defined Network 1833**

Information About User Defined Network 1833

Restrictions for User Defined Network 1835

Configuring a User Defined Network 1835

Configuring a User Defined Network (GUI) 1836

Verifying User Defined Network Configuration 1837

---

**CHAPTER 188**

**Hotspot 2.0 1841**

Introduction to Hotspot 2.0 1841

Open Roaming	1843
Configuring Hotspot 2.0	1845
Configuring an Access Network Query Protocol Server	1845
Configuring ANQP Global Server Settings (GUI)	1848
Configuring Open Roaming (CLI)	1848
Configuring Open Roaming (GUI)	1849
Configuring NAI Realms (GUI)	1850
Configuring Organizational Identifier Alias (GUI)	1850
Configuring WAN Metrics (GUI)	1851
Configuring WAN Metrics	1851
Configuring Beacon Parameters (GUI)	1852
Configuring Authentication and Venue (GUI)	1853
Configuring 3GPP/Operator (GUI)	1854
Configuring OSU Provider (GUI)	1855
Configuring an Online Sign-Up Provider	1856
Configuring Hotspot 2.0 WLAN	1857
Configuring an Online Subscription with Encryption WLAN	1857
Attaching an ANQP Server to a Policy Profile	1858
Configuring Interworking for Hotspot 2.0	1859
Configuring the Generic Advertisement Service Rate Limit	1859
Configuring Global Settings	1860
Configuring Advice of Charge	1860
Configuring Terms and Conditions	1861
Defining ACL and URL Filter in AP for FlexConnect	1862
Configuring an OSEN WLAN (Single SSID)	1864
Verifying Hotspot 2.0 Configuration	1865
Verifying Client Details	1866
<b>CHAPTER 189</b>	<b>Client Roaming Across Policy Profile 1867</b>
	Information about Client Roaming Policy Profile 1867
	Configuring Client Roaming Across Policy Profile 1868
	Verifying Client Roaming Across Policy Profiles 1869
<b>CHAPTER 190</b>	<b>Assisted Roaming 1875</b>

802.11k Neighbor List and Assisted Roaming 1875

Restrictions for Assisted Roaming 1876

How to Configure Assisted Roaming 1876

    Configuring Assisted Roaming (GUI) 1876

    Configuring Assisted Roaming (CLI) 1877

Verifying Assisted Roaming 1878

Configuration Examples for Assisted Roaming 1878

---

CHAPTER 191

**802.11r BSS Fast Transition 1881**

Information About 802.11r Fast Transition 1881

Restrictions for 802.11r Fast Transition 1882

Monitoring 802.11r Fast Transition (CLI) 1883

Configuring 802.11r BSS Fast Transition on a Dot1x Security Enabled WLAN (CLI) 1884

Configuring 802.11r Fast Transition in an Open WLAN (CLI) 1885

Configuring 802.11r Fast Transition on a PSK Security–Enabled WLAN (CLI) 1887

Disabling 802.11r Fast Transition (GUI) 1888

Disabling 802.11r Fast Transition (CLI) 1888

---

CHAPTER 192

**802.11v 1889**

Information About 802.11v 1889

    Enabling 802.11v Network Assisted Power Savings 1889

Prerequisites for Configuring 802.11v 1890

Restrictions for 802.11v 1890

Enabling 802.11v BSS Transition Management 1890

Configuring 802.11v BSS Transition Management (GUI) 1891

Configuring 802.11v BSS Transition Management (CLI) 1891

---

PART XVIII

**Cisco DNA Service for Bonjour 1893**

---

CHAPTER 193

**Cisco DNA Service for Bonjour Solution Overview 1895**

About the Cisco DNA Service for Bonjour Solution 1895

Solution Components 1896

Supported Platforms 1897

Supported Network Design 1898



	Traditional Wired and Wireless Networks	1898
	Wired Networks	1899
	Wireless Networks	1901
	Cisco SD-Access Wired and Wireless Networks	1902
	BGP EVPN Networks	1904
<hr/>		
<b>CHAPTER 194</b>	<b>Configuring Local and Wide Area Bonjour Domains</b>	<b>1907</b>
	Cisco DNA Service for Bonjour Solution Overview	1907
	Restrictions	1907
	Cisco Wide Area Bonjour Service Workflow	1908
	Cisco Wide Area Bonjour Supported Network Design	1909
	Traditional Wired and Wireless Networks	1909
	Cisco SD Access Wired and Wireless Networks	1910
	Local and Wide Area Bonjour Policies	1910
	Default mDNS Service Configurations	1917
	HSRP-Aware mDNS Service-Routing	1917
	mDNS Service-Gateway SSO Support	1918
	Configuring Local and Wide Area Bonjour Domains	1919
	How to configure Multicast DNS Mode for LAN and Wired Networks	1919
	Enabling mDNS Gateway on the Device	1919
	Creating Custom Service Definition (GUI)	1920
	Creating Custom Service Definition	1920
	Creating Service List (GUI)	1921
	Creating Service List	1921
	Creating Service Policy (GUI)	1923
	Creating Service Policy	1923
	Associating Service Policy to an Interface	1924
	How to Configure Local Area Bonjour in Multicast DNS Mode for Wireless Networks	1925
	Enabling mDNS Gateway on the Device	1927
	Creating Custom Service Definition	1928
	Creating Service List	1929
	Creating Service Policy	1930
	Associating Service Policy with Wireless Profile Policy	1931
	Configuring Wide Area Bonjour Domain	1932

Enabling mDNS Gateway on the Device	1932
Creating Custom Service Definition	1933
Creating Service List	1934
Creating Service Policy	1935
Associating Service Policy with the Controller in Wide Area Bonjour Domain	1936
Configuring Hot Standby Router Protocol-aware (HSRP-aware) mDNS Service-Routing on SDG	1937
Configuring Hot Standby Router Protocol-aware (HSRP-aware) mDNS Service-Routing on Service-Peer (CLI)	1938
Verifying Local Area Bonjour in Multicast DNS Mode for LAN and Wireless Networks	1938
Verifying SDG-Agent Status	1938
Verifying Wide Area Bonjour Controller Status	1940
Verifying mDNS Cache Configurations	1941
Verifying Additional mDNS Cache Configurations	1942
Verifying Local Area Bonjour Configuration for LAN and Wireless Networks	1943
Additional References for DNA Service for Bonjour	1944
Feature History for Cisco DNA Service for Bonjour	1944

**CHAPTER 195**

<b>Configuring Local Area Bonjour for Wireless Local Mode</b>	<b>1947</b>
Overview of Local Area Bonjour for Wireless Local Mode	1947
Prerequisites for Local Area Bonjour for Wireless Local Mode	1947
Restrictions for Local Area Bonjour for Wireless Local Mode	1948
Understanding Local Area Bonjour for Wireless Local Mode	1948
Configuring Wireless AP Multicast	1949
Configuring Wireless AP Multicast (GUI)	1950
Configuring Wireless AP Multicast (CLI)	1950
Configuring Multicast in IP Network (CLI)	1951
Configuring Local Area Bonjour for Wireless Local Mode	1952
Configuring mDNS Service Policy (GUI)	1952
Configuring mDNS Service Policy (CLI)	1953
Configuring Custom Service Definition (GUI)	1955
Configuring Custom Service Definition (CLI)	1956
Configuring mDNS Gateway on WLAN (GUI)	1956
Configuring mDNS Gateway on WLAN (CLI)	1957
Configuring Service-Routing on Service-Peer	1957

Configuring Location-Based mDNS on Service-Peer (GUI)	1959
Configuring Location-Based mDNS on Service-Peer (CLI)	1961
Verifying mDNS Gateway Configuration	1963
Reference	1965

**CHAPTER 196****Configuring Local Area Bonjour for Wireless FlexConnect Mode 1967**

Overview of Local Area Bonjour for Wireless FlexConnect Mode	1967
Restrictions for Local Area Bonjour for Wireless FlexConnect Mode	1967
Prerequisites for Local Area Bonjour for Wireless FlexConnect Mode	1968
Understanding mDNS Gateway Alternatives for Wireless FlexConnect Mode	1968
Understanding Local Area Bonjour for Wireless FlexConnect Mode	1970
Configuring Local Area Bonjour for Wireless FlexConnect Mode	1972
Configuring mDNS Gateway Mode (CLI)	1972
Configuring mDNS Service Policy (CLI)	1973
Configuring mDNS Location-Filter (CLI)	1976
Configuring Custom Service Definition (CLI)	1979
Configuring Service-Routing on Service-Peer (CLI)	1980
Configuring Location-Based mDNS	1982
Configuring Service-Routing on SDG Agent (CLI)	1982
Verifying Local Area Bonjour in Service-Peer Mode	1984
Verifying Local Area Bonjour in SDG Agent Mode	1986
Reference	1988

**CHAPTER 197****Configuration Example for Local Mode - Wireless and Wired 1989**

Overview	1989
Configuring Wireless AP Multicast Mode	1990
Configuration Example for Default Service List and Policy in Wide Area Bonjour Between Multilayer Wired and Wireless Endpoints	1991
Example: Wired and Wireless Access Layer Service Peer Configuration	1991
Example: Wired and Wireless Distribution Layer SDG Agent Configuration	1992
Configuration Example for Customized Service List and Policy in Wide Area Bonjour Between Multilayer Wired and Wireless Endpoints	1993
Example: Wired and Wireless Access Layer Service Peer Configuration	1993
Example: Wired and Wireless Distribution Layer SDG Agent Configuration	1995

Cisco Catalyst Center Traditional Multilayer Wired and Wireless Configuration	1996
Configuring Service Filters for Traditional Multilayer Wired and Wireless - Local Mode (GUI)	1996
Configuring Source SDG Agents in Traditional Multilayer Wired and Wireless - Local Mode (GUI)	1997
Configuring Query SDG Agents in Traditional Multilayer Wired and Wireless - Local Mode (GUI)	1997
Verifying Wide Area Bonjour Between Multilayer Wired and Wireless Local Mode	1998
Verifying Wired Service-Peer Configuration	1998
Verifying Wired SDG Agent Configuration and Service-Routing Status	2000
Verifying Wireless Service-Peer Configuration and Service Status	2002
Verifying Wireless SDG Agent Configuration and Service-Routing Status	2003
Verifying Cisco Catalyst Center Configuration and Service-Routing Status	2004
Reference	2005

## CHAPTER 198

**Configuration Example for FlexConnect Mode - Wireless and Wired** 2007

Overview	2007
Configuration Example for Default Service List and Policy in FlexConnect Mode - Wireless and Wired	2008
Example: Wired and Wireless Access Layer Service Peer Configuration	2008
Example: Wired and Wireless Distribution Layer SDG Agent Configuration	2010
Configuration Example for Customized Service List and Policy in FlexConnect Mode - Wireless and Wired	2011
Example: Wired and Wireless Access Layer Service Peer Configuration	2011
Example: Wired and Wireless Distribution Layer SDG Agent Configuration	2012
Cisco Catalyst Center Traditional Multilayer Wired and Wireless Configuration	2013
Configuring Service Filters for Traditional Multilayer Wired and Wireless FlexConnect Local-Switching Mode (GUI)	2013
Configuring Source SDG Agents in Traditional Multilayer Wired and Wireless FlexConnect Local-Switching Mode (GUI)	2014
Configuring Query SDG Agents in Traditional Multilayer Wired and Wireless FlexConnect Local-Switching Mode (GUI)	2015
Verifying Configuration Example for FlexConnect Mode - Wireless and Wired	2015
Verifying Wired Service-Peer Configuration	2015
Verifying Wired SDG Agent Configuration and Service-Routing Status	2017
Verifying Cisco Catalyst Center Configuration and Service Routing Status	2019

Reference 2019

---

**PART XIX**

**Multicast Domain Name System 2021**

---

**CHAPTER 199**

**Multicast Domain Name System 2023**

- Introduction to mDNS Gateway 2024
- Guidelines and Restrictions for Configuring mDNS AP 2024
- Enabling mDNS Gateway (GUI) 2026
- Enabling or Disabling mDNS Gateway (GUI) 2026
- Enabling or Disabling mDNS Gateway (CLI) 2026
- Creating Default Service Policy 2028
- Creating Custom Service Definition (GUI) 2028
- Creating Custom Service Definition 2028
- Creating Service List (GUI) 2029
- Creating Service List 2030
- Creating Service Policy (GUI) 2032
- Creating Service Policy 2032
- Configuring a Local or Native Profile for an mDNS Policy 2033
- Configuring an mDNS Flex Profile (GUI) 2034
- Configuring an mDNS Flex Profile (CLI) 2034
- Applying an mDNS Flex Profile to a Wireless Flex Connect Profile (GUI) 2035
- Applying an mDNS Flex Profile to a Wireless Flex Connect Profile (CLI) 2036
- Enabling the mDNS Gateway on the VLAN Interface 2036
- Location-Based Service Filtering 2037
  - Prerequisite for Location-Based Service Filtering 2037
  - Configuring mDNS Location-Based Filtering Using SSID 2037
  - Configuring mDNS Location-Based Filtering Using AP Name 2038
  - Configuring mDNS Location-Based Filtering Using AP Location 2038
  - Configuring mDNS Location-Based Filtering Using Regular Expression 2039
- Configuring mDNS AP 2040
- Enabling mDNS Gateway on the RLAN Interface 2041
- Enabling mDNS Gateway on Guest LAN Interface 2043
- Associating mDNS Service Policy with Wireless Profile Policy (GUI) 2044
- Associating mDNS Service Policy with Wireless Profile Policy 2045

Enabling or Disabling mDNS Gateway for WLAN (GUI)	2048
Enabling or Disabling mDNS Gateway for WLAN	2048
mDNS Gateway with Guest Anchor Support and mDNS Bridging	2049
Configuring mDNS Gateway on Guest Anchor	2050
Configuring mDNS Gateway on Guest Foreign (Guest LAN)	2050
Configuring mDNS Gateway on Guest Anchor	2051
Configuring mDNS Gateway on Guest Foreign (Guest WLAN)	2052
Verifying mDNS Gateway Configurations	2052



## Preface

This preface describes the conventions of this document and information on how to obtain other documentation. It also provides information on what's new in Cisco product documentation.

- [Document Conventions](#) , on page lxxxvii
- [Related Documentation](#), on page lxxxix
- [Communications, Services, and Additional Information](#), on page lxxxix

## Document Conventions

This document uses the following conventions:

Convention	Description
^ or Ctrl	Both the ^ symbol and Ctrl represent the Control (Ctrl) key on a keyboard. For example, the key combination <b>^D</b> or <b>Ctrl-D</b> means that you hold down the Control key while you press the D key. (Keys are indicated in capital letters but are not case sensitive.)
<b>bold font</b>	Commands and keywords and user-entered text appear in <b>bold font</b> .
<i>Italic font</i>	Document titles, new or emphasized terms, and arguments for which you supply values are in <i>italic font</i> .
Courier font	Terminal sessions and information the system displays appear in <code>courier font</code> .
<b>Bold Courier font</b>	<b>Bold Courier font</b> indicates text that the user must enter.
[x]	Elements in square brackets are optional.
...	An ellipsis (three consecutive nonbolded periods without spaces) after a syntax element indicates that the element can be repeated.
	A vertical line, called a pipe, indicates a choice within a set of keywords or arguments.
[x   y]	Optional alternative keywords are grouped in brackets and separated by vertical bars.

Convention	Description
{x   y}	Required alternative keywords are grouped in braces and separated by vertical bars.
[x {y   z}]	Nested set of square brackets or braces indicate optional or required choices within optional or required elements. Braces and a vertical bar within square brackets indicate a required choice within an optional element.
string	A nonquoted set of characters. Do not use quotation marks around the string or the string will include the quotation marks.
<>	Nonprinting characters such as passwords are in angle brackets.
[ ]	Default responses to system prompts are in square brackets.
!, #	An exclamation point (!) or a pound sign (#) at the beginning of a line of code indicates a comment line.

### Reader Alert Conventions

This document may use the following conventions for reader alerts:



**Note** Means *reader take note*. Notes contain helpful suggestions or references to material not covered in the manual.



**Tip** Means *the following information will help you solve a problem*.



**Caution** Means *reader be careful*. In this situation, you might do something that could result in equipment damage or loss of data.



**Timesaver** Means *the described action saves time*. You can save time by performing the action described in the paragraph.



**Warning** IMPORTANT SAFETY INSTRUCTIONS

Before you work on any equipment, be aware of the hazards involved with electrical circuitry and be familiar with standard practices for preventing accidents. Read the installation instructions before using, installing, or connecting the system to the power source. Use the statement number provided at the end of each warning statement to locate its translation in the translated safety warnings for this device. Statement 1071

SAVE THESE INSTRUCTIONS



## Related Documentation



---

**Note** Before installing or upgrading the device, refer to the release notes at <https://www.cisco.com/c/en/us/support/wireless/catalyst-9800-series-wireless-controllers/products-release-notes-list.html>.

---

- Cisco Catalyst 9800-40 Wireless Controller documentation, located at:  
<http://www.cisco.com/go/c9800>
- Cisco Catalyst 9800-80 Wireless Controller documentation, located at:  
<http://www.cisco.com/go/c9800>
- Cisco Catalyst 9800-L Wireless Controller documentation, located at:  
<http://www.cisco.com/go/c9800>

## Communications, Services, and Additional Information

- To receive timely, relevant information from Cisco, sign up at [Cisco Profile Manager](#).
- To get the business impact you're looking for with the technologies that matter, visit [Cisco Services](#).
- To submit a service request, visit [Cisco Support](#).
- To discover and browse secure, validated enterprise-class apps, products, solutions, and services, visit [Cisco DevNet](#).
- To obtain general networking, training, and certification titles, visit [Cisco Press](#).
- To find warranty information for a specific product or product family, access [Cisco Warranty Finder](#).

## Cisco Bug Search Tool

[Cisco Bug Search Tool](#) (BST) is a gateway to the Cisco bug-tracking system, which maintains a comprehensive list of defects and vulnerabilities in Cisco products and software. The BST provides you with detailed defect information about your products and software.

## Documentation Feedback

To provide feedback about Cisco technical documentation, use the feedback form available in the right pane of every online document.





## CHAPTER 1

# Overview of Cisco 9800 Series Wireless Controllers

---

Cisco Catalyst 9800 Series Wireless Controllers are the next generation of wireless controllers built for the Intent-based networking. The Cisco Catalyst 9800 Series Controllers are IOS XE based and integrates the RF Excellence from Aironet with Intent-based Networking capabilities of IOS XE to create the best-in-class wireless experience for your evolving and growing organization.

The controllers are deployable in physical and virtual (private and public cloud) form factors and can be managed using Cisco Catalyst Center, Netconf/YANG, Cisco Prime Infrastructure, web-based GUI, or CLI.

The Cisco Catalyst 9800 Series Wireless Controllers are available in multiple form factors to cater to your deployment options:

- Cisco Catalyst 9800 Series Wireless Controller Appliance
- Cisco Catalyst 9800 Series Wireless Controller for Cloud
- Cisco Catalyst 9800 Embedded Wireless for Switch

The configuration data model is based on design principles of reusability, simplified provisioning, enhanced flexibility and modularization to help manage networks as they scale up and simplify the management of dynamically changing business and IT requirements.

- [Elements of the New Configuration Model, on page 1](#)
- [Configuration Workflow, on page 2](#)
- [Initial Setup, on page 3](#)
- [Interactive Help, on page 4](#)

## Elements of the New Configuration Model

The following diagram depicts the elements of the new configuration model.

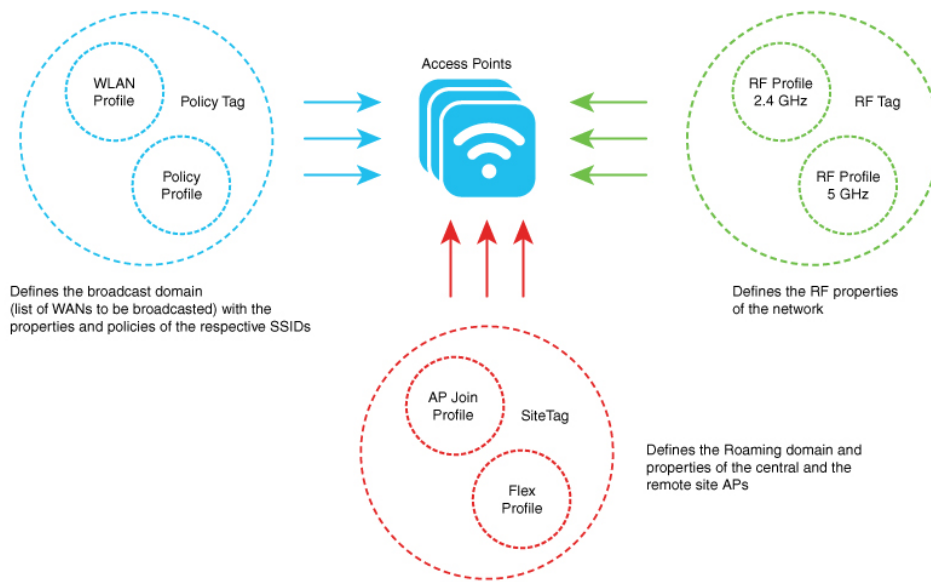

### Tags

The property of a tag is defined by the property of the policies associated to it, which in turn is inherited by an associated client or an AP. There are various type of tags, each of which is associated to different profiles. Every tag has a default that is created when the system boots up.

### Profiles

Profiles represent a set of attributes that are applied to the clients associated to the APs or the APs themselves. Profiles are reusable entities that can be used across tags.

## Configuration Workflow

The following set of steps defines the logical order of configuration. Apart from the WLAN profile, all the profiles and tags have a default object associated with it.

#### 1. Create the following profiles:

- WLAN
- Policy
- AP Join
- Flex
- RF

#### 2. Create the following tags:

- Policy
- Site

- RF

3. Associate tags to an AP.

Figure 1: Configuration Workflow

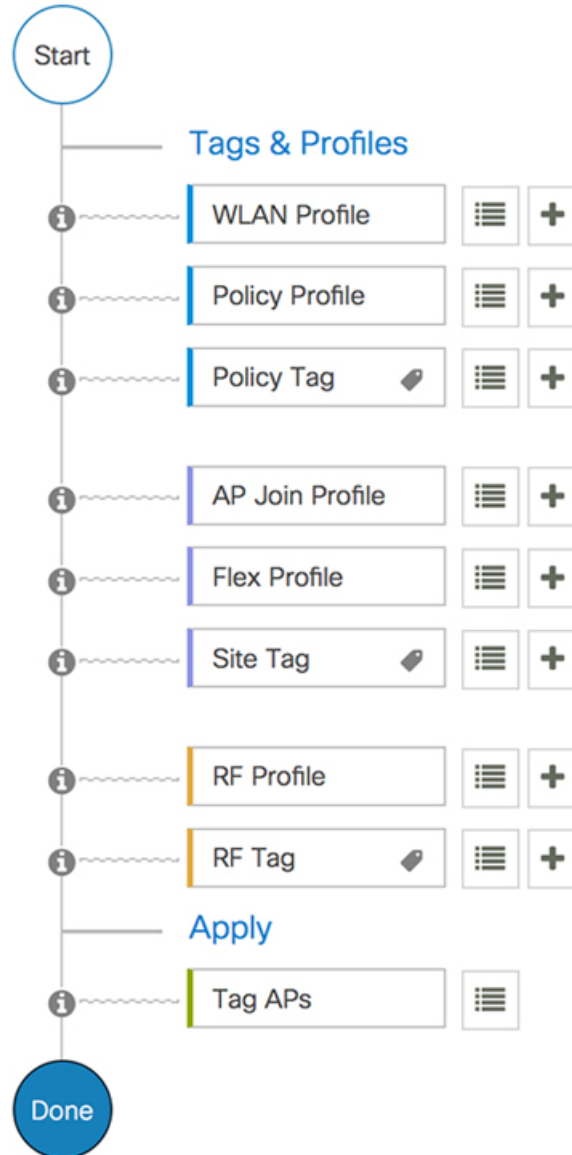

365513

# Initial Setup

## Setting up the Controller

The initial configuration wizard in Cisco Catalyst 9800 Series Wireless Controller is a simplified, out-of-the-box installation and configuration interface for controller. This section provides instructions to set up a controller

to operate in a small, medium, or large network wireless environment, where access points can join and together as a simple solution provide various services, such as corporate employee or guest wireless access on the network.

### Setting Up the Controller Using GUI

To set up the controller using GUI, see the *Configuring Wireless Controller* section in [Cisco Catalyst 9800 Wireless Controller Series Web UI Deployment Guide](#).



#### Note

- If you make configuration changes in the Command Line Interface (CLI) and in the GUI simultaneously, you must click the **Refresh** button in the GUI to synch both the changes. You should always click the **Refresh** button in the GUI, to update the changes done through CLI.
- The banner text is fetched from the controller when you land on the login page. You will be able to see this request on the RADIUS server.

### Setting Up the Controller Using CLI

To set up the controller using CLI, see the *Performing the Initial Configuration on the Controller* section of your respective controller installation guides.

- [Cisco Catalyst 9800-80 Wireless Controller Hardware Installation Guide](#)
- [Cisco Catalyst 9800-40 Wireless Controller Hardware Installation Guide](#)
- [Cisco Catalyst 9800-L Wireless Controller Hardware Installation Guide](#)
- [Cisco Catalyst 9800-CL Cloud Wireless Controller Installation Guide](#)

## Interactive Help

The Cisco Catalyst 9800 Series Wireless Controller GUI features an interactive help that walks you through the GUI and guides you through complex configurations.

You can start the interactive help in the following ways:

- By hovering your cursor over the blue flap at the right-hand corner of a window in the GUI and clicking **Interactive Help**.
- By clicking **Walk-me Thru** in the left pane of a window in the GUI.
- By clicking **Show me How** displayed in the GUI. Clicking **Show me How** triggers a specific interactive help that is relevant to the context you are in.

For instance, **Show me How** in **Configure > AAA** walks you through the various steps for configuring a RADIUS server. Choose **Configuration > Wireless Setup > Advanced** and click **Show me How** to trigger the interactive help that walks you through the steps relating to various kinds of authentication.

The following features have an associated interactive help:

- Configuring AAA

- Configuring FlexConnect Authentication
- Configuring 802.1x Authentication
- Configuring Local Web Authentication
- Configuring OpenRoaming
- Configuring Mesh APs



---

**Note** If the WalkMe launcher is unavailable on Safari, modify the settings as follows:

1. Choose **Preferences > Privacy**.
  2. In the **Website tracking** section, uncheck the **Prevent cross-site tracking** check box to disable this action.
  3. In the **Cookies and website data** section, uncheck the **Block all cookies** check box to disable this action.
-







## PART I

# System Configuration

- [New Configuration Model](#), on page 9
- [Wireless Management Interface](#), on page 43
- [BIOS Protection](#), on page 53
- [Smart Licensing Using Policy](#), on page 55
- [Boot Integrity Visibility](#), on page 165
- [Management over Wireless](#), on page 169
- [Link Aggregation Group](#), on page 171
- [Best Practices](#), on page 181





## CHAPTER 2

# New Configuration Model

---

- [Information About New Configuration Model](#), on page 9
- [Configuring a Wireless Profile Policy \(GUI\)](#), on page 12
- [Configuring a Wireless Profile Policy \(CLI\)](#), on page 12
- [Configuring a Flex Profile \(GUI\)](#), on page 13
- [Configuring a Flex Profile](#), on page 14
- [Configuring an AP Profile \(GUI\)](#), on page 15
- [Configuring an AP Profile \(CLI\)](#), on page 19
- [Configuring User for AP Management \(CLI\)](#), on page 21
- [Setting a Private Configuration Key for Password Encryption](#), on page 21
- [Configuring an RF Profile \(GUI\)](#), on page 22
- [Configuring an RF Profile \(CLI\)](#), on page 22
- [Configuring a Site Tag \(GUI\)](#), on page 23
- [Configuring a Site Tag \(CLI\)](#), on page 24
- [Configuring Policy Tag \(GUI\)](#), on page 25
- [Configuring a Policy Tag \(CLI\)](#), on page 25
- [Configuring Wireless RF Tag \(GUI\)](#), on page 26
- [Configuring Wireless RF Tag \(CLI\)](#), on page 27
- [Attaching a Policy Tag and Site Tag to an AP \(GUI\)](#), on page 28
- [Attaching Policy Tag and Site Tag to an AP \(CLI\)](#), on page 28
- [Configuring a Radio Profile](#), on page 29
- [AP Filter](#), on page 33
- [Configuring Access Point for Location Configuration](#), on page 37

## Information About New Configuration Model

The configuration of Cisco Catalyst 9800 Series Wireless Controllers is simplified using different tags, namely rf-tag, policy-tag, and site-tag. The access points would derive their configuration from the profiles that are contained within the tags.

Profiles are a collection of feature-specific attributes and parameters applied to tags. The rf-tag contains the radio profiles, the site-tag contains flex-profile and ap-join-profile, and the policy-tag contains the WLAN profile and policy profile.

The FlexConnect configuration helps the central controller to manage sites that are geo-distributed, for example, retail, campus, and so on.

### Policy Tag

The policy tag constitutes mapping of the WLAN profile to the policy profile. The WLAN profile defines the wireless characteristics of the WLAN. The policy profile defines the network policies and the switching policies for the client (Quality of Service [QoS] is an exception which constitutes AP policies as well).

The policy tag contains the map of WLAN policy profile. There are 16 such entries per policy tag. Changes to the map entries are effected based on the status of the WLAN profile and policy profile. For example, if a map (WLAN1 and Policy1) is added to the policy tag, and both the WLAN profile and the policy profile are enabled, the definitions are pushed to the APs using the policy tag. However, if one of them is in disabled state, the definition is not pushed to the AP. Similarly, if a WLAN profile is already being broadcast by an AP, it can be deleted using the no form of the command in the policy tag.

### Site Tag

The site tag defines the properties of a site and contains the flex profile and the AP join profile. The attributes that are specific to the corresponding flex or remote site are part of the flex profile. Apart from the flex profile, the site tag also comprises attributes that are specific to the physical site (and hence cannot be a part of the profile that is a reusable entity). For example, the list of primary APs for efficient upgrade is a part of a site tag rather than that of a flex profile.

If a flex profile name or an AP profile name is changed in the site tag, the AP is forced to rejoin the controller by disconnecting the Datagram Transport Layer Security (DTLS) session. When a site tag is created, the AP and flex profiles are set to default values (default-ap-profile and default-flex-profile).

### RF Tag

The RF tag contains the 2.4 GHz and 5 GHz RF profiles. The default RF tag contains the global configuration. Both these profiles contain the same default values for global RF profiles for the respective radios.

### Profiles

Profiles are a collection of feature-specific attributes and parameters applied to tags. Profiles are reusable entities that can be used across tags. Profiles (used by tags) define the properties of the APs or its associated clients.

### WLAN Profile

WLAN profiles are configured with same or different service set identifiers (SSIDs). An SSID identifies the specific wireless network for the controller to access. Creating WLANs with the same SSID allows to assign different Layer 2 security policies within the same wireless LAN.

To distinguish WLANs having the same SSID, create a unique profile name for each WLAN. WLANs with the same SSID must have unique Layer 2 security policies so that clients can select a WLAN based on the information advertised in the beacon and probe responses. The switching and network policies are not part of the WLAN definition.

### Policy Profile

Policy profile broadly consists of network and switching policies. Policy profile is a reusable entity across tags. Anything that is a policy for a client that is applied on an AP or controller is moved to the policy profile, for example, VLAN, ACL, QoS, session timeout, idle timeout, AVC profile, bonjour profile, local profiling, device classification, BSSID QoS, and so on. However, all the wireless-related security attributes and features on the WLAN are grouped under the WLAN profile.

## Flex Profile

Flex profile contains policy attributes and remote site-specific parameters. For example, the EAP profiles that can be used when the AP acts as an authentication server for local RADIUS server information, VLAN-ACL mapping, VLAN name-to-ID mapping, and so on.

## AP Join Profile

The default AP join profile values will have the global AP parameters and the AP group parameters. The AP join profile contains attributes that are specific to AP, such as CAPWAP, IPv4 and IPv6, UDP Lite, High Availability, Retransmit config parameters, Global AP failover, Hyperlocation config parameters, Telnet and SSH, 11u parameters, and so on.



---

**Note** Telnet is not supported for the following Cisco AP models: 1542D, 1542I, 1562D, 1562E, 1562I, 1562PS, 1800S, 1800T, 1810T, 1810W, 1815M, 1815STAR, 1815TSN, 1815T, 1815W, 1832I, 1840I, 1852E, 1852I, 2802E, 2802I, 2802H, 3700C, 3800, 3802E, 3802I, 3802P, 4800, IW6300, ESW6300, 9105AXI, 9105AXW, 9115AXI, 9115AXE, 9117I, APVIRTUAL, 9120AXI, 9120AXE, 9124AXI, 9124AXD, 9130AXI, 9130AXE, 9136AXI, 9162I, 9164I, and 9166I.

---

## RF Profile

RF profile contains the common radio configuration for the APs. RF profiles are applied to all the APs that belong to an AP group, where all the APs in that group have the same profile settings.

## Association of APs

APs can be associated using different ways. The default option is by using Ethernet MAC address, where the MAC is associated with policy-tag, site tag, and RF tag.

In filter-based association, APs are mapped using regular expressions. A regular expression (regex) is a pattern to match against an input string. Any number of APs matching that regex will have policy-tag, site tag, and RF tag mapped to them, which is created as part of the AP filter.

In AP-based association, tag names are configured at the PnP server and the AP stores them and sends the tag name as part of discovery process.

In location-based association, tags are mapped as per location and are pushed to any AP Ethernet MAC address mapped to that location.

## Modifying AP Tags

Modifying an AP tag results in DTLS connection reset, forcing the AP to rejoin the controller. If only one tag is specified in the configuration, default tags are used for other types, for example, if only policy tag is specified, the default-site-tag and default-rf-tag will be used for site tag and RF tag.

## Configuring a Wireless Profile Policy (GUI)

### Procedure

---

- Step 1** Choose **Configuration** > **Tags & Profiles** > **Policy**.
- Step 2** On the **Policy Profile** page, click **Add**.
- Step 3** In the **Add Policy Profile** window, in **General** tab, enter a name and description for the policy profile. The name can be ASCII characters from 32 to 126, without leading and trailing spaces. Do not use spaces as it causes system instability.
- Step 4** To enable the policy profile, set **Status** as **Enabled**.
- Step 5** Use the slider to enable or disable **Passive Client** and **Encrypted Traffic Analytics**.
- Step 6** In the **CTS Policy** section, choose the appropriate status for the following:
- Inline Tagging—a transport mechanism using which a controller or access point understands the source SGT.
  - SGACL Enforcement
- Step 7** Specify a default **SGT**. The valid range is from 2 to 65519.
- Step 8** In the **WLAN Switching Policy** section, choose the following, as required:
- Central Switching: Tunnels both the wireless user traffic and all control traffic via CAPWAP to the centralized controller where the user traffic is mapped to a dynamic interface/VLAN on the controller. This is the normal CAPWAP mode of operation.
  - Central Authentication: Tunnels client data to the controller, as the controller handles client authentication.
  - Central DHCP: The DHCP packets received from AP are centrally switched to the controller and then forwarded to the corresponding VLAN based on the AP and the SSID.
  - Central Association Enable: When central association is enabled, all switching is done on the controller.
  - Flex NAT/PAT: Enables Network Address Translation(NAT) and Port Address Translation (PAT) mode.
- Step 9** Click **Save & Apply to Device**.
- 

## Configuring a Wireless Profile Policy (CLI)

Follow the procedure given below to configure a wireless profile policy:



---

**Note** When a client moves from an old controller to a new controller (managed by Cisco Prime Infrastructure), the old IP address of the client is retained, if the IP address is learned by ARP or data gleaning. To avoid this scenario, ensure that you enable **ipv4 dhcp required** command in the policy profile. Otherwise, the IP address gets refreshed only after a period of 24 hours.

---

## Procedure

	Command or Action	Purpose
<b>Step 1</b>	<b>configure terminal</b> <b>Example:</b> Device# configure terminal	Enters global configuration mode.
<b>Step 2</b>	<b>wireless profile policy <i>profile-policy</i></b> <b>Example:</b> Device(config)# wireless profile policy rr-xyz-policy-1	Configures WLAN policy profile and enters wireless policy configuration mode.
<b>Step 3</b>	<b>idle-timeout <i>timeout</i></b> <b>Example:</b> Device(config-wireless-policy)# idle-timeout 1000	(Optional) Configures the duration of idle timeout, in seconds.
<b>Step 4</b>	<b>vlan <i>vlan-id</i></b> <b>Example:</b> Device(config-wireless-policy)# vlan 24	Configures VLAN name or VLAN ID.
<b>Step 5</b>	<b>accounting-list <i>list-name</i></b> <b>Example:</b> Device(config-wireless-policy)# accounting-list user1-list	Sets the accounting list for IEEE 802.1x.
<b>Step 6</b>	<b>no shutdown</b> <b>Example:</b> Device(config-wireless-policy)# no shutdown	Saves the configuration and exits configuration mode and returns to privileged EXEC mode.
<b>Step 7</b>	<b>show wireless profile policy summary</b> <b>Example:</b> Device# show wireless profile policy summary	Displays the configured policy profiles. <b>Note</b> (Optional) To view detailed information about a policy profile, use the <b>show wireless profile policy detailed <i>policy-profile-name</i></b> command.

## Configuring a Flex Profile (GUI)

## Procedure

- 
- Step 1** Choose **Configuration > Tags & Profiles > Flex**.
- Step 2** Click **Add**.

- Step 3** Enter the **Name** of the Flex Profile. The name can be ASCII characters from 32 to 126, without leading and trailing spaces.
- Step 4** In the **Description** field, enter a description for the Flex Profile.
- Step 5** Click **Apply to Device**.

## Configuring a Flex Profile

Follow the procedure given below to set a flex profile:

### Procedure

	Command or Action	Purpose
<b>Step 1</b>	<b>configure terminal</b> <b>Example:</b> Device# configure terminal	Enters global configuration mode.
<b>Step 2</b>	<b>wireless profile flex <i>flex-profile</i></b> <b>Example:</b> Device(config)# wireless profile flex rr-xyz-flex-profile	Configures a Flex profile and enters Flex profile configuration mode.
<b>Step 3</b>	<b>description</b> <b>Example:</b> Device(config-wireless-flex-profile)# description xyz-default-flex-profile	(Optional) Enables default parameters for the flex profile.
<b>Step 4</b>	<b>arp-caching</b> <b>Example:</b> Device(config-wireless-flex-profile)# arp-caching	(Optional) Enables ARP caching.
<b>Step 5</b>	<b>end</b> <b>Example:</b> Device(config-wireless-flex-profile)# end	Saves the configuration and exits configuration mode and returns to privileged EXEC mode.
<b>Step 6</b>	<b>show wireless profile flex summary</b> <b>Example:</b> Device# show wireless profile flex summary	(Optional) Displays the flex-profile parameters. <b>Note</b> To view detailed parameters about the flex profile, use the <b>show wireless profile flex detailed <i>flex-profile-name</i></b> command.



# Configuring an AP Profile (GUI)

## Before you begin

The default AP join profile values will have the global AP parameters and the AP group parameters. The AP join profile contains attributes that are specific to AP, such as CAPWAP, IPv4/IPv6, UDP Lite, High Availability, retransmit configuration parameters, global AP failover, Hyperlocation configuration parameters, Telnet/SSH, 11u parameters, and so on.

## Procedure

**Step 1** Choose **Configuration > Tags & Profiles > AP Join**.

**Step 2** On the **AP Join Profile** page, click **Add**.

The **Add AP Join Profile** page is displayed.

**Note** DHCP fallback is enabled by default. So, if an AP is assigned a static IP address and unable to reach the controller, the AP falls back to the DHCP. To stop an AP from moving the static IP to DHCP, you must disable the DHCP fallback configuration in an AP join profile.

**Step 3** In the **General** tab, enter a name and description for the AP join profile. The name can be ASCII characters from 32 to 126, without leading and trailing spaces.

**Step 4** Check the **LED State** check box to set the LED state of all APs connected to the device to blink so that the APs are easily located. The LED state is enabled by default.

**Step 5** In the **Client** tab and **Statistics Timer** section, enter the time in seconds that the AP sends its 802.11 statistics to the controller.

**Step 6** In the **TCP MSS Configuration** section, check the **Adjust MSS Enable** check box to enter value for Adjust MSS. You can enter or update the maximum segment size (MSS) for transient packets that traverse a router. TCP MSS adjustment enables the configuration of the maximum segment size (MSS) for transient packets that traverse a router, specifically TCP segments with the SYN bit set.

In a CAPWAP environment, a lightweight access point discovers a device by using CAPWAP discovery mechanisms, and then sends a CAPWAP join request to the device. The device sends a CAPWAP join response to the access point that allows the access point to join the device.

When the access point joins the device, the device manages its configuration, firmware, control transactions, and data transactions.

**Step 7** In the **CAPWAP** tab, you can configure the following:

- High Availability

You can configure primary and secondary backup controllers for all access points (which are used if primary, secondary, or tertiary controllers are not responsive) in this order: primary, secondary, tertiary, primary backup, and secondary backup. In addition, you can configure various timers, including heartbeat timers and discovery request timers. To reduce the controller failure detection time, you can configure the fast heartbeat interval (between the controller and the access point) with a smaller timeout value. When the fast heartbeat timer expires (at every heartbeat interval), the access point determines if any data packets have been received from the controller within the last interval. If no packets have been received, the access point sends a fast echo request to the controller.

- a) In the **High Availability** tab, enter the time (in seconds) in the **Fast Heartbeat Timeout** field to configure the heartbeat timer for all access points. Specifying a small heartbeat interval reduces the amount of time it takes to detect device failure.
- Note** Configure **Fast Heartbeat Timeout** to assist AP in sending primary discovery request periodically to the configured backup controllers along with the primary, secondary, and tertiary-base controllers.
- b) In the **Heartbeat Timeout** field, enter the time (in seconds) to configure the heartbeat timer for all access points. Specifying a small heartbeat interval reduces the amount of time it takes to detect device failure.
  - c) In the **Discovery Timeout** field, enter a value between 1 and 10 seconds (inclusive) to configure the AP discovery request timer.
  - d) In the **Primary Discovery Timeout** field, enter a value between 30 and 3000 seconds (inclusive) to configure the access point primary discovery request timer.
  - e) In the **Primed Join Timeout** field, enter a value between 120 and 43200 seconds (inclusive) to configure the access point primed join timeout.
  - f) In the **Retransmit Timers Count** field, enter the number of times that you want the AP to retransmit the request to the device and vice-versa. Valid range is between 3 and 8.
  - g) In the **Retransmit Timers Interval** field, enter the time duration between retransmission of requests. Valid range is between 2 and 5.
  - h) Check the **Enable Fallback** check box to enable fallback.
  - i) Enter the **Primary Controller** name and IP address.
  - j) Enter the **Secondary Controller** name and IP address.
  - k) Click **Save & Apply to Device**.

**Note** The primary and secondary settings in the AP join profile are not used for AP fallback. This means that the AP will not actively probe for those controllers (which are a part of the AP join profile), when it has joined one of them.

This setting is used only when the AP loses its connection with the controller, and then prioritizes which other controller it should join. These controllers have a priority of 4 and 5, following APs in the **High Availability** tab of the AP page.

The APs that are added as the primary, secondary, and tertiary APs in the **High Availability** tab of the AP configuration page, are actively probed and are used for the AP fallback option.

- Advanced

- a) In the **Advanced** tab, check the **Enable VLAN Tagging** check box to enable VLAN tagging.
- b) Check the **Enable Data Encryption** check box to enable Datagram Transport Layer Security (DTLS) data encryption.
- c) Check the **Enable Jumbo MTU** to enable big maximum transmission unit (MTU). MTU is the largest physical packet size, measured in bytes, that a network can transmit. Any messages larger than the MTU are divided into smaller packets before transmission. Jumbo frames are frames that are bigger than the standard Ethernet frame size, which is 1518 bytes (including Layer 2 (L2) header and FCS). The definition of frame size is vendor-dependent, as these are not part of the IEEE standard.
- d) Use the **Link Latency** drop-down list to select the link latency. Link latency monitors the round-trip time of the CAPWAP heartbeat packets (echo request and response) from the AP to the controller and back.
- e) From the **Preferred Mode** drop-down list, choose the mode.
- f) Click **Save & Apply to Device**.

### Step 8

In the **AP** tab, you can configure the following:

- General

- In the **General** tab, check the **Switch Flag** check box to enable switches.
- Check the **Power Injector State** check box if power injector is being used. Power Injector increases wireless LAN deployment flexibility of APs by providing an alternative powering option to local power, inline power-capable multiport switches, and multiport power patch panels.

Power Injector Selection parameter enables you to protect your switch port from an accidental overload if the power injector is inadvertently bypassed.

- From the **Power Injector Type** drop-down list, choose power injector type from the following options:
  - **Installed**—This option examines and remembers the MAC address of the currently connected switch port and assumes that a power injector is connected. Choose this option if your network contains older Cisco 6-Watt switches and you want to avoid possible overloads by forcing a double-check of any relocated access points.

If you want to configure the switch MAC address, enter the MAC address in the Injector Switch MAC Address text box. If you want the access point to find the switch MAC address, leave the Injector Switch MAC Address text box blank.

**Note** Each time an access point is relocated, the MAC address of the new switch port fails to match the remembered MAC address, and the access point remains in low-power mode. You must then physically verify the existence of a power injector and reselect this option to cause the new MAC address to be remembered.

- **Override**—This option allows the access point to operate in high-power mode without first verifying a matching MAC address. You can use this option if your network does not contain any older Cisco 6-W switches that could be overloaded if connected directly to a 12-W access point. The advantage of this option is that if you relocate the access point, it continues to operate in high-power mode without any further configuration. The disadvantage of this option is that if the access point is connected directly to a 6-W switch, an overload occurs.

- In the **Injector Switch MAC** field, enter the MAC address of the switch either in xx:xx:xx:xx:xx:xx, xx-xx-xx-xx-xx-xx, or xxxx.xxxx.xxxx format.
- From the **EAP Type** drop-down list, choose the EAP type as *EAP-FAST*, *EAP-TLS*, or *EAP-PEAP*.
- From the **AP Authorization Type** drop-down list, choose the type as either *CAPWAP DTLS +* or *CAPWAP DTLS*.
- In the **Client Statistics Reporting Interval** section, enter the interval for 5 GHz and 2.4 GHz radios in seconds.
- Check the **Enable** check box to enable extended module.
- From the **Profile Name** drop-down list, choose a profile name for mesh.
- Click **Save & Apply to Device**.

- **Hyperlocation**: Cisco Hyperlocation is a location solution that allows to track the location of wireless clients with the accuracy of one meter. Selecting this option disables all other fields in the screen, except NTP Server.

- In the **Hyperlocation** tab, check the **Enable Hyperlocation** check box.
- Enter the **Detection Threshold** value to filter out packets with low RSSI. The valid range is -100 dBm to -50 dBm.
- Enter the **Trigger Threshold** value to set the number of scan cycles before sending a BAR to clients. The valid range is 0 to 99.

- d) Enter the **Reset Threshold** value to reset value in scan cycles after trigger. The valid range is 0 to 99.
- e) Enter the **NTP Server** IP address.
- f) Click **Save & Apply to Device**.
  - BLE: If your APs are Bluetooth Low Energy (BLE) enabled, they can transmit beacon messages that are packets of data or attributes transmitted over a low energy link. These BLE beacons are frequently used for health monitoring, proximity detection, asset tracking, and in-store navigation. For each AP, you can customize BLE Beacon settings configured globally for all APs.
- a) In the **BLE** tab, enter a value in the **Beacon Interval** field to indicate how often you want your APs to send out beacon advertisements to nearby devices. The range is from 1 to 10, with a default of 1.
- b) In the **Advertised Attenuation Level** field, enter the attenuation level. The range is from 40 to 100, with a default of 59.
- c) Click **Save & Apply to Device**.
  - Packet Capture: Packet Capture feature allows to capture the packets on the AP for the wireless client troubleshooting. The packet capture operation is performed on the AP by the radio drivers on the current channel on which it is operational, based on the specified packet capture filter.
- a) In the **Packet Capture** tab, choose an **AP Packet Capture Profile** from the drop-down list.
- b) You can also create a new profile by clicking the + sign.
- c) Enter a name and description for the AP packet capture profile.
- d) Enter the **Buffer Size**.
- e) Enter the **Duration**.
- f) Enter the **Truncate Length** information.
- g) In the **Server IP** field, enter the IP address of the TFTP server.
- h) In the **File Path** field, enter the directory path.
- i) Enter the username and password details.
- j) From the **Password Type** drop-down list, choose the type.
- k) In the **Packet Classifiers** section, use the option to select or enter the packets to be captured.
- l) Click **Save**.
- m) Click **Save & Apply to Device**.

**Step 9**

In the **Management** tab, you can configure the following:

- Device
  - a) In the **Device** tab, enter the **IPv4/IPv6 Address** of the TFTP server, **TFTP Downgrade** section.
  - b) In the **Image File Name** field, enter the name of the software image file.
  - c) From the **Facility Value** drop-down list, choose the appropriate facility.
  - d) Enter the IPv4 or IPv6 address of the host.
  - e) Choose the appropriate **Log Trap Value**.
  - f) Enable Telnet and/or SSH configuration, if required.
  - g) Enable core dump, if required.
  - h) Click **Save & Apply to Device**.
- User
  - a) In the **User** tab, enter username and password details.
  - b) Choose the appropriate password type.
  - c) In the **Secret** field, enter a custom secret code.

- d) Choose the appropriate secret type.
- e) Choose the appropriate encryption type.
- f) Click **Save & Apply to Device**.
  - Credentials
    - a) In the **Credentials** tab, enter local username and password details.
    - b) Choose the appropriate local password type.
    - c) Enter 802.1x username and password details.
    - d) Choose the appropriate 802.1x password type.
    - e) Enter the time in seconds after which the session should expire.
    - f) Enable local credentials and/or 802.1x credentials as required.
    - g) Click **Save & Apply to Device**.
      - CDP Interface
        - a) In the **CDP Interface** tab, enable the CDP state, if required.
        - b) Click **Save & Apply to Device**.

**Step 10** In the **Rogue AP** tab, check the **Rogue Detection** check box to enable rogue detection.

**Step 11** In the **Rogue Detection Minimum RSSI** field, enter the RSSI value.

This field specifies the minimum RSSI value for which a Rogue AP should be reported. All Rogue APs with RSSI lower than what is configured will not be reported to controller.

**Step 12** In the **Rogue Detection Transient Interval** field, enter the transient interval value.

This field indicates how long the Rogue AP should be seen before reporting the controller.

**Step 13** In the **Rogue Detection Report Interval** field, enter the report interval value.

This field indicates the frequency (in seconds) of Rogue reports sent from AP to controller.

**Step 14** Check the **Rogue Containment Automatic Rate Selection** check box to enable rogue containment automatic rate selection.

Here, the AP selects the best rate for the target Rogue, based on its RSSI.

**Step 15** Check the **Auto Containment on FlexConnect Standalone** check box to enable the feature.

Here, the AP will continue containment in case it moves to FlexConnect standalone mode.

**Step 16** Click **Save & Apply to Device**.

---

## Configuring an AP Profile (CLI)

Follow the procedure given below to configure and AP profile:

## Procedure

	Command or Action	Purpose
<b>Step 1</b>	<b>configure terminal</b> <b>Example:</b> Device# configure terminal	Enters global configuration mode.
<b>Step 2</b>	<b>ap profile <i>ap-profile</i></b> <b>Example:</b> Device(config)# ap profile xyz-ap-profile	Configures an AP profile and enters AP profile configuration mode. <b>Note</b> In an AP profile, the <b>EAP-FAST</b> is the default EAP type. <b>Note</b> When you delete a named profile, the APs associated with that profile will not revert to the default profile.
<b>Step 3</b>	<b>description <i>ap-profile-name</i></b> <b>Example:</b> Device(config-ap-profile)# description "xyz ap profile"	Adds a description for the ap profile.
<b>Step 4</b>	<b>ip dhcp fallback</b> <b>Example:</b> Device(config-ap-profile)# ip dhcp fallback	Configures DHCP fallback. <b>Note</b> DHCP fallback is enabled by default. So, if an AP is assigned a static IP address and unable to reach the controller, the AP falls back to the DHCP. To stop an AP from moving the static IP to DHCP, you must disable the DHCP fallback configuration in an AP join profile.
<b>Step 5</b>	<b>cdp</b> <b>Example:</b> Device(config-ap-profile)# cdp	Enables CDP for all Cisco APs.
<b>Step 6</b>	<b>end</b> <b>Example:</b> Device(config-ap-profile)# end	Saves the configuration and exits configuration mode and returns to privileged EXEC mode.
<b>Step 7</b>	<b>show ap profile name <i>profile-name</i> detailed</b> <b>Example:</b> Device# show ap profile name xyz-ap-profile detailed	(Optional) Displays detailed information about an AP join profile.

## Configuring User for AP Management (CLI)

Follow the procedure given below to configure a user for the AP management:

### Procedure

	Command or Action	Purpose
<b>Step 1</b>	<b>configure terminal</b>  <b>Example:</b> Device# configure terminal	Enters global configuration mode.
<b>Step 2</b>	<b>ap profile <i>ap-profile</i></b>  <b>Example:</b> Device(config)# ap profile default-ap-profile	Configures an AP profile and enters AP profile configuration mode.
<b>Step 3</b>	<b>mgmtuser username &lt;username&gt; password {0   8} &lt;password&gt;</b>  <b>Example:</b> Device(config-ap-profile)# mgmtuser username myusername password 0 12345678	Specifies the AP management username and password for managing all of the access points configured to the controller.  <ul style="list-style-type: none"> <li>• <b>0</b>: Specifies an UNENCRYPTED password.</li> <li>• <b>8</b>: Specifies an AES encrypted password.</li> </ul> <p><b>Note</b> While configuring an username, ensure that special characters are not used as it results in error with bad configuration.</p>
<b>Step 4</b>	<b>end</b>  <b>Example:</b> Device(configure-ap-profile)# end	Returns to privileged EXEC mode.

## Setting a Private Configuration Key for Password Encryption

Follow the procedure given below to set a private configuration key for password encryption:

### Procedure

	Command or Action	Purpose
<b>Step 1</b>	<b>configure terminal</b>  <b>Example:</b> Device# configure terminal	Enters global configuration mode.

	Command or Action	Purpose
<b>Step 2</b>	<b>key config-key password encrypt key</b> <code>&lt;config-key&gt;</code>  <b>Example:</b> <pre>Device(config)# key config-key password-encrypt 12345678</pre>	Sets the password encryption keyword.  Here, <i>config-key</i> refers to any key value with minimum 8 characters.  <b>Note</b> The <i>config-key</i> value must not begin with the following special characters:  !, #, and ;
<b>Step 3</b>	<b>password encryption aes</b>  <b>Example:</b> <pre>Device(config)# password encryption aes</pre>	Enables the encrypted preshared key.
<b>Step 4</b>	<b>end</b>  <b>Example:</b> <pre>Device(config)# end</pre>	Returns to privileged EXEC mode. Alternatively, you can also press <b>Ctrl-Z</b> to exit global configuration mode.

## Configuring an RF Profile (GUI)

### Procedure

- 
- Step 1** Choose **Configuration > Tags & Profiles > RF**.
  - Step 2** On the **RF Profile** page, click **Add**.
  - Step 3** In the **General** tab, enter a name for the RF profile. The name can be ASCII characters from 32 to 126, without leading and trailing spaces.
  - Step 4** Choose the appropriate **Radio Band**.
  - Step 5** To enable the profile, set the status as **Enable**.
  - Step 6** Enter a **Description** for the RF profile.
  - Step 7** Click **Save & Apply to Device**.
- 

## Configuring an RF Profile (CLI)

Follow the procedure given below to configure an RF profile:

### Before you begin

Ensure that you use the same RF profile name that you create here, when configuring the wireless RF tag too. If there is a mismatch in the RF profile name (for example, if the RF tag contains an RF profile that does not exist), the corresponding radios will not come up.



## Procedure

	Command or Action	Purpose
<b>Step 1</b>	<b>configure terminal</b> <b>Example:</b> Device# configure terminal	Enters global configuration mode.
<b>Step 2</b>	<b>ap dot11 24ghz rf-profile rf-profile</b> <b>Example:</b> Device(config)# ap dot11 24ghz rf-profile rfprof24_1	Configures an RF profile and enters RF profile configuration mode. <b>Note</b> Use the <b>24ghz</b> command to configure the 802.11b parameters. Use the <b>5ghz</b> command to configure the 802.11a parameters.
<b>Step 3</b>	<b>default</b> <b>Example:</b> Device(config-rf-profile)# default	(Optional) Enables default parameters for the RF profile.
<b>Step 4</b>	<b>no shutdown</b> <b>Example:</b> Device(config-rf-profile)# no shutdown	Enables the RF profile on the device.
<b>Step 5</b>	<b>end</b> <b>Example:</b> Device(config-rf-profile)# end	Exits configuration mode and returns to privileged EXEC mode.
<b>Step 6</b>	<b>show ap rf-profile summary</b> <b>Example:</b> Device# show ap rf-profile summary	(Optional) Displays the summary of the available RF profiles.
<b>Step 7</b>	<b>show ap rf-profile name rf-profile detail</b> <b>Example:</b> Device# show ap rf-profile name rfprof24_1 detail	(Optional) Displays detailed information about a particular RF profile.

## Configuring a Site Tag (GUI)

## Procedure

- 
- Step 1** Choose **Configuration > Tags & Profiles > Tags**.
- Step 2** On the **Manage Tags** page, click the **Site** tab.
- Step 3** Click **Add** to view the **Add Site Tag** window.
- Step 4** Enter a name and description for the site tag. The name can be ASCII characters from 32 to 126, without leading and trailing spaces.

- Step 5** Choose the required **AP Join Profile** to be attached to the site tag.
- Step 6** Choose the required **Control Plane Name**.
- Step 7** If required, enable the **Local Site**.  
Disabling Local Site means that the site is remote and the deployment is FlexConnect mode.
- Step 8** Click **Save & Apply to Device**.

## Configuring a Site Tag (CLI)

Follow the procedure given below to configure a site tag:

### Procedure

	Command or Action	Purpose
<b>Step 1</b>	<b>configure terminal</b> <b>Example:</b> Device# configure terminal	Enters global configuration mode.
<b>Step 2</b>	<b>wireless tag site <i>site-name</i></b> <b>Example:</b> Device(config)# wireless tag site rr-xyz-site	Configures a site tag and enters site tag configuration mode.
<b>Step 3</b>	<b>flex-profile <i>flex-profile-name</i></b> <b>Example:</b> Device(config-site-tag)# flex-profile rr-xyz-flex-profile	Configures a flex profile. <b>Note</b> You cannot remove the flex profile configuration from a site tag if local site is configured on the site tag. <b>Note</b> The <b>no local-site</b> command needs to be used to configure the Site Tag as Flexconnect, otherwise the Flex profile config does not take effect.
<b>Step 4</b>	<b>description <i>site-tag-name</i></b> <b>Example:</b> Device(config-site-tag)# description "default site tag"	Adds a description for the site tag.
<b>Step 5</b>	<b>end</b> <b>Example:</b> Device(config-site-tag)# end	Saves the configuration and exits configuration mode and returns to privileged EXEC mode.
<b>Step 6</b>	<b>show wireless tag site summary</b> <b>Example:</b>	(Optional) Displays the number of site tags.

	Command or Action	Purpose
	Device# show wireless tag site summary	<p><b>Note</b> To view detailed information about a site, use the <b>show wireless tag site detailed</b> <i>site-tag-name</i> command.</p> <p><b>Note</b> The output of the <b>show wireless loadbalance tag affinity wncd</b> <i>wncd-instance-number</i> command displays default tag (site-tag) type, if both site tag and policy tag are not configured.</p>

## Configuring Policy Tag (GUI)

### Procedure

- 
- Step 1** Choose **Configuration > Tags & Profiles > Tags > Policy**.
- Step 2** Click **Add** to view the **Add Policy Tag** window.
- Step 3** Enter a name and description for the policy tag. The name can be ASCII characters from 32 to 126, without leading and trailing spaces.
- Step 4** Click **Add** to map WLAN and policy.
- Step 5** Choose the WLAN profile to map with the appropriate policy profile, and click the tick icon.
- Step 6** Click **Save & Apply to Device**.
- 

## Configuring a Policy Tag (CLI)

Follow the procedure given below to configure a policy tag:

### Procedure

	Command or Action	Purpose
<b>Step 1</b>	<p><b>enable</b></p> <p><b>Example:</b></p> <pre>Device&gt; enable</pre>	<p>Enables privileged EXEC mode.</p> <ul style="list-style-type: none"> <li>• Enter your password if prompted.</li> </ul>
<b>Step 2</b>	<p><b>configure terminal</b></p> <p><b>Example:</b></p> <pre>Device# configure terminal</pre>	<p>Enters global configuration mode.</p>

	Command or Action	Purpose
<b>Step 3</b>	<b>wireless tag policy</b> <i>policy-tag-name</i> <b>Example:</b> <pre>Device(config-policy-tag)# wireless tag policy default-policy-tag</pre>	Configures policy tag and enters policy tag configuration mode. <b>Note</b> When performing LWA, the clients connected to a controller gets disconnected intermittently before session timeout.
<b>Step 4</b>	<b>description</b> <i>description</i> <b>Example:</b> <pre>Device(config-policy-tag)# description "default-policy-tag"</pre>	Adds a description to a policy tag.
<b>Step 5</b>	<b>remote-lan</b> <i>name</i> <b>policy</b> <i>profile-policy-name</i> <b>{ext-module  port-id }</b> <b>Example:</b> <pre>Device(config-policy-tag)# remote-lan rr-xyz-rlan-aa policy rr-xyz-rlan-policy1 port-id 2</pre>	Maps a remote-LAN profile to a policy profile.
<b>Step 6</b>	<b>wlan</b> <i>wlan-name</i> <b>policy</b> <i>profile-policy-name</i> <b>Example:</b> <pre>Device(config-policy-tag)# wlan rr-xyz-wlan-aa policy rr-xyz-policy-1</pre>	Maps a policy profile to a WLAN profile.
<b>Step 7</b>	<b>end</b> <b>Example:</b> <pre>Device(config-policy-tag)# end</pre>	Exits policy tag configuration mode, and returns to privileged EXEC mode.
<b>Step 8</b>	<b>show wireless tag policy summary</b> <b>Example:</b> <pre>Device# show wireless tag policy summary</pre>	(Optional) Displays the configured policy tags. <b>Note</b> To view detailed information about a policy tag, use the <b>show wireless tag policy detailed</b> <i>policy-tag-name</i> command.

## Configuring Wireless RF Tag (GUI)

### Procedure

- 
- Step 1** a) Choose **Configuration > Tags & Profiles > Tags > RF**.
- Step 2** Click **Add** to view the **Add RF Tag** window.
- Step 3** Enter a name and description for the RF tag. The name can be ASCII characters from 32 to 126, without leading and trailing spaces.

- Step 4** Choose the required **5 GHz Band RF Profile** and **2.4 GHz Band RF Profile** to be associated with the RF tag.
- Step 5** Click **Update & Apply to Device**.

## Configuring Wireless RF Tag (CLI)

Follow the procedure given below to configure a wireless RF tag:

### Before you begin

- You can use only two profiles (2.4-GHz and 5-GHz band RF profiles) in an RF tag.
- Ensure that you use the same AP tag name that you created when configuring the AP tag task too.

### Procedure

	Command or Action	Purpose
<b>Step 1</b>	<b>configure terminal</b> <b>Example:</b> Device# configure terminal	Enters global configuration mode.
<b>Step 2</b>	<b>wireless tag rf <i>rf-tag</i></b> <b>Example:</b> Device(config)# wireless tag rf rftag1	Creates an RF tag and enters wireless RF tag configuration mode.
<b>Step 3</b>	<b>24ghz-rf-policy <i>rf-policy</i></b> <b>Example:</b> Device(config-wireless-rf-tag)# 24ghz-rf-policy rfprof24_1	Attaches an IEEE 802.11b RF policy to the RF tag.  To configure a dot11a policy, use the <b>5ghz-rf-policy</b> command.
<b>Step 4</b>	<b>description <i>policy-description</i></b> <b>Example:</b> Device(config-wireless-rf-tag)# description Test	Adds a description for the RF tag.
<b>Step 5</b>	<b>end</b> <b>Example:</b> Device(config-wireless-rf-tag)# end	Exits configuration mode and returns to privileged EXEC mode.
<b>Step 6</b>	<b>show wireless tag rf summary</b> <b>Example:</b> Device# show wireless tag rf summary	Displays the available RF tags.
<b>Step 7</b>	<b>show wireless tag rf detailed <i>rf-tag</i></b> <b>Example:</b>	Displays detailed information of a particular RF tag.

	Command or Action	Purpose
	Device# show wireless tag rf detailed rftag1	

## Attaching a Policy Tag and Site Tag to an AP (GUI)

### Procedure

- 
- Step 1** Choose **Configuration > Wireless > Access Points**.  
The **All Access Points** section displays details of all the APs on your network.
- Step 2** To edit the configuration details of an AP, select the row for that AP.  
The **Edit AP** window is displayed.
- Step 3** In the **General** tab and **Tags** section, specify the appropriate policy, site, RF tags, and radio profile that you created on the **Configuration > Tags & Profiles > Tags** page.
- Step 4** Click **Update & Apply to Device**.
- 

## Attaching Policy Tag and Site Tag to an AP (CLI)

Follow the procedure given below to attach a policy tag and a site tag to an AP:

### Procedure

	Command or Action	Purpose
<b>Step 1</b>	<b>configure terminal</b>  <b>Example:</b> Device# configure terminal	Enters global configuration mode.
<b>Step 2</b>	<b>ap mac-address</b>  <b>Example:</b> Device(config)# ap F866.F267.7DFB	Configures a Cisco AP and enters AP profile configuration mode.  <b>Note</b> The <i>mac-address</i> should be a wired mac address.
<b>Step 3</b>	<b>policy-tag policy-tag-name</b>  <b>Example:</b> Device(config-ap-tag)# policy-tag rr-xyz-policy-tag	Maps a policy tag to the AP.
<b>Step 4</b>	<b>site-tag site-tag-name</b>  <b>Example:</b>	Maps a site tag to the AP.

	Command or Action	Purpose
	Device(config-ap-tag)# site-tag rr-xyz-site	
<b>Step 5</b>	<b>rf-tag</b> <i>rf-tag-name</i>  <b>Example:</b> Device(config-ap-tag)# rf-tag rf-tag1	Associates the RF tag.
<b>Step 6</b>	<b>end</b>  <b>Example:</b> Device(config-ap-tag)# end	Saves the configuration, exits configuration mode, and returns to privileged EXEC mode.
<b>Step 7</b>	<b>show ap tag summary</b>  <b>Example:</b> Device# show ap tag summary	(Optional) Displays AP details and the tags associated to it.
<b>Step 8</b>	<b>show ap name</b> <i>&lt;ap-name&gt;</i> <b>tag info</b>  <b>Example:</b> Device# show ap name <i>ap-name</i> tag info	(Optional) Displays the AP name with tag information.
<b>Step 9</b>	<b>show ap name</b> <i>&lt;ap-name&gt;</i> <b>tag detail</b>  <b>Example:</b> Device# show ap name <i>ap-name</i> tag detail	(Optional) Displays the AP name with tag details.

## Configuring a Radio Profile

### Information About Wireless Radio Profile

From Cisco IOS XE Bengaluru 17.6.1 onwards, you can configure radio profiles for the slots in access points (APs). In this release, you can configure radio profiles for beam-selection APs with the C-ANT9104 antenna and configure antenna count for Cisco Catalyst 9124AXI/D outdoor Access Points. You can configure the antenna beam-selection for the 5-GHz slots—slot 1 and slot 2. Because there is no default value for the beam-selection configuration, you must explicitly configure the beam selection mode for APs with the C-ANT9104 antenna.

The C-ANT9104 antenna-enabled Cisco Catalyst 9130AX Series APs have precise control over the antennae pattern. Therefore, a configuration knob in the controller is introduced to select the beam-steering direction for the antennae. The C-ANT9104 antenna-enabled Cisco Catalyst 9130AX Series APs can operate on the following beam-steering modes:

- Wide beam
- Narrow beam
- Narrow beam with 10 degrees tilt
- Narrow beam with 20 degrees tilt

After creating the radio profile, you must link or attach the radio profile under the radio frequency (RF) tag configuration, so that the radio profile is applied to the APs.



**Note** When you add Cisco ANT9104 antennas to the wireless controller, RRM configuration is not supported for these antennas.

The sections in this topic describe the steps to configure radio profile, beam selection, antenna count, and how to link the radio profile to the slots.



**Note** Cisco Catalyst 9130 Series Access Points enabled with Cisco ANT9104 antenna are able to function with unsupported versions, for example, Cisco IOS XE Bengaluru 17.5.1.

If the AP that is enabled with Cisco ANT9104 antenna, has a software version that is earlier than Cisco IOS XE 17.6.1, the AP joins the controller but the AP will not be functional as the operation status of the radios will be down.

## Configuring a Wireless Radio Profile (GUI)

### Procedure

- 
- Step 1** Choose **Configuration > Tags & Profiles > RF/Radio**.
- Step 2** On the **Radio Profile** page, click **Add**.
- Step 3** Enter a name for the Radio profile. Enter a description for the Radio profile.
- Step 4** Choose the appropriate **Antenna Beam** selection.
- Note** The antenna beam selection is set to **Not Configured** if no settings are detected.  
This option is to be configured for APs connected with the C-ANT9104 antenna.
- Step 5** Enter the number in the **Number of antenna to be enabled** field.
- Note** The option is available for the Cisco Catalyst 9124AXE Outdoor Access Points.
- Step 6** Click **Save & Apply to Device**.
- 

## Configuring a Radio Profile and Beam Selection

### Procedure

	Command or Action	Purpose
<b>Step 1</b>	configure terminal Example:	Enters global configuration mode.



	Command or Action	Purpose
	Device# configure terminal	
<b>Step 2</b>	<b>wireless profile radio</b> <i>wireless-radio-profile</i> <b>Example:</b> Device(config)# wireless profile radio <i>wireless-radio-profile</i>	Configures the radio profile. Enters the wireless radio profile configuration mode.
<b>Step 3</b>	<b>antenna beam-selection</b> { narrow tilt {10   20}   wide} <b>Example:</b> Device(config-wireless-radio-profile)# antenna beam-selection narrow tilt 10	Configures the beam selection of the antenna under the new radio profile.

## Configuring the Antenna Count in a Wireless Radio Profile

To configure the number of antennae for each slot, complete the following steps:

### Procedure

	Command or Action	Purpose
<b>Step 1</b>	<b>configure terminal</b> <b>Example:</b> Device# configure terminal	Enters global configuration mode.
<b>Step 2</b>	<b>wireless profile radio</b> <i>wireless-radio-profile</i> <b>Example:</b> Device(config)# wireless profile radio <i>wireless-radio-profile</i>	Configures the radio profile. Enters the wireless radio profile configuration mode.
<b>Step 3</b>	<b>antenna count</b> <0 - 8> <b>Example:</b> Device(config-wireless-radio-profile)# antenna count 4	Configures the number of antennas to be enabled under the new radio profile.

## Configuring a Slot Per Radio in the RF Tag Profile

It is mandatory to link radio profiles under an RF tag for the radio profile configurations to get applied. To configure a radio profile for each slot in an RF tag profile, complete the following steps:

### Procedure

	Command or Action	Purpose
<b>Step 1</b>	<b>configure terminal</b> <b>Example:</b>	Enters global configuration mode.

	Command or Action	Purpose
	Device# configure terminal	
<b>Step 2</b>	<b>wireless tag rf</b> <i>wireless-rf-tagname</i> <b>Example:</b> Device(config)# wireless tag rf <i>wireless-rf-tagname</i>	Configures the RF tag. Enters the wireless RF tag configuration mode.
<b>Step 3</b>	<b>dot11 { 24ghz slot0   5ghz { slot1   slot2 }            radio-profile radio-profile-name }</b> <b>Example:</b> Device(config-wireless-rf-tag)# dot11 5ghz slot1 radio-profile <i>wireless-radio-profile</i>	Configures the 802.11a/802.11b radio profile.

## Verifying a Radio Profile

To view the summary of all the configured radio profiles, use the following command:

```
Device# show wireless profile radio summary
```

```
Number of radio-profiles: 3
```

```

Antenna Profile Name          Description
-----
radio-profile-1               Custom profile for Slot1
antenna-ewlc                  Add description
default_radio_profile         Preconfigured default radio profile

```

To view detailed information about the parameters configured for a radio profile, use the following command:

```

Device# show wireless profile radio detailed radio-profile-name
Radio Profile name           : radio-profile-1
Description                   : Custom profile for slot1
Beam-Selection                : Wide beam

```

To view radio profile and RF tag information, use the following command:

```

Device # show ap name Cisco-AP tag info
AP Name                       : Cisco-AP
AP Mac                         : 04xx.40xx.XXXX

```

```
Applied Tags :
```

```

-----
Tag Type          Tag Name
-----
RF Tag            test-rf
Site Tag          default-site-tag
Policy Tag        default-policy-tag

```

```
Tag/Profile Type Misconfigured
```

```

-----
RF Tag No
Policy Tag No
Site Tag No
Flex profile No
AP join profile No
2.4GHz Rf Profile No
5 GHz Rf Profile No

```

```
5 GHz Slot1 Radio Profile NO
5 GHz Slot2 Radio Profile Yes
```

```
Resolved Tags :
```

```
-----
Tag Source          : Static
```

```
Tag Type           Tag Name
-----
RF Tag             test-rf
Site Tag           default-site-tag
Policy Tag         default-policy-tag
```

To display beam selection and the number of antennas, run the following commands:

```
Device# show wireless profile radio detailed radio-profile-1
Radio Profile name : radio-profile-1
Description        : Custom profile for slot1
Beam-Selection     : Wide beam

Device# show ap name cisco-ap config slot 1 | section 11n
802.11n Antennas
  Number of Antennas selected          : 2
  Supported Antenna modes              : 1x1 2x2 4x4
  Antenna port mapping                 : AB
  SIA Status                           : Not Present

Device# show ap name cisco-ap config slot 1 | include beam
Beam Selection : Narrow from centre 20
```

## AP Filter

### Introduction to AP Filter

The introduction of tags in the new configuration model in the Cisco Catalyst 9800 Series Wireless Controller has created multiple sources for tags to be associated with access points (APs). Tag sources can be static configuration, AP filter engine, per-AP PNP, or default tag sources. In addition to this, the precedence of the tags also plays an important role. The AP filter feature addresses these challenges in a seamless and intuitive manner.

AP filters are similar to the access control lists (ACLs) used in the controller and are applied at the global level. You can add AP names as filters, and other attributes can be added as required. Add the filter criteria as part of the discovery requests.

The AP Filter feature organizes tag sources with the right priority, based on the configuration.

You cannot disable the AP filter feature. However, the relative priority of a tag source can be configured using **ap filter-priority** *priority filter-name* command.



---

**Note** You can configure tag names at the PnP server (similar to the Flex group and AP group) and the AP stores and send the tag name as part of discovery and join requests.

---

## Set Tag Priority (GUI)

### Procedure

- 
- Step 1** Choose **Configuration > Tags & Profiles > Tags > AP > Tag Source**.
- Step 2** Drag and Drop the Tag Sources to change priorities.
- 

## Set Tag Priority

Multiple tag sources might result in ambiguity for network administrators. To address this, you can define priority for tags. When an AP joins the controller, the tags are picked based on priority. If precedence is not set, the defaults are used.

Use the following procedure to set tag priority:

### Procedure

	Command or Action	Purpose
<b>Step 1</b>	<b>configure terminal</b> <b>Example:</b> Device# configure terminal	Enters the global configuration mode.
<b>Step 2</b>	<b>ap tag-source-priority source-priority source {filter   pnp}</b> <b>Example:</b> Device(config)# ap tag-source-priority 2 source pnp	Configures AP tag source priority. <b>Note</b> It is not mandatory to configure AP filter. It comes with default priorities for Static, Filter, and PnP.
<b>Step 3</b>	<b>end</b> <b>Example:</b> Device(config)# end	Exits configuration mode and returns to privileged EXEC mode.
<b>Step 4</b>	<b>ap tag-sources revalidate</b> <b>Example:</b> Device# ap tag-sources revalidate	Revalidates AP tag sources. The priorities become active only after this command is run. <b>Note</b> If you change the priorities for Filter and PnP, and want to evaluate them, run the <b>revalidate</b> command.

## Create an AP Filter (GUI)

### Procedure

- 
- Step 1** Choose **Configuration > Tags & Profiles > Tags > AP > Filter**.
- Step 2** Click **Add**.
- Step 3** In the **Associate Tags to AP** dialog box which is displayed, enter the **Rule Name**, the **AP name regex** and the **Priority**. Optionally, you can also choose the policy tag from the **Policy Tag Name** drop-down list, the site tag from the **Site Tag Name** drop-down list and the RF tag from the **RF Tag Name** drop-down list.
- Step 4** Click **Apply to Device**.
- 

## Create an AP Filter (CLI)

### Procedure

	Command or Action	Purpose
<b>Step 1</b>	<b>configure terminal</b>  <b>Example:</b> Device# configure terminal	Enters the global configuration mode.
<b>Step 2</b>	<b>ap filter name</b> <i>filter_name</i>  <b>Example:</b> Device(config)# ap filter filter-1	Configures an AP filter.
<b>Step 3</b>	<b>ap name-regex</b> <i>regular-expression</i>  <b>Example:</b> Device(config-ap-filter)# ap name-regex testany	Configures the AP filter based on regular expression.  For example, if you have named an AP as <b>ap-1ab-12</b> , then you can configure the filter with a regular expression, such as <b>ap-1ab-\d+</b> , to match the AP name.
<b>Step 4</b>	<b>tag policy</b> <i>policy-tag</i>  <b>Example:</b> Device(config-ap-filter)# tag policy pol-tag1	Configures a policy tag for this filter.
<b>Step 5</b>	<b>tag rf</b> <i>rf-tag</i>  <b>Example:</b> Device(config-ap-filter)# tag rf rf-tag1	Configures an RF tag for this filter.
<b>Step 6</b>	<b>tag site</b> <i>site-tag</i>  <b>Example:</b> Device(config-ap-filter)# tag site sitel	Configures a site tag for this filter.

	Command or Action	Purpose
<b>Step 7</b>	<b>end</b>  <b>Example:</b> Device(config-ap-filter)# end	Exits configuration mode and returns to privileged EXEC mode.

## Set Up and Update Filter Priority (GUI)

### Procedure

- 
- Step 1** Choose **Configuration > Tags & Profiles > Tags > AP > Filter**.
- Step 2**
- If you want to setup a new AP filter, then click **Add**. In the **Associate Tags to AP** dialog box which is displayed, enter the **Rule Name**, the **AP name regex** and the **Priority**. Optionally, you can also select the **Policy Tag Name**, the **Site Tag Name** and the **RF Tag Name**. Click **Apply to Device**.
  - If you want to update the priority of an existing AP filter, click on the Filter and in the **Edit Tags** dialog box and change the **Priority**. In case the Filter is Inactive, no priority can be set to it. Click **Update and Apply to Device**.
- 

## Set Up and Update Filter Priority

Follow the procedure given below to set and update filter priority:

### Procedure

	Command or Action	Purpose
<b>Step 1</b>	<b>configure terminal</b>  <b>Example:</b> Device# configure terminal	Enters global configuration mode.
<b>Step 2</b>	<b>ap filter priority <i>priority</i> filter-name</b> <i>filter-name</i>  <b>Example:</b> Device(config)# ap filter priority 10 filter-name test1	Configure AP filter priority. Valid values range from 0 to 1023; 0 is the highest priority.  <b>Note</b> A filter without a priority is not active. Similarly, you cannot set a filter priority without a filter.
<b>Step 3</b>	<b>end</b>  <b>Example:</b> Device(config-ap)# end	Exits configuration mode and returns to privileged EXEC mode.

## Verify AP Filter Configuration

The following **show** commands are used to display tag sources and filters, and their priorities.

To view the tag source priorities, use the following command:

```
Device# show ap tag sources
```

```
Priority Tag source
-----
0 Static
1 Filter
2 AP
3 Default
```

To view the available filters, use the following command:

```
Device# show ap filter all
```

Filter Name Tag	regex	Policy Tag	RF Tag	Site
first	abcd	pol-tag1	rf-tag1	
site-tag1				
test1	testany			site1
filter1	testany			

To view the list of active filters, use the following command:

```
Device# show ap filters active
```

Priority Site Tag	Filter Name	regex	Policy Tag	RF Tag
10	test1	testany		
site1				

To view the source of an AP tag, use the following command:

```
Device# show ap tag summary
```

```
Number of APs: 4
```

AP Name	AP Mac	Site Tag Name	Policy Tag Name	RF Tag Name	Misconfigured Tag Source
AP002A.1034.CA78	002a.1034.ca78	named-site-tag	named-policy-tag	named-rf-tag	No Filter
AP00A2.891C.2480	00a2.891c.2480	named-site-tag	named-policy-tag	named-rf-tag	No Filter
AP58AC.78DE.9946	58ac.78de.9946	default-site-tag	default-policy-tag	default-rf-tag	No AP
AP0081.C4F4.1F34	0081.c4f4.1f34	default-site-tag	default-policy-tag	default-rf-tag	No Default

## Configuring Access Point for Location Configuration

### Information About Location Configuration

During location configuration, you can perform the following:

- Configure a site or location for an AP.

- Configure a set of tags for this location.
- Add APs to this location.

Any location comprises of the following components:

- A set of unique tags, one for each kind, namely: Policy, RF and Site.
- A set of ethernet MAC addresses that applies to the tags.

This feature works in conjunction with the existing tag resolution scheme. The location is considered as a new tag source to the existing system. Similar, to the static tag source.

## Prerequisite for Location Configuration

If you configure an access point in one location, you cannot configure the same access point in another location.

## Configuring a Location for an Access Point (GUI)

### Before you begin



**Note** When you create local and remote sites in the Basic Setup workflow, corresponding policies and tags are created in the backend. These tags and policies that are created in the Basic Setup cannot be modified using the Advanced workflow, and vice versa.

### Procedure

- Step 1** Choose **Configuration > Wireless Setup > Basic**.
- Step 2** On the **Basic Wireless Setup** page, click **Add**.
- Step 3** In the **General** tab, enter a name and description for the location.
- Step 4** Set the **Location Type** as either *Local* or *Flex*.
- Step 5** Use the slider to set **Client Density** as *Low*, *Typical* or *High*.
- Step 6** Click **Apply**.

## Configuring a Location for an Access Point (CLI)

### Procedure

	Command or Action	Purpose
<b>Step 1</b>	<b>configure terminal</b>  <b>Example:</b> Device# configure terminal	Enters global configuration mode.



	Command or Action	Purpose
<b>Step 2</b>	<b>ap location name</b> <i>location_name</i> <b>Example:</b> Device(config)# <b>ap location name</b> <b>location1</b>	Configures a location for an access point. Run the <b>no</b> form of this command to remove location for an access point.
<b>Step 3</b>	<b>tag</b> { <b>policy</b> <i>policy_name</i>   <b>rf</b> <i>rf_name</i>   <b>site</b> <i>site_name</i> } <b>Example:</b> Device(config-ap-location)# <b>tag policy</b> <b>policy_tag</b> Device(config-ap-location)# <b>tag rf</b> <i>rf_tag</i> Device(config-ap-location)# <b>tag site</b> <b>site_tag</b>	Configures tags for the location.
<b>Step 4</b>	<b>location</b> <i>description</i> <b>Example:</b> Device(config-ap-location)# <b>location</b> <b>description</b>	Adds description to the location.
<b>Step 5</b>	<b>end</b> <b>Example:</b> Device(config-ap-location)# <b>end</b>	Returns to privileged EXEC mode. Alternatively, you can also press <b>Ctrl-Z</b> to exit global configuration mode.

## Adding an Access Point to the Location (GUI)



**Note** When the tag source is not set to location, the AP count and AP location tagging will not be correctly reflected on the web UI. To change static tag source on the AP, run the **no ap ap-mac** command on the controller to change AP tag source to default (which is location).

### Procedure

- Step 1** Choose **Configuration > Wireless Setup > Basic**.
- Step 2** On the **Basic Wireless Setup** page, click **Add** to configure the following:
- General
  - Wireless Networks
  - AP Provisioning
- Step 3** In the **AP Provisioning** tab and **Add/Select APs** section, enter the AP MAC address and click the right arrow to add the AP to the associated list. The MAC address can be either in *xx:xx:xx:xx:xx:xx*, *xx-xx-xx-xx-xx-xx*, or *xxxx.xxxx.xxxx* format.

You can also add a CSV file from your system. Ensure that the CSV has the MAC Address column.

- Step 4** Use the search option in the **Available AP List** to select the APs from the Selected AP list and click the right arrow to add the AP to the associated list.
- Step 5** Click **Apply**.

## Adding an Access Point to the Location (CLI)

### Procedure

	Command or Action	Purpose
<b>Step 1</b>	<b>configure terminal</b>  <b>Example:</b> Device# <code>configure terminal</code>	Enters global configuration mode.
<b>Step 2</b>	<b>ap location name</b> <i>location_name</i>  <b>Example:</b> Device(config)# <code>ap location name location1</code>	Configures a location for an access point.
<b>Step 3</b>	<b>ap-eth-mac</b> <i>ap_ethernet_mac</i>  <b>Example:</b> Device(config-ap-location)# <code>ap-eth-mac 188b.9dbe.6eac</code>	Adds an access point to the location.
<b>Step 4</b>	<b>end</b>  <b>Example:</b> Device(config-ap-location)# <code>end</code>	Returns to privileged EXEC mode. Alternatively, you can also press <b>Ctrl-Z</b> to exit global configuration mode.  <b>Note</b> After adding an AP to a location, the AP may reset automatically to get the new configuration

## Configuring SNMP in Location Configuration

### SNMP MIB

The SNMP MIB provides information on a set of managed objects that represent logical and physical entities, and relationships between them.

*Table 1: MIB Objects and Notes*

MIB Objects	Notes
<code>cLApLocationName</code>	Provides the name of the AP location.

MIB Objects	Notes
<b>cLApLocationPolicyTag</b>	Provides the policy tag configured on the location.
<b>cLApLocationSitetag</b>	Provides the site tag configured on the location.
<b>cLApLocationRfTag</b>	Provides the RF tag configured on the location.
<b>cLAssociatedApsApMac</b>	Provides the configured APs on the location.

## Verifying Location Configuration

To view the summary of AP location configuration, use the following command:

```
Device# show ap location summary
```

```
Location Name      Description      Policy Tag      RF Tag      Site Tag
-----
first              first floor     default-policy-tag  default-rf-tag  default-site-tag
second             second floor    default-policy-tag  default-rf-tag  default-site-tag
```

To view the AP location configuration details for a specific location, use the following command:

```
Device# show ap location details first
```

```
Location Name.....: first
Location description.....: first floor
Policy tag.....: default-policy-tag
Site tag.....: default-site-tag
RF tag.....: default-rf-tag
```

```
Configured list of APs
005b.3400.0af0
005b.3400.0bf0
```

To view the AP tag summary, use the following command:

```
Device# show ap tag summary
```

```
Number of APs: 4
AP Name      AP Mac      Site Tag Name      Policy Tag Name      RF Tag Name
Misconfigured Tag Source
-----
Asim_5-1     005b.3400.02f0  default-site-tag  default-policy-tag  default-rf-tag  Yes
Filter
Asim_5-2     005b.3400.03f0  default-site-tag  default-policy-tag  default-rf-tag  No
Default
Asim_5-9     005b.3400.0af0  default-site-tag  default-policy-tag  default-rf-tag  No
Location
Asim_5-10    005b.3400.0bf0  default-site-tag  default-policy-tag  default-rf-tag  No
Location
```

## Verifying Location Statistics

To view the AP location statistics, use the following command:

```
Device# show ap location stats
```

```
Location name      APs joined      Clients joined      Clients on 11a      Clients on 11b
-----
```

## Verifying Location Statistics

first	2	0	3	4
second	0	0	0	0



## CHAPTER 3

# Wireless Management Interface

- [Information About Wireless Management Interface, on page 43](#)
- [Recommendations for Wireless Management Interface, on page 44](#)
- [Configuring your Controller with Wireless Management Interface \(CLI\), on page 45](#)
- [Verifying Wireless Management Interface Settings, on page 47](#)
- [Information About Network Address Translation \(NAT\), on page 48](#)
- [Information About CAPWAP Discovery, on page 48](#)
- [Configuring Wireless Management Interface with a NAT Public IP \(CLI\), on page 49](#)
- [Configuring CAPWAP Discovery to Respond Only with Public or Private IP \(CLI\), on page 50](#)
- [Verifying NAT Settings, on page 51](#)

## Information About Wireless Management Interface

The Wireless Management Interface (WMI) is the mandatory Layer 3 interface on the Cisco Catalyst 9800 Wireless Controller. It is used for all communications between the controller and access points. Also, it is used for all CAPWAP or inter-controller mobility messaging and tunneling traffic.

WMI is also the default interface for in-band management and connectivity to enterprise services, such as, AAA, syslog, SNMP, and so on. You can use the WMI IP address to remotely connect to the device using SSH or Telnet (or) access the Graphical User Interface (GUI) using HTTP or HTTPS by entering the wireless management interface IP address of the controller in the address field of your browser.

The Cisco Catalyst 9800 Series Wireless Controller should be able to use Ethernet Service Port (SP) (Management Interface VRF/GigabitEthernet 0) for the below management/control plane protocols from release 17.6.1 onwards:

- SNMP
- RADIUS (both for user authentication to the box and wireless client authorization)
- TACACS
- Syslog
- NTP
- SSH/NETCONF/HTTPS
- NetFlow

## Recommendations for Wireless Management Interface

The Wireless Management Interface is a Layer 3 interface, which can be configured only with a single IP address (IPv4 or IPv6) or using a dual-stack configuration.

It is always recommended to use a wireless management VLAN and configure WMI as a Switched VLAN Interface (SVI). If the uplink port or port-channel to the next-hop switch is configured as a dot1q trunk, the wireless management VLAN would be one of the allowed tagged VLAN on the trunk.

The recommendation is true, independent of the deployment mode of APs (local, FlexConnect, or SDA) with the following exceptions:

- The WMI is configured as an L3 port for Cisco Catalyst 9800 Wireless Controller deployed in a Public Cloud environment.
- The WMI is configured as a loopback interface for embedded wireless controller in Cisco Catalyst 9000 switches.

It is always recommended to statically assign IPv6 address in WMI and not configure using the **ipv6 auto-config** command.



---

**Note** The **ipv6 auto-config** command is not supported.

---



---

**Note** You can use only one AP manager interface on Cisco Catalyst 9800 Wireless Controller called the WMI to terminate CAPWAP traffic.

---



---

**Note** There is only one Wireless Management Interface (WMI) on the controller.

---



---

**Note** Layer 3 interface is not supported in Cisco Catalyst 9800-CL Cloud Wireless Controller Guest anchor scenarios. Instead, it is recommended to use the Layer 2 interfaces and SVI for WMI.

It is recommended to use Layer 3 interface for Public cloud deployments only and not for on-premise as it poses some limitations.

The following are the sample Layer 3 and Layer 2 interface configurations:

**Layer 3 interface configuration:**

```
interface GigabitEthernet2
no switchport
ip address <ip_address> <mask>
negotiation auto
no mop enabled
no mop sysid
end
```

**Layer 2 interface configuration:**

```
interface GigabitEthernet2
switchport trunk allowed vlan 25,169,504
switchport mode trunk
negotiation auto
no mop enabled
no mop sysid
end
```

---



---

**Note** To change the WMI interface when RMI is configured, perform the following:

1. Unconfigure the RMI, save the changes using the **write memory** command, and reload the controller.
  2. Change the WMI interface.
  3. Reconfigure the RMI in the same interface as WMI, save the changes using the **write memory** command, and reload the controller.
- 

## Configuring your Controller with Wireless Management Interface (CLI)

You can configure the Wireless Management interface using CLI by directly accessing the physical console (for the Cisco Catalyst 9800 appliances) (or) using the virtual console in case of the Cisco Catalyst 9800-CL Cloud Wireless Controller.



**Note** The example assumes that:

- You have a Cisco Catalyst 9800-CL Cloud Wireless Controller and the GigabitEthernet 2 is connected to a trunk interface on the uplink switch.
- You want to configure multiple VLANs and dedicate one for Wireless Management interface.

## Procedure

**Step 1** Access the CLI using VGA or monitor console from the hypervisor of your choice.

**Step 2** Terminate the configuration wizard.

```
Would you like to enter the initial configuration dialog? [yes/no]:
no
Would you like to terminate autoinstall? [yes]:
yes
```

**Step 3** Enter the configuration mode and add the login credentials using the following command:

```
Device# conf t
Enter configuration commands, one per line. End with CNTL/Z.
Device(config)# username <name> privilege 15 password <yourpwd>
```

**Step 4** (Optional) Set a hostname.

```
Device(config)# hostname C9800
```

**Step 5** Configure the VLAN for wireless management interface:

```
Device(config)# vlan 201
Device(config-vlan)# name wireless_management
```

**Step 6** Configure the L3 SVI for wireless management interface:

```
Device(config)# int vlan 201
Device(config-if)# description wireless-management-interface
Device(config-if)# ip address 172.16.201.21 255.255.255.192
Device(config-if)# no shutdown
```

**Step 7** Configure the interface GigabitEthernet 2 as trunk and allow the wireless management VLAN:

```
Device(config-if)# interface GigabitEthernet2
Device(config-if)# switchport mode trunk
Device(config-if)# switchport trunk allowed vlan 201,210,211
Device(config-if)# shut
Device(config-if)# no shut
```

**Note** VLANs 210 and 211 are added to the trunk to carry client traffic.

**Step 8** Configure a default route (or a more specific route) to reach the device:



```
Device(config-if)# ip route 0.0.0.0 0.0.0.0 172.16.201.1
```

At this point you can use SSH or Telnet, or GUI to access the device, or use the Cisco Catalyst Center or Cisco Prime to continue with the DAY 0 configuration.

## Verifying Wireless Management Interface Settings

To verify if the Layer 3 interface is configured correctly, use the following command:

```
Device# show run int vlan 201

Building configuration...

Current configuration : 128 bytes
!
interface Vlan201
  description wireless-management-interface
  ip address 172.16.201.21 255.255.255.0
  no mop enabled
  no mop sysid
end
```

To verify if the wireless management VLAN is active on the uplink to the network, use the following command. In this case the uplink is a trunk interface, so the VLAN needs to be active and forwarding state.

```
Device# show interfaces trunk

Port      Mode           Encapsulation  Status        Native vlan
Gi2       on             802.1q         trunking      1
.....
Port      Vlans allowed on trunk
Gi2       201,210-211
.....
Port      Vlans allowed and active in management domain
Gi2       201,210-211
....
Port      Vlans in spanning tree forwarding state and not pruned
Gi2       201,210-211
.....
```

To verify if the wireless management interface is up, use the following command:

```
Device# show ip int brief | i Vlan201
Vlan201  172.16.201.21 YES NVRAM  up  up
```

To verify if the selected interface has been configured as wireless management, use the following command:

```
Device# show wireless interface summary

Wireless Interface Summary

Interface Name Interface Type VLAN ID IP Address      IP Netmask  NAT-IP Address MAC Address
-----
Vlan201      Management      201  172.16.201.21  255.255.255.0  0.0.0.0      001e.e51c.a7ff
```

## Information About Network Address Translation (NAT)

NAT enables private IP networks that use non-registered IP addresses to connect to the Internet. NAT operates on a device, usually connecting two networks. Before packets are forwarded onto another network, NAT translates the private (not globally unique) addresses from the internal network into public addresses. NAT can be configured to advertise to the outside world only few addresses for the entire internal network. This ability provides more security by effectively hiding the private network details.

If you want to deploy your Cisco Catalyst 9800 Wireless Controller on a private network and make it reachable from internet, you need to have the controller behind a router, firewall, or other gateway device that uses one-to-one mapping Network Address Translation (NAT).

To do so, perform the following:

- Configure the NAT device with 1:1 static mapping of the Wireless Management interface IP address (private IP) to a unique external (public) IP address configured on the NAT device.
- Enable the NAT feature on the Wireless Controller and specify its external public IP address. This public IP is used in the discovery responses to APs, so that the APs can then send CAPWAP packets to the right destination.
- Make sure that the external APs discover the public IP of the controller using DHCP, DNS, or PnP.



---

**Note** You need not enable NAT if the Cisco Catalyst 9800 Wireless Controller is deployed with a public address. Instead you will need to configure the public IP directly on the Wireless Management Interface (WMI).

---

## Information About CAPWAP Discovery

In a CAPWAP environment, a lightweight access point discovers a wireless controller by using CAPWAP discovery mechanisms, and then sends a CAPWAP join request to the controller. The controller sends a CAPWAP join response to the access point that allows the access point to join the controller.

If the wireless controller is behind a NAT device, the controller responds to the discovery response in the following ways:

- Using the public IP.
- Using the private IP.
- Using public and private IP.

The Public IP needs to be mapped to the controller's Private IP using static 1:1 NAT configuration on the router or firewall performing the NAT translation.

If your wireless controller manages only Access Points reachable through the public internet (external APs), you need to configure the controller so it responds with only the Public IP in the discovery response.

If your wireless controller manages both internal and external APs, you need to configure the controller so it responds with both Public and Private IPs in the discovery response.



**Note** In NAT deployments, the APs running internally and externally must use different AP join profiles with CAPWAP Discovery Private and Public enabled separately. This behaviour was introduced from the 17.9.5 release and applies to APs upgraded to Cisco IOS XE 17.12.x and later.

## Configuring Wireless Management Interface with a NAT Public IP (CLI)

The first step is to configure the controller to use the public NAT IP (this is the public IP that has been configured on the NAT device to statically map 1:1 the WMI's private IP address).

### Procedure

	Command or Action	Purpose
<b>Step 1</b>	<b>configure terminal</b>  <b>Example:</b> Device# configure terminal	Enters global configuration mode.
<b>Step 2</b>	<b>wireless management interface</b> <i>interface-type</i> <i>interface-number</i>  <b>Example:</b> Device(config)# wireless management interface vlan 20	Defines the management interface. Here, <ul style="list-style-type: none"> <li>• <i>interface-type</i>—Refers to the VLAN, Gigabit, or loopback types.</li> <li>• <i>interface-number</i>—Is the interface number.</li> </ul>
<b>Step 3</b>	<b>public-ip</b> <i>external-public-ip</i>  <b>Example:</b> Device(config-mgmt-interface)# public-ip 2.2.2.2	Defines the external NAT or Public IP.
<b>Step 4</b>	<b>end</b>  <b>Example:</b> Device(config-mgmt-interface)# end	Returns to privileged EXEC mode.

## Configuring CAPWAP Discovery to Respond Only with Public or Private IP (CLI)



**Note** By default, if the wireless management interface is configured with a public IP, the controller responds with both Public and Private IP in the CAPWAP discovery response.

The setting to determine the IP (private or public) to include in the discovery response is available in the AP Join profile.

### Configuring the Controller to Respond only with a Public IP (CLI)

Configure the Controller to respond only with a Public IP using commands.

#### Procedure

	Command or Action	Purpose
<b>Step 1</b>	<b>configure terminal</b> <b>Example:</b> Device# <code>configure terminal</code>	Enters global configuration mode.
<b>Step 2</b>	<b>ap profile <i>profile-name</i></b> <b>Example:</b> Device(config)# <code>ap profile xyz-ap-profile</code>	Configures an AP profile and enters AP profile configuration mode.
<b>Step 3</b>	<b>no capwap-discovery private</b> <b>Example:</b> Device(config-ap-profile)# <code>no capwap-discovery private</code>	Instructs the controller to not respond with the internal IP. Enables AP to join the controller over Public IP only.
<b>Step 4</b>	<b>end</b> <b>Example:</b> Device(config-ap-profile)# <code>end</code>	Returns to privileged EXEC mode.

### Configuring the Controller to Respond only with a Private IP (CLI)

#### Procedure

	Command or Action	Purpose
<b>Step 1</b>	<b>configure terminal</b> <b>Example:</b>	Enters global configuration mode.

	Command or Action	Purpose
	Device# configure terminal	
<b>Step 2</b>	<b>ap profile profile-name</b> <b>Example:</b> Device(config)# ap profile xyz-ap-profile	Configures an AP profile and enters AP profile configuration mode.
<b>Step 3</b>	<b>no capwap-discovery public</b> <b>Example:</b> Device(config-ap-profile)# no capwap-discovery public	Instructs the controller to not respond with the public IP. Enables AP to join the controller over private IP only.
<b>Step 4</b>	<b>end</b> <b>Example:</b> Device(config-ap-profile)# end	Returns to privileged EXEC mode.

## Verifying NAT Settings

Verify NAT Settings using commands.

```
Device# show wireless interface summary
```

```
Wireless Interface Summary
```

```
Interface Name Interface Type VLAN ID IP Address      IP Netmask      NAT-IP Address  MAC
Address
-----
Vlan20          Management   20      10.58.20.25    255.255.255.0  2.2.2.2        001e.4963.1cff
```

To verify the settings in the AP join profile, use the following command

```
Device# show run | b ap profile
```

```
ap profile default-ap-profile
 no capwap-discovery private
 description "default ap profile"
 ...
```





## CHAPTER 4

# BIOS Protection

---

- [BIOS Protection on the Controller, on page 53](#)
- [BIOS or ROMMON Upgrade with BIOS Protection, on page 53](#)
- [Upgrading BIOS, on page 54](#)

## BIOS Protection on the Controller

BIOS Protection enables you to protect and securely update BIOS flash for Intel-based platforms. If BIOS Protection is not used, the flash utility that stores the BIOS for an Intel platform is not write-protected. As a result, when BIOS updates are applied, malicious code also makes its way through.

By default, BIOS Protection works by bundling the flash containing the BIOS image, and by accepting updates only through the BIOS capsules that enable writing on the BIOS Flash.

## BIOS or ROMMON Upgrade with BIOS Protection

To upgrade BIOS or ROMMON use the BIOS Protection feature as follows:

1. The new BIOS image capsule bundled together with the ROMMON binary is inserted into the media of the Cisco device by the ROMMON upgrade scripts.
2. The Cisco device is then reset for the new BIOS/ROMMON upgrade to take place.
3. On reset, the original BIOS detects the updated capsule and determines if the updated BIOS is available.
4. The original BIOS then verifies the digital signature of the BIOS capsule. If the signature is valid, the original BIOS will remove write-protection from the flash utility and update the SPI flash with the new BIOS image. If the BIOS capsule is invalid, the SPI flash is not updated.
5. After the new BIOS/ROMMON image is written to the SPI flash, the required regions of the SPI flash are once again write-protected.
6. After the card is reset, the updated BIOS is rebooted.
7. The capsule is deleted by BIOS.

# Upgrading BIOS

## Procedure

---

Use the **upgrade rom-monitor filename** command to update the BIOS capsule.

### Example:

```
upgrade rom-monitor filename bootflash:capsule.pkg <slot>
```

---

## Example

The following example shows you how to verify a BIOS Protection upgrade:

```
Device# upgrade rom-monitor filename bootflash:qwlc-rommon-capsule-p106.pkg all
Verifying the code signature of the ROMMON package...
Chassis model AIR-CT5540-K9 has a single rom-monitor.
```

```
Upgrade rom-monitor
```

```
Target copying rom-monitor image file
```

```
Secure update of the ROMMON image will occur after a reload.
```

```
8388608+0 records in
8388608+0 records out
8388608 bytes (8.4 MB, 8.0 MiB) copied, 11.9671 s, 701 kB/s
131072+0 records in
131072+0 records out
131072 bytes (131 kB, 128 KiB) copied, 0.414327 s, 316 kB/s
Copying ROMMON environment
8388608+0 records in
8388608+0 records out
8388608 bytes (8.4 MB, 8.0 MiB) copied, 31.1199 s, 270 kB/s
131072+0 records in
131072+0 records out
131072 bytes (131 kB, 128 KiB) copied, 2.44015 s, 53.7 kB/s
131072+0 records in
131072+0 records out
131072 bytes (131 kB, 128 KiB) copied, 2.43394 s, 53.9 kB/s
ROMMON upgrade complete.
To make the new ROMMON permanent, you must restart the RP.
Device#reload
```





## CHAPTER 5

# Smart Licensing Using Policy

- [Introduction to Smart Licensing Using Policy, on page 55](#)
- [Information About Smart Licensing Using Policy, on page 56](#)
- [How to Configure Smart Licensing Using Policy: Workflows by Topology , on page 79](#)
- [Migrating to Smart Licensing Using Policy, on page 92](#)
- [Task Library for Smart Licensing Using Policy, on page 113](#)
- [Troubleshooting Smart Licensing Using Policy, on page 153](#)
- [Additional References for Smart Licensing Using Policy, on page 163](#)
- [Feature History for Smart Licensing Using Policy, on page 163](#)

## Introduction to Smart Licensing Using Policy

Smart Licensing Using Policy is an enhanced version of Smart Licensing, with the overarching objective of providing a licensing solution that does not interrupt the operations of your network, rather, one that enables a compliance relationship to account for the hardware and software licenses you purchase and use.

Smart Licensing Using Policy is supported starting with Cisco IOS XE Amsterdam 17.3.2a.

The primary benefits of this enhanced licensing model are:

- Seamless day-0 operations

After a license is ordered, no preliminary steps, such as registration or generation of keys etc., are required unless you use an export-controlled or enforced license. There are no export-controlled or enforced licenses on Cisco Catalyst Wireless Controllers and product features can be configured on the device right-away.

- Consistency in Cisco IOS XE

Campus and industrial ethernet switching, routing, and wireless devices that run Cisco IOS XE software, have a uniform licensing experience.

- Visibility and manageability

Tools, telemetry and product tagging, to know what is in-use.

- Flexible, time series reporting to remain compliant

Easy reporting options are available, whether you are directly or indirectly connected to Cisco Smart Software Manager (CSSM), or in an air-gapped network.

This document provides conceptual, configuration, and troubleshooting information for Smart Licensing Using Policy on Cisco Catalyst Wireless Controllers.

For a more detailed overview on Cisco Licensing, go to [cisco.com/go/licensingguide](https://cisco.com/go/licensingguide).

## Information About Smart Licensing Using Policy

This section provides conceptual information about Smart Licensing Using Policy, supported products, an overview of each supported topology, and explains how Smart Licensing Using Policy interacts, with other features.

### Overview

Smart Licensing Using Policy is a software license management solution that provides a seamless experience with the various aspects of licensing.

- Purchase licenses: Purchase licenses through the existing channels and use the Cisco Smart Software Manager (CSSM) portal to view product instances and licenses.



**Note** To simplify your implementation of Smart Licensing Using Policy, provide your Smart Account and Virtual Account information when placing an order for new hardware or software. This allows Cisco to install applicable policies and authorization codes (terms explained in the [#unique\\_81](#) section below), at the time of manufacturing.

- Use: All licenses on Cisco Catalyst Wireless Controllers are unenforced. This means that you do not have to complete any licensing-specific operations, such as registering or generating keys before you start using the software and the licenses that are tied to it. License usage is recorded on your device with timestamps and the required workflows can be completed at a later date.
- Report license usage to CSSM: Multiple options are available for license usage reporting. You can use Cisco Smart Licensing Utility (CSLU), or report usage information directly to CSSM. For air-gapped networks, a provision for offline reporting where you download usage information and upload it to CSSM, is also available. The usage report is in plain text XML format. See: [#unique\\_82](#).
- Reconcile: For situations where delta billing applies (purchased versus consumed).

### Supported Products

This section provides information about the Cisco IOS-XE product instances that support Smart Licensing Using Policy. All models (Product IDs or PIDs) in a product series are supported – unless indicated otherwise.

**Table 2: Supported Product Instances: Cisco Catalyst Wireless Controllers**

Cisco Catalyst Wireless Controllers	When Support for Smart Licensing Using Policy was Introduced
Cisco Catalyst 9800-40 Wireless Controller	Cisco IOS XE Amsterdam 17.3.2a

Cisco Catalyst Wireless Controllers	When Support for Smart Licensing Using Policy was Introduced
Cisco Catalyst 9800-L Wireless Controller	Cisco IOS XE Amsterdam 17.3.2a
Cisco Catalyst 9800-CL Wireless Controller	Cisco IOS XE Amsterdam 17.3.2a
Cisco Catalyst 9800 embedded Wireless Controller	Cisco IOS XE Amsterdam 17.3.2a
Cisco Embedded Wireless Controller on Cisco Catalyst 9100 Access Points (EWC-AP)	Cisco IOS XE Amsterdam 17.3.2a

## Architecture

This section explains the various components that can be part of your implementation of Smart Licensing Using Policy. One or more components make up a topology.

### Product Instance

A product instance is a single instance of a Cisco product, identified by a Unique Device Identifier (UDI).

A product instance records and reports license usage (RUM reports), and provides alerts and system messages about overdue reports, communication failures, etc. RUM reports and usage data are securely stored in the product instance.

Throughout this document, the term *product instance* refers to all supported physical and virtual product instances - unless noted otherwise. For information about the product instances that are within the scope of this document, see [#unique\\_86](#).

### CSLU

Cisco Smart License Utility (CSLU) is a Windows-based reporting utility that provides aggregate licensing workflows. This utility performs the following key functions:

- Provides options relating to how workflows are triggered. The workflows can be triggered by CSLU or by a product instance.
- Collects usage reports from one or more product instances and uploads these usage reports to the corresponding Smart Account or Virtual Account – online, or offline, using files. Similarly, the RUM report ACK is collected online, or offline, and sent back to the product instance.
- Sends authorization code requests to CSSM and receives authorization codes from CSSM, if applicable.

CSLU can be part of your implementation in the following ways:

- Install the windows application, to use CSLU as a standalone tool that is connected to CSSM.
- Install the windows application, to use CSLU as a standalone tool that is disconnected from CSSM. With this option, the required usage information is downloaded to a file and then uploaded to CSSM. This is suited to air-gapped networks.
- Embedded (by Cisco) in a controller such as Cisco Catalyst Center.

## CSSM

Cisco Smart Software Manager (CSSM) is a portal that enables you to manage all your Cisco software licenses from a centralized location. CSSM helps you manage current requirements and review usage trends to plan for future license requirements.

You can access the CSSM Web UI at <https://software.cisco.com>. Under the **License** tab, click the **Smart Software Licensing** link.

See the [#unique\\_89](#) section to know about the different ways in which you can connect to CSSM

In CSSM you can:

- Create, manage, or view virtual accounts.
- Create and manage Product Instance Registration Tokens.
- Transfer licenses between virtual accounts or view licenses.
- Transfer, remove, or view product instances.
- Run reports against your virtual accounts.
- Modify your email notification settings.
- View overall account information.

## Controller

A management application or service that manages multiple product instances.



---

**Note** Throughout this chapter, and in the context of Smart Licensing Using Policy, the term "controller" or "Controller" always means a management application or service that manages a product instance. The term is not used to refer to Cisco Catalyst Wireless Controllers, which are *product instances*.

---

On Cisco Catalyst Wireless Controllers, Cisco Catalyst Center is the supported controller. Information about the controller, product instances that support the controller, and minimum required software versions on the controller and on the product instance is provided below:

Table 3: Support Information for Controller: Cisco Catalyst Center

Minimum Required Cisco Catalyst Center Version for Smart Licensing Using Policy <sup>1</sup>	Minimum Required Cisco IOS XE Version <sup>2</sup>	Supported Product Instances
Cisco Catalyst Center Release 2.2.2	Cisco IOS XE Amsterdam 17.3.2a	<ul style="list-style-type: none"> <li>• Cisco Catalyst 9800-40 Wireless Controller</li> <li>• Cisco Catalyst 9800-80 Wireless Controller</li> <li>• Cisco Catalyst 9800-L Wireless Controller</li> <li>• Cisco Catalyst 9800-CL Wireless Controller</li> <li>• Cisco Catalyst 9800 embedded Wireless Controller</li> <li>• Cisco Embedded Wireless Controller on Cisco Catalyst 9100 Access Points (EWC-AP)</li> </ul>

<sup>1</sup> The minimum required software version on the controller. This means support continues on all subsequent releases - unless noted otherwise

<sup>2</sup> The minimum required software version on the product instance. This means support continues on all subsequent releases - unless noted otherwise.

For more information about Cisco Catalyst Center, see the support page at:

<https://www.cisco.com/c/en/us/support/cloud-systems-management/dna-center/series.html>.

## SSM On-Prem

Smart Software Manager On-Prem (SSM On-Prem) is an asset manager, which works in conjunction with CSSM. It enables you to administer products and licenses on your premises instead of having to directly connect to CSSM.

Information about the required software versions to implement Smart Licensing Using Policy with SSM On-Prem, is provided below:

Minimum Required SSM On-Prem Version for Smart Licensing Using Policy <sup>3</sup>	Minimum Required Cisco IOS XE Version <sup>4</sup>	Supported Product Instances
Version 8, Release 202102	Cisco IOS XE Amsterdam 17.3.3	<ul style="list-style-type: none"> <li>• Cisco Catalyst 9800-40 Wireless Controller</li> <li>• Cisco Catalyst 9800-80 Wireless Controller</li> <li>• Cisco Catalyst 9800-L Wireless Controller</li> <li>• Cisco Catalyst 9800-CL Wireless Controller</li> <li>• Cisco Catalyst 9800 embedded Wireless Controller</li> <li>• Cisco Embedded Wireless Controller on Cisco Catalyst 9100 Access Points (EWC-AP)</li> </ul>

<sup>3</sup> The minimum required SSM On-Prem version. This means support continues on all subsequent releases - unless noted otherwise

<sup>4</sup> The minimum required software version on the product instance. This means support continues on all subsequent releases - unless noted otherwise.

For more information about SSM On-Prem, see [Smart Software Manager On-Prem](#) on the Software Download page. Hover over the .iso image to display the documentation links.

## Concepts

This section explains the key concepts of Smart Licensing Using Policy.

### License Enforcement Types

A given license belongs to one of three enforcement types. The enforcement type indicates if the license requires authorization before use, or not.

- Unenforced or Not Enforced

Unenforced licenses *do not* require authorization before use in air-gapped networks, or registration, in connected networks. The terms of use for such licenses are as per the [General Terms and Conditions](#).

All licenses available on Cisco Catalyst Wireless Controllers are unenforced licenses.

- Enforced

Licenses that belong to this enforcement type require authorization before use. The required authorization is in the form of an authorization code, which must be installed in the corresponding product instance.

An example of an enforced license is the Media Redundancy Protocol (MRP) Client license, which is available on Cisco's Industrial Ethernet Switches.

- Export-Controlled

Licenses that belong to this enforcement type are export-restricted by U.S. trade-control laws and these licenses require authorization before use. The required authorization code must be installed in the corresponding product instance for these licenses as well. Cisco may pre-install export-controlled licenses when ordered with hardware purchase.

An example of an export-controlled license is the High Speed Encryption (HSECK9) license, which is available on certain Cisco Routers.

## License Duration

This refers to the duration or term for which a purchased license is valid. A given license may belong to any one of the enforcement types mentioned above and be valid for the following durations:

- Perpetual: There is no expiration date for such a license.

AIR Network Essentials and AIR Network Advantage licenses are examples of unenforced, perpetual licenses that are available on Cisco Catalyst Wireless Controllers.

- Subscription: The license is valid only until a certain date.

AIR Digital Network Architecture (DNA) Essentials and AIR DNA Advantage licenses are examples of unenforced subscription licenses that are available on Cisco Catalyst Wireless Controllers.

## Authorization Code

The Smart Licensing Authorization Code (SLAC) allows activation and continued use of a license that is export-controlled or enforced.

A SLAC is not required for any of the licenses available on Cisco Catalyst Wireless Controllers, but if you are upgrading from an earlier licensing model to Smart Licensing Using Policy, you may have a Specific License Reservation (SLR) with its own authorization code. The SLR authorization code is supported after upgrade to Smart Licensing Using Policy.



---

**Note** While existing SLRs are carried over after upgrade, you cannot request a new SLR in the Smart Licensing Using Policy environment, because the notion of “reservation” does not apply. For an air-gapped network, the [No Connectivity to CSSM and No CSLU](#) topology applies instead

---

For more information about how the SLR authorization code is handled, see [#unique\\_97](#). If you want to return an SLR authorization code, see [#unique\\_98](#).

## Policy

A policy provides the product instance with these reporting instructions:

- License usage report acknowledgement requirement (Reporting ACK required): The license usage report is known as a RUM Report and the acknowledgement is referred to as an ACK (See [RUM Report and Report Acknowledgement](#)). This is a yes or no value which specifies if the report for this product instance requires CSSM acknowledgement or not. The default policy is always set to “yes”.
- First report requirement (days): The first report must be sent within the duration specified here.

If the value here is zero, no first report is required.

- Reporting frequency (days): The subsequent report must be sent within the duration specified here.  
If the value here is zero, it means no further reporting is required *unless* there is a usage change.
- Report on change (days): In case of a change in license usage, a report must be sent within the duration specified here.  
If the value here is zero, no report is required on usage change.  
If the value here is not zero, reporting *is* required after the change is made. All the scenarios listed below count as changes in license usage on the product instance:
  - Changing licenses consumed (includes changing to a different license, and, adding or removing a license).
  - Going from consuming zero licenses to consuming one or more licenses.
  - Going from consuming one or more licenses to consuming zero licenses.



**Note** If a product instance has *never* consumed a license, reporting is not required even if the policy has a non-zero value for any of the reporting requirements (First report requirement, Reporting frequency, Report on change).

### Understanding Policy Selection

CSSM determines the policy that is applied to a product instance. Only one policy is in use at a given point in time. The policy and its values are based on a number of factors, including the licenses being used.

`Cisco default` is the default policy that is always available in the product instance. If no other policy is applied, the product instance applies this default policy. The table below ([#unique\\_101 unique\\_101\\_Connect\\_42\\_table\\_kz1\\_snm\\_wmb](#)) shows the `Cisco default` policy values.

While you cannot configure a policy, you can request for a customized one, by contacting the Cisco Global Licensing Operations team. Go to [Support Case Manager](#). Click **OPEN NEW CASE** > Select **Software Licensing**. The licensing team will contact you to start the process or for any additional information. Customized policies are also made available through your Smart account in CSSM.



**Note** To know which policy is applied (the policy in-use) and its reporting requirements, enter the **show license all** command in privileged EXEC mode.

**Table 4: Policy: Cisco default**

Policy: <code>Cisco default</code>	Default Policy Values
Export (Perpetual/Subscription)	Reporting ACK required: Yes
<b>Note</b> Applied only to licenses with enforcement type "Export-Controlled".	First report requirement (days): 0
	Reporting frequency (days): 0
	Report on change (days): 0



Policy: Cisco default	Default Policy Values
Enforced (Perpetual/Subscription) <b>Note</b> Applied only to licenses with enforcement type "Enforced".	Reporting ACK required: Yes First report requirement (days): 0 Reporting frequency (days): 0 Report on change (days): 0
Unenforced/Non-Export Perpetual <sup>5</sup>	Reporting ACK required: Yes First report requirement (days): 365 Reporting frequency (days): 0 Report on change (days): 90
Unenforced/Non-Export Subscription	Reporting ACK required: Yes First report requirement (days): 90 Reporting frequency (days): 90 Report on change (days): 90

<sup>5</sup> For Unenforced/Non-Export Perpetual: the default policy's first report requirement (within 365 days) applies only if you have purchased hardware or software from a distributor or partner.

## RUM Report and Report Acknowledgement

A Resource Utilization Measurement report (RUM report) is a license usage report, which fulfils reporting requirements as specified by the policy. RUM reports are generated by the product instance and consumed by CSSM. The product instance records license usage information and all license usage changes in an open RUM report. At system-determined intervals, open RUM reports are closed and new RUM reports are opened to continue recording license usage. A closed RUM report is ready to be sent to CSSM.

A RUM acknowledgement (RUM ACK or ACK) is a response from CSSM and provides information about the status of a RUM report.

The reporting method, that is, how a RUM report is sent to CSSM, depends on the topology you implement.

CSSM displays license usage information as per the last received RUM report.

A RUM report may be accompanied by other requests, such as a trust code request, or a SLAC request. So in addition to the RUM report IDs that have been received, an ACK from CSSM may include authorization codes, trust codes, and policy files.

The policy that is applied to a product instance determines the following aspects of the reporting requirement:

- Whether a RUM report is sent to CSSM and the maximum number of days provided to meet this requirement.
- Whether the RUM report requires an acknowledgement (ACK) from CSSM.
- The maximum number of days provided to report a change in license consumption.

## Trust Code

A *UDI-tied public key*, which the product instance uses to

- Sign a RUM report. This prevents tampering and ensures data authenticity.
- Enable secure communication with CSSM.

If a trust code is installed on the product instance, the output of the **show license status** command displays a timestamp in the `Trust Code Installed:` field.

## Supported Topologies

This section describes the various ways in which you can implement Smart Licensing Using Policy. For each topology, refer to the accompanying overview to know the how the set-up is designed to work, and refer to the considerations and recommendations, if any.

### After Topology Selection

After you have selected a topology, see [#unique\\_105](#). These workflows are only for new deployments. They provide the simplest and fastest way to implement a topology.

If you are migrating from an existing licensing model, see [#unique\\_106](#).

After initial implementation, for any additional configuration tasks you have to perform, for instance, changing the AIR license, or synchronizing RUM reports, see the *Task Library for Smart Licensing Using Policy*.



---

**Note** Always check the “Supported topologies” where provided, before you proceed.

---

## Connected to CSSM Through CSLU

### Overview:

Here, product instances in the network are connected to CSLU, and CSLU becomes the single point of interface with CSSM. A product instance can be configured to *push* the required information to CSLU. Alternatively, CSLU can be set-up to *pull* the required information from a product instance at a configurable frequency.

Product instance-initiated communication (push): A product instance initiates communication with CSLU, by connecting to a REST endpoint in CSLU. Data that is sent includes RUM reports and requests for authorization codes, UDI-tied trust codes, and policies. You can configure the product instance to automatically send RUM reports to CSLU at required intervals. This is the default method for a product instance.

CSLU-initiated communication (pull): To initiate the retrieval of information from a product instance, CSLU uses NETCONF, or RESTCONF, or gRPC with YANG models, or native REST APIs, to connect to the product instance. Supported workflows include retrieving RUM reports from the product instance and sending the same to CSSM, authorization code installation, UDI-tied trust code installation, and application of policies.

Figure 2: Topology: Connected to CSSM Through CSLU

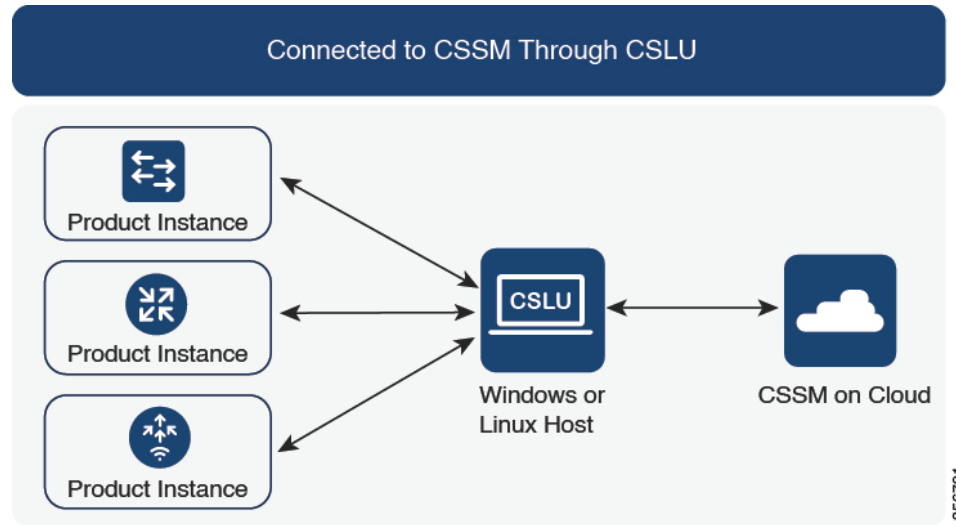

#### Considerations or Recommendations:

Choose the method of communication depending on your network's security policy.

#### Release-Wise Changes and Enhancements:

This section outlines important release-wise software changes and enhancements that affect this topology.

- RUM report throttling

In the product instance-initiated mode, the minimum reporting frequency is throttled to one day. This means the product instance does not send more than one RUM report a day. This resolves the problem of too many RUM reports being generated and sent for certain licenses. It also resolves the memory-related issues and system slow-down caused by an excessive generation of RUM reports.

You can override the throttling restriction by entering the **license smart sync** command in privileged EXEC mode.

RUM report throttling applies to the Cisco IOS XE Amsterdam 17.3.6 and later releases of the 17.3.x train and Cisco IOS XE Bengaluru 17.6.4 and later releases of the 17.6.x train.

#### Where to Go Next:

To implement this topology, see [#unique\\_108](#).

## Connected Directly to CSSM

#### Overview:

This topology is available in the earlier version of Smart Licensing and continues to be supported with Smart Licensing Using Policy.

Here, you establish a *direct* and *trusted* connection from a product instance to CSSM. The direct connection, requires network reachability to CSSM. For the product instance to then exchange messages and communicate with CSSM, configure one of the transport options available with this topology (described below). Lastly, the

establishment of trust requires the generation of a token from the corresponding Smart Account and Virtual Account in CSSM, and installation on the product instance.

You can configure a product instance to communicate with CSSM in the following ways:

- Use Smart transport to communicate with CSSM

Smart transport is a transport method where a Smart Licensing (JSON) message is contained within an HTTPs message, and exchanged between a product instance and CSSM, to communicate. The following Smart transport configuration options are available:

- Smart transport: In this method, a product instance uses a specific Smart transport licensing server URL. This must be configured exactly as shown in the workflow section.
- Smart transport through an HTTPs proxy: In this method, a product instance uses a proxy server to communicate with the licensing server, and eventually, CSSM.

- Use Call Home to communicate with CSSM.

Call Home provides e-mail-based and web-based notification of critical system events. This method of connecting to CSSM is available in the earlier Smart Licensing environment, and continues to be available with Smart Licensing Using Policy. The following Call Home configuration options are available:

- Direct cloud access: In this method, a product instance sends usage information directly over the internet to CSSM; no additional components are needed for the connection.
- Direct cloud access through an HTTPs proxy: In this method, a product instance sends usage information over the internet through a proxy server - either a Call Home Transport Gateway or an off-the-shelf proxy (such as Apache) to CSSM.

**Figure 3: Topology: Connected Directly to CSSM**

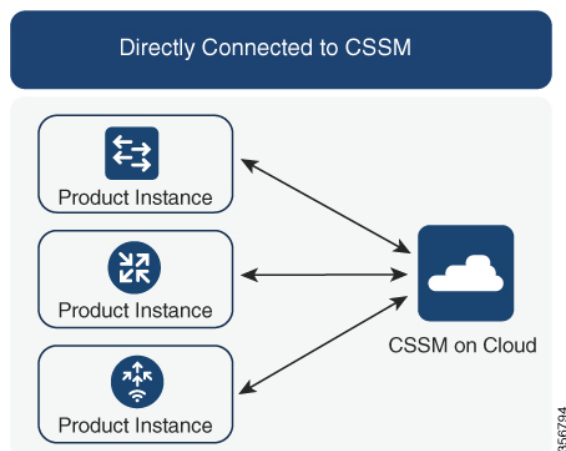

#### Considerations or Recommendations:

Smart transport is the recommended transport method when directly connecting to CSSM. This recommendation applies to:

- New deployments.
- Earlier licensing models. Change configuration after migration to Smart Licensing Using Policy.

- Registered licenses that currently use the Call Home transport method. Change configuration after migration to Smart Licensing Using Policy.
- Evaluation or expired licenses in an earlier licensing model. Change configuration after migration to Smart Licensing Using Policy.

To change configuration after migration, see [#unique\\_110](#) > Product Instance Configuration > Configure a connection method and transport type > Option 1.

### Release-Wise Changes and Enhancements:

This section outlines important release-wise software changes and enhancements that affect this topology.

- RUM report throttling

The minimum reporting frequency for this topology, is throttled to one day. This means the product instance does not send more than one RUM report a day. This resolves the problem of too many RUM reports being generated and sent for certain licenses. It also resolves the memory-related issues and system slow-down caused by an excessive generation of RUM reports.

You can override the throttling restriction by entering the **license smart sync** command in privileged EXEC mode.

RUM report throttling applies to the Cisco IOS XE Amsterdam 17.3.6 and later releases of the 17.3.x train and Cisco IOS XE Bengaluru 17.6.4 and later releases of the 17.6.x train.

### Where to Go Next:

To implement this topology, see [#unique\\_110](#).

## CSLU Disconnected from CSSM

### Overview:

Here, a product instance communicates with CSLU, and you have the option of implementing product instance-initiated communication or CSLU-initiated communication (as in the *Connected to CSSM Through CSLU* topology). The other side of the communication, between CSLU and CSSM, is offline. CSLU provides you with the option of working in a mode that is disconnected from CSSM.

Communication between CSLU and CSSM is sent and received in the form of signed files that are saved offline and then uploaded to or downloaded from CSLU or CSSM, as the case may be.

Figure 4: Topology: CSLU Disconnected from CSSM

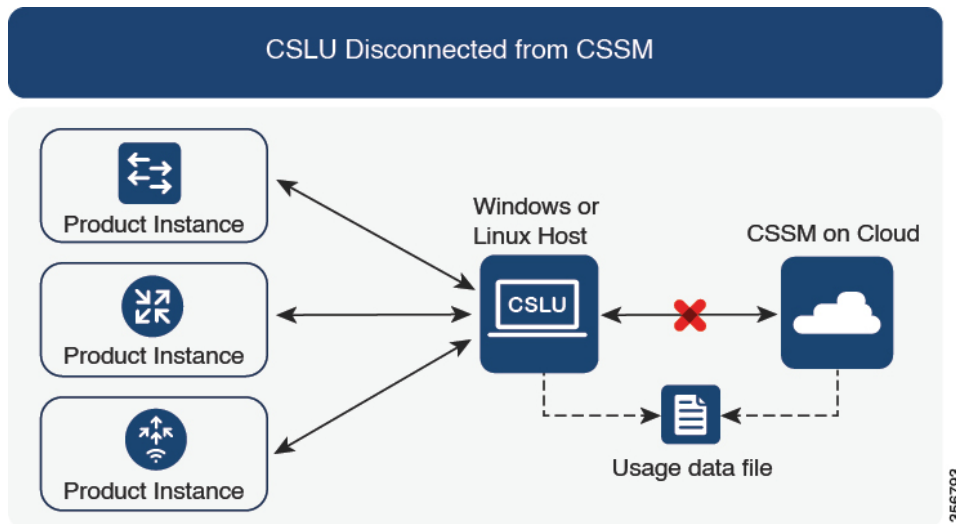
**Considerations or Recommendations:**

Choose the method of communication depending on your network's security policy.

**Release-Wise Changes and Enhancements:**

This section outlines important release-wise software changes and enhancements that affect this topology.

- RUM report throttling

In the product instance-initiated mode, the minimum reporting frequency is throttled to one day. This means the product instance does not send more than one RUM report a day. This resolves the problem of too many RUM reports being generated and sent for certain licenses. It also resolves the memory-related issues and system slow-down caused by an excessive generation of RUM reports.

You can override the throttling restriction by entering the **license smart sync** command in privileged EXEC mode.

RUM report throttling applies to the Cisco IOS XE Amsterdam 17.3.6 and later releases of the 17.3.x train and Cisco IOS XE Bengaluru 17.6.4 and later releases of the 17.6.x train.

**Where to Go Next:**

To implement this topology, see [#unique\\_112](#).

**Connected to CSSM Through a Controller**

When you use a controller to manage a product instance, the controller connects to CSSM, and is the interface for all communication to and from CSSM. The supported controller for Cisco Catalyst Wireless Controllers is Cisco Catalyst Center

**Overview:**

If a product instance is managed by Cisco Catalyst Center as the controller, the product instance records license usage and saves the same, but it is the Cisco Catalyst Center that initiates communication with the

product instance to retrieve RUM reports, report to CSSM, and return the ACK for installation on the product instance.

All product instances that must be managed by Cisco Catalyst Center must be part of its inventory and must be assigned to a site. Cisco Catalyst Center uses the NETCONF protocol to provision configuration and retrieve the required information from the product instance - the product instance must therefore have NETCONF enabled, to facilitate this.

In order to meet reporting requirements, Cisco Catalyst Center retrieves the applicable policy from CSSM and provides the following reporting options:

- Ad hoc reporting: You can trigger an ad hoc report when required.
- Scheduled reporting: Corresponds with the reporting frequency specified in the policy and is automatically handled by Cisco Catalyst Center.



**Note** Ad hoc reporting must be performed at least once before a product instance is eligible for scheduled reporting.

The first ad hoc report enables Cisco Catalyst Center to determine the Smart Account and Virtual Account to which subsequent RUM reports must be uploaded. You will receive notifications if ad hoc reporting for a product instance has not been performed even once.

Cisco Catalyst Center also enables you to install and remove SLAC for export-controlled licenses. Since all available licenses on Cisco Catalyst Wireless Controllers are unenforced licenses, SLAC installation and removal do not apply.

A trust code is *not* required.

**Figure 5: Topology: Connected to CSSM Through a Controller**

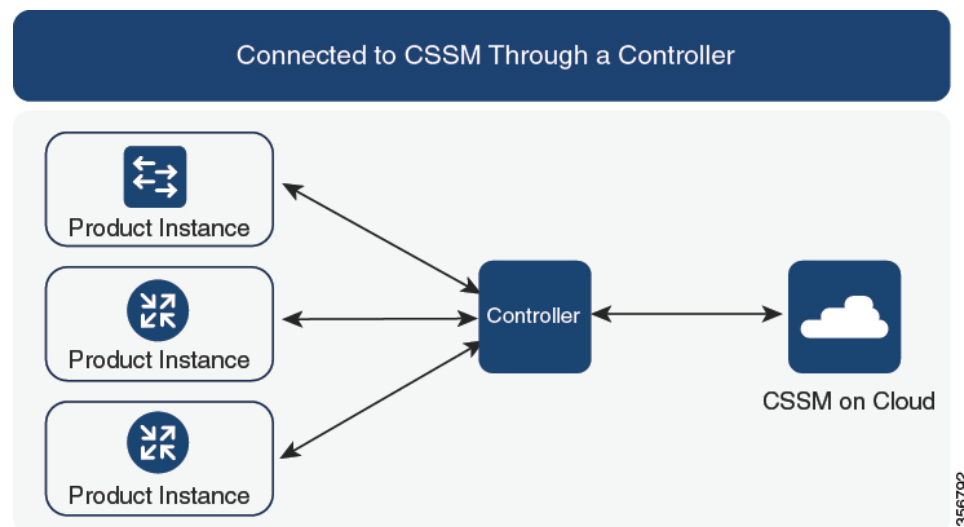

#### Considerations or Recommendations:

This is the recommended topology if you are using Cisco Catalyst Center.

**Where to Go Next:**

To implement this topology, see [Workflow for Topology: Connected to CSSM Through a Controller, on page 85](#).

**No Connectivity to CSSM and No CSLU****Overview:**

Here you have a product instance and CSSM disconnected from each other, and without any other intermediary utilities or components. All communication is in the form of uploaded and downloaded files. These files can be RUM reports .

**Figure 6: Topology: No Connectivity to CSSM and No CSLU**

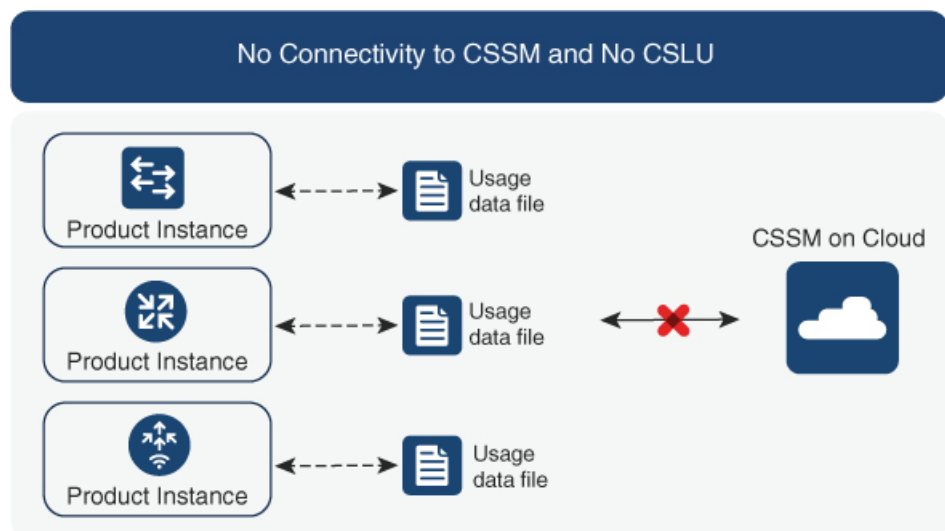
**Considerations or Recommendations:**

This topology is suited to a high-security deployment where a product instance cannot communicate online, with anything outside its network.

**Where to Go Next:**

To implement this topology, see [#unique\\_116](#).

**SSM On-Prem Deployment****Overview:**

SSM On-Prem is designed to work as an extension of CSSM that is deployed on your premises.

Here, a product instance is connected to SSM On-Prem, and SSM On-Prem becomes the single point of interface with CSSM. Each instance of SSM On-Prem must be made known to CSSM through a mandatory registration and synchronization of the local account in SSM On-Prem, with a Virtual Account in CSSM.



When you deploy SSM On-Prem to manage a product instance, the product instance can be configured to *push* the required information to SSM On-Prem. Alternatively, SSM On-Prem can be set-up to *pull* the required information from a product instance at a configurable frequency.

- Product instance-initiated communication (push): The product instance initiates communication with SSM On-Prem, by connecting to a REST endpoint in SSM On-Prem. Data that is sent includes RUM reports and requests for authorization codes, trust codes, and policies.

Options for communication between the product instance and SSM On-Prem in this mode:

- Use a CLI command to push information to SSM On-Prem as and when required.
- Use a CLI command and configure a reporting interval, to automatically send RUM reports to SSM On-Prem at a scheduled frequency.

- SSM On-Prem-initiated communication (pull): To initiate the retrieval of information from a product instance, SSM On-Prem NETCONF, RESTCONF, and native REST API options, to connect to the product instance. Supported workflows include receiving RUM reports from the product instance and sending the same to CSSM, authorization code installation, trust code installation, and application of policies.

Options for communication between the product instance and SSM On-Prem in this mode:

- Collect usage information from one or more product instances as and when required (on-demand).
- Collect usage information from one or more product instances at a scheduled frequency.

In SSM On-Prem, the reporting interval is set to the default policy on the product instance. You can change this, but only to report more frequently (a narrower interval), or you can install a custom policy if available.

After usage information is available in SSM On-Prem, you must synchronize the same with CSSM, to ensure that the product instance count, license count and license usage information is the same on both, CSSM and SSM On-Prem. Options for usage synchronization between SSM On-Prem and CSSM – for the push *and* pull mode:

- Perform ad-hoc synchronization with CSSM (Synchronize now with Cisco).
- Schedule synchronization with CSSM for specified times.
- Communicate with CSSM through signed files that are saved offline and then upload to or download from SSM On-Prem or CSSM, as the case may be.



---

**Note**

This topology involves two different kinds of synchronization between SSM On-Prem and CSSM. The first is where the *local account* is synchronized with CSSM - this is for the SSM On-Prem instance to be known to CSSM and is performed by using the **Synchronization** widget in SSM On-Prem. The second is where *license usage* is synchronized with CSSM, either by being connected to CSSM or by downloading and uploading files. You must synchronize the local account before you can synchronize license usage.

---

Figure 7: Topology: SSM On-Prem Deployment

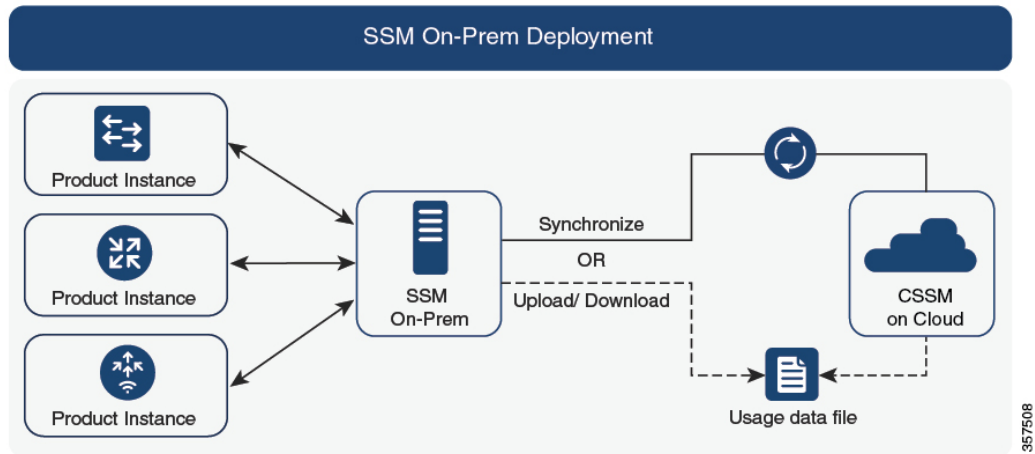
**Considerations or Recommendations:**

This topology is suited to the following situations:

- If you want to manage your product instances on your premises, as opposed communicating directly with CSSM for this purpose.
- If your company's policies prevent your product instances from reporting license usage directly to Cisco (CSSM).
- If your product instances are in an air-gapped network and cannot communicate online, with anything outside their network.

Apart from support for Smart Licensing Using Policy, some of the key benefits of SSM On-Prem *Version 8* include:

- **Multi-tenancy:** One tenant constitutes one Smart Account-Virtual Account pair. SSM On-Prem enables you to manage multiple pairs. Here you create local accounts that reside in SSM On-Prem. Multiple local accounts roll-up to a Smart Account-Virtual Account pair in CSSM. For more information, see the [Cisco Smart Software Manager On-Prem User Guide > About Accounts and Local Virtual Accounts](#).



**Note** The relationship between CSSM and SSM On-Prem instances is still one-to-one.

- **Scale:** Supports up to a total of 300,000 product instances
- **High-Availability:** Enables you to run two SSM On-Prem servers in the form of an active-standby cluster. For more information, see the [Cisco Smart Software On-Prem Installation Guide > Appendix 4. Managing a High Availability \(HA\) Cluster in Your System](#).

High-Availability deployment is supported on the SSM On-Prem console and the required command details are available in the [Cisco Smart Software On-Prem Console Guide](#).

- Options for online and offline connectivity to CSSM.

SSM On-Prem Limitations:

- Proxy support for communication with CSSM, for the purpose of *license usage* synchronization is available only from Version 8 202108 onwards. The use of a proxy for *local account* synchronization, which is performed by using the **Synchronization** widget, is available from the introductory SSM On-Prem release where Smart Licensing Using Policy is supported.
- SSM On-Prem-initiated communication is not supported on a product instance that is in a Network Address Translation (NAT) set-up. You must use product instance-initiated communication, and further, you must *enable* SSM On-Prem to support a product instance that is in a NAT setup. Details are provided in the workflow for this topology.

### Release-Wise Changes and Enhancements:

This section outlines important release-wise software changes and enhancements that affect this topology.

#### From Cisco IOS XE Cupertino 17.9.1:

- RUM report throttling

In the product instance-initiated mode, the minimum reporting frequency is throttled to one day. This means the product instance does not send more than one RUM report a day. This resolves the problem of too many RUM reports being generated and sent for certain licenses. It also resolves the memory-related issues and system slow-down caused by an excessive generation of RUM reports.

You can override the throttling restriction by entering the **license smart sync** command in privileged EXEC mode.

RUM report throttling applies to the Cisco IOS XE Amsterdam 17.3.6 and later releases of the 17.3.x train and Cisco IOS XE Bengaluru 17.6.4 and later releases of the 17.6.x train.

### Where to Go Next:

To implement this topology, see [Workflow for Topology: SSM On-Prem Deployment, on page 87](#)

If you are migrating from an existing version of SSM On-Prem, the sequence in which you perform the various upgrade-related activities is crucial. See [Migrating to a Version of SSM On-Prem That Supports Smart Licensing Using Policy, on page 111](#)

## Interactions with Other Features

### High Availability

This section explains considerations that apply to a High Availability configuration, when running a software version that supports Smart Licensing Using Policy. The following High Availability set-ups are within the scope of this document:

A dual-chassis set-up (could be fixed or modular), with the active in one chassis and a standby in the other chassis.

A wireless N+1 topology, where “n” number of wireless controllers act as primary and a “+1” wireless controller acts as the secondary or fallback wireless controller for Access Points (APs). Each Access Point is configured with a primary and a secondary wireless controller. In case of a failure on the primary, all access points that were connected to the primary now fallback to the secondary wireless controller.

### Trust Code Requirements in a High Availability Set-Up

The number of trust codes required depends on the number of UDIs. The active product instance can submit requests for all devices in the High Availability set-up and install all the trust codes that are returned in an ACK.

### Policy Requirements in a High Availability Set-Up

There are no policy requirements that apply exclusively to a High Availability set-up. As in the case of a standalone product instance, only one policy exists in a High Availability set-up as well, and this is on the active. The policy on the active applies to any standbys in the set-up.

### Product Instance *Functions* in a High Availability Set-Up

This section explains general product instance functions in a High Availability set-up, as well as what the product instance does when a new standby or secondary is added to an existing High Available set-up.

For authorization and trust codes: The active product instance can request (if required) and install authorization codes and trust codes for standbys.

For policies: The active product instance synchronizes with the standby.

For reporting: Only the active product instance reports usage. The active reports usage information for all devices in the High Availability set-up. In addition to scheduled reporting, the following events trigger reporting:

- The addition or removal of a standby. The RUM report includes information about the standby that was added or removed.
- A switchover.
- A reload.

When one of the above events occur, the “Next report push” date of the **show license status** privileged EXEC command is updated. But it is the implemented topology and associated reporting method that determine if the report is sent by the product instance or not. For example, if you have implemented a topology where the product instance is disconnected (Transport Type is Off), then the product instance does not send RUM reports even if the “Next report push” date is updated.

For addition or removal of a new standby:

- A product instance that is connected to CSLU, does not take any further action.
- A product instance that is directly connected to CSSM, performs trust synchronization. Trust synchronization involves the following:

Installation of trust code on the standby if not installed already.

If a trust code is already installed, the trust synchronization process ensures that the new standby is in the same Smart Account and Virtual Account as the active. If it is not, the new standby is *moved* to the same Smart Account and Virtual Account as the active.

Installation of an authorization code, policy, and purchase information, if applicable

Sending of a RUM report with current usage information.

For addition or removal of a secondary:

There are no product instance functions that apply exclusively to the addition or removal of a secondary product instance. Further, all the secondary product instances are in the same Smart Account and Virtual Account as the primary product instance.

## Upgrades

This section describes how upgrade or migration to Smart Licensing Using Policy is handled. It clarifies how Smart Licensing Using Policy handles all earlier licensing models including: the earlier version of Smart Licensing, Specific License Reservation (SLR), and how evaluation or expired licenses from any of the earlier licensing models.

To migrate to Smart Licensing Using Policy, you must upgrade to a software version that supports Smart Licensing Using Policy. After you upgrade, Smart Licensing Using Policy is the only supported licensing model and the product instance continues to operate *without any licensing changes*. The [#unique\\_106](#) section provides details and examples for migration scenarios that apply to Cisco Catalyst Wireless Controllers.

Device-led conversion is not supported for migration to Smart Licensing Using Policy.

### Identifying the Current Licensing Model Before Upgrade

Before you upgrade to Smart Licensing Using Policy, if you want to know the current licensing model that is effective on the product instance, enter the **show license all** command in privileged EXEC mode.

### How Upgrade Affects Enforcement Types for Existing Licenses

When you upgrade to a software version which supports Smart Licensing Using Policy, the way existing licenses are handled, depends primarily on the license enforcement type.

- An unenforced license that was being used before upgrade, continues to be available after the upgrade. All licenses on Cisco Catalyst Wireless Controllers are unenforced licenses. This includes licenses from all earlier licensing models:
  - Smart Licensing
  - Specific License Reservation (SLR), which has an accompanying authorization code. The authorization code continues to be valid after upgrade to Smart Licensing Using Policy and authorizes existing license consumption.
  - Evaluation or expired licenses from any of the above mentioned licensing models.
- An enforced or export-controlled license that was being used before upgrade, continues to be available after upgrade if the required authorization exists.

There are no export-controlled or enforced licenses on any of the supported Cisco Catalyst Wireless Controllers, therefore, these enforcement types and the requisite SLAC do not apply.

### How Upgrade Affects Reporting for Existing Licenses

Existing License	Reporting Requirements After Migration to Smart Licensing Using Policy
Specific License Reservation (SLR)	Required only if there is a change in license consumption. An existing SLR authorization code authorizes existing license consumption after upgrade to Smart Licensing Using Policy.

Existing License	Reporting Requirements After Migration to Smart Licensing Using Policy
Smart Licensing (Registered and Authorized license)	Depends on the policy.
Evaluation or expired licenses	Based on the reporting requirements of the Cisco default policy.

### How Upgrade Affects Transport Type for Existing Licenses

The transport type, if configured in your existing set-up, is retained after upgrade to Smart Licensing Using Policy.

When compared to the earlier version of Smart Licensing, additional transport types are available with Smart Licensing Using Policy. There is also a change in the default transport mode. The following table clarifies how this may affect upgrades:

Transport type Before Upgrade	License or License State Before Upgrade	Transport Type After Upgrade
Default (callhome)	evaluation	cslu (default in Smart Licensing Using Policy)
	SLR	off
	registered	callhome
smart	evaluation	off
	SLR	off
	registered	smart

### How Upgrade Affects the Token Registration Process

In the earlier version of Smart Licensing, a token was used to register and connect to CSSM. ID token registration is not required in Smart Licensing Using Policy. The token generation feature is still available in CSSM, and is used to *establish trust* when a product instance is directly connected to CSSM. See [Connected Directly to CSSM](#).

## Downgrades

To downgrade, you must downgrade the software version on the product instance. This section provides information about downgrades for new deployments and existing deployments (you upgraded to Smart Licensing Using Policy and now want to downgrade).

### New Deployment Downgrade

This section describes considerations and actions that apply if a newly purchased product instance with a software version where Smart Licensing Using Policy is enabled by default, is downgraded to a software version where Smart Licensing Using Policy is not supported.

The outcome of the downgrade depends on whether a trust code was installed while still operating in the Smart Licensing Using Policy environment, and further action may be required depending on the release you downgrade to.

If the topology you implemented while in the Smart Licensing Using Policy environment was "Connected Directly to CSSM", then a trust code installation can be expected or assumed, because it is required as part of topology implementation. For any of the other topologies, trust establishment is not mandatory. Downgrading product instances with one of these other topologies will therefore mean that you have to restore licenses to a registered and authorized state by following the procedures that are applicable in the Smart Licensing environment. See the table (*Outcome and Action for New Deployment Downgrade to Smart Licensing*) below.

**Table 5: Outcome and Action for New Deployment Downgrade to Smart Licensing**

In the Smart Licensing Using Policy Environment	Downgrade to..	Outcome and Further Action
Standalone product instance, connected directly to CSSM, and trust established.	Cisco IOS XE Amsterdam 17.3.1 OR Cisco IOS XE Gibraltar 16.12.4 and later releases in Cisco IOS XE Gibraltar 16.12.x	No further action is required.  The product instance attempts to renew trust with CSSM after downgrade.  After a successful renewal, licenses are in a registered state and the earlier version of Smart Licensing is effective on the product instance.
	Any other release (other than the ones mentioned in the row above) that supports Smart Licensing	Action is required: You must reregister the product instance.  Generate an ID token in the CSSM Web UI and on the product instance, configure the <b>license smart register idtoken idtoken</b> command in global configuration mode.
High Availability set-up, connected directly to CSSM, and trust established.	Any release that supports Smart Licensing	Action is required: You must reregister the product instance.  Generate an ID token in the CSSM Web UI and on the product instance, configure the <b>license smart register idtoken idtoken all</b> command in global configuration mode.
Any other topology. (Connected to CSSM Through CSLU, CSLU Disconnected from CSSM, No Connectivity to CSSM and No CSLU)	Any release that supports Smart Licensing	Action is required.  Restore licenses to a registered and authorized state by following the procedures that are applicable in the Smart Licensing environment.

## Upgrade and Then Downgrade

This section describes considerations and actions that apply if a product instance is upgraded to a software version that supports Smart Licensing Using Policy and then downgraded to an earlier licensing model.

When you downgrade such a product instance, *license consumption does not change* and any product features you have configured on the product instance are preserved – only the features and functions that are available with Smart Licensing Using Policy are not available anymore. Refer to the corresponding section below to know more about reverting to an earlier licensing model.

### Upgrade to Smart Licensing Using Policy and then Downgrade to Smart Licensing

The outcome of the downgrade depends on whether a trust code was installed while you were still operating in the Smart Licensing Using Policy environment, and further action may be required depending on the release you downgrade to. See the table below.

**Table 6: Outcome and Action for Upgrade to Smart Licensing Using Policy and then Downgrade to Smart Licensing**

In the Smart Licensing Using Policy Environment	Downgrade to..	Outcome and Further Action
Standalone product instance, connected directly to CSSM, and trust established.	Cisco IOS XE Amsterdam 17.3.1 OR Cisco IOS XE Gibraltar 16.12.4 and later releases in Cisco IOS XE Gibraltar 16.12.x	No further action is required.  The system recognizes the trust code and converts it back to a registered ID token, and this reverts the license to an AUTHORIZED and REGISTERED state.
	Any other release (other than the ones mentioned in the row above) that supports Smart Licensing	Action is required: You must reregister the product instance.  Generate an ID token in the CSSM Web UI and on the product instance, configure the <b>license smart register idtoken idtoken</b> command in global configuration mode.
High Availability set-up, connected directly to CSSM, and trust established.	Any release that supports Smart Licensing	Action is required: You must reregister the product instance.  Generate an ID token in the CSSM Web UI and on the product instance, configure the <b>license smart register idtoken idtoken all</b> command in global configuration mode.
Any other topology (Connected to CSSM Through CSLU, CSLU Disconnected from CSSM, No Connectivity to CSSM and No CSLU)	Any release that supports Smart Licensing.	Action is required.  Restore licenses to a registered and authorized state by following the procedures that are applicable in the Smart Licensing environment.





---

**Note** Licenses that were in an evaluation or expired state in the Smart Licensing environment, revert to that same state after downgrade.

---

### Upgrade to Smart Licensing Using Policy and then Downgrade to SLR

To revert to SLR, all that is required is for the image to be downgraded. The license remains reserved and authorized – no further action is required.

However, if you have returned an SLR while in the Smart Licensing Using Policy environment, then you must repeat the process of procuring an SLR as required, in the supported release.

## How to Configure Smart Licensing Using Policy: Workflows by Topology

This section provides the simplest and fastest way to implement a topology.



---

**Note** These workflows are meant for new deployments only. If you are migrating from an existing licensing model, see [#unique\\_106](#).

---

## Workflow for Topology: Connected to CSSM Through CSLU

Depending on whether you want to implement a product instance-initiated or CSLU-initiated method of communication, complete the corresponding sequence of tasks:

- [Tasks for Product Instance-Initiated Communication](#)
- [Tasks for CSLU-Initiated Communication](#)

### Tasks for Product Instance-Initiated Communication

**CSLU Installation** → **CSLU Preference Settings** → **Product Instance Configuration**

#### 1. *CSLU Installation*

Where task is performed: A Windows host (laptop, desktop, or a Virtual Machine (VM))

Download the file from [Smart Software Manager](#) > **Smart Licensing Utility**.

Refer to [Cisco Smart License Utility Quick Start Setup Guide](#) for help with installation and set-up.

#### 2. *CSLU Preference Settings*

Where tasks are performed: CSLU

- a. [#unique\\_134](#)
- b. [#unique\\_135](#)
- c. [#unique\\_136](#)

### 3. Product Instance Configuration

Where tasks are performed: Product Instance

a. [#unique\\_137](#)

b. Ensure that transport type is set to **cslu**.

CSLU is the default transport type. If you have configured a different option, enter the **license smart transport cslu** command in global configuration mode. Save any changes to the configuration file.

```
Device(config)# license smart transport cslu
Device(config)# exit
Device# copy running-config startup-config
```

c. Specify how you want CSLU to be discovered (*choose one*):

• Option 1:

No action required. Name server configured for Zero-touch DNS discovery of `cslu-local`

Here, if you have configured DNS (the name server IP address is configured on the product instance), and the DNS server has an entry where hostname `cslu-local` is mapped to the CSLU IP address, then no further action is required. The product instance automatically discovers hostname `cslu-local`.

• Option 2:

No action required. Name server and domain configured for Zero-touch DNS discovery of `cslu-local.<domain>`

Here if you have configured DNS (the name server IP address and domain is configured on the product instance), and the DNS server has an entry where `cslu-local.<domain>` is mapped to the CSLU IP address, then no further action is required. The product instance automatically discovers hostname `cslu-local`.

• Option 3:

Configure a specific URL for CSLU.

Enter the **license smart url cslu** `http://<cslu_ip_or_host>:8182/cslu/v1/pi` command in global configuration mode. For `<cslu_ip_or_host>`, enter the hostname or the IP address of the windows host where you have installed CSLU. 8182 is the port number and it is the only port number that CSLU uses.

```
Device(config)# license smart url cslu http://192.168.0.1:8182/cslu/v1/pi
Device(config)# exit
Device# copy running-config startup-config
```

**Result:**

Since the product instance initiates communication, it automatically sends out the first RUM report at the scheduled time, as per the policy. CSLU forwards the RUM report to CSSM and retrieves the ACK, which also contains the trust code. The ACK is applied to the product instance the next time the product instance contacts CSLU.

In the Cisco IOS XE Amsterdam 17.3.6 and later releases of the 17.3.x train, Cisco IOS XE Bengaluru 17.6.4 and later releases of the 17.6.x train: The product instance does not send more than one RUM report a day. You can override this for an on-demand synchronization between the product instance and CSSM, by entering the **license smart sync** command in privileged EXEC mode.

To know when the product instance will be sending the next RUM report, enter the **show license all** command in privileged EXEC mode and in the output, check the date in the `Next report push` field.

In case of a change in license usage, see [#unique\\_138](#) to know how it affects reporting.

### Tasks for CSLU-Initiated Communication

**CSLU Installation** → **CSLU Preference Settings** → **Product Instance Configuration** → **Usage Synchronization**

#### 1. *CSLU Installation*

Where task is performed: A Windows host (laptop, desktop, or a Virtual Machine (VM))

Download the file from [Smart Software Manager](#) > **Smart Licensing Utility**.

Refer to [Cisco Smart License Utility Quick Start Setup Guide](#) for help with installation and set-up.

#### 2. *CSLU Preference Settings*

Where tasks is performed: CSLU

a. [#unique\\_134](#)

b. [#unique\\_135](#)

c. [#unique\\_139](#)

#### 3. *Product Instance Configuration*

Where tasks is performed: Product Instance

[#unique\\_140](#)

#### 4. *Usage Synchronization*

Where tasks is performed: Product Instance

[#unique\\_141](#)

#### **Result:**

Since CSLU is logged into CSSM, the reports are automatically sent to the associated Smart Account and Virtual Account in CSSM and CSSM will send an ACK to CSLU as well as to the product instance. It gets the ACK from CSSM and sends this back to the product instance for installation. The ACK from CSSM contains the trust code and SLAC if this was requested.

In case of a change in license usage, see [#unique\\_138](#) to know how it affects reporting.

## Workflow for Topology: Connected Directly to CSSM

**Smart Account Set-Up** → **Product Instance Configuration** → **Trust Establishment with CSSM**

#### 1. *Smart Account Set-Up*

Where task is performed: CSSM Web UI, <https://software.cisco.com/>

Ensure that you have a user role with proper access rights to a Smart Account and the required Virtual Accounts.

## 2. Product Instance Configuration

Where tasks are performed: Product Instance

- a. Set-Up product instance connection to CSSM: [#unique\\_143](#)
- b. Configure a connection method and transport type (choose one)

- Option 1:

Smart transport: Set transport type to **smart** and configure the corresponding URL.

If the transport mode is set to **license smart transport smart**, and you configure **license smart url default**, the Smart URL (<https://smarterceiver.cisco.com/licservice/license>) is automatically configured. Save any changes to the configuration file.

```
Device(config)# license smart transport smart
Device(config)# license smart url default
Device(config)# exit
Device# copy running-config startup-config
```

- Option 2:

Configure Smart transport through an HTTPs proxy. See [#unique\\_144](#)

- Option 3:

Configure Call Home service for direct cloud access. See [#unique\\_145](#).

- Option 4:

Configure Call Home service for direct cloud access through an HTTPs proxy. See [#unique\\_146](#).

## 3. Trust Establishment with CSSM

Where task is performed: CSSM Web UI and then the product instance

- a. Generate one token for each *Virtual Account* you have. You can use same token for all the product instances that are part of one Virtual Account: [#unique\\_147](#)
- b. Having downloaded the token, you can now install the trust code on the product instance: [#unique\\_148](#)

### Result:

After establishing trust, CSSM returns a policy. The policy is automatically installed on all product instances of that Virtual Account. The policy specifies if and how often the product instance reports usage.

In the Cisco IOS XE Amsterdam 17.3.6 and later releases of the 17.3.x train, Cisco IOS XE Bengaluru 17.6.4 and later releases of the 17.6.x train: The product instance does not send more than one RUM report a day. You can override this for an on-demand synchronization between the product instance and CSSM, by entering the **license smart sync** command in privileged EXEC mode.

To change the reporting interval, configure the **license smart usage interval** command in global configuration mode. For syntax details see the *license smart (privileged EXEC)* command in the Command Reference for the corresponding release.

In case of a change in license usage, see [#unique\\_138](#) to know how it affects reporting.

## Workflow for Topology: CSLU Disconnected from CSSM

Depending on whether you want to implement a product instance-initiated or CSLU-initiated method of communication. Complete the corresponding table of tasks below.

- [Tasks for Product Instance-Initiated Communication](#)
- [Tasks for CSLU-Initiated Communication](#)

### Tasks for Product Instance-Initiated Communication

**CSLU Installation** → **CSLU Preference Settings** → **Product Instance Configuration** → **Usage Synchronization**

#### 1. *CSLU Installation*

Where task is performed: A Windows host (laptop, desktop, or a Virtual Machine (VM))

Download the file from [Smart Software Manager](#) > **Smart Licensing Utility**.

Refer to [Cisco Smart License Utility Quick Start Setup Guide](#) for help with installation and set-up.

#### 2. *CSLU Preference Settings*

Where tasks are performed: CSLU

- In the CSLU Preferences tab, click the **Cisco Connectivity** toggle switch to **off**. The field switches to “Cisco Is Not Available”.
- [#unique\\_135](#)
- [#unique\\_136](#)

#### 3. *Product Instance Configuration*

Where tasks are performed: Product Instance

- [#unique\\_137](#)
- Ensure that transport type is set to **cslu**.

CSLU is the default transport type. If you have configured a different option, enter the **license smart transport cslu** command in global configuration mode. Save any changes to the configuration file.

```
Device(config)# license smart transport cslu
Device(config)# exit
Device# copy running-config startup-config
```

- Specify how you want CSLU to be discovered (*choose one*)

- Option 1:

No action required. Name server configured for Zero-touch DNS discovery of `cslu-local`

Here, if you have configured DNS (the name server IP address is configured on the product instance), and the DNS server has an entry where hostname `cslu-local` is mapped to the CSLU IP address, then no further action is required. The product instance automatically discovers hostname `cslu-local`.

- Option 2:

No action required. Name server and domain configured for Zero-touch DNS discovery of `cslu-local.<domain>`

Here if you have configured DNS (the name server IP address and domain is configured on the product instance), and the DNS server has an entry where `cslu-local.<domain>` is mapped to the CSLU IP address, then no further action is required. The product instance automatically discovers hostname `cslu-local`.

- Option 3:

Configure a specific URL for CSLU.

Enter the **license smart url cslu** `http://<cslu_ip_or_host>:8182/cslu/v1/pi` command in global configuration mode. For `<cslu_ip_or_host>`, enter the hostname or the IP address of the windows host where you have installed CSLU. 8182 is the port number and it is the only port number that CSLU uses.

```
Device(config)# license smart url cslu http://192.168.0.1:8182/cslu/v1/pi
Device(config)# exit
Device# copy running-config startup-config
```

#### 4. Usage Synchronization

Where tasks are performed: CSLU and CSSM

Since the product instance initiates communication, it automatically sends out the first RUM report at the scheduled time, as per the policy. You can also enter the **license smart sync** privileged EXEC command to trigger this. Along with this first report, if applicable, it sends a request for a UDI-tied trust code. Since CSLU is disconnected from CSSM, perform the following tasks to send the RUM Reports to CSSM.

- [#unique\\_150](#)
- [#unique\\_151](#)
- [#unique\\_152](#)

#### Result:

The ACK is applied to the product instance the next time the product instance contacts CSLU.

In the Cisco IOS XE Amsterdam 17.3.6 and later releases of the 17.3.x train, Cisco IOS XE Bengaluru 17.6.4 and later releases of the 17.6.x train: The product instance does not send more than one RUM report a day. You can override this for an on-demand synchronization between the product instance and CSSM, by entering the **license smart sync** command in privileged EXEC mode.

To know when the product instance will be sending the next RUM report, enter the **show license all** command in privileged EXEC mode and in the output, check the date for the `Next report push` field.

In case of a change in license usage, see [#unique\\_138](#) to know how it affects reporting.

#### Tasks for CSLU-Initiated Communication

**CSLU Installation** → **CSLU Preference Settings** → **Product Instance Configuration** → **Usage Synchronization**

##### 1. CSLU Installation

Where task is performed: A Windows host (laptop, desktop, or a Virtual Machine (VM))

Download the file from [Smart Software Manager](#) > **Smart Licensing Utility**.

Refer to [Cisco Smart License Utility Quick Start Setup Guide](#) for help with installation and set-up.

## 2. *CSLU Preference Settings*

Where tasks is performed: CSLU

- a. In the CSLU Preferences tab, click the **Cisco Connectivity** toggle switch to **off**. The field switches to “Cisco Is Not Available”.
- b. [#unique\\_135](#)
- c. [#unique\\_139](#)
- d. [#unique\\_141](#)

## 3. *Product Instance Configuration*

Where task is performed: Product Instance

[#unique\\_140](#)

## 4. *Usage Synchronization*

Where tasks are performed: CSLU and CSSM

Collect usage data from the product instance. Since CSLU is disconnected from CSSM, you then save usage data which CSLU has collected from the product instance to a file. Along with this first report, if applicable, an authorization code and a UDI-tied trust code request is included in the RUM report. Then, from a workstation that is connected to Cisco, upload it to CSSM. After this, download the ACK from CSSM. In the workstation where CSLU is installed and connected to the product instance, upload the file to CSLU.

- a. [#unique\\_150](#)
- b. [#unique\\_151](#)
- c. [#unique\\_152](#)

### *Result:*

The ACK you have imported from CSSM contains the trust code and SLAC if this was requested. The uploaded ACK is applied to the product instance the next time CSLU runs an update.

In case of a change in license usage, see [#unique\\_138](#) to know how it affects reporting.

# Workflow for Topology: Connected to CSSM Through a Controller

To deploy Cisco Catalyst Center as the controller, complete the following workflow:

**Product Instance Configuration** → Cisco Catalyst Center **Configuration**

## 1. *Product Instance Configuration*

Where task is performed: Product Instance

Enable NETCONF. Cisco Catalyst Center uses the NETCONF protocol to provision configuration and retrieve the required information from the product instance - the product instance must therefore have NETCONF enabled, to facilitate this.

For more information, see the [Programmability Configuration Guide, Cisco IOS XE Amsterdam 17.3.x](#). In the guide, go to *Model-Driven Programmability > NETCONF Protocol*.

## 2. Cisco Catalyst Center Configuration

Where tasks is performed: Cisco Catalyst Center GUI

An outline of the tasks you must complete and the accompanying documentation reference is provided below. The document provides detailed steps you have to complete in the Cisco Catalyst Center GUI:

### a. Set-up the Smart Account and Virtual Account.

Enter the same log in credentials that you use to log in to the CSSM Web UI. This enables Cisco Catalyst Center to establish a connection with CSSM.

See the [Cisco Catalyst Center Administrator Guide](#) of the required release (Release 2.2.2 onwards) > *Manage Licenses > Set Up License Manager*.

### b. Add the required product instances to Cisco Catalyst Center inventory and assign them to a site.

This enables Cisco Catalyst Center to push any necessary configuration, including the required certificates, for Smart Licensing Using Policy to work as expected.

See the [Cisco Catalyst Center User Guide](#) of the required release (Release 2.2.2 onwards) > *Display Your Network Topology > Assign Devices to a Site*.

### Result:

After you implement the topology, *you* must trigger the very first ad hoc report in Cisco Catalyst Center, to establish a mapping between the Smart Account and Virtual Account, and product instance. See the [Cisco Catalyst Center Administrator Guide](#) of the required release (Release 2.2.2 onwards) > *Manage Licenses > Upload Resource Utilization Details to CSSM*. Once this is done, Cisco Catalyst Center handles subsequent reporting based on the reporting policy.

If multiple policies are available, Cisco Catalyst Center maintains the narrowest reporting interval. You can change this, but only to report more frequently (a narrower interval). See the [Cisco Catalyst Center Administrator Guide](#) of the required release (Release 2.2.2 onwards) > *Manage Licenses > Modify License Policy*.

If you want to change the license level after this, see the [Cisco Catalyst Center Administrator Guide](#) of the required release (Release 2.2.2 onwards) > *Manage Licenses > Change License Level*.

## Workflow for Topology: No Connectivity to CSSM and No CSLU

Since you do not have to configure connectivity to any other component, the list of tasks required to set-up the topology is a small one. See, the **Results** section at the end of the workflow to know how you can complete requisite usage reporting after you have implemented this topology.

### Product Instance Configuration

Where task is performed: Product Instance

Set transport type to **off**.



Enter the **license smart transport off** command in global configuration mode. Save any changes to the configuration file.

```
Device(config)# license smart transport off
Device(config)# exit
Device# copy running-config startup-config
```

**Result:**

All communication to and from the product instance is disabled. To report license usage you must save RUM reports to a file on the product instance. From a workstation that has connectivity to the Internet and Cisco, upload the file to CSSM:

1. Generate and save RUM reports

Enter the **license smart save usage** command in privileged EXEC mode. In the example below, all RUM reports are saved to the flash memory of the product instance, in file `all_rum.txt`.

In the example below, the file is first saved to bootflash and then copied to a TFTP location:

```
Device# license smart save usage all file bootflash:all_rum.txt
Device# copy bootflash:all_rum.txt tftp://10.8.0.6/all_rum.txt
```

2. Upload usage data to CSSM: [#unique\\_151](#).
3. Install the ACK on the product instance: [#unique\\_154](#)

If you want to change license usage, see [#unique\\_138](#).

If you want to return an SLR authorization code, see [Removing and Returning an Authorization Code, on page 140](#).

## Workflow for Topology: SSM On-Prem Deployment

Depending on whether you want to implement a product instance-initiated (push) or SSM On-Prem-initiated (pull) method of communication, complete the corresponding sequence of tasks.

### Tasks for Product Instance-Initiated Communication

**SSM On-Prem Installation → Addition and Validation of Product Instances (Only if Applicable) → Product Instance Configuration → Initial Usage Synchronization**

1. **SSM On-Prem Installation**

Where task is performed: A physical server such as a Cisco UCS C220 M3 Rack Server, or a hardware-based server that meets the necessary requirements.

Download the file from [Smart Software Manager](#) > **Smart Software Manager On-Prem**.

Refer to the [Cisco Smart Software On-Prem Installation Guide](#) and the [Cisco Smart Software On-Prem User Guide](#) for help with installation.

Installation is complete when you have deployed SSM On-Prem, configured a common name on SSM On-Prem (**Security Widget** > **Certificates**), synchronized the NTP server (**Settings** widget > **Time Settings**), and created, registered, and synchronized (**Synchronization** widget) the SSM On-Prem local account with your Smart Account and Virtual Account in CSSM.



---

**Note** Licensing functions in the **On-Prem Licensing Workspace** are greyed-out until you complete the creation, registration, and synchronization of the local account with your Smart Account in CSSM. The *local accounts* synchronization with CSSM is for the SSM On-Prem instance to be known to CSSM, and is different from usage synchronization which is performed in **4. Initial Usage Synchronization** below.

---

## 2. Addition and Validation of Product Instances

Where tasks are performed: SSM On-Prem UI

This step ensures that the product instances are validated and mapped to the applicable Smart Account and Virtual account in CSSM. This step is required only in the following cases:

- If you want your product instances to be added and validated in SSM On-Prem before they are reported in CSSM (for added security).
  - If you have created local virtual accounts (in addition to the default local virtual account) in SSM On-Prem. In this case you must provide SSM On-Prem with the Smart Account and Virtual Account information for the product instances in these local virtual accounts, so that SSM On-Prem can report usage to the correct license pool in CSSM.
- a. [Assigning a Smart Account and Virtual Account \(SSM On-Prem UI\), on page 122](#)
  - b. [Validating Devices \(SSM On-Prem UI\), on page 123](#)



---

**Note** If your product instance is in a NAT set-up, also enable support for a NAT Setup when you enable device validation – both toggle switches are in the same window.

---

## 3. Product Instance Configuration

Where tasks are performed: Product Instance and the SSM On-Prem UI

Remember to save any configuration changes on the product instance, by entering the **copy running-config startup-config** command in privileged EXEC mode.

- a. [Ensuring Network Reachability for Product Instance-Initiated Communication, on page 123](#)
- b. [Retrieving the Transport URL \(SSM On-Prem UI\), on page 125](#)
- c. [Setting the Transport Type, URL, and Reporting Interval, on page 147](#)

The transport type configuration for CSLU and SSM On-Prem are the same (**license smart transport cslu** command in global configuration mode), but the URLs are different.

## 4. Initial Usage Synchronization

Where tasks are performed: Product instance, SSM On-Prem, CSSM

- a. Synchronize the product instance with SSM On-Prem.

On the product instance, enter the **license smart sync {all | local}** command, in privileged EXEC mode. This synchronizes the product instance with SSM On-Prem, to send and receive any pending data. For example:

```
Device# license smart sync local
```

You can verify this in the SSM On-Prem UI. Log in and select the **Smart Licensing** workspace. Navigate to the **Inventory > SL Using Policy** tab. In the **Alerts** column of the corresponding product instance, the following message is displayed: Usage report from product instance.



---

**Note** If you have not performed Step 2 above (Addition and Validation of Product Instances), completing this sub-step will add the product instance to the SSM On-Prem database.

---

**b.** Synchronize usage information with CSSM (*choose one*):

- Option 1:

SSM On-Prem is connected to CSSM: In the SSM On-Prem UI, Smart Licensing workspace, navigate to **Reports > Usage Schedules > Synchronize now with Cisco**.

- Option 2:

SSM On-Prem is not connected to CSSM: See [Exporting and Importing Usage Data \(SSM On-Prem UI\), on page 126](#).

**Result:**

You have completed initial usage synchronization. Product instance and license usage information is now displayed in SSM On-Prem.

For subsequent reporting, you have the following options:

- To synchronize data between the product instance and SSM On-Prem:

Schedule periodic synchronization between the product instance and the SSM On-Prem, by configuring the reporting interval. Enter the **license smart usage interval interval\_in\_days** command in global configuration mode.

In the Cisco IOS XE Amsterdam 17.3.6 and later releases of the 17.3.x train, Cisco IOS XE Bengaluru 17.6.4 and later releases of the 17.6.x train: The product instance does not send more than one RUM report a day. You can override this for an on-demand synchronization between the product instance and CSSM, by entering the **license smart sync** command in privileged EXEC mode.

To know when the product instance will be sending the next RUM report, enter the **show license all** command in privileged EXEC mode and in the output, check the `Next report push:` field.

- To synchronize usage information with CSSM schedule periodic synchronization, or , upload and download the required files:
  - Schedule periodic synchronization with CSSM. In the SSM On-Prem UI, navigate to **Reports > Usage Schedules > Synchronization schedule with Cisco**. Enter the following frequency information and save:
    - **Days:** Refers to how *often* synchronization occurs. For example, if you enter 2, synchronization occurs once every two days.
    - **Time of Day:** Refers to the time at which synchronization occurs, in the 24-hour notation system. For example, if you enter 14 hours and 0 minutes, synchronization occurs at 2 p.m. (1400) in your local time zone.

- Upload and download the required files for reporting: [Exporting and Importing Usage Data \(SSM On-Prem UI\)](#), on page 126).

## Tasks for SSM On-Prem Instance-Initiated Communication

**SSM On-Prem Installation** → **Product Instance Addition** → **Product Instance Configuration** → **Initial Usage Synchronization**

### 1. *SSM On-Prem Installation*

Where task is performed: A physical server such as a Cisco UCS C220 M3 Rack Server, or a hardware-based server that meets the necessary requirements.

Download the file from [Smart Software Manager](#) > **Smart Software Manager On-Prem**.

Refer to the [Cisco Smart Software On-Prem Installation Guide](#) and the [Cisco Smart Software On-Prem User Guide](#) for help with installation.

Installation is complete when you have deployed SSM On-Prem, configured a common name on SSM On-Prem (**Security Widget** > **Certificates**), synchronized the NTP server (**Settings** widget > **Time Settings**), and created, registered, and synchronized (**Synchronization** widget) the SSM On-Prem local account with your Smart Account and Virtual Account in CSSM.



---

**Note** Licensing functions in the **On-Prem Licensing Workspace** are greyed-out until you complete the creation, registration, and synchronization of the local account with your Smart Account in CSSM. The *local account* synchronization with CSSM is for the SSM On-Prem instance to be known to CSSM, and is different from usage synchronization which is performed in **4. Initial Usage Synchronization** below.

---

### 2. *Product Instance Addition*

Where task is performed: SSM On-Prem UI

Depending on whether you want to add a single product instance or multiple product instances, follow the corresponding sub-steps: [Adding One or More Product Instances \(SSM On-Prem UI\)](#), on page 127.

### 3. *Product Instance Configuration*

Where tasks are performed: Product Instance and the SSM On-Prem UI

Remember to save any configuration changes on the product instance, by entering the **copy running-config startup-config** command in privileged EXEC mode: [Ensuring Network Reachability for SSM On-Prem-Initiated Communication](#), on page 128.

### 4. *Initial Usage Synchronization*

Where tasks are performed: SSM On-Prem UI, and CSSM

- Retrieve usage information from the product instance.

In the SSM On-Prem UI, navigate to **Reports** > **Synchronization pull schedule with the devices** > **Synchronize now with the device**.

In the **Alerts** column, the following message is displayed: Usage report from product instance.



**Tip** It takes 60 seconds before synchronization is triggered. To view progress, navigate to the **On-Prem Admin Workspace**, and click the **Support Centre** widget. The system logs here display progress.

**b.** Synchronize usage information with CSSM (*choose one*)

• Option 1:

SSM On-Prem is connected to CSSM: In the SSM On-Prem UI, Smart Licensing workspace, navigate to **Reports > Usage Schedules > Synchronize now with Cisco**.

• Option 2:

SSM On-Prem is not connected to CSSM. See: [Exporting and Importing Usage Data \(SSM On-Prem UI\)](#), on page 126.

**Result:**

You have completed initial usage synchronization. Product instance and license usage information is now displayed in SSM On-Prem. SSM On-Prem automatically sends the ACK back to the product instance. To verify that the product instance has received the ACK, enter the **show license status** command in privileged EXEC mode, and in the output, check the date for the `Last ACK received` field.

For subsequent reporting, you have the following options:

- To retrieve usage information from the product instance, you can:
  - In the SSM On-Prem UI, Smart Licensing workspace, navigate to **Reports > Usage Schedules > Synchronize now with Cisco**.
  - Schedule periodic retrieval of information from the product instance by configuring a frequency. In the SSM On-Prem UI, Smart Licensing workspace, navigate to **Reports > Usage Schedules > Synchronization pull schedule with the devices**. Enter values in the following fields:
    - **Days:** Refers to how *often* synchronization occurs. For example, if you enter 2, synchronization occurs once every two days.
    - **Time of Day:** Refers to the time at which synchronization occurs, in the 24-hour notation system. For example, if you enter 14 hours and 0 minutes, synchronization occurs at 2 p.m. (1400).
  - Collect usage data from the product instance without being connected to CSSM. In the SSM On-Prem UI, Smart Licensing workspace, navigate to **Inventory > SL Using Policy** tab. Select one or more product instances by enabling the corresponding check box. Click **Actions for Selected... > Collect Usage**. On-Prem connects to the selected Product Instance(s) and collects the usage reports. These usage reports are then stored in On-Prem's local library. These reports can then be transferred to Cisco if On-Prem is connected to Cisco, or (if you are not connected to Cisco) you can manually trigger usage collection by selecting **Export/Import All.. > Export Usage to Cisco**.
- To synchronize usage information with CSSM, you can:
  - Schedule periodic synchronization with CSSM. In the SSM On-Prem UI, navigate to **Reports > Usage Schedules > Synchronization schedule with Cisco**. Enter the following frequency information and save:

- **Days:** Refers to how *often* synchronization occurs. For example, if you enter 2, synchronization occurs once every two days.
- **Time of Day:** Refers to the time at which synchronization occurs, in the 24-hour notation system. For example, if you enter 14 hours and 0 minutes, synchronization occurs at 2 p.m. (1400).
- Upload and download the required files for reporting: [Exporting and Importing Usage Data \(SSM On-Prem UI\)](#), on page 126).

## Migrating to Smart Licensing Using Policy

To upgrade to Smart Licensing Using Policy, you must upgrade the software version (image) on the product instance to a supported version.

### Before you Begin

Ensure that you have read the [#unique\\_97](#) section, to understand how Smart Licensing Using Policy handles all earlier licensing models.

Smart Licensing Using Policy is introduced in Cisco IOS XE Amsterdam 17.3.2a. This is therefore the minimum required version for Smart Licensing Using Policy.

Note that all the licenses that you are using prior to migration will be available after upgrade. This means that not only registered and authorized licenses (including reserved licenses), but also evaluation licenses will be migrated. The advantage with migrating registered and authorized licenses is that you will have fewer configuration steps to complete after migration, because your configuration is retained after upgrade (transport type configuration and configuration for connection to CSSM, all authorization codes). This ensures a smoother transition to the Smart Licensing Using Policy environment.

Device-led conversion is not supported for migration to Smart Licensing Using Policy.

### Upgrading the Wireless Controller Software

For information about the upgrade procedure:

- For Cisco Embedded Wireless Controller on Cisco Catalyst 9100 Access Points, see the *Software Upgrade* section in the [Cisco Embedded Wireless Controller on Catalyst Access Points Online Help](#)
- For all other supported wireless controllers, see the *System Upgrade > Upgrading the Cisco Catalyst 9800 Wireless Controller Software* section of the [Cisco Catalyst 9800 Series Wireless Controller Software Configuration Guide](#) for the required release.

You can use the procedure to upgrade in install mode or ISSU (ISSU only on supported platforms and supported releases)

### After Upgrading the Software Version

- Complete topology implementation.

If a transport mode is available in your pre-upgrade set-up, this is retained after you upgrade. Only in some cases, like with evaluation licenses or with licensing models where the notion of a transport type

does not exist, the default (**cslu**) is applied - in these cases you may have a few more steps to complete before you are set to operate in the Smart Licensing Using Policy environment.

No matter which licensing model you upgrade from, you can change the topology after upgrade.

- Synchronize license usage with CSSM

No matter which licensing model you are upgrading from and no matter which topology you implement, synchronize your usage information with CSSM. For this you have to follow the reporting method that applies to the topology you implement. This initial synchronization ensures that up-to-date usage information is reflected in CSSM and a custom policy (if available), is applied. The policy that is applicable after this synchronization also indicates subsequent reporting requirements. These rules are also tabled here: [How Upgrade Affects Reporting for Existing Licenses, on page 75](#)



---

**Note** After initial usage synchronization is completed, reporting is required only if the policy, or, system messages indicate that it is.

---

### Sample Migration Scenarios

Sample migration scenarios have been provided considering the various existing licensing models and licenses. All scenarios provide sample outputs before and after migration, any CSSM Web UI changes to look out for (as an indicator of a successful migration or further action), and how to identify and complete any necessary post-migration steps.



---

**Note** For SSM On-Prem, the sequence in which you perform the various upgrade-related activities is crucial. So only for this scenario, the migration sequence has been provided - and not an example.

---

## Example: Smart Licensing to Smart Licensing Using Policy

The following is an example of a Cisco Catalyst 9800-CL Wireless Controller migrating from Smart Licensing to Smart Licensing Using Policy.

- [#unique\\_168 unique\\_168\\_Connect\\_42\\_table\\_11p\\_yvl\\_knb](#)
- [#unique\\_168 unique\\_168\\_Connect\\_42\\_section\\_wgh\\_yvl\\_knb](#)
- [#unique\\_168 unique\\_168\\_Connect\\_42\\_section\\_crc\\_yvl\\_knb](#)

The **show** command outputs below call-out key fields to check, before and after migration.

**Table 7: Smart Licensing to Smart Licensing Using Policy: show Commands**

Before Upgrade (Smart Licensing)	After Upgrade (Smart Licensing Using Policy)
<p><b>show license summary</b></p> <p>The <code>Status</code> and <code>License Authorization</code> fields show that the license is <code>REGISTERED</code> and <code>AUTHORIZED</code>.</p>	<p><b>show license summary</b></p> <p>The <code>Status</code> field shows that the licenses are now <code>IN USE</code> instead of <code>registered</code> and <code>authorized</code>.</p>

Before Upgrade (Smart Licensing)	After Upgrade (Smart Licensing Using Policy)
<pre> Device# show license summary  Smart Licensing is ENABLED  Registration:   Status: REGISTERED   Smart Account: SA-Eg-Company-02   Virtual Account: Dept-02   Export-Controlled Functionality: ALLOWED   Last Renewal Attempt: None   Next Renewal Attempt: May 01 08:19:02 2021 IST  License Authorization:   Status: AUTHORIZED   Last Communication Attempt: SUCCEEDED   Next Communication Attempt: Dec 02 08:19:09 2020 IST  License Usage:   License                Entitlement tag      Count   Status -----   AP Perpetual Network... (DNA_NWSTACK_E)      1 <b>AUTHORIZED</b>   Aironet DNA Essentia... (AIR-DNA-E)      1 <b>AUTHORIZED</b> </pre>	<pre> Device# show license summary  License Usage:   License                Entitlement Tag      Count   Status -----   air-network-essentials (DNA_NWSTACK_E) 1 <b>IN USE</b>   air-dna-essentials     (AIR-DNA-E) 1 <b>IN USE</b> </pre>
Before Upgrade (Smart Licensing)	After Upgrade (Smart Licensing Using Policy)
<pre> show license usage  One perpetual and one subscription license are being used before upgrade. </pre>	<pre> show license usage  All licenses are migrated and the Enforcement Type field displays NOT ENFORCED.  There are no export-controlled or enforced licenses on Cisco Catalyst Wireless Controllers. </pre>



Before Upgrade (Smart Licensing)	After Upgrade (Smart Licensing Using Policy)
<pre>Device# show license usage  License Authorization:   Status: AUTHORIZED on Nov 02 08:21:29 2020 IST  <b>AP Perpetual Networkstack Essentials (DNA_NWSTACK_E):</b>   Description: AP Perpetual Network Stack entitled with   DNA-E   <b>Count: 1</b>   Version: 1.0   Status: AUTHORIZED   Export status: NOT RESTRICTED  <b>Aironet DNA Essentials Term Licenses (AIR-DNA-E):</b>   Description: DNA Essentials for Wireless   <b>Count: 1</b>   Version: 1.0   Status: AUTHORIZED   Export status: NOT RESTRICTED</pre>	<pre>Device# show license usage  License Authorization:   Status: Not Applicable  air-network-essentials (DNA_NWSTACK_E):   Description: air-network-essentials   Count: 1   Version: 1.0   Status: IN USE   Export status: NOT RESTRICTED   Feature Name: air-network-essentials   Feature Description: air-network-essentials   <b>Enforcement type: NOT ENFORCED</b>   <b>License type: Perpetual</b>  air-dna-essentials (AIR-DNA-E):   Description: air-dna-essentials   Count: 1   Version: 1.0   Status: IN USE   Export status: NOT RESTRICTED   Feature Name: air-dna-essentials   Feature Description: air-dna-essentials   <b>Enforcement type: NOT ENFORCED</b>   <b>License type: Perpetual</b></pre>

Before Upgrade (Smart Licensing)	After Upgrade (Smart Licensing Using Policy)
<pre>show license status</pre>	<pre>show license status</pre> <p>The <code>Transport:</code> field shows that the transport type, which was configured before update, is retained after upgrade.</p> <p>The <code>Policy:</code> header and details show that a custom policy was available in the Smart Account or Virtual Account – this has also been automatically installed on the product instance. (After establishing trust, CSSM returns a policy. The policy is then automatically installed.)</p> <p>The <code>Usage Reporting:</code> header: The <code>Next report push:</code> field provides information about when the product instance will send the next RUM report to CSSM.</p> <p>The <code>Trust Code Installed:</code> field shows that the ID token is successfully converted and a trusted connected has been established with CSSM.</p>

Before Upgrade (Smart Licensing)	After Upgrade (Smart Licensing Using Policy)
<pre> Device# show license status  Smart Licensing is ENABLED  Utility:   Status: DISABLED  Data Privacy:   Sending Hostname: yes   Callhome hostname privacy: DISABLED   Smart Licensing hostname privacy: DISABLED   Version privacy: DISABLED  Transport:   Type: Callhome  Registration:   Status: REGISTERED   Smart Account: SA-Eg-Company-02   Virtual Account: Dept-02   Export-Controlled Functionality: ALLOWED   Initial Registration: SUCCEEDED on Nov 02 08:19:02 2020 IST   Last Renewal Attempt: None   Next Renewal Attempt: May 01 08:19:01 2021 IST   Registration Expires: Nov 02 08:14:06 2021 IST  License Authorization:   Status: AUTHORIZED on Nov 02 08:21:29 2020 IST   Last Communication Attempt: SUCCEEDED on Nov 02 08:21:29 2020 IST   Next Communication Attempt: Dec 02 08:19:09 2020 IST   Communication Deadline: Jan 31 08:14:15 2021 IST  Export Authorization Key:   Features Authorized:     &lt;none&gt; </pre>	<pre> Device# show license status Utility:   Status: DISABLED  Smart Licensing Using Policy:   Status: ENABLED  Data Privacy:   Sending Hostname: yes   Callhome hostname privacy: DISABLED   Smart Licensing hostname privacy: DISABLED   Version privacy: DISABLED  Transport:   Type: Callhome  Policy:   Policy in use: Installed On Nov 02 09:09:47 2020 IST   Policy name: <b>SLE Policy</b>   Reporting ACK required: <b>yes (Customer Policy)</b>   Unenforced/Non-Export Perpetual Attributes:     First report requirement (days): 60 (Customer Policy)     Reporting frequency (days): 60 (Customer Policy)     Report on change (days): 60 (Customer Policy)   Unenforced/Non-Export Subscription Attributes:     First report requirement (days): 30 (Customer Policy)     Reporting frequency (days): 30 (Customer Policy)     Report on change (days): 30 (Customer Policy)   Enforced (Perpetual/Subscription) License Attributes:      First report requirement (days): 0 (CISCO default)     Reporting frequency (days): 90 (Customer Policy)     Report on change (days): 90 (Customer Policy)   Export (Perpetual/Subscription) License Attributes:     First report requirement (days): 0 (CISCO default)     Reporting frequency (days): 90 (Customer Policy)     Report on change (days): 90 (Customer Policy)  Miscellaneous:   Custom Id: &lt;empty&gt;  Usage Reporting:   Last ACK received: Nov 02 09:09:47 2020 IST   Next ACK deadline: Jan 01 09:09:47 2021 IST   Reporting push interval: 30 days   Next ACK push check: Nov 02 09:13:54 2020 IST   <b>Next report push:</b> Dec 02 09:05:45 2020 IST   Last report push: Nov 02 09:05:45 2020 IST   Last report file write: &lt;none&gt;  Trust Code Installed:   Active: PID:C9800-CL-K9,SN:93BBAH93MGS   INSTALLED on Nov 02 08:59:26 2020 IST   Standby: PID:C9800-CL-K9,SN:9XECPSUU4XN   INSTALLED on Nov 02 09:00:45 2020 IST </pre>

Before Upgrade (Smart Licensing)	After Upgrade (Smart Licensing Using Policy)
<b>show license udi</b>	<b>show license udi</b> This is a High Availability set-up and the command displays all UDIs in the set-up. There is no change in the sample output before and after migration.
Device# <b>show license udi</b> UDI: PID:C9800-CL-K9,SN:93BBAH93MGS  HA UDI List: Active:PID:C9800-CL-K9,SN:93BBAH93MGS Standby:PID:C9800-CL-K9,SN:9XECPSUU4XN	Device# <b>show license udi</b> UDI: PID:C9800-CL-K9,SN:93BBAH93MGS  HA UDI List: Active:PID:C9800-CL-K9,SN:93BBAH93MGS Standby:PID:C9800-CL-K9,SN:9XECPSUU4XN

### The CSSM Web UI After Migration

Log in to the CSSM Web UI at <https://software.cisco.com> and click **Smart Software Licensing**. Under **Inventory > Product Instances**.

The product instance previously displayed with the host name (Catalyst 9800CL Cloud Wireless Controller in this example) is now displayed with the UDI instead. All migrated UDIs are displayed, that is, PID:C9800-CL-K9,SN:93BBAH93MGS, and PID:C9800-CL-K9,SN:9XECPSUU4XN.

Only the active product instance reports usage, therefore, PID:C9800-CL-K9,SN:93BBAH93MGS displays license consumption information under **License Usage**. The standby does not report usage and the **License Usage** for the standby displays No Records Found.

Figure 8: Smart Licensing to Smart Licensing Using Policy: Hostname of Product Instance on the CSSM Web UI Before Migration

### Device

Overview High Availability Event Log

#### Description

Catalyst 9800CL Cloud Wireless Controller

#### General

Name: Device ← Hostname before upgrade

Product: Catalyst 9800CL Cloud Wireless Controller

Host Identifier: -

MAC Address: -

PID: C9800-CL-K9

Serial Number: 93BBAH93MGS

UUID: -

Virtual Account: Dept-02

Registration Date: 2020-Nov-02 10:44:08

Last Contact: 2020-Nov-02 10:46:33

#### License Usage

License	Billing	Expires	Required
Aironet DNA Essentials Term Licenses	Prepaid	-	1
AP Perpetual Networkstack Essentials	Prepaid	-	1

Figure 9: Smart Licensing to Smart Licensing Using Policy: UDI and License Usage Under Active Product Instance After Migration

The screenshot displays the configuration page for a Catalyst 9800CL Cloud Wireless Controller. At the top, the UDI is shown as **UDI\_PID:C9800-CL-K9; UDI\_SN:93BBAH93MGS;**, which is highlighted with a red box and labeled "Active product instance". Below this, the "General" section lists various identifiers, with the "Name" field containing the same UDI string, highlighted by a red box and labeled "UDI after upgrade". The "License Usage" section at the bottom is also highlighted with a red box and labeled "License usage information under active product instance". It contains a table with two rows of license information.

License	Billing	Expires	Required
Aironet DNA Essentials Term Licenses	Prepaid	-	1
AP Perpetual Networkstack Essentials	Prepaid	-	1

Figure 10: Smart Licensing to Smart Licensing Using Policy: Standby Product Instance After Migration

The screenshot displays the configuration page for a Catalyst 9800CL Cloud Wireless Controller. The 'General' section shows the following details:

Name:	UDI_PID:C9800-CL-K9; UDI_SN:9XECPSUU4XN;
Product:	Catalyst 9800CL Cloud Wireless Controller
Host Identifier:	-
MAC Address:	-
PID:	C9800-CL-K9
Serial Number:	9XECPSUU4XN
UUID:	-
Virtual Account:	Dept-02
Registration Date:	2020-Nov-02 11:25:51
Last Contact:	2020-Nov-02 11:25:51

The 'License Usage' section is highlighted in red and contains the following table:

License	Billing	Expires	Required
No Records Found			

It is always the active that reports usage, so if the active in this High Availability set-up changes, the new active product instance will display license consumption information and report usage.

### Reporting After Migration

The product instance sends the next RUM report to CSSM, based on the policy.

If you want to change your reporting interval to report more frequently: on the product instance, configure the **license smart usage interval** command in global configuration mode. For syntax details see the *license smart (global config)* command in the Command Reference for the corresponding release.

## Example: SLR to Smart Licensing Using Policy

The following is an example of a Cisco Catalyst 9800-CL Wireless Controller migrating from Specific License Reservation (SLR) to Smart Licensing Using Policy. This is a High Availability set-up with an active and standby.

License conversion is automatic and authorization codes are migrated. No further action is required to complete migration. After migration the [#unique\\_96](#) topology is effective. For information about the SLR authorization code in the Smart Licensing Using Policy environment, see [#unique\\_170](#).

- [#unique\\_171 unique\\_171\\_Connect\\_42\\_table\\_dsr\\_wtl\\_knb](#)
- [#unique\\_171 unique\\_171\\_Connect\\_42\\_section\\_n1l\\_xtl\\_knb](#)
- [#unique\\_171 unique\\_171\\_Connect\\_42\\_section\\_oqy\\_wtl\\_knb](#)

The **show** command outputs below call-out key fields to check, before and after migration.

**Table 8: SLR to Smart Licensing Using Policy: show Commands**

Before Upgrade (SLR)	After Upgrade (Smart Licensing Using Policy)																												
<p><b>show license summary</b></p> <p>The Registration and License Authorization status fields show that the license was REGISTERED - SPECIFIC LICENSE RESERVATION and AUTHORIZED - RESERVED.</p> <p>Device# <b>show license summary</b></p> <p>Smart Licensing is ENABLED License Reservation is ENABLED</p> <p>Registration:</p> <p><b>Status: REGISTERED - SPECIFIC LICENSE RESERVATION</b> Export-Controlled Functionality: ALLOWED</p> <p>License Authorization: Status: AUTHORIZED - RESERVED</p> <p>License Usage:</p> <table border="1"> <thead> <tr> <th>License</th> <th>Entitlement tag</th> <th>Count</th> </tr> </thead> <tbody> <tr> <td colspan="3">-----</td> </tr> <tr> <td>AP Perpetual Network... (DNA_NWStack)</td> <td></td> <td>1 AUTHORIZED</td> </tr> <tr> <td>Aironet DNA Advantag... (AIR-DNA-A)</td> <td></td> <td>1 AUTHORIZED</td> </tr> </tbody> </table>	License	Entitlement tag	Count	-----			AP Perpetual Network... (DNA_NWStack)		1 AUTHORIZED	Aironet DNA Advantag... (AIR-DNA-A)		1 AUTHORIZED	<p><b>show license summary</b></p> <p>Licenses are migrated , but none of the APs have joined the controller, current consumption (Count) is therefore zero, and the Status field shows that the licenses are NOT IN USE.</p> <p>Device# <b>show license summary</b> License Reservation is ENABLED</p> <p>License Usage:</p> <table border="1"> <thead> <tr> <th>License</th> <th>Entitlement Tag</th> <th>Count</th> <th>Status</th> </tr> </thead> <tbody> <tr> <td colspan="4">-----</td> </tr> <tr> <td>Aironet DNA Advantag... (AIR-DNA-A)</td> <td></td> <td>0</td> <td>NOT IN USE</td> </tr> <tr> <td>AP Perpetual Network... (DNA_NWStack)</td> <td></td> <td>0</td> <td>NOT IN USE</td> </tr> </tbody> </table>	License	Entitlement Tag	Count	Status	-----				Aironet DNA Advantag... (AIR-DNA-A)		0	NOT IN USE	AP Perpetual Network... (DNA_NWStack)		0	NOT IN USE
License	Entitlement tag	Count																											
-----																													
AP Perpetual Network... (DNA_NWStack)		1 AUTHORIZED																											
Aironet DNA Advantag... (AIR-DNA-A)		1 AUTHORIZED																											
License	Entitlement Tag	Count	Status																										
-----																													
Aironet DNA Advantag... (AIR-DNA-A)		0	NOT IN USE																										
AP Perpetual Network... (DNA_NWStack)		0	NOT IN USE																										
Before Upgrade (SLR)	After Upgrade (Smart Licensing Using Policy)																												
<p><b>show license reservation</b></p>	<p><b>show license authorization</b></p> <p>The Last Confirmation code: field shows that the SLR authorization code is successfully migrated for the active and standby product instances in the High Availability set-up.</p> <p>The Specified license reservations: header shows that a perpetual license (AP Perpetual Networkstack Advantage) and a subscription license (Aironet DNA Advantage Term Licenses) are the migrated SLR licenses.</p>																												

Before Upgrade (SLR)	After Upgrade (Smart Licensing Using Policy)
<pre> Device# show license reservation License reservation: ENABLED  Overall status:   Active: PID:C9800-CL-K9,SN:93BBAH93MGS     Reservation status: SPECIFIC INSTALLED on Nov 02 03:16:01 2020 IST     Export-Controlled Functionality: ALLOWED     Last Confirmation code: 102fc949   Standby: PID:C9800-CL-K9,SN:9XECPSUU4XN     Reservation status: SPECIFIC INSTALLED on Nov 02 03:15:45 2020 IST     Export-Controlled Functionality: ALLOWED     Last Confirmation code: ad4382fe  Specified license reservations:   Aironet DNA Advantage Term Licenses (AIR-DNA-A):     Description: DNA Advantage for Wireless     Total reserved count: 20     Term information:       Active: PID:C9800-CL-K9,SN:93BBAH93MGS         License type: TERM         Start Date: 2020-OCT-14 UTC         End Date: 2021-APR-12 UTC         Term Count: 5         License type: TERM         Start Date: 2020-JUN-18 UTC         End Date: 2020-DEC-15 UTC         Term Count: 5       Standby: PID:C9800-CL-K9,SN:9XECPSUU4XN         License type: TERM         Start Date: 2020-OCT-14 UTC         End Date: 2021-APR-12 UTC         Term Count: 10   AP Perpetual Networkstack Advantage (DNA_NWStack):     Description: AP Perpetual Network Stack entitled with DNA-A     Total reserved count: 20     Term information:       Active: PID:C9800-CL-K9,SN:93BBAH93MGS         License type: TERM         Start Date: 2020-OCT-14 UTC         End Date: 2021-APR-12 UTC         Term Count: 5         License type: TERM         Start Date: 2020-JUN-18 UTC         End Date: 2020-DEC-15 UTC         Term Count: 5       Standby: PID:C9800-CL-K9,SN:9XECPSUU4XN         License type: TERM         Start Date: 2020-OCT-14 UTC         End Date: 2021-APR-12 UTC         Term Count: 10 </pre>	



Before Upgrade (SLR)	After Upgrade (Smart Licensing Using Policy)
	<pre> Device# show license authorization Overall status:   Active: PID:C9800-CL-K9,SN:93BBAH93MGS         Status: SPECIFIC INSTALLED on Nov 02 03:16:01 2020         IST         <b>Last Confirmation code: 102fc949</b>   Standby: PID:C9800-CL-K9,SN:9XECPSUU4XN         Status: SPECIFIC INSTALLED on Nov 02 03:15:45 2020         IST         <b>Last Confirmation code: ad4382fe</b>  Specified license reservations: <b>Aironet DNA Advantage Term Licenses (AIR-DNA-A):</b>   Description: DNA Advantage for Wireless   Total reserved count: 20   Enforcement type: NOT ENFORCED   Term information:     Active: PID:C9800-CL-K9,SN:93BBAH93MGS     Authorization type: SPECIFIC INSTALLED on Nov 02 03:15:45 2020 IST     License type: TERM     Start Date: 2020-OCT-14 UTC     End Date: 2021-APR-12 UTC     Term Count: 5     Authorization type: SPECIFIC INSTALLED on Nov 02 03:15:45 2020 IST     License type: TERM     Start Date: 2020-JUN-18 UTC     End Date: 2020-DEC-15 UTC     Term Count: 5     Standby: PID:C9800-CL-K9,SN:9XECPSUU4XN     Authorization type: SPECIFIC INSTALLED on Nov 02 03:15:45 2020 IST     License type: TERM     Start Date: 2020-OCT-14 UTC     End Date: 2021-APR-12 UTC     Term Count: 10 <b>AP Perpetual Networkstack Advantage (DNA_NWStack):</b>   Description: AP Perpetual Network Stack entitled with DNA-A   Total reserved count: 20   Enforcement type: NOT ENFORCED   Term information:     Active: PID:C9800-CL-K9,SN:93BBAH93MGS     Authorization type: SPECIFIC INSTALLED on Nov 02 03:15:45 2020 IST     License type: TERM     Start Date: 2020-OCT-14 UTC     End Date: 2021-APR-12 UTC     Term Count: 5     Authorization type: SPECIFIC INSTALLED on Nov 02 03:15:45 2020 IST     License type: TERM     Start Date: 2020-JUN-18 UTC     End Date: 2020-DEC-15 UTC     Term Count: 5     Standby: PID:C9800-CL-K9,SN:9XECPSUU4XN     Authorization type: SPECIFIC INSTALLED on Nov 02 03:15:45 2020 IST     License type: TERM     Start Date: 2020-OCT-14 UTC     End Date: 2021-APR-12 UTC </pre>

Before Upgrade (SLR)	After Upgrade (Smart Licensing Using Policy)
	<p>Term Count: 10</p> <p>Purchased Licenses: No Purchase Information Available</p>
Before Upgrade (SLR)	After Upgrade (Smart Licensing Using Policy)
<p>show license status</p>	<p>show license status</p> <p>Under the <code>Transport:</code> header, the <code>Type:</code> field displays that the transport type is set to off.</p> <p>Under the <code>Usage Reporting:</code> header, the <code>Next report push:</code> field displays if and when the next RUM report must be uploaded to CSSM.</p>

Before Upgrade (SLR)	After Upgrade (Smart Licensing Using Policy)
-	<pre> Device# show license status  Utility:   Status: DISABLED  Smart Licensing Using Policy:   Status: ENABLED  Data Privacy:   Sending Hostname: yes   Callhome hostname privacy: DISABLED   Smart Licensing hostname privacy: DISABLED   Version privacy: DISABLED  Transport:   Type: Transport Off  Policy:   Policy in use: Merged from multiple sources.   Reporting ACK required: yes (CISCO default)   Unenforced/Non-Export Perpetual Attributes:     First report requirement (days): 365 (CISCO default)      Reporting frequency (days): 0 (CISCO default)     Report on change (days): 90 (CISCO default)   Unenforced/Non-Export Subscription Attributes:     First report requirement (days): 90 (CISCO default)      Reporting frequency (days): 90 (CISCO default)     Report on change (days): 90 (CISCO default)   Enforced (Perpetual/Subscription) License Attributes:      First report requirement (days): 0 (CISCO default)     Reporting frequency (days): 0 (CISCO default)     Report on change (days): 0 (CISCO default)   Export (Perpetual/Subscription) License Attributes:     First report requirement (days): 0 (CISCO default)     Reporting frequency (days): 0 (CISCO default)     Report on change (days): 0 (CISCO default)  Miscellaneous:   Custom Id: &lt;empty&gt;  Usage Reporting:   Last ACK received: &lt;none&gt;   Next ACK deadline: &lt;none&gt;   Reporting push interval: 0 (no reporting)   Next ACK push check: Nov 01 20:31:46 2020 IST   Next report push: &lt;none&gt;   Last report push: &lt;none&gt;   Last report file write: &lt;none&gt;  Trust Code Installed: &lt;none&gt; </pre>

### The CSSM Web UI After Migration

Log in to the CSSM Web UI at <https://software.cisco.com> and click **Smart Software Licensing**. Under **Inventory > Product Instances**.

There are no changes in the **Product Instances** tab. The Last Contact column displays "Reserved Licenses" since there has been no usage reporting yet. After the requisite RUM report is uploaded and acknowledged "Reserved Licenses" is no longer displayed and license usage is displayed only in the active product instance.

**Figure 11: SLR to Smart Licensing Using Policy: Active Product Instance Before Upgrade**

The screenshot displays the configuration page for a Catalyst 9800CL Cloud Wireless Controller. The page is divided into several sections:

- Overview** and **Event Log** tabs are visible at the top.
- Description**: Catalyst 9800CL Cloud Wireless Controller.
- General** section contains the following details:
  - Name: UDI\_PID:C9800-CL-K9; UDI\_SN:93BBAH93MGS;
  - Product: Catalyst 9800CL Cloud Wireless Controller
  - Host Identifier: -
  - MAC Address: -
  - PID: C9800-CL-K9
  - Serial Number: 93BBAH93MGS
  - UUID: -
  - Virtual Account: Dept-02
  - Registration Date: 2020-Nov-02 05:36:20
  - Last Contact: 2020-Nov-02 05:36:20 (Reserved Licenses) - [Download Reservation Authorization Code](#)
- License Usage** section shows a table of reserved licenses. A note above the table states: "These licenses are reserved on this product instance [Update reservation](#)".

License	Billing	Expires	Required
Aironet DNA Advantage Term Licenses	Prepaid	<a href="#">multiple terms</a>	10
AP Perpetual Networkstack Advantage	Prepaid	<a href="#">multiple terms</a>	10

Annotations in the image include a red box around the UDI information at the top, a grey box labeled "Active product instance" with an arrow pointing to it, and another red box around the Last Contact information at the bottom, with a grey box labeled "SLR before upgrade" and an arrow pointing to it.

Figure 12: SLR to Smart Licensing Using Policy: Active Product Instance After Upgrade

The screenshot displays the configuration page for a Catalyst 9800CL Cloud Wireless Controller. The 'General' tab is selected, showing the following details:

- Name:** UDI\_PID:C9800-CL-K9; UDI\_SN:93BBAH93MGS; (highlighted as 'Active product instance')
- Product:** Catalyst 9800CL Cloud Wireless Controller
- Host Identifier:** -
- MAC Address:** -
- PID:** C9800-CL-K9
- Serial Number:** 93BBAH93MGS
- UUID:** -
- Virtual Account:** Dept-02
- Registration Date:** 2020-Nov-02 06:08:58
- Last Contact:** 2020-Nov-02 06:09:01 (highlighted as 'SLR after upgrade and usage reporting')

The 'License Usage' section contains the following table:

License	Billing	Expires	Required
Aironet DNA Advantage Term Licenses	Prepaid	-	1
AP Perpetual Networkstack Advantage	Prepaid	-	1

## Reporting After Migration

SLR licenses require reporting only when there is a change in license consumption (For example, when using a subscription license which is for specified term).

In an air-gapped network, use the `Next report push: date` in the **show license status** output to know when the next usage report must be sent. This ensures that the product instance and CSSM are synchronized.

Since all communication to and from the product instance is disabled, to report license usage you must save RUM reports to a file and upload it to CSSM (from a workstation that has connectivity to the internet, and Cisco):

### 1. Generate and save RUM reports

Enter the **license smart save usage** command in privileged EXEC mode. In the example below, all RUM reports are saved to the flash memory of the product instance, in file `all_rum.txt`. For syntax details see the *license smart (privileged EXEC)* command in the Command Reference. In the example, the file is first saved to bootflash and then copied to a TFTP location:

```
Device# license smart save usage all bootflash:all_rum.txt
Device# copy bootflash:all_rum.txt tftp://10.8.0.6/all_rum.txt
```

### 2. Upload usage data to CSSM: `#unique_151`

### 3. Install the ACK on the product instance: `#unique_154`

## Example: Evaluation or Expired to Smart Licensing Using Policy

The following is an example of a Cisco Catalyst 9800-CL Wireless Controller with evaluation expired licenses (Smart Licensing) that are migrated to Smart Licensing Using Policy.

The notion of evaluation licenses does not apply to Smart Licensing Using Policy. When the software version is upgraded to one that supports Smart Licensing Using Policy, all licenses are displayed as IN USE and the Cisco default policy is applied to the product instance. Since all licenses on Cisco Catalyst Wireless Controllers are unenforced (enforcement type), no functionality is lost.

- [#unique\\_173 unique\\_173\\_Connect\\_42\\_table\\_hdp\\_4tl\\_knb](#)
- [#unique\\_173 unique\\_173\\_Connect\\_42\\_section\\_qfh\\_3wl\\_knb](#)
- [#unique\\_173 unique\\_173\\_Connect\\_42\\_section\\_y12\\_ptl\\_knb](#)

The table below calls out key changes or new fields to check for in the **show** command outputs, after upgrade to Smart Licensing Using Policy

**Table 9: Evaluation or Expired to Smart Licensing Using Policy: show Commands**

Before Upgrade (Smart Licensing, Evaluation Mode)	After Upgrade (Smart Licensing Using Policy)
<p><b>show license summary</b></p> <p>Licenses are UNREGISTERED and in EVAL MODE.</p> <pre>Device# show license summary Smart Licensing is ENABLED  Registration:   Status: UNREGISTERED   Export-Controlled Functionality: NOT ALLOWED  License Authorization:   Status: EVAL EXPIRED  License Usage:   License           Entitlement tag    Count Status -----</pre> <pre>EXPIRED           (DNA_NWStack)      1  EVAL EXPIRED           (AIR-DNA-A)        1  EVAL</pre>	<p><b>show license summary</b></p> <p>All licenses are migrated and IN USE. There are no EVAL MODE licenses.</p> <pre>Device# show license summary License Usage:   License           Entitlement Tag    Count   Status  -----</pre> <pre>air-network-advantage (DNA_NWStack)      1 IN USE air-dna-advantage     (AIR-DNA-A)        1 IN USE</pre>
Before Upgrade (Smart Licensing, Evaluation Mode)	After Upgrade (Smart Licensing Using Policy)
<p><b>show license usage</b></p>	<p><b>show license usage</b></p> <p>The <code>Enforcement Type</code> field displays NOT ENFORCED. (There are no export-controlled or enforced licenses on Cisco Catalyst Wireless Controllers).</p>

Before Upgrade (Smart Licensing, Evaluation Mode)	After Upgrade (Smart Licensing Using Policy)
<pre>Device# show license usage License Authorization:   Status: EVAL EXPIRED on Apr 14 18:20:46 2020 UTC  (DNA_NWStack):   Description:   Count: 1   Version: 1.0   Status: EVAL EXPIRED   Export status: NOT RESTRICTED  (AIR-DNA-A):   Description:   Count: 1   Version: 1.0   Status: EVAL EXPIRED   Export status: NOT RESTRICTED</pre>	<pre>Device# show license usage License Authorization:   Status: Not Applicable  air-network-advantage (DNA_NWStack):   Description: air-network-advantage   Count: 1   Version: 1.0   Status: IN USE   Export status: NOT RESTRICTED   Feature Name: air-network-advantage   Feature Description: air-network-advantage   Enforcement type: NOT ENFORCED   License type: Perpetual  air-dna-advantage (AIR-DNA-A):   Description: air-dna-advantage   Count: 1   Version: 1.0   Status: IN USE   Export status: NOT RESTRICTED   Feature Name: air-dna-advantage   Feature Description: air-dna-advantage   Enforcement type: NOT ENFORCED   License type: Perpetual</pre>
Before Upgrade (Smart Licensing, Evaluation Mode)	After Upgrade (Smart Licensing Using Policy)
<pre>show license status</pre>	<pre>show license status</pre> <p>The <code>Transport:</code> field displays that the default type is set, but a URL or a method for the product instance to discover CSLU is not specified.</p> <p>The <code>Trust Code Installed:</code> field displays that a trust code is not installed.</p> <p>The <code>Policy:</code> header and details show that the Cisco default policy is applied.</p> <p>Under the <code>Usage Reporting:</code> header, the <code>Next report push:</code> field provides information about when the next RUM report must be sent to CSSM.</p>

Before Upgrade (Smart Licensing, Evaluation Mode)	After Upgrade (Smart Licensing Using Policy)
<pre> Device# show license status  Smart Licensing is ENABLED  Utility:   Status: DISABLED  Data Privacy:   Sending Hostname: yes   Callhome hostname privacy: DISABLED   Smart Licensing hostname privacy: DISABLED   Version privacy: DISABLED  Transport:   Type: Callhome  Registration:   Status: UNREGISTERED   Export-Controlled Functionality: NOT ALLOWED  License Authorization:   Status: EVAL EXPIRED on Apr 14 18:20:46 2020 UTC  Export Authorization Key:   Features Authorized:     &lt;none&gt; </pre>	<pre> Device# show license status Utility:   Status: DISABLED  Smart Licensing Using Policy:   Status: ENABLED  Data Privacy:   Sending Hostname: yes   Callhome hostname privacy: DISABLED   Smart Licensing hostname privacy: DISABLED   Version privacy: DISABLED  Transport:   Type: cslu   Cslu address: &lt;empty&gt;   Proxy:     Not Configured  Policy:   Policy in use: Merged from multiple sources.   Reporting ACK required: yes (CISCO default)   Unenforced/Non-Export Perpetual Attributes:     First report requirement (days): 365 (CISCO default)      Reporting frequency (days): 0 (CISCO default)     Report on change (days): 90 (CISCO default)   Unenforced/Non-Export Subscription Attributes:     First report requirement (days): 90 (CISCO default)      Reporting frequency (days): 90 (CISCO default)     Report on change (days): 90 (CISCO default)   Enforced (Perpetual/Subscription) License Attributes:      First report requirement (days): 0 (CISCO default)     Reporting frequency (days): 0 (CISCO default)     Report on change (days): 0 (CISCO default)   Export (Perpetual/Subscription) License Attributes:     First report requirement (days): 0 (CISCO default)     Reporting frequency (days): 0 (CISCO default)     Report on change (days): 0 (CISCO default)  Miscellaneous:   Custom Id: &lt;empty&gt;  Usage Reporting:   Last ACK received: &lt;none&gt;   Next ACK deadline: &lt;none&gt;   Reporting push interval: 0 (no reporting)   Next ACK push check: &lt;none&gt;   Next report push: &lt;none&gt;   Last report push: &lt;none&gt;   Last report file write: &lt;none&gt;  Trust Code Installed: &lt;none&gt; </pre>



### The CSSM Web UI After Migration

Log in to the CSSM Web UI at <https://software.cisco.com> and click **Smart Software Licensing**. Under **Inventory > Product Instances**, the Last Contact field for the migrated product instances display an updated timestamp after migration.

### Reporting After Migration

Implement any one of the supported topologies, and fulfil reporting requirements. See [#unique\\_89](#) and [#unique\\_105](#). The reporting method you can use depends on the topology you implement.

## Migrating to a Version of SSM On-Prem That Supports Smart Licensing Using Policy

If you are using a version of SSM On-Prem that is earlier than the minimum required version (See [SSM On-Prem, on page 59](#)), you can use this section as an outline of the process and sequence you have to follow to migrate the SSM On-Prem version and the product instance.

1. Upgrade SSM On-Prem.

Upgrade to the minimum required Version 8, Release 202102 or a later version.

Refer to the [Cisco Smart Software Manager On-Prem Migration Guide](#).

2. Upgrade the product instance.

For information about the minimum required software version, see [SSM On-Prem, on page 59](#).

For information about the upgrade procedure, see [#unique\\_106 unique\\_106\\_Connect\\_42\\_section\\_ixm\\_qty\\_jqb](#).

3. Re-Register a local account with CSSM

Online and Offline options are available. Refer to the [Cisco Smart Software Manager On-Prem Migration Guide > Re-Registering a local Account \(Online Mode\)](#) or [Manually Re-Registering a Local Account \(Offline Mode\)](#).

Once re-registration is complete, the following events occur automatically:

- SSM On-Prem responds with new transport URL that points to the tenant in SSM On-Prem.
- The transport type configuration on the product instance changes from **call-home** or **smart**, to **cslu**. The transport URL is also updated automatically.

4. Save configuration changes on the product instance, by entering the **copy running-config startup-config** command in privileged EXEC mode.

5. Clear older On-Prem Smart Licensing certificates on the product instance and reload the product instance. Do not save configuration changes after this.



---

**Note** This step is required only if the software version running on the product instance is Cisco IOS XE Amsterdam 17.3.x or Cisco IOS XE Bengaluru 17.4.x.

---

Enter the **license smart factory reset** and then the **reload** commands in privileged EXEC mode.

```
Device# license smart factory reset
Device# reload
```

## 6. Perform usage synchronization

- a. On the product instance, enter the **license smart sync {all|local}** command, in privileged EXEC mode. This synchronizes the product instance with SSM On-Prem, to send and receive any pending data.

```
Device(config)# license smart sync local
```

You can verify this in the SSM On-Prem UI. Go to **Inventory > SL Using Policy**. In the **Alerts** column, the following message is displayed: Usage report from product instance.

- b. Synchronize usage information with CSSM (*choose one*)

- Option 1:

SSM On-Prem is connected to CSSM: In the SSM On-Prem UI, Smart Licensing workspace, navigate to **Reports > Usage Schedules > Synchronize now with Cisco**.

- Option 2:

SSM On-Prem is not connected to CSSM. See [Exporting and Importing Usage Data \(SSM On-Prem UI\), on page 126](#).

### **Result:**

You have completed migration and initial usage synchronization. Product instance and license usage information is now displayed in SSM On-Prem.

For subsequent reporting, you have the following options:

- To synchronize data between the product instance and SSM On-Prem:
  - Schedule periodic synchronization between the product instance and SSM On-Prem, by configuring the reporting interval. Enter the **license smart usage interval *interval\_in\_days*** command in global configuration mode.
 

To know when the product instance will be sending the next RUM report, enter the **show license all** command in privileged EXEC mode and in the output, check the `Next report push:` field.
  - Enter the **license smart sync** privileged EXEC command, for ad hoc or on-demand synchronization between the product instance and SSM On-Prem.
- To synchronize usage information with CSSM:
  - Schedule periodic synchronization with CSSM. In the SSM On-Prem UI, navigate to **Reports > Usage Schedules > Synchronization schedule with Cisco**. Enter the following frequency information and save:
    - **Days:** Refers to how *often* synchronization occurs. For example, if you enter 2, synchronization occurs once every two days.
    - **Time of Day:** Refers to the time at which synchronization occurs, in the 24-hour notation system. For example, if you enter 14 hours and 0 minutes, synchronization occurs at 2 p.m. (1400) in your local time zone.

- Upload and download the required files for reporting. See [Exporting and Importing Usage Data \(SSM On-Prem UI\)](#), on page 126.

## Task Library for Smart Licensing Using Policy

This section is a grouping of tasks that apply to Smart Licensing Using Policy. It includes tasks performed on a product instance, on the CSLU interface, and on the CSSM Web UI.

To implement a particular topology, refer to the corresponding workflow to know the sequential order of tasks that apply. See [#unique\\_105](#).

To perform any additional configuration tasks, for instance, to configure a different license, or use an add-on license, or to configure a narrower reporting interval, refer to the corresponding task here. Check the "Supported Topologies" where provided, before you proceed.

### Logging into Cisco (CSLU Interface)

Depending on your needs, when working in CSLU, you can either be in connected or disconnected mode. To work in the connected mode, complete these steps to connect with Cisco.

#### Procedure

- 
- Step 1** From the CSLU Main screen, click **Login to Cisco** (located at the top right corner of the screen).
  - Step 2** Enter: **CCO User Name** and **CCO Password**.
  - Step 3** In the CSLU Preferences tab, check that the Cisco connectivity toggle displays "Cisco Is Available".
- 

### Configuring a Smart Account and a Virtual Account (CSLU Interface)

Both the Smart Account and Virtual Account are configured through the Preferences tab. Complete the following steps to configure both Smart and Virtual Accounts for connecting to Cisco.

#### Procedure

- 
- Step 1** Select the **Preferences Tab** from the CSLU home screen.
  - Step 2** Perform these steps for adding both a Smart Account and Virtual Account:
    - a) In the Preferences screen navigate to the **Smart Account** field and add the **Smart Account Name**.
    - b) Next, navigate to the **Virtual Account** field and add the **Virtual Account Name**.

If you are connected to CSSM (In the Preferences tab, **Cisco is Available**), you can select from the list of available SA/VAs.

If you are not connected to CSSM (In the Preferences tab, **Cisco Is Not Available**), enter the SA/VAs manually.

**Note** SA/VA names are case sensitive.

**Step 3** Click **Save**. The SA/VA accounts are saved to the system

Only one SA/VA pair can reside on CSLU at a time. You cannot add multiple accounts. To change to another SA/VA pair, repeat Steps 2a and 2b then Save. A new SA/VA account pair replaces the previous saved pair

## Adding a Product-Initiated Product Instance in CSLU (CSLU Interface)

Complete these steps to add a device-created Product Instance using the Preferences tab.

### Procedure

- Step 1** Select the **Preferences** tab.
- Step 2** In the Preferences screen, de-select the **Validate Device** check box.
- Step 3** Set the **Default Connect Method** to **Product Instance Initiated** and then click **Save**.

## Ensuring Network Reachability for Product Instance-Initiated Communication

This task provides *possible* configurations that may be required to ensure network reachability for product instance-initiated communication. Steps marked as "(Required)" are required for all product instances, all other steps may be required or optional, depending the kind of product instance and network requirements. Configure the applicable commands:

### Before you begin

Supported topologies: Connected to CSSM Through CSLU (product instance-initiated communication).

### Procedure

	Command or Action	Purpose
<b>Step 1</b>	<b>enable</b> <b>Example:</b> Device> <b>enable</b>	Enables privileged EXEC mode. Enter your password, if prompted.
<b>Step 2</b>	<b>configure terminal</b> <b>Example:</b> Device# <b>configure terminal</b>	Enters global configuration mode.
<b>Step 3</b>	<b>interface interface-type-number</b> <b>Example:</b> Device (config)# interface gigabitethernet0/0	Enters interface configuration mode and specifies the Ethernet interface, subinterface, or VLAN to be associated with the VRF.

	Command or Action	Purpose
<b>Step 4</b>	<b>vrf forwarding</b> <i>vrf-name</i>  <b>Example:</b> Device(config-if) # <b>vrf forwarding</b> <b>Mgmt-vrf</b>	Associates the VRF with the Layer 3 interface. This command activates multiprotocol VRF on an interface
<b>Step 5</b>	<b>ip address</b> <i>ip-address mask</i>  <b>Example:</b> Device(config-if) # <b>ip address</b> <b>192.168.0.1</b> <b>255.255.0.0</b>	Defines the IP address for the VRF.
<b>Step 6</b>	<b>negotiation auto</b>  <b>Example:</b> Device(config-if) # <b>negotiation auto</b>	Enables auto-negotiation operation for the speed and duplex parameters of an interface.  <b>Note</b> Cisco Catalyst 9800-L-F Wireless Controller 10G Ports do not support in an auto-negotiation operation.
<b>Step 7</b>	<b>end</b>  <b>Example:</b> Device(config-if) # <b>end</b>	Exits the interface configuration mode and enters global configuration mode.
<b>Step 8</b>	<b>ip http client source-interface</b> <i>interface-type-number</i>  <b>Example:</b> Device(config) # <b>ip http client</b> <b>source-interface gigabitethernet0/0</b>	Configures a source interface for the HTTP client.
<b>Step 9</b>	<b>ip route</b> <i>ip-address ip-mask subnet mask</i>  <b>Example:</b> Device(config) # <b>ip route vrf mgmt-vrf</b> <b>192.168.0.1 255.255.0.0 192.168.255.1</b>	(Required) Configures a route and gateway on the product instance. You can configure either a static route or a dynamic route.
<b>Step 10</b>	<b>{ip   ipv6} name-server</b> <i>server-address 1</i> <i>...server-address 6</i>  <b>Example:</b> Device(config) # <b>Device(config) # ip</b> <b>name-server</b> <b>vrf mgmt-vrf 173.37.137.85</b>	Configures Domain Name System (DNS) on the VRF interface.
<b>Step 11</b>	<b>ip domain lookup source-interface</b> <i>interface-type-number</i>  <b>Example:</b> Device(config) # <b>ip domain lookup</b> <b>source-interface gigabitethernet0/0</b>	Configures the source interface for the DNS domain lookup.

	Command or Action	Purpose
<b>Step 12</b>	<b>ip domain name</b> <i>domain-name</i> <b>Example:</b> Device (config)# <b>ip domain name</b> <b>example.com</b>	Configure DNS discovery of your domain. In accompanying example, the name-server creates entry <code>cslu-local.example.com</code> .

## Adding a CSLU-Initiated Product Instance in CSLU (CSLU Interface)

Using the CSLU interface, you can configure the connect method to be CSLU Initiated. This connect method (mode) enables CSLU to retrieve Product Instance information from the Product Instance.



**Note** The default Connect Method is set in the **Preferences** tab.

Complete these steps to add a Product Instance from the Inventory tab

### Procedure

- Step 1** Go to the **Inventory** tab and from the Product Instances table, select **Add Single Product**.
- Step 2** Enter the **Host** (IP address of the Host).
- Step 3** Select the **Connect Method** and select one of the CSLU Initiated connect methods.
- Step 4** In the right panel, click **Product Instance Login Credentials**. The left panel of the screen changes to show the User Name and Password fields.
- Step 5** Enter the product instance **User Name** and **Password**.
- Step 6** Click **Save**.

The information is saved to the system and the device is listed in the Product Instances table with the Last Contact listed as never.

## Collecting Usage Reports: CSLU Initiated (CSLU Interface)

CSLU also allows you to manually trigger the gathering of usage reports from devices.

After configuring and selecting a product instance (selecting **Add Single Product**, filling in the **Host** name and selecting a CSLU-initiated connect method), click **Actions for Selected** > **Collect Usage**. CSLU connects to the selected product instances and collects the usage reports. These usage reports are stored in CSLU's local library. These reports can then be transferred to Cisco if CSLU is connected to Cisco, or (if you are not connected to Cisco) you can manually trigger usage collection by selecting **Data** > **Export to CSSM**.

If you are working in CSLU-initiated mode, complete these steps to configure CSLU to collect RUM reports from Product Instances.

## Procedure

---

- Step 1** Click the **Preference** tab and enter a valid **Smart Account** and **Virtual Account**, and then select an appropriate CSLU-initiated collect method. (If there have been any changes in Preferences, make sure you click **Save**).
- Step 2** Click the **Inventory** tab and select one or more product instances.
- Step 3** Click **Actions for Selected > Collect Usage**.

RUM reports are retrieved from each selected device and stored in the CSLU local library. The Last Contacted column is updated to show the time the report was received, and the Alerts column shows the status.

If CSLU is currently logged into Cisco the reports will be automatically sent to the associated Smart Account and Virtual Account in Cisco and Cisco will send an acknowledgement to CSLU as well as to the product instance. The acknowledgement will be listed in the alerts column of the Product Instance table. To manually transfer usage reports Cisco, from the CSLU main screen select **Data > Export to CSSM**.

- Step 4** From the **Export to CSSM** modal, select the local directory where the reports are to be stored. (<CSLU\_WORKING\_Directory>/data/default/rum/unsent)

At this point, the usage reports are saved in your local directory (library). To upload these usage reports to Cisco, follow the steps described in [#unique\\_151](#).

**Note** The Windows operating system can change the behavior of a usage report file properties by dropping the extension when that file is renamed. The behavior change happens when you rename the downloaded file and the renamed file drops the extension. For example, the downloaded default file named `UD_xxx.tar` is renamed to `UD_yyy`. The file loses its TAR extension and cannot function. To enable the usage file to function normally, after re-naming a usage report file, you must also add the TAR extension back to the file name, for example `UD_yyy.tar`.

---

## Export to CSSM (CSLU Interface)

The Download All for Cisco menu option is a manual process used for offline purposes. Complete these steps to use the Download For Cisco menu option

### Procedure

---

- Step 1** Go to the **Preferences** tab, and turn off the **Cisco Connectivity** toggle switch. The field switches to “Cisco Is Not Available”.
- Step 2** From the main menu in the CSLU home screen navigate to **Data > Export to CSSM**.
- Step 3** Select the file from the modal that opens and click **Save**. You now have the file saved.
- Note** At this point you have a DLC file, RUM file, or both.
- Step 4** Go to a station that has connectivity to Cisco, and complete the following: [#unique\\_151](#)  
Once the file is downloaded, you can import it into CSLU, see [#unique\\_152](#).
-

## Import from CSSM (CSLU Interface)

Once you have received the ACK or other file (such as an authorization code) from Cisco, you are ready to Upload that file to your system. This procedure can be used for workstations that are offline. Complete these steps to select and upload files from Cisco.

### Procedure

- 
- Step 1** Ensure that you have downloaded the file to a location that is accessible to CSLU.
- Step 2** From the main menu in the CSLU home screen, navigate to **Data > Import from CSSM**.
- Step 3** An Import from CSSM modal open for you to either:
- Drag and Drop a file that resides on your local drive, or
  - Browse for the appropriate \*.xml file, select the file and click **Open**.
- If the upload is successful, you will get message indicating that the file was successfully sent to the server. If the upload is not successful, you will get an import error.
- Step 4** When you have finished uploading, click the **x** at the top right corner of the modal to close it.
- 

## Ensuring Network Reachability for CSLU-Initiated Communication

This task provides *possible* configurations that may be required to ensure network reachability for CSLU-initiated communication. Steps marked as "(Required)" are required for all product instances, all other steps may be required or optional, depending the kind of product instance and network requirements. Configure the applicable commands:

### Before you begin

Supported topologies: Connected to CSSM Through CSLU (CSLU-initiated communication).

### Procedure

	Command or Action	Purpose
<b>Step 1</b>	<b>enable</b> <b>Example:</b> Device> <b>enable</b>	Enables privileged EXEC mode. Enter your password, if prompted.
<b>Step 2</b>	<b>configure terminal</b> <b>Example:</b> Device# <b>configure terminal</b>	Enters global configuration mode.
<b>Step 3</b>	<b>aaa new model</b> <b>Example:</b> Device(config)# <b>aaa new model</b>	(Required) Enable the authentication, authorization, and accounting (AAA) access control model.



	Command or Action	Purpose
<b>Step 4</b>	<b>aaa authentication login default local</b> <b>Example:</b> Device(config)# aaa authentication login default local	(Required) Sets AAA authentication to use the local username database for authentication.
<b>Step 5</b>	<b>aaa authorization exec default local</b> <b>Example:</b> Device(config)# aaa authorization exec default local	Sets the parameters that restrict user access to a network. The user is allowed to run an EXEC shell.
<b>Step 6</b>	<b>ip routing</b> <b>Example:</b> Device(config)# ip routing	Enables IP routing.
<b>Step 7</b>	<b>{ip   ipv6} name-server server-address 1 ...server-address 6]</b> <b>Example:</b> Device(config)# ip name-server vrf Mgmt-vrf 192.168.1.100 192.168.1.200 192.168.1.300	(Optional) Specifies the address of one or more name servers to use for name and address resolution.  You can specify up to six name servers. Separate each server address with a space. The first server specified is the primary server. The device sends DNS queries to the primary server first. If that query fails, the backup servers are queried.
<b>Step 8</b>	<b>ip domain lookup source-interface interface-type-number</b> <b>Example:</b> Device(config)# ip domain lookup source-interface gigabitethernet0/0	Enables DNS-based hostname-to-address translation on your device. This feature is enabled by default.  If your network devices require connectivity with devices in networks for which you do not control name assignment, you can dynamically assign device names that uniquely identify your devices by using the global Internet naming scheme (DNS).
<b>Step 9</b>	<b>ip domain name name</b> <b>Example:</b> Device(config)# ip domain name vrf Mgmt-vrf cisco.com	Defines a default domain name that the software uses to complete unqualified hostnames (names without a dotted-decimal domain name).
<b>Step 10</b>	<b>no username name</b> <b>Example:</b> Device(config)# no username admin	(Required) Clears the specified username, if it exists. For <i>name</i> , enter the same username you will create in the next step. This ensures that a duplicate of the username you are going to create in the next step does not exist.  If you plan to use REST APIs for CSLU-initiated retrieval of RUM reports, you have to log in to CSLU. Duplicate usernames

	Command or Action	Purpose
		may cause the feature to work incorrectly if there are duplicate usernames in the system.
<b>Step 11</b>	<b>username</b> <i>name</i> <b>privilege</b> <i>level</i> <b>password</b> <i>password</i> <b>Example:</b> <pre>Device(config)# username admin privilege 15 password 0 lab</pre>	<p>(Required) Establishes a username-based authentication system.</p> <p>The <b>privilege</b> keyword sets the privilege level for the user. A number between 0 and 15 that specifies the privilege level for the user.</p> <p>The password allows access to the name argument. A password must be from 1 to 25 characters, can contain embedded spaces, and must be the last option specified in the <b>username</b> command.</p> <p>This enables CSLU to use the product instance native REST.</p> <p><b>Note</b> Enter this username and password in CSLU (<a href="#">#unique_141</a> → <i>Step 4. f.</i> CSLU can then collect RUM reports from the product instance.</p>
<b>Step 12</b>	<b>interface</b> <i>interface-type-number</i> <b>Example:</b> <pre>Device (config)# interface gigabitethernet0/0</pre>	Enters interface configuration mode and specifies the Ethernet interface, subinterface, or VLAN to be associated with the VRF.
<b>Step 13</b>	<b>vrf forwarding</b> <i>vrf-name</i> <b>Example:</b> <pre>Device(config-if)# vrf forwarding Mgmt-vrf</pre>	Associates the VRF with the Layer 3 interface. This command activates multiprotocol VRF on an interface
<b>Step 14</b>	<b>ip address</b> <i>ip-address mask</i> <b>Example:</b> <pre>Device(config-if)# ip address 192.168.0.1 255.255.0.0</pre>	Defines the IP address for the VRF.
<b>Step 15</b>	<b>negotiation auto</b> <b>Example:</b> <pre>Device(config-if)# negotiation auto</pre>	Enables auto-negotiation operation for the speed and duplex parameters of an interface.
<b>Step 16</b>	<b>no shutdown</b> <b>Example:</b> <pre>Device(config-if)# no shutdown</pre>	Restarts a disabled interface.
<b>Step 17</b>	<b>end</b> <b>Example:</b>	Exits the interface configuration mode and enters global configuration mode.

	Command or Action	Purpose
	Device(config-if)# <b>end</b>	
<b>Step 18</b>	<b>ip http server</b> <b>Example:</b> Device(config)# <b>ip http server</b>	(Required) Enables the HTTP server on your IP or IPv6 system, including a Cisco web browser user interface. The HTTP server uses the standard port 80, by default.
<b>Step 19</b>	<b>ip http authentication local</b> <b>Example:</b> <b>ip http authentication local</b> Device(config)#	(Required) Specifies a particular authentication method for HTTP server users.  The <b>local</b> keyword means that the login user name, password and privilege level access combination specified in the local system configuration (by the username global configuration command) should be used for authentication and authorization.
<b>Step 20</b>	<b>ip http secure-server</b> <b>Example:</b> Device(config)# <b>ip http server</b>	(Required) Enables a secure HTTP (HTTPS) server. The HTTPS server uses the Secure Sockets Layer (SSL) version 3.0 protocol.
<b>Step 21</b>	<b>ip http max-connections</b> <b>Example:</b> Device(config)# <b>ip http max-connections</b> <b>16</b>	(Required) Configures the maximum number of concurrent connections allowed for the HTTP server. Enter an integer in the range from 1 to 16. The default is 5.
<b>Step 22</b>	<b>ip tftp source-interface interface-type-number</b> <b>Example:</b> Device(config)# <b>ip tftp source-interface</b> <b>GigabitEthernet0/0</b>	Specifies the IP address of an interface as the source address for TFTP connections.
<b>Step 23</b>	<b>ip route ip-address ip-mask subnet mask</b> <b>Example:</b> Device(config)# <b>ip route vrf mgmt-vrf</b> <b>192.168.0.1 255.255.0.0 192.168.255.1</b>	Configures a route and gateway on the product instance. You can configure either a static route or a dynamic route.
<b>Step 24</b>	<b>logging host</b> <b>Example:</b> Device(config)# <b>logging host</b> <b>172.25.33.20</b> <b>vrf Mgmt-vrf</b>	Logs system messages and debug output to a remote host.
<b>Step 25</b>	<b>end</b> <b>Example:</b> Device(config)# <b>end</b>	Exits the global configuration mode and enters privileged EXEC mode.
<b>Step 26</b>	<b>show ip http server session-module</b> <b>Example:</b>	(Required) Verifies HTTP connectivity. In the output, check that <code>SL_HTTP</code> is active.

	Command or Action	Purpose
	Device# <code>show ip http server session-module</code>	<p>Additionally, you can also perform the following checks :</p> <ul style="list-style-type: none"> <li>• From device where CSLU is installed, verify that you can ping the product instance. A successful ping confirms that the product instance is reachable.</li> <li>• From a Web browser on the device where CSLU is installed verify <code>https://&lt;product-instance-ip&gt;/</code>. This ensures that the REST API from CSLU to the product instance works as expected.</li> </ul>

## Assigning a Smart Account and Virtual Account (SSM On-Prem UI)

You can use this procedure to import one or more product instances along with corresponding Smart Account and Virtual Account information, into the SSM On-Prem database. This enables SSM On-Prem to map product instances that are part of local virtual accounts (other than the default local virtual account), to the correct license pool in CSSM:

### Before you begin

Supported topologies: SSM On-Prem Deployment (product instance-initiated communication).

### Procedure

- 
- Step 1** Log into the SSM On-Prem and select the **Smart Licensing** workspace.
- Step 2** Navigate to **Inventory > SL Using Policy > Export/Import All > Import Product Instances List**.  
The **Upload Product Instances** window is displayed.
- Step 3** Click **Download** to download the .csv template file and enter the required information for all the product instances in the template.
- Step 4** Once you have filled-out the template, click **Inventory > SL Using Policy > Export/Import All > Import Product Instances List**.  
The **Upload Product Instances** window is displayed.
- Step 5** Now, click **Browse** and upload the filled-out .csv template.  
Smart Account and Virtual Account information for all uploaded product instances is now available in SSM On-Prem.
-

## Validating Devices (SSM On-Prem UI)

When device validation is enabled, RUM reports from an unknown product instance (not in the SSM On-Prem database) are rejected.

By default, devices are not validated. Complete the following steps to enable it:

### Before you begin

Supported topologies: SSM On-Prem Deployment (product instance-initiated communication).

### Procedure

- 
- Step 1** In the **On-Prem License Workspace** window, click **Admin Workspace** and log in, if prompted. The **On-Prem Admin Workspace** window is displayed.
- Step 2** Click the **Settings** widget. The **Settings** window is displayed.
- Step 3** Navigate to the **CSLU** tab and turn-on the **Validate Device** toggle switch. RUM reports from an unknown product instance will now be rejected. If you haven't already, you must now add the required product instances to the SSM On-Prem database before sending RUM reports. See [Assigning a Smart Account and Virtual Account \(SSM On-Prem UI\)](#), on page 122
- 

## Ensuring Network Reachability for Product Instance-Initiated Communication

This task provides *possible* configurations that may be required to ensure network reachability for product instance-initiated communication. Steps marked as "(Required)" are required for all product instances, all other steps may be required or optional, depending the kind of product instance and network requirements. Configure the applicable commands:



---

**Note** Ensure that you configure steps 13, 14, and 15 exactly as shown below. These commands must be configured to ensure that the correct trustpoint is used and that the necessary certificates are accepted for network reachability.

---

### Before you begin

Supported topologies: SSM On-Prem Deployment(product instance-initiated communication).

### Procedure

	Command or Action	Purpose
<b>Step 1</b>	<b>enable</b> <b>Example:</b>	Enables privileged EXEC mode. Enter your password, if prompted.

	Command or Action	Purpose
	Device> <b>enable</b>	
<b>Step 2</b>	<b>configure terminal</b> <b>Example:</b> Device# <b>configure terminal</b>	Enters global configuration mode.
<b>Step 3</b>	<b>interface interface-type-number</b> <b>Example:</b> Device (config)# <b>interface</b> gigabitethernet0/0	Enters interface configuration mode and specifies the Ethernet interface, subinterface, or VLAN to be associated with the VRF.
<b>Step 4</b>	<b>vrf forwarding vrf-name</b> <b>Example:</b> Device (config-if)# <b>vrf forwarding</b> Mgmt-vrf	Associates the VRF with the Layer 3 interface. This command activates multiprotocol VRF on an interface
<b>Step 5</b>	<b>ip address ip-address mask</b> <b>Example:</b> Device (config-if)# <b>ip address</b> 192.168.0.1 255.255.0.0	Defines the IP address for the VRF.
<b>Step 6</b>	<b>negotiation auto</b> <b>Example:</b> Device (config-if)# <b>negotiation auto</b>	Enables auto-negotiation operation for the speed and duplex parameters of an interface.
<b>Step 7</b>	<b>end</b> <b>Example:</b> Device (config-if)# <b>end</b>	Exits the interface configuration mode and enters global configuration mode.
<b>Step 8</b>	<b>ip http client source-interface interface-type-number</b> <b>Example:</b> Device (config)# <b>ip http client</b> source-interface gigabitethernet0/0	Configures a source interface for the HTTP client.
<b>Step 9</b>	<b>ip route ip-address ip-mask subnet mask</b> <b>Example:</b> Device (config)# <b>ip route vrf mgmt-vrf</b> 192.168.0.1 255.255.0.0 192.168.255.1	(Required) Configures a route and gateway on the product instance. You can configure either a static route or a dynamic route.
<b>Step 10</b>	<b>{ip   ipv6} name-server server-address 1 ...server-address 6]</b> <b>Example:</b> Device (config)# <b>Device (config)# ip</b> <b>name-server</b> <b>vrf mgmt-vrf 198.51.100.1</b>	Configures Domain Name System (DNS) on the VRF interface.

	Command or Action	Purpose
<b>Step 11</b>	<b>ip domain lookup source-interface</b> <i>interface-type-number</i>  <b>Example:</b> Device(config)# <b>ip domain lookup</b> <b>source-interface gigabitethernet0/0</b>	Configures the source interface for the DNS domain lookup.
<b>Step 12</b>	<b>ip domain name</b> <i>domain-name</i>  <b>Example:</b> Device(config)# <b>ip domain name</b> <b>example.com</b>	Configure DNS discovery of your domain. In the accompanying example, the name-server creates entry <code>cslu-local.example.com</code> .
<b>Step 13</b>	<b>crypto pki trustpoint SLA-TrustPoint</b>  <b>Example:</b> Device(config)# <b>crypto pki trustpoint</b> <b>SLA-TrustPoint</b> Device(ca-trustpoint)#	(Required) Declares that the product instance should use trustpoint “SLA-TrustPoint” and enters the ca-trustpoint configuration mode. The product instance does not recognize any trustpoints until you declare a trustpoint using this command.
<b>Step 14</b>	<b>enrollment terminal</b>  <b>Example:</b> Device(ca-trustpoint)# <b>enrollment</b> <b>terminal</b>	(Required) Specifies the certificate enrollment method.
<b>Step 15</b>	<b>revocation-check none</b>  <b>Example:</b> Device(ca-trustpoint)# <b>revocation-check</b> <b>none</b>	(Required) Specifies a method that is to be used to ensure that the certificate of a peer is not revoked. For the SSM On-Prem Deployment topology, enter the <b>none</b> keyword. This means that a revocation check will not be performed and the certificate will always be accepted.
<b>Step 16</b>	<b>exit</b>  <b>Example:</b> Device(ca-trustpoint)# <b>exit</b> Device(config)# <b>exit</b>	Exits the ca-trustpoint configuration mode and then the global configuration mode and returns to privileged EXEC mode.
<b>Step 17</b>	<b>copy running-config startup-config</b>  <b>Example:</b> Device# <b>copy running-config</b> <b>startup-config</b>	Saves your entries in the configuration file.

## Retrieving the Transport URL (SSM On-Prem UI)

You must configure the transport URL on the product instance when you deploy the product instance-initiated communication with SSM On-Prem deployment. This task show you how to easily copy the complete URL including the tenant ID from SSM On-Prem.

**Before you begin**

Supported topologies: SSM On-Prem Deployment (product instance-initiated communication).

**Procedure**

- 
- Step 1** Log into SSM On-Prem and select the **Smart Licensing** workspace.
- Step 2** Navigate to the **Inventory** tab and from the dropdown list of local virtual accounts (top right corner), select the *default local virtual account*. When you do, the area under the **Inventory** tab displays **Local Virtual Account: Default**.
- Step 3** Navigate to the **General** tab.  
The **Product Instance Registration Tokens** area is displayed.
- Step 4** In the **Product Instance Registration Tokens** area click **CSLU Transport URL**.  
The **Product Registration URL** pop-window is displayed.
- Step 5** Copy the entire URL and save it in an accessible place.  
You will require the URL when you configure the transport type and URL on the product instance.
- Step 6** Configure the transport type and URL. See: [Setting the Transport Type, URL, and Reporting Interval, on page 147](#).
- 

## Exporting and Importing Usage Data (SSM On-Prem UI)

You can use this procedure to complete usage synchronization between SSM On-Prem and CSSM when SSM On-Prem is disconnected from CSSM.

**Before you begin**

Supported topologies:

- SSM On-Prem Deployment (SSM On-Prem-initiated communication)
- SSM On-Prem Deployment (product instance-initiated communication).

Reporting data must be available in SSM On-Prem. You must have either pushed the necessary reporting data from the product instance to SSM On-Prem (product instance-initiated communication) or retrieved the necessary reporting data from the product instance (SSM On-Prem-initiated communication).

**Procedure**

- 
- Step 1** Log into SSM On-Prem and select **Smart Licensing**.
- Step 2** Navigate to **Inventory > SL Using Policy** tab.
- Step 3** In the **SL Using Policy** tab area, click **Export/Import All... > Export Usage to Cisco**.  
This generates one .tar file with *all* the usage reports available in the SSM On-Prem server.



- Step 4** Complete this task in CSSM: [#unique\\_151](#).  
At the end of this task you will have an ACK file to import into SSM On-Prem.
- Step 5** Again navigate to the **Inventory > SL Using Policy** tab.
- Step 6** In the **SL Using Policy** tab area, click **Export/Import All... > Import From Cisco** . Upload the .tar ACK file.  
To verify ACK import, in the **SL Using Policy** tab area check the **Alerts** column of the corresponding product instance. The following message is displayed: Acknowledgement received from CSSM.
- 

## Adding One or More Product Instances (SSM On-Prem UI)

You can use this procedure to add one product instance or to import and add multiple product instances. It enables SSM On-Prem to retrieve information from the product instance.

### Before you begin

Supported topologies: SSM On-Prem Deployment (SSM On-Prem-initiated communication).

### Procedure

---

- Step 1** Log into the SSM On-Prem UI and click **Smart Licensing**.
- Step 2** Navigate to **Inventory** tab. Select a local virtual account from the drop-down list in the top right corner.
- Step 3** Navigate to the **SL Using Policy** tab.
- Step 4** Add a single product or import multiple product instances (*choose one*).
- **To add a single product instance:**
    - a. In the **SL Using Policy** tab area, click **Add Single Product**.
    - b. In the **Host** field, enter the IP address of the host (product instance).
    - c. From the **Connect Method** dropdown list, select an appropriate SSM On-Prem-initiated connect method.  
  
The available connect methods for SSM On-Prem-initiated communication are: NETCONF, RESTCONF, and REST API.
    - d. In the right panel, click **Product Instance Login Credentials**.  
The **Product Instance Login Credentials** window is displayed.  
**Note** You need the login credentials only if a product instance requires a SLAC.
    - e. Enter the **User ID** and **Password**, and click **Save**.  
  
This is the same user ID and password that you configured as part of commands required to establish network reachability ([Ensuring Network Reachability for SSM On-Prem-Initiated Communication, on page 128](#)).  
  
Once validated, the product instance is displayed in the listing in the **SL Using Policy** tab area.

- **To import multiple product instances:**

- In **SL Using Policy** tab, click **Export/Import All... > Import Product Instances List**.

The **Upload Product Instances** window is displayed.

- Click **Download** to download the predefined .csv template.

- Enter the required information for all the product instances in the .csv template.

In the template, ensure that you provide **Host**, **Connect Method** and **Login Credentials** for all product instances.

The available connect methods for SSM On-Prem-initiated communication are: NETCONF, RESTCONF, and REST API.

Login credentials refer to the user ID and password that you configured as part of commands required to establish network reachability ([Ensuring Network Reachability for SSM On-Prem-Initiated Communication, on page 128](#)).

- Again navigate to **Inventory > SL Using Policy** tab. Click **Export/Import All... > Import Product Instances List**.

The **Upload Product Instances** window is displayed.

- Now upload the filled-out .csv template.

Once validated, the product instances are displayed in the listing in the **SL Using Policy** tab.

## Ensuring Network Reachability for SSM On-Prem-Initiated Communication

This task provides *possible* configurations that may be required to ensure network reachability for SSM On-Prem-initiated communication. Steps marked as "(Required)" are required for all product instances, all other steps may be required or optional, depending the kind of product instance and network requirements. Configure the applicable commands:



**Note** Ensure that you configure steps 25, 26, and 27 exactly as shown below. These commands must be configured to ensure that the correct trustpoint is used and that the necessary certificates are accepted for network reachability.

### Before you begin

Supported topologies: SSM On-Prem Deployment (SSM On-Prem-initiated communication).

### Procedure

	Command or Action	Purpose
<b>Step 1</b>	<b>enable</b> <b>Example:</b>	Enables privileged EXEC mode. Enter your password, if prompted.

	Command or Action	Purpose
	Device> <b>enable</b>	
<b>Step 2</b>	<b>configure terminal</b> <b>Example:</b> Device# <b>configure terminal</b>	Enters global configuration mode.
<b>Step 3</b>	<b>aaa new model</b> <b>Example:</b> Device(config)# <b>aaa new model</b>	(Required) Enable the authentication, authorization, and accounting (AAA) access control model.
<b>Step 4</b>	<b>aaa authentication login default local</b> <b>Example:</b> Device(config)# <b>aaa authentication login default local</b>	(Required) Sets AAA authentication to use the local username database for authentication.
<b>Step 5</b>	<b>aaa authorization exec default local</b> <b>Example:</b> Device(config)# <b>aaa authorization exec default local</b>	Sets the parameters that restrict user access to a network. The user is allowed to run an EXEC shell.
<b>Step 6</b>	<b>ip routing</b> <b>Example:</b> Device(config)# <b>ip routing</b>	Enables IP routing.
<b>Step 7</b>	<b>{ ip   ipv6 } name-server server-address 1 ...server-address 6]</b> <b>Example:</b> Device(config)# <b>ip name-server vrf Mgmt-vrf 192.168.1.100 192.168.1.200 192.168.1.300</b>	(Optional) Specifies the address of one or more name servers to use for name and address resolution.  You can specify up to six name servers. Separate each server address with a space. The first server specified is the primary server. The device sends DNS queries to the primary server first. If that query fails, the backup servers are queried.
<b>Step 8</b>	<b>ip domain lookup source-interface interface-type-number</b> <b>Example:</b> Device(config)# <b>ip domain lookup source-interface gigabitethernet0/0</b>	Enables DNS-based hostname-to-address translation on your device. This feature is enabled by default.  If your network devices require connectivity with devices in networks for which you do not control name assignment, you can dynamically assign device names that uniquely identify your devices by using the global Internet naming scheme (DNS).
<b>Step 9</b>	<b>ip domain name name</b> <b>Example:</b>	Defines a default domain name that the software uses to complete unqualified hostnames (names without a dotted-decimal domain name).

	Command or Action	Purpose
	Device (config) # <b>ip domain name vrf</b> <b>Mgmt-vrf cisco.com</b>	
<b>Step 10</b>	<b>no username name</b>  <b>Example:</b> Device (config) # no username admin	(Required) Clears the specified username, if it exists. For <i>name</i> , enter the same username you will create in the next step. This ensures that a duplicate of the username you are going to create in the next step does not exist.  If you plan to use REST APIs for SSM On-Prem-initiated retrieval of RUM reports, you have to log in to SSM On-Prem. Duplicate usernames may cause the feature to work incorrectly if there are present in the system.
<b>Step 11</b>	<b>username name privilege level password password</b>  <b>Example:</b> Device (config) # username admin privilege 15 password 0 lab	(Required) Establishes a username-based authentication system.  The <b>privilege</b> keyword sets the privilege level for the user. A number between 0 and 15 that specifies the privilege level for the user.  The password allows access to the name argument. A password must be from 1 to 25 characters, can contain embedded spaces, and must be the last option specified in the <b>username</b> command.  This enables SSM On-Prem to use the product instance native REST.  <b>Note</b> Enter this username and password in SSM On-Prem ( <a href="#">Adding One or More Product Instances (SSM On-Prem UI), on page 127</a> ). This enables SSM On-Prem to collect RUM reports from the product instance.
<b>Step 12</b>	<b>interface interface-type-number</b>  <b>Example:</b> Device (config) # interface gigabitethernet0/0	Enters interface configuration mode and specifies the Ethernet interface, subinterface, or VLAN to be associated with the VRF.
<b>Step 13</b>	<b>vrf forwarding vrf-name</b>  <b>Example:</b> Device (config-if) # <b>vrf forwarding</b> <b>Mgmt-vrf</b>	Associates the VRF with the Layer 3 interface. This command activates multiprotocol VRF on an interface
<b>Step 14</b>	<b>ip address ip-address mask</b>  <b>Example:</b> Device (config-if) # <b>ip address</b> <b>192.168.0.1 255.255.0.0</b>	Defines the IP address for the VRF.

	Command or Action	Purpose
<b>Step 15</b>	<b>negotiation auto</b> <b>Example:</b> Device(config-if)# <b>negotiation auto</b>	Enables auto-negotiation operation for the speed and duplex parameters of an interface.
<b>Step 16</b>	<b>no shutdown</b> <b>Example:</b> Device(config-if)# <b>no shutdown</b>	Restarts a disabled interface.
<b>Step 17</b>	<b>end</b> <b>Example:</b> Device(config-if)# <b>end</b>	Exits the interface configuration mode and enters global configuration mode.
<b>Step 18</b>	<b>ip http server</b> <b>Example:</b> Device(config)# <b>ip http server</b>	(Required) Enables the HTTP server on your IP or IPv6 system, including a Cisco web browser user interface. The HTTP server uses the standard port 80, by default.
<b>Step 19</b>	<b>ip http authentication local</b> <b>Example:</b> <b>ip http authentication local</b> Device(config)#	(Required) Specifies a particular authentication method for HTTP server users.  The <b>local</b> keyword means that the login user name, password and privilege level access combination specified in the local system configuration (by the username global configuration command) should be used for authentication and authorization.
<b>Step 20</b>	<b>ip http secure-server</b> <b>Example:</b> Device(config)# <b>ip http server</b>	(Required) Enables a secure HTTP (HTTPS) server. The HTTPS server uses the Secure Sockets Layer (SSL) version 3.0 protocol.
<b>Step 21</b>	<b>ip http max-connections</b> <b>Example:</b> Device(config)# <b>ip http max-connections</b> <b>16</b>	(Required) Configures the maximum number of concurrent connections allowed for the HTTP server. Enter an integer in the range from 1 to 16. The default is 5.
<b>Step 22</b>	<b>ip tftp source-interface interface-type-number</b> <b>Example:</b> Device(config)# <b>ip tftp source-interface</b> <b>GigabitEthernet0/0</b>	Specifies the IP address of an interface as the source address for TFTP connections.
<b>Step 23</b>	<b>ip route ip-address ip-mask subnet mask</b> <b>Example:</b> Device(config)# <b>ip route vrf mgmt-vrf</b> <b>192.168.0.1 255.255.0.0 192.168.255.1</b>	Configures a route and gateway on the product instance. You can configure either a static route or a dynamic route.

	Command or Action	Purpose
Step 24	<b>logging host</b> <b>Example:</b> <pre>Device(config)# logging host 172.25.33.20 vrf Mgmt-vrf</pre>	Logs system messages and debug output to a remote host.
Step 25	<b>crypto pki trustpoint SLA-TrustPoint</b> <b>Example:</b> <pre>Device(config)# crypto pki trustpoint SLA-TrustPoint Device(ca-trustpoint)#</pre>	(Required) Declares that the product instance should use trustpoint “SLA-TrustPoint” and enters the ca-trustpoint configuration mode. The product instance does not recognize any trustpoints until you declare a trustpoint using this command.
Step 26	<b>enrollment terminal</b> <b>Example:</b> <pre>Device(ca-trustpoint)# enrollment terminal</pre>	(Required) Specifies the certificate enrollment method.
Step 27	<b>revocation-check none</b> <b>Example:</b> <pre>Device(ca-trustpoint)# revocation-check none</pre>	(Required) Specifies a method that is to be used to ensure that the certificate of a peer is not revoked. For the SSM On-Prem Deployment topology, enter the <b>none</b> keyword. This means that a revocation check will not be performed and the certificate will always be accepted.
Step 28	<b>end</b> <b>Example:</b> <pre>Device(ca-trustpoint)# exit Device(config)# end</pre>	Exits the ca-trustpoint configuration mode and then the global configuration mode and returns to privileged EXEC mode.
Step 29	<b>show ip http server session-module</b> <b>Example:</b> <pre>Device# show ip http server session-module</pre>	(Required) Verifies HTTP connectivity. In the output, check that <code>SL_HTTP</code> is active. Additionally, you can also perform the following checks : <ul style="list-style-type: none"> <li>• From device where SSM On-Prem is installed, verify that you can ping the product instance. A successful ping confirms that the product instance is reachable.</li> <li>• From a Web browser on the device where SSM On-Prem is installed verify <code>https://&lt;product-instance-ip&gt;/</code>. This ensures that the REST API from SSM On-Prem to the product instance works as expected.</li> </ul>

	Command or Action	Purpose
<b>Step 30</b>	<b>copy running-config startup-config</b>  <b>Example:</b> Device# <code>copy running-config startup-config</code>	Saves your entries in the configuration file.

## Setting Up a Connection to CSSM

The following steps show how to set up a Layer 3 connection to CSSM to verify network reachability. Steps marked as "(Required)" are required for all product instances, all other steps may be required or optional, depending the kind of product instance and network requirements. Configure the applicable commands:

### Procedure

	Command or Action	Purpose
<b>Step 1</b>	<b>enable</b>  <b>Example:</b> Device> <code>enable</code>	Enables privileged EXEC mode. Enter your password, if prompted.
<b>Step 2</b>	<b>configure terminal</b>  <b>Example:</b> Device# <code>configure terminal</code>	Enters global configuration mode.
<b>Step 3</b>	<b>{ ip   ipv6 } name-server server-address 1 ...server-address 6]</b>  <b>Example:</b> Device(config)# <code>ip name-server 209.165.201.1 209.165.200.225 209.165.201.14 209.165.200.230</code>	Specifies the address of one or more name servers to use for name and address resolution.  You can specify up to six name servers. Separate each server address with a space. The first server specified is the primary server. The device sends DNS queries to the primary server first. If that query fails, the backup servers are queried.
<b>Step 4</b>	<b>ip name-server vrf Mgmt-vrf server-address 1...server-address 6</b>  <b>Example:</b> Device(config)# <code>ip name-server vrf Mgmt-vrf 209.165.201.1 209.165.200.225 209.165.201.14 209.165.200.230</code>	(Optional) Configures DNS on the VRF interface. You can specify up to six name servers. Separate each server address with a space.  <b>Note</b> This command is an alternative to the <b>ip name-server</b> command.
<b>Step 5</b>	<b>ip domain lookup source-interface interface-type interface-number</b>  <b>Example:</b> Device(config)# <code>ip domain lookup source-interface Vlan100</code>	Configures the source interface for the DNS domain lookup.

	Command or Action	Purpose
<b>Step 6</b>	<b>ip domain name</b> <i>domain-name</i> <b>Example:</b> Device(config)# <b>ip domain name</b> <b>example.com</b>	Configures the domain name.
<b>Step 7</b>	<b>ip host tools.cisco.com</b> <i>ip-address</i> <b>Example:</b> Device(config)# <b>ip host tools.cisco.com</b> <b>209.165.201.30</b>	Configures static hostname-to-address mappings in the DNS hostname cache if automatic DNS mapping is not available.
<b>Step 8</b>	<b>interface</b> <i>interface-type-number</i> <b>Example:</b> Device(config)# <b>interface Vlan100</b> Device(config-if)# <b>ip address 192.0.2.10</b> <b>255.255.255.0</b> Device(config-if)# <b>exit</b>	Configures a Layer 3 interface. Enter an interface type and number or a VLAN.
<b>Step 9</b>	<b>ntp server</b> <i>ip-address</i> [ <b>version number</b> ] [ <b>key</b> <i>key-id</i> ] [ <b>prefer</b> ] <b>Example:</b> Device(config)# <b>ntp server</b> <b>198.51.100.100 version 2 prefer</b>	(Required) Activates the NTP service (if it has not already been activated) and enables the system to synchronize the system software clock with the specified NTP server. This ensures that the device time is synchronized with CSSM.  Use the <b>prefer</b> keyword if you need to use this command multiple times and you want to set a preferred server. Using this keyword reduces switching between servers.
<b>Step 10</b>	<b>switchport access vlan</b> <i>vlan_id</i> <b>Example:</b> Device(config)# <b>interface</b> <b>GigabitEthernet1/0/1</b> Device(config-if)# <b>switchport access</b> <b>vlan 100</b> Device(config-if)# <b>switchport mode</b> <b>access</b> Device(config-if)# <b>exit</b> OR Device(config)#	Enables the VLAN for which this access port carries traffic and sets the interface as a nontrunking nontagged single-VLAN Ethernet interface.  <b>Note</b> This step is to be configured only if the switchport access mode is required. The <b>switchport access vlan</b> command may apply to Catalyst switching product instances, for example, and for routing product instances you may want to configure the <b>ip address</b> <i>ip-address mask</i> command instead.
<b>Step 11</b>	<b>ip route</b> <i>ip-address ip-mask subnet mask</i> <b>Example:</b> Device(config)# <b>ip route 192.0.2.0</b> <b>255.255.255.255 192.0.2.1</b>	Configures a route on the device. You can configure either a static route or a dynamic route.



	Command or Action	Purpose
<b>Step 12</b>	<b>ip http client source-interface</b> <i>interface-type-number</i>  <b>Example:</b> Device(config)# <b>ip http client</b> <b>source-interface</b> Vlan100	(Required) Configures a source interface for the HTTP client. Enter an interface type and number or a VLAN.
<b>Step 13</b>	<b>exit</b>  <b>Example:</b> Device(config)# <b>exit</b>	Exits global configuration mode and returns to privileged EXEC mode.
<b>Step 14</b>	<b>copy running-config startup-config</b>  <b>Example:</b> Device# <b>copy running-config</b> <b>startup-config</b>	Saves your entries in the configuration file.

## Configuring Smart Transport Through an HTTPs Proxy

To use a proxy server to communicate with CSSM when using the Smart transport mode, complete the following steps:

### Procedure

	Command or Action	Purpose
<b>Step 1</b>	<b>enable</b>  <b>Example:</b> Device> <b>enable</b>	Enables privileged EXEC mode. Enter your password, if prompted.
<b>Step 2</b>	<b>configure terminal</b>  <b>Example:</b> Device# <b>configure terminal</b>	Enters global configuration mode.
<b>Step 3</b>	<b>license smart transport smart</b>  <b>Example:</b> Device(config)# <b>license smart transport</b> <b>smart</b>	Enables Smart transport mode.
<b>Step 4</b>	<b>license smart url default</b>  <b>Example:</b> Device(config)# <b>license smart transport</b> <b>default</b>	Automatically configures the Smart URL ( <a href="https://smartreceiver.cisco.com/licservice/license">https://smartreceiver.cisco.com/licservice/license</a> ). For this option to work as expected, the transport mode in the previous step must be configured as <b>smart</b> .
<b>Step 5</b>	<b>license smart proxy { address</b> <i>address_hostname</i>   <b>port</b> <i>port_num</i> }  <b>Example:</b>	Configures a proxy for the Smart transport mode. When a proxy is configured, licensing messages are sent to the proxy along with the

	Command or Action	Purpose
	<pre>Device(config)# license smart proxy address 192.168.0.1 Device(config)# license smart proxy port 3128</pre>	<p>final destination URL (CSSM). The proxy sends the message on to CSSM. Configure the proxy address and port number separately:</p> <ul style="list-style-type: none"> <li>• <b>address</b> <i>address_hostname</i>: Specifies the proxy address. Enter the IP address or hostname of the proxy server.</li> <li>• <b>port</b> <i>port_num</i>: Specifies the proxy port. Enter the proxy port number.</li> </ul> <p>Note the change in the criteria for the acceptance of proxy servers, starting with Cisco IOS XE Bengaluru 17.6.1: only the status code of the proxy server response is verified by the system and not the reason phrase. The RFC format is <code>status-line = HTTP-version SP status-code SP reason-phrase CRLF</code>. For more information about the status line, see <a href="#">section 3.1.2 of RFC 7230</a>.</p>

## Configuring the Call Home Service for Direct Cloud Access

The Call Home service provides email-based and web-based notification of critical system events to CSSM. To configure the transport mode, enable the Call Home service, and configure a destination profile (A destination profile contains the required delivery information for an alert notification. At least one destination profile is required.), complete the following steps:



**Note** All steps are required unless specifically called-out as “(Optional)”.

### Procedure

	Command or Action	Purpose
<b>Step 1</b>	<p><b>enable</b></p> <p><b>Example:</b></p> <pre>Device&gt; enable</pre>	Enables privileged EXEC mode. Enter your password, if prompted.
<b>Step 2</b>	<p><b>configure terminal</b></p> <p><b>Example:</b></p> <pre>Device# configure terminal</pre>	Enters global configuration mode.
<b>Step 3</b>	<p><b>license smart transport callhome</b></p> <p><b>Example:</b></p> <pre>Device(config)# license smart transport callhome</pre>	Enables Call Home as the transport mode.

	Command or Action	Purpose
Step 4	<b>license smart url</b> <i>url</i> <b>Example:</b> Device(config)# <b>license smart url</b> <a href="https://tools.cisco.com/its/service/otba/services/DCService">https://tools.cisco.com/its/service/otba/services/DCService</a>	For the <b>callhome</b> transport mode, configure the CSSM URL exactly as shown in the example.
Step 5	<b>service call-home</b> <b>Example:</b> Device(config)# <b>service call-home</b>	Enables the Call Home feature.
Step 6	<b>call-home</b> <b>Example:</b> Device(config)# <b>call-home</b>	Enters Call Home configuration mode.
Step 7	<b>no http secure server-identity-check</b> <b>Example:</b> Device(config-call-home)# <b>no http secure</b> <b>server-identity-check</b>	Disables server identity check when HTTP connection is established.
Step 8	<b>contact-email-address</b> <i>email-address</i> <b>Example:</b> Device(config-call-home)# <b>contact-email-addr</b> <b>username@example.com</b>	Assigns customer's email address and enables Smart Call Home service full reporting capability and sends a full inventory message from Call-Home TAC profile to Smart Call Home server to start full registration process. You can enter up to 200 characters in email address format with no spaces.
Step 9	<b>profile</b> <i>name</i> <b>Example:</b> Device(config-call-home)# <b>profile</b> <b>CiscoTAC-1</b> Device(config-call-home-profile)#	Enters the Call Home destination profile configuration submode for the specified destination profile.  By default: <ul style="list-style-type: none"> <li>• The CiscoTAC-1 profile is inactive. To use this profile with the Call Home service, you must enable the profile.</li> <li>• The CiscoTAC-1 profile sends a full report of all types of events subscribed in the profile. The alternative is to additionally configure            Device(cfg-call-home-profile)#            anonymous-reporting-only            anonymous-reporting-only. When this is set, only crash, inventory, and test messages will be sent.</li> </ul> Use the <b>show call-home profile all</b> command to check the profile status.

	Command or Action	Purpose
<b>Step 10</b>	<b>active</b> <b>Example:</b> Device(config-call-home-profile)# <b>active</b>	Enables the destination profile.
<b>Step 11</b>	<b>destination transport-method http {email  http}</b> <b>Example:</b> Device(config-call-home-profile)# <b>destination transport-method</b> <b>http</b> AND Device(config-call-home-profile)# <b>no</b> <b>destination transport-method</b> <b>email</b>	Enables the message transport method. In the example, Call Home service is enabled via HTTP and transport via email is disabled.  The <b>no</b> form of the command disables the method.
<b>Step 12</b>	<b>destination address { email email_address  http url}</b> <b>Example:</b> Device(config-call-home-profile)# <b>destination address http</b> <b>https://tools.cisco.com/its/service/otbe/services/DOEService</b> AND Device(config-call-home-profile)# <b>no</b> <b>destination address http</b> <b>https://tools.cisco.com/its/service/otbe/services/DOEService</b>	Configures the destination e-mail address or URL to which Call Home messages are sent. When entering a destination URL, include either <b>http://</b> (default) or <b>https://</b> , depending on whether the server is a secure server.  In the example provided here, a <b>http://</b> destination URL is configured; and the <b>no</b> form of the command is configured for <b>https://</b> .
<b>Step 13</b>	<b>exit</b> <b>Example:</b> Device(config-call-home-profile)# <b>exit</b>	Exits Call Home destination profile configuration mode and returns to Call Home configuration mode.
<b>Step 14</b>	<b>exit</b> <b>Example:</b> Device(config-call-home)# <b>end</b>	Exits Call Home configuration mode and returns to privileged EXEC mode.
<b>Step 15</b>	<b>copy running-config startup-config</b> <b>Example:</b> Device# <b>copy running-config</b> <b>startup-config</b>	Saves your entries in the configuration file.
<b>Step 16</b>	<b>show call-home profile {name  all}</b>	Displays the destination profile configuration for the specified profile or all configured profiles.

## Configuring the Call Home Service for Direct Cloud Access through an HTTPs Proxy Server

The Call Home service can be configured through an HTTPs proxy server. This configuration requires no user authentication to connect to CSSM.



**Note** Authenticated HTTPs proxy configurations are not supported.

To configure and enable the Call Home service through an HTTPs proxy, complete the following steps:



**Note** All steps are required unless specifically called-out as “(Optional)”.

### Procedure

	Command or Action	Purpose
<b>Step 1</b>	<b>enable</b> <b>Example:</b> Device> <b>enable</b>	Enables privileged EXEC mode. Enter your password, if prompted.
<b>Step 2</b>	<b>configure terminal</b> <b>Example:</b> Device# <b>configure terminal</b>	Enters global configuration mode.
<b>Step 3</b>	<b>license smart transport callhome</b> <b>Example:</b> Device(config)# <b>license smart transport callhome</b>	Enables Call Home as the transport mode.
<b>Step 4</b>	<b>service call-home</b> <b>Example:</b> Device(config)# <b>service call-home</b>	Enables the Call Home feature.
<b>Step 5</b>	<b>call-home</b> <b>Example:</b> Device(config)# <b>call-home</b>	Enters Call Home configuration mode.
<b>Step 6</b>	<b>http-proxy proxy-address proxy-port port-number</b> <b>Example:</b> Device(config-call-home)# <b>http-proxy 198.51.100.10 port 5000</b>	Configures the proxy server information to the Call Home service.  Note the change in the criteria for the acceptance of proxy servers, starting with Cisco IOS XE Bengaluru 17.6.1: only the status code of the proxy server response is verified by the system and not the reason phrase. The RFC

	Command or Action	Purpose
		format is status-line = HTTP-version SP status-code SP reason-phrase CRLF. For more information about the status line, see <a href="#">section 3.1.2 of RFC 7230</a> .
<b>Step 7</b>	<b>exit</b> <b>Example:</b> Device(config-call-home)# <b>exit</b>	Exits Call Home configuration mode and enters global configuration mode.
<b>Step 8</b>	<b>exit</b> <b>Example:</b> Device(config)# <b>exit</b>	Exits global configuration mode and enters privileged EXEC mode.
<b>Step 9</b>	<b>copy running-config startup-config</b> <b>Example:</b> Device# <b>copy running-config startup-config</b>	Saves your entries in the configuration file.

## Removing and Returning an Authorization Code

To remove and return an SLR authorization code, complete the following steps.

### Before you begin

Supported topologies: all

### Procedure

	Command or Action	Purpose
<b>Step 1</b>	<b>enable</b> <b>Example:</b> Device> <b>enable</b>	Enables privileged EXEC mode. Enter your password, if prompted.
<b>Step 2</b>	<b>show license summary</b> <b>Example:</b> Device# <b>show license summary</b>	Ensure that the license that you want to remove and return is not in-use. If it is in-use, you must first disable the feature.
<b>Step 3</b>	<b>license smart authorization return {all   local} {offline [path]   online}</b> <b>Example:</b> Device# <b>license smart authorization return all online</b>  Enter this return code in Cisco Smart Software Manager portal: UDI: PID:C9800-CL-K9,SN:93BBAH93MGS	Returns an authorization code back to the license pool in CSSM. A return code is displayed after you enter this command.  Specify the product instance: <ul style="list-style-type: none"> <li>• <b>all</b>: Performs the action for all connected product instances in a High Availability set-up.</li> </ul>

	Command or Action	Purpose
	<pre> Return code: CqaUPW-WSPYiq-ZNU2ci-SnWydS-hBCXHP-MuyPqY- PJ1GiG-tPTGQj-S2h UDI: PID:C9800-CL-K9,SN:9XECPSUU4XN Return code: CNLwxR-eWiAEJ-XaTEQg-j4rrYW-dSRz9j-37VpcP- imjuLD-mNeA4k-TXA  OR  Device# license smart authorization return local offline Enter this return code in Cisco Smart Software Manager portal: UDI: PID:C9800-CL-K9,SN:93BBAH93MGS Return code: CqaUPW-WSPYiq-ZNU2ci-SnWydS-hBCXHP-MuyPqY- PJ1GiG-tPTGQj-S2h UDI: PID:C9800-CL-K9,SN:9XECPSUU4XN Return code: CNLwxR-eWiAEJ-XaTEQg-j4rrYW-dSRz9j-37VpcP- imjuLD-mNeA4k-TXA  OR  Device# license smart authorization return local offline bootflash:return-code.txt </pre>	<ul style="list-style-type: none"> <li>• <b>local</b>: Performs the action for the active product instance. This is the default option.</li> </ul> <p>Specify if you are connected to CSSM or not:</p> <ul style="list-style-type: none"> <li>• If connected to CSSM, enter <b>online</b>. The code is automatically returned to CSSM and a confirmation is returned and installed on the product instance. If you choose this option, the return code is automatically submitted to CSSM.</li> <li>• If not connected to CSSM, enter <b>offline[path]</b>.</li> </ul> <p>If you enter only the <b>offline</b> keyword, you must copy the return code that is displayed on the CLI and enter it in CSSM.</p> <p>If you specify a file name and path, the return code is saved in the specified location. The file format can be any readable format. For example: <code>Device# license smart authorization return local offline bootflash:return-code.txt</code>.</p> <p>For software versions Cisco IOS XE Cupertino 17.7.1 and later only: After you save the return request in a file, you can upload the file to CSSM in the same location and in the same way as you upload a RUM report: <a href="#">#unique_151</a>.</p> <p>To enter the return code in CSSM, complete this task: <a href="#">Removing the Product Instance from CSSM, on page 142</a>. Proceed with the next step only after you complete this step.</p>
<b>Step 4</b>	<p><b>configure terminal</b></p> <p><b>Example:</b></p> <pre>Device# configure terminal</pre>	Enters the global configuration mode.
<b>Step 5</b>	<p><b>no license smart reservation</b></p> <p><b>Example:</b></p> <pre>Device(config)# no license smart reservation</pre>	<p>Disables SLR configuration on the product instance.</p> <p>You must complete the authorization code return process in Step 3 above - whether online or offline, before you enter the no license smart reservation command in this step. Otherwise, the return may not be reflected in CSSM or in</p>

	Command or Action	Purpose
		the show command, and you will have to contact your Cisco technical support representative to rectify the problem.
<b>Step 6</b>	<b>exit</b> <b>Example:</b> Device(config)# <b>exit</b>	Returns to privileged EXEC mode.
<b>Step 7</b>	<b>show license all</b> <b>Example:</b> Device# <b>show license all</b> <output truncated> License Authorizations ===== Overall status: Active: PID:C9800-CL-K9,SN:93BBAH93MGS  Status: NOT INSTALLED Last return code: CpUEW-WSPYiq-ZN2ci-SWycS-tEXHP-MYRy-BJIGt-PTGj-SZn  Standby: PID:C9800-CL-K9,SN:9XECPSUU4XN  Status: NOT INSTALLED Last return code: QNLvR-eVIAEJ-YaIEQg-j4mW-dSRz9j-37MpcP-irjULd-mNeMk-TZA <output truncated>	Displays licensing information. Check the License Authorizations header in the output. If the return process is completed correctly, the Last return code: field displays the return code.

## Removing the Product Instance from CSSM

To remove a product instance and return all licenses to the license pool, complete the following task:

### Before you begin

Supported topologies: No Connectivity to CSSM and No CSLU

If you are removing a product instance that is using reserved licenses (SLR) ensure that you have generated a return code as shown in [Removing and Returning an Authorization Code, on page 140](#). (Enter it in Step 7 in this task).

### Procedure

**Step 1** Log in to the CSSM Web UI at <https://software.cisco.com> and click **Smart Software Licensing**.

Log in using the username and password provided by Cisco.

**Step 2** Click the **Inventory** tab.

**Step 3** From the **Virtual Account** drop-down list, choose your Virtual Account.

**Step 4** Click the **Product Instances** tab.

The list of product instances that are available is displayed.



- Step 5** Locate the required product instance from the product instances list. Optionally, you can enter a name or product type string in the search tab to locate the product instance.
- Step 6** In the **Actions** column of the product instance you want to remove, click the **Remove** link.
- If the product instance is *not* using a license with an SLR authorization code then the **Confirm Remove Product Instance** window is displayed.
  - If the product instance *is* using a license with an SLR authorization code, then the **Remove Product Instance** window, with a field for return code entry is displayed.
- Step 7** In the **Reservation Return Code** field, enter the return code you generated.
- Note** This step applies only if the product instance is using a license with an SLR authorization code.
- Step 8** Click **Remove Product Instance**.
- The license is returned to the license pool and the product instance is removed.
- 

## Generating a New Token for a Trust Code from CSSM

To generate a token to request a trust code, complete the following steps.

Generate one token for each *Virtual Account* you have. You can use same token for all the product instances that are part of one Virtual Account.

### Before you begin

Supported topologies: Connected Directly to CSSM

### Procedure

---

- Step 1** Log in to the CSSM Web UI at <https://software.cisco.com> and click **Smart Software Licensing**.  
Log in using the username and password provided by Cisco.
- Step 2** Click the **Inventory** tab.
- Step 3** From the **Virtual Account** drop-down list, choose the required virtual account
- Step 4** Click the **General** tab.
- Step 5** Click **New Token**. The **Create Registration Token** window is displayed.
- Step 6** In the **Description** field, enter the token description
- Step 7** In the **Expire After** field, enter the number of days the token must be active.
- Step 8** (Optional) **In the Max. Number of Uses** field, enter the maximum number of uses allowed after which the token expires.
- Step 9** Click **Create Token**.

**Note** If you enter a value here, ensure that you stagger the installation of the trust code on the product instances, which is the next part of the process. If you want to simultaneously install the trust code on a large number of product instances, we recommend that you leave this field blank. Entering a limit here and simultaneously installing it on a large number of devices causes a bottleneck in the processing of these requests in CSSM and installation on some devices may fail, with the following error: `Failure Reason: Server error occurred: LS_LICENSE_FAIL_TO_CONNECT.`

**Step 10** You will see your new token in the list. Click **Actions** and download the token as a `.txt` file.

## Installing a Trust Code

To manually install a trust code, complete the following steps

### Before you begin

Supported topologies:

- Connected Directly to CSSM

### Procedure

	Command or Action	Purpose
<b>Step 1</b>	<code>#unique_147</code>	In case you have not completed this already, generate and download a trust code file from CSSM.
<b>Step 2</b>	<b>enable</b> <b>Example:</b> Device> <code>enable</code>	Enables privileged EXEC mode. Enter your password, if prompted
<b>Step 3</b>	<b>license smart trust idtoken</b> <i>id_token_value</i> { <b>local</b>   <b>all</b> } [ <b>force</b> ] <b>Example:</b> Device# <code>license smart trust idtoken</code> <code>NGMwMjk5mYtNZaxMS00NzZmtgWm all force</code>	Enables you to establish a trusted connection with CSSM. For <i>id_token_value</i> , enter the token you generated in CSSM.  Enter one of following options: <ul style="list-style-type: none"> <li>• <b>local</b>: Submits the trust request only for the active device in a High Availability set-up. This is the default option.</li> <li>• <b>all</b>: Submits the trust request for all devices in a High Availability set-up.</li> </ul> Enter the <b>force</b> keyword to submit the trust code request in spite of an existing trust code on the product instance.  Trust codes are node-locked to the UDI of the product instance. If a UDI is already registered, CSSM does not allow a new registration for the

	Command or Action	Purpose
		same UDI. Entering the <b>force</b> keyword sets a force flag in the message sent to CSSM to create a new trust code even if one already exists.
<b>Step 4</b>	<b>show license status</b> <b>Example:</b> <pre>&lt;output truncated&gt; Trust Code Installed:   Active: PID:C9800-CL-K9,SN:93BBAH93MGS        INSTALLED on Nov 02 08:59:26 2020 IST   Standby: PID:C9800-CL-K9,SN:9XECPSUU4XN        INSTALLED on Nov 02 09:00:45 2020 IST</pre>	Displays date and time if trust code is installed. Date and time are in the local time zone. See field <code>Trust Code Installed:</code> .

## Downloading a Policy File from CSSM

If you have requested a custom policy or if you want to apply a policy that is different from the default that is applied to the product instance, complete the following task:

### Before you begin

Supported topologies:

- No Connectivity to CSSM and No CSLU
- CSLU Disconnected from CSSM

### Procedure

- 
- Step 1** Log in to the CSSM Web UI at <https://software.cisco.com> and click **Smart Software Licensing**.  
Log in using the username and password provided by Cisco.
- Step 2** Follow this directory path: **Reports > Reporting Policy**.
- Step 3** Click **Download**, to save the `.xml` policy file.  
You can now install the file on the product instance. See [#unique\\_154](#)
- 

## Uploading Data or Requests to CSSM and Downloading a File

You can use this task to:

- To upload a RUM report to CSSM and download an ACK.
- To upload a SLAC or SLR authorization code return request.

This applies only to the *No Connectivity to CSSM and No CSLU* topology and is supported starting with Cisco IOS XE Cupertino 17.7.1.

To upload a RUM report to CSSM and download an ACK *when the product instance is not connected to CSSM or CSLU*, complete the following task:

### Before you begin

Supported topologies:

- No Connectivity to CSSM and No CSLU
- CSLU Disconnected from CSSM
- SSM On-Prem Deployment (Product instance-initiated communication and SSM On-Prem-initiated communication)

### Procedure

---

- Step 1** Log in to the CSSM Web UI at <https://software.cisco.com>.  
Log in using the username and password provided by Cisco.
- Step 2** Select the **Smart Account** (upper left-hand corner of the screen) that will receive the report.
- Step 3** Select **Smart Software Licensing** → **Reports** → **Usage Data Files**.
- Step 4** Click **Upload Usage Data**. Browse to the file location (RUM report in tar format), select, and click **Upload Data**.  
Upload a RUM report (.tar format), or a SLAC return request file (.txt format).  
You cannot delete a usage report in CSSM, after it has been uploaded.
- Step 5** From the Select Virtual Accounts pop-up, select the **Virtual Account** that will receive the uploaded file. The file is uploaded to Cisco and is listed in the Usage Data Files table in the Reports screen showing the File Name, time it was Reported, which Virtual Account it was uploaded to, the Reporting Status, Number of Product Instances reported, and the Acknowledgement status.
- Step 6** In the Acknowledgement column, click **Download** to save the .txt ACK file for the report you uploaded.  
Wait for the ACK to appear in the Acknowledgement column. If there are many RUM reports or requests to process, CSSM may take a few minutes.  
Depending on the topology you have implemented, you can now install the file on the product instance, or transfer it to CSLU, or import it into SSM On-Prem.
- 

## Installing a File on the Product Instance

To install a SLAC, or policy, or ACK, on the product instance *when the product instance is not connected to CSSM or CSLU*, complete the following task:

**Before you begin**

Supported topologies: No Connectivity to CSSM and No CSLU

You must have the corresponding file saved in a location that is accessible to the product instance.

- For a policy, see [#unique\\_194](#)
- For an ACK, see [#unique\\_151](#)

**Procedure**

	Command or Action	Purpose
<b>Step 1</b>	<b>enable</b> <b>Example:</b> Device> <b>enable</b>	Enables privileged EXEC mode. Enter your password, if prompted
<b>Step 2</b>	<b>copy source bootflash:file-name</b> <b>Example:</b> Device# <b>copy tftp://10.8.0.6/example.txt bootflash:</b>	Copies the file from its source location or directory to the flash memory of the product instance. <ul style="list-style-type: none"> <li>• <b>source:</b> This is the location of the source file or directory to be copied. The source can be either local or remote</li> <li>• <b>bootflash:</b> This is the destination for boot flash memory.</li> </ul>
<b>Step 3</b>	<b>license smart import bootflash: file-name</b> <b>Example:</b> Device# <b>license smart import bootflash:example.txt</b>	Imports and installs the file on the product instance. After installation, a system message displays the type of file you just installed.
<b>Step 4</b>	<b>show license all</b> <b>Example:</b> Device# <b>show license all</b>	Displays license authorization, policy and reporting information for the product instance.

## Setting the Transport Type, URL, and Reporting Interval

To configure the mode of transport for a product instance, complete the following task:

**Before you begin**

Supported topologies: all

## Procedure

	Command or Action	Purpose
<b>Step 1</b>	<b>enable</b> <b>Example:</b> Device> <b>enable</b>	Enables privileged EXEC mode. Enter your password, if prompted.
<b>Step 2</b>	<b>configure terminal</b> <b>Example:</b> Device# <b>configure terminal</b>	
<b>Step 3</b>	<b>license smart</b> <b>transport</b> { <b>automatic</b>   <b>callhome</b>   <b>cslu</b>   <b>off</b>   <b>smart</b> } <b>Example:</b> Device(config)# <b>license smart transport cslu</b>	Configures a mode of transport for the product instance to use. Choose from the following options: <ul style="list-style-type: none"> <li>• <b>automatic</b>: Sets the transport mode <b>cslu</b>.</li> <li>• <b>callhome</b>: Enables Call Home as the transport mode.</li> <li>• <b>cslu</b>: This is the default transport mode. Enter this keyword if you are using CSLU or SSM On-Prem, with product instance-initiated communication. While the transport mode keyword is the same for CSLU and SSM On-Prem, the transport URLs are different. See <b>license smart url cslu cslu_or_on-prem_url</b> in the next step.</li> <li>• <b>off</b>: Disables all communication from the product instance.</li> <li>• <b>smart</b>: Enables Smart transport.</li> </ul>
<b>Step 4</b>	<b>license smart url</b> { <b>url</b>   <b>cslu cslu_or_on-prem_url</b>   <b>default</b>   <b>smart smart_url</b>   <b>utility smart_url</b> } <b>Example:</b> Device(config)# <b>license smart url cslu http://192.168.0.1:8182/cslu/v1/pi</b>	Sets a URL for the configured transport mode. Depending on the transport mode you've chosen in the previous step, configure the corresponding URL here: <ul style="list-style-type: none"> <li>• <b>url</b>: If you have configured the transport mode as <b>callhome</b>, configure this option. Enter the CSSM URL exactly as follows:   <a href="https://tools.cisco.com/its/service/otte/services/DOSService">https://tools.cisco.com/its/service/otte/services/DOSService</a>             The <b>no license smart url url</b> command reverts to the default URL.</li> <li>• <b>cslu cslu_or_on-prem_url</b>: If you have configured the transport mode as <b>cslu</b>, configure this option with the URL for CSLU or SSM On-Prem, as applicable.</li> </ul>

	Command or Action	Purpose
		<ul style="list-style-type: none"> <li>If you are using CSLU, enter the URL as follows:  <pre>http://&lt;cslu_ip_or_host&gt;:8182/cslu/v1/pi</pre> For &lt;cslu_ip_or_host&gt;, enter the hostname or the IP address of the windows host where you have installed CSLU. 8182 is the port number and it is the only port number that CSLU uses.  The <b>no license smart url cslu cslu_url</b> command reverts to  <pre>http://cslu-local:8182/cslu/v1/pi</pre> </li> <li>If you are using SSM On-Prem, enter the URL as follows:  <pre>http://&lt;ip&gt;/cslu/v1/pi/&lt;tenant ID&gt;</pre> For &lt;ip&gt;, enter the hostname or the IP address of the server where you have installed SSM On-Prem. The &lt;tenantID&gt; must be the default local virtual account ID.  <b>Tip</b> You can retrieve the entire URL from SSM On-Prem. See <a href="#">Retrieving the Transport URL (SSM On-Prem UI)</a>, on page 125  The <b>no license smart url cslu cslu_url</b> command reverts to  <pre>http://cslu-local:8182/cslu/v1/pi</pre> </li> </ul> <p>• <b>default:</b> Depends on the configured transport mode. Only the <b>smart</b> and <b>cslu</b> transport modes are supported with this option.</p> <p>If the transport mode is set to <b>cslu</b>, and you configure <b>license smart url default</b>, the CSLU URL is configured automatically (<a href="https://cslu-local:8182/cslu/v1/pi">https://cslu-local:8182/cslu/v1/pi</a>).</p> <p>If the transport mode is set to <b>smart</b>, and you configure <b>license smart url default</b>, the Smart URL is configured automatically (<a href="https://smartreceiver.cisco.com/licservice/license">https://smartreceiver.cisco.com/licservice/license</a>).</p>

	Command or Action	Purpose
		<ul style="list-style-type: none"> <li>• <b>smart</b> <i>smart_url</i>: If you have configured the transport type as <b>smart</b>, configure this option. Enter the URL exactly as follows:  <code>https://smarterceiver.cisco.com/licservice/license</code>  When you configure this option, the system automatically creates a duplicate of the URL in <b>license smart url url</b>. You can ignore the duplicate entry, no further action is required.  The <b>no license smart url smartsmart_url</b> command reverts to the default URL.</li> <li>• <b>utility</b> <i>smart_url</i>: Although available on the CLI, this option is not supported.</li> </ul>
<b>Step 5</b>	<b>license smart usage interval</b> <i>interval_in_days</i>  <b>Example:</b> <pre>Device(config)# license smart usage interval 40</pre>	(Optional) Sets the reporting interval in days. By default the RUM report is sent every 30 days. The valid value range is 1 to 3650.  If you do not configure an interval, the reporting interval is determined entirely by the policy value.
<b>Step 6</b>	<b>exit</b>  <b>Example:</b> <pre>Device(config)# exit</pre>	Exits global configuration mode and returns to privileged EXEC mode.
<b>Step 7</b>	<b>copy running-config startup-config</b>  <b>Example:</b> <pre>Device# copy running-config startup-config</pre>	Saves your entries in the configuration file.

## Configuring an AIR License

In the Smart Licensing Using Policy environment, you can use this task to configure a license, or change the license being used on the product instance, or configure an add-on license on the product instance. For example, if you are currently using AIR Network Advantage and you also want to use features available with a corresponding Digital Networking Architecture (DNA) Advantage license, you can configure the same using this task. Or for example, if you do not want to use an add-on license any more, reconfigure this command to use only the AIR Network Advantage license.

Information about available licenses can be found Smart Account or Virtual Account. The available licenses may be one of the following:

- AIR Network Essential
- AIR Network Advantage
- AIR DNA Essential



- AIR DNA Advantage

To configure or change the license in-use, follow this procedure:

### Before you begin

Supported topologies: all

### Procedure

	Command or Action	Purpose
<b>Step 1</b>	<b>enable</b> <b>Example:</b> Device> <b>enable</b>	Enables the privileged EXEC mode. Enter your password, if prompted.
<b>Step 2</b>	<b>configure terminal</b> <b>Example:</b> Device# <b>configure terminal</b>	Enters the global configuration mode.
<b>Step 3</b>	<b>license air level {air-network-advantage [addon air-dna-advantage ]   air-network-essentials [addon air-dna-essentials ] }</b> <b>Example:</b> Device(config)# <b>license air level air-network-essentials addon air-dna-essentials</b>	Activates the configured license on the product instance. In the accompanying example, the product instance activates the AIR DNA Essentials (along with the AIR Network Essential) license after reload.
<b>Step 4</b>	<b>exit</b> <b>Example:</b> Device(config)# <b>exit</b>	Returns to the privileged EXEC mode.
<b>Step 5</b>	<b>copy running-config startup-config</b> <b>Example:</b> Device# <b>copy running-config startup-config</b>	Saves configuration changes.
<b>Step 6</b>	<b>reload</b> <b>Example:</b> Device# <b>reload</b>	Reloads the device.
<b>Step 7</b>	<b>show version</b> <b>Example:</b> Device# show version Cisco IOS XE Software, Version 17.03.02 Cisco IOS Software [Amsterdam], C9800-CL Software (C9800-CL-K9_IOSXE), Version 17.3.2, RELEASE SOFTWARE <output truncated>	Displays currently used license and the license that is effective at the next reload information.



# Troubleshooting Smart Licensing Using Policy

This section provides the list of Smart Licensing Using Policy-related system messages you may encounter, possible reasons for failure, and recommended action.

## System Message Overview

The system software sends system messages to the console (and, optionally, to a logging server on another system). Not all system messages mean problems with your system. Some messages are informational, and others can help diagnose problems with communications lines, internal hardware, or the system software.

### How to Read System Messages

System log messages can contain up to 80 characters. Each system message begins with a percent sign (%) and is structured as follows:

```
%FACILITY-SEVERITY-MNEMONIC: Message-text
```

#### %FACILITY

Two or more uppercase letters that show the facility to which the message refers. A facility can be a hardware device, a protocol, or a module of the system software

#### SEVERITY

A single-digit code from 0 to 7 that reflects the severity of the condition. The lower the number, the more serious the situation.

**Table 10: Message Severity Levels**

Severity Level	Description
0 - emergency	System is unusable.
1 - alert	Immediate action required.
2 - critical	Critical condition.
3 - error	Error condition.
4 - warning	Warning condition.
5 - notification	Normal but significant condition.
6 - informational	Informational message only.
7 - debugging	Message that appears during debugging only.

#### MNEMONIC

A code that uniquely identifies the message.

#### Message-text

Message-text is a text string describing the condition. This portion of the message sometimes contains detailed information about the event, including terminal port numbers, network addresses, or addresses that correspond to locations in the system memory address space. Because the information in these variable fields changes from message to message, it is represented here by short strings enclosed in square brackets ([ ]). A decimal number, for example, is represented as [dec].

**Table 11: Variable Fields in Messages**

Severity Level	Description
[char]	Single character
[chars]	Character string
[dec]	Decimal number
[enet]	Ethernet address (for example, 0000.FEED.00C0)
[hex]	Hexadecimal number
[inet]	Internet address (for example, 10.0.2.16)
[int]	Integer
[node]	Address or node name
[t-line]	Terminal line number in octal (or in decimal if the decimal-TTY service is enabled)
[clock]	Clock (for example, 01:20:08 UTC Tue Mar 2 1993)

## System Messages

This section provides the list of Smart Licensing Using Policy-related system messages you may encounter, possible reasons for failure (in case it is a failure message), and recommended action (if action is required).

For all error messages, if you are not able to solve the problem, contact your Cisco technical support representative with the following information:

The message, exactly as it appears on the console or in the system log.

The output from the **show license tech support**, **show license history message**, and the **show platform software sl-infra** privileged EXEC commands.

- %SMART\_LIC-3-POLICY\_INSTALL\_FAILED
- %SMART\_LIC-3-AUTHORIZATION\_INSTALL\_FAILED
- %SMART\_LIC-3-COMM\_FAILED
- %SMART\_LIC-3-COMM\_RESTORED
- %SMART\_LIC-3-POLICY\_REMOVED
- %SMART\_LIC-3-TRUST\_CODE\_INSTALL\_FAILED
- %SMART\_LIC-4-REPORTING\_NOT\_SUPPORTED

- %SMART\_LIC-6-POLICY\_INSTALL\_SUCCESS
- %SMART\_LIC-6-AUTHORIZATION\_INSTALL\_SUCCESS
- %SMART\_LIC-6-AUTHORIZATION\_REMOVED
- %SMART\_LIC-6-REPORTING\_REQUIRED
- %SMART\_LIC-6-TRUST\_CODE\_INSTALL\_SUCCESS

Error Message %SMART\_LIC-3-POLICY\_INSTALL\_FAILED: The installation of a new licensing policy has failed: [chars].

**Explanation:** A policy was installed, but an error was detected while parsing the policy code, and installation failed. [chars] is the error string with details of the failure.

Possible reasons for failure include:

- A signature mismatch: This means that the system clock is not accurate.
- A timestamp mismatch: This means the system clock on the product instance is not synchronized with CSSM.



---

**Note** The device should have a valid clock and the NTP configuration.

---

**Recommended Action:**

For both possible failure reasons, ensure that the system clock is accurate and synchronized with CSSM. Configure the **ntp server** command in global configuration mode. For example:

```
Device(config)# ntp server 198.51.100.100 version 2 prefer
```

If the above does not work and policy installation still fails, and contact your Cisco technical support representative.

---



---

Error Message %SMART\_LIC-3-AUTHORIZATION\_INSTALL\_FAILED: The install of a new licensing authorization code has failed on [chars]: [chars].

This message is not applicable to Cisco Catalyst Access, Core, and Aggregation Switches, because there are no enforced or export-controlled licenses on these product instances.

---



---

Error Message %SMART\_LIC-3-COMM\_FAILED: Communications failure with the [chars] : [chars]

**Explanation:** Smart Licensing communication either with CSSM, or CSLU, or SSM On-Prem failed. The first [chars] is the currently configured transport type, and the second [chars] is the error string with details of the failure. This message appears for every communication attempt that fails.

Possible reasons for failure include:

- CSSM, CSLU, SSM On-Prem is not reachable: This means that there is a network reachability problem.

- 404 host not found: This means the CSSM server is down.

For topologies where the product instance initiates the sending of RUM reports (Connected to CSSM Through CSLU: Product Instance-Initiated Communication, Connected Directly to CSSM, CSLU Disconnected from CSSM: Product Instance-Initiated Communication, and SSM On-Prem Deployment: Product Instance-Initiated Communication) if this communication failure message coincides with scheduled reporting (**license smart usage interval** *interval\_in\_days* global configuration command), the product instance attempts to send out the RUM report for up to four hours after the scheduled time has expired. If it is still unable to send out the report (because the communication failure persists), the system resets the interval to 15 minutes. Once the communication failure is resolved, the system reverts the reporting interval to last configured value.

### Recommended Action:

Troubleshooting steps are provided for when CSSM is not reachable or there is a missing client certificate, when CSLU is not reachable, and when SSM On-Prem is not reachable.

- If CSSM is not reachable and the configured transport type is **smart**:
  1. Check if the smart URL is configured correctly. Use the **show license status** command in privileged EXEC mode, to check if the URL is exactly as follows: <https://smartreceiver.cisco.com/licservice/license>. If it is not, reconfigure the **license smart url smart** *smar\_URL* command in global configuration mode.
  2. Check DNS resolution. Verify that the product instance can ping `smartreceiver.cisco.com` or the nslookup translated IP. The following example shows how to ping the translated IP

```
Device# ping 171.70.168.183
Type escape sequence to abort.
Sending 5, 100-byte ICMP Echos to 171.70.168.183, timeout is 2 seconds:
!!!!
Success rate is 100 percent (5/5), round-trip min/avg/max = 1/1/2 ms
```

- If CSSM is not reachable and the configured transport type is **callhome**:
  1. Check if the URL is entered correctly. Use the **show license status** command in privileged EXEC mode, to check if the URL is exactly as follows: <https://tools.cisco.com/its/service/oddce/services/DDCEService>.
  2. Check if Call Home profile `CiscoTAC-1` is active and destination URL is correct. Use the **show call-home profile all** command in privileged EXEC mode:

```
Current smart-licensing transport settings:
Smart-license messages: enabled
Profile: CiscoTAC-1 (status: ACTIVE)
Destination URL(s): https://tools.cisco.com/its/service/oddce/services/DDCEService
```

3. Check DNS Resolution. Verify that the product instance can ping `tools.cisco.com`, or the nslookup translated IP.

```
Device# ping tools.cisco.com
Type escape sequence to abort.
Sending 5, 100-byte ICMP Echos to 173.37.145.8, timeout is 2 seconds:
!!!!
Success rate is 100 percent (5/5), round-trip min/avg/max = 41/41/42 ms
```

If the above does not work check the following: if the product instance is set, if the product instance IP network is up. To ensure that the network is up, configure the **no shutdown** command in interface configuration mode.

Check if the device is subnet masked with a subnet IP, and if the DNS IP is configured.

4. Verify that the HTTPs client source interface is correct.

Use the **show ip http client** command in privileged EXEC mode to display current configuration. Use **ip http client source-interface** command in global configuration mode to reconfigure it.

In case the above does not work, double-check your routing rules, and firewall settings.

- If CSLU is not reachable:

1. Check if CSLU discovery works.

- Zero-touch DNS discovery of `cslu-local` or DNS discovery of your domain..

In the **show license all** command output, check if the `Last ACK received:` field. If this has a recent timestamp it means that the product instance has connectivity with CSLU. If it is not, proceed with the following checks:

Check if the product instance is able to ping `cslu-local`. A successful ping confirms that the product instance is reachable.

If the above does not work, configure the name server with an entry where hostname `cslu-local` is mapped to the CSLU IP address (the windows host where you installed CSLU). Configure the **ip domain name** `domain-name` and **ip name-server** `server-address` commands in global configuration mode. Here the CSLU IP is 192.168.0.1 and name-server creates entry `cslu-local.example.com`:

```
Device(config)# ip domain name example.com
Device(config)# ip name-server 192.168.0.1
```

- CSLU URL is configured.

In the **show license all** command output, under the `Transport:` header check the following: The `Type:` must be `cslu` and `Cslu address:` must have the hostname or the IP address of the windows host where you have installed CSLU. Check if the rest of the address is configured as shown below and check if the port number is 8182.

```
Transport:
  Type: cslu
  Cslu address: http://192.168.0.1:8182/cslu/v1/pi
```

If it is not, configure the **license smart transport cslu** and **license smart url cslu** `http://<cslu_ip_or_host>:8182/cslu/v1/pi` commands in global configuration mode

2. For CSLU-initiated communication, in addition to the CSLU discovery checks listed above, check the following:

Verify HTTP connectivity. Use the **show ip http server session-module** command in privileged EXEC mode. In the output, under header `HTTP server current connections:`, check that `SL_HTTP` is active. If it is not re-configure the **ip http** commands as mentioned in [#unique\\_140](#)

From a Web browser on the device where CSLU is installed, verify `https://<product-instance-ip>/`. This ensures that the REST API from CSLU to the product instance works as expected.

- If SSM On-Prem is not reachable:

1. For product instance-initiated communication, check if the SSM On-Prem transport type and URL are configured correctly.

In the **show license all** command output, under the `Transport:` header check the following: The `Type:` must be `cslu` and `Cslu address:` must have the hostname or the IP address of the server where you have installed SSM On-Prem and `<tenantID>` of the *default* local virtual account. See the example below:

```
Transport:
  Type: cslu
  Cslu address: https://192.168.0.1/cslu/v1/pi/on-prem-default
```

Check if you have the correct URL from SSM On-Prem ([Retrieving the Transport URL \(SSM On-Prem UI\), on page 125](#)) and then configure **license smart transport cslu** and **license smart url cslu** `http://<ip>/cslu/v1/pi/<tenant ID>` commands in global configuration mode.

Check that you have configured any other required commands for your network as mentioned in [Ensuring Network Reachability for Product Instance-Initiated Communication, on page 123](#).

2. For SSM On-Prem-initiated communication, check HTTPs connectivity.

Use the **show ip http server session-module** command in privileged EXEC mode. In the output, under header `HTTP server current connections:`, check that `SL_HTTP` is active. If it is not re-configure the **ip http** commands as mentioned in [Ensuring Network Reachability for SSM On-Prem-Initiated Communication, on page 128](#).

3. Check trustpoint and that certificates are accepted.

For both forms of communication in an SSM On-Prem Deployment, ensure that the correct trustpoint is used and that the necessary certificates are accepted:

```
Device(config)# crypto pki trustpoint SLA-TrustPoint
Device(ca-trustpoint)#
Device(ca-trustpoint)# enrollment terminal
Device(ca-trustpoint)# revocation-check none
Device(ca-trustpoint)# end
Device# copy running-config startup-config
```

If the above does not work and policy installation still fails, contact your Cisco technical support representative.

```
-----
-----
Error Message %SMART_LIC-3-COMM_RESTORED: Communications with the [chars] restored.
[chars] - depends on the transport type
         - Cisco Smart Software Manager (CSSM)
         - Cisco Smart License utility (CSLU)
Smart Agent communication with either the Cisco Smart Software Manager (CSSM) or the Cisco
Smart License
utility (CSLU) has been restored. No action required.
```

**Explanation:** Product instance communication with either the CSSM, or CSLU, or SSM On-Prem is restored.

**Recommended Action:** No action required.

```
-----
-----
Error Message %SMART_LIC-3-POLICY_REMOVED: The licensing policy has been removed.
```



**Explanation:** A previously installed *custom* licensing policy has been removed. The `Cisco default` policy is then automatically effective. This may cause a change in the behavior of smart licensing.

Possible reasons for failure include:

If you have entered the **license smart factory reset** command in privileged EXEC mode all licensing information including the policy is removed.

**Recommended Action:**

If the policy was removed intentionally, then no further action is required.

If the policy was removed inadvertently, you can reapply the policy. Depending on the topology you have implemented, follow the corresponding method to retrieve the policy:

- Connected Directly to CSSM:

Enter **show license status**, and check field `Trust Code Installed:`. If trust is established, then CSSM will automatically return the policy again. The policy is automatically re-installed on product instances of the corresponding Virtual Account.

If trust has not been established, complete these tasks: [#unique\\_147](#) and [#unique\\_148](#). When you have completed these tasks, CSSM will automatically return the policy again. The policy is then automatically installed on all product instances of that Virtual Account.

- Connected to CSSM Through CSLU:

- For product instance-initiated communication), enter the **license smart sync** command in privileged EXEC mode. The synchronization request causes CSLU to push the missing information (a policy or authorization code) to the product instance.
- For CSLU-initiated communication, complete this task: [#unique\\_141](#). This causes CSLU to detect and re-furnish the missing policy in an ACK response.

- CSLU Disconnected from CSSM:

- For product instance-initiated communication), enter the **license smart sync** command in privileged EXEC mode. The synchronization request causes CSLU to push the missing information (a policy or authorization code) to the product instance. Then complete these tasks in the given order: [#unique\\_150 > Uploading Data or Requests to CSSM and Downloading a File, on page 145](#) > [#unique\\_152](#).
- For CSLU-initiated communication, complete this task: [#unique\\_141](#). This causes CSLU to detect and re-furnish the missing policy in an ACK response. Then complete these tasks in the given order: [#unique\\_150 > Uploading Data or Requests to CSSM and Downloading a File, on page 145](#) > [#unique\\_152](#).

- No Connectivity to CSSM and No CSLU

If you are in an entirely air-gapped network, from a workstation that has connectivity to the internet and CSSM complete this task: [#unique\\_194](#).

Then complete this task on the product instance: [#unique\\_154](#).

- SSM On-Prem Deployment

- For product instance-initiated communication), enter the **license smart sync** command in privileged EXEC mode. The causes the product instance to synchronize with SSM On-Prem and restore any required or missing information. Then synchronize SSM On-Prem with CSSM if required:

- For SSM On-Prem-initiated communication: In the SSM On-Prem UI, navigate to **Reports > Synchronization pull schedule with the devices > Synchronize now with the device**.

For both forms of communication in an SSM On-Prem Deployment, synchronize with CSSM using either option:

- SSM On-Prem is connected to CSSM: In the SSM On-Prem UI, Smart Licensing workspace, navigate to **Reports > Usage Schedules > Synchronize now with Cisco**.
- SSM On-Prem is not connected to CSSM: [Exporting and Importing Usage Data \(SSM On-Prem UI\)](#), on page 126.

---



---

```
Error Message %SMART_LIC-3-TRUST_CODE_INSTALL_FAILED: The install of a new licensing trust code has failed on [chars]: [chars].
```

**Explanation:** Trust code installation has failed. The first [chars] is the UDI where trust code installation was attempted. The second [chars] is the error string with details of the failure.

Possible reasons for failure include:

- A trust code is already installed: Trust codes are node-locked to the UDI of the product instance. If the UDI is already registered, and you try to install another one, installation fails.
- Smart Account-Virtual Account mismatch: This means the Smart Account or Virtual Account (for which the token ID was generated) does not include the product instance on which you installed the trust code. The token generated in CSSM, applies at the Smart Account or Virtual Account level and applies only to all product instances in that account.
- A signature mismatch: This means that the system clock is not accurate.
- Timestamp mismatch: This means the product instance time is not synchronized with CSSM, and can cause installation to fail.

#### Recommended Action:

- A trust code is already installed: If you want to install a trust code inspite of an existing trust code on the product instance, re-configure the **license smart trust idtoken id\_token\_value {local | all} [force]** command in privileged EXEC mode, and be sure to include the **force** keyword this time. Entering the **force** keyword sets a force flag in the message sent to CSSM to create a new trust code even if one already exists.
- Smart Account-Virtual Account mismatch:

Log in to the CSSM Web UI at <https://software.cisco.com> and click **Smart Software Licensing>Inventory > Product Instances**.

Check if the product instance on which you want to generate the token is listed in the selected Virtual Account. If it is, proceed to the next step. If not, check and select the correct Smart Account and Virtual Account. Then complete these tasks again: [#unique\\_147](#) and [#unique\\_148](#).

- Timestamp mismatch and signature mismatch: Configure the **ntp server** command in global configuration mode. For example:

```
Device(config)# ntp server 198.51.100.100 version 2 prefer
```

```
-----  
-----  
Error Message %SMART_LIC-4-REPORTING_NOT_SUPPORTED: The CSSM OnPrem that this  
product instance is connected to is down rev and does not support the enhanced policy and  
usage  
reporting mode.
```

**Explanation:** Cisco Smart Software Manager On-Prem (formerly known as Cisco Smart Software Manager satellite) is supported in the Smart Licensing Using Policy environment starting with Cisco IOS XE Amsterdam 17.3.3 only (See [SSM On-Prem, on page 59](#)). In *unsupported* releases, the product instance will behave as follows:

- Stop sending registration renewals and authorization renewals.
- Start recording usage and saving RUM reports locally.

**Recommended Action:**

You have the following options:

- Refer to and implement one of the supported topologies instead. See: [#unique\\_89](#).
- Upgrade to a release where SSM On-Prem is supported with Smart Licensing Using Policy. See [Migrating to a Version of SSM On-Prem That Supports Smart Licensing Using Policy, on page 111](#).

```
-----  
-----  
Error Message %SMART_LIC-6-POLICY_INSTALL_SUCCESS: A new licensing policy  
was successfully installed.
```

**Explanation:** A policy was installed in one of the following ways:

- Using Cisco IOS commands.
- CSLU-initiated communication.
- As part of an ACK response.

**Recommended Action:** No action is required. If you want to know which policy is applied (the policy in-use) and its reporting requirements, enter the **show license all** command in privileged EXEC mode.

```
-----  
-----  
Error Message %SMART_LIC-6-AUTHORIZATION_INSTALL_SUCCESS: A new licensing  
authorization code was successfully installed on: [chars].
```

This message is not applicable to Cisco Catalyst Access, Core, and Aggregation Switches, because there are no enforced or export-controlled licenses on these product instances.

Error Message %SMART\_LIC-6-AUTHORIZATION\_REMOVED: A licensing authorization code has been removed from [chars]

**Explanation:** [chars] is the UDI where the authorization code was installed. The authorization code has been removed. This removes the licenses from the product instance and may cause a change in the behavior of smart licensing and the features using licenses.

**Recommended Action:** No action is required. If you want to see the current state of the license, enter the **show license all** command in privileged EXEC mode.

-----  
 Error Message %SMART\_LIC-6-REPORTING\_REQUIRED: A Usage report acknowledgement will be required in [dec] days.

**Explanation:** This is an alert which means that RUM reporting to Cisco is required. [dec] is the amount of time (in days) left to meet this reporting requirements.

**Recommended Action:** Ensure that RUM reports are sent within the requested time. The topology you have implemented determines the reporting method.

- Connected to CSSM Through CSLU
    - For product instance-initiated communication: Enter the **license smart sync** command in privileged EXEC mode. If CSLU is currently logged into CSSM the reports will be automatically sent to the associated Smart Account and Virtual Account in CSSM.
    - For CSLU-initiated communication, complete this task: [#unique\\_141](#).
  - Connected Directly to CSSM: Enter the **license smart sync** command in privileged EXEC mode.
  - Connected to CSSM Through a Controller: If the product instance is managed by a controller, the controller will send the RUM report at the scheduled time.
- If you are using Cisco Catalyst Center as the controller, you have the option of ad-hoc reporting. See the [Cisco Catalyst Center Administrator Guide](#) of the required release (Release 2.2.2 onwards) > *Manage Licenses > Upload Resource Utilization Details to CSSM*.
- CSLU Disconnected from CSSM: If the product instance is connected to CSLU, synchronize with the product instance as shown for "Connected to CSSM Through CSLU" above, then complete these tasks: [#unique\\_150](#), [#unique\\_151](#), and [#unique\\_152](#).
  - No Connectivity to CSSM and No CSLU: Enter the **license smart save usage** command in privileged EXEC mode, to save the required usage information in a file. Then, from a workstation where you have connectivity to CSSM, complete these tasks: [#unique\\_151](#) > [#unique\\_154](#).

- SSM On-Prem Deployment:

Synchronize the product instance with SSM On-Prem:

- For product instance-initiated communication: Enter the **license smart sync** command in privileged EXEC mode. If CSLU is currently logged into CSSM the reports will be automatically sent to the associated Smart Account and Virtual Account in CSSM.
- For SSM On-Prem-initiated communication, complete this task: In the SSM On-Prem UI, navigate to **Reports > Synchronization pull schedule with the devices > Synchronize now with the device**.

Synchronize usage information with CSSM (*choose one*)

- SSM On-Prem is connected to CSSM: In the SSM On-Prem UI, Smart Licensing workspace, navigate to **Reports > Usage Schedules > Synchronize now with Cisco**.
- SSM On-Prem is not connected to CSSM: [Exporting and Importing Usage Data \(SSM On-Prem UI\)](#), on page 126.

---



---

```
Error Message %SMART_LIC-6-TRUST_CODE_INSTALL_SUCCESS: A new licensing trust code
was successfully installed on [chars].
```

**Explanation:**[chars] is the UDI where the trust code was successfully installed.

**Recommended Action:** No action is required. If you want to verify that the trust code is installed, enter the **show license status** command in privileged EXEC mode. Look for the updated timestamp under header `Trust Code Installed:` in the output.

---



---

## Additional References for Smart Licensing Using Policy

Topic	Document Title
For complete syntax and usage information for the commands used in this chapter, see the Command Reference of the corresponding release.	<a href="#">Cisco Catalyst 9800 Series Wireless Controller Command Reference</a>
Cisco Smart Software Manager Help	<a href="#">Smart Software Manager Help</a>
Cisco Smart License Utility (CSLU) installation and user guides	<a href="#">Cisco Smart License Utility Quick Start Setup Guide</a> <a href="#">Cisco Smart License Utility User Guide</a>

## Feature History for Smart Licensing Using Policy

This table provides release and related information for features explained in this module.

These features are available on all releases subsequent to the one they were introduced in, unless noted otherwise.

Release	Feature	Feature Information
Cisco IOS XE Gibraltar 16.10.1	Smart Licensing	A cloud-based, software license management solution that allows you to manage and track the status of your license, hardware, and software usage trends.

Release	Feature	Feature Information
Cisco IOS XE Amsterdam 17.3.2a	Smart Licensing Using Policy	<p>An enhanced version of Smart Licensing, with the overarching objective of providing a licensing solution that does not interrupt the operations of your network, rather, one that enables a compliance relationship to account for the hardware and software licenses you purchase and use.</p> <p>Starting with this release, Smart Licensing Using Policy is automatically enabled on the device. This is also the case when you upgrade to this release.</p> <p>By default, your Smart Account and Virtual Account in CSSM is enabled for Smart Licensing Using Policy.</p>
	Cisco Catalyst Center Support for Smart Licensing Using Policy	<p>Cisco Catalyst Center supports Smart Licensing Using Policy functionality starting with Cisco Catalyst Center Release 2.2.2. When you use Cisco Catalyst Center to manage a product instance, Cisco Catalyst Center connects to CSSM, and is the interface for all communication to and from CSSM.</p> <p>For information about the compatible controller and product instance versions, see <a href="#">Controller, on page 58</a>.</p> <p>For information about this topology, see <a href="#">Connected to CSSM Through a Controller, on page 68</a> and <a href="#">Workflow for Topology: Connected to CSSM Through a Controller, on page 85</a>.</p>
Cisco IOS XE Amsterdam 17.3.3	Smart Software Manager On-Prem (SSM On-Prem) Support for Smart Licensing Using Policy	<p>SSM On-Prem is an asset manager, which works in conjunction with CSSM. It enables you to administer products and licenses on your premises instead of having to directly connect to CSSM.</p> <p>For information about the compatible SSM On-Prem and product instance versions, see: <a href="#">SSM On-Prem, on page 59</a>.</p> <p>For an overview of this topology, and to know how to implement it see <a href="#">SSM On-Prem Deployment, on page 70</a> and <a href="#">Workflow for Topology: SSM On-Prem Deployment, on page 87</a>.</p> <p>For information about migrating from an existing version of SSM On-Prem, to one that supports Smart Licensing Using Policy, see <a href="#">Migrating to a Version of SSM On-Prem That Supports Smart Licensing Using Policy, on page 111</a>.</p>



## CHAPTER 6

# Boot Integrity Visibility

- [Overview of Boot Integrity Visibility, on page 165](#)
- [Verifying Software Image and Hardware, on page 165](#)
- [Verifying Platform Identity and Software Integrity, on page 166](#)

## Overview of Boot Integrity Visibility

Boot Integrity Visibility allows the Cisco platform identity and software integrity information to be visible and actionable. Platform identity provides the platform's manufacturing installed identity. Software integrity exposes boot integrity measurements that can be used to assess whether the platform has booted trusted code.

During the boot process, the software creates a checksum record of each stage of the bootloader activities.

You can retrieve this record and compare it with a Cisco-certified record to verify if your software image is genuine. If the checksum values do not match, you may be running a software image that is either not certified by Cisco or has been altered by an unauthorized party.

## Verifying Software Image and Hardware

This task describes how to retrieve the checksum record that was created during a switch bootup. Enter the following commands in privileged EXEC mode.



**Note** On executing the following commands, you might see the message **% Please Try After Few Seconds** displayed on the CLI. This does not indicate a CLI failure, but indicates setting up of underlying infrastructure required to get the required output. We recommend waiting for a few minutes and then try the command again.

The messages **% Error retrieving SUDI certificate** and **% Error retrieving integrity data** signify a real CLI failure.

### Procedure

	Command or Action	Purpose
<b>Step 1</b>	<code>show platform sudi certificate [sign [nonce nonce]]</code>	Displays checksum record for the specific SUDI.

	Command or Action	Purpose
	<b>Example:</b> Device# show platform sudi certificate sign nonce 123	<ul style="list-style-type: none"> <li>• (Optional) <b>sign</b> - Show signature.</li> <li>• (Optional) <b>nonce</b> - Enter a nonce value.</li> </ul>
<b>Step 2</b>	<b>show platform integrity [sign [nonce nonce]]</b>  <b>Example:</b> Device# show platform integrity sign nonce 123	Displays checksum record for boot stages. <ul style="list-style-type: none"> <li>• (Optional) <b>sign</b> - Show signature.</li> <li>• (Optional) <b>nonce</b> - Enter a nonce value.</li> </ul>

## Verifying Platform Identity and Software Integrity

### Verifying Platform Identity

The following example displays the Secure Unique Device Identity (SUDI) chain in PEM format. Encoded into the SUDI is the Product ID and Serial Number of each individual device such that the device can be uniquely identified on a network of thousands of devices. The first certificate is the Cisco Root CA 2048 and the second is the Cisco subordinate CA (ACT2 SUDI CA). Both certificates can be verified to match those published on <https://www.cisco.com/security/pki/>. The third is the SUDI certificate.



**Important** All the CLI outputs provided here are intended only for reference. The output differs based on the configuration of the device.

```

Device# show platform sudi certificate sign nonce 123
-----BEGIN CERTIFICATE-----
MIIDQzCCAiugAwIBAgIQX/h7KctU3I1CoxW1aMmt/zANBgkqhkiG9w0BAQUFADA1
MRYwFAYDVQQKEw1DaXNjbyBTeXN0ZW1zMRswGQYDVQQDExJDaXNjbyBSb290IENB
IDIwNDgwHhcNMDQwNTE0MjAxNzEyWhcNMjkwNTE0MjAyNTQyWjA1MRYwFAYDVQQK
Ew1DaXNjbyBTeXN0ZW1zMRswGQYDVQQDExJDaXNjbyBSb290IENBIDIwNDgwggEg
MA0GCSqGSIb3DQEBAQUAA4IBDQAwggEIAoIBAQCwmrmrp68Kd6ficba0ZmKUeIhH
xmJVhEAYv8CrLqUccda8bnuoqrpu0hWISEWdovyD0My5jOamaHBKeN8hF570YQXJ
FcjPFto1YmUQ6iEqdGYeJu5Tm8sUxJsZr2tKys7McQr/4NEb7Y9JHcJ6r8qqB9q
VvYgDxFU14F1pyXOWWqCZe+36ufijXWLBvLdT6ZeYpzPEApk0E5tzivMM/VgppSdh
jWn0f84bcN5wGyDWbs2mAag8EtKpP6BrXruOIIt6ke01a06g58QBdKhTCytKmg9l
Eg6CTY5j/e/rmxrbU6YTYK/CfdFHbBc11HP7R2RQgYCUtOG/rksc35LtLgXfAgED
o1EwTzALBgNVHQ8EBAMCAYYwDwYDVR0TAAQH/BAUwAwEB/zAdBgNVHQ4EFgQUJ/PI
FR5umgIJFq0roIlgX9p7L6owEAYJKwYBBAGCNxUBBAMCAQAwDQYJKoZIhvcNAQEF
BQADggEBAJ2dhISjQal8dwy3U8pORFBI71R803UXHOjgkxhLtv5M0hmBvrbW7hmW
Yqpao2TB9k5UM8Z3/sUcuuVdJcr18JOagxEu5sv4dEX+5wW4q+ffY0vhN4TauYuX
cB7w4ovXsNgOnbFp1iqRe6lJT37mjpxYgyC81WhJDtSd9i7rp77rMKsSH0T8Lasz
Bvt9YArEtIpsjYp8qS5UwGH0GikJ3+r/+n6yUA4iGe00caEb1fJU9u6ju7AQ7L4
CYNu/2bPPu8Xs1gYJQk0XuPL1hS27PKSb3TkL4Eq1ZKR4OCXPDJoBYVL0fdX41Id
kxpUnwVwwEpxYB5DC2Ae/qPOgRnhCzU=
-----END CERTIFICATE-----
-----BEGIN CERTIFICATE-----
MIIEPCCAySgAwIBAgIKYQlufQAAAAAADANBgkqhkiG9w0BAQUFADA1MRYwFAYD
VQQKEw1DaXNjbyBTeXN0ZW1zMRswGQYDVQQDExJDaXNjbyBSb290IENBIDIwNDgw
HhcNMTcwNjMwMTE0MjAxNzEyWhcNMjkwNTE0MjAyNTQyWjAnMQ4wDAYDVQQKEw1DaXNj
bzEvEMBMGA1UEAxMMQUNUMiBTVURJIEBNIIBIjANBgkqhkiG9w0BAQEFAAOCAQ8A
MIIBCgKCAQEAm5l3THIx9tN/hS5qR/6UZRpdd+9aE2JbFkNjht6gfHKd477AkS
5XAtUs5oxDYvt/zEbs1Zq3+LR6qrqKQVv6JYvH05UYLBqCj38s76NLk53905Wzp
9pRcmRCPuX+a6tHF/qRuoiJ44mdeDYz03qPCpxzprWJDpC1M4iYKHUMQMqmgmg+

```



```
xghHiooWS80BOcdiynEbeP5rZ7qRuewKMpl1TiI3WdBNjZjnpfjg66F+P4SaDkGb
BXdGj13vVeF+EyFWLrFjj97fL2+8oaUv43Qrvnf3d/GfqXj7ew+z/sX1XtEOjSXJ
URsyMEj53Rdd9tJwHky8neapszs+r+kdVQIDAQABo4IBWjCCAVYwCwYDVR0PBAQD
AgHGMB0GA1UdDgQWBRI2PHxwnDVW7t8cwmTr7i4MAP4fzAfBgNVHSMEGDAWgBQn
88gVHm6aAgkWrSugiWbf2nsqvjBDBgNVHR8EPDA6MDIqNqA0hjJodHRwOi8vd3d3
LmNpc2NvLmNvbS9zZW51cm10eS9wa2kvY3JsL2NyY2EyMDQ4LmNybDBQBggrBgEF
BQcBAQREMEIwQAYIKwYBBQUHMAKGNgh0dHA6Ly93d3cuY2lzY28uY29tL3NlY3Vy
aXR5L3BraS9jZlZ0cy9jcmNhMjA0OC5jZlXiwXAYDVR0gBFUwUzBRBgorBgEEAQkV
AQwAMEMwQQYIKwYBBQUHAgEWNWh0dHA6Ly93d3cuY2lzY28uY29tL3NlY3VyYXR5
L3BraS9wb2xpY2llcy9pbmRleC5odG1sMBIGA1UdEwEB/wQIMAYBAf8CAQAwdQYJ
KoZiThvcNAQEFBQADggEBAGhlqclr9tx4hzWgDERm371yeuEmqcIfi9b9+GbmSjbi
ZHC/CcC10lJu0a9zTXA9w47H9/t61eduGxb4WeLxcwCiUgvFta51lkl8nNbcKY
/4dwlex+7amATUQO4QggIE67wVIPu6bgAE3Ja/nRS3xKYSnj8H5TehimBSv6TECi
i5jUhOWryAK4dVo8hCjkkEz3ufBTJapnv89g9OE+H3VKM4L+/KdkUO+52djFkn
hyl47d7cZR4DY4LIuFM2P1As8YyjoNpK/urSRI14WdIlplRlnH7KND15618yfvP
0IFJZBGrooCRBjOSwFv8cpWCbmWdPaCQT2nwIjTfy8c=
-----END CERTIFICATE-----
-----BEGIN CERTIFICATE-----
MIIDfTCCAmWgAwIBAgIEAwQD7zANBgkqhkiG9w0BAQsFADANMQ4wDAYDVQQKEwVD
aXNjbzEVMBMGAlUEAxMMQUNUMiBTvURJIENBMB4XDTE4MDkyMzIyMzIwLjE1ODI1
MDUxNDIwMjU0MjUwMjU0MjU0MjU0MjU0MjU0MjU0MjU0MjU0MjU0MjU0MjU0MjU0
MzZMMFESMQ4wDAYDVQQKEwVDaXNjbzEYMBYGA1UECzMpQUNULTIqTG10ZSBTVURJ
MRQwEgYDVQDEwtDOTYwMCI3VVAATMTCCASiWdQYJKoZiThvcNAQEFBQADggEPADCC
AQwCggEBANsh0jcvgh1pdOjP9KnffDnDc/zEHDzbcTWPJi2FZcsaSE5jvq6CUBQc4
MYpNAZU2Jym7NSD8iQbMXwbnCtoL64QtxQeFhRymc4d5o933M7GwpEH0I7HUSbO/
Fxp77JbMGPPgAkY7rKsYENiNK2hiR7Q2O7X2BidOKknEuofWdJMNyMaZgLYLOhbJ
5oXaORxhUy3VRaxN16qI7kYxuugg2LcAbZ539sRXe8JtHyK811URNSGMIQ0S17pS
idGmrJJ0pEHA0EUVTZqEny3z+Nw9uxLVSzu6+hEJYlqfI+Yef0DbVZl1y1cy5r/jf
yNdGuGKvd5agvgCly8aYMza3P+D5S8sCAwEAANvMG0wDgYDVR0PBAQH/BAQDAgXg
MAwGA1UdEwEB/wQCMAAwTQYDVR0REBEYwRKBCBgkrBgEEAQkVAgoNRMzQ2hpcE1E
PVUxUk5TVE13TVRjd05qSTFBQUFwZndBQUFBQUFBQUFBQUFBQUFBQUhUhtSlU9MAOG
CSqGSIB3DQEBcWUAA4IBAQRcpHo/CUyk5Hs/asIcYw0ep8KocSknNh8qamyd4oWD
e/MGJW9Bs5f09IEbILWpdytCCS2lSyJbxz2HvVDzdxQdxjDwUNiWuu3dWMXN/i67
yuCGM+lA1AAG5dT6lNgWYHh+YzsZm9eoq1+4NM+JuMXwsnzAK8rSy+dSpBxqFsBq
E00lPsaK7y2h8gs+XrV9x+D48OZQkTRXpxhJfiWvs+EbdgsAM/vBxTAoTJFPVmxWN
Cmcj9X52X13i4MdOUXocZLO2kh6JSgOYGkFeZifJ0iDvMfaf0cJ6+cEF6bSxAqBL
veel+8LmeiE/209h6qGHPPDacCaXA2oJCDHveAt8iPTG
-----END CERTIFICATE-----
```

Signature version: 1

Signature:

-----BEGIN RSA SIGNATURE-----

The optional RSA 2048 signature is across the three certificates, the signature version and the user-provided nonce.

```
RSA PKCS#1v1.5 Sign {<Nonce (UINT64)> || <Signature Version (UINT32)> || <Cisco Root CA
2048 cert (DER)> ||
<Cisco subordinate CA (DER)> || <SUDI certificate (DER)> }
```

Cisco management solutions are equipped with the ability to interpret the above output. However, a simple script using OpenSSL commands can also be used to display the identity of the platform and to verify the signature, thereby ensuring its Cisco unique device identity.

```
[linux-host:~]openssl x509 -in sudi_id.pem -subject -noout
subject= /serialNumber=PID:C9600-SUP-1 SN:CAT2239L06B/CN=C9600-SUP-1-70b3171eaa00
```

### Verifying Software Integrity

The following example displays the checksum record for the boot stages. The hash measurements are displayed for each of the three stages of software successively booted. These hashes can be compared against

Cisco-provided reference values. An option to sign the output gives a verifier the ability to ensure the output is genuine and is not altered. A nonce can be provided to protect against replay attacks.



---

**Note** Boot integrity hashes are not MD5 hashes. For example, if you run **verify /md5 cat9k\_iosxe.16.10.01.SPA.bin** command for the bundle file, the hash will not match.

---

The following is a sample output of the **show platform integrity sign nonce 123** command. This output includes measurements of each installed package file.

```
Device# show platform integrity sign nonce 123
Platform: C9800-L-F-K9
Boot 0 Version: R04.1173930452019-06-11
Boot 0 Hash: A6C92C44976FC77DD42234444FFD87798FB9036A2762FAA4999A190A0258B18C
Boot Loader Version: 16.12(1r)
Boot Loader Hash:
#####
OS Version: 2020-03-19_20.26
OS Hashes:
C9800-L-universalk9_wlc.2020-03-19_20.26.SSA.bin:
53E2DF1A1A082E36EA4CAB817C1794EC9D69AC0E90B0CBFE99BCD0BCA9385AA9E9372AEF7431E4A08FC5E5B9670131C09D158E5B8A7B457501FE77AB9F1C26D
C9800-L-mono-universalk9_wlc.2020-03-19_20.26.SSA.pkg:
1D3279D53B0311CE42C669824DF86FB5596CD7CA45CA8D7FDC3D10657B8C9A48F4B0508D7BCFFD645CB6571AC1E674A57A82414E3D6E1666BE64E6132F707671
PCR0: EE14A2D5099DA343B3941C54A429C4AC1D3EE8E9B609F1AC00049768A470734E
PCR8: 78794D0F5667F8FA4E425E3CA2AF3CD99B90B219FD90222D622B3D563416BBAA
```



---

**Note** Only OS and package hashes are supported.

---



## CHAPTER 7

# Management over Wireless

---

- [Information About Management over Wireless](#), on page 169
- [Restrictions on Management over Wireless](#), on page 169
- [Enabling Management over Wireless on Controller \(GUI\)](#), on page 169
- [Enabling Management over Wireless on Controller \(CLI\)](#), on page 170

## Information About Management over Wireless

The Management over Wireless feature allows operators to monitor and configure the controller using wireless clients connected to the wireless controller network.



---

**Note** By default, the Management over Wireless feature is disabled. You will need to keep the Management over Wireless feature disabled, if security is a concern.

---

This feature blocks the wireless management access to the same controller that the wireless client device is currently associated with. It does not prevent management access to a wireless client associated with another controller entirely. To completely block management access to wireless clients based on VLAN and so on, we recommend that you use Access Control Lists (ACLs) or a similar mechanism.

## Restrictions on Management over Wireless

- The Management over Wireless feature does not work for Embedded Wireless Controller (EWC).

## Enabling Management over Wireless on Controller (GUI)

### Procedure

---

- Step 1** Choose **Configuration > Wireless > Wireless Global**.
- Step 2** Check the **Management via Wireless** check box.

**Step 3** Click **Apply**.

---

## Enabling Management over Wireless on Controller (CLI)

### Procedure

	Command or Action	Purpose
<b>Step 1</b>	<b>configure terminal</b> <b>Example:</b> Device# configure terminal	Enters global configuration mode.
<b>Step 2</b>	<b>wireless mgmt-via-wireless</b> <b>Example:</b> Device(config)# wireless mgmt-via-wireless	Enables management over wireless.  Use the <b>no</b> form of this command to disable the management over wireless.
<b>Step 3</b>	<b>end</b> <b>Example:</b> Device(config)# end	Returns to privileged EXEC mode.



## CHAPTER 8

# Link Aggregation Group

- [Information About Link Aggregation Group, on page 171](#)

## Information About Link Aggregation Group

A link aggregation group (LAG) bundles all of the controller's distribution system ports into a single 802.3ad port channel. This reduces the number of IP addresses required to configure the ports on your controller. When LAG is enabled, the system dynamically manages port redundancy and load balances access points transparently to the corresponding user.

LAG simplifies controller configuration because you no longer have to configure ports for each interface. If any of the controller ports fail, traffic is automatically migrated to one of the other ports. As long as at least one controller port is functioning, the system continues to operate, access points remain connected to the network, and wireless clients continue to send and receive data.



---

**Note** The wireless management VLAN can only be part of one port channel.

---



---

**Note** LACP is supported on a standalone controller from Cisco IOS XE Gibraltar 16.12.x release. LACP is supported on an SSO pair from Cisco IOS XE Amsterdam 17.1.1s onwards.

---

## Link Aggregation Control Protocol

Link Aggregation Control Protocol (LACP) is a part of an IEEE specification (802.3ad) that allows you to bundle several physical ports together to form a single logical channel. LACP allows a switch to negotiate an automatic bundle by sending LACP packets to a peer. By using the LACP, the wireless controller learns the identity of peers that are capable of supporting LACP, and the capabilities of each port. The LACP then dynamically groups similarly configured ports into a single logical link (channel or aggregate port). Similarly, configured ports are grouped based on hardware, administrative, and port parameter constraints. If any of the controller ports fail, traffic is automatically migrated to one of the other ports. As long as at least one controller port is functioning, the system continues to operate, access points remain connected to the network, and wireless clients continue to send and receive data.

## Configuring LAG Using LACP

To configure LAG using LACP, multiple port-channel interfaces must be created, and these interfaces should be added to the corresponding port bundle. LACP should also be configured on the uplink switch for the LACP bundle to come up.

- [Create a port-channel interface](#)
- [Add interface to the port-channel](#)
- [Add VLAN to LAG](#)
- [Add interface to the port-channel](#)

## Port Aggregation Protocol

Port Aggregation Protocol (PAgP) is a Cisco-proprietary protocol that you can run on controllers. PAgP facilitates the automatic creation of EtherChannels by exchanging PAgP packets between Ethernet ports. PAgP packets are sent between Fast EtherChannel-capable ports in order to form a channel. When any of the active ports fail, a standby port becomes active.

By using PAgP, the controller learns the identity of partners that are capable of supporting PAgP and the capabilities of each port. PAgP then dynamically groups similarly configured ports (on a single device in a stack) into a single logical link (channel or aggregate port). Similarly, configured ports are grouped based on hardware, administrative, and port parameter constraints.

## Configuring LAG Using PAgP

To configure LAG using PAgP, multiple port-channel interfaces must be created, and these interfaces should be added to the corresponding port bundle. PAgP should also be configured on the uplink switch for the PAgP bundle to come up.

- [Create a port-channel interface](#)
- [Add interface to the port-channel](#)

## Information About Port Channel Interface Number

From Cisco IOS XE Bengaluru 17.5.1 onwards, the flexibility to number the port channel interface numbers between 1 and 64 is supported on the following Cisco Catalyst 9800 Series Wireless Controllers:

- Cisco Catalyst 9800-CL Wireless Controller for Cloud: The available range on the CLI is 1 to 64. The maximum supported port channel interfaces are 64.
- Cisco Catalyst 9800-L Wireless Controller: The available range on the CLI is 1 to 64. The maximum supported port channel interfaces are 14.
- Cisco Catalyst 9800-40 Wireless Controller: The available range on the CLI is 1 to 64. The maximum supported port channel interfaces are 16.
- Cisco Catalyst 9800-80 Wireless Controller: The available range on the CLI is 1 to 64. The maximum supported port channel interfaces are 64.

For example on the Cisco Catalyst 9800-L Wireless Controller, port-channel interface numbers can be anywhere between 1 and 64, as long as the total number of port-channel interfaces are 14 or lesser.



**Note** If you have configured 16 port-channel interfaces on the Cisco Catalyst 9800-40 Wireless Controller, and if the configured port-channel interfaces have reached their limitation, the following error message is displayed when you try to configure the 17th port-channel interface:

```
Device(config)#
Dec 15 08:58:22.209 CST: %ETC-5-CANNOT_ALLOCATE_AGGREGATOR: Aggregator limit reached, cannot
allocate aggregator for group 17
```

When you downgrade from Cisco IOS XE Bengaluru 17.5.1 to an earlier version, and if the port channels are configured with a higher range than the supported range in the earlier version, the following errors are displayed when the earlier version is started. The non supported port channels disappear after the downgrade is completed.

```
interface Port-channel29
^% Invalid input detected at '^' marker.
interface Port-channel35
^% Invalid input detected at '^' marker.
```

Note that the HA pairing remains intact after downgrade.

## Configuring LAG in ON Mode

To configure LAG in ON mode, multiple port-channel interfaces must be created, and these interfaces should be added to the corresponding port bundle. LACP should also be configured on the uplink switch for the LACP bundle to come up.

- [#unique\\_224](#)

## Multichassis Link Aggregation Group

From Cisco IOS XE Amsterdam 17.2.1, Multichassis Link Aggregation Group (multi-LAG), which provides flexibility in connecting the controller to a switch's infrastructure is supported. Using multi-LAG, you can connect the multiple uplinks from the controller to the separated uplink switches. The controller supports VLAN-based traffic splitting when connected to a multiswitch topology. This provides the ability to distribute traffic on different uplinks, based on VLANs, for example, supporting a use case where guest traffic can be completely isolated to a different switch or network from the enterprise network. Same VLAN cannot be configured on both the uplinks.

You can connect a LAG to a single switch. However, different VLANs must be connected to different LAGs. The redundancy port must be connected to the same distribution switch as the uplinks, or back to back.

Multi-LAG is supported in LAG ON mode, LACP, and PAgP modes.

## Prerequisites for Multi-LAG

- Each LAG must be connected to a single switch.
- Different VLANs must be assigned to different LAGs.

## Restrictions for Multi-LAG

- If the primary LAG fails, automatic failover to secondary LAG is not supported.
- The interface on the controller does not come up when you shut or unshut the port on the switch port.



**Note** This is specific to Cisco Catalyst 9800-CL Cloud Wireless Controller in KVM environment for SR-IOV.

## Supported Topologies

The Cisco Catalyst 9800-80 Wireless Controller has eight ports, while the Cisco Catalyst 9800-40 and Cisco Catalyst 9800-L wireless controllers have four ports each. You can create multi-LAGs of ports with similar capabilities, for example, 2.5 G and 2.5 G, or 10 G and 10 G. You cannot have a 2.5 G and a 10 G port in a port channel group with a minimum of two ports in one LAG.

**Figure 13: Single Controller with Multi-LAG**

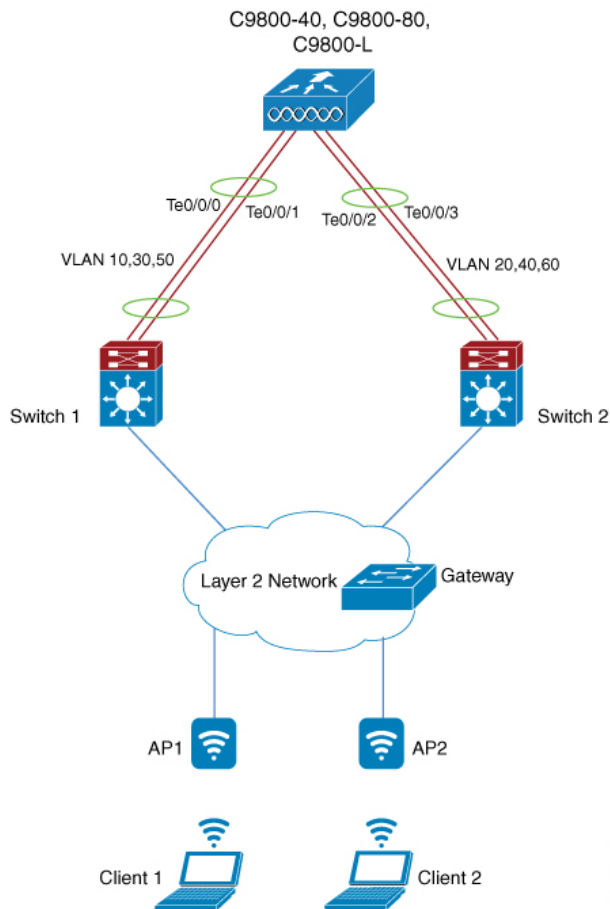
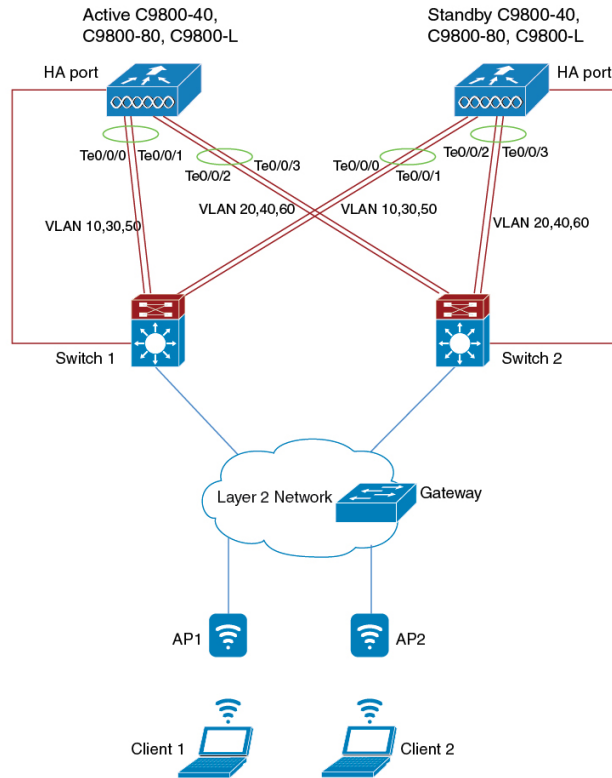



Figure 14: SSO Pair with Multi-LAG



## Configuring a Port Channel Interface (GUI)

### Procedure

- 
- Step 1** Choose **Configuration > Interface > Logical**.
- Step 2** Click the **Port Channel** tab to configure the Port Channel interface.  
The **Port Channel** tab lists all the logical port-channel interfaces on the device.
- Step 3** Click **Add** to add to a new logical port channel interface.  
The **Add Port Channel Interface** window is displayed.
- Step 4** In the **Add Port Channel Interface** complete the following procedure:
- In the **Port Channel Number** field, enter the port channel number. The valid values are between 1 to 64.
  - In the **Description** field, enter the port channel description.
  - Click the **Admin Status** toggle button to set the admin status as *UP* or *DOWN*.
  - Click the **Enable Layer 3 Address** toggle button to enable the Layer 3 address.
  - In the Port Members section, select the port members from the list displayed in the **Available** list box, and add it to the **Associated** list.
  - From the **Switchport Mode** drop-down list, choose a switch mode for the interface.

- If you choose *access* as the switch mode, enter the access VLAN ID in the **Access VLAN** field.
- If you choose *trunk* as the switch mode, enter the VLAN IDs that you want to assign as trunk links. To allow all VLAN IDs as trunk links, set the **Allowed VLANs** to **All**. Specify a native VLAN.
- If you choose *dynamic auto* or *dynamic desirable* as the switch mode, enter the access VLAN ID. Enter the VLAN IDs you want to assign as trunk links. To allow all VLAN IDs as trunk links, set the **Allowed VLANs** to **All**. Specify a native VLAN.

g) Click **Update & Apply to Device**.

## Create a Port-Channel Interface

Follow the procedure given below to create a port-channel interface.

### Procedure

	Command or Action	Purpose
<b>Step 1</b>	<b>configure terminal</b>  <b>Example:</b> Device# configure terminal	Enters global configuration mode.
<b>Step 2</b>	<b>interface port-channel</b> <i>port-channel</i>  <b>Example:</b> Device(config)# interface port-channel 2	Configures the port channel and enters interface configuration mode.  The valid values for the port channel number ranges from 1 to 64.
<b>Step 3</b>	<b>switchport mode trunk</b>  <b>Example:</b> Device(config-if)# switchport mode trunk	Configures the port as trunk.
<b>Step 4</b>	<b>no shutdown</b>  <b>Example:</b> Device(config-if)# no shutdown	Enables the interface.

## Configuring LAG in ON Mode

Follow the procedure given below to configure LAG in ON mode.

### Procedure

	Command or Action	Purpose
<b>Step 1</b>	<b>configure terminal</b>  <b>Example:</b> Device# configure terminal	Enters global configuration mode.

	Command or Action	Purpose
<b>Step 2</b>	<b>interface TenGigabitEthernet <i>port-slot</i></b> <b>Example:</b> Device(config)# interface TenGigabitEthernet0/0/0	Configures the port.
<b>Step 3</b>	<b>switchport mode trunk</b> <b>Example:</b> Device(config-if)# switchport mode trunk	Configures the port as trunk.
<b>Step 4</b>	<b>no shutdown</b> <b>Example:</b> Device(config-if)# no shutdown	Disables the interface.
<b>Step 5</b>	<b>channel-group <i>group-number</i> mode on</b> <b>Example:</b> Device(config-if)# channel-group 3 mode on	Assigns the port to a channel group, and specifies the ON mode.  The valid values for the port channel number ranges from 1 to 64.
<b>Step 6</b>	<b>switchport trunk allowed vlan <i>vlan-id</i></b> <b>Example:</b> Device(config-if)# switchport trunk allowed vlan 16,17	Assigns the allowed VLAN ID to the port when it is in trunking mode.

## Add an Interface to a Port Channel (LACP)

Follow the procedure given below to add an interface to a port channel using the LACP.

### Procedure

	Command or Action	Purpose
<b>Step 1</b>	<b>configure terminal</b> <b>Example:</b> Device# configure terminal	Enters global configuration mode.
<b>Step 2</b>	<b>interface TenGigabitEthernet <i>port-slot</i></b> <b>Example:</b> Device(config)# interface TenGigabitEthernet0/0/0	Configures the port.
<b>Step 3</b>	<b>channel-group <i>group-number</i> {active   passive}</b> <b>Example:</b> Device(config-if)# channel-group 1 mode active	Assigns the port to a channel group, and specifies the LACP mode.  The valid values for the port channel number ranges from 1 to 64.

	Command or Action	Purpose
<b>Step 4</b>	<b>switchport mode trunk</b>  <b>Example:</b> Device(config-if)# switchport mode trunk	Configures the port as trunk.

## Add an Interface to a Port Channel (PAgP)

Follow the procedure given below to add an interface to a port channel using the PAgP.

### Procedure

	Command or Action	Purpose
<b>Step 1</b>	<b>configure terminal</b>  <b>Example:</b> Device# configure terminal	Enters global configuration mode.
<b>Step 2</b>	<b>interface TenGigabitEthernet <i>port-slot</i></b>  <b>Example:</b> Device(config)# interface TenGigabitEthernet0/0/0	Configures the TenGigabit Ethernet interface.
<b>Step 3</b>	<b>channel-group <i>group-number</i> {auto   desirable}</b>  <b>Example:</b> Device(config-if)# channel-group 1 mode auto	Assigns the port to a channel group, and specifies the PAgP mode.  The valid values for the port channel number ranges from 1 to 64.
<b>Step 4</b>	<b>switchport mode trunk</b>  <b>Example:</b> Device(config-if)# switchport mode trunk	Configures the port as trunk.

## Add a VLAN to a Port Channel

Follow the procedure given below to add different VLANs under a port channel.

### Procedure

	Command or Action	Purpose
<b>Step 1</b>	<b>configure terminal</b>  <b>Example:</b> Device# configure terminal	Enters global configuration mode.
<b>Step 2</b>	<b>interface port-channel <i>port-channel</i></b>  <b>Example:</b>	Configures the port channel.

	Command or Action	Purpose
	Device(config)# interface port-channel 1	Valid values for the port channel number range from 1 to 64.
<b>Step 3</b>	<b>switchport trunk allowed vlan</b> <i>vlan-id</i>  <b>Example:</b> Device(config-if)# switchport trunk allowed vlan 10,30,50	Adds VLANs to the list of allowed VLANs.

## Remove a Port Channel Group from a Physical Interface

Perform this task to remove a port channel group from a physical port.

### Procedure

	Command or Action	Purpose
<b>Step 1</b>	<b>configure terminal</b>  <b>Example:</b> Device# configure terminal	Enters global configuration mode.
<b>Step 2</b>	<b>interface TenGigabitEthernet</b> <i>port-slot</i>  <b>Example:</b> Device(config)# interface TenGigabitEthernet0/0/0	Enters the TenGigabit Ethernet interface.
<b>Step 3</b>	<b>no channel-group</b>  <b>Example:</b> Device(config-if)# no channel-group	Removes the port channel group from the physical port.
<b>Step 4</b>	<b>end</b>  <b>Example:</b> Device(config-if)# end	Exits interface configuration mode.

## Verify the LAG Configuration

To view a port channel's state, use the following command:

```
Device# show etherchannel summary
```

```
Flags: D - down          P - bundled in port-channel
       I - stand-alone  s - suspended
       H - Hot-standby (LACP only)
       R - Layer3       S - Layer2
       U - in use       f - failed to allocate aggregator

       M - not in use, minimum links not met
       u - unsuitable for bundling
       w - waiting to be aggregated
       d - default port
```

```

      A - formed by Auto LAG
Number of channel-groups in use: 1
Number of aggregators:          1
Group  Port-channel  Protocol  Ports
-----+-----+-----+-----+-----
3      Po3(SU)        LACP    Tw0/0/0(P)   Tw0/0/1(P)
4      Po4(SU)        LACP    Tw0/0/2(P)   Tw0/0/3(P)

```

To verify an LACP or PAgP configuration, use the following commands:

```
Device# show running-config interface tenGigabitEthernet 0/0/0
```

```
Building configuration...
```

```
Current configuration : 114 bytes
!
interface TwoGigabitEthernet0/0/0
 switchport trunk allowed vlan 16,17
 switchport mode trunk
 speed 1000
 no negotiation auto
 no snmp trap link-status
 channel-group 3 mode on

```

```
Device# show running-config interface port-channel 1
```

```
Building configuration...
```

```
Current configuration : 54 bytes
!
interface Port-channell
 switchport mode trunk
 switchport trunk allowed vlan 10,30,50
end

```



## CHAPTER 9

# Best Practices

---

- [Introduction, on page 181](#)

## Introduction

This chapter covers the best practices recommended for configuring a typical Cisco Catalyst 9800 Series wireless infrastructure. The objective is to provide common settings that you can apply to most wireless network implementations. However, not all networks are the same. Therefore, some of the tips might not be applicable to your installation. Always verify them before you perform any changes on a live network.

For more information, see [Cisco Catalyst 9800 Series Configuration Best Practices](#) guide.







## PART II

# System Upgrade

- [Upgrading the Cisco Catalyst 9800 Wireless Controller Software, on page 185](#)
- [In-Service Software Upgrade, on page 193](#)
- [Software Maintenance Upgrade, on page 203](#)
- [Efficient Image Upgrade, on page 221](#)
- [Predownloading an Image to an Access Point, on page 227](#)
- [N+1 Hitless Rolling AP Upgrade, on page 235](#)
- [NBAR Dynamic Protocol Pack Upgrade, on page 239](#)
- [Wireless Sub-Package for Switch, on page 241](#)





## CHAPTER 10

# Upgrading the Cisco Catalyst 9800 Wireless Controller Software

---

- [Overview of Upgrading the Controller Software, on page 185](#)
- [Upgrading the Controller Software \(GUI\), on page 186](#)
- [Upgrade the Controller Software \(CLI\), on page 187](#)
- [Converting From Bundle-Mode to Install-Mode, on page 188](#)
- [Copying a WebAuth Tar Bundle to the Standby Controller, on page 191](#)

## Overview of Upgrading the Controller Software

This section describes the upgrade process and the methods to upgrade the Cisco Catalyst 9800 Series Wireless Controller Software.

Newer versions of the controller software are released at regular intervals. This includes major releases as well as rebuild releases that focus on bug fixes. The version of the AP software is also tied to the controller software release. Every major Cisco IOS XE software release contains new sets of features that are essential for the enterprise-class customers.

Each Cisco IOS XE software release is classified as either a Standard-Support release or an Extended-Support release.

### Standard-Support Release

- A sustaining support lifetime of 12 months from First Customer Shipment (FCS) with two scheduled rebuilds
- Rebuilds are typically released at 6 months intervals after FCS.

### Extended-Support release Details

- A sustaining support lifetime of 36 months from FCS with ten scheduled rebuilds.
- These rebuilds are at 3, 4, 4, 6, 7 months intervals after FCS or via SMU support. Last 12 months of support will be via SMU.

Based on your requirement, such as upgrading the full image or applying a software patch for bugs, you can go for an appropriate software upgrade, using either GUI or CLI.

- [Upgrade the Controller Software \(GUI\)](#)

- [Upgrade the Controller Software \(CLI\)](#)

### Software Upgrade Options

- **Software Maintenance Upgrade:** This method installs a software package on the system to provide a patch fix or a security resolution to a released image. This upgrade package is provided on a per release and per component basis, and is specific to the platform.
- **Hitless Upgrade:** This method allows the APs to be upgraded in a staggered manner, while still being connected to the same controller. This avoids upgrade downtime even for N+1 networks.
- **In-Service Software Upgrade:** This method upgrades a wireless controller image to a later release while the network forwards packets. This feature is supported only within and between major releases.



---

**Note** We recommend In-Service Software Upgrade if you are upgrading the entire image or cold controller SMU. Use [Software Maintenance Upgrade](#) for software patches or bug fixes.

---

The software upgrade time is estimated to be less than 6 hours for a large network. However, the upgrade time depends on factors such as the number of APs, the percentage of APs to upgrade in each iteration, the controller type (9800-80, 9800-L, and so on), and the connectivity between the controller and the APs.

### Device Upgrade Options

The following device upgrade options are available:

- **NBAR Dynamic Protocol Pack Upgrade:** Protocol packs are software packages that update the Network-Based Application Recognition (NBAR) engine protocol support on a device without replacing the Cisco software on the device. A protocol pack contains information on applications that are officially supported by NBAR, and are compiled and packed together.
- **Field Programmable Upgrade:** These are hardware programmable packages released by Cisco to upgrade the hardware programmable firmware. Hardware programmable package upgrade is necessary only when a system message indicates that one of the field programmable devices needs an upgrade or when a Cisco technical support representative suggests an upgrade.

## Upgrading the Controller Software (GUI)

### Before you begin

Clean up the old installation files using the **Remove Inactive Files** link.



---

**Note** For GUI options such as *Software Maintenance Upgrade*, *AP Service Package*, and *AP Device Package*, see the respective feature sections.

---

## Procedure

---

**Step 1** Choose **Administration > Software Management** .

**Step 2** Choose an option from the **Upgrade Mode** drop-down list:

- **INSTALL**: The Install mode uses a package-provisioning file named *packages.conf* in order to boot a device.
- **BUNDLE**: The Bundle mode uses monolithic Cisco IOS images to boot a device. The Bundle mode consumes more memory than the Install mode because the packages are extracted from the bundle and copied to RAM.

**Note** You get to view the **Destination** field only for BUNDLE upgrade mode.

**Step 3** From the **Transport Type** drop-down list, choose the transfer type to transfer the software image to your device as **TFTP**, **SFTP**, **FTP**, **Device**, or **Desktop (HTTP)**.

- If you choose **TFTP** as the **Transport Type**, enter the **Server IP Address** of the TFTP server that you want to use. Also, enter the complete **File Path**.

In controllers, the IP TFTP source is mapped to the service port by default.

- If you choose **SFTP** as the **Transport Type**, enter the **Server IP Address** of the SFTP server that you want to use. Also, enter the **SFTP Username**, **SFTP Password**, and the complete **File Path**.
- If you choose **FTP** as the **Transport Type**, enter the **Server IP Address** of the FTP server that you want to use. Also, enter the **FTP Username**, **FTP Password**, and the complete **File Path**.
- If you choose **Device** as the **Transport Type**, choose the **File System** from the drop-down list. In the **File Path** field, browse through the available images or packages from the device and select one of the options, and click **Select**.
- If you choose **Desktop (HTTPS)** as the **Transport Type**, choose the **File System** from the drop-down list. In the **Source File Path** field, click **Select File** to select the file, and click **Open**.

**Step 4** Click **Download & Install**.

**Step 5** To boot your device with the new software image, click **Save Configuration & Activate**.

**Step 6** Click **Commit** after the device reboots to make the activation changes persistent across reloads.

**Note** For 17.4 and later releases, this step is mandatory for the upgrade to be persistent. If you do not click **Commit**, the auto-timer terminates the upgrade operation after 6 hours, and the controller reverts back to the previous image.

---

# Upgrade the Controller Software (CLI)

## Before you begin

- Determine the Cisco IOS release that is currently running on your controller, and the filename of the system image using the **show version** command in user EXEC or privileged EXEC mode.

- Clean up the old installation files using the **install remove inactive** command.
- Use the **show version | include Installation mode** to verify the boot mode.



---

**Note** We recommend that you use install mode for the software upgrade.

---

For steps on converting the device from bundle-mode to install-mode, see [Converting from Bundle-Mode to Install-Mode](#).

### Procedure

---

**Step 1** Download the software from Cisco.com: <https://software.cisco.com/download/home/286322524>

- Click IOS XE Software link.
- Select the release number you want to install, for example Gibraltar-16.12.3.

**Note** Cisco recommended release is selected by default. For release designation information, see: <https://software.cisco.com/download/static/assets/i18n/reldesignation.html?context=sds>

- Click **Download**.

**Step 2** Copy the new image to flash using the command: **copy tftp:image flash:**

**Step 3** Verify that the image has been successfully copied to flash using the command: **dir flash:**

**Step 4** Upgrade the software by choosing an upgrade process from the options that are currently supported.

For a list of upgrade options, see [Software Upgrade Options, on page 186](#).

---

## Converting From Bundle-Mode to Install-Mode

Use the procedure given below to boot in install-mode:

### Before you begin

- Clean up the old installation files using the command **install remove inactive**
- Verify the boot mode using the command: **show version | include Installation mode**
- Download the software image from Cisco.com.

For steps on how to download the software, see *Upgrading the Controller Software (CLI)*.

### Procedure

---

**Step 1** Copy the new image to flash using the command: **copy tftp:image flash:**

```
Device# copy tftp://xx.x.x.x//C9800-universalk9_wlc.xx.xx.xx.SSA.bin flash:
```

```

Destination filename [C9800-universalk9_wlc.xx.xx.xx.SSA.bin]?
Accessing tftp://xx.x.x.x/C9800-universalk9_wlc.xx.xx.xx.SSA.bin...
Loading /C9800-universalk9_wlc.xx.xx.xx.SSA.bin from xx.x.x.x (via GigabitEthernet0/0):
!!!!!!!!!!!!!!!!!!!!!!!!!!!!!!!!!!!!!!!!!!!!!!!!!!!!!!!!!!!!!!!!!!!!!!!!!!!!!!!!!!!!!!!!!!!!!!!!!!!!!!!!!!!!!!!!!!!!!!!!
[OK - 601216545 bytes]
601216545 bytes copied in 50.649 secs (11870255 bytes/sec)

```

**Step 2** Verify that the image has been successfully copied to flash using the command: **dir flash:**

```

Device# dir flash:*.bin

Directory of bootflash:/*.bin

On Active

Directory of bootflash:/

   12 -rw- 1231746613 Jun 11 2020 23:15:49 +00:00
C9800-universalk9_wlc.BLD_POLARIS_DEV_LATEST_20200611_101837.SSA.bin
   17 -rw- 1232457039 Jun 9 2020 21:14:40 +00:00
C9800-universalk9_wlc.BLD_POLARIS_DEV_LATEST_20200609_031801.SSA.bin
   21 -rw- 1219332990 Jun 10 2020 02:06:14 +00:00
C9800-universalk9_wlc.BLD_V173_THROTTLE_LATEST_20200608_003622_V17_3_0_183.SSA.bin
   18 -rw- 1232167230 Jun 8 2020 02:42:22 +00:00
C9800-universalk9_wlc.BLD_POLARIS_DEV_LATEST_20200607_002322.SSA.bin
24811823104 bytes total (16032391168 bytes free)

On Standby
Directory of stby-bootflash:/*.bin

Directory of stby-bootflash:/

   18 -rw- 1232167230 Jun 8 2020 02:42:22 +00:00
C9800-universalk9_wlc.BLD_POLARIS_DEV_LATEST_20200607_002322.SSA.bin
   20 -rw- 1231746613 Jun 11 2020 23:15:49 +00:00
C9800-universalk9_wlc.BLD_POLARIS_DEV_LATEST_20200611_101837.SSA.bin
   17 -rw- 1232457039 Jun 9 2020 21:14:40 +00:00
C9800-universalk9_wlc.BLD_POLARIS_DEV_LATEST_20200609_031801.SSA.bin
   16 -rw- 1219332990 Jun 10 2020 02:06:14 +00:00
C9800-universalk9_wlc.BLD_V173_THROTTLE_LATEST_20200608_003622_V17_3_0_183.SSA.bin
26462998528 bytes total (17686335488 bytes free)

```

**Step 3** Set the boot variable to **bootflash:packages.conf**.

```
Device(config)# boot sys flash bootflash:packages.conf
```

**Step 4** Save your changes by entering this command: **write memory**.

```
Device(config)# write memory
```

**Step 5** Verify whether the boot variable is set to **bootflash:packages.conf** using the command: **show boot**

```

Device# show boot

BOOT variable = bootflash:packages.conf,12;
CONFIG_FILE variable =
BOOTLDR variable does not exist
Configuration register is 0x2102

Standby BOOT variable = bootflash:packages.conf,12;
Standby CONFIG_FILE variable =

```

```
Standby BOOTLDR variable does not exist
Standby Configuration register is 0x2102
```

### Step 6 Move the device from bundle-mode to install-mode using the command: **install add file image.bin location activate commit**

```
Device# install add file bootflash:C9800-universalk9_wlc.xx.xx.xx.SPA.bin activate commit

install_add_activate_commit: START Thu Dec 6 15:43:57 UTC 2018
Dec 6 15:43:58.669 %INSTALL-5-INSTALL_START_INFO: R0/0: install_engine: Started install
one-shot bootflash:C9800-xx-universalk9.xx.xx.xx.SPA.bin
install_add_activate_commit: Adding PACKAGE

--- Starting initial file syncing ---
Info: Finished copying bootflash:C9800-xx-universalk9.xx.xx.xx.SPA.bin to the selected
chassis
Finished initial file syncing

--- Starting Add ---
Performing Add on all members
[1] Add package(s) on chassis 1
[1] Finished Add on chassis 1
Checking status of Add on [1]
Add: Passed on [1]
Finished Add

Image added. Version: xx.xx.xx.216
install_add_activate_commit: Activating PACKAGE
Following packages shall be activated:
/bootflash/C9800-xx-rpboot.xx.xx.xx.SPA.pkg
/bootflash/C9800-xx-mono-universalk9.xx.xx.xx.SPA.pkg
This operation requires a reload of the system. Do you want to proceed? [y/n]y
--- Starting Activate ---
Performing Activate on all members
[1] Activate package(s) on chassis 1
--- Starting list of software package changes ---
Old files list:
Removed C9800-xx-mono-universalk9.BLD_Vxxxx_THROTTLE_LATEST_20181022_153332.SSA.pkg
Removed C9800-xx-rpboot.BLD_Vxxxx_THROTTLE_LATEST_20181022_153332.SSA.pkg
New files list:

Added C9800-xx-mono-universalk9.xx.xx.xx.SPA.pkg
Added C9800-xx-rpboot.xx.xx.xx.SPA.pkg
Finished list of software package changes
[1] Finished Activate on chassis 1
Checking status of Activate on [1]
Activate: Passed on [1]
Finished Activate

--- Starting Commit ---
Performing Commit on all members
[1] Commit package(s) on chassis 1
[1] Finished Commit on chassis 1
Checking status of Commit on [1]
Commit: Passed on [1]
Finished Commit

Install will reload the system now!
SUCCESS: install_add_activate_commit Thu Dec 6 15:49:21 UTC 2018
Dec 6 15:49:21.294 %INSTALL-5-INSTALL_COMPLETED_INFO: R0/0: install_engine: Completed
install one-shot PACKAGE bootflash:C9800-xx-universalk9.xx.xx.xx.SPA.bin
```



**Note** The system reloads automatically after executing the **install add file activate commit** command. You do not have to manually reload the system.

If upgrade fails, cleanup is required before attempting the upgrade procedure again. An upgrade failure may occur due lack of disk space, validation failure of extracted image, system crashes, and so on. Should a system failure occurs during upgrade process, wait till the system is back in service and check the system image version.

- If it is a new image, check for the stability and functionality of the system, and decide whether to commit and complete the upgrade procedure or discard the upgrade procedure.
- If it is a new image, use the cleanup procedure and reattempt the upgrade procedure.

**Step 7** Click **yes** to all the prompts.

**Step 8** Verify the boot mode using the command: **show version**

```
Device# show version | in Installation mode is  
  
Installation mode is INSTALL
```

---

## Copying a WebAuth Tar Bundle to the Standby Controller

Use the following procedure to copy a WebAuth tar bundle to the standby controller, in a high-availability configuration.

### Procedure

---

**Step 1** Choose **Administration > Management > Backup & Restore**.

**Step 2** From the **Copy** drop-down list, choose **To Device**.

**Step 3** From the **File Type** drop-down list, choose **WebAuth Bundle**.

**Step 4** From the **Transfer Mode** drop-down list, choose **TFTP**, **SFTP**, **FTP**, or **HTTP**.

The **Server Details** options change based on the file transfer option selected.

- **TFTP**

- **IP Address (IPv4/IPv6)**: Enter the server IP address (IPv4 or IPv6) of the TFTP server that you want to use.
- **File Path**: Enter the file path. The file path should start with slash a (*/path*).
- **File Name**: Enter a file name.

The file name should not contain spaces. Underscores ( `_` ) and hyphen ( `-` ) are the only special characters that are supported. Ensure that file name ends with `.tar`, for example, `webauthbundle.tar`.

- **SFTP**

- **IP Address (IPv4/IPv6)**: Enter the server IP address (IPv4 or IPv6) of the SFTP server that you want to use.

- **File Path:** Enter the file path. The file path should start with slash a (*/path*).
- **File Name:** Enter a file name.  
The file name should not contain spaces. Underscores ( `_` ) and hyphen ( `-` ) are the only special characters that are supported. Ensure that file name ends with `.tar`, for example, `webauthbundle.tar`.
- **Server Login UserName:** Enter the SFTP server login user name.
- **Server Login Password:** Enter the SFTP server login passphrase.

- **FTP**

- **IP Address (IPv4/IPv6):** Enter the server IP address (IPv4 or IPv6) of the TFTP server that you want to use.
- **File Path:** Enter the file path. The file path should start with slash a (*/path*).
- **File Name:** Enter a file name.  
The file name should not contain spaces. Underscores ( `_` ) and hyphen ( `-` ) are the only special characters that are supported. Ensure that file name ends with `.tar`, for example, `webauthbundle.tar`.
- **Logon Type:** Choose the login type as either **Anonymous** or **Authenticated**. If you choose **Authenticated**, the following fields are activated:
  - **Server Login UserName:** Enter the FTP server login user name.
  - **Server Login Password:** Enter the FTP server login passphrase.

- **HTTP**

- **Source File Path:** Click **Select File** to select the configuration file, and click **Open**.

**Step 5** Click the **Yes** or **No** radio button to back up the existing startup configuration to Flash.

Save the configuration to Flash to propagate the WebAuth bundle to other members, including the standby controller. If you do not save the configuration to Flash, the WebAuth bundle will not be propagated to other members, including the standby controller.

**Step 6** Click **Download File**.

---



## CHAPTER 11

# In-Service Software Upgrade

- [Information About In-Service Software Upgrade, on page 193](#)
- [Prerequisites for Performing In-Service Software Upgrade, on page 194](#)
- [Guidelines and Restrictions for In-Service Software Upgrade, on page 194](#)
- [Upgrading Software Using In-Service Software Upgrade , on page 195](#)
- [Upgrading Software Using ISSU \(GUI\), on page 196](#)
- [Upgrading Software Using In-Service Software Upgrade with Delayed Commit, on page 197](#)
- [Monitoring In-Service Software Upgrade, on page 198](#)
- [Troubleshooting ISSU, on page 200](#)

## Information About In-Service Software Upgrade

In-Service Software Upgrade (ISSU) is a procedure to upgrade a wireless controller image to a later release while the network continues to forward packets. ISSU helps network administrators avoid a network outage when performing a software upgrade.

ISSU can also be used to apply cold patches without impacting the active network.

ISSU is supported only on the following Cisco Catalyst 9800 Series Wireless Controllers, and supports only upgrade.

- Cisco Catalyst 9800-80 Wireless Controller
- Cisco Catalyst 9800-40 Wireless Controller
- Cisco Catalyst 9800-L Wireless Controller
- Cisco Catalyst 9800-CL Wireless Controller (Private Cloud)

### High-Level Workflow of ISSU

1. Onboard the controller software image to the flash memory.
2. Download the AP image to the AP.
3. Install the controller software image.
4. Commit the changes.

## Prerequisites for Performing In-Service Software Upgrade

- Ensure that both Active and Standby controllers are in install mode and are booted from *bootflash:/packages.conf*.
- Ensure that the network or device is not being configured during the upgrade.
- Schedule the upgrade when your network is stable and steady.
- Ensure uninterrupted power supply. A power interruption during upgrade procedure might corrupt the software image.

## Guidelines and Restrictions for In-Service Software Upgrade

- If you do not run the **install commit** command within 6 hours of the **install activate issu** command, the system will revert to the original commit position. You can choose to delay the commit using the [Delayed Commit](#) procedure.
- During ISSU upgrade, while AP rolling upgrade is in progress, the **install abort** command won't work. You should use the **install abort issu** command, instead to cancel the upgrade.
- During ISSU upgrade, the system displays a warning message similar to:
 

```
found 46 disjoint TDL objects
```

. You can ignore the warning message because it doesn't have any functional impact.
- During ISSU upgrade, if both the controllers (active and standby) have different images after the power cycle, an auto cancel of ISSU is triggered to bring both the controllers to the same version. The following is a sample scenario: Install Version1 (V1) software on the active controller and then apply a SMU hot patch and perform a commit. Now, upgrade the software to Version2 using ISSU, and then power cycle the active controller. At this point, the system has a version mismatch (V1 and V2). The active controller reloads at this stage, after the completion of bulk synchronization. Now, both the controllers come up with the same version (V1 and V1).
- An ISSU upgrade that is canceled because of configuration synchronization failure on the standby controller rolls back to V1 of the software image. However, this information isn't available in the **show install** command log. Run the **show issu state detail** command to see the current ISSU state.
- To enable the **clear install** command, you should first run the **service internal** command in global configuration mode, and then run the **clear install** command in privileged EXEC mode.
- Image rollback could be affected if the controller has a stale rollback history and the stack gets formed afterwards. We recommend that you run the **clear install state** command to clear stale information and boot the controller in bundle mode.
- The **clear install state** command doesn't delete the SMU file from flash or storage. To remove a SMU, use either the **install remove file** command or the **install remove inactive** command.
- When the new active controller comes up, after the image upgrade, it doesn't retain the old logs on web GUI window as part of show logs.

- If a stateful switchover (SSO) or a high-availability (HA) event occurs during the rolling AP upgrade procedure of the ISSU feature, the rolling AP upgrade stops. You should then use the **ap image upgrade** command to restart the upgrade process.
- If HA fails to form after the ISSU procedure, you should reload any one chassis again to form HA again.
- Use clear **ap predownload statistics** command before using the **show ap image** command. This ensures that you get the right data after every pre-download.
- Manually cancel the ISSU process using the **install issu abort** command in the scenarios given below, to avoid a software version mismatch between the active controller and the standby controller.
  - An RP link is brought down after standby HOT during an ISSU procedure and the links remains down even after the auto-abort timer expiry.
  - An RP link is brought down before the standby controller reaches standby HOT during an ISSU procedure.
- Cisco TrustSec (CTS) is not supported on the RMI interfaces.
- If a switchover occurs while performing an AP upgrade using ISSU, the upgrade process will restart automatically after the switchover.

## Upgrading Software Using In-Service Software Upgrade

Use the following procedure to perform a complete image upgrade, that is, from one image to another.



**Note** ISSU is supported only within and between major releases, for example, 17.3.x to 17.3.y, 17.6.x to 17.6.y (within a major release) and 17.3.x to 17.6.x, 17.3.x to 17.9.x (among major releases), that is, for two releases after the current supported release. ISSU is NOT supported within and between minor releases or between minor and major releases, for example 17.4.x to 17.4.y or 17.4.x to 17.5.x or 17.3.x to 17.4.x.

ISSU downgrade is not supported for Cisco Catalyst 9800 Series Wireless Controller platforms.



**Note** We recommend that you configure the percentage of APs to be upgraded by using the **ap upgrade staggered** command.

### Procedure

	Command or Action	Purpose
Step 1	<b>install add file</b> <i>file-name</i> <b>Example:</b>	The controller software image is added to the flash and expanded.

	Command or Action	Purpose
	Device# install add file <>	<b>Note</b> In Cisco Catalyst 9800 Wireless Controller for Switch, run the <b>install add file sub-package-file-name</b> command to expand the wireless subpackage file.
<b>Step 2</b>	<b>ap image predownload</b> <b>Example:</b> Device# ap image predownload	Performs predownload of the AP image.  To see the progress of the predownload, use the <b>show ap image</b> command.
<b>Step 3</b>	<b>install activate issu [ auto-abort-timer timer]</b> <b>Example:</b> Device# install activate issu	Runs compatibility checks, installs the package, and updates the package status details.  Optionally, you can configure the time limit to cancel the addition of new software without committing the image. Valid values are from 30 to 1200 minutes.
<b>Step 4</b>	Run either of the following commands: <ul style="list-style-type: none"> <li>• <b>install abort issu</b>                Device# install abort issu                 Cancels the upgrade process and returns the device to the previous installation state. This is applicable for both controller and the AP.</li> <li>• <b>install commit</b>                Device# install commit                 Commits the activation changes to be persistent across reloads.</li> </ul> <b>Note</b> If you do not run the <b>install commit</b> command within 6 hours of completing the previous step, the system will revert to the original commit position.	

## Upgrading Software Using ISSU (GUI)

### Before you begin

1. The device should be in Install mode.
2. The device should have an HA pair. The standby controller should be online and is in SSO mode.

You can verify the details using **show issu state detail** command.

## Procedure

- Step 1** Choose **Administration > Software Management**.
- Step 2** Under the **Software Upgrade** tab, check the **ISSU Upgrade (HA Upgrade) (Beta)** check box.
- Step 3** In the **AP Upgrade Configuration** section, from the **AP Upgrade per Iteration** drop-down list choose the percentage of APs to be upgraded.
- Step 4** Click **Download & Install**.
- This initiates the upgrade process and you can view the progress in the **Status** dialog box.
- Click the **Show Logs** link to view the upgrade process details.
- Note** An SSO takes place while activating the image on the active controller. After the SSO, you should login again to the controller.
- Step 5** The system enables the **Commit** and **ISSU Abort** buttons after the upgrade.
- Click **Commit** to commit the activation changes, or **ISSU Abort** to terminate the upgrade process and return the device to the previous installation state.

# Upgrading Software Using In-Service Software Upgrade with Delayed Commit

Use this procedure to upgrade the controller software with delayed commit, which will help you to run and test the new software without committing the image.

## Procedure

	Command or Action	Purpose
<b>Step 1</b>	<b>install add file</b> <i>file-name</i> <b>Example:</b> Device# install add file <file>	Adds and expands the controller software image to the flash. <b>Note</b> In Cisco Catalyst 9800 Wireless Controller for Switch, run the <b>install add file sub-package-file-name</b> command to expand the wireless subpackage file.
<b>Step 2</b>	<b>ap image predownload</b> <b>Example:</b> Device# ap image predownload	Performs predownload of the AP image.
<b>Step 3</b>	<b>install auto-abort-timer stop</b> <b>Example:</b> Device# install auto-abort-timer stop	Stops the termination timer so that the upgrade process is not terminated after the default termination time of 6-8 hours.

	Command or Action	Purpose
<b>Step 4</b>	<b>install activate issu</b> <b>Example:</b> Device# install activate issu	Runs compatibility checks, installs the package, and updates the package status details.
<b>Step 5</b>	<b>install commit</b> <b>Example:</b> Device# install commit	Commits the activation changes to be persistent across reloads.

## Monitoring In-Service Software Upgrade

To view the ISSU state after the install add ISSU and before the install activate ISSU, use the following command:

```
Device# show issu state detail

-- Starting local lock acquisition on chassis 1 ---
Finished local lock acquisition on chassis 1
Current ISSU Status: Enabled
Previous ISSU Operation: Abort Successful
=====
System Check Status
-----
Platform ISSU Support Yes
Standby Online Yes
Autoboot Enabled Yes
SSO Mode Yes
Install Boot Yes
Valid Boot Media Yes
=====
No ISSU operation is in progress
show install summary
[ Chassis 1 2 ] Installed Package(s) Information:
State (St): I - Inactive, U - Activated & Uncommitted,
C - Activated & Committed, D - Deactivated & Uncommitted
-----
Type St Filename/Version
-----
IMG I 17.1.1.0.432
IMG C 16.12.2.0.2707
-----
Auto abort timer: inactive
-----
```

To view the ISSU state after activating ISSU, use the following command:

```
Device# show issu state detail

Current ISSU Status: In Progress
Previous ISSU Operation: Abort Successful
=====
System Check Status
-----
Platform ISSU Support Yes
Standby Online Yes
Autoboot Enabled Yes
SSO Mode Yes
```



```

Install Boot Yes
Valid Boot Media Yes
=====
Operation type: Step-by-step ISSU
Install type : Image installation using ISSU
Current state : Activated state
Last operation: Switchover
Completed operations:
Operation Start time
-----
Activate location standby Chassis 2 2019-09-17:23:41:12
Activate location active Chassis 1 2019-09-17:23:50:06
Switchover 2019-09-17:23:52:03
State transition: Added -> Standby activated -> Active switched-over
Auto abort timer: automatic, remaining time before rollback: 05:41:53
Running image: bootflash:packages.conf
Operating mode: sso, terminal state reached
show install summary
[ Chassis 1/R0 2/R0 ] Installed Package(s) Information:
State (St): I - Inactive, U - Activated & Uncommitted,
C - Activated & Committed, D - Deactivated & Uncommitted
-----
Type St Filename/Version
-----
IMG U 17.1.1.0.432
-----
Auto abort timer: active on install_activate, time before rollback - 05:41:49
-----

```

To view the ISSU state after installing the commit, use the following command:

```

Device# show issu state detail

--- Starting local lock acquisition on chassis 1 ---
Finished local lock acquisition on chassis 1
Current ISSU Status: Enabled
Previous ISSU Operation: Successful
=====
System Check Status
-----
Platform ISSU Support Yes
Standby Online Yes
Autoboot Enabled Yes
SSO Mode Yes
Install Boot Yes
Valid Boot Media Yes
=====
No ISSU operation is in progress
show install summary
[ Chassis 1/R0 2/R0 ] Installed Package(s) Information:
State (St): I - Inactive, U - Activated & Uncommitted,
C - Activated & Committed, D - Deactivated & Uncommitted
-----
Type St Filename/Version
-----
IMG C 17.1.1.0.432
-----
Auto abort timer: inactive
-----

```

To view the ISSU state after terminating the ISSU process, use the following command:

```

Device# show issu state detail
Current ISSU Status: In Progress

```

```

Previous ISSU Operation: Abort Successful
=====
System Check Status
-----
Platform ISSU Support Yes
Standby Online Yes
Autoboot Enabled Yes
SSO Mode Yes
Install Boot Yes
Valid Boot Media Yes
=====
Operation type: Step-by-step ISSU
Install type : Image installation using ISSU
Current state : Timeout-error state
Last operation: Commit Chassis 1
Completed operations:
Operation Start time
-----
Activate location standby Chassis 2 2019-09-17:23:41:12
Activate location active Chassis 1 2019-09-17:23:50:06
Switchover 2019-09-17:23:52:03
Abort 2019-09-18:00:14:13
Commit Chassis 1 2019-09-18:00:28:23
State transition: Added -> Standby activated -> Active switched-over -> Activated ->
Timeout-error
Auto abort timer: inactive
Running image: bootflash:packages.conf
Operating mode: sso, terminal state reached

```

To view the summary of the active packages in a system, use the following command:

```

Device# show install summary

[ Chassis 1 2 ] Installed Package(s) Information:
State (St): I - Inactive, U - Activated & Uncommitted,
C - Activated & Committed, D - Deactivated & Uncommitted
-----
Type St Filename/Version
-----
IMG C 16.12.2.0.2707
-----
Auto abort timer: inactive
-----

```

## Troubleshooting ISSU

Using **install activate issu** command before completing AP pre-download.

The following scenario is applicable when you run the **install activate issu** command before completing AP pre-download. In such instances, you should run the **ap image predownload** command and then proceed with the activation.

```

Device# install activate issu

install_activate: START Wed Jan  8 04:48:04 UTC 2020
System configuration has been modified.
Press Yes(y) to save the configuration and proceed.
Press No(n) for proceeding without saving the configuration.
Press Quit(q) to exit, you may save configuration and re-enter the command. [y/n/q]
y
Building configuration...

```

```
[OK]Modified configuration has been saved
install_activate: Activating ISSU
NOTE: Going to start Activate ISSU install process
STAGE 0: System Level Sanity Check
=====
--- Verifying install_issu supported ---
--- Verifying standby is in Standby Hot state ---
--- Verifying booted from the valid media ---
--- Verifying AutoBoot mode is enabled ---
--- Verifying Platform specific ISSU admission criteria ---
CONSOLE: FAILED: Install operation is not allowed.
Reason -> AP pre-image download is mandatory f
or hitless software upgrade.
Action -> Trigger AP pre-image download.
FAILED: Platform specific ISSU admission criteria
ERROR: install_activate exit(2 ) Wed Jan 8 04:48:37 UTC 2020
```





## CHAPTER 12

# Software Maintenance Upgrade

---

- [Introduction to Software Maintenance Upgrade, on page 203](#)
- [Information About AP Device Package, on page 208](#)
- [Information About Per Site or Per AP Model Service Pack \(APSP\), on page 211](#)

## Introduction to Software Maintenance Upgrade

Software Maintenance Upgrade (SMU) is a package that can be installed on a system to provide a patch fix or a security resolution to a released image. A SMU package is provided for each release and per component basis, and is specific to the corresponding platform.

A SMU provides a significant benefit over classic Cisco IOS software because it allows you to address the network issue quickly while reducing the time and scope of the testing required. The Cisco IOS XE platform internally validates the SMU compatibility and does not allow you to install noncompatible SMUs.

All the SMUs are integrated into the subsequent Cisco IOS XE software maintenance releases. A SMU is an independent and self-sufficient package and does not have any prerequisites or dependencies. You can choose which SMUs to install or uninstall in any order.



---

**Note** SMUs are supported only on Extended Maintenance releases and for the full lifecycle of the underlying software release.

---



---

**Note** You can activate the file used in the **install add file** command only from the filesystems of the active device. You cannot use the file from the standby or member filesystems; the **install add file** command will fail in such instances.

---



**Note** When the SMU file is deleted and a reboot is performed, the device may display the following error message:

```
--- Starting SMU Add operation ---
Performing SMU_ADD on all members
  FAILED: Improper State./bootflash/<previously-installed-smu-filename>.smu.bin not
present. Please restore file for stability.
Checking status of SMU_ADD on [1/R0]
SMU_ADD: Passed on []. Failed on [1/R0]
Finished SMU Add operation
FAILED: add_activate_commit /bootflash/<tobeinstalled-wlc-smu-filename>.smu.bin Wed Aug 02
08:30:18 UTC 2023.
```

This error occurs because the previous SMU file was not properly removed from the controller. It may lead to functional errors, such as the inability to install new SMU or APSP files.

We recommend that you use the `install remove` file command to remove previous instances of APSP or SMU files from the bootflash.

SMU infrastructure can be used to meet the following requirements in the wireless context:

- Controller SMU: Controller bug fixes or Cisco Product Security Incident Response information (PSIRT).
- APSP: AP bug fixes, PSIRTs, or minor features that do not require any controller changes.
- APDP: Support for new AP models without introduction of new hardware or software capabilities.



**Note** The `show ap image` command displays cumulative statistics regarding the AP images in the controller. We recommend that you clear the statistics using the `clear ap predownload statistics` command, before using the `show ap image` command, to ensure that correct data is displayed.

### SMU Workflow

The SMU process should be initiated with a request to the SMU committee. Contact your customer support to raise an SMU request. During the release, the SMU package is posted on the Cisco Software Download page and can be downloaded and installed.

### SMU Package

An SMU package contains the metadata and fix for the reported issue the SMU is requested for.

### SMU Reload

The SMU type describes the effect on a system after installing the corresponding SMU. SMUs can be nontraffic-affecting or can result in device restart, reload, or switchover.

A controller cold patch require a cold reload of the system during activation. A cold reload is the complete reload of the operating system. This action affects the traffic flow for the duration of the reload (~5 min). This reload ensures that all the processes are started with the correct libraries and files that are installed as part of the corresponding SMU.

Controller hot patching support allows the SMU to be effective immediately after activation, without reloading the system. After the SMU is committed, the activation changes are persistent across reloads. Hot patching

SMU packages contain metadata that lists all processes that need to be restarted in order to activate the SMU. During SMU activation, each process in this list will be restarted one at a time until the SMU is fully applied.

## Installing a SMU (GUI)

### Procedure

- 
- Step 1** Choose **Administration > Software Management** and click the **Software Maintenance Upgrade** tab.
- Step 2** Click **Add** to add a SMU image.
- Step 3** From the **Transport Type** drop-down list, choose the transfer type to transfer the software image to your device as TFTP, SFTP, FTP, Device, or Desktop (HTTP).
- If you choose **TFTP** as the **Transport Type**, you need to enter the **Server IP Address (IPv4/IPv6)**, **File path** and choose a **File System** from the drop-down list. For example, if the SMU file is at the root of the TFTP server you can enter `/C9800-universalk9_wlc.17.03.02a.CSCvw55275.SPA.smu.bin` in the **File path** field.
  - If you choose **SFTP** as the **Transport Type**, you need to enter the **Server IP Address (IPv4/IPv6)**, **SFTP Username**, **SFTP Password**, **File path** and choose a **File System** from the drop-down list.
  - If you choose **FTP** as the **Transport Type**, you need to enter the **Server IP Address (IPv4/IPv6)**, **FTP Username**, **FTP Password**, **File path**, and choose a **File System** from the drop-down list.
  - If you choose **Device** as the **Transport Type**, you need to enter the **File path** and choose a **File System** from the drop-down list. This is possible when the software is already present on the device due to an earlier download and activation, followed by a subsequent deactivation.  
**Note** The File System depends upon the kind of device you are using. On physical controllers, you have the option to store the file to the bootflash or hard disk, whereas in case of virtual controllers, you can only store it in the bootflash.
- e) If you choose **Desktop (HTTPS)** as the **Transport Type**, you need to choose a **File System** from the drop-down list and click **Select File** to navigate to the **Source File Path**.
- Step 4** Enter the **File Name** and click **Add File**.
- This operation copies the maintenance update package from the location you selected above to the device and performs a compatibility check for the platform and image versions and adds the SMU package for all the members. After a SMU is successfully added to the system, a message is displayed about the successful operation and that the SMU can be activated on the device. The message displays the name of the package (SMU) that is now available to be activated. It lists the SMU Details - Name, Version, State (active or inactive), Type (reload, restart, or non-reload) and other compatibility details. If SMU is of the Type - reload, then any operation (activate, deactivate or rollback) will cause the device to reload; restart involves only a process restart and if it is non reload- no change in process takes place.
- Step 5** Select the SMU and click on **Activate** to activate the SMU on the system and install the package, and update the package status details.
- Step 6** Select the SMU and click **Commit** to make the activation changes persistent across reloads.
- The Commit operation creates commit points. These commit points are similar to snapshots using which you can determine which specific change you want to be activated or rolled back to, in case there is any issue with

the SMU. The commit can be done after activation when the system is up, or after the first reload. If a package is activated, but not committed, it remains active after the first reload, but not after the second reload.

## Installing SMU

### Procedure

	Command or Action	Purpose
<b>Step 1</b>	<b>install add file bootflash:</b> <i>filename</i> <b>Example:</b> Device# install add file bootflash:<Filename>	Copies the maintenance update package from a remote location to the device, and performs a compatibility check for the platform and image versions.  This command runs base compatibility checks on a file to ensure that the SMU package is supported on the platform. It also adds an entry in the package/SMU.sta file, so that its status can be monitored and maintained.
<b>Step 2</b>	<b>install activate file bootflash:</b> <i>filename</i> <b>Example:</b> Device# install activate file bootflash:<Filename>	Runs compatibility checks, installs the package, and updates the package status details.  For a restartable package, the command triggers the appropriate post-install scripts to restart the necessary processes, and for non-restartable packages it triggers a reload.
<b>Step 3</b>	<b>install commit</b> <b>Example:</b> Device# install commit	Commits the activation changes to be persistent across reloads.  The commit can be done after activation while the system is up, or after the first reload. If a package is activated but not committed, it remains active after the first reload, but not after the second reload.
<b>Step 4</b>	<b>show version</b> <b>Example:</b> Device# show version	Displays the image version on the device.
<b>Step 5</b>	<b>show install summary</b> <b>Example:</b> Device# show install summary	Displays information about the active package.  The output of this command varies according to the install commands that are configured.



## Roll Back an Image (GUI)

### Procedure

- 
- Step 1** Choose **Administration > Software Management**.
  - Step 2** Go to **SMU, APSP** or **APDP**.
  - Step 3** Click **Rollback**.
  - Step 4** In the **Rollback to** drop-down list, choose **Base, Committed** or **Rollback Point**.
  - Step 5** Click **Add File**.
- 

## Rollback SMU

### Procedure

	Command or Action	Purpose
<b>Step 1</b>	<b>install rollback to</b> { <b>base</b>   <b>committed</b>   <b>id</b>   <b>committed</b> } <i>committed ID</i>  <b>Example:</b> Device(config)# install rollback to id 1234	Returns the device to the previous installation state. After the rollback, a reload is required.
<b>Step 2</b>	<b>install commit</b>  <b>Example:</b> Device# install commit	Commits the activation changes to be persistent across reloads.

## Deactivate SMU

### Procedure

	Command or Action	Purpose
<b>Step 1</b>	<b>install deactivate file bootflash:</b> <i>filename</i>  <b>Example:</b> Device# install deactivate file bootflash:<Filename>	Deactivates an active package, updates the package status, and triggers a process to restart or reload.
<b>Step 2</b>	<b>install commit</b>  <b>Example:</b> Device# install commit	Commits the activation changes to be persistent across reloads.

## Configuration Examples for SMU

The following is sample of the SMU configuration, after the install add for the SMU is done:

```
Device#show install summary

[ Chassis 1 2 ] Installed Package(s) Information:
State (St): I - Inactive, U - Activated & Uncommitted,
           C - Activated & Committed, D - Deactivated & Uncommitted
-----
Type  St   Filename/Version
-----
IMG   C    16.8.1.0.39751
-----
Auto abort timer: inactive
-----
```

## Information About AP Device Package

The controller supports rolling out critical bug fixes using Software Maintenance Upgrade (SMU). Similarly, if any new AP hardware model is introduced, the AP models need to be connected to the existing wireless network.

Currently, when a new AP hardware model is introduced, those get shipped along with the corresponding controller related major software version. Then you need to wait for the release of a corresponding controller version relative to the new AP model and upgrade the entire network.

From 16.11.1 onwards, you can introduce the new AP model into your wireless network using the SMU infrastructure without the need to upgrade to the new controller version. This solution is termed as AP Device Package (APDP).

### SMU Process or Workflow

The SMU process builds APDP to detect code changes and build APDP. It also supports addition of a new file (AP image file) to APDP and inclusion of those AP images into APDP.

The workflow is as follows:

- install add
- install activate
- install commit

For more details, see *Managing AP Device Package*.



---

**Note** To ensure completion of the APSP or APDP activation or deactivation process, ensure that you run the **install commit** command after the **install activate** or **install deactivate** command. Failing to do so within 6 hours of the deactivate operation terminates the deactivate operation and moves it back to the original commit position.

---

### SMU Package

A SMU package contains the metadata that carry AP model and its capability related details.

### AP Image Changes

When new AP models are introduced, there may or may not be corresponding new AP images. This means that AP images are mapped to the AP model families. If a new AP model belongs to an existing AP model family then you will have existing AP image entries (Example: ap3g3, ap1g5, and so on). For instance, if an AP model belongs to either ap3g3 or ap1g5, the respective image file is updated with the right AP image location. Also, the corresponding metadata file is updated with the new AP model capability information.

If a new AP model belongs to a new AP model family and new image file, the new image entry file is created in the right AP image location. Also, the corresponding metadata file is updated with the new AP model capability information.

During AP image bundling and packaging of APDP, the new AP model images and metadata file are packaged into APDP.



---

**Note** The APDP images must not be renamed to avoid impact on its functionality.

---

## Installing AP Device Package (GUI)

### Procedure

---

- Step 1** Choose **Administration > Software Management**.
- Step 2** Click **AP Device Package (APDP)** tab.
- Step 3** Click **Add**.
- Step 4** From the **Transport Type** drop-down list, choose the transfer type to transfer the software image to your device as TFTP, SFTP, FTP, Device, or Desktop (HTTP).
- If you choose **TFTP** as the **Transport Type**, you need to enter the **Server IP Address (IPv4/IPv6)**, **File path** and choose a **File System** from the drop-down list.
  - If you choose **SFTP** as the **Transport Type**, you need to enter the **Server IP Address (IPv4/IPv6)**, **SFTP Username**, **SFTP Password**, **File path** and choose a **File System** from the drop-down list.
  - If you choose **FTP** as the **Transport Type**, you need to enter the **Server IP Address (IPv4/IPv6)**, **FTP Username**, **FTP Password**, **File path**, and choose a **File System** from the drop-down list.
  - If you choose **Device** as the **Transport Type**, you need to enter the **File path** and choose a **File System** from the drop-down list.
  - If you choose **Desktop (HTTPS)** as the **Transport Type**, you need to choose a **File System** from the drop-down list and click **Select File** to navigate to the **Source File Path**.
- Step 5** Enter the **File Name** and click **Add File**.
- Step 6** From the **AP Upgrade Configuration** section, choose the percentage of APs to be included from the **AP Upgrade per iteration** drop-down list.
- Step 7** Click **Apply**.
-

## Installing AP Device Package (CLI)

### Procedure

	Command or Action	Purpose
<b>Step 1</b>	<b>install add file bootflash: filename</b>  <b>Example:</b> Device# install add file bootflash:<Filename>	Extracts AP images from APDP and places them in SMU or APDP specific mount location.  <b>Note</b> Here, the SMU does not trigger the Wireless module.
<b>Step 2</b>	<b>install activate file bootflash: filename</b>  <b>Example:</b> Device# install activate file bootflash:<Filename>	Adds the AP software in APDP to the existing current active AP image list.  Also, updates the capability information for the new AP models in the controller .  <b>Note</b> Even if the new AP module supports new hardware capabilities, the controller recognizes only the capability information that its base version supports.  At this point, the controller accepts the new connection from the new AP model. The new AP model then joins the controller .
<b>Step 3</b>	<b>install commit</b>  <b>Example:</b> Device# install commit	Commits the new AP software to be persistent across reloads.  The commit can be done after activation while the system is up, or after the first reload. If a package is activated but not committed, it remains active after the first reload, but not after the second reload.
<b>Step 4</b>	<b>install deactivate file bootflash: filename</b>  <b>Example:</b> Device# install deactivate file bootflash:<Filename>	(Optional) Deactivates an active APDP, updates the package status, and triggers a process to restart or reload.
<b>Step 5</b>	<b>show version</b>  <b>Example:</b> Device# show version	Displays the image version on the device.

## Verifying APDP on the Controller

To verify the status of APDP packages on the controller , use the following command:

```
Device# show install summary
```

```
[ Chassis 1 ] Installed Package(s) Information:
State (St): I - Inactive, U - Activated & Uncommitted,
           C - Activated & Committed, D - Deactivated & Uncommitted
-----
Type  St   Filename/Version
-----
APDP  I     bootflash:apdp_CSCvpl2345.bin
IMG   C     17.1.0.0
-----
Auto abort timer: inactive
-----
```



**Note** The output of this command varies based on the packages, and the package states that are installed.

## Information About Per Site or Per AP Model Service Pack (APSP)

The controller supports critical updates to the access points (APs) using Software Maintenance Update (SMU). Using the Per Site or Per AP Model Service Pack feature, you can roll out critical AP bug fixes to a subset of APs, on a site or group of sites, using SMU in a staggered manner.

This feature allows to control the propagation of a SMU in your network by selecting the sites, to be included in the SMU activation, using Per Site AP SMU rollout. However, all sites should be brought to the same SMU level before a new SMU can be rolled out to a subset of sites or for a subsequent image upgrade to be initiated on the system..

Using Per AP model SMU, you can limit the update to only certain AP models. The software is predownloaded and is activated only to certain AP models, within a site. Note that if a certain number of model images are included in a SMU, all the future updates must contain software images for those models.

This feature is supported in the flex-connect mode, local mode, and Software-Defined Access (SD-Access) wireless scenarios.



**Note** After applying the AP site filter for per site SMU upgrade, a new image installation will not be allowed without applying the site filter to all the other sites, or removing the existing site filter.

### Workflow of AP SMU Upgrade

- Run a query to check whether there are ongoing activities, such as AP image predownload or AP rolling upgrade.
- Identify the site or sites to install the SMU in, and set up a site filter.
- Trigger the predownload of SMU to the sites in the site filter.
- Activate the SMU after the predownload is complete.
- Commit the update.



---

**Note** You can add more sites to a filter after setting up the filter. However, you have to apply the filter again using the **ap image site-filter file *file-name* apply** command. If you clear the site filter, the update is made on all the remaining sites. Deactivation and rollback of the images are not filtered per site, and are applicable to all the sites.

---

## Rolling AP Upgrade

Rolling AP upgrade is a method of upgrading the APs in a staggered manner such that some APs are always up in the network and provide seamless coverage to clients, while the other APs are selected to be upgraded.



---

**Note** The AP images should be downloaded before the rolling upgrade is triggered, so that all the APs that are to be upgraded have the new image version.

---

## Rolling AP Upgrade Process

Rolling AP upgrade is done on a per controller basis. The number of APs to be upgraded at a given time, is the percentage of the total number of APs that are connected to the controller. The percentage is capped at a user configured value. The default percentage is 15. The non-client APs will be upgraded before the actual upgrade of APs begin.

The upgrade process is as follows:

### 1. Candidate AP Set Selection

In this stage, a set of AP candidates are selected based on neighboring AP information. For example, if you identify an AP for upgrade, a certain number (N) of its neighbors are excluded from candidate selection. The N values are generated in the following manner:

If the user configurable capped percentage is 25%, then  $N=6$  (Expected number of iterations =5)

If the user configurable capped percentage is 15%, then  $N=12$  (Expected number of iterations=12)

If the user configurable capped percentage is 5%, then  $N=24$  (Expected number of iterations =22)

If the candidates cannot be selected using the neighboring AP information, select candidates from indirect neighbors. If you still are not able to select candidates, the AP will be upgraded successfully without any failure.



---

**Note** After the candidates are selected, if the number of candidates are more than the configured percentage value, the extra candidates are removed to maintain the percentage cap.

---

### 2. Client Steering

Clients that are connected to the candidate APs are steered to APs that are not there in the candidate AP list, prior to rebooting the candidate APs. The AP sends out a request to each of its associated clients with a list of APs that are best suited for them. This does not include the candidate APs. The candidate APs are marked as unavailable for neighbor lists. Later, the markings are reset in the AP rejoin and reload process.

### 3. AP Rejoin and Reload Process

After the client steering process, if the clients are still connected to the candidate AP, the clients are sent a de-authorization and the AP is reloaded and comes up with a new image. A three-minute timer is set for the APs to rejoin. When this timer expires, all the candidates are checked and marked if they have either joined the controller or the mobility peer. If 90% of the candidate APs have joined, the iteration is concluded; if not, the timer is extended to three more minutes. The same check is repeated after three minutes. After checking thrice, the iteration ends and the next iteration begins. Each iteration may last for about 10 minutes.

For rolling AP upgrade, there is only one configuration that is required. It is the number of APs to be upgraded at a time, as a percentage of the total number of APs in the network.

Default value will be 15.

```
Device (config)#ap upgrade staggered <25 | 15 | 5>
```

Use the following command to trigger the rolling AP upgrade:

```
Device#ap image upgrade [test]
```



**Note** Rolling AP upgrade is not resumed after an SSO. You should run the **ap image upgrade** command to restart the rolling AP upgrade from the beginning and it affects all the APs, including the Mesh APs.

## Installing AP Service Package (GUI)

### Procedure

- Step 1** Choose **Administration > Software Management**.
- Step 2** Click **AP Service Package (APSP)** tab.
- Step 3** Click **Add**.
- Step 4** From the **Transport Type** drop-down list, choose the transfer type to transfer the software image to your device as TFTP, SFTP, FTP, Device, or Desktop (HTTP).
  - a) If you choose **TFTP** as the **Transport Type**, you need to enter the **Server IP Address (IPv4/IPv6)**, **File path** and choose a **File System** from the drop-down list.
  - b) If you choose **SFTP** as the **Transport Type**, you need to enter the **Server IP Address (IPv4/IPv6)**, **SFTP Username**, **SFTP Password**, **File path** and choose a **File System** from the drop-down list.
  - c) If you choose **FTP** as the **Transport Type**, you need to enter the **Server IP Address (IPv4/IPv6)**, **FTP Username**, **FTP Password**, **File path**, and choose a **File System** from the drop-down list.
  - d) If you choose **Device** as the **Transport Type**, you need to enter the **File path** and choose a **File System** from the drop-down list.
  - e) If you choose **Desktop (HTTPS)** as the **Transport Type**, you need to choose a **File System** from the drop-down list and click **Select File** to navigate to the **Source File Path**.
- Step 5** Enter the **File Name** and click **Add File**.
- Step 6** From the **AP Upgrade Configuration** section, choose the percentage of APs to be included from the **AP Upgrade per iteration** drop-down list.

**Step 7** Click **Apply**.

## Installing AP Service Package (CLI)

Use the following procedure to roll out critical bug fixes to a subset of APs using SMU.

### Procedure

	Command or Action	Purpose
<b>Step 1</b>	<b>install add file</b> <i>file-name</i>  <b>Example:</b> Device# install add file flash:<file-name>	Checks for ongoing activities, such as AP image predownload or AP rolling upgrade. If there are no such activities, populates the predownload directory to install a package file to the system.
<b>Step 2</b>	<b>ap image site-filter file</b> <i>file-name</i> <b>add</b> <i>site-tag</i>  <b>Example:</b> Device# ap image site-filter file flash:<file-name> add bg118	Adds a site tag to a site filter.
<b>Step 3</b>	<b>ap image site-filter file</b> <i>file-name</i> <b>remove</b> <i>site-tag</i>  <b>Example:</b> Device# ap image site-filter file flash:<file-name> remove bg118	(Optional) Removes a site tag from a site filter.
<b>Step 4</b>	<b>ap image predownload</b>  <b>Example:</b> Device# ap image predownload	(Optional) Performs predownload of an AP image. This image predownload will be filtered by the site filter, set up in the previous step.
<b>Step 5</b>	<b>install activate file</b> <i>file-name</i>  <b>Example:</b> Device# install activate file flash:<file-name>	Triggers the AP upgrade in rolling a staggered fashion for the APs added in site filter.
<b>Step 6</b>	<b>install commit</b>  <b>Example:</b> Device# install commit	Commits the image update.  During the commit, the mapping from file to site is saved in the persistent database so that it is available even after a reload.



## Adding a Site to a Filter

### Procedure

	Command or Action	Purpose
<b>Step 1</b>	<b>ap image site-filter file <i>file-name</i> add <i>site-tag</i></b> <b>Example:</b> Device# ap image site-filter file flash:<file-name> add bgl18	Adds a site tag to a site filter.  Repeat this step again to set up a multisite filter.
<b>Step 2</b>	<b>ap image site-filter file <i>file-name</i> apply</b> <b>Example:</b> Device# ap image site-filter file flash:<file-name> apply	Predownloads the image and upgrades the APs based on the site filter.
<b>Step 3</b>	<b>ap image site-filter file <i>file-name</i> clear</b> <b>Example:</b> Device# ap image site-filter file flash:<file-name> clear	Clears the site filter table and predownloads the image and does a rolling AP upgrade to all sites where it is not active.

## Deactivating an Image

### Procedure

	Command or Action	Purpose
<b>Step 1</b>	<b>install deactivate file flash <i>file-name</i></b> <b>Example:</b> Device# install deactivate file flash:<file-name>	Performs rolling AP upgrade based on the AP models present in the prepare file.  Deactivation is not filtered by site. Therefore, deactivation applies to all the sites.  <b>Note</b> Action is taken if the APs in a site are not running the SMU that is being deactivated. Only internal tables are updated to remove the SMU.

## Roll Back APSP

### Procedure

	Command or Action	Purpose
<b>Step 1</b>	<b>install add profile <i>rollback_profile-name</i></b> <b>Example:</b> Device# install add profile rollback_id1	(Optional) Moves back to any rollback points in a graceful way with AP image predownload support.

	Command or Action	Purpose
		<b>Note</b> To get a list of available rollback profile names, use <b>show install profile</b> command.
<b>Step 2</b>	<b>ap image predownload</b> <b>Example:</b> Device# ap image predownload	(Optional) Performs predownload of an AP image. This image predownload will be filtered by the site filter, set up in the previous step.
<b>Step 3</b>	<b>install rollback to <i>rollback_id</i></b> <b>Example:</b> Device# install rollback to <i>rollback_id</i>	Performs rollback of the image for the affected AP models. The roll back action is not filtered by site. Therefore, rollback applies to all the sites. <b>Note</b> The APs that are in the base image or in a point before the rollback action takes effect are not affected.

## Canceling the Upgrade

### Procedure

	Command or Action	Purpose
<b>Step 1</b>	<b>install abort</b> <b>Example:</b> Device# install abort	Aborts the upgrade by resetting the APs in rolling fashion.

## Verifying the Upgrade

To see the summary of the AP software install files, use the following command:

```
Device# show ap image file summary
```

```
AP Image Active List
=====
Install File Name: base_image.bin
-----
AP Image Type      Capwap Version  Size (KB)      Supported AP models
-----
ap1g1              17.3.0.30      13300  NA
ap1g2              17.3.0.30      34324  NA
ap1g3              17.3.0.30      98549  AP803
ap1g4              17.3.0.30      34324  AP1852E, AP1852I, AP1832I, AP1830I, AP1810W,
OEAP1810
ap1g5              17.3.0.30      23492  AP1815W, AP1815T, OEAP1815, AP1815I, AP1800I,
```

```

AP1800S, AP1815M, 1542D, AP1542I, AP1100AC, AP1101AC, AP1840I
    ap1g6      17.3.0.30      93472      AP2900I, C9117AXI
    ap1g6a     17.3.0.30      247377     C9130AXI, C9130AXE, C9140AXI, C9140AXD,
C9140AXT
    ap1g7      17.3.0.30      23988      AP1900I, C9115AXI, AP1900E, C9115AXE,
C9120AXE, C9120AXP, C9120AXI
    ap1g8      17.3.0.30      23473     C9105AXI, C9105AXW, C9110AXI, C9110AXE
    ap3g1      17.3.0.30      23422     NA
    ap3g2      17.3.0.30      23411     AP1702I
    ap3g3      17.3.0.30      23090     AP3802E, AP3802I, AP3802P, AP4800, AP2802E,
AP2802I, AP2802H, AP3800, AP1562E, AP1562I, AP1562D, AP1562PS, IW-6300H-DC, IW-6300H-AC,
IW-6300H-DCW, ESW-6300
    c1570      17.3.0.30      13000     AP1572E, 1573E, AP1572I
    c3700      17.3.0.30      14032     AP3702E, AP3701E, AP3701I, AP3702I, AP3701P,
AP3702P, AP2702E, AP2702I, AP3702, IW3702, AP3701, AP3700C
    virtApImg  17.3.0.30      177056     APVIRTUAL

```

## AP Image Prepare List\*\*

```

=====
Install File Name: base_image.bin
-----

```

```

-----
Install File Name: base_image.bin
-----

```

AP Image Type	Capwap Version	Size (KB)	Supported AP models
ap1g1	17.3.0.30	13300	NA
ap1g2	17.3.0.30	34324	NA
ap1g3	17.3.0.30	98549	AP803
ap1g4	17.3.0.30	34324	AP1852E, AP1852I, AP1832I, AP1830I, AP1810W, OEAP1810
ap1g5	17.3.0.30	23492	AP1815W, AP1815T, OEAP1815, AP1815I, AP1800I, AP1800S, AP1815M, 1542D, AP1542I, AP1100AC, AP1101AC, AP1840I
ap1g6	17.3.0.30	93472	AP2900I, C9117AXI
ap1g6a	17.3.0.30	247377	C9130AXI, C9130AXE, C9140AXI, C9140AXD, C9140AXT
ap1g7	17.3.0.30	23988	AP1900I, C9115AXI, AP1900E, C9115AXE, C9120AXE, C9120AXP, C9120AXI
ap1g8	17.3.0.30	23473	C9105AXI, C9105AXW, C9110AXI, C9110AXE
ap3g1	17.3.0.30	23422	NA
ap3g2	17.3.0.30	23411	AP1702I

```

ap3g3      17.3.0.30    23090          AP3802E, AP3802I, AP3802P, AP4800, AP2802E,
AP2802I, AP2802H, AP3800, AP1562E, AP1562I, AP1562D, AP1562PS, IW-6300H-DC, IW-6300H-AC,
IW-6300H-DCW, ESW-6300

c1570      17.3.0.30    13000          AP1572E, 1573E, AP1572I

c3700      17.3.0.30    14032          AP3702E, AP3701E, AP3701I, AP3702I, AP3701P,
AP3702P, AP2702E, AP2702I, AP3702, IW3702, AP3701, AP3700C

virtApImg  17.3.0.30          177056          APVIRTUAL

```

\*\*Difference of Active and Prepare list gives images being predownloaded to Access Points.

To see the summary of the AP site-filtered upgrades, use the following command:

```
Device# show ap image site summary
```

```
Install File Name: vwlc_apsp_16.11.1.0_74.bin
```

Site Tag	Prepared	Activated	Committed
bgl-18-1	Yes	Yes	Yes
bgl-18-2	Yes	Yes	Yes
bgl-18-3	Yes	Yes	Yes
default-site-tag	Yes	Yes	Yes

To see the summary of AP upgrades, use the following command:

```
Device# show ap upgrade summary
```

To check the status of an APSP, use the following command:

```
Device# show install summary
```

```
[ Chassis 1 ] Installed Package(s) Information:
```

```
State (St): I - Inactive, U - Activated & Uncommitted,
```

```
C - Activated & Committed, D - Deactivated & Uncommitted
```

```
-----
Type St Filename/Version
-----
```

```
APSP I bootflash:vwlc_apsp_16.11.1.0_74.bin
```

```
IMG C 16.11.1.0.1249
-----
```

```
Auto abort timer: inactive
-----
```

## Verifying of AP Upgrade on the Controller

Use the following **show** command to verify the AP upgrade on the controller:

```
Device #show ap upgrade

AP upgrade is in progress
From version: 8 16.9.1.6
To version: 9 16.9.1.30
Started at: 03/09/2018 21:33:37 IST
Percentage complete: 0
Expected time of completion: 03/09/2018 22:33:37 IST
Progress Report
-----
Iterations
-----
Iteration Start time End time AP count
-----
0 03/09/2018 21:33:37 IST 03/09/2018 21:33:37 IST 0
1 03/09/2018 21:33:37 IST ONGOING 0
Upgraded
-----
Number of APs: 0
AP Name Ethernet MAC Iteration Status
-----
In Progress
-----
Number of APs: 1
AP Name Ethernet MAC
-----
APf07f.06a5.d78c f07f.06cf.b910
Remaining
-----
Number of APs: 3
AP Name Ethernet MAC
-----
APCC16.7EDB.6FA6 0081.c458.ab30
AP38ED.18CA.2FD0 38ed.18cb.25a0
AP881d.fce7.5ee4 d46d.50ee.33a0
```





## CHAPTER 13

# Efficient Image Upgrade

---

- [Efficient Image Upgrade](#), on page 221
- [Enable Pre-Download \(GUI\)](#), on page 221
- [Enable Pre-Download \(CLI\)](#), on page 222
- [Configuring a Site Tag \(CLI\)](#), on page 222
- [Attaching Policy Tag and Site Tag to an AP \(CLI\)](#), on page 223
- [Trigger Predownload to a Site Tag](#), on page 224

## Efficient Image Upgrade

Efficient Image upgrade is an optimized method of predownloading images to FlexConnect APs. For each Site Tag with FlexConnect APs joined, one AP per model in that Site Tag is selected as the primary AP, and downloads its image from the controller through the WAN link. Once the primary AP has the downloaded image, the APs in that Site Tag start downloading the image from the primary AP, via TFTP. At most three subordinate APs can download simultaneously from the primary. This reduces load on the WAN link.



---

**Note** Make sure that all APs joined via a Site Tag are at the same location, before enabling this feature.

---

## Enable Pre-Download (GUI)

### Procedure

---

- Step 1** Choose **Configuration > Wireless > Access Points**.
  - Step 2** In the **Access Points** page, expand the **All Access Points** section and click the name of the AP to edit.
  - Step 3** In the **Edit AP** page, click the **Advanced** tab and from the **AP Image Management** section, click **Predownload**.
  - Step 4** Click **Update & Apply to Device**.
-

## Enable Pre-Download (CLI)

### Procedure

	Command or Action	Purpose
<b>Step 1</b>	<b>configure terminal</b> <b>Example:</b> Device# configure terminal	Enters the global configuration mode.
<b>Step 2</b>	<b>wireless profile flex <i>flex-profile</i></b> <b>Example:</b> Device(config)# wireless profile flex rr-xyz-flex-profile	Configures a flex profile and enters the flex profile configuration mode.
<b>Step 3</b>	<b>predownload</b> <b>Example:</b> Device(config-wireless-flex-profile)# predownload	Enables predownload of the image.
<b>Step 4</b>	<b>end</b> <b>Example:</b> Device(config-wireless-flex-profile)# end	Exits the configuration mode and returns to privileged EXEC mode.

## Configuring a Site Tag (CLI)

Follow the procedure given below to configure a site tag:

### Procedure

	Command or Action	Purpose
<b>Step 1</b>	<b>configure terminal</b> <b>Example:</b> Device# configure terminal	Enters global configuration mode.
<b>Step 2</b>	<b>wireless tag site <i>site-name</i></b> <b>Example:</b> Device(config)# wireless tag site rr-xyz-site	Configures a site tag and enters site tag configuration mode.
<b>Step 3</b>	<b>flex-profile <i>flex-profile-name</i></b> <b>Example:</b>	Configures a flex profile.



	Command or Action	Purpose
	<pre>Device(config-site-tag) # flex-profile rr-xyz-flex-profile</pre>	<p><b>Note</b> You cannot remove the flex profile configuration from a site tag if local site is configured on the site tag.</p> <p><b>Note</b> The <b>no local-site</b> command needs to be used to configure the Site Tag as Flexconnect, otherwise the Flex profile config does not take effect.</p>
<b>Step 4</b>	<p><b>description</b> <i>site-tag-name</i></p> <p><b>Example:</b></p> <pre>Device(config-site-tag) # description "default site tag"</pre>	Adds a description for the site tag.
<b>Step 5</b>	<p><b>end</b></p> <p><b>Example:</b></p> <pre>Device(config-site-tag) # end</pre>	Saves the configuration and exits configuration mode and returns to privileged EXEC mode.
<b>Step 6</b>	<p><b>show wireless tag site summary</b></p> <p><b>Example:</b></p> <pre>Device# show wireless tag site summary</pre>	<p>(Optional) Displays the number of site tags.</p> <p><b>Note</b> To view detailed information about a site, use the <b>show wireless tag site detailed</b> <i>site-tag-name</i> command.</p> <p><b>Note</b> The output of the <b>show wireless loadbalance tag affinity wncd</b> <i>wncd-instance-number</i> command displays default tag (site-tag) type, if both site tag and policy tag are not configured.</p>

## Attaching Policy Tag and Site Tag to an AP (CLI)

Follow the procedure given below to attach a policy tag and a site tag to an AP:

### Procedure

	Command or Action	Purpose
<b>Step 1</b>	<p><b>configure terminal</b></p> <p><b>Example:</b></p> <pre>Device# configure terminal</pre>	Enters global configuration mode.
<b>Step 2</b>	<p><b>ap</b> <i>mac-address</i></p> <p><b>Example:</b></p>	Configures a Cisco AP and enters AP profile configuration mode.

	Command or Action	Purpose
	Device(config)# ap F866.F267.7DFB	<b>Note</b> The <i>mac-address</i> should be a wired mac address.
<b>Step 3</b>	<b>policy-tag</b> <i>policy-tag-name</i> <b>Example:</b> Device(config-ap-tag)# policy-tag rr-xyz-policy-tag	Maps a policy tag to the AP.
<b>Step 4</b>	<b>site-tag</b> <i>site-tag-name</i> <b>Example:</b> Device(config-ap-tag)# site-tag rr-xyz-site	Maps a site tag to the AP.
<b>Step 5</b>	<b>rf-tag</b> <i>rf-tag-name</i> <b>Example:</b> Device(config-ap-tag)# rf-tag rf-tag1	Associates the RF tag.
<b>Step 6</b>	<b>end</b> <b>Example:</b> Device(config-ap-tag)# end	Saves the configuration, exits configuration mode, and returns to privileged EXEC mode.
<b>Step 7</b>	<b>show ap tag summary</b> <b>Example:</b> Device# show ap tag summary	(Optional) Displays AP details and the tags associated to it.
<b>Step 8</b>	<b>show ap name</b> <i>&lt;ap-name&gt;</i> <b>tag info</b> <b>Example:</b> Device# show ap name ap-name tag info	(Optional) Displays the AP name with tag information.
<b>Step 9</b>	<b>show ap name</b> <i>&lt;ap-name&gt;</i> <b>tag detail</b> <b>Example:</b> Device# show ap name ap-name tag detail	(Optional) Displays the AP name with tag details.

## Trigger Predownload to a Site Tag

Follow the procedure given below to trigger image download to the APs:

### Procedure

	Command or Action	Purpose
<b>Step 1</b>	<b>enable</b> <b>Example:</b> Device> configure terminal	Enters the privileged EXEC mode.

	Command or Action	Purpose
<b>Step 2</b>	<b>ap image predownload site-tag <i>site-tag</i> start</b> <b>Example:</b> Device# ap image predownload site-tag rr-xyz-site start	Instructs the primary APs to start image predownload.
<b>Step 3</b>	<b>show ap master list</b> <b>Example:</b> Device# show ap master list	Displays the list of primary APs per AP model per site tag.
<b>Step 4</b>	<b>show ap image</b> <b>Example:</b> Device# show ap image	Displays the predownloading state of primary and subordinate APs .  <b>Note</b> To check if Flexefficient image upgrade is enabled in the AP, use the <b>show capwap client rcb</b> command on the AP console.

The following sample outputs display the functioning of the Efficient Image Upgrade feature:

The following output displays the primary AP.

```
Device# show ap master list
AP Name                               WTP Mac           AP Model           Site Tag
-----
AP0896.AD9D.3124                       f80b.cb20.2460    AIR-AP2802I-D-K9  ST1
```

The following output shows that the primary AP has started predownloading the image.

```
Device# show ap image
Total number of APs: 6

AP Name           Primary Image   Backup Image   Predownload Status   Predownload Version
  Next Retry Time   Retry Count
-----
APE00E.DA99.687A  16.6.230.37    0.0.0.0       None                  0.0.0.0
  N/A              0
AP188B.4500.4208  16.6.230.37    8.4.100.0     None                  0.0.0.0
  N/A              0
AP188B.4500.4480  16.6.230.37    0.0.0.0       None                  0.0.0.0
  N/A              0
AP188B.4500.5E28  16.6.230.37    16.4.230.35  None                  0.0.0.0
  N/A              0
AP0896.AD9D.3124 16.6.230.37    8.4.100.0    Predownloading    16.6.230.36
  0              0
AP2C33.1185.C4D0  16.6.230.37    8.4.100.0     None                  0.0.0.0
  N/A              0
```

The following output shows that the primary AP has completed predownload and the predownload has been initiated in the subordinate AP.

```
Device# show ap image

Total number of APs: 6
```

AP Name Next Retry Time	Primary Image Retry Count	Backup Image	Predownload Status	Predownload Version
APE00E.DA99.687A N/A	16.6.230.37 0	0.0.0.0	Initiated	16.6.230.36
AP188B.4500.4208 N/A	16.6.230.37 0	8.4.100.0	None	0.0.0.0
AP188B.4500.4480 N/A	16.6.230.37 0	0.0.0.0	None	0.0.0.0
AP188B.4500.5E28 N/A	16.6.230.37 0	16.4.230.35	None	0.0.0.0
AP0896.AD9D.3124 0	16.6.230.37 0	8.4.100.0	Complete	16.6.230.36
<b>AP2C33.1185.C4D0</b> <b>0</b>	<b>16.6.230.37</b> <b>0</b>	<b>8.4.100.0</b>	<b>Initiated</b>	<b>16.6.230.36</b>

The following output shows image status of a particular AP.

```
Device# show ap name APe4aa.5dd1.99b0 image
AP Name : APe4aa.5dd1.99b0
Primary Image : 16.6.230.46
Backup Image : 3.0.51.0
Predownload Status : None
Predownload Version : 000.000.000.000
Next Retry Time : N/A
Retry Count : 0
```

The following output shows predownload completion on all APs.

```
Device# show ap image
Total number of APs: 6
```

```
Number of APs
  Initiated : 0
  Predownloading : 0
  Completed predownloading : 3
  Not Supported : 0
  Failed to Predownload : 0
```

AP Name Next Retry Time	Primary Image Retry Count	Backup Image	Predownload Status	Predownload Version
APE00E.DA99.687A N/A	16.6.230.37 0	16.6.230.36	Complete	16.6.230.36
AP188B.4500.4208 N/A	16.6.230.37 0	8.4.100.0	None	0.0.0.0
AP188B.4500.4480 N/A	16.6.230.37 0	0.0.0.0	None	0.0.0.0
AP188B.4500.5E28 N/A	16.6.230.37 0	16.4.230.35	None	0.0.0.0
AP0896.AD9D.3124 0	16.6.230.37 0	16.6.230.36	Complete	16.6.230.36
<b>AP2C33.1185.C4D0</b> <b>0</b>	<b>16.6.230.37</b> <b>0</b>	<b>16.6.230.36</b>	<b>Complete</b>	<b>16.6.230.36</b>



## CHAPTER 14

# Predownloading an Image to an Access Point

- [Information About Predownloading an Image to an Access Point, on page 227](#)
- [Restrictions for Predownloading an Image to an Access Point, on page 227](#)
- [Predownloading an Image to Access Points \(CLI\), on page 228](#)
- [Predownloading an Image to Access Points \(GUI\), on page 230](#)
- [Predownloading an Image to Access Points \(YANG\), on page 230](#)
- [Monitoring the Access Point Predownload Process, on page 231](#)
- [Information About AP Image Download Time Enhancement \(OEAP or Teleworker Only\), on page 232](#)
- [Configuring AP Image Download Time Enhancement \(GUI\), on page 233](#)
- [Configuring AP Image Download Time Enhancement \(CLI\), on page 233](#)
- [Verifying AP Image Download Time Enhancement Configuration, on page 234](#)

## Information About Predownloading an Image to an Access Point

To minimize network outages, download an upgrade image to an access point from the device without resetting the access point or losing network connectivity. Previously, you could download an upgrade image to the device and reset it, causing the access point to go into discovery mode. After the access point discovered the controller with the new image, the access point would download the new image, reset it, go into discovery mode, and rejoin the device.

You can now download the upgrade image to the controller. When the controller is up with the upgrade image, the AP joins the controller and moves to Registered state, because the AP image has been predownloaded to the AP.

## Restrictions for Predownloading an Image to an Access Point

The following are the restrictions for predownloading an image to an access point:

- The maximum number of concurrent predownloads are limited to 100 per wncd instance (25 for 9800-L) in the controller. However, the predownloads are triggered in sets of 16 per wncd instance at the start, and is repeated every 60 seconds.
- Access points with 16-MB total available memory may not have enough free memory to download an upgrade image and may automatically delete crash information files, radio files, and backup images, if any, to free up space. However, this limitation does not affect the predownload process because the predownload image replaces backup image, if any, on the access point.

- All of the primary, secondary, and tertiary controllers should run the same images. Otherwise, the feature will not be effective.
- At the time of reset, you must make sure that all of the access points have downloaded the image.
- An access point can store only 2 software images.
- The Cisco Wave 1 APs may download the image twice while moving from Cisco AireOS Release 8.3 to Cisco IOS XE Gibraltar 16.10.1. This increases the AP downtime during migration.
- The **show ap image** command displays cumulative statistics regarding the AP images in the controller. We recommend that you clear the statistics using the **clear ap predownload statistics** command, before using the show ap image command, to ensure that correct data is displayed.
- Cisco Catalyst 9800-CL Wireless Controller supports only self-signed certificates and does not support Cisco certificates. When you move the access points between Cisco Catalyst 9800-CL Wireless Controllers, and if the AP join failure occurs on the Cisco Catalyst 9800-CL controller, execute the **capwap ap erase all** command to remove the hash string stored on the APs.
- During AP image pre-download, the WNCDCPU may rise to 99 percent, which is normal and doesn't cause a crash or client or AP disconnect problems.

## Predownloading an Image to Access Points (CLI)

### Before you begin

There are some prerequisites that you must keep in mind while predownloading an image to an access point:

- Predownloading can be done only when the device is booted in the install mode.
- You can copy the new image either from the TFTP server, flash image, or USB.
- If the latest upgrade image is already present in the AP, predownload will not be triggered. Check whether the primary and backup image versions are the same as the upgrade image, using the **show ap image** command.
- The **show ap image** command displays cumulative statistics regarding the AP images in the controller. We recommend that you clear the statistics using the **clear ap predownload statistics** command, before using the **show ap image** command, to ensure that correct data is displayed.
- AP continues to be in predownloading state, if AP flaps post SSO during AP predownload. We recommend that you issue the **ap image predownload abort** command and then the **clear ap predownload stats** command only then the predownload can be initiated again.

### Procedure

	Command or Action	Purpose
<b>Step 1</b>	<b>install add file bootflash:</b> <i>file-name</i>  <b>Example:</b> Device# install add file bootflash:image.bin	The controller software image is added to the flash and expanded.

	Command or Action	Purpose
<b>Step 2</b>	<b>ap image predownload</b> or <b>ap name <i>ap-name</i> image predownload</b> <b>Example:</b> Device# ap image predownload Device# ap name ap1 image predownload	Downloads the new image to all the access points or a specific access point connected to the device.
<b>Step 3</b>	<b>show ap image</b> <b>Example:</b> Device# show ap image	Verifies the access point's predownload status.  This command initially displays the status as Predownloading and then moves to Completed, when download is complete.
<b>Step 4</b>	<b>show ap name <i>ap-name</i> image</b> <b>Example:</b> Device# show ap name ap1 image	Provides image details of a particular AP.
<b>Step 5</b>	<b>ap image swap</b> or <b>ap name <i>ap-name</i> image swap</b> or <b>ap image swap completed</b> <b>Example:</b> Device# ap image swap	Swaps the images of the APs that have completed predownload.  <b>Note</b> You can swap the AP images using <b>ap image swap</b> command even without pre-downloading a new image to the AP and there are no restrictions or prerequisites to swap the image.
<b>Step 6</b>	<b>install activate</b> <b>Example:</b> Device# install activate	Runs compatibility checks, installs the package, and updates the package status details.  For a restartable package, the command triggers the appropriate post-install scripts to restart the necessary processes, and for non-restartable packages it triggers a reload.  <b>Note</b> This step reloads the complete controller stack (both primary and secondary controllers, if HA is used).
<b>Step 7</b>	<b>install commit</b> <b>Example:</b> Device# install commit	Commits the activation changes to be persistent across reloads.  The commit can be done after activation while the system is up, or after the first reload. If the package is activated but not committed, it remains active after the first reload, but not after the second reload.

## Predownloading an Image to Access Points (GUI)

### Procedure

- 
- Step 1** Choose **Administration** > **Software Management** and click the **Software Upgrade** tab.  
Note that you must be in the Install Mode to continue with the following steps.
- Step 2** Select the **Transport Type, File System and File Path** of your choice to from receive the file.
- Step 3** Select the **AP Image Predownload** check box.  
If you already have an inactive image file on your device, a dialog box prompts you to remove the unused image and proceed with the latest image download.
- Step 4** Click **Download & Install**.  
This initiates the upgrade process and you can view and verify the predownload progress in the **Status** dialog box. You can also check the progress log by clicking on **Show Logs** icon.
- Step 5** Click the **Save Configuration & Activate** button after the predownload operation is successful.
- Step 6** Click **Yes** to confirm the activate operation.  
This operation runs compatibility checks, installs the package, and updates the package status details. The device reloads after a successful activation. If there are uncommitted files, you are prompted to remove those.
- Step 7** Click the **Commit** button to complete the upgrade process.
- 

## Predownloading an Image to Access Points (YANG)

YANG can be used with NETCONF and RESTCONF to provide the desired solution of automated and programmable network operations.

The following RPC is used for Predownloading an Image to an Access Point:

```
<rpc xmlns="urn:ietf:params:xml:ns:netconf:base:1.0" message-id="101">
  <set-rad-predownload-all
xmlns="http://cisco.com/ns/yang/Cisco-IOS-XE-wireless-access-point-cmd-rpc">
    <uuid>12312341231234</uuid>
  </set-rad-predownload-all>
</rpc>
```

For more information on the YANG models, see the Cisco IOS XE Programmability Configuration Guide and YANG Data Models on Github at <https://github.com/YangModels/yang/tree/master/vendor/cisco/xe>.

You can contact the Developer Support Community for NETCONF/YANG features using the following link:

<https://developer.cisco.com/>



# Monitoring the Access Point Predownload Process

This section describes the commands that you can use to monitor the access point predownload process.

While downloading an access point predownload image, enter the **show ap image** command to verify the predownload progress on the corresponding access point:

```
Device# show ap image
Total number of APs : 1
```

```
Number of APs
  Initiated           : 1
  Predownloading      : 1
  Completed predownloading : 0
  Not Supported        : 0
  Failed to Predownload : 0
```

AP Name	Predownload Ver...	Next Retry Time	Primary Image Retry Count	Backup Image	Predownload Status
AP1	10.0.1.67	NA	10.0.1.66 0	10.0.1.66	Predownloading

```
Device# show ap image
```

```
Total number of APs : 1
```

```
Number of APs
  Initiated           : 1
  Predownloading      : 0
  Completed predownloading : 1
  Not Supported        : 0
  Failed to Predownload : 0
```

AP Name	Predownload Ver...	Next Retry Time	Primary Image Retry Count	Backup Image	Predownload Status
AP1	10.0.1.67	NA	10.0.1.66 0	10.0.1.67	Complete

Use the following command to view the image details of a particular AP:

```
Device# show ap name APe4aa.5dd1.99b0 image
```

```
AP Name : APe4aa.5dd1.99b0
Primary Image : 16.6.230.46
Backup Image : 3.0.51.0
Predownload Status : None
Predownload Version : 000.000.000.000
Next Retry Time : N/A
Retry Count : 0
```

## Information About AP Image Download Time Enhancement (OEAP or Teleworker Only)

The wireless controller and the access point (AP) communicate with each other using CAPWAP. The CAPWAP has two channels, namely control and data. The control channel is used to send configuration messages, download images and client keys, or the context to the AP. The control channel has a single window in the current implementation. A single window means that every message that is sent from the controller has to be acknowledged by the AP. The next control packet is not transmitted till the earlier one is acknowledged by the AP.

The AP Image Download Time Enhancement feature adds support to multiple sliding windows for control packets going from controller to AP. The sliding window can be set to N (static) instead of a single window. The request queue size is decided based on the maximum window size the AP supports.

**Table 12: Recommended Window Size**

Link Bandwidth <sup>6</sup>	Less than 200 ms RTT	Greater than 200 ms RTT
More than 20 Mbps	10	15
Between 5 and 20 Mbps	10	15
Between 1 and 5 Mbps	5	10
Less than 1 Mbps	3	5

<sup>6</sup> The window size recommendation provided in the table is for packet loss of less than one percent (< 1%). If the network supporting the CAPWAP link has packet loss of more than one percent (> 1%), use a smaller value for window size. For good links with round-trip time (RTT) of about 100ms and packet drops of less than half a percent (< 0.5%), use a window size of up to 20 for better performance.



### Note

- The window size can be changed only during the AP join process.
- All image upgrades should be in the **install** mode for faster upgrade. Image upgrade should be done from the **one-shot** command to include OEAP predownload.
- Configure the window size only for AP profiles that are exclusively used for Teleworker or Office Extend Access Points (OEAP).
- An AP reload is not required after disabling this feature.
- This feature is supported only on the OEAP profiles.
- GUI does not support AP predownload. Therefore, the AP downloads after disjoining the controller during CAPWAP join phase. This causes a long disruption in the network as the Image download for AP can take upto one hour.



**Important** If you downgrade the software to Cisco IOS XE Gibraltar 16.12.4 or earlier from Cisco IOS XE Amsterdam 17.3.1, you should reset the CAPWAP multi window to a single window prior to the downgrade. Failure to do so necessitates a manual AP recovery.

### High-Level Workflow of AP Image Download Time Enhancement

1. Select an existing AP join profile or create a new one.
2. Set the CAPWAP window size.
3. Associate the AP join profile to an existing site tag or new one.
4. Apply the site tag to the AP using: Static, Filter, Location, AP, or Default mapping method.

## Configuring AP Image Download Time Enhancement (GUI)

### Procedure

- Step 1** Choose **Configuration > Tags & Profiles > AP Join > CAPWAP > Advanced**.
- Step 2** In the **CAPWAP Window Size** field, enter the unit of measurement of the window.
- Step 3** Click **Save & Apply to Device**.

## Configuring AP Image Download Time Enhancement (CLI)

### Procedure

	Command or Action	Purpose
<b>Step 1</b>	<b>configure terminal</b>  <b>Example:</b> Device# configure terminal	Enters the global configuration mode.
<b>Step 2</b>	<b>ap-profile <i>ap-profile</i></b>  <b>Example:</b> Device(config)# ap profile capwap_multiwindow	Configures an AP profile.
<b>Step 3</b>	<b>capwap window size <i>window-size</i></b>  <b>Example:</b>	Configures the AP CAPWAP control packet transmit queue size.

	Command or Action	Purpose
	Device(config-ap-profile)# capwap window size 20	<b>Note</b> Configure the window size only for AP profiles that are exclusively used for teleworker or OEAP.  Be aware that any change in window size may impact other APs.
<b>Step 4</b>	<b>end</b>  <b>Example:</b> Device(config-ap-profile)# end	Returns to privileged EXEC mode.

## Verifying AP Image Download Time Enhancement Configuration

To view the CAPWAP window size present in an AP profile, use the following command:

```
Device# show ap profile name default-ap-profile detailed | in wind
Capwap window size : 10
```

To view the CAPWAP status and modes, use the following command:

```
Device# show capwap client rcb

OperationState           : UP
Name                     : AP4001.7A39.2D5A
MwarHwVer                : 0.0.0.0
Location                 : default location
ApMode                   : Remote Bridge
ApSubMode                : Not Configured
CAPWAP Path MTU         : 1485
Software Initiated Reload Reason : Reload command
CAPWAP Sliding Window
Active Window Size       : 10
Last Request Send To Application : 184
Expected Seq Num        : 185
Received Seq Num        : 184
Request Packet Count    : 42424
Out Of Range Packets Count : 0
Window Moved Packets Count : 0
In Range Packets Count  : 960
Expected Packets Count  : 41464
```

To view the AP configuration details, including the CAPWAP window size, use the following command:

```
Device# show ap config general | in Wind

Capwap Active Window Size : 5
Capwap Active Window Size : 10
Capwap Active Window Size : 1
```



## CHAPTER 15

# N+1 Hitless Rolling AP Upgrade

- [N+1 Hitless Rolling AP Upgrade, on page 235](#)
- [Configuring Hitless Upgrade, on page 236](#)
- [Verifying Hitless Upgrade, on page 237](#)

## N+1 Hitless Rolling AP Upgrade

The existing CAPWAP implementation on the Cisco Catalyst 9800 Series Wireless Controller requires that the controller and all its associated APs have the same software version. It is possible to upgrade a set of APs using the N+1 Hitless Rolling AP Upgrade feature. However, all the APs cannot be upgraded at the same time without network downtime.

You can upgrade wireless networks without network downtime when the same version skew is supported between the controller and the APs. This enables the APs to be upgraded in a staggered manner, while still being connected to the same controller. The version skew method can avoid upgrade downtime even for N+1 networks by using N+1 Hitless Rolling AP Upgrade feature and a spare controller.

The following is the workflow for the N+1 Hitless Rolling AP Upgrade feature:

1. Establish a mobility tunnel from the controller (WLC1) to a mobility member (WLC2).
2. Upgrade the controller software (WLC1) using the command **install add file bootflash:new\_version.bin**.
3. Optionally, you can also upgrade the AP image. For more information, see [Predownloading an Image to an Access Point](#) chapter.
4. Use the **ap image upgrade destination** *controller-name controller-ip report-name* privileged EXEC command to upgrade and move all the APs from WLC1 (source) to WLC2 (destination).
5. Activate the new image in WLC1 using the **install activate** command.
6. Commit the changes using the **install commit** command.
7. Move the APs back to WLC1 from WLC2 using the **ap image move destination** *controller-name controller-ip report-name* command.



**Note** The **ap image upgrade destination** command does not work without an image pre-download. If you do not perform an image pre-download, use the **ap image move** command to move the APs. When APs download the image and join the destination controller, you must set the iteration time as high. Also, you can customize the iteration time by configuring the **ap upgrade staggered iteration timeout** command.

## Configuring Hitless Upgrade

Follow the procedure given below to achieve a zero downtime network upgrade in an N+1 deployment.

### Before you begin

- Ensure that the hostname and wireless management IP of the destination controller is provided in the privileged EXEC command.
- Ensure that access points are predownloaded with the image running on the destination controller.

### Procedure

	Command or Action	Purpose
<b>Step 1</b>	<b>ap image upgrade destination</b> <i>wlc-name</i> <i>wlc-ip</i> <b>Example:</b> Device# ap image upgrade destination wlc2 10.7.8.9	Moves APs to the specified destination controller with the swap and reset command. After this, the parent controller activates new image, and reloads with the new image. After the mobility tunnel comes up, APs are moved back to the parent controller without a swap and reset. <b>Note</b> Ensure that you establish a mobility tunnel from controller (WLC1) to a mobility member (WLC2) before image upgrade.
<b>Step 2</b>	<b>ap image upgrade destination</b> <i>wlc-name</i> <i>wlc-ip</i> <b>Example:</b> Device# ap image upgrade destination wlc2 10.7.8.9	(Optional) Moves APs to the specified destination controller with a swap and reset command. <b>Note</b> Perform Steps 2 to 4 only if you are not performing Step 1.
<b>Step 3</b>	<b>ap image move destination</b> <i>wlc-name wlc-ip</i> <b>Example:</b> Device# ap image move destination wlc1 10.7.8.6	Move the APs back to the parent controller.
<b>Step 4</b>	<b>ap image upgrade destination</b> <i>wlc-name</i> <i>wlc-ip</i> [fallback]	(Optional) Moves APs to the specified destination controller with a swap and reset command. After that, APs are moved back to

	Command or Action	Purpose
	<b>Example:</b> Device# ap image upgrade destination wlc2 10.7.8.9 fallback	the parent controller (without a swap and reset) after manual install activate of the new image and reloading of the parent controller.
<b>Step 5</b>	<b>ap image upgrade destination</b> <i>wlc-name</i> <i>wlc-ip</i> [reset] <b>Example:</b> Device# ap image upgrade destination wlc2 10.7.8.9 reset	(Optional) Moves APs to the specified destination controller with a swap and reset command. After this, the parent controller activates the new image and reloads with the new image.

## Verifying Hitless Upgrade

Use the following **show** commands to verify hitless upgrade.

To view all the upgrade report names, use the following command:

```
Device# show ap upgrade summary

Report Name      Start time
-----
AP_upgrade_from_VIGK_CSR_2042018171639 05/20/2018 17:16:39 UTC
```

To view AP upgrade information based on the upgrade report name, use the following command:

```
Device# show ap upgrade name test-report

AP upgrade is complete
From version: 16.10.1.4
To version: 16.10.1.4
Started at: 05/20/2018 17:16:39 UTC
Percentage complete: 100
End time: 05/20/2018 17:25:39 UTC
Progress Report
-----
Iterations
-----
Iteration Start time End time AP count
-----
0 05/20/2018 17:16:39 UTC 05/20/2018 17:16:39 UTC 0
1 05/20/2018 17:16:39 UTC 05/20/2018 17:25:39 UTC 1
Upgraded
-----
Number of APs: 1
AP Name Ethernet MAC Iteration Status
-----
AP-SIDD-CLICK 70db.9848.8f60 1 Joined
In Progress
-----
Number of APs: 0
AP Name Ethernet MAC
-----
Remaining
-----
Number of APs: 0
AP Name Ethernet MAC
-----
```







## CHAPTER 16

# NBAR Dynamic Protocol Pack Upgrade

- [NBAR Dynamic Protocol Pack Upgrade, on page 239](#)
- [Upgrading the NBAR2 Protocol Pack, on page 240](#)

## NBAR Dynamic Protocol Pack Upgrade

Protocol packs are software packages that update the Network-Based Application Recognition (NBAR) engine protocol support on a device without replacing the Cisco software on the device. A protocol pack contains information on applications that are officially supported by NBAR, and are compiled and packed together. In each application, the protocol pack includes information on application signatures and application attributes. Each software release has a built-in protocol pack bundled with it.

The Application Visibility and Control (AVC) feature (used for deep-packet inspection [DPI]) supports wireless products using a distributed approach that benefits from NBAR running on the access points (AP) or controller whose goal is to run DPI and report the result using NetFlow messages.

The AVC DPI technology supports the ability to update recognized traffic and to define the custom type of traffic (known as custom applications). The NBAR runs on the controller in local mode, and on the APs in Flex and Fabric modes. In local mode, all the traffic coming from the APs are tunneled towards the wireless controller.



### Note

- Although NBAR is supported in all the modes, upgrade of NBAR protocol packs is supported only in local mode (central switching) and in FlexConnect mode (central switching).
- Custom applications are available only in local mode (central switching) and in FlexConnect mode (central switching).
- When you upgrade the AVC protocol pack, copy the protocol pack to both RPs (active and standby). Otherwise, the protocol pack on the standby upgrade will fail and cause the synchronization failure crash.

Protocol packs provide the following features:

- They can be loaded easily and quickly.
- They can be upgraded to a later version protocol pack or revert to an earlier version protocol pack.
- Device reload is not required.

- They do not disrupt any service.

### Protocol Pack Upgrade

Using protocol pack upgrades, you can update the NBAR engine to recognize new types of protocols or traffic without updating the entire switch or appliance image. It also eliminates the need to restart the entire system.

NBAR protocol packs are available for download from Cisco Software Center: <https://software.cisco.com/download/navigator.html>

### Custom Applications

Using custom applications, you can force the NBAR engine to recognize traffic based on a set of custom rules, for example, destination IP, hostname, URL, and so on.

The custom application names then appear in the web UI or in the NetFlow collector.

## Upgrading the NBAR2 Protocol Pack

Follow the procedure given below to upgrade the NBAR2 protocol pack:

### Before you begin

Download the protocol pack from [Software Download](#) page and copy it into the bootflash.

### Procedure

	Command or Action	Purpose
<b>Step 1</b>	<b>configure terminal</b>  <b>Example:</b> Device# configure terminal	Enters global configuration mode.
<b>Step 2</b>	<b>ip nbar protocol-pack bootflash:pack-name</b>  <b>Example:</b> Device(config)# ip nbar protocol-pack bootflash:mypp.pack	Loads the protocol pack.



# CHAPTER 17

## Wireless Sub-Package for Switch

---

- [Introduction to Wireless Sub-package, on page 241](#)
- [Booting in Install Mode, on page 242](#)
- [Installing Sub-Package in a Single Step \(GUI\), on page 243](#)
- [Installing Sub-Package in a Single Step, on page 243](#)
- [Multi-step Installation of Sub-Package, on page 244](#)
- [Installing on a Stack, on page 244](#)
- [Upgrading to a Newer Version of Wireless Package, on page 245](#)
- [Deactivating the Wireless Package, on page 245](#)
- [Enabling or Disabling Auto-Upgrade, on page 245](#)

### Introduction to Wireless Sub-package

Wireless-only Fabric uses fabric constructs to garner the benefits of a fabric. In this architecture, a fabric is built on top of existing traditional network designs such as multi-tier, Routed Access, and VSS network. It uses a LISP control plane together with VXLAN encapsulation for the overlay data plane traffic. The wireless control plane remains intact with CAPWAP tunnels initiating on the APs and terminating on a Cisco Catalyst 9800 Series Wireless Controller or AireOS controller. The Cisco Catalyst 9800 Series Wireless Controller can function in a dedicated appliance, directly in a switch, or in a VM.

Cisco Catalyst 9800 Wireless Controller for Switch delivers all the benefits of a centralized control and management plane (easy to configure, upgrade, troubleshoot, etc) and the maximum throughput or performance of a distributed forwarding plane. The distributed data plane allows services such as AVC to scale. In this new model, the wireless control plane is not split between MC and MA. The switch is detached from the wireless control plane and the controller takes care of the wireless function and the traffic switching is done by the Cisco Access Switch.

Since the wireless functionality is required to be enabled only on few nodes of the network, you can install Cisco Catalyst 9800 Series Wireless Controller as a separate package on the switch on a need basis. The sub-package is installed on top of the base image and a reload is required to activate the sub-package.



---

**Note** The sub-package is an optional binary that contains the entire Cisco Catalyst 9800 Series Wireless Controller software.

---



---

**Note** SNMP is not supported on Catalyst 9800 Embedded Wireless Controller for Switch.

---

#### How to Install Wireless Package

1. Install the base image (without wireless) on the switch.
2. Install the wireless package on the switch.
3. Upgrade the AP image.
4. Reload the switch.
5. Enable wireless on the switch using the **wireless-controller** configuration command, and configure wireless features.

#### How to Remove Wireless Package

1. Uninstall the wireless package from the switch.
2. Reload the switch.
3. Run the **write** command. This removes the wireless configuration from the startup-configuration.

#### Upgrading to a Newer Version of Wireless Package

1. Install the base image (without wireless) on the switch.
2. Install the updated wireless package.
3. Reload the switch.
4. Commit the installation.

## Booting in Install Mode

Use the procedure given below to boot the switch in install-mode:

#### Before you begin

The sub-package does not work in bundle-mode. Use the **show version** command to verify the boot mode.

#### Procedure

---

**Step 1** **install add file** *image.bin* **location activate commit.**

This command moves the switch from bundle-mode to install-mode. Note that *image.bin* is the base image.

**Step 2** Click **yes** to all the prompts.

**Step 3** **reload**

Reloads the switch. Ensure that you boot from *flash:packages.conf*. After the reload, the switch will be in install-mode.

**Note** During Install mode image upgrade/downgrade, “Install add file” with `flash:<file_name>` command is not supported. Instead of that “bootflash:<filename>” needs to be used.

```
Install add file bootflash:<file_name> activate commit
```

---

### What to do next

Verify the boot mode using the `show version` command.

## Installing Sub-Package in a Single Step (GUI)

### Procedure

---

- Step 1** Choose **Administration > Software Management > Software Upgrade**.
  - Step 2** Choose the upgrade mode from the **Upgrade Mode** drop-down list, the transport type from the **Transport Type** drop-down list and enter the **Server IP Address (IPv4/IPv6)**, the **File System** and choose the location from the **Source File Path** drop-down list.
  - Step 3** Click **Download & Install**.
- 

## Installing Sub-Package in a Single Step

Use the procedure given below to install sub-package in a single step:

### Before you begin

- Ensure that the switch is in install-mode.
- Ensure that you boot only from *flash:packages.conf*.

### Procedure

---

- Step 1** **install add file *flash:<controller>.bin* activate commit**  
Installs the Cisco Catalyst 9800 Wireless Controller for Switch sub-package.  
**Note** The sub-package (`flash:<controller>.bin`) is available on [www.cisco.com](http://www.cisco.com). You can also install the sub-package directly from TFTP server.
  - Step 2** Click **yes** to all the prompts.
-

**What to do next**

Use the **show install summary** command to verify the installed image or package.

## Multi-step Installation of Sub-Package

Use the procedure given below to install sub-package:

**Before you begin**

- Ensure that the switch is in install-mode.
- Ensure that you boot only from *flash:packages.conf*.

**Procedure**

---

**Step 1**    **install add file** *flash:<controller>.bin*

The sub-package is added to the flash and expanded.

**Step 2**    **install activate file** *flash:<controller>.bin*

Installs the sub-package.

**Step 3**    **install commit**

Completes the installation by writing the files.

---

**What to do next**

Use the **show install summary** command to verify the installed image or package.

## Installing on a Stack

You can install the package on a stack using either [Single-step Package Installation](#) or [#unique\\_313](#).

If a new member joins the stack, the two possible scenarios are:

- **If auto-upgrade is enabled:** The required software is installed on to the new member. It will match the version of software running on the stack as well as the wireless package.
- **If auto-upgrade is disabled:** As the software version is not the same as in the stack, the new member will remain in version mismatch state and it will not join the stack. You have to manually run the **install autoupgrade** command in EXEC mode to initiate the auto-upgrade procedure.

## Upgrading to a Newer Version of Wireless Package

Use the procedure given below to upgrade to a newer version of wireless package:

### Procedure

- 
- Step 1**    **install add file** *flash:<base-image>.bin*
- The base image (without wireless) is added to the flash and expanded.
- Step 2**    **install add file** *flash:<controller-sub-package>.bin*
- The sub-package is added to the flash and expanded.
- Step 3**    **install active**
- Installs the base image and sub-package and triggers a reload. However, you can also rollback to the previous state after the reload.
- Step 4**    **install commit**
- Completes the installation by writing the files.
- 

## Deactivating the Wireless Package

Follow the procedure given below to deactivate the wireless sub-package:

### Procedure

	Command or Action	Purpose
<b>Step 1</b>	<b>install deactivate file</b> <i>flash:&lt;controller&gt;.bin</i> <b>Example:</b> <pre>Device# install deactivate file flash:&lt;controller&gt;.bin</pre>	Removes the package and forces the switch to reboot.
<b>Step 2</b>	<b>install commit</b> <b>Example:</b> <pre>Device# install commit</pre>	Commits the switch without wireless package.

## Enabling or Disabling Auto-Upgrade

Follow the procedure given below to enable or disable auto-upgrade:

**Procedure**

	<b>Command or Action</b>	<b>Purpose</b>
<b>Step 1</b>	<b>software auto-upgrade enable</b> <b>Example:</b> Device(config)# software auto-upgrade enable	Enables software auto-upgrade.
<b>Step 2</b>	<b>no software auto-upgrade enable</b> <b>Example:</b> Device(config)# no software auto-upgrade enable	Disables software auto-upgrade.





## PART **III**

# Lightweight Access Points

- [Country Codes, on page 249](#)
- [Regulatory Compliance \(Rest of the World\) for Domain Reduction, on page 255](#)
- [Sniffer Mode, on page 267](#)
- [Monitor Mode, on page 273](#)
- [AP Priority, on page 275](#)
- [FlexConnect, on page 277](#)
- [OEAP Link Test, on page 331](#)
- [Data DTLS, on page 335](#)
- [AP Crash File Upload, on page 339](#)
- [Access Point Plug-n-Play, on page 341](#)
- [802.11 Parameters for Cisco Access Points, on page 343](#)
- [802.1x Support, on page 359](#)
- [CAPWAP Link Aggregation Support, on page 367](#)
- [DHCP and NAT Functionality on Root Access Point, on page 373](#)
- [OFDMA Support for 11ax Access Points, on page 375](#)
- [AP Audit Configuration, on page 385](#)
- [AP Support Bundle, on page 389](#)
- [Cisco Flexible Antenna Port, on page 391](#)
- [LED States for Access Points, on page 393](#)
- [Access Points Memory Information, on page 397](#)
- [Real-Time Access Points Statistics, on page 399](#)
- [Access Point Tag Persistency, on page 405](#)
- [Configuring the AP Console, on page 409](#)





## CHAPTER 18

# Country Codes

- [Information About Country Codes](#), on page 249
- [Prerequisites for Configuring Country Codes](#), on page 249
- [Configuring Country Codes \(GUI\)](#), on page 250
- [Configuring Country Codes \(CLI\)](#), on page 250
- [Configuration Examples for Configuring Country Codes](#), on page 252

## Information About Country Codes

Controllers and access points are designed for use in many countries with varying regulatory requirements. The radios within the access points are assigned to a specific regulatory domain at the factory (such as -E for Europe), but the country code enables you to specify a particular country of operation (such as FR for France or ES for Spain). Configuring a country code ensures that each radio's broadcast frequency bands, interfaces, channels, and transmit power levels are compliant with country-specific regulations.

### Information About Japanese Country Codes

Country codes define the channels that can be used legally in each country. These country codes are available for Japan:

- J2: Allows only -P radios to join the controller
- J4: Allows 2.4G JPQU and 5G PQU to join the controller.

## Prerequisites for Configuring Country Codes

- Generally, you should configure one country code per device; you configure one code that matches the physical location of the device and its access points. You can configure up to 200 country codes per device. This multiple-country support enables you to manage access points in various countries from a single device.
- When the multiple-country feature is used, all the devices that are going to join the same RF group must be configured with the same set of countries, configured in the same order.
- Access points are capable of using all the available legal frequencies. However, access points are assigned to the frequencies that are supported in their relevant domains.

- The country list configured on the RF group leader determines which channels the members will operate on. This list is independent of which countries have been configured on the RF group members.
- For devices in the Japan regulatory domain, you should have one or more Japan country codes (JP, J2, or J3) configured on your device at the time you last booted your device.
- For devices in the Japan regulatory domain, you should have one or more Japan country codes (J2, or J4) configured on your device at the time you last booted your device.
- For devices in the Japan regulatory domain, you must have at least one access point with a -J regulatory domain joined to your device.
- You cannot delete any country code using the configuration command **wireless country country-code** if the specified country was configured using the **ap country list** command and vice-versa.

## Configuring Country Codes (GUI)

### Procedure

- 
- Step 1** Choose **Configuration > Wireless > Access Points > Country**.
- Step 2** On the **Country** page, select the check box for each country where your access points are installed. If you selected more than one check box, a message is displayed indicating that RRM channels and power levels are limited to common channels and power levels.
- Step 3** Click **Apply**.
- 

## Configuring Country Codes (CLI)

### Procedure

	Command or Action	Purpose
<b>Step 1</b>	<b>enable</b>  <b>Example:</b> Device# enable	Enters privileged EXEC mode.
<b>Step 2</b>	<b>show wireless country supported</b>  <b>Example:</b> Device# show wireless country supported	Displays a list of all the available country codes.
<b>Step 3</b>	<b>configure terminal</b>  <b>Example:</b> Device# configure terminal	Enters global configuration mode.

	Command or Action	Purpose
<b>Step 4</b>	<b>ap dot11 { 24ghz   5ghz } shutdown</b> <b>Example:</b> Device(config)# ap dot11 5ghz shutdown	Disables the 802.11b/g network, if you use 24ghz. Disables the 802.11a network, if you use 5ghz.
<b>Step 5</b>	<b>ap country country_code</b> <b>Example:</b> Device(config)# ap country IN	Configures country code on the controller, so that access points joining controller matches the country code and its corresponding regulatory domain codes for the AP. <b>Note</b> More than one country code can be configured.
<b>Step 6</b>	<b>wireless country country_code</b> <b>Example:</b> Device(config)# wireless country IN	Configures 200 country codes per device. <b>Note</b> This CLI is applicable for deployments having more than 20 countries.
<b>Step 7</b>	<b>exit</b> <b>Example:</b> Device(config)# exit	Returns to privileged EXEC mode.
<b>Step 8</b>	<b>show wireless country configured</b> <b>Example:</b> Device# show wireless country configured	Displays the configured countries.
<b>Step 9</b>	<b>show wireless country channels</b> <b>Example:</b> Device# show wireless country channels	Displays the list of available channels for the country codes configured on your device. <b>Note</b> Perform Steps 9 through 17 only if you have configured multiple country codes in Step 6.
<b>Step 10</b>	<b>configure terminal</b> <b>Example:</b> Device# configure terminal	Enters global configuration mode.
<b>Step 11</b>	<b>no ap dot11 { 24ghz   5ghz } shutdown</b> <b>Example:</b> Device(config)# no ap dot11 5ghz shutdown	Enables the 802.11b/g network, if you use 24ghz. Enables the 802.11a network, if you use 5ghz.
<b>Step 12</b>	<b>ap name cisco-ap shutdown</b> <b>Example:</b> Device# ap name AP02 shutdown	Disables the access point. <b>Note</b> Ensure that you disable only the access point for which you are configuring country codes.

	<b>Command or Action</b>	<b>Purpose</b>
<b>Step 13</b>	<b>configure terminal</b> <b>Example:</b> Device# configure terminal	Enters global configuration mode.
<b>Step 14</b>	<b>ap name cisco-ap country country_code</b> <b>Example:</b> Device# ap name AP02 country US	Assigns each access point with a country code from the controller country code list.  <b>Note</b> <ul style="list-style-type: none"> <li>• Ensure that the country code that you choose is compatible with the regulatory domain of at least one of the access point's radios.</li> <li>• Disable the access point before changing country code.</li> </ul>
<b>Step 15</b>	<b>ap name cisco-ap no shutdown</b> <b>Example:</b> Device# ap name AP02 no shutdown	Enables the access point.

## Configuration Examples for Configuring Country Codes

### Viewing Channel List for Country Codes

This example shows how to display the list of available channels for the country codes on your device:

```
Device# show wireless country channels

Configured Country.....: US - United States
KEY: * = Channel is legal in this country and may be configured manually.
     A = Channel is the Auto-RF default in this country.
     . = Channel is not legal in this country.
     C = Channel has been configured for use by Auto-RF.
     x = Channel is available to be configured for use by Auto-RF.
     (-,-) = (indoor, outdoor) regulatory domain allowed by this country.
-----:++++-++++-++++-++++-++++-
802.11bg      :
Channels      :              1 1 1 1 1
              1 2 3 4 5 6 7 8 9 0 1 2 3 4
-----:++++-++++-++++-++++-++++-
(-A,-AB) US   : A * * * * A * * * * A . . .
Auto-RF       : . . . . .
-----:++++-++++-++++-++++-++++-
802.11a       :
Channels      :              1 1 1 1 1 1 1 1 1 1 1 1 1 1 1 1 1 1
              3 3 3 4 4 4 4 4 5 5 6 6 0 0 1 1 2 2 2 3 3 4 4 5 5 6 6
              4 6 8 0 2 4 6 8 2 6 0 4 0 4 8 2 6 0 4 8 2 6 0 9 3 7 1 5
-----:++++-++++-++++-++++-++++-
(-A,-AB) US   : . A . A . A . A A A A * * * * * . . . * * * A A A *
Auto-RF       : . . . . .
-----:++++-++++-++++-++++-++++-
4.9GHz 802.11a :
Channels      :              1 1 1 1 1 1 1 1 1 1 2 2 2 2 2 2 2 2
```

```

          1 2 3 4 5 6 7 8 9 0 1 2 3 4 5 6 7 8 9 0 1 2 3 4 5 6
-----: +--+--+--+--+--+--+--+--+--+--+--+--+--+--+--+--+--+
US (-A , -AB ) : * * * * * * * * * * * * * * * * * A * * * * * A
Auto-RF       : . . . . . . . . . . . . . . . . . . . . . . . . .
```







## CHAPTER 19

# Regulatory Compliance (Rest of the World) for Domain Reduction

---

- [Information About Regulatory Compliance Domain](#), on page 255
- [Configuring Country Code for Rest of the World \(CLI\)](#), on page 264

## Information About Regulatory Compliance Domain

Controllers and access points (AP) are designed for use in many countries with varying regulatory requirements. Country code enables to specify a particular country of operation (such as FR for France or ES for Spain). Configuring a country code ensures that each radio's broadcast frequency bands, interfaces, channels, and transmit power levels are compliant with country-specific regulations.

This feature helps to reduce the number of regulatory domains by modifying the existing pre-provision domains workflow to determine the regulatory domain at runtime for each country code. A new Rest of World (RoW) domain has been introduced and merged to include the nine pre-existing domains. Every AP can determine its own regulatory domain from one of these domains, with the regulated power table and the allowed radio channels.



---

**Note** The transmission power value in the TPC IE of the beacon can differ from that of the transmission power value of the AP displayed in the **show controllers dot11radio** command, by a maximum difference of 2 dB. The maximum deviation allowed in TPC IE of beacon is 2 dB.

---

## Global Country-Level Domains

Table 13: Power Table and Supported Channels of Countries in Global Domain (2.4-GHz and 5-GHz)

Country and Code	Outdoor Power Table 2.4-GHz	Outdoor Power Table 5-GHz	Supported Channels 2.4-GHz	Supported Secondary Channels 5-GHz
Albania: AL	2G-E	5G-E	1-2-3-4-5 6-7-8-9-10-11-12-13	100-104-108- 112-116-132-136-140
Belgium: BE	2G-E	5G-E	1-2-3-4-5- 6-7-8-9-10-11-12-13	100-104-108- 112-116-132-136-140
Bulgaria: BG	2G-E	5G-E	1-2-3-4-5-6, 7-8-9-10-11-12-13	100-104-108- 112-116-132-136-140
Canada: CA	2G-A	5G-A	1-2-3-4-5-6 7-8-9-10-11	100-104-108-112-116- 132-136-140-149-153-157- 161-165
Croatia: HR	2G-E	5G-E	1-2-3-4-5- 6-7-8-9-10-11-12-13	100-104-108- 112-116-132-136-140
Czech Republic: CZ	2G-E	5G-E	1-2-3-4-5- 6-7-8-10-11-12-13	100-104-108- 112-116-132-136-140
Estonia: EE	2G-E	5G-E	1-2-3-4-5- 6-7-8-9-10-11-12-13	100-104-108- 112-116-132-136-140
Finland: FI	2G-E	5G-E	1-2,-3-4-5 6-7-8-9-10-11-12-13	100-104-108 112-116-132-136-140
France: FR	2G-E	5G-E	1-2-3-4-5-6 7-8-9-10-11-12-13	100-104-108- 112-116-132-136-140
Germany: DE	2G-E	5G-E	1-2-3-4-5-6 7-8-9-10-11-12-13	100-104-108- 112-116-132-136-140
Greece: GR	2G-E	5G-E	1-2-3-4-5-6 7-8-9-10-11-12-13	100-104-108- 112-116-132-136-140
Hungary: HU	2G-E	5G-E	1-2-3-4-5- 6-7-8-9-10-11-12-13	100-104-108 112-116-132-136-140

Country and Code	Outdoor Power Table 2.4-GHz	Outdoor Power Table 5-GHz	Supported Channels 2.4-GHz	Supported Secondary Channels 5-GHz
Iceland: IS	2G-E	5G-E	1-2-3-4-5-6 7-8-9-10-11-12-13	100-104-108 112-116-132-136-140
Indonesia: ID	2G-F	5G-F	1-2-3-4-5-6 7-8-9-10-11-12-13	149-153-157-161
Italy: IT	2G-E	5G-E	1-2-3-4-5- 6-7-8-9-10-11-12-13	100-104-108 112-116-132-136-140
Japan: JP	2G-Q	5G-Q	1-2-3-4-5-6 7-8-9-10-11-12-13	100-104-108- 112-116-120-124-128-132- 136-140-144
Latvia: LV	2G-E	5G-E	1-2-3-4-5- 6-7-8-9-10-11-12-13	100-104-108 112-116-132-136-140
Liechtenstein: LI	2G-E	5G-E	1-2-3-4-5- 6-7-8-9-10-11-12-13	100-104-108- 112-116-132-136-140
Lithuania: LT	2G-E	5G-E	1, 2, 3, 4, 5, 6, 7, 8, 9, 10, 11, 12, and 13	100-104-108-112 -116-132-136-140
Luxembourg: LU	2G-E	5G-E	1-2-3-4-5-6 7-8-9-10-11-12-13	100-104-108 112-116-132-136-140
Malta: MT	2G-E	5G-E	1-2-3-4-5- 6-7-8-9-10-11-12-13	100-104-108- 112-116-132-136-140
Netherlands: NL	2G-E	5G-E	1-2-3-4-5- 6-7-8-9-10-11-12-13	100-104-108- 112-116-132-136-140
New Zealand: NZ	2G-A	5G-E	1-2-3-4-5- 6-7-8-9-10-11	100-104-108-112- 116-132-136-140- 149-153-161-165
Norway: NO	2G-E	5G-E	1-2-3-4-5-6 7-8-9-10-11-12-13	100-104-108- 112-116-132-136-140
Poland: PL	2G-E	5G-E	1-2-3-4-5- 6-7-8-9-10-11-12-13	100-104-108- 112-116-132-136-140

Country and Code	Outdoor Power Table 2.4-GHz	Outdoor Power Table 5-GHz	Supported Channels 2.4-GHz	Supported Secondary Channels 5-GHz
Portugal: PT	2G-E	5G-E	1-2-3-4-5- 6-7-8-9-10-11-12-13	100-104-108- 112-116-132-136-140
Puerto Rico: PR	2G-A	5G-B	1-2-3-4-5- 6-7-8-9-10-11	36-40-44-48- 52-56-60-64-100-104- 108-112-116-120-128-132-140- 144-149-153- 157-161-165
Romania: RO	2G-E	5G-E	1-2-3-4-5-6-7-8 -9-10-11- 12-13	100-104-108-112- 116-132-136-140
Russian Federation: RU	2G-R	5G-R	1-2-3-4-5- 6-7-8-9-10-11-12-13	36-40-44-48- 52-56-60-64-136-140- 144-149-153-157-161-165
Slovak Republic: SK	2G-E	5G-E	1-2,-3-4-5- 6-7-8-9-10-11-12-13	100-104-108-112- 116-132-136-140
Slovenia: SI	2G-E	5G-E	1-2-3-4-5- 6-7-8-9-10-11-12-13	100-104-108- 112-116-132-136-140
Spain: ES	2G-E	5G-E	1-2-3-4-5- 6-7-8-9-10-11-12-13	100-104-108- 112-116-132-136-140
Sweden: SE	2G-E	5G-E	1-2-3-4-5- 6-7-8-9-10-11-12-13	100-104-108- 112-116-132-136-140
Switzerland: CH	2G-E	5G-E	1-2-3-4-5- 6-7-8-9-10-11-12-13	100-104-108- 112-116-132-136-140
United States of America: US	2G-A	5G-B	1-2-3-4-5- 6-7-8-9-10-11	36-40-44-48-52-56-60-64- 100-104-108-112-116-120-128- 132-140-144-149-153 157-161-165

## Restrictions on Regulatory Compliance Domain

- Cisco Catalyst 9124 AXE APs (9124AXE-F) are not supported in Indonesia. The AP radios are operationally down.

## Rest of World Domain

Until Cisco IOS XE Bengaluru 17.5.1, APs used the global controller country list to configure and validate the country codes. From Cisco IOS XE Bengaluru 17.6.1 onwards, RoW domain support was added.

The following APs support RoW domain:

- Cisco Catalyst 9124AX outdoor Access Points
- Cisco Catalyst 9136 Access Points
- Cisco Catalyst 9164 Series Access Points
- Cisco Catalyst 9166 Series Access Points

**Table 14: Power Table and Supported Channels of Countries in RoW Domain**

Country and Code	Outdoor Power Table 2.4-GHz	Outdoor Power Table 5-GHz	Supported Channels 2.4 GHz	Supported Channels 5 GHz
Algeria: DZ	2G-E	5G-C1	1-2-3-4-5-6-7-8-9-10-11-12-13	52-56-60-64-100-104-108-112-116-132
Argentina: AR	2G-Z	5G-A1	1-2-3-4-5-6-7-8-9-10- 11	36-40-44-48-52-56-60-64-100-104-108-112-116-132-136-140-149-153-157-161-165
Bahamas: BS	2G-A	5G-B1	1-2-3-4-5-6-7-8-9-10-11	36-40-44-48-52-56-60-64-149-153-157-161-165
Bahrain: BH	2G-E	5G-C1	1-2-3-4-5-6-7-8-9-10-11-12-13	149-153-157-161-165
Bangladesh: BD	2G-A	5G-A2	1-2-3-4-5-6-7-8-9-10- 11	149-153-157-161-165
Barbados: BB	2G-A	5G-B1	1-2-3-4-5-6-7-8-9-10- 11	36-40-44-48-52-56-60-64-149-153-157-161-165
Bolivia: BO	2G-A	5G-A10	1-2-3-4-5-6-7-8-9-10- 11	149-153-157-161-165
Bosnia: BA	2G-E	5G-E	1-2-3-4-5-6-7-8-9-0-11-12-13	100-104-108-112-116-132-136-140
Brazil: BR	2G-Z	5G-Z1	1-2-3-4-5-6-7-8-9-10-11-12-13	100- 104-112-116-120-124-128-132-136-140-149-153-157- 161-165

Country and Code	Outdoor Power Table 2.4-GHz	Outdoor Power Table 5-GHz	Supported Channels 2.4 GHz	Supported Channels 5 GHz
Brunei: BN	2G-V1	5G-M3	1-2-3-4-5-6-7-8-9-10 11-12-13	36-40-44-48-52-56-60-64- 116-120-124-128-132-136-140- 149-153-157-161-165
Cameroon: CM	2G-E	5G-E	1-2-3-4-5-6-7-8-9-10 11-12-13	100-104-108-112-116-132-136-140
Chile: CL	2G-A	5G-A3	1-2-3-4-5-6-7-8-9-10- 11	52-56-60-64-100-104- 108-112-116-120-124-128-132- 136 140-149-153-157-161-165
China: CN	2G-E	5G-H1	1-2-3-4-5-6-7-8-9-10 11-12-13	149-153-157-161-165
Colombia: CO	2G-A	5G-B2	1-2-3- 4-5-6-7-8-9-10- 11	36-40-44-48-52-56-60-64-100-108-112-116-120-124-128- 132 136-140-149-153-157-161-165
Cost Rica: CR	2G-A	5G-A4	1-2-3-4-5-6-7-8-9-10- 11	36-40-44-48-52-56-60-64- 100-104-108-112-116-120-124- 128-132-136-140-149-153-157-161-165
Dominican Republic: DO	2G-A	5G-A5	1-2-3-4-5-6-7-8-9-10- 11	36-40-44-48-52-58-60-64- 100-104-108-112- 116-120-124-128- 132-136-140-149-153-157-161-165
Ecuador: EC	2G-A	5G-A4	1-2-3-4-5-6-7-8-9-10-11	36-40-44-48-52-56-60-64- 100-104-108-112- 116-120-124-128- 132-136-140-149-153-157-161-165
Egypt: EG	2G-E	5G-C1	1-2-3-4-5-6-7-8-9-10- 11-12-13	36-40-44-48-52-56-60-64
El Salvador: SV	2G-A	5G-A	1-2-3-4-5-6-7-8-9-10- 11	52-56-60-64-149-153- 157-161-165
Ghana: GH	2G-E	5G-E	1-2-3-4-5-6-7-8-9-10- 11-12-13	100-104-108-112-116- 132-136-140
Gibraltar: GI	2G-E	5G-E	1-2-3-4-5- 6-7-8-9-10-11-12-13	100-104-108 112-116-132-136-140

Country and Code	Outdoor Power Table 2.4-GHz	Outdoor Power Table 5-GHz	Supported Channels 2.4 GHz	Supported Channels 5 GHz
Hong Kong: HK	2G-Z	5G-Z1	1-2-3-4-5-6-7-8-9-10- 11	100-104-108-112-116-120-124-128-132-136-140-149-153-157-161-165
India: IN	2G-Z	5G-D1	1-2-3-4-5-6-8-9-10-11	36-40-44-48-52-56-60- 100-104-108-112-116-124-128-132-136-140-144-153-157-161-165-169
Israel: IL	2G-E	5G-E	1-2-3-4-5-6-7-8-9-10-11-12-13	—
Jamaica: JM	2G-E	5G-Z	1-2-3-4-5-6-7-8-9-10- 11	52-56-60-64-100-104-108-112-116-120-124-128-132-136-140-153-161-165
Jordan: JO	2G-E	5G-E	1-2-3-4-5-6-7-8-9-10-11-12-13	36-40-44-52-56-60-64-100-104-108-112-116-120-124-128-132-136-140-149-153-157-161-165-169-172
Kenya: KE	2G-E	5G-E	1, 2, 3, 4, 5, 6, 7, 8, 9, 10, 11, 12, and 13	100-104-108-112-116-132-136-140
Korea: KR	2G-E	5G-K1	1-2-3-4-5-6-7-8-9-10-11-12-13	36-40-44-48-52-56-60 64-100-104-108-112-116-120-124-128-132-136-140-149-153-157-161-165
Lebanon: LB	2G-E	5G-E	1-2-3-4-5-6-7-8-9-10-11-12-13	100-104-108-112-116-132-136-140
Macedonia: MK	2G-E	5G-E	1-2-3-4-5-6-7-8-9-10-11-12-13	100-104-108-112-116-132-136-140
Macao: MO	2G-V1	5G-M3	1- 2-3-4-5-6-7-8-9-10-11-12-13	36-40-44-48-52-56-60-64-116-120-124-128-132-140-149-153-157-161-165
Malaysia: MY	2G-F	5G-C2	1-2-3-4-5-6-7-8-9-10-11-12-13	100-104-108-112-116-120-124-128-149-153-157-161-165

<b>Country and Code</b>	<b>Outdoor Power Table 2.4-GHz</b>	<b>Outdoor Power Table 5-GHz</b>	<b>Supported Channels 2.4 GHz</b>	<b>Supported Channels 5 GHz</b>
Mexico: MX	2G-A1	5G-A6	1-2-3-4-5-6-7-8-9-10 11-12-13	36-40-44-48-52-56-60- 64-149-153-157-161-165
Mongolia: MN	2G-E1	5G-E6	1-2-3-4-5-6-7-8-9-10 11-12-13	36-40-44-48-52-56-60-64 116-120-124-128- 132-140-149-153 157-161-165
Monaco: MC	2G-E	5G-E	1-2-3-4-5- 6-7-8-9-10-11-12-13	100-104-108 112-116-132-136-140
Montenegro: ME	2G-E	5G-E	1-2-3-4-5- 6-7-8-9-10-11-12-13	100-104-108 112-116-132-136-140
Oman: OM	2G-E	5G-E	1-2-3-4-5-6 7-8-9-10-11-12-13	100-104-108- 112-116-132-136-140
Pakistan: PK	2G-A1	5G-E7	1-2-3-4-5-6-7-8-9-10- 11	149-153-157-161
Panama: PA	2G-A	5G-B2	1-2-3-4-5-6-7-8-9-10-11	36-40-44-48-52-56-60- 64-100-104-108-112- 116-120-124-128 132-136-140-149-153-157-161-165
Paraguay: PY	2G-A	5G-Z1	1-2-3-4-5-6-7-8-9-10- 11	36-40-44-48-52-56-60- 64-100-104-108-112- 116-120-124-128- 132-136-140-149-153-157-161-165
Peru: PE	2G-A	5G-A	1-2-3-4-5-6-7-8-9-10- 11	56-60-64-100-104-108 112-116-132-136-140- 149-153-157 161-165
Philippines: PH	2G-E	5G-A7	1-2-3-4-5-6-7-8-9-10- 11	36-40-44-48-52-56-60-64 100-104-108-112-116-120-128-136 140-149-153-157-161-165
Rest of the World (Default)	2G-RW	5G-RW	1-2-3-4-5-6-7-8-9-10 11-12-13	—
Saudi Arabia: SA	2G-E	5G-M1	1-2-3-4-5-6-7-8-9-10 11-12-13	100-104-108-112-116 120-124-128-132-136-140
Serbia: RS	2G-E	5G-E	1-2-3-4-5- 6-7- 8-9-10-11-12-13	100-104-108- 112-116-132-136-140



Country and Code	Outdoor Power Table 2.4-GHz	Outdoor Power Table 5-GHz	Supported Channels 2.4 GHz	Supported Channels 5 GHz
Singapore: SG	2G-V1	5G-M3	1-2-3-4-5-6-7-8-9-10 11-12-13	36-40-44-48-52-56-60-64 116-120-124-128- 132-136-140-144 149-153-157-161-165
Slovak Republic: SK	2G-E	5G-E	1-2-3-4-5-6-7-8-9-10 11-12-13	100-104-108-112-116- 132-136-140
South Africa: ZA	2G-E	5G-Z	1-2-3-4-5-6-7-8-9-10- 11-12-13	100-104-108-112-116- 132-136-140-149-153- 157-161-165
Taiwan: TW	2G-Z	5G-B	1-2-3-4-5-6-7-8-9-10- 11	36-40-44-48-52-56-60-64- 100-104-108-112- 116-120-128-132 140-144-149-153-157-161-165
Thailand: TH	2G-E	5G-M3	1-2-3-4-5-6-7-8-9-10 11-12-13	36-40-44-48-52-56-60- 64- 116-120-124-128-132-136- 140-149- 153-157-161-165
Trinidad: TI	2G-A1	5G-M2	1-2-3-4-5-6-7-8-9-10- 11-12-13	100-104-108-112-116 124-128-132-136-140
Tunisia: TN	2G-E	5G-C1	1-2-3-4-5-6-7-8-9-10- 11-12-13	100-104-108-112-116- 132-136-140
Turkey: TR	2G-E	5G-E	1-2-3-4-5- 6-7-8-9-10-11-12-13	100-104-108- 112-116-132-136-140
United Arab Emirates: AE	2G-E	5G-E	1-2-3-4-5- 6-7-8 9-10-11-12-13	100-104-108- 112-116-132-136-140
United Kingdom: GB	2G-E	5G-E1	1-2-3-4-5-6-7-8-9-10- 11-12-13	100-104-108-112-116- 132-136-140
Venezuela: VE	2G-A	5G-A8	1-2-3-4-5-6-7-8-9-10- 11	36-40-44-48-52-56-60-64- 149-153-157-161-165
Vietnam: VN	2G-V1	5G-M2	1-2-3-4-5-6-7-8-9-10- 11-12-13	52-56-60-64-100-104- 112-116-124-128-132-136- 140-153- 157-161-165

## Configuring Country Code for Rest of the World (CLI)

This configuration is mandatory for the RoW.

Follow the procedure given below to configure the country code.

### Before you begin

- Before configuring the country code in the AP profile, ensure that the country is present in the global country list. If the configured country code is not present in the global list, the AP retains the previous country code configuration. In addition, the misconfigured operation triggers a default flag and brings the radio operations down.
- If the configured country code does not match with the regulatory domain of one or more radio slots, the AP retains the previous country code configuration. In addition, the misconfigured operation triggers a default flag and brings the radio operations down.

### Procedure

	Command or Action	Purpose
<b>Step 1</b>	<b>configure terminal</b>  <b>Example:</b> Device# configure terminal	Enters global configuration mode.
<b>Step 2</b>	<b>ap profile <i>ap-profile</i></b>  <b>Example:</b> Device(config)# ap profile default-ap-profile	Configures an AP profile and enters AP profile configuration mode.  <b>Note</b> The Cisco Embedded Wireless Controller (EWC) supports only the default AP profile.
<b>Step 3</b>	<b>country <i>code</i></b>  <b>Example:</b> Device(config-ap-profile)# country IN	Sets the country code. Use the <b>no</b> form of this command to delete the country code.  <b>Note</b> From Cisco IOS XE Bengaluru 17.6.1, the <b>ap country <i>code</i></b> command was modified. The <b>ap</b> keyword was removed. The modified command is <b>country <i>code</i></b> .
<b>Step 4</b>	<b>end</b>  <b>Example:</b> Device(config-ap-profile)# end	Returns to privileged EXEC mode.
<b>Step 5</b>	<b>show ap profile name default-ap-profile detailed</b>  <b>Example:</b> Device# show ap profile name default-ap-profile detailed	Displays the AP country code for the AP join profile.  If a country is not configured in the AP join profile, the country code will be displayed as “Not configured”.

	<b>Command or Action</b>	<b>Purpose</b>
	AP Profile Name : default-ap-profile Description : default ap profile . . . Country code : IN	The regulatory domain of RoW APs will be displayed as ROW.





## CHAPTER 20

# Sniffer Mode

---

- [Information about Sniffer, on page 267](#)
- [Prerequisites for Sniffer, on page 267](#)
- [Restrictions on Sniffer, on page 268](#)
- [How to Configure Sniffer, on page 268](#)
- [Verifying Sniffer Configurations, on page 270](#)
- [Examples for Sniffer Configurations and Monitoring, on page 271](#)

## Information about Sniffer

The controller enables you to configure an access point as a network “sniffer”, which captures and forwards all the packets on a particular channel to a remote machine that runs packet analyzer software. These packets contain information on time stamps, signal strength, packet sizes, and so on.

Sniffers allow you to monitor and record network activity, and detect problems.

The packet analyzer machine configured receives the 802.11 traffic encapsulated using the AiropEEK protocol from the controller management IP address with source port UDP/5555 and destination UDP/5000.

You must use **Clear** in AP mode to return the AP back to client-serving mode, for example the local mode or FlexConnect mode depending on the remote site tag configuration.

## Prerequisites for Sniffer

To perform sniffing, you need the following hardware and software:

- A dedicated access point—An access point configured as a sniffer cannot simultaneously provide wireless access service on the network. To avoid disrupting coverage, use an access point that is not part of your existing wireless network.
- A remote monitoring device—A computer capable of running the analyzer software.
- Software and supporting files, plug-ins, or adapters—Your analyzer software may require specialized files before you can successfully enable.

## Restrictions on Sniffer

- Supported third-party network analyzer software applications are as follows:
  - Wildpackets Omnipcap or Airopeek
  - AirMagnet Enterprise Analyzer
  - Wireshark
- The latest version of Wireshark can decode the packets by going to the Analyze mode. Select **decode as**, and switch UDP5555 to decode as PEEKREMOTE..
- Sniffer mode is not supported when the controller L3 interface is the Wireless Management Interface (WMI).
- When an AP or a radio operates in the sniffer mode, irrespective of its current channel width settings, the AP sniffs or captures only on the primary channel.

## How to Configure Sniffer

### Configuring an Access Point as Sniffer (GUI)

#### Procedure

---

- Step 1** Choose **Configuration** > **Wireless** > **Access Points**.
- Step 2** On the **General** tab, update the name of the AP. The AP name can be ASCII characters from 33 to 126, without leading and trailing spaces.
- Step 3** Specify the physical location where the AP is present.
- Step 4** Choose the **Admin Status** as **Enabled** if the AP is to be in enabled state.
- Step 5** Choose the mode for the AP as *Sniffer*.
- Step 6** In the **Tags** section, specify the appropriate policy, site, and RF tags that you created on the **Configuration** > **Tags & Profiles** > **Tags** page.
- Note** If the AP is in sniffer mode, you do not want to assign any tag.
- Step 7** Click **Update & Apply to Device**.
- Step 8** Choose the mode for the AP as **Clear** to return the AP back to the client-serving mode depending on the remote site tag configuration.
-

## Configuring an Access Point as Sniffer (CLI)

### Procedure

	Command or Action	Purpose
<b>Step 1</b>	<b>enable</b> <b>Example:</b> Device>enable	Enables privileged EXEC mode.
<b>Step 2</b>	<b>ap name <i>ap-name</i> mode sniffer</b> <b>Example:</b> Device# ap name access1 mode sniffer	Configures the access point as a sniffer.  Where,  <i>ap-name</i> is the name of the Cisco lightweight access point.  Use the <b>no</b> form of this command to disable the access point as a sniffer.

## Enabling or Disabling Sniffing on the Access Point (GUI)

### Before you begin

Change the access point AP mode to sniffer mode.

### Procedure

- 
- Step 1** Choose **Configuration > Wireless > Access Points**.
- Step 2** On the **Access Points** page, click the AP name from the 5 GHz or 2.4 GHz list.
- Step 3** In the **Edit Radios > Configure > Sniffer Channel Assignment** section, check the **Sniffer Channel Assignment** checkbox to enable.  
  
Uncheck the checkbox to disable sniffing on the access point.
- Step 4** From the **Sniff Channel** drop-down list, select the channel.
- Step 5** Enter the IP address in the **Sniffer IP** field.
- Step 6** **Note** The section will be enabled for editing only if the **Assignment Method** is set to **Custom**.

In the **RF Channel Assignment** section, configure the following:

- From the **RF Channel Width** drop-down list, select the channel width.
- From the **Assignment Method** drop-down list, choose the the type of assignment.

**Note** If you choose Custom, you must select a channel width and specify an RF channel number to the access point radio.

**Step 7** Click **Update & Apply to Device**.

## Enabling or Disabling Sniffing on the Access Point (CLI)

### Procedure

	Command or Action	Purpose
<b>Step 1</b>	<b>enable</b> <b>Example:</b> Device> enable	Enables privileged EXEC mode.
<b>Step 2</b>	<b>ap name <i>ap-name</i> dot11 {24ghz   5ghz   6ghz} slot 3 sniff channel server-ip-address</b> <b>Example:</b> Device# ap name access1 dot11 6ghz slot 3 sniff 1 9.9.48.5	Enables sniffing on the access point. <ul style="list-style-type: none"> <li><i>channel</i> is the valid channel to be sniffed. For 802.11a, the range is 36 to 165. For 802.11b, the range is 1 to 14.</li> <li><i>server-ip-address</i> is the IP address of the remote machine running Omnipcap, Airopeek, AirMagnet, or Wireshark software.</li> </ul>
<b>Step 3</b>	<b>ap name <i>ap-name</i> dot11 {24ghz   5ghz   6ghz} slot 3 no sniff channel server-ip-address</b> <b>Example:</b> Device# ap name access1 dot11 6ghz slot 3 sniff 1 9.9.48.5	Disables sniffing on the access point.

## Verifying Sniffer Configurations

Table 15: Commands for verifying sniffer configurations

Commands	Description
show ap name <i>ap-name</i> config dot11 {24ghz   5ghz   dual-band}	Displays the sniffing details.
show ap name <i>ap-name</i> config slot <i>slot-ID</i>	Displays the sniffing configuration details. <i>slot-ID</i> ranges from 0 to 3. All access points have slot 0 and 1.



## Examples for Sniffer Configurations and Monitoring

This example shows how to configure an access point as Sniffer:

```
Device# ap name access1 mode sniffer
```

This example shows how to enable sniffing on the access point:

```
Device# ap name access1 sniff dot11b 1 9.9.48.5
```

This example shows how to disable sniffing on the access point:

```
Device# ap name access1 no sniff dot11b
```

This example shows how to display the sniffing configuration details:

```
Device# show ap name access1 config dot11 24ghz
```

```
Device# show ap name access1 config slot 0
```





## CHAPTER 21

# Monitor Mode

---

- [Introduction to Monitor Mode, on page 273](#)
- [Enable Monitor Mode \(GUI\), on page 273](#)
- [Enable Monitor Mode \(CLI\), on page 274](#)

## Introduction to Monitor Mode

To optimize the monitoring and location calculation of RFID tags, you can enable tracking optimization on up to four channels within the 2.4-GHz band of an 802.11b/g/x access point radio. This feature allows you to scan only the channels on which tags are usually programmed to operate (such as channels 1, 6, and 11).



---

**Note** You can move an AP to a particular mode (sensor mode to local mode or flex mode) using the site tag with the corresponding mode. If the AP is not tagged to any mode, it will fall back to the mode specified in the default site tag.

---

You must use clear in AP mode to return the AP back to client-serving mode, for example the local mode or FlexConnect mode depending on the remote site tag configuration.

## Enable Monitor Mode (GUI)

### Procedure

---

- Step 1** Choose **Configuration** > **Wireless** > **Access Points**.
  - Step 2** In the **Access Points** page, expand the **All Access Points** section and click the name of the AP to edit.
  - Step 3** In the **Edit AP** page, click the **General** tab and from the **AP Mode** drop-down list, choose **Monitor**.
  - Step 4** Click **Update & Apply to Device**.
  - Step 5** Choose the mode for the AP as **clear** to return the AP back to the client-serving mode depending on the remote site tag configuration.
-

## Enable Monitor Mode (CLI)

### Procedure

	Command or Action	Purpose
<b>Step 1</b>	<b>ap name <i>ap-name</i> mode monitor</b> <b>Example:</b> Device# ap name 3602a mode monitor	Enables monitor mode for the access point.
<b>Step 2</b>	<b>ap name <i>ap-name</i> monitor tracking-opt</b> <b>Example:</b> Device# ap name 3602a monitor tracking-opt	Configures the access point to scan only the Dynamic Channel Assignment (DCA) channels supported by its country of operation.
<b>Step 3</b>	<b>ap name <i>ap-name</i> monitor-mode dot11b fast-channel [<i>first-channel second-channel third-channel fourth-channel</i> ]</b> <b>Example:</b> Device# ap name 3602a monitor dot11b 1 2 3 4	Chooses up to four specific 802.11b channels to be scanned by the access point.  In the United States, you can assign any value from 1 to 11 (inclusive) to the channel variable. Other countries support additional channels. You must assign at least one channel.  <b>Note</b> Use the <b>show ap dot11 24ghz channel</b> command to see the available channels.
<b>Step 4</b>	<b>show ap dot11 {24ghz   5ghz} channel</b> <b>Example:</b> Device# show ap dot11 5ghz channel	Shows configuration and statistics of 802.11a channel assignment.



## CHAPTER 22

# AP Priority

---

- [Failover Priority for Access Points](#), on page 275
- [Setting AP Priority \(GUI\)](#), on page 275
- [Setting AP Priority](#), on page 276

## Failover Priority for Access Points

Each controller has a defined number of communication ports for access points. When multiple controllers with unused access point ports are deployed on the same network and one controller fails, the dropped access points automatically poll for unused controller ports and associate with them.

The following are some guidelines for configuring failover priority for access points:

- You can configure your wireless network so that the backup controller recognizes a join request from a higher-priority access point, and if necessary, disassociates a lower-priority access point as a means to provide an available port.
- Failover priority is not in effect during the regular operation of your wireless network. It takes effect only if there are more associations requests to controller than the available AP capacity on the controller.
- AP priority is checked while connecting to the controller when the controller is in full scale or the primary controller fails, the APs fallback to the secondary controller.
- You can enable failover priority on your network and assign priorities to the individual access points.
- By default, all access points are set to priority level 1, which is the lowest priority level. Therefore, you need to assign a priority level only to those access points that warrant a higher priority.

## Setting AP Priority (GUI)

### Procedure

---

- Step 1** Choose **Configuration > Wireless > Access Points**.
- Step 2** Click the Access Point.
- Step 3** In the **Edit AP** dialog box, go to **High Availability** tab.

- Step 4** Choose the priority from the **AP failover priority** drop-down list.
- Step 5** Click **Update and Apply to Device**.

## Setting AP Priority



**Note** Priority of access points ranges from 1 to 4, with 4 being the highest.

### Procedure

	Command or Action	Purpose
<b>Step 1</b>	<b>ap name</b> <i>ap-name</i> <b>priority</b> <i>priority</i> <b>Example:</b> Device# ap name AP44d3.ca52.48b5 priority 1	Specifies the priority of an access point.
<b>Step 2</b>	<b>show ap config general</b> <b>Example:</b> Device# show ap config general	Displays common information for all access points.
<b>Step 3</b>	<b>show ap name</b> <i>ap-name</i> <b>config general</b> <b>Example:</b> Device# show ap name AP44d3.ca52.48b5 config general	Displays the configuration of a particular access point.



## CHAPTER 23

# FlexConnect

---

- [Information About FlexConnect, on page 277](#)
- [Guidelines and Restrictions for FlexConnect, on page 281](#)
- [Configuring a Site Tag, on page 285](#)
- [Configuring a Policy Tag \(CLI\), on page 286](#)
- [Attaching a Policy Tag and a Site Tag to an Access Point \(GUI\), on page 287](#)
- [Attaching Policy Tag and Site Tag to an AP \(CLI\), on page 287](#)
- [Linking an ACL Policy to the Defined ACL \(GUI\), on page 288](#)
- [Applying ACLs on FlexConnect, on page 289](#)
- [Configuring FlexConnect, on page 290](#)
- [Flex AP Local Authentication \(GUI\), on page 296](#)
- [Flex AP Local Authentication \(CLI\), on page 297](#)
- [Flex AP Local Authentication with External Radius Server, on page 299](#)
- [Configuration Example: FlexConnect with Central and Local Authentication , on page 302](#)
- [NAT-PAT for FlexConnect, on page 302](#)
- [Split Tunneling for FlexConnect, on page 306](#)
- [VLAN-based Central Switching for FlexConnect, on page 313](#)
- [OfficeExtend Access Points for FlexConnect, on page 315](#)
- [Proxy ARP, on page 320](#)
- [Overlapping Client IP Address in Flex Deployment, on page 321](#)
- [Flex Resilient with Flex and Bridge Mode Access Points, on page 324](#)

## Information About FlexConnect

FlexConnect is a wireless solution for branch office and remote office deployments. It enables customers to configure and control access points (AP) in a branch or remote office from the corporate office through a wide area network (WAN) link without deploying a controller in each office. The FlexConnect access points can also switch client data traffic locally and perform client authentication locally when their connection to the controller is lost. When they are connected to the controller, they can also send traffic back to the controller. FlexConnect access points support multiple SSIDs. In the connected mode, the FlexConnect access point can also perform local authentication.

Figure 15: FlexConnect Deployment

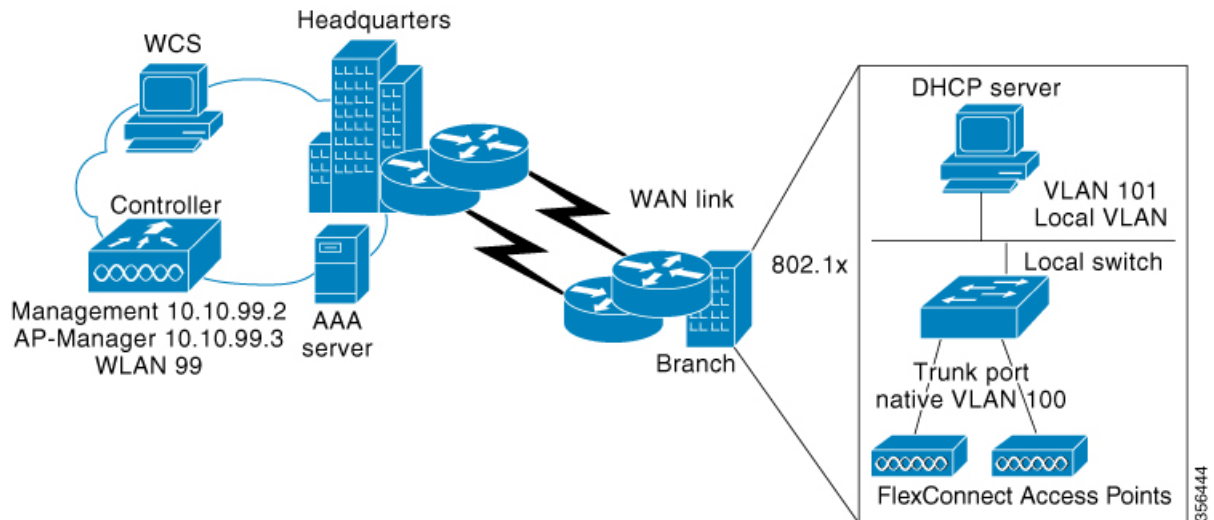

The controller software has a more robust fault tolerance methodology to FlexConnect access points. In previous releases, whenever a FlexConnect access point disassociates from a controller, it moves to the standalone mode. The clients that are centrally switched are disassociated. However, the FlexConnect access point continues to serve locally switched clients. When the FlexConnect access point rejoins the controller (or a standby controller), all the clients are disconnected and are authenticated again. This functionality has been enhanced and the connection between the clients and the FlexConnect access points are maintained intact and the clients experience seamless connectivity. When both the access point and the controller have the same configuration, the connection between the clients and APs is maintained.

After the client connection is established, the controller does not restore the original attributes of the client. The client username, current rate and supported rates, and listen interval values are reset to the default or new configured values only after the session timer expires.

The controller can send multicast packets in the form of unicast or multicast packets to an access point. In FlexConnect mode, an access point can receive only multicast packets.

In Cisco Catalyst 9800 Series Wireless Controller, you can define a flex connect site. A flex connect site can have a flex connect profile associate with it. You can have a maximum of 100 access points for each flex connect site.

FlexConnect access points support a 1-1 network address translation (NAT) configuration. They also support port address translation (PAT) for all features except true multicast. Multicast is supported across NAT boundaries when configured using the Unicast option. FlexConnect access points also support a many-to-one NAT or PAT boundary, except when you want true multicast to operate for all centrally switched WLANs.

Workgroup bridges and Universal Workgroup bridges are supported on FlexConnect access points for locally switched clients.

FlexConnect supports IPv6 clients by bridging the traffic to local VLAN, similar to an IPv4 operation. FlexConnect supports Client Mobility for a group of up to 100 access points.

An access point does not have to reboot when moving from local mode to FlexConnect mode and vice-versa.



## FlexConnect Authentication

When an access point boots up, it looks for a controller. If it finds one, it joins the controller, downloads the latest software image and configuration from the controller, and initializes the radio. It saves the downloaded configuration in nonvolatile memory for use in standalone mode.



---

**Note** Once the access point is rebooted after downloading the latest controller software, it must be converted to the FlexConnect mode.

---



---

**Note** 802.1X is not supported on the AUX port for Cisco Aironet 2700 series APs.

---

A FlexConnect access point can learn the controller IP address in one of these ways:

- If the access point has been assigned an IP address from a DHCP server, it can discover a controller through the regular CAPWAP or LWAPP discovery process.



---

**Note** OTAP is not supported.

---

- If the access point has been assigned a static IP address, it can discover a controller through any of the discovery process methods except DHCP option 43. If the access point cannot discover a controller through Layer 3 broadcast, we recommend DNS resolution. With DNS, any access point with a static IP address that knows of a DNS server can find at least one controller.
- If you want the access point to discover a controller from a remote network where CAPWAP or LWAPP discovery mechanisms are not available, you can use priming. This method enables you to specify (through the access point CLI) the controller to which the access point is to connect.



---

**Note** The LEDs on the access point change as the device enters different FlexConnect modes. See the hardware installation guide for your access point for information on LED patterns.

---

When a client associates to a FlexConnect access point, the access point sends all authentication messages to the controller and either switches the client data packets locally (locally switched) or sends them to the controller (centrally switched), depending on the WLAN configuration. With respect to client authentication (open, shared, EAP, web authentication, and NAC) and data packets, the WLAN can be in any one of the following states depending on the configuration and state of controller connectivity:



---

**Note** For the FlexConnect local switching, central authentication deployments, whenever passive client is enabled, the IP Learn timeout is disabled by default.

---

- central authentication, central switching—In this state, the controller handles client authentication, and all client data is tunneled back to the controller. This state is valid only in connected mode.

- central authentication, local switching—In this state, the controller handles client authentication, and the FlexConnect access point switches data packets locally. After the client authenticates successfully, the controller sends a configuration command with a new payload to instruct the FlexConnect access point to start switching data packets locally. This message is sent per client. This state is applicable only in connected mode.
- local authentication, local switching—In this state, the FlexConnect access point handles client authentication and switches client data packets locally. This state is valid in standalone mode and connected mode.

In connected mode, the access point provides minimal information about the locally authenticated client to the controller. The following information is not available to the controller:

- Policy type
- Access VLAN
- VLAN name
- Supported rates
- Encryption cipher

Local authentication is useful where you cannot maintain a remote office setup of a minimum bandwidth of 128 kbps with the round-trip latency no greater than 100 ms and the maximum transmission unit (MTU) no smaller than 576 bytes. In local authentication, the authentication capabilities are present in the access point itself. Local authentication reduces the latency requirements of the branch office.

- Notes about local authentication are as follows:
  - Guest authentication cannot be done on a FlexConnect local authentication-enabled WLAN.
  - Local RADIUS on the controller is not supported.
  - Once the client has been authenticated, roaming is only supported after the controller and the other FlexConnect access points in the group are updated with the client information.
- authentication down, switch down—In this state, the WLAN disassociates existing clients and stops sending beacon and probe requests. This state is valid in both standalone mode and connected mode.
- authentication down, local switching—In this state, the WLAN rejects any new clients trying to authenticate, but it continues sending beacon and probe responses to keep existing clients alive. This state is valid only in standalone mode.

When a FlexConnect access point enters standalone mode, WLANs that are configured for open, shared, WPA-PSK, or WPA2-PSK authentication enter the “local authentication, local switching” state and continue new client authentications. This configuration is also correct for WLANs that are configured for 802.1X, WPA-802.1X, WPA2-802.1X, or Cisco Centralized Key Management, but these authentication types require that an external RADIUS server be configured.

Other WLANs enter either the “authentication down, switching down” state (if the WLAN was configured for central switching) or the “authentication down, local switching” state (if the WLAN was configured for local switching).

When FlexConnect access points are connected to the controller (rather than in standalone mode), the controller uses its primary RADIUS servers and accesses them in the order specified on the RADIUS Authentication Servers page or in the **config radius auth add** CLI command (unless the server order is overridden for a

particular WLAN). However, to support 802.1X EAP authentication, FlexConnect access points in standalone mode need to have their own backup RADIUS server to authenticate clients.



**Note** A controller does not use a backup RADIUS server. The controller uses the backup RADIUS server in local authentication mode.

You can configure a backup RADIUS server for individual FlexConnect access points in standalone mode by using the controller CLI or for groups of FlexConnect access points in standalone mode by using either the GUI or CLI. A backup server configured for an individual access point overrides the backup RADIUS server configuration for a FlexConnect.

When web-authentication is used on FlexConnect access points at a remote site, the clients get the IP address from the remote local subnet. To resolve the initial URL request, the DNS is accessible through the subnet's default gateway. In order for the controller to intercept and redirect the DNS query return packets, these packets must reach the controller at the data center through a CAPWAP connection. During the web-authentication process, the FlexConnect access points allows only DNS and DHCP messages; the access points forward the DNS reply messages to the controller before web-authentication for the client is complete. After web-authentication for the client is complete, all the traffic is switched locally.

When a FlexConnect access point enters into a standalone mode, the following occurs:

- The access point checks whether it is able to reach the default gateway via ARP. If so, it will continue to try and reach the controller.

If the access point fails to establish the ARP, the following occurs:

- The access point attempts to discover for five times and if it still cannot find the controller, it tries to renew the DHCP on the ethernet interface to get a new DHCP IP.
- The access point will retry for five times, and if that fails, the access point will renew the IP address of the interface again, this will happen for three attempts.
- If the three attempts fail, the access point will fall back to the static IP and will reboot (only if the access point is configured with a static IP).
- Reboot is done to remove the possibility of any unknown error the access point configuration.

Once the access point reestablishes a connection with the controller, it disassociates all clients, applies new configuration information from the controller, and allows client connectivity again.

## Guidelines and Restrictions for FlexConnect

- FlexConnect mode can support only 16 VLANs per AP.
- You can deploy a FlexConnect access point with either a static IP address or a DHCP address. In the context of DHCP, a DHCP server must be available locally and must be able to provide the IP address for the access point at bootup.
- FlexConnect supports up to 4 fragmented packets, or a minimum 576-byte maximum transmission unit (MTU) WAN link.

- Round-trip latency must not exceed 300 milliseconds (ms) between the access point and the controller, and CAPWAP control packets must be prioritized over all other traffic. In scenarios where you cannot achieve the 300-ms round-trip latency, configure the access point to perform local authentication.
- Client connections are restored only for locally switched clients that are in the RUN state when the access point moves from standalone mode to connected mode. After the access point moves, the access point's radio is also reset.
- When multiple APs come from standalone mode to connected mode on FlexConnect and all the APs send the client entry in hybrid-REAP payload to the controller. In this scenario, the controller sends disassociation messages to the WLAN client. However, the WLAN client comes back successfully and joins the controller.
- When APs are in standalone mode, if a client roams to another AP, the source AP cannot determine whether the client has roamed or is just idle. So, the client entry at source AP will not be deleted until idle timeout.
- The configuration on the controller must be the same between the time the access point went into standalone mode and the time the access point came back to connected mode. Similarly, if the access point is falling back to a secondary or backup controller, the configuration between the primary and the secondary or backup controller must be the same.
- A newly connected access point cannot be booted in FlexConnect mode.
- FlexConnect mode requires that the client send traffic before learning the client's IPv6 address. Compared to in local mode where the controller learns the IPv6 address by snooping the packets during Neighbor Discovery to update the IPv6 address of the client.
- 802.11r fast transition roaming is not supported on APs operating in local authentication.
- The primary and secondary controllers for a FlexConnect access point must have the same configuration. Otherwise, the access point might lose its configuration, and certain features, such as WLAN overrides, VLANs, static channel number, and so on, might not operate correctly. In addition, make sure you duplicate the SSID of the FlexConnect access point and its index number on both controllers.
- If you configure a FlexConnect access point with a syslog server configured on the access point, after the access point is reloaded and the native VLAN other than 1, at the time of initialization, a few syslog packets from the access point are tagged with VLAN ID 1.
- MAC filtering is not supported on FlexConnect access points in standalone mode. However, MAC filtering is supported on FlexConnect access points in connected mode with local switching and central authentication. Also, Open SSID, MAC Filtering, and RADIUS NAC for a locally switched WLAN with FlexConnect access points is a valid configuration, where MAC is checked by Cisco ISE.
- FlexConnect does not display any IPv6 client addresses in the Client Detail window.
- FlexConnect access points with locally switched WLANs cannot perform IP source guard and prevent ARP spoofing. For centrally switched WLANs, the wireless controller performs IP source guard and ARP spoofing.
- To prevent ARP spoofing attacks in FlexConnect APs with local switching, we recommend that you use ARP inspection.
- Proxy ARP for VM clients (with any wireless host) does not work since the client includes many IP addresses for the same MAC. To avoid this issue, disable the ARP-caching option in the Flex profile.

- When you enable local switching on policy profile for FlexConnect APs, the APs perform local switching. However, for the APs in local mode, central switching is performed.

In a scenario where the roaming of a client between FlexConnect mode AP and Local mode AP is not supported, the client may not get the correct IP address due to VLAN difference after the move. Also, L2 and L3 roaming between FlexConnect mode AP and Local mode AP are not supported.

FlexConnect local switching is not supported on Cisco Aironet Cisco 1810T and 1815T (Teleworker) Access Points.

- Cisco Centralized Key Management (CCKM) is not supported in FlexConnect standalone mode. Hence, CCKM enabled client will not be able to connect when AP is in FlexConnect standalone mode.
- For Wi-Fi Protected Access Version 2 (WPA2) in FlexConnect standalone mode or local authentication in connected mode or Cisco Centralized Key Management fast roaming in connected mode, only Advanced Encryption Standard (AES) is supported.
- For Wi-Fi Protected Access (WPA) in FlexConnect standalone mode or local-auth in connected mode or Cisco Centralized Key Management fast-roaming in connected mode, only Temporal Key Integrity Protocol (TKIP) is supported.
- WPA2 with TKIP and WPA with AES is not supported in standalone mode, local-auth in connected mode, and Cisco Centralized Key Management fast-roaming in connected mode.
- Only open, WPA (PSK and 802.1x), and WPA2 (AES) authentication is supported on the Cisco Aironet 1830 Series and 1850 Series APs.
- Only 802.11r fast-transition roaming is supported on the Cisco Aironet 1830 Series and 1850 Series APs.
- AVC on locally switched WLANs is supported on second-generation APs.
- Local authentication fallback is not supported when a user is not available in the external RADIUS server.
- For WLANs configured for FlexConnect APs in local switching and local authentication, synchronization of dot11 client information is supported.
- DNS override is not supported on the Cisco Aironet 1830 Series and 1850 Series APs.
- The Cisco Aironet 1830 Series and 1850 Series APs do not support IPv6. However, a wireless client can pass IPv6 traffic across these APs.
- VLAN group is not supported in Flex mode under flex-profile.
- Configuring maximum number of allowed media streams on individual client or radio is not supported in FlexConnect mode.
- The WLAN client association limit will not work when the AP is in FlexConnect mode (connected or standalone) and is performing local switching and local authentication.
- A local switching client on FlexConnect mode will not get IP address for RLAN profile on the Cisco Aironet 1810 Series AP.
- Standard ACL is not supported on FlexConnect AP mode.
- IPv6 RADIUS Server is not configurable for FlexConnect APs. Only IPv4 configuration is supported.
- In Flex mode, IPv4 ACLs configured on WLAN gets pushed to AP but IPv6 ACLs does not.

- The client delete reason counters that are a part of the **show wireless stats client delete reasons** command, will be incremented only when the client record entry persists for join.

For example, when an AP in the FlexConnect mode performs local authentication with ACL mismatch, then the AP deletes the client, and the controller does not create any client record.

- Cisco Centralized Key Management (CCKM) is supported in wave 1 APs in FlexConnect when you use local association.
- If the client roams from one AP to another and the roaming is successful, the following occurs:
  - The client does not send any traffic to the new AP.
  - The client's state is IP LEARN pending.
  - The client is deauthenticated after 180 seconds, if there is no traffic for the entire duration. In case the DHCP Required flag is set, the deauthentication occurs after 60 seconds.
- Using custom VLANs under the policy profile of the FlexConnect locally switched WLANs stops the SSID broadcast. In such scenarios, run the **shut** and **no shut** commands on the policy profile to start the SSID broadcast.

SSIDs are broadcasted when you:

- Perform VLAN name to id mapping under FlexConnect profile and map the custom VLAN name under the policy profile.
- Use VLAN id or standard VLAN name, for example, VLANxxxx.
- In the FlexConnect mode, the group temporal key (GTK) timer is set to 3600 seconds by default on Cisco Wave 2 AP, and this value cannot be reconfigured.
- When FlexConnect AP sends CAPWAP discovery request and the FlexConnect AP does not get any response after 18 CAPWAP discovery requests, the AP performs DHCP renew.



---

**Note** The clients must not disconnect when AP performs DHCP renew.

---

- For Flex mode deployments, local association configured policy profiles are not supported at a given time on the WLAN. Only the local association command must be enabled.
- From Cisco IOS XE Amsterdam 17.1.1 release onwards, the police rate per client in the flex connect APs in the controller, is represented as **rate\_out** for Ingress (input) and **rate\_in** for Egress (output). To verify police rate on the flex AP, use the **show rate-limit client** command.
- FlexConnect APs do not forward the DHCP packets after Change of Authorization (CoA) and change of VLANs using 802.1X encryption. You must disconnect the client from the WLAN and reconnect the client to enable the client to get an IP address in the second VLAN.
- Cisco Wave 2 and Catalyst Wi-Fi6 APs in FlexConnect local switching mode do not support Layer2(PSK, 802.1X) + Layer3(LWA, CWA, redirection-based posturing) + Dynamic AAA override + NAC.
- Network access control (NAC) is not supported in FlexConnect local authentication.
- Multicast traffic on an AAA overridden VLAN is not supported. Using this configuration may result in potential traffic leaks between VLANs.

# Configuring a Site Tag

## Procedure

	Command or Action	Purpose
<b>Step 1</b>	<b>configure terminal</b> <b>Example:</b> Device# configure terminal	Enters global configuration mode.
<b>Step 2</b>	<b>wireless tag site <i>site-name</i></b> <b>Example:</b> Device(config)# wireless tag site default-site-tag	Configures site tag and enters site tag configuration mode.
<b>Step 3</b>	<b>flex-profile <i>flex-profile-name</i></b> <b>Example:</b> Device(config-site-tag)# flex-profile rr-xyz-flex-profile	Maps a flex profile to a site tag.
<b>Step 4</b>	<b>ap-profile <i>ap-profile</i></b> <b>Example:</b> Device(config-site-tag)# ap-profile xyz-ap-profile	Assigns an AP profile to the wireless site.
<b>Step 5</b>	<b>description <i>site-tag-name</i></b> <b>Example:</b> Device(config-site-tag)# description "default site tag"	Adds a description for the site tag.
<b>Step 6</b>	<b>no local-site</b> <b>Example:</b> Device(config-site-tag)# no local-site	Moves the access point to FlexConnect mode.
<b>Step 7</b>	<b>end</b> <b>Example:</b> Device(config-site-tag)# end	Saves the configuration, exits the configuration mode, and returns to privileged EXEC mode.
<b>Step 8</b>	<b>show wireless tag site summary</b> <b>Example:</b> Device# show wireless tag site summary	(Optional) Displays the summary of site tags.

## Configuring a Policy Tag (CLI)

Follow the procedure given below to configure a policy tag:

### Procedure

	Command or Action	Purpose
<b>Step 1</b>	<b>enable</b> <b>Example:</b> Device> enable	Enables privileged EXEC mode. <ul style="list-style-type: none"> <li>• Enter your password if prompted.</li> </ul>
<b>Step 2</b>	<b>configure terminal</b> <b>Example:</b> Device# configure terminal	Enters global configuration mode.
<b>Step 3</b>	<b>wireless tag policy <i>policy-tag-name</i></b> <b>Example:</b> Device(config-policy-tag)# wireless tag policy default-policy-tag	Configures policy tag and enters policy tag configuration mode. <b>Note</b> When performing LWA, the clients connected to a controller gets disconnected intermittently before session timeout.
<b>Step 4</b>	<b>description <i>description</i></b> <b>Example:</b> Device(config-policy-tag)# description "default-policy-tag"	Adds a description to a policy tag.
<b>Step 5</b>	<b>remote-lan <i>name</i> policy <i>profile-policy-name</i></b> <b>{<i>ext-module</i>  <i>port-id</i> }</b> <b>Example:</b> Device(config-policy-tag)# remote-lan rr-xyz-rlan-aa policy rr-xyz-rlan-policy1 port-id 2	Maps a remote-LAN profile to a policy profile.
<b>Step 6</b>	<b>wlan <i>wlan-name</i> policy <i>profile-policy-name</i></b> <b>Example:</b> Device(config-policy-tag)# wlan rr-xyz-wlan-aa policy rr-xyz-policy-1	Maps a policy profile to a WLAN profile.
<b>Step 7</b>	<b>end</b> <b>Example:</b> Device(config-policy-tag)# end	Exits policy tag configuration mode, and returns to privileged EXEC mode.
<b>Step 8</b>	<b>show wireless tag policy summary</b> <b>Example:</b>	(Optional) Displays the configured policy tags.



	Command or Action	Purpose
	Device# show wireless tag policy summary	<b>Note</b> To view detailed information about a policy tag, use the <b>show wireless tag policy detailed</b> <i>policy-tag-name</i> command.

## Attaching a Policy Tag and a Site Tag to an Access Point (GUI)

### Procedure

- Step 1** Choose **Configuration > Wireless > Access Points**.
- Step 2** Click the **Access Point** name.
- Step 3** Go to the **Tags** section.
- Step 4** Choose the **Policy Tag** from the **Policy** drop-down list.
- Step 5** Choose the **Site Tag** from the **Site** drop-down list.
- Step 6** Click **Update and Apply to Device**.

## Attaching Policy Tag and Site Tag to an AP (CLI)

Follow the procedure given below to attach a policy tag and a site tag to an AP:

### Procedure

	Command or Action	Purpose
<b>Step 1</b>	<b>configure terminal</b> <b>Example:</b> Device# configure terminal	Enters global configuration mode.
<b>Step 2</b>	<b>ap mac-address</b> <b>Example:</b> Device(config)# ap F866.F267.7DFB	Configures a Cisco AP and enters AP profile configuration mode. <b>Note</b> The <i>mac-address</i> should be a wired mac address.
<b>Step 3</b>	<b>policy-tag policy-tag-name</b> <b>Example:</b> Device(config-ap-tag)# policy-tag rr-xyz-policy-tag	Maps a policy tag to the AP.
<b>Step 4</b>	<b>site-tag site-tag-name</b> <b>Example:</b>	Maps a site tag to the AP.

	Command or Action	Purpose
	Device(config-ap-tag)# site-tag rr-xyz-site	
<b>Step 5</b>	<b>rf-tag</b> <i>rf-tag-name</i> <b>Example:</b> Device(config-ap-tag)# rf-tag rf-tag1	Associates the RF tag.
<b>Step 6</b>	<b>end</b> <b>Example:</b> Device(config-ap-tag)# end	Saves the configuration, exits configuration mode, and returns to privileged EXEC mode.
<b>Step 7</b>	<b>show ap tag summary</b> <b>Example:</b> Device# show ap tag summary	(Optional) Displays AP details and the tags associated to it.
<b>Step 8</b>	<b>show ap name &lt;ap-name&gt; tag info</b> <b>Example:</b> Device# show ap name ap-name tag info	(Optional) Displays the AP name with tag information.
<b>Step 9</b>	<b>show ap name &lt;ap-name&gt; tag detail</b> <b>Example:</b> Device# show ap name ap-name tag detail	(Optional) Displays the AP name with tag details.

## Linking an ACL Policy to the Defined ACL (GUI)

### Procedure

- 
- Step 1** Choose **Configuration > Tags & Profiles > Flex**.
  - Step 2** Click **Add**.
  - Step 3** In the **General** tab, enter the **Name** of the Flex Profile. The name can be ASCII characters from 32 to 126, without leading and trailing spaces.
  - Step 4** In the **Policy ACL** tab, click **Add**.
  - Step 5** Select the ACL from the **ACL Name** drop-down list and click **Save**.
  - Step 6** Click **Apply to Device**.
-

# Applying ACLs on FlexConnect

## Procedure

	Command or Action	Purpose
<b>Step 1</b>	<b>configure terminal</b> <b>Example:</b> Device# configure terminal	Enters global configuration mode.
<b>Step 2</b>	<b>wireless profile flex <i>flex-profile-name</i></b> <b>Example:</b> Device(config)# wireless profile flex Flex-profile-1	Configures a wireless flex profile and enters wireless flex profile configuration mode.
<b>Step 3</b>	<b>acl-policy <i>acl-policy-name</i></b> <b>Example:</b> Device(config-wireless-flex-profile)# acl-policy ACL1	Configures an ACL policy. Access control lists (ACLs) perform packet filtering to control the movement of packets through a network.
<b>Step 4</b>	<b>exit</b> <b>Example:</b> Device(config-wireless-flex-profile-acl)# exit	Returns to wireless flex profile configuration mode.
<b>Step 5</b>	<b>native-vlan-id</b> <b>Example:</b> Device(config-wireless-flex-profile)# native-vlan-id 25	Configures native vlan-id information.
<b>Step 6</b>	<b>vlan <i>vlan-name</i></b> <b>Example:</b> Device(config-wireless-flex-profile)# vlan-name VLAN0169	Configures a VLAN.
<b>Step 7</b>	<b>acl <i>acl-name</i></b> <b>Example:</b> Device(config-wireless-flex-profile-vlan)# acl ACL1	Configures an ACL for the interface.
<b>Step 8</b>	<b>vlan-id <i>vlan-id</i></b> <b>Example:</b> Device(config-wireless-flex-profile-vlan)# vlan-id 169	Configures VLAN information.

# Configuring FlexConnect

## Configuring a Switch at a Remote Site

### Procedure

- Step 1** Attach the access point, which will be enabled for FlexConnect, to a trunk or access port on the switch.
- Note** The sample configuration in this procedure shows the FlexConnect access point connected to a trunk port on the switch.

- Step 2** The following example configuration shows you how to configure a switch to support a FlexConnect access point.

In this sample configuration, the FlexConnect access point is connected to the trunk interface FastEthernet 1/0/2 with native VLAN 100. The access point needs IP connectivity on the native VLAN. The remote site has local servers or resources on VLAN 101. A DHCP pool is created in the local switch for both the VLANs in the switch. The first DHCP pool (NATIVE) is used by the FlexConnect access point, and the second DHCP pool (LOCAL-SWITCH) is used by the clients when they associate to a WLAN that is locally switched.

```
.
.
.
ip dhcp pool NATIVE
  network 209.165.200.224 255.255.255.224
  default-router 209.165.200.225
  dns-server 192.168.100.167
!
ip dhcp pool LOCAL-SWITCH
  network 209.165.201.224 255.255.255.224
  default-router 209.165.201.225
  dns-server 192.168.100.167
!
interface Gig1/0/1
  description Uplink port
  no switchport
  ip address 209.165.202.225 255.255.255.224
!
interface Gig1/0/2
  description the Access Point port
  switchport trunk encapsulation dot1q
  switchport trunk native vlan 100
  switchport trunk allowed vlan 101
  switchport mode trunk
!
interface Vlan100
  ip address 209.165.200.225 255.255.255.224
!
interface Vlan101
  ip address 209.165.201.225 255.255.255.224
end
!
```

.

.

## Configuring the Controller for FlexConnect

You can configure the controller for FlexConnect in two environments:

- Centrally switched WLAN
- Locally switched WLAN

The controller configuration for FlexConnect consists of creating centrally switched and locally switched WLANs. This table shows three WLAN scenarios.

**Table 16: WLAN Scenarios**

WLAN	Security	Authentication	Switching	Interface Mapping (GUEST VLAN)
Employee	WPA1+WPA2	Central	Central	Management (centrally switched GUEST VLAN)
Employee-local	WPA1+WPA2 (PSK)	Local	Local	101 (locally switched GUEST VLAN)
Guest-central	Web authentication	Central	Central	Management (centrally switched GUEST VLAN)
Employee-local-auth	WPA1+WPA2	Local	Local	101 (locally switched VLAN)

## Configuring Local Switching in FlexConnect Mode (GUI)

### Procedure

- 
- Step 1** Choose **Configuration > Tags & Profiles > Policy**.
  - Step 2** On the **Policy Profile** page, click the name of a policy profile to edit it or click **Add** to create a new one.
  - Step 3** In the **Add/Edit Policy Profile** window that is displayed, uncheck the **Central Switching** check box.
  - Step 4** Click **Update & Apply to Device**.
-

## Configuring Local Switching in FlexConnect Mode (CLI)

### Procedure

	Command or Action	Purpose
<b>Step 1</b>	<b>configure terminal</b>  <b>Example:</b> Device# <b>configure terminal</b>	Enters global configuration mode.
<b>Step 2</b>	<b>wireless profile policy <i>profile-policy</i></b>  <b>Example:</b> Device(config)# <b>wireless profile policy rr-xyz-policy-1</b>	Configures WLAN policy profile and enters the wireless policy configuration mode.
<b>Step 3</b>	<b>no central switching</b>  <b>Example:</b> Device(config-wireless-policy)# <b>no central switching</b>	Configures the WLAN for local switching.
<b>Step 4</b>	<b>end</b>  <b>Example:</b> Device(config)# <b>end</b>	Returns to privileged EXEC mode. Alternatively, you can also press <b>Ctrl-Z</b> to exit global configuration mode.

## Configuring Central Switching in FlexConnect Mode (GUI)

### Before you begin

Ensure that the policy profile is configured. If the policy profile is not configured, see *Configuring a Policy Profile (GUI)* section.

### Procedure

- 
- Step 1** Choose **Configuration > Tags & Profiles > Policy**.
  - Step 2** On the **Policy Profile** page, select a policy.
  - Step 3** In the **Edit Policy Profile** window, in General Tab, use the slider to enable or disable **Central Switching**.
  - Step 4** Click **Update & Apply to Device**.
-

## Configuring Central Switching in FlexConnect Mode

### Procedure

	Command or Action	Purpose
<b>Step 1</b>	<b>configure terminal</b> <b>Example:</b> Device# <code>configure terminal</code>	Enters global configuration mode.
<b>Step 2</b>	<b>wireless profile policy <i>profile-policy</i></b> <b>Example:</b> Device(config)# <code>wireless profile policy rr-xyz-policy-1</code>	Configures WLAN policy profile and enters the wireless policy configuration mode.
<b>Step 3</b>	<b>central switching</b> <b>Example:</b> Device(config-wireless-policy)# <code>central switching</code>	Configures the WLAN for central switching.
<b>Step 4</b>	<b>end</b> <b>Example:</b> Device(config)# <code>end</code>	Returns to privileged EXEC mode. Alternatively, you can also press <b>Ctrl-Z</b> to exit global configuration mode.

## Configuring an Access Point for FlexConnect

For more information, see *Configuring a Site Tag (CLI)* topic in New Configuration Model chapter.

## Configuring an Access Point for Local Authentication on a WLAN (GUI)

### Procedure

- 
- Step 1** Choose **Configuration > Tags & Profiles > Policy**.
  - Step 2** In the **Policy Profile** page, select a policy profile name. The **Edit Policy Profile** window is displayed.
  - Step 3** In the General tab, deselect **Central Authentication** check box.
  - Step 4** Click **Update & Apply to Device**.
-

## Configuring an Access Point for Local Authentication on a WLAN (CLI)

### Procedure

	Command or Action	Purpose
<b>Step 1</b>	<b>configure terminal</b>  <b>Example:</b> Device# <code>configure terminal</code>	Enters global configuration mode.
<b>Step 2</b>	<b>wireless profile policy <i>profile-policy</i></b>  <b>Example:</b> Device(config)# <code>wireless profile policy rr-xyz-policy-1</code>	Configures WLAN policy profile and enters the wireless policy configuration mode.
<b>Step 3</b>	<b>no central authentication</b>  <b>Example:</b> Device(config-wireless-policy)# <code>no central authentication</code>	Configures the WLAN for local authentication.
<b>Step 4</b>	<b>end</b>  <b>Example:</b> Device(config)# <code>end</code>	Returns to privileged EXEC mode. Alternatively, you can also press <b>Ctrl-Z</b> to exit global configuration mode.

## Connecting Client Devices to WLANs

Follow the instructions for your client device to create profiles to connect to the WLANs you created, as specified in the [#unique\\_373](#).

In the example scenarios (see [#unique\\_373](#)), there are three profiles on the client:

1. To connect to the *employee* WLAN, create a client profile that uses WPA or WPA2 with PEAP-MSCHAPV2 authentication. After the client is authenticated, the client is allotted an IP address by the management VLAN of the controller.
2. To connect to the *local-employee* WLAN, create a client profile that uses WPA or WPA2 authentication. After the client is authenticated, the client is allotted an IP address by VLAN 101 on the local switch.
3. To connect to the *guest-central* WLAN, create a client profile that uses open authentication. After the client is authenticated, the client is allocated an IP address by VLAN 101 on the network local to the access point. After the client connects, a local user can enter any HTTP address in the web browser. The user is automatically directed to the controller to complete the web authentication process. When the web login window appears, the user should enter the username and password.



# Configuring FlexConnect Ethernet Fallback

## Information About FlexConnect Ethernet Fallback

You can configure an AP to shut down its radio when the Ethernet link is not operational. When the Ethernet link comes back to operational state, you can configure the AP to set its radio back to operational state. This feature is independent of the AP being in connected or standalone mode. When the radios are shut down, the AP does not broadcast the WLANs, and therefore, the clients cannot connect to the AP, either through first association or through roaming.

## Configuring FlexConnect Ethernet Fallback

### Before you begin

This feature is not applicable to APs with multiple ports.

### Procedure

	Command or Action	Purpose
<b>Step 1</b>	<b>configure terminal</b> <b>Example:</b> Device# configure terminal	Enters global configuration mode.
<b>Step 2</b>	<b>wireless profile flex <i>flex-profile-name</i></b> <b>Example:</b> Device(config)# wireless profile flex test	Configures a wireless flex profile and enters wireless flex profile configuration mode.
<b>Step 3</b>	<b>fallback-radio-shut</b> <b>Example:</b> Device(config-wireless-flex-profile)# fallback-radio-shut	Enables radio interface shutdown.
<b>Step 4</b>	<b>end</b> <b>Example:</b> Device(config-wireless-flex-profile)# end	Exits configuration mode and returns to privileged EXEC mode.
<b>Step 5</b>	<b>show wireless profile flex detailed <i>flex-profile-name</i></b> <b>Example:</b> Device# show wireless profile flex detailed test	(Optional) Displays detailed information about the selected profile.

# Flex AP Local Authentication (GUI)

## Procedure

---

**Step 1** Choose **Configuration** > **Tags & Profiles** > **Flex**.

**Step 2** In the **Flex** page, click the name of the **Flex Profile** or click **Add** to create a new one.

**Step 3** In the **Add/Edit Flex Profile** window that is displayed, click the **Local Authentication** tab.

When local authentication and association is enabled in Access Point with Flex mode, the following occurs:

- AP handles the authentication.
- AP handles the rejection of client joins (in Mobility).

**Note** The controller does not increment statistics when AP rejects client association.

**Step 4** Choose the server group from the **RADIUS Server Group** drop-down list.

**Step 5** Use the **Local Accounting RADIUS Server Group** drop down to select the RADIUS server group.

**Step 6** Check the **Local Client Roaming** check box to enable client roaming.

**Step 7** Choose the profile from the **EAP Fast Profile** drop-down list.

**Step 8** Choose to enable or disable the following:

- LEAP: Lightweight Extensible Authentication Protocol (LEAP) is an 802.1X authentication type for wireless LANs and supports strong mutual authentication between the client and a RADIUS server using a logon password as the shared secret. It provides dynamic per-user, per-session encryption keys.
- PEAP: Protected Extensible Authentication Protocol (PEAP) is a protocol that encapsulates the Extensible Authentication Protocol (EAP) within an encrypted and authenticated Transport Layer Security (TLS) tunnel.
- TLS: Transport Layer Security (TLS) is a cryptographic protocol that provide communications security over a computer network.
- RADIUS: Remote Authentication Dial-In User Service (RADIUS) is a networking protocol that provides centralized Authentication, Authorization, and Accounting (AAA or Triple A) management for users who connect and use a network service.

**Step 9** In the **Users** section, click **Add**.

**Step 10** Enter username and password details and click **Save**.

**Step 11** Click **Save & Apply to Device**.

---

# Flex AP Local Authentication (CLI)



**Note** The Cisco Catalyst 9800 Series Wireless Controller + FlexConnect local authentication + AP acting as RADIUS are not supported on Cisco COS and IOS APs.

## Procedure

	Command or Action	Purpose
<b>Step 1</b>	<b>aaa new-model</b> <b>Example:</b> Device(config)# aaa new-model	Creates a AAA authentication model.
<b>Step 2</b>	<b>aaa session-id common</b> <b>Example:</b> Device(config)# aaa session-id common	Ensures that all the session IDs information that is sent out from the RADIUS group for a given call are identical.
<b>Step 3</b>	<b>dot1x system-auth-control</b> <b>Example:</b> Device(config)# dot1x system-auth-control	Enables system authorization control for the RADIUS group.
<b>Step 4</b>	<b>eap profile name</b> <b>Example:</b> Device(config)# eap profile aplocal-test	Creates an EAP profile.
<b>Step 5</b>	<b>method fast</b> <b>Example:</b> Device(config-eap-profile)# method fast	Configures the FAST method on the profile.
<b>Step 6</b>	<b>exit</b> <b>Example:</b> Device(config-radius-server)# exit	Returns to configuration mode.
<b>Step 7</b>	<b>wireless profile flex flex-profile</b> <b>Example:</b> Device(config)# wireless profile flex default-flex-profile	Configures the flex policy.
<b>Step 8</b>	<b>local-auth ap eap-fast name</b> <b>Example:</b> Device(config-wireless-flex-profile)# local-auth ap eap-fast aplocal-test	Configures EAP-FAST profile details.

	Command or Action	Purpose
<b>Step 9</b>	<b>local-auth ap leap</b> <b>Example:</b> Device(config-wireless-flex-profile)# local-auth ap leap	Configures the LEAP method.
<b>Step 10</b>	<b>local-auth ap peap</b> <b>Example:</b> Device(config-wireless-flex-profile)# local-auth ap peap	Configures the PEAP method.
<b>Step 11</b>	<b>local-auth ap username <i>username</i></b> <b>Example:</b> Device(config-wireless-flex-profile)# local-auth ap username test1 test1	Configures username and password.
<b>Step 12</b>	<b>local-auth ap username <i>username password</i></b> <b>Example:</b> Device(config-wireless-flex-profile)# local-auth ap username test2 test2	Configures another username and password.
<b>Step 13</b>	<b>exit</b> <b>Example:</b> Device(config-wireless-flex-profile)# exit	Returns to configuration mode.
<b>Step 14</b>	<b>wireless profile policy <i>policy-profile</i></b> <b>Example:</b> Device(config)# wireless profile policy default-policy-profile	Configures profile policy.
<b>Step 15</b>	<b>shutdown</b> <b>Example:</b> Device(config-wireless-policy)# shutdown	Disables the policy profile.
<b>Step 16</b>	<b>no central authentication</b> <b>Example:</b> Device(config)# no central authentication	Disables central (controller) authentication.
<b>Step 17</b>	<b>vlan-id <i>vlan-id</i></b> <b>Example:</b> Device(config)# vlan-id 54	Configures VLAN name or VLAN ID.
<b>Step 18</b>	<b>no shutdown</b> <b>Example:</b> Device(config)# no shutdown	Enables the configuration.

# Flex AP Local Authentication with External Radius Server

In this mode, an access point handles client authentication and switches client data packets locally. This state is valid in standalone mode and connected mode.

## Procedure

	Command or Action	Purpose
<b>Step 1</b>	<b>aaa new-model</b> <b>Example:</b> Device(config)# aaa new-model	Creates a AAA authentication model.
<b>Step 2</b>	<b>aaa session-id common</b> <b>Example:</b> Device(config)# aaa session-id common	Ensures that all the session ID's information that is sent out, from the RADIUS group for a given call are identical.
<b>Step 3</b>	<b>dot1x system-auth-control</b> <b>Example:</b> Device(config)# dot1x system-auth-control	Enables the system authorization control for the RADIUS group.
<b>Step 4</b>	<b>radius server <i>server-name</i></b> <b>Example:</b> Device(config)# radius server Test-SERVER1	Specifies the RADIUS server name.  <b>Note</b> To authenticate clients with freeradius over RADSEC, you should generate an RSA key longer than 1024 bit. Use the <b>crypto key generate rsa general-keys exportable label <i>name</i></b> command to achieve this.  Do not configure <b>key-wrap</b> option under the radius server and radius server group, as it may lead to clients getting stuck in authentication state.
<b>Step 5</b>	<b>address {ipv4   ipv6} ip address {auth-port port-number   acct-port port-number }</b> <b>Example:</b> Device(config-radius-server)# address ipv4 124.3.50.62 auth-port 1112 acct-port 1113  Device(config-radius-server)# address ipv6 2001:DB8:0:20::15 auth-port 1812 acct-port 1813	Specifies the primary RADIUS server parameters.

	Command or Action	Purpose
<b>Step 6</b>	<b>key string</b> <b>Example:</b> <pre>Device(config-radius-server)# key test123</pre>	Specifies the authentication and encryption key used between the device and the RADIUS daemon running on the RADIUS server.  <b>Note</b> The maximum number of characters allowed for the shared secret is 63.
<b>Step 7</b>	<b>radius server server-name</b> <b>Example:</b> <pre>Device(config)# radius server Test-SERVER2</pre>	Specifies the RADIUS server name.
<b>Step 8</b>	<b>address {ipv4   ipv6} ip address {auth-port port-number   acct-port port-number }</b> <b>Example:</b> <pre>Device(config-radius-server)# address ipv4 124.3.52.62 auth-port 1112 acct-port 1113  Device(config-radius-server)# address ipv6 2001:DB8:0:21::15 auth-port 1812 acct-port 1813</pre>	Specifies the secondary RADIUS server parameters.
<b>Step 9</b>	<b>key string</b> <b>Example:</b> <pre>Device(config-radius-server)# key test113</pre>	Specifies the authentication and encryption key used between the device and the RADIUS daemon running on the RADIUS server.
<b>Step 10</b>	<b>exit</b> <b>Example:</b> <pre>Device(config-radius-server)# exit</pre>	Returns to configuration mode.
<b>Step 11</b>	<b>aaa group server radius server-group</b> <b>Example:</b> <pre>Device(config)# aaa group server radius aaa_group_name</pre>	Creates a RADIUS server group identification.  <b>Note</b> <i>server-group</i> refers to the server group name. The valid range is from 1 to 32 alphanumeric characters.
<b>Step 12</b>	<b>radius server server-name</b> <b>Example:</b> <pre>Device(config)# radius server Test-SERVER1</pre>	Specifies the RADIUS server name.
<b>Step 13</b>	<b>radius server server-name</b> <b>Example:</b> <pre>Device(config-radius-server)# radius server Test-SERVER2</pre>	Specifies the RADIUS server name.

	Command or Action	Purpose
<b>Step 14</b>	<b>exit</b> <b>Example:</b> Device(config-radius-server)# exit	Exit from RADIUS server configuration mode.
<b>Step 15</b>	<b>wireless profile flex</b> <i>flex-profile</i> <b>Example:</b> Device(config)# wireless profile flex default-flex-profile	Creates a new flex policy.
<b>Step 16</b>	<b>local-auth radius-server-group</b> <i>server-group</i> <b>Example:</b> Device(config-wireless-flex-profile)# local-auth radius-server-group aaa_group_name	Configures the authentication server group name.
<b>Step 17</b>	<b>exit</b> <b>Example:</b> Device(config-wireless-flex-profile)# exit	Returns to configuration mode.
<b>Step 18</b>	<b>wireless profile policy</b> <i>policy-profile</i> <b>Example:</b> Device(config)# wireless profile policy default-policy-profile	Configures a WLAN policy profile.
<b>Step 19</b>	<b>shutdown</b> <b>Example:</b> Device(config-wireless-policy)# shutdown	Disables a policy profile.
<b>Step 20</b>	<b>no central authentication</b> <b>Example:</b> Device(config-wireless-policy)# no central authentication	Disables central (controller) authentication.
<b>Step 21</b>	<b>vlan-id</b> <i>vlan-id</i> <b>Example:</b> Device(config-wireless-policy)# vlan-id 54	Configures a VLAN name or VLAN Id.
<b>Step 22</b>	<b>no shutdown</b> <b>Example:</b> Device(config-wireless-policy)# no shutdown	Enables the configuration.

# Configuration Example: FlexConnect with Central and Local Authentication

To see configuration example on how to configure a controller for FlexConnect central and local authentication, see the [FlexConnect Configuration with Central and Local Authentication on Catalyst 9800 Wireless Controllers](#) document.

## NAT-PAT for FlexConnect

If you want to use a central DHCP server to service clients across remote sites, NAT-PAT should be enabled. An AP translates the traffic coming from a client and replaces the client's IP address with its own IP address.



**Note** You must enable local switching, central DHCP, and DHCP required using the (**ipv4 dhcp required**) command to enable NAT and PAT.

## Configuring NAT-PAT for a WLAN or a Remote LAN

### Creating a WLAN

Follow the steps given here to create a WLAN.

#### Procedure

	Command or Action	Purpose
<b>Step 1</b>	<b>configure terminal</b> <b>Example:</b> Device# configure terminal	Enters global configuration mode.
<b>Step 2</b>	<b>wlan wlan-name wlan-id SSID-name</b> <b>Example:</b> Device(config)# wlan wlan-demo 1 ssid-demo	Enters the WLAN configuration sub-mode. <ul style="list-style-type: none"> <li>• <i>wlan-name</i>—Enter the profile name. The range is from 1 to 32 alphanumeric characters.</li> <li>• <i>wlan-id</i>—Enter the WLAN ID. The range is from 1 to 512.</li> <li>• <i>SSID-name</i>—Enter the Service Set Identifier (SSID) for this WLAN. If the SSID is not specified, the WLAN profile name is set as the SSID.</li> </ul>



	Command or Action	Purpose
		<b>Note</b> If you have already configured WLAN, enter <code>wlan wlan-name</code> command.
<b>Step 3</b>	<b>no shutdown</b> <b>Example:</b> Device(config-wlan)# no shutdown	Shut down the WLAN.
<b>Step 4</b>	<b>end</b> <b>Example:</b> Device(config-wlan)# end	Returns to privileged EXEC mode. Alternatively, you can also press <b>Ctrl-Z</b> to exit global configuration mode.

## Configuring a Wireless Profile Policy and NAT-PAT (GUI)

### Procedure

- 
- Step 1** Choose **Configuration > Tags & Profiles > Policy**.
  - Step 2** Click **Add**.
  - Step 3** In the **General** tab, enter the **Name** of the policy.
  - Step 4** Disable the **Central Switching** toggle button.
  - Step 5** Enable the **Central DHCP** toggle button.
  - Step 6** Enable the **Flex NAT/PAT** toggle button.
  - Step 7** In the **Advanced** tab, under the **DHCP Settings**, check the **IPv4 DHCP Required** check box.
  - Step 8** Click **Apply to Device**.
- 

## Configuring a Wireless Profile Policy and NAT-PAT

Follow the procedure given below to configure a wireless profile policy and NAT-PAT:

### Procedure

	Command or Action	Purpose
<b>Step 1</b>	<b>configure terminal</b> <b>Example:</b> Device# configure terminal	Enters global configuration mode.
<b>Step 2</b>	<b>wireless profile policy <i>profile-policy</i></b> <b>Example:</b> Device(config)# wireless profile policy nat-enabled-policy	Configures the policy profile for NAT.

	Command or Action	Purpose
<b>Step 3</b>	<b>no central switching</b> <b>Example:</b> Device(config-wireless-policy)# no central switching	Configures the WLAN for local switching.
<b>Step 4</b>	<b>ipv4 dhcp required</b> <b>Example:</b> Device(config-wireless-policy)# ipv4 dhcp required	Configures the DHCP parameters for WLAN.
<b>Step 5</b>	<b>central dhcp</b> <b>Example:</b> Device(config-wireless-policy)# central dhcp	Configures the central DHCP for locally switched clients.
<b>Step 6</b>	<b>flex nat-pat</b> <b>Example:</b> Device(config-wireless-policy)# flex nat-pat	Enables NAT-PAT.
<b>Step 7</b>	<b>no shutdown</b> <b>Example:</b> Device(config-wireless-policy)# no shutdown	Enables policy profile.
<b>Step 8</b>	<b>end</b> <b>Example:</b> Device(config-wireless-policy)# end	Returns to privileged EXEC mode. Alternatively, you can also press <b>Ctrl-Z</b> to exit global configuration mode.

## Mapping a WLAN to a Policy Profile

Follow the procedure given below to map a WLAN to a policy profile:

### Procedure

	Command or Action	Purpose
<b>Step 1</b>	<b>configure terminal</b> <b>Example:</b> Device# configure terminal	Enters global configuration mode.
<b>Step 2</b>	<b>wireless tag policy <i>policy-tag-name</i></b> <b>Example:</b> Device(config)# wireless tag policy demo-tag	Configures a policy tag and enters policy tag configuration mode.

	Command or Action	Purpose
<b>Step 3</b>	<b>wlan</b> <i>wlan-name</i> <b>policy</b> <i>profile-policy-name</i> <b>Example:</b> Device(config-policy-tag)# wlan wlan-demo policy nat-enabled-policy	Maps a policy profile to a WLAN profile.
<b>Step 4</b>	<b>end</b> <b>Example:</b> Device(config-policy-tag)# end	Returns to privileged EXEC mode. Alternatively, you can also press <b>Ctrl-Z</b> to exit global configuration mode.

## Configuring a Site Tag

Follow the procedure given below to configure a site tag:

### Procedure

	Command or Action	Purpose
<b>Step 1</b>	<b>configure terminal</b> <b>Example:</b> Device# configure terminal	Enters global configuration mode.
<b>Step 2</b>	<b>wireless tag site</b> <i>site-name</i> <b>Example:</b> Device(config)# wireless tag site flex-site	Configures a site tag and enters site tag configuration mode.
<b>Step 3</b>	<b>no local-site</b> <b>Example:</b> Device(config-site-tag)# no local-site	Moves an access point to FlexConnect mode.
<b>Step 4</b>	<b>end</b> <b>Example:</b> Device(config-site-tag)# end	Returns to privileged EXEC mode. Alternatively, you can also press <b>Ctrl-Z</b> to exit global configuration mode.

## Attaching a Policy Tag and a Site Tag to an Access Point (GUI)

### Procedure

- Step 1** Choose **Configuration > Wireless > Access Points**.
- Step 2** Click the **Access Point** name.
- Step 3** Go to the **Tags** section.
- Step 4** Choose the **Policy Tag** from the **Policy** drop-down list.
- Step 5** Choose the **Site Tag** from the **Site** drop-down list.

**Step 6** Click **Update and Apply to Device**.

## Attaching a Policy Tag and a Site Tag to an Access Point

Follow the procedure given below to attach a policy tag and a site tag to an access point:

### Procedure

	Command or Action	Purpose
<b>Step 1</b>	<b>configure terminal</b> <b>Example:</b> Device# configure terminal	Enters global configuration mode.
<b>Step 2</b>	<b>ap mac-address</b> <b>Example:</b> Device(config)# ap F866.F267.7DFB	Configures Cisco APs and enters ap-tag configuration mode.
<b>Step 3</b>	<b>policy-tag policy-tag-name</b> <b>Example:</b> Device(config-ap-tag)# policy-tag demo-tag	Maps a policy tag to the AP.
<b>Step 4</b>	<b>site-tag site-tag-name</b> <b>Example:</b> Device(config-ap-tag)# site-tag flex-site	Maps a site tag to the AP.
<b>Step 5</b>	<b>end</b> <b>Example:</b> Device(config-ap-tag)# end	Returns to privileged EXEC mode.

## Split Tunneling for FlexConnect

If a client that connects over a WAN link that is associated with a centrally switched WLAN has to send traffic to a device present in the local site, this traffic should be sent over CAPWAP to the controller, and the same traffic is sent back to the local site either over CAPWAP or with the help of some off-band connectivity.

This process consumes WAN link bandwidth unnecessarily. To avoid this, you can use the Split Tunneling feature, which allows the traffic sent by a client to be classified based on the packet contents. The matching packets are locally switched and the rest of the traffic is centrally switched. The traffic that is sent by the client that matches the IP address of the device present in the local site can be classified as locally switched traffic, and the rest of the traffic as centrally switched.

To configure local split tunneling on an AP, ensure that you have enabled DHCP Required on the policy profile using the (**ipv4 dhcp required**) command. This ensures that the client that is associating with the split WLAN does DHCP.



---

**Note** Apple iOS clients need option 6 (DNS) to be set in DHCP offer for split tunneling to work.

---



- Note**
- FlexConnect split tunneling (vlan-based central switching for FlexConnect) on auto-anchor deployment is not supported.
  - Split tunneling does not work on RLAN clients. When the **split-tunnel** option is enabled on RLAN, traffic denied by the split tunnel ACL is not translated based on the IP address, instead the traffic is sent back to the controller through CAPWAP.
  - URL filter must not be configured with wildcard URLs such as \* and \*.\*
- 

## Configuring Split Tunneling for a WLAN or Remote LAN

### Defining an Access Control List for Split Tunneling (GUI)

#### Procedure

---

- Step 1** Choose **Configuration** > **Security** > **ACL**.
- Step 2** Click **Add**.
- Step 3** In the **Add ACL Setup** dialog box, enter the **ACL Name**.
- Step 4** Choose the ACL type from the **ACL Type** drop-down list.
- Step 5** Under the **Rules** settings, enter the **Sequence** number and choose the **Action** as either **permit** or **deny**.
- Step 6** Choose the required source type from the **Source Type** drop-down list.
- a) If you choose the source type as **Host**, then you must enter the **Host Name/IP**.
  - b) If you choose the source type as **Network**, then you must specify the **Source IP** address and **Source Wildcard** mask.
- Step 7** Check the **Log** check box if you want the logs.
- Step 8** Click **Add**.
- Step 9** Add the rest of the rules and click **Apply to Device**.
- 

### Defining an Access Control List for Split Tunneling

Follow the procedure given below to define an Access Control List (ACL) for split tunneling:

**Procedure**

	<b>Command or Action</b>	<b>Purpose</b>
<b>Step 1</b>	<b>configure terminal</b> <b>Example:</b> Device# configure terminal	Enters global configuration mode.
<b>Step 2</b>	<b>ip access-list extended <i>name</i></b> <b>Example:</b> Device(config)# ip access-list extended split_mac_acl	Defines an extended IPv4 access list using a name, and enters access-list configuration mode.
<b>Step 3</b>	<b>deny ip any host <i>hostname</i></b> <b>Example:</b> Device(config-ext-nacl)# deny ip any host 9.9.2.21	Allows the traffic to switch centrally.
<b>Step 4</b>	<b>permit ip any any</b> <b>Example:</b> Device(config-ext-nacl)# permit ip any any	Allows the traffic to switch locally.
<b>Step 5</b>	<b>end</b> <b>Example:</b> Device(config-ext-nacl)# end	Exits configuration mode and returns to privileged EXEC mode.

**Linking an ACL Policy to the Defined ACL**

Follow the procedure given below to link an ACL policy to the defined ACL:

**Procedure**

	<b>Command or Action</b>	<b>Purpose</b>
<b>Step 1</b>	<b>configure terminal</b> <b>Example:</b> Device# configure terminal	Enters global configuration mode.
<b>Step 2</b>	<b>wireless profile flex <i>flex-profile</i></b> <b>Example:</b> Device(config)# wireless profile flex flex-profile	Configures the Flex profile and enters flex profile configuration mode.
<b>Step 3</b>	<b>acl-policy <i>acl policy name</i></b> <b>Example:</b> Device(config-wireless-flex-profile)# acl-policy split_mac_acl	Configures an ACL policy for the defined ACL.

	Command or Action	Purpose
<b>Step 4</b>	<b>end</b> <b>Example:</b> Device(config-wireless-flex-profile)# end	Exits configuration mode and returns to privileged EXEC mode.

## Creating a WLAN

Follow the procedure given below to create a WLAN.

### Procedure

	Command or Action	Purpose
<b>Step 1</b>	<b>configure terminal</b> <b>Example:</b> Device# configure terminal	Enters global configuration mode.
<b>Step 2</b>	<b>wlan wlan-name wlan-id SSID-name</b> <b>Example:</b> Device(config)# wlan wlan-demo 1 ssid-demo	Specifies the WLAN name and ID: <ul style="list-style-type: none"> <li>• <i>wlan-name</i>—Enter the profile name. The range is from 1 to 32 alphanumeric characters.</li> <li>• <i>wlan-id</i>—Enter the WLAN ID. The range is from 1 to 512.</li> <li>• <i>SSID-name</i>—Enter the Service Set Identifier (SSID) for this WLAN. If the SSID is not specified, the WLAN profile name is set as the SSID.</li> </ul>
<b>Step 3</b>	<b>no shutdown</b> <b>Example:</b> Device(config-wlan)# no shutdown	Enables the WLAN.
<b>Step 4</b>	<b>end</b> <b>Example:</b> Device(config-wlan)# end	Returns to privileged EXEC mode. Alternatively, you can also press <b>Ctrl-Z</b> to exit global configuration mode.

## Configuring a Wireless Profile Policy and a Split MAC ACL Name (GUI)

### Procedure

- Step 1** Choose **Configuration > Tags & Profiles > Policy**.
- Step 2** Click **Add**.
- Step 3** In the **General** tab, enter the **Name** of the policy.

- Step 4** Enable the **Central Switching** toggle button.
- Step 5** Enable the **Central DHCP** toggle button.
- Step 6** In the **Advanced** tab, under the **DHCP** settings, check the **IPv4 DHCP Required** check box and enter the **DHCP Server IP Address**.
- Step 7** Under the **WLAN Flex Policy** settings, choose the split MAC ACL from the **Split MAC ACL** drop-down list.
- Step 8** Click **Apply to Device**.

## Configuring a Wireless Profile Policy and a Split MAC ACL Name

Follow the procedure given below to configure a wireless profile policy and a split MAC ACL name:

### Procedure

	Command or Action	Purpose
<b>Step 1</b>	<b>configure terminal</b>  <b>Example:</b> Device# configure terminal	Enters global configuration mode.
<b>Step 2</b>	<b>wireless profile policy <i>profile-policy</i></b>  <b>Example:</b> Device(config)# wireless profile policy split-tunnel-enabled-policy	Configures a WLAN policy profile and enters wireless policy configuration mode.
<b>Step 3</b>	<b>flex split-mac-acl <i>split-mac-acl-name</i></b>  <b>Example:</b> Device(config-wireless-policy)# flex split-mac-acl split_mac_acl	Configures a split MAC ACL name.  <b>Note</b> You should use the same ACL name for linking the flex and the policy profile.
<b>Step 4</b>	<b>central switching</b>  <b>Example:</b> Device(config-wireless-policy)# central switching	Configures WLAN for central switching.
<b>Step 5</b>	<b>central dhcp</b>  <b>Example:</b> Device(config-wireless-policy)# central dhcp	Enables central DHCP for centrally switched clients.
<b>Step 6</b>	<b>ipv4 dhcp required</b>  <b>Example:</b> Device(config-wireless-policy)# ipv4 dhcp required	Configures the DHCP parameters for a WLAN.
<b>Step 7</b>	<b>ipv4 dhcp server <i>ip_address</i></b>  <b>Example:</b>	Configures the override IP address of the DHCP server.



	Command or Action	Purpose
	Device(config-wireless-policy)# ipv4 dhcp server 9.1.0.100	
<b>Step 8</b>	<b>no shutdown</b>  <b>Example:</b> Device(config-wireless-policy)# no shutdown	Enables a policy profile.

## Mapping a WLAN to a Policy Profile (GUI)

### Procedure

- 
- Step 1** Choose **Configuration > Tags & Profiles > Tags**.
  - Step 2** Click **Add**.
  - Step 3** Enter the **Name** of the Tag Policy.
  - Step 4** Under **WLAN-POLICY Maps** tab, click **Add**.
  - Step 5** Choose the WLAN Profile from the **WLAN Profile** drop-down list.
  - Step 6** Choose the Policy Profile from the **Policy Profile** drop-down list.
  - Step 7** Click the **Tick** Icon.
  - Step 8** Click **Apply to Device**.
- 

## Mapping WLAN to a Policy Profile

Follow the procedure given below to map WLAN to a policy profile.

### Procedure

	Command or Action	Purpose
<b>Step 1</b>	<b>configure terminal</b>  <b>Example:</b> Device# configure terminal	Enters global configuration mode.
<b>Step 2</b>	<b>wireless tag policy <i>policy-tag-name</i></b>  <b>Example:</b> Device(config)# wireless tag policy split-tunnel-enabled-tag	Configures a policy tag and enters policy tag configuration mode.
<b>Step 3</b>	<b>wlan <i>wlan-name</i> policy <i>profile-policy-name</i></b>  <b>Example:</b> Device(config-policy-tag)# wlan wlan-demo policy split-tunnel-enabled-policy	Maps a policy profile to a WLAN profile.

	Command or Action	Purpose
<b>Step 4</b>	<b>end</b> <b>Example:</b> Device(config-policy-tag)# end	Returns to privileged EXEC mode. Alternatively, you can also press <b>Ctrl-Z</b> to exit global configuration mode.

## Configuring a Site Tag

Follow the procedure given below to configure a site tag:

### Procedure

	Command or Action	Purpose
<b>Step 1</b>	<b>configure terminal</b> <b>Example:</b> Device# configure terminal	Enters global configuration mode.
<b>Step 2</b>	<b>wireless tag site <i>site-name</i></b> <b>Example:</b> Device(config)# wireless tag site flex-site	Configures a site tag and enters site tag configuration mode.
<b>Step 3</b>	<b>no local-site</b> <b>Example:</b> Device(config-site-tag)# no local-site	<b>Local site</b> is not configured on the site tag.
<b>Step 4</b>	<b>flex-profile <i>flex-profile-name</i></b> <b>Example:</b> Device(config-site-tag)# flex-profile flex-profile	Configures a flex profile.
<b>Step 5</b>	<b>end</b> <b>Example:</b> Device(config-site-tag)# end	Returns to privileged EXEC mode. Alternatively, you can also press <b>Ctrl-Z</b> to exit global configuration mode.

## Attaching a Policy Tag and Site Tag to an Access Point

Follow the procedure given below to attach a policy tag and site tag to an access point.

### Procedure

	Command or Action	Purpose
<b>Step 1</b>	<b>configure terminal</b> <b>Example:</b> Device# configure terminal	Enters global configuration mode.

	Command or Action	Purpose
<b>Step 2</b>	<b>ap</b> <i>ethernet-mac-address</i> <b>Example:</b> Device(config)# ap 188b.9dbe.6eac	Configures an AP and enters ap tag configuration mode.
<b>Step 3</b>	<b>policy-tag</b> <i>policy-tag-name</i> <b>Example:</b> Device(config-ap-tag)# policy-tag split-tunnel-enabled-tag	Maps a policy tag to an AP.
<b>Step 4</b>	<b>site-tag</b> <i>site-tag-name</i> <b>Example:</b> Device(config-ap-tag)# site-tag flex-site	Maps a site tag to an AP.
<b>Step 5</b>	<b>end</b> <b>Example:</b> Device(config-ap-tag)# end	Returns to privileged EXEC mode. Alternatively, you can also press <b>Ctrl-Z</b> to exit global configuration mode.

## VLAN-based Central Switching for FlexConnect

In FlexConnect local switching, if the VLAN definition is not available in an access point, the corresponding client does not pass traffic. This scenario is applicable when the AAA server returns the VLAN as part of client authentication.

When a WLAN is locally switched in flex and a VLAN is configured on the AP side, the traffic is switched locally. When a VLAN is not defined in an AP, the VLAN drops the packet.

When VLAN-based central switching is enabled, the corresponding AP tunnels the traffic back to the controller. The controller then forwards the traffic to its corresponding VLAN.



### Note

- For VLAN-based central switching, ensure that VLAN is defined on the controller.
- VLAN-based central switching is not supported by mac filter.
- For local switching, ensure that VLAN is defined on the policy profile and FlexConnect profile.
- VLAN-based central switching with central web authentication enabled in Flex profile is not supported.

## Configuring VLAN-based Central Switching (GUI)

### Procedure

- Step 1** Choose **Configuration > Tags & Profiles > Policy**.

- Step 2** Click the name of the policy profile.
- Step 3** In the **Edit Policy Profile** window, perform these tasks:
- Set **Central Switching** to **Disabled** state.
  - Set **Central DHCP** to **Disabled** state.
  - Set **Central Authentication** to **Enabled** state.
- Step 4** Click the **Advanced** tab.
- Step 5** Under **AAA Policy**, check the **Allow AAA Override** check box to enable AAA override.
- Step 6** Under **WLAN Flex Policy**, check the **VLAN Central Switching** check box, to enable VLAN-based central switching on the policy profile.
- Step 7** Click **Update & Apply to Device**.

## Configuring VLAN-based Central Switching (CLI)

Follow the procedure given below to configure VLAN-based central switching.

### Procedure

	Command or Action	Purpose
<b>Step 1</b>	<b>configure terminal</b>  <b>Example:</b> Device# configure terminal	Enters global configuration mode.
<b>Step 2</b>	<b>wireless profile policy <i>profile-policy</i></b>  <b>Example:</b> Device(config)# wireless profile policy default-policy-profile	Configures a wireless policy profile.
<b>Step 3</b>	<b>no central switching</b>  <b>Example:</b> Device(config-wireless-policy)# no central switching	Configures a WLAN for local switching.
<b>Step 4</b>	<b>no central dhcp</b>  <b>Example:</b> Device(config-wireless-policy)# no central dhcp	Configures local DHCP mode, where the DHCP is performed in an AP.
<b>Step 5</b>	<b>central authentication</b>  <b>Example:</b> Device(config-wireless-policy)# central authentication	Configures a WLAN for central authentication.
<b>Step 6</b>	<b>aaa-override</b>  <b>Example:</b>	Configures AAA policy override.

	Command or Action	Purpose
	<code>Device(config-wireless-policy)# aaa-override</code>	
<b>Step 7</b>	<b>flex vlan-central-switching</b>  <b>Example:</b> <code>Device(config-wireless-policy)# flex vlan-central-switching</code>	Configures VLAN-based central switching.
<b>Step 8</b>	<b>end</b>  <b>Example:</b> <code>Device(config-wireless-policy)# end</code>	Returns to privileged EXEC mode.
<b>Step 9</b>	<b>show wireless profile policy detailed default-policy-profile</b>  <b>Example:</b> <code>Device# show wireless profile policy detailed default-policy-profile</code>	(Optional) Displays detailed information of the policy profile.

## OfficeExtend Access Points for FlexConnect

A Cisco OfficeExtend access point (OEAP) provides secure communications from a controller to a Cisco AP at a remote location, seamlessly extending the corporate WLAN over the Internet to an employee's residence. A user's experience at the home office is exactly the same as it would be at the corporate office. Datagram Transport Layer Security (DTLS) encryption between an access point and the controller ensures that all communications have the highest level of security.



**Note** Preconfigure the controller IP for a zero-touch deployment with OEAP. All other home users can use the same access point to connect for home use by configuring the local SSID from AP.



**Note** In releases prior to Cisco IOS XE Amsterdam 17.3.2, when an AP is converted to OEAP, the local DHCP server on the AP is enabled by default. If the DHCP server on home router has a similar configuration, a network conflict occurs and AP will not be able to join back to the controller. In such a scenario, we recommend that you change the default DHCP server on the Cisco AP using OEAP GUI.



**Note** For OEAP, when configuration changes are made from the OEAP GUI to the following: Radio Status, Radio Interface Status, 802.11 n-mode, 802.11 ac-mode, Bandwidth, and Channel Selection (2.4 GHz or 5 GHz), CAPWAP should be restarted for the configuration sync to take place between the AP and the controller. During this interval, the AP GUI may not respond until the AP rejoins the controller. We recommend that you wait for the AP to rejoin the controller (for about 1-2 minutes), before you make further changes from the OEAP GUI.



**Note** In Cisco OfficeExtend access point (Cisco OEAP), if the OEAP local DHCP server is enabled and the user configures DNS IP from OEAP GUI, the wireless and wired clients connected to Cisco OEAP will receive that IP as DNS server IP in DHCP ACK.

## Configuring OfficeExtend Access Points

Follow the procedure given below to configure OfficeExtend access points.

### Procedure

	Command or Action	Purpose
<b>Step 1</b>	<b>configure terminal</b> <b>Example:</b> Device# configure terminal	Enters global configuration mode.
<b>Step 2</b>	<b>wireless profile flex <i>flex-profile-name</i></b> <b>Example:</b> Device(config)# wireless profile flex test	Configures a wireless flex profile and enters wireless flex profile configuration mode.
<b>Step 3</b>	<b>office-extend</b> <b>Example:</b> Device(config-wireless-flex-profile)# office-extend	Enables the OfficeExtend AP mode for a FlexConnect AP.
<b>Step 4</b>	<b>end</b> <b>Example:</b> Device(config-wireless-flex-profile)# end	Exits configuration mode and returns to privileged EXEC mode.  <b>Note</b> After creating a flex profile, ensure that OEAP is in flex connect mode and mapped to its corresponding site tag.  OfficeExtend is disabled by default. To clear the access point's configuration and return it to the factory-defaults, use the <b>clear ap config <i>cisco-ap</i></b> command.

## Disabling OfficeExtend Access Point

Follow the procedure given below to disable an OfficeExtend access point.

**Procedure**

	<b>Command or Action</b>	<b>Purpose</b>
<b>Step 1</b>	<b>configure terminal</b> <b>Example:</b> Device# configure terminal	Enters global configuration mode.
<b>Step 2</b>	<b>wireless profile flex <i>flex-profile-name</i></b> <b>Example:</b> Device(config)# wireless profile flex test	Configures a wireless flex profile and enters wireless flex profile configuration mode.
<b>Step 3</b>	<b>no office-extend</b> <b>Example:</b> Device(config-wireless-flex-profile)# no office-extend	Disables OfficeExtend AP mode for a FlexConnect AP.
<b>Step 4</b>	<b>end</b> <b>Example:</b> Device(config-wireless-flex-profile)# end	Exits configuration mode and returns to privileged EXEC mode.

## Support for OEAP Personal SSID

### Information About OEAP Personal SSID Support

The Cisco OfficeExtend Access Point supports personal SSID. This enables a local home client to use the same OfficeExtend Access Point for local networking and internet connectivity. With the help of the OEAP personal SSID feature, you can enable or disable personal SSID, enable or disable Datagram Transport Layer Security (DTLS) encryption between an access point and the controller, and enable rogue detection, using the knobs that are present on the AP profile page in the GUI. The local network access and DTLS encryption are enabled by default. The configurations described in this chapter is applicable for OEAP or for APs in the OEAP mode.

### Configuring OEAP Personal SSID (GUI)

**Procedure**

- 
- Step 1** Choose **Configuration > AP Tags & Profiles > AP Join**.  
The **AP Join Profile** section displays all the AP Join profiles.
- Step 2** To edit the configuration details of an AP Join profile, select APs in the OEAP mode.  
The **Edit AP Join Profile** window is displayed.
- Step 3** In the **General** tab, under the **OfficeExtend AP Configuration** section, configure the following:
- Check the **Local Access** check box to enable the local network. By default, **Local Access** is enabled. After the AP joins the controller using AP join profile where local access is enabled, the AP will not

broadcast the default personal SSID. Since the local access is enabled, you can login to the AP GUI and configure the personal SSID.

- b) Check the **Link Encryption** check box to enable data DTLS. By default, **Link Encryption** is enabled.
- c) Check the **Rogue Detection** check box to enable rogue detection. Rogue detection is disabled by default for OfficeExtend APs because these APs, deployed in a home environment, are likely to detect a large number of rogue devices.

## Configuring OEAP Personal SSID (CLI)

### Procedure

	Command or Action	Purpose
<b>Step 1</b>	<b>configure terminal</b> <b>Example:</b> Device# configure terminal	Enters global configuration mode.
<b>Step 2</b>	<b>ap profile <i>ap-profile</i></b> <b>Example:</b> Device(config)# ap profile <i>ap-profile</i>	Configures an AP profile and enters the AP profile configuration mode.
<b>Step 3</b>	<b>[no] oead local-access</b> <b>Example:</b> Device(config-ap-profile)# oead local-access	Enables the local access to AP. Local access consist of local AP GUI, LAN ports and personal SSID. The <b>no</b> form of this command disables the feature. If the local access is disabled, you will not be able to access the AP GUI, the local LAN port will be disabled, and personal SSID will not be broadcasted.
<b>Step 4</b>	<b>[no] oead link-encryption</b> <b>Example:</b> Device(config-ap-profile)# oead link-encryption	Enables DTLS encryption for OEAP APs or APs moving to the OEAP mode. The <b>no</b> form of this command disables the feature. This feature is enabled by default.
<b>Step 5</b>	<b>[no] oead rogue-detection</b> <b>Example:</b> Device(config-ap-profile)# no oead rogue-detection	Enables OEAP DTLS encryption in the AP profile configuration mode. This feature is disabled by default.

## Viewing OEAP Personal SSID Configuration

To view the OEAP personal SSID configuration, run the following command.

```
Device# show ap profile name default-ap-profile detailed
.
.
.
OEAP Mode Config
Link Encryption : ENABLED
```



```
Rogue Detection : DISABLED
Local Access : ENABLED
```

## Clearing Personal SSID from an OfficeExtend Access Point

To clear the personal SSID from an access point, run the following command:

```
ap name Cisco_AP clear-personal-ssid
```

## Example: Viewing OfficeExtend Configuration

This example displays an OfficeExtend configuration:

```
Device# show ap config general

Cisco AP Name      : ap_name
=====

Cisco AP Identifier      : 70db.986d.a860
Country Code           : Multiple Countries : US,IN
Regulatory Domain Allowed by Country : 802.11bg:-A 802.11a:-ABDN
AP Country Code        : US - United States
AP Regulatory Domain
  Slot 0               : -A
  Slot 1               : -D
MAC Address            : 002c.c899.7b84
IP Address Configuration : DHCP
IP Address             : 9.9.48.51
IP Netmask             : 255.255.255.0
Gateway IP Address     : 9.9.48.1
CAPWAP Path MTU       : 1485
Telnet State           : Disabled
SSH State              : Disabled
Jumbo MTU Status       : Disabled
Cisco AP Location      : default location
Site Tag Name          : flex-site
RF Tag Name            : default-rf-tag
Policy Tag Name        : split-tunnel-enabled-tag
AP join Profile        : default-ap-profile
Primary Cisco Controller Name : unname-controller
Primary Cisco Controller IP Address : 9.9.48.34
Secondary Cisco Controller Name : unname-controller1
Secondary Cisco Controller IP Address : 0.0.0.0
Tertiary Cisco Controller Name : unname-ewlc2
Tertiary Cisco Controller IP Address : 0.0.0.0
Administrative State   : Enabled
Operation State        : Registered
AP Mode                : FlexConnect
AP Submode             : Not Configured
Office Extend Mode     : Enabled
Remote AP Debug        : Disabled
Logging Trap Severity Level : information
Software Version       : 16.8.1.1
Boot Version           : 1.1.2.4
Mini IOS Version       : 0.0.0.0
Stats Reporting Period : 0
LED State              : Enabled
PoE Pre-Standard Switch : Disabled
PoE Power Injector MAC Address : Disabled
Power Type/Mode        : PoE/Full Power (normal mode)
```

# Proxy ARP

Proxy address resolution protocol (ARP) is the most common method for learning about MAC address through a proxy device. Enabling Proxy ARP known as ARP caching in Cisco Catalyst 9800 Series Wireless Controller means that the AP owning client is the destination of the ARP request, replies on behalf of that client and therefore does not send the ARP request to the client over the air. Access points not owning the destination client and receiving an ARP request through their wired connection will drop the ARP request. When the ARP caching is disabled, the APs bridge the ARP requests from wired-to-wireless and vice-versa increasing the air time usage and broadcasts over wireless.

The AP acts as an ARP proxy to respond to ARP requests on behalf of the wireless clients.

## Enabling Proxy ARP for FlexConnect APs (GUI)

### Procedure

- 
- Step 1** Choose **Configuration > Tags & Profiles > Flex**.
  - Step 2** Click **Add**.
  - Step 3** In the **General** tab, enter the **Name** of the Flex Profile and check the **ARP Caching** check box. The name can be ASCII characters from 32 to 126, without leading and trailing spaces.
  - Step 4** Click **Apply to Device**.
- 

## Enabling Proxy ARP for FlexConnect APs

Follow the procedure given below to configure proxy ARP for FlexConnect APs.

### Procedure

	Command or Action	Purpose
<b>Step 1</b>	<b>configure terminal</b>  <b>Example:</b> Device# configure terminal	Enters global configuration mode.
<b>Step 2</b>	<b>wireless profile flex flex-policy</b>  <b>Example:</b> Device(config)# wireless profile flex flex-test	Configures WLAN policy profile and enters wireless flex profile configuration mode.
<b>Step 3</b>	<b>arp-caching</b>  <b>Example:</b> Device(config-wireless-flex-profile)# arp-caching	Enables ARP caching.  <b>Note</b> Use the <b>no arp-caching</b> command to disable ARP caching.

	Command or Action	Purpose
<b>Step 4</b>	<b>end</b> <b>Example:</b> Device(config-wireless-flex-profile)# end	Returns to privileged EXEC mode.
<b>Step 5</b>	<b>show running-config   section wireless profile flex</b> <b>Example:</b> Device# show running-config   section wireless profile flex	Displays ARP configuration information.
<b>Step 6</b>	<b>show wireless profile flex detailed</b> <i>flex-profile-name</i> <b>Example:</b> Device# show wireless profile flex detailed flex-test	(Optional) Displays detailed information of the flex profile.
<b>Step 7</b>	<b>show arp summary</b> <b>Example:</b> Device# show arp summary	(Optional) Displays ARP summary.

# Overlapping Client IP Address in Flex Deployment

## Overview of Overlapping Client IP Address in Flex Deployment

In flex deployments, you can use cookie cutter configuration across sites and branches which also includes local DHCP servers configured with the same subnet. In this topology, controllers detect multiple client sessions with the same IP as IP THEFT and clients are put in blocked list.

The Overlapping Client IP Address in Flex Deployment feature offers overlapping IP address across various flex sites and provides all the functionalities that are supported in flex deployments.

## Enabling Overlapping Client IP Address in Flex Deployment (GUI)

### Procedure

- 
- Step 1** Choose **Configuration > Tags & Profiles > Flex** and click **Add**.
  - Step 2** On the **Add Flex Profile** window and **General** tab.
  - Step 3** Check the **IP Overlap** check box to enable overlapping client IP Address in Flex deployment.
  - Step 4** Click **Apply to Device**.
-

## Enabling Overlapping Client IP Address in Flex Deployment

### Procedure

	Command or Action	Purpose
<b>Step 1</b>	<b>configure terminal</b> <b>Example:</b> Device# configure terminal	Enters global configuration mode.
<b>Step 2</b>	<b>wireless profile flex <i>flex-profile</i></b> <b>Example:</b> Device(config)# wireless profile flex flex1	Configures a Flex profile and enters Flex profile configuration mode.
<b>Step 3</b>	<b>[no] ip overlap</b> <b>Example:</b> Device(config-wireless-flex-profile)# [no] ip overlap	Enables overlapping client IP address in flex deployment.  <b>Note</b> By default, the configuration is disabled.

## Verifying Overlapping Client IP Address in Flex Deployment (GUI)

### Procedure

- 
- Step 1** Choose **Monitoring > Wireless > Clients**.
- Step 2** Click the client in the table to view properties and statistics for each client.
- Step 3** On the **Client** window and **General** tab, click **Client Statistics** tab to view the following details:
- Number of Bytes Received from Client
  - Number of Bytes Sent to Client
  - Number of Packets Received from Client
  - Number of Packets Sent to Client
  - Number of Policy Errors
  - Radio Signal Strength Indicator
  - Signal to Noise Ratio
  - IP - Zone ID Mapping
- Step 4** Click **OK**.
-

## Verifying Overlapping Client IP Address in Flex Deployment

To verify if the overlapping client IP address in Flex deployment feature is enabled or not, use the following command:

```
Device# show wireless profile flex detailed flex1
Fallback Radio shut      : DISABLED
ARP caching              : ENABLED
Efficient Image Upgrade  : ENABLED
OfficeExtend AP         : DISABLED
Join min latency        : DISABLED
IP overlap status       : DISABLED
```

To view additional details about the overlapping client IP address in Flex deployment feature, use the following command:

```
Device# show wireless device-tracking database ip
```

IP	ZONE-ID	STATE	DISCOVERY	MAC
9.91.59.154	0x00000002	Reachable	IPv4 Packet	
6038.e0dc.3182				
1000:1:2:3:90d8:dd1a:11ab:23c0	0x00000002	Reachable	IPv6 Packet	
58ef.680d.c6c3				
1000:1:2:3:f9b5:3074:d0da:f93b	0x00000002	Reachable	IPv6 Packet	
58ef.680d.c6c3				
2001:9:3:59:90d8:dd1a:11ab:23c0	0x00000002	Reachable	IPv6 NDP	
58ef.680d.c6c3				
2001:9:3:59:f9b5:3074:d0da:f93b	0x00000002	Reachable	IPv6 NDP	
58ef.680d.c6c3				
fe80::f9b5:3074:d0da:f93b	0x80000001	Reachable	IPv6 NDP	
58ef.680d.c6c3				

To view APs in various site tags, use the following command:

```
Device# show ap tag summary
Number of APs: 5
```

AP Name	AP Mac	Site Tag Name	Policy Tag Name	RF Tag Name	Misconfigured Tag	Source
AP3802	70b3.17f6.37aa	flex_ip_overlap-site-tag-auto-3	flex_ip_overlap_policy_tag_1	flex_ip_overlap_policy_tag_1		
		default-rf-tag	No Static			
AP-9117AX	0cd0.f894.0f8c	default-site-tag	default-policy-tag	default-rf-tag	No Default	
AP1852JJ9	38ed.18ca.2b48	flex_ip_overlap-site-tag-auto-2	flex_ip_overlap_policy_tag_2	flex_ip_overlap_policy_tag_2		
		default-rf-tag	No Static			
AP1852I	38ed.18cc.61c0	flex_ip_overlap-site-tag-auto-1	flex_ip_overlap_policy_tag_1	flex_ip_overlap_policy_tag_1		
		default-rf-tag	No Static			
AP1542JJ9	700f.6a84.1b30	flex_ip_overlap-site-tag-auto-2	flex_ip_overlap_policy_tag_2	flex_ip_overlap_policy_tag_2		
		default-rf-tag	No Static			

To view APs in FlexConnect mode, use the following command:

```
Device# show ap status
AP Name      Status      Mode          Country
-----
AP3802      Disabled   FlexConnect   IN
AP1852I     Enabled    FlexConnect   US
AP-9117AX   Enabled    FlexConnect   IN
AP1542JJ9   Disabled   FlexConnect   US
AP1852JJ9   Enabled    FlexConnect   US
```

## Troubleshooting Overlapping Client IP Address in Flex Deployment

To verify the WNCD instance for each of the APs, use the following command:

```
Device# show wireless loadbalance ap affinity wncd 0
AP Mac                Discovery Timestamp    Join Timestamp          Tag
-----
0cd0.f894.0f8c        10/27/20 22:11:05     10/27/20 22:11:14     default-site-tag
38ed.18ca.2b48        10/27/20 22:06:09     10/27/20 22:06:19     flex_ip_overlap-site-tag-auto-2
700f.6a84.1b30        10/27/20 22:25:03     10/27/20 22:25:13     flex_ip_overlap-site-tag-auto-2
```

# Flex Resilient with Flex and Bridge Mode Access Points

## Information About Flex Resilient with Flex and Bridge Mode Access Points

The Flex Resilient with Flex and Bridge Mode Access Points describe how to set up a controller with Flex+Bridge mode Access Points (APs) and Flex Resilient feature. The Flex Resilient feature works only in Flex+Bridge mode APs. The feature resides in Mesh link formed between RAP - MAP, once the link is UP and RAP loses connection to the CAPWAP controller, both RAP and MAP continue to bridge the traffic. A child Mesh AP (MAP) maintains its link to a parent AP and continues to bridge till the parent link is lost. A child MAP cannot establish a new parent or child link till it reconnects to the CAPWAP controller.



**Note** Existing wireless clients in locally switching WLAN can stay connected with their AP in this mode. No new or disconnected wireless client can associate to the Mesh AP in this mode. Client traffic in Flex+Bridge MAP is dropped at RAP switchport for the locally switched WLANs.

## Configuring a Flex Profile (GUI)

### Procedure

- Step 1** Choose **Configuration > Tags & Profiles > Flex**.
- Step 2** Click a **Flex Profile Name**. The **Edit Flex Profile** dialog box appears.
- Step 3** Under the **General** tab, choose the **Flex Resilient** check box to enable the Flex Resilient feature.
- Step 4** Under the **VLAN** tab, choose the required VLANs.
- Step 5** (Optionally) Under the **Local Authentication** tab, choose the desired server group from the **Local Accounting RADIUS Server Group** drop-down list. Also, choose the **RADIUS** check box.
- Step 6** Click **Update & Apply to Device**.

## Configuring a Flex Profile (CLI)

### Procedure

	Command or Action	Purpose
<b>Step 1</b>	<b>configure terminal</b> <b>Example:</b> Device# configure terminal	Enters global configuration mode
<b>Step 2</b>	<b>wireless profile flex <i>flex-profile</i></b> <b>Example:</b> Device(config)# wireless profile flex new-flex-profile	Configures a Flex profile and enters Flex profile configuration mode.
<b>Step 3</b>	<b>arp-caching</b> <b>Example:</b> Device(config-wireless-flex-profile)# arp-caching	Enables ARP caching.
<b>Step 4</b>	<b>description <i>description</i></b> <b>Example:</b> Device(config-wireless-flex-profile)# description "new flex profile"	Enables default parameters for the Flex profile.
<b>Step 5</b>	<b>native-vlan-id</b> <b>Example:</b> Device(config-wireless-flex-profile)# native-vlan-id 2660	Configures native vlan-id information.
<b>Step 6</b>	<b>resilient</b> <b>Example:</b> Device(config-wireless-flex-profile)# resilient	Enables the resilient feature.
<b>Step 7</b>	<b>vlan-name <i>vlan_name</i></b> <b>Example:</b> Device(config-wireless-flex-profile)# vlan-name VLAN2659	Configures VLAN name.
<b>Step 8</b>	<b>vlan-id <i>vlan_id</i></b> <b>Example:</b> Device(config-wireless-flex-profile)# vlan-id 2659	Configures VLAN ID. The valid VLAN ID ranges from 1 to 4096.
<b>Step 9</b>	<b>end</b> <b>Example:</b> Device(config-wireless-flex-profile)# end	Exits configuration mode and returns to privileged EXEC mode.

## Configuring a Site Tag (CLI)

### Procedure

	Command or Action	Purpose
<b>Step 1</b>	<b>configure terminal</b> <b>Example:</b> Device# configure terminal	Enters global configuration mode
<b>Step 2</b>	<b>wireless tag site <i>site-name</i></b> <b>Example:</b> Device(config)# wireless tag site new-flex-site	Configures a site tag and enters site tag configuration mode.
<b>Step 3</b>	<b>flex-profile <i>flex-profile-name</i></b> <b>Example:</b> Device(config-site-tag) # flex-profile new-flex-profile	Configures a flex profile.
<b>Step 4</b>	<b>no local-site</b> <b>Example:</b> Device(config-site-tag) # no local-site	<b>Local site</b> is not configured on the site tag.
<b>Step 5</b>	<b>site-tag <i>site-tag-name</i></b> <b>Example:</b> Device(config-site-tag) # site-tag new-flex-site	Maps a site tag to an AP.
<b>Step 6</b>	<b>end</b> <b>Example:</b> Device(config-site-tag) # end	Exits configuration mode and returns to privileged EXEC mode.

## Configuring a Mesh Profile (CLI)

### Procedure

	Command or Action	Purpose
<b>Step 1</b>	<b>configure terminal</b> <b>Example:</b> Device# configure terminal	Enters global configuration mode
<b>Step 2</b>	<b>wireless profile mesh <i>profile-name</i></b> <b>Example:</b> Device(config)# wireless profile mesh Mesh_Profile	Configures a Mesh profile and enters the Mesh profile configuration mode.



	Command or Action	Purpose
<b>Step 3</b>	<b>no ethernet-vlan-transparent</b> <b>Example:</b> Device(config-wireless-profile-mesh)# no ethernet-vlan-transparent	Disables VLAN transparency to ensure that the bridge is VLAN aware.
<b>Step 4</b>	<b>end</b> <b>Example:</b> Device(config-wireless-profile-mesh)# end	Exits configuration mode and returns to privileged EXEC mode.

## Associating Wireless Mesh to an AP Profile (CLI)

### Procedure

	Command or Action	Purpose
<b>Step 1</b>	<b>configure terminal</b> <b>Example:</b> Device# configure terminal	Enters global configuration mode
<b>Step 2</b>	<b>ap profile <i>ap-profile-name</i></b> <b>Example:</b> Device(config)# ap profile new-ap-join-profile	Configures the AP profile and enters AP profile configuration mode.
<b>Step 3</b>	<b>mesh-profile <i>mesh-profile-name</i></b> <b>Example:</b> Device(config-ap-profile)# mesh-profile Mesh_Profile	Configures the Mesh profile in AP profile configuration mode.
<b>Step 4</b>	<b>ssh</b> <b>Example:</b> Device(config-ap-profile)# ssh	Configures the Secure Shell (SSH).
<b>Step 5</b>	<b>mgmtuser username <i>username</i> password {0   8} <i>password</i></b> <b>Example:</b> Device(config-ap-profile)# mgmtuser username Cisco password 0 Cisco secret 0 Cisco	Specifies the AP management username and password for managing all of the access points configured to the controller. <ul style="list-style-type: none"> <li>• <b>0</b>: Specifies an UNENCRYPTED password.</li> <li>• <b>8</b>: Specifies an AES encrypted password.</li> </ul> <p><b>Note</b> While configuring an username, ensure that special characters are not used as it results in error with bad configuration.</p>

	Command or Action	Purpose
<b>Step 6</b>	<b>end</b> <b>Example:</b> Device(config-ap-profile)# end	Exits configuration mode and returns to privileged EXEC mode.

## Attaching Site Tag to an Access Point (CLI)

### Procedure

	Command or Action	Purpose
<b>Step 1</b>	<b>configure terminal</b> <b>Example:</b> Device# configure terminal	Enters global configuration mode
<b>Step 2</b>	<b>ap mac-address</b> <b>Example:</b> Device(config)# ap F866.F267.7DFB	Configures Cisco APs and enters ap-tag configuration mode.
<b>Step 3</b>	<b>site-tag site-tag-name</b> <b>Example:</b> Device(config-ap-tag)# site-tag new-flex-site	Maps a site tag to the AP. <b>Note</b> Associating Site Tag causes the associated AP to reconnect.
<b>Step 4</b>	<b>end</b> <b>Example:</b> Device(config-ap-tag)# end	Exits configuration mode and returns to privileged EXEC mode.

## Configuring Switch Interface for APs (CLI)

### Procedure

	Command or Action	Purpose
<b>Step 1</b>	<b>configure terminal</b> <b>Example:</b> Device# configure terminal	Enters global configuration mode
<b>Step 2</b>	<b>interface interface-id</b> <b>Example:</b> Device(config)# interface <int-id>	Enters the interface to be added to the VLAN.
<b>Step 3</b>	<b>switchport trunk native vlan vlan-id</b> <b>Example:</b>	Assigns the allowed VLAN ID to the port when it is in trunking mode.

	Command or Action	Purpose
	Device(config-if)# switchport trunk native vlan 2660	
<b>Step 4</b>	<b>switchport trunk allowed vlan <i>vlan-id</i></b> <b>Example:</b> Device(config-if)# switchport trunk allowed vlan 2659,2660	Assigns the allowed VLAN ID to the port when it is in trunking mode.
<b>Step 5</b>	<b>switchport mode trunk</b> <b>Example:</b> Device(config-if)# switchport mode trunk	Sets the trunking mode to trunk unconditionally. <b>Note</b> When the controller works as a host for spanning tree, ensure that you configure portfast trunk, using <b>spanning-tree portfast trunk</b> command, in the uplink switch to ensure faster convergence.
<b>Step 6</b>	<b>end</b> <b>Example:</b> Device(config-if)# end	Exits configuration mode and returns to privileged EXEC mode.

## Verifying Flex Resilient with Flex and Bridge Mode Access Points Configuration

To view the AP mode and model details, use the following command:

```
Device# show ap name <ap-name> config general | inc AP Mode
AP Mode                : Flex+Bridge
AP Model               : AIR-CAP3702I-A-K9
```

To view the MAP mode details, use the following command:

```
Device# show ap name MAP config general | inc AP Mode
AP Mode                : Flex+Bridge
AP Model               : AIR-CAP3702I-A-K9
```

To view the RAP mode details, use the following command:

```
Device# show ap name RAP config general | inc AP Mode
AP Mode                : Flex+Bridge
AP Model               : AIR-AP2702I-A-K9
```

To view if the Flex Profile - Resilient feature is enabled or not, use the following command:

```
Device# show wireless profile flex detailed FLEX_TAG | inc resilient
Flex resilient        : ENABLED
```





# CHAPTER 24

## OEAP Link Test

- [Feature History for OEAP Link Test, on page 331](#)
- [Information About OEAP Link Test, on page 331](#)
- [Configuring OEAP Link Test \(CLI\), on page 332](#)
- [Performing OEAP Link Test \(GUI\), on page 332](#)
- [Verifying OEAP Link Test, on page 332](#)

## Feature History for OEAP Link Test

This table provides release and related information for the feature explained in this module.

This feature is also available in all the releases subsequent to the one in which they are introduced in, unless noted otherwise.

*Table 17: Feature History for OEAP Link Test*

Release	Feature	Feature Information
Cisco IOS XE Bengaluru 17.5.1	OEAP Link Test	The Cisco OEAP Link Test feature allows you to determine the DTLS upload, link latency, and jitter of the link between an AP and the controller.

## Information About OEAP Link Test

The Cisco OEAP Link Test feature allows you to determine the DTLS upload speed of the link between an AP and the controller. This feature helps in identifying network bottlenecks and reasons for functionality failures. You can determine the link latency by running a test on demand.

A link test is used to determine the quality of the link between the controller and an AP in OEAP mode. The AP sends synthetic packets to the controller and the controller echoes them back to the AP, which can then estimate the link quality.

### Feature Scenarios

Cisco OfficeExtend Access Point (OEAP) users are complaining of poor performance when connected to a teleworker AP.

**Use Cases**

This feature allows OEAP network admins to troubleshoot low throughput from the Cisco Catalyst 9800 Controller GUI by running OEAP link test.

The OEAP link test provides DTLS upload speed, link latency, and link jitter, all of which help the network administrators to narrow down the problem.

## Configuring OEAP Link Test (CLI)

**Procedure**

	Command or Action	Purpose
<b>Step 1</b>	<b>enable</b> <b>Example:</b> Device> enable	Enters privileged EXEC mode.
<b>Step 2</b>	<b>ap name <i>ap-name</i> network-diagnostic</b> <b>Example:</b> Device# ap name ap18 network-diagnostic	Triggers network diagnostics on an OfficeExtend AP.

## Performing OEAP Link Test (GUI)

**Procedure**

**Step 1** Choose **Monitoring > Wireless > AP Statistics**.

In the list of APs, a **Link Test** icon is displayed in the **AP Name** column for OEAP-capable APs.

**Note** The **Link Test** icon is displayed only if an AP is OEAP capable and is configured to operate as OEAP.

**Step 2** Click **Link Test**.

A link test is run and the results are shown.

## Verifying OEAP Link Test

The following example shows how to verify network diagnostics information:

```
Device# show FlexConnect office-extend diagnostics
```

```
Summary of OfficeExtend AP Link Latency
```

```
CAPWAP Latency Heartbeat
```

Current: current latency (ms)  
Min: minimum latency (ms)  
Max: maximum latency (ms)

Link Test

Upload: DTLS Upload (Mbps)  
Latency: DTLS Link Latency (ms)  
Jitter: DTLS Link Jitter (ms)

AP Name Last Latency Heartbeat from AP Current Max Min Last Link Test Run Upload Latency  
Jitter

```
-----  
ap-18 1 minute 1 second 0 0 0 12/04/20 09:19:48 8 2  
0
```







## CHAPTER 25

### Data DTLS

---

- [Information About Data Datagram Transport Layer Security, on page 335](#)
- [Configuring Data DTLS \(GUI\), on page 336](#)
- [Configuring Data DTLS \(CLI\), on page 336](#)

## Information About Data Datagram Transport Layer Security

Data Datagram Transport Layer Security (DTLS) enables you to encrypt CAPWAP data packets that are sent between an access point and the controller using DTLS, which is a standards-track IETF protocol that can encrypt both control and data packets based on TLS. CAPWAP control packets are management packets that are exchanged between a controller and an access point while CAPWAP data packets encapsulate forwarded wireless frames. CAPWAP control and data packets are sent over separate UDP ports: 5246 (control) and 5247 (data).

If an access point does not support DTLS data encryption, DTLS is enabled only for the control plane, and a DTLS session for the data plane is not established.

If an access point supports Data DTLS, it enables data DTLS after receiving the new configuration from the controller. The access point performs a DTLS handshake on port 5247 and after successfully establishing the DTLS session. All the data traffic (from the access point to the controller and the controller to the access point) is encrypted.



---

**Note** The throughput is affected for some APs that have data encryption enabled.

---

The controller does not perform a DTLS handshake immediately after processing client-hello with a cookie, if the following incorrect settings are configured:

- ECDHE-ECDSA cipher in “ap dtls-cipher <>” and RSA-based certificate in “wireless management trustpoint”.
- RSA cipher in “ap dtls-cipher <>” and EC-based certificate in “wireless management trustpoint”.



---

**Note** This is applicable when you move from CC -> FIPS -> non-FIPS mode.

---



**Note** If the AP's DHCP lease time is less and the DHCP pool is small, access point join failure or failure in establishing the Data Datagram Transport Layer Security (DTLS) session may occur. In such scenarios, associate the AP with a named site-tag and increase the DHCP lease time for at least 8 days.

## Configuring Data DTLS (GUI)

Follow the procedure to enable DTLS data encryption for the access points on the controller :

### Procedure

- Step 1** Click **Configuration > Tags and Profile > AP Join**.
- Step 2** Click **Add** to create a new **AP Join Profile** or click an existing profile to edit it.
- Step 3** Click **CAPWAP > Advanced**.
- Step 4** Check **Enable Data Encryption** check box to enable Datagram Transport Layer Security (DTLS) data encryption.
- Step 5** Click **Update & Apply to Device**.

## Configuring Data DTLS (CLI)

Follow the procedure given below to enable DTLS data encryption for the access points on the controller :

### Procedure

	Command or Action	Purpose
<b>Step 1</b>	<b>configure terminal</b>  <b>Example:</b> Device# configure terminal	Enters global configuration mode.
<b>Step 2</b>	<b>ap profile ap-profile</b>  <b>Example:</b> Device(config)# ap profile test-ap-profile	Configures an AP profile and enters AP profile configuration mode.  <b>Note</b> You can use the default AP profile (default-ap-profile) or create a named AP profile, as shown in the example.
<b>Step 3</b>	<b>link-encryption</b>  <b>Example:</b> Device(config-ap-profile)# link-encryption	Enables link encryption based on the profile. Answer yes, when the system prompts you with this message:

	Command or Action	Purpose
		<p><b>Note</b> If you set stats-timer as as zero (0) under the AP profile, then the AP will not send the link encryption statistics.</p> <p>Enabling link-encryption will reboot the APs with link-encryption.</p> <p>Are you sure you want to continue? (y/n) [y]:</p>
<b>Step 4</b>	<p><b>end</b></p> <p><b>Example:</b> Device(config-ap-profile)# end</p>	Returns to privileged EXEC mode.
<b>Step 5</b>	<p><b>show wireless dtls connections</b></p> <p><b>Example:</b> Device# show wireless dtls connections</p>	(Optional) Displays the DTLS session established for the AP that has joined this controller.
<b>Step 6</b>	<p><b>show ap link-encryption</b></p> <p><b>Example:</b> Device# show ap link-encryption</p>	(Optional) Displays the link encryption-related statistics (whether link encryption is enabled or disabled) counter received from the AP.





## CHAPTER 26

# AP Crash File Upload

---

- [AP Crash File Upload, on page 339](#)
- [Configuring AP Crash File Upload \(CLI\), on page 340](#)

## AP Crash File Upload

When a converted access point unexpectedly reboots, the access point stores a crash file on its local flash memory at the time of the crash. After the unit reboots, it sends the reason for the reboot to the device. If the unit rebooted because of a crash, the device pulls up the crash file using the existing CAPWAP messages and stores it in the device flash memory. The crash information copy is removed from the access point's flash memory when the device pulls it from the access point:



---

**Note** The system does not generate reports in case of a reload.

---

During a process crash, the following are collected locally from the device:

- Full process core
- Trace logs
- Cisco IOS syslogs (not guaranteed in case of nonactive crashes)
- System process information
- Bootup logs
- Reload logs
- Certain types of proc information

All this information is stored in separate files, which are then archived and compressed into one bundle. This makes it convenient to get a crash snapshot in one place, and can be then moved off the box for analysis. This report is generated before the device goes down to ROMMON/bootloader.



---

**Note** Except for the full core and tracelogs, everything else is a text file.

---

# Configuring AP Crash File Upload (CLI)

## Procedure

---

- Step 1**    **enable**  
Enters privileged EXEC mode.
- Step 2**    **ap name *ap-name* crash-file get-crash-data**  
Collects AP crash information. The crash file is uploaded automatically after the AP reloads to ready state. Therefore, this command does not have to be manually executed.
- Step 3**    **ap name *ap-name* crash-file get-radio-core-dump slot {0 | 1}**  
Collects the AP core dump file for slot 0 or slot 1.
- Step 4**    **ap name *ap-name* core-dump *tftp-ip* *crash-file* uncompress**  
Uploads the AP crash coredump file to the given TFTP location.
- Step 5**    **show ap crash-file**  
Displays the AP crash file, as well as the radio crash file.
- Step 6**    **dir bootflash**  
Displays the crash file in bootflash with .crash extension.
-



## CHAPTER 27

# Access Point Plug-n-Play

- [Overview of Access Point Plug-n-Play, on page 341](#)
- [Provisioning AP from PnP Server, on page 341](#)
- [Verifying AP Tag Configuration, on page 342](#)

## Overview of Access Point Plug-n-Play

The Plug and Play (PnP) server provides staging parameters to an access point (AP) before it joins a controller. Using this staging configuration, the AP receives the runtime configuration when it joins the controller.

The AP PnP feature enables the PnP server to provide all tag-related information, as part of the preconfigured information to the AP and in turn, to the controller.

You can upload configuration in PNP server in either *TXT* or *JSON* format and also add the AP details. The AP details are then mapped with the details in the *TXT* or *JSON* configuration file. While provisioning AP from PnP server, the AP acquires this configuration details. Based on the configuration details, the AP then joins the corresponding controller with the tag details.

## Provisioning AP from PnP Server

You can provision AP from PnP Server in either ways:

- Configure DHCP server or switch with *Option 43*. For example, you can refer to the following code sample:

```
ip dhcp pool vlan10
network 9.10.10.0 255.255.255.0
default-router 9.10.10.1
option 43 ascii 5A1D;B2;K4;|9.10.60.5;J80
```

- Configure DHCP server with DNS. For example, you can refer to the following code sample:

```
ip dhcp pool vlan10
network 9.10.10.0 255.255.255.0
default-router 9.10.10.1
dns-server 9.8.65.5
domain-name dns.com
```

## Verifying AP Tag Configuration

The following example shows how to verify the AP tag configuration:

```
Device# show ap tag summary
Number of APs: 5
```

AP Name RF Tag Name	AP Mac Misconfigured	Site Tag Name Tag Source	Policy Tag Name
APd42c.4482.6102 default-rf-tag	d42c.4482.6102 No	default-site-tag Default	default-policy-tag
AP00c1.64d8.6af0 named-rf-tag	00c1.64d8.6af0 No	named-site-tag AP	named-policy-tag



**Note** The details in the second row reflect the tag source coming from a PNP server.





## CHAPTER 28

# 802.11 Parameters for Cisco Access Points

- [2.4-GHz Radio Support, on page 343](#)
- [5-GHz Radio Support, on page 345](#)
- [Information About Dual-Band Radio Support, on page 348](#)
- [Configuring Default XOR Radio Support, on page 349](#)
- [Configuring XOR Radio Support for the Specified Slot Number \(GUI\), on page 351](#)
- [Configuring XOR Radio Support for the Specified Slot Number, on page 351](#)
- [Receiver Only Dual-Band Radio Support, on page 353](#)
- [Configuring Client Steering \(CLI\), on page 355](#)
- [Verifying Cisco Access Points with Dual-Band Radios, on page 356](#)

## 2.4-GHz Radio Support

### Configuring 2.4-GHz Radio Support for the Specified Slot Number

#### Before you begin



**Note** The term *802.11b radio* or *2.4-GHz radio* will be used interchangeably.

#### Procedure

	Command or Action	Purpose
<b>Step 1</b>	<b>enable</b>  <b>Example:</b> Device# enable	Enters privileged EXEC mode.
<b>Step 2</b>	<b>ap name <i>ap-name</i> dot11 24ghz slot 0 SI</b>  <b>Example:</b> Device# ap name AP-SIDD-A06 dot11 24ghz slot 0 SI	Enables Spectrum Intelligence (SI) for the dedicated 2.4-GHz radio hosted on slot 0 for a specific access point. For more information, see the <i>Spectrum Intelligence</i> section in this guide.

	Command or Action	Purpose
		Here, <b>0</b> refers to the Slot ID.
<b>Step 3</b>	<p><b>ap name</b> <i>ap-name</i> <b>dot11 24ghz slot 0 antenna</b> {<b>ext-ant-gain</b> <i>antenna_gain_value</i>   <b>selection</b> [<b>internal</b>   <b>external</b>]}</p> <p><b>Example:</b></p> <pre>Device# ap name AP-SIDD-A06 dot11 24ghz slot 0 antenna selection internal</pre>	<p>Configures 802.11b antenna hosted on slot 0 for a specific access point.</p> <ul style="list-style-type: none"> <li>• <b>ext-ant-gain:</b> Configures the 802.11b external antenna gain. <i>antenna_gain_value</i>- Refers to the external antenna gain value in multiples of .5 dBi units. The valid range is from 0 to 4294967295.</li> <li>• <b>selection:</b> Configures the 802.11b antenna selection (internal or external).</li> </ul> <p><b>Note</b></p> <ul style="list-style-type: none"> <li>• For APs supporting self-identifying antennas (SIA), the gain depends on the antenna, and not on the AP model. The gain is learned by the AP and there is no need for controller configuration.</li> <li>• For APs that do not support SIA, the APs send the antenna gain in the configuration payload, where the default antenna gain depends on the AP model.</li> <li>• Cisco Catalyst 9120E and 9130E APs support self-identifying antennas (SIA). Cisco Catalyst 9115E APs do not support SIA antennas. Although Cisco Catalyst 9115E APs work with SIA antennas, the APs do not auto-detect SIA antennas nor add the correct external gain.</li> </ul>
<b>Step 4</b>	<p><b>ap name</b> <i>ap-name</i> <b>dot11 24ghz slot 0 beamforming</b></p> <p><b>Example:</b></p> <pre>Device# ap name AP-SIDD-A06 dot11 24ghz slot 0 beamforming</pre>	Configures beamforming for the 2.4-GHz radio hosted on slot 0 for a specific access point.
<b>Step 5</b>	<p><b>ap name</b> <i>ap-name</i> <b>dot11 24ghz slot 0 channel</b> {<i>channel_number</i>   <b>auto</b>}</p> <p><b>Example:</b></p> <pre>Device# ap name AP-SIDD-A06 dot11 24ghz slot 0 channel auto</pre>	Configures advanced 802.11 channel assignment parameters for the 2.4-GHz radio hosted on slot 0 for a specific access point.

	Command or Action	Purpose
<b>Step 6</b>	<b>ap name</b> <i>ap-name</i> <b>dot11 24ghz slot 0 cleanair</b> <b>Example:</b> Device# <b>ap name AP-SIDD-A06 dot11 24ghz slot 0 cleanair</b>	Enables CleanAir for 802.11b radio hosted on slot 0 for a specific access point.
<b>Step 7</b>	<b>ap name</b> <i>ap-name</i> <b>dot11 24ghz slot 0 dot11n antenna {A   B   C   D}</b> <b>Example:</b> Device# <b>ap name AP-SIDD-A06 dot11 24ghz slot 0 dot11n antenna A</b>	Configures 802.11n antenna for 2.4-GHz radio hosted on slot 0 for a specific access point.  Here, <b>A:</b> Is the antenna port A. <b>B:</b> Is the antenna port B. <b>C:</b> Is the antenna port C. <b>D:</b> Is the antenna port D.
<b>Step 8</b>	<b>ap name</b> <i>ap-name</i> <b>dot11 24ghz slot 0 shutdown</b> <b>Example:</b> Device# <b>ap name AP-SIDD-A06 dot11 24ghz slot 0 shutdown</b>	Disables 802.11b radio hosted on slot 0 for a specific access point.
<b>Step 9</b>	<b>ap name</b> <i>ap-name</i> <b>dot11 24ghz slot 0 txpower {tx_power_level   auto}</b> <b>Example:</b> Device# <b>ap name AP-SIDD-A06 dot11 24ghz slot 0 txpower auto</b>	Configures transmit power level for 802.11b radio hosted on slot 0 for a specific access point. <ul style="list-style-type: none"> <li>• <i>tx_power_level</i>: Is the transmit power level in dBm. The valid range is from 1 to 8.</li> <li>• <b>auto</b>: Enables auto-RF.</li> </ul>

## 5-GHz Radio Support

### Configuring 5-GHz Radio Support for the Specified Slot Number

#### Before you begin



**Note** The term *802.11a radio* or *5-GHz radio* will be used interchangeably in this document.

#### Procedure

	Command or Action	Purpose
<b>Step 1</b>	<b>enable</b> <b>Example:</b>	Enters privileged EXEC mode.

	Command or Action	Purpose
	Device# enable	
<b>Step 2</b>	<b>ap name</b> <i>ap-name</i> <b>dot11 5ghz slot 1 SI</b> <b>Example:</b> Device# <b>ap name AP-SIDD-A06 dot11 5ghz slot 1 SI</b>	Enables Spectrum Intelligence (SI) for the dedicated 5-GHz radio hosted on slot 1 for a specific access point. Here, <b>1</b> refers to the Slot ID.
<b>Step 3</b>	<b>ap name</b> <i>ap-name</i> <b>dot11 5ghz slot 1 antenna ext-ant-gain</b> <i>antenna_gain_value</i> <b>Example:</b> Device# <b>ap name AP-SIDD-A06 dot11 5ghz slot 1 antenna ext-ant-gain</b>	Configures external antenna gain for 802.11a radios for a specific access point hosted on slot 1. <i>antenna_gain_value</i> —Refers to the external antenna gain value in multiples of .5 dBi units. The valid range is from 0 to 4294967295. <b>Note</b> <ul style="list-style-type: none"> <li>• For APs supporting self-identifying antennas (SIA), the gain depends on the antenna, and not on the AP model. The gain is learned by the AP and there is no need for controller configuration.</li> <li>• For APs that do not support SIA, the APs send the antenna gain in the configuration payload, where the default antenna gain depends on the AP model.</li> <li>• Cisco Catalyst 9120E and 9130E APs support self-identifying antennas (SIA). Cisco Catalyst 9115E APs do not support SIA antennas. Although Cisco Catalyst 9115E APs work with SIA antennas, the APs do not auto-detect SIA antennas nor add the correct external gain.</li> </ul>
<b>Step 4</b>	<b>ap name</b> <i>ap-name</i> <b>dot11 5ghz slot 1 antenna mode</b> [ <b>omni</b>   <b>sectorA</b>   <b>sectorB</b> ] <b>Example:</b> Device# <b>ap name AP-SIDD-A06 dot11 5ghz slot 1 antenna mode sectorA</b>	Configures the antenna mode for 802.11a radios for a specific access point hosted on slot 1.
<b>Step 5</b>	<b>ap name</b> <i>ap-name</i> <b>dot11 5ghz slot 1 antenna selection</b> [ <b>internal</b>   <b>external</b> ] <b>Example:</b> Device# <b>ap name AP-SIDD-A06 dot11 5ghz slot 1 antenna selection internal</b>	Configures the antenna selection for 802.11a radios for a specific access point hosted on slot 1.

	Command or Action	Purpose
Step 6	<b>ap name <i>ap-name</i> dot11 5ghz slot 1 beamforming</b> <b>Example:</b> <pre>Device# ap name AP-SIDD-A06 dot11 5ghz slot 1 beamforming</pre>	Configures beamforming for the 5-GHz radio hosted on slot 1 for a specific access point.
Step 7	<b>ap name <i>ap-name</i> dot11 5ghz slot 1 channel {<i>channel_number</i>   auto   width [20   40   80   160]}</b> <b>Example:</b> <pre>Device# ap name AP-SIDD-A06 dot11 5ghz slot 1 channel auto</pre>	Configures advanced 802.11 channel assignment parameters for the 5-GHz radio hosted on slot 1 for a specific access point.  Here,  <i>channel_number</i> - Refers to the channel number. The valid range is from 1 to 173.
Step 8	<b>ap name <i>ap-name</i> dot11 5ghz slot 1 cleanair</b> <b>Example:</b> <pre>Device# ap name AP-SIDD-A06 dot11 5ghz slot 1 cleanair</pre>	Enables CleanAir for 802.11a radio hosted on slot 1 for a given or specific access point.
Step 9	<b>ap name <i>ap-name</i> dot11 5ghz slot 1 dot11n antenna {A   B   C   D}</b> <b>Example:</b> <pre>Device# ap name AP-SIDD-A06 dot11 5ghz slot 1 dot11n antenna A</pre>	Configures 802.11n for 5-GHz radio hosted on slot 1 for a specific access point.  Here,  <b>A</b> - Is the antenna port A. <b>B</b> - Is the antenna port B. <b>C</b> - Is the antenna port C. <b>D</b> - Is the antenna port D.
Step 10	<b>ap name <i>ap-name</i> dot11 5ghz slot 1 rrm channel <i>channel</i></b> <b>Example:</b> <pre>Device# ap name AP-SIDD-A06 dot11 5ghz slot 1 rrm channel 2</pre>	Is another way of changing the channel hosted on slot 1 for a specific access point.  Here,  <i>channel</i> - Refers to the new channel created using 802.11h channel announcement. The valid range is from 1 to 173, provided 173 is a valid channel in the country where the access point is deployed.
Step 11	<b>ap name <i>ap-name</i> dot11 5ghz slot 1 shutdown</b> <b>Example:</b> <pre>Device# ap name AP-SIDD-A06 dot11 5ghz slot 1 shutdown</pre>	Disables 802.11a radio hosted on slot 1 for a specific access point.
Step 12	<b>ap name <i>ap-name</i> dot11 5ghz slot 1 txpower {<i>tx_power_level</i>   auto}</b> <b>Example:</b>	Configures 802.11a radio hosted on slot 1 for a specific access point.

	Command or Action	Purpose
	Device# <code>ap name AP-SIDD-A06 dot11 5ghz slot 1 txpower auto</code>	<ul style="list-style-type: none"> <li>• <code>tx_power_level</code>- Is the transmit power level in dBm. The valid range is from 1 to 8.</li> <li>• <code>auto</code>- Enables auto-RF.</li> </ul>

## Information About Dual-Band Radio Support

The Dual-Band (XOR) radio in Cisco 2800, 3800, 4800, and the 9120 series AP models offer the ability to serve 2.4-GHz or 5-GHz bands or passively monitor both the bands on the same AP. These APs can be configured to serve clients in 2.4-GHz and 5-GHz bands, or serially scan both 2.4-GHz and 5-GHz bands on the flexible radio while the main 5-GHz radio serves clients.

Cisco APs models up and through the Cisco 9120 APs are designed to support dual 5-GHz band operations with the *i* model supporting a dedicated Macro/Micro architecture and the *e* and *p* models supporting Macro/Macro. The Cisco 9130AXI APs and the Cisco 9136 APs support dual 5-GHz operations as Micro/Messo cell.

When a radio moves between bands (from 2.4-GHz to 5-GHz and vice versa), clients need to be steered to get an optimal distribution across radios. When an AP has two radios in the 5-GHz band, client steering algorithms contained in the Flexible Radio Assignment (FRA) algorithm are used to steer a client between the same band co-resident radios.

The XOR radio support can be steered manually or automatically:

- Manual steering of a band on a radio—The band on the XOR radio can only be changed manually.
- Automatic client and band steering on the radios is managed by the FRA feature that monitors and changes the band configurations as per site requirements.



**Note** RF measurement will not run when a static channel is configured on slot 1. Due to this, the dual band radio slot 0 will move only with 5-GHz radio and not to the monitor mode.

When slot 1 radio is disabled, RF measurement will not run, and the dual band radio slot 0 will be only on 2.4-GHz radio.



**Note** Only one of the 5-GHz radios can operate in the UNII band (100 - 144), due to an AP limitation to keep the power budget within the regulatory limit.

# Configuring Default XOR Radio Support

## Before you begin



**Note** The default radio points to the XOR radio hosted on slot 0.

## Procedure

	Command or Action	Purpose
<b>Step 1</b>	<b>enable</b> <b>Example:</b> Device# <b>enable</b>	Enters privileged EXEC mode.
<b>Step 2</b>	<b>ap name <i>ap-name</i> dot11 dual-band antenna ext-ant-gain <i>antenna_gain_value</i></b> <b>Example:</b> Device# ap name <i>ap-name</i> dot11 dual-band antenna ext-ant-gain 2	Configures the 802.11 dual-band antenna on a specific Cisco access point.  <i>antenna_gain_value</i> : The valid range is from 0 to 40.
<b>Step 3</b>	<b>ap name <i>ap-name</i> [no] dot11 dual-band shutdown</b> <b>Example:</b> Device# ap name <i>ap-name</i> dot11 dual-band shutdown	Shuts down the default dual-band radio on a specific Cisco access point.  Use the <b>no</b> form of the command to enable the radio.
<b>Step 4</b>	<b>ap name <i>ap-name</i> dot11 dual-band role manual client-serving</b> <b>Example:</b> Device# ap name <i>ap-name</i> dot11 dual-band role manual client-serving	Switches to client-serving mode on the Cisco access point.
<b>Step 5</b>	<b>ap name <i>ap-name</i> dot11 dual-band band 24ghz</b> <b>Example:</b> Device# ap name <i>ap-name</i> dot11 dual-band band 24ghz	Switches to 2.4-GHz radio band.
<b>Step 6</b>	<b>ap name <i>ap-name</i> dot11 dual-band txpower {<i>transmit_power_level</i>   auto}</b> <b>Example:</b>	Configures the transmit power for the radio on a specific Cisco access point.

	Command or Action	Purpose
	Device# ap name <i>ap-name</i> dot11 dual-band txpower 2	<b>Note</b> When an FRA-capable radio (slot 0 on 9120 AP[for instance]) is set to Auto, you cannot configure static channel and Txpower on this radio.  If you want to configure static channel and Txpower on this radio, you will need to change the radio role to Manual Client-Serving mode.
<b>Step 7</b>	<b>ap name <i>ap-name</i> dot11 dual-band channel <i>channel-number</i></b>  <b>Example:</b> Device# ap name <i>ap-name</i> dot11 dual-band channel 2	Enters the channel for the dual band.  <i>channel-number</i> —The valid range is from 1 to 173.
<b>Step 8</b>	<b>ap name <i>ap-name</i> dot11 dual-band channel auto</b>  <b>Example:</b> Device# ap name <i>ap-name</i> dot11 dual-band channel auto	Enables the auto channel assignment for the dual-band.
<b>Step 9</b>	<b>ap name <i>ap-name</i> dot11 dual-band channel width {20 MHz   40 MHz   80 MHz   160 MHz}</b>  <b>Example:</b> Device# ap name <i>ap-name</i> dot11 dual-band channel width 20 MHz	Chooses the channel width for the dual band.
<b>Step 10</b>	<b>ap name <i>ap-name</i> dot11 dual-band cleanair</b>  <b>Example:</b> Device# ap name <i>ap-name</i> dot11 dual-band cleanair	Enables the Cisco CleanAir feature on the dual-band radio.
<b>Step 11</b>	<b>ap name <i>ap-name</i> dot11 dual-band cleanair band {24 GHz   5 GMHz}</b>  <b>Example:</b> Device# ap name <i>ap-name</i> dot11 dual-band cleanair band 5 GHz  Device# ap name <i>ap-name</i> [no] dot11 dual-band cleanair band 5 GHz	Selects a band for the Cisco CleanAir feature.  Use the <b>no</b> form of this command to disable the Cisco CleanAir feature.
<b>Step 12</b>	<b>ap name <i>ap-name</i> dot11 dual-band dot11n antenna {A   B   C   D}</b>  <b>Example:</b> Device# ap name <i>ap-name</i> dot11 dual-band dot11n antenna A	Configures the 802.11n dual-band parameters for a specific access point.



	Command or Action	Purpose
<b>Step 13</b>	<b>show ap name <i>ap-name</i> auto-rf dot11 dual-band</b>  <b>Example:</b> Device# show ap name <i>ap-name</i> auto-rf dot11 dual-band	Displays the auto-RF information for the Cisco access point.
<b>Step 14</b>	<b>show ap name <i>ap-name</i> wlan dot11 dual-band</b>  <b>Example:</b> Device# show ap name <i>ap-name</i> wlan dot11 dual-band	Displays the list of BSSIDs for the Cisco access point.

## Configuring XOR Radio Support for the Specified Slot Number (GUI)

### Procedure

- 
- Step 1** Click **Configuration > Wireless > Access Points**.
- Step 2** In the **Dual-Band Radios** section, select the AP for which you want to configure dual-band radios. The AP name, MAC address, CleanAir capability and slot information for the AP are displayed. If the Hyperlocation method is HALO, the antenna PID and antenna design information are also displayed.
- Step 3** Click **Configure**.
- Step 4** In the **General** tab, set the **Admin Status** as required.
- Step 5** Set the **CleanAir Admin Status** field to Enable or Disable.
- Step 6** Click **Update & Apply to Device**.
- 

## Configuring XOR Radio Support for the Specified Slot Number

### Procedure

	Command or Action	Purpose
<b>Step 1</b>	<b>enable</b>  <b>Example:</b> Device# enable	Enters privileged EXEC mode.

	Command or Action	Purpose
Step 2	<p><b>ap name</b> <i>ap-name</i> <b>dot11 dual-band slot 0 antenna ext-ant-gain</b> <i>external_antenna_gain_value</i></p> <p><b>Example:</b></p> <pre>Device# ap name AP-SIDD-A06 dot11 dual-band slot 0 antenna ext-ant-gain 2</pre>	<p>Configures dual-band antenna for the XOR radio hosted on slot 0 for a specific access point.</p> <p><i>external_antenna_gain_value</i> - Is the external antenna gain value in multiples of .5 dBi unit. The valid range is from 0 to 40.</p> <p><b>Note</b></p> <ul style="list-style-type: none"> <li>• For APs supporting self-identifying antennas (SIA), the gain depends on the antenna, and not on the AP model. The gain is learned by the AP and there is no need for controller configuration.</li> <li>• For APs that do not support SIA, the APs send the antenna gain in the configuration payload, where the default antenna gain depends on the AP model.</li> </ul>
Step 3	<p><b>ap name</b> <i>ap-name</i> <b>dot11 dual-band slot 0 band</b> {24ghz   5ghz}</p> <p><b>Example:</b></p> <pre>Device# ap name AP-SIDD-A06 dot11 dual-band slot 0 band 24ghz</pre>	Configures current band for the XOR radio hosted on slot 0 for a specific access point.
Step 4	<p><b>ap name</b> <i>ap-name</i> <b>dot11 dual-band slot 0 channel</b> {<i>channel_number</i>   auto   width [160   20   40   80]}</p> <p><b>Example:</b></p> <pre>Device# ap name AP-SIDD-A06 dot11 dual-band slot 0 channel 3</pre>	Configures dual-band channel for the XOR radio hosted on slot 0 for a specific access point.
Step 5	<p><b>ap name</b> <i>ap-name</i> <b>dot11 dual-band slot 0 cleanair band</b> {24Ghz   5Ghz}</p> <p><b>Example:</b></p> <pre>Device# ap name AP-SIDD-A06 dot11 dual-band slot 0 cleanair band 24Ghz</pre>	Enables CleanAir features for dual-band radios hosted on slot 0 for a specific access point.
Step 6	<p><b>ap name</b> <i>ap-name</i> <b>dot11 dual-band slot 0 dot11n antenna</b> {A   B   C   D}</p> <p><b>Example:</b></p> <pre>Device# ap name AP-SIDD-A06 dot11 dual-band slot 0 dot11n antenna A</pre>	<p>Configures 802.11n dual-band parameters hosted on slot 0 for a specific access point.</p> <p>Here,</p> <p><b>A</b>- Enables antenna port A.</p> <p><b>B</b>- Enables antenna port B.</p> <p><b>C</b>- Enables antenna port C.</p> <p><b>D</b>- Enables antenna port D.</p>

	Command or Action	Purpose
<b>Step 7</b>	<b>ap name</b> <i>ap-name</i> <b>dot11 dual-band slot 0 role</b> { <b>auto</b>   <b>manual</b> [ <b>client-serving</b>   <b>monitor</b> ]}  <b>Example:</b> <pre>Device# ap name AP-SIDD-A06 dot11 dual-band slot 0 role auto</pre>	Configures dual-band role for the XOR radio hosted on slot 0 for a specific access point.  The following are the dual-band roles: <ul style="list-style-type: none"> <li>• <b>auto</b>- Refers to the automatic radio role selection.</li> <li>• <b>manual</b>- Refers to the manual radio role selection.</li> </ul>
<b>Step 8</b>	<b>ap name</b> <i>ap-name</i> <b>dot11 dual-band slot 0 shutdown</b>  <b>Example:</b> <pre>Device# ap name AP-SIDD-A06 dot11 dual-band slot 0 shutdown  Device# ap name AP-SIDD-A06 [no] dot11 dual-band slot 0 shutdown</pre>	Disables dual-band radio hosted on slot 0 for a specific access point.  Use the <b>no</b> form of this command to enable the dual-band radio.
<b>Step 9</b>	<b>ap name</b> <i>ap-name</i> <b>dot11 dual-band slot 0 txpower</b> { <i>tx_power_level</i>   <b>auto</b> }  <b>Example:</b> <pre>Device# ap name AP-SIDD-A06 dot11 dual-band slot 0 txpower 2</pre>	Configures dual-band transmit power for XOR radio hosted on slot 0 for a specific access point. <ul style="list-style-type: none"> <li>• <i>tx_power_level</i>- Is the transmit power level in dBm. The valid range is from 1 to 8.</li> <li>• <b>auto</b>- Enables auto-RF.</li> </ul>

## Receiver Only Dual-Band Radio Support

### Information About Receiver Only Dual-Band Radio Support

This feature configures the dual-band Rx-only radio features for an access point with dual-band radios.

This dual-band Rx-only radio is dedicated for Analytics, Hyperlocation, Wireless Security Monitoring, and BLE AoA\*.

This radio will always continue to serve in monitor mode, therefore, you will not be able to make any channel and *tx-rx* configurations on the 3rd radio.

### Configuring Receiver Only Dual-Band Parameters for Access Points

#### Enabling CleanAir with Receiver Only Dual-Band Radio on a Cisco Access Point (GUI)

##### Procedure

- 
- Step 1** Choose **Configuration > Wireless > Access Points**.

- Step 2** In the **Dual-Band Radios** settings, click the AP for which you want to configure the dual-band radios.
- Step 3** In the **General** tab, enable the **CleanAir** toggle button.
- Step 4** Click **Update & Apply to Device**.

## Enabling CleanAir with Receiver Only Dual-Band Radio on a Cisco Access Point

### Procedure

	Command or Action	Purpose
<b>Step 1</b>	<b>enable</b>  <b>Example:</b> Device# enable	Enters privileged EXEC mode.
<b>Step 2</b>	<b>ap name <i>ap-name</i> dot11 rx-dual-band slot 2 cleanair band {24Ghz   5Ghz}</b>  <b>Example:</b> Device# ap name AP-SIDD-A06 dot11 rx-dual-band slot 2 cleanair band 24Ghz  Device# ap name AP-SIDD-A06 [no] dot11 rx-dual-band slot 2 cleanair band 24Ghz	Enables CleanAir with receiver only (Rx-only) dual-band radio on a specific access point.  Here, 2 refers to the slot ID.  Use the <b>no</b> form of this command to disable CleanAir.

## Disabling Receiver Only Dual-Band Radio on a Cisco Access Point (GUI)

### Procedure

- Step 1** Choose **Configuration > Wireless > Access Points**.
- Step 2** In the **Dual-Band Radios** settings, click the AP for which you want to configure the dual-band radios.
- Step 3** In the **General** tab, disable the **CleanAir Status** toggle button.
- Step 4** Click **Update & Apply to Device**.

## Disabling Receiver Only Dual-Band Radio on a Cisco Access Point

### Procedure

	Command or Action	Purpose
<b>Step 1</b>	<b>enable</b>  <b>Example:</b> Device# enable	Enters privileged EXEC mode.
<b>Step 2</b>	<b>ap name <i>ap-name</i> dot11 rx-dual-band slot 2 shutdown</b>	Disables receiver only dual-band radio on a specific Cisco access point.

	Command or Action	Purpose
	<b>Example:</b> Device# <code>ap name AP-SIDD-A06 dot11 rx-dual-band slot 2 shutdown</code>  Device# <code>ap name AP-SIDD-A06 [no] dot11 rx-dual-band slot 2 shutdown</code>	Here, 2 refers to the slot ID.  Use the <b>no</b> form of this command to enable receiver only dual-band radio.

## Configuring Client Steering (CLI)

### Before you begin

Enable Cisco CleanAir on the corresponding dual-band radio.

### Procedure

	Command or Action	Purpose
<b>Step 1</b>	<b>enable</b>  <b>Example:</b> Device# <code>enable</code>	Enters privileged EXEC mode.
<b>Step 2</b>	<b>configure terminal</b>  <b>Example:</b> Device# <code>configure terminal</code>	Enters global configuration mode.
<b>Step 3</b>	<b>wireless macro-micro steering transition-threshold balancing-window number-of-clients(0-65535)</b>  <b>Example:</b> Device(config)# <code>wireless macro-micro steering transition-threshold balancing-window 10</code>	Configures the micro-macro client load-balancing window for a set number of clients.
<b>Step 4</b>	<b>wireless macro-micro steering transition-threshold client count number-of-clients(0-65535)</b>  <b>Example:</b> Device(config)# <code>wireless macro-micro steering transition-threshold client count 10</code>	Configures the macro-micro client parameters for a minimum client count for transition.
<b>Step 5</b>	<b>wireless macro-micro steering transition-threshold macro-to-micro RSSI-in-dBm( -128-0)</b>  <b>Example:</b>	Configures the macro-to-micro transition RSSI.

	Command or Action	Purpose
	Device(config)# wireless macro-micro steering transition-threshold macro-to-micro -100	
<b>Step 6</b>	<b>wireless macro-micro steering transition-threshold micro-to-macro <i>RSSI-in-dBm(-128—0)</i></b>  <b>Example:</b> Device(config)# wireless macro-micro steering transition-threshold micro-to-macro -110	Configures the micro-to-macro transition RSSI.
<b>Step 7</b>	<b>wireless macro-micro steering probe-suppression aggressiveness <i>number-of-cycles(-128—0)</i></b>  <b>Example:</b> Device(config)# wireless macro-micro steering probe-suppression aggressiveness -110	Configures the number of probe cycles to be suppressed.
<b>Step 8</b>	<b>wireless macro-micro steering probe-suppression hysteresis <i>RSSI-in-dBm</i></b>  <b>Example:</b> Device(config)# wireless macro-micro steering probe-suppression hysteresis -5	Configures the macro-to-micro probe in RSSI. The range is between -6 to -3.
<b>Step 9</b>	<b>wireless macro-micro steering probe-suppression probe-only</b>  <b>Example:</b> Device(config)# wireless macro-micro steering probe-suppression probe-only	Enables probe suppression mode.
<b>Step 10</b>	<b>wireless macro-micro steering probe-suppression probe-auth</b>  <b>Example:</b> Device(config)# wireless macro-micro steering probe-suppression probe-auth	Enables probe and single authentication suppression mode.
<b>Step 11</b>	<b>show wireless client steering</b>  <b>Example:</b> Device# show wireless client steering	Displays the wireless client steering information.

## Verifying Cisco Access Points with Dual-Band Radios

To verify the access points with dual-band radios, use the following command:

```
Device# show ap dot11 dual-band summary
```

AP Name	Subband	Radio	Mac	Status	Channel	Power Level	Slot ID	Mode
4800	All	3890.a5e6.f360	Enabled	(40) *	*1/8	(22 dBm)	0	Sensor
4800	All	3890.a5e6.f360	Enabled	N/A	N/A	2		Monitor







## CHAPTER 29

# 802.1x Support

---

- [Introduction to the 802.1X Authentication, on page 359](#)
- [Limitations of the 802.1X Authentication, on page 360](#)
- [Topology - Overview, on page 361](#)
- [Configuring 802.1X Authentication Type and LSC AP Authentication Type \(GUI\), on page 361](#)
- [Configuring 802.1X Authentication Type and LSC AP Authentication Type, on page 362](#)
- [Enabling 802.1X on the Switch Port, on page 364](#)
- [Verifying 802.1X on the Switch Port, on page 366](#)
- [Verifying the Authentication Type, on page 366](#)

## Introduction to the 802.1X Authentication

IEEE 802.1X port-based authentication is configured on a device to prevent unauthorized devices from gaining access to the network. The device can combine the function of a router, switch, and access point, depending on the fixed configuration. Any device connecting to a switch port where 802.1X authentication is enabled must go through relevant EAP authentication model to start exchanging traffic.

Currently, the Cisco Wave 2 and Wi-Fi 6 (802.11AX) APs support 802.1X authentication with switch port for EAP-FAST, EAP-TLS and EAP-PEAP methods. Now, you can enable configurations and provide credentials to the AP from the controller .



---

**Note** If the AP is dot1x EAP-FAST, when the AP reboots, it should perform an anonymous PAC provision. For performing PAC provision, the ADH cipher suites should be used to establish an authenticated tunnel. If the ADH cipher suites are not supported by radius servers, AP will fail to authenticate on reload.

---

## EAP-FAST Protocol

In the EAP-FAST protocol developed by Cisco, in order to establish a secured TLS tunnel with RADIUS, the AP requires a strong shared key (PAC), either provided via in-band provisioning (in a secured channel) or via out-band provisioning (manual).



---

**Note** The EAP-FAST type configuration requires 802.1x credentials configuration for AP, since AP will use EAP-FAST with MSCHAP Version 2 method.

---



---

**Note** Local EAP is not supported on the Cisco 7925 phones.

---



---

**Note** In Cisco Wave 2 APs, for 802.1x authentication using EAP-FAST after PAC provisioning (caused by the initial connection or after AP reload), ensure that you configure the switch port to trigger re-authentication using one of the following commands: **authentication timer restart num** or **authentication timer reauthenticate num**.

---

Starting from Cisco IOS XE Amsterdam 17.1.1, TLS 1.2 is supported in EAP-FAST authentication protocol.

## EAP-TLS/EAP-PEAP Protocol

The EAP-TLS protocol or EAP-PEAP protocol provides certificate based mutual EAP authentication.

In EAP-TLS, both the server and the client side certificates are required, where the secured shared key is derived for the particular session to encrypt or decrypt data. Whereas, in EAP-PEAP, only the server side certificate is required, where the client authenticates using password based protocol in a secured channel.



---

**Note** The EAP-PEAP type configuration requires Dot1x credentials configuration for AP; and the AP also needs to go through LSC provisioning. AP uses the PEAP protocol with MSCHAP Version 2 method.

---

## Limitations of the 802.1X Authentication

- 802.1X is not supported on dynamic ports or Ethernet Channel ports.
- 802.1X is not supported in a mesh AP scenario.
- There is no recovery from the controller on credential mismatch or the expiry/invalidity of the certificate on AP. The 802.1X authentication has to be disabled on the switch port to connect the AP back to fix the configurations.
- There are no certificate revocation checks implemented on the certificates installed in AP.
- Only one Locally Significant Certificates (LSC) can be provisioned on the AP and the same certificate must be used for CAPWAP DTLS session establishment with controller and the 802.1X authentication with the switch. If global LSC configuration on the controller is disabled; AP deletes LSC which is already provisioned.
- If clear configurations are applied on the AP, then the AP will lose the 802.1X EAP type configuration and the LSC certificates. AP should again go through staging process if 802.1X is required.

- 802.1X for trunk port APs on multi-host authentication mode is supported. Network Edge Authentication Topology (NEAT) is not supported on COS APs.

## Topology - Overview

The 802.1X authentication events are as follows:

1. The AP acts as the 802.1X supplicant and is authenticated by the switch against the RADIUS server which supports EAP-FAST along with EAP-TLS and EAP-PEAP. When dot1x authentication is enabled on a switch port, the device connected to it authenticates itself to receive and forward data other than 802.1X traffic.
2. In order to authenticate with EAP-FAST method, the AP requires the credentials of the RADIUS server. It can be configured at the controller, from where it will be passed on to the AP via configuration update request. For, EAP-TLS or EAP-PEAP the APs use the certificates (device/ID and CA) made significant by the local CA server.

Figure 16: Figure: 1 Topology for 802.1X Authentication

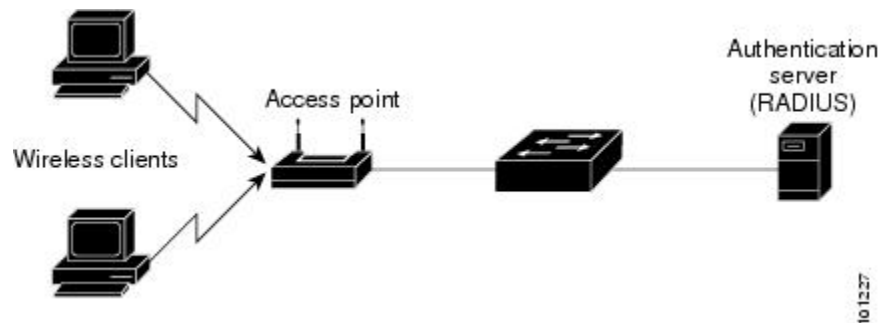

## Configuring 802.1X Authentication Type and LSC AP Authentication Type (GUI)

### Procedure

- 
- Step 1** Choose **Configuration > Tags & Profiles > AP Join**.
- Step 2** On the **AP Join Profile** page, click **Add**.  
The **Add AP Join Profile** page is displayed.
- Step 3** In the **AP > General** tab, navigate to the **AP EAP Auth Configuration** section.
- Step 4** From the **EAP Type** drop-down list, choose the EAP type as *EAP-FAST*, *EAP-TLS*, or *EAP-PEAP* to configure the dot1x authentication type.
- Step 5** From the **AP Authorization Type** drop-down list, choose the type as either **CAPWAP DTLS +** or **CAPWAP DTLS**.

**Step 6** Click **Save & Apply to Device**.

## Configuring 802.1X Authentication Type and LSC AP Authentication Type

### Procedure

	Command or Action	Purpose
<b>Step 1</b>	<b>enable</b> <b>Example:</b> Device> enable	Enables privileged EXEC mode.
<b>Step 2</b>	<b>configure terminal</b> <b>Example:</b> Device# configure terminal	Enters global configuration mode.
<b>Step 3</b>	<b>ap profile</b> <i>profile-name</i> <b>Example:</b> Device(config)# ap profile new-profile	Specify a profile name.
<b>Step 4</b>	<b>dot1x</b> { <b>max-sessions</b>   <b>username</b>   <b>eap-type</b>   <b>lsc-ap-auth-state</b> } <b>Example:</b> Device(config-ap-profile)# dot1x eap-type	Configures the dot1x authentication type. <b>max-sessions:</b> Configures the maximum 802.1X sessions initiated per AP. <b>username:</b> Configures the 802.1X username for all Aps. <b>eap-type:</b> Configures the dot1x authentication type with the switch port. <b>lsc-ap-auth-state:</b> Configures the LSC authentication state on the AP.
<b>Step 5</b>	<b>dot1x eap-type</b> { <b>EAP-FAST</b>   <b>EAP-TLS</b>   <b>EAP-PEAP</b> } <b>Example:</b> Device(config-ap-profile)# dot1x eap-type	Configures the dot1x authentication type: EAP-FAST, EAP-TLS, or EAP-PEAP.
<b>Step 6</b>	<b>dot1x lsc-ap-auth-state</b> { <b>CAPWAP-DTLS</b>   <b>Dot1x-port-auth</b>   <b>Both</b> } <b>Example:</b> Device(config-ap-profile)#dot1x lsc-ap-auth-state Dot1x-port-auth	Configures the LSC authentication state on the AP. <b>CAPWAP-DTLS:</b> Uses LSC only for CAPWAP DTLS. <b>Dot1x-port-auth:</b> Uses LSC only for dot1x authentication with port.

	Command or Action	Purpose
		<b>Both:</b> Uses LSC for both CAPWAP-DTLS and Dot1x authentication with port.
<b>Step 7</b>	<b>end</b> <b>Example:</b> Device(config-ap-profile)# end	Exits the AP profile configuration mode and enters privileged EXEC mode.

## Configuring the 802.1X Username and Password (GUI)

### Procedure

- 
- Step 1** Choose **Configuration > Tags & Profiles > AP Join**.
  - Step 2** On the **AP Join** page, click the name of the AP Join profile or click **Add** to create a new one.
  - Step 3** Click the **Management** tab and then click the **Credentials** tab.
  - Step 4** Enter the local username and password details.
  - Step 5** Choose the appropriate local password type.
  - Step 6** Enter 802.1X username and password details.
  - Step 7** Choose the appropriate 802.1X password type.
  - Step 8** Enter the time in seconds after which the session should expire.
  - Step 9** Enable local credentials and/or 802.1X credentials as required.
  - Step 10** Click **Update & Apply to Device**.
- 

## Configuring the 802.1X Username and Password (CLI)

The following procedure configures the 802.1X password for all the APs:

### Procedure

	Command or Action	Purpose
<b>Step 1</b>	<b>enable</b> <b>Example:</b> Device> enable	Enables privileged EXEC mode.
<b>Step 2</b>	<b>configure terminal</b> <b>Example:</b> Device# configure terminal	Enters global configuration mode.
<b>Step 3</b>	<b>ap profile <i>profile-name</i></b> <b>Example:</b> Device(config)# ap profile new-profile	Specify a profile name.

	Command or Action	Purpose
<b>Step 4</b>	<b>dot1x {max-sessions   username   eap-type   lsc-ap-auth-state}</b>  <b>Example:</b> <pre>Device(config-ap-profile)# dot1x eap-type</pre>	Configures the dot1x authentication type.  <b>max-sessions:</b> Configures the maximum 802.1X sessions initiated per AP.  <b>username:</b> Configures the 802.1X username for all Aps.  <b>eap-type:</b> Configures the dot1x authentication type with the switch port.  <b>lsc-ap-auth-state:</b> Configures the LSC authentication state on the AP.
<b>Step 5</b>	<b>dot1x username &lt;username&gt; password {0   8} &lt;password&gt;</b>  <b>Example:</b> <pre>Device(config-ap-profile)#dot1x username username password 0 password</pre>	Configures the dot1x password for all the APs.  0: Specifies an unencrypted password will follow.  8: Specifies an AES encrypted password will follow.

## Enabling 802.1X on the Switch Port

The following procedure enables 802.1X on the switch port:

### Procedure

	Command or Action	Purpose
<b>Step 1</b>	<b>enable</b>  <b>Example:</b> <pre>Device&gt; enable</pre>	Enables privileged EXEC mode.
<b>Step 2</b>	<b>configure terminal</b>  <b>Example:</b> <pre>Device# configure terminal</pre>	Enters global configuration mode.
<b>Step 3</b>	<b>aaa new-model</b>  <b>Example:</b> <pre>Device(config)# aaa new-model</pre>	Enables AAA.
<b>Step 4</b>	<b>aaa authentication dot1x {default   listname} method1[method2...]</b>  <b>Example:</b> <pre>Device(config)# aaa authentication dot1x default group radius</pre>	Creates a series of authentication methods that are used to determine user privilege to access the privileged command level so that the device can communicate with the AAA server.

	Command or Action	Purpose
<b>Step 5</b>	<b>aaa authorization network group</b> <b>Example:</b> <pre>aaa authorization network group</pre>	Enables AAA authorization for network services on 802.1X.
<b>Step 6</b>	<b>dot1x system-auth-control</b> <b>Example:</b> <pre>Device(config)# dot1x system-auth-control</pre>	Globally enables 802.1X port-based authentication.
<b>Step 7</b>	<b>interface type slot/port</b> <b>Example:</b> <pre>Device(config)# interface fastethernet2/1</pre>	Enters interface configuration mode and specifies the interface to be enabled for 802.1X authentication.
<b>Step 8</b>	<b>authentication port-control {auto   force-authorized   force-unauthorized}</b> <b>Example:</b> <pre>Device(config-if)# authentication port-control auto</pre>	<p>Enables 802.1X port-based authentication on the interface.</p> <p><b>auto</b>—Enables IEEE 802.1X authentication and causes the port to begin in the unauthorized state, allowing only EAPOL frames to be sent and received through the port. The authentication process begins when the link state of the port changes from down to up or when an EAPOL-start frame is received. The Device requests the identity of the supplicant and begins relaying authentication messages between the supplicant and the authentication server. Each supplicant attempting to access the network is uniquely identified by the Device by using the supplicant MAC address.</p> <p><b>force-authorized</b>—Disables IEEE 802.1X authentication and causes the port to change to the authorized state without any authentication exchange required. The port sends and receives normal traffic without IEEE 802.1X-based authentication of the client. This is the default setting.</p> <p><b>force-unauthorized</b>—Causes the port to remain in the unauthorized state, ignoring all attempts by the supplicant to authenticate. The Device cannot provide authentication services to the supplicant through the port.</p>
<b>Step 9</b>	<b>dot1x pae [supplicant   authenticator   both]</b> <b>Example:</b> <pre>Device(config-if)# dot1x pae authenticator</pre>	Enables 802.1X authentication on the port with default parameters.

	Command or Action	Purpose
Step 10	<b>end</b>  <b>Example:</b> Device(config-if)# end	Enters privileged EXEC mode.

## Verifying 802.1X on the Switch Port

The following show command displays the authentication state of 802.1X on the switch port:

```
Device# show dot1x all
Sysauthcontrol          Enabled
Dot1x Protocol Version  2
Dot1x Info for FastEthernet1
-----
PAE                      = AUTHENTICATOR
PortControl              = AUTO
ControlDirection        = Both
HostMode                 = MULTI_HOST
ReAuthentication         = Disabled
QuietPeriod              = 60
ServerTimeout            = 30
SuppTimeout              = 30
ReAuthPeriod             = 3600 (Locally configured)
ReAuthMax                = 2
MaxReq                   = 2
TxPeriod                 = 30
RateLimitPeriod          = 0
Device#
```

## Verifying the Authentication Type

The following show command displays the authentication state of an AP profile:

```
Device#show ap profile <profile-name> detailed ?
  chassis  Chassis
  |        Output modifiers
  <cr>

Device#show ap profile <profile-name> detailed

AP Profile Name      : default-ap-profile
Description           : default ap profile
...
Dot1x EAP Method     : [EAP-FAST/EAP-TLS/EAP-PEAP/Not-Configured]
LSC AP AUTH STATE    : [CAPWAP DTLS / DOT1x port auth / CAPWAP DTLS + DOT1x port auth
```





## CHAPTER 30

# CAPWAP Link Aggregation Support

- [Information About CAPWAP LAG Support, on page 367](#)
- [Restrictions for CAPWAP LAG Support, on page 368](#)
- [Enabling CAPWAP LAG Support on Controller \(GUI\), on page 368](#)
- [Enabling CAPWAP LAG Support on Controller, on page 368](#)
- [Enabling CAPWAP LAG Globally on Controller, on page 369](#)
- [Disabling CAPWAP LAG Globally on Controller, on page 369](#)
- [Enabling CAPWAP LAG for an AP Profile \(GUI\), on page 369](#)
- [Enabling CAPWAP LAG for an AP Profile, on page 370](#)
- [Disabling CAPWAP LAG for an AP Profile, on page 370](#)
- [Disabling CAPWAP LAG Support on Controller , on page 371](#)
- [Verifying CAPWAP LAG Support Configurations, on page 371](#)

## Information About CAPWAP LAG Support

Link aggregation (LAG) simplifies controller configuration because you no longer require to configure primary and secondary ports for each interface. If any of the controller ports fail, traffic is automatically migrated to one of the other ports. As long as at least one controller port is functioning, the system continues to operate, access points remain connected to the network, and wireless clients continue to send and receive data.

The CAPWAP LAG support feature is applicable for access points that support multiple ethernet ports for CAPWAP.

The 11AC APs with dual ethernet ports require the CAPWAP AP LAG support for data channel.

Cisco Aironet 1850, 2800, and 3800 Series APs' second Ethernet port is used as a link aggregation port, by default. It is possible to use this LAG port as an RLAN port when LAG is disabled.

The following APs use LAG port as an RLAN port:

- 1852E
- 1852I
- 2802E
- 2802I
- 3802E

- 3802I
- 3802P

## Restrictions for CAPWAP LAG Support

- APs must be specifically enabled for CAPWAP AP LAG support.
- CAPWAP data does not support IPv6.
- Data DTLS must not be enabled when LAG is enabled.
- APs behind NAT and PAT are not supported.

## Enabling CAPWAP LAG Support on Controller (GUI)

### Procedure

- 
- Step 1** Choose **Configuration > Wireless > Wireless Global**.
- Step 2** Check the **AP LAG Mode** check box.
- Step 3** Click **Apply**.
- 

## Enabling CAPWAP LAG Support on Controller

### Procedure

	Command or Action	Purpose
<b>Step 1</b>	<b>configure terminal</b> <b>Example:</b> Device# configure terminal	Enters global configuration mode.
<b>Step 2</b>	<b>ap lag support</b> <b>Example:</b> Device(config)# ap lag support	Enables CAPWAP LAG support on the controller.  <b>Note</b> After executing this command, you get to view the following warning statement:  <i>Changing the lag support will cause all the APs to disconnect.</i>  Thus, all APs with LAG capability reboots and joins the enabled CAPWAP LAG.

	Command or Action	Purpose
<b>Step 3</b>	<b>end</b> <b>Example:</b> Device (config) # <b>end</b>	Returns to privileged EXEC mode. Alternatively, you can also press <b>Ctrl-Z</b> to exit global configuration mode.

## Enabling CAPWAP LAG Globally on Controller

If the CAPWAP LAG is enabled globally on the controller, the following occurs:

- AP joins the controller.
- AP exchanges its CAPWAP support.
- LAG mode starts, if LAG is enabled on AP.

## Disabling CAPWAP LAG Globally on Controller

If the CAPWAP LAG is disabled globally on the controller, the following occurs:

- AP joins the controller.
- AP exchanges its CAPWAP support.
- AP LAG config is sent to AP, if LAG is already enabled on AP.
- AP reboots.
- AP joins back with the disabled LAG.

## Enabling CAPWAP LAG for an AP Profile (GUI)

### Procedure

- 
- Step 1** Choose **Configuration > Tags & Profiles > AP Join**.
- Step 2** Click **Add**.
- Step 3** Under the **General** tab, enter the **Name** of the AP Profile and check the **LAG Mode** check box to set the CAPWAP LAG for the AP profile.
- Step 4** Click **Apply to Device**.
-

## Enabling CAPWAP LAG for an AP Profile

### Procedure

	Command or Action	Purpose
<b>Step 1</b>	<b>configure terminal</b> <b>Example:</b> Device# <code>configure terminal</code>	Enters global configuration mode.
<b>Step 2</b>	<b>ap profile <i>ap-profile</i></b> <b>Example:</b> Device (config) # <code>ap profile xyz-ap-profile</code>	Configures an AP profile and enters AP profile configuration mode. <b>Note</b> When you delete a named profile, the APs associated with that profile will not revert to the default profile.
<b>Step 3</b>	<b>lag</b> <b>Example:</b> Device (config-ap-profile) # <code>lag</code>	Enables CAPWAP LAG for an AP profile.
<b>Step 4</b>	<b>end</b> <b>Example:</b> Device (config-ap-profile) # <code>end</code>	Exits configuration mode and returns to privileged EXEC mode.

## Disabling CAPWAP LAG for an AP Profile

### Procedure

	Command or Action	Purpose
<b>Step 1</b>	<b>configure terminal</b> <b>Example:</b> Device# <code>configure terminal</code>	Enters global configuration mode.
<b>Step 2</b>	<b>ap profile <i>ap-profile</i></b> <b>Example:</b> Device (config) # <code>ap profile xyz-ap-profile</code>	Configures an AP profile and enters AP profile configuration mode. <b>Note</b> When you delete a named profile, the APs associated with that profile will not revert to the default profile.
<b>Step 3</b>	<b>no lag</b> <b>Example:</b> Device (config-ap-profile) # <code>no lag</code>	Disables CAPWAP LAG for an AP profile.

	Command or Action	Purpose
<b>Step 4</b>	<b>end</b> <b>Example:</b> Device(config-ap-profile)# <b>end</b>	Exits configuration mode and returns to privileged EXEC mode.

## Disabling CAPWAP LAG Support on Controller

### Procedure

	Command or Action	Purpose
<b>Step 1</b>	<b>configure terminal</b> <b>Example:</b> Device# <code>configure terminal</code>	Enters global configuration mode.
<b>Step 2</b>	<b>no ap lag support</b> <b>Example:</b> Device(config)# <code>no ap lag support</code>	Disables CAPWAP LAG support on the controller . <b>Note</b> All APs with LAG capability reboots and joins the disabled CAPWAP LAG.
<b>Step 3</b>	<b>end</b> <b>Example:</b> Device(config)# <b>end</b>	Exits configuration mode and returns to privileged EXEC mode.

## Verifying CAPWAP LAG Support Configurations

To verify the global LAG status for all Cisco APs, use the following command:

```
Device# show ap lag-mode
AP Lag-Mode Support Enabled
```

To verify the AP LAG configuration status, use the following command:

```
Device# show ap name <ap-name> config general
Cisco AP Identifier : 0008.3291.6360
Country Code : US
Regulatory Domain Allowed by Country : 802.11bg:-A 802.11a:-AB
AP Country Code : US - United States
::
AP Lag Configuration Status : Enabled/Disabled
Has AP negotiated lag based on AP capability and per AP config.
```





## CHAPTER 31

# DHCP and NAT Functionality on Root Access Point

---

- [Information About DHCP and NAT Functionality on Root AP \(RAP\), on page 373](#)
- [Configuring DHCP Server on Root Access Point \(RAP\), on page 374](#)
- [Verifying DHCP Server for Root AP Configuration, on page 374](#)

## Information About DHCP and NAT Functionality on Root AP (RAP)



---

**Note** This feature is applicable for Cisco Aironet 1542 series outdoor access points only.

---

The access points associated to a mesh network can play one of the two roles:

- Root Access Point (RAP) - An access point can be a root access point for multiple mesh networks.
- Mesh Access Point (MAP) - An access point can be a mesh access point for only one single mesh network at a time.

### DHCP and NAT Functionality on Root AP - IPv4 Scenario

This feature enables the controller to send a TLV to RAP when a new RAP joins the controller.

The following covers the workflow:

- Controller pushes TLV to RAP for enabling DHCP and NAT functionality.
- Client associates to an SSID.
- RAP executes DHCP functionality to assign private IPv4 address to the client.
- RAP executes NAT functionality to get the private IPv4 address of the client and allow access to the network.

## Configuring DHCP Server on Root Access Point (RAP)

### Procedure

	Command or Action	Purpose
<b>Step 1</b>	<b>configure terminal</b>  <b>Example:</b> Device# configure terminal	Enters global configuration mode.
<b>Step 2</b>	<b>ap profile <i>ap-profile-name</i></b>  <b>Example:</b> Device(config)# ap profile ap-profile-name	Configures an AP Profile.
<b>Step 3</b>	<b>dhcp-server</b>  <b>Example:</b> Device(config-ap-profile)# dhcp-server	Configures DHCP server on the root access point.
<b>Step 4</b>	<b>end</b>  <b>Example:</b> Device(config-ap-profile)# end	Saves the configuration and exits configuration mode and returns to privileged EXEC mode.

## Verifying DHCP Server for Root AP Configuration

To verify the DHCP server for root AP configuration, use the following command:

```
Device# show ap config general
Cisco AP Name   : AP4C77.6DF2.D588
=====
<SNIP>
Dhcp Server                               : Enabled
```





## CHAPTER 32

# OFDMA Support for 11ax Access Points

- [Information About OFDMA Support for 11ax Access Points, on page 375](#)
- [Configuring 11AX \(GUI\), on page 376](#)
- [Configuring Channel Width, on page 376](#)
- [Configuring 802.11ax Radio Parameters \(GUI\), on page 377](#)
- [Configuring 802.11ax Radio Parameters \(CLI\), on page 377](#)
- [Setting up the 802.11ax Radio Parameters, on page 378](#)
- [Configuring OFDMA on a WLAN, on page 379](#)
- [Verifying Channel Width, on page 380](#)
- [Verifying Client Details, on page 381](#)
- [Verifying Radio Configuration, on page 382](#)

## Information About OFDMA Support for 11ax Access Points

The Cisco Catalyst 9100 series access points are the next generation WiFi 802.11ax access point, which is ideal for high-density high-definition applications.

The IEEE 802.11ax protocol aims to improve user experience and network performance in high density deployments for both 2.4 GHz and 5 GHz. The 802.11ax APs supports transmission or reception to more than one client simultaneously using Orthogonal Frequency Division Multiplexing (OFDMA).

The IEEE 802.11ax supports uplink MU-MIMO and also adds OFDMA for multiple users in the uplink and downlink. All the users in IEEE 802.11ax OFDMA have the same time allocations and it ends at the same time. In MU-MIMO and OFDMA, multiple stations (STAs) either simultaneously transmit to a single STA or simultaneously receive from a single STA independent data streams over the same radio frequencies.

## Supported Modes on 11ax Access Points

The following AP modes are supported:

- Local mode
- Flex-connect mode
- Bridge mode
- Flex+Mesh mode

## Configuring 11AX (GUI)

You can configure 11ax for the frequencies, 5 GHz and 2.4 GHz.

### Procedure

- 
- Step 1** Choose **Configuration > Radio Configurations > High Throughput**.
- Step 2** Click the **5 GHz Band** tab.
- Expand the **11ax** section.
  - Select the **Enable 11ax** and **Multiple Bssid** check boxes, if required.
  - Check either the **Select All** check box to configure all the data rates or select the desired options from the available data rates list.
- Step 3** Click the **2.4 GHz Band** tab.
- Expand the **11ax** section.
  - Select the **Enable 11ax** and **Multiple Bssid** check boxes, if required.
  - Check either the **Select All** check box to configure all the data rates or select the desired options from the available data rates list.
- 

## Configuring Channel Width

### Procedure

	Command or Action	Purpose
<b>Step 1</b>	<b>configure terminal</b>  <b>Example:</b> Device# configure terminal	Enters the global configuration mode.
<b>Step 2</b>	<b>ap dot11 { 24ghz   5ghz } rrm channel dca chan-width 160</b>  <b>Example:</b> Device(config)# ap dot11 5ghz rrm channel dca chan-width 160	Configures channel width for 802.11 radios as 160.  Use the <b>no</b> form of the command to disable the configuration.  <b>Note</b> Cisco Catalyst 9115 and C9120 series APs do not support 80+80 channel width. Cisco Catalyst 9117 series APs do not support OFDMA in 160 channel width.
<b>Step 3</b>	<b>ap dot11 { 24ghz   5ghz } rf-profile <i>profile-name</i></b>  <b>Example:</b>	Configures an RF profile and enters RF profile configuration mode.

	Command or Action	Purpose
	Device(config)# ap dot11 5ghz rf-profile ax-profile	
<b>Step 4</b>	<b>channel chan-width 160</b>  <b>Example:</b> Device(config-rf-profile)# channel chan-width 160	Configures the RF profile DCA channel width.

## Configuring 802.11ax Radio Parameters (GUI)

### Procedure

- 
- Step 1** Choose **Configuration > Radio Configurations > High Throughput > 5 GHz Band > 11ax**.
- Step 2** Check or uncheck the **Enable 11 n** check box.
- Step 3** Check the check boxes for the desired MCS/(data rate) or to select all of them, check the **Select All** check box.
- Step 4** Click **Apply**.
- Step 5** Choose **Configuration > Radio Configurations > High Throughput > 2.4 GHz Band > 11ax**.
- Step 6** Check or uncheck the **Enable 11 n** check box.
- Step 7** Check the check boxes for the desired MCS/(data rate) or to select all of them, check the **Select All** check box.
- Step 8** Click **Apply**.
- Step 9** Choose **Configuration > Wireless > Access Points**.
- Step 10** Click the Access Point.
- Step 11** In the **Edit AP** dialog box, enable the **LED State** toggle button and choose the LED brightness level from the **LED Brightness Level** drop-down list.
- Step 12** Click **Update and Apply to Device**.
- 

## Configuring 802.11ax Radio Parameters (CLI)

Follow the procedure given below to configure radio parameters:

### Procedure

	Command or Action	Purpose
<b>Step 1</b>	<b>configure terminal</b>  <b>Example:</b> Device# configure terminal	Enters the global configuration mode.

	Command or Action	Purpose
<b>Step 2</b>	<b>ap dot11 { 24ghz   5ghz } dot11ax</b> <b>Example:</b> Device(config)# ap dot11 5ghz dot11ax	Enables the 11ax 5 Ghz band radio.  Use the <b>no</b> form of the command to disable the configuration.
<b>Step 3</b>	<b>ap dot11 { 24ghz   5ghz } dot11ax mcs tx index index spatial-stream spatial-stream-value</b> <b>Example:</b> Device(config)# ap dot11 5ghz dot11ax mcs tx index 11 spatial-stream 8	Enables the 11ax 5 Ghz band modulation and coding scheme (MCS) transmission rates.
<b>Step 4</b>	<b>ap led-brightness brightness-level</b> <b>Example:</b> Device(config)# ap led-brightness 6	(Optional) Configures the led brightness level.

## Setting up the 802.11ax Radio Parameters

### Procedure

	Command or Action	Purpose
<b>Step 1</b>	<b>enable</b> <b>Example:</b> Device# enable	Enters privileged EXEC mode.
<b>Step 2</b>	<b>ap name ap-name led-brightness-level brightness-level</b> <b>Example:</b> Device# ap name ax-ap led-brightness-level 6	Configures the led brightness level.
<b>Step 3</b>	<b>ap name ap-namedot11 { 24ghz   5ghz } dot11n antenna antenna-port</b> <b>Example:</b> Device# ap name ap1 dot11 5ghz dot11n antenna A	Configures the 802.11n - 5 GHz antenna selection.  Use the <b>no</b> form of the command to disable the configuration.
<b>Step 4</b>	<b>ap name ap-name dot11 { 24ghz   5ghz } channel width channel-width</b> <b>Example:</b> Device# ap name ap1 dot11 5ghz channel width 160	Configures 802.11 channel width.

	Command or Action	Purpose
<b>Step 5</b>	<b>ap name</b> <i>ap-name</i> <b>dot11</b> { <b>24ghz</b>   <b>5ghz</b> } <b>secondary-80</b> <i>channel-num</i>  <b>Example:</b> Device# ap name ap1 dot11 5ghz secondary-80 12	Configures the advanced 802.11 secondary 80Mhz channel assignment parameters.

## Configuring OFDMA on a WLAN



**Note** For Cisco Catalyst 9115 and 9120 series APs, the configuration given below are per radio, and not per WLAN. This feature remains enabled on the controller, if it is enabled on any of the WLANs.

### Procedure

	Command or Action	Purpose
<b>Step 1</b>	<b>configure terminal</b>  <b>Example:</b> Device# configure terminal	Enters the global configuration mode.
<b>Step 2</b>	<b>wlan</b> <i>wlan1</i>  <b>Example:</b> Device(config)# wlan wlan1	Enters the WLAN configuration mode.
<b>Step 3</b>	<b>dot11ax</b> <i>downlink-ofdma</i>  <b>Example:</b> Device(config-wlan)# dot11ax downlink-ofdma	Enables the downlink connection that uses the OFDMA technology.  Use the <b>no</b> form of the command to disable the configuration.
<b>Step 4</b>	<b>dot11ax</b> <i>uplink-ofdma</i>  <b>Example:</b> Device(config-wlan)# dot11ax uplink-ofdma	Enables the uplink connection that uses the OFDMA technology .
<b>Step 5</b>	<b>dot11ax</b> <i>downlink-mumimo</i>  <b>Example:</b> Device(config-wlan)# dot11ax downlink-mumimo	Enables the downlink connection that uses the MUMIMO technology.
<b>Step 6</b>	<b>dot11ax</b> <i>uplink-mumimo</i>  <b>Example:</b> Device(config-wlan)# dot11ax uplink-mumimo	Enables the uplink connection that uses the MUMIMO technology.

	Command or Action	Purpose
<b>Step 7</b>	<b>dot11ax twt-broadcast-support</b>  <b>Example:</b> Device (config-wlan)# dot11ax twt-broadcast-support	Enables the TWT broadcast support operation.

## Verifying Channel Width

To verify the channel width and other channel information, use the following **show** commands:

Device# **show ap dot11 5ghz summary**

AP Name Twpwr	Mac Address	Slot	Admin State	Oper State	Channel	Width
AP80e0.1d75.6954 1 (*)	80e0.1d7a.7620	1	Enabled	Up	(52)*	160

Device# **show ap dot11 dual-band summary**

AP Name Mode	Subband	Radio Mac	Status	Channel	Power Level	Slot ID
kart128021mi REAP	All	002a.1058.38a0	Enabled	(52)*	(1)*	1

Device# **show ap name <ap-name> channel**

```

802.11b/g Current Channel           : 11
Slot ID                             : 0
Allowed Channel List                : 1,2,3,4,5,6,7,8,9,10,11
802.11a Current Channel ..... 52 (160 MHz)
Slot ID                             : 1
Allowed Channel List                :
36,40,44,48,52,56,60,64,100,104,108,112,116,132,136,140,149,153,157,161,165

```

Device# **show ap name <ap-name> config slot <slot-num>**

```

.
.
.
Phy OFDM Parameters
    Configuration                   : Automatic
    Current Channel                  : 52
    Extension Channel                : No Extension
    Channel Width                   : 160 MHz
    Allowed Channel List             :
36,40,44,48,52,56,60,64,100,104,108,112,116,132,136,140,149,153,157,161,165
    TI Threshold                     : 0

```

Device# **show ap dot11 5ghz channel**

```

.
.
.
DCA Sensitivity Level               : MEDIUM : 15 dB
DCA 802.11n/ac Channel Width       : 160 MHz
DCA Minimum Energy Limit           : -95 dBm
.
.
.

```

```

Device# show ap rf-profile name <name> detail
.
.
.
Unused Channel List           : 165
DCA Bandwidth                 : 160 MHz
DCA Foreign AP Contribution   : Enabled
.
.
.

```

## Verifying Client Details

To verify the client information, use the following **show** commands:

```

Device# show wireless client mac-address <mac-address> detail

```

```

Client MAC Address : a886.ddb2.05e9
Client IPv4 Address : 169.254.175.214
Client IPv6 Addresses : fe80::b510:a381:8099:4747
                        2009:300:300:57:4007:6abb:2c9a:61e2

```

```

Client Username: N/A
Voice Client Type : Unknown
AP MAC Address : c025.5c55.e400
AP Name: APe4c7.22b2.948e
Device Type: N/A
Device Version: N/A
AP slot : 0
Client State : Associated
Policy Profile : default-policy-profile
Flex Profile : default-flex-profile
Wireless LAN Id : 1
Wireless LAN Name: SSS_OPEN
BSSID : c025.5c55.e406
Connected For : 23 seconds
Protocol : 802.11ax - 5 GHz
Channel : 8
Client IIF-ID : 0xa0000001
Association Id : 1
Authentication Algorithm : Open System
Client CCX version : No CCX support
Session Timeout : 86400 sec (Remaining time: 86378 sec)

```

```

.
.
.

```

```

Device# show wireless client summary

```

```

Number of Local Clients: 1

```

MAC Address Role	AP Name	WLAN	State	Protocol Method
a886.ddb2.05e9 Local	APe4c7.22b2.948e	1	Run	11ax(5) None

```

Device# show wireless stats client detail

```

```
Total Number of Clients : 1
```

```
Protocol Statistics
```

```
-----
Protocol          Client Count
802.11b           0
802.11g           0
802.11a           0
802.11n-2.4 GHz  0
802.11n-5 GHz    0
802.11ac          0
80211ax         1
```

## Verifying Radio Configuration

To verify the radio configuration information, use the following **show** commands:

```
Device# show ap dot11 5ghz network
```

```
802.11a Network           : Enabled
.
.
.
802.11ax                   : Enabled
  DynamicFrag             : Enabled
  MultiBssid               : Disabled
802.11ax MCS Settings:
  MCS 7, Spatial Streams = 1 : Disabled
  MCS 9, Spatial Streams = 1 : Disabled
  MCS 11, Spatial Streams = 1 : Disabled
  MCS 7, Spatial Streams = 2 : Supported
  MCS 9, Spatial Streams = 2 : Supported
  MCS 11, Spatial Streams = 2 : Supported
  MCS 7, Spatial Streams = 3 : Supported
  MCS 9, Spatial Streams = 3 : Disabled
  MCS 11, Spatial Streams = 3 : Disabled
  MCS 7, Spatial Streams = 4 : Supported
  MCS 9, Spatial Streams = 4 : Supported
  MCS 11, Spatial Streams = 4 : Supported
  MCS 7, Spatial Streams = 5 : Supported
  MCS 9, Spatial Streams = 5 : Supported
  MCS 11, Spatial Streams = 5 : Supported
  MCS 7, Spatial Streams = 6 : Supported
  MCS 9, Spatial Streams = 6 : Supported
  MCS 11, Spatial Streams = 6 : Supported
  MCS 7, Spatial Streams = 7 : Supported
  MCS 9, Spatial Streams = 7 : Supported
  MCS 11, Spatial Streams = 7 : Supported
  MCS 7, Spatial Streams = 8 : Supported
  MCS 9, Spatial Streams = 8 : Supported
  MCS 11, Spatial Streams = 8 : Supported
Beacon Interval           : 100
.
.
.
Maximum Number of Clients per AP Radio : 200

Device# show ap dot11 24ghz network

802.11b Network           : Enabled
```



```

.
.
.
802.11axSupport..... Enabled
    dynamicFrag..... Disabled
    multiBssid..... Disabled
802.11ax
    DynamicFrag          : Enabled
    MultiBssid           : Enabled
802.11ax MCS Settings:
    MCS 7, Spatial Streams = 1      : Supported
    MCS 9, Spatial Streams = 1      : Supported
    MCS 11, Spatial Streams = 1     : Supported
    MCS 7, Spatial Streams = 2      : Supported
    MCS 9, Spatial Streams = 2      : Supported
    MCS 11, Spatial Streams = 2     : Supported
    MCS 7, Spatial Streams = 3      : Supported
    MCS 9, Spatial Streams = 3      : Supported
    MCS 11, Spatial Streams = 3     : Supported
    MCS 7, Spatial Streams = 4      : Disabled
    MCS 9, Spatial Streams = 4      : Disabled
    MCS 11, Spatial Streams = 4     : Disabled
Beacon Interval          : 100
.
.
.
Maximum Number of Clients per AP Radio : 200

```

Device# **show wlan ID <wlan-id>**

```

WLAN Profile Name      : ax-wlc
=====
Identifier              : 1
Network Name (SSID)    : ax-wlc
Status                  : Enabled
Broadcast SSID         : Enabled
Universal AP Admin     : Disabled
Max Associated Clients per WLAN : 0
Max Associated Clients per AP per WLAN : 0
Max Associated Clients per AP Radio per WLAN : 200
Number of Active Clients : 0
CHD per WLAN           : Enabled
Multicast Interface    : Unconfigured
.
.
.
802.11ac MU-MIMO      : Disabled
802.11ax paramters
    OFDMA Downlink    : Enabled
    OFDMA Uplink      : Enabled
    MU-MIMO Downlink  : Enabled
    MU-MIMO Uplink    : Enabled
    BSS Color         : Enabled
    Partial BSS Color : Enabled
    BSS Color Code    : 0
    BSS Target Wake Up Time : Enabled

```

Device# **show ap led-brightness-level summary**

AP Name	LED Brightness level
AP00FC.BA01.CC00	Not Supported
AP70DF.2FA2.72EE	8
AP7069.5A74.6678	2
APb838.6159.e184	Not Supported





## CHAPTER 33

# AP Audit Configuration

- [Information About AP Audit Configuration, on page 385](#)
- [Restrictions for AP Audit Configuration, on page 385](#)
- [Configure AP Audit Parameters \(CLI\), on page 386](#)
- [Verifying AP Audit Report Summary, on page 386](#)
- [Verifying AP Audit Report Detail, on page 386](#)

## Information About AP Audit Configuration

The AP Audit Configuration feature helps to detect wireless service synchronization issues between the controller and an AP. In Cisco IOS XE Amsterdam, Release 17.3.1, two methods are implemented to support AP audit configuration.

- **Config Checker:** This functionality helps in auditing the application of wireless policies during the AP join phase. Any discrepancies at this stage is reported on the controller. This is a built-in functionality and you cannot disable the same. When you try to configure any of the AP attributes such as name, IP address, controller information, tag, mode, radio mode, and radio admin state, the AP parses the CAPWAP payload configuration from the controller and reports errors detected back to the controller with proper code. If a discrepancy is detected, the controller flags errors using the syslog.
- **Config Audit:** This functionality helps to perform periodic comparison of operational states between an AP and the controller after the AP join phase and while the corresponding AP is still connected. Discrepancies, if any, are reported immediately on the controller. The consolidated report is available at the controller anytime. This functionality is disabled by default. The periodic auditing interval is a configurable parameter.

Use the **ap audit-report** command to enable and configure audit report parameters. When triggered, AP sends configurations from the database to the controller, and the controller compares the configurations against the current configuration. If a discrepancy is detected, the controller flags the error using the syslog.

## Restrictions for AP Audit Configuration

- Config checker alerts are available only through the syslog.
- IOS AP is not supported.

- The audit reports are not synchronized from the active to the standby controller. After SSO, they are not readily available until the next reporting interval of the already-connected APs.
- The audit reports are not available when an AP is in standalone mode.
- This feature is supported only on APs in FlexConnect mode.

## Configure AP Audit Parameters (CLI)

The AP Audit Configuration feature helps you compare the operational states between an AP and the controller. The AP sends state view details to the controller, and the controller compares it with what it perceives as the AP state. This feature is disabled by default.

### Procedure

	Command or Action	Purpose
<b>Step 1</b>	<b>configure terminal</b>  <b>Example:</b> Device# configure terminal	Enters global configuration mode.
<b>Step 2</b>	<b>ap audit-report enable</b>  <b>Example:</b> Device(config)# ap audit-report enable	Enables audit reporting.
<b>Step 3</b>	<b>ap audit-report interval <i>interval</i></b>  <b>Example:</b> Device(config)# ap audit-report interval 1300	Configures AP audit reporting interval. The default value for interval is 1440 minutes. The valid range is from 10 to 43200.

## Verifying AP Audit Report Summary

To verify the AP audit report summary, use the **ap audit-report summary** command:

```
Device# show ap audit-report summary
WTP Mac           Radio           Wlan           IPv4 Acl
IPv6 Acl         Last Report Time
-----
1880.90fd.6b40   OUT_OF_SYNC    OUT_OF_SYNC    IN_SYNC        IN_SYNC        01/01/1970
05:30:00 IST
```

## Verifying AP Audit Report Detail

To verify an AP audit report's details, use the **show ap name ap-name audit-report detail** command:

```
Device# show ap name Cisco-AP audit-report detail
Cisco AP Name     : Cisco-AP
=====
IPV4 ACL Audit Report Status      : IN_SYNC
```

IPv6 ACL Audit Report Status : IN\_SYNC

Radio Audit Report Status : IN\_SYNC

WLAN Audit Report Status :

Slot-id	Wlan-id	Vlan	State	SSID	Auth-Type	Other-Flag
0	4	IN_SYNC	IN_SYNC	IN_SYNC	IN_SYNC	IN_SYNC
1	4	IN_SYNC	IN_SYNC	IN_SYNC	IN_SYNC	IN_SYNC

bh-csrl#show ap audit-report summary

WTP-Mac	Radio	Wlan	IPv4-Acl	IPv6-Acl	Last-Report-Time
4001.7aca.5140 13:17:39 IST	IN_SYNC	IN_SYNC	IN_SYNC	IN_SYNC	06/22/2020
4001.7aca.5a60 13:18:25 IST	IN_SYNC	IN_SYNC	IN_SYNC	IN_SYNC	06/22/2020
7070.8b23.a1a0 13:18:29 IST	IN_SYNC	IN_SYNC	IN_SYNC	IN_SYNC	06/22/2020
a0f8.49dc.9460 13:16:43 IST	IN_SYNC	IN_SYNC	IN_SYNC	IN_SYNC	06/22/2020
a0f8.49dc.96e0 13:17:55 IST	IN_SYNC	IN_SYNC	IN_SYNC	IN_SYNC	06/22/2020





## CHAPTER 34

# AP Support Bundle

- [Access Point Support Bundle](#), on page 389
- [Exporting an AP Support Bundle \(GUI\)](#), on page 389
- [Exporting an AP Support Bundle \(CLI\)](#), on page 390
- [Monitoring the Status of Support Bundle Export](#), on page 390

## Access Point Support Bundle

An access point (AP) support bundle contains core files, crash files, **show run-configuration**, configuration commands, msglogs, and traplogs.

This topic describes how you can retrieve the support bundle information of an AP and export it to the controller or to an external server. (Until Cisco IOS XE, Release 17.2.1, you had to log in to the AP console to retrieve the AP support-bundle information.)

The Access Point Support Bundle feature is supported only on Cisco Wave2 APs and Cisco Catalyst APs.

## Exporting an AP Support Bundle (GUI)

### Procedure

- Step 1** Choose **Configuration** > **Wireless** > **Access Points**.
- Step 2** Click the corresponding AP name.  
The **Edit AP** window is displayed.
- Step 3** Click the **Support Bundle** tab.
- Step 4** From the **Destination** drop-down list, choose one of the following:
  - **This Device**: If you choose this, enter the values for the **Server IP**, **Destination File Path**, **Username**, and **Password** fields.  
**Note** When you choose **This Device**, a bundle is sent through Secure Copy (SCP) to the controller (if you have configured the **ip scp server enable** command globally on the controller). You can easily retrieve the bundle later from your browser, using the controller file manager.
  - **External Server**: If you choose this, from the **Transfer Mode** drop-down list, choose either **scp** or **tftp**.

If you choose the **scp** transfer mode, enter the values for the **Server IP**, **Destination File Path**, **Username**, and **Password** fields.

If you choose the **tftp** transfer mode, enter the values for the **Server IP**, and **Destination File Path** fields.

**Note** Information about the **Last Export Status**, such as **State**, **Transfer Mode**, **Server IP**, **File Path**, and **Time of Export**, is displayed on the right-hand side of the window.

**Step 5** Click **Start Transfer**.

## Exporting an AP Support Bundle (CLI)

### Procedure

	Command or Action	Purpose
<b>Step 1</b>	<b>enable</b> <b>Example:</b> Device> enable	Enables privileged EXEC mode. Enter your password, if prompted.
<b>Step 2</b>	<b>ap name</b> <i>Cisco-AP-name</i> <b>export</b> <b>support-bundle mode</b> { <b>scp</b>   <b>tftp</b> } <b>target</b> <b>ip-address</b> { <i>A.B.C.D</i>   <i>X:X:X:X::X</i> } <b>path</b> <i>file-path</i> <b>Example:</b> Device> ap name <i>Cisco-AP-name</i> export support-bundle mode scp target ip-address 10.1.1.1 path <i>file-path</i>	Exports the AP support bundle through the SCP or TFTP transfer modes. If you select the <b>scp</b> , you will be prompted to provide your username and password. For <b>tftp</b> , username and password is not required.

## Monitoring the Status of Support Bundle Export

To monitor the status of a support bundle export, run the following command:

```
Device# show ap support-bundle summary
AP Name      Server-IP    Status      Last Successful Time    Path File-name
-----
AP_28XXX     81.1.1.10   Copy Success  04/24/2020 07:27:38 UTC
AP_28XXX_support.17.4.0.2.2020.07XXX.tgz
```





## CHAPTER 35

# Cisco Flexible Antenna Port

---

- [Information About Cisco Flexible Antenna Port, on page 391](#)
- [Configuring a Cisco Flexible Antenna Port \(GUI\), on page 391](#)
- [Configuring a Cisco Flexible Antenna Port \(CLI\), on page 392](#)
- [Verifying Flexible Antenna Port Configuration, on page 392](#)

## Information About Cisco Flexible Antenna Port

The presence of multiple antennas on the transmitters and the receivers of access points (APs), results in better performance and reliability of the APs. Multiple antennas improve reception through the selection of stronger signals or a combination of individual signals, at the receiver. You can configure the antenna ports to be used in the APs as either dual-band antennas or as single-band antennas to optimize radio coverage.

- **Dual-band antenna mode:** APs operate in both the 2.4-GHz and 5-GHz bandwidth with all the four antennas—A, B, C, and D. An example of a dual-band antenna mode AP is the Cisco Industrial Wireless 3702 AP.
- **Single-band antenna mode:** Among the APs, antennas A and B operate in the 2.4-GHz bandwidth, and the antennas C and D operate in the 5-GHz bandwidth. An example of a single-band antenna mode AP is the Cisco Catalyst Industrial Wireless 6300 AP.

## Configuring a Cisco Flexible Antenna Port (GUI)

### Procedure

---

- |               |   |
|---------------|---|
| <b>Step 1</b> | Choose <b>Configuration &gt; Wireless &gt; Access Points</b> .        |
| <b>Step 2</b> | Click <b>AP Name</b> .  |
| <b>Step 3</b> | Click the <b>Advanced</b> tab.  |
| <b>Step 4</b> | From the <b>Antenna Mode</b> drop-down list, choose the antenna mode. |
| <b>Step 5</b> | Click <b>Apply &amp; Update</b> .                                     |
-

## Configuring a Cisco Flexible Antenna Port (CLI)

### Procedure

	Command or Action	Purpose
<b>Step 1</b>	<b>ap name</b> <i>ap-name</i> <b>antenna-band-mode</b> { <b>dual</b>   <b>single</b> }  <b>Example:</b> Device# ap name <i>ap-name</i> antenna-band-mode single	Configures antenna band mode as single or dual.

## Verifying Flexible Antenna Port Configuration

The following is a sample output of the **show ap name** *ap\_name* **config general** command that shows the bands selected on a specific AP:

```
Device# show ap name APXXXX.31XX.83XX config general
Cisco AP Name      : APXXXX.31XX.83XX
=====
Cisco AP Identifier          : b4de.312e.00c0
Country Code                : Multiple Countries : US,IN
Regulatory Domain Allowed by Country : 802.11bg:-A 802.11a:-ABDN

AP Submode                 : Not Configured
Antenna Band Mode          : Dual
```

The following is a sample output of the **show ap name** *ap\_name* **config slot 0** command that shows the bands selected on a specific AP with dual-band mode enabled:

```
Device# show ap name APXXXX.31XX.83XX config slot 0 | sec 802.11n Antennas
802.11n Antennas
A                               : ENABLED
B                               : ENABLED
C                               : ENABLED
D                               : ENABLED

802.11n Antennas
MIMO                            : x
Tx                              : Unknown
Rx                              : Unknown
```

The following is a sample output of the **show ap name** *ap\_name* **config slot 1** command that shows the bands selected on a specific AP with single-band mode enabled:

```
Device# show ap name APXXXX.31XX.83XX config slot 1 | sec 802.11n Antennas
802.11n Antennas
A                               : DISABLED
B                               : DISABLED
C                               : ENABLED
D                               : ENABLED

802.11n Antennas
MIMO                            : x
Tx                              : Unknown
Rx                              : Unknown
```



## CHAPTER 36

# LED States for Access Points

---

- [Information About LED States for Access Points](#), on page 393
- [Configuring LED State in Access Points \(GUI\)](#), on page 393
- [Configuring LED State for Access Points in the Global Configuration Mode \(CLI\)](#), on page 394
- [Configuring LED State in the AP Profile](#), on page 394
- [Verifying LED State for Access Points](#), on page 395

## Information About LED States for Access Points

In a wireless LAN network where there are a large number of access points, it is difficult to locate a specific access point associated with the controller. You can configure the controller to set the LED state of an access point so that it blinks and the access point can be located. This configuration can be done in the wireless network on a global as well as per-AP level.

The LED state configuration at the global level takes precedence over the AP level.

## Configuring LED State in Access Points (GUI)

### Procedure

---

- Step 1** Choose **Configuration > Wireless > Access Points**.
  - Step 2** Click an AP from the AP list.  
The **Edit AP** window is displayed.
  - Step 3** In the **General** tab, under the General section, click the box adjacent to the **LED State** field to enable or disable the LED state.
  - Step 4** From the **LED Brightness Level** drop-down list, choose a value from 1 to 8.
  - Step 5** Click **Update & Apply to Device**.
-

## Configuring LED State for Access Points in the Global Configuration Mode (CLI)

### Procedure

	Command or Action	Purpose
<b>Step 1</b>	<b>enable</b> <b>Example:</b> Device> enable	Enables privileged EXEC mode. Enter your password if prompted.
<b>Step 2</b>	<b>ap name <i>Cisco-AP-name</i> led</b> <b>Example:</b> Device# ap name <i>Cisco-AP-name</i> led	Enables the LED state for Cisco APs, globally.
<b>Step 3</b>	<b>ap name <i>Cisco-AP-name</i> led-brightness-level <i>1-8</i></b> <b>Example:</b> Device# ap name <i>Cisco-AP-name</i> led-brightness-level 4	Configures the LED brightness level. Value of the brightness is from 1 to 8.

## Configuring LED State in the AP Profile

### Procedure

	Command or Action	Purpose
<b>Step 1</b>	<b>configure terminal</b> <b>Example:</b> Device# configure terminal	Enters global configuration mode.
<b>Step 2</b>	<b>ap profile <i>default-ap-profile</i></b> <b>Example:</b> Device(config)#ap profile <i>default-ap-profile</i>	Enters the AP profile configuration mode.
<b>Step 3</b>	<b>led</b> <b>Example:</b> Device(config-ap-profile)# led	Enables the LED-state for all Cisco APs.

## Verifying LED State for Access Points

To verify the LED state of the access points, use the following command:

**show ap name AXXX-APXXXX.bdXX.f2XX config general**

```
Device# show ap name AXXX-APXXXX.bdXX.f2XX config general
Cisco AP Name : AXXX-APXXXX.bdXX.f2XX
=====
Cisco AP Identifier : 0cXX.bdXX.65XX
Country Code : Multiple Countries : FR,IN,US
Regulatory Domain Allowed by Country : 802.11bg:-AE 802.11a:-ABDEN
AP Country Code : US - United States
AP Regulatory Domain
802.11bg : -A
802.11a : -B
.
.
.
CAPWAP Preferred mode : IPv4
CAPWAP UDP-Lite : Not Configured
AP Submode : WIPS
Office Extend Mode : Disabled
Dhcp Server : Disabled
Remote AP Debug : Disabled
Logging Trap Severity Level : information
Logging Syslog facility : kern
Software Version : 17.X.0.XXX
Boot Version : 1.1.X.X
Mini IOS Version : 0.0.0.0
Stats Reporting Period : 180
LED State : Enabled
MDNS Group Id : 0
.
.
.
```





## CHAPTER 37

# Access Points Memory Information

- [Information About Access Point Memory Information, on page 397](#)
- [Verifying Access Point Memory Information, on page 397](#)

## Information About Access Point Memory Information

With the introduction of the Access Point Memory Information feature, you can view the access point (AP) memory type, the CPU type, and the memory size per AP, after single sign-on authentication. APs share the memory information with the controller during the join phase.

To view the memory information of a specific AP, use the **show ap name AP-NAME config general** command.

## Verifying Access Point Memory Information

To verify the memory information of a specified AP, including the CPU type, memory type and memory size, use the following command:

```
Device# show ap name AP-NAME config general
Cisco AP Name      : AP-NAME
=====
Cisco AP Identifier      : 00XX.f1XX.e0XX
Country Code           : Multiple Countries : FR,IN,US
Regulatory Domain Allowed by Country : 802.11bg:-AE 802.11a:-ABDEN
AP Country Code        : US - United States
AP Regulatory Domain
  802.11bg              : -A
  802.11a               : -B
.
.
.
CPU Type                : ARMv7 Processor rev 1 (v7l)
Memory Type             : DDR4
Memory Size             : 1028096 KB
.
.
.
```







## CHAPTER 38

# Real-Time Access Points Statistics

---

- [Information About Access Point Real-Time Statistics](#), on page 399
- [Configuring Access Point Real-Time Statistics \(GUI\)](#), on page 399
- [Configuring Access Point Real-Time Statistics \(CLI\)](#), on page 400
- [Monitoring Access Point Real-Time Statistics \(GUI\)](#), on page 401
- [Verifying Access Point Real-Time Statistics](#), on page 402

## Information About Access Point Real-Time Statistics

From Cisco IOS XE Bengaluru 17.5.1 onwards, you can track the CPU utilization and memory usage of an AP, and monitor the health of an AP, by generating real-time statistics for an AP.

SNMP traps are defined for CPU and memory utilization of APs and the controller. An SNMP trap is sent out when the threshold is crossed. The sampling period and statistics interval can be configured using SNMP, YANG, and CLI.

Statistics interval is used to process the data coming from an AP, and the average CPU utilization and memory utilization is computed over time. You can also configure an upper threshold for these statistics. When a statistic value surpasses the upper threshold, an alarm is enabled, and an SNMP trap is triggered.

## Configuring Access Point Real-Time Statistics (GUI)

### Procedure

---

- |               |   |
|---------------|---|
| <b>Step 1</b> | Choose <b>Configuration &gt; Tags &amp; Profiles &gt; AP Join</b> .                   |
| <b>Step 2</b> | Click <b>Add</b> .<br>The <b>Add AP Join Profile</b> page is displayed.               |
| <b>Step 3</b> | Click the <b>AP</b> tab.  |
| <b>Step 4</b> | Under the <b>AP</b> tab, click the <b>AP Statistics</b> tab.                          |
| <b>Step 5</b> | Click the <b>Monitor Real Time Statistics</b> toggle button to <b>Enabled</b> status. |
| <b>Step 6</b> | Click the <b>Trigger Alarm for AP</b> toggle button to <b>Enabled</b> status.         |

- Step 7** In the **CPU Threshold to Trigger Alarm** field, enter the threshold percentage of CPU usage. When the CPU usage crosses this threshold, an alarm is triggered.
- Step 8** In the **Memory Threshold to Trigger Alarm** field, enter the threshold percentage of memory usage. When the memory usage exceeds this threshold, an alarm is triggered.
- Step 9** In the **Interval to Hold Alarm** field, enter the time, in seconds, for which the alarm is held before it gets triggered.
- Step 10** In the **Trap Retransmission Time** field, enter the time, in seconds, between retransmissions of the alarm.
- Step 11** In the **Sampling Interval** field, enter the value, in seconds. The sampling interval defines how often data is collected from the AP.
- Step 12** In the **Statistics Interval** field, enter the value, in seconds. The statistics interval defines the interval for which statistics are to be calculated for the AP.
- Step 13** Click **Apply to Device** to save the configuration.

## Configuring Access Point Real-Time Statistics (CLI)

To configure AP real-time statistics for an AP profile, follow the steps given below.

### Procedure

	Command or Action	Purpose
<b>Step 1</b>	<b>configure terminal</b> <b>Example:</b> Device# configure terminal	Enters global configuration mode.
<b>Step 2</b>	<b>ap profile ap-profile-name</b> <b>Example:</b> Device(config)# ap profile ap-profile-name	Configures the AP profile. The default AP join profile name is <i>default-ap-profile</i> .
<b>Step 3</b>	<b>stats-timer 0-65535</b> <b>Example:</b> Device(config-ap-profile)# stats-timer 60	Configures the statistics timer. This command is used to change the frequency of the statistics reports coming from the AP.
<b>Step 4</b>	<b>statistics ap-system-monitoring enable</b> <b>Example:</b> Device(config-ap-profile)# statistics ap-system-monitoring enable	Enables monitoring of AP real-time statistics (CPU and memory).
<b>Step 5</b>	<b>statistics ap-system-monitoring alarm-enable</b> <b>Example:</b> Device(config-ap-profile)# statistics ap-system-monitoring alarm-enable	Enables alarms for AP real-time statistics (CPU and memory).

	Command or Action	Purpose
<b>Step 6</b>	<b>statistics ap-system-monitoring cpu-threshold</b> <i>&lt;0-100&gt; percentage</i>  <b>Example:</b> Device(config-ap-profile)# statistics ap-system-monitoring cpu-threshold 90	Defines the threshold for CPU usage on the AP (percentage) to trigger alarms.
<b>Step 7</b>	<b>statistics ap-system-monitoring mem-threshold</b> <i>&lt;0-100&gt; percentage</i>  <b>Example:</b> Device(config-ap-profile)# statistics ap-system-monitoring mem-threshold 90	Define the threshold for used memory usage on the AP (percentage) to trigger an alarm.
<b>Step 8</b>	<b>exit</b>  <b>Example:</b> Device(config-ap-profile)# exit	Exits from AP profile configuration mode and returns to global configuration mode.
<b>Step 9</b>	<b>trapflags ap ap-stats</b>  <b>Example:</b> Device(config)# trapflags ap ap-stats	Enables or disables sending AP-related traps. Traps are sent when statistics exceed the configured threshold.

### Example

The following example shows how to configure AP real-time statistics.

```
Device(config)# ap profile default-policy-profile
Device(config-ap-profile)# statistics ap-system-monitoring enable
Device(config-ap-profile)#statistics ap-system-monitoring sampling-interval 90
Device(config-ap-profile)#statistics ap-system-monitoring stats-interval 120
Device(config-ap-profile)#statistics ap-system-monitoring alarm-enable
Device(config-ap-profile)#statistics ap-system-monitoring alarm-hold-time 3
Device(config-ap-profile)#statistics ap-system-monitoring alarm-retransmit-time 10
Device(config-ap-profile)#statistics ap-system-monitoring cpu-threshold 90
Device(config-ap-profile)#statistics ap-system-monitoring mem-threshold 90
Device(config)# trapflags ap ap-stats
```



**Note** The **sampling-interval**, **stats-interval**, **alarm-enable**, **alarm-hold-time**, and **alarm-retransmit**, keyword configurations are optional.

## Monitoring Access Point Real-Time Statistics (GUI)

### Procedure

**Step 1** Choose **Monitoring > Wireless > AP Statistics**.

- Step 2** Click the **General** tab.
- Step 3** Click an AP name. The **General** window is displayed.
- Step 4** To view the AP Statistics data, click the **AP Statistics** tab.

The following information is displayed:

- **Memory alarm last send time:** Displays the time of the last memory trap sent.
- **Memory Alarm Status:** Displays the state of the memory alarm. An alarm can be **ACTIVE**, **INACTIVE**, **INACTIVE\_SOAKING**, **ACTIVE\_SOAKING**. An alarm is soaked until the configured hold time has passed.
- **Memory alarm raise time:** Displays the last time the memory alarm was active.
- **Memory alarm clear time:** Displays the last time the memory alarm was inactive.
- **Last statistics received:** Displays the time of the last statistics report received from the AP.
- **Current CPU Usage:** Displays the latest percentage of CPU usage reported.
- **Average CPU Usage:** Displays the average CPU usage calculated.
- **Current Memory Usage:** Displays the latest percentage of memory usage reported.
- **Average Memory Usage:** Displays the average memory usage calculated.
- **Current window size:** Displays the window size. The window size is calculated by dividing the statistics interval by the sampling interval. The average CPU and memory usage is calculated by the window size.
- **CPU alarm last send time:** Displays the time of the last CPU trap sent.
- **CPU Alarm Status:** Displays the state of the CPU alarm. An alarm can be **ACTIVE**, **INACTIVE**, **INACTIVE\_SOAKING**, **ACTIVE\_SOAKING**. An alarm is soaked until the configured hold time has passed.
- **CPU alarm raise time:** Displays the last time the CPU alarm was active.
- **CPU alarm clear time:** Displays the last time the CPU alarm was inactive.

- Step 5** Click **OK**.

## Verifying Access Point Real-Time Statistics

To verify AP real-time statistics, run the **show ap config general | section AP statistics** command:

```
Device# show ap config general | section AP statistics
!Last Statistics
AP statistics : Enabled
Current CPU usage : 4
Average CPU usage : 49
Current memory usage : 35
Average memory usage : 35
Last statistics received : 03/09/2021 15:25:08
!Statistics Configuration
Current window size : 1
Sampling interval : 30
```

```
Statistics interval : 300
AP statistics alarms : Enabled
!Alarm State - Active, Inactive, Inactive_Soaking, Inactive_Soaking
Memory alarm status : Active
Memory alarm raise time : 03/09/2021 15:24:29
Memory alarm clear time : NA
Memory alarm last send time : 03/09/2021 15:24:59
CPU alarm status : Inactive
CPU alarm raise time : 03/09/2021 15:24:25
CPU alarm clear time : 03/09/2021 15:25:05
CPU alarm last send time : 03/09/2021 15:25:05
!Alarm Configuration
Alarm hold time : 6
Alarm retransmission time : 30
Alarm threshold cpu : 30
Alarm threshold memory : 32
```

To verify the statistics reporting period, run the **show ap config general | i Stats Reporting Period** command:

```
Device# show ap config general | i Stats Reporting Period
Stats Reporting Period : 10
```





## CHAPTER 39

# Access Point Tag Persistency

---

- [Information About Access Point Tag Persistency](#), on page 405
- [Configuring AP Tag Persistency \(GUI\)](#), on page 405
- [Configuring AP Tag Persistency \(CLI\)](#), on page 406
- [Verifying AP Tag Persistency](#), on page 407

## Information About Access Point Tag Persistency

From Cisco IOS XE Bengaluru 17.6.1 onwards, AP tag persistency is enabled globally on the controller. When APs join a controller with tag persistency enabled, the mapped tags are saved on the APs without having to write the tag configurations on each AP, individually.

## Configuring AP Tag Persistency (GUI)

### Procedure

---

- Step 1** Choose **Configuration > Tags & Profiles > Tags**.
- Step 2** Click the **AP** tab.
- Step 3** In the **Tag Source** tab, check the **Enable AP Tag Persistency** check box to configure AP Tag persistency globally.
- When APs join a controller with the tag persistency enabled, the mapped tags are saved on the AP without having to write the tag configurations on each AP individually.
- Step 4** Click **Apply to Device**.
- 

### What to do next

Save tags on an AP.

## Saving Tags on an Access Point (GUI)

### Procedure

---

- Step 1** Choose **Configuration > Wireless > Access Points**.
  - Step 2** Click an AP from the list.  
The **Edit AP** page is displayed.
  - Step 3** Click the **General** tab.
  - Step 4** In the **Tags** section, specify the appropriate policy, site, and RF tags that you created in the **Configuration > Tags & Profiles > Tags** page.
  - Step 5** From the **Policy** drop-down list, select a value.
  - Step 6** From the **Site** drop-down list, select a value.
  - Step 7** From the **RF** drop-down list, select a value.
  - Step 8** Check the **Write Tag Config to AP** check box to push the tags to the AP so that the AP can save and remember this information even when the AP is moved from one controller to another.
  - Step 9** Click **Update & Apply to Device**.
- 

## Deleting Saved Tags on the Access Point

### Procedure

---

- Step 1** Choose **Configuration > Wireless > Access Points**.
  - Step 2** Click an AP from the list of APs.  
The **Edit AP** window is displayed.
  - Step 3** In the **Edit AP** window, choose the **Advanced** tab.
  - Step 4** In the **Set to Factory Default** section, check the **Clear Resolved Tag Config** check box to clear the saved tags on an AP.
  - Step 5** Click **Update & Apply to Device**.
- 

## Configuring AP Tag Persistency (CLI)

### Before you begin

For an AP to preserve its policy tag, site tag, and RF tag configured from the primary controller, these tags must also exist on the other controllers that the AP connect to. If all the three tags do not exist, the AP applies the default policy tag, site tag, and RF tag. Similarly, the tag policy is applicable even if one or two tags exist. AP tag persistency helps in priming an AP in N+1 redundancy scenarios. For more information about configuring tags, see

[https://www.cisco.com/c/en/us/td/docs/wireless/controller/9800/17-6/config-guide/b\\_wl\\_17\\_6\\_cg/m\\_config\\_model.html](https://www.cisco.com/c/en/us/td/docs/wireless/controller/9800/17-6/config-guide/b_wl_17_6_cg/m_config_model.html).





**Note** After being enabled, AP tag persistency is performed during AP join. Therefore, if there are any APs that are already joined to the controller, those APs must rejoin the controller.

### Procedure

	Command or Action	Purpose
<b>Step 1</b>	<b>configure terminal</b> <b>Example:</b> Device# configure terminal	Enters global configuration mode.
<b>Step 2</b>	<b>ap tag persistency enable</b> <b>Example:</b> Device(config)# ap tag persistency enable	Configures AP tag persistency.
<b>Step 3</b>	<b>end</b> <b>Example:</b> Device(config)# end	Exits configuration mode and returns to privileged EXEC mode.

## Verifying AP Tag Persistency

To verify AP tag persistency in the primary controller, use the following command:

```
Device# show ap tag summary
Number of APs: 1
```

AP Name	AP Mac	Site Tag Name	Policy Tag Name	RF Tag Name
Misconfigured	Tag Source			
Cisco01_AP	xxxx.xxxx.xxxx	default-site-tag	OpenRoaming	default-rf-tag
No	Static			



**Note** If the Tag Source displays **Static** or **Filter**, it means that the AP tag mappings were configured on the primary controller. If the source displays **Default**, it means that the AP received the default tags when joining the controller.

To verify the AP tag persistency in the secondary controller, use the following command:

```
Device# show ap tag summary
Number of APs: 1
```

AP Name	AP Mac	Site Tag Name	Policy Tag Name	RF Tag Name
Misconfigured	Tag Source			
Cisco01_AP	xxxx.xxxx.xxxx	default-site-tag	OpenRoaming	default-rf-tag
No	AP			



---

**Note** If the Tag Source displays **AP**, it means that the policy tag, site tag, and RF tag match what was configured on the primary controller, indicating that the AP tags have persisted across controllers.

---



## CHAPTER 40

# Configuring the AP Console

- [Feature History for Configuring the Access Point Console, on page 409](#)
- [Information About Configuring the Access Point Console, on page 409](#)
- [Configuring the AP Console \(GUI\), on page 410](#)
- [Configuring the AP Console \(CLI\), on page 410](#)
- [Verifying the AP Console Status, on page 410](#)

## Feature History for Configuring the Access Point Console

This table provides release and related information about the feature explained in this section.

This feature is also available in all the releases subsequent to the one in which they are introduced in, unless noted otherwise.

**Table 18: Feature History for Configuring the Access Point Console**

Release	Feature	Feature Information
Cisco IOS XE Bengaluru 17.6.4	Configuring the Access Point Console	This feature allows you to configure the Access Point (AP) console from the controller.

## Information About Configuring the Access Point Console

From Cisco IOS XE Bengaluru 17.6.x onwards, a new option (a configuration knob) is introduced to enable the Access Point console from the controller, which is independent of the FIPS mode or the high-security mode (CC mode). This configuration knob can be activated through the controller GUI and CLI.

Console enablement is isolated from the FIPS mode and is configured through the AP join profile. In the CC mode, the console and SSH are disabled. When you enable the CC mode, it overrides the AP console configurations, if any, done from the AP profile.

## Configuring the AP Console (GUI)

### Procedure

- 
- Step 1** Choose **Configuration > Tags & Profiles > AP Join**.
- Step 2** In the **Management** tab, in the **Telnet/SSH Configuration** section, check the **Serial Console** check box.
- Step 3** Click **Apply to Device**.
- 

## Configuring the AP Console (CLI)

### Procedure

	Command or Action	Purpose
<b>Step 1</b>	<b>configure terminal</b>  <b>Example:</b> Device# configure terminal	Enters global configuration mode.
<b>Step 2</b>	<b>ap profile <i>ap-profile-name</i></b>  <b>Example:</b> Device(config)# ap profile <i>ap-profile-name</i>	Configures an AP profile and enters AP profile configuration mode.
<b>Step 3</b>	<b>[no] console</b>  <b>Example:</b> Device(config-ap-profile)# console	Enables the AP serial console port. Use the <b>no</b> form of this command to disable the AP serial console port.

## Verifying the AP Console Status

To verify the AP console status from the controller, run the following command:

```
Device# show ap config general | include ap-Name | console
Cisco AP Name : CiscoAP
=====

Cisco AP Identifier : 6XXX.bXXX.aXXX
Country Code : US
Regulatory Domain Allowed by Country : 802.11bg:-A 802.11a:-AB 802.11 6GHz:-B
AP Country Code : US - United States
AP Regulatory Domain
802.11bg : -A
802.11a : -B
MAC Address : 6XXX.bXXX.0XXX
IP Address Configuration : DHCP
```

```
IP Address : 30.30.30.26
IP Netmask : 255.255.255.0
Gateway IP Address : 30.30.30.1
Fallback IP Address Being Used :
Domain :
Name Server :
CAPWAP Path MTU : 1485
Capwap Active Window Size : 1
Telnet State : Disabled
CPU Type : ARmv8 Processor rev 4 (v8l)
Memory Type : DDR3
Memory Size : 1752064 KB
SSH State : Enabled
Serial Console State : Enabled
```





## PART IV

# Radio Resource Management

- [Radio Resource Management, on page 415](#)
- [Coverage Hole Detection, on page 447](#)
- [Optimized Roaming, on page 453](#)
- [Cisco Flexible Radio Assignment, on page 455](#)
- [XOR Radio Support, on page 461](#)
- [Cisco Receiver Start of Packet, on page 467](#)
- [Client Limit, on page 471](#)
- [IP Theft, on page 473](#)
- [Unscheduled Automatic Power Save Delivery, on page 479](#)
- [Target Wake Time, on page 481](#)
- [Enabling USB Port on Access Points, on page 487](#)
- [Dynamic Frequency Selection, on page 491](#)
- [Cisco Access Points with Tri-Radio, on page 493](#)
- [Cisco Catalyst Center Assurance Wi-Fi 6 Dashboard, on page 501](#)
- [Antenna Disconnection Detection, on page 505](#)
- [Neighbor Discovery Protocol Mode on Access Points, on page 511](#)







## CHAPTER 41

# Radio Resource Management

- [Information About Radio Resource Management, on page 415](#)
- [Restrictions for Radio Resource Management, on page 424](#)
- [How to Configure RRM, on page 424](#)
- [Monitoring RRM Parameters and RF Group Status, on page 443](#)
- [Examples: RF Group Configuration, on page 444](#)
- [Information About ED-RRM, on page 445](#)

## Information About Radio Resource Management

The Radio Resource Management (RRM) software that is embedded in the device acts as a built-in Radio Frequency (RF) engineer to consistently provide real-time RF management of your wireless network. RRM enables devices to continually monitor their associated lightweight access points for the following information:

- **Traffic load**—The total bandwidth used for transmitting and receiving traffic. It enables wireless LAN managers to track and plan network growth ahead of client demand.
- **Interference**—The amount of traffic coming from other 802.11 sources.
- **Noise**—The amount of non-802.11 traffic that is interfering with the currently assigned channel.
- **Coverage**—The Received Signal Strength (RSSI) and signal-to-noise ratio (SNR) for all connected clients.
- **Other** —The number of nearby access points.

RRM performs these functions:

- Radio resource monitoring
- Power control transmission
- Dynamic channel assignment
- Coverage hole detection and correction
- RF grouping



---

**Note** RRM grouping does not occur when an AP operates in a static channel that is not in the DCA channel list. The Neighbor Discovery Protocol (NDP) is sent only on DCA channels; therefore, when a radio operates on a non-DCA channel, it does not receive NDP on the channel.

---

## Radio Resource Monitoring

RRM automatically detects and configures new devices and lightweight access points as they are added to the network. It then automatically adjusts the associated and nearby lightweight access points to optimize coverage and capacity.

Lightweight access points can scan all the valid channels for the country of operation as well as for channels available in other locations. The access points in local mode go *offchannel* for a period not greater than 70 ms to monitor these channels for noise and interference. Packets collected during this time are analyzed to detect rogue access points, rogue clients, ad-hoc clients, and interfering access points.



---

**Note** In the presence of voice traffic or other critical traffic (in the last 100 ms), access points can defer off-channel measurements. The access points also defer off-channel measurements based on the WLAN scan priority configurations.

---

Each access point spends only 0.2 percent of its time off channel. This activity is distributed across all the access points so that adjacent access points are not scanning at the same time, which could adversely affect wireless LAN performance.

## Information About RF Groups

An RF group is a logical collection of controllers that coordinate to perform RRM in a globally optimized manner to perform network calculations on a per-radio basis. Separate RF groups exist for 2.4-GHz and 5-GHz networks. Clustering Cisco Catalyst 9800 Series Wireless Controller into a single RF group enables the RRM algorithms to scale beyond the capabilities of a single Cisco Catalyst 9800 Series Wireless Controller.

An RF group is created based on the following parameters:

- User-configured RF network name.
- Neighbor discovery performed at the radio level.
- Country list configured on the controller.

RF grouping runs between controllers .

Lightweight access points periodically send out neighbor messages over the air. Access points using the same RF group name validate messages from each other.

When access points on different controllers hear validated neighbor messages at a signal strength of  $-80$  dBm or stronger, the controllers dynamically form an RF neighborhood in auto mode. In static mode, the leader is manually selected and the members are added to the RF Group.



---

**Note** RF groups and mobility groups are similar, in that, they both define clusters of controllers, but they are different in terms of their use. An RF group facilitates scalable, system-wide dynamic RF management, while a mobility group facilitates scalable, system-wide mobility and controller redundancy.

---

## RF Group Leader

RF Group Leader can be configured in two ways as follows:



---

**Note** RF Group Leader is selected based on the controller with the greatest AP capacity (platform limit). If multiple controllers have the same capacity, the leader is selected based on the Group ID, which is a combination of the management IP address, AP capacity, random number, and so on. The one with the highest Group ID is selected as the leader.

---

- **Auto Mode:** In this mode, the members of an RF group elect an RF group leader to maintain a *primary* power and channel scheme for the group. The RF grouping algorithm dynamically chooses the RF group leader and ensures that an RF group leader is always present. Group leader assignments can and do change (for instance, if the current RF group leader becomes inoperable or RF group members experience major changes).
- **Static Mode:** In this mode, a user selects a controller as an RF group leader manually. In this mode, the leader and the members are manually configured and fixed. If the members are unable to join the RF group, the reason is indicated. The leader tries to establish a connection with a member every minute if the member has not joined in the previous attempt.

The RF group leader analyzes real-time radio data collected by the system, calculates the power and channel assignments, and sends them to each of the controllers in the RF group. The RRM algorithms ensure system-wide stability, and restrain channel and power scheme changes to the appropriate local RF neighborhoods.



---

**Note** When a controller becomes both leader and member for a specific radio, you get to view the IPv4 and IPv6 address as part of the group leader.

When a Controller A becomes a member and Controller B becomes a leader, the Controller A displays either IPv4 or IPv6 address of Controller B using the address it is connected.

So, if both leader and member are not the same, you get to view only one IPv4 or IPv6 address as a group leader in the member.

---

If Dynamic Channel Assignment (DCA) needs to use the worst-performing radio as the single criterion for adopting a new channel plan, it can result in pinning or cascading problems.

The main cause of both pinning and cascading is that any potential channel plan changes are controlled by the RF circumstances of the worst-performing radio. The DCA algorithm does not do this; instead, it does the following:

- **Multiple local searches:** The DCA search algorithm performs multiple local searches initiated by different radios in the same DCA run rather than performing a single global search that is driven by a single radio.

This change addresses both pinning and cascading, while maintaining the desired flexibility and adaptability of DCA and without jeopardizing stability.

- **Multiple Channel Plan Change Initiators (CPCIs):** Previously, the single worst radio was the sole initiator of a channel plan change. Now each radio in an RF group is evaluated and prioritized as a potential initiator. Intelligent randomization of the resulting list ensures that every radio is eventually evaluated, which eliminates the potential for pinning.
- **Limiting the propagation of channel plan changes (Localization):** For each CPCI radio, the DCA algorithm performs a local search for a better channel plan, but only the CPCI radio itself and its one-hop neighboring access points are actually allowed to change their current transmit channels. The impact of an access point triggering a channel plan change is felt only to within two RF hops from that access point, and the actual channel plan changes are confined to within a one-hop RF neighborhood. Because this limitation applies across all CPCI radios, cascading cannot occur.
- **Non-RSSI-based cumulative cost metric:** A cumulative cost metric measures how well an entire region, neighborhood, or network performs with respect to a given channel plan. The individual cost metrics of all the access points in that area are considered in order to provide an overall understanding of the channel plan's quality. These metrics ensure that the improvement or deterioration of each single radio is factored into any channel plan change. The objective is to prevent channel plan changes in which a single radio improves, but at the expense of multiple other radios experiencing a considerable performance decline.

The RRM algorithms run at a specified updated interval, which is 600 seconds by default. Between update intervals, the RF group leader sends keepalive messages to each of the RF group members and collects real-time RF data.



---

**Note** Several monitoring intervals are also available. See the Configuring RRM section for details.

---

### RF Grouping Failure Reason Codes

RF Grouping failure reason codes and their explanations are listed below:

**Table 19: RF Grouping Failure Reason Codes**

Reason Code	Description
1	Maximum number (20) of controllers are already present in the group.
2	If the following conditions are met: <ul style="list-style-type: none"> <li>• The request is from a similar powered controller and,               <ul style="list-style-type: none"> <li>• Controller is the leader for the other band,</li> </ul> </li> <li>OR</li> <li>• Requestor group is larger.</li> </ul>
3	Group ID do not match.
4	Request does not include source type.

Reason Code	Description
5	Group spilt message to all member while group is being reformed.
6	Auto leader is joining a static leader, during the process deletes all the members.
9	Grouping mode is turned off.
11	Country code does not match.
12	Controller is up in hierarchy compared to sender of join command (static mode). Requestor is up in hierarchy (auto mode).
13	Controller is configured as static leader and receives join request from another static leader.
14	Controller is already a member of static group and receives a join request from another static leader.
15	Controller is a static leader and receives join request from non-static member.
16	Join request is not intended to the controller. Controller name and IP do not match.
18	RF domain do not match.
19	Controller received a Hello packet at incorrect state.
20	Controller has already joined Auto leader, now gets a join request from static leader.
21	Group mode change. Domain name change from CLI. Static member is removed from CLI.
22	Max switch size (350) is reached

### Additional Reference

*Radio Resource Management White Paper:* [https://www.cisco.com/c/en/us/td/docs/wireless/controller/technotes/8-3/b\\_RRM\\_White\\_Paper/b\\_RRM\\_White\\_Paper\\_chapter\\_011.html](https://www.cisco.com/c/en/us/td/docs/wireless/controller/technotes/8-3/b_RRM_White_Paper/b_RRM_White_Paper_chapter_011.html)

## RF Group Name

A controller is configured in an RF group name, which is sent to all the access points joined to the controller and used by the access points as the shared secret for generating the hashed MIC in the neighbor messages. To create an RF group, you configure all of the controllers to be included in the group with the same RF group name.

If there is any possibility that an access point joined to a controller might hear RF transmissions from an access point on a different controller, you should configure the controller with the same RF group name. If

RF transmissions between access points can be heard, then system-wide RRM is recommended to avoid 802.11 interference and contention as much as possible.

## Rogue Access Point Detection in RF Groups

After you have created an RF group of controller, you need to configure the access points connected to the controller to detect rogue access points. The access points will then select the beacon or probe-response frames in neighboring access point messages to see if they contain an authentication information element (IE) that matches that of the RF group. If the selection is successful, the frames are authenticated. Otherwise, the authorized access point reports the neighboring access point as a rogue, records its BSSID in a rogue table, and sends the table to the controller.

## Secure RF Groups

Secure RF groups enable to encrypt and secure RF grouping and RRM message exchanges over DTLS tunnel. During the DTLS handshake controllers authenticate each other with wireless management trust-point certificate.



---

**Note** If a controller has to be part of secure RF-group, that controller must be part of the same mobility group.

---

## Transmit Power Control

The device dynamically controls access point transmit power based on the real-time wireless LAN conditions.

The Transmit Power Control (TPC) algorithm increases and decreases an access point's power in response to changes in the RF environment. In most instances, TPC seeks to lower an access point's power to reduce interference, but in the case of a sudden change in the RF coverage, for example, if an access point fails or becomes disabled, TPC can also increase power on the surrounding access points. This feature is different from coverage hole detection, which is primarily concerned with clients. TPC provides enough RF power to achieve the required coverage levels while avoiding channel interference between access points. We recommend that you select TPCv1; TPCv2 option is deprecated. With TPCv1, you can select the channel aware mode; we recommend that you select this option for 5 GHz, and leave it unchecked for 2.4 GHz.

## Overriding the TPC Algorithm with Minimum and Maximum Transmit Power Settings

The TPC algorithm balances RF power in many diverse RF environments. However, it is possible that automatic power control will not be able to resolve some scenarios in which an adequate RF design was not possible to implement due to architectural restrictions or site restrictions, for example, when all the access points must be mounted in a central hallway, placing the access points close together, but requiring coverage to the edge of the building.

In these scenarios, you can configure maximum and minimum transmit power limits to override TPC recommendations. The maximum and minimum TPC power settings apply to all the access points through RF profiles in a RF network.

To set the Maximum Power Level Assignment and Minimum Power Level Assignment, enter the maximum and minimum transmit power used by RRM in the fields in the **Tx Power Control** window. The range for these parameters is -10 to 30 dBm. The minimum value cannot be greater than the maximum value; the maximum value cannot be less than the minimum value.

If you configure a maximum transmit power, RRM does not allow any access point attached to the controller, to exceed this transmit power level (whether the power is set by RRM TPC or by coverage hole detection). For example, if you configure a maximum transmit power of 11 dBm, no access point will transmit above 11 dBm, unless the access point is configured manually.

Cisco APs support power level changes in 3 dB granularity. TPC Min and Max power settings allow for values in 1 dB increments. The resulting power level will be rounded to the nearest value supported in the allowed powers entry for the AP model and the current serving channel.

Each AP model has its own set of power levels localized for its regulatory country and region. Moreover, the power levels for the same AP model will vary based on the band and channel it is set to. For more information on Allowed Power Level vs. Actual power(in dBm), use the **show ap name <name> config slot <0|1|2|3>** command to view the specific number of power levels, the range of power levels allowed, and the current power level setting on the AP.

## Dynamic Channel Assignment

Two adjacent access points on the same channel can cause either signal contention or signal collision. In a collision, data is not received by the access point. This functionality can become a problem, for example, when someone reading an e-mail in a café affects the performance of the access point in a neighboring business. Even though these are separate networks, someone sending traffic to the café on channel 1 can disrupt communication in an enterprise using the same channel. Devices can dynamically allocate access point channel assignments to avoid conflict and increase capacity and performance. Channels are *reused* to avoid wasting scarce RF resources. In other words, channel 1 is allocated to a different access point far from the café, which is more effective than not using channel 1 altogether.

The device's Dynamic Channel Assignment (DCA) capabilities are also useful in minimizing adjacent channel interference between access points. For example, two overlapping channels in the 802.11b/g band, such as 1 and 2, cannot simultaneously use 11 or 54 Mbps. By effectively reassigning channels, the device keeps adjacent channels that are separated.



---

**Note** We recommend that you use only nonoverlapping channels (1, 6, 11, and so on).

---



---

**Note** Channel change does not require you to shut down the radio.

---

The device examines a variety of real-time RF characteristics to efficiently handle channel assignments as follows:

- Access point received energy: The received signal strength measured between each access point and its nearby neighboring access points. Channels are optimized for the highest network capacity.
- Noise: Noise can limit signal quality at the client and access point. An increase in noise reduces the effective cell size and degrades user experience. By optimizing channels to avoid noise sources, the device can optimize coverage while maintaining system capacity. If a channel is unusable due to excessive noise, that channel can be avoided.
- 802.11 interference: Interference is any 802.11 traffic that is not a part of your wireless LAN, including rogue access points and neighboring wireless networks. Lightweight access points constantly scan all the channels looking for sources of interference. If the amount of 802.11 interference exceeds a predefined

configurable threshold (the default is 10 percent), the access point sends an alert to the device. Using the RRM algorithms, the device may then dynamically rearrange channel assignments to increase system performance in the presence of the interference. Such an adjustment could result in adjacent lightweight access points being on the same channel, but this setup is preferable to having the access points remain on a channel that is unusable due to an interfering foreign access point.

In addition, if other wireless networks are present, the device shifts the usage of channels to complement the other networks. For example, if one network is on channel 6, an adjacent wireless LAN is assigned to channel 1 or 11. This arrangement increases the capacity of the network by limiting the sharing of frequencies. If a channel has virtually no capacity remaining, the device may choose to avoid this channel. In huge deployments in which all nonoverlapping channels are occupied, the device does its best, but you must consider RF density when setting expectations.

- **Load and utilization:** When utilization monitoring is enabled, capacity calculations can consider that some access points are deployed in ways that carry more traffic than other access points, for example, a lobby versus an engineering area. The device can then assign channels to improve the access point that has performed the worst. The load is taken into account when changing the channel structure to minimize the impact on the clients that are currently in the wireless LAN. This metric keeps track of every access point's transmitted and received packet counts to determine how busy the access points are. New clients avoid an overloaded access point and associate to a new access point. This *Load and utilization* parameter is disabled by default.

The device combines this RF characteristic information with RRM algorithms to make system-wide decisions. Conflicting demands are resolved using soft-decision metrics that guarantee the best choice for minimizing network interference. The end result is optimal channel configuration in a three-dimensional space, where access points on the floor above and below play a major factor in an overall wireless LAN configuration.



---

**Note** DCA supports only 20-MHz channels in 2.4-GHz band.

---



---

**Note** In a Dynamic Frequency Selection (DFS) enabled AP environment, ensure that you enable the UNII2 channels option under the DCA channel to allow 100-MHz separation for the dual 5-GHz radios.

---

The RRM startup mode is invoked in the following conditions:

- In a single-device environment, the RRM startup mode is invoked after the device is upgraded and rebooted.
- In a multiple-device environment, the RRM startup mode is invoked after an RF Group leader is elected.
- You can trigger the RRM startup mode from the CLI.

The RRM startup mode runs for 100 minutes (10 iterations at 10-minute intervals). The duration of the RRM startup mode is independent of the DCA interval, sensitivity, and network size. The startup mode consists of 10 DCA runs with high sensitivity (making channel changes easy and sensitive to the environment) to converge to a steady-state channel plan. After the startup mode is finished, DCA continues to run at the specified interval and sensitivity.





---

**Note** DCA algorithm interval is set to 1 hour, but DCA algorithm always runs in default interval of 10 min, channel allocation occurs at 10-min intervals for the first 10 cycles, and channel changes occur as per the DCA algorithm every 10 min. After that the DCA algorithm goes back to the configured time interval. This is common for both DCA interval and anchor time because it follows the steady state.

Invoking channel update will not result in any immediate changes until the next DCA interval is triggered.

---



---

**Note** If Dynamic Channel Assignment (DCA)/Transmit Power Control (TPC) is turned off on the RF group member, and auto is set on RF group leader, the channel or TX power on a member gets changed as per the algorithm that is run on the RF group leader.

---

## Dynamic Bandwidth Selection

While upgrading from 11n to 11ac, the Dynamic Bandwidth Selection (DBS) algorithm provides a smooth transition for various configurations.

The following pointers describe the functionalities of DBS:

- It applies an additional layer of bias on top of those applied to the core DCA, for channel assignment in order to maximize the network throughput by dynamically varying the channel width.
- It fine tunes the channel allocations by constantly monitoring the channel and Base Station Subsystem (BSS) statistics.
- It evaluates the transient parameters, such as 11n or 11ac client mix, load, and traffic flow types.
- It reacts to the fast-changing statistics by varying the BSS channel width or adapting to the unique and new channel orientations through 11ac for selection between 40 MHz and 80 MHz bandwidths.

## Coverage Hole Detection and Correction

The RRM coverage hole detection algorithm can detect areas of radio coverage in a wireless LAN that are below the level needed for robust radio performance. This feature can alert you to the need for an additional (or relocated) lightweight access point.

If clients on a lightweight access point are detected at threshold levels (RSSI, failed client count, percentage of failed packets, and number of failed packets) lower than those specified in the RRM configuration, the access point sends a “coverage hole” alert to the device. The alert indicates the existence of an area where clients are continually experiencing poor signal coverage, without having a viable access point to which to roam. The device discriminates between coverage holes that can and cannot be corrected. For coverage holes that can be corrected, the device mitigates the coverage hole by increasing the transmit power level for that specific access point. The device does not mitigate coverage holes caused by clients that are unable to increase their transmit power or are statically set to a power level because increasing their downstream transmit power might increase interference in the network.

# Restrictions for Radio Resource Management

- The number of APs in a RF-group is limited to 3000.
- If an AP tries to join the RF-group that already holds the maximum number of APs it can support, the device rejects the application and throws an error.
- Disabling all data rates for default rf-profile or custom rf-profile, impacts ISSU upgrade and client join process after the software upgrade (ISSU or non-ISSU). To prevent this, you must enable at least one data rate (for example, **ap dot11 24 rate RATE\_5\_5M enable**) on the default rf-profile or custom rf-profile. We recommend that you enable the lowest data rate if efficiency is of prime concern.
- Keywords such as secure cannot be used a RF group name.

## How to Configure RRM

### Configuring Neighbor Discovery Type (GUI)

#### Procedure

---

- Step 1** Choose **Configuration > Radio Configurations > RRM**.
- Step 2** On the **Radio Resource Management** page, click either the **5 GHz Band** or the **2.4 GHz Band** tab.
- Step 3** In the **General** tab, under each section enter the corresponding field details:
- a) Under the **Profile Threshold For Traps** section, enter the:
    1. **Interference Percentage**: The foreign interference threshold is between 0 and 100 %. The default is 10 %.
    2. **Clients**: The client threshold between 1 and 75 clients. The default is 12.
    3. **Noise**: The foreign noise threshold between -127 dBm and 0dBm. The default is -70 dBm.
    4. **Utilization Percentage**: The RF utilization threshold between 0 and 100 %. The default is 80 %.
    5. **Throughput**: The average rate of successful messages delivery over a communication channel. Value ranges from 1000 to 1000000 bps.
  - b) Under the **Noise/Interference/Rogue/CleanAir/SI Monitoring Channels** section, choose the:
    1. **Channel List** from the drop-down list:
      - All Channels
      - Country Channels
      - DCA Channels
    2. **RRM Neighbor Discover Type** from the drop-down list:

- **Transparent:** Packets are sent as is.
- **Protected:** Packets are protected.

### 3. RRM Neighbor Discovery Mode:

- **AUTO:** If the NDP mode configured is AUTO, the controller selects On-Channel as the NDP mode. The default is set as AUTO.
- **OFF-CHANNEL:** If the NDP mode configured is Off-Channel, the controller selects Off-Channel as the NDP mode.

c) Under the **Monitor** section, set:

- **Neighbor Packet Frequency (seconds):** Frequency (in seconds) in which the Neighbor Discovery Packets are sent. The default is 180 seconds.
- **Reporting Interval (seconds):** The default is 180 seconds. Each channel dwell has to be completed within 180 seconds.
- **Neighbor Timeout factor:** Value in seconds used to determine when to prune access points from the neighbor list that have timed out. The default is 20 seconds.

**Step 4** Click Apply to save your configuration.

## Configuring Neighbor Discovery Type (CLI)

### Procedure

	Command or Action	Purpose
<b>Step 1</b>	<b>configure terminal</b>  <b>Example:</b> Device# <code>configure terminal</code>	Enters global configuration mode.
<b>Step 2</b>	<b>ap dot11 {24ghz   5ghz} rrm ndp-type {protected   transparent}</b>  <b>Example:</b>  Device(config)# <code>ap dot11 24ghz rrm ndp-type protected</code>  Device(config)# <code>ap dot11 24ghz rrm ndp-type transparent</code>	Configures the neighbor discovery type. By default, the mode is set to “transparent”.  <ul style="list-style-type: none"> <li>• <b>protected:</b> Sets the neighbor discover type to protected. Packets are encrypted.</li> <li>• <b>transparent:</b> Sets the neighbor discover type to transparent. Packets are sent as is.</li> </ul>
<b>Step 3</b>	<b>end</b>  <b>Example:</b> Device(config)# <code>end</code>	Returns to privileged EXEC mode. Alternatively, you can also press <b>Ctrl-Z</b> to exit global configuration mode.

## Configuring RF Groups

This section describes how to configure RF groups through either the GUI or the CLI.



**Note** When the multiple-country feature is being used, all controllers intended to join the same RF group must be configured with the same set of countries, configured in the same order.

### Configuring RF Group Selection Mode (GUI)

#### Procedure

- Step 1** Choose **Configuration > Radio Configurations > RRM**.
- Step 2** On the **RRM** page, click the relevant band's tab: either **5 GHz Band** or **2.4 GHz Band**.
- Step 3** Click the **RF Grouping** tab.
- Step 4** Choose the appropriate **Group Mode** from these options:
  - **Automatic**: Sets the 802.11 RF group selection to automatic update mode
  - **Leader**: Sets the 802.11 RF group selection to leader mode
  - **Off**: Disables the 802.11 RF group selection
- Step 5** Save the configuration.

### Configuring RF Group Selection Mode (CLI)

#### Procedure

	Command or Action	Purpose
<b>Step 1</b>	<b>configure terminal</b>  <b>Example:</b> Device# <code>configure terminal</code>	Enters global configuration mode.
<b>Step 2</b>	<b>ap dot11 {24ghz   5ghz} rrm group-mode {auto   leader   off}</b>  <b>Example:</b> Device(config)# <code>ap dot11 24ghz rrm group-mode leader</code>	Configures RF group selection mode for 802.11 bands. <ul style="list-style-type: none"> <li>• <b>auto</b>: Sets the 802.11 RF group selection to automatic update mode.</li> <li>• <b>leader</b>: Sets the 802.11 RF group selection to leader mode.</li> <li>• <b>off</b>: Disables the 802.11 RF group selection.</li> </ul>

	Command or Action	Purpose
<b>Step 3</b>	<b>end</b> <b>Example:</b> Device(config)# <b>end</b>	Returns to privileged EXEC mode. Alternatively, you can also press <b>Ctrl-Z</b> to exit global configuration mode.

## Configuring an RF Group Name (CLI)

### Procedure

	Command or Action	Purpose
<b>Step 1</b>	<b>configure terminal</b> <b>Example:</b> Device# <b>configure terminal</b>	Enters global configuration mode.
<b>Step 2</b>	<b>wireless rf-network <i>name</i></b> <b>Example:</b> Device (config)# <b>wireless rf-network test1</b>	Creates an RF group. The group name should be ASCII String up to 19 characters and is case sensitive.  <b>Note</b> Repeat this procedure for each controller that you want to include in the RF group.
<b>Step 3</b>	<b>end</b> <b>Example:</b> Device(config)# <b>end</b>	Returns to privileged EXEC mode. Alternatively, you can also press <b>Ctrl-Z</b> to exit global configuration mode.

## Configuring a Secure RF Group (CLI)

### Procedure

	Command or Action	Purpose
<b>Step 1</b>	<b>configure terminal</b> <b>Example:</b> Device# <b>configure terminal</b>	Enters global configuration mode.
<b>Step 2</b>	<b>wireless rf-network secure</b> <b>Example:</b> Device(config)# <b>wireless rf-network secure</b>	Creates a secure RF group.
<b>Step 3</b>	<b>end</b> <b>Example:</b> Device(config)# <b>end</b>	Returns to privileged EXEC mode.

	Command or Action	Purpose
<b>Step 4</b>	<b>show ap dot11 {24ghz 5ghz} group</b> <b>Example:</b> Device# show ap dot11 24ghz group	Displays configuration and statistics of 2.4-GHz and 5-GHz band grouping.

## Configuring Members in an 802.11 Static RF Group (GUI)

### Procedure

- 
- Step 1** Choose **Configuration** > **Radio Configurations** > **RRM**.
- Step 2** On the **RRM** page, click either the **5 GHz Band** or **2.4 GHz Band** tab.
- Step 3** Click the **RF Grouping** tab.
- Step 4** Choose the appropriate **Group Mode** from the following options:
- **Automatic(default)**: Members of an RF group elect an RF group leader to maintain a primary power and channel scheme for the group. The RF grouping algorithm dynamically chooses the RF group leader and ensures that an RF group leader is always present. Group leader assignments can and do change (for instance, if the current RF group leader becomes inoperable or if RF group members experience major changes).
  - **Leader**: A device as an RF group leader, manually. In this mode, the leader and the members are manually configured and are therefore fixed. If the members are unable to join the RF group, the reason is indicated. The members' management IP addresses and system name are used to request the member to join the leader. The leader tries to establish a connection with a member every 1 minute if the member has not joined in the previous attempt.
  - **Off**: No RF group is configured.
- Step 5** Under **Group Members** section, click **Add**.
- Step 6** In the **Add Static Member** window that is displayed, enter the controller name and the IPv4 or IPv6 address of the controller.
- Step 7** Click **Save & Apply to Device**.
- 

## Configuring Members in an 802.11 Static RF Group (CLI)

### Procedure

	Command or Action	Purpose
<b>Step 1</b>	<b>configure terminal</b> <b>Example:</b> Device# <b>configure terminal</b>	Enters global configuration mode.
<b>Step 2</b>	<b>ap dot11 {24ghz   5ghz} rrm group-member</b> <i>group_name ip_addr</i> <b>Example:</b>	Configures members in a 802.11 static RF group. The group mode should be set as leader for the group member to be active.

	Command or Action	Purpose
	Device(config)#ap dot11 24ghz rrm group-member Grpmem01 10.1.1.1	
<b>Step 3</b>	<b>end</b>  <b>Example:</b> Device(config)# <b>end</b>	Returns to privileged EXEC mode. Alternatively, you can also press <b>Ctrl-Z</b> to exit global configuration mode.

## Configuring Transmit Power Control

### Configuring Transmit Power (GUI)

#### Procedure

- 
- Step 1** Choose **Configuration > Radio Configurations > RRM**.
- Step 2** On the **5 GHz Band** or **2.4 GHz Band** tab, click the **TPC** tab.
- Step 3** Choose of the following dynamic transmit power assignment modes:
- *Automatic*(default): The transmit power is periodically updated for all APs that permit this operation.
  - *On Demand*: The transmit power is updated on demand. If you choose this option, you get to view the **Invoke Power Update Once**. Click **Invoke Power Update Once** to apply the RRM data successfully.
  - *Fixed*: No dynamic transmit power assignments occur and values are set to their global default.
- Step 4** Enter the maximum and minimum power level assignment on this radio. If you configure maximum transmit power, RRM does not allow any access point attached to the device to exceed this transmit power level (whether the power is set by RRM TPC or by coverage hole detection). For example, if you configure a maximum transmit power of 11 dBm, then no access point would transmit above 11 dBm, unless the access point is configured manually. The range is –10 dBm to 30 dBm.
- Step 5** In the **Power Threshold** field, enter the cutoff signal level used by RRM when determining whether to reduce an access point's power.
- The default value for this parameter varies depending on the TPC version you choose. For TPCv1, the default value is –70 dBm, and for TPCv2, the default value is –67 dBm. The default value can be changed when access points are transmitting at higher (or lower) than desired power levels. The range for this parameter is –80 to –50 dBm.
- Increasing this value (between –65 and –50 dBm) causes the access points to operate at higher transmit power rates. Decreasing the value has the opposite effect. In applications with a dense population of access points, it may be useful to decrease the threshold to –80 or –75 dBm in order to reduce the number of BSSIDs (access points) and beacons seen by the wireless clients. Some wireless clients might have difficulty processing a large number of BSSIDs or a high beacon rate and might exhibit problematic behavior with the default threshold.
- Step 6** Click **Apply**.
-

## Configuring the Tx-Power Control Threshold (CLI)

### Procedure

	Command or Action	Purpose
<b>Step 1</b>	<b>configure terminal</b>  <b>Example:</b> Device# <code>configure terminal</code>	Enters global configuration mode.
<b>Step 2</b>	<b>ap dot11 {24ghz   5ghz} rrm tpc-threshold threshold_value</b>  <b>Example:</b>  Device(config)# <code>ap dot11 24ghz rrm tpc-threshold -60</code>	Configures the Tx-power control threshold used by RRM for auto power assignment. The range is from -80 to -50.
<b>Step 3</b>	<b>end</b>  <b>Example:</b> Device(config)# <code>end</code>	Returns to privileged EXEC mode. Alternatively, you can also press <b>Ctrl-Z</b> to exit global configuration mode.

## Configuring the Tx-Power Level (CLI)

### Procedure

	Command or Action	Purpose
<b>Step 1</b>	<b>configure terminal</b>  <b>Example:</b> Device# <code>configure terminal</code>	Enters global configuration mode.
<b>Step 2</b>	<b>ap dot11 {24ghz   5ghz} rrm txpower {trans_power_level   auto   max   min   once}</b>  <b>Example:</b>  Device(config)# <code>ap dot11 24ghz rrm txpower auto</code>	Configures the 802.11 tx-power level <ul style="list-style-type: none"> <li>• <b>trans_power_level</b>—Sets the transmit power level.</li> <li>• <b>auto</b>—Enables auto-RF.</li> <li>• <b>max</b>—Configures the maximum auto-RF tx-power.</li> <li>• <b>min</b>—Configures the minimum auto-RF tx-power.</li> <li>• <b>once</b>—Enables one-time auto-RF.</li> </ul>
<b>Step 3</b>	<b>end</b>  <b>Example:</b> Device(config)# <code>end</code>	Returns to privileged EXEC mode.



# Configuring 802.11 RRM Parameters

## Configuring Advanced 802.11 Channel Assignment Parameters (GUI)

### Procedure

- 
- Step 1** Choose **Configuration > Radio Configurations > RRM**.
- Step 2** In the **DCA** tab, choose a **Channel Assignment Mode** to specify the DCA mode:
- *Automatic*(default)—Causes the device to periodically evaluate and, if necessary, update the channel assignment for all joined APs.
  - *Freeze*—Causes the device to evaluate and update the channel assignment for all joined APs. If you choose this option, you get to view the Invoke Channel Update Once. Click **Invoke Channel Update Once** to apply the RRM data successfully.
  - *Off*—Turns off DCA and sets all AP radios to the first channel of the band, which is the default value. If you choose this option, you must manually assign channels on all radios.
- Step 3** From the **Interval** drop-down list, choose the interval that tells how often the DCA algorithm is allowed to run. The default interval is 10 minutes.
- Step 4** From the **AnchorTime** drop-down list, choose a number to specify the time of day when the DCA algorithm must start. The options are numbers between 0 and 23 (inclusive) representing the hour of the day from 12:00 a.m. to 11:00 p.m.
- Step 5** Check the **Avoid Foreign AP Interference** check box to cause the device's RRM algorithms to consider 802.11 traffic from foreign APs (those not included in your wireless network) when assigning channels to lightweight APs, or uncheck it to disable this feature. For example, RRM may adjust the channel assignment to have access points avoid channels close to foreign APs. By default, this feature is in enabled state.
- Step 6** Check the **Avoid Cisco AP Load** check box to cause the device's RRM algorithms to consider 802.11 traffic from Cisco lightweight APs in your wireless network when assigning channels. For example, RRM can assign better reuse patterns to access points that carry a heavier traffic load. By default, this feature is in disabled state.
- Step 7** Check the **Avoid Non-802.11a Noise** check box to cause the device's RRM algorithms to consider noise (non-802.11 traffic) in the channel when assigning channels to lightweight APs. For example, RRM may have APs avoid channels with significant interference from non-AP sources, such as microwave ovens. By default, this feature is in enabled state.
- Step 8** Check the **Avoid Persistent Non-Wi-Fi Interference** check box to enable the device to take into account persistent non-Wi-Fi interference in DCA calculations. A persistent interfering device is any device from the following categories, which has been seen in the past 7 days - Microwave Oven, Video Camera, Canopy, WiMax Mobile, WiMax Fixed, Exalt Bridge. With **Avoid Persistent Non-Wi-Fi Interference** enabled, if a Microwave Oven is detected, that interference from the Microwave Oven is taken into account in the DCA calculations for the next 7 days. After 7 days, if the interfering device is not detected anymore, it is no longer considered in the DCA calculations.
- Step 9** From the **DCA Channel Sensitivity** drop-down list, choose one of the following options to specify how sensitive the DCA algorithm is to environmental changes such as signal, load, noise, and interference when determining whether to change channels:
- *Low*—The DCA algorithm is not particularly sensitive to environmental changes. The DCA threshold is 30 dB.

- *Medium* (default)—The DCA algorithm is moderately sensitive to environmental changes. The DCA threshold is 15 dB.
- *High* —The DCA algorithm is highly sensitive to environmental changes. The DCA threshold is 5 dB.

**Step 10** Set the **Channel Width** as required. You can choose the RF channel width as 20 MHz, 40 MHz, 80 MHz, 160 MHz, or Best. This is applicable only for 802.11a/n/ac (5 GHz) radio.

**Step 11** The **Auto-RF Channel List** section shows the channels that are currently selected. To choose a channel, check the corresponding check box.

**Note** If you disable the serving radio channel of the root AP from the **Auto-RF Channel List**, you will not be able to view the neighboring APs in the root APs.

**Step 12** In the **Event Driven RRM** section, check the **EDRRM** check box to run RRM when CleanAir-enabled AP detects a significant level of interference. If enabled, set the sensitivity threshold level at which the RRM is invoked, enter the custom threshold, and check the **Rogue Contribution** check box to enter the rogue duty-cycle.

**Step 13** Click **Apply**.

## Configuring Advanced 802.11 Channel Assignment Parameters (CLI)

### Procedure

	Command or Action	Purpose
<b>Step 1</b>	<b>configure terminal</b>  <b>Example:</b> Device# <b>configure terminal</b>	Enters global configuration mode.
<b>Step 2</b>	<b>ap dot11 {24ghz   5ghz} rrm channel cleanair-event sensitivity {high   low   medium}</b>  <b>Example:</b> Device (config)# <b>ap dot11 24ghz rrm channel cleanair-event sensitivity high</b>	Configures CleanAir event-driven RRM parameters. <ul style="list-style-type: none"> <li>• <b>High</b>—Specifies the most sensitivity to non-Wi-Fi interference as indicated by the air quality (AQ) value.</li> <li>• <b>Low</b>—Specifies the least sensitivity to non-Wi-Fi interference as indicated by the AQ value.</li> <li>• <b>Medium</b>—Specifies medium sensitivity to non-Wi-Fi interference as indicated by the AQ value.</li> </ul>
<b>Step 3</b>	<b>ap dot11 {24ghz   5ghz} rrm channel dca {add channel-number   anchor-time   global {auto   once}   interval   min-metric   remove channel-number   sensitivity {high   low   medium}}</b>  <b>Example:</b>	Configures Dynamic Channel Assignment (DCA) algorithm parameters for the 802.11 band. <ul style="list-style-type: none"> <li>• <b>add channel-number</b>—Enter a channel number to be added to the DCA list. The range is between 1 to 14.</li> </ul>

	Command or Action	Purpose
	<pre>Device(config)#ap dot11 24ghz rrm channel dca interval 2</pre>	<ul style="list-style-type: none"> <li>• <b>anchor-time</b>—Configures the anchor time for the DCA. The range is between 0 and 23 hours.</li> <li>• <b>global</b>—Configures the DCA mode for all 802.11 Cisco APs. <ul style="list-style-type: none"> <li>• <b>auto</b>—Enables auto-RF.</li> <li>• <b>once</b>—Enables auto-RF only once.</li> </ul> </li> <li>• <b>interval</b>—Configures the DCA interval value. The values are 1, 2, 3, 4, 6, 8, 12 and 24 hours and the default value 0 denotes 10 minutes.</li> <li>• <b>min-metric</b>—Configures the DCA minimum RSSI energy metric. The range is between -100 and -60.</li> <li>• <b>remove channel-number</b>—Enter the channel number to be removed from the DCA list. The range is between 1 to 14.</li> <li>• <b>sensitivity</b>—Configures the DCA sensitivity level to changes in the environment. <ul style="list-style-type: none"> <li>• <b>high</b>—Specifies the most sensitivity.</li> <li>• <b>low</b>—Specifies the least sensitivity.</li> <li>• <b>medium</b>—Specifies medium sensitivity.</li> </ul> </li> </ul>
<b>Step 4</b>	<pre>ap dot11 5ghz rrm channel dca chan-width {20   40   80   best}</pre> <p><b>Example:</b></p> <pre>Device(config)#ap dot11 5ghz rrm channel dca chan-width best</pre>	Configures the DCA channel bandwidth for all 802.11 radios in the 5-GHz band. Sets the channel bandwidth to 20 MHz, 40 MHz, or 80 MHz, ; 20 MHz is the default value for channel bandwidth. 80 MHz is the default value for best. Set the channel bandwidth to best before configuring the constraints.
<b>Step 5</b>	<pre>ap dot11 5ghz rrm channel dca chan-width width-max {WIDTH_20MHz   WIDTH_40MHz   WIDTH_80MHz   WIDTH_MAX}</pre> <p><b>Example:</b></p> <pre>Device(config)#ap dot11 5ghz rrm channel</pre>	Configures the maximum channel bandwidth that can be assigned to a channel. In this example, <i>WIDTH_80MHz</i> assigns the channel bandwidth to 20 MHz, 40 MHz, or 80 MHz but not greater than that.

	Command or Action	Purpose
	<code>dca chan-width width-max WIDTH_80MHz</code>	
<b>Step 6</b>	<b>ap dot11 {24ghz   5ghz} rrm channel device</b> <b>Example:</b> Device(config)# <code>ap dot11 24ghz rrm channel device</code>	Configures the persistent non-Wi-Fi device avoidance in the 802.11 channel assignment.
<b>Step 7</b>	<b>ap dot11 {24ghz   5ghz} rrm channel foreign</b> <b>Example:</b> Device(config)# <code>ap dot11 24ghz rrm channel foreign</code>	Configures the foreign AP 802.11 interference avoidance in the channel assignment.
<b>Step 8</b>	<b>ap dot11 {24ghz   5ghz} rrm channel load</b> <b>Example:</b> Device(config)# <code>ap dot11 24ghz rrm channel load</code>	Configures the Cisco AP 802.11 load avoidance in the channel assignment.
<b>Step 9</b>	<b>ap dot11 {24ghz   5ghz} rrm channel noise</b> <b>Example:</b> Device(config)# <code>ap dot11 24ghz rrm channel noise</code>	Configures the 802.11 noise avoidance in the channel assignment.
<b>Step 10</b>	<b>end</b> <b>Example:</b> Device(config)# <code>end</code>	Returns to privileged EXEC mode. Alternatively, you can also press <b>Ctrl-Z</b> to exit global configuration mode.

## Configuring 802.11 Coverage Hole Detection (GUI)

### Procedure

- 
- Step 1** Choose **Configuration > Radio Configurations > RRM** to configure Radio Resource Management parameters for 802.11a/n/ac (5-GHz) and 802.11b/g/n (2.4-GHz) radios.
- Step 2** On the **Radio Resource Management** page, click **Coverage** tab.
- Step 3** To enable coverage hole detection, check the **Enable Coverage Hole Detection** check box.
- Step 4** In the **Data Packet Count** field, enter the number of data packets.
- Step 5** In the **Data Packet Percentage** field, enter the percentage of data packets.
- Step 6** In the **Data RSSI Threshold** field, enter the actual value in dBm. Value ranges from -60 dBm to -90 dBm; the default value is -80 dBm.
- Step 7** In the **Voice Packet Count** field, enter the number of voice data packets.
- Step 8** In the **Voice Packet Percentage** field, enter the percentage of voice data packets.

- Step 9** In the **Voice RSSI Threshold** field, enter the actual value in dBm. Value ranges from -60 dBm to -90 dBm; the default value is -80 dBm.
- Step 10** In the **Minimum Failed Client per AP** field, enter the minimum number of clients on an AP with a signal-to-noise ratio (SNR) below the coverage threshold. Value ranges from 1 to 75 and the default value is 3.
- Step 11** In the **Percent Coverage Exception Level per AP** field, enter the maximum desired percentage of clients on an access point's radio operating below the desired coverage threshold and click **Apply**. Value ranges from 0 to 100% and the default value is 25%.

## Configuring 802.11 Coverage Hole Detection (CLI)

### Procedure

	Command or Action	Purpose
<b>Step 1</b>	<b>configure terminal</b>  <b>Example:</b> Device# <code>configure terminal</code>	Enters global configuration mode.
<b>Step 2</b>	<b>ap dot11 {24ghz   5ghz} rrm coverage data {fail-percentage   packet-count   rssi-threshold}</b>  <b>Example:</b> Device(config)# <code>ap dot11 24ghz rrm coverage data fail-percentage 60</code>	Configures the 802.11 coverage hole detection for data packets. <ul style="list-style-type: none"> <li>• <b>fail-percentage:</b> Configures the 802.11 coverage failure-rate threshold for uplink data packets as a percentage that ranges from 1 to 100%.</li> <li>• <b>packet-count:</b> Configures the 802.11 coverage minimum failure count threshold for uplink data packets that ranges from 1 to 255.</li> <li>• <b>rssi-threshold:</b> Configures the 802.11 minimum receive coverage level for data packets that range from -90 to -60 dBm.</li> </ul>
<b>Step 3</b>	<b>ap dot11 {24ghz   5ghz} rrm coverage exception global <i>exception level</i></b>  <b>Example:</b> Device(config)# <code>ap dot11 24ghz rrm coverage exception global 50</code>	Configures the 802.11 Cisco AP coverage exception level as a percentage that ranges from 0 to 100%.
<b>Step 4</b>	<b>ap dot11 {24ghz   5ghz} rrm coverage level global <i>cli_min exception level</i></b>  <b>Example:</b> Device(config)# <code>ap dot11 24ghz rrm</code>	Configures the 802.11 Cisco AP client minimum exception level that ranges from 1 to 75 clients.

	Command or Action	Purpose
	<pre>coverage level global 10</pre>	
<b>Step 5</b>	<p><b>ap dot11 {24ghz   5ghz} rrm coverage voice {fail-percentage   packet-count   rssi-threshold}</b></p> <p><b>Example:</b></p> <pre>Device(config)#ap dot11 24ghz rrm coverage voice packet-count 10</pre>	<p>Configures the 802.11 coverage hole detection for voice packets.</p> <ul style="list-style-type: none"> <li>• <b>fail-percentage:</b> Configures the 802.11 coverage failure-rate threshold for uplink voice packets as a percentage that ranges from 1 to 100%.</li> <li>• <b>packet-count:</b> Configures the 802.11 coverage minimum failure count threshold for uplink voice packets that ranges from 1 to 255.</li> <li>• <b>rssi-threshold:</b> Configures the 802.11 minimum receive coverage level for voice packets that range from -90 to -60 dBm.</li> </ul>
<b>Step 6</b>	<p><b>end</b></p> <p><b>Example:</b></p> <pre>Device(config)# end</pre>	<p>Returns to privileged EXEC mode. Alternatively, you can also press <b>Ctrl-Z</b> to exit global configuration mode.</p>

## Configuring 802.11 Event Logging (CLI)

### Procedure

	Command or Action	Purpose
<b>Step 1</b>	<p><b>configure terminal</b></p> <p><b>Example:</b></p> <pre>Device# configure terminal</pre>	<p>Enters global configuration mode.</p>
<b>Step 2</b>	<p><b>ap dot11 24ghz   5ghz rrm logging {channel   coverage   foreign   load   noise   performance   txpower}</b></p> <p><b>Example:</b></p> <pre>Device(config)#ap dot11 24ghz rrm logging channel  Device(config)#ap dot11 24ghz rrm logging coverage  Device(config)#ap dot11 24ghz rrm logging foreign  Device(config)#ap dot11 24ghz rrm logging load</pre>	<p>Configures event-logging for various parameters.</p> <ul style="list-style-type: none"> <li>• <b>channel</b>—Configures the 802.11 channel change logging mode.</li> <li>• <b>coverage</b>—Configures the 802.11 coverage profile logging mode.</li> <li>• <b>foreign</b>—Configures the 802.11 foreign interference profile logging mode.</li> <li>• <b>load</b>—Configures the 802.11 load profile logging mode.</li> <li>• <b>noise</b>—Configures the 802.11 noise profile logging mode.</li> </ul>

	Command or Action	Purpose
	<pre>Device(config)#ap dot11 24ghz rrm logging noise</pre> <pre>Device(config)#ap dot11 24ghz rrm logging performance</pre> <pre>Device(config)#ap dot11 24ghz rrm logging txpower</pre>	<ul style="list-style-type: none"> <li>• <b>performance</b>—Configures the 802.11 performance profile logging mode.</li> <li>• <b>txpower</b>—Configures the 802.11 transmit power change logging mode.</li> </ul>
<b>Step 3</b>	<pre>end</pre> <p><b>Example:</b></p> <pre>Device(config)# end</pre>	Returns to privileged EXEC mode. Alternatively, you can also press <b>Ctrl-Z</b> to exit global configuration mode.

## Configuring 802.11 Statistics Monitoring (GUI)

### Procedure

- Step 1** Choose **Configuration > Radio Configurations > RRM** to configure Radio Resource Management parameters for 802.11a/n/ac (5 GHz) and 802.11b/g/n (2.4 GHz) radios.
- Step 2** In the **Monitor Intervals(60 to 3600secs)** section, proceed as follows:
- To configure the 802.11 noise measurement interval (channel scan interval), set the **AP Noise Interval**. The valid range is from 60 to 3600 seconds.
  - To configure the 802.11 signal measurement interval (neighbor packet frequency), set the **AP Signal Strength Interval**. The valid range is from 60 to 3600 seconds.
  - To configure the 802.11 coverage measurement interval, set the **AP Coverage Interval**. The valid range is from 60 to 3600 seconds.
  - To configure the 802.11 load measurement, set the **AP Load Interval**. The valid range is from 60 to 3600 seconds.
- Step 3** Click **Apply**.

## Configuring 802.11 Statistics Monitoring (CLI)

### Procedure

	Command or Action	Purpose
<b>Step 1</b>	<pre>configure terminal</pre> <p><b>Example:</b></p> <pre>Device# configure terminal</pre>	Enters global configuration mode.
<b>Step 2</b>	<pre>ap dot11 24ghz   5ghz rrm monitor channel-list {all   country   dca}</pre> <p><b>Example:</b></p>	Sets the 802.11 monitoring channel-list for parameters such as noise/interference/rogue. <ul style="list-style-type: none"> <li>• <b>all</b>— Monitors all channels.</li> </ul>

	Command or Action	Purpose
	<pre>Device(config)#ap dot11 24ghz rrm monitor channel-list all</pre>	<ul style="list-style-type: none"> <li>• <b>country</b>— Monitor channels used in configured country code.</li> <li>• <b>dca</b>— Monitor channels used by dynamic channel assignment.</li> </ul>
<b>Step 3</b>	<p><b>ap dot11 24ghz   5ghz rrm monitor coverage interval</b></p> <p><b>Example:</b></p> <pre>Device(config)#ap dot11 24ghz rrm monitor coverage 600</pre>	Configures the 802.11 coverage measurement interval in seconds that ranges from 60 to 3600.
<b>Step 4</b>	<p><b>ap dot11 24ghz   5ghz rrm monitor load interval</b></p> <p><b>Example:</b></p> <pre>Device(config)#ap dot11 24ghz rrm monitor load 180</pre>	Configures the 802.11 load measurement interval in seconds that ranges from 60 to 3600.
<b>Step 5</b>	<p><b>ap dot11 24ghz   5ghz rrm monitor noise interval</b></p> <p><b>Example:</b></p> <pre>Device(config)#ap dot11 24ghz rrm monitor noise 360</pre>	Configures the 802.11 noise measurement interval (channel scan interval) in seconds that ranges from 60 to 3600.
<b>Step 6</b>	<p><b>ap dot11 24ghz   5ghz rrm monitor signal interval</b></p> <p><b>Example:</b></p> <pre>Device(config)#ap dot11 24ghz rrm monitor signal 480</pre>	Configures the 802.11 signal measurement interval (neighbor packet frequency) in seconds that ranges from 60 to 3600.
<b>Step 7</b>	<p><b>end</b></p> <p><b>Example:</b></p> <pre>Device(config)# end</pre>	Returns to privileged EXEC mode. Alternatively, you can also press <b>Ctrl-Z</b> to exit global configuration mode.

## Configuring the 802.11 Performance Profile (GUI)

### Procedure

- 
- Step 1** Choose **Configuration > Tags & Profiles > AP Join**.
  - Step 2** On the **AP Join** page, click the name of the profile or click **Add** to create a new one.
  - Step 3** In the **Add/Edit RF Profile** window, click the **RRM** tab.
  - Step 4** In the **General** tab that is displayed, enter the following parameters:



- a) In the **Interference (%)** field, enter the threshold value for 802.11 foreign interference that ranges between 0 and 100 percent.
- b) In the **Clients** field, enter the threshold value for 802.11 Cisco AP clients that range between 1 and 75 clients.
- c) In the **Noise (dBm)** field, enter the threshold value for 802.11 foreign noise ranges between –127 and 0 dBm.
- d) In the **Utilization(%)** field, enter the threshold value for 802.11 RF utilization that ranges between 0 to 100 percent.

**Step 5** Click **Update & Apply to Device**.

## Configuring the 802.11 Performance Profile (CLI)

### Procedure

	Command or Action	Purpose
<b>Step 1</b>	<b>configure terminal</b> <b>Example:</b> Device# configure terminal	Enters global configuration mode.
<b>Step 2</b>	<b>ap dot11 {24ghz   5ghz} rrm profile clients</b> <i>cli_threshold_value</i> <b>Example:</b> Device(config)#ap dot11 24ghz rrm profile clients 20	Sets the threshold value for 802.11 Cisco AP clients that range between 1 and 75 clients.
<b>Step 3</b>	<b>ap dot11 {24ghz   5ghz} rrm profile foreign</b> <i>int_threshold_value</i> <b>Example:</b> Device(config)#ap dot11 24ghz rrm profile foreign 50	Sets the threshold value for 802.11 foreign interference that ranges between 0 and 100%.
<b>Step 4</b>	<b>ap dot11 {24ghz   5ghz} rrm profile noise</b> <i>for_noise_threshold_value</i> <b>Example:</b> Device(config)#ap dot11 24ghz rrm profile noise -65	Sets the threshold value for 802.11 foreign noise ranges between –127 and 0 dBm.
<b>Step 5</b>	<b>ap dot11 {24ghz   5ghz} rrm profile throughput</b> <i>throughput_threshold_value</i> <b>Example:</b> Device(config)#ap dot11 24ghz rrm profile throughput 10000	Sets the threshold value for 802.11 Cisco AP throughput that ranges between 1000 and 10000000 bytes per second.

	Command or Action	Purpose
<b>Step 6</b>	<b>ap dot11 {24ghz   5ghz} rrm profile utilization rf_util_threshold_value</b>  <b>Example:</b>  Device (config) # <b>ap dot11 24ghz rrm profile utilization 75</b>	Sets the threshold value for 802.11 RF utilization that ranges between 0 to 100%.
<b>Step 7</b>	<b>end</b>  <b>Example:</b>  Device (config) # <b>end</b>	Returns to privileged EXEC mode.

## Configuring Advanced 802.11 RRM

### Enabling Channel Assignment (GUI)

#### Procedure

- 
- Step 1** Choose **Configuration > Radio Configurations > RRM**.
- Step 2** In the **RRM** page, click the relevant band's tab: either **5 GHz Band** or **2.4 GHz Band**.
- Step 3** Click the **DCA** tab
- Step 4** In the **Dynamic Channel Assignment Algorithm** section, choose the appropriate **Channel Assignment Mode** from these options:
- Automatic: Sets the channel assignment to automatic.
  - Freeze: Locks the channel assignment. Click **Invoke Channel Update Once** to refresh the assigned channels.
- Step 5** Click **Apply**.
- 

### Enabling Channel Assignment (CLI)

#### Procedure

	Command or Action	Purpose
<b>Step 1</b>	<b>enable</b>  <b>Example:</b>  Device# <b>enable</b>	Enters privileged EXEC mode.
<b>Step 2</b>	<b>ap dot11 {24ghz   5ghz} rrm channel-update</b>  <b>Example:</b>	Enables the 802.11 channel selection update for each of the Cisco access points.

	Command or Action	Purpose
	Device# <code>ap dot11 24ghz rrm channel-update</code>	<b>Note</b> After you enable <code>ap dot11 {24ghz   5ghz} rrm channel-update</code> , a token is assigned for channel assignment in the DCA algorithm.

## Restarting DCA Operation

### Procedure

	Command or Action	Purpose
<b>Step 1</b>	<code>enable</code> <b>Example:</b> Device# <code>enable</code>	Enters privileged EXEC mode.
<b>Step 2</b>	<code>ap dot11 {24ghz   5ghz} rrm dca restart</code> <b>Example:</b> Device# <code>ap dot11 24ghz rrm dca restart</code>	Restarts the DCA cycle for 802.11 radio.

## Updating Power Assignment Parameters (GUI)

### Procedure

- Step 1** Choose **Configuration > Wireless > Access Points**.
- Step 2** On the **Access Points** page, click the AP name from the 5GHz or 2.4 GHz list.
- Step 3** In the **Edit Radios > Configure > Tx Power Level Assignment** section, choose **Custom** from the **Assignment Method** group-down list.
- Step 4** Choose the value for **Transmit Power** from the drop-down list.
- Step 5** Click **Update & Apply to Device**.

## Updating Power Assignment Parameters (CLI)

### Procedure

	Command or Action	Purpose
<b>Step 1</b>	<code>enable</code> <b>Example:</b> Device# <code>enable</code>	Enters privileged EXEC mode.

	Command or Action	Purpose
<b>Step 2</b>	<b>ap dot11 {24ghz   5ghz} rrm txpower update</b> <b>Example:</b> Device# <code>ap dot11 24ghz rrm txpower update</code>	Updates the 802.11 transmit power for each of the Cisco access points.

## Configuring Rogue Access Point Detection in RF Groups

### Configuring Rogue Access Point Detection in RF Groups (CLI)

#### Before you begin

Ensure that each controller in the RF group has been configured with the same RF group name.



**Note** The name is used to verify the authentication IE in all beacon frames. If the controller have different names, false alarms will occur.

#### Procedure

	Command or Action	Purpose
<b>Step 1</b>	<b>ap name Cisco_AP mode { monitor   clear   sensor   sniffer }</b> <b>Example:</b> Device# <code>ap name ap1 mode clear</code>	Perform this step for every access point connected to the controller . Configures the following AP modes of operation: <ul style="list-style-type: none"> <li>• <b>monitor</b>: Sets the AP mode to monitor mode.</li> <li>• <b>clear</b>: Resets AP mode to local or remote based on the site.</li> <li>• <b>sensor</b>: Sets the AP mode to sensor mode.</li> <li>• <b>sniffer</b>: Sets the AP mode to wireless sniffer mode.</li> </ul>
<b>Step 2</b>	<b>end</b> <b>Example:</b> Device(config)# <code>end</code>	Returns to privileged EXEC mode. Alternatively, you can also press <b>Ctrl-Z</b> to exit global configuration mode.
<b>Step 3</b>	<b>configure terminal</b> <b>Example:</b> Device# <code>configure terminal</code>	Enters global configuration mode.

	Command or Action	Purpose
Step 4	<b>wireless wps ap-authentication</b> <b>Example:</b> Device (config)# <b>wireless wps ap-authentication</b>	Enables rogue access point detection.
Step 5	<b>wireless wps ap-authentication threshold value</b> <b>Example:</b> Device (config)# <b>wireless wps ap-authentication threshold 50</b>	<p>Specifies when a rogue access point alarm is generated. An alarm occurs when the threshold value (which specifies the number of access point frames with an invalid authentication IE) is met or exceeded within the detection period.</p> <p>The valid threshold range is from 1 to 255, and the default threshold value is 1. To avoid false alarms, you may want to set the threshold to a higher value.</p> <p><b>Note</b> Enable rogue access point detection and threshold value on every controller in the RF group.</p> <p><b>Note</b> If rogue access point detection is not enabled on every controller in the RF group, the access points on the controller with this feature disabled are reported as rogues.</p>

## Monitoring RRM Parameters and RF Group Status

### Monitoring RRM Parameters

Table 20: Commands for monitoring Radio Resource Management

Commands	Description
<b>show ap dot11 24ghz channel</b>	Displays the configuration and statistics of the 802.11b channel assignment.
<b>show ap dot11 24ghz coverage</b>	Displays the configuration and statistics of the 802.11b coverage.
<b>show ap dot11 24ghz group</b>	Displays the configuration and statistics of the 802.11b grouping.
<b>show ap dot11 24ghz logging</b>	Displays the configuration and statistics of the 802.11b event logging.
<b>show ap dot11 24ghz monitor</b>	Displays the configuration and statistics of the 802.11b monitoring.
<b>show ap dot11 24ghz profile</b>	Displays 802.11b profiling information for all Cisco APs.
<b>show ap dot11 24ghz summary</b>	Displays the configuration and statistics of the 802.11b Cisco APs.

Commands	Description
<b>show ap dot11 24ghz txpower</b>	Displays the configuration and statistics of the 802.11b transmit power control.
<b>show ap dot11 5ghz channel</b>	Displays the configuration and statistics of the 802.11a channel assignment.
<b>show ap dot11 5ghz coverage</b>	Displays the configuration and statistics of the 802.11a coverage.
<b>show ap dot11 5ghz group</b>	Displays the configuration and statistics of the 802.11a grouping.
<b>show ap dot11 5ghz logging</b>	Displays the configuration and statistics of the 802.11a event logging.
<b>show ap dot11 5ghz monitor</b>	Displays the configuration and statistics of the 802.11a monitoring.
<b>show ap dot11 5ghz profile</b>	Displays 802.11a profiling information for all Cisco APs.
<b>show ap dot11 5ghz summary</b>	Displays the configuration and statistics of the 802.11a Cisco APs.
<b>show ap dot11 5ghz txpower</b>	Displays the configuration and statistics of the 802.11a transmit power control.

## Verifying RF Group Status (CLI)

This section describes the new commands for RF group status.

The following commands can be used to verify RF group status on the .

**Table 21: Verifying Aggressive Load Balancing Command**

Command	Purpose
<b>show ap dot11 5ghz group</b>	Displays the controller name which is the RF group leader for the 802.11a RF network.
<b>show ap dot11 24ghz group</b>	Displays the controller name which is the RF group leader for the 802.11b/g RF network.

## Examples: RF Group Configuration

This example shows how to configure RF group name:

```
Device# configure terminal
Device(config)# wireless rf-network test1
Device(config)# ap dot11 24ghz shutdown
Device(config)# end
Device # show network profile 5
```

This example shows how to configure rogue access point detection in RF groups:

```
Device# ap name ap1 mode clear
Device# end
```

```

Device# configure terminal
Device(config)# wireless wps ap-authentication
Device(config)# wireless wps ap-authentication threshold 50
Device(config)# end

```

## Information About ED-RRM

Spontaneous interference is interference that appears suddenly on a network, perhaps jamming a channel or a range of channels completely. The Cisco CleanAir spectrum event-driven RRM feature allows you to set a threshold for air quality (AQ) that, if exceeded, triggers an immediate channel change for the affected access point. Once a channel change occurs due to event-driven RRM, the channel is blocked list for three hours to avoid selection. Most RF management systems can avoid interference, but this information takes time to propagate through the system. Cisco CleanAir relies on AQ measurements to continuously evaluate the spectrum and can trigger a move within 30 seconds. For example, if an access point detects interference from a video camera, it can recover by changing channels within 30 seconds of the camera becoming active.

## Configuring ED-RRM on the Cisco Wireless Controller (CLI)

### Procedure

- 
- Step 1** Trigger spectrum event-driven radio resource management (RRM) to run when a Cisco CleanAir-enabled access point detects a significant level of interference by entering these commands:
- ap dot11 {24ghz | 5ghz} rrm channel cleanair-event** —Configures CleanAir driven RRM parameters for the 802.11 Cisco lightweight access points.
- ap dot11 {24ghz | 5ghz} rrm channel cleanair-event sensitivity {low | medium | high | custom}**—Configures CleanAir driven RRM sensitivity for the 802.11 Cisco lightweight access points. Default selection is Medium.
- ap dot11 {24ghz | 5ghz} rrm channel cleanair-event custom-threshold *custom-threshold-value***—Triggers the ED-RRM event at the set threshold value. The custom threshold values range from 1 to 99.
- ap dot11 {24ghz | 5ghz} rrm channel cleanair-event rogue-contribution**—Enables rogue contribution.
- ap dot11 {24ghz | 5ghz} rrm channel cleanair-event rogue-contribution duty-cycle *thresholdvalue***—Configures threshold value for rogue contribution. The valid range is from 1 to 99, with 80 as the default.
- Step 2** Save your changes by entering this command:
- write memory**
- Step 3** See the CleanAir configuration for the 802.11a/n/ac or 802.11b/g/n network by entering this command:
- show ap dot11 {24ghz | 5ghz} cleanair config**
- Information similar to the following appears:

```

CleanAir Solution..... : Enabled
Air Quality Settings:
Air Quality Reporting..... : Enabled
Air Quality Reporting Period (min)..... : 15

```

```

Air Quality Alarms..... : Disabled
Air Quality Alarm Threshold..... : 10
Unclassified Interference..... : Disabled
Unclassified Severity Threshold..... : 35
Interference Device Settings:
Interference Device Reporting..... : Enabled
BLE Beacon..... : Enabled
Bluetooth Link..... : Enabled
Microwave Oven..... : Enabled
802.11 FH..... : Enabled
Bluetooth Discovery..... : Enabled
TDD Transmitter..... : Enabled
Jammer..... : Enabled
Continuous Transmitter..... : Enabled
DECT-like Phone..... : Enabled
Video Camera..... : Enabled
802.15.4..... : Enabled
WiFi Inverted..... : Enabled
WiFi Invalid Channel..... : Enabled
SuperAG..... : Enabled
Canopy..... : Enabled
Microsoft Device..... : Enabled
WiMax Mobile..... : Enabled
WiMax Fixed..... : Enabled
Interference Device Types Triggering Alarms:
BLE Beacon..... : Disabled
Bluetooth Link..... : Disabled
Microwave Oven..... : Disabled
802.11 FH..... : Disabled
Bluetooth Discovery..... : Disabled
TDD Transmitter..... : Disabled
Jammer..... : Disabled
Continuous Transmitter..... : Disabled
DECT-like Phone..... : Disabled
Video Camera..... : Disabled
802.15.4..... : Disabled
WiFi Inverted..... : Enabled
WiFi Invalid Channel..... : Enabled
SuperAG..... : Disabled
Canopy..... : Disabled
Microsoft Device..... : Disabled
WiMax Mobile..... : Disabled
WiMax Fixed..... : Disabled
Interference Device Alarms..... : Disabled
AdditionalClean Air Settings:
CleanAir Event-driven RRM State..... : Disabled
CleanAir Driven RRM Sensitivity..... : LOW
CleanAir Driven RRM Sensitivity Level..... : 35
CleanAir Event-driven RRM Rogue Option..... : Disabled
CleanAir Event-driven RRM Rogue Duty Cycle... : 80
CleanAir Persistent Devices state..... : Disabled
CleanAir Persistent Device Propagation..... : Disabled

```

---





## CHAPTER 42

# Coverage Hole Detection

---

- [Coverage Hole Detection and Correction, on page 447](#)

## Coverage Hole Detection and Correction

The RRM coverage hole detection algorithm can detect areas of radio coverage in a wireless LAN that are below the level needed for robust radio performance. This feature can alert you to the need for an additional (or relocated) lightweight access point.

If clients on a lightweight access point are detected at threshold levels (RSSI, failed client count, percentage of failed packets, and number of failed packets) lower than those specified in the RRM configuration, the access point sends a “coverage hole” alert to the device. The alert indicates the existence of an area where clients are continually experiencing poor signal coverage, without having a viable access point to which to roam. The device discriminates between coverage holes that can and cannot be corrected. For coverage holes that can be corrected, the device mitigates the coverage hole by increasing the transmit power level for that specific access point. The device does not mitigate coverage holes caused by clients that are unable to increase their transmit power or are statically set to a power level because increasing their downstream transmit power might increase interference in the network.

## Configuring Coverage Hole Detection (GUI)

Follow the procedure given below to configure client accounting.

### Procedure

---

- Step 1** Click **Configuration > Radio Configurations > RRM**.
- On this page, you can configure Radio Resource Management parameters for 802.11a/n/ac (5 GHz) and 802.11b/g/n (2.4 GHz) radios, and flexible radio assignment parameters.
- Step 2** Check the **Enable Coverage Hole Detection** check box.
- Enables coverage hole detection.
-

## Configuring Coverage Hole Detection (CLI)

Coverage Hole Detection (CHD) is based on upstream RSSI metrics observed by the AP.



**Note** To revert back radios from 5-GHz to 24-GHz for CHD, ensure that the 5-GHz radio is UP and Client Network Preference value is other than the default.

Follow the procedure given below to configure CHD:

### Before you begin

Disable the 802.11 network before applying the configuration.

### Procedure

	Command or Action	Purpose
<b>Step 1</b>	<b>ap dot11 {24ghz   5ghz} rrm coverage</b> <b>Example:</b> Device(config)# ap dot11 24ghz rrm coverage	Configures the 802.11 coverage level for data packets.  Use the <b>no</b> form of the command to disable CHD.
<b>Step 2</b>	<b>ap dot11 {24ghz   5ghz} rrm coverage data {fail-percentage   packet-count   rssi-threshold}</b> <b>Example:</b> Device(config)# ap dot11 24ghz rrm coverage data fail-percentage 60	Configures the 802.11 coverage level for data packets. <ul style="list-style-type: none"> <li>• <b>fail-percentage:</b> Configures the 802.11 coverage failure-rate threshold for uplink data packets as a percentage that ranges from 1 to 100%.</li> <li>• <b>packet-count:</b> Configures the 802.11 coverage minimum failure count threshold for uplink data packets that ranges from 1 to 255.</li> <li>• <b>rssi-threshold:</b> Configures the 802.11 minimum receive coverage level for data packets that range from -90 to -60 dBm.</li> </ul>
<b>Step 3</b>	<b>ap dot11 {24ghz   5ghz} rrm coverage exception global <i>exception level</i></b> <b>Example:</b> Device(config)# ap dot11 24ghz rrm coverage exception global 50	Configures the 802.11 Cisco AP coverage exception level as a percentage that ranges from 0 to 100%.

	Command or Action	Purpose
<b>Step 4</b>	<b>ap dot11{24ghz   5ghz}rrm coverage level global cli_min exception level</b>  <b>Example:</b>  <pre>Device(config)# ap dot11 24ghz rrm coverage level global 10</pre>	Configures the 802.11 Cisco AP client minimum exception level that ranges from 1 to 75 clients.
<b>Step 5</b>	<b>ap dot11 {24ghz   5ghz} rrm coverage voice {fail-percentage   packet-count   rssi-threshold}</b>  <b>Example:</b>  <pre>Device(config)# ap dot11 24ghz rrm coverage voice packet-count 10</pre>	Configures the 802.11 coverage hole detection for voice packets. <ul style="list-style-type: none"> <li>• <b>fail-percentage:</b> Configures the 802.11 coverage failure-rate threshold for uplink voice packets as a percentage that ranges from 1 to 100%.</li> <li>• <b>packet-count:</b> Configures the 802.11 coverage minimum failure count threshold for uplink voice packets that ranges from 1 to 255.</li> <li>• <b>rssi-threshold:</b> Configures the 802.11 minimum receive coverage level for voice packets that range from -90 to -60 dBm.</li> </ul>
<b>Step 6</b>	<b>end</b>  <b>Example:</b>  <pre>Device(config)# end</pre>	Returns to privileged EXEC mode. Alternatively, you can also press <b>Ctrl-Z</b> to exit global configuration mode.
<b>Step 7</b>	<b>show ap dot11 {24ghz   5ghz} coverage</b>  <b>Example:</b>  <pre>Device# show ap dot11 5ghz coverage</pre>	Displays the CHD details.



**Note** If both the number and percentage of failed packets exceed the values entered in the **packet-count** and **fail-rate** commands for a 5-second period, the client is considered to be in a pre-alarm condition. The controller uses this information to distinguish between real and false coverage holes. False positives are generally due to the poor roaming logic implemented on most clients. A coverage hole is detected if both the number and percentage of failed clients meet or exceed the values entered in the **coverage level global** and **coverage exception global** commands over a 90-second period. The controller determines if the coverage hole can be corrected and, if appropriate, mitigates the coverage hole by increasing the transmit power level for that specific access point.

## Configuring CHD for RF Tag Profile (GUI)

### Procedure

- 
- Step 1** Choose **Configuration > Radio Configurations > RRM**.
- Step 2** On the **Coverage** tab, select the **Enable Coverage Hole Detection** check box.
- Step 3** In the **Data Packet Count** field, enter the number of data packets.
- Step 4** In the **Data Packet Percentage** field, enter the percentage of data packets.
- Step 5** In the **Data RSSI Threshold** field, enter the actual value in dBm. Value ranges from -60 dBm to -90 dBm; the default value is -80 dBm.
- Step 6** In the **Voice Packet Count** field, enter the number of voice data packets.
- Step 7** In the **Voice Packet Percentage** field, enter the percentage of voice data packets.
- Step 8** In the **Voice RSSI Threshold** field, enter the actual value in dBm. Value ranges from -60 dBm to -90 dBm; the default value is -80 dBm.
- Step 9** In the **Minimum Failed Client per AP** field, enter the minimum number of clients on an AP with a signal-to-noise ratio (SNR) below the coverage threshold. Value ranges from 1 to 75 and the default value is 3.
- Step 10** In the **Percent Coverage Exception Level per AP** field, enter the maximum desired percentage of clients on an access point's radio operating below the desired coverage threshold and click **Apply**. Value ranges from 0 to 100% and the default value is 25%.
- Step 11** Click **Apply**.
- 

## Configuring CHD for RF Profile (CLI)

Follow the procedure given below to configure Coverage Hole Detection (CHD) for RF profile.

### Before you begin

Ensure that the RF profile is already created.

### Procedure

	Command or Action	Purpose
<b>Step 1</b>	<b>configure terminal</b>  <b>Example:</b> Device# <code>configure terminal</code>	Enters global configuration mode.
<b>Step 2</b>	<b>ap dot11 {24ghz   5ghz } rf-profile</b> <i>rf-profile-tag</i>  <b>Example:</b> Device(config)# <code>ap dot11 24ghz rf-profile</code> <code>alpha-rfprofile-24ghz</code>	Configures the 802.11 coverage hole detection for data packets.

	Command or Action	Purpose
<b>Step 3</b>	<b>coverage data rssi threshold <i>threshold-value</i></b> <b>Example:</b> <pre>Device(config-rf-profile)# coverage data rssi threshold -80</pre>	Configures the minimum RSSI value for data packets received by the access point. Valid values range from -90 to -60 in dBm.
<b>Step 4</b>	<b>end</b> <b>Example:</b> <pre>Device(config-rf-profile)# end</pre>	Returns to privileged EXEC mode.
<b>Step 5</b>	<b>show ap dot11 24ghz rf-profile summary</b> <b>Example:</b> <pre>Device# show ap dot11 24ghz rf-profile summary</pre>	Displays summary of the available RF profiles.





## CHAPTER 43

# Optimized Roaming

- [Optimized Roaming](#), on page 453
- [Restrictions for Optimized Roaming](#), on page 453
- [Configuring Optimized Roaming \(GUI\)](#), on page 454
- [Configuring Optimized Roaming \(CLI\)](#), on page 454

## Optimized Roaming

Optimized roaming resolves the problem of sticky clients that remain associated to access points that are far away and outbound clients that attempt to connect to a Wi-Fi network without having a stable connection. This feature disassociates clients based on the RSSI of the client data packets and data rate. The client is disassociated if the RSSI alarm condition is met and the current data rate of the client is lower than the optimized roaming data rate threshold. You can disable the data rate option so that only RSSI is used for disassociating clients.

Optimized roaming also prevents client association when the client's RSSI is low. This feature checks the RSSI of the incoming client against the RSSI threshold. This check prevents the clients from connecting to a Wi-Fi network unless the client has a viable connection. In many scenarios, even though clients can hear beacons and connect to a Wi-Fi network, the signal might not be strong enough to support a stable connection.

You can also configure the client coverage reporting interval for a radio by using optimized roaming. The client coverage statistics include data packet RSSIs, Coverage Hole Detection and Mitigation (CHDM) pre-alarm failures, retransmission requests, and current data rates.

Optimized roaming is useful in the following scenarios:

- Addresses the sticky client challenge by proactively disconnecting clients.
- Actively monitors data RSSI packets.
- Disassociates client when the RSSI is lower than the set threshold.

This section contains the following subsections:

## Restrictions for Optimized Roaming

- You cannot configure the optimized roaming interval until you disable the 802.11a/b network.

- When basic service set (BSS) transition is sent to 802.11v-capable clients, and if the clients are not transitioned to other BSS before the disconnect timer expires, the corresponding client is disconnected forcefully. BSS transition is enabled by default for 802.11v-capable clients.
- The Cisco Catalyst 9800 controller increments the 802.11v smart roam failed counter while disconnecting the client due to optimized roaming.
- We recommend that you do not use the optimized roaming feature with RSSI low check.

## Configuring Optimized Roaming (GUI)

### Procedure

- 
- Step 1** Choose **Configuration > Wireless > Advanced**.
- Step 2** On the **Advanced** page, click the relevant band's tab: either **5 GHz Band** or **2.4 GHz Band**.
- Step 3** Check the **Optimized Roaming Mode** check box to enable the feature.
- Step 4** Choose the required **Optimized Roaming Data Rate Threshold**. The threshold value options are different for 802.11a and 802.11b networks.
- Optimized roaming disassociates clients based on the RSSI of the client data packet and data rate. The client is disassociated if the current data rate of the client is lower than the Optimized Roaming Data Rate Threshold.
- Step 5** Click **Apply** to save the configuration.
- 

## Configuring Optimized Roaming (CLI)

### Procedure

	Command or Action	Purpose
<b>Step 1</b>	<b>ap dot11 5ghz rrm optimized-roam</b>	Configures 802.11a or 802.11b optimized roaming.  By default, optimized roaming is disabled.
<b>Step 2</b>	<b>ap dot11 5ghz rrm optimized-roam data-rate-threshold <i>mbps</i></b>	Configure the threshold data rate for 802.11a networks.  For 802.11a, the configurable data rates are 1, 2, 6, 9, 12, 18, 24, 36, 48, and 54. You can configure DISABLE to disable the data rate.
<b>Step 3</b>	<b>show wireless statistics ap dot11 5ghz optimized-roaming statistics</b>	Displays optimized roaming statistics for each band.





## CHAPTER 44

# Cisco Flexible Radio Assignment

- [Information About Flexible Radio Assignment, on page 455](#)
- [Configuring an FRA Radio \(CLI\), on page 456](#)
- [Configuring an FRA Radio \(GUI\), on page 458](#)

## Information About Flexible Radio Assignment

Flexible Radio Assignment (FRA) takes advantage of the dual-band radios included in APs. The FRA is a new feature added to the RRM to analyze the Neighbor Discovery Protocol (NDP) measurements, which manages the hardware used to determine the role of the new flexible radio (2.4 GHz, 5 GHz, or monitor) in your network.

Traditional legacy dual-band APs always had 2 radio slots, (1 slot per band) and were organized by the band they were serving, that is slot 0= 802.11b,g,n and slot 1=802.11a,n,ac.

### XOR Support in 2.4-GHz or 5-GHz Bands

The flexible radio (XOR) offers the ability to serve the 2.4-GHz or the 5-GHz bands, or passively monitor both bands on the same AP. The AP models that are offered are designed to support dual 5-GHz band operations, with the Cisco APs *i* model supporting a dedicated Macro/Micro architecture, and the *e* and *p* models supporting Macro/Macro architecture.

When using FRA with the internal antenna (*i* series models), two 5-GHz radios can be used in a Micro/Macro cell mode. When using FRA with external antenna (*e* and *p* models) the antennas may be placed to enable the creation of two completely separate macro (wide-area cells) or two micro cells (small cells) for HDX or any combination.

FRA calculates and maintains a measurement of redundancy for 2.4-GHz radios and represents this as a new measurement metric called COF (Coverage Overlap Factor).

This feature is integrated into existing RRM and runs in mixed environments with legacy APs. The **AP MODE** selection sets the entire AP (slot 0 and slot1) into one of several operating modes, including:

- Local Mode
- Monitor Mode
- FlexConnect Mode
- Sniffer Mode
- Spectrum Connect Mode

Before XOR was introduced, changing the mode of an AP propagated the change to the entire AP, that is both radio slot 0 and slot 1. The addition of the XOR radio in the slot 0 position provides the ability to operate a single radio interface in many of the previous modes, eliminating the need to place the whole AP into a mode. When this concept is applied to a single radio level, it is called *role*. Three such roles can be assigned now:

- Client Serving
- Either 2.4 GHz(1) or 5 GHz(2)
- Monitor-Monitor mode (3)

**Note**

- MODE: Assigned to a whole AP (slot 0 and slot 1)
- ROLE: Assigned to a single radio interface (slot 0)

## Benefits of the FRA

- Solves the problem of 2.4-GHz over coverage.
- Creating two diverse 5-GHz cells doubles the airtime that is available.
- Permits one AP with one Ethernet drop to function like two 5-GHz APs.
- Introduces the concept of Macro/Micro cells for airtime efficiency.
- Allows more bandwidth to be applied to an area within a larger coverage cell.
- Can be used to address nonlinear traffic.
- Enhances the High-Density Experience (HDX) with one AP.
- XOR radio can be selected by the corresponding user in either band-servicing client mode or monitor mode.

## Configuring an FRA Radio (CLI)

### Procedure

	Command or Action	Purpose
<b>Step 1</b>	<b>enable</b>  <b>Example:</b> Device# <b>enable</b>	Enters privileged EXEC mode.
<b>Step 2</b>	<b>configure terminal</b>  <b>Example:</b> Device# <b>configure terminal</b>	Enters global configuration mode.

	Command or Action	Purpose
<b>Step 3</b>	<b>[no] ap fra</b> <b>Example:</b> Device(config)# <b>[no] ap fra</b>	Enables or disables FRA on the AP.
<b>Step 4</b>	<b>ap fra interval</b> <b>Example:</b> Device(config)# <b>ap fra interval 3</b>	Configures the FRA interval in hours. The range is 1 to 24 hours. <b>Note</b> The FRA interval has to be more than the configured RRM interval.
<b>Step 5</b>	<b>ap fra sensitivity {high   medium   low}</b> <b>Example:</b> Device(config)# <b>ap fra sensitivity high</b>	Configures the FRA sensitivity. <ul style="list-style-type: none"> <li>• <b>high:</b> Sets the FRA Coverage Overlap Sensitivity to <b>high</b>.</li> <li>• <b>medium:</b> Sets the FRA Coverage Overlap Sensitivity to <b>medium</b>.</li> <li>• <b>low:</b> Sets the FRA Coverage Overlap Sensitivity to <b>low</b>.</li> </ul>
<b>Step 6</b>	<b>end</b> <b>Example:</b> Device(config)# <b>end</b>	Returns to privileged EXEC mode. Alternatively, you can also press <b>Ctrl-Z</b> to exit global configuration mode.
<b>Step 7</b>	<b>ap fra revert {all   auto-only} {auto   static}</b> <b>Example:</b> Device# <b>ap fra revert all auto</b>	Rolls back the XOR Radio state. <ul style="list-style-type: none"> <li>• <b>all:</b> Reverts all XOR Radios</li> <li>• <b>auto-only:</b> Revert only XOR radios currently in automatic band selection.</li> <li>• <b>auto:</b> Sets the XOR radios in automatic band selection.</li> <li>• <b>static:</b> Sets the XOR radio in static 2.4-GHz band.</li> </ul>
<b>Step 8</b>	<b>show ap dot11 {24ghz   5ghz} summary</b> <b>Example:</b> Device# <b>show ap dot11 5ghz summary</b>	Shows the configuration and statistics of 802.11 Cisco APs
<b>Step 9</b>	Device# <b>show ap fra</b> <b>Example:</b> Device# <b>show ap fra</b>  FRA State : Disabled FRA Sensitivity : medium (95%) FRA Interval	Shows the current FRA configuration.

	Command or Action	Purpose
	<pre> : 1 Hour(s)  AP Name          MAC Address Slot ID  Current-Band      COF % Suggested Mode AP00A6.CA36.295A    006b.f09c.8290 0          2.4GHz          None 2.4GHz  COF : Coverage Overlap Factor  test_machine# </pre>	
<b>Step 10</b>	<p><b>show ap name <i>ap-name</i> config dot11 dual-band</b></p> <p><b>Example:</b></p> <pre> Device# show ap name config dot11 dual-band </pre>	Shows the current 802.11 dual-band parameters in a given AP.

## Configuring an FRA Radio (GUI)

### Procedure

- Step 1** Choose **Configuration > Radio Configurations > RRM > FRA**.
- Step 2** In the **Flexible Radio Assignment** window, enable FRA status and determine the overlapping 2.4 GHz or 5 GHz coverage for each AP, choose **Enabled** in the **FRA Status** field. By default, the FRA status is disabled.
- Step 3** Under the From the **FRA Interval** drop-down list, choose the FRA run interval. The interval values range from 1 hour to 24 hours. You can choose the FRA run interval value only after you enable the FRA status.
- Step 4** From the **FRA Sensitivity** drop-down list, choose the percentage of Coverage Overlap Factor (COF) required to consider a radio as redundant. You can select the supported value only after you enable the FRA status.

The supported values are as follows:

- Low: 100 percent
- Medium (default): 95 percent
- High: 90 percent

The **Last Run** and **Last Run Time** fields will show the time FRA was run last and the time it was run.

- Step 5** Check the **Client Aware** check box to take decisions on redundancy.

When enabled, the **Client Aware** feature monitors the dedicated 5-GHz radio and when the client load passes a pre-set threshold, automatically changes the Flexible Radio assignment from a monitor role into a 5-GHz role, effectively doubling the capacity of the cell on demand. Once the capacity crisis is over and Wi-Fi load returns to normal, the radios resume their previous roles.

**Step 6** In the **Client Select** field, enter a value for client selection. The valid values range between 0 and 100 percent. The default value is 50 percent.

This means that if the dedicated 5-GHz interface reaches 50% channel utilization, this will trigger the monitor role dual-band interface to transition to a 5-GHz client-serving role.

**Step 7** In the **Client Reset** field, enter a reset value for the client. The valid values range between 0 and 100 percent. The default value is 5 percent.

Once the AP is operating as a dual 5-GHz AP, this setting indicates the reduction in the combined radios' overall channel utilization required to reset the dual-band radio to monitor role.

**Step 8** Click **Apply** to save the configuration.

---





## CHAPTER 45

# XOR Radio Support

---

- [Information About Dual-Band Radio Support](#) , on page 461
- [Configuring Default XOR Radio Support](#), on page 462
- [Configuring XOR Radio Support for the Specified Slot Number \(GUI\)](#), on page 464
- [Configuring XOR Radio Support for the Specified Slot Number](#), on page 464

## Information About Dual-Band Radio Support

The Dual-Band (XOR) radio in Cisco 2800, 3800, 4800, and the 9120 series AP models offer the ability to serve 2.4-GHz or 5-GHz bands or passively monitor both the bands on the same AP. These APs can be configured to serve clients in 2.4-GHz and 5-GHz bands, or serially scan both 2.4-GHz and 5-GHz bands on the flexible radio while the main 5-GHz radio serves clients.

Cisco APs models up and through the Cisco 9120 APs are designed to support dual 5-GHz band operations with the *i* model supporting a dedicated Macro/Micro architecture and the *e* and *p* models supporting Macro/Macro. The Cisco 9130AXI APs and the Cisco 9136 APs support dual 5-GHz operations as Micro/Messo cell.

When a radio moves between bands (from 2.4-GHz to 5-GHz and vice versa), clients need to be steered to get an optimal distribution across radios. When an AP has two radios in the 5-GHz band, client steering algorithms contained in the Flexible Radio Assignment (FRA) algorithm are used to steer a client between the same band co-resident radios.

The XOR radio support can be steered manually or automatically:

- Manual steering of a band on a radio—The band on the XOR radio can only be changed manually.
- Automatic client and band steering on the radios is managed by the FRA feature that monitors and changes the band configurations as per site requirements.



---

**Note** RF measurement will not run when a static channel is configured on slot 1. Due to this, the dual band radio slot 0 will move only with 5-GHz radio and not to the monitor mode.

When slot 1 radio is disabled, RF measurement will not run, and the dual band radio slot 0 will be only on 2.4-GHz radio.

---



**Note** Only one of the 5-GHz radios can operate in the UNII band (100 - 144), due to an AP limitation to keep the power budget within the regulatory limit.

## Configuring Default XOR Radio Support

### Before you begin



**Note** The default radio points to the XOR radio hosted on slot 0.

### Procedure

	Command or Action	Purpose
<b>Step 1</b>	<b>enable</b>  <b>Example:</b> Device# <b>enable</b>	Enters privileged EXEC mode.
<b>Step 2</b>	<b>ap name</b> <i>ap-name</i> <b>dot11 dual-band antenna ext-ant-gain</b> <i>antenna_gain_value</i>  <b>Example:</b> Device# ap name <i>ap-name</i> dot11 dual-band antenna ext-ant-gain 2	Configures the 802.11 dual-band antenna on a specific Cisco access point.  <i>antenna_gain_value</i> : The valid range is from 0 to 40.
<b>Step 3</b>	<b>ap name</b> <i>ap-name</i> <b>[no] dot11 dual-band shutdown</b>  <b>Example:</b> Device# ap name <i>ap-name</i> dot11 dual-band shutdown	Shuts down the default dual-band radio on a specific Cisco access point.  Use the <b>no</b> form of the command to enable the radio.
<b>Step 4</b>	<b>ap name</b> <i>ap-name</i> <b>dot11 dual-band role manual client-serving</b>  <b>Example:</b> Device# ap name <i>ap-name</i> dot11 dual-band role manual client-serving	Switches to client-serving mode on the Cisco access point.
<b>Step 5</b>	<b>ap name</b> <i>ap-name</i> <b>dot11 dual-band band 24ghz</b>  <b>Example:</b> Device# ap name <i>ap-name</i> dot11 dual-band band 24ghz	Switches to 2.4-GHz radio band.
<b>Step 6</b>	<b>ap name</b> <i>ap-name</i> <b>dot11 dual-band txpower</b> <i>{transmit_power_level   auto}</i>	Configures the transmit power for the radio on a specific Cisco access point.



	Command or Action	Purpose
	<p><b>Example:</b></p> <pre>Device# ap name ap-name dot11 dual-band txpower 2</pre>	<p><b>Note</b> When an FRA-capable radio (slot 0 on 9120 AP[for instance]) is set to Auto, you cannot configure static channel and Txpower on this radio.</p> <p>If you want to configure static channel and Txpower on this radio, you will need to change the radio role to Manual Client-Serving mode.</p>
<b>Step 7</b>	<p><b>ap name <i>ap-name</i> dot11 dual-band channel <i>channel-number</i></b></p> <p><b>Example:</b></p> <pre>Device# ap name ap-name dot11 dual-band channel 2</pre>	<p>Enters the channel for the dual band.</p> <p><i>channel-number</i>—The valid range is from 1 to 173.</p>
<b>Step 8</b>	<p><b>ap name <i>ap-name</i> dot11 dual-band channel auto</b></p> <p><b>Example:</b></p> <pre>Device# ap name ap-name dot11 dual-band channel auto</pre>	<p>Enables the auto channel assignment for the dual-band.</p>
<b>Step 9</b>	<p><b>ap name <i>ap-name</i> dot11 dual-band channel width {20 MHz   40 MHz   80 MHz   160 MHz}</b></p> <p><b>Example:</b></p> <pre>Device# ap name ap-name dot11 dual-band channel width 20 MHz</pre>	<p>Chooses the channel width for the dual band.</p>
<b>Step 10</b>	<p><b>ap name <i>ap-name</i> dot11 dual-band cleanair</b></p> <p><b>Example:</b></p> <pre>Device# ap name ap-name dot11 dual-band cleanair</pre>	<p>Enables the Cisco CleanAir feature on the dual-band radio.</p>
<b>Step 11</b>	<p><b>ap name <i>ap-name</i> dot11 dual-band cleanair band {24 GHz   5 GMHz}</b></p> <p><b>Example:</b></p> <pre>Device# ap name ap-name dot11 dual-band cleanair band 5 GHz  Device# ap name ap-name [no] dot11 dual-band cleanair band 5 GHz</pre>	<p>Selects a band for the Cisco CleanAir feature.</p> <p>Use the <b>no</b> form of this command to disable the Cisco CleanAir feature.</p>
<b>Step 12</b>	<p><b>ap name <i>ap-name</i> dot11 dual-band dot11n antenna {A   B   C   D}</b></p> <p><b>Example:</b></p> <pre>Device# ap name ap-name dot11 dual-band dot11n antenna A</pre>	<p>Configures the 802.11n dual-band parameters for a specific access point.</p>

	Command or Action	Purpose
<b>Step 13</b>	<b>show ap name <i>ap-name</i> auto-rf dot11 dual-band</b>  <b>Example:</b> Device# show ap name <i>ap-name</i> auto-rf dot11 dual-band	Displays the auto-RF information for the Cisco access point.
<b>Step 14</b>	<b>show ap name <i>ap-name</i> wlan dot11 dual-band</b>  <b>Example:</b> Device# show ap name <i>ap-name</i> wlan dot11 dual-band	Displays the list of BSSIDs for the Cisco access point.

## Configuring XOR Radio Support for the Specified Slot Number (GUI)

### Procedure

- 
- Step 1** Click **Configuration > Wireless > Access Points**.
- Step 2** In the **Dual-Band Radios** section, select the AP for which you want to configure dual-band radios.
- The AP name, MAC address, CleanAir capability and slot information for the AP are displayed. If the Hyperlocation method is HALO, the antenna PID and antenna design information are also displayed.
- Step 3** Click **Configure**.
- Step 4** In the **General** tab, set the **Admin Status** as required.
- Step 5** Set the **CleanAir Admin Status** field to Enable or Disable.
- Step 6** Click **Update & Apply to Device**.
- 

## Configuring XOR Radio Support for the Specified Slot Number

### Procedure

	Command or Action	Purpose
<b>Step 1</b>	<b>enable</b>  <b>Example:</b> Device# enable	Enters privileged EXEC mode.

	Command or Action	Purpose
Step 2	<p><b>ap name</b> <i>ap-name</i> <b>dot11 dual-band slot 0 antenna ext-ant-gain</b> <i>external_antenna_gain_value</i></p> <p><b>Example:</b></p> <pre>Device# ap name AP-SIDD-A06 dot11 dual-band slot 0 antenna ext-ant-gain 2</pre>	<p>Configures dual-band antenna for the XOR radio hosted on slot 0 for a specific access point.</p> <p><i>external_antenna_gain_value</i> - Is the external antenna gain value in multiples of .5 dBi unit. The valid range is from 0 to 40.</p> <p><b>Note</b></p> <ul style="list-style-type: none"> <li>• For APs supporting self-identifying antennas (SIA), the gain depends on the antenna, and not on the AP model. The gain is learned by the AP and there is no need for controller configuration.</li> <li>• For APs that do not support SIA, the APs send the antenna gain in the configuration payload, where the default antenna gain depends on the AP model.</li> </ul>
Step 3	<p><b>ap name</b> <i>ap-name</i> <b>dot11 dual-band slot 0 band</b> {24ghz   5ghz}</p> <p><b>Example:</b></p> <pre>Device# ap name AP-SIDD-A06 dot11 dual-band slot 0 band 24ghz</pre>	<p>Configures current band for the XOR radio hosted on slot 0 for a specific access point.</p>
Step 4	<p><b>ap name</b> <i>ap-name</i> <b>dot11 dual-band slot 0 channel</b> {<i>channel_number</i>   auto   width [160   20   40   80]}</p> <p><b>Example:</b></p> <pre>Device# ap name AP-SIDD-A06 dot11 dual-band slot 0 channel 3</pre>	<p>Configures dual-band channel for the XOR radio hosted on slot 0 for a specific access point.</p> <p><i>channel_number</i>- The valid range is from 1 to 165.</p>
Step 5	<p><b>ap name</b> <i>ap-name</i> <b>dot11 dual-band slot 0 cleanair band</b> {24Ghz   5Ghz}</p> <p><b>Example:</b></p> <pre>Device# ap name AP-SIDD-A06 dot11 dual-band slot 0 cleanair band 24Ghz</pre>	<p>Enables CleanAir features for dual-band radios hosted on slot 0 for a specific access point.</p>
Step 6	<p><b>ap name</b> <i>ap-name</i> <b>dot11 dual-band slot 0 dot11n antenna</b> {A   B   C   D}</p> <p><b>Example:</b></p> <pre>Device# ap name AP-SIDD-A06 dot11 dual-band slot 0 dot11n antenna A</pre>	<p>Configures 802.11n dual-band parameters hosted on slot 0 for a specific access point.</p> <p>Here,</p> <p><b>A</b>- Enables antenna port A.</p> <p><b>B</b>- Enables antenna port B.</p> <p><b>C</b>- Enables antenna port C.</p> <p><b>D</b>- Enables antenna port D.</p>

	Command or Action	Purpose
<b>Step 7</b>	<p><b>ap name</b> <i>ap-name</i> <b>dot11 dual-band slot 0 role</b> {<b>auto</b>   <b>manual</b> [<b>client-serving</b>   <b>monitor</b>]}</p> <p><b>Example:</b></p> <pre>Device# ap name AP-SIDD-A06 dot11 dual-band slot 0 role auto</pre>	<p>Configures dual-band role for the XOR radio hosted on slot 0 for a specific access point.</p> <p>The following are the dual-band roles:</p> <ul style="list-style-type: none"> <li>• <b>auto</b>- Refers to the automatic radio role selection.</li> <li>• <b>manual</b>- Refers to the manual radio role selection.</li> </ul>
<b>Step 8</b>	<p><b>ap name</b> <i>ap-name</i> <b>dot11 dual-band slot 0 shutdown</b></p> <p><b>Example:</b></p> <pre>Device# ap name AP-SIDD-A06 dot11 dual-band slot 0 shutdown</pre> <pre>Device# ap name AP-SIDD-A06 [no] dot11 dual-band slot 0 shutdown</pre>	<p>Disables dual-band radio hosted on slot 0 for a specific access point.</p> <p>Use the <b>no</b> form of this command to enable the dual-band radio.</p>
<b>Step 9</b>	<p><b>ap name</b> <i>ap-name</i> <b>dot11 dual-band slot 0 txpower</b> {<i>tx_power_level</i>   <b>auto</b>}</p> <p><b>Example:</b></p> <pre>Device# ap name AP-SIDD-A06 dot11 dual-band slot 0 txpower 2</pre>	<p>Configures dual-band transmit power for XOR radio hosted on slot 0 for a specific access point.</p> <ul style="list-style-type: none"> <li>• <i>tx_power_level</i>- Is the transmit power level in dBm. The valid range is from 1 to 8.</li> <li>• <b>auto</b>- Enables auto-RF.</li> </ul>



## CHAPTER 46

# Cisco Receiver Start of Packet

- [Information About Receiver Start of Packet Detection Threshold](#), on page 467
- [Restrictions for Rx SOP](#), on page 467
- [Configuring Rx SOP \(CLI\)](#), on page 468
- [Customizing RF Profile \(CLI\)](#), on page 468

## Information About Receiver Start of Packet Detection Threshold

The Receiver Start of Packet (Rx SOP) Detection Threshold feature determines the Wi-Fi signal level in dBm at which an access point's radio demodulates and decodes a packet. As the Wi-Fi level increases, the radio sensitivity decreases and the receiver cell size becomes smaller. Reduction of the cell size affects the distribution of clients in the network.

Rx SOP is used to address clients with weak RF links, sticky clients, and client load balancing across access points. Rx SOP helps to optimize the network performance in high-density deployments, such as stadiums and auditoriums where access points need to optimize the nearest and strongest clients.

## Restrictions for Rx SOP

- Rx SOP configuration is not applicable to the third radio module pluggable on Cisco Aironet 3600 Series APs.
- Rx SOP configurations are supported only in Local, FlexConnect, Bridge, and Flex+Bridge modes.
- Rx SOP configurations are not supported in the FlexConnect+PPPoE, FlexConnect+PPPoE-wIPS, and FlexConnect+OEAP submodes.

The following table shows the permitted range for the Rx SOP threshold.

**Table 22: Rx SOP Threshold**

Radio Band	Threshold High	Threshold Medium	Threshold Low
2.4 GHz	-79 dBm	-82 dBm	-85 dBm
5 GHz	-76 dBm	-78 dBm	-80 dBm

## Configuring Rx SOP (CLI)

### Procedure

	Command or Action	Purpose
<b>Step 1</b>	<b>configure terminal</b> <b>Example:</b> Device# <code>configure terminal</code>	Enters global configuration mode.
<b>Step 2</b>	<b>ap dot11 {24ghz   5ghz} rx-sop threshold {auto   custom   high   low   medium}</b> <b>Example:</b> Device(config)# <code>ap dot11 5ghz rx-sop threshold high</code>	Configures the 802.11bg/802.11a radio Rx SOP threshold.
<b>Step 3</b>	<code>end</code>	Returns to privileged EXEC mode.
<b>Step 4</b>	<b>show ap dot11 {24ghz   5ghz} high-density</b> <b>Example:</b> Device# <code>show ap dot11 5ghz high-density</code>	Displays the 802.11bg/802.11a high-density parameters.
<b>Step 5</b>	<b>show ap summary</b> <b>Example:</b> Device# <code>show ap summary</code>	Displays a summary of all the connected Cisco APs.

## Customizing RF Profile (CLI)

### Procedure

	Command or Action	Purpose
<b>Step 1</b>	<b>configure terminal</b> <b>Example:</b> Device# <code>configure terminal</code>	Enters global configuration mode.
<b>Step 2</b>	<b>ap dot11 {24ghz   5ghz } rf-profile <i>profile-name</i></b> <b>Example:</b> Device(config)# <code>ap dot11 24ghz rf-profile AHS_2.4ghz</code>	Configures the 802.11a and 11b parameters.

	Command or Action	Purpose
<b>Step 3</b>	<b>high-density rx-sop threshold {auto   custom   high   low   medium}</b> <b>Example:</b> Device(config-rf-profile)# <b>high-density rx-sop threshold high</b>	Configures the 802.11bg, 802.11a high-density parameters.
<b>Step 4</b>	<b>show ap summary</b> <b>Example:</b> Device# <b>show ap summary</b>	Displays a summary of all the connected Cisco APs.
<b>Step 5</b>	end	Returns to privileged EXEC mode. <b>Note</b> <ul style="list-style-type: none"> <li>• Irrespective of radio mode, the controller configures the radio with configured RX-SOP value. The AP determines whether to use the configured RX-SOP value.</li> <li>• For the XOR radio (Slot 0), when the AP is in monitor mode the RX-SOP value that gets pushed to AP depends on the band it was operating before moving to monitor mode (basically if radio operating band is 24g then RX-SOP params picked from 24GHz RF profile (or default rf-profile). If it was in 5g then RX-SOP params picked from 5GHz RF profile (or default rf-profile) configured for the AP).</li> </ul>







# CHAPTER 47

## Client Limit

- [Information About Client Limit](#), on page 471
- [Configuring Client Limit Per WLAN \(GUI\)](#), on page 471
- [Configuring Client Limit Per WLAN \(CLI\)](#), on page 471

### Information About Client Limit

This feature enforces a limit on the number of clients that can be associated with an AP. Further, you can configure the number of clients that can be associated with each AP radio.

### Configuring Client Limit Per WLAN (GUI)

#### Procedure

- Step 1** Choose **Configuration > Tags & Profiles > WLANs**.
- Step 2** Click a WLAN from the list of WLANs.
- Step 3** Click the **Advanced** tab.
- Step 4** Under the **Max Client Connections** settings, enter the client limit for **Per WLAN**, **Per AP Per WLAN**, and **Per AP Radio Per WLAN**.
- Step 5** Click **Update & Apply to Device**.

### Configuring Client Limit Per WLAN (CLI)

#### Procedure

	Command or Action	Purpose
Step 1	enable Example:	Enters privileged EXEC mode.

	Command or Action	Purpose
	Device# <b>enable</b>	
<b>Step 2</b>	<b>configure terminal</b> <b>Example:</b> Device# <b>configure terminal</b>	Enters global configuration mode.
<b>Step 3</b>	<b>wlan wlan-name</b> <b>Example:</b> Device(config)# <b>wlan ramban</b>	Specifies the WLAN name.
<b>Step 4</b>	<b>client association limit</b> <i>maximum-clients-per-WLAN</i> <b>Example:</b> Device(config-wlan)# <b>client association limit 110</b>	Configures the maximum number of clients that can be associated to the given WLAN.
<b>Step 5</b>	<b>client association limit ap</b> <i>max-clients-per-AP-per-WLAN</i> <b>Example:</b> Device(config-wlan)# <b>client association limit ap 120</b>	Configures the maximum number of clients that can be associated to an AP in the WLAN.
<b>Step 6</b>	<b>client association limit radio</b> <i>max-clients-per-AP-radio-per-WLAN</i> <b>Example:</b> Device(config-wlan)# <b>client association limit radio 100</b>	Configures the maximum number of clients that can be associated to an AP radio in the WLAN.
<b>Step 7</b>	<b>end</b> <b>Example:</b> Device(config)# <b>end</b>	Returns to privileged EXEC mode. Alternatively, you can also press <b>Ctrl-Z</b> to exit global configuration mode.
<b>Step 8</b>	<b>show wlan id wlan-id</b> <b>Example:</b> Device# <b>show wlan id 2</b>	Displays the current configuration of the WLAN and the corresponding client association limits.



# CHAPTER 48

## IP Theft

---

- [Introduction to IP Theft, on page 473](#)
- [Configuring IP Theft \(GUI\), on page 474](#)
- [Configuring IP Theft, on page 474](#)
- [Configuring the IP Theft Exclusion Timer, on page 474](#)
- [Adding Static Entries for Wired Hosts, on page 475](#)
- [Verifying IP Theft Configuration, on page 476](#)

## Introduction to IP Theft

The IP Theft feature prevents the usage of an IP address that is already assigned to another device. If the controller finds that two wireless clients are using the same IP address, it declares the client with lesser precedence binding as the IP thief and allows the other client to continue. If blocked list is enabled, the client is put on the exclusion list and thrown out.

The IP Theft feature is enabled by default on the controller. The preference level of the clients (new and existing clients in the database) are also used to report IP theft. The preference level is a learning type or source of learning, such as Dynamic Host Configuration Protocol (DHCP), Address Resolution Protocol (ARP), data glean (looking at the IP data packet that shows what IP address the client is using), and so on. The wired clients always get a higher preference level. If a wireless client tries to steal the wired IP, that client is declared as a thief.



---

**Note** Some devices might use different MAC addresses but the same IPv6 link-local addresses, for different WLANs. If the devices switch WLANs when they are not in range of the APs, an IP theft event is triggered. To avoid this, we recommend that you lower the idle timeout for the devices. When the devices are out of the APs' range, the idle timeout takes effect and the old entries in the initial WLAN are deleted.

---

The order of preference for IPv4 clients are:

1. DHCPv4
2. ARP
3. Data packets

The order of preference for IPv6 clients are:

1. DHCPv6
2. NDP
3. Data packets



**Note** The static wired clients have a higher preference over DHCP.

## Configuring IP Theft (GUI)

### Procedure

- 
- Step 1** Choose **Configuration > Security > Wireless Protection Policies > Client Exclusion Policies**.
  - Step 2** Check the **IP Theft or IP Reuse** check box.
  - Step 3** Click **Apply**.
- 

## Configuring IP Theft

Follow the procedure given below to configure the IP Theft feature:

### Procedure

	Command or Action	Purpose
<b>Step 1</b>	<b>configure terminal</b> <b>Example:</b> Device# configure terminal	Enters global configuration mode.
<b>Step 2</b>	<b>wireless wps client-exclusion ip-theft</b> <b>Example:</b> Device(config)# wireless wps client-exclusion ip-theft	Configures the client exclusion policy.

## Configuring the IP Theft Exclusion Timer

Follow the procedure given below to configure the IP theft exclusion timer:

**Procedure**

	<b>Command or Action</b>	<b>Purpose</b>
<b>Step 1</b>	<b>configure terminal</b> <b>Example:</b> Device# configure terminal	Enters global configuration mode.
<b>Step 2</b>	<b>wireless profile policy <i>profile-policy</i></b> <b>Example:</b> Device(config)# wireless profile policy default-policy-profile	Configures a WLAN policy profile and enters wireless policy configuration mode.
<b>Step 3</b>	<b>exclusionlist timeout <i>time-in-seconds</i></b> <b>Example:</b> Device(config-wireless-policy)# exclusionlist timeout 5	Specifies the timeout, in seconds. The valid range is from 0-2147483647. Enter zero (0) for no timeout.

## Adding Static Entries for Wired Hosts

Follow the procedure given below to create static wired bindings:



**Note** The statically configured wired bindings and locally configured SVI IP addresses have a higher precedence than DHCP.

**Procedure**

	<b>Command or Action</b>	<b>Purpose</b>
<b>Step 1</b>	<b>configure terminal</b> <b>Example:</b> Device# configure terminal	Enters global configuration mode.
<b>Step 2</b>	Use the first option to configure an IPv4 static entry or the second option to create an IPv6 static entry.  <ul style="list-style-type: none"> <li>• <b>device-tracking binding vlan <i>vlan-id</i></b> <i>ipv4-address interface</i> <b>gigabitEthernet</b><i>ge-intf-num</i> <i>hardware-or-mac-address</i></li> <li>• <b>device-tracking binding vlan <i>vlan-id</i></b> <i>ipv6-address interface</i> <b>gigabitEthernet</b><i>ge-intf-num</i> <i>hardware-or-mac-address</i></li> </ul> <b>Example:</b>	Configures IPv4 or IPv6 static entry.

Command or Action	Purpose
<pre>Device(config)# device-tracking binding vlan 20 20.20.20.5 interface gigabitEthernet 1 0000.1111.2222</pre> <p><b>Example:</b></p> <pre>Device(config)# device-tracking binding vlan 20 2200:20:20::6 interface gigabitEthernet 1 0000.444.3333</pre>	

## Verifying IP Theft Configuration

Use the following command to check if the IP Theft feature is enabled or not:

```
Device# show wireless wps summary
```

```
Client Exclusion Policy
  Excessive 802.11-association failures : Enabled
  Excessive 802.11-authentication failures: Enabled
  Excessive 802.1x-authentication      : Enabled
  IP-theft                             : Enabled
  Excessive Web authentication failure : Enabled
  Cids Shun failure                    : Enabled
  Misconfiguration failure             : Enabled
  Failed Qos Policy                    : Enabled
  Failed Epm                           : Enabled
```

Use the following commands to view additional details about the IP Theft feature:

```
Device# show wireless client summary
```

```
Number of Local Clients: 1
```

MAC Address	AP Name	WLAN State	Protocol	Method	Role
000b.bbb1.0001	SimAP-1	2 Run	11a	None	Local

```
Number of Excluded Clients: 1
```

MAC Address	AP Name	WLAN State	Protocol	Method
10da.4320.cce9	charlie2	2 Excluded	11ac	None

```
Device# show wireless device-tracking database ip
```

IP	VLAN	STATE	DISCOVERY	MAC
20.20.20.2	20	Reachable	Local	001e.14cc.cbff
20.20.20.6	20	Reachable	IPv4 DHCP	000b.bbb1.0001

```
Device# show wireless exclusionlist
```

```
Excluded Clients
```

MAC Address	Description	Exclusion Reason	Time Remaining
-------------	-------------	------------------	----------------

---

10da.4320.cce9

IP address theft

59



---

**Note** Client exclusion timer deletes the entry from exclusion list with a granularity of 10 seconds. The entry is checked to retain or delete after every 10 seconds. There are chances that the running timer value for excluded clients might display negative values upto 10 seconds.

---

```
Device# show wireless exclusionlist client mac 12da.4820.cce9 detail
```

```
Client State : Excluded
Client MAC Address : 12da.4820.cce9
Client IPv4 Address: 20.20.20.6
Client IPv6 Address: N/A
Client Username: N/A
Exclusion Reason : IP address theft
Authentication Method : None
Protocol: 802.11ac
AP MAC Address : 58ac.780e.08f0
AP Name: charlie2
AP slot : 1
Wireless LAN Id : 2
Wireless LAN Name: mhe-ewlc
VLAN Id : 20
```







## CHAPTER 49

# Unscheduled Automatic Power Save Delivery

- [Information About Unscheduled Automatic Power Save Delivery, on page 479](#)
- [Viewing Unscheduled Automatic Power Save Delivery \(CLI\), on page 479](#)

## Information About Unscheduled Automatic Power Save Delivery

Unscheduled automatic power save delivery (U-APSD) is a QoS facility that is defined in IEEE 802.11e that extends the battery life of mobile clients. In addition to extending the battery life, this feature reduces the latency of traffic flow that is delivered over the wireless media. Because U-APSD does not require the client to poll each individual packet that is buffered at the access point, it allows delivery of multiple downlink packets by sending a single uplink trigger packet.

U-APSD is enabled automatically when WMM is enabled.

## Viewing Unscheduled Automatic Power Save Delivery (CLI)

### Procedure

```
show wireless client mac-address client_mac detail
```

### Example:

```
Device# show wireless client mac-address 2B:5B:B3:18:56:E9 detail
Output Policy State : Unknown
Output Policy Source : Unknown
WMM Support : Enabled
U-APSD Support : Enabled
  U-APSD value : 15
  APSD ACs      : BK(T/D), BE, VI(T/D), VO(T/D)
Power Save : OFF
Current Rate :

-----
BK : Background
BE : Best Effort
VI : Video
VO : Voice.

T: UAPSD Trigger Enabled
```

```
D: UAPSD Delivery Enabled  
T/D : UAPSD Trigger and Delivery Enabled
```

Show detailed information of a client by MAC address.

---



## CHAPTER 50

# Target Wake Time

- [Target Wake Time, on page 481](#)
- [Configuring Target Wake Time at the Radio Level \(CLI\), on page 482](#)
- [Configuring Target Wake Time on WLAN, on page 483](#)
- [Configuring Target Wake Time \(GUI\), on page 485](#)
- [Verifying Target Wakeup Time, on page 485](#)

## Target Wake Time

The existing Wi-Fi client power-saving mechanisms have been in use since 802.11b, where the client devices sleep between AP beacons or multiple beacons, waking up only when they have data to transmit (they can transmit at any time, as AP does not sleep), and beacons containing the Delivery Traffic Indication Map (DTIM), a bit-map, indicates that the AP has downlink traffic buffered for transmission to particular clients.

If a client has a DTIM bit set, it can retrieve data from the AP by sending a Power-Save Poll (PS-Poll) frame to the AP. This power-save scheme is effective but only allows clients to doze for a small beacon interval. Clients still need to wake up several times per second to read DTIM from the beacon frame of the AP.

With 802.11e, the new power-saving mechanism was introduced that helps voice-capable Wi-Fi devices, as voice packets are transmitted at short time intervals, typically 20 ms/sec. Unscheduled automatic power-save delivery (U-APSD) allows a power-save client to sleep at intervals within a beacon period. AP buffers the downlink traffic until the client wakes up and requests its delivery.

## Extended Power-Savings Using Target Wake Time

Target wake time (TWT) allows an AP to manage activity in the Wi-Fi network, in order to minimize medium contention between Stations (STAs), and to reduce the required amount of time that an STA in the power-save mode needs to be awake. This is achieved by allocating STAs to operate at non-overlapping times, and/or frequencies, and concentrate the frame exchanges in predefined service periods.

TWT capable STA can either negotiate an individual TWT agreement with TWT-scheduling AP, or it can elect to be part or member of Broadcast TWT agreement existing on the AP. An STA does not need to be aware that a TWT service period (SP) can be used to exchange frames with other STAs. Frames transmitted during a TWT SP can be carried in any PPDU format supported by the pair of STAs that have established the TWT agreement corresponding to that TWT SP, including High Efficiency Multi-User Physical Protocol Data Unit (HE MU PPDU), High Efficiency Trigger-Based Physical Protocol Data Unit (HE TB PPDU), and so on.

Following are the TWT Agreement Types:

### Individual TWT

Single TWT session is negotiated between AP and an STA. This ensures a specific service period of DL and UL between AP and STA with expected traffic to be limited within the negotiated SP of 99% accuracy. The service period starts at specific offset from the target beacon transmission time (TBTT) and runs for the SP duration and repeats every SP interval.

TWT Requesting STA communicates the Wake Scheduling information to its TWT responding AP, which then devises a schedule and delivers the TWT values to the TWT requesting STA when a TWT agreement has been established between them.

### Solicited TWT

STA initiates the TWT session with the AP.

### Unsolicited TWT

AP initiates TWT setup with STA. AP sends TWT response with service period which is accepted by STA.

### Broadcast TWT

High-Efficiency AP requests the STA to participate in the broadcast TWT operation, either on-going broadcast SP or new SP.

## Configuring Target Wake Time at the Radio Level (CLI)

### Procedure

	Command or Action	Purpose
<b>Step 1</b>	<b>configure terminal</b> <b>Example:</b> Device# configure terminal	Enters global configuration mode.
<b>Step 2</b>	<b>ap dot11 {24ghz   5ghz } shutdown</b> <b>Example:</b> Device(config)#ap dot11 24ghz shutdown	Disables the 802.11a or 802.11b network.
<b>Step 3</b>	<b>ap dot11 {24ghz   5ghz } dot11ax</b> <b>Example:</b> Device(conf)#ap dot11 24ghz dot11ax	Configures the 802.11ax parameters.
<b>Step 4</b>	<b>[no] ap dot11 {24ghz   5ghz } dot11ax target-wakeup-time</b> <b>Example:</b> Device(config)#ap dot11 24ghz dot11ax target-wakeup-time	Configures the 802.11ax target wake-up time.
<b>Step 5</b>	<b>[no] ap dot11 {24ghz   5ghz } dot11ax target-waste-time</b>	Configures the 802.11ax target waste-time.

	Command or Action	Purpose
	<b>Example:</b> Device(config)#ap dot11 24ghz dot11ax target waste-time	
<b>Step 6</b>	<b>no ap dot11 { 24ghz   5ghz } shutdown</b> <b>Example:</b> Device(config)#no ap dot11 24ghz shutdown	Enables the 802.11a or 802.11b network.
<b>Step 7</b>	<b>show ap dot11 { 24ghz   5ghz } network</b> <b>Example:</b> Device(config)#show ap dot11 24ghz network	Displays the 802.11ax network configuration details, which includes information about Target Wakeup Time and Target Wakeup Broadcast.

## Configuring Target Wake Time on WLAN

### Enabling Target Wake Time on WLAN (CLI)

#### Procedure

	Command or Action	Purpose
<b>Step 1</b>	<b>configure terminal</b> <b>Example:</b> Device# configure terminal	Enters global configuration mode.
<b>Step 2</b>	<b>wlan wlan-profile</b> <b>Example:</b> Device(config)# wlan wlan-profile	Enters WLAN configuration submode. The <i>wlan-profile</i> is the profile name of the configured WLAN.
<b>Step 3</b>	<b>shutdown</b> <b>Example:</b> Device(conf-wlan)#shutdown	Disables the WLAN network
<b>Step 4</b>	<b>dot11ax target-waketime</b> <b>Example:</b> Device(conf-wlan)#dot11ax target-waketime	Configures target wake time mode on WLAN.
<b>Step 5</b>	<b>dot11ax twt-broadcast-support</b> <b>Example:</b> Device(conf-wlan)#dot11ax twt-broadcast-support	Configures the TWT broadcast support on WLAN.

	Command or Action	Purpose
<b>Step 6</b>	<b>no shutdown</b> <b>Example:</b> Device(conf-wlan)#no shutdown	Enables WLAN.
<b>Step 7</b>	<b>show wlan {all   id   name   summary}</b> <b>Example:</b> Device# show wlan all Device# show wlan id Device# show wlan name	Displays the details of the configured WLAN, including Target Wakeup Time and Target Wakeup Time Broadcast.

## Disabling Target Wakeup Time on WLAN (CLI)

### Procedure

	Command or Action	Purpose
<b>Step 1</b>	<b>configure terminal</b> <b>Example:</b> Device# configure terminal	Enters global configuration mode.
<b>Step 2</b>	<b>wlan <i>profile-name</i></b> <b>Example:</b> Device(config)# wlan <i>wlan-profile</i>	Enters WLAN configuration submode. The <i>wlan-profile</i> is the profile name of the configured WLAN.
<b>Step 3</b>	<b>shutdown</b> <b>Example:</b> Device(conf-wlan)#shutdown	Disables the WLAN network
<b>Step 4</b>	<b>no dot11ax target-waketime</b> <b>Example:</b> Device(conf-wlan)#no dot11ax target-waketime	Disables the target wake time mode on WLAN.
<b>Step 5</b>	<b>no dot11ax twt-broadcast-support</b> <b>Example:</b> Device(conf-wlan)#no dot11ax twt-broadcast-support	Disables the TWT broadcast support on WLAN.
<b>Step 6</b>	<b>no shutdown</b> <b>Example:</b> Device(conf-wlan)#no shutdown	Enables WLAN.

# Configuring Target Wake Time (GUI)

## Procedure

---

- Step 1** Choose **Configuration > Radio Configurations > Parameters**.
- The parameters page is displayed where you can configure global parameters for 5 GHz Band and 2.4 GHz Band radios.
- Step 2** In the **11ax Parameters** section, check the **Target Wakeup Time** check box and the **Target Wakeup Time Broadcast** check box to configure target wakeup time and broadcast target wakeup time.
- 

## Verifying Target Wakeup Time

To verify Target Wakeup Time and Target Wakeup Time Broadcast, use the following command:

**show ap dot11 24ghz network**

The following is a sample output:

```
Device#show ap dot11 24ghz network
.
.
.
802.11ax                : Enabled
Target Wakeup Time      : Enabled
Target Wakeup Time Broadcast : Enabled
.
.
.
```







## CHAPTER 51

# Enabling USB Port on Access Points

---

- [USB Port as Power Source for Access Points](#), on page 487
- [Configuring an AP Profile \(CLI\)](#), on page 488
- [Configuring USB Settings for an Access Point \(CLI\)](#), on page 489
- [Configuring USB Settings for an Access Point \(GUI\)](#), on page 489
- [Monitoring USB Configurations for Access Points \(CLI\)](#), on page 490

## USB Port as Power Source for Access Points

Some Cisco APs have a USB port that can act as a source of power for some USB devices. The power can be up to 2.5W; if a USB device draws more than 2.5W of power, the USB port shuts down automatically. The port is enabled when the power draw is 2.5W and lower. Refer to the datasheet of your AP to check if the AP has a USB port that can act as a source of power.



---

**Note** Both IW6300 and ESW6300 APs have a USB port that can act as a source of power up to 4.5W for some USB devices.

---



---

**Note** The controller records the last five power-overdrawn incidents in its logs.

---



**Caution** When unsupported USB device is connected to the Cisco AP, the following message is displayed:

The inserted USB module is not a supported device. The behavior of this USB device and the impact to the Access Point is not guaranteed. If Cisco determines that a fault or defect can be isolated due to the use of third-party USB modules installed by a customer or reseller, Cisco may withhold support under warranty or support program under contract. In the course of providing support for Cisco networking products, the end user may be required to install Cisco-supported USB modules in the event Cisco determines that removing third-party parts will assist Cisco in diagnosing root cause for troubleshooting purposes. Cisco also reserves the right to charge the customer per then-current time and material rates for services provided to the customer when Cisco determines, after having provided such services, that an unsupported device caused the root cause of the defective product

## Configuring an AP Profile (CLI)

### Procedure

	Command or Action	Purpose
<b>Step 1</b>	<b>configure terminal</b>  <b>Example:</b> Device# <code>configure terminal</code>	Enters global configuration mode.
<b>Step 2</b>	<b>ap profile <i>ap-profile</i></b>  <b>Example:</b> Device(config)# <code>ap profile xyz-ap-profile</code>	Configures an AP profile and enters the AP profile configuration mode.  <b>Note</b> When you delete a named profile, the APs associated with that profile will not revert to the default profile.
<b>Step 3</b>	<b>usb-enable</b>  <b>Example:</b> Device(config-ap-profile)# <code>usb-enable</code>	Enables USB for each AP profile.  <b>Note</b> By default, the USB for each AP profile is enabled.  Use the <b>no usb-enable</b> command to disable USB for each AP profile.
<b>Step 4</b>	<b>end</b>  <b>Example:</b> Device(config-ap-profile)# <code>end</code>	Returns to privileged EXEC mode. Alternatively, you can also press <b>Ctrl-Z</b> to exit global configuration mode.

## Configuring USB Settings for an Access Point (CLI)

### Procedure

	Command or Action	Purpose
<b>Step 1</b>	<b>enable</b> <b>Example:</b> Device# <b>enable</b>	Enters privileged EXEC mode.
<b>Step 2</b>	<b>ap name <i>ap-name</i> usb-module</b> <b>Example:</b> Device# <b>ap name AP44d3.xy45.69a1 usb-module</b>	Enables the USB port on the AP.  Use the <b>ap name <i>ap-name</i> no usb-module</b> command to disable the USB port on the AP.  <b>Note</b> If you are using Cisco Catalyst 9105AXW AP and if you enable the USB port (.3at PoE-in), it is not possible to enable the USB PoE-out at the same time.
<b>Step 3</b>	<b>ap name <i>ap-name</i> usb-module override</b> <b>Example:</b> Device# <b>ap name AP44d3.xy45.69a1 usb-module override</b>	Overrides USB status of the AP profile and considers the local AP configuration.  Use the <b>ap name <i>ap-name</i> no usb-module override</b> command to override USB status of the AP and consider the AP profile configuration.  <b>Note</b> You can configure the USB status for an AP only if you enable USB override for it.

## Configuring USB Settings for an Access Point (GUI)

### Procedure

- Step 1** Choose **Configuration > Wireless > Access Points**.
- Step 2** In the **Access Points** window, click the name of the AP.
- Step 3** In the **Edit AP** window, click the **Interfaces** tab.
- Step 4** In the **USB Settings** section, configure the **USB Module State** as either of the following:

- **ENABLED:** Enables the USB port on the AP
- **DISABLED:** Disables the USB port on the AP

**Note** If you are using Cisco Catalyst 9105AXW AP and if you enable the USB port (.3at PoE-in), it is not possible to enable the USB PoE-out at the same time.

**Step 5** Configure **USB Override** as either of the following:

- **ENABLED**: Overrides USB status of the AP profile and considers the local AP configuration
- **DISABLED**: Overrides USB status of the AP and considers the AP profile configuration

**Note** You can configure the USB status for an AP only if you enable USB override for it.

**Step 6** Click **Apply & Update to Device**.

## Monitoring USB Configurations for Access Points (CLI)

- To view the inventory details of APs, use the following command:

**show ap name *ap-name* inventory**

The following is a sample output:

```
Device# show ap name AP500F.8059.1620 inventory
NAME: AP2800 , DESCR: Cisco Aironet 2800 Series (IEEE 802.11ac) Access Point
PID: AIR-AP2802I-D-K9 , VID: 01, SN: XXX1111Y2ZZZZ2800
NAME: SanDisk , DESCR: Cruzer Blade
PID: SanDisk , SN: XXXX1110010, MaxPower: 224
```

- To view the summary of an AP module, use the following command:

**show ap module summary**

The following is a sample output:

```
Device# show ap module summary
AP Name           External Module   External Module PID   External Module
Description
-----
AP500F.1111.2222   Enable           SanDisk                Cruzer Blade
```

- To view the USB configuration details for each AP, use the following command:

**show ap name *ap-name* config general**

The following is a sample output:

```
Device# show ap name AP500F.111.2222 config general
.
.
.
USB Module Type..... USB Module
USB Module Status..... Disabled
USB Module Operational State..... Enabled
USB Override ..... Enabled
```

- To view status of the USB module, use the following command:

**show ap profile name *xyz* detailed**

The following is a sample output:

```
Device# show ap profile name xyz detailed
USB Module           : ENABLED
```



## CHAPTER 52

# Dynamic Frequency Selection

- [Feature History for Channel Availability Check \(CAC\), on page 491](#)
- [Information About Dynamic Frequency Selection, on page 491](#)
- [Information About Channel Availability Check \(CAC\), on page 492](#)
- [Verifying DFS, on page 492](#)

## Feature History for Channel Availability Check (CAC)

This table provides release and related information for features explained in this module.

These features are available on all releases subsequent to the one they were introduced in, unless noted otherwise.

**Table 23: Feature History for Channel Availability Check (CAC)**

Release	Feature	Feature Information
Cisco IOS XE Bengaluru 17.5.1	Channel Availability Check (CAC)	When a DFS channel is selected for an AP radio, the AP radio scans the channel to check for any radar signals before transmitting any frames in the DFS frequency. This process is called Channel Availability Check (CAC).

## Information About Dynamic Frequency Selection

Dynamic Frequency Selection (DFS) is the process of detecting radar signals and automatically setting the frequency on a DFS-enabled 5.0-GHz (802.11a/h) radio to avoid interference with the radar signals. Radios configured for use in a regulatory domain must not interfere with radar systems.

In normal DFS, when a radar signal is detected on any of the channels in the 40-MHz or 80-MHz bandwidth, the whole channel is blocked. With Flex DFS, if the radar signals are not detected on the secondary channel, the AP is moved to a secondary channel with a reduction in the bandwidth, usually, by half.

## Information About Channel Availability Check (CAC)

When a DFS channel is selected for an AP radio, the AP radio scans the channel to check for any radar signals before transmitting any frames in the DFS frequency. This process is called Channel Availability Check (CAC).



---

**Note** CAC is executed before you set a DFS channel for the radio.

---

If the AP detects that a radar is using a specific DFS channel, the AP marks the channel as non-available and excludes it from the list of available channels. This state lasts for 30 minutes after which the AP checks again to see, if the channel can be used for Wi-Fi transmissions.



---

**Note**

- The CAC performed during a boot process takes anywhere between 1 and 10 minutes depending on the country. This is the reason as to why the DFS channels are not available immediately when an AP reboots.

---

## Verifying DFS

Use the following commands to verify the DFS configuration:

To display the 802.11h configuration, use the following command:

```
Device# show wireless dot11h
```

To display the auto-rF information for 802.11h configuration, use the following command:

```
Device# show ap auto-rf dot11 5ghz
```

To display the auto-rF information for a Cisco AP, use the following command:

```
Device# show ap name ap1 auto-rf dot11 5gh
```

To display the channel details for a Cisco AP, use the following command:

```
Device# show ap dot11 5ghz summary
AP Name Mac Address Slot Admin State Oper State Width Txpwr Channel
-----
pnp-ap 04eb.409e.b560 1 Enabled Up 40 *8/8 (3 dBm) (52,56)
BLDG1-9130-RACK-1568 04eb.409f.11a0 1 Disabled Down 40 4/8 (15 dBm) (100,104)#
```



---

**Note** In the show command, # is added right next to the channel whenever CAC is running on an AP radio.

---



## CHAPTER 53

# Cisco Access Points with Tri-Radio

- [Cisco Access Points with Tri-Radio, on page 493](#)
- [Guidelines and Restrictions for Tri-Radio Access Points, on page 495](#)
- [Configuring Tri-Radio, on page 495](#)

## Cisco Access Points with Tri-Radio

This topic describes the Tri-Radio feature for Cisco Access Points (APs).

Access Points with three radios are designed for high density environments. The APs by default run one dedicated 2.4-GHz 4x4 mode radio and one 5-GHz 8x8 mode radio. In the default mode, the radios are managed by the Flexible Radio Assignment (FRA), and the Dual Radio Mode is in the disabled state indicating that the radios have either been assigned as client serving 8x8 radio or have not yet been evaluated by FRA.

When you enable the dual radio mode setting, the 8x8 radio is split to two independent 5-GHz 4x4 radios. In this mode, slot 1 and slot 2 are active independent 4x4 radio interfaces. They can serve different user groups with different assigned channels.



**Note** To disable the dual radio mode, you must first disable the admin status of the subordinate radio. Otherwise, a warning message is displayed.

A tri-radio AP has upto two configurable 5-GHz radios. The following table describes the radio role and its deployment benefits:

**Table 24: 5-GHz Radio Operational Modes and Criteria**

Radio Role		Driving Factors
<b>Radio 1</b>	<b>Radio 2</b>	
8x8 Client-Serving	None	<ul style="list-style-type: none"><li>• Preferred operation: 160 MHz or 80 + 80 MHz</li><li>• Higher MU-MIMO stations</li><li>• Required higher number of Spatial Streams (SS)</li></ul>

Radio Role		Driving Factors
Radio 1	Radio 2	
4x4 Client-Serving	4x4 Client-Serving	<ul style="list-style-type: none"> <li>• Preferred operation: 80 MHz or below</li> <li>• High Capacity in low or medium density</li> <li>• Directional antenna units (Coverage Slicing)</li> </ul>
4x4 Client-Serving	4x4 Monitor	<ul style="list-style-type: none"> <li>• Preferred operation: 80 MHz or below</li> <li>• Lower MU-MIMO stations</li> <li>• Better channel reuse in high density</li> <li>• Monitoring application requires 4x4 Rx</li> </ul>

The following table lists the different radio modes and roles supported by the AP:

**Table 25: Tri-Radio AP Radio Configuration**

Setup	Radio Mode	Maximum Radio Capability	Dual Role Mode
1	2.4-GHz + 5-GHz	2.4-GHz, 4 antennas, 4SS, and 20 MHz 5-GHz, 8 antennas, 4SS, and 160 MHz	Disabled
2	2.4-GHz + 5-GHz	2.4-GHz, 4 antennas, 4SS, and 20 MHz 5-GHz, 8 antennas, 8SS, and 80 MHz	Disabled
3	2.4-GHz + 5-GHz + 5-GHz	2.4-GHz, 4 antennas, 4SS, and 20 MHz 5-GHz, 4 antennas, 4SS, and 80 MHz 5-GHz, 4 antennas, 4SS, and 80 MHz	Enabled

In the Cisco IOS XE 17.2.1 Release, FRA manages the role assignment for each radio independently. You can set the radio mode as automatic or manual, and select either Client-Serving role or Monitor role as the



radio role. Based on the dual radio mode configuration, the role selection is available for one or for both interfaces.

## Guidelines and Restrictions for Tri-Radio Access Points

- Dual radio mode is set to **Auto** by default. FRA manages the dual radio mode in **Auto** mode.
- The tri-radio support for AP with external antenna is as follows:
  - RP-TNC antenna is supported in Cisco Catalyst 9130AX Series APs.
  - The C-ANT9101, C-ANT9102, and C-ANT9103 antennas on Cisco Catalyst 9130AX Series APs support 2 radios (2.4-GHz (4x4) and 5-GHz (8x8)). This antennas does not support two 5-GHz (4x4) radios due to hardware limitation.

## Configuring Tri-Radio

### Configuring Tri-Radio for AP (GUI)

#### Procedure

- 
- Step 1** Choose **Configuration > Radio Configurations > Network**.  
The **Network > 5 GHz Radios** page is displayed.
- Step 2** In the **General** tab, select the **Tri-Radio Mode** check box to enable the Tri-Radio mode.
- Step 3** Click **Apply**
- 

### Configuring the Tri-Radio (CLI)

In Cisco IOS XE Dublin 17.13.1, the **ap tri-radio** command cannot be configured, since the Tri-radio settings are enabled by default, and cannot be disabled.

#### Procedure

	Command or Action	Purpose
<b>Step 1</b>	<b>configure terminal</b> <b>Example:</b> Device# <code>configure terminal</code>	Enters global configuration mode.

	Command or Action	Purpose
<b>Step 2</b>	<p>[no] ap tri-radio</p> <p><b>Example:</b></p> <pre>Device(config)# ap tri-radio</pre>	Configures all supporting tri-radio AP's dual radio role in auto mode. Use the <b>[no]</b> form of the command to disable the feature.

## Configuring 5-GHz Dual Radio Mode for AP (GUI)

### Procedure

- 
- Step 1** Choose **Configuration > Wireless > Access Points**.
- Step 2** On the **Access Points** page, click the **5 GHz Radios** section and select a Cisco 9130 Series AP from the list. The **Edit Radios 5 GHz Band** window is displayed.
- Step 3** In the **Edit Radios 5-GHz Band > Configure > General** tab, under **Dual Radio Mode**, select one from the following radio button options
- Auto: Permits FRA to decide the mode for this AP.
  - Enabled: Enables Dual Radio mode for this AP.
  - Disabled: Disables Dual Radio mode for this AP.
- Step 4** Click **Update & Apply to Device**.
- 

## Configuring the Dual Radio Mode and Enabling Slots (CLI)

### Procedure

	Command or Action	Purpose
<b>Step 1</b>	<p>ap name <i>ap-name</i> dot11 5ghz slot { <b>1</b>   <b>2</b> } shutdown</p> <p><b>Example:</b></p> <pre>Device# ap name ap-name dot11 5ghz slot 1 shutdown</pre>	(Optional) Disables the 802.11a radio on Cisco AP.
<b>Step 2</b>	<p>ap name <i>ap-name</i> dot11 5ghz slot <b>1</b> dual-radio mode { <b>disable</b>   <b>enable</b>   <b>auto</b> }</p> <p><b>Example:</b></p> <pre>Device# ap name ap-name dot11 5ghz slot 1 dual-radio mode enable</pre>	<p>Configures the 802.11a dual and tri-radio on the AP. Enable <b>auto</b> to allow RRM to switch the AP between dual radio or tri radio mode based on the channel width configuration. In <b>auto</b> mode, the slot 2 state is managed by the RRM. Use the <b>disable</b> keyword to disable the dual-radio.</p> <p><b>Note</b> When the AP is set to <b>auto</b> mode, the dual radio mode is disabled by default.</p>

	Command or Action	Purpose
<b>Step 3</b>	<b>ap name <i>ap-name</i> no dot11 5ghz slot { 1   2 } shutdown</b>  <b>Example:</b> Device# ap name <i>ap-name</i> no dot11 5ghz slot 1 shutdown	Enables the 802.11a radio on Cisco AP.

## Setting Radio Roles for Slots

The following section is applicable only if FRA is enabled.

### Procedure

	Command or Action	Purpose
<b>Step 1</b>	<b>ap name <i>ap-name</i> dot11 { 24ghz   5ghz } shutdown</b>  <b>Example:</b> Device# ap name <i>ap-name</i> dot11 5ghz shutdown	Disables the radio on the AP.
<b>Step 2</b>	<b>ap name <i>ap-name</i> dot11 { 24ghz   5ghz } slot &lt;slot ID&gt; radio role { auto   manual { monitor   client-serving } }</b>  <b>Example:</b> Device# ap name <i>ap-name</i> dot11 5ghz slot 2 radio role manual monitor	Sets the radio role manual to either client serving or monitor.
<b>Step 3</b>	<b>ap name <i>ap-name</i> no dot11 { 24ghz   5ghz } shutdown</b>  <b>Example:</b> Device# ap name <i>ap-name</i> no dot11 5ghz shutdown	Enables the radio on the AP.  <b>Note</b> The RRM dynamic channel allocation (DCA) algorithm changes the radio role for slot2 and standby 5-GHz radio to monitor mode if: <ul style="list-style-type: none"> <li>• The metric for the standby channel is not exhaustive (or)</li> <li>• The available channel is not suitable for standby 5-GHz radio</li> </ul> The standby 5-GHz radio and slot2 role changes to client-serving mode once the DCA is able to locate a suitable channel for slot2 or the metric for the channel is suitable.

## Configuring the Tri-Radio Dual Radio Role (CLI)

### Procedure

	Command or Action	Purpose
<b>Step 1</b>	<b>ap name <i>ap-name</i> dot11 5ghz slot { 1   2 } radio role { auto   manual { client-serving   monitor } }</b>  <b>Example:</b> Device# ap name 9130axtrial dot11 5ghz slot 1 radio role manual monitor	Configures the 802.11a radio role independently for each supporting AP's radio. The channel and the Tx power values can be configured when the radio role is set to <b>manual</b> mode.
<b>Step 2</b>	<b>ap name <i>ap-name</i> dot11 24ghz slot 0 radio role { auto   manual { client-serving   monitor } }</b>  <b>Example:</b> Device# ap name 9130axtrial dot11 24ghz slot 0 radio role manual client-serving	Configures the 802.11b radio role independently for the supporting AP's radio.

## Verifying Tri-Radio Configuration on the Controller

To verify that the dual radio mode is enabled, use the following **show** command:

```

• Device# show ap name APXXXX.4XXX.04XX config slot 1 | inc Dual
  Dual Radio Capable           : True
  Dual Radio Mode              : Enabled
  Dual Radio Operation mode    : Auto
  
```

To verify the tri-radio status, use the following **show** command:

```

• Device# show ap triradio status
  Tri-Radio Status : Enabled
  
```

To verify that the slots are **enabled** and **up**, use the following show commands:

```

• Device# show ap triradio summary
  AP Name                               Mac Address      Slot      Admin State  Oper
  State
  -----
  APXXXX.4XXX.04XX                      04eb.409e.89c0  2         Enabled      Up

• Device# show ap dot11 5ghz summary
  AP Name                               Mac Address      Slot      Admin State  Oper State
  Width      Txpwr          Channel
  -----
  APXXXX.4XXX.04XX                      04XX.40XX.8XXX  1         Enabled      Up
  20         *5/8 (14 dBm)  (36)*          Local
  APXXXX.4XXX.04XX                      04XX.40XX.8XXX  2         Enabled      Up
  20         *8/8 (1 dBm)  (36)*
  
```

To verify that the radio role is set, use the following **show** command:

```
• show ap name ap-name config slot <slot_number> | i Radio
Radio Type                : 802.11ax - 5 GHz
Radio Subband             : All
Radio Role                 : Auto
Radio Mode                 : Local
Radio SubType             : Main
```





## CHAPTER 54

# Cisco Catalyst Center Assurance Wi-Fi 6 Dashboard

- [Cisco Catalyst Center Assurance Wi-Fi 6 Dashboard, on page 501](#)
- [Configuring Cisco Catalyst Center Assurance Wi-Fi 6 Dashboard Parameters \(CLI\), on page 502](#)
- [Verifying AP DFS Counters \(CLI\), on page 503](#)
- [Verifying Wi-Fi 6 Access Point Parameters, on page 504](#)

## Cisco Catalyst Center Assurance Wi-Fi 6 Dashboard



**Note** We recommend you manage this feature using the Cisco Catalyst Center UI. The procedures are to be executed with for debugging purposes only.

The Cisco Catalyst Center Assurance Wi-Fi 6 Dashboard provides a visual representation of your wireless network. The dashboard contains various dashlets which show you the Wi-Fi 6 Readiness, and the efficiency of the Wi-Fi 6 networks compared to non-Wi-Fi 6 networks. For more information, see the **Monitor Wi-Fi 6 Readiness** section in the [Cisco DNA Assurance User Guide](#).

- **Client Distribution by Capability:** This dashlet shows all the clients associated and their capability in the wireless network. The inner circle shows the wireless protocol capabilities of all the different clients in the network. Capability here is the ability of wireless clients to associate with Wi-Fi 6 APs or non-Wi-Fi 6 APs. The outer arc segment shows how many 802.11ax capable clients are joined to a Wi-Fi 6 network as well as how many of them are not.
- **Wi-Fi 6 Network Readiness:** This dashlet shows all the APs in the network. The inner circle shows the APs which are Wi-Fi 6 APs and non Wi-Fi 6 APs. The outer arc segment shows the number of Wi-Fi 6 enabled AP in the network.
- **AP Distribution by Protocol:** This dashlet shows the protocols enabled on your APs in real time.
- **Wireless Airtime Efficiency:** This dashlet compares and displays the Airtime Efficiency between your Wi-Fi 6 network and Non-Wi-Fi 6 network for each of the access categories (voice, video, best effort, background).

The spectrum is efficiently utilized if the AP's radios can send more traffic (successful bytes transmitted to the client) in less airtime (microseconds) than other networks under similar RF conditions.

- **Wireless Latency by Client Count:** This Dashlet compares the Wireless Latency between your Wi-Fi 6 and Non-Wi-Fi 6 Network for each of the access categories (voice, video, best effort, background).

Wireless latency is measured by the time (microseconds) it takes for a packet to be successfully transmitted from an AP to the client. Hence, AP radios with a higher client count generally have higher latency than compared to those with a lower client count under similar RF conditions.



**Note** **Client count** in this dashlet refers to the clients that are actively sending traffic for a given Access Category and are not just associated clients.

## Configuring Cisco Catalyst Center Assurance Wi-Fi 6 Dashboard Parameters (CLI)

### Procedure

	Command or Action	Purpose
<b>Step 1</b>	<b>configure terminal</b> <b>Example:</b> Device# <b>configure terminal</b>	Enters global configuration mode.
<b>Step 2</b>	<b>ap profile <i>profile-name</i></b> <b>Example:</b> Device(config)# <b>ap profile pp-1</b>	Enables configuration for all the APs that are associated with the specified AP profile name.
<b>Step 3</b>	<b>statistics traffic-distribution</b> <b>Example:</b> Device(config-ap-profile)# <b>statistics traffic-distribution</b>	Enables traffic distribution feature with the specified AP profile.
<b>Step 4</b>	<b>statistics traffic-distribution interval <i>interval-secs</i></b> <b>Example:</b> Device(config-ap-profile)# <b>statistics traffic-distribution interval 300</b>	Configures the interval at which the AP sends the traffic distribution statistics. Default value is 300 seconds. Valid range is between 30 and 3600 seconds. <b>Note</b> Execute this command only with the assistance from Cisco Technical Assistance Center (TAC) support engineer.
<b>Step 5</b>	<b>end</b> <b>Example:</b> Device(config-ap-profile)# <b>exit</b>	Returns to privileged EXEC mode.



	Command or Action	Purpose
Step 6	<pre>show wireless stats ap name <i>ap-name</i> traffic-distribution slot <i>slot-id</i> packet-count signal { average  good   poor } [ last-received ]</pre> <p><b>Example:</b></p> <pre>Device#show wireless stats ap name ff123a traffic-distribution slot 1 packet-count signal good</pre>	Displays traffic distribution data by signal strength, if received from the AP in the latest statistics update interval. Use <b>last-received</b> keyword to view the statistics received in any statistics update interval from the AP.
Step 7	<pre>show wireless stats ap name <i>ap-name</i> traffic-distribution slot <i>slot-id</i> airtime access-category { background   best-effort   video   voice } [ last-received ]</pre> <p><b>Example:</b></p> <pre>Device#show wireless stats ap name ff123a traffic-distribution slot 1 airtime access-category best-effort</pre>	Displays the Airtime efficiency data based on access category, if received from the AP in the latest statistics update interval. Use <b>last-received</b> keyword to view the statistics received in any statistics update interval from the AP.
Step 8	<pre>show wireless stats ap name <i>ap-name</i> traffic-distribution slot <i>slot-id</i> airtime traffic-type { legacy   mu   ofdma   su } [ last-received ]</pre> <p><b>Example:</b></p> <pre>Device#show wireless stats ap name ff123a traffic-distribution slot 1 traffic-type ofdma</pre>	Displays the Airtime efficiency data based on traffic type, if received from the AP in the latest statistics update interval. Use <b>last-received</b> keyword to view the statistics received in any statistics update interval from the AP.
Step 9	<pre>show wireless stats ap name <i>ap-name</i> traffic-distribution slot <i>slot-id</i> latency access-category { background   best-effort   video   voice } [ last-received ]</pre> <p><b>Example:</b></p> <pre>Device#show wireless stats ap name ff123a traffic-distribution slot 1 latency access-category best-effort</pre>	Displays wireless latency data based on access category, if received from the AP in the latest statistics update interval. Use <b>last-received</b> keyword to view the statistics received in any statistics update interval from the AP.

## Verifying AP DFS Counters (CLI)

### Procedure

- To verify the DFS counter for the selected radio band, use the following command:

```
show ap auto-rf dot11 { 24ghz | 5ghz | dual-band } ]
```

**Example:**

```
Device#show ap auto-rf dot11 dual-band
```

- To verify the DFS counter for the selected radio band of a specific AP, use the following command:

```
show ap name ap-name auto-rf dot11 { 24ghz | dual-band }
```

**Example:**

```
Device#show ap name ff32a auto-rf dot11 dual-band
```

- To verify the DFS counter for the selected 5-GHz slot of a specific AP, use the following command:

```
show ap name ap-name auto-rf dot11 5ghz slot slot-id
```

**Example:**

```
Device#show ap name ff32a auto-rf dot11 5ghz slot 1
```

## Verifying Wi-Fi 6 Access Point Parameters

Enter these commands in the AP console.

- To verify the traffic distribution statistics configuration, use the following command: **show ap traffic distribution configuration**
- To verify the exported data from the AP to the controller, use the following command: **show interfaces dot11Radio *slot-id* traffic distribution {cumulative | instantaneous | periodic} database**
- To verify Access Point DFS counters, use the following command: **show interfaces dot11radio *slot-id*dfs**
- To debug the traffic distribution statistics, use the following command: **{no} debug traffic wireless distribution dump {periodic | aggregated}**
- To clear the traffic distribution dump, use the following command: **clear traffic distribution dump**



## CHAPTER 55

# Antenna Disconnection Detection

- [Feature History for Antenna Disconnection Detection](#), on page 505
- [Information About Antenna Disconnection Detection](#), on page 505
- [Recommendations and Limitations](#), on page 506
- [Configuring Antenna Disconnection Detection \(CLI\)](#), on page 506
- [Configuring Antenna Disconnection Detection \(GUI\)](#), on page 507
- [Detecting Broken Antenna Using SNMP Trap \(CLI\)](#), on page 508
- [Detecting Broken Antenna Using SNMP Trap \(GUI\)](#), on page 508
- [Verifying Antenna Disconnection Detection](#), on page 509
- [Verifying Antenna Disconnection Detection \(GUI\)](#), on page 510

## Feature History for Antenna Disconnection Detection

This table provides release and related information for the features explained in this module.

These features are available in all releases subsequent to the one they were introduced in, unless noted otherwise.

Release	Feature	Feature Information
Cisco IOS XE Bengaluru 17.4.1	Antenna Disconnection Detection	This feature detects the signal strength delta across the antennas on the receiver. If the delta is more than the defined limit for a specific duration, the corresponding antenna is considered to have issues.

## Information About Antenna Disconnection Detection

Having multiple antennas on the transmitter and receiver of an access point (AP) results in better performance and reliability. Multiple antennas improve reception through the selection of the stronger signal or a combination of individual signals at the receiver. Therefore, detection of an impaired antenna or physical breakage of an antenna is critical to the reliability of APs.

The Antenna Disconnection Detection feature is based on the signal strength delta across the antennas on the receiver. If the delta is more than the defined limit for a specific duration, the antenna is considered to have issues.

For every detection time period that you configure, the AP sends an Inter-Access Point Protocol (IAPP) message that carries the antenna condition. This message is sent only once when the issue is detected and is displayed in the controller trap messages, SNMP traps, and controller debug logs.

### Configuration Workflow

1. Configure APs.
2. Configure an AP profile.
3. Enable the feature in AP profile.
4. Configure feature parameters.
5. Verify the configuration.

## Recommendations and Limitations

- The feature is supported only on the following APs:
  - Cisco Catalyst 9120AX Series Access Points
  - Cisco Catalyst 9130AX Series Access Points
  - Cisco Aironet 2800e Access Points
  - Cisco Aironet 3800e Access Points
- The SNMP trap is not supported on the Cisco Embedded Wireless Controller.
- The IAPP message is sent only when there is a change in the error condition.

## Configuring Antenna Disconnection Detection (CLI)

Antenna disconnection detection works by comparing the received signal strength intensity (RSSI) of each antenna with the antenna receiving the higher RSSI. If the delta is higher than the RSSI failure threshold, the corresponding antenna is declared as broken.

The *weak-rssi* is an absolute RSSI threshold value, expressed in dBm. If the antennas detect a lower RSSI value than the one configured in *weak-rssi*, all the antennas are reported as malfunctioning. The RSSI failure threshold is evaluated only if an antenna detects a signal over the *weak-rssi* value.

Follow the procedure given below to configure antenna disconnection detection:

### Procedure

	Command or Action	Purpose
<b>Step 1</b>	<b>configure terminal</b>  <b>Example:</b> Device# configure terminal	Enters global configuration mode.

	Command or Action	Purpose
<b>Step 2</b>	<b>ap profile</b> <i>ap-profile</i> <b>Example:</b> Device(config)# ap profile xyz-ap-profile	Configures an AP profile and enters AP profile configuration mode.
<b>Step 3</b>	<b>antenna monitoring</b> <b>Example:</b> Device(config-ap-profile)# antenna monitoring	Enables antenna disconnection detection.  To disable antenna disconnection detection, use the <b>no antenna monitoring</b> command.
<b>Step 4</b>	<b>antenna monitoring rssi-failure-threshold</b> <i>threshold-value</i> <b>Example:</b> Device(config-ap-profile)# antenna monitoring rssi-failure-threshold 20	Configures RSSI failure threshold value, in dB. Valid values range from 10 to 90, with a default of 40.
<b>Step 5</b>	<b>antenna monitoring weak-rssi</b> <i>weak-rssi-value</i> <b>Example:</b> Device(config-ap-profile)# antenna monitoring weak-rssi -90	Configures weak RSSI value, in dBm. Valid values range from -90 to -10, with a default of 60.
<b>Step 6</b>	<b>antenna monitoring detection-time</b> <i>detect-time-in-mins</i> <b>Example:</b> Device(config-ap-profile)# antenna monitoring detection-time 20	Configures the antenna disconnection detection time, in minutes. Valid values range from 9 to 180, with a default of 120.
<b>Step 7</b>	<b>end</b> <b>Example:</b> Device(config-ap-profile)# end	Saves the configuration and returns to privileged EXEC mode.

## Configuring Antenna Disconnection Detection (GUI)

### Procedure

- 
- Step 1** Choose **Configuration > Tags & Profiles > AP Join**.
  - Step 2** In the **AP Join Profile** window, click the **General** tab.
  - Step 3** In the **Antenna Monitoring** check box to enable antenna monitoring.
  - Step 4** In the **RSSI Fail Threshold(dB)** field, enter a value, in dB. Valid values range from 10 to 90, with a default of 40.
  - Step 5** In the **Weak RSSI(dBm)** field, enter a value, in dBm. Valid values range from -90 to -10, with a default of 60.

- Step 6** In the **Detection Time(min)** field, enter the antenna disconnection detection time, in minutes. Valid values range from 9 to 180, with a default of 120.
- Step 7** Click **Update & Apply to Device**.

## Detecting Broken Antenna Using SNMP Trap (CLI)

### Procedure

	Command or Action	Purpose
<b>Step 1</b>	<b>configure terminal</b> <b>Example:</b> Device# configure terminal	Enters global configuration mode.
<b>Step 2</b>	<b>snmp-server enable traps</b> <b>Example:</b> Device(config)# snmp-server enable traps	Enables all the SNMP notification types that are available on the system.
<b>Step 3</b>	<b>trapflags ap broken-antenna</b> <b>Example:</b> Device(config)# trapflags ap broken-antenna	Enables an SNMP trap, which will be sent when an antenna fails in any Cisco AP.
<b>Step 4</b>	<b>end</b> <b>Example:</b> Device(config)# end	Returns to privileged EXEC mode.

## Detecting Broken Antenna Using SNMP Trap (GUI)

### Procedure

- Step 1** Choose **Administration > Management > SNMP**.
- Step 2** Click the **Wireless Traps** tab.
- Step 3** Set the **Access Point** status as **Enabled**, if not done already.
- Step 4** Check the **Broken Antenna** check box to enable the trap.
- Step 5** Click **Apply**.

## Verifying Antenna Disconnection Detection

To verify the Antenna Disconnection Detection feature configuration on an AP, use the following command:

```
Device# show ap name 3800-AP config general
```

```
Cisco AP Name: 3800-AP
```

```
=====
Cisco AP Identifier           : f4db.e632.df40
Country Code                 : Multiple Countries : US,IN,CN,CU
Regulatory Domain Allowed by Country : 802.11bg:-ACE 802.11a:-ABCDHN
AP Country Code              : CN - China
AP Regulatory Domain
  Slot 0                     : -E
  Slot 1                     : -C
MAC Address                  : f4db.e62f.165a
IP Address Configuration     : DHCP
IP Address                   : 9.9.33.3
IP Netmask                   : 255.255.255.0
Gateway IP Address          : 9.9.33.1
Fallback IP Address Being Used :
Domain                       :
Name Server                  :
CAPWAP Path MTU              : 1485
Capwap Active Window Size    : 1

.
.
.

AP broken antenna detection  : Enabled
RSSI threshold                : 40
Weak RSSI                     : -80
Detection Time                : 120

.
.
.
```

To verify the Antenna Disconnection Detection feature configuration on an AP profile, use the following command:

```
Device# show ap profile name rf-profile-24g detailed
```

```
AP Profile Name: rf-profile-24g
```

```
.
.
.
AP broken antenna detection:
  Status                       : ENABLED
  RSSI threshold                : 40
  Weak RSSI                     : -80
  Detection Time                : 120
```

# Verifying Antenna Disconnection Detection (GUI)

## Procedure

---

**Step 1** Choose **Monitoring > Wireless > AP Statistics**.

**Step 2** Click an AP name or anywhere on the row corresponding to an AP in order to activate **General** window.

**Step 3** Click the **360 View** tab.

The 360 View tab is the default selection. The **Antenna Monitoring** field indicates whether the AP supports monitoring or not.

---





## CHAPTER 56

# Neighbor Discovery Protocol Mode on Access Points

---

- [Information About Neighbor Discovery Protocol Mode](#), on page 511
- [Configuring RRM Neighbor Discovery Mode \(GUI\)](#), on page 512
- [Configuring the Neighbor Discovery Protocol Mode \(CLI\)](#), on page 512
- [Configuring Neighbor Discovery Protocol Mode in the RF Profile \(GUI\)](#), on page 513
- [Configuring Neighbor Discovery Protocol Mode in the RF Profile \(CLI\)](#), on page 513
- [Monitoring Radio Statistics-NDP Capability and NDP Mode \(GUI\)](#), on page 514
- [Verifying Neighbor Discovery Protocol Mode](#), on page 515

## Information About Neighbor Discovery Protocol Mode

In Cisco Catalyst 9124AX outdoor Access Points, the Neighbor Discovery Protocol (NDP) packets are transmitted either ON-channel on the serving radio, or OFF-channel on the RF ASIC conventional radio. The controller has a knob to select the NDP mode for Cisco Catalyst 9124AX outdoor APs based on the deployment requirements. In Cisco IOS XE Bengaluru 17.5.1, Cisco Catalyst 9124AX outdoor APs support both ON-Channel and OFF-Channel NDP mode.

The Cisco Catalyst 9124AX outdoor AP advertises the following NDP mode capabilities while joining the controller:

- ON-Channel (Serving channel)
- OFF-Channel (RF ASIC radio)
- Both (Serving channel and RF ASIC radio)

The supported values for NDP mode are AUTO and OFF-Channel. By default, the NDP mode is set to AUTO.

If the configured NDP mode is AUTO, the AP determines which NDP mode is to be used. The Cisco Catalyst 9124AX outdoor AP uses ON-Channel when the controller is configured for AUTO NDP mode. If the NDP mode that is configured is OFF-Channel, the AP uses OFF-Channel for NDP mode.

### Use Cases

You must configure the controller NDP mode to OFF-channel in order to support brownfield deployment. A brownfield deployment refers to the mixed deployment of Cisco Catalyst 9124AX with other APs that do not

support RF ASIC conventional radio. APs that support RF ASIC conventional radio are Cisco Catalyst 9120 Series Access Points, Cisco Catalyst 9130 Series Access Points, and Cisco Catalyst 9124 Series Access Points.

## Configuring RRM Neighbor Discovery Mode (GUI)

### Procedure

- 
- Step 1** Choose **Configuration > Radio Configurations > RRM**.
- Step 2** In the **Radio Resource Management** window, click either the **5 GHz Band** or the **2.4 GHz Band** tab.
- Step 3** In the **General** tab, under the **Noise/Interference/Rogue/CleanAir/SI Monitoring Channels** section, click the **RRM Neighbor Discovery Mode** toggle button to configure either of the following modes:
- **AUTO**: If the NDP mode that is configured is **AUTO**, the controller selects ON-Channel as the NDP mode. (The default is set as AUTO).
  - **OFF-CHANNEL**: If the NDP mode configured is **OFF-CHANNEL**, the controller selects **OFF-CHANNEL** as the NDP mode.
- Step 4** Click **Apply**.
- 

## Configuring the Neighbor Discovery Protocol Mode (CLI)

To configure the NDP mode for an AP, follow these steps:

### Procedure

	Command or Action	Purpose
<b>Step 1</b>	<b>configure terminal</b>  <b>Example:</b> Device# configure terminal	Enters global configuration mode.
<b>Step 2</b>	<b>ap dot11 {24ghz   5ghz} rrm ndp-mode {auto   off-channel}</b>  <b>Example:</b> Device(config)# ap dot11 24ghz rrm ndp-mode off-channel	Configures the operating mode for 802.11a neighbor discovery. The <b>Off-channel</b> command enables NDP packets on the RF ASIC radio and the <b>auto</b> command enables the auto mode.

## Configuring Neighbor Discovery Protocol Mode in the RF Profile (GUI)

### Procedure

- 
- Step 1** Choose **Configuration > Tags & Profiles > RF**.
- Step 2** Click **Add**.  
The **Add RF Profile** window is displayed.
- Step 3** Click the **General** tab.
- Step 4** Click the **NDP Mode** toggle button to select the NDP mode as **AUTO** or as **OFF-CHANNEL**.
- Step 5** Click **Apply to Device**.
- 

## Configuring Neighbor Discovery Protocol Mode in the RF Profile (CLI)

To configure the NDP mode for an AP under the RF profile, follow these steps:

### Procedure

	Command or Action	Purpose
<b>Step 1</b>	<b>configure terminal</b>  <b>Example:</b> Device# configure terminal	Enters global configuration mode.
<b>Step 2</b>	<b>ap dot11 {24ghz   5ghz } rf-profile</b> <i>rf-profile-name</i>  <b>Example:</b> Device(config)# ap dot11 24ghz rf-profile <i>rf-profile-name</i>	Enters the RF profile configuration.
<b>Step 3</b>	<b>ndp-mode {auto   off-channel}</b>  <b>Example:</b> Device(config-rf-profile)# ndp-mode off-channel	Configures the operating mode for neighbor discovery. <b>Off-channel</b> enables NDP packets on the RF ASIC radio and <b>auto</b> enables the auto mode.

# Monitoring Radio Statistics-NDP Capability and NDP Mode (GUI)

## Procedure

---

- Step 1** Choose **Monitoring > Wireless > Radio Statistics**.
- Step 2** Click either **5 GHz Radios**, **2.4 GHz Radios**, or **Dual-Band Radios** tab. The corresponding radio band window displays the list of configured APs.
- Step 3** To view the general attributes of an AP, click the corresponding AP to display the **General** tab. The following information is displayed:
- **AP Name:** Displays the assigned identifier for the AP, which is unique within the network. The AP name can be ASCII characters from 32 to 126, without leading and trailing spaces.
  - **IP Address:** Displays the IP address assigned to the AP in dotted-decimal format.
  - **AP Mode:** Displays the configured AP mode. The supported modes are:
    - **Local:** It is the default mode, and it offers a basic service set (BSS) on a specific channel. When the AP does not transmit wireless client frame, it scans other channels to measure noise interference, discover rogue devices, and check for matches against Intrusion Detection System (IDS) events.
    - **Monitor:** An AP in monitor mode does not transmit. It is a dedicated sensor that checks IDS events, detects rogue APs, and determines the position of wireless stations.
    - **Sniffer:** The controller enables you to configure an AP as a network *sniffer*, which captures and forwards all the packets on a particular channel to a remote machine that runs packet analyzer software. These packets contain information on time stamps, signal strength, packet sizes, and so on. Sniffers allow you to monitor and record network activity and detect problems.
    - **Bridge:** The AP becomes a dedicated point-to-point or point-to-multipoint bridge. Two APs in bridge mode can connect two remote sites. Multiple APs can also form an indoor or outdoor mesh. Note that you cannot connect to the bridge with clients.
    - **Clear:** Returns the AP back to client-serving mode depending on the remote site tag configuration.
  - **MAC Address:** Displays the registered MAC address on the controller.
  - **Number of Slots :** Displays the number of slots supported by the AP.
  - **Radio Type:** Displays the radio band configured on the controller. By default, both, 802.11b/g/n (2.4-GHz) and 802.11a/n/ac (5-GHz) bands are enabled.
  - **Slot ID:** Displays the slot on which radio is installed.
  - **Sub band Type:** Displays the configured radio sub-band.
  - **NDP Capability:** Displays the supported Neighbor Discovery Protocol (NDP) capability. The AP advertises the following NDP mode capabilities while joining the controller:
    - ON-Channel (Serving channel)

- OFF-Channel (RHL radio)
- Both (Serving channel and RHL radio)

**Note** Only Cisco Catalyst 9124AX outdoor Access Points support both ON-channel and OFF-channel NDP capability from Cisco IOS XE Bengaluru 17.5.1.

- **NDP Mode:** Displays the configured NDP mode. If the NDP mode that is configured is AUTO, the controller selects ON-Channel as the NDP mode. If the NDP-mode that is configured is OFF-Channel, the controller selects OFF-Channel as the NDP mode.

## Verifying Neighbor Discovery Protocol Mode

To verify the NDP mode, run the following commands:

```

Device# show ap rf-profile name test-24g
Description                : test
RF Profile Name            : test-24g
Band                       : 2.4 GHz
Transmit Power Threshold v1 : -70 dBm
Min Transmit Power        : -10 dBm
Max Transmit Power        : 30 dBm
.
.
.
NDP mode                    : Auto
.
.
.

Device# show ap rf-profile name test-5g detail
Description                : Test
RF Profile Name            : test-5g
Band                       : 5 GHz
Transmit Power Threshold v1 : -70 dBm
Min Transmit Power        : -10 dBm
Max Transmit Power        : 30 dBm
.
.
.
NDP mode                    : Off-channel
.
.
.

Device# show ap name ap-name config dot11 24ghz
Cisco AP Identifier        : 3cxx.0exx.36xx
Cisco AP Name              : Cisco-9105AXW-AP
Country Code               : Multiple Countries: US,MK,J4,IN
Regulatory Domain Allowed by Country : 802.11bg:-AEJPQU 802.11a:-ABDEIJNPQU
AP Country Code            : US - United States
AP Regulatory Domain       : -A
MAC Address                 : 5cxx.0dxx.e0xx
IP Address Configuration   : DHCP
.
.
.

```

```

NDP mode                               : Off-channel
.
.
.
Device# show ap name ap-name config dot11 5ghz
Cisco AP Identifier                     : 3cxx.0exx.36xx
Cisco AP Name                           : Cisco-9105AXW-AP
Country Code                            : Multiple Countries: US,MK,J4,IN
Regulatory Domain Allowed by Country    : 802.11bg:-AEJPQU 802.11a:-ABDEIJNPQU
AP Country Code                          : US - United States
AP Regulatory Domain                     : -B
MAC Address                              : 5cxx.0dxx.e0xx
IP Address Configuration                 : DHCP
IP Address                               : Disabled
.
.
.
NDP mode                               : On-channel
.
.
.
Device# show ap dot11 24ghz monitor
Default 802.11b AP monitoring
 802.11b Monitor Mode                   : Enabled
 802.11b Monitor Channels                : Country channels
 802.11b RRM Neighbor Discover Type     : Transparent
 802.11b AP Coverage Interval           : 180 seconds
 802.11b AP Load Interval               : 60 seconds
 802.11b AP Measurement Interval        : 180 seconds
 802.11b AP Reporting Interval          : 180 seconds
 802.11b NDP RSSI Normalization         : Enabled
 802.11b Neighbor Timeout factor        : 20
 802.11b NDP mode                       : Auto

Device# show ap dot11 5ghz monitor
Default 802.11a AP monitoring
 802.11a Monitor Mode                   : Enabled
 802.11a Monitor Channels                : Country channels
 802.11a RRM Neighbor Discover Type     : Transparent
 802.11a AP Coverage Interval           : 180 seconds
 802.11a AP Load Interval               : 60 seconds
 802.11a AP Measurement Interval        : 180 seconds
 802.11a AP Reporting Interval          : 180 seconds
 802.11a NDP RSSI Normalization         : Enabled
 802.11a Neighbor Timeout factor        : 20
 802.11a NDP mode                       : Auto

```



## PART **V**

# Network Management

- [AP Packet Capture](#), on page 519
- [DHCP Option82](#), on page 523
- [RADIUS Realm](#), on page 535
- [RADIUS Accounting](#), on page 541
- [RADIUS Call Station Identifier](#), on page 543
- [RADIUS VSA](#), on page 545
- [Cisco StadiumVision](#), on page 551
- [Persistent SSID Broadcast](#), on page 555
- [Network Monitoring](#), on page 557
- [Creating a Lobby Ambassador Account](#), on page 561
- [Lobby Ambassador Account](#), on page 565
- [Guest User Accounts](#), on page 573
- [Link Local Bridging](#), on page 577







## CHAPTER 57

# AP Packet Capture

---

- [Introduction to AP Client Packet Capture, on page 519](#)
- [Enabling Packet Capture \(GUI\), on page 519](#)
- [Enabling Packet Capture \(CLI\), on page 520](#)
- [Create AP Packet Capture Profile and Map to an AP Join Profile \(GUI\), on page 520](#)
- [Create AP Packet Capture Profile and Map to an AP Join Profile, on page 521](#)
- [Start or Stop Packet Capture, on page 521](#)

## Introduction to AP Client Packet Capture

The AP Client Packet Capture feature allows the packets on an AP to be captured for wireless client troubleshooting. The packet capture operation is performed on the AP by the radio drivers on the current channel on which it is operational, based on the specified packet capture filter. All the packets that are captured for a specific client are uploaded to a file in the FTP server. This file can be opened in Wireshark for packet inspection.

### Limitations for AP Client Packet Capture

- The packet capture task can be performed for only one client at a time per site.
- Packet capture can be started on a specific AP or a set of APs using static mode. It can be started or stopped for the same client on different APs, when the capture is in progress.

When packet capture is started in auto mode, system automatically selects the set of nearby APs to start packet capture for a specific client. In this mode, you cannot start or stop packet capture on individual APs. Use the **stop all** command to stop the packet capture when it is started in auto-mode.

- After the SSO is complete, the packet capture action will not continue after a switchover.

## Enabling Packet Capture (GUI)

### Procedure

---

- Step 1** Choose **Troubleshooting > AP Packet Capture**.

- Step 2** On the **Troubleshooting** page, in the **Start Packet Capture** section, in the **Client MAC Address** field, enter the client's MAC address. Enter the MAC address either in *xx:xx:xx:xx:xx:xx*, *xx-xx-xx-xx-xx-xx*, or *xxxx.xxxx.xxxx* format.
- Step 3** From the **Capture Mode** options, choose **Auto**.
- Step 4** Click **Start**.

## Enabling Packet Capture (CLI)

Follow the procedure given below to enable packet capture:

### Procedure

	Command or Action	Purpose
<b>Step 1</b>	<b>enable</b>  <b>Example:</b> Device# enable	Enters privileged EXEC mode.
<b>Step 2</b>	<b>ap packet-capture start <i>client-mac-address</i></b> <b>auto</b>  <b>Example:</b> Device# ap packet-capture start 0011.0011.0011 auto	Enables packet capture for the specified client on a set of nearby access points.

## Create AP Packet Capture Profile and Map to an AP Join Profile (GUI)

### Procedure

- Step 1** Click **Configuration > Tags & Profiles > AP Join Profile**.
- Step 2** Click **Add** to create a new AP Join Profile and enter the requisite details.
- Step 3** In the **Add AP Join Profile** area, click **AP > Packet Capture**.
- Step 4** Click the **Plus** icon to create a new Packet Capture profile or select one from the drop-down menu.
- Step 5** Click **Save**.

# Create AP Packet Capture Profile and Map to an AP Join Profile

While packet capture profile configurations are used for an AP, the packet capture profile is mapped to an AP profile. The AP profile is in turn mapped to site tag.

While starting packet capture, APs use the packet capture profile configurations based on the site and AP join profile they belong to.

Follow the procedure given below to create an AP packet capture profile and map it to an AP join profile:

## Procedure

	Command or Action	Purpose
<b>Step 1</b>	<b>configure terminal</b>  <b>Example:</b> Device# configure terminal	Enters global configuration mode..
<b>Step 2</b>	<b>wireless profile ap packet-capture</b> <i>packet-capture-profile-name</i>  <b>Example:</b> Device(config)# wireless profile ap packet-capture test1	Configures an AP profile.
<b>Step 3</b>	<b>ap profile</b> <i>profile-name</i>  <b>Example:</b> Device(config)# ap profile default-ap-profile	Configures an AP packet capture profile.
<b>Step 4</b>	<b>packet-capture</b> <i>profile-name</i>  <b>Example:</b> Device(config-ap-profile)# packet-capture capture-test	Enables packet capture on the AP profile.
<b>Step 5</b>	<b>end</b>  <b>Example:</b> Device(config-ap-profile)# end	Exits the AP profile configuration mode.
<b>Step 6</b>	<b>show wireless profile ap packet-capture</b> <b>detailed</b> <i>profile-name</i>  <b>Example:</b> Device# show wireless profile ap packet-capture detailed test1	Displays detailed information of the selected AP packet capture profile.

## Start or Stop Packet Capture

Perform either of these tasks to start or stop a packet capture procedure.

## Procedure

	Command or Action	Purpose
<b>Step 1</b>	<b>ap packet-capture start</b> <i>client-mac-address</i> { <b>auto</b>   <b>static</b> <i>ap-name</i> }  <b>Example:</b> Device# ap packet-capture start 0011.0011.0011 auto	Enables packet capture for a client.
<b>Step 2</b>	<b>ap packet-capture stop</b> <i>client-mac-address</i> { <b>all</b>   <b>static</b> <i>ap-name</i> }  <b>Example:</b> Device# ap packet-capture stop 0011.0011.0011 all	Disables packet capture for a client.



## CHAPTER 58

# DHCP Option82

- [Information About DHCP Option 82, on page 523](#)
- [Configuring DHCP Option 82 Global Interface, on page 525](#)
- [Configuring DHCP Option 82 Format, on page 527](#)
- [Configuring DHCP Option82 Through a VLAN Interface, on page 528](#)

## Information About DHCP Option 82

DHCP Option 82 is organized as a single DHCP option that contains information known by the relay agent. This feature provides additional security when DHCP is used to allocate network addresses, and enables the Cisco controller to act as a DHCP relay agent to prevent DHCP client requests from untrusted sources.

The controller can be configured to add Option 82 information to DHCP requests from clients before forwarding the requests to a DHCP server. The DHCP server can then be configured to allocate IP addresses to the wireless client based on the information present in DHCP Option 82.

DHCP provides a framework for passing configuration information to hosts on a TCP/IP network. Configuration parameters and other control information are carried in tagged data items that are stored in the Options field of the DHCP message. The data items themselves are also called options. Option 82 contains information known by the relay agent.

The Relay Agent Information option is organized as a single DHCP option that contains one or more suboptions that convey information known by the relay agent. Option 82 was designed to allow a DHCP Relay Agent to insert circuit-specific information into a request that is being forwarded to a DHCP server. This option works by setting two suboptions:

- Circuit ID
- Remote ID

The Circuit ID suboption includes information that is specific to the circuit the request came in on. This suboption is an identifier that is specific to the relay agent. Thus, the circuit that is described will vary depending on the relay agent.

The Remote ID suboption includes information on the remote host-end of the circuit. This suboption usually contains information that identifies the relay agent. In a wireless network, this would likely be a unique identifier of the wireless access point.



---

**Note** All valid Remote ID combinations are separated with a colon (:) as the delimiter.

---

You can configure the following DHCP Option 82 options in a controller :

- DHCP Enable
- DHCP Opt82 Enable
- DHCP Opt82 Ascii
- DHCP Opt82 RID
- DHCP Opt Format
- DHCP AP MAC
- DHCP SSID
- DHCP AP ETH MAC
- DHCP AP NAME
- DHCP Site Tag
- DHCP AP Location
- DHCP VLAN ID



---

**Note** The controller includes the SSID in ASCII and the VLAN-ID in hexadecimal format within the remote-ID sub-option of option 82 in the outgoing DHCP packets to the server for the following configurations:

```
ipv4 dhcp opt82 format ssid
ipv4 dhcp opt82 format vlan-id
```

However, if *ipv4 dhcp opt82 ascii* configuration is also present, the controller adds VLAN-ID and SSID in ASCII format.

---

For Cisco Catalyst 9800 Series Configuration Best Practices, see the following link: <https://www.cisco.com/c/en/us/products/collateral/wireless/catalyst-9800-series-wireless-controllers/guide-c07-743627.html>

# Configuring DHCP Option 82 Global Interface

## Configuring DHCP Option 82 Globally Through Server Override (CLI)

### Procedure

	Command or Action	Purpose
<b>Step 1</b>	<b>configure terminal</b> <b>Example:</b> Device# <code>configure terminal</code>	Enters global configuration mode.
<b>Step 2</b>	<b>ip dhcp-relay information option server-override</b> <b>Example:</b> Device(config)# <code>ip dhcp-relay information option server-override</code>	Inserts global server override and link selection suboptions.

## Configuring DHCP Option 82 Through Server Override (CLI)

### Procedure

	Command or Action	Purpose
<b>Step 1</b>	<b>configure terminal</b> <b>Example:</b> Device# <code>configure terminal</code>	Enters global configuration mode.
<b>Step 2</b>	<b>ip dhcp compatibility suboption server-override [cisco   standard]</b> <b>Example:</b> Device(config)# <code>ip dhcp compatibility suboption server-override cisco</code>	Configures the server override suboption to an RFC or Cisco specific value.
<b>Step 3</b>	<b>ip dhcp compatibility suboption link-selection [cisco   standard]</b> <b>Example:</b> Device(config)# <code>ip dhcp compatibility suboption link-selection cisco</code>	Configures the link-selection suboption to an RFC or Cisco specific value.

## Configuring DHCP Option 82 Globally Through Different SVIs (GUI)

### Procedure

- 
- Step 1** Choose **Configuration > VLAN**.
- Step 2** Choose a VLAN from the drop-down list.  
The **Edit SVI** window appears.
- Step 3** Click the **Advanced** tab.
- Step 4** Choose an option from the **IPv4 Inbound ACL** drop-down list.
- Step 5** Choose an option from the **IPv4 Outbound ACL** drop-down list.
- Step 6** Choose an option from the **IPv6 Inbound ACL** drop-down list.
- Step 7** Choose an option from the **IPv6 Outbound ACL** drop-down list.
- Step 8** Enter an IP address in the **IPv4 Helper Address** field.
- Step 9** Set the status to **Enabled** if you want to enable the **Relay Information Option** setting.
- Step 10** Enter the **Subscriber ID**.
- Step 11** Set the status to **Enabled** if you want to enable the **Server ID Override** setting.
- Step 12** Set the status to **Enabled** if you want to enable the **Option Insert** setting.
- Step 13** Choose an option from the **Source-Interface Vlan** drop-down list.
- Step 14** Click **Update & Apply to Device**.
- 

## Configuring DHCP Option 82 Globally Through Different SVIs (CLI)

### Procedure

	Command or Action	Purpose
<b>Step 1</b>	<b>configure terminal</b>  <b>Example:</b>  Device# <code>configure terminal</code>	Enters global configuration mode.
<b>Step 2</b>	<b>ip dhcp-relay source-interface vlan <i>vlan-id</i></b>  <b>Example:</b>  Device(config)# <code>ip dhcp-relay source-interface vlan 74</code>	Sets global source interface for relayed messages.



# Configuring DHCP Option 82 Format

## Procedure

	Command or Action	Purpose
<b>Step 1</b>	<b>configure terminal</b> <b>Example:</b> Device# <b>configure terminal</b>	Enters global configuration mode.
<b>Step 2</b>	<b>wireless profile policy <i>policy-name</i></b> <b>Example:</b> Device (config) # <b>wireless profile policy pp3</b>	Enables configuration for the specified profile policy.
<b>Step 3</b>	<b>shutdown</b> <b>Example:</b> Device (config-wireless-policy) # <b>shutdown</b>	Shuts down the profile policy.
<b>Step 4</b>	<b>vlan <i>vlan-name</i></b> <b>Example:</b> Device (config-wireless-policy) # <b>vlan 72</b>	Assigns the profile policy to a VLAN.
<b>Step 5</b>	<b>session-timeout <i>value-btwn-20-86400</i></b> <b>Example:</b> Device (config-wireless-policy) # <b>session-timeout 300</b>	(Optional) Sets the session timeout value in seconds. The range is between 20-86400.
<b>Step 6</b>	<b>idle-timeout <i>value-btwn-15-100000</i></b> <b>Example:</b> Device (config-wireless-policy) # <b>idle-timeout 15</b>	(Optional) Sets the idle timeout value in seconds. The range is between 15-100000.
<b>Step 7</b>	<b>central switching</b> <b>Example:</b> Device (config-wireless-policy) # <b>central switching</b>	Enables central switching.
<b>Step 8</b>	<b>ipv4 dhcp opt82</b> <b>Example:</b> Device (config-wireless-policy) # <b>ipv4 dhcp opt82</b>	Enables DHCP Option 82 for the wireless clients.
<b>Step 9</b>	<b>ipv4 dhcp opt82 ascii</b> <b>Example:</b>	(Optional) Enables ASCII on the DHCP Option 82 feature.

	Command or Action	Purpose
	Device(config-wireless-policy)# <b>ipv4 dhcp opt82 ascii</b>	
<b>Step 10</b>	<b>ipv4 dhcp opt82 rid</b>  <b>Example:</b> Device(config-wireless-policy)# <b>ipv4 dhcp opt82 rid</b>	(Optional) Supports the addition of Cisco 2 byte Remote ID (RID) for the DHCP Option 82 feature.
<b>Step 11</b>	<b>ipv4 dhcp opt82 format</b> { <b>ap-dmac</b>   <b>ap-hcafn</b>   <b>apmac</b>   <b>apname</b>   <b>policy</b>   <b>eg</b>   <b>sid</b>   <b>vlan id</b> }  <b>Example:</b> Device(config-wireless-policy)# <b>ipv4 dhcp opt82 format apmac</b>	Enables DHCP Option 82 on the corresponding AP.  For information on the various options available with the command, see <a href="#">Cisco Catalyst 9800 Series Wireless Controller Command Reference</a> .
<b>Step 12</b>	<b>no shutdown</b>  <b>Example:</b> Device(config-wireless-policy)# <b>no shutdown</b>	Enables the profile policy.

## Configuring DHCP Option82 Through a VLAN Interface

### Configuring DHCP Option 82 Through Option-Insert Command (CLI)

#### Procedure

	Command or Action	Purpose
<b>Step 1</b>	<b>configure terminal</b>  <b>Example:</b> Device# <b>configure terminal</b>	Enters global configuration mode.
<b>Step 2</b>	<b>interface vlan</b> <i>vlan-id</i>  <b>Example:</b> Device(config)# <b>interface vlan 72</b>	Configures a VLAN ID.
<b>Step 3</b>	<b>ip dhcp relay information option-insert</b>  <b>Example:</b> Device(config-if)# <b>ip dhcp relay information option-insert</b>	Inserts relay information in BOOTREQUEST.
<b>Step 4</b>	<b>ip address</b> <i>ip-address</i>  <b>Example:</b>	Configures the IP address for the interface.

	Command or Action	Purpose
	Device(config-if)# <b>ip address 9.3.72.38 255.255.255.0</b>	
<b>Step 5</b>	<b>ip helper-address <i>ip-address</i></b> <b>Example:</b> Device(config-if)# <b>ip helper-address 9.3.72.1</b>	Configures the destination address for UDP broadcasts.
<b>Step 6</b>	<b>[no] mop enabled</b> <b>Example:</b> Device(config-if)# <b>no mop enabled</b>	Disables the MOP for an interface.
<b>Step 7</b>	<b>[no] mop sysid</b> <b>Example:</b> Device(config-apgroup)# <b>[no] mop sysid</b>	Disables the task of sending MOP periodic system ID messages.

## Configuring DHCP Option 82 Through the server-ID-override Command (CLI)

### Procedure

	Command or Action	Purpose
<b>Step 1</b>	<b>configure terminal</b> <b>Example:</b> Device# <b>configure terminal</b>	Enters global configuration mode.
<b>Step 2</b>	<b>ip dhcp compatibility suboption server-override cisco</b> <b>Example:</b> Device(config)# <b>ip dhcp compatibility suboption server-override cisco</b>	Configures the server-id override suboption to an RFC or Cisco specific value.
<b>Step 3</b>	<b>ip dhcp compatibility suboption link-selection cisco</b> <b>Example:</b> Device(config)# <b>ip dhcp compatibility suboption link-selection cisco</b>	Configures the link-selection suboption to an RFC or Cisco specific value.
<b>Step 4</b>	<b>interface vlan <i>vlan-id</i></b> <b>Example:</b> Device(config)# <b>interface vlan 72</b>	Configures a VLAN ID.
<b>Step 5</b>	<b>ip dhcp relay information option server-id-override</b> <b>Example:</b>	Inserts the server id override and link selection suboptions.

	Command or Action	Purpose
	Device(config-if)# <b>ip dhcp relay information option server-id-override</b>	
<b>Step 6</b>	<b>ip address</b> <i>ip-address</i>  <b>Example:</b> Device(config-if)# <b>ip address 9.3.72.38 255.255.255.0</b>	Configures the IP address for the interface.
<b>Step 7</b>	<b>ip helper-address</b> <i>ip-address</i>  <b>Example:</b> Device(config-if)# <b>ip helper-address 9.3.72.1</b>	Configures the destination address for UDP broadcasts.
<b>Step 8</b>	<b>[no] mop enabled</b>  <b>Example:</b> Device(config-if)# <b>no mop enabled</b>	Disables MOP for an interface.
<b>Step 9</b>	<b>[no] mop sysid</b>  <b>Example:</b> Device(config-if)# <b>[no] mop sysid</b>	Disables the task of sending MOP periodic system ID messages.

## Configuring DHCP Option 82 Through a Subscriber-ID (CLI)

### Procedure

	Command or Action	Purpose
<b>Step 1</b>	<b>configure terminal</b>  <b>Example:</b> Device# <b>configure terminal</b>	Enters global configuration mode.
<b>Step 2</b>	<b>interface vlan</b> <i>vlan-id</i>  <b>Example:</b> Device(config)# <b>interface vlan 72</b>	Configures a VLAN ID.
<b>Step 3</b>	<b>ip dhcp relay information option subscriber-id</b> <i>subscriber-id</i>  <b>Example:</b> Device(config-if)# <b>ip dhcp relay information option subscriber-id test10</b>	Inserts the subscriber identifier suboption.
<b>Step 4</b>	<b>ip address</b> <i>ip-address</i>  <b>Example:</b>	Configures the IP address for the interface.

	Command or Action	Purpose
	Device(config-if)# ip address 9.3.72.38 255.255.255.0	
<b>Step 5</b>	<b>ip helper-address</b> <i>ip-address</i>  <b>Example:</b> Device(config-if)# ip helper-address 9.3.72.1	Configures the destination address for UDP broadcasts.
<b>Step 6</b>	<b>[no] mop enabled</b>  <b>Example:</b> Device(config-if)# no mop enabled	Disables MOP for an interface.
<b>Step 7</b>	<b>[no] mop sysid</b>  <b>Example:</b> Device(config-apgroup)# [no] mop sysid	Disables the task of sending MOP periodic system ID messages.

## Configuring DHCP Option 82 Through server-ID-override and subscriber-ID Commands (CLI)

### Procedure

	Command or Action	Purpose
<b>Step 1</b>	<b>configure terminal</b>  <b>Example:</b> Device# configure terminal	Enters global configuration mode.
<b>Step 2</b>	<b>interface vlan</b> <i>vlan-id</i>  <b>Example:</b> Device(config)# interface vlan 72	Configures a VLAN ID.
<b>Step 3</b>	<b>ip dhcp relay information option</b> <b>server-id-override</b>  <b>Example:</b> Device(config-if)# ip dhcp relay information option server-id-override	Inserts server ID override and link selection suboptions.
<b>Step 4</b>	<b>ip dhcp relay information option</b> <b>subscriber-id</b> <i>subscriber-id</i>  <b>Example:</b> Device(config-if)# ip dhcp relay information option subscriber-id test10	Inserts the subscriber identifier suboption.

	Command or Action	Purpose
<b>Step 5</b>	<b>ip address</b> <i>ip-address</i>  <b>Example:</b> Device(config-if)# <b>ip address 9.3.72.38</b> 255.255.255.0	Configures the IP address for the interface.
<b>Step 6</b>	<b>ip helper-address</b> <i>ip-address</i>  <b>Example:</b> Device(config-if)# <b>ip helper-address</b> 9.3.72.1	Configures the destination address for UDP broadcasts.
<b>Step 7</b>	<b>[no] mop enabled</b>  <b>Example:</b> Device(config-if)# <b>no mop enabled</b>	Disables the MOP for an interface.
<b>Step 8</b>	<b>[no] mop sysid</b>  <b>Example:</b> Device(config-apgroup)# <b>[no] mop sysid</b>	Disables the task of sending MOP periodic system ID messages.

## Configuring DHCP Option 82 Through Different SVIs (CLI)

### Procedure

	Command or Action	Purpose
<b>Step 1</b>	<b>configure terminal</b>  <b>Example:</b> Device# <b>configure terminal</b>	Enters global configuration mode.
<b>Step 2</b>	<b>interface vlan</b> <i>vlan-id</i>  <b>Example:</b> Device(config)# <b>interface vlan 72</b>	Configures a VLAN ID.
<b>Step 3</b>	<b>ip dhcp relay source-interface vlan</b> <i>vlan-id</i>  <b>Example:</b> Device(config-if)# <b>ip dhcp relay</b> <b>source-interface vlan 74</b>	Configures a source interface for relayed messages on a VLAN ID.
<b>Step 4</b>	<b>ip address</b> <i>ip-address</i>  <b>Example:</b> Device(config-if)# <b>ip address 9.3.72.38</b> 255.255.255.0	Configures the IP address for the interface.

	<b>Command or Action</b>	<b>Purpose</b>
<b>Step 5</b>	<b>ip helper-address</b> <i>ip-address</i> <b>Example:</b> Device(config-if)# <b>ip helper-address</b> 9.3.72.1	Configure the destination address for UDP broadcasts.
<b>Step 6</b>	<b>[no] mop enabled</b> <b>Example:</b> Device(config-if)# <b>no mop enabled</b>	Disables the MOP for an interface.
<b>Step 7</b>	<b>[no] mop sysid</b> <b>Example:</b> Device(config-apgroup)# <b>[no] mop sysid</b>	Disables the task of sending MOP periodic system ID messages.







## CHAPTER 59

# RADIUS Realm

- [Information About RADIUS Realm, on page 535](#)
- [Enabling RADIUS Realm, on page 536](#)
- [Configuring Realm to Match the RADIUS Server for Authentication and Accounting, on page 536](#)
- [Configuring the AAA Policy for a WLAN, on page 537](#)
- [Verifying the RADIUS-Realm Configuration, on page 539](#)

## Information About RADIUS Realm

The RADIUS Realm feature is associated with the domain of the user. Using this feature, a client can choose the RADIUS server through which authentication and accounting is to be processed.

When mobile clients are associated with a WLAN, RADIUS realm is received as a part of Extensible Authentication Protocol Method for UMTS Authentication and Key Agreement (EAP-AKA) identity response request in the authentication request packet. The Network Access Identifier (NAI) format (EAP-AKA) for WLAN can be specified as *username@domain.com*. The realm in the NAI format is represented after the @ symbol, which is specified as domain.com. If vendor-specific attributes are added as *test*, the NAI format is represented as *test@domain.com*.

The RADIUS Realm feature can be enabled and disabled on a WLAN. If Realm is enabled on a WLAN, the corresponding user should send the username in the NAI format. The controller sends the authentication request to the AAA server only when the realm, which is in the NAI format and is received from the client, is compiled as per the given standards. Apart from authentication, accounting requests are also required to be sent to the AAA server based on realm filtering.

### Realm Support on a WLAN

Each WLAN is configured to support NAI realms. After the realm is enabled on a particular SSID, the lookup is done to match the realms received in the EAP identity response against the configured realms on the RADIUS server. If the client does not send a username with the realm, the default RADIUS server that is configured on the WLAN is used for authentication. If the realm that is received from the client does not match the configured realms on the WLAN, the client is deauthenticated and dropped.

If the RADIUS Realm feature is not enabled on a WLAN, the username that is received as part of the EAP identity request is directly used as the username and the configured RADIUS server is used for authentication and accounting. By default, the RADIUS Realm feature is disabled on WLANs.

- **Realm Match for Authentication:** In dot1x with EAP methods (similar to EAP AKA), the username is received as part of an EAP identity response. A realm is derived from the username and are matched

with the realms that are already configured in the corresponding RADIUS authentication server. If there is a match, the authentication requests are forwarded to the RADIUS server. If there is a mismatch, the client is deauthenticated.

- **Realm Match for Accounting:** A client's username is received through an access-accept message. When accounting messages are triggered, the realm is derived from the corresponding client's username and compared with the accounting realms configured on the RADIUS accounting server. If there is a match, accounting requests are forwarded to the RADIUS server. If there is a mismatch, accounting requests are dropped.

## Enabling RADIUS Realm

Follow the procedure given below to enable RADIUS realm:

### Procedure

	Command or Action	Purpose
<b>Step 1</b>	<b>configure terminal</b>  <b>Example:</b> Device# configure terminal	Enters global configuration mode.
<b>Step 2</b>	<b>wireless aaa policy <i>aaa-policy</i></b>  <b>Example:</b> Device(config)# wireless aaa policy policy-1	Creates a new AAA policy.
<b>Step 3</b>	<b>aaa-realm enable</b>  <b>Example:</b> Device(config-aaa-policy)# aaa-realm enable	Enables AAA RADIUS realm selection.  <b>Note</b> Use the <b>no aaa-realm enable</b> or the <b>default aaa-realm enable</b> command to disable the RADIUS realm.

## Configuring Realm to Match the RADIUS Server for Authentication and Accounting

Follow the procedure given below to configure the realm to match the RADIUS server for authentication and accounting:

### Procedure

	Command or Action	Purpose
<b>Step 1</b>	<b>configure terminal</b>  <b>Example:</b> Device# configure terminal	Enters global configuration mode.

	Command or Action	Purpose
<b>Step 2</b>	<b>aaa new-model</b> <b>Example:</b> Device(config)# aaa new-model	Creates a AAA authentication model.
<b>Step 3</b>	<b>aaa authorization network default group radius-server-group</b> <b>Example:</b> Device(config)# aaa authorization network default group aaa_group_name	Sets the authorization method.
<b>Step 4</b>	<b>aaa authentication dot1x realm group radius-server-group</b> <b>Example:</b> Device(config)# aaa authentication dot1x cisco.com group cisco1	Indicates that dot1x must use the realm group RADIUS server.
<b>Step 5</b>	<b>aaa authentication login realm group radius-server-group</b> <b>Example:</b> Device(config)# aaa authentication login cisco.com group cisco1	Defines the authentication method at login.
<b>Step 6</b>	<b>aaa accounting identity realm start-stop group radius-server-group</b> <b>Example:</b> Device(config)# aaa accounting identity cisco.com start-stop group cisco1	Enables accounting to send a start-record accounting notice when a client is authorized, and a stop-record at the end.

## Configuring the AAA Policy for a WLAN

Follow the procedure given below to configure the AAA policy for a WLAN:

### Procedure

	Command or Action	Purpose
<b>Step 1</b>	<b>configure terminal</b> <b>Example:</b> Device# configure terminal	Enters global configuration mode.
<b>Step 2</b>	<b>wireless aaa policy aaa-policy-name</b> <b>Example:</b> Device(config)# wireless aaa policy aaa-policy-1	Creates a new AAA policy for wireless.

	Command or Action	Purpose
<b>Step 3</b>	<b>aaa-realm enable</b> <b>Example:</b> Device(config-aaa-policy)# aaa-realm enable	Enables AAA RADIUS server selection by realm.
<b>Step 4</b>	<b>exit</b> <b>Example:</b> Device(config-aaa-policy)# exit	Returns to global configuration mode.
<b>Step 5</b>	<b>wireless profile policy wlan-policy-profile</b> <b>Example:</b> Device(config)# wireless profile policy wlan-policy-a	Configures a WLAN policy profile.
<b>Step 6</b>	<b>aaa-policy aaa-policy</b> <b>Example:</b> Device(config-wireless-policy)# aaa-policy aaa-policy-1	Maps the AAA policy.
<b>Step 7</b>	<b>accounting-list acct-config-realm</b> <b>Example:</b> Device(config-wireless-policy)# accounting-list cisco.com	Sets the accounting list.
<b>Step 8</b>	<b>exit</b> <b>Example:</b> Device(config-wireless-policy)# exit	Returns to global configuration mode.
<b>Step 9</b>	<b>wlan wlan-name wlan-id ssid</b> <b>Example:</b> Device(config)# wlan wlan2 14 wlan-aaa	Configures a WLAN.
<b>Step 10</b>	<b>security dot1x authentication-list auth-list-realm</b> <b>Example:</b> Device(config-wlan)# security dot1x authentication-list cisco.com	Enables the security authentication list for IEEE 802.1x.
<b>Step 11</b>	<b>exit</b> <b>Example:</b> Device(config-wireless-policy)# exit	Returns to global configuration mode.
<b>Step 12</b>	<b>wireless tag policy policy</b> <b>Example:</b> Device(config)# wireless tag policy tag-policy-1	Configures a policy tag.

	Command or Action	Purpose
<b>Step 13</b>	<b>wlan wlan-name policy policy-profile</b>  <b>Example:</b> Device(config-policy-tag)# wlan Abc-wlan policy wlan-policy-a	Maps a policy profile to the WLAN.
<b>Step 14</b>	<b>exit</b>  <b>Example:</b> Device(config-policy-tag)# exit	Returns to global configuration mode.

## Verifying the RADIUS-Realm Configuration

Use the following command to verify the RADIUS-realm configuration:

```
Device# show wireless client mac-address 14bd.61f3.6a24 detail
```

```
Client MAC Address : 14bd.61f3.6a24
Client IPv4 Address : 9.4.113.103
Client IPv6 Addresses : fe80::286e:9fe0:7fa6:8f4
Client Username : sacthoma@cisco.com
AP MAC Address : 4c77.6d79.5a00
AP Name: AP4c77.6d53.20ec
AP slot : 1
Client State : Associated
Policy Profile : name-policy-profile
Flex Profile : N/A
Wireless LAN Id : 3
Wireless LAN Name: ha_realm_WLAN_WPA2_AES_DOT1X
BSSID : 4c77.6d79.5a0f
Connected For : 26 seconds
Protocol : 802.11ac
Channel : 44
Client IIF-ID : 0xa0000001
Association Id : 1
Authentication Algorithm : Open System
Client CCX version : No CCX support
Re-Authentication Timeout : 1800 sec (Remaining time: 1775 sec)
Input Policy Name : None
Input Policy State : None
Input Policy Source : None
Output Policy Name : None
Output Policy State : None
Output Policy Source : None
WMM Support : Enabled
U-APSD Support : Enabled
  U-APSD value : 0
  APSD ACs : BK, BE, VI, VO
Fastlane Support : Disabled
Power Save : OFF
Supported Rates : 9.0,18.0,36.0,48.0,54.0
Mobility:
  Move Count : 0
  Mobility Role : Local
  Mobility Roam Type : None
  Mobility Complete Timestamp : 06/12/2018 19:52:35 IST
Policy Manager State: Run
```

```

NPU Fast Fast Notified : No
Last Policy Manager State : IP Learn Complete
Client Entry Create Time : 25 seconds
Policy Type : WPA2
Encryption Cipher : CCMP (AES)
Authentication Key Management : 802.1x
Encrypted Traffic Analytics : No
Management Frame Protection : No
Protected Management Frame - 802.11w : No
EAP Type : PEAP
VLAN : 113
Multicast VLAN : 0
Access VLAN : 113
Anchor VLAN : 0
WFD capable : No
Managed WFD capable : No
Cross Connection capable : No
Support Concurrent Operation : No
Session Manager:
  Interface       : capwap_9040000f
  IIF ID          : 0x9040000f
  Authorized      : TRUE
  Session timeout : 1800
  Common Session ID: 097704090000000DF4607B3B
  Acct Session ID : 0x00000fa2
  Aaa Server Details
  Server IP       : 9.4.23.50
  Auth Method Status List
    Method : Dot1x
      SM State      : AUTHENTICATED
      SM Bend State : IDLE
  Local Policies:
    Service Template : wlan_svc_name-policy-profile_local (priority 254)
      Absolute-Timer : 1800
      VLAN           : 113
  Server Policies:
  Resultant Policies:
    VLAN           : 113
    Absolute-Timer : 1800
DNS Snooped IPv4 Addresses : None
DNS Snooped IPv6 Addresses : None
Client Capabilities
  CF Pollable : Not implemented
  CF Poll Request : Not implemented
  Short Preamble : Not implemented
  PBCC : Not implemented
  Channel Agility : Not implemented
  Listen Interval : 0
Fast BSS Transition Details :
  Reassociation Timeout : 0
11v BSS Transition : Not implemented
FlexConnect Data Switching : Central
FlexConnect Dhcp Status : Central
FlexConnect Authentication : Central
FlexConnect Central Association : No
.
.
.
Fabric status : Disabled
Client Scan Reports
Assisted Roaming Neighbor List

```



# CHAPTER 60

## RADIUS Accounting

- [Information About RADIUS Accounting of AP Events, on page 541](#)
- [Configuring Accounting Method-List for an AP Profile, on page 541](#)
- [Verifying the AP Accounting Information, on page 542](#)

### Information About RADIUS Accounting of AP Events

This topic describes the configuration of a RADIUS server to monitor a network with regards to Access Points (APs). Prior to Cisco IOS XE Amsterdam 17.1.1 release, during times of network issues, the controller would not send accounting messages when APs join and disjoin from the controller. From Cisco IOS XE Amsterdam 17.1.1 release onwards, the RADIUS server keeps a record of all the APs that were down and have come up.

### Configuring Accounting Method-List for an AP Profile

#### Procedure

	Command or Action	Purpose
<b>Step 1</b>	<b>configure terminal</b>  <b>Example:</b> Device#configure terminal	Enters global configuration mode.
<b>Step 2</b>	<b>ap profile</b> <i>ap-profile-name</i>  <b>Example:</b> Device(config)# ap profile <i>ap-profile-name</i>	Configures the AP profile. The default AP join profile name is <i>default-ap-profile</i> .
<b>Step 3</b>	<b>[no] accounting method-list</b> <i>method-list-name</i>  <b>Example:</b> Device(config-ap-profile)# [no] accounting method-list <i>method-list-name</i>	Configures the accounting method list for the AP profile.  Use the <b>no</b> form of this command to disable the command.

## Verifying the AP Accounting Information

To verify the AP accounting information, use the following command:

```
Device#show wireless stats ap accounting
Base MAC          Total packet Send   Total packet Received Methodlist
-----
00b0.e192.0f20    4           3           abc
38ed.18cc.5788    8           8           ML_M
70ea.1ae0.af08    0           0           ML_A
```

To view the details of a method list that is configured for an AP profile, use the following command:

```
Device#show ap profile name Method-list detailed
AP Profile Name      : test-profile
Description          :
.
.
.
Method-list name     : Method-list
Packet Sequence Jump DELBA : ENABLED
Lag status           : DISABLED
.
Client RSSI Statistics
  Reporting           : ENABLED
  Reporting Interval  : 30 seconds
```





## CHAPTER 61

# RADIUS Call Station Identifier

---

- [RADIUS Call Station Identifier, on page 543](#)
- [Configuring a RADIUS Call Station Identifier, on page 544](#)

## RADIUS Call Station Identifier

The RADIUS called station identifier attribute allows a Network Access Server (NAS) to capture the Access-Request packet used by a phone number by means of Dialed Number Identification (DNIS) or similar technology. The IEEE 802.1X authenticators can use this attribute to store the bridge or Access Point MAC address in ASCII format.

The called station identifier allows a RADIUS server to specify the MAC addresses or networks that a client can connect. One such attribute can be added in the Access-Request packet. The called station identifier is useful in scenarios where preauthentication is supported. In such instances, the called station identifier enables the RADIUS server to restrict the networks and attachment points the client can connect.



---

**Note** The called station identifier attribute is applicable only for Access-Request and not for Access-Accept or CoA-Request.

---

In Cisco IOS XE Bengaluru 17.4.1, the RADIUS called station identifier configuration is enhanced to include more attributes. The newly added options for authentication and accounting are listed below:

- policy-tag-name
- flex-profile-name
- ap-macaddress-ssid-flexprofilename
- ap-macaddress-ssid-policytagname
- ap-macaddress-ssid-sitetagname
- ap-ethmac-ssid-flexprofilename
- ap-ethmac-ssid-policytagname
- ap-ethmac-ssid-sitetagname

For more information on the attributes listed above, see the following commands:

- radius-server attribute wireless accounting call-station-id
- radius-server attribute wireless authentication call-station-id

## Configuring a RADIUS Call Station Identifier

### Procedure

	Command or Action	Purpose
<b>Step 1</b>	<b>configure terminal</b> <b>Example:</b> Device# configure terminal	Enters global configuration mode.
<b>Step 2</b>	<b>radius-server attribute wireless authentication call-station-id policy-tag-name</b> <b>Example:</b> Device(config)# radius-server attribute wireless authentication call-station-id policy-tag-name	Configures a call station identifier sent in the RADIUS authentication messages.
<b>Step 3</b>	<b>radius-server attribute wireless accounting call-station-id policy-tag-name</b> <b>Example:</b> Device(config)# radius-server attribute wireless accounting call-station-id policy-tag-name	Configures a call station identifier sent in the RADIUS accounting messages.



## CHAPTER 62

# RADIUS VSA

---

- [Information About RADIUS VSA, on page 545](#)
- [Create an Attribute List, on page 546](#)
- [Create a AAA Policy and Map it to Attribute List, on page 547](#)
- [Map a AAA Policy to the WLAN Policy Profile, on page 548](#)
- [Map the WLAN Policy Profile to a WLAN, on page 549](#)

## Information About RADIUS VSA

The Internet Engineering Task Force (IETF) draft standard specifies a method for communicating vendor-specific information between the network access server and the RADIUS server by using vendor specific attributes (VSA). VSA allow vendors to support their own extended attributes otherwise not suitable for general use. The controller uses these attributes value in authentication or accounting packets, or both based on specified usage format.

VSA contains these three elements:

- Type
- Length
- String (also known as data)
  - Vendor-ID
  - Vendor-Type
  - Vendor-Length
  - Vendor-Data

This feature is supported only in FlexConnect central authentication mode with local switching. FlexConnect local authentication mode is not supported.

This feature is supported only for wireless sessions.

This feature supports the following set of VSAs per WLAN for authentication and accounting requests, in addition to the existing AAA attributes.

Table 26: Newly Supported Attributes

Attribute Name	Well-known Attribute	VSA Sub-attribute	Vendor ID
SVR-Zip-Code	26	14	14369
SVR-Device-Type	26	17	14369
SVR-Device-Model-Number	26	18	14369
SVR-Lat-Long	26	19	14369
SVR-Venue-Category	26	20	14369
SVR-Network-Type	26	21	14369
Aggregation-AAA	26	22	14369
BW-Venue-Id	26	7	22472
BW-Venue-TZ	26	8	22472
BW-Class	26	10	22472
BW-Venue-Description	26	11	22472
BW-ISO-Country-Code	26	14	22472
BW-E164-Country-Code	26	15	22472
BW-State-Name	26	16	22472
BW-City-Name	26	17	22472
BW-Area-Code	26	18	22472
BW-User-Group	26	27	22472
BW-Venue-Name	26	29	22472
BW-Operator-Name	26	37	22472

## Create an Attribute List

### Procedure

	Command or Action	Purpose
<b>Step 1</b>	<b>configure terminal</b> <b>Example:</b> Device# configure terminal	Enters global configuration mode.

	Command or Action	Purpose
<b>Step 2</b>	<b>aaa attribute list</b> <i>list</i> <b>Example:</b> Device(config)# aaa attribute list TEST	Creates a AAA attribute list.
<b>Step 3</b>	<b>attribute type</b> <i>attribute-type</i> <b>Example:</b> Device(config-attr-list)# attribute type BW-City-Name "MUMBAI"	Specifies a AAA attribute type.
<b>Step 4</b>	<b>attribute type</b> <i>attribute-type</i> <b>Example:</b> Device(config-attr-list)# attribute type BW-State-Name "MAHARASHTRA"	(Optional) Specifies a AAA attribute type.
<b>Step 5</b>	<b>attribute type</b> <i>attribute-type</i> <b>Example:</b> Device(config-attr-list)#attribute type BW-Venue-Name "WANKHEDE"	(Optional) Specifies a AAA attribute type.
<b>Step 6</b>	<b>end</b> <b>Example:</b> Device(config-attr-list)# end	Returns to Privileged EXEC mode.

**What to do next**

Create a AAA policy and map the attribute list.

## Create a AAA Policy and Map it to Attribute List

**Procedure**

	Command or Action	Purpose
<b>Step 1</b>	<b>configure terminal</b> <b>Example:</b> Device# configure terminal	Enters global configuration mode.
<b>Step 2</b>	<b>wireless aaa policy</b> <i>aaa-policy</i> <b>Example:</b> Device(config)# wireless aaa policy policy-1	Creates a new AAA policy.
<b>Step 3</b>	<b>attrlist authentication</b> <i>authentication-attr-list</i> <b>Example:</b>	Configures VSA authentication attribute list.

	Command or Action	Purpose
	Device(config-aaa-policy)# attrlist authentication auth-attr-list	
<b>Step 4</b>	<b>attrlist accounting</b> <i>accounting-attr-list</i> <b>Example:</b> Device(config-aaa-policy)# attrlist accounting acct-attr-list	Configures VSA accounting attribute list.
<b>Step 5</b>	<b>end</b> <b>Example:</b> Device(config-aaa-policy)# end	Returns to Privileged EXEC mode.

**What to do next**

Map the AAA policy to the WLAN policy profile.

## Map a AAA Policy to the WLAN Policy Profile

**Procedure**

	Command or Action	Purpose
<b>Step 1</b>	<b>configure terminal</b> <b>Example:</b> Device# configure terminal	Enters global configuration mode.
<b>Step 2</b>	<b>wireless profile policy</b> <i>profile-policy</i> <b>Example:</b> Device(config)# wireless profile policy EAP-AKA	Creates a new wireless policy profile.
<b>Step 3</b>	<b>aaa-policy</b> <i>aaa-policy</i> <b>Example:</b> Device(config-wireless-policy)# aaa-policy Verizon-aaa-policy	Creates a new AAA policy.
<b>Step 4</b>	<b>end</b> <b>Example:</b> Device(config-wireless-policy)# end	Returns to Privileged EXEC mode.

**What to do next**

Map the WLAN policy profile to a WLAN.

# Map the WLAN Policy Profile to a WLAN

## Procedure

	Command or Action	Purpose
<b>Step 1</b>	<b>configure terminal</b> <b>Example:</b> Device# configure terminal	Enters global configuration mode.
<b>Step 2</b>	<b>wireless tag policy <i>policy-name</i></b> <b>Example:</b> Device(config)# wireless tag policy EAP-AKA	Creates a new policy tag.
<b>Step 3</b>	<b>wlan <i>wlan-profile-name</i> policy <i>aaa-policy</i></b> <b>Example:</b> Device(config-policy-tag)# wlan EAP-AKA policy EAP-AKA	Maps the policy profile to a WLAN.
<b>Step 4</b>	<b>end</b> <b>Example:</b> Device(config-policy-tag)# end	Returns to Privileged EXEC mode.







## CHAPTER 63

# Cisco StadiumVision

---

- [Cisco StadiumVision Overview](#), on page 551
- [Configure Parameters for Cisco StadiumVision \(GUI\)](#), on page 552
- [Configure Parameters for Cisco StadiumVision \(CLI\)](#), on page 552
- [Verify StadiumVision Configurations](#), on page 553

## Cisco StadiumVision Overview

Cisco StadiumVision solution is a proven, end-to-end, high-definition IPTV solution that provides advanced digital content management and delivery that can transform the look and feel of venues. It is built on top of the Cisco Connected Stadium solution and centrally-managed through the StadiumVision Director. Cisco StadiumVision solution enables the integration and automated delivery of customized and dynamic content from multiple sources to different areas of the stadium in high definition quality.

This technology allows you to replay certain exciting and critical moments of a game on Wi-Fi capable devices.

To enable Cisco StadiumVision solution on the controller , you need to configure these parameters:

1. On Wireless Controller :
  - Multicast Data Rate
  - RX Sensitivity SOP
  - Multicast Buffer
2. CAPWAP
3. AP Radio Driver and Firmware:
  - Multicast Data Rate
  - RX Sensitivity SOP
  - Multicast Buffer

## Configure Parameters for Cisco StadiumVision (GUI)

### Procedure

- 
- Step 1** Choose **Configuration > Wireless > Advanced**.
  - Step 2** Click the **High Density** tab.
  - Step 3** In the **Multicast Data Rate** section, set the data rate for 5 GHz radio or 2.4 GHz radio using the drop-down lists.
  - Step 4** Click **Apply** .
- 

## Configure Parameters for Cisco StadiumVision (CLI)



**Note** Multicast buffer and data rate configurations are supported for all AP models.

### Procedure

	Command or Action	Purpose
<b>Step 1</b>	<b>wlan</b> <i>wlan-name wlan-id</i> <b>Example:</b> Device(config)# wlan wlan1 10	Configures a WLAN.
<b>Step 2</b>	<b>multicast buffer</b> <i>multicast-buffer-number</i> <b>Example:</b> Device(config-wlan)# multicast buffer 45	Configures enhanced multicast buffer size between 30 (default) and 60 on a WLAN. <b>Note</b> You can enable only two out of the possible 512 WLANs configured on Controller embedded wireless controller for enhanced multicast buffers.
<b>Step 3</b>	<b>ap dot11 [5ghz  24ghz] multicast data-rate rate</b> <b>Example:</b> Device(config)# ap dot11 [5ghz  24ghz] rx-sop threshold custom -70	Configures the radio receive sensitivity SOP threshold between -60 to -85 dB, which can also be configured as predefined auto, low, high, medium values specific to 5ghz or 24ghz bands. By default, the configuration is disabled and it's value is set to <i>auto</i> . If the RxSOP value of <i>auto</i> (0) is pushed, then the AP considers the value burnt-in during manufacturing.

# Verify StadiumVision Configurations

- **show ap rf-profile name *rf-name* detail**
- **show ap dot11 5ghz *high-density***

## Rx SOP

```
Device#show ap rf-profile name Typical_Client_Density_rf_5gh detail | i SOP
Rx SOP Threshold           : auto
```

## Multicast Buffer

```
Device#show wlan id 1 | sec Buffer
Multicast Buffer           : Enabled
Multicast Buffer Size      : 45
```

Device#

```
Device#sh wlan name vwlc-OpenAuth | inc Buffer
Multicast Buffer           : Enabled
Multicast Buffer Size      : 45
Device#
```

## Multicast Data Rate

```
Device#sh ap dot11 24ghz high-density
AP Name           Mac Address           Slot           Rxsop
Threshold Type Value (dbm)           Multicast Data Rate(Mbps)
-----
test-1800-AP      aaaa.bbbb.cccc           0             auto
0                54
AP4001.7AB2.BEB6  aaab.bbbb.cccc           2             auto
0                54
AP70DF.2FA2.72EE  aaac.bbbb.cccc           0             auto
0                0
```

```
Device#show ap dot11 5ghz high-density
AP Name           Mac Address           Slot           Rxsop
Threshold Type Value (dbm)           Multicast Data Rate(Mbps)
-----
Saji-1800-AP      aaab.bbbb.cccc           1             auto
0                12
Saji-2802I-AP     aaab.bbbb.cccc           0             custom
-82              12
Saji-2802I-AP     aaac.bbbb.cccc           1             custom
-82              12
AP4001.7AB2.BEB6  aaad.bbbb.cccc           0             custom
-82              12
AP4001.7AB2.BEB6  aaae.bbbb.cccc           1             custom
-82              0
AP500F.8086.8B56  aaaf.bbbb.cccc           0             custom
-82              12
AP500F.8086.8B56  aaag.bbb.cccc           1             custom
```

```
          -82                12
AP70DF.2FA2.72EE          aaah.bbbb.cccc        1        auto
          0                  0
```

```
Device#
Device(config)#ap dot11 5ghz rf-profile test_5ghz_rf
Device(config-rf-profile)#high-density multicast data-rate RATE_18M
```

```
Device# show ap rf-profile name test_5ghz_rf detail | inc Multicast
Multicast Data Rate          : 18 Mbps
Device#
```



# CHAPTER 64

## Persistent SSID Broadcast

- [Persistent SSID Broadcast, on page 555](#)
- [Configuring Persistent SSID Broadcast, on page 555](#)
- [Verifying Persistent SSID Broadcast, on page 556](#)

### Persistent SSID Broadcast

Access Points within a mesh network work as Root Access Points (RAP) or Mesh Access Points (MAP). RAPs have wired connection to the controller and MAPs have wireless connection to the controller. This feature is applicable only to the Cisco Aironet 1542 Access Points in the Flex+Bridge mode.

This feature is about the Root Access Points (RAPs) and Mesh Access Points (MAPs) broadcasting the SSID even when the WAN connectivity is down. This is required in order to isolate the responsibility; whether the fault is with backhaul or with the access wireless network, since there can be different operators owning each part of the network.

RAPs and MAPs broadcast SSID while in standalone mode, as long as the default gateway is reachable.

Also refer [Mesh Deployment Guide for Cisco Catalyst 9800 Series Wireless Controllers](#).

### Configuring Persistent SSID Broadcast

#### Procedure

	Command or Action	Purpose
<b>Step 1</b>	<b>configure terminal</b> <b>Example:</b> Device# configure terminal	Enters global configuration mode.
<b>Step 2</b>	<b>ap profile</b> <i>ap-profile-name</i> <b>Example:</b> Device(config)# ap profile ap-profile-name	Configures the AP profile.

	Command or Action	Purpose
<b>Step 3</b>	<p><b>[no]ssid broadcast persistent</b></p> <p><b>Example:</b></p> <pre>Device(config-ap-profile)# [no] ssid broadcast persistent</pre>	<p>The <b>ssid broadcast</b> command configures the SSID broadcast mode. The <b>persistent</b> keyword enables a persistent SSID broadcast, where the associated APs will re-join. Use the <b>[no]</b> form of the command to disable the feature.</p> <p><b>Note</b> Enabling or disabling this feature causes the AP to re-join.</p>

## Verifying Persistent SSID Broadcast

To view the configuration of all Cisco APs, use the following **show** command:

```
Device#show ap config general
Cisco AP Name   : AP4C77.6DF2.D598
=====
Office Extend Mode           : Disabled
Persistent SSID Broadcast    : Enabled
Remote AP Debug              : Disabled
```



## CHAPTER 65

# Network Monitoring

---

- [Network Monitoring](#) , on page 557
- [Status Information Received Synchronously - Configuration Examples](#), on page 557
- [Alarm and Event Information Received Asynchronously - Configuration Examples](#), on page 559

## Network Monitoring

The mechanism that is used to transfer data to the third-party system is NETCONF/YANG. YANG can be used with the Network Configuration Protocol (NETCONF) to provide the desired solution of automated and programmable network operations.

You can contact the API or Developer Support for NETCONF/YANG features using the following link:

<https://developer.cisco.com/site/support/#>

The two types of information provided are:

- Status information received synchronously - NETCONF is the management interface used for status information, which allows to publish the operational state of the device, including the controller .
- Alarm and event information sent asynchronously - NETCONF/YANG push is the solution used for alarm and event information, which provides the mechanism to send NETCONF notifications subscribed for.

## Status Information Received Synchronously - Configuration Examples

NETCONF/YANG interface is used to accomplish customer requests.

The prerequisite configuration for Status Information and Alarm and Event Information is to enable NETCONF server on the controller by using the following command:

```
netconf-yang
```



**Note** The Cisco Catalyst 9800 wireless controller currently only supports RSA keys for the trustpoint used by the ncssh process. Using EC keys instead of the RSA keys will cause the ncssh process to crash and it will prevent using NETCONF.

The above command not only enables notifications, but also allows for configuration and operation access (OAM) via Netconf/Yang. For more information on Netconf/Yang, see the *NETCONF Protocol* chapter of the Programmability Configuration Guide at: <https://www.cisco.com/c/en/us/support/ios-nx-os-software/ios-xe-17/products-installation-and-configuration-guides-list.html>

In the Status Information Received Synchronously type, the following information is exported through NETCONF:

- Name of the village
- APs in each village
- Status of each AP
- Number of clients currently connected and logged on in each village and each AP

All the data for the items listed above is already available as the controller operational data exported through NETCONF. The examples below explain where the data items listed are available.

The following command is used in the controller :

```
wireless tag site village_name_1
```

The site tags can be retrieved by NETCONF using the **get-config** operation.

Example output for **Name of the Village**:

```
<site-cfg-data xmlns="http://cisco.com/ns/yang/Cisco-IOS-XE-wireless-site-cfg">
[... ]
<site-tag-configs>
  <site-tag-config>
    <site-tag-name>village_name_1</site-tag-name>
    <description>custom user site tag for a village</description>
  </site-tag-config>
[... ]
</site-tag-configs>
```

The controller 's operational data contains all the connected (joined) APs and lists their site tags. The example output displays the detailed information about the APs and the site tags. The following example displays the relevant fields and the corresponding controller show commands:

Example output of **Access Point per Village**:

```
<data>
  <access-point-oper-data
xmlns="http://cisco.com/ns/yang/Cisco-IOS-XE-wireless-access-point-oper">
  [...]
  <radio-oper-data>
    <wtp-mac>00:1b:0c:00:02:00</wtp-mac>      #show ap dot11 {24ghz|5ghz} summary "MAC
Address"
    <radio-slot-id>0</radio-slot-id>          #show ap dot11 {24ghz|5ghz} summary "Slot"
    <ap-mac>00:1b:0c:00:02:00</ap-mac>
    <slot-id>0</slot-id>
    <radio-type>1</radio-type>                # 1 - 2.4GHz, 2 - 5GHz
    <admin-state>enabled</admin-state>       #show ap dot11 {24ghz|5ghz} summary "Admin"
```



```

State"
  <oper-state>radio-up</oper-state>          #show ap dot11 {24ghz|5ghz} summary "Oper
State"
  [...]
[...]
  <capwap-data>
    <wtp-mac>00:1b:0c:00:02:00</wtp-mac>      #show ap summary "Radio MAC"
    <ap-operation-state>registered</ap-operation-state> #show ap summary "State"
    <ip-addr>10.102.140.10</ip-addr>        #show ap summary "IP Address"
    [...]
    <admin-state>1</admin-state>            #show ap status "Status", 1 - Enabled,
2 - Disabled
    <location>default-location </location>   #show ap summary "Location"
    <country-code>CH </country-code>
    <name>AP_A-1</name>                      #show ap summary "AP Name"
  [...]
  <tag-info>
    [...]
    <site-tag>
      <site-tag-name>village_name_1</site-tag-name> #show ap name AP_A-1 config general
"Site Tag Name"
      [...]
    </site-tag>
  [...]

```

The operational data of the controller contains all the connected wireless clients information, which includes detailed client device information, such as the MAC address, IP address, State and the AP name.

Example output of the **Number of clients currently online and logged in each village and each AP:**

```

<data>
  <client-oper-data xmlns="http://cisco.com/ns/yang/Cisco-IOS-XE-wireless-client-oper">
    <common-oper-data>
      <client-mac>00:00:1a:04:00:02</client-mac>      #show wireless client summary "MAC
Address"
      <ap-name>AP_A-1</ap-name>                      #show wireless client summary "AP
Name"
      [...]
      <co-state>client-status-run</co-state>          #show wireless client summary "State"
    </common-oper-data>
  </client-oper-data>

```

## Alarm and Event Information Received Asynchronously - Configuration Examples

The push functionality for the alarm and event information is fulfilled with on-change notifications through NETCONF dynamic subscriptions, with XML encoding.

Example output of **AP Up/Down Events - Subscription**

Request:

```

<?xml version="1.0" encoding="UTF-8"?>
<rpc message-id="urn:uuid:b0c581c9-ff5a-4352-9e64-7f2ce1ec603a"
xmlns="urn:iETF:params:xml:ns:netconf:base:1.0">
  <establish-subscription xmlns="urn:iETF:params:xml:ns:yang:iETF-event-notifications"
xmlns:yp="urn:iETF:params:xml:ns:yang:iETF-yang-push">
    <stream>yp:yang-push</stream>
  </establish-subscription>
</rpc>

```

```

    <yp:xpath-filter>/access-point-oper-data/capwap-data/ap-operation-state</yp:xpath-filter>

    <yp:dampening-period>0</yp:dampening-period>
  </establish-subscription>
</rpc>

```

Reply:

```

<?xml version="1.0" encoding="UTF-8"?>
<rpc-reply xmlns="urn:ietf:params:xml:ns:netconf:base:1.0"
message-id="urn:uuid:673b42b2-e988-4e20-a6c3-0679c08e6114"><subscription-result
xmlns='urn:ietf:params:xml:ns:yang:ietf-event-notifications'
xmlns:notif-bis="urn:ietf:params:xml:ns:yang:ietf-event-notifications">notif-bis:ok</subscription-result>
<subscription-id
xmlns='urn:ietf:params:xml:ns:yang:ietf-event-notifications'>2147483652</subscription-id>
</rpc-reply>
-->>
(Default Callback)
Event time      : 2018-03-09 15:08:21.880000+00:00
Subscription Id : 2147483651
Type           : 2
Data           :
<datastore-changes-xml xmlns="urn:ietf:params:xml:ns:yang:ietf-yang-push">
  <yang-patch xmlns="urn:ietf:params:xml:ns:yang:ietf-yang-patch">
    <patch-id>null</patch-id>
    <edit>
      <edit-id>edit1</edit-id>
      <operation>merge</operation>
      <target>/access-point-oper-data/capwap-data</target>
      <value>
        <capwap-data xmlns="http://cisco.com/ns/yang/Cisco-IOS-XE-wireless-access-point-oper">

          <ap-operation-state>registered</ap-operation-state>
          <wtp-mac>00ab11006600</wtp-mac>
        </capwap-data>
      </value>
    </edit>
  </yang-patch>
</datastore-changes-xml>
<<--

```



## CHAPTER 66

# Creating a Lobby Ambassador Account

---

- [Information About Lobby Ambassador Account, on page 561](#)
- [Creating a Lobby Ambassador User Account \(GUI\), on page 561](#)
- [Creating a Lobby Ambassador Account \(CLI\), on page 563](#)

## Information About Lobby Ambassador Account

A global administrator can create a lobby ambassador (lobby admin) user for creating guest users.

While creating a guest user, a lobby ambassador can create and delete a guest user, besides setting the following parameters for a guest user:

- Password
- Lifetime of the guest user
- Guest role profiles (Quality-of-Service profiles that should be applied on a guest using the AAA attribute list).

You must ensure that the RADIUS server must be configured with Cisco-AV-pair privilege level with a value greater than zero.



---

**Note** You can create a lobby admin from a RADIUS or TACACS server, instead of creating one locally. Only the admin can create WLAN and web authentication policies. The admin can also create an AAA attribute list, which the lobby admin can use to map to the corresponding guest user. After an upgrade to Cisco Catalyst 9800 Controller Software release 17.2.x , you must clear the browser cache data to view the lobby admin GUI correctly.

---

## Creating a Lobby Ambassador User Account (GUI)

You can configure administrator or lobby ambassador usernames and passwords to prevent unauthorized users from reconfiguring the controller and viewing configuration information.

# Creating a User Account

## Procedure

---

- Step 1** From the home page, choose **Administration > User Administration**.
- Step 2** Click **Add**.
- Step 3** In the **User Name** field, enter a user name for the new account.
- Step 4** From the **Policy** drop-down list, choose the policy that you want to associate with the user.
- Step 5** From the **Privilege** drop-down list, choose the privilege level that you want to associate with the user by clicking the user privilege icon. The following are the options:

- **Go to Basic Mode**
- **Go to Advanced Mode**

**Go to Basic Mode:** This privilege level defines the commands that users can enter using the CLI after they have logged into the device. Privilege 1 allows access in user EXEC mode and privilege 15 allows access in Privileged EXEC mode.

### Go to Advanced Mode:

**Admin:** Users with Privilege 15 can execute all the **show**, **config**, and **exec** commands on the device. These users will have access to all the sections of the GUI.

**Read Only:** Users with Privileges 1 to 14 are considered read-only users. The default privilege is 1 if a user is created using the GUI. These users will have access only to the Dashboard and the Monitoring sections.

**No Access:** Users with Privilege 0 can log in to the device through Telnet or SSH and access the CLI. However, they cannot access the GUI.

**Lobby Admin:** Users who can create only guest user accounts. While creating a guest user, a lobby ambassador can create and delete a guest user, besides setting the following parameters for a guest user:

- Password
- Lifetime of the guest user
- Guest role profiles (quality-of-service) profiles that should be applied on a guest using the AAA attribute list.

- Step 6** In the **Password** field, enter a password for the new account.
- Step 7** In the **Confirm Password** field, enter the same password again to reconfirm.
- Step 8** Click **Apply to Device**.
-

## Logging In Using the Lobby Account



**Note** Execute the following commands before logging in using the lobby credentials:

```
aaa new-model
aaa authorization exec default local
ip http authentication aaa
```

Logout from the Administrator account and login using the lobby credentials.

You get to view the **Guest User** page.

## Creating a Lobby Ambassador Account (CLI)

### Procedure

	Command or Action	Purpose
<b>Step 1</b>	<b>configure terminal</b> <b>Example:</b> Device# configure terminal	Enters global configuration mode.
<b>Step 2</b>	<b>user-name <i>user-name</i></b> <b>Example:</b> Device(config)# user-name example-user	Creates a user account.
<b>Step 3</b>	<b>type lobby-admin</b> <b>Example:</b> Device(config-user-name)# type lobby-admin	Specifies the account type as lobby admin.
<b>Step 4</b>	<b>password 0 <i>password</i></b> <b>Example:</b> Device(config-user-name)# password 0 example-password	Creates a password for the lobby administrator account.
<b>Step 5</b>	<b>aaa attribute list <i>user-name</i></b> <b>Example:</b> Device(config-user-name)# aaa attribute list example-user	Creates attribute list for lobby admin access.
<b>Step 6</b>	<b>attribute type <i>wlan-profile-name</i></b> <b>Example:</b> Device(config-user-name)# attribute type wlan_wl_mab	Creates attribute type for lobby admin access.

	Command or Action	Purpose
<b>Step 7</b>	<b>exit</b>  <b>Example:</b> Device(config-user-name)# exit	Returns to global configuration mode.



## CHAPTER 67

# Lobby Ambassador Account

---

- [Information About Lobby Ambassador Account, on page 565](#)
- [Creating a Lobby Ambassador User Account \(GUI\), on page 566](#)
- [Creating a Lobby Ambassador Account \(CLI\), on page 567](#)
- [Configuring WLAN \(GUI\), on page 568](#)
- [Client Allowed List, on page 569](#)
- [Restrictions for Client Allowed List, on page 569](#)
- [Creating a Client Allowed List \(GUI\), on page 569](#)
- [Managing Guest Users, on page 570](#)
- [Viewing a Client Allowed List, on page 571](#)

## Information About Lobby Ambassador Account

A global administrator can create a lobby ambassador (lobby admin) user for creating guest users.

While creating a guest user, a lobby ambassador can create and delete a guest user, besides setting the following parameters for a guest user:

- Password
- Lifetime of the guest user
- Guest role profiles (Quality-of-Service profiles that should be applied on a guest using the AAA attribute list).

You must ensure that the RADIUS server must be configured with Cisco-AV-pair privilege level with a value greater than zero.



---

**Note** You can create a lobby admin from a RADIUS or TACACS server, instead of creating one locally.

Only the admin can create WLAN and web authentication policies. The admin can also create an AAA attribute list, which the lobby admin can use to map to the corresponding guest user.

After an upgrade to Cisco Catalyst 9800 Controller Software release 17.2.x, you must clear the browser cache data to view the lobby admin GUI correctly.

---

# Creating a Lobby Ambassador User Account (GUI)

You can configure administrator or lobby ambassador usernames and passwords to prevent unauthorized users from reconfiguring the controller and viewing configuration information.

## Creating a User Account

### Procedure

---

- Step 1** From the home page, choose **Administration > User Administration**.
- Step 2** Click **Add**.
- Step 3** In the **User Name** field, enter a user name for the new account.
- Step 4** From the **Policy** drop-down list, choose the policy that you want to associate with the user.
- Step 5** From the **Privilege** drop-down list, choose the privilege level that you want to associate with the user by clicking the user privilege icon. The following are the options:

- **Go to Basic Mode**
- **Go to Advanced Mode**

**Go to Basic Mode:** This privilege level defines the commands that users can enter using the CLI after they have logged into the device. Privilege 1 allows access in user EXEC mode and privilege 15 allows access in Privileged EXEC mode.

**Go to Advanced Mode:**

**Admin:** Users with Privilege 15 can execute all the **show**, **config**, and **exec** commands on the device. These users will have access to all the sections of the GUI.

**Read Only:** Users with Privileges 1 to 14 are considered read-only users. The default privilege is 1 if a user is created using the GUI. These users will have access only to the Dashboard and the Monitoring sections.

**No Access:** Users with Privilege 0 can log in to the device through Telnet or SSH and access the CLI. However, they cannot access the GUI.

**Lobby Admin:** Users who can create only guest user accounts. While creating a guest user, a lobby ambassador can create and delete a guest user, besides setting the following parameters for a guest user:

- Password
- Lifetime of the guest user
- Guest role profiles (quality-of-service) profiles that should be applied on a guest using the AAA attribute list.

- Step 6** In the **Password** field, enter a password for the new account.
- Step 7** In the **Confirm Password** field, enter the same password again to reconfirm.
- Step 8** Click **Apply to Device**.
-



## Logging In Using the Lobby Account



**Note** Execute the following commands before logging in using the lobby credentials:

```
aaa new-model
aaa authorization exec default local
ip http authentication aaa
```

Logout from the Administrator account and login using the lobby credentials.

You get to view the **Guest User** page.

## Creating a Lobby Ambassador Account (CLI)

### Procedure

	Command or Action	Purpose
<b>Step 1</b>	<b>configure terminal</b> <b>Example:</b> Device# configure terminal	Enters global configuration mode.
<b>Step 2</b>	<b>user-name <i>user-name</i></b> <b>Example:</b> Device(config)# user-name example-user	Creates a user account.
<b>Step 3</b>	<b>type lobby-admin</b> <b>Example:</b> Device(config-user-name)# type lobby-admin	Specifies the account type as lobby admin.
<b>Step 4</b>	<b>password 0 <i>password</i></b> <b>Example:</b> Device(config-user-name)# password 0 example-password	Creates a password for the lobby administrator account.
<b>Step 5</b>	<b>aaa attribute list <i>user-name</i></b> <b>Example:</b> Device(config-user-name)# aaa attribute list example-user	Creates attribute list for lobby admin access.
<b>Step 6</b>	<b>attribute type <i>wlan-profile-name</i></b> <b>Example:</b> Device(config-user-name)# attribute type wlan_wl_mab	Creates attribute type for lobby admin access.

	Command or Action	Purpose
<b>Step 7</b>	<b>exit</b>  <b>Example:</b> Device(config-user-name)# exit	Returns to global configuration mode.

## Configuring WLAN (GUI)

### Before you begin

You need to enable MAC filtering for Layer 2 authentication to download the redirect URL and ACL.

### Procedure

- 
- Step 1** Choose **Configuration > Tags & Profiles > WLANs**.
- Step 2** In the **WLANs** window, click the name of the **WLAN** or click **Add** to create a new one.
- Step 3** In the **Add/Edit WLAN** window that is displayed, click the **General** tab to configure the following parameters.
- In the **Profile Name** field, enter or edit the name of the profile.
  - In the **SSID** field, enter or edit the SSID name.  
The SSID name can be alphanumeric, and up to 32 characters in length.
  - In the **WLAN ID** field, enter or edit the ID number. The valid range is between 1 and 512.
  - From the **Radio Policy** drop-down list, choose the **802.11** radio band.
  - Using the **Broadcast SSID** toggle button, change the status to either **Enabled** or **Disabled**.
  - Using the **Status** toggle button, change the status to either **Enabled** or **Disabled**.
- Step 4** Click the **Security** tab, and then **Layer 2** tab to configure the following parameters:
- From the **Layer 2 Security Mode** drop-down list, choose **None**. This setting disables Layer 2 security.
  - Enter the **Reassociation Timeout** value, in seconds. This is the time after which a fast transition reassociation times out.
  - Check the **Over the DS** check box to enable Fast Transition over a distributed system.
  - Choose OWE, Opportunistic Wireless Encryption (OWE) provides data confidentiality with encryption over the air between an AP radio and a wireless client. OWE Transition Mode is meant to provide a sort of backwards compatibility.
  - Choose Fast Transition, 802.11r which is the IEEE standard for fast roaming, introduces a new concept of roaming where the initial handshake with a new AP is done even before the corresponding client roams to the target access point. This concept is called Fast Transition.
  - Check the check box to enable MAC filtering in the WLAN.
  - Check the **Lobby Admin Access** check box to enable Lobby Admin access.

**Step 5** Click **Save & Apply to Device**.

---

## Client Allowed List

Clients in universities and hotels need access to networks for a limited period of time. These locations also receive many guests with multiple devices. Therefore it becomes important to protect the networks from misuse or unauthorized access, and allow legitimate clients to connect to the corresponding network.

The client listing feature addresses the need of creating an allowed list for clients on a particular WLAN or SSID- based MAC address.

When you create a new client MAC address as an allowed list user with an invalid WLAN profile name, you must be careful while you map the client MAC to the WLAN profile.

Client allowed list is supported only with MAC addresses that are without a delimiter format.

Two types of administrator roles defined are:

- **Global Administrator:** Creates a lobby admin user on the controller and enables the lobby administrators access each to the WLAN.
- **Lobby Administrator:** Adds or deletes a client from the allowed list to manage the association to a WLAN or SSID through the GUI only. Existing lobby administrators can also be used to configure the allowed list.

## Restrictions for Client Allowed List

A lobby admin can add clients to allowed list only through the graphical user interface (GUI) and not through the command-line interface (CLI).

## Creating a Client Allowed List (GUI)

This section provides multiple methods that you can use as a lobby administrator to create an allowed list for valid users for a WLAN.

## Adding Single MAC Address to Allowed List

### Procedure

---

- Step 1** Log into Lobby Admin portal.
- Step 2** Click **Whitelist Users**.
- Step 3** From the drop-down list, choose **WLAN**.
- Step 4** Click **Add New Whitelist User**.
- Step 5** Select **By MAC Address** radio button.

- Step 6** Enter the **MAC address** and **Description**.
  - Step 7** Click **Apply to Device**.
- 

## Adding Bulk MAC Address to Allowed List

### Procedure

---

- Step 1** Log into Lobby Admin portal.
  - Step 2** Click **Whitelist Users**.
  - Step 3** From the drop-down list, choose the WLAN.
  - Step 4** Click **Add New Whitelist User**.
  - Step 5** Select **Bulk Import** radio button.
  - Step 6** Select the CSV file that lists the clients in MAC Address, Description format.
  - Step 7** Click **Apply to Device**.
- 

## Managing Guest Users

### Procedure

---

- Step 1** Log in to Lobby Admin portal using the lobby admin credentials.
  - Step 2** Click **Whitelist Users**.
  - Step 3** From the **WLAN** drop-down list, choose the corresponding **WLAN**.
  - Step 4** From the **WLAN Mode**, select **Onboarding** to enable clients to access the network.
  - Step 5** Click **Apply**.
  - Step 6** From the **Connected/Not Whitelisted** in the Whitelist window, select a MAC address . Once the clients join the controller, the MAC addresses are listed in the **Connected/Not Whitelisted**. In the Onboarding mode, MAC filtering in the selected WLAN is disabled. In such a scenario you can change the mode using **Secure** mode.
  - Step 7** Select **Secure** to automatically add the clients that are connected to the allowed list. In the secure mode, MAC filtering in the selected WLAN is enabled.
  - Step 8** Click **Apply to Device**.  
The clients are listed in the **Connected/Whitelisted**.
-

# Viewing a Client Allowed List

## Procedure

---

- Step 1** Log in to the Lobby Admin portal.
- Step 2** Click **Whitelist Users**.
- Step 3** From the **WLAN** drop-down list, choose the corresponding **WLAN**.

The window lists the following information:

- **Connected/Whitelisted:** Lists the clients that are connected and added to the allowed list by the Lobby admin.
  - **Connected/Not Whitelisted:** Lists the clients that are connected, but not added to the allowed list by the Lobby admin.
  - **Not Connected/Whitelisted:** Lists the clients that are not connected but added to the allowed list.
-





## CHAPTER 68

# Guest User Accounts

---

- [Information About Creating Guest User Accounts, on page 573](#)
- [Creating a Guest User Account \(GUI\), on page 573](#)
- [Creating a Guest User Account \(CLI\), on page 574](#)
- [Verifying Guest User Account, on page 575](#)
- [Assigning Username to Guest Users in a WLAN \(CLI\), on page 576](#)

## Information About Creating Guest User Accounts

The controller can provide guest user access on WLANs for which you must create guest user accounts. Guest user accounts can be created by network administrators, or, if you would like a non-administrator to be able to create guest user accounts on demand, you can do so through a lobby administrator account. The lobby ambassador has limited configuration privileges and access only to the web pages used to manage the guest user accounts.

The lobby ambassador can specify the amount of time that the guest user accounts remain active. After the specified time elapses, the guest user accounts expire automatically.

You can associate user name with WLAN profile name to restrict guest users in a specific WLAN.

### Prerequisites for Guest Users

- Guest users are created by administrator or lobby ambassador.
- Guest user should not have device access either through telnet/ssh or WebUI.
- Guest user should be role-based.
- Guest user should be able to connect to the network and access internet.

## Creating a Guest User Account (GUI)

### Procedure

---

- Step 1** Choose **Configuration > Security > Guest User**.

- Step 2** On the **Guest User** page, click **Add**.
- Step 3** Enter a user name, password, and description for the new account. Check the **Generate password** check box to automatically generate a password.
- Step 4** Enter the number of simultaneous user logins. Valid values range between 0 to 64.  
Enter 0 for unlimited users.
- Step 5** In the **Lifetime** section, choose the number of years, months, days, hours, and minutes.
- Step 6** Click **Save & Apply to Device**.

## Creating a Guest User Account (CLI)

### Procedure

	Command or Action	Purpose
<b>Step 1</b>	<b>configure terminal</b> <b>Example:</b> Device# configure terminal	Enters global configuration mode.
<b>Step 2</b>	<b>user-name</b> <i>guest-user-name</i> <b>Example:</b> Device(config)# user-name guest	Creates a guest user account.
<b>Step 3</b>	<b>type network-user description</b> <i>description</i> <b>guest-user max-login-limit</b> <i>number of simultaneous logins</i> <b>lifetime year yy month mm day day hour hour minute minute second second</b> <b>Example:</b> Device(config-user-name)# type network-user description sample-description guest-user max-login-limit 3 lifetime 1 years 0 months 0 days 0 hours 0 mins 0 secs	Specifies the account type as guest user account.
<b>Step 4</b>	<b>password 0</b> <i>password</i> <b>Example:</b> Device(config-user-name)# password 0 guest	Creates a password for the guest user account.
<b>Step 5</b>	<b>aaa attribute list</b> <i>aaa-attribute-list-name</i> <b>Example:</b> Device(config-user-name)# aaa attribute list aaa-attribute-list-name	Creates a AAA attribute list to apply QoS profiles on the guest user account.



	Command or Action	Purpose
<b>Step 6</b>	<b>exit</b>  <b>Example:</b> Device(config-user-name)# exit	Returns to global configuration mode.  <b>Note</b> If the lobby admin is local, enter the following command:  <pre>aaa authentication login default local</pre> If the lobby admin is a remote user, enter the following commands:  <pre>aaa authentication login default group radius/tacacs aaa remote username &lt;remote-lobby-admin-name&gt;</pre> In case of local or remote lobby, enter the following command to map the authorization policies:  <pre>aaa authorization exec default local</pre>

## Verifying Guest User Account

Verify Guest User Account.

```
Device# show aaa local guest_user all
User-Name          : new4
  Type              : GUEST USER
  Password          : *
  Is_passwd_encrypted : No
  Attribute-List    : Not-Configured
  Viewname          : Not-Configured
  Lobby Admin Name  : NEW_LOBBY_ADMIN
  Max Login Limit   : 0
  Description       : guest
  Start-Time        : 07:56:39 IST Jan 25 2019
  Lifetime          : 1 years 0 months 0 days 0 hours 0 mins 0 secs
  Expiry-Time       : 07:56:39 IST Jan 20 2020 Remaining Lifetime : 0 years 11 months
29 days 22 hours 52 mins 49 secs
```

To verify a specific guest user account, use the following command:

```
Device# show aaa local guest_user new_guest3
User-Name          : new_guest3
  Type              : GUEST USER
  Password          : *
  Is_passwd_encrypted : No
  Attribute-List    : Not-Configured
  Viewname          : Not-Configured
  Lobby Admin Name  : INVALID_ADMIN
  Max Login Limit   : 9
  Description       : new
  Start-Time        : 04:39:01 IST Feb 4 2019
  Lifetime          : 1 years 0 months 0 days 0 hours 0 mins 0 secs
```

Expiry-Time : 04:39:01 IST Jan 30 2020  
 Remaining Lifetime : 0 years 11 months 11 days 21 hours 16 mins 34 secs

## Assigning Username to Guest Users in a WLAN (CLI)

### Before you begin

- If wlan-profile-name is configured for a user, guest user authentication is allowed only from that WLAN.
- If wlan-profile-name is not configured for a user, guest user authentication is allowed on any WLAN.
- To work in a connected mode, you need to configure AAA policy override under both SSID policies before assigning a username to a guest user on a WLAN.

### Procedure

	Command or Action	Purpose
<b>Step 1</b>	<b>configure terminal</b> <b>Example:</b> Device# configure terminal	Enters configuration mode.
<b>Step 2</b>	<b>username user_name mac wlan-profile-name profile_name</b> <b>Example:</b> Device(config)# username user_name mac wlan-profile-name profile_name	Assigns a username to the WLAN profile. <b>Note</b> The wlan-profile-name per user is applicable for MAC type users.
<b>Step 3</b>	<b>show aaa local guest_user new_guest3</b> <b>Example:</b> Device# show aaa local guest_user new_guest3	(Optional) Displays the values of the WLAN profile.
<b>Step 4</b>	<b>end</b> <b>Example:</b> Device# end	Returns to privileged EXEC mode.



## CHAPTER 69

# Link Local Bridging

- [Feature History for Link Local Bridging, on page 577](#)
- [Information About Link Local Bridging , on page 577](#)
- [Use Case for Link Local Bridging, on page 578](#)
- [Guidelines and Restrictions for Link Local Bridging, on page 578](#)
- [Enabling Link Local Bridging Per Policy Profile \(GUI\), on page 578](#)
- [Enabling Link Local Bridging Per Policy Profile \(CLI\), on page 579](#)
- [Verifying Link Local Bridging, on page 579](#)

## Feature History for Link Local Bridging

This table provides release and related information for the feature explained in this module.

This feature is available in all the releases subsequent to the one in which it is introduced in, unless noted otherwise.

**Table 27: Feature History for Link Local Bridging**

Release	Feature	Feature Information
Cisco IOS XE Bengaluru 17.6.1	Link Local Bridging	The Link Local Bridging feature allows you to manage link-local traffic in intercontroller and intracontroller roaming scenarios.

## Information About Link Local Bridging

In Cisco IOS XE Bengaluru 17.5.1 and earlier releases, client packets were forwarded through the access VLAN of a client. The client also received all the IPv4 or IPv6 packets from its assigned access VLAN.

When an L3 client roamed from one controller to another controller, the point-of-presence (PoP) remained with the first controller, also known as the anchor controller or the home controller, and the point-of-attachment (PoA) moved to the second controller, also known as the foreign controller or the visited controller. In this anchor-foreign scenario, the client packets were tunneled back to the anchor controller to be forwarded on the access VLAN of the client.

Similarly, in case of L3 intracontroller roaming, when the feature Roaming Across Policy Profile is enabled, the client access VLAN is maintained, regardless of the policy profile VLAN. In such a scenario, the PoA becomes the destination policy profile VLAN.

A roaming wireless client is served better by the local services present near its PoA rather than discovering services present at its PoP. Therefore, from Cisco IOS XE Bengaluru 17.6.1 onwards, the intracontroller and intercontroller roaming scenarios described above, can now be managed with the help of the Link Local Bridging feature. Link Local Bridging is disabled by default.

## Use Case for Link Local Bridging

If you have a local mode deployment, and L3 roaming is used to manage roaming clients across physical locations, the Link Local Bridging feature helps you to discover services, for example, using mDNS, which are physically close to the wireless client.

## Guidelines and Restrictions for Link Local Bridging

- The Link Local Bridging feature is supported in local-mode or FlexConnect central switching.
- Only mDNS bridge mode is supported with Link Local Bridging.
- Guest profiles are not supported.
- Wired Guest LAN, Remote LAN (RLAN), and Inter-Release Controller Mobility (IRCM) are not supported.
- Mesh and IP Source Guard (IPSG) is not supported when the Link Local Bridging feature is enabled.
- Enabling Link Local Bridging on the anchor controller and disabling it on the foreign controller is not supported, even if roaming is successful.
- Access VLAN and bridge VLAN should be operational, for the Link Local Bridging feature to work.
- Link Local Bridging must be enabled across policy profiles for the same SSID.
- Wireless multicast-over-multicast (**wireless multicast** *multicast IP address*) must be configured, before enabling the Link Local Bridging feature. Therefore, the **wireless multicast link-local** command is enabled by default when wireless multicast is enabled.

## Enabling Link Local Bridging Per Policy Profile (GUI)

### Procedure

---

- Step 1** Choose **Configuration > Tags & Profiles > Policy**.
- Step 2** Click **Add**.  
The **Add Policy Profile** window is displayed.
- Step 3** In the **Add Policy Profile** page, in the **General** tab, enter the name of the policy profile.

**Step 4** In the **Advanced** tab, check the **Link-Local Bridging** check box to enable link-local bridging on the policy profile.

**Note** When link-local bridging is enabled, Export Anchor will be disabled and Central Switching will be enabled automatically.

**Step 5** Click **Apply to Device**.

## Enabling Link Local Bridging Per Policy Profile (CLI)

To enable link local bridging per policy profile, follow these steps.

### Before you begin

Ensure that wireless multicast-over-multicast and wireless multicast link-local are enabled.



**Note** From Cisco IOS XE Bengaluru 17.6.1, the wireless multicast link-local setting is enabled by default as soon as multicast is enabled. This means that all the downstream multicast link-local frames will be forwarded to wireless clients. In the Cisco IOS XE Bengaluru 17.5.x and the earlier releases, only mDNS multicast link-local frames were forwarded.

### Procedure

	Command or Action	Purpose
<b>Step 1</b>	<b>configure terminal</b> <b>Example:</b> Device# configure terminal	Enters global configuration mode.
<b>Step 2</b>	<b>wireless profile policy <i>profile-name</i></b> <b>Example:</b> Device(config)# wireless profile policy wireless-profile1	Creates policy profile for the WLAN.
<b>Step 3</b>	<b>link-local-bridging</b> <b>Example:</b> Device(config-wireless-policy)# link-local-bridging	Enables link local bridging per policy profile.

## Verifying Link Local Bridging

To verify the configuration status of Link Local Bridging, use the following command:

```
Device# show wireless profile policy detailed policy1
Policy Profile Name          : policy1
```

```

Description                               :
Status                                    : ENABLED
VLAN                                       : 81
Multicast VLAN                            : 0
OSEN client VLAN                          :
Multicast Filter                          : DISABLED
QBSS Load                                  : ENABLED
Passive Client                             : DISABLED
ET-Analytics                              : DISABLED
StaticIP Mobility                          : DISABLED
WLAN Switching Policy
  Flex Central Switching                   : ENABLED
  Flex Central Authentication               : ENABLED
  Flex Central DHCP                        : ENABLED
  Flex NAT PAT                             : DISABLED
.
.
.
-----
mDNS Gateway
  mDNS Service Policy name                 : default-mdns-service-policy
  User Defined (Private) Network           : Disabled
  User Defined (Private) Network Unicast Drop : Disabled
  Policy Proxy Settings
    ARP Proxy State                        : DISABLED
    IPv6 Proxy State                       : None
  Airtime-fairness Profile
    2.4Ghz ATF Policy                      : default-atf-policy
    5Ghz ATF Policy                       : default-atf-policy
  Link-local bridging                      : ENABLED

```

To verify if Link Local Bridging VLAN is included, use the following command:

```

Device# show wireless client mac 7xxx.3xxx.3xxx detail
Client MAC Address : 7xxx.3xxx.3xxx
.
.
.
Link-local bridging VLAN: 3
.
.
.
WiFi Direct Capabilities:
  WiFi Direct Capable                     : No

```

To verify if link local multicast traffic is enabled, use the following command:

```

Device# show wireless multicast
Multicast                                 : Disabled
AP Capwap Multicast                       : Unicast
Wireless Broadcast                        : Disabled
Wireless Multicast non-ip-mcast           : Disabled
Wireless Multicast link-local             : Enabled

```



## PART VI

# System Management

- [Network Mobility Services Protocol, on page 583](#)
- [Application Visibility and Control, on page 597](#)
- [Cisco Hyperlocation, on page 619](#)
- [FastLocate for Cisco Catalyst Series Access Points, on page 633](#)
- [IoT Services Management, on page 637](#)
- [IoT Module Management in the Controller, on page 643](#)
- [Cisco Spaces, on page 645](#)
- [EDCA Parameters, on page 649](#)
- [Adaptive Client Load-Based EDCA, on page 653](#)
- [802.11 parameters and Band Selection, on page 657](#)
- [NBAR Protocol Discovery, on page 677](#)
- [Conditional Debug, Radioactive Tracing, and Packet Tracing, on page 679](#)
- [Aggressive Client Load Balancing, on page 691](#)
- [Accounting Identity List, on page 695](#)
- [Support for Accounting Session ID, on page 699](#)
- [Interim Accounting, on page 703](#)
- [Wireless Multicast, on page 705](#)
- [Map-Server Per-Site Support, on page 725](#)
- [Volume Metering, on page 733](#)
- [Enabling Syslog Messages in Access Points and Controller for Syslog Server, on page 735](#)
- [Login Banner, on page 747](#)
- [Wi-Fi Alliance Agile Multiband , on page 749](#)
- [SNMP Traps, on page 755](#)
- [Disabling Clients with Random MAC Address, on page 761](#)

- [Dataplane Packet Logging](#), on page 765
- [Streaming Telemetry](#), on page 771
- [Wireless Clients Threshold Warning](#), on page 785





## CHAPTER 70

# Network Mobility Services Protocol

- [Information About Network Mobility Services Protocol, on page 583](#)
- [Radioactive Tracing for NMSP, on page 584](#)
- [Enabling NMSP on Premises Services, on page 584](#)
- [Modifying the NMSP Notification Interval for Clients, RFID Tags, and Rogues , on page 585](#)
- [Modifying the NMSP Notification Threshold for Clients, RFID Tags, and Rogues, on page 585](#)
- [Configuring NMSP Strong Cipher, on page 586](#)
- [Verifying NMSP Settings, on page 586](#)
- [Examples: NMSP Settings Configuration, on page 589](#)
- [NMSP by AP Groups with Subscription List from CMX, on page 589](#)
- [Verifying NMSP by AP Groups with Subscription List from CMX, on page 589](#)
- [Probe RSSI Location, on page 591](#)
- [Configuring Probe RSSI , on page 591](#)
- [RFID Tag Support, on page 593](#)
- [Configuring RFID Tag Support, on page 593](#)
- [Verifying RFID Tag Support, on page 594](#)

## Information About Network Mobility Services Protocol

Cisco Network Mobility Services Protocol (NMSP) is a secure two-way protocol that can be run over a connection-oriented (TLS) or HTTPS transport. The wireless infrastructure runs the NMSP server and Cisco Connected Mobile Experiences (Cisco CMX) acts as an NMSP client. The controller supports multiple services and multiple Cisco CMXs can connect to the NMSP server to get the data for the services (location of wireless devices, probe RSSI, hyperlocation, wIPS, and so on.) over the NMSP or HTTPS session.

NMSP defines the intercommunication between Cisco CMX and the controller. Cisco CMX communicates to the controller over a routed IP network. Both publish-subscribe and request-reply communication models are supported. Typically, Cisco CMX establishes a subscription to receive services data from the controller in the form of periodic updates. The controller acts as a data publisher, broadcasting services data to multiple CMXs. Besides subscription, Cisco CMX can also send requests to the controller, causing the controller to send a response back.

The following is a list of the Network Mobility Services Protocol features:

- NMSP is disabled by default.
- NMSP communicates with Cisco CMX using TCP, and uses TLS for encryption.

- Wireless intrusion prevention system (wIPS) is supported only over TCP and TLS.
- Bidirectional communication is supported and Cisco CMX can send a message asynchronously over the established channel.



**Note** HTTPS is not supported for data transport between controller and Cisco CMX.

## Radioactive Tracing for NMSP

This feature collects and provides all CMX-related events.

When a controller is added to CMX with an existing logging or serviceability tools, the following occurs:

- CMX reaches out to the controller through SNMP and CLI.
- Configures the CMX hash key on the controller.
- CMX requests the controller to open an NMSP connection.

RA tracing simplifies troubleshooting by allowing:

- RA trace the CMX IP on the controller.
- Collect all logs about it.

## Enabling NMSP on Premises Services

### Procedure

	Command or Action	Purpose
<b>Step 1</b>	<b>configure terminal</b> <b>Example:</b> Device# <code>configure terminal</code>	Enters global configuration mode.
<b>Step 2</b>	<b>nmsp enable</b> <b>Example:</b> Device(config)# <code>nmsp enable</code>	Enables NMSP on premises services. <b>Note</b> By default, the NMSP is enabled on the controller.
<b>Step 3</b>	<b>end</b> <b>Example:</b> Device(config)# <code>end</code>	Returns to privileged EXEC mode. Alternatively, you can also press <b>Ctrl-Z</b> to exit global configuration mode.

## Modifying the NMSP Notification Interval for Clients, RFID Tags, and Rogues

NMSP manages communication between the Cisco Connected Mobile Experience (Cisco CMX) and the controller for incoming and outgoing traffic. If your application requires more frequent location updates, you can modify the NMSP notification interval (to a value between 1 and 180 seconds) for clients, active RFID tags, and rogue access points and clients.



**Note** The TCP port (16113) that the controller and Cisco CMX communicate over must be open (not blocked) on any firewall that exists between the controller and the Cisco CMX for NMSP to function.

### Procedure

	Command or Action	Purpose
<b>Step 1</b>	<b>configure terminal</b>  <b>Example:</b> Device# <code>configure terminal</code>	Enters global configuration mode.
<b>Step 2</b>	<b>nmosp notification interval</b> { <i>rssi</i> { <i>clients</i>   <i>rfid</i>   <i>rogues</i> { <i>ap</i>   <i>client</i> }   <i>spectrum interferers</i> } <i>interval</i> }  <b>Example:</b> Device(config)# <code>nmosp notification interval rssi rfid 50</code>	Sets the NMSP notification interval value for clients, RFID tags, rogue clients, and access points.  <i>interval</i> -NMSP notification interval value, in seconds for RSSI measurement. Valid range is from 1 to 180.
<b>Step 3</b>	<b>end</b>  <b>Example:</b> Device(config)# <code>end</code>	Returns to privileged EXEC mode. Alternatively, you can also press <b>Ctrl-Z</b> to exit global configuration mode.

## Modifying the NMSP Notification Threshold for Clients, RFID Tags, and Rogues

### Procedure

	Command or Action	Purpose
<b>Step 1</b>	<b>configure terminal</b>  <b>Example:</b> Device# <code>configure terminal</code>	Enters global configuration mode.

	Command or Action	Purpose
<b>Step 2</b>	<b>location notify-threshold</b> {clients   rogues ap   tags } <i>threshold</i> <b>Example:</b> Device(config)# <b>location notify-threshold clients 5</b>	Configures the NMSP notification threshold for clients, RFID tags, rogue clients, and access points.  <i>threshold</i> - RSSI threshold value in db. Valid range is from 0 to 10, with a default value of 0..
<b>Step 3</b>	<b>end</b> <b>Example:</b> Device(config)# <b>end</b>	Returns to privileged EXEC mode. Alternatively, you can also press <b>Ctrl-Z</b> to exit global configuration mode.

## Configuring NMSP Strong Cipher

### Procedure

	Command or Action	Purpose
<b>Step 1</b>	<b>configure terminal</b> <b>Example:</b> Device# <b>configure terminal</b>	Enters global configuration mode.
<b>Step 2</b>	<b>nmsp strong-cipher</b> <b>Example:</b> Device(config)# <b>nmsp strong-cipher</b>	Enable strong ciphers for NMSP server, which contains "ECDHE-RSA-AES128-GCM-SHA256;, ECDHE-ECDSA-AES128-GCM-SHA256;, AES256-SHA256:AES256-SHA;, and AES128-SHA256:AES128-SHA".  Normal cipher suite contains, "ECDHE-RSA-AES128-GCM-SHA256;, ECDHE-ECDSA-AES128-GCM-SHA256;, and AES128-SHA".
<b>Step 3</b>	<b>end</b> <b>Example:</b> Device(config)# <b>end</b>	Returns to privileged EXEC mode. Alternatively, you can also press <b>Ctrl-Z</b> to exit global configuration mode.

## Verifying NMSP Settings

To view the NMSP capabilities of the controller, use the following command:

```
Device# show nmsp capability
Service          Subservice
-----
RSSI              Rogue, Tags, Mobile Station,
```

```
Spectrum          Aggregate Interferer, Air Quality, Interferer,
Info              Rogue, Mobile Station,
Statistics        Rogue, Tags, Mobile Station,
AP Monitor        Subscription
On Demand Services Device Info
AP Info           Subscription
```

To view the NMSp notification intervals, use the following command:

```
Device# show nmsp notification interval
NMSp Notification Intervals
```

```
-----
RSSI Interval:
Client           : 2 sec
RFID             : 50 sec
Rogue AP         : 2 sec
Rogue Client     : 2 sec
Spectrum         : 2 sec
```

To view the connection-specific statistics counters for all CMX connections, use the following command:

```
Device# show nmsp statistics connection
NMSp Connection Counters
```

```
-----
CMX IP Address: 10.22.244.31, Status: Active
State:
  Connections : 1
  Disconnections : 0
  Rx Data Frames : 13
  Tx Data Frames : 99244
  Unsupported messages : 0
Rx Message Counters:
  ID  Name                               Count
-----
   1  Echo Request                         6076
   7  Capability Notification                2
  13  Measurement Request                    5
  16  Information Request                    3
  20  Statistics Request                     2
  30  Service Subscribe Request              1

Tx Message Counters:
  ID  Name                               Count
-----
   2  Echo Response                         6076
   7  Capability Notification                1
  14  Measurement Response                   13
  15  Measurement Notification              91120
  17  Information Response                   6
  18  Information Notification              7492
  21  Statistics Response                    2
  22  Statistics Notification               305
  31  Service Subscribe Response            1
  67  AP Info Notification                  304
```

To view the common statistic counter of the controller's NMSp service, use the following command:

```
Device# show nmsp statistics summary
NMSp Global Counters
-----
Number of restarts           :

SSL Statistics
-----
Total amount of verifications : 6
```

```

Verification failures           : 6
Verification success           : 0
Amount of connections created  : 8
Amount of connections closed   : 7
Total amount of accept attempts : 8
Failures in accept             : 0
Amount of successful accepts    : 8
Amount of failed registrations : 0

```

#### AAA Statistics

```

-----
Total amount of AAA requests   : 7
Failed to send requests        : 0
Requests sent to AAA           : 7
Responses from AAA             : 7
Responses from AAA to validate : 7
Responses validate error       : 6
Responses validate success     : 1

```

To view the overall NMSP connections, use the following command:

```
Device# show nmosp status
```

```
NMSP Status
```

```
-----
```

CMX IP Address	Active	Tx Echo Resp	Rx Echo Req	Tx Data	Rx Data	Transport
127.0.0.1	Active	6	6	1	2	TLS

To view all mobility services subscribed by all CMXs, use the following command:

```
Device# show nmosp subscription detail
```

```
CMX IP address 127.0.0.1:
```

```
Service           Subservice
```

```
-----
```

```

RSSI              Rogue, Tags, Mobile Station,
Spectrum
Info              Rogue, Mobile Station,
Statistics        Tags, Mobile Station,
AP Info           Subscription

```

To view all mobility services subscribed by a specific CMX, use the following command:

```
Device# show nmosp subscription detail <ip_addr>
```

```
CMX IP address 127.0.0.1:
```

```
Service           Subservice
```

```
-----
```

```

RSSI              Rogue, Tags, Mobile Station,
Spectrum
Info              Rogue, Mobile Station,
Statistics        Tags, Mobile Station,
AP Info           Subscription

```

To view the overall mobility services subscribed by all CMXs, use the following command:

```
Device# show nmosp subscription summary
```

```
Service           Subservice
```

```
-----
```

```

RSSI              Rogue, Tags, Mobile Station,
Spectrum
Info              Rogue, Mobile Station,
Statistics        Tags, Mobile Station,
AP Info           Subscription

```

## Examples: NMSP Settings Configuration

This example shows how to configure the NMSP notification interval for RFID tags:

```
Device# configure terminal
Device(config)# nmsp notification interval rssi rfid 50
Device(config)# end
Device# show nmsp notification interval
```

This example shows how to configure the NMSP notification interval for clients:

```
Device# configure terminal
Device(config)# nmsp notification interval rssi clients 180
Device(config)# end
Device# show nmsp notification interval
```

## NMSP by AP Groups with Subscription List from CMX

The Cisco CMX group support allows you to send only the required Network Mobility Services Protocol (NMSP) data to Cisco CMX (applicable to both on-premises and cloud-based CMX). The Cisco CMX can subscribe to NMSP data of specific APs or AP groups based on the active services in the wireless controller.

This feature helps in load balancing and optimizing the data flow load, when the APs are distributed across different CMX servers. The Cisco CMX server creates a CMX AP group giving it a unique name and groups the APs under it.



---

**Note** The Cisco CMX AP Group is the list of Cisco APs managed by the Cisco CMX for location services. This AP group is not the same as the wireless controller AP group.

---

This feature supports the following services:

- Client
- Probe client filtering
- Hyperlocation
- BLE Services



---

**Note** NMSP subscription is available only for those services that are in enabled state in the wireless controller.

---

## Verifying NMSP by AP Groups with Subscription List from CMX

To verify mobility services group subscription summary of all CMX connections, use the following command:

```
Device# show nmsp subscription group summary
```

```
CMX IP address: 127.0.0.1
Groups subscribed by this CMX server:
Group name: Group1
```

To view the services that are subscribed for an AP group by a CMX connection, use the following command:

```
Device# show nmsp subscription group details services group-name cmx-IP-address
```

```
CMX IP address: 127.0.0.1
CMX Group name: Group1
CMX Group filtered services:
Service          Subservice
-----
RSSI              Mobile Station,
Spectrum
Info
Statistics
```

To view the AP MAC list that is subscribed for an AP group by a CMX connection, use the following command:

```
Device show nmsp subscription group detail ap-list group-name cmx-IP-address
```

```
CMX IP address: 127.0.0.1
CMX Group name: Group1
CMX Group AP MACs:
: 0000.0000.7002 0000.0000.6602 0099.0000.0002 0000.00bb.0002
  0000.0000.5502 0000.0000.5002 0033.0000.0002 00d0.0000.0002
  0010.0010.0002 0000.0006.0002 0000.0002.0002 0000.0000.4002
  0000.0099.0002 0000.0000.a002 0000.7700.0002 0022.0000.0002
  0000.0000.0092 0000.0000.0082 0000.0000.0302 aa00.0000.0002
  0000.0050.0042 0000.0d00.0002 0000.0000.0032 0000.00cc.0002
  0000.0088.0002 2000.0000.0002 1000.0000.0002 0100.0000.0002
  0000.0000.0002 0000.0000.0001 0000.0000.0000
```

To view CMX-AP grouping details for all CMXs, use the following command:

```
Device# show nmsp subscription group detail all
CMX IP address: 127.0.0.1
Groups subscribed by this CMX server:
Group name: Group1
  CMX Group filtered services:
  Service          Subservice
  -----
  RSSI              Mobile Station,
  Spectrum
  Info
  Statistics

  CMX Group AP MACs:
  : 0000.0000.0003 0000.0000.0002 0000.0000.0001

Group name: Group2
  CMX Group filtered services:
  Service          Subservice
  -----
  RSSI              Tags,
  Spectrum
  Info
  Statistics
```



```

CMX Group AP MACs:
: 0000.0000.0300 0000.0000.0200 0000.0000.0100

Group name: Group3
CMX Group filtered services:
Service          Subservice
-----
RSSI              Rogue,
Spectrum
Info
Statistics

CMX Group AP MACs:
: 0000.0003.0000 0000.0002.0000 0000.0001.0000

```

To view all the AP lists subscribed by all CMXs, use the following command:

```
Device# show nmsp subscription group detail ap-list <group> <cmx-ip>
```

To view all the services subscribed by all CMXs, use the following command:

```
Device# show nmsp subscription group detail services <group> <cmx-ip>
```

## Probe RSSI Location

The Probe RSSI Location feature allows the wireless controller and Cisco CMX to support the following:

- Load balancing
- Coverage Hole detection
- Location updates to CMX

When a wireless client is enabled, it sends probe requests to identify the wireless networks in the vicinity and also to find the received signal strength indication (RSSI) associated with the identified Service Set Identifiers (SSIDs).

The wireless client periodically performs active scanning in background even after being connected to an access point. This helps them to have an updated list of access points with best signal strength to connect. When the wireless client can no longer connect to an access point, it uses the access point list stored to connect to another access point that gives it the best signal strength. The access points in the WLAN gather these probe requests, RSSI and MAC address of the wireless clients and forwards them to the wireless controllers. The Cisco CMX gathers this data from the wireless controller and uses it to compute the updated location of the wireless client when it roams across the network.

## Configuring Probe RSSI

### Procedure

	Command or Action	Purpose
<b>Step 1</b>	<b>configure terminal</b>  <b>Example:</b> Device# configure terminal	Enters global configuration mode.

	Command or Action	Purpose
<b>Step 2</b>	<b>wireless probe filter</b> <b>Example:</b> <pre>Device(config)# wireless probe filter</pre>	<p>Enables filtering of unacknowledged probe requests from AP to improve the location accuracy. Filtering is enabled by default.</p> <p>Use the <b>no</b> form of the command to disable the feature. This will forward both acknowledged and unacknowledged probe requests to the controller.</p>
<b>Step 3</b>	<b>wireless probe limit <i>limit-value interval</i></b> <b>Example:</b> <pre>Device(config)# wireless probe limit 10 100</pre>	<p>Configures the number of probe request reported to the wireless controller from the AP for the same client on a given interval.</p> <p>Use the <b>no</b> form of the command to revert to the default limit, which is 2 probes at an interval of 500 ms.</p>
<b>Step 4</b>	<b>wireless probe locally-administered-mac</b> <b>Example:</b> <pre>Device(config)# wireless probe locally-administered-mac</pre>	<p>Enables the reporting of probes from clients having locally administered MAC address.</p>
<b>Step 5</b>	<b>location algorithm rssi-average</b> <b>Example:</b> <pre>Device(config)# location algorithm rssi-average</pre>	<p>Sets the probe RSSI measurement updates to a more accurate algorithm but with more CPU overhead.</p>
<b>Step 6</b>	<b>location algorithm simple</b> <b>Example:</b> <pre>Device(config)# location algorithm simple</pre>	<p>(Optional) Sets the probe RSSI measurement updates to a faster algorithm with smaller CPU overhead, but less accuracy.</p> <p>Use the <b>no</b> form of the command to revert the algorithm type to the default one, which is <i>rssi-average</i>.</p>
<b>Step 7</b>	<b>location expiry client <i>interval</i></b> <b>Example:</b> <pre>Device(config)# location expiry client 300</pre>	<p>Configures the timeout for RSSI values.</p> <p>The <b>no</b> form of the command sets it to a default value of 15.</p>
<b>Step 8</b>	<b>location notify-threshold client <i>threshold-db</i></b> <b>Example:</b> <pre>Device(config)# location notify-threshold client 5</pre>	<p>Configures the notification threshold for clients.</p> <p>The <b>no</b> form of the command sets it to a default value of 0.</p>
<b>Step 9</b>	<b>location rssi-half-life client <i>time-in-seconds</i></b> <b>Example:</b> <pre>Device(config)# location rssi-half-life client 20</pre>	<p>Configures half life when averaging two RSSI readings.</p> <p>To disable this option, set the value to 0.</p>

**What to do next**

Use the **show wireless client probing** command to view each probing client (associated and probing only) by batch of 10 MAC addresses.

## RFID Tag Support

The controller enables you to configure radio frequency identification (RFID) tag tracking. RFID tags are small wireless battery-powered tags that continuously broadcast their own signal and are affixed to assets for real-time location tracking. They operate by advertising their location using special 802.11 packets, which are processed by access points, the controller, and the Cisco CMX. Only active RFIDs are supported. A combination of active RFID tags and wireless controller allows you to track the current location of equipment. *Active* tags are typically used in real-time tracking of high-value assets in *closed-loop* systems (that is,) systems in which the tags are not intended to physically leave the control premises of the tag owner or originator.

**General Guidelines**

- You can verify the RFID tags on the controller.
- High Availability for RFID tags are supported.

## Configuring RFID Tag Support

**Procedure**

	Command or Action	Purpose
<b>Step 1</b>	<b>configure terminal</b> <b>Example:</b> Device# configure terminal	Enters global configuration mode.
<b>Step 2</b>	<b>wireless rfid</b> <b>Example:</b> Device(config)# wireless rfid	Enables RFID tag tracking. The default value is enabled. Use the <b>no</b> form of this command to disable RFID tag tracking.
<b>Step 3</b>	<b>wireless rfid timeout <i>timeout-value</i></b> <b>Example:</b> Device(config)# wireless rfid timeout 90	Configures the RFID tag data timeout value to cleanup the table. The timeout value is the amount of time that the controller maintains tags before expiring them. For example, if a tag is configured to beacon every 30 seconds, we recommend that you set the timeout value to 90 seconds (approximately three times the beacon value). The default value is 1200 seconds.

## Verifying RFID Tag Support

To view the summary of RFID tags that are clients, use the following command:

```
Device# show wireless rfid client
```

To view the detailed information for an RFID tag, use the following command:

```
Device# show wireless rfid detail <rfid-mac-address>
```

```
RFID address 000c.cc96.0001
Vendor Cisco
Last Heard 6 seconds ago
Packets Received 187
Bytes Received 226

Content Header
=====
  CCX Tag Version 0
  Tx power: 12
  Channel: 11
  Reg Class: 4
CCX Payload
=====
  Last Sequence Control 2735
  Payload length 221
  Payload Data Hex Dump:
00000000 00 02 00 00 01 09 00 00 00 00 0c b8 ff ff ff 02 |.....|
00000010 07 42 03 20 00 00 0b b8 03 4b 00 00 00 00 00 00 |.B. ....K.....|
00000020 00 00 00 00 00 00 00 00 00 00 00 00 00 00 00 00 |.....|
00000030 00 00 00 00 00 00 00 00 00 00 00 00 00 00 00 00 |.....|
00000040 00 00 00 00 00 00 00 00 00 00 00 00 00 00 00 00 |.....|
```

To view the summary information for all known RFID tags, use the following command:

```
Device# show wireless rfid summary
```

```
Total RFID entries: : 16
Total Unique RFID entries : 16
RFID ID VENDOR Closet AP RSSI Time Since Last Heard
0012.b80a.c791 Cisco 7069.5a63.0520 -31 3 minutes 30 seconds ago
0012.b80a.c953 Cisco 7069.5a63.0460 -33 4 minutes 5 seconds ago
0012.b80b.806c Cisco 7069.5a63.0520 -46 15 seconds ago
0012.b80d.e9f9 Cisco 7069.5a63.0460 -38 4 minutes 28 seconds ago
0012.b80d.ea03 Cisco 7069.5a63.0520 -43 4 minutes 29 seconds ago
0012.b80d.ea6b Cisco 7069.5a63.0460 -39 4 minutes 26 seconds ago
0012.b80d.ebe8 Cisco 7069.5a63.0520 -43 3 minutes 21 seconds ago
0012.b80d.ebeb Cisco 7069.5a63.0520 -43 4 minutes 28 seconds ago
0012.b80d.ec48 Cisco 7069.5a63.0460 -42 4 minutes 7 seconds ago
0012.b80d.ec55 Cisco 7069.5a63.0520 -41 1 minute 52 seconds ago
```

To view the location-based system RFID statistics, use the following command:

```
Device# show wireless rfid stats
```

```
RFID stats :
=====
RFID error db full : 0
RFID error invalid payload : 0
RFID error invalid tag : 0
RFID error dot11 hdr : 0
```

```
RFID error pkt len : 0
RFID error state drop : 0
RFID total pkt received : 369
RFID populated error value : 0
RFID error insert records : 0
RFID error update records : 0
RFID total insert record : 16
RFID ccx payload error : 0
RFID total delete record : 0
RFID error exceeded ap count : 0
RFID error record remove : 0
RFID old rssi expired count : 0
RFID smallest rssi expired count : 0
RFID total query insert : 0
RFID error invalid rssi count : 0
```

To view the NMSP notification interval, use the following command:

```
Device# show nmsp notification interval
```

```
NMSP Notification Intervals
```

```
-----
```

```
RSSI Interval:
```

```
Client           : 2 sec
RFID              : 50 sec
Rogue AP         : 2 sec
Rogue Client     : 2 sec
Spectrum         : 2 sec
```





## CHAPTER 71

# Application Visibility and Control

- [Information About Application Visibility and Control, on page 597](#)
- [Create a Flow Monitor, on page 600](#)
- [Configuring a Flow Monitor \(GUI\), on page 601](#)
- [Create a Flow Record, on page 602](#)
- [Create a Flow Exporter , on page 604](#)
- [Configuring a Policy Tag, on page 605](#)
- [Attaching a Policy Profile to a WLAN Interface \(GUI\), on page 605](#)
- [Attaching a Policy Profile to a WLAN Interface \(CLI\), on page 606](#)
- [Attaching a Policy Profile to an AP, on page 607](#)
- [Verify the AVC Configuration, on page 607](#)
- [Default DSCP on AVC, on page 608](#)
- [AVC-Based Selective Reanchoring, on page 611](#)
- [Restrictions for AVC-Based Selective Reanchoring, on page 611](#)
- [Configuring the Flow Exporter, on page 611](#)
- [Configuring the Flow Monitor, on page 612](#)
- [Configuring the AVC Reanchoring Profile, on page 613](#)
- [Configuring the Wireless WLAN Profile Policy , on page 613](#)
- [Verifying AVC Reanchoring, on page 615](#)

## Information About Application Visibility and Control

Application Visibility and Control (AVC) is a subset of the entire Flexible NetFlow (FNF) package that can provide traffic information. The AVC feature employs a distributed approach that benefits from NBAR running on the access point (AP) or controller whose goal is to run deep packet inspection (DPI) and reports the results using FNF messages.

AVC enables you to perform real-time analysis and create policies to reduce network congestion, costly network link usage, and infrastructure upgrades. Traffic flows are analyzed and recognized using the NBAR2 engine. The specific flow is marked with the recognized protocol or application. This per-flow information can be used for application visibility using FNF. After the application visibility is established, a user can define control rules with policing mechanisms for a client.

Using AVC rules, you can limit the bandwidth of a particular application for all the clients joined on the WLAN. These bandwidth contracts coexist with per-client downstream rate limiting that takes precedence over the per-application rate limits.

FNF feature is supported in wireless, and relies on the NetFlow enablement on the controller for all modes: flex, local and Fabric.

In local mode, the NBAR runs on the controller hardware and the process client traffic flows through the data plane of the controller using the AP CAPWAP tunnels.

In FlexConnect or Fabric mode, NBAR runs on the AP, and only statistics are sent to the controller. When operating in these two modes, APs regularly send FNFv9 reports back to the controller. The controller's FNF feature consumes those FNFv9 reports to provide the application statistics shown by AVC.

The Fabric mode of operation does not populate the FNF cache. It relays the FNFv9 reports at the time they arrive. As a result, some configuration of flow monitors, for example, cache timeout, is not taken into account.

The behavior of the AVC solution changes based on the wireless deployments. The following sections describe the commonalities and differences in all scenarios:

### Local Mode

- NBAR is enabled on the controller.
- AVC does not push the FNF configuration to the APs.
- Roaming events are ignored.

However, AVC supports L3 roams in local mode as traffic flows through the anchor controller (where NBAR was initially processing the roaming client's traffic when the client joined).

- IOSd needs to trigger NBAR attach.
- Supports flow monitor cache.
- Supports NetFlow exporter.

### Flex Mode

- NBAR is enabled on an AP
- AVC pushes the FNF configuration to the APs.
- Supports context transfer for roaming in AVC-FNF.
- Supports flow monitor cache.
- Supports NetFlow exporter.

### Fabric Mode

- NBAR is enabled on an AP.
- AVC pushes the FNF configuration to the APs.
- Supports context transfer for roaming in AVC-FNF.
- Flow monitor cache is not supported.
- Supports NetFlow exporter (for the C9800 embedded on Catalyst switches for SDA, there is no FNF cache on the box).



## Prerequisites for Application Visibility and Control

- The access points should be AVC capable.  
However, this requirement is not applicable in Local mode.
- For the control part of AVC (QoS) to work, the application visibility feature with FNF has to be configured.

## Restrictions for Application Visibility and Control

- IPv6 (including ICMPv6 traffic) packet classification is not supported in FlexConnect mode and Fabric mode. However, it is supported in Local mode.
- Layer 2 roaming is not supported across controller controllers.
- Multicast traffic is not supported.
- AVC is supported only on the following access points:
  - Cisco Catalyst 9100 Series Access Points
  - Cisco Aironet 1800 Series Access Points
  - Cisco Aironet 2700 Series Access Point
  - Cisco Aironet 2800 Series Access Point
  - Cisco Aironet 3700 Series Access Points
  - Cisco Aironet 3800 Series Access Points
  - Cisco Aironet 4800 Series Access Points
  - Cisco Industrial Wireless 3702 Access Point
- AVC is not supported on Cisco Aironet 702W, 702I (128 M memory), and 1530 Series access points.
- Only the applications that are recognized with App visibility can be used for applying QoS control.
- Data link is not supported for NetFlow fields in AVC.
- You cannot map the same WLAN profile to both the AVC-not-enabled policy profile and the AVC-enabled policy profile.
- AVC is not supported on the management port (Gig 0/0).
- NBAR-based QoS policy configuration is allowed only on wired physical ports. Policy configuration is not supported on virtual interfaces, for example, VLAN, port channel and other logical interfaces.

When AVC is enabled, the AVC profile supports only up to 23 rules, which includes the default DSCP rule. The AVC policy will not be pushed down to the AP, if rules are more than 23.

## AVC Configuration Overview

To configure AVC, follow these steps:

1. Create a flow monitor using the **record wireless avc basic** command.

2. Create a wireless policy profile.
3. Apply the flow monitor to the wireless policy profile.
4. Create a wireless policy tag.
5. Map the WLAN to the policy profile
6. Attach the policy tag to the APs.

## Create a Flow Monitor

The NetFlow configuration requires a flow record, a flow monitor, and a flow exporter. This configuration should be the first step in the overall AVC configuration.



**Note** In Flex mode and Local mode, the default values for **cache timeout active** and **cache timeout inactive** commands are not optimal for AVC. We recommend that you set both the values to 60 in the flow monitor. For Fabric mode, the cache timeout configuration does not apply.

### Procedure

	Command or Action	Purpose
<b>Step 1</b>	<b>configure terminal</b> <b>Example:</b> Device# configure terminal	Enters global configuration mode.
<b>Step 2</b>	<b>flow monitor <i>monitor-name</i></b> <b>Example:</b> Device(config)# flow monitor fm_avc	Creates a flow monitor.
<b>Step 3</b>	<b>record wireless avc {ipv4   ipv6} basic</b> <b>Example:</b>	Specifies the basic IPv4 or IPv6 wireless AVC flow template.

	Command or Action	Purpose
	<pre>Device(config-flow-monitor)# record wireless avc ipv6 basic</pre>	<p><b>Note</b> If you want to have both Application Performance Monitoring (APM) and AVC-FNF in the device simultaneously, use the <b>record wireless avc {ipv4   ipv6} assurance</b> command, which is a superset of the fields contained in <b>record wireless avc {ipv4   ipv6} basic</b> command. If the containing flow monitor is configured with the local exporter using <b>destination wlc local</b> command, AVC-FNF will populate the statistics exactly as that of the <b>record wireless avc {ipv4   ipv6} basic</b> configuration. As a result, both APM and AVC-FNF can be configured simultaneously with two flow monitors per direction, per IP version, in local (central switching) mode.</p> <p><b>Note</b> The <b>record wireless avc basic</b> command is same as <b>record wireless avc ipv4 basic</b> command. However, <b>record wireless avc ipv4 basic</b> command is not supported in Flex or Fabric modes. In such scenarios, use the <b>record wireless avc basic</b> command.</p>
<b>Step 4</b>	<p><b>cache timeout active</b> <i>value</i></p> <p><b>Example:</b></p> <pre>Device(config-flow-monitor)# cache timeout active 60</pre>	Sets the active flow timeout in seconds.
<b>Step 5</b>	<p><b>cache timeout inactive</b> <i>value</i></p> <p><b>Example:</b></p> <pre>Device(config-flow-monitor)# cache timeout inactive 60</pre>	Sets the inactive flow timeout in seconds.

## Configuring a Flow Monitor (GUI)

### Before you begin

You must have created a flow exporter to export data from the flow monitor.

## Procedure

- Step 1** Choose **Configuration > Services > Application Visibility** and go to the **Flow Monitor** tab .
- Step 2** In the **Monitor** area, click **Add** to add a flow monitor.
- Step 3** In the **Flow Monitor** window, add a flow monitor and a description.
- Step 4** Select the Flow exporter from the drop-down list to export the data from the flow monitor to a collector.

**Note** To export wireless netflow data, use the templates below:

- ETA (Encrypted Traffic Analysis)
- wireless avc basic
- wireless avc basic IPv6

- Step 5** Click **Apply to Device** to save the configuration.

# Create a Flow Record

The default flow record cannot be edited or deleted. If you require a new flow record, you need to create one and map it to the flow monitor from CLI.

## Procedure

	Command or Action	Purpose
<b>Step 1</b>	<b>flow record</b> <i>flow_record_name</i> <b>Example:</b> Device(config)# flow record record1	Creates a flow record. <b>Note</b> When a custom flow record is configured in Flex and Fabric modes, the optional fields (fields that are not present in record wireless avc basic) are ignored.
<b>Step 2</b>	<b>description</b> <i>string</i> <b>Example:</b> Device(config-flow-record)# description IPv4flow	(Optional) Describes the flow record as a maximum 63-character string.
<b>Step 3</b>	<b>match ipv4 protocol</b> <b>Example:</b> Device(config-flow-record)# match ipv4 protocol	Specifies a match to the IPv4 protocol.
<b>Step 4</b>	<b>match ipv4 source address</b> <b>Example:</b>	Specifies a match to the IPv4 source address-based field.

	Command or Action	Purpose
	Device(config-flow-record)# match ipv4 source address	
<b>Step 5</b>	<b>match ipv4 destination address</b> <b>Example:</b> Device(config-flow-record)# match ipv4 destination address	Specifies a match to the IPv4 destination address-based field.
<b>Step 6</b>	<b>match transport source-port</b> <b>Example:</b> Device(config-flow-record)# match transport source-port	Specifies a match to the transport layer's source port field.
<b>Step 7</b>	<b>match transport destination-port</b> <b>Example:</b> Device(config-flow-record)# match transport destination-port	Specifies a match to the transport layer's destination port field.
<b>Step 8</b>	<b>match flow direction</b> <b>Example:</b> Device(config-flow-record)# match flow direction	Specifies a match to the direction the flow was monitored in.
<b>Step 9</b>	<b>match application name</b> <b>Example:</b> Device(config-flow-record)# match application name	Specifies a match to the application name. <b>Note</b> This action is mandatory for AVC support because this allows the flow to be matched against the application.
<b>Step 10</b>	<b>match wireless ssid</b> <b>Example:</b> Device(config-flow-record)# match wireless ssid	Specifies a match to the SSID name identifying the wireless network.
<b>Step 11</b>	<b>collect counter bytes long</b> <b>Example:</b> Device(config-flow-record)# collect counter bytes long	Collects the counter field's total bytes.
<b>Step 12</b>	<b>collect counter packets long</b> <b>Example:</b> Device(config-flow-record)# collect counter bytes long	Collects the counter field's total packets.
<b>Step 13</b>	<b>collect wireless ap mac address</b> <b>Example:</b> Device(config-flow-record)# collect wireless ap mac address	Collects the BSSID with the MAC addresses of the access points that the wireless client is associated with.

	Command or Action	Purpose
<b>Step 14</b>	<b>collect wireless client mac address</b> <b>Example:</b> <pre>Device(config-flow-record)# collect wireless client mac address</pre>	Collects the MAC address of the client on the wireless network.

## Create a Flow Exporter

You can create a flow exporter to define the export parameters for a flow. This is an optional procedure for configuring flow exporter parameters.



**Note** For the AVC statistics to be visible at the controller, you should configure a local flow exporter using the following commands:

- **flow exporter** *my\_local*
- **destination local wlc**

Also, your flow monitor must use this local exporter for the statistics to be visible at the controller.

### Procedure

	Command or Action	Purpose
<b>Step 1</b>	<b>flow exporter</b> <i>flow-export-name</i> <b>Example:</b> <pre>Device(config)# flow exporter export-test</pre>	Creates a flow monitor.
<b>Step 2</b>	<b>description</b> <i>string</i> <b>Example:</b> <pre>Device(config-flow-exporter)# description IPv4flow</pre>	Describes the flow record as a maximum 63-character string.
<b>Step 3</b>	<b>destination</b> { <i>hostname/ipv4address</i>   <i>hostname/ipv6address</i>   <i>local {wlc}</i> } <b>Example:</b> <pre>Device(config-flow-exporter)# destination local wlc</pre>	Specifies the hostname or IP address of the system or the local WLC to which the exporter sends data.
<b>Step 4</b>	<b>transport udp</b> <i>port-value</i> <b>Example:</b> <pre>Device(config-flow-exporter)# transport udp 1024</pre>	(Optional) Configures the destination UDP port to reach the external collector. The default value is 9995.  <b>Note</b> This step is required only for external collectors; not required for local wlc collector.

	Command or Action	Purpose
<b>Step 5</b>	<b>option application-table timeout <i>seconds</i></b> <b>Example:</b> Device(config-flow-exporter)# option application-table timeout 500	(Optional) Specifies the application table timeout option, in seconds. The valid range is from 1 to 86400.
<b>Step 6</b>	<b>end</b> <b>Example:</b> Device(config-flow-exporter)# end	Returns to privileged EXEC mode.
<b>Step 7</b>	<b>show flow exporter</b> <b>Example:</b> Device# show flow exporter	(Optional) Verifies your configuration.

## Configuring a Policy Tag

### Procedure

	Command or Action	Purpose
<b>Step 1</b>	<b>configure terminal</b> <b>Example:</b> Device# configure terminal	Enters global configuration mode.
<b>Step 2</b>	<b>wireless tag policy <i>policy-tag-name</i></b> <b>Example:</b> Device(config-policy-tag)# wireless tag policy rr-xyz-policy-tag	Configures policy tag and enters policy tag configuration mode.
<b>Step 3</b>	<b>end</b> <b>Example:</b> Device(config-policy-tag)# end	Saves the configuration and exits configuration mode and returns to privileged EXEC mode.

## Attaching a Policy Profile to a WLAN Interface (GUI)

### Procedure

- 
- Step 1** Choose **Configuration** > **Tags & Profiles** > **Tags**.
  - Step 2** On the **Manage Tags** page, click **Policy** tab.
  - Step 3** Click **Add** to view the **Add Policy Tag** window.

- Step 4** Enter a name and description for the policy tag.
  - Step 5** Click **Add** to map WLAN and policy.
  - Step 6** Choose the WLAN profile to map with the appropriate policy profile, and click the tick icon.
  - Step 7** Click **Save & Apply to Device**.
- 

## Attaching a Policy Profile to a WLAN Interface (CLI)

### Before you begin

- Do not attach different AVC policy profiles on the same WLAN across different policy tags.

The following is an example of incorrect configuration:

```
wireless profile policy avc_pol1
  ipv4 flow monitor fm-avc1 input
  ipv4 flow monitor fm-avc1 output
  no shutdown
wireless profile policy avc_pol2
  ipv4 flow monitor fm-avc2 input
  ipv4 flow monitor fm-avc2 output
  no shutdown
wireless tag policy avc-tag1
wlan wlan1 policy avc_pol1
wireless tag policy avc-tag2
wlan wlan1 policy avc_pol2
```

This example violates the restriction stated earlier, that is, the WLAN *wlan1* is mapped to 2 policy profiles, *avc\_pol1* and *avc\_pol2*. This configuration is, therefore, incorrect because the WLAN *wlan1* should be mapped to either *avc\_pol1* or *avc\_pol2* everywhere.

- Conflicting policy profiles on the same WLAN are not supported. For example, policy profile (with and without AVC) applied to the same WLAN in different policy tags.

The following is an example of an incorrect configuration:

```
wireless profile policy avc_pol1
  no shutdown
wireless profile policy avc_pol2
  ipv4 flow monitor fm-avc2 input
  ipv4 flow monitor fm-avc2 output
  no shutdown
wireless tag policy avc-tag1
wlan wlan1 policy avc_pol1
wireless tag policy avc-tag2
wlan wlan1 policy avc_pol2
```

In this example, a policy profile with and without AVC is applied to the same WLAN in different tags.



**Procedure**

	Command or Action	Purpose
<b>Step 1</b>	<b>wireless tag policy</b> <i>avc-tag</i> <b>Example:</b> Device(config)# wireless tag policy avc-tag	Creates a policy tag.
<b>Step 2</b>	<b>wlan</b> <i>wlan-avc</i> <b>policy</b> <i>avc-policy</i> <b>Example:</b> Device(config-policy-tag)# wlan wlan_avc policy avc_pol	Attaches a policy profile to a WLAN profile.

**What to do next**

- Run the **no shutdown** command on the WLAN after completing the configuration.
- If the WLAN is already in **no shutdown** mode, run the **shutdown** command, followed by **no shutdown** command.

## Attaching a Policy Profile to an AP

**Procedure**

	Command or Action	Purpose
<b>Step 1</b>	<b>ap</b> <i>ap-ether-mac</i> <b>Example:</b> Device(config)# ap 34a8.2ec7.4cf0	Enters AP configuration mode.
<b>Step 2</b>	<b>policy-tag</b> <i>policy-tag</i> <b>Example:</b> Device(config)# policy-tag avc-tag	Specifies the policy tag that is to be attached to the access point.

## Verify the AVC Configuration

**Procedure**

	Command or Action	Purpose
<b>Step 1</b>	<b>show avc wlan</b> <i>wlan-name</i> <b>top</b> <i>num-of-applications</i> <b>applications</b> { <b>aggregate</b>   <b>downstream</b>   <b>upstream</b> }	Displays information about top applications and users using these applications.

	Command or Action	Purpose
	<b>Example:</b> Device# show avc wlan wlan_avc top 2 applications aggregate	<b>Note</b> Ensure that wireless clients are associated to the WLAN and generating traffic, and then wait for 90 seconds (to ensure the availability of statistics) before running the command.
<b>Step 2</b>	<b>show avc client mac top num-of-applications applications {aggregate   downstream   upstream}</b>  <b>Example:</b> Device# show avc client 9.3.4 top 3 applications aggregate	Displays information about the top number of applications.  <b>Note</b> Ensure that wireless clients are associated to the WLAN and generating traffic, and then wait for 90 seconds (to ensure the availability of statistics) before running the command.
<b>Step 3</b>	<b>show avc wlan wlan-name application app-name top num-of-clients aggregate</b>  <b>Example:</b> Device# show avc wlan wlan_avc application app top 4 aggregate	Displays information about top applications and users using these applications.
<b>Step 4</b>	<b>show ap summary</b>  <b>Example:</b> Device# show ap summary	Displays a summary of all the access points attached to the controller .
<b>Step 5</b>	<b>show ap tag summary</b>  <b>Example:</b> Device# show ap tag summary	Displays a summary of all the access points with policy tags.

## Default DSCP on AVC

### Configuring Default DSCP for AVC Profile (GUI)

#### Procedure

- 
- Step 1** Choose **Configuration > Services > QoS**.
  - Step 2** Click **Add**.
  - Step 3** Enter the **Policy Name**.
  - Step 4** Click **Add Class-Maps**.
  - Step 5** Choose **AVC** in the **AVC/User Defined** drop-down list.
  - Step 6** Click either **Any** or **All** match type radio button.
  - Step 7** Choose **DSCP** in the **Mark Type** drop-down list.

- Step 8** a) Check the **Drop** check box to drop traffic from specific sources.  
 b) If you do not want to drop the traffic, enter the **Police(kbps)** and choose the match type from the **Match Type** drop-down list. Choose the items from the available list and click move them to the selected list.
- Step 9** Click **Save**.
- Step 10** Click **Apply to Device**.

## Configuring Default DSCP for AVC Profile

In Cisco Catalyst 9800 Series Wireless Controller, only up to 32 filters can be specified in the policy. As there was no way of classifying the packets that are not specified in the filters, now, you can mark down these packets in the policy.

The marking action can be applied to the traffic when creating a class map and creating a policy map.

## Creating Class Map

### Procedure

	Command or Action	Purpose
<b>Step 1</b>	<b>Configure Terminal</b>  <b>Example:</b> Device# configure terminal	Enters global configuration mode.
<b>Step 2</b>	<b>class class-map-name ]</b>  <b>Example:</b> Device(config-pmap)# class-map avc-class	Creates a class map.
<b>Step 3</b>	<b>match protocol { application-name   attribute category category-name   attribute sub-category sub-category-name   attribute application-group application group-name</b>  <b>Example:</b> Device(config)# class-map avc-class Device(config-cmap)# match protocol avc-media Device(config)# class-map class-avc-category Device(config-cmap)# match protocol attribute category avc-media  Device# class-map class-avc-sub-category Device(config-cmap)# match protocol attribute sub-category avc-media  Device# class-map avcS-webex-application-group Device(config-cmap)# match protocol attribute application-group webex-media	Specifies match to the application name, category name, subcategory name, or application group.

	Command or Action	Purpose
Step 4	<b>end</b> <b>Example:</b> Device(config)# end	Returns to privileged EXEC mode. Alternatively, you can also press Ctrl-Z to exit global configuration mode.

## Creating Policy Map

### Procedure

	Command or Action	Purpose
Step 1	<b>Configure Terminal</b> <b>Example:</b> Device# configure terminal	Enters global configuration mode.
Step 2	<b>policy-map</b> <i>policy-map-name</i> <b>Example:</b> Device(config)#policy-map avc-policy	<p>Creates a policy map by entering the policy map name, and enters policy-map configuration mode.</p> <p>By default, no policy maps are defined.</p> <p>The default behavior of a policy map is to set the DSCP to 0 if the packet is an IP packet and to set the CoS to 0 if the packet is tagged. No policing is performed.</p> <p><b>Note</b> To delete an existing policy map, use the no policy-map policy-map-name global configuration command.</p>
Step 3	<b>class</b> [ <i>class-map-name</i>   <b>class-default</b> ] <b>Example:</b> Device(config-pmap)# class-map avc-class	<p>Defines a traffic classification, and enters policy-map class configuration mode.</p> <p>By default, no policy map and class maps are defined.</p> <p>If a traffic class has already been defined by using the class-map global configuration command, specify its name for class-map-name in this command.</p> <p>A class-default traffic class is predefined and can be added to any policy. It is always placed at the end of a policy map. With an implied match any is included in the class-default class, all packets that have not already matched the other traffic classes will match class-default .</p> <p><b>Note</b> To delete an existing class map, use the no class class-map-name policy-map configuration command.</p>

	Command or Action	Purpose
<b>Step 4</b>	<b>set dscp</b> <i>new-dscp</i>  <b>Example:</b> Device(config-pmap-c)# set dscp 45	Classifies IP traffic by setting a new value in the packet. For <b>dscp new-dscp</b> , enter a new DSCP value to be assigned to the classified traffic. The range is 0 to 63.
<b>Step 5</b>	<b>class</b> <i>class-default</i>	Specifies the default class so that you can configure or modify its policy.
<b>Step 6</b>	<b>set dscp default</b>	Configures the default DSCP.
<b>Step 7</b>	<b>end</b>	Returns to privileged EXEC mode. Alternatively, you can also press Ctrl-Z to exit global configuration mode.

## AVC-Based Selective Reanchoring

The AVC-Based Selective Reanchoring feature is designed to reanchor clients when they roam from one controller to another. Reanchoring of clients prevents the depletion of IP addresses available for new clients in Cisco WLC. The AVC profile-based statistics are used to decide whether a client must be reanchored or deferred. This is useful when a client is actively running a voice or video application defined in the AVC rules.

The reanchoring process also involves deauthentication of anchored clients. The clients get deauthenticated when they do not transmit traffic for the applications listed in the AVC rules while roaming between WLCs.

## Restrictions for AVC-Based Selective Reanchoring

- This feature is supported only in local mode. FlexConnect and fabric modes are not supported.
- This feature is not supported in guest tunneling and export anchor scenarios.
- The old IP address is not released after reanchoring, until IP address' lease period ends.

## Configuring the Flow Exporter

### Procedure

	Command or Action	Purpose
<b>Step 1</b>	<b>configure terminal</b>  <b>Example:</b> Device# configure terminal	Enters global configuration mode.
<b>Step 2</b>	<b>flow exporter</b> <i>name</i>  <b>Example:</b>	Creates a flow exporter and enters flow exporter configuration mode.

	Command or Action	Purpose
	Device(config)# flow exporter avc-reanchor	<b>Note</b> You can use this command to modify an existing flow exporter too.
<b>Step 3</b>	<b>destination local wlc</b>  <b>Example:</b> Device(config-flow-exporter)# destination local wlc	Sets the exporter as local.

## Configuring the Flow Monitor

### Procedure

	Command or Action	Purpose
<b>Step 1</b>	<b>configure terminal</b>  <b>Example:</b> Device# configure terminal	Enters global configuration mode.
<b>Step 2</b>	<b>flow monitor <i>monitor-name</i></b>  <b>Example:</b> Device(config)# flow monitor fm_avc	Creates a flow monitor and enters Flexible NetFlow flow monitor configuration mode.  <b>Note</b> You can use this command to modify an existing flow monitor too.
<b>Step 3</b>	<b>exporter <i>exporter-name</i></b>  <b>Example:</b> Device(config-flow-monitor)# exporter avc-reanchor	Specifies the name of an exporter.
<b>Step 4</b>	<b>record wireless avc basic</b>  <b>Example:</b> Device(config-flow-monitor)# record wireless avc basic	Specifies the flow record to use to define the cache.
<b>Step 5</b>	<b>cache timeout active <i>value</i></b>  <b>Example:</b> Device(config-flow-monitor)# cache timeout active 60	Sets the active flow timeout, in seconds.
<b>Step 6</b>	<b>cache timeout inactive <i>value</i></b>  <b>Example:</b> Device(config-flow-monitor)# cache timeout inactive 60	Sets the inactive flow timeout, in seconds.

# Configuring the AVC Reanchoring Profile

## Before you begin

- Ensure that you use the AVC-Reanchor-Class class map. All other class-map names are ignored by Selective Reanchoring.
- During boot up, the system checks for the existence of the AVC-Reanchor-Class class map. If it is not found, default protocols, for example, jabber-video, WiFi-calling, and so on, are created. If AVC-Reanchor-Class class map is found, configuration changes are not made and updates to the protocols that are saved to the startup configuration persist across reboots.

## Procedure

	Command or Action	Purpose
<b>Step 1</b>	<b>configure terminal</b>  <b>Example:</b> Device# configure terminal	Enters global configuration mode.
<b>Step 2</b>	<b>class-map <i>cmap-name</i></b>  <b>Example:</b> Device(config)# class-map AVC-Reanchor-Class	Configures the class map.
<b>Step 3</b>	<b>match any</b>  <b>Example:</b> Device(config-cmap)# match any	Instructs the device to match with any of the protocols that pass through it.
<b>Step 4</b>	<b>match protocol jabber-audio</b>  <b>Example:</b> Device(config-cmap)# match protocol jabber-audio	Specifies a match to the application name.  You can edit the class-map configuration later, in order to add or remove protocols, for example, jabber-video, wifi-calling, and so on, if required.

# Configuring the Wireless WLAN Profile Policy

Follow the procedure given below to configure the WLAN profile policy:



**Note** Starting with Cisco IOS XE Amsterdam 17.1.1, IPv6 flow monitor is supported on Wave 2 APs. You can attach two flow monitors in a policy profile per direction (input and output) and per IP version (IPv4 and IPv6) in local (central switching) mode, when NBAR runs in the controller. However, only one flow monitor is supported per direction (input and output) and per IP version (IPv4 and IPv6) in FlexConnect and fabric modes on Wave 2 APs, when NBAR runs on the corresponding AP.

## Procedure

	Command or Action	Purpose
<b>Step 1</b>	<b>configure terminal</b> <b>Example:</b> Device# configure terminal	Enters global configuration mode.
<b>Step 2</b>	<b>wireless profile policy <i>policy-name</i></b> <b>Example:</b> Device(config)# wireless profile policy default-policy-profile	Configures the WLAN policy profile and enters wireless policy configuration mode.
<b>Step 3</b>	<b>shutdown</b> <b>Example:</b> Device(config-wireless-policy)# shutdown	Disables the policy profile.
<b>Step 4</b>	<b>no central switching</b> <b>Example:</b> Device(config-wireless-policy)# no central switching	Disables central switching.
<b>Step 5</b>	<b>ipv4 flow monitor <i>monitor-name</i> input</b> <b>Example:</b> Device(config-wireless-policy)# ipv4 flow monitor fm_avc input	Specifies the name of the IPv4 ingress flow monitor.
<b>Step 6</b>	<b>ipv4 flow monitor <i>monitor-name</i> output</b> <b>Example:</b> Device(config-wireless-policy)# ipv4 flow monitor fm_avc output	Specifies the name of the IPv4 egress flow monitor.
<b>Step 7</b>	<b>ipv6 flow monitor <i>monitor-name</i> input</b> <b>Example:</b> Device(config-wireless-policy)# ipv6 flow monitor fm_v6_avc input	Specifies the name of the IPv6 ingress flow monitor.
<b>Step 8</b>	<b>ipv6 flow monitor <i>monitor-name</i> output</b> <b>Example:</b> Device(config-wireless-policy)# ipv6 flow monitor fm_v6_avc output	Specifies the name of the IPv6 egress flow monitor.
<b>Step 9</b>	<b>no shutdown</b> <b>Example:</b> Device(config-wireless-policy)# no shutdown	Enables the policy profile.



## Verifying AVC Reanchoring

Use the following commands to verify the AVC reanchoring configuration:

```
Device# show wireless profile policy detailed avc_reanchor_policy
```

```
Policy Profile Name      : avc_reanchor_policy
Description              :
Status                  : ENABLED
VLAN                    : 1
Wireless management interface VLAN      : 34
!
.
.
.
AVC VISIBILITY          : Enabled
Flow Monitor IPv4
  Flow Monitor Ingress Name : fm_avc
  Flow Monitor Egress Name  : fm_avc
Flow Monitor IPv6
  Flow Monitor Ingress Name : Not Configured
  Flow Monitor Egress Name  : Not Configured
NBAR Protocol Discovery  : Disabled
Reanchoring              : Enabled
Classmap name for Reanchoring
  Reanchoring Classmap Name : AVC-Reanchor-Class
!
.
.
.
-----
```

```
Device# show platform software trace counter tag wstatsd chassis active R0 avc-stats debug
```

```
Counter Name Thread ID Counter Value
-----
Reanch_deassociated_clients 28340 1
Reanch_tracked_clients      28340 4
Reanch_deleted_clients      28340 3
```

```
Device# show platform software trace counter tag wncd chassis active R0 avc-afc debug
```

```
Counter Name Thread ID Counter Value
-----
Reanch_co_ignored_clients 30063 1
Reanch_co_anchored_clients 30063 5
Reanch_co_deauthed_clients 30063 4
```

```
Device# show platform software wlavc status wncd
```

Event history of WNCDB:

```
AVC key: [1,wlan_avc,N/A,Reanc,default-policy-tag]
Current state : READY
Wlan-id : 1
Wlan-name : wlan_avc
Feature type : Reanchoring
Flow-mon-name : N/A
Policy-tag : default-policy-tag
Switching Mode : CENTRAL
```

```
Timestamp FSM State Event RC Ctx
```

```
-----
06/12/2018 16:45:30.630342 3 :ZOMBIE 1 :FSM_AFM_BIND 0 2
06/12/2018 16:45:28.822780 2 :READY 2 :FSM_AFM_UNBIND 0 0
06/12/2018 16:45:28.822672 2 :READY 2 :FSM_AFM_UNBIND 0 0
06/12/2018 16:45:15.172073 3 :ZOMBIE 1 :FSM_AFM_BIND 0 2
06/12/2018 16:45:12.738367 2 :READY 2 :FSM_AFM_UNBIND 0 0
06/12/2018 16:45:12.738261 2 :READY 2 :FSM_AFM_UNBIND 0 0
06/12/2018 16:45:01.162689 3 :ZOMBIE 1 :FSM_AFM_BIND 0 2
06/12/2018 16:44:55.757643 2 :READY 2 :FSM_AFM_UNBIND 0 0
06/12/2018 16:44:55.757542 2 :READY 2 :FSM_AFM_UNBIND 0 0
06/12/2018 16:44:04.468749 3 :ZOMBIE 1 :FSM_AFM_BIND 0 2
06/12/2018 16:44:02.18857 2 :READY 2 :FSM_AFM_UNBIND 0 0
06/12/2018 16:44:02.18717 2 :READY 2 :FSM_AFM_UNBIND 0 0
06/12/2018 16:38:20.164304 2 :READY 3 :FSM_AFM_SWEEP 0 2
06/12/2018 16:35:20.163877 2 :READY 1 :FSM_AFM_BIND 0 2
06/12/2018 16:35:18.593257 1 :INIT 1 :FSM_AFM_BIND 0 2
06/12/2018 16:35:18.593152 1 :INIT 24:CREATE_FSM 0 0
```

```
AVC key: [1,wlan_avc,fm_avc,v4-In,default-policy-tag]
Current state : READY
Wlan-id : 1
Wlan-name : wlan_avc
Feature type : Flow monitor IPv4 Ingress
Flow-mon-name : fm_avc
Policy-tag : default-policy-tag
Switching Mode : CENTRAL
```

```
Timestamp FSM State Event RC Ctx
```

```
-----
06/12/2018 16:45:30.664772 3 :ZOMBIE 1 :FSM_AFM_BIND 0 2
06/12/2018 16:45:28.822499 2 :READY 2 :FSM_AFM_UNBIND 0 0
06/12/2018 16:45:28.822222 2 :READY 2 :FSM_AFM_UNBIND 0 0
06/12/2018 16:45:15.207605 3 :ZOMBIE 1 :FSM_AFM_BIND 0 2
06/12/2018 16:45:12.738105 2 :READY 2 :FSM_AFM_UNBIND 0 0
06/12/2018 16:45:12.737997 2 :READY 2 :FSM_AFM_UNBIND 0 0
06/12/2018 16:45:01.164225 3 :ZOMBIE 1 :FSM_AFM_BIND 0 2
06/12/2018 16:44:55.757266 2 :READY 2 :FSM_AFM_UNBIND 0 0
06/12/2018 16:44:55.757181 2 :READY 2 :FSM_AFM_UNBIND 0 0
06/12/2018 16:44:04.472778 3 :ZOMBIE 1 :FSM_AFM_BIND 0 2
06/12/2018 16:44:02.15413 2 :READY 2 :FSM_AFM_UNBIND 0 0
06/12/2018 16:44:02.15263 2 :READY 2 :FSM_AFM_UNBIND 0 0
06/12/2018 16:38:20.164254 2 :READY 3 :FSM_AFM_SWEEP 0 2
06/12/2018 16:35:20.163209 1 :INIT 1 :FSM_AFM_BIND 0 2
06/12/2018 16:35:20.163189 1 :INIT 24:CREATE_FSM 0 0
```

```
AVC key: [1,wlan_avc,fm_avc,v4-Ou,default-policy-tag]
Current state : READY
Wlan-id : 1
Wlan-name : wlan_avc
Feature type : Flow monitor IPv4 Egress
Flow-mon-name : fm_avc
Policy-tag : default-policy-tag
Switching Mode : CENTRAL
```

```
Timestamp FSM State Event RC Ctx
```

```
-----
06/12/2018 16:45:30.630764 3 :ZOMBIE 1 :FSM_AFM_BIND 0 2
06/12/2018 16:45:28.822621 2 :READY 2 :FSM_AFM_UNBIND 0 0
06/12/2018 16:45:28.822574 2 :READY 2 :FSM_AFM_UNBIND 0 0
06/12/2018 16:45:15.172357 3 :ZOMBIE 1 :FSM_AFM_BIND 0 2
06/12/2018 16:45:12.738212 2 :READY 2 :FSM_AFM_UNBIND 0 0
06/12/2018 16:45:12.738167 2 :READY 2 :FSM_AFM_UNBIND 0 0
06/12/2018 16:45:01.164048 3 :ZOMBIE 1 :FSM_AFM_BIND 0 2
```

```

06/12/2018 16:44:55.757403 2 :READY 2 :FSM_AFM_UNBIND 0 0
06/12/2018 16:44:55.757361 2 :READY 2 :FSM_AFM_UNBIND 0 0
06/12/2018 16:44:04.472561 3 :ZOMBIE 1 :FSM_AFM_BIND 0 2
06/12/2018 16:44:02.18660 2 :READY 2 :FSM_AFM_UNBIND 0 0
06/12/2018 16:44:02.18588 2 :READY 2 :FSM_AFM_UNBIND 0 0
06/12/2018 16:38:20.164293 2 :READY 3 :FSM_AFM_SWEEP 0 2
06/12/2018 16:35:20.163799 1 :INIT 1 :FSM_AFM_BIND 0 2
06/12/2018 16:35:20.163773 1 :INIT 24:CREATE_FSM 0 0

```

Device# **show platform software wlavc status wncmgrd**

Event history of WNCMGr DB:

```

AVC key: [1,wlan_avc,N/A,Reanc,default-policy-tag]
Current state : READY
Wlan-id : 1
Wlan-name : wlan_avc
Feature type : Reanchoring
Flow-mon-name : N/A
Policy-tag : default-policy-tag
Switching Mode : CENTRAL
Policy-profile : AVC_POL_PYATS

```

Timestamp FSM State Event RC Ctx

```

-----
06/12/2018 16:45:30.629278 3 :WLAN_READY 24:BIND_WNCD 0 0
06/12/2018 16:45:30.629223 3 :WLAN_READY 4 :FSM_BIND_ACK 0 0
06/12/2018 16:45:30.629179 3 :WLAN_READY 4 :FSM_BIND_ACK 0 0
06/12/2018 16:45:30.510867 2 :PLUMB_READY 22:BIND_IOSD 0 0
06/12/2018 16:45:30.510411 2 :PLUMB_READY 2 :FSM_WLAN_UP 0 0
06/12/2018 16:45:30.510371 2 :PLUMB_READY 1 :FSM_WLAN_FM_PLUMB 0 0
06/12/2018 16:45:28.886377 2 :PLUMB_READY 20:UNBIND_ACK_IOSD 0 0
!
```

```

AVC key: [1,wlan_avc,fm_avc,v4-In,default-policy-tag]
Current state : READY
Wlan-id : 1
Wlan-name : wlan_avc
Feature type : Flow monitor IPv4 Ingress
Flow-mon-name : fm_avc
Policy-tag : default-policy-tag
Switching Mode : CENTRAL
Policy-profile : AVC_POL_PYATS

```

Timestamp FSM State Event RC Ctx

```

-----
06/12/2018 16:45:30.664032 3 :WLAN_READY 24:BIND_WNCD 0 0
06/12/2018 16:45:30.663958 3 :WLAN_READY 4 :FSM_BIND_ACK 0 0
06/12/2018 16:45:30.663921 3 :WLAN_READY 4 :FSM_BIND_ACK 0 0
06/12/2018 16:45:30.511151 2 :PLUMB_READY 22:BIND_IOSD 0 0
06/12/2018 16:45:30.510624 2 :PLUMB_READY 2 :FSM_WLAN_UP 0 0
06/12/2018 16:45:30.510608 2 :PLUMB_READY 1 :FSM_WLAN_FM_PLUMB 0 0
06/12/2018 16:45:28.810867 2 :PLUMB_READY 20:UNBIND_ACK_IOSD 0 0
06/12/2018 16:45:28.807239 4 :READY 25:UNBIND_WNCD 0 0
06/12/2018 16:45:28.807205 4 :READY 23:UNBIND_IOSD 0 0
06/12/2018 16:45:28.806734 4 :READY 3 :FSM_WLAN_DOWN 0 0
!
```

```

AVC key: [1,wlan_avc,fm_avc,v4-Ou,default-policy-tag]
Current state : READY
Wlan-id : 1
Wlan-name : wlan_avc
Feature type : Flow monitor IPv4 Egress
Flow-mon-name : fm_avc

```

```
Policy-tag : default-policy-tag
Switching Mode : CENTRAL
Policy-profile : AVC_POL_PYATS
```

```
Timestamp FSM State Event RC Ctx
```

```
-----
06/12/2018 16:45:30.629414 3 :WLAN_READY 24:BIND_WNCD 0 0
06/12/2018 16:45:30.629392 3 :WLAN_READY 4 :FSM_BIND_ACK 0 0
06/12/2018 16:45:30.629380 3 :WLAN_READY 4 :FSM_BIND_ACK 0 0
06/12/2018 16:45:30.510954 2 :PLUMB_READY 22:BIND_IOSD 0 0
06/12/2018 16:45:30.510572 2 :PLUMB_READY 2 :FSM_WLAN_UP 0 0
06/12/2018 16:45:30.510532 2 :PLUMB_READY 1 :FSM_WLAN_FM_PLUMB 0 0
06/12/2018 16:45:28.886293 2 :PLUMB_READY 20:UNBIND_ACK_IOSD 0 0
06/12/2018 16:45:28.807844 4 :READY 25:UNBIND_WNCD 0 0
06/12/2018 16:45:28.807795 4 :READY 23:UNBIND_IOSD 0 0
06/12/2018 16:45:28.806990 4 :READY 3 :FSM_WLAN_DOWN 0 0
!
```



## CHAPTER 72

# Cisco Hyperlocation

- [Information About Cisco Hyperlocation, on page 619](#)
- [Restrictions on Cisco Hyperlocation, on page 621](#)
- [Support for IPv6 in Cisco Hyperlocation or BLE Configuration, on page 622](#)
- [Configuring Cisco Hyperlocation \(GUI\), on page 622](#)
- [Configuring Cisco Hyperlocation \(CLI\), on page 623](#)
- [Configuring Hyperlocation BLE Beacon Parameters for AP \(GUI\), on page 624](#)
- [Configuring Hyperlocation BLE Beacon Parameters for AP \(CLI\), on page 624](#)
- [Configuring Hyperlocation BLE Beacon Parameters \(CLI\), on page 625](#)
- [Information About AP Group NTP Server, on page 626](#)
- [Configuring an AP Group NTP Server, on page 626](#)
- [Configuring AP Timezone, on page 627](#)
- [Verifying Cisco Hyperlocation, on page 627](#)
- [Verifying Hyperlocation BLE Beacon Configuration, on page 631](#)
- [Verifying Hyperlocation BLE Beacon Configuration for AP, on page 631](#)

## Information About Cisco Hyperlocation

Cisco Hyperlocation is an ultraprecise location solution that allows you to track the location of wireless clients. This is possible with the Cisco Hyperlocation radio module in the Cisco Aironet 3600, 3700, and 4800 Series Access Points. The Cisco Hyperlocation module combines Wi-Fi and Bluetooth Low Energy (BLE) technologies to allow beacons, inventory, and personal mobile devices to be pinpointed.

Hyperlocation is also supported in Fabric mode. In particular, when the wireless controller is running on the switch, the controller takes the necessary steps to provision the APs, so that they can generate Hyperlocation VxLAN packets that can traverse the fabric network taking advantage of the fabric infrastructure and be correctly delivered to the destination CMX.

The Hyperlocation VxLAN packets are special packets marked with SGT 0 and using the L3VNID of the APs. For more information, refer to the SDA documentation.

The Cisco Hyperlocation radio module provides the following:

- WSM or WSM2 radio module functions that are extended to:
  - 802.11ac
  - Wi-Fi Transmit

- 20-MHz, 40-MHz, and 80-MHz channel bandwidth.
- Expanded location functionality:
  - Low-latency location optimized channel scanning
  - 32-antenna angle of arrival (AoA); available only with the WSM2 module.



---

**Note** When using the WSM2 module (includes the WSM module and the antenna add-on), the accuracy of tracking the location of wireless clients can be as close as one meter.

---

Cisco Hyperlocation works in conjunction with Cisco Connected Mobile Experiences (CMX). Combining the Cisco Hyperlocation feature on Cisco Catalyst 9800 Series Wireless Controller with a CMX device allows you to achieve better location accuracy, which can result in delivering more targeted content to users. When you use CMX with Cisco CleanAir frequency scanning, it is simple to locate failed, lost, and even rogue beacons.

The Cisco Hyperlocation radio module with an integrated BLE radio allows transmission of Bluetooth Low Energy (BLE) broadcast messages by using up to 5 BLE transmitters. Cisco Catalyst 9800 Series Wireless Controller is used to configure transmission parameters such as interval for the beacons, universally unique identifier (UUID), and transmission power, per beacon globally for all the access points. Also, the controller can configure major, minor, and transmission power value of each AP to provide more beacon granularity.



---

**Note** The Cisco Hyperlocation feature must be enabled on the controller and CMX and CMX must be connected for BLE to work.

---

In the absence of a Cisco Hyperlocation radio module, Hyperlocation will still work in a modality named *Hyperlocation Local Mode*, which guarantees a slightly lower location accuracy in the range between five meters and seven meters. This is accomplished through CPU cycle stealing.

Using the controller, you can configure Cisco Hyperlocation for APs based on their profile.

### Network Time Protocol Server

Cisco Hyperlocation requires the AP to be synchronized with regard to time. To achieve this, the controller sends network time protocol (NTP) information to the AP. The AP then uses the NTP server to synchronize its clock. Therefore, the AP needs connectivity to the NTP server.

APs can be geographically dispersed. Therefore, it is necessary to provide different NTP servers to different APs. This is achieved by allowing the configuration of NTP server information on a per AP profile basis. If NTP information is not configured on the AP profile, the controller uses one of the global NTP peers defined on its configuration or the management IP address is sent as the NTP server to be used if the controller is acting as an NTP server. If the NTP server is not available, Cisco Hyperlocation will be disabled.



---

**Note** In scale setup, the NTP server should be configured on the respective AP profiles, so that the APs and CA servers used for LSC provisioning are time synchronized. If the NTP server is not configured, a few APs would fail in LSC provisioning.

---

### Bluetooth Low Energy Configuration

The BLE configuration is split into two parts: per-AP profile and per AP. The BLE feature can be configured partially from the AP profile (by default, the AP profile BLE configuration is applied) and partially per-AP (some or all the attributes are applied).

**Table 28: BLE Configuration Details**

Attribute	BLE Configuration Per AP Profile	BLE Configuration Per AP
Attributes with per-AP granularity (global for all the beacons)	<ul style="list-style-type: none"> <li>• Interval</li> <li>• Advertised transmission power</li> </ul>	<ul style="list-style-type: none"> <li>• Interval</li> <li>• Advertised transmission power</li> </ul>
Attributes with per-AP per0-beacon granularity	<ul style="list-style-type: none"> <li>• Transmission power</li> <li>• UUID</li> <li>• Status</li> </ul>	<ul style="list-style-type: none"> <li>• Transmission power</li> <li>• UUID</li> <li>• Status</li> <li>• Major</li> <li>• Minor</li> </ul>



**Note** The *default-ap-profile* BLE configuration can be considered the default BLE configuration because all the APs will join the *default-ap-profile* AP profile in case the other profiles are removed.

For more information about Cisco Hyperlocation, see the following documents:

- [Cisco Hyperlocation Solution](#)
- [Cisco CMX Configuration Guide to enable Cisco Hyperlocation](#)
- [Cisco CMX Release Notes](#)

## Restrictions on Cisco Hyperlocation

- It is not possible to modify detection, trigger, and reset thresholds while Hyperlocation is in enabled state.
- Changes to the reset threshold are allowed for values in the range of zero to one less than the current threshold value. For example, if the current threshold reset value is 10, changes to the reset threshold are allowed for values in the range of 0 to 9.
- When Cisco Hyperlocation is in use on the Cisco Catalyst 9800 Series Wireless Controller in a non-Fabric deployment, CMX must be reachable through an SVI interface (VLAN). Deployments where CMX is reachable through an L3 port results in an error.
- In Fabric deployments, the wireless management interface (typically loopback interface) must not be in Fabric.

- It is not possible to set the wireless management interface to a loopback interface in non-Fabric deployments.

## Support for IPv6 in Cisco Hyperlocation or BLE Configuration

Until Release 16.12, IPv4 was the only valid configuration. From Release 17.1 onwards, IPv6 is also supported for specific deployments.



**Note** CMX accepts only one IP configuration at a time (either IPv4 or IPv6).

The configuration combinations listed in the following tables are the valid deployments.

**Table 29: Flex Deployment Mode**

Controller Management Interface and AP	CMX
IPv4	IPv4
IPv6	IPv6

**Table 30: Fabric Deployment Mode**

Controller Management Interface and AP	CMX
IPv4	IPv4



**Note** Any other combination of IPv4 or IPv6 is not supported.

## Configuring Cisco Hyperlocation (GUI)

Cisco Hyperlocation is a location solution that allows to track the location of wireless clients with the accuracy of one meter. Selecting this option disables all other fields in the screen, except NTP Server.

### Procedure

- Step 1** In the **Configuration > Tags & Profiles > AP Join** page, click **Add**.  
The **Add AP Join Profile** dialog box appears.
- Step 2** Under the **AP > Hyperlocation** tab, select the **Enable Hyperlocation** check box.
- Step 3** In the **Detection Threshold (dBm)** field, enter a value to filter out packets with low RSSI. You must enter a value between  $-100$  dBm and  $-50$  dBm.



- Step 4** In the **Trigger Threshold (cycles)** field, enter a value to set the number of scan cycles before sending a BAR to clients. You must enter a value between 0 and 99.
- Step 5** In the **Reset Threshold is required** field, enter a value to reset value in scan cycles after trigger. You must enter a value between 0 and 99.
- Step 6** Click **Save & Apply to Device**.

## Configuring Cisco Hyperlocation (CLI)

### Procedure

	Command or Action	Purpose
<b>Step 1</b>	<b>configure terminal</b>  <b>Example:</b> Device# configure terminal	Enters global configuration mode.
<b>Step 2</b>	<b>ap profile <i>profile-name</i></b>  <b>Example:</b> Device(config)# ap profile <i>profile-name</i>	Configures an AP profile and enters AP profile configuration mode.
<b>Step 3</b>	<b>[no] hyperlocation</b>  <b>Example:</b> Device(config-ap-profile)# [no] hyperlocation	Enables Cisco Hyperlocation feature on all the supported APs that are associated with this AP profile.  Use the <b>no</b> form of the command to disable the Cisco Hyperlocation feature.
<b>Step 4</b>	<b>[no] hyperlocation threshold detection <i>value-in-dBm</i></b>  <b>Example:</b> Device(config-ap-profile)# [no] hyperlocation threshold detection -100	Sets threshold to filter out packets with low RSSI. The <b>no</b> form of this command resets the threshold to its default value. Valid range is between -100 and -50.
<b>Step 5</b>	<b>[no] hyperlocation threshold reset <i>value-btwn-0-99</i></b>  <b>Example:</b> Device(config-ap-profile)# [no] hyperlocation threshold reset 8	Resets the value of scan cycles after a trigger. The <b>no</b> form of this command resets the threshold to its default value.
<b>Step 6</b>	<b>[no] hyperlocation threshold trigger <i>value-btwn-1-100</i></b>  <b>Example:</b> Device(config-ap-profile)# [no] hyperlocation threshold trigger 10	Sets the number of scan cycles before sending a block acknowledgment request (BAR) to clients. The <b>no</b> form of this command resets the threshold to its default value.

	Command or Action	Purpose
<b>Step 7</b>	<p><code>[no] ntp ip ip-address</code></p> <p><b>Example:</b></p> <pre>Device(config-ap-profile)# [no] ntp ip 9.0.0.4</pre>	Sets the IP address of the NTP server. The <b>no</b> form of this command removes the NTP server.

## Configuring Hyperlocation BLE Beacon Parameters for AP (GUI)

### Procedure

- 
- Step 1** In the **Configuration > Tags & Profiles > AP Join** page, click **Add**.  
The **Add AP Join Profile** dialog box appears.
- Step 2** Under the **AP** tab, click **BLE**.
- Step 3** In the **Beacon Interval (Hz)** field, enter a value.
- Step 4** In the **Advertised Attenuation Level (dBm)** field, enter a value.
- Step 5** Select the check box against each ID and click **Reset**, if required.
- Step 6** Optional, click an ID to edit the values of the following fields, and click **Save**.
- **Status**
  - **Tx Power (dBm)**
  - **UUID**
- Step 7** Click **Save & Apply to Device**.
- 

## Configuring Hyperlocation BLE Beacon Parameters for AP (CLI)

Follow the procedure given below to configure hyperlocation BLE beacon parameters for an AP:

### Procedure

	Command or Action	Purpose
<b>Step 1</b>	<p><code>ap name ap-name hyperlocation ble-beacon beacon-id {enable   major major-value   minor minor-value   txpwr value-in-dBm   uuid uuid-value }</code></p> <p><b>Example:</b></p> <pre>Device# ap name test-ap hyperlocation ble-beacon 3 major 65535</pre>	<p>Configures Hyperlocation and related parameters for an AP, and the specified beacon ID:</p> <ul style="list-style-type: none"> <li>• <b>enable</b>—Enables BLE beacon on the AP.</li> <li>• <b>major major-value</b>—Configures BLE beacon's major parameter. Valid value is</li> </ul>

	Command or Action	Purpose
		<p>between 0 and 65535; the default value is 0.</p> <ul style="list-style-type: none"> <li>• <b>minor</b> <i>minor-value</i>—Configures BLE beacon's minor parameter. Valid value is between 0 and 65535; the default value is 0.</li> <li>• <b>txpwr</b> <i>value-in-dBm</i>—Configures BLE beacon attenuation level. Valid value is between -52 dBm and 0 dBm.</li> <li>• <b>uuid</b> <i>uuid-value</i>—Configures a UUID.</li> </ul>
<b>Step 2</b>	<p><b>ap name</b> <i>ap-name</i> <b>hyperlocation ble-beacon advpwr</b> <i>value-in-dBm</i></p> <p><b>Example:</b></p> <pre>Device# ap name test-ap hyperlocation ble-beacon advpwr 90</pre>	Configures BLE beacon's advertised attenuation level for an AP. The valid range for <i>value-in-dBm</i> is between -40 dBm and -100 dBm; the default value is -59 dBm (all values must be entered as positive integers).

## Configuring Hyperlocation BLE Beacon Parameters (CLI)

### Before you begin

For Hyperlocation BLE to be enabled, CMX must be fully joined and enabled for Hyperlocation.

### Procedure

	Command or Action	Purpose
<b>Step 1</b>	<p><b>ap profile</b> <i>profile-name</i></p> <p><b>Example:</b></p> <pre>Device(config)# ap profile profile-name</pre>	Enables configuration for all the APs that are associated with the specified AP profile name.
<b>Step 2</b>	<p><b>hyperlocation ble-beacon</b> <i>beacon-id</i></p> <p><b>Example:</b></p> <pre>Device(config-ap-profile)# hyperlocation ble-beacon 3</pre>	Specifies the BLE beacon parameters and enters BLE configuration mode.
<b>Step 3</b>	<p><b>enabled</b></p> <p><b>Example:</b></p> <pre>Device(config-halo-ble)# enabled</pre>	Enables BLE for the beacon ID specified.
<b>Step 4</b>	<p><b>exit</b></p> <p><b>Example:</b></p> <pre>Device(config-halo-ble)# exit</pre>	Returns to AP profile configuration mode.

	Command or Action	Purpose
<b>Step 5</b>	<b>hyperlocation ble-beacon interval</b> <i>value-in-hertz</i>  <b>Example:</b> <pre>Device(config-ap-profile)# hyperlocation ble-beacon interval 1</pre>	Configures the BLE beacon interval as 1 Hz for the selected profile.
<b>Step 6</b>	<b>hyperlocation ble-beacon advpwr</b> <i>value-in-dBm</i>  <b>Example:</b> <pre>Device(config-ap-profile)# hyperlocation ble-beacon advpwr 40</pre>	Configures the BLE beacon-advertised attenuation level. Valid range is between -40 dBm and -100 dBm. The default value is -59 dBm.

## Information About AP Group NTP Server

Features such as Cisco Hyperlocation, BLE Angle of Arrival (AoA), and Intelligent Capture (iCAP) require precise time across APs within an AP group to achieve location accuracy. Because the controller and controller global NTP server are configured on the WAN, they might have large synchronization delays from the APs, and this might compromise location accuracy.

If all the APs in an AP group synchronize with the same NTP server, accurate data can be obtained to calculate the location. Configuring the NTP server locally for all the APs in an AP group helps achieve better synchronization among APs.

## Configuring an AP Group NTP Server

### Procedure

	Command or Action	Purpose
<b>Step 1</b>	<b>configure terminal</b>  <b>Example:</b> <pre>Device# configure terminal</pre>	Enters global configuration mode.
<b>Step 2</b>	<b>ap profile</b> <i>profile-name</i>  <b>Example:</b> <pre>Device(config)# ap profile profile-name</pre>	Configures an AP profile and enters AP profile configuration mode.
<b>Step 3</b>	<b>[no] ntp ip</b> <i>ip-address</i>  <b>Example:</b> <pre>Device(config-ap-profile)# [no] ntp ip 9.0.0.4</pre>	Sets the IP address of the NTP server. The <b>no</b> form of this command removes the NTP server.
<b>Step 4</b>	<b>[no] ntp auth-key</b> <i>key-index type type format</i> <i>format key encryption-type server-key</i>	Configures NTP server per AP profile to support authentication. The <b>no ntp auth-key</b>

	Command or Action	Purpose
	<b>Example:</b> Device(config-ap-profile)# ntp auth-key index 1 type md5 format ascii key 0 3434324	command removes the NTP server from each AP profile.  <b>Note</b> For ASCII key, ensure that the length is less than 21 bytes. For HEX key, the length should be less than 41, using only numbers between 0-9 and characters from a-f.

## Configuring AP Timezone

### Procedure

	Command or Action	Purpose
<b>Step 1</b>	<b>configure terminal</b>  <b>Example:</b> Device# configure terminal	Enters global configuration mode.
<b>Step 2</b>	<b>ap profile profile-name</b>  <b>Example:</b> Device(config)# ap profile test	Configures the AP profile and enters AP profile configuration mode.
<b>Step 3</b>	<b>timezone {use-controller   delta hour            offset-hour minute offset-minute}</b>  <b>Example:</b> Device(config-ap-profile)# timezone delta hour -12 minute 2	Configures the timezone offset for AP.  You can configure the AP timezone only for each AP profile. You cannot configure timezone for each AP.  To configure the timezone, either apply the current controller timezone or the time difference. By default, timezone is disabled.

## Verifying Cisco Hyperlocation

To display the hyperlocation status values and parameters for all the AP profiles, use the following command:

```
Device# show ap hyperlocation summary
```

```
Profile Name: custom-profile
```

```
Hyperlocation operational status: Down
Reason: Hyperlocation is administratively disabled
Hyperlocation NTP server: 209.165.200.224
Hyperlocation admin status: Disabled
Hyperlocation detection threshold (dBm): -100
Hyperlocation trigger threshold: 10
Hyperlocation reset threshold: 8
```

```

Profile Name: default-ap-profile

Hyperlocation operational status: Up
Reason: N/A
Hyperlocation NTP server: 209.165.200.224
Hyperlocation admin status: Enabled
Hyperlocation detection threshold (dBm): -90
Hyperlocation trigger threshold: 22
Hyperlocation reset threshold: 8

```

To display both the overall and the per-AP configuration values and operational status, use the following command:

```
Device# show ap hyperlocation detail
```

```

Profile Name: house24

Hyperlocation operational status: Up
Reason: NTP server is not properly configured
Hyperlocation NTP server: 198.51.100.1
Hyperlocation admin status: Enabled
Hyperlocation detection threshold (dBm): -90
Hyperlocation trigger threshold: 8
Hyperlocation reset threshold: 7

```

AP Name	Radio MAC	Method	CMX IP	AP Profile
APe865.49d9.bfe0	e865.49ea.a4b0	WSM2+Ant	198.51.100.2	house24
APa89d.21b9.69d0	a89d.21b9.69d0	Local	198.51.100.3	house24
APe4aa.5d3f.d750	e4aa.5d5f.3630	WSM	198.51.100.4	house24

To display the overall (profile specific) configuration values and operational status for a given profile, use the following command:

```
Device# show ap profile profile-name hyperlocation summary
```

```

Profile Name: profile-name
Hyperlocation operational status: Up
Reason: N/A
Hyperlocation NTP server: 209.165.200.224
Hyperlocation admin status: Enabled
Hyperlocation detection threshold (dBm): -100
Hyperlocation trigger threshold: 10
Hyperlocation reset threshold: 8

```

To display both the overall (profile specific) and per-AP configuration values and operational status for a given profile, use the following command. The APs listed are only those APs that belong to the specified join profile.

```
Device# show ap profile profile-name hyperlocation detail
```

```

Profile Name: profile-name
Hyperlocation operational status: Up
Reason: N/A
Hyperlocation NTP server: 209.165.200.224
Hyperlocation admin status: Enabled
Hyperlocation detection threshold (dBm): -90

```

```
Hyperlocation trigger threshold: 8
Hyperlocation reset threshold: 7
```

AP Name	Radio MAC	Method	CMX IP
APf07f.0635.2d40	f07f.0635.2d40	WSM2+Ant	198.51.100.2
APf07f.0635.2d41	f07f.0635.2d41	Local	198.51.100.3
APf07f.0635.2d42	f07f.0635.2d42	WSM	198.51.100.4

To display configuration values for an AP profile, use the following command:

```
Device# show ap profile profile-name detailed
```

```
Hyperlocation :
  Admin State           : ENABLED
  PAK RSSI Threshold Detection: -100
  PAK RSSI Threshold Trigger : 10
  PAK RSSI Threshold Reset  : 8
.
.
.
```

To display the Cisco CMXs that are correctly joined and used by hyperlocation, use the following command:

```
Device# show ap hyperlocation cmx summary
```

```
Hyperlocation-enabled CMXs
```

IP	Port	Dest MAC	Egress src MAC	Egress VLAN	Ingress src MAC	Join time
198.51.100.4	2003	aaaa.bbbb.cccc	aabb.cccd.eeff	2	0000.0001.0001	12/14/18 09:27:14

To display the hyperlocation client statistics, use the following command:

```
Device# show platform hardware chassis active qfp
feature wireless wlclient cpp-client summary
```

```
Client Type Abbreviations:
  RG - REGULAR BL - BLE
  HL - HALO LI - LWFL INT
Auth State Abbreviations:
  UK - UNKNOWN IP - LEARN IP IV - INVALID
  L3 - L3 AUTH RN - RUN
Mobility State Abbreviations:
  UK - UNKNOWN IN - INIT
  LC - LOCAL AN - ANCHOR
  FR - FOREIGN MT - MTE
  IV - INVALID
EoGRE Abbreviations:
  N - NON EOGRE Y - EOGRE
CPP IF_H DPIDX MAC Address VLAN CT MCVL AS MS E WLAN POA
-----
  0X32 0XF0000001 0000.0001.0001 9 HL 0 RN LC N NULL
```

To display the interface handle value statistics, use the following command:

```
Device# show platform hardware chassis active
qfp feature wireless wlclient datapath cpp-if-handle 0x32 statistics start
```

To display the recorded flow, use the following command:

```
Device# show platform hardware chassis active
qfp feature wireless wlclient datapath cpp-if-handle 0X32 statistics

          Pkts          Bytes
Rx          26          3628
```

To stop statistics capture, use the following command:

```
Device# show platform hardware chassis active
qfp feature wireless wlclient datapath cpp-if-handle 0x32 statistics stop
```

To view the APs requested by Cisco CMX with AP groups' support, use the following commands:

```
Device# show nmsp subscription group summary

CMX IP address: 198.51.100.4
  Groups subscribed by this CMX server:
  Group name: CMX_1198.51.100.4

Device# show nmsp subscription group detail ap-list CMX_198.51.100.1 198.51.100.1

CMX IP address: 198.51.100.1
CMX Group name: CMX_198.51.100.1
CMX Group AP MACs:
: aa:bb:cc:dd:ee:01 aa:bb:cc:dd:ee:02 aa:bb:cc:dd:ee:03 aa:bb:cc:dd:ee:03
```

To display the NTP IP address and authentication parameters, use the following command:

```
Device# show ap profile profile-name detailed
.
.
.
NTP Authentication : ENABLED
Key id : 2
Key type : SHA1
Key format : HEX
Key : 3a2275c74c250c362ca63e4af06fa3f3cd8d4aec
Encryption type : Clear

.
.
.
```

To display the NTP status for each AP, use the following command:

```
Device# show ap name AP-G1-230 ntp status

ap-name          enabled v4/v6 IPAddress      Status      Stratum LastSync  SyncOffset
AP-G1-230        Y           v4      198.51.100.5  AuthFail   4         1000     100
```

To display NTP status for all the APs, use the following command:

```
Device# show ap ntp status

ap-name          enabled v4/v6 IPAddress      Status      Stratum LastSync  SyncOffset
```



```

AP-G1-230      Y      v4  5.5.5.5  AuthFail 2      Never
AP-G1-231      Y      v4  5.5.5.10 Synced 3      1000      100
AP-G1-232      Y      v4  5.5.5.15 Synced 16     2000      50

```

To display the instant status of NTP synchronization in an AP, use the following command. The following output is from an AP and not from the controller.

```
Device# show ntp
```

```
!This error message is displayed when NTP is not configured.
%Error: ntpd is not running
```

```
!The following output is displayed when NTP is configured.
Stratum Version Last Received Delay Offset Jitter NTP server
13 4 7sec ago 1.124ms 0.536ms 0.001ms 198.51.100.5
```

To display AP timezone information, use the following command:

```
Device# show ap timezone
```

```

AP Name      Status      Offsets(h/m)
-----
AP1          Disabled    0:0
AP2          Enabled     1:0

```

## Verifying Hyperlocation BLE Beacon Configuration

To verify the list of configured BLE beacons, use the following command:

```
Device# show ap profile ap-profile-name hyperlocation ble-beacon
BLE Beacon interval (Hz): 1
BLE Beacon advertised attenuation value (dBm): -59
```

```

ID              UUID              TX Power (dBm) Status
-----
0 ffffffff-aaaa-aaaa-aaaa-aaaaaaaaaaaa 0 Enabled
1 ffffffff-bbbb-bbbb-bbbb-bbbbbbbbbbbb 0 Enabled
2 ffffffff-gggg-gggg-gggg-gggggggggggg 0 Enabled
3 ffffffff-dddd-dddd-dddd-dddddddddddd 0 Enabled
4 ffffffff-eeee-eeee-eeee-eeeeeeeeeeee 0 Enabled

```

## Verifying Hyperlocation BLE Beacon Configuration for AP

To verify the Hyperlocation BLE Beacon configuration for an AP, use the following command:

```
Device# show ap name test-ap hyperlocation ble-beacon
BLE Beacon interval (Hz): 1
BLE Beacon advertised attenuation value (dBm): -60
```

```

ID Status UUID Major Minor TXPower (dBm)
-----
0 Enabled 99999999-9999-9999-9999-999999999999 8 0 -0
1 Enabled bbbbbbbb-bbbb-bbbb-bbbb-bbbbbbbbbbbb 8 1 -0
2 Enabled 88888888-8888-8888-8888-888888888888 8 2 -0
3 Enabled dddddddd-dddd-dddd-dddd-dddddddddddd 8 3 -0

```

```
4 Enabled eeeeeeee-eeee-eeee-eeee-eeeeeeeeeeee 8 4 -0
```



## CHAPTER 73

# FastLocate for Cisco Catalyst Series Access Points

---

- [Information About FastLocate, on page 633](#)
- [Restrictions on FastLocate, on page 633](#)
- [Supported Access Points, on page 634](#)
- [FastLocate Network Components, on page 634](#)
- [Configuring FastLocate \(GUI\), on page 635](#)
- [Verifying FastLocate on Cisco Catalyst APs, on page 635](#)

## Information About FastLocate

Current Wi-Fi location technology relies on mobile devices sending received signal strength indication (RSSI) or location information, based on probe request messaging, to access points. This information is sent on most channels by the mobile device and received by neighbor APs on different channels. This helps in location estimation.

Wi-Fi clients are moving towards lesser probing to discover an AP. This helps to conserve battery power. Depending on the client, operating system, driver, battery, current, and client activity, device probing frequency varies anywhere from 10 seconds to 5 minutes. This variation results in inadequate data points to represent real-world movement.

Since data packets are more frequent than probe request packets, they can be aggregated better. FastLocate enables higher location refresh rates by collecting RSSI or location information through data packets received by the APs. Using these data packets, location-based services (LBS) updates are initiated by the network and are available more frequently.

## Restrictions on FastLocate

In Fabric deployments, the Wireless Management Interface (WMI) cannot be an L3 interface (Loopback Interface).



---

**Note** It is recommended to use a VLAN interface as the WMI, if you want to use FastLocate in Fabric deployment.

---

## Supported Access Points

Beginning with IOS XE 17.1.1, FastLocate feature is supported on the Cisco Catalyst 9120 Series Access Points.

In IOS XE 17.3.1, the following APs support the FastLocate feature:

- Cisco Catalyst 9130 Series Access Points
- Cisco Catalyst 9120 Series Access Points
- Cisco Aironet 4800 Series Access Points.
- Cisco Aironet 3800 Series Access Points.
- Cisco Aironet 2800 Series Access Points.

In addition, Cisco Aironet 4800 Series Access Points also supports the Angle of Arrival based location calculation (Hyperlocation).

When FastLocate is enabled, the Cisco RF ASIC radios of these APs act as a WSSI module and transform into a monitoring role and off-channel scanning mode. The Cisco RF ASIC radios scan through all the 2.4-GHz channels and 5-GHz channels in a linear fashion, with each channel scanned for 150 milliseconds. This period is called the dwell time.

The Cisco RF ASIC radios of the APs are synchronized with the NTP server. Using FastPath, all data packet RSSI records that are collected during one off-channel dwell is sent in a specific packet format to the Cisco controller, at the end of the dwell time.

## FastLocate Network Components

For successful packet RSSI location computation, the following components with necessary functionalities are needed:

- Wireless client
  - Send data, management, and control packets
- Cisco Catalyst 9800 Series Wireless Controller
  - Configure NTP server information and location parameters on AP
  - Forward clients' RSSI related information to CMX/MSE via FastPath/datapath
- Cisco Catalyst 9120 Series AP
  - Location radio in monitor or equivalent role
  - Time synchronized with NTP server
  - Collect RSSI related data sent by clients (both associated and unassociated)
  - Send clients' RSSI data to the Cisco controller through CAPWAP
- Cisco CMX

- Parse fastpath location data received by WLC
- Calculate exact physical location of the client and render on GUI using algorithms

## Configuring FastLocate (GUI)

### Procedure

- 
- Step 1** Choose **Configuration > Tags & Profiles > AP Join**.
  - Step 2** On the **AP Join** page, click the **default-ap-profile** AP join profile.
  - Step 3** In the **Edit AP Join Profile** window, click the **AP** tab.
  - Step 4** Under **Hyperlocation**, select the **Enable Hyperlocation** check box.
  - Step 5** Click **Update & Apply to Device**.
- 

## Verifying FastLocate on Cisco Catalyst APs

To verify FastLocate, use the below commands on the AP:

Device# **show ntp**

```
Stratum    Version    Last Received    Delay    Offset    Jitter    NTP server
 1          4          123sec ago      1.169ms -3.262ms  10.050ms   7.7.7.2
```

Device# **show ap fast-path statistics**

```
total packets sent      : 90001
invalid app ID drops    : 0
application              : 0 (HALO)
packets sent (CAPWAP)   : 90001
packets sent (APP HOST INTF) : 0
admin state drops       : 0
no dest IP drops        : 0
```

To view FastLocate admin status details on the AP, use the following command:

Device# **show capwap client rcb**

```
Hyperlocation Admin State : Enabled
MSE Gateway MAC           : 00:50:56:86:0F:9D
WLC Hyperlocation Source Port: 9999
MSE IP Address             : 10.0.0.1
```

To view FastPath-related parameters on the AP like source and destination IP addresses, port numbers, and the gateway MAC address, use the following command:

Device# **show ap fast-path configuration hyperlocation**

```
source IP address        : 10.0.0.2
destination IP address: 10.0.0.1
```

```

source port (WLC)      : 9999
destination port (MSE): 2003
gateway MAC           : 00:50:56:86:0F:9D
ewlc hyperlocation MAC: 00:00:00:01:00:01

```

To verify FastLocate on the Cisco Catalyst controller, use the appropriate command given below.

To view the summary of applications that send fastpath or datapath data, use the below command. The hexcode for the HyperLocation and BLE port numbers are displayed.

```

Device# show platform hardware chassis active qfp feature wireless wlclient
cpp-client summary

```

```

Client Type Abbreviations:
RG - REGULAR      BL - BLE
HL - HALO         LI - LWFL INT
Auth State Abbreviations:
UK - UNKNOWN     IP - LEARN IP   IV - INVALID
L3 - L3 AUTH     RN - RUN
Mobility State Abbreviations:
UK - UNKNOWN     IN - INIT
LC - LOCAL       AN - ANCHOR
FR - FOREIGN     MT - MTE
IV - INVALID
EoGRE Abbreviations:
N - NON EOGRE   Y - EOGRE
CPP IF_H      DPIDX          MAC Address VLAN CT MCVL AS MS E WLAN POA
-----
0X31  0XF0000002 0000.0003.0001 122 BL 0 RN LC N NULL 0X32 0XF0000001 0000.0001.0001 122
HL 0 RN LC N NULL

```

To capture statistics of a selected application, use the below command:

```

Device# show platform hardware chassis active qfp feature wireless wlclient
datapath
cpp-if-handle register-code statistics start

```

The hex-value of the register-code is obtained from the **show platform hardware chassis active qfp feature wireless wlclient cpp-client summary** command mentioned earlier.

```

Device# show platform hardware chassis active qfp feature wireless wlclient
datapath cpp-if-handle 0x32 statistics start

```

To display the statistics of the selected application, use the below command:

```

Device# show platform hardware chassis active qfp feature wireless wlclient
datapath
cpp-if-handle register-code statistics

```

The hex-value of the register-code is obtained from the **show platform hardware chassis active qfp feature wireless wlclient cpp-client summary** command mentioned earlier.

```

Device# show platform hardware chassis active qfp feature wireless wlclient
datapath cpp-if-handle 0x32 statistics
      Pkts  Bytes
Rx    232  38850

```



# CHAPTER 74

## IoT Services Management

- [Information About IoT Services Management, on page 637](#)
- [Enabling the Dot15 Radio, on page 638](#)
- [Configuring the gRPC Token, on page 638](#)
- [Enabling gRPC in an AP Profile, on page 639](#)
- [Verifying BLE State and Mode, on page 639](#)
- [Verifying BLE Details, on page 640](#)
- [Verifying gRPC Summary, Status, and Statistics, on page 641](#)

### Information About IoT Services Management

Cisco Catalyst 9800 devices running the Cisco IOS-XE image Version 17.3.2 support Cisco Spaces: IoT Services along with the Network Assurance on Cisco Catalyst Center. However, IoT Services and the Intelligent Capture (iCAP) port configuration are mutually exclusive. That is, if the iCAP feature needs to be enabled on a device, then IoT Services cannot be deployed. Similarly, if IoT Services needs to be enabled on a device, then iCAP feature cannot be deployed. From Cisco IOS XE Cupertino 17.7.1 Release onwards, IoT Services and Intelligent Capture (iCAP) port configuration are allowed to co-exist. That is, when both IoT Services and iCAP features are enabled on the controller, there will be two gRPC connections from the AP.

Following is a table that shows the pairs of configurations that can or cannot coexist on IOS-XE image version 17.3.2 and 17.7.

Cisco DNA-C Configuration	Cisco Spaces Configuration	Coexistence on IOS-XE Image Version 17.3.2
<b>network-assurance enable</b>	<b>ap cisco-dna token <i>token</i></b>	yes
<b>network-assurance icap server port <i>port</i></b>	<b>ap cisco-dna token <i>token</i></b>	no

Cisco Spaces: IoT Services is an end-to-end solution. Hence, you do not need to manually enable IoT services or Dot15 radio on the controller. Dot15 radio is enabled or disabled automatically through Cisco Spaces. However, you can verify if Dot15 radio is enabled from the controller.

Similarly, Cisco Spaces enables gRPC in the **default ap profile configuration** of the controller. You do not need to manually enable it. However, you can verify the same on the controller.

Cisco Spaces enables the **apphost** configuration, which is required for the **default ap profile** configuration. If **apphost** is not enabled by Cisco Spaces, then you must manually enable it. This is required in order to host IOx applications on an AP.

## Enabling the Dot15 Radio

When you enable the BLE radio configuration globally, the APs that are joined to the controller enable their BLE radio, if they have the BLE radio chip in their hardware. This configuration will be applied to all the APs that will join the controller after the configuration is enabled.

### Procedure

	Command or Action	Purpose
<b>Step 1</b>	<b>configure terminal</b>  <b>Example:</b> Device# configure terminal	Enters global configuration mode.
<b>Step 2</b>	<b>no ap dot15 shutdown</b>  <b>Example:</b> Device(config)# no ap dot15 shutdown	Enables the dot15 radios for APs, globally.
<b>Step 3</b>	<b>ap dot15 shutdown</b>  <b>Example:</b> Device(config)# ap dot15 shutdown	Disables the dot15 radio for all APs, globally.

## Configuring the gRPC Token



### Note

- The configuration is pushed automatically from Cisco Spaces. There is no need to manually enable gRPC on the **default ap profile** configuration. You can verify the same on the controller
- The NETCONF (NETCONF/YANG configuration) must be enabled on the device for the Cisco Spaces to push the required configuration to the controller. Secure Copy (**ip scp server enable**) must be enabled on the controller so that Cisco Spaces can push the gRPC certificate to the controller.
- The iCAP server port configuration should not be present in the configuration. If it exists, then run the iCAP server port 0 command.

### Procedure

	Command or Action	Purpose
<b>Step 1</b>	<b>configure terminal</b>  <b>Example:</b> Device# configure terminal	Enters global configuration mode.
<b>Step 2</b>	<b>ap cisco-dna token {0 8} cisco-token-number</b>	Configures the Cisco Spaces gRPC token.



	Command or Action	Purpose
	<b>Example:</b> Device(config)# ap cisco-dna token 0 <i>cisco-token-number</i>	<b>0:</b> Specifies the string as an UNENCRYPTED password.  <b>8:</b> Indicates the placeholder for backward compatibility.

## Enabling gRPC in an AP Profile

The Manage Streams feature of Cisco Spaces pushes the gRPC configuration only to the default AP profile, currently. If you are using a different AP profile, you must manually configure gRPC.

The following procedure explains how to manually enable gRPC on an AP profile that is not the default-ap-profile. Cisco Spaces may not push gRPC on all the AP profiles. Therefore, the following commands can be used to enable gRPC for individual AP profiles.

### Procedure

	Command or Action	Purpose
<b>Step 1</b>	<b>configure terminal</b>  <b>Example:</b> Device# configure terminal	Enters global configuration mode.
<b>Step 2</b>	<b>ap profile <i>ap-profile-name</i></b>  <b>Example:</b> Device(config)# ap profile <i>ap-profile-name</i>	Configures the AP profile and enters the AP profile configuration mode.
<b>Step 3</b>	<b>cisco-dna grpc</b>  <b>Example:</b> Device(config-ap-profile)# cisco-dna grpc	Enables the gRPC channel on the APs, in the AP profile.

## Verifying BLE State and Mode

To verify the BLE state and mode, run the following command:

```
Device# show ap ble summary
AP Name          BLE AP State      BLE mode
-----
Axel-1           Up                Advanced (IOx)
Axel-2           Up                Advanced (IOx)
9117-1           Up                Advanced (IOx)
3800-1           Up                Base (Native)
1815             Up                Base (Native)
9120-3           Up                Advanced (IOx)
9120-1           Up                Base (Native)
9115-ax          Up                Base (Native)
9120-2           Up                Base (Native)
```

## Verifying BLE Details

To verify BLE details, run the following command:

```

Device# show ap name APXXXX.BDXX.29XX ble detail
Mode report time      : 07/28/2020 09:40:57
Mode                  : Base (Native)
Radio mode            : BLE
Admin state report time : 07/28/2020 09:40:57
Admin state           : Up
Interface report time  : 07/28/2020 09:40:57
Interface              : MSM1
Interface state        : Open
Type                   : Integrated
Capability report time  : 07/14/2020 17:10:49
Capability              : BLE, Zigbee, USB,
Host data report time   : 07/28/2020 09:52:04
Host data
  Device name          : APXXXXBDX
  Dot15 Radio MAC      : 18:04:ed:c5:0e:c8
  API version           : 1
  FW version            : 2.7.16
  Broadcast count       : 4389
  Uptime                : 596050 deciseconds
  Active profile        : viBeacon
Scan Statistics report time : 07/28/2020 09:40:57
Scan statistics
  Total scan records    : 0
Scan role report time   : 07/28/2020 09:43:19
Scan role
  Scan state            : Disable
  Scan interval         : 0 seconds
  Scan window           : 800 milliseconds
  Scan max value        : 8
  Scan filter           : Enable
Broadcaster role
  Current profile type: iBeacon
  Last report time     : N/A
  UUID                 : Unknown
  Major                : Unknown
  Minor                : Unknown
  Transmit power       : Unknown
  Frequency             : Unknown
  Advertised transmit power : Unknown
  Current profile type: Eddystone URL
  Last report time     : 07/28/2020 09:47:17
  URL                  : https://www.cisco.com
  Current profile type: Eddystone UID
  Last report time     : 07/28/2020 09:43:25
  Namespace            : 04d77XXXXXXXXXXXXXXXXXX
  Instance id          : 5df5XXXXXXXXXX
  Current profile type: viBeacon
  Last report time     : 07/28/2020 09:52:04
  Interval              : 450 milliseconds
  Beacon ID            : 0
  UUID                 : 30XXXXXX-3XXX-4XXX-9XXX-d3XXXXXXXXXX
  Major                : 36341
  Minor                : 33196
  Transmit power       : 3 dBm
  Advertised transmit power : 60 dBm
  Enable                : Enable
  Beacon ID            : 1

```

```
UUID : 57XXXXXX-cXXX-4XXX-aXXX-85XXXXXXXXXX
Major : 3875
Minor : 567
Transmit power : 2 dBm
Advertised transmit power : 69 dBm
Enable : Enable
.
.
.
```

## Verifying gRPC Summary, Status, and Statistics

To verify the gRPC summary, run the following command:

```
Device# show ap grpc summary
AP Name          AP Mac          gRPC Status
-----
APXXXX.BDXX.F2XX 0cXX.bdXX.66XX  Up
```

To verify the packet statistics on the gRPC channel that also shows the transmit and receive failures, run the following command:

```
Device# show ap name APXXXX.BDXX.F2XX grpc detail
gRPC channel status : Up
Packets transmit attempts : 62
Packets transmit failures : 0
Packets receive count : 62
Packets receive failures : 0
```





# CHAPTER 75

## IoT Module Management in the Controller

- [Information About IoT Module Management in the Controller, on page 643](#)
- [Enabling a USB on the Controller, on page 643](#)
- [Verifying the USB Modules, on page 644](#)

### Information About IoT Module Management in the Controller

The IoT Module Management feature uses the USB interface on the Cisco Catalyst 9105AXI, 9105AXW, 9115AX, 9117AX, 9120AX, and 9130AX Series access points (APs), to connect to the Cisco Internet of Things (IoT) connector. These APs host the third-party application software components, that act as containers. Cisco Catalyst Center helps in the provisioning, deployment, and life cycle management of the container applications on the APs. The controller and the APs are managed by Cisco Catalyst Center.

You can connect the USB modules to the APs, and then log in to the controller and run commands to enable the USB modules and the Cisco IOx application in the APs associated with an AP profile group.

### Enabling a USB on the Controller

To enable a USB for all the APs connected in an AP profile and to enable Cisco IOx on all the APs, follow this procedure.

#### Procedure

	Command or Action	Purpose
<b>Step 1</b>	<b>configure terminal</b> <b>Example:</b> Device# <code>configure terminal</code>	Enters global configuration mode.
<b>Step 2</b>	<b>ap profile <i>ap profile name</i></b> <b>Example:</b> Device(config)# <code>ap profile ap-profile-test</code>	Configures an AP profile and enters AP profile configuration mode.  <b>Note</b> You can use the default AP profile (default-ap-profile) or create a named AP profile, as shown in the example in the adjacent column.

	Command or Action	Purpose
<b>Step 3</b>	<b>apphost</b> <b>Example:</b> Device(config-ap-profile)# apphost	Enables the apphost framework on Cisco APs.
<b>Step 4</b>	<b>usb-enable</b> <b>Example:</b> Device(config-ap-profile)# usb-enable	Enables a USB for Cisco APs.
<b>Step 5</b>	<b>exit</b> <b>Example:</b> Device(config-ap-profile)# exit	Exits AP profile configuration mode.
<b>Step 6</b>	<b>copy running-config startup-config</b> <b>Example:</b> Device(config)# copy running-config startup-config	Writes running configuration to the memory.

## Verifying the USB Modules

To verify the state of USB modules, run the following command:

```
Device# show ap config general
USB Module Type      : USB Module
USB Module State     : Enabled
USB Operational State : Enabled
USB Override         : Disabled
```

To verify the apphost status, run the following command:

```
Device# show ap apphost summary
AP Name          AP Mac              Apphost Status      CAF Port
Apphost HW capable
-----
SS-2027          00xx.abXX.bXXX      Up                   8443           Yes
Axel-2036        04xx.40XX.aXXX      Up                   8443           Yes
Haida-PrePilot  0cxx.f8XX.0XXX      Up                   8443           Yes
Sommer-infra-2022 3cxx.0eXX.0XXX      Up                   8443           Yes
AP5C71.0DEC.DB5C 3cxx.0eXX.0XXX      Up                   8443           Yes
AP5C71.0DEC.E3D8 3cxx.0eXX.4XXX      Up                   8443           Yes
Sommer-WP-2021   3cxx.0eXX.5XXX      Up                   8443           Yes
AP5C71.0DEC.EC60 3cxx.0eXX.9XXX      Up                   8443           Yes
SS-2005          6cXX.05XX.dXXX      Up                   8443           Yes
Vanc-2042        d4XX.bdXX.2XXX      Up                   8443           Yes
```

To verify the apphost status, run the following command:

```
Device# show ap module summary
AP Name          External Module      External Module PID  External Module Description
-----
Axel-2036        Enable 10xx/eaXX/100 CP2XXXXX             USB to UART Bridge C
Haxx-PrePilot   Enable 10xx/eaXX/100 CP2XXXXX             USB to UART Bridge C
APXXX.0XXX.EXX  Enable 10xx/eaXX/100 CP2XXXXX             USB to UART Bridge C
SS-2005          Enable 10xx/eaXX/100 CP2XXXXX             USB to UART Bridge C
Vaxx-2006        Enable 10xx/eaXX/100 CP2XXXXX             USB to UART Bridge C
```



# CHAPTER 76

## Cisco Spaces

- [Cisco Spaces, on page 645](#)
- [Configuring Cisco Spaces, on page 645](#)
- [Verifying Cisco Spaces Configuration, on page 646](#)

## Cisco Spaces

Cisco Spaces is the next generation indoor location services platform. The Network Mobility Services Protocol (NMSP) cloud-service of the wireless controller communicates with Cisco Spaces using HTTPS as a transport protocol.

## Configuring Cisco Spaces

Follow the procedure given below to configure Cisco Spaces:

### Before you begin

- **Configure DNS**—To resolve fully qualified domain names used by NMSP cloud-services, configure a DNS using the **ip name-server *server\_address*** configuration command as shown in Step 2.
- **Import 3rd party root CAs**—The controller verifies the peer and the host based on the certificate that is sent by the CMX when a connection is established. However, root CAs are not preinstalled on the controller. You have to import a set of root CAs trusted by Cisco to the trustpool of the crypto PKI by using the **crypto pki trustpool import url <url>** configuration command as shown in Step 3.
- A successful registration to Cisco Spaces is required to enable **server url** and **server token** parameters configuration which is needed to complete this setup.

### Procedure

	Command or Action	Purpose
Step 1	<b>configure terminal</b>  <b>Example:</b> Device# <code>configure terminal</code>	Enters global configuration mode.

	Command or Action	Purpose
<b>Step 2</b>	<b>ip name-server</b> <i>namesvr-ip-addr</i>  <b>Example:</b> Device(config)#ip name-server 10.10.10.205	Configures the DNS on the controller to resolve the FQDN names used by the NMSP cloud-services.
<b>Step 3</b>	<b>crypto pki trustpool import url</b> <i>url</i>  <b>Example:</b> Device(config)#crypto pki trustpool import url http://www.cisco.com/security/pki/trs/ios.p7b	Imports the 3rd party root CA. The controller verifies the peer using the imported certificate.
<b>Step 4</b>	<b>[no] nmsp cloud-services server url</b> <i>url</i>  <b>Example:</b> Device(config)# nmsp cloud-services server url https://cisco.com	Configures the URL used for cloud services. Use the <b>no</b> form of the command to delete the server url from the configuration.
<b>Step 5</b>	<b>[no] nmsp cloud-services server token</b> <i>token</i>  <b>Example:</b> Device(config)# nmsp cloud-services server token test	Configures the authentication token for the NMSP cloud service. Use the <b>no</b> form of the command to delete the server token from the configuration.
<b>Step 6</b>	<b>[no] nmsp cloud-services http-proxy</b> <i>proxy-server port</i>  <b>Example:</b> Device(config)# nmsp cloud-services http-proxy 10.0.0.1 10	(Optional) Configures HTTP proxy details for the NMSP cloud service. Use the <b>no</b> form of the command to disable the use of a HTTP proxy.
<b>Step 7</b>	<b>[no] nmsp cloud-services enable</b>  <b>Example:</b> Device(config)# nmsp cloud-services enable	Enables NMSP cloud services. Use the <b>no</b> form of the command to disable the feature.

## Verifying Cisco Spaces Configuration

Use the following commands to verify the Cisco Spaces configuration.

To view the status of active NMSP connections, use the following command:

```
Device# show nmsp status
```

```
MSE IP Address   Tx Echo Resp  Rx Echo Req   Tx Data      Rx Data      Transport
-----
9.9.71.78       0              0              1             1             TLS
64.103.36.133  0              0             1230          2391          HTTPs
```

To view the NMSP cloud service status, use the following command:

```
Device# show nmsp cloud-services summary
```

```
CMX Cloud-Services Status
```



```
-----  
Server: https://yenth8.cmxcisco.com  
IP Address: 64.103.36.133  
Cmx Service: Enabled  
Connectivity: https: UP  
Service Status: Active  
Last Request Status: HTTP/1.1 200 OK  
Heartbeat Status: OK
```

To view the NMSP cloud service statistics, use the following command:

```
Device# show nmsp cloud-services statistics
```

```
CMX Cloud-Services Statistics  
-----
```

```
Tx DataFrames: 3213  
Rx DataFrames: 1606  
Tx HeartBeat Req: 31785  
Heartbeat Timeout: 0  
Rx Subscr Req: 2868  
Tx DataBytes: 10069  
Rx DataBytes: 37752  
Tx HeartBeat Fail: 2  
Tx Data Fail: 0  
Tx Conn Fail: 0
```

To view the mobility services summary, use the following command:

```
Device# show nmsp subscription summary
```

```
Mobility Services Subscribed:
```

```
Index Server IP Services  
-----
```

```
1 209.165.200.225 RSSI, Info, Statistics, AP Monitor, AP Info  
2 209.165.200.225 RSSI, Statistics, AP Info
```





## CHAPTER 77

# EDCA Parameters

---

- [Enhanced Distributed Channel Access Parameters, on page 649](#)
- [Configuring EDCA Parameters \(GUI\), on page 649](#)
- [Configuring EDCA Parameters \(CLI\), on page 650](#)

## Enhanced Distributed Channel Access Parameters

Enhanced Distributed Channel Access (EDCA) parameters are designed to provide preferential wireless channel access for voice, video, and other quality of service (QoS) traffic.

This section contains the following subsections:

## Configuring EDCA Parameters (GUI)

### Procedure

---

- Step 1** Choose **Configuration > Radio Configurations > Parameters**. Using this page, you can configure global parameters for 802.11a/n/ac (5 GHz) and 802.11b/g/n (2.4 GHz) radios.
- Note** You cannot configure or modify parameters, if the radio network is enabled. Disable the network status on the **Configuration > Radio Configurations > Network** page before you proceed.
- Step 2** In the **EDCA Parameters** section, choose an EDCA profile from the **EDCA Profile** drop-down list. Enhanced Distributed Channel Access (EDCA) parameters are designed to provide preferential wireless channel access for voice, video, and other quality-of-service (QoS) traffic.
- Step 3** For 802.11a/n/ac (5 GHz) radios, in the (DFS 802.11h) section, enter the local power constraint. You cannot configure power constraint if the DTPC Support check box on the **Configure > Radio Configurations > Network** page is checked. The valid range is between 0 dBm and 30 dBm.
- Step 4** Check the **Channel Switch Announcement Mode** check box, if you want the AP to announce when it is switching to a new channel and the new channel number. The default value is disabled.
- Step 5** Check the **Smart DFS** check box to enable Dynamic Frequency Selection (DFS) and avoid interference with the radar signals.

**Step 6** Click **Apply**.

## Configuring EDCA Parameters (CLI)

### Procedure

	Command or Action	Purpose
<b>Step 1</b>	<b>configure terminal</b> <b>Example:</b> Device# <code>configure terminal</code>	Enters global configuration mode.
<b>Step 2</b>	<b>ap dot11 {5ghz   24ghz } shutdown</b> <b>Example:</b> Device(config)# <code>ap dot11 5ghz shutdown</code>	Disables the radio network.
<b>Step 3</b>	<b>ap dot11 {5ghz   24ghz} edca-parameters {custom-voice   fastlane   optimized-video-voice   optimized-voice   svp-voice   wmm-default}</b> <b>Example:</b> Device(config)# <code>ap dot11 5ghz edca-parameters optimized-voice</code>	Enables specific EDCA parameters for the 802.11a or 802.11b/g network. <b>Note</b> The <b>custom-voice</b> option is not supported for Cisco Catalyst 9800 Series Wireless Controller.  <ul style="list-style-type: none"> <li>• <b>custom-voice:</b> Enables custom voice parameters for the 802.11a or 802.11b/g network.</li> <li>• <b>fastlane:</b> Enables the fastlane parameters for the 802.11a or 802.11b/g network.</li> <li>• <b>optimized-video-voice:</b> Enables EDCA voice-optimized and video-optimized parameters for the 802.11a or 802.11b/g network. Choose this option when both voice and video services are deployed on your network.</li> <li>• <b>optimized-voice:</b> Enables non-SpectraLink voice-optimized profile parameters for the 802.11a or 802.11b/g network. Choose this option when voice services other than SpectraLink are deployed on your network.</li> <li>• <b>svp-voice:</b> Enables SpectraLink voice-priority parameters for the 802.11a or 802.11b/g network. Choose this option if SpectraLink phones are deployed on your network to improve the quality of calls.</li> </ul>

	Command or Action	Purpose
		<ul style="list-style-type: none"> <li>• <b>wmm-default</b>: Enables the Wi-Fi Multimedia (WMM) default parameters for the 802.11a or 802.11b/g network. This is the default option. Choose this option when voice or video services are not deployed on your network.</li> </ul>
<b>Step 4</b>	<b>no ap dot11 {5ghz   24ghz} shutdown</b> <b>Example:</b> Device(config)# <b>no ap dot11 5ghz shutdown</b>	Re-enables the radio network.
<b>Step 5</b>	<b>end</b> <b>Example:</b> Device(config)# <b>end</b>	Returns to privileged EXEC mode.
<b>Step 6</b>	<b>show ap dot11 {5ghz   24ghz} network</b> <b>Example:</b> Device# <b>show ap dot11 5ghz network</b>	Displays the current status of MAC optimization for voice.





## CHAPTER 78

# Adaptive Client Load-Based EDCA

- [Feature History for Adaptive Client Load-Based EDCA](#), on page 653
- [Information About Adaptive Client Load-Based EDCA](#), on page 653
- [Restrictions for Adaptive Client Load-Based EDCA](#), on page 654
- [Configuration Workflow](#), on page 654
- [Configuring Adaptive Client Load-Based EDCA \(GUI\)](#), on page 654
- [Configuring Adaptive Client Load-Based EDCA \(CLI\)](#), on page 655
- [Verifying Adaptive Client Load-Based EDCA Configuration](#), on page 655

## Feature History for Adaptive Client Load-Based EDCA

This table provides release and related information for the features explained in this module.

These features are available in all the releases subsequent to the one they were introduced in, unless noted otherwise.

**Table 31: Feature History for Adaptive Client Load-Based EDCA**

Release	Feature	Feature Information
Cisco IOS XE Bengaluru 17.5.1	Adaptive Client Load-Based EDCA	This Adaptive Client Load-Based EDCA feature dynamically changes Enhanced Distributed Channel Access (EDCA) parameters of clients based on the active client and load that significantly reduce collisions.

## Information About Adaptive Client Load-Based EDCA

The static EDCA configuration is good for small number of clients. In an enterprise multienterprise deployment scenario, access points (APs) experience excessive collisions as the number of clients increases resulting in significant performance degradation. To overcome such a scenario, the Adaptive Client Load-Based EDCA feature has been introduced.

This feature dynamically changes EDCA parameters of clients based on the active client and load that significantly reduce collisions.

**Feature Scenario**

Run-time EDCA configuration based on active clients and load.

**Use Case**

In a dense multiclient deployment scenario, when a customer was testing 40 iPads in a class room or auditorium setup, he observed that the channel utilization was 60 to 70 percent. The overall AP throughput was less because of air collusion and RTS retries.

After the adaptive client load-based EDCA feature was enabled, the overall throughput increased by 15 to 20 percent and collision decreased by 30 to 40 percent.

## Restrictions for Adaptive Client Load-Based EDCA

- You must disable the 802.11b network if you want to access the 802.11a network.

## Configuration Workflow

- [Configuring Adaptive Client Load-Based EDCA \(GUI\)](#)
- [Configuring Adaptive Client Load-Based EDCA \(CLI\)](#)

## Configuring Adaptive Client Load-Based EDCA (GUI)

### Procedure

- 
- Step 1** Choose **Configuration > Radio Configurations > Parameters** to configure global parameters for 802.11a/n/ac (5-GHz) and 802.11b/g/n (2.4-GHz) radios.
- Step 2** In the **EDCA Parameters** section, from the **EDCA Profile** drop-down list, choose an EDCA profile.
- Step 3** Click the **Client Load Based Configuration** toggle button to enable or disable. It is enabled by default.
- Step 4** For 802.11a/n/ac (5-GHz) radios, in the **DFS (802.11h)** section, enter the local power constraint. You cannot configure power constraint if the **DPTC Support** check box in **Configuration > Radio Configurations > Network** is checked. The valid range for power constraint is between 0 dBm and 30 dBm.
- Step 5** From the **Channel Switch Announcement Mode** drop-down list, choose either the **Loud** or **Quiet** mode.
- Step 6** Click the **Smart DFS** toggle button to enable or disable. It is enabled by default.
- Step 7** In the **11ax Parameters** section, enable or disable the following, using the corresponding toggle button:
- **Target Wakeup Time**
  - **Target Wakeup Time Broadcast**
  - **Multiple Bssid**
- Step 8** Enable BSS color globally for the 5-GHz and 2.4-GHz radios by checking the **BSS Color** check box.



**Step 9** Click **Apply**.

## Configuring Adaptive Client Load-Based EDCA (CLI)

### Procedure

	Command or Action	Purpose
<b>Step 1</b>	<b>configure terminal</b>  <b>Example:</b> Device# <code>configure terminal</code>	Enters global configuration mode.
<b>Step 2</b>	<b>ap dot11 {24ghz   5ghz } edca-parameters client-load-based</b>  <b>Example:</b> Device(config)# <code>ap dot11 24ghz edca-parameters client-load-based</code>	Enables client load-based EDCA configuration for 802.11 radios.  Use the <b>no</b> form of this command to disable the configuration.  <b>Note</b> To enable the configuration on an 802.11a radio, you must disable the 802.11b network.
<b>Step 3</b>	<b>end</b>  <b>Example:</b> Device(config)# <code>end</code>	Returns to privileged EXEC mode.

## Verifying Adaptive Client Load-Based EDCA Configuration

To verify whether the Adaptive Client Load-Based EDCA feature is enabled on an 802.11a or an 802.11b radio, use the following command:

```
Device# show ap dot11 24ghz network
Device# show ap dot11 5ghz network
EDCA profile type check           : default-wmm
Client Load Based EDCA Config    : Enabled
```

To verify whether the Adaptive Client Load-Based EDCA feature is enabled on APs, use the following command:

```
Device# show capwap client config

Client Load Based EDCA      : Enabled
```

To view the Adaptive EDCA parameters running on the driver, use the following command:

```
Device# show controllers dot11Radio 0/1

EDCA Config:
=====
L:Local C:Cell A:Adaptive EDCA params
```

```
AC Type CwMin CwMax Aifs Txop ACM
AC_BE L 4 6 3 0 0
AC_BK L 4 10 7 0 0
AC_VI L 3 4 1 94 0
AC_VO L 2 3 1 47 0
AC_BE C 4 10 3 0 0
AC_BK C 4 10 7 0 0
AC_VI C 3 4 2 94 0
AC_VO C 2 3 2 47 0
AC_BE A 4 10 7 0 0
AC_BK A 4 10 3 0 0
AC_VI A 3 4 2 94 0
AC_VO A 2 3 2 47 0
```



## CHAPTER 79

# 802.11 parameters and Band Selection

- [Information About Configuring Band Selection, 802.11 Bands, and Parameters, on page 657](#)
- [Restrictions for Band Selection, 802.11 Bands, and Parameters, on page 659](#)
- [How to Configure 802.11 Bands and Parameters, on page 659](#)
- [Monitoring Configuration Settings for Band Selection, 802.11 Bands, and Parameters, on page 669](#)
- [Configuration Examples for Band Selection, 802.11 Bands, and Parameters, on page 674](#)

## Information About Configuring Band Selection, 802.11 Bands, and Parameters

### Band Select

Band select enables client radios that are capable of dual-band (2.4 and 5-GHz) operations to move to a less congested 5-GHz access point. The 2.4-GHz band is often congested. Clients on this band typically experience interference from Bluetooth devices, microwave ovens, and cordless phones as well as co-channel interference from other access points because of the 802.11b/g limit of 3 nonoverlapping channels. To prevent these sources of interference and improve overall network performance, configure band selection on the device.

Band select works by regulating probe responses to clients and it can be enabled on a per-WLAN basis. It makes 5-GHz channels more attractive to clients by delaying probe responses to clients on 2.4-GHz channels. In an access point, the band select table can be viewed by running the **show dot11 band-select** command. It can also be viewed by running the **show cont d0/d1 | begin Lru** command.



---

**Note** You can enable both band selection and aggressive load balancing on the controller. They run independently and do not impact one another.

---

### Band Select Algorithm

The band select algorithm affects clients that use 2.4-GHz band. Initially, when a client sends a probe request to an access point, the corresponding client probe's Active and Count values (as seen from the band select table) become 1. The algorithm functions based on the following scenarios:

- Scenario1: Client RSSI (as seen from the **show cont d0/d1 | begin RSSI** command output) is greater than both Mid RSSI and Acceptable Client RSSI.

- Dual-band clients: No 2.4-GHz probe responses are seen at any time; 5-GHz probe responses are seen for all 5-GHz probe requests.
  - Single-band (2.4-GHz) clients: 2.4-GHz probe responses are seen only after the probe suppression cycle.
  - After the client's probe count reaches the configured probe cycle count, the algorithm waits for the Age Out Suppression time and then marks the client probe's Active value as 0. Then, the algorithm is restarted.
- Scenario2: Client RSSI (as seen from **show cont d0/d1 | begin RSSI**) lies between Mid-RSSI and Acceptable Client RSSI.
    - All 2.4-GHz and 5-GHz probe requests are responded to without any restrictions.
    - This scenario is similar to the band select disabled.



---

**Note** The client RSSI value (as seen in the **sh cont d0 | begin RSSI** command output) is the average of the client packets received, and the Mid RSSI feature is the instantaneous RSSI value of the probe packets. As a result, the client RSSI is seen as weaker than the configured Mid RSSI value (7-dB delta). The 802.11b probes from the client are suppressed to push the client to associate with the 802.11a band.

---

## 802.11 Bands

You can configure the 802.11b/g/n (2.4 GHz) and 802.11a/n (5 GHz) bands for the controller to comply with the regulatory requirements in your country. By default, both 802.11b/g/n and 802.11a/n are enabled.

This section contains the following subsections:

## 802.11n Parameters

This section provides instructions for managing 802.11n access points on your network. The 802.11n devices support the 2.4 and 5-GHz bands and offer high throughput data rates.

The 802.11n high throughput rates are available on all the 802.11n access points for the WLANs using WMM with no Layer 2 encryption or with WPA2/AES encryption enabled.



---

**Note** To disable MCS rates for 802.11n, 802.11ac and 802.11ax, ensure that at least one MCS rate is enabled. To disable 802.11n on the controller to force APs to use only legacy 802.11a/b/g rates, first disable 802.11ax and 802.11ac on the controller for a particular band. Irrespective of the APs mapped to a Custom-RF-Profile, disabling 802.11n globally on the controller applies to all the APs.

---

## 802.11h Parameters

802.11h informs client devices about channel changes and can limit the transmit power of those client devices.

# Restrictions for Band Selection, 802.11 Bands, and Parameters

- Band selection-enabled WLANs do not support time-sensitive applications such as voice and video because of roaming delays.
- Band selection is supported only on Cisco Wave 2 and 802.11ax APs.  
For more information about support on specific APs, see [https://www.cisco.com/c/en/us/td/docs/wireless/access\\_point/feature-matrix/ap-feature-matrix.html](https://www.cisco.com/c/en/us/td/docs/wireless/access_point/feature-matrix/ap-feature-matrix.html).
- Band selection operates only on APs that are connected to a controller. A FlexConnect AP without a controller connection does not perform band selection after a reboot.
- The band-selection algorithm directs dual-band clients only from the 2.4-GHz radio to the 5-GHz radio of the same AP, and it only runs on an AP when both the 2.4-GHz and 5-GHz radios are up and running.
- It is not possible to enable or disable band selection and client load balancing globally through the controller GUI or CLI. You can, however, enable or disable band selection and client load balancing for a particular WLAN. Band selection and client load balancing are enabled globally by default.

## How to Configure 802.11 Bands and Parameters

### Configuring Band Selection (GUI)

#### Before you begin

Ensure that you have configured an AP Join Profile prior to configuring the primary and backup controllers.

#### Procedure

- 
- Step 1** Choose **Configuration > Wireless Advanced > Band Select**.
  - Step 2** In the **Cycle Count** field, enter a value between 1 and 10. The cycle count sets the number of suppression cycles for a new client. The default cycle count is 2.
  - Step 3** In the **Cycle Threshold (milliseconds)** field, enter a value between 1 and 1000 milliseconds for the scan cycle period threshold. This setting determines the time threshold during which new probe requests from a client come from a new scanning cycle. The default cycle threshold is 200 milliseconds.
  - Step 4** In the **Age Out Suppression (seconds)** field, enter a value between 10 and 200 seconds. Age-out suppression sets the expiration time for pruning previously known 802.11b/g/n clients. The default value is 20 seconds. After this time elapses, clients become new and are subject to probe response suppression.
  - Step 5** In the **Age Out Dual Band (seconds)** field, enter a value between 10 and 300 seconds. The age-out period sets the expiration time for pruning previously known dual-band clients. The default value is 50 seconds. After this time elapses, clients become new and are subject to probe response suppression.
  - Step 6** In the **Client RSSI (dbm)** field, enter a value between -90 to -20. This is the average of the client packets received.
  - Step 7** In the **Client Mid RSSI (dbm)** field, enter a value between -90 to -20. This is the instantaneous RSSI value of the probe packets.

**Step 8** On the **AP Join Profile** page, click the AP Join Profile name.

**Step 9** Click **Apply**.

## Configuring Band Selection (CLI)

### Procedure

	Command or Action	Purpose
<b>Step 1</b>	<b>configure terminal</b>  <b>Example:</b> Device# <code>configure terminal</code>	Enters global configuration mode.
<b>Step 2</b>	<b>wireless client band-select cycle-count</b> <i>cycle_count</i>  <b>Example:</b> Device(config)# <code>wireless client band-select cycle-count 3</code>	Sets the probe cycle count for band select. Valid range is between 1 and 10.
<b>Step 3</b>	<b>wireless client band-select cycle-threshold</b> <i>milliseconds</i>  <b>Example:</b> Device(config)# <code>wireless client band-select cycle-threshold 5000</code>	Sets the time threshold for a new scanning cycle period. Valid range is between 1 and 1000.
<b>Step 4</b>	<b>wireless client band-select expire suppression</b> <i>seconds</i>  <b>Example:</b> Device(config)# <code>wireless client band-select expire suppression 100</code>	Sets the suppression expire to the band select. Valid range is between 10 and 200.
<b>Step 5</b>	<b>wireless client band-select expire dual-band</b> <i>seconds</i>  <b>Example:</b> Device(config)# <code>wireless client band-select expire dual-band 100</code>	Sets the dual band expire. Valid range is between 10 and 300.
<b>Step 6</b>	<b>wireless client band-select client-rssi</b> <i>client_rssi</i>  <b>Example:</b> Device(config)# <code>wireless client band-select client-rssi 40</code>	Sets the client RSSI threshold. Valid range is between 20 and 90.
<b>Step 7</b>	<b>wlan wlan_profile_name wlan_ID SSID_network_name band-select</b>  <b>Example:</b>	Configures band selection on specific WLANs. Valid range is between 1 and 512. You can enter up to 32 alphanumeric characters for <i>SSID_network_name</i> parameter.

	Command or Action	Purpose
	Device(config)# <b>wlan wlan1 25 ssid12</b>	
	Device(config-wlan)# <b>band-select</b>	

## Configuring the 802.11 Bands (GUI)

### Procedure

- 
- Step 1** Choose **Configuration > Radio Configurations > Network**.
- Step 2** Click either **5 GHz Band** or **2.4 GHz Band**.
- Step 3** Uncheck the **Network Status** check box to disable the network in order to be able to configure the network parameters.
- Step 4** In the **Beacon Interval** field, enter the rate at which the SSID is broadcast by the APs, from 100 to 600 milliseconds. The default is 100 milliseconds.
- Step 5** For 802.11b/g/n (2.4-GHz) radios, to enable short preamble on the radio, check the **Short Preamble** check box. A short preamble improves throughput performance.
- Step 6** In the **Fragmentation Threshold (in bytes)** field, enter a value between 256 to 2346 bytes. Packets larger than the size you specify here will be fragmented.
- Step 7** Check the **DTPC Support** check box to advertise the transmit power level of the radio in the beacons and the probe responses. Client devices using dynamic transmit power control (DTPC) receive the channel and power level information from the access points and adjust their settings automatically. For example, a client device used primarily in Japan could rely on DTPC to adjust its channel and power settings automatically when it travels to Italy and joins a network there. You cannot configure a power constraint value on your 802.11a/n/ac (5-GHz) radio network if the **DTPC Support** check box is checked.
- Step 8** Click **Apply**.
- Step 9** In the **CCX Location Measurement** section, check the **Mode** check box to globally enable CCX radio management for the network. This parameter causes the APs connected to this device to issue broadcast radio measurement requests to clients running CCX v2 or later releases.
- Step 10** In the **Interval** field, enter a value to specify how often the APs must issue broadcast radio measurement requests.
- Step 11** Click **Apply**.
- Step 12** In the **Data Rates** section, choose a value to specify the rates at which data can be transmitted between the access point and the client:
- **Mandatory:** Clients must support this data rate in order to associate to an access point on the controller embedded wireless controller.
  - **Supported:** Any associated clients that support this data rate may communicate with the access point using that rate.
  - **Disabled:** The clients specify the data rates used for communication.
- Step 13** Click **Apply**.
- Step 14** Save the configuration.
-

## Configuring the 802.11 Bands (CLI)

Follow the procedure given below to configure 802.11 bands and parameters:

### Procedure

	Command or Action	Purpose
<b>Step 1</b>	<b>configure terminal</b>  <b>Example:</b> Device# <code>configure terminal</code>	Enters global configuration mode.
<b>Step 2</b>	<b>ap dot11 5ghz shutdown</b>  <b>Example:</b> Device (config)# <code>ap dot11 5ghz shutdown</code>	Disables the 802.11a band.  <b>Note</b> You must disable the 802.11a band before configuring the 802.11a network parameters.
<b>Step 3</b>	<b>ap dot11 24ghz shutdown</b>  <b>Example:</b> Device (config)# <code>ap dot11 24ghz shutdown</code>	Disables the 802.11b band.  <b>Note</b> You must disable the 802.11b band before configuring the 802.11b network parameters.
<b>Step 4</b>	<b>ap dot11 {5ghz   24ghz} beaconperiod</b> <i>time_unit</i>  <b>Example:</b> Device (config)# <code>ap dot11 5ghz beaconperiod 500</code>	Specifies the rate at which the SSID is broadcast by the corresponding access point.  The beacon interval is measured in time units (TUs). One TU is 1024 microseconds. You can configure the access point to send a beacon every 20 to 1000 milliseconds.
<b>Step 5</b>	<b>ap dot11 {5ghz   24ghz} fragmentation</b> <i>threshold</i>  <b>Example:</b> Device (config)# <code>ap dot11 5ghz fragmentation 300</code>	Specifies the size at which packets are fragmented.  The threshold is a value between 256 and 2346 bytes (inclusive). Specify a low number for areas where communication is poor or where there is a great deal of radio interference.
<b>Step 6</b>	<b>[no] ap dot11 {5ghz   24ghz} dtpc</b>  <b>Example:</b> Device (config)# <code>ap dot11 5ghz dtpc</code> Device (config)# <code>no ap dot11 24ghz dtpc</code>	Enables access points to advertise their channels and transmit the power levels in beacons and probe responses.  The default value is enabled. Client devices using dynamic transmit power control (DTPC) receive the channel-level and power-level information from the access points and adjust their settings automatically. For example, a client device used primarily in Japan can rely on DTPC to adjust its channel and power settings automatically when it travels to Italy and joins a network there.



	Command or Action	Purpose
		The <b>no</b> form of the command disables the DTPC setting.
<b>Step 7</b>	<p><b>wireless client association limit</b> <i>number</i> <b>interval</b> <i>milliseconds</i></p> <p><b>Example:</b> Device(config)# <b>wireless client association limit 50 interval 1000</b></p>	<p>Specifies the maximum allowed clients that can be configured.</p> <p>You can configure the maximum number of association requests on a single access point slot at a given interval. The range of association limit that you can configure is from 1 to 100.</p> <p>The association request limit interval is measured between 100 to 10000 milliseconds.</p>
<b>Step 8</b>	<p><b>ap dot11 {5ghz   24ghz} rate</b> <i>rate</i> {<b>disable</b>   <b>mandatory</b>   <b>supported</b>}</p> <p><b>Example:</b> Device(config)# <b>ap dot11 5ghz rate 36 mandatory</b></p>	<p>Specifies the rate at which data can be transmitted between the controller embedded wireless controller and the client.</p> <ul style="list-style-type: none"> <li>• <b>disable</b>: Defines that the clients specify the data rates used for communication.</li> <li>• <b>mandatory</b>: Defines that the clients support this data rate in order to associate to an access point on the controller embedded wireless controller.</li> <li>• <b>supported</b>: Any associated clients that support this data rate can communicate with the access point using that rate. However, the clients are not required to use this rate in order to associate.</li> <li>• <b>rate</b>: Specifies the rate at which data is transmitted. For the 802.11a and 802.11b bands, the data is transmitted at the rate of 1, 2, 5.5, 6, 9, 11, 12, 18, 24, 36, 48, or 54 Mbps.</li> </ul>
<b>Step 9</b>	<p><b>no ap dot11 5ghz shutdown</b></p> <p><b>Example:</b> Device(config)# <b>no ap dot11 5ghz shutdown</b></p>	<p>Enables the 802.11a band.</p> <p><b>Note</b> The default value is enabled.</p>
<b>Step 10</b>	<p><b>no ap dot11 24ghz shutdown</b></p> <p><b>Example:</b> Device(config)# <b>no ap dot11 24ghz shutdown</b></p>	<p>Enables the 802.11b band.</p> <p><b>Note</b> The default value is enabled.</p>
<b>Step 11</b>	<p><b>ap dot11 24ghz dot11g</b></p> <p><b>Example:</b></p>	<p>Enables or disables 802.11g network support.</p>

	Command or Action	Purpose
	Device (config) # <b>ap dot11 24ghz dot11g</b>	The default value is enabled. You can use this command only if the 802.11b band is enabled. If you disable this feature, the 802.11b band is enabled without 802.11g support.
<b>Step 12</b>	<b>end</b>  <b>Example:</b> Device (config) # <b>end</b>	Returns to privileged EXEC mode.

## Configuring a Band-Select RF Profile (GUI)

### Procedure

- 
- Step 1** Choose **Configuration > Wireless > Advanced**.
- Step 2** In the **Band Select** tab, enter a value between 1 and 10 in the **Cycle Count** field. The cycle count sets the number of suppression cycles for a new client. The default cycle count is 2.
- Step 3** In the **Cycle Threshold** field, enter a value between 1 and 1000 milliseconds for the scan cycle period threshold. This setting determines the time threshold during which new probe requests from a client come from a new scanning cycle. The default cycle threshold is 200 milliseconds.
- Step 4** In the **Age Out Suppression** field, enter a value between 10 and 200 seconds. Age-out suppression sets the expiration time for pruning previously known 802.11b/g/n clients. The default value is 20 seconds. After this time elapses, clients become new and are subject to probe response suppression.
- Step 5** In the **Age Out Dual Band** field, enter a value between 10 and 300 seconds. The age-out period sets the expiration time for pruning previously known dual-band clients. The default value is 50 seconds. After this time elapses, clients become new and are subject to probe response suppression.
- Step 6** In the **Client RSSI** field, enter a value between -90 dBm and -20 dBm. This is the minimum RSSI for a client to respond to a probe.
- Step 7** In the **Client Mid RSSI** field, enter a value between -20 dBm and -90 dBm. This parameter sets the mid-RSSI, whose value can be used for toggling 2.4 GHz probe suppression based on the RSSI value.
- Step 8** Click **Apply**.
- 

## Configuring a Band-Select RF Profile (CLI)

### Procedure

	Command or Action	Purpose
<b>Step 1</b>	<b>configure terminal</b>  <b>Example:</b> Device# <code>configure terminal</code>	Enters global configuration mode.

	Command or Action	Purpose
<b>Step 2</b>	<b>ap dot11 24ghz rf-profile</b> <i>rf-profile</i> <b>Example:</b> Device(config)# ap dot11 24ghz rf-profile test1	Configures the RF profile name and enters RF profile configuration mode.
<b>Step 3</b>	<b>band-select client</b> { <b>mid-rssi</b>   <b>rssi</b> } <i>dbm</i> <b>Example:</b> Device(config-rf-profile)# band-select client rssi -90	Sets the band-select client threshold.
<b>Step 4</b>	<b>band-select cycle</b> { <b>count</b>   <b>threshold</b> } <i>count</i> <b>Example:</b> Device(config-rf-profile)# band-select cycle count 10	Sets the band-select cycle parameters.
<b>Step 5</b>	<b>band-select expire</b> { <b>dual-band</b>   <b>suppression</b> } <i>time</i> <b>Example:</b> Device(config-rf-profile)# band-select expire dual-band 100	Configures the RF profile's band-select expiry time.
<b>Step 6</b>	<b>band-select probe-response</b> <b>Example:</b> Device(config-rf-profile)# band-select probe-response	Enables the RF profile's band-select probe response.

## Configuring 802.11n Parameters (GUI)

### Procedure

- 
- Step 1** Choose **Configuration** > **Tags & Profiles** > **RF**.
- Step 2** Click **Add** to view the **Add RF Profile** window.
- Step 3** In the **802.11** tab, proceed as follows:
- a) Choose the required operational rates.
  - b) Select the required **802.11n MCS Rates** by checking the corresponding check boxes.
- Step 4** Click **Save & Apply to Device**.
-

## Configuring 802.11n Parameters (CLI)

### Procedure

	Command or Action	Purpose
<b>Step 1</b>	<b>configure terminal</b> <b>Example:</b> Device# <b>configure terminal</b>	Enters global configuration mode.
<b>Step 2</b>	<b>ap dot11 {5ghz   24ghz} dot11n</b> <b>Example:</b> Device (config)# <b>ap dot11 5ghz dot11n</b>	Enables 802.11n support on the network.  The <b>no</b> form of this command disables the 802.11n support on the network.
<b>Step 3</b>	<b>ap dot11 {5ghz   24ghz} dot11n mcs tx rtu</b> <b>Example:</b> Device (config)# <b>ap dot11 5ghz dot11n mcs tx 20</b>	Specifies the modulation and coding scheme (MCS) rates at which data can be transmitted between the access point and the client.  <i>rtu</i> —The valid range is between 0 and 23.  The <b>no</b> form of this command disables the MCS rates that are configured.
<b>Step 4</b>	<b>wlan wlan_profile_name wlan_ID SSID_network_name wmm require</b> <b>Example:</b> Device (config)# <b>wlan wlan1 25 ssid12</b> Device (config-wlan)# <b>wmm require</b>	Enables WMM on the WLAN and uses the 802.11n data rates that you configured.  The <b>require</b> keyword requires client devices to use WMM. Devices that do not support WMM cannot join the WLAN.
<b>Step 5</b>	<b>ap dot11 {5ghz   24ghz} shutdown</b> <b>Example:</b> Device (config)# <b>ap dot11 5ghz shutdown</b>	Disables the network.
<b>Step 6</b>	<b>{ap   no ap} dot11 {5ghz   24 ghz} dot11n a-mpdu tx priority {all   0-7}</b> <b>Example:</b> Device (config)# <b>ap dot11 5ghz dot11n a-mpdu tx priority all</b>	Specifies the aggregation method used for 802.11n packets.  Aggregation is the process of grouping packet data frames together, rather than transmitting them separately. Two aggregation methods are available: Aggregated MAC Protocol Data Unit (A-MPDU) and Aggregated MAC Service Data Unit (A-MSDU). Both A-MPDU and A-MSDU are performed in the software.  You can specify the aggregation method for various types of traffic from the access point to the clients.  The list defines the priority levels (0-7) assigned per traffic type.  • 0—Best effort

	Command or Action	Purpose
		<ul style="list-style-type: none"> <li>• 1—Background</li> <li>• 2—Spare</li> <li>• 3—Excellent effort</li> <li>• 4—Controlled load</li> <li>• 5—Video, less than 100-ms latency and jitter</li> <li>• 6—Voice, less than 100-ms latency and jitter</li> <li>• 7—Network control</li> </ul> <p>You can configure each priority level independently, or you can use all the parameters to configure all the priority levels at once. You can configure priority levels so that the traffic uses either A-MPDU transmission or A-MSDU transmission.</p> <ul style="list-style-type: none"> <li>• When you use the <b>ap</b> command along with the other options, the traffic associated with that priority level uses A-MPDU transmission.</li> <li>• When you use the <b>no ap</b> command along with the other options, the traffic associated with that priority level uses A-MSDU transmission.</li> </ul> <p>Configure the priority levels to match the aggregation method used by the clients. By default, A-MPDU is enabled for priority level 0, 4, and 5, and the rest are disabled. By default, A-MPDU is enabled for all priorities except 6 and 7.</p>
<b>Step 7</b>	<b>no ap dot11 {5ghz   24ghz} shutdown</b>  <b>Example:</b> <pre>Device(config)# no ap dot11 5ghz shutdown</pre>	Re-enables the network.
<b>Step 8</b>	<b>ap dot11 {5ghz   24ghz} dot11n guard-interval {any   long}</b>  <b>Example:</b> <pre>Device(config)# ap dot11 5ghz dot11n guard-interval long</pre>	Configures the guard interval for the network.

	Command or Action	Purpose
<b>Step 9</b>	<b>ap dot11 {5ghz   24ghz} dot11n rifs rx</b> <b>Example:</b> Device(config)# <b>ap dot11 5ghz dot11n rifs rx</b>	Configures the Reduced Interframe Space (RIFS) for the network.
<b>Step 10</b>	<b>end</b> <b>Example:</b> Device(config)# <b>end</b>	Returns to privileged EXEC mode. Alternatively, you can also press <b>Ctrl-Z</b> to exit global configuration mode.

## Configuring 802.11h Parameters (CLI)

### Procedure

	Command or Action	Purpose
<b>Step 1</b>	<b>ap dot11 5ghz shutdown</b> <b>Example:</b> Device(config)# <b>ap dot11 5ghz shutdown</b>	Disables the 802.11 network.
<b>Step 2</b>	<b>{ap   no ap} dot11 5ghz channelswitch mode <i>switch_mode</i></b> <b>Example:</b> Device(config)# <b>ap dot11 5ghz channelswitch mode 0</b>	Enables or disables the access point to announce when it is switching to a new channel.  <i>switch_mode</i> --Enter 0 or 1 to specify whether transmissions are restricted until the actual channel switch ( <b>0</b> ) or are not restricted ( <b>1</b> ). The default value is disabled.
<b>Step 3</b>	<b>ap dot11 5ghz power-constraint <i>value</i></b> <b>Example:</b> Device(config)# <b>ap dot11 5ghz power-constraint 200</b>	Configures the 802.11h power constraint value in dB. The valid range is from 0 to 255.  The default value is 3.
<b>Step 4</b>	<b>no ap dot11 5ghz shutdown</b> <b>Example:</b> Device(config)# <b>no ap dot11 5ghz shutdown</b>	Re-enables the 802.11a network.

# Monitoring Configuration Settings for Band Selection, 802.11 Bands, and Parameters

## Verifying Configuration Settings Using Band Selection and 802.11 Bands Commands

The following commands can be used to verify band selection, 802.11 bands, and parameters on the .

*Table 32: Monitoring Configuration Settings Using Band Selection and 802.11 Band Commands*

Command	Purpose
<b>show ap dot11 5ghz network</b>	Displays 802.11a band network parameters, 802.11a operational rates, 802.11n MCS settings, and 802.11n status information.
<b>show ap dot11 24ghz network</b>	Displays 802.11b band network parameters, 802.11b/g operational rates, 802.11n MCS settings, and 802.11n status information.
<b>show wireless dot11h</b>	Displays 802.11h configuration parameters.
<b>show wireless band-select</b>	Displays band-select configuration settings.

### Example: Viewing the Configuration Settings for the 5-GHz Band

```

Device# show ap dot11 5ghz network
802.11a Network : Enabled
11nSupport : Enabled
  802.11a Low Band : Enabled
  802.11a Mid Band : Enabled
  802.11a High Band : Enabled

802.11a Operational Rates
  802.11a 6M : Mandatory
  802.11a 9M : Supported
  802.11a 12M : Mandatory
  802.11a 18M : Supported
  802.11a 24M : Mandatory
  802.11a 36M : Supported
  802.11a 48M : Supported
  802.11a 54M : Supported
802.11n MCS Settings:
  MCS 0 : Supported
  MCS 1 : Supported
  MCS 2 : Supported
  MCS 3 : Supported
  MCS 4 : Supported
  MCS 5 : Supported
  MCS 6 : Supported
  MCS 7 : Supported
  MCS 8 : Supported
  MCS 9 : Supported

```

## Example: Viewing the Configuration Settings for the 5-GHz Band

```

MCS 10 : Supported
MCS 11 : Supported
MCS 12 : Supported
MCS 13 : Supported
MCS 14 : Supported
MCS 15 : Supported
MCS 16 : Supported
MCS 17 : Supported
MCS 18 : Supported
MCS 19 : Supported
MCS 20 : Supported
MCS 21 : Supported
MCS 22 : Supported
MCS 23 : Supported
802.11n Status:
A-MPDU Tx:
  Priority 0 : Enabled
  Priority 1 : Disabled
  Priority 2 : Disabled
  Priority 3 : Disabled
  Priority 4 : Enabled
  Priority 5 : Enabled
  Priority 6 : Disabled
  Priority 7 : Disabled
A-MSDU Tx:
  Priority 0 : Enabled
  Priority 1 : Enabled
  Priority 2 : Enabled
  Priority 3 : Enabled
  Priority 4 : Enabled
  Priority 5 : Enabled
  Priority 6 : Disabled
  Priority 7 : Disabled
Guard Interval : Any
Rifs Rx : Enabled
Beacon Interval : 100
CF Pollable mandatory : Disabled
CF Poll Request Mandatory : Disabled
CFP Period : 4
CFP Maximum Duration : 60
Default Channel : 36
Default Tx Power Level : 1
DTPC Status : Enabled
Fragmentation Threshold : 2346
Pico-Cell Status : Disabled
Pico-Cell-V2 Status : Disabled
TI Threshold : 0
Legacy Tx Beamforming setting : Disabled
Traffic Stream Metrics Status : Disabled
Expedited BW Request Status : Disabled
EDCA profile type check : default-wmm
Call Admission Control (CAC) configuration
Voice AC
  Voice AC - Admission control (ACM) : Disabled
  Voice Stream-Size : 84000
  Voice Max-Streams : 2
  Voice Max RF Bandwidth : 75
  Voice Reserved Roaming Bandwidth : 6
  Voice Load-Based CAC mode : Enabled
  Voice tspec inactivity timeout : Enabled
CAC SIP-Voice configuration
  SIP based CAC : Disabled
  SIP Codec Type : CODEC_TYPE_G711
  SIP call bandwidth : 64

```



```
SIP call bandwidth sample-size : 20
Video AC
Video AC - Admission control (ACM) : Disabled
Video max RF bandwidth : Infinite
Video reserved roaming bandwidth : 0
```

## Example: Viewing the Configuration Settings for the 2.4-GHz Band

```
Device# show ap dot11 24ghz network
802.11b Network : Enabled
11gSupport : Enabled
11nSupport : Enabled
```

```
802.11b/g Operational Rates
802.11b 1M : Mandatory
802.11b 2M : Mandatory
802.11b 5.5M : Mandatory
802.11g 6M : Supported
802.11g 9M : Supported
802.11b 11M : Mandatory
802.11g 12M : Supported
802.11g 18M : Supported
802.11g 24M : Supported
802.11g 36M : Supported
802.11g 48M : Supported
802.11g 54M : Supported
802.11n MCS Settings:
MCS 0 : Supported
MCS 1 : Supported
MCS 2 : Supported
MCS 3 : Supported
MCS 4 : Supported
MCS 5 : Supported
MCS 6 : Supported
MCS 7 : Supported
MCS 8 : Supported
MCS 9 : Supported
MCS 10 : Supported
MCS 11 : Supported
MCS 12 : Supported
MCS 13 : Supported
MCS 14 : Supported
MCS 15 : Supported
MCS 16 : Supported
MCS 17 : Supported
MCS 18 : Supported
MCS 19 : Supported
MCS 20 : Supported
MCS 21 : Supported
MCS 22 : Supported
MCS 23 : Supported
802.11n Status:
A-MPDU Tx:
Priority 0 : Enabled
Priority 1 : Disabled
Priority 2 : Disabled
Priority 3 : Disabled
Priority 4 : Enabled
Priority 5 : Enabled
Priority 6 : Disabled
Priority 7 : Disabled
A-MSDU Tx:
```

## Example: Viewing the status of 802.11h Parameters

```

Priority 0 : Enabled
Priority 1 : Enabled
Priority 2 : Enabled
Priority 3 : Enabled
Priority 4 : Enabled
Priority 5 : Enabled
Priority 6 : Disabled
Priority 7 : Disabled
Guard Interval : Any
Rifs Rx : Enabled
Beacon Interval : 100
CF Pollable Mandatory : Disabled
CF Poll Request Mandatory : Disabled
CFP Period : 4
CFP Maximum Duration : 60
Default Channel : 11
Default Tx Power Level : 1
DTPC Status : true
Call Admission Limit : 105
G711 CU Quantum : 15
ED Threshold : -50
Fragmentation Threshold : 2346
PBCC Mandatory : Disabled
Pico-Cell Status : Disabled
Pico-Cell-V2 Status : Disabled
RTS Threshold : 2347
Short Preamble Mandatory : Enabled
Short Retry Limit : 7
Legacy Tx Beamforming setting : Disabled
Traffic Stream Metrics Status : Disabled
Expedited BW Request Status : Disabled
EDCA profile type : default-wmm
Call Admission Control (CAC) configuration
Voice AC
  Voice AC - Admission control (ACM) : Disabled
  Voice Stream-Size : 84000
  Voice Max-Streams : 2
  Voice Max RF Bandwidth : 75
  Voice Reserved Roaming Bandwidth : 6
  Voice Load-Based CAC mode : Enabled
  Voice tspec inactivity timeout : Enabled
CAC SIP-Voice configuration
  SIP based CAC : Disabled
  SIP Codec Type : CODEC_TYPE_G711
  SIP call bandwidth : 64
  SIP call bandwidth sample-size : 20
Video AC
  Video AC - Admission control (ACM) : Disabled
  Video max RF bandwidth : Infinite
  Video reserved roaming bandwidth : 0

```

## Example: Viewing the status of 802.11h Parameters

```

Device# show wireless dot11h
Power Constraint: 0
Channel Switch: 0
Channel Switch Mode: 0

```

## Example: Verifying the Band-Selection Settings

The following example displays a band-select configuration:

```
Device# show wireless band-select

Band Select Probe Response : per WLAN enabling
Cycle Count                : 2
Cycle Threshold (millisec) : 200
Age Out Suppression (sec)  : 20
Age Out Dual Band (sec)    : 60
Client RSSI (dBm)         : -80
Client Mid RSSI (dBm)     : -80
```

The following example displays an AP RF profile details:

```
Device# show ap rf-profile name vid detail

Description                :
RF Profile Name            : vid
Band                       : 2.4 GHz
802.11n client only       : Disabled
Transmit Power Threshold v1 : -70 dBm
Min Transmit Power        : -10 dBm
Max Transmit Power        : 30 dBm
Operational Rates
  802.11b 1M Rate          : Mandatory
  802.11b 2M Rate          : Mandatory
  802.11b 5.5M Rate        : Mandatory
  802.11b 11M Rate         : Mandatory
  802.11b 6M Rate          : Supported
  802.11b 9M Rate          : Supported
  802.11b 12M Rate         : Supported
  802.11b 18M Rate         : Supported
  802.11b 24M Rate         : Supported
  802.11b 36M Rate         : Supported
  802.11b 48M Rate         : Supported
  802.11b 54M Rate         : Supported
Max Clients                : 200
Trap Threshold
  Clients                  : 12 clients
  Interference              : 10%
  Noise                     : -80 dBm
  Utilization               : 10%
Multicast Data Rate        : auto
Rx SOP Threshold           : auto
Band Select
  Probe Response           : Disabled
  Cycle Count              : 2 cycles
  Cycle Threshold          : 200 milliseconds
  Expire Suppression       : 20 seconds
  Expire Dual Band        : 60 seconds
  Client RSSI              : -80 dBm
  Client Mid RSSI         : -80 dBm
High Speed Roam
  hsr mode                 : Disabled
  hsr neighbor timeout    : 5
Load Balancing
  Window                   : 5 clients
  Denial                   : 3 count
Coverage Data
  Data                     : -62 dBm
  Voice                    : -80 dBm
```

```

    Minimum Client Level           : 12 clients
    Exception Level                 : 48%
    DCA Channel List                : 1,6,11
    Unused Channel List            : 2,3,4,5,7,8,9,10
    DCA Foreign AP Contribution    : Enabled
    802.11n MCS Rates
    MCS 0                          : Enabled
    MCS 1                          : Enabled
    MCS 2                          : Enabled
    MCS 3                          : Enabled
    MCS 4                          : Enabled
    MCS 5                          : Enabled
    MCS 6                          : Enabled
    MCS 7                          : Enabled
    MCS 8                          : Enabled
    MCS 9                          : Enabled
    MCS 10                         : Enabled
    MCS 11                         : Enabled
    MCS 12                         : Enabled
    MCS 13                         : Enabled
    MCS 14                         : Enabled
    MCS 15                         : Enabled
    MCS 16                         : Enabled
    MCS 17                         : Enabled
    MCS 18                         : Enabled
    MCS 19                         : Enabled
    MCS 20                         : Enabled
    MCS 21                         : Enabled
    MCS 22                         : Enabled
    MCS 23                         : Enabled
    MCS 24                         : Enabled
    MCS 25                         : Enabled
    MCS 26                         : Enabled
    MCS 27                         : Enabled
    MCS 28                         : Enabled
    MCS 29                         : Enabled
    MCS 30                         : Enabled
    MCS 31                         : Enabled
    State                           : Up
    Client Network Preference       : connectivity

```

## Configuration Examples for Band Selection, 802.11 Bands, and Parameters

### Examples: Band Selection Configuration

This example shows how to set the probe cycle count and time threshold for a new scanning cycle period for band select:

```

Device# configure terminal
Device(config)# wireless client band-select cycle-count 3
Device(config)# wireless client band-select cycle-threshold 5000
Device(config)# end

```

This example shows how to set the suppression expiry time to the band select:

```
Device# configure terminal
Device(config)# wireless client band-select expire suppression 100
Device(config)# end
```

This example shows how to set the dual-band expiry time for the band select:

```
Device# configure terminal
Device(config)# wireless client band-select expire dual-band 100
Device(config)# end
```

This example shows how to set the client RSSI threshold for the band select:

```
Device# configure terminal
Device(config)# wireless client band-select client-rssi 40
Device(config)# end
```

This example shows how to configure band selection on specific WLANs:

```
Device# configure terminal
Device(config)# wlan wlan1 25 ssid12
Device(config-wlan)# band-select
Device(config)# end
```

## Examples: 802.11 Bands Configuration

This example shows how to configure 802.11 bands using beacon interval, fragmentation, and dynamic transmit power control:

```
Device# configure terminal
Device(config)# ap dot11 5ghz shutdown
Device(config)# ap dot11 24ghz shutdown
Device(config)# ap dot11 5ghz beaconperiod 500
Device(config)# ap dot11 5ghz fragmentation 300
Device(config)# ap dot11 5ghz dtpc
Device(config)# wireless client association limit 50 interval 1000
Device(config)# ap dot11 5ghz rate 36 mandatory
Device(config)# no ap dot11 5ghz shutdown
Device(config)# no ap dot11 24ghz shutdown
Device(config)# ap dot11 24ghz dot11g
Device(config)#end
```

## Examples: 802.11n Configuration

This example shows how to configure 802.11n parameters for 5-GHz band using aggregation method:

```
Device# configure terminal
Device(config)# ap dot11 5ghz dot11n
Device(config)# ap dot11 5ghz dot11n mcs tx 20
Device(config)# wlan wlan1 25 ssid12
Device(config-wlan)# wmm require\
Device(config-wlan)# exit
Device(config)# ap dot11 5ghz shutdown
Device(config)# ap dot11 5ghz dot11n a-mpdu tx priority all
```

```
Device(config)# no ap dot11 5ghz shutdown
Device(config)#exit
```

This example shows how to configure the guard interval for 5-GHz band:

```
Device# configure terminal
Device(config)# ap dot11 5ghz dot11n
Device(config)# ap dot11 5ghz dot11n mcs tx 20
Device(config)# wlan wlan1 25 ssid12
Device(config-wlan)# wmm require\
Device(config-wlan)# exit
Device(config)# no ap dot11 5ghz shutdown
Device(config)# ap dot11 5ghz dot11n guard-interval long
Device(config)#end
```

This example shows how to configure the RIFS for 5-GHz band:

```
Device# configure terminal
Device(config)# ap dot11 5ghz dot11n
Device(config)# ap dot11 5ghz dot11n mcs tx 20
Device(config)# wlan wlan1 25 ssid12
Device(config-wlan)# wmm require\
Device(config-wlan)# exit
Device(config)# ap dot11 5ghz shutdown
Device(config)# ap dot11 5ghz dot11n rifs rx
Device(config)#end
```

## Examples: 802.11h Configuration

This example shows how to configure the access point to announce when it is switching to a new channel using restriction transmission:

```
Device# configure terminal
Device(config)# ap dot11 5ghz shutdown
Device(config)# ap dot11 5ghz channelswitch mode 0
Device(config)# no ap dot11 5ghz shutdown
Device(config)#end
```

This example shows how to configure the 802.11h power constraint for 5-GHz band:

```
Device# configure terminal
Device(config)# ap dot11 5ghz shutdown
Device(config)# ap dot11 5ghz power-constraint 200
Device(config)# no ap dot11 5ghz shutdown
Device(config)#end
```



# CHAPTER 80

## NBAR Protocol Discovery

- [Introduction to NBAR Protocol Discovery, on page 677](#)
- [Configuring NBAR Protocol Discovery, on page 677](#)
- [Verifying Protocol Discovery Statistics, on page 678](#)

### Introduction to NBAR Protocol Discovery

The NBAR Protocol Discovery feature provides an easy way of discovering the application protocols passing through an interface. Network Based Application Recognition (NBAR) determines which protocols and applications are currently running on the network. With Protocol Discovery, you can discover any protocol traffic that is supported by NBAR and obtain statistics that are associated with that protocol.

NBAR provides several classification features that identify applications and protocols from Layer 4 through Layer 7. NBAR is also used in Cisco Application Visibility and Control (AVC). With AVC, NBAR provides better application performance through better QoS and policing, and provides finer visibility about the network that is being used.

### Configuring NBAR Protocol Discovery

Follow the procedure given below to enable protocol discovery:

#### Procedure

	Command or Action	Purpose
<b>Step 1</b>	<b>configure terminal</b> <b>Example:</b> Device# configure terminal	Enters global configuration mode.
<b>Step 2</b>	<b>wireless profile policy <i>profile-policy</i></b> <b>Example:</b> Device(config)# wireless profile policy nbar-proto-policy	Configures a WLAN policy profile and enters wireless policy configuration mode.

	Command or Action	Purpose
<b>Step 3</b>	<b>central switching</b> <b>Example:</b> Device(config-wireless-policy)# central switching	Configures the wireless policy profile for central switching.  <b>Note</b> NBAR Protocol Discovery is supported in local mode (central switching) and in FlexConnect (central switching) mode.
<b>Step 4</b>	<b>ip nbar protocol-discovery</b> <b>Example:</b> Device(config-wireless-policy)# ip nbar protocol-discovery	Enables application recognition on the wireless policy profile by activating the NBAR2 engine.

## Verifying Protocol Discovery Statistics

To view protocol discovery statistics, use the following command:

```
Device# show ip nbar protocol-discovery wlan wlan-profile-name
wlan_profile_name (iif_id 0xF0400002)
Last clearing of "show ip nbar protocol-discovery" counters 00:07:12
```

Protocol	Input	Output
	-----	-----
	Packet Count	Packet Count
	Byte Count	Byte Count
	5min Bit Rate (bps)	5min Bit Rate (bps)
	5min Max Bit Rate (bps)	5min Max Bit Rate (bps)
	-----	-----
unknown	22	0
	4173	0
	0	0
	2000	0
dhcp	3	2
	1166	724
	0	0
	0	0
ping	2	2
	204	236
	0	0
	0	0
Total	27	4
	5543	960
	0	0
	2000	0

To clear protocol discovery statistics, use the following command:

```
Device# clear ip nbar protocol-discovery wlan wlan-profile-name
```





## CHAPTER 81

# Conditional Debug, Radioactive Tracing, and Packet Tracing

---

- [Introduction to Conditional Debugging, on page 679](#)
- [Introduction to Radioactive Tracing, on page 680](#)
- [Conditional Debugging and Radioactive Tracing, on page 680](#)
- [Location of Tracefiles, on page 681](#)
- [Configuring Conditional Debugging \(GUI\), on page 681](#)
- [Configuring Conditional Debugging, on page 682](#)
- [Radioactive Tracing for L2 Multicast, on page 683](#)
- [Recommended Workflow for Trace files, on page 683](#)
- [Copying Tracefiles Off the Box, on page 684](#)
- [Configuration Examples for Conditional Debugging, on page 684](#)
- [Verifying Conditional Debugging, on page 685](#)
- [Example: Verifying Radioactive Tracing Log for SISF, on page 685](#)
- [Information About Packet Tracing, on page 686](#)
- [Configuring Conditional Debugging Packet Tracing, on page 687](#)
- [Configuring Conditional Debugging Packet Tracing per AP, on page 688](#)
- [Configuring Conditional Debugging Packet Tracing per Client \(GUI\), on page 689](#)
- [Configuring Conditional Debugging Packet Tracing per Client, on page 689](#)
- [Verifying Conditional Debugging Packet Tracing Configuration, on page 689](#)

## Introduction to Conditional Debugging

The Conditional Debugging feature allows you to selectively enable debugging and logging for specific features based on the set of conditions you define. This feature is useful in systems where a large number of features are supported.

The Conditional debug allows granular debugging in a network that is operating at a large scale with a large number of features. It allows you to observe detailed debugs for granular instances within the system. This is very useful when we need to debug only a particular session among thousands of sessions. It is also possible to specify multiple conditions.

A condition refers to a feature or identity, where identity could be an interface, IP Address, or a MAC address and so on.

This is in contrast to the general debug command, that produces its output without discriminating on the feature objects that are being processed. General debug command consumes a lot of system resources and impacts the system performance.

## Introduction to Radioactive Tracing

Radioactive tracing (RA) provides the ability to stitch together a chain of execution for operations of interest across the system, at an increased verbosity level. This provides a way to conditionally print debug information (up to DEBUG Level or a specified level) across threads, processes and function calls.



### Note

- The radioactive tracing supports First-Hop Security (FHS).  
For more information on First Hop Security features, see *System Management > Wireless Multicast > Information About Wireless Multicast > Information About IPv6 Snooping*.
- The radioactive tracing filter does not work, if the certificate is not valid.
- For effective debugging of issues on mesh features, ensure that you add both Ethernet and Radio MAC address as conditional MAC for RA tracing, while collecting logs.
- To enable debug for wireless IPs, use the **debug platform condition feature wireless ip ip-address** command.

**Table 33: Components Supporting Radio Active Tracing**

Components	Details
SISF or FHS	The first-hop security features, includes IPv6 Address Glean and IPv6 Device Tracking. For more information, see <i>Information About IPv6 Snooping</i> .
LISP	Locator or ID Separation Protocol.

## Conditional Debugging and Radioactive Tracing

Radioactive Tracing when coupled with Conditional Debugging, enable us to have a single debug CLI to debug all execution contexts related to the condition. This can be done without being aware of the various control flow processes of the feature within the box and without having to issue debugs at these processes individually.



### Note

Use the **clear platform condition all** command to remove the debug conditions applied to the platform.

## Location of Tracefiles

By default the tracefile logs will be generated for each process and saved into either the **/tmp/rp/trace** or **/tmp/fp/trace** directory. In this temp directory, the trace logs are written to files, which are of 1 MB size each. You can verify these logs (per-process) using the **show platform software trace message process\_name chassis active R0** command. The directory can hold up to a maximum of 25 such files for a given process. When a tracefile in the **/tmp** directory reaches its 1MB limit or whatever size was configured for it during the boot time, it is rotated out to an archive location in the **/crashinfo** partition under **tracelogs** directory.

The **/tmp** directory holds only a single tracefile for a given process. Once the file reaches its file size limit it is rotated out to **/crashinfo/tracelogs**. In the archive directory, up to 25 files are accumulated, after which the oldest one is replaced by the newly rotated file from **/tmp**. File size is process dependent and some processes uses larger file sizes (upto 10MB). Similarly, the number of files in the **tracelogs** directory is also decided by the process. For example, WNCNCD process uses a limit of 400 files per instance, depending on the platform.

The tracefiles in the crashinfo directory are located in the following formats:

1. Process-name\_Process-ID\_running-counter.timestamp.gz  
Example: IOSRP\_R0-0.bin\_0.14239.20151101234827.gz
2. Process-name\_pmanlog\_Process-ID\_running-counter.timestamp.bin.gz  
Example: wncmgrd\_R0-0.27958\_1.20180902081532.bin.gz

## Configuring Conditional Debugging (GUI)

### Procedure

---

- Step 1** Choose **Troubleshooting > Radioactive Trace**.
  - Step 2** Click **Add**.
  - Step 3** Enter the **MAC/IP Address**. The MAC address can be either in *xx:xx:xx:xx:xx:xx*, *xx-xx-xx-xx-xx-xx*, or *xxxx.xxxx.xxxx* format.
  - Step 4** Click **Apply to Device**.
  - Step 5** Click **Start** to start or **Stop** to stop the conditional debug.
  - Step 6** Click **Generate** to create a radioactive trace log.
  - Step 7** Click the radio button to set the time interval.
  - Step 8** Click the **Download Logs** icon that is displayed next to the trace file name, to download the logs to your local folder.
  - Step 9** Click the **View Logs** icon that is displayed next to the trace file name, to view the log files on the GUI page. Click **Load More** to view more lines of the log file.
  - Step 10** Click **Apply to Device**.
-

# Configuring Conditional Debugging

Follow the procedure given below to configure conditional debugging:

## Procedure

	Command or Action	Purpose
<b>Step 1</b>	<b>debug platform condition feature wireless mac {mac-address}</b>  <b>Example:</b> Device# <code>debug platform condition feature wireless mac b838.61a1.5433</code>	Configures conditional debugging for a feature using the specified MAC address.  <b>Note</b> This is supported with AP or client MAC/IP and also on CMX IP address and mobility peer IP.
<b>Step 2</b>	<b>debug platform condition start</b>  <b>Example:</b> Device# <code>debug platform condition start</code>	Starts conditional debugging (this will start radioactive tracing if there is a match on one of the conditions above).  <b>Note</b> This is supported with AP or client MAC/IP and also on CMX IP address and mobility peer IP.
<b>Step 3</b>	<b>show platform condition OR show debug</b>  <b>Example:</b> Device# <code>show platform condition</code> Device# <code>show debug</code>	Displays the current conditions set.
<b>Step 4</b>	<b>debug platform condition stop</b>  <b>Example:</b> Device# <code>debug platform condition stop</code>	Stops conditional debugging (this will stop radioactive tracing).  <b>Note</b> This is supported with AP or client MAC/IP and also on CMX IP address and mobility peer IP.
<b>Step 5</b>	<b>show logging profile wireless [counter   [last]{x days/hours}   filter mac {&lt;mac address&gt;} [to-file]{&lt;destination&gt;}</b>  <b>Example:</b> Device# <code>show logging profile wireless start last 20 minutes to-file bootflash:logs.txt</code>	Displays the logs from the latest wireless profile.  <b>Note</b> You can use either the <i>show logging profile wireless</i> command or <i>show logging process</i> command to collect the logs.
<b>Step 6</b>	<b>show logging process &lt;process name&gt;</b>  <b>Example:</b> Device# <code>show logging process wncd to-file flash:wncd.txt</code>	Displays the logs collection specific to the process.

	Command or Action	Purpose
<b>Step 7</b>	<b>clear platform condition all</b> <b>Example:</b> Device# <code>clear platform condition all</code>	Clears all conditions.

#### What to do next



**Note** The command **request platform software trace filter-binary wireless** {*mac-address*} generates 3 flash files:

- *collated\_log\_<.date..>*
- *mac\_log <..date..>*
- *mac\_database .. file*

Of these, *mac\_log <..date..>* is the most important file, as it gives the messages for the MAC address we are debugging. The command **show platform software trace filter-binary** also generates the same flash files, and also prints the *mac\_log* on the screen.

## Radioactive Tracing for L2 Multicast

To identify a specific multicast receiver, specify the MAC address of the joiner or the receiver client, Group Multicast IP address and Snooping VLAN. Additionally, enable the trace level for the debug. The debug level will provide detailed traces and better visibility into the system.

```
debug platform condition feature multicast controlplane mac client-mac-addr ip  
group-ip-addr vlan id level debug level
```

## Recommended Workflow for Trace files

The Recommended Workflow for Trace files is listed below:

1. To request the tracelogs for a specific time period.  
 EXAMPLE 1 day.  
 Use the command:  
 Device#**show logging process wncd to-file flash:wncd.txt**
2. The system generates a text file of the tracelogs in the location /flash:
3. Copy the file off the switchdevice. By copying the file, the tracelogs can be used to work offline. For more details on copying files, see section below.
4. Delete the tracelog file (.txt) file from /flash: location. This will ensure enough space on the switchdevice for other operations.

## Copying Tracefiles Off the Box

An example of the tracefile is shown below:

```
Device# dir crashinfo:/tracelogs
Directory of crashinfo:/tracelogs/

50664 -rwx 760 Sep 22 2015 11:12:21 +00:00 plogd_F0-0.bin_0.gz
50603 -rwx 991 Sep 22 2015 11:12:08 +00:00 fed_pmanlog_F0-0.bin_0.9558.20150922111208.gz
50610 -rw- 11 Nov 2 2015 00:15:59 +00:00 timestamp
50611 -rwx 1443 Sep 22 2015 11:11:31 +00:00
auto_upgrade_client_sh_pmanlog_R0-.bin_0.3817.20150922111130.gz
50669 -rwx 589 Sep 30 2015 03:59:04 +00:00 cfgwr-8021_R0-0.bin_0.gz
50612 -rwx 1136 Sep 22 2015 11:11:46 +00:00 reflector_803_R0-0.bin_0.1312.20150922111116.gz
50794 -rwx 4239 Nov 2 2015 00:04:32 +00:00 IOSRP_R0-0.bin_0.14239.20151101234827.gz
50615 -rwx 131072 Nov 2 2015 00:19:59 +00:00 linux_iosd_image_pmanlog_R0-0.bin_0
```

The trace files can be copied using one of the various options shown below:

```
Device# copy crashinfo:/tracelogs ?
crashinfo: Copy to crashinfo: file system
flash: Copy to flash: file system
ftp: Copy to ftp: file system
http: Copy to http: file system
https: Copy to https: file system
null: Copy to null: file system
nvram: Copy to nvram: file system
rcp: Copy to rcp: file system
running-config Update (merge with) current system configuration
scp: Copy to scp: file system
startup-config Copy to startup configuration
syslog: Copy to syslog: file system
system: Copy to system: file system
tftp: Copy to tftp: file system
tmpsys: Copy to tmpsys: file system
```

The general syntax for copying onto a TFTP server is as follows:

```
Device# copy source: tftp:
Device# copy crashinfo:/tracelogs/IOSRP_R0-0.bin_0.14239.20151101234827.gz tftp:
Address or name of remote host []? 2.2.2.2
Destination filename [IOSRP_R0-0.bin_0.14239.20151101234827.gz]?
```



---

**Note** It is important to clear the generated report or archive files off the switch in order to have flash space available for tracelog and other purposes.

---

## Configuration Examples for Conditional Debugging

The following is an output example of the *show platform condition* command.

```
Device# show platform condition
Conditional Debug Global State: Stop
Conditions Direction
```

```
-----|-----
MAC Address 0024.D7C7.0054 N/A
Feature Condition Type Value
```

```
-----|-----
Device#
```

The following is an output example of the *show debug* command.

```
Device# show debug
IOSXE Conditional Debug Configs:
Conditional Debug Global State: Start
Conditions Direction
```

```
-----|-----
MAC Address 0024.D7C7.0054 N/A
Feature Condition Type Value
```

```
-----|-----
Packet Infra debugs:
Ip Address Port
```

```
-----|-----
Device#
```

## Verifying Conditional Debugging

The table shown below lists the various commands that can be used to verify conditional debugging:

Command	Purpose
<b>show platform condition</b>	Displays the current conditions set.
<b>show debug</b>	Displays the current debug conditions set.
<b>show platform software trace filter-binary</b>	Displays logs merged from the latest tracefile.
<b>request platform software trace filter-binary</b>	Displays historical logs of merged tracefiles on the system.

## Example: Verifying Radioactive Tracing Log for SISF

The following is an output example of the *show platform software trace message ios chassis active R0 | inc sisf* command.

```
Device# show platform software trace message ios chassis active R0 | inc sisf
```

```
2017/10/26 13:46:22.104 {IOSRP_R0-0}{1}: [parser]: [5437]: UUID: 0, ra: 0 (note): CMD:
'show platform software trace message ios switch active R0 | inc sisf' 13:46:22 UTC Thu Oct
26 2017
```

```
2017/10/26 13:46:10.667 {IOSRP_R0-0}{1}: [sisf]: [5437]: UUID: 4800000000060, ra: 7 (debug):
FF8E802918 semaphore system unlocked
```

```
2017/10/26 13:46:10.667 {IOSRP_R0-0}{1}: [sisf]: [5437]: UUID: 4800000000060, ra: 7 (debug):
Unlocking, count is now 0
```

```
2017/10/26 13:46:10.667 {IOSRP_R0-0}{1}: [sisf]: [5437]: UUID: 4800000000060, ra: 7 (debug):
FF8E802918 semaphore system unlocked
```

```
2017/10/26 13:46:10.667 {IOSRP_R0-0}{1}: [sisf]: [5437]: UUID: 4800000000060, ra: 7 (debug):
Unlocking, count is now 1
```

```

2017/10/26 13:46:10.667 {IOSRP_R0-0}{1}: [sisf]: [5437]: UUID: 4800000000060, ra: 7 (debug):
  Gil/0/5 vlan 10 aaaa.bbbb.cccc Setting State to 2
2017/10/26 13:46:10.667 {IOSRP_R0-0}{1}: [sisf]: [5437]: UUID: 4800000000060, ra: 7 (debug):
  Gil/0/5 vlan 10 aaaa.bbbb.cccc Start timer 0
2017/10/26 13:46:10.667 {IOSRP_R0-0}{1}: [sisf]: [5437]: UUID: 4800000000060, ra: 7 (debug):
  Gil/0/5 vlan 10 aaaa.bbbb.cccc Timer value/granularity for 0 :299998/1000
2017/10/26 13:46:10.667 {IOSRP_R0-0}{1}: [sisf]: [5437]: UUID: 4800000000060, ra: 7 (debug):
  Gil/0/5 vlan 10 aaaa.bbbb.cccc Updated Mac Timer : 299998
2017/10/26 13:46:10.667 {IOSRP_R0-0}{1}: [sisf]: [5437]: UUID: 4800000000060, ra: 7 (debug):
  Gil/0/5 vlan 10 aaaa.bbbb.cccc Before Timer : 350000
2017/10/26 13:46:10.667 {IOSRP_R0-0}{1}: [sisf]: [5437]: UUID: 4800000000060, ra: 7 (debug):
  Gil/0/5 vlan 10 aaaa.bbbb.cccc Timer 0, default value is 350000
2017/10/26 13:46:10.667 {IOSRP_R0-0}{1}: [sisf]: [5437]: UUID: 4800000000060, ra: 7 (debug):
  Allocating timer wheel for 0
2017/10/26 13:46:10.667 {IOSRP_R0-0}{1}: [sisf]: [5437]: UUID: 4800000000060, ra: 7 (debug):
  Gil/0/5 vlan 10 aaaa.bbbb.cccc No timer running
2017/10/26 13:46:10.667 {IOSRP_R0-0}{1}: [sisf]: [5437]: UUID: 4800000000060, ra: 7 (debug):
  Granularity for timer MAC_T1 is 1000
2017/10/26 13:46:10.667 {IOSRP_R0-0}{1}: [sisf]: [5437]: UUID: 4800000000060, ra: 7 (debug):
  Gil/0/5 vlan 10 aaaa.bbbb.cccc Current State :MAC-STALE, Req Timer : MAC_T1 Current Timer
  MAC_T1

```

## Information About Packet Tracing

The Packet tracing feature cover details on how to perform data plane packet tracing for Cisco Catalyst 9800 Series Wireless Controller for Cloud software.

This feature identifies the following issues:

- Misconfiguration
- Capacity overload
- Software bugs while troubleshooting

This feature identifies what happens to a packet in your system. The conditional debugging packet tracing feature is used for accounting and capturing per-packet processing details for user-defined conditions.

You can trace packets on the controller using the following steps:

1. Enable conditional debugging on selected packets or traffic you want to trace on the controller.
2. Enable packet tracing (per-AP or per-Client).



---

**Note** You need to use per AP conditional debugging with MAC address as a filter when AP and controllers are in the same VLAN. If they are not in the same VLAN, the per AP packet tracing with MAC address does not capture packets as MAC address varies.

---

### Limitation of Conditional Debugging Packet Tracing

MAC or IP filter only applies to the outer Ethernet or IP header, so if a packet is CAPWAP encapsulated, the MAC or IP does not apply to the inner 802.11 MAC or IP.



# Configuring Conditional Debugging Packet Tracing

## Procedure

	Command or Action	Purpose
<b>Step 1</b>	<b>enable</b>  <b>Example:</b> Device> enable	Enables privileged EXEC mode.  Enter your password, if prompted.
<b>Step 2</b>	<b>debug platform packet-trace packet</b> <i>packet-count circular fia-trace data-size</i> <i>data-size</i>  <b>Example:</b> Device# debug platform packet-trace packet 8192 circular fia-trace data-size 2048	Configures packet tracing to capture the last set of packets.  Here,  <i>packet-count</i> —Valid range is from 16 to 8192.  <i>data-size</i> —Valid range is from 2048 to 16384 bytes.
<b>Step 3</b>	<b>debug platform packet-trace copy packet</b> <i>both size packet-size</i>  <b>Example:</b> Device# debug platform packet-trace copy packet both size 2048	Configures packet tracing for a copy of packet data.  Here,  <i>packet-size</i> —Valid range is from 16 to 2048 bytes.
<b>Step 4</b>	<b>debug platform condition interface</b> { <i>intf-name</i>   <b>cpp</b> } { <b>mac</b>   <b>ipv4</b>   <b>match</b> } { <b>both</b>   <b>ingress</b>   <b>egress</b> }  <b>Example:</b> Enables conditional debugging for TenGigabitEthernet 0/0/0 and match packets whose source and destination MAC is 0001.0001.0001:  Device# debug platform condition interface TenGigabitEthernet 0/0/0 mac 0001.0001.0001 both	Enables conditional debugging for an interface, MAC, or IP filter.  An interface refers to any physical port, port channel, internal vlan, SVI, or wireless client.
<b>Step 5</b>	<b>debug platform condition start</b>  <b>Example:</b> Device# debug platform condition start	Starts conditional debugging packet tracing.
<b>Step 6</b>	<b>debug platform condition stop</b>  <b>Example:</b> Device# debug platform condition stop	Stops conditional debugging packet tracing.
<b>Step 7</b>	<b>show platform hardware chassis active qfp</b> <b>feature packet-trace packet all   redirect</b> <b>bootflash:packet_trace.txt</b>	Redirects all traced packets to bootflash.

	Command or Action	Purpose
	<b>Example:</b> <pre>Device# show platform hardware chassis active qfp feature packet-trace packet all   redirect bootflash:packet_trace.txt</pre>	Converts the packet_trace.txt to pcap and downloads the pcap files. You can do so using the following link:  <a href="http://wwwin-dharton-dev.cisco.com/pactrac2pcap.html">http://wwwin-dharton-dev.cisco.com/pactrac2pcap.html</a>

## Configuring Conditional Debugging Packet Tracing per AP

### Procedure

	Command or Action	Purpose
<b>Step 1</b>	<b>enable</b>  <b>Example:</b> <pre>Device&gt; enable</pre>	Enables privileged EXEC mode.  Enter your password, if prompted.
<b>Step 2</b>	<b>debug platform condition interface</b> <i>{intf-name   cpp}</i> <i>{mac [mac-address   access-list acl-name]   ipv4   match}</i> <i>{both   ingress   egress}</i>  <b>Example:</b> <pre>Device# debug platform condition interface TenGigabitEthernet 0/0/0 mac 0001.0001.0001 both  Device# debug platform condition interface TenGigabitEthernet 0/0/0 mac access-list mac-acl-name both</pre>	Enables conditional debugging with MAC filter.  Herein, the CLI matches the packets whose source or destination MAC address is 0001.0001.0001.
<b>Step 3</b>	<b>debug platform condition interface</b> <b>TenGigabitEthernet</b> <i>intf-number</i> <b>match mac</b> <i>{H.H.H   any   host}</i> <i>{both   ingress   egress}</i>  <b>Example:</b> <pre>Device# debug platform condition interface TenGigabitEthernet 0/0/0 match mac 0001.0001.0001 both</pre>	Enables conditional debugging with inline MAC ACL.
<b>Step 4</b>	<b>debug platform condition interface</b> <b>TenGigabitEthernet</b> <i>intf-number</i> <b>ipv4</b> <i>{A.B.C.D/nn   access-list acl-name   both   egress   ingress}</i> <i>{both   egress   ingress}</i>  <b>Example:</b> <pre>Device# debug platform condition interface TenGigabitEthernet 0/0/0 ipv4 192.168.1.2/32 both  Device# debug platform condition interface TenGigabitEthernet 0/0/0 ipv4 access-list ip-acl-name both</pre>	Enables conditional debugging with IP filter.  Here,  <i>intf-number</i> —Is the GigabitEthernet interface number. Valid range is from 1 to 32.

	Command or Action	Purpose
	Device# debug platform condition interface TenGigabitEthernet 0/0/0 match ipv4 192.168.1.2/32 both	

## Configuring Conditional Debugging Packet Tracing per Client (GUI)

### Procedure

- 
- Step 1** Choose **Troubleshooting > Radioactive Trace**.
  - Step 2** Click **Add**.
  - Step 3** In the Add MAC/IP Address window, enter the **MAC/IP Address**.
  - Step 4** Click **Apply to Device**.
- 

## Configuring Conditional Debugging Packet Tracing per Client

### Procedure

	Command or Action	Purpose
<b>Step 1</b>	<b>enable</b>  <b>Example:</b> Device> enable	Enables privileged EXEC mode.  Enter your password, if prompted.
<b>Step 2</b>	<b>debug platform condition interface</b> { <i>intf-name</i>   <b>cpp</b> <i>cpp-handle-index</i> } { <b>mac</b>   <b>ipv4</b>   <b>match</b> [ <b>ipv4</b>   <b>ipv6</b>   <b>mac</b> ]} { <b>both</b>   <b>ingress</b>   <b>egress</b> }  <b>Example:</b> Device# debug platform condition interface cpp 0xa0000001 match ipv4 protocol icmp host 192.168.1.100 host 192.168.1.1 both	Enables conditional debugging for a wireless client interface.  Here,  <i>cpp-handle-index</i> —Valid range is from 1 to 4294967295.

## Verifying Conditional Debugging Packet Tracing Configuration

To view the summary of the traced packet, use the following command:

```
Device# show platform packet-trace summary
```

To view a specific traced packet, use the following command:

```
Device# show platform packet-trace packet packet-number
```

To view the wireless client interface handle, use the following command:

```
Device# show platform hardware chassis active qfp feature wireless wlclient cpp-client
mac-address client-mac details
Device# show platform hardware chassis active qfp feature wireless wlclient cpp-client
mac-address 8825.93b0.b51f details
Client Details for client cpp_if_handle: 0x34
Name : WLCLIENT-IF-0x00a0000001
Mac Addr : 8825.93b0.b51f
pal_if_handle : 0xa0000001
Mobility State : LOCAL
Multicast Action : FORWARD
Auth State : RUN
```



## CHAPTER 82

# Aggressive Client Load Balancing

- [Information About Aggressive Client Load Balancing](#), on page 691
- [Enabling Aggressive Client Load Balancing \(GUI\)](#), on page 692
- [Configuring Aggressive Client Load Balancing \(GUI\)](#), on page 692
- [Configuring Aggressive Client Load Balancing \(CLI\)](#), on page 693

## Information About Aggressive Client Load Balancing

The Aggressive Client Load Balancing feature allows lightweight access points to load balance wireless clients across access points.

When a wireless client attempts to associate to a lightweight access point, the associated response packets are sent to a client with an 802.11 response packet including status code 17. This code 17 indicates that the corresponding AP is busy. The AP does not respond with the response 'success' if the AP threshold is not met, and with code 17 (AP busy) if the AP utilization threshold is exceeded, and another less busy AP hears the client request.

For example, if the number of clients on AP1 is more than the number of clients on AP2 and the load-balancing window, then AP1 is considered to be busier than AP2. When a client attempts to associate to AP1, the client receives an 802.11 response packet with status code 17, indicating that the access point is busy, and the client attempts to associate to a different access point.

You can configure the controller to deny client associations up to 10 times (if a client attempts to associate 11 times, it will be allowed to associate on the 11th try). You can also enable or disable load balancing on a particular WLAN, which is useful if you want to disable load balancing for a select group of clients, such as time-sensitive voice clients.



---

**Note** A voice client does not authenticate when delay is configured to more than 300 ms. To avoid this, configure a central-authentication, local-switching WLAN with Cisco Centralized Key Management (CCKM), configure a pagent router between an AP and WLC with a delay of 600 ms (300 ms UP and 300 ms DOWN), and try associating the voice client.

---



---

**Note** For a FlexConnect AP, the association is locally handled. The load-balancing decisions are taken at the controller. A FlexConnect AP sends an initial response to the client before knowing the result of the calculations in the controller. Load-balancing does not take effect when the FlexConnect AP is in standalone mode.

A FlexConnect AP does not send (re)association response with status 17 for load balancing the way local-mode APs do; instead, it first sends (re)association with status 0 (success) and then deauth with reason 5.

---



---

**Note** This feature is not supported on the APs joined on default-site-tag.  
This feature is not supported on the APs across different named site-tags.  
This feature is supported only on the APs within a named-site-tag.

---

## Enabling Aggressive Client Load Balancing (GUI)

### Procedure

---

- Step 1** Choose **Configuration > Wireless > WLANs > Wireless Networks**.
  - Step 2** Select a **WLAN** to view the **Edit WLAN** window.
  - Step 3** Click **Advanced** tab.
  - Step 4** Select the **Load Balance** check box to enable the feature.
  - Step 5** Click **Update & Apply to Device**.
- 

## Configuring Aggressive Client Load Balancing (GUI)

### Procedure

---

- Step 1** Choose **Configuration > Wireless > Advanced**.  
The **Load Balancing** window is displayed.
  - Step 2** In the **Aggressive Load Balancing Window (clients)** field, enter the number of clients for the aggressive load balancing client window.
  - Step 3** In the **Aggressive Load Balancing Denial Count** field, enter the load balancing denial count.
  - Step 4** Click **Apply**.
-

# Configuring Aggressive Client Load Balancing (CLI)

## Procedure

	Command or Action	Purpose
<b>Step 1</b>	<b>enable</b> <b>Example:</b> Device# <b>enable</b>	Enters privileged EXEC mode.
<b>Step 2</b>	<b>configure terminal</b> <b>Example:</b> Device# <b>configure terminal</b>	Enters global configuration mode.
<b>Step 3</b>	<b>wlan wlan-name</b> <b>Example:</b> Device(config)# <b>wlan test-wlan</b>	Specifies the WLAN name.
<b>Step 4</b>	<b>shutdown</b> <b>Example:</b> Device(config-wlan)# <b>shutdown</b>	Disables the WLAN.
<b>Step 5</b>	<b>load-balance</b> <b>Example:</b> Device(config-wlan)# <b>load-balance</b>	Configures a guest controller as mobility controller, in order to enable client load balance to a particular WLAN.  Configure the WLAN security settings as the WLAN requirements.
<b>Step 6</b>	<b>no shutdown</b> <b>Example:</b> Device(config-wlan)# <b>no shutdown</b>	Enables WLAN.
<b>Step 7</b>	<b>end</b> <b>Example:</b> Device(config)# <b>end</b>	Returns to privileged EXEC mode. Alternatively, you can also press <b>Ctrl-Z</b> to exit global configuration mode.
<b>Step 8</b>	<b>configure terminal</b> <b>Example:</b> Device# <b>configure terminal</b>	Enters global configuration mode.
<b>Step 9</b>	<b>ap dot11 {24ghz   5ghz} load-balancing denial denial-count</b> <b>Example:</b> Device(config)# <b>ap dot11 5ghz load-balancing denial 10</b>	Configures the load balancing denial count.

	Command or Action	Purpose
<b>Step 10</b>	<b>ap dot11 { 24ghz   5ghz } load-balancing window <i>number-of-clients</i></b>  <b>Example:</b> Device(config)# <b>ap dot11 5ghz load-balancing window 10</b>	Configures the number of clients for the aggressive load balancing client window.
<b>Step 11</b>	<b>end</b>  <b>Example:</b> Device(config-wlan)# <b>end</b>	Returns to privileged EXEC mode.
<b>Step 12</b>	<b>show running-config   section <i>wlan-name</i></b>  <b>Example:</b> Device# <b>show running-config   section test-wlan</b>	Displays a filtered section of the current configuration.





## CHAPTER 83

# Accounting Identity List

---

- [Configuring Accounting Identity List \(GUI\), on page 695](#)
- [Configuring Accounting Identity List \(CLI\), on page 695](#)
- [Configuring Client Accounting \(GUI\), on page 696](#)
- [Configuring Client Accounting \(CLI\), on page 696](#)

## Configuring Accounting Identity List (GUI)

### Procedure

---

- Step 1** Choose **Configuration > Security > AAA**.
  - Step 2** In the **AAA Method List** tab, go to the **Accounting** section, and click **Add**.
  - Step 3** In the **Quick Setup: AAA Accounting** window that is displayed, enter a name for your method list.
  - Step 4** Choose the type of authentication as identity, in the **Type** drop-down list.
  - Step 5** Choose the server groups you want to use to authenticate access to your network, from the **Available Server Groups** list and click **>** icon to move them to the **Assigned Server Groups** list.
  - Step 6** Click **Save & Apply to Device**.
- 

## Configuring Accounting Identity List (CLI)

Accounting is the process of logging the user actions and keeping track of their network usage. Whenever a user successfully executes an action, the RADIUS accounting server logs the changed attributes, the user ID of the person who made the change, the remote host where the user is logged in, the date and time when the command was executed, the authorization level of the user, and a description of the action performed and the values provided.

Follow the procedure given below to configure accounting identity list.

### Before you begin

Configure the RADIUS server and AAA group server.

**Procedure**

	Command or Action	Purpose
<b>Step 1</b>	<b>aaa accounting identity <i>named-list</i> start-stop group <i>server-group-name</i></b>  <b>Example:</b> Device(config)# aaa accounting identity user1 start-stop group aaa-test	Enables accounting to send a start-record accounting notice when a client is authorized and a stop-record at the end.  <b>Note</b> You can also use the default list, instead of a named list.

Whenever there is a change in the client attribute, for example, change in IP address, client roaming, and so on, an accounting interim update is sent to the RADIUS server.

## Configuring Client Accounting (GUI)

**Procedure**

- 
- Step 1** Choose **Configuration > Tags & Profiles > Policy**.
  - Step 2** Click the **Policy Profile Name** and in the **Edit Policy Profile** window, go to the **Advanced** tab.
  - Step 3** From the **Accounting List** drop-down, select the appropriate accounting list for this policy profile. This will ensure that the policy profile undergoes that type of accounting you want to perform, before allowing it access to the network.
  - Step 4** Click **Save & Apply to Device**.
- 

## Configuring Client Accounting (CLI)

Follow the procedure given below to configure client accounting.

**Before you begin**

Ensure that RADIUS accounting is configured.

**Procedure**

	Command or Action	Purpose
<b>Step 1</b>	<b>wireless profile policy <i>profile-policy</i></b>  <b>Example:</b> Device(config)# wireless profile policy default-policy-profile	Configures WLAN policy profile and enters wireless policy configuration mode.
<b>Step 2</b>	<b>shutdown</b>  <b>Example:</b>	Disables the policy profile.

	<b>Command or Action</b>	<b>Purpose</b>
	Device(config-wireless-policy)# shutdown	
<b>Step 3</b>	<b>accounting-list</b> <i>list-name</i> <b>Example:</b> Device(config-wireless-policy)# accounting-list user1	Sets the accounting list.
<b>Step 4</b>	<b>no shutdown</b> <b>Example:</b> Device(config-wireless-policy)# no shutdown	Enables the policy profile.





# CHAPTER 84

## Support for Accounting Session ID

- [Information About Accounting Session ID, on page 699](#)
- [Configuring an Accounting Session ID \(CLI\), on page 699](#)
- [Verifying an Account Session ID, on page 700](#)

### Information About Accounting Session ID

Accounting ID is a unique identifier for a wireless client session. This ID helps to identify the accounting data of a client in the AAA server. Accounting session ID is generated by the AAA module.

From Cisco IOS XE Bengaluru, Release 17.4.1 onwards, Accounting Session ID is supported in the AAA access request, while authenticating wireless client using IEEE 802.1x method. In the Cisco IOS XE Amsterdam, Release 17.3.x and earlier releases, the Accounting Session ID was sent only as part of the accounting request. From Cisco IOS XE Bengaluru, Release 17.4.1 onwards, the Accounting Session ID is sent as part of the access request too.

### Configuring an Accounting Session ID (CLI)

#### Procedure

	Command or Action	Purpose
<b>Step 1</b>	<b>configure terminal</b> <b>Example:</b> Device# configure terminal	Enters global configuration mode.
<b>Step 2</b>	<b>radius-server attribute wireless 44 include-in-access-req</b> <b>Example:</b> Device(config)# radius-server attribute wireless 44 include-in-access-req	Sends the RADIUS authentication attribute 44, in the access request packet.
<b>Step 3</b>	<b>aaa accounting identity <i>accounting-list-name</i> start-stop group <i>server-group-name</i></b> <b>Example:</b>	Configures the accounting session identity of the AAA server.

	Command or Action	Purpose
	Device(config)# aaa accounting identity <i>accounting-list-name</i> start-stop group AAA_GROUP_1	
<b>Step 4</b>	<b>wireless profile policy</b>  <b>Example:</b> Device(config)# wireless profile policy default-policy-profile <i>accounting-list-name</i> start-stop group AAA_GROUP_1	Configures the WLAN policy profile.
<b>Step 5</b>	<b>accounting-list <i>accounting-list-name</i></b>  <b>Example:</b> Device(config-wireless-policy)# accounting-list <i>accounting-list-name</i>	Configures the accounting list.  <b>Note</b> The Accounting Session ID is added as part of the account request, only if <b>radius-server attribute wireless 44 include-in-access-req</b> is enabled along with the accounting configuration under the wireless policy.
<b>Step 6</b>	<b>description <i>description-name</i></b>  <b>Example:</b> Device(config-wireless-policy)# description <i>accounting-description</i>	Adds a description for the policy profile.
<b>Step 7</b>	<b>vlan <i>vlan-id</i></b>  <b>Example:</b> Device(config-wireless-policy)# vlan 40	Configures the VLAN name or ID.
<b>Step 8</b>	<b>no shutdown</b>  <b>Example:</b> Device(config-wireless-policy)# no shutdown	Saves the configuration and exits configuration mode and returns to privileged EXEC mode.

## Verifying an Account Session ID

To verify if an Account Session ID is populated, use the following command:

```
Device# show wireless pmk-cache
Number of PMK caches in total : 1
Type      Station      Entry Lifetime  VLAN Override  IP Override
Accounting-Session-Id  Audit-Session-Id  Username
```

```
RSN      6c19.c0e6.a444      1768      NA
0x00000006      052DA8C1000000104E634C77      cwa-user
```

To display the current Accounting Session ID, use the following command:

```
Device# show wireless client mac-address<H.H.H>detail
Central NAT : DISABLED
Session Manager:
  Point of Attachment : capwap_90000005
  IIF ID               : 0x90000005
  Authorized           : TRUE
  Session timeout      : 1800
  Common Session ID: 0000000000000000B14E9130A
  Acct Session ID     : 0x0000000c
  Last Tried Aaa Server Details:
    Server IP : 9.10.8.247
  Auth Method Status List
    Method : Dot1x
            SM State      : AUTHENTICATED
            SM Bend State : IDLE
  Local Policies:
    Service Template : wlan_svc_default-policy-profile (priority 254)
    VLAN              : 1
  Server Policies:
    Absolute-Timer   : 1800
  Resultant Policies:
    VLAN Name        : default
    VLAN             : 1
    Absolute-Timer   : 1800
```







## CHAPTER 85

# Interim Accounting

---

- [Information About Interim Accounting](#), on page 703
- [Disabling Interim Accounting \(CLI\)](#), on page 704
- [Verifying Interim Accounting](#), on page 704

## Information About Interim Accounting

RADIUS accounting sends accounting-request packets, with the relevant accounting information, from the network access server (NAS) to a RADIUS server.



---

**Note** The RADIUS accounting requests send data, such as VLAN ID, authentication methods, and so on, to a session.

---

RADIUS accounting covers the following updates:

- **Interim Updates:** When RADIUS accounting covers DHCP\_TLVs, HTTP\_TLVs, IP, or ROAM (state machine) changes, the updates are referred to as interim updates or interim accounting.
- **Periodic Updates:** When RADIUS accounting is specified by a timer value, the updates are referred to as periodic updates.



---

**Note** Disable the interim updates for the following reasons:

- They cause unnecessary traffic to be sent.
- They drive up error rates.
- They impact alarm thresholds and other metrics that are used for venue-authentication performance.

By default, the Interim Accounting feature is enabled with the **aaa accounting Identity default start-stop group radius** command.

---

# Disabling Interim Accounting (CLI)

## Before you begin

You must disable the Policy Profile before performing this procedure.

## Procedure

	Command or Action	Purpose
<b>Step 1</b>	<b>configure terminal</b> <b>Example:</b> Device# configure terminal	Enters global configuration mode.
<b>Step 2</b>	<b>wireless profile policy <i>profile-policy</i></b> <b>Example:</b> Device(config)# wireless profile policy default-policy-profile	Configures WLAN policy profile and enters wireless policy configuration mode.
<b>Step 3</b>	<b>no accounting-interim</b> <b>Example:</b> Device(config-wireless-policy)# no accounting-interim	Disables interim accounting.
<b>Step 4</b>	<b>end</b> <b>Example:</b> Device(config-wireless-policy)# end	Returns to privileged EXEC mode.

## Verifying Interim Accounting

To verify the interim accounting updates, run the following command:

```
Device# show wireless profile policy detailed default-policy-profile | s Interim
Interim Accounting Updates: DISABLED
```



## CHAPTER 86

# Wireless Multicast

- [Information About Wireless Multicast, on page 705](#)
- [Prerequisites for Configuring Wireless Multicast, on page 708](#)
- [Restrictions on Configuring Wireless Multicast, on page 709](#)
- [Configuring Wireless Multicast, on page 709](#)
- [IPv6 Multicast-over-Multicast, on page 711](#)
- [Directed Multicast Service, on page 714](#)
- [Wireless Broadcast, Non-IP Multicast and Multicast VLAN, on page 716](#)
- [Multicast Filtering, on page 722](#)

## Information About Wireless Multicast

If the network supports packet multicasting, the multicast method that the controller uses can be configured. The controller performs multicast routing in two modes:

- **Unicast mode:** The controller unicasts every multicast packet to every access point associated to the controller. This mode is inefficient and generates a lot of extra traffic in the device and the network, but is required on networks that do not support multicast routing (needed if the APs are on different subnets than the device's wireless management interface).
- **Multicast mode:** The controller sends multicast packets to a CAPWAP multicast group. This method reduces the overhead on the controller processor and shifts the work of packet replication to the network, which is much more efficient than the unicast method.

The FlexConnect mode has two submodes: local switching and central switching. In local switching mode, the data traffic is switched at the AP level and the controller does not see any multicast traffic. In central switching mode, the multicast traffic reaches the controller. However, IGMP snooping takes place at the AP.

When the multicast mode is enabled and the controller receives a multicast packet from the wired LAN, the controller encapsulates the packet using CAPWAP and forwards the packet to the CAPWAP multicast group address. The controller always uses the management VLAN for sending multicast packets. Access points in the multicast group receive the packet and forward it to all the BSSIDs mapped to the VLAN on which clients receive multicast traffic.

The controller supports all the capabilities of IGMP v1, including Multicast Listener Discovery (MLD) v1 snooping, but the IGMP v2 and IGMP v3 capabilities are limited. This feature keeps track of and delivers IPv6 multicast flows to the clients that request them. To support IPv6 multicast, global multicast mode should be enabled.

Internet Group Management Protocol (IGMP) snooping is introduced to better direct multicast packets. When this feature is enabled, the controller snooping gathers IGMP reports from the clients, processes them, creates unique multicast group IDs (MGIDs) based on the Layer 3 multicast address and the VLAN number, and sends the IGMP reports to the IGMP querier. The controller then updates the access-point MGID table on the corresponding access point with the client MAC address. When the controller receives multicast traffic for a particular multicast group, it forwards it to all the access points, but only those access points that have active clients listening or subscribed to that multicast group send multicast traffic on that particular WLAN. IP packets are forwarded with an MGID that is unique for an ingress VLAN and the destination multicast group. Layer 2 multicast packets are forwarded with an MGID that is unique for the ingress VLAN.

MGID is a 14-bit value filled in the 16-bit reserved field of wireless information in the CAPWAP header. The remaining two bits should be set to zero.

## Multicast Optimization

Multicast optimization enables you to create a multicast VLAN that can be used for multicast traffic. One of the VLANs in the device can be configured as a multicast VLAN where multicast groups are registered. The clients are allowed to listen to a multicast stream on the multicast VLAN. The MGID is generated using the multicast VLAN and multicast IP addresses. If multiple clients on different VLANs of the same WLAN are listening to a single multicast IP address, a single MGID is generated. The device makes sure that all the multicast streams from the clients on this VLAN group always go out on the multicast VLAN to ensure that the upstream router has one entry for all the VLANs of the VLAN group. Only one multicast stream hits the VLAN group even if the clients are on different VLANs. Therefore, the multicast packets that are sent out over the network is just one stream.



---

**Note** When VLAN groups are defined and uses multicast communication, then you need to enable the multicast VLAN.

---

## IPv6 Global Policies

IPv6 global policies provide storage and access policy database services. IPv6 ND inspection and IPv6 RA guard are IPv6 global policies features. Every time an ND inspection is configured globally, the policy attributes are stored in the software policy database. The policy is then applied to an interface, and the software policy database entry is updated to include this interface to which the policy is applied.

IPv6 RA guard is enabled by default on the controller. RA from the wired side should be forwarded to the wireless clients if the Stateless Address Auto-Configuration (SLAAC) is deployed in the network.

## Information About IPv6 Snooping

The following sections provide information about IPv6 snooping.

### IPv6 Neighbor Discovery Inspection

The IPv6 Neighbor Discovery Inspection, or IPv6 snooping feature bundles several Layer 2 IPv6 first-hop security features, including IPv6 Address Glean and IPv6 Device Tracking. IPv6 neighbor discovery (ND) inspection operates at Layer 2, or between Layer 2 and Layer 3, and provides IPv6 features with security and scalability. This feature mitigates some of the inherent vulnerabilities for the neighbor discovery mechanism,

such as attacks on duplicate address detection (DAD), address resolution, device discovery, and the neighbor cache.

IPv6 ND inspection learns and secures bindings for stateless autoconfiguration addresses in Layer 2 neighbor tables and analyzes ND messages in order to build a trusted binding table. IPv6 ND messages that do not have valid bindings are dropped. An ND message is considered trustworthy if its IPv6-to-MAC mapping is verifiable. This feature mitigates some of the inherent vulnerabilities for the neighbor discovery mechanism, such as attacks on duplicate address detection (DAD), address resolution, device discovery, and the neighbor cache.

When IPv6 ND inspection is configured on a target (which varies depending on platform target support and may include device ports, switch ports, Layer 2 interfaces, Layer 3 interfaces, and VLANs), capture instructions are downloaded to the hardware to redirect the ND protocol and Dynamic Host Configuration Protocol (DHCP) for IPv6 traffic up to the switch integrated security features (SISF) infrastructure in the routing device. For ND traffic, messages such as NS, NA, RS, RA, and REDIRECT are directed to SISF. For DHCP, UDP messages sourced from port 546 or 547 are redirected.

IPv6 ND inspection registers its "capture rules" to the classifier, which aggregates all rules from all features on a given target and installs the corresponding ACL down into the platform-dependent modules. Upon receiving redirected traffic, the classifier calls all entry points from any registered feature (for the target on which the traffic is being received), including the IPv6 ND inspection entry point. This entry point is the last to be called, so any decision (such as drop) made by another feature supersedes the IPv6 ND inspection decision.

## IPv6 Device Tracking

IPv6 device tracking provides IPv6 host liveness tracking so that a neighbor table can be immediately updated when an IPv6 host disappears.

### *IPv6 First-Hop Security Binding Table*

The IPv6 First-Hop Security Binding Table recovery mechanism feature enables the binding table to recover in the event of a device reboot. A database table of IPv6 neighbors connected to the device is created from information sources such as ND snooping. This database, or binding, table is used by various IPv6 guard features to validate the link-layer address (LLA), the IPv4 or IPv6 address, and prefix binding of the neighbors to prevent spoofing and redirect attacks.

This mechanism enables the binding table to recover in the event of a device reboot. The recovery mechanism will block any data traffic sourced from an unknown source; that is, a source not already specified in the binding table and previously learned through ND or DHCP gleaning. This feature recovers the missing binding table entries when the resolution for a destination address fails in the destination guard. When a failure occurs, a binding table entry is recovered by querying the DHCP server or the destination host, depending on the configuration.

### Recovery Protocols and Prefix Lists

The IPv6 First-Hop Security Binding Table Recovery Mechanism feature introduces the capability to provide a prefix list that is matched before the recovery is attempted for both DHCP and NDP.

If an address does not match the prefix list associated with the protocol, then the recovery of the binding table entry will not be attempted with that protocol. The prefix list should correspond to the prefixes that are valid for address assignment in the Layer 2 domain using the protocol. The default is that there is no prefix list, in which case the recovery is attempted for all addresses. The command to associate a prefix list to a protocol is **protocol {dhcp | ndp} [prefix-list prefix-list-name]**.

## IPv6 Address Glean

IPv6 address glean is the foundation for many other IPv6 features that depend on an accurate binding table. It inspects ND and DHCP messages on a link to glean addresses, and then populates the binding table with these addresses. This feature also enforces address ownership and limits the number of addresses any given node is allowed to claim.

The following figure shows how IPv6 address glean works.

Figure 17: IPv6 Address Glean

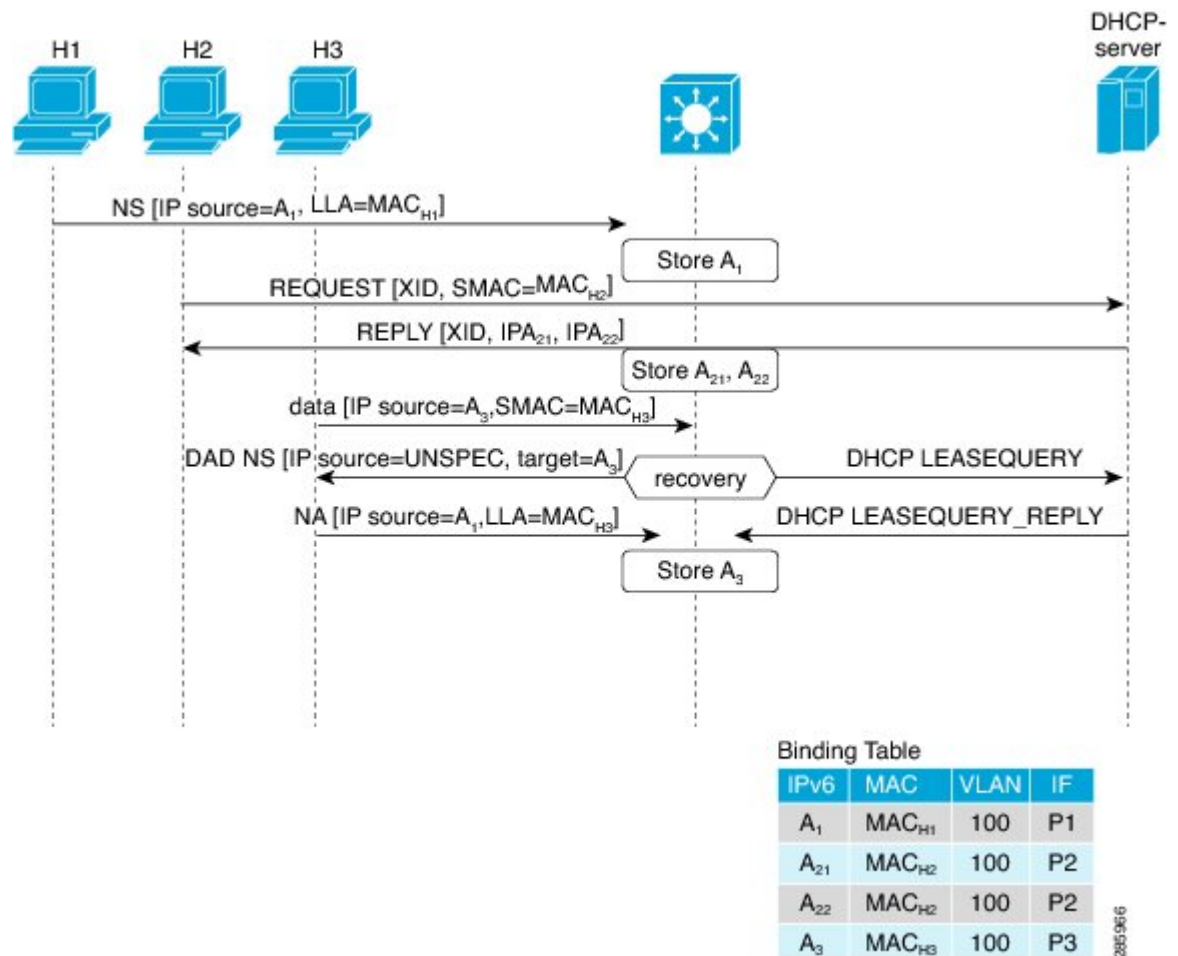

## Prerequisites for Configuring Wireless Multicast

- To participate in IP multicasting, the multicast hosts, routers, and multilayer switches must have IGMP operating.
- When enabling multicast mode on the controller, a CAPWAP multicast group address should also be configured. Access points listen to the CAPWAP multicast group using IGMP.

- You must be cautious when using IGMPv3 with switches that are enabled for IGMP snooping. The IGMPv3 messages are different from the messages used in IGMP Version 1 (IGMPv1) and Version 2 (IGMPv2). If your switch does not recognize IGMPv3 messages, the hosts do not receive traffic when IGMPv3 is used.

IGMPv3 devices do not receive multicast traffic in either cases:

- When IGMP snooping is disabled.
- When IGMPv2 is configured on the interface.

It is recommended to enable IGMPv3 on all intermediate or other Layer 3 network devices. Primarily, on each subnet used by multicast devices including controller and AP subnets.

## Restrictions on Configuring Wireless Multicast

The following are the restrictions for configuring IP multicast forwarding:

- Access points in monitor mode, sniffer mode, or rogue-detector mode do not join the CAPWAP multicast group address.
- The CAPWAP multicast group configured on the controllers should be different for different controllers.
- Multicast routing should not be enabled for the management interface.
- Multicast with VLAN group is only supported in local mode AP.
- Multicast traffic from wireless clients in non-multicast VLAN should be routed by the uplink switch.
- Multicast traffic on an AAA overridden VLAN is not supported.

## Restrictions for IPv6 Snooping

The IPv6 snooping feature is not supported on EtherChannel ports.

## Configuring Wireless Multicast

The following sections provide information about the various wireless multicast configuration tasks:

### Configuring Wireless Multicast-MCMC Mode (CLI)

#### Procedure

	Command or Action	Purpose
Step 1	<b>wireless multicast</b> <i>ip-addr</i> <b>Example:</b> Device(config)# wireless multicast 231.1.1.1	Enables multicast-over-multicast. Use the <b>no</b> form of this command to disable the feature.

	Command or Action	Purpose
<b>Step 2</b>	<b>end</b>  <b>Example:</b> Device(config)# end	Exits configuration mode.

## Configuring Wireless Multicast-MCUC Mode



**Note** The wireless multicast to unicast (MCUC) mode is only supported in 9800-CL small template.

### Procedure

	Command or Action	Purpose
<b>Step 1</b>	<b>configure terminal</b>  <b>Example:</b> Device# configure terminal	Enters global configuration mode.
<b>Step 2</b>	<b>wireless multicast</b>  <b>Example:</b> Device(config)# wireless multicast	Enables the multicast traffic for wireless clients.
<b>Step 3</b>	<b>end</b>  <b>Example:</b> Device(config)# end	Exits configuration mode.

## Configuring Multicast Listener Discovery Snooping (GUI)

### Procedure

- Step 1** Choose **Configuration > Services > Multicast**.
- Step 2** Click **MLD Snooping**.
- Step 3** In the **MLD Snooping** section, click the toggle button to enable or disable MLD snooping.
- Step 4** Enter the **MLD Query Interval**, in milliseconds. The value range is between 100 ms and 32767 ms. The default value is 1000 ms.
- Step 5** Move the required VLAN IDs listed in the **Disabled** section to the **Enabled** section. (By default, this feature is disabled on the VLAN.)

You can also search for a VLAN ID using the search field. You can click **Disable All** to move all the VLAN IDs from the **Enabled** list to the **Disabled** list, or click **Enable All** to move all the VLAN IDs from the **Disabled** list to the **Enabled** list.



**Step 6** Click **Apply to Device**.

## Configuring IPv6 MLD Snooping

### Procedure

	Command or Action	Purpose
<b>Step 1</b>	<b>configure terminal</b>  <b>Example:</b> Device# ipv6 mld snooping	Enters global configuration mode.
<b>Step 2</b>	<b>ipv6 mld snooping</b>  <b>Example:</b> Device(config)# ipv6 mld snooping	Enables MLD snooping.

## Verifying the Multicast VLAN Configuration

To view the multicast VLAN associated with a policy profile along with the VLAN assigned to that profile, use the following command:

```
Device# show wireless profile policy detail default-policy-profile

Policy Profile Name      : default-policy-profile
Description              : default policy profile
Status                  : ENABLED
VLAN                    : vlan-pool1
Multicast VLAN       : 84
Client count            : 0
Passive Client          : DISABLED
```

To view the multicast VLAN associated with a client, use the following command:

```
Device# show wireless client mac ac2b.6e4b.551e detail

Client MAC Address : ac2b.6e4b.551e
Client IPv4 Address : 84.84.0.20
.....
VLAN : 82
Access VLAN : 82
Multicast VLAN: 84
```

## IPv6 Multicast-over-Multicast

IPv6 multicast allows a host to send a single data stream to a subset of all the hosts (group transmission) simultaneously. When IPv6 Multicast over Multicast is configured, all the APs join the IPv6 multicast address, and the multicast traffic from the wireless controller to the AP flows over the IPv6 multicast tunnel.

In mixed deployments (IPv4 and IPv6), the APs might join the wireless controller over IPv4 or IPv6. To enable Multicast over Multicast in mixed deployments, configure both IPv4 and IPv6 multicast tunnels. The IPv4 APs have a unicast IPv4 CAPWAP tunnel and join the IPv4 multicast group. The IPv6 APs will have a unicast IPv6 CAPWAP tunnel and joins the IPv6 multicast group.



**Note** Mixed mode of Multicast over Unicast and Multicast over Multicast over IPv4 and IPv6 is not supported in Cisco IOS XE Gibraltar 16.10.1.

**Table 34: Multicast Support Per Platform**

Platform	Multicast Support - Multicast over Unicast	Multicast Support - Multicast over Multicast
Cisco Catalyst 9800-40 Wireless Controller	No	Yes
Cisco Catalyst 9800-80 Wireless Controller	No	Yes
Cisco Catalyst 9800 Wireless Controller for Cloud - Small Template	Yes	Yes
Cisco Catalyst 9800 Wireless Controller for Cloud - Medium Template	No	Yes
Cisco Catalyst 9800 Wireless Controller for Cloud - Large Template	No	Yes
Cisco Catalyst 9800-L Wireless Controller	Yes	Yes

## Configuring IPv6 Multicast-over-Multicast (GUI)

### Procedure

- 
- Step 1** Choose **Configuration > Services > Multicast**.
  - Step 2** From the **AP Capwap Multicast** drop-down list, select **Multicast**.
  - Step 3** Enter the **AP Capwap IPv6 Multicast group Address**.
  - Step 4** Click **Apply**.
-

## Configuring IPv6 Multicast-over-Multicast

### Procedure

	Command or Action	Purpose
<b>Step 1</b>	<b>configure terminal</b>  <b>Example:</b> Device# configure terminal	Enters global configuration mode.
<b>Step 2</b>	<b>wireless multicast { ipv4-address   ipv6 ipv6-address }</b>  <b>Example:</b> Device(config)# wireless multicast ipv6 ff45:1234::86	Configures IPv6 multicast-over-multicast address.

## Verifying IPv6 Multicast-over-Multicast

To verify the IPv6 multicast-over-multicast configuration, use the following commands:

```
Device# show wireless multicast

Multicast : Enabled
AP Capwap Multicast : Multicast
AP Capwap IPv4 Multicast group Address : 231.1.1.1
AP Capwap IPv6 Multicast group Address : ff45:1234::86
Wireless Broadcast : Disabled
Wireless Multicast non-ip-mcast : Disabled

Device# show running-configuration | inc multicast

show run | inc multicast:--

wireless multicast
wireless multicast ipv6 ff45:1234::86
wireless multicast 231.1.1.1
```

## Verifying the Multicast Connection Between the Controller and the AP

Cisco Catalyst 9800 Series Wireless Controller initiates a ping request that passes through the CAPWAP multicast tunnel onto the CAPWAP multicast receiver, which is the AP. In response, the AP pings the packets for CAPWAP multicast group IP address, and sends back the response to the controller. You can view the statistics on the AP for transmitted and received traffic to analyze the data that are sent and received through the multicast tunnel. Alternatively, you can also verify by enhancing the existing statistics on the AP for transmitted and received traffic to explicitly list the joins, leaves, data packets transmitted and received through the multicast tunnel.

To confirm if the APs receive multicast to multicast (mom) traffic sent by the controller, use the following command

```
Device# show ap multicast mom

AP Name                MOM-IP      TYPE MOM-  STATUS
```

```

-----
SS-E-1                IPv4                Up
SS-E-2                IPv4                Up
9130E-r3-sw2-g1012   IPv4                Up
9115i-r3-sw2-te1-0-38 IPv4                Up
AP9120-r3-sw3-Gi1-0-46 IPv4                Up
ap3800i-r2-sw1-te2-0-2 IPv4                Up

```

## Directed Multicast Service

The Directed Multicast Service (DMS) feature allows a client to request access points (AP) to transmit multicast packets as unicast frames. After receiving this request, an AP buffers the multicast traffic for a client and transmits it as a unicast frame when the client wakes up. This allows the client to receive the multicast packets that were ignored while in sleep mode (to save battery power) and also ensures Layer 2 reliability. The unicast frames are transmitted to the client at a potentially higher wireless link rate, which enables the client to receive the packet quickly by enabling the radio for a shorter duration, thus saving more battery power. Without DMS, the client has to wake up at each Delivery Traffic Indication Map (DTIM) interval to receive multicast traffic.

## Configuring Directed Multicast Service(GUI)

### Procedure

- 
- Step 1** Choose **Configuration > Wireless > WLANs > Wireless Networks**.
  - Step 2** Select a **WLAN** to view the **Edit WLAN** window.
  - Step 3** Click **Advanced** tab.
  - Step 4** Check the **Directed Multicast Service** check box to enable the feature.
  - Step 5** Click **Update & Apply to Device**.
- 

## Configuring Directed Multicast Service

### Before you begin

- This feature is enabled on receiving a request from a client. Ensure that this feature is configured under WLAN.
- This feature is supported only on 802.11v-capable clients, such as Apple iPad and Apple iPhone.

### Procedure

	Command or Action	Purpose
<b>Step 1</b>	<b>configure terminal</b>  <b>Example:</b> Device# configure terminal	Enters global configuration mode.

	Command or Action	Purpose
<b>Step 2</b>	<b>wlan profile-name</b> <b>Example:</b> Device(config)# wlan test5	Configures the WLAN profile and enters WLAN profile configuration mode.
<b>Step 3</b>	<b>shutdown</b> <b>Example:</b> Device(config-wlan)# shutdown	Disables the WLAN profile.
<b>Step 4</b>	<b>dms</b> <b>Example:</b> Device(config-wlan)# dms	Configures DMS processing per WLAN.
<b>Step 5</b>	<b>no shutdown</b> <b>Example:</b> Device(config-wlan)# no shutdown	Enables the WLAN profile.

## Verifying the Directed Multicast Service Configuration

To verify the status of the DMS configuration on the controller, use **show** commands below. The DMS status is displayed under *IEEE 802.11v Parameters*.

```
Device# show wlan id 5

WLAN Profile Name      : test
=====
Identifier              : 5
Network Name (SSID)    : test
Status                  : Disabled
Broadcast SSID         : Enabled
Universal AP Admin     : Disabled
Max Associated Clients per WLAN : 0
Max Associated Clients per AP per WLAN : 0
Max Associated Clients per AP Radio per WLAN : 200
!
.
.
.
Assisted-Roaming
  Neighbor List        : Disabled
  Prediction List      : Disabled
  Dual Band Support    : Disabled

! DMS status is displayed below.

IEEE 802.11v parameters
  Directed Multicast Service : Enabled
  BSS Max Idle              : Disabled
  Protected Mode            : Disabled
  Traffic Filtering Service  : Disabled
  BSS Transition            : Enabled
  Disassociation Imminent   : Disabled
  Optimized Roaming Timer   : 40
  Timer                     : 200
  WNM Sleep Mode            : Disabled
```

```

802.11ac MU-MIMO                : Disabled
802.11ax parameters
  OFDMA Downlink                : unknown
  OFDMA Uplink                  : unknown
  MU-MIMO Downlink              : unknown
  MU-MIMO Uplink                : unknown
  BSS Color                      : unknown
  Partial BSS Color             : unknown
  BSS Color Code

```

To verify the status of the DMS configuration on the controller for clients, use the following command:

```

Device# show wireless client mac-address 6c96.cff2.83a0 detail | inc 11v

11v BSS Transition : implemented
11v DMS Capable   : Yes

```

To verify the DMS request and response statistics, use the following command:

```

Device# show wireless stats client detail | inc DMS

Total DMS requests received in action frame      : 0
Total DMS responses sent in action frame         : 0
Total DMS requests received in Re-assoc Request : 0
Total DMS responses sent in Re-assoc Response   : 0

```

To verify the DMS configuration Cisco Aironet 2700 and 3700 Series APs, use the following command:

```

AP# show controllers dot11Radio 0/1 | begin Global DMS

Global DMS - requests:0 uc:0 drop:408
DMS enabled on WLAN(s): dms-open
test-open

```

To verify the DMS configuration on the Cisco Aironet 2800, 3800, and 4800 Series APs, use the following command:

```

AP# show multicast dms all

vapid   client                dmsid   TClas
0       1C:9E:46:7C:AF:C0       1       mask:0x55, version:4, proto:0x11, dscp:0x0, sport:0,
dport:9, sip:0.0.0.0, dip:224.0.0.251

```

## Wireless Broadcast, Non-IP Multicast and Multicast VLAN

### Restrictions

- Wireless broadcast does not support VLAN groups.
- When a VLAN pool is mapped to the WLAN profile, support for forwarding non-IPv4 multicast and broadcast is unavailable.
- Non-IPv4 multicasts and broadcasts are restricted to clients on the VLAN mapped to the WLAN and are not forwarded on VLANs returned by AAA override.

## Configuring Non-IP Wireless Multicast (CLI)

### Before you begin

- The non-IP Multicast feature is disabled globally, by default.
- For non-IP multicast, global wireless multicast must be enabled for traffic to pass.
- This feature is not supported in Fabric or Flex deployments.

### Procedure

	Command or Action	Purpose
<b>Step 1</b>	<b>wireless multicast non-ip</b> <b>Example:</b> Device(config)# wireless multicast non-ip	Enables non-IP multicast in all the VLANs. By default, the non-IP multicast in all the VLANs is in Disabled state. Wireless multicast must be enabled for the traffic to pass. Use the <b>no</b> form of this command to disable non-IP multicast in all the VLANs.
<b>Step 2</b>	<b>wireless multicast non-ip vlan <i>vlanid</i></b> <b>Example:</b> Device(config)# wireless multicast non-ip vlan 5	Enables non-IP multicast per VLAN. By default, non-IP multicast per VLAN is in Disabled state. Both wireless multicast and wireless multicast non-IP must be enabled for traffic to pass. Use the <b>no</b> form of this command to disable non-IP multicast per VLAN.
<b>Step 3</b>	<b>end</b> <b>Example:</b> Device(config)# end	Exits configuration mode.

## Configuring Wireless Broadcast (GUI)

### Procedure

- 
- Step 1** Choose **Configuration > Services > Multicast**.
- Step 2** In the Multicast page, change the status of the **Wireless Broadcast** to enabled to broadcast packets for wireless clients.  
The default value is disabled.
- Step 3** From the Disabled VLAN table, click the arrow adjacent to the VLAN ID in the **Disabled** state to the **Enabled** state to enable broadcast packets for a VLAN.  
The default value is disabled.
- Step 4** Save the configuration.
-

## Configuring Wireless Broadcast (CLI)

### Before you begin

- This feature is applicable only to non-ARP and DHCP broadcast packets.
- This feature is disable globally, by default.
- This feature is not supported in Fabric or Flex deployments.

### Procedure

	Command or Action	Purpose
<b>Step 1</b>	<b>wireless broadcast</b>  <b>Example:</b> Device(config)# wireless broadcast	Enables broadcast packets for wireless clients. By default, the broadcast packets for wireless clients is in Disabled state. Enabling <b>wireless broadcast</b> enables broadcast traffic for each VLAN. Use the <b>no</b> form of this command to disable broadcasting packets.
<b>Step 2</b>	<b>wireless broadcast vlan <i>vlanid</i></b>  <b>Example:</b> Device(config)# wireless broadcast vlan 3	Enables broadcast packets for single VLAN. By default, the Broadcast Packets for a Single VLAN feature is in Disabled state. Wireless broadcast must be enabled for broadcasting. Use the <b>no</b> form of this command to disable broadcast traffic for each VLAN.
<b>Step 3</b>	<b>end</b>  <b>Example:</b> Device(config)# end	Exits configuration mode.

## Configuring Multicast-over-Multicast for AP Multicast Groups (CLI)

### Procedure

	Command or Action	Purpose
<b>Step 1</b>	<b>ap capwap multicast <i>IP address</i></b>  <b>Example:</b> Device(config)# ap capwap multicast 239.4.4.4	Configures an all-AP multicast group to send a single packet to all the APs.
<b>Step 2</b>	<b>wireless multicast <i>IP address</i></b>  <b>Example:</b> Device(config)# wireless multicast 239.4.4.4	Enables Multicast-over-Multicast for multicasting client multicast group traffic to all the APs through the underlying all-AP multicast group.  <i>IP address</i> —Multicast-over-multicast IP address.



	Command or Action	Purpose
Step 3	<b>end</b> <b>Example:</b> Device(config)# end	Exits configuration mode.

## Verifying Wireless Multicast

Table 35: Commands for Verifying Wireless Multicast

Command	Description
<b>show wireless multicast</b>	Displays the multicast status and IP multicast mode, and each VLAN's broadcast and non-IP multicast status. Also displays the Multicast Domain Name System (mDNS) bridging state.
<b>show wireless multicast group summary</b>	Displays all (Group and VLAN) lists and the corresponding MGID values.
<b>show wireless multicast</b> [source <i>source</i> ] <b>group</b> <i>group</i> <b>vlan</b> <i>vlanid</i>	Displays details of the specified (S,G,V) and shows all the clients associated with and their MC2UC status.
<b>show ip igmp snooping wireless mcast-ipc-count</b>	Displays the number of multicast IPCs per MGID sent to the wireless controller module.
<b>show ip igmp snooping wireless mgid</b>	Displays the MGID mappings.
<b>show ip igmp snooping igmpv2-tracking</b>	Displays the client-to-SGV mappings and the SGV-to-client mappings.
<b>show ip igmp snooping querier vlan</b> <i>vlanid</i>	Displays the IGMP querier information for the specified VLAN.
<b>show ip igmp snooping querier detail</b>	Displays the detailed IGMP querier information of all the VLANs.
<b>show ipv6 mld snooping querier vlan</b> <i>vlanid</i>	Displays the MLD querier information for the specified VLAN.
<b>show ipv6 mld snooping wireless mgid</b>	Displays MGIDs for the IPv6 multicast group.

## Multicast Optimization

Multicast used to be based on the group of the multicast addresses and the VLAN as one entity, MGID. With the VLAN group, duplicate packets might increase. Using the VLAN group feature, every client listens to the multicast stream on a different VLAN. As a result, the device creates different MGIDs for each multicast address and the VLAN. Therefore, the upstream router sends a copy for each VLAN, which results in as many copies as the number of VLANs in the group. Because the WLAN remains the same for all the clients, multiple copies of the multicast packet are sent over the wireless network. To suppress the duplication of a multicast stream on the wireless medium between the device and the access points, the multicast optimization feature can be used.

Multicast optimization enables you to create a multicast VLAN that can be used for multicast traffic. One of the VLANs in the device can be configured as a multicast VLAN where multicast groups are registered. The clients are allowed to listen to a multicast stream on the multicast VLAN. The MGID is generated using the multicast VLAN and multicast IP addresses. If multiple clients on different VLANs of the same WLAN are listening to a single multicast IP address, a single MGID is generated. The device makes sure that all the multicast streams from the clients on this VLAN group always go out on the multicast VLAN to ensure that the upstream router has one entry for all the VLANs of the VLAN group. Only one multicast stream hits the VLAN group even if the clients are on different VLANs. Therefore, the multicast packets that are sent out over the network is just one stream.

## Configuring IP Multicast VLAN for WLAN (GUI)

### Procedure

- 
- Step 1** Choose **Configuration > Tags & Profiles > Policy**.
- Step 2** Click **Add**.
- Step 3** In the **General** tab, enter the **Name** and **Description**.
- Step 4** Enable the **Central Switching** and **Central Association** toggle buttons.
- Step 5** In the **Access Policies** tab, under the **VLAN** settings, choose the vlans from the **VLAN/VLAN Group** drop-down list and enter the **Multicast VLAN**.
- Step 6** Click **Apply to Device**.
- 

## Configuring IP Multicast VLAN for WLAN

### Before you begin

- This feature is not supported in Fabric or Flex deployments.
- Multicast VLAN is used for both IPv4 and IPv6 multicast forwarding to APs.

### Procedure

	Command or Action	Purpose
<b>Step 1</b>	<b>configure terminal</b>  <b>Example:</b> Device# configure terminal	Enters global configuration mode.
<b>Step 2</b>	<b>wireless profile policy profile-policy</b>  <b>Example:</b> Device(config)# wireless profile policy default-policy-profile	Configures WLAN policy profile and enters wireless policy configuration mode.

	Command or Action	Purpose
<b>Step 3</b>	<b>central association</b> <b>Example:</b> Device(config-wireless-policy)# central association	Configures central association for locally switched clients.
<b>Step 4</b>	<b>central switching</b> <b>Example:</b> Device(config-wireless-policy)# central switching	Configures WLAN for central switching.
<b>Step 5</b>	<b>description <i>policy-profile-name</i></b> <b>Example:</b> Device(config-wireless-policy)# description "test"	(Optional) Adds a description for the policy profile.
<b>Step 6</b>	<b>vlan <i>vlan-name</i></b> <b>Example:</b> Device(config-wireless-policy)# vlan 32	Assigns the profile policy to the VLAN.
<b>Step 7</b>	<b>multicast vlan <i>vlan-id</i></b> <b>Example:</b> Device(config-wireless-policy)# multicast vlan 84	Configures multicast for the VLAN.
<b>Step 8</b>	<b>no shutdown</b> <b>Example:</b> Device(config-wireless-policy)# no shutdown	Enables the profile policy.

## Verifying the Multicast VLAN Configuration

To view the multicast VLAN associated with a policy profile along with the VLAN assigned to that profile, use the following command:

```
Device# show wireless profile policy detail default-policy-profile
```

```
Policy Profile Name      : default-policy-profile
Description              : default policy profile
Status                  : ENABLED
VLAN                    : vlan-pool1
Multicast VLAN       : 84
Client count            : 0
Passive Client          : DISABLED
```

To view the multicast VLAN associated with a client, use the following command:

```
Device# show wireless client mac ac2b.6e4b.551e detail
```

```
Client MAC Address : ac2b.6e4b.551e
Client IPv4 Address : 84.84.0.20
```

```

.....
VLAN : 82
Access VLAN : 82
Multicast VLAN: 84

```

# Multicast Filtering

## Information About Multicast Filtering

In Cisco IOS XE Amsterdam, Release 17.2.1, the Multicast Filtering feature is supported on Layer 3 for IPv4.

You can enable or disable the multicast filtering feature per WLAN from the controller. When you enable this feature, the APs drop the Internet Group Management Protocol (IGMP) join request from a client that is part of the WLAN, for any Layer 3 multicast group address. When you disable this feature, the APs honor the IGMP join request from the client that is part of the WLAN.

In the Cisco IOS XE Amsterdam, Release 17.3.1, the Multicast Filtering feature is supported on Layer 3 for IPv6.

You can enable or disable the Multicast Filtering feature per WLAN, from the controller. The following table shows the AP behavior with IPv4 and IPv6:

The Multicast Filtering feature is disabled by default.

**Table 36: Multicast Filtering per WLAN**

Multicast Filtering Feature Status	IPv4	IPv6
Enabled	AP drops the Internet Group Management Protocol (IGMP) membership report from a client that is a part of a WLAN.	AP drops the Multicast Listener Discovery (MLD) report with multicast group address scope value greater than three, from a client that is a part of a WLAN.
Disabled	AP honors the IGMP membership report from the client that is a part of a WLAN.	AP honors the MLD report from the client that is a part of a WLAN.

### Supported L3 Multicast Report for Filtering

APs will not honor and drop IGMP and MLD join requests from a client part of WLAN for any L3 multicast group address as per the below filtering options:

- IPv4: IGMP versions to be filtered:
  - V1 membership report (0x12)
  - V2 membership report (0x16)
  - V3 membership report (0x22)
- IPv6: ICMPv6 types to be filtered, except link-local multicast packets:

- Multicast Listener report: MLD Version 1 (131)
- Multicast Listener report: MLD Version 2 (143)



**Note** Filtering of supported types will prevent the creation or addition of a client entry to the AP multicast group table.

## Configuring Multicast Filtering

Perform the procedure given here to create a policy profile and then enable Multicast Filtering on a WLAN:

### Before you begin

Create a WLAN.

### Procedure

	Command or Action	Purpose
<b>Step 1</b>	<b>configure terminal</b>  <b>Example:</b> Device# configure terminal	Enters global configuration mode.
<b>Step 2</b>	<b>wireless profile policy <i>profile-policy</i></b>  <b>Example:</b> Device(config)# wireless profile policy rr-xyz-policy-1	Configures a WLAN policy profile and enters wireless policy configuration mode.
<b>Step 3</b>	<b>multicast filter</b>  <b>Example:</b> Device(config-wireless-policy)#multicast filter	Configures a multicast filter. (Use the <b>no</b> form of this command to disable the feature.)

### What to do next

1. Create a policy tag. For more information about creating policy tags, see *Configuring a Policy Tag (CLI)*.
2. Map the policy tag to an AP. For more information about mapping a policy tag to an AP, see *Attaching a Policy Tag and Site Tag to an AP (CLI)*.

## Verifying Multicast Filtering

To verify if multicast filtering is enabled, use the **show wireless profile policy detailed *named-policy-profile*** command:

```
Device# show wireless profile policy detailed named-policy-profile
Policy Profile Name           : named-policy-profile
```

```
Description          :  
Status                : DISABLED  
VLAN                  : 91  
Multicast VLAN        : 0  
OSEN client VLAN     :  
Multicast Filter      : ENABLED
```



## CHAPTER 87

# Map-Server Per-Site Support

- [Information About Map Server Per Site Support, on page 725](#)
- [Configuring the Default Map Server \(GUI\), on page 726](#)
- [Configuring the Default Map Server \(CLI\), on page 726](#)
- [Configuring a Map Server Per Site \(GUI\), on page 727](#)
- [Configuring a Map Server Per Site \(CLI\), on page 727](#)
- [Creating a Map Server for Each VNID \(GUI\), on page 728](#)
- [Creating a Map Server for Each VNID, on page 728](#)
- [Creating a Fabric Profile and Associating a Tag and VNID \(GUI\), on page 729](#)
- [Creating a Fabric Profile and Associating a Tag and VNID \(CLI\), on page 729](#)
- [Verifying the Map Server Configuration, on page 730](#)

## Information About Map Server Per Site Support

The Map Server Per Site feature supports per-site map server and the selection of map server based on the client's subnet. This enables the controller to support multiple sites and to segregate each site's traffic.

This feature is applicable to both Enterprise and Guest map servers. For the Layer 2 virtual extensible LAN network identifier-based (L2VNID-based) map server, the appropriate map server should be selected based on the L2 VNID.

The following list shows the map server selection order for AP query and client registration:

- Per-L3 VNID map server
- Per site (ap-group) map server
- Default or global map server

### Benefits

Some of the benefits of using Map Server Per Site feature are listed below:

- You can use a single large site with horizontal scaling of the map server and border nodes.
- You can share the controller across multiple sites, with each site can having its own map server and virtual network or VNID and still segment traffic from each site.
- You can share Guest map-server across multiple sites while keeping the Enterprise map-server separate.

- You can use the same SSID across different sites. Within a site, they can belong to a different virtual network domain.

## Configuring the Default Map Server (GUI)

### Procedure

- 
- Step 1** Choose **Configuration > Wireless > Fabric**.
  - Step 2** On the **Fabric** page, click the **Control Plane** tab.
  - Step 3** In the **Control Plane Name** list, click **default-control-plane**.
  - Step 4** In the **Edit Control Plane** window that is displayed, click **Add**.
  - Step 5** Enter the IP address of the map server.
  - Step 6** Set the **Password Type** as either **Unencrypted** or **AES**.
  - Step 7** Enter the **Pre Shared Key**.
  - Step 8** Click **Save**.
  - Step 9** Click **Update & Apply to Device**.
- 

## Configuring the Default Map Server (CLI)

Follow the procedure given below to configure the default map server.

### Before you begin

- The global map server is the default map server that is used for both AP query (when an AP joins) as well as for client registration (when a client joins).
- We recommend that you configure map servers in pairs to ensure redundancy because the LISP control-plane does not support redundancy inherently.
- To share a map server set, create a map server group, which can be shared across site profiles, fabric profiles, Layer 2 and Layer3 VNID, as well with the default map server.

### Procedure

	Command or Action	Purpose
<b>Step 1</b>	<b>configure terminal</b>  <b>Example:</b> Device# <code>configure terminal</code>	Enters global configuration mode.
<b>Step 2</b>	<b>wireless fabric control-plane</b> <i>control-plane-name</i>	Configures the control plane name.



	Command or Action	Purpose
	<b>Example:</b> Device(config)# wireless fabric control-plane test-map	If you do not provide a control plane name, the default-control-plane that is auto generated is used.
<b>Step 3</b>	<b>ip address</b> <i>ip-address</i> <b>key</b> <i>pre-shared-key</i> <b>Example:</b> Device((config-wireless-cp)#ip address 10.12.13.14 key secret	Configures IP address and the key for the control plane.

## Configuring a Map Server Per Site (GUI)

### Before you begin

Ensure that you have configured an AP Join Profile prior to configuring the primary and backup controllers.

### Procedure

- 
- Step 1** Choose **Configuration > Tags & Profiles > AP Join**.
  - Step 2** On the **AP Join Profile** page, click the AP Join Profile name.
  - Step 3** In the **Edit AP Join Profile** window, click the **CAPWAP** tab.
  - Step 4** In the **High Availability** tab under **Backup Controller Configuration**, check the **Enable Fallback** check box.
  - Step 5** Enter the primary and secondary controller names and IP addresses.
  - Step 6** Click **Update & Apply to Device**.
- 

## Configuring a Map Server Per Site (CLI)

Follow the procedure given below to configure per-site MAP server under site-tag.

### Before you begin

You can configure map server for each site or each AP group. . If a map server is not configured for each VNID or subnet, per-site map server is used for AP queries and client registration.

### Procedure

	Command or Action	Purpose
<b>Step 1</b>	<b>configure terminal</b> <b>Example:</b> Device# configure terminal	Enters global configuration mode.

	Command or Action	Purpose
<b>Step 2</b>	<b>wireless tag site</b> <i>site-tag</i> <b>Example:</b> Device(config)# wireless tag site test-site	Configures a site tag and enters site tag configuration mode.
<b>Step 3</b>	<b>fabric control-plane</b> <i>map-server-name</i> <b>Example:</b> Device(config-wireless-site)# fabric control-plane test-map	Associates a fabric control plane name with a site tag.

## Creating a Map Server for Each VNID (GUI)

### Procedure

- 
- Step 1** Click **Configuration > Wireless Plus > Fabric > Fabric Configuration**.
  - Step 2** In the **Profiles** tab, click **Add** to add a new Fabric Profile.
  - Step 3** In the **Add New Profile** window that is displayed, enter a name and description for the profile.
  - Step 4** Specify the L2 VNID and SGT Tag details.
  - Step 5** In the **Map Servers** section, specify the IP address and preshared key details for Server 1.
  - Step 6** Optionally, you can specify the IP address and preshared key details for Server 2.
  - Step 7** Click **Save & Apply to Device**.
- 

## Creating a Map Server for Each VNID

Follow the procedure given below to configure map server for each VNID in Layer 2 and Layer 3 or a map server for a client VNID.

### Procedure

	Command or Action	Purpose
<b>Step 1</b>	<b>configure terminal</b> <b>Example:</b> Device# configure terminal	Enters global configuration mode.
<b>Step 2</b>	Choose one of the following: <ul style="list-style-type: none"> <li>• <b>wireless fabric name</b> <i>vnid-map</i> <b>l2-vnid</b> <i>l2-vnid</i> <b>l3-vnid</b> <i>l3vnid</i> <b>ip</b> <i>network-ip</i> <i>subnet-mask</i> <b>control-plane</b> <i>control-plane-name</i></li> </ul>	Configures a map server for each VNID in Layer 2 and Layer 3 or a map server for a client VNID.

	Command or Action	Purpose
	<ul style="list-style-type: none"> <li>• wireless fabric name <i>vnid-map l2-vnid l2-vnid control-plane control-plane-name</i></li> </ul> <p><b>Example:</b></p> <pre>Device(config)# wireless fabric name test1 l2-vnid 12 l3-vnid 10 ip 10.8.6.2 255.255.255.236 control-plane cp1</pre> <p><b>Example:</b></p> <pre>Device(config)# wireless fabric name test1 l2-vnid 22 control-plane cp1</pre>	

## Creating a Fabric Profile and Associating a Tag and VNID (GUI)

### Procedure

- 
- Step 1** Click **Configuration > Wireless > Fabric**.
  - Step 2** In the **Profiles** tab on **Fabric Configuration** page, click **Add** to add a new profile.
  - Step 3** In the **Add New Profile** window that is displayed, enter a name and description for the profile.
  - Step 4** Specify the L2 VNID and SGT Tag details.
  - Step 5** Click **Save & Apply to Device**.
- 

## Creating a Fabric Profile and Associating a Tag and VNID (CLI)

Follow the procedure given below to create a fabric profile and associate the VNID to which the client belongs and the SGT tag to this profile.

### Procedure

	Command or Action	Purpose
<b>Step 1</b>	<p><b>configure terminal</b></p> <p><b>Example:</b></p> <pre>Device# configure terminal</pre>	Enters global configuration mode.
<b>Step 2</b>	<p><b>wireless profile fabric <i>fabric-profile-name</i></b></p> <p><b>Example:</b></p> <pre>Device(config)# wireless profile fabric test-fabric</pre>	Configures a fabric profile.
<b>Step 3</b>	<p><b>sgt-tag <i>value</i></b></p> <p><b>Example:</b></p>	Configures an SGT tag.

	Command or Action	Purpose
	Device(config-wireless-fabric)# sgt-tag 5	
<b>Step 4</b>	<b>client-l2-vnid</b> <i>vnid</i>  <b>Example:</b> Device(config-wireless-fabric)# client-l2-vnid 10	Configures a client Layer 2 VNID.

## Verifying the Map Server Configuration

Use the following commands to verify the map server configuration:

```
Device# show wireless fabric summary
```

```
Fabric Status      : Enabled
```

```
Control-plane:
```

Name	IP-address	Key	Status
test-map	10.12.13.14	test1	Down

```
Fabric VNID Mapping:
```

Name	L2-VNID	L3-VNID	IP Address	Subnet
Control plane name				
test1	12	10	10.6.8.9	255.255.255.236
test2				

```
Device# show wireless fabric vnid mapping
```

```
Fabric VNID Mapping:
```

Name	L2-VNID	L3-VNID	IP Address	Subnet	Control Plane Name
fabric1	1	0	9.6.51.0	255.255.255.0	map-server-name

```
Device# show wireless profile fabric detailed profile-name
```

```
Profile-name      : fabric-ap
VNID              : 1
SGT               : 500
Type              : Guest
```

```
Control Plane Name      Control-Plane IP      Control-Plane Key
```

Ent-map-server	5.4.3.2	guest_1
----------------	---------	---------

```
Device# show ap name ap-name config general
```

```
Fabric status           : Enabled
RLOC                    : 2.2.2.2
Control Plane Name     : ent-map-server
```

```
Device# show wireless client mac mac-address detail
```

```
Fabric status : Enabled
RLOC          : 2.2.2.2
Control Plane Name : ent-map-server
```

```
Device# show wireless tag site detailed site-tag
```

```
Site Tag Name      : default-site-tag
Description        : default site tag
-----
AP Profile         : default-ap-profile
Local-site        : Yes
Fabric-control-plane: Ent-map-server
```





## CHAPTER 88

# Volume Metering

- [Volume Metering, on page 733](#)
- [Configuring Volume Metering, on page 733](#)

## Volume Metering

The Volume Metering feature allows you to configure the interval at which an access point (AP) updates client accounting statistics to the controller and in turn to the RADIUS server. Currently, the report is sent from an AP to the controller every 90 seconds. With this feature, you can configure the time from 5 to 90 seconds. This helps reduce the delay in accounting data usage by a device.

## Configuring Volume Metering

Follow the procedure given below to configure volume metering:

### Procedure

	Command or Action	Purpose
<b>Step 1</b>	<b>configure terminal</b> <b>Example:</b> Device# configure terminal	Enters global configuration mode.
<b>Step 2</b>	<b>ap profile <i>profile-name</i></b> <b>Example:</b> Device(config)# ap profile yy-ap-profile	Configures an AP profile and enters ap profile configuration mode.
<b>Step 3</b>	<b>dot11 24ghz reporting-interval <i>reporting-interval</i></b> <b>Example:</b> Device(config-ap-profile)# dot11 24ghz reporting-interval 60	Configures the dot11 parameters.

	<b>Command or Action</b>	<b>Purpose</b>
<b>Step 4</b>	<p><b>dot11 5ghz reporting-interval</b> <i>reporting-interval</i></p> <p><b>Example:</b></p> <pre>Device(config-ap-profile)# dot11 5ghz reporting-interval 60</pre>	Configures the dot11 parameters.
<b>Step 5</b>	<p><b>exit</b></p> <p><b>Example:</b></p> <pre>Device(config-ap-profile)# exit</pre>	Returns to global configuration mode.
<b>Step 6</b>	<p><b>aaa accounting update periodic</b> <i>interval-in-minutes</i></p> <p><b>Example:</b></p> <pre>Device(config)# aaa accounting update periodic 75</pre>	Sets the time interval (in minutes) at which the controller sends interim accounting updates of the client to the RADIUS server.
<b>Step 7</b>	<p><b>exit</b></p> <p><b>Example:</b></p> <pre>Device(config)# exit</pre>	Exits configuration mode and returns to privileged EXEC mode.





## CHAPTER 89

# Enabling Syslog Messages in Access Points and Controller for Syslog Server

---

- [Information About Enabling Syslog Messages in Access Points and Controller for Syslog Server, on page 735](#)
- [Configuring Syslog Server for an AP Profile, on page 737](#)
- [Configuring Syslog Server for the Controller \(GUI\), on page 738](#)
- [Configuring Syslog Server for the Controller , on page 739](#)
- [Information About Syslog Support for Client State Change, on page 740](#)
- [Configuring Syslog Support for Client State Change \(CLI\), on page 741](#)
- [Sample Syslogs, on page 741](#)
- [Verifying Syslog Server Configurations, on page 742](#)

## Information About Enabling Syslog Messages in Access Points and Controller for Syslog Server

The Syslog server on access points and controller has many levels and facilities.

The following are the Syslog levels:

- Emergencies
- Alerts
- Critical
- Errors
- Warnings
- Notifications
- Informational
- Debugging

The following options are available for the Syslog facility:

- auth—Authorization system.

- cron—Cron/ at facility.
- daemon—System daemons.
- kern—Kernel.
- local0—Local use.
- local1—Local use.
- local2—Local use.
- local3—Local use.
- local4—Local use.
- local5—Local use.
- local6—Local use.
- local7—Local use.
- lpr—Line printer system.
- mail—Mail system.
- news—USENET news.
- sys10—System use.
- sys11—System use.
- sys12—System use.
- sys13—System use.
- sys14—System use.
- sys9—System use.
- syslog—Syslog itself.
- user—User process.
- uucp—Unix-to-Unix copy system.



---

**Note** For more information about the usage of the syslog facilities and levels, refer to [RFC 5424](#) (*The Syslog Protocol*).

---

# Configuring Syslog Server for an AP Profile

## Procedure

	Command or Action	Purpose
<b>Step 1</b>	<b>configure terminal</b> <b>Example:</b> Device# <code>configure terminal</code>	Enters global configuration mode.
<b>Step 2</b>	<b>ap profile <i>ap-profile</i></b> <b>Example:</b> Device(config)# <code>ap profile xyz-ap-profile</code>	Configures an AP profile and enters the AP profile configuration mode.
<b>Step 3</b>	<b>syslog facility</b> <b>Example:</b> Device(config-ap-profile)# <code>syslog facility</code>	Configures the facility parameter for Syslog messages.
<b>Step 4</b>	<b>syslog host <i>ip-address</i></b> <b>Example:</b> Device(config-ap-profile)# <code>syslog host 9.3.72.1</code>	Configures the Syslog server IP address and parameters.
<b>Step 5</b>	<b>syslog level {alerts   critical   debugging   emergencies   errors   informational   notifications   warnings}</b> <b>Example:</b> Device(config-ap-profile)# <code>syslog level</code>	Configures the Syslog server logging level. The following are the Syslog server logging levels: <ul style="list-style-type: none"> <li>• <b>emergencies</b>—Signifies severity 0. Implies that the system is not usable.</li> <li>• <b>alerts</b>—Signifies severity 1. Implies that an immediate action is required.</li> <li>• <b>critical</b>—Signifies severity 2. Implies critical conditions.</li> <li>• <b>errors</b>—Signifies severity 3. Implies error conditions.</li> <li>• <b>warnings</b>—Signifies severity 4. Implies warning conditions.</li> <li>• <b>notifications</b>—Signifies severity 5. Implies normal but significant conditions.</li> <li>• <b>informational</b>—Signifies severity 6. Implies informational messages.</li> <li>• <b>debugging</b>—Signifies severity 7. Implies debugging messages.</li> </ul>

	Command or Action	Purpose
		<p><b>Note</b> To know the number of Syslog levels supported, you need to select a Syslog level. Once a Syslog level is selected, all the levels below it are also enabled.</p> <p>If you enable <i>critical</i> Syslog level then all levels below it are also enabled. So, all three of them, namely, <i>critical</i>, <i>alerts</i>, and <i>emergencies</i> are enabled.</p>
<b>Step 6</b>	<p><b>end</b></p> <p><b>Example:</b></p> <p>Device(config-ap-profile)# <b>end</b></p>	Returns to privileged EXEC mode. Alternatively, you can also press <b>Ctrl-Z</b> to exit global configuration mode.

## Configuring Syslog Server for the Controller (GUI)

### Procedure

- 
- Step 1** Choose **Troubleshooting > Logs**.
- Step 2** Click **Manage Syslog Servers** button.
- Step 3** In **Log Level Settings**, from the **Syslog** drop-down list, choose a security level.
- Step 4** From the **Message Console** drop-down list, choose a logging level.
- Step 5** In **Message Buffer Configuration**, from the **Level** drop-down list, choose a server logging level.
- Step 6** In **Size (bytes)**, enter the buffer size. The value can range between 4096 to 2147483647.
- Step 7** In **IP Configuration** settings, click **Add**.
- Step 8** Choose the **Server Type**, from the **IPv4 / IPv6** or **FQDN** option.
- Step 9** For Server Type **IPv4 / IPv6**, enter the **IPv4 / IPv6 Server Address**. For Server Type **FQDN**, enter the **Host Name**, choose the IP type and the appropriate **VRF Name** from the drop-down lists.
- To delete a syslog server, click 'x' next to the appropriate server entry, under the **Remove** column.
- Note** When creating a host name, spaces are not allowed.
- Step 10** Click **Apply to Device**.
- Note** When you click on **Apply to Device**, the changes are configured. If you click on **Cancel**, the configurations are discarded.
-

# Configuring Syslog Server for the Controller

## Procedure

	Command or Action	Purpose
<b>Step 1</b>	<b>configure terminal</b> <b>Example:</b> Device# <code>configure terminal</code>	Enters global configuration mode.
<b>Step 2</b>	<b>logging host {hostname   ipv6}</b> <b>Example:</b> Device(config)# <code>logging host 124.3.52.62</code>	Enables Syslog server IP address and parameters.
<b>Step 3</b>	<b>logging facility {auth   cron   daemon   kern   local0   local1   local2   local3   local4   local5   local6   local7   lpr   mail   news   sys10   sys11   sys12   sys13   sys14   sys9   syslog   user   uucp}</b> <b>Example:</b> Device(config)# <code>logging facility syslog</code>	Enables facility parameter for the Syslog messages.  You can enable the following facility parameter for the Syslog messages: <ul style="list-style-type: none"> <li>• <b>auth</b>—Authorization system.</li> <li>• <b>cron</b>—Cron facility.</li> <li>• <b>daemon</b>—System daemons.</li> <li>• <b>kern</b>—Kernel.</li> <li>• <b>local0</b> to <b>local7</b>—Local use.</li> <li>• <b>lpr</b>—Line printer system.</li> <li>• <b>mail</b>—Mail system.</li> <li>• <b>news</b>—USENET news.</li> <li>• <b>sys10</b> to <b>sys14</b> and <b>sys9</b>—System use.</li> <li>• <b>syslog</b>—Syslog itself.</li> <li>• <b>user</b>—User process.</li> <li>• <b>uucp</b>—Unix-to-Unix copy system.</li> </ul>
<b>Step 4</b>	<b>logging trap {severity-level   alerts   critical   debugging   emergencies   errors   informational   notifications   warnings}</b> <b>Example:</b> Device(config)# <code>logging trap 2</code>	Enables Syslog server logging level.  <i>severity-level</i> - Refers to the logging severity level. The valid range is from 0 to 7.  The following are the Syslog server logging levels: <ul style="list-style-type: none"> <li>• <b>emergencies</b>—Signifies severity 0. Implies that the system is not usable.</li> </ul>

	Command or Action	Purpose
		<ul style="list-style-type: none"> <li>• <b>alerts</b>—Signifies severity 1. Implies that an immediate action is required.</li> <li>• <b>critical</b>—Signifies severity 2. Implies critical conditions.</li> <li>• <b>errors</b>—Signifies severity 3. Implies error conditions.</li> <li>• <b>warnings</b>—Signifies severity 4. Implies warning conditions.</li> <li>• <b>notifications</b>—Signifies severity 5. Implies normal but significant conditions.</li> <li>• <b>informational</b>—Signifies severity 6. Implies informational messages.</li> <li>• <b>debugging</b>—Signifies severity 7. Implies debugging messages.</li> </ul> <p><b>Note</b> To know the number of Syslog levels supported, you need to select a Syslog level. Once a Syslog level is selected, all the levels below it are also enabled.</p> <p>If you enable <i>critical</i> Syslog level then all levels below it are also enabled. So, all three of them, namely, <i>critical</i>, <i>alerts</i>, and <i>emergencies</i> are enabled.</p>
<b>Step 5</b>	<p><b>end</b></p> <p><b>Example:</b></p> <pre>Device(config)# end</pre>	<p>Returns to privileged EXEC mode. Alternatively, you can also press <b>Ctrl-Z</b> to exit global configuration mode.</p>

## Information About Syslog Support for Client State Change

When a client joins, dissociates, or rejoins a wireless network, the Syslog Support for Client State Change feature enables you to track client details such as IP addresses, AP names, and so on.

A syslog is generated in the following scenarios:

- When a client moves to RUN state.
- When a client gets a new IP (IPv4 or IPv6) address in the RUN state.
- When a client in RUN state is deleted.



**Note** When Syslog Support for Client State Change feature is enabled, and the AP moves from standalone to connected, you may observe that usernames are null in **syslog messages and in client detail** for the 802.1X clients associated with that AP. You can ignore this behavior, as it does not have any operational impact. The usernames will get updated after 30 seconds.

## Configuring Syslog Support for Client State Change (CLI)

### Procedure

	Command or Action	Purpose
<b>Step 1</b>	<b>configure terminal</b> <b>Example:</b> Device# configure terminal	Enters global configuration mode.
<b>Step 2</b>	<b>wireless client syslog-detailed</b> <b>Example:</b> Device(config)# wireless client syslog-detailed	Enables detailed syslogs for client events.
<b>Step 3</b>	<b>end</b> <b>Example:</b> Device(config)# end	Returns to privileged EXEC mode.

## Sample Syslogs

### 802.11x Authentication

The following example shows a client IP update:

```
Oct 1 14:41:27.785 IST: %CLIENT_ORCH_LOG-7-CLIENT_IP_UPDATED:
Chassis 1 R0/0: wncd: Username (dev2), MAC: 0062.xxxx.0077,
IP fe80::262:aff:xxxx:77 101.6.2.119 2001:300:8:0:362:aff:xxxx:77 2001:300:8:0:762:aff:xxxx:77
2001:300:8:0:562:aff:xxxx:77 2001:300:8:0:962:aff:xxxx:77 2001:300:8:0:462:aff:xxxx:77
IP address updated, associated to AP (Asim_06-11) with SSID (dev_abcd_wlan_1)
```

The following example shows a client RUN state:

```
Oct 1 14:41:27.779 IST: %CLIENT_ORCH_LOG-7-CLIENT_MOVED_TO_RUN_STATE:
Chassis 1 R0/0: wncd: Username (dev2), MAC: 0062.xxxx.006a, IP 101.xxxx.2.106 associated
to AP
(Asim_06-10) with SSID (dev_abcd_wlan_1)
```

### Open Authentication

The following example shows a client IP update:

```
Sep 18 03:22:35.902: %CLIENT_ORCH_LOG-7-CLIENT_IP_UPDATED:
Chassis 1 R0/0: wncd: Username (null), MAC: 6014.xxxx.c5fb, IP 9.9.xxxx.252
fe80::643c:87c1:xxxx:c1c4 IP address updated,
associated to AP (AP2C5A.xxxx.159A) with SSID (test1)
```

The following example shows a client RUN state:

```
Sep 18 03:22:35.257: %CLIENT_ORCH_LOG-7-CLIENT_MOVED_TO_RUN_STATE:
Chassis 1 R0/0: wncd: Username (null), MAC: 6014.xxxx.c5fb, IP 9.9.xxxx.252 associated to
AP (AP2C5A.xxxx.159A) with SSID (test1)
```

The following example shows a client delete state:

```
Sep 18 03:24:45.083: %CLIENT_ORCH_LOG-7-CLIENT_MOVED_TO_DELETE_STATE:
Chassis 1 R0/0: wncd: Username (null), MAC: 6014.xxxx.c5fb, IP fe80::643c:xxxx:e316:c1c4
2001:300:42:0:643c:87c1:xxxx:c1c4
2001:300:42:0:xxxx:82ce:1ae4:5a32 9.9.xxxx.252 disconnected from AP (AP2C5A.xxxx.159A) with
SSID (test1)
```

## Verifying Syslog Server Configurations

### Verifying Global Syslog Server Settings for all Access Points

To view the global Syslog server settings for all access points that joins the controller, use the following command:

```
Device# show ap config general
Cisco AP Name : APA0F8.4984.5E48
=====

Cisco AP Identifier : a0f8.4985.d360
Country Code : IN
Regulatory Domain Allowed by Country : 802.11bg:-A 802.11a:-DN
AP Country Code : IN - India
AP Regulatory Domain
Slot 0 : -A
Slot 1 : -D
MAC Address : a0f8.4984.5e48
IP Address Configuration : DHCP
IP Address : 9.4.172.111
IP Netmask : 255.255.255.0
Gateway IP Address : 9.4.172.1
Fallback IP Address Being Used :
Domain :
Name Server :
CAPWAP Path MTU : 1485
Telnet State : Disabled
SSH State : Disabled
Jumbo MTU Status : Disabled
Cisco AP Location : default location
Site Tag Name : ST1
RF Tag Name : default-rf-tag
Policy Tag Name : PT3
AP join Profile : default-ap-profile
Primary Cisco Controller Name : WLC2
Primary Cisco Controller IP Address : 9.4.172.31
```



```
Secondary Cisco Controller Name : Not Configured
Secondary Cisco Controller IP Address : 0.0.0.0
Tertiary Cisco Controller Name : Not Configured
Tertiary Cisco Controller IP Address : 0.0.0.0
Administrative State : Enabled
Operation State : Registered
AP Certificate type : Manufacturer Installed Certificate
AP Mode : Local
AP VLAN tagging state : Disabled
AP VLAN tag : 0
CAPWAP Preferred mode : Not Configured
AP Submode : Not Configured
Office Extend Mode : Disabled
Remote AP Debug : Disabled
Logging Trap Severity Level : notification
Software Version : 16.10.1.24
Boot Version : 1.1.2.4
Mini IOS Version : 0.0.0.0
Stats Reporting Period : 180
LED State : Enabled
PoE Pre-Standard Switch : Disabled
PoE Power Injector MAC Address : Disabled
Power Type/Mode : PoE/Full Power (normal mode)
Number of Slots : 3
AP Model : AIR-AP1852I-D-K9
IOS Version : 16.10.1.24
Reset Button : Disabled
AP Serial Number : KWC212904UB
Management Frame Protection Validation : Disabled
AP User Mode : Automatic
AP User Name : Not Configured
AP 802.1X User Mode : Global
AP 802.1X User Name : Not Configured
Cisco AP System Logging Host : 9.4.172.116
AP Up Time : 11 days 1 hour 15 minutes 52 seconds
AP CAPWAP Up Time : 6 days 3 hours 11 minutes 6 seconds
Join Date and Time : 09/05/2018 04:18:52
Join Taken Time : 3 minutes 1 second
Join Priority : 1
Ethernet Port Duplex : Auto
Ethernet Port Speed : Auto
AP Link Latency : Disable
AP Lag Configuration Status : Disabled
AP Lag Operational Status : Disabled
Lag Support for AP : Yes
Rogue Detection : Enabled
Rogue Containment auto-rate : Disabled
Rogue Containment of standalone FlexConnect APs : Disabled
Rogue Detection Report Interval : 10
Rogue AP minimum RSSI : -90
Rogue AP minimum transient time : 0
AP TCP MSS Adjust : Enabled
AP TCP MSS Size : 1250
AP IPv6 TCP MSS Adjust : Enabled
AP IPv6 TCP MSS Size : 1250
Hyperlocation Admin Status : Disabled
Retransmit count : 5
Retransmit interval : 3
Fabric status : Disabled
FIPS status : Disabled
WLANCC status : Disabled
USB Module Type : USB Module
USB Module State : Enabled
USB Operational State : Disabled
```

```

USB Override : Disabled
Lawful-Interception Admin status : Disabled
Lawful-Interception Oper status : Disabled

```

### Verifying Syslog Server Settings for a Specific Access Point

To view the Syslog server settings for a specific access point, use the following command:

```

Device# show ap name <ap-name> config general
show ap name APA0F8.4984.5E48 config general
Cisco AP Name : APA0F8.4984.5E48
=====

Cisco AP Identifier : a0f8.4985.d360
Country Code : IN
Regulatory Domain Allowed by Country : 802.11bg:-A 802.11a:-DN
AP Country Code : IN - India
AP Regulatory Domain
Slot 0 : -A
Slot 1 : -D
MAC Address : a0f8.4984.5e48
IP Address Configuration : DHCP
IP Address : 9.4.172.111
IP Netmask : 255.255.255.0
Gateway IP Address : 9.4.172.1
Fallback IP Address Being Used :
Domain :
Name Server :
CAPWAP Path MTU : 1485
Telnet State : Disabled
SSH State : Disabled
Jumbo MTU Status : Disabled
Cisco AP Location : default location
Site Tag Name : ST1
RF Tag Name : default-rf-tag
Policy Tag Name : PT3
AP join Profile : default-ap-profile
Primary Cisco Controller Name : WLC2
Primary Cisco Controller IP Address : 9.4.172.31
Secondary Cisco Controller Name : Not Configured
Secondary Cisco Controller IP Address : 0.0.0.0
Tertiary Cisco Controller Name : Not Configured
Tertiary Cisco Controller IP Address : 0.0.0.0
Administrative State : Enabled
Operation State : Registered
AP Certificate type : Manufacturer Installed Certificate
AP Mode : Local
AP VLAN tagging state : Disabled
AP VLAN tag : 0
CAPWAP Preferred mode : Not Configured
AP Submode : Not Configured
Office Extend Mode : Disabled
Remote AP Debug : Disabled
Logging Trap Severity Level : notification
Software Version : 16.10.1.24
Boot Version : 1.1.2.4
Mini IOS Version : 0.0.0.0
Stats Reporting Period : 180
LED State : Enabled
PoE Pre-Standard Switch : Disabled
PoE Power Injector MAC Address : Disabled
Power Type/Mode : PoE/Full Power (normal mode)
Number of Slots : 3
AP Model : AIR-AP1852I-D-K9

```

```
IOS Version : 16.10.1.24
Reset Button : Disabled
AP Serial Number : KWC212904UB
Management Frame Protection Validation : Disabled
AP User Mode : Automatic
AP User Name : Not Configured
AP 802.1X User Mode : Global
AP 802.1X User Name : Not Configured
Cisco AP System Logging Host : 9.4.172.116
AP Up Time : 11 days 1 hour 15 minutes 52 seconds
AP CAPWAP Up Time : 6 days 3 hours 11 minutes 6 seconds
Join Date and Time : 09/05/2018 04:18:52
Join Taken Time : 3 minutes 1 second
Join Priority : 1
Ethernet Port Duplex : Auto
Ethernet Port Speed : Auto
AP Link Latency : Disable
AP Lag Configuration Status : Disabled
AP Lag Operational Status : Disabled
Lag Support for AP : Yes
Rogue Detection : Enabled
Rogue Containment auto-rate : Disabled
Rogue Containment of standalone FlexConnect APs : Disabled
Rogue Detection Report Interval : 10
Rogue AP minimum RSSI : -90
Rogue AP minimum transient time : 0
AP TCP MSS Adjust : Enabled
AP TCP MSS Size : 1250
AP IPv6 TCP MSS Adjust : Enabled
AP IPv6 TCP MSS Size : 1250
Hyperlocation Admin Status : Disabled
Retransmit count : 5
Retransmit interval : 3
Fabric status : Disabled
FIPS status : Disabled
WLANCC status : Disabled
USB Module Type : USB Module
USB Module State : Enabled
USB Operational State : Disabled
USB Override : Disabled
Lawful-Interception Admin status : Disabled
Lawful-Interception Oper status : Disabled
```





## CHAPTER 90

# Login Banner

---

- [Information About Login Banner, on page 747](#)
- [Configuring a Login Banner \(GUI\), on page 747](#)
- [Configuring a Login Banner, on page 748](#)

## Information About Login Banner

Login banner is used to display a warning or message when you try to login to the controller.

To create a login banner, you must configure a delimiting character that notifies the system that the following text string must be displayed as the banner, and then the text string itself. The delimiting character is repeated at the end of the text string to signify the end of the banner. The delimiting character can be any single character in the extended ASCII character set, but once defined as the delimiter, that character cannot be used in the text string for the banner.



---

**Note** When HTTP authentication is configured using TACACS+/RADIUS, the banner message does not display on the Web UI.

---

## Configuring a Login Banner (GUI)

### Procedure

---

- Step 1** Choose **Administration > Device**.
  - Step 2** In the **General** tab, in the **Banner** field, enter a name for the device and a message.
  - Step 3** Click **Apply**.
-

# Configuring a Login Banner

## Procedure

	Command or Action	Purpose
<b>Step 1</b>	<b>enable</b> <b>Example:</b> Device# enable	Enables privileged EXEC mode. Enter your password if prompted.
<b>Step 2</b>	<b>configure terminal</b> <b>Example:</b> Device# configure terminal	Enters global configuration mode.
<b>Step 3</b>	<b>banner login c message c</b> <b>Example:</b> Device(config)# banner login \$ Access for authorized users only. Please enter your username and password. \$	Specifies the login message. <ul style="list-style-type: none"> <li>• <b>c</b>— Enters the delimiting character of your choice, for example, a pound sign (#), and press the <b>Return</b> key. The delimiting character signifies the beginning and end of the banner text. Characters after the ending delimiter are discarded.</li> <li>• <b>message</b>— Enters a login message up to 255 characters. You cannot use the delimiting character in the message.</li> </ul>
<b>Step 4</b>	<b>end</b> <b>Example:</b> Device(config)# end	Returns to privileged EXEC mode. Alternatively, you can also press <b>Ctrl-Z</b> to exit global configuration mode.
<b>Step 5</b>	<b>show running-config</b> <b>Example:</b> Device# show running-config	Verifies your entries.
<b>Step 6</b>	<b>copy running-config startup-config</b> <b>Example:</b> Device# copy running-config startup-config	(Optional) Saves your entries in the configuration file.



# CHAPTER 91

## Wi-Fi Alliance Agile Multiband

- [Introduction to Wi-Fi Alliance Agile Multiband, on page 749](#)
- [Limitations of MBO, on page 751](#)
- [Configuring MBO on a WLAN, on page 751](#)
- [Verifying MBO Configuration, on page 752](#)

### Introduction to Wi-Fi Alliance Agile Multiband

The Wi-Fi Alliance Agile Multiband (MBO) feature enables better use of Wi-Fi network resources. This feature is built on the fundamental premise that both Wi-Fi networks and client devices have information that can enable better roaming decisions and improve the overall performance of Wi-Fi networks and user experience.



---

**Note** This feature applies to MBO certified clients only.

---

This feature certifies the interoperability of a bundle of features that are defined by the IEEE standard amendments 802.11k, 802.11v, and 802.11u, as well as the Wi-Fi-Alliance defined specifications. These technologies are used to exchange access points (AP), band, and channel preferences, link quality, and status information between AP and client device.

MBO focuses on the following:

- Interactions between the wireless clients and APs
- Exchange of AP and client knowledge about the wireless medium (such as RF neighbors)
- Allow clients to work with APs and take intelligent decisions on the connection and improve the quality of service.

#### Wi-Fi Alliance Agile Multiband Topology

Multiple components form a Wi-Fi Agile Multiband wireless infrastructure network, which may vary based on the wireless network deployment.

The following figure depicts the system topology for connecting Wi-Fi Agile Multiband devices.

Figure 18: Wi-Fi Agile Multiband Wireless Infrastructure Network

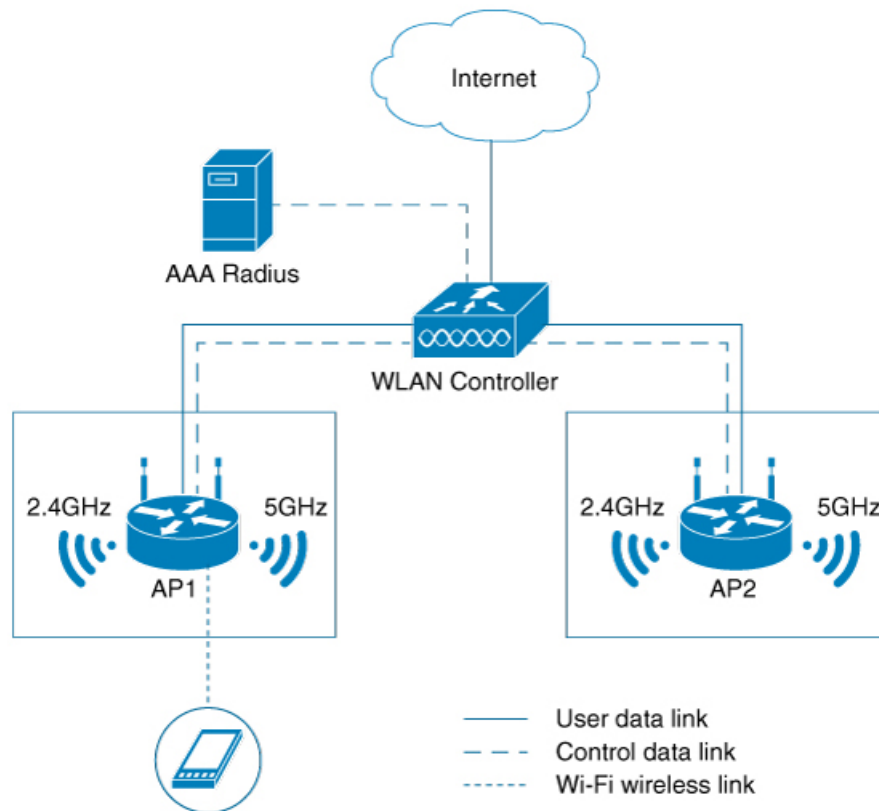

The following components form a Wi-Fi Agile Multiband wireless infrastructure network:

- Access Point (AP): A Wi-Fi Agile Multiband wireless infrastructure network contains one or more Wi-Fi Agile Multiband APs.
- WLAN Controller: A Wi-Fi Agile Multiband wireless infrastructure network contains zero or more WLAN controllers that provide centralized management and other features to the interconnected APs.
- Client Station (STA): A Wi-Fi Agile Multiband wireless infrastructure network contains zero or more STAs. These client STAs are single WLAN capable only.
- RADIUS Server: A Wi-Fi Agile Multiband wireless infrastructure network contains zero or more RADIUS Servers that provide Authentication, Authorization, and Accounting (AAA) services.

### Supported MBO Components

#### MBO AP Capability

A new information element is added to the Beacon, Probe Response, Association Response and Re Association Response Frames for 802.11ax APs to inform clients about MBO support.



**Note** The new information element indicates that Cisco APs are not cellular data aware.



When an SSID is configured on an AP, the MBO AP capability is enabled.

#### 802.11k/v/r Support

One of the prerequisites for MBO is that APs need to support 802.11k/v/r standard-based technologies. Each of the technologies has their own requirements, such as:

- 802.11k – For 802.11k, send the preferred list of AP neighbors to the client upon request and send a beacon request to a client when AP requires a beacon report from the client.
- 802.11v – For 802.11v, steer the client to a less congested AP (not in a MBO client's non-prefer/non-operable channel list that is sent during the association request and/or WNM notification request) using BSS transition.
- 802.11r – The 802.11r MBO-related capabilities are not supported.

#### 802.11u ANQP or GAS Support

For MBO, the 802.11ax APs must have 802.11u ANQP or GAS support.

The following are the prerequisites:

- ANQP responds to the ANQP request for a neighbor report ANQP-element.
- Before authentication, Layer 2 transport needs to be available in the network between a mobile device and server for an advertisement protocol frame.

#### MBO Beacon Request

Whenever an AP sends a beacon request to the client, the MBO-compliant client responds with a beacon report.

#### MBO Associate Disallowed IE

Cisco APs include an **Associate Disallowed IE** in their Beacon/Probe response/(Re) association response when they cannot accommodate any new client.

## Limitations of MBO

All non-802.11ax access points are not supported.

## Configuring MBO on a WLAN

### Procedure

	Command or Action	Purpose
<b>Step 1</b>	<b>configure terminal</b>  <b>Example:</b> Device# <code>configure terminal</code>	Enters global configuration mode.
<b>Step 2</b>	<b>wlan wlan-name wlan-id ssid</b>  <b>Example:</b>	Configures a WLAN and enters the WLAN configuration mode.

	Command or Action	Purpose
	Device(config)# wlan wlan-demo 1 ssid-demo	<b>Note</b> If you use WPA2 WLAN while configuring MBO for WLAN, you need to enable PMF in your configuration.
<b>Step 3</b>	<b>mbo</b>  <b>Example:</b> Device(config-wlan)# mbo	Configures MBO support on WLAN.  <b>Note</b> Use the <b>no mbo</b> command to disable MBO configuration.
<b>Step 4</b>	<b>end</b>  <b>Example:</b> Device(config-wlan)# end	Returns to privileged EXEC mode.  Alternatively, you can also press <b>Ctrl-Z</b> to exit global configuration mode.

## Verifying MBO Configuration

To view the MBO configuration, use the following command:

```
Device# show wlan id 1
WLAN Profile Name      : wlan-demo
=====
Identifier              : 1
Description             :
Network Name (SSID)    : ssid-demo
Status                 : Disabled
Broadcast SSID         : Enabled
802.11ax parameters
  OFDMA Downlink       : Enabled
  OFDMA Uplink         : Enabled
  MU-MIMO Downlink     : Enabled
  MU-MIMO Uplink      : Enabled
  BSS Color            : Enabled
  Partial BSS Color    : Enabled
  BSS Color Code       : 0
  BSS Target Wake Up Time : Enabled
  BSS Target Wake Up Time Broadcast Support : Enabled
mDNS Gateway Status    : Bridge
WIFI Alliance Agile Multiband : Enabled
```

To view the non-operational or non-preferred channels, use the following command:

```
Device# show wireless client mac-address 3413.e8b5.f252 detail
Client MAC Address : 3413.e8b5.f252
Client IPv4 Address : 192.165.1.53
Client IPv6 Addresses : fe80::98bb:ea89:f016:3332
Client Username: N/A
AP MAC Address : 00ee.ab18.d920
AP Name: ssap-pp
AP slot : 1
Client State : Associated
Policy Profile : prof
Flex Profile : N/A
Wireless LAN Id: 1
WLAN Profile Name: mbo_1
Wireless LAN Network Name (SSID): mbo_1
BSSID : 00ee.ab18.d92f
```

```
Connected For : 25 seconds
Protocol : 802.11ax - 5 GHz
Channel : 36
Client IIF-ID : 0xa0000001
Association Id : 1
Authentication Algorithm : Open System
Session Timeout : 1800 sec (Remaining time: 1779 sec)
Session Warning Time : Timer not running
Input Policy Name : None
Input Policy State : None
Input Policy Source : None
Output Policy Name : None
Output Policy State : None
Output Policy Source : None
WMM Support : Enabled
U-APSD Support : Enabled
  U-APSD value : 0
  APSD ACs : BK, BE, VI, VO
Fastlane Support : Disabled
Client Active State : Active
Power Save : OFF
Current Rate : 1.5
Supported Rates : 9.0,18.0,36.0,48.0,54.0
Mobility:
  Move Count : 0
  Mobility Role : Local
  Mobility Roam Type : None
  Mobility Complete Timestamp : 05/15/2019 16:03:34 IST
Client Join Time:
  Join Time Of Client : 05/15/2019 16:03:34 IST
Policy Manager State: Run
Last Policy Manager State : IP Learn Complete
Client Entry Create Time : 26 seconds
Policy Type : N/A
Encryption Cipher : None
User Personal Network : Disabled
Encrypted Traffic Analytics : No
Protected Management Frame - 802.11w : No
EAP Type : Not Applicable
VLAN : default
Multicast VLAN : 0
WFD capable : No
Managed WFD capable : No
Cross Connection capable : No
Support Concurrent Operation : No
Session Manager:
  Point of Attachment : capwap_90400001
  IIF ID : 0x90400001
  Authorized : TRUE
  Session timeout : 1800
  Common Session ID: 0000000000000000BB92939C5
  Acct Session ID : 0x00000000
  Last Tried Aaa Server Details:
  Server IP :
  Auth Method Status List
  Method : None
  Local Policies:
  Service Template : wlan_svc_prof_local (priority 254)
  VLAN : 165
  Absolute-Timer : 1800
  Server Policies:
  Resultant Policies:
  VLAN Name : VLAN0165
  VLAN : 165
```

```
Absolute-Timer      : 1800
DNS Snooped IPv4 Addresses : None
DNS Snooped IPv6 Addresses : None
Client Capabilities
  CF Pollable      : Not implemented
  CF Poll Request  : Not implemented
  Short Preamble   : Not implemented
  PBCC             : Not implemented
  Channel Agility  : Not implemented
  Listen Interval  : 0
Fast BSS Transition Details :
  Reassociation Timeout : 0
11v BSS Transition : Implemented
11v DMS Capable    : No
QoS Map Capable    : Yes
Non-Preferred Channels : 40
Non-Operable Channels : 56
FlexConnect Data Switching : N/A
FlexConnect Dhcp Status : N/A
FlexConnect Authentication : N/A
FlexConnect Central Association : N/A
Client Statistics:
  Number of Bytes Received : 0
  Number of Bytes Sent     : 0
  Number of Packets Received : 0
  Number of Packets Sent    : 0
  Number of Policy Errors   : 0
  Radio Signal Strength Indicator : -34 dBm
  Signal to Noise Ratio     : 56 dB
Fabric status          : Disabled
Client Scan Reports
Assisted Roaming Neighbor List
Nearby AP Statistics:
EoGRE                  : No/Simple client
```



## CHAPTER 92

# SNMP Traps

- [Information About Configuring SNMP Traps, on page 755](#)
- [Configuring SNMP Traps \(GUI\), on page 756](#)
- [Enabling Access Points Traps \(CLI\), on page 756](#)
- [Enabling Wireless Client Traps \(CLI\), on page 757](#)
- [Enabling Mesh Traps \(CLI\), on page 757](#)
- [Enabling RF Traps \(CLI\), on page 758](#)
- [Enabling Rogue, Mobility, RRM, and General Traps \(CLI\), on page 758](#)
- [Verifying SNMP Wireless Traps, on page 759](#)

## Information About Configuring SNMP Traps

Simple Network Management Protocol (SNMP) Traps are alert messages sent from a remote SNMP-enabled device such as the controller, to an SNMP manager. Traps are unreliable because the receiver does not send acknowledgments when the device receives traps. Hence, the sender cannot determine if the traps were received.

In order to configure the controller to send SNMP notifications, you must enter at least one **snmp-server host** command. If you do not enter an **snmp-server host** command, no notifications are sent.

In order to enable multiple hosts, you must specify separate **snmp-server host** command for each host. You can specify multiple notification types in the command for each host. When multiple **snmp-server host** commands are given for the same host and notification of either trap or inform, each command overwrites the previous command. Only the last **snmp-server host** command is taken into account. For example, if you enter an **snmp-server host** inform command for a host and then enter another **snmp-server host** inform command for the same host, the second command replaces the first.

Specify the **snmp-server enable traps wireless <TrapName>** command in order to specify which SNMP notifications are sent globally. In order for a host to receive wireless notifications, at least one **snmp-server enable traps wireless <TrapName>** command and the **snmp-server host** command for that host must be enabled. However, some notification types cannot be controlled with the **snmp-server enable** command. And some notification types are enabled by default. For example, few AP related traps **crash**, **register**, and **noradiocards** are enabled by default.

## Configuring SNMP Traps (GUI)

### Procedure

- 
- Step 1** Choose **Administration > Management > SNMP**.  
The SNMP page is displayed. By default, the SNMP mode is disabled. To enable or disable SMNP, click the **SNMP Mode** toggle button.
- Step 2** Choose the **Wireless Traps** tab.  
By default, all SNMP wireless traps are disabled except the **Access Point** trap. To enable all the wireless traps, click **Enable All**.
- Step 3** Select the wireless SNMP trap that you wish to enable. Click the **Select All** check box to enable all the trapflags present in the trap. For example, to enable all the trapflags in the **Mesh** trap section, check the **Select All** check box present at the right-hand corner of the section. Uncheck the **Select All** check box to remove selection.
- Note** In the **Access Point** trap, **Crash**, **No Radio Cards**, and **Register** trapflags are enabled by default. Select **Broken Antenna** trapflag to detect broken antenna. Select **AP Stats** trapflag to enable a trap for AP statistics.
- Step 4** Click **Apply**.
- 

## Enabling Access Points Traps (CLI)

### Procedure

	Command or Action	Purpose
<b>Step 1</b>	<b>configure terminal</b>  <b>Example:</b> Device# configure terminal	Enters global configuration mode.
<b>Step 2</b>	<b>snmp-server enable traps wireless AP</b>  <b>Example:</b> Device# snmp-server enable traps wireless AP	Enables wireless SNMP traps for access points.
<b>Step 3</b>	<b>trapflags ap { authorization   broken-antenna   crash   interfaceup   ipaddrfallback   mfp   mode   noradiocards   register }</b>  <b>Example:</b> Device# trapflags ap authorization	Enables or disables sending AP related trapflags. The <b>crash</b> , <b>noradiocards</b> , and <b>register</b> trapflags are enabled by default.

## Enabling Wireless Client Traps (CLI)

### Procedure

	Command or Action	Purpose
<b>Step 1</b>	<b>configure terminal</b> <b>Example:</b> Device# configure terminal	Enters global configuration mode.
<b>Step 2</b>	<b>snmp-server enable traps wireless bsnMobileStation</b> <b>Example:</b> Device# snmp-server enable traps wireless bsnMobileStation	Enables wireless client traps.
<b>Step 3</b>	<b>trapflags client dot11 { assocfail   associate   authenticate   authfail   deauthenticate   disassociate }</b> <b>Example:</b> Device# trapflags client dot11 assocfail	Enables or disables dot11 related trapflags for clients.
<b>Step 4</b>	<b>trapflags client excluded</b> <b>Example:</b> Device# trapflags client excluded	Enables the excluded trapflags for clients.

## Enabling Mesh Traps (CLI)

### Procedure

	Command or Action	Purpose
<b>Step 1</b>	<b>configure terminal</b> <b>Example:</b> Device# configure terminal	Enters global configuration mode.
<b>Step 2</b>	<b>snmp-server enable traps wireless MESH</b> <b>Example:</b> Device# snmp-server enable traps wireless MESH	Enables wireless mesh traps.
<b>Step 3</b>	<b>trapflags mesh { abate-snr   authentication-failure   child-moved  </b>	Enables or disables mesh trapflags.

	Command or Action	Purpose
	<b>excessive-children   excessive-hopcount   onset-snr   parent-change }</b>  <b>Example:</b> Device# trapflags mesh abate-snr	

## Enabling RF Traps (CLI)

### Procedure

	Command or Action	Purpose
<b>Step 1</b>	<b>configure terminal</b>  <b>Example:</b> Device# configure terminal	Enters global configuration mode.
<b>Step 2</b>	<b>snmp-server enable traps wireless bsnAutoRF</b>  <b>Example:</b> Device# snmp-server enable traps wireless bsnAutoRF	Enables wireless RF related traps.
<b>Step 3</b>	<b>trapflags rrm-params{channels   tx-power }</b>  <b>Example:</b> Device# trapflags rrm-params channels	Enables or disables sending RRM parameter update related traps.
<b>Step 4</b>	<b>trapflags rrm-profile{coverage   interference   load   noise }</b>  <b>Example:</b> Device# trapflags rrm-profile coverage	Enables or disables RRM profile related traps.

## Enabling Rogue, Mobility, RRM, and General Traps (CLI)

### Procedure

	Command or Action	Purpose
<b>Step 1</b>	<b>configure terminal</b>  <b>Example:</b> Device# configure terminal	Enters global configuration mode.



	Command or Action	Purpose
<b>Step 2</b>	<b>snmp-server enable traps wireless rogue</b> <b>Example:</b> Device# snmp-server enable traps wireless rogue	Enables traps for wireless rogue.
<b>Step 3</b>	<b>trapflags rogue-ap</b> <b>Example:</b> Device# trapflags rogue-ap	Enables rogue AP detection trapflag.
<b>Step 4</b>	<b>trapflags rogue-client</b> <b>Example:</b> Device# trapflags rogue-client	Enables rogue client detection trapflag.
<b>Step 5</b>	<b>snmp-server enable traps wireless wireless_mobility</b> <b>Example:</b> Device# snmp-server enable traps wireless wireless_mobility	Enables traps for wireless mobility.
<b>Step 6</b>	<b>trapflags anchor</b> <b>Example:</b> Device# trapflags anchor	Enables anchor trapflags.
<b>Step 7</b>	<b>snmp-server enable traps wireless RRM</b> <b>Example:</b> Device# snmp-server enable traps wireless RRM	Enables traps for wireless RRM.
<b>Step 8</b>	<b>trapflags rrm-params group</b> <b>Example:</b> Device# trapflags rrm-params group	Enables or disables the RRM parameter related traps, when the RF manager group changes.
<b>Step 9</b>	<b>snmp-server enable traps wireless bsnGeneral</b> <b>Example:</b> Device# snmp-server enable traps wireless bsnGeneral	Enables general controller traps.

## Verifying SNMP Wireless Traps

To verify the various SNMP traps enabled, use the following command:

```
Device# show run | sec trapflag
trapflags ap crash
trapflags ap noradiocards
```

```
trapflags ap register
trapflags rogue-client
```



## CHAPTER 93

# Disabling Clients with Random MAC Address

- [Information About Disabling Clients with Random MAC Addresses, on page 761](#)
- [Configuring Random MAC Address Deny \(CLI\), on page 761](#)
- [Verifying Denial of Clients with a Random MAC Address, on page 762](#)

## Information About Disabling Clients with Random MAC Addresses

Wireless clients used to associate with a wireless network using the MAC address that is assigned, for the Wi-Fi network interface card (NIC), during manufacture. This globally unique MAC address assigned by the manufacturer is also known as burn-in address (BIA). BIA tracks end users with the help of the MAC address of the Wi-Fi. To improve the privacy of end user products, a locally enabled random MAC address is enabled for Wi-Fi operations.

Prior to Cisco IOS XE Bengaluru 17.5.1 Release, clients joining a wireless network using a random MAC address could not be tracked with ease. From Cisco IOS XE Bengaluru 17.5.1 Release onwards, the controller is equipped with a knob that denies the entry of clients with a random MAC address into the network. When the *local-admin-mac deny* knob is enabled on the controller, the association of a client joining the network with a random MAC address is rejected. By default, this feature is disabled on the controller.

This feature is not supported in Cisco Wave 1 access points.

## Configuring Random MAC Address Deny (CLI)

To stop the entry of clients with a random MAC addresses from joining a wireless network, enable the random MAC address deny knob, by following the steps given below.

### Procedure

	Command or Action	Purpose
Step 1	<b>configure terminal</b>  <b>Example:</b> Device# configure terminal	Enters global configuration mode.

	Command or Action	Purpose
<b>Step 2</b>	<b>wlan</b> <i>wlan-profile-name</i> <1-4096> <i>SSID-network-name</i>  <b>Example:</b> Device(config)# wlan <i>wlan-profile-name</i> 8 <i>ssid-network-name</i>	Configures the WLAN policy profile.
<b>Step 3</b>	<b>shutdown</b>  <b>Example:</b> Device(config-wlan)# shutdown	Shuts down the WLAN.
<b>Step 4</b>	<b>[no] local-admin-mac deny</b>  <b>Example:</b> Device(config-wlan)# local-admin-mac deny	Enables the random MAC address deny knob.  Use the <b>no</b> form of this command to disable the feature.
<b>Step 5</b>	<b>no shutdown</b>  <b>Example:</b> Device(config-wlan)# no shutdown	Enables the WLAN.
<b>Step 6</b>	<b>end</b>  <b>Example:</b> Device(config-wlan)# end	Saves the configuration, exits the configuration mode, and returns to privileged EXEC mode.

## Verifying Denial of Clients with a Random MAC Address

To verify the denial of a client with a random MAC address, run the **show wlan name** *wlan-profile-name* | **begin locally** command:

```
Device# show wlan name laa | begin locally
Locally Administered Address Configuration
Deny LAA clients                : Enabled
```

To verify if a client address is a random MAC address, run the **show wireless client mac-address** *MAC-address* **detail** command:

```
Device# show wireless client mac-address 72xx.38xx.2axx detail
Client MAC Address : 72xx.38xx.2axx
Client MAC Type   : Locally Administered Address
Client IPv4 Address : 9.1.1.1
Client IPv6 Addresses : fexx::71xx:27xx:a7xx:efxx
Client Username   : 72xx.38xx.2axx
```

To verify how many random MAC clients are present in the system, run the **show wireless stats client detail** command:

```
Device# show wireless stats client detail
Client Summary
-----
Current Clients : 1
Excluded Clients: 0
Disabled Clients: 0
Foreign Clients : 0
```

```
Anchor Clients : 0
Local Clients  : 1
Idle Clients   : 0
Locally Administered MAC Clients: 1
```

To display the statistics of a specific client, run the **show wlan id <1-4096> client stats** command:

```
Device# show wlan id 8 client stats
Wlan Profile Name: wlan-profile, Wlan Id: 8
Current client state statistics:
```

```
-----
Authenticating      : 0
Mobility            : 0
IP Learn            : 0
WebAuth Pending     : 0
Run                 : 1
Locally Administered MAC Clients : 1
```



---

**Note** Run the **show configuration wlan wlan-name** command on an AP, to view the status of the locally administered address (LAA) on the WLAN.

---





## CHAPTER 94

# Dataplane Packet Logging

- [Information About Dataplane Packet Logging, on page 765](#)
- [Enabling or Disabling Debug Level \(CLI\), on page 766](#)
- [Enabling Packet Logging in Global and Filtered Buffer in Ingress Path \(CLI\), on page 766](#)
- [Enabling Packet Logging in Global and Filtered Buffer in Punt-Inject Path \(CLI\), on page 767](#)
- [Verifying Dataplane Packet Logging, on page 768](#)
- [Clearing Logs and Conditions in Global and Filtered Trace Buffers, on page 769](#)

## Information About Dataplane Packet Logging

While onboarding wireless clients, you might encounter problems arising from client IP address allocation, Address Resolution Protocol (ARP) resolution, and so on, which require debugging. For rapid debugging of such issues on the controller, the Dynamic Host Configuration Protocol (DHCP), Neighbor Discovery, and ARP packets that go to and from the wireless clients are unconditionally logged.

Packet-logging serviceability captures connectivity information related to wireless clients. Serviceability is divided into the following categories:

- **Global Trace Log:** Global trace logging is a mechanism to capture client connectivity information, and is enabled by default.
- **Filtered Trace Log:** To start packet logging on a filtered trace buffer, you must enable filters using **debug** commands. Filters capture only the specific packet type or the packets based on the MAC address of the clients.

The following are the features of packet logging:

- In addition to DHCP, Neighbor Discovery, and ARP packets, you can also add or remove other packet capture filters.
- Display filters are set to pick a subset of logged packets.
- Packet-logging data provides information such as the client MAC address, client IP address, VLAN, interface, packet type and time delta, that is required for debugging.

## Enabling or Disabling Debug Level (CLI)

To enable or disable debug information for global and filtered logic, follow these steps.

### Procedure

	Command or Action	Purpose
<b>Step 1</b>	<b>enable</b> <b>Example:</b> Device> enable	Enables privileged EXEC mode. Enter your password, if prompted.
<b>Step 2</b>	<b>[no] debug platform hardware chassis active qfp feature wireless datapath trace-buffer debug-level {all   error   info   trace   warning}</b> <b>Example:</b> Device# debug platform hardware chassis active qfp feature wireless datapath trace-buffer debug-level all	Enables the debug level information for global and filtered logic. Use the <b>no</b> form of this command to disable the feature.

## Enabling Packet Logging in Global and Filtered Buffer in Ingress Path (CLI)

To enable packet logging in global and filtered buffer in the ingress path, follow these steps.

### Procedure

	Command or Action	Purpose
<b>Step 1</b>	<b>enable</b> <b>Example:</b> Device> enable	Enables privileged EXEC mode. Enter your password, if prompted.
<b>Step 2</b>	<b>[no] debug platform hardware chassis active qfp feature wireless datapath trace-buffer ingress global-trace</b> <b>Example:</b> Device# [no] debug platform hardware chassis active qfp feature wireless datapath trace-buffer ingress global-trace	Enables the Quantum Flow Processor on global trace buffer in the ingress path. Use the <b>no</b> form of this command to disable the feature.
<b>Step 3</b>	<b>[no] debug platform hardware chassis active qfp feature wireless datapath trace-buffer</b>	Enables the condition for CAPWAP to log packet information to the filtered trace buffer.



	Command or Action	Purpose
	<b>ingress filtered-trace capwap</b> {ipv4 <i>A.B.C.D</i>   ipv6 <i>X:X:X::X</i>   <b>keepalive</b> }  <b>Example:</b> <pre>Device# [no] debug platform hardware chassis active qfp feature wireless datapath trace-buffer ingress filtered-trace capwap ipv4 209.165.200.224/27</pre>	Use the <b>no</b> form of this command to disable the feature.
<b>Step 4</b>	<b>[no] debug platform hardware chassis active qfp feature wireless datapath trace-buffer ingress filtered-trace wclient</b> {ipv6-nd   ipv6-ra   <b>mac-address</b> <i>H.H.H</i> }  <b>Example:</b> <pre>Device# [no] debug platform hardware chassis active qfp feature wireless datapath trace-buffer ingress filtered-trace wclient ipv6-nd</pre>	<p>Enables the condition to log packet information of the wireless client to the filtered trace buffer.</p> <p>Use the <b>no</b> form of this command to disable the feature.</p>

## Enabling Packet Logging in Global and Filtered Buffer in Punt-Inject Path (CLI)

To enable packet logging in global and filtered trace buffer in the punt-inject path, follow these steps.

### Procedure

	Command or Action	Purpose
<b>Step 1</b>	<b>enable</b>  <b>Example:</b> <pre>Device&gt; enable</pre>	<p>Enables privileged EXEC mode.</p> <p>Enter your password, if prompted.</p>
<b>Step 2</b>	<b>[no] debug platform hardware chassis active qfp feature wireless datapath trace-buffer punt-inject global-trace</b>  <b>Example:</b> <pre>Device# [no] debug platform hardware chassis active qfp feature wireless datapath trace-buffer punt-inject global-trace</pre>	<p>Enables the Quantum Flow Processor in global trace buffer in the punt-inject path.</p> <p>Use the <b>no</b> form of this command to disable the feature.</p>
<b>Step 3</b>	<b>[no] debug platform hardware chassis active qfp feature wireless datapath trace-buffer punt-inject filtered-trace capwap</b> {ipv4 <i>A.B.C.D</i>   ipv6 <i>X:X:X::X</i>   <b>keepalive</b> }  <b>Example:</b>	<p>Enables the condition for CAPWAP to log packet information to the filtered trace buffer in the punt-inject path.</p> <p>Use the <b>no</b> form of this command to disable the feature.</p>

	Command or Action	Purpose
	Device# [no] debug platform hardware chassis active qfp feature wireless datapath trace-buffer punt-inject filtered-trace capwap ipv4 209.165.200.224/27	
<b>Step 4</b>	<p><b>[no] debug platform hardware chassis active qfp feature wireless datapath trace-buffer punt-inject filtered-trace wlclient {ipv6-nd   ipv6-ra   mac-address H.H.H}</b></p> <p><b>Example:</b></p> <pre>Device# [no] debug platform hardware chassis active qfp feature wireless datapath trace-buffer punt-inject filtered-trace wlclient lpv6-nd</pre>	<p>Enables the condition to log packet information of the wireless client to the filtered trace buffer, in the punt-inject path.</p> <p>Use the <b>no</b> form of this command to disable the feature.</p>

## Verifying Dataplane Packet Logging

To show trace buffer-configured conditions, use the following command:

```
Device# show platform hardware chassis active qfp feature wireless trace-buffer ingress conditions
LogTrace Event: Enabled
Trace wlclient-MACs:
    8c85.90ee.ca92
allow_all_AP_kalives: enabled
AP_kalive cnt=1, AP_kalive6 cnt=0
IP0: 49.1.0.73
```

To view all the log entries in the filtered trace buffer, use the following command:

```
Device# show platform hardware chassis active qfp feature wireless trace-buffer ingress filtered-trace all
Trace wlclient-MACs: 8c85.90ee.ca92
Trace-Buffer for Ingress: Enabled
Total allocated global-log buffer: 16384
Total allocated filtered-log v=buffers: 4096

<0 KEEP_ALIVE: CAPWAP peer=49.1.0.73 udp=5256 local=49.1.1.2 udp=5247 vlan=49, dt=213207 c=0
<1 KEEP_ALIVE: CAPWAP peer=49.1.0.73 udp=5256 local=49.1.1.2 udp=5247 vlan=49, dt=213236 c=0
<2 KEEP_ALIVE: CAPWAP peer=49.1.0.73 udp=5256 local=49.1.1.2 udp=5247 vlan=49, dt=213264 c=0
<3 KEEP_ALIVE: CAPWAP peer=49.1.0.73 udp=5256 local=49.1.1.2 udp=5247 vlan=49, dt=213293 c=0
<4 KEEP_ALIVE: CAPWAP peer=49.1.0.73 udp=5256 local=49.1.1.2 udp=5247 vlan=49, dt=213321 c=0
<5 KEEP_ALIVE: CAPWAP peer=49.1.0.73 udp=5256 local=49.1.1.2 udp=5247 vlan=49, dt=213350 c=0
```

To view the number of entries based on a count, use the following command:

```
Device# show platform hardware chassis active qfp feature wireless trace-buffer ingress filtered-trace 3
Trace wlclient-MACs: 8c85.90ee.ca92
Trace-Buffer for Ingress: Enabled
Total allocated global-log buffer: 16384
```

```
Total allocated filtered-log v=buffers: 4096

<18 KEEP_ALIVE: CAPWAP peer=49.1.0.73 udp=5256 local=49.1.1.2 udp=5247 vlan=49, dt=213720
c=0
<19 KEEP_ALIVE: CAPWAP peer=49.1.0.73 udp=5256 local=49.1.1.2 udp=5247 vlan=49, dt=213748
c=0
<20 KEEP_ALIVE: CAPWAP peer=49.1.0.73 udp=5256 local=49.1.1.2 udp=5247 vlan=49, dt=213777
c=0

>> 3 entries displayed
    21 entries found in filtered-log buffer
    21 entries ever collected for filtered-log buffer
```

## Clearing Logs and Conditions in Global and Filtered Trace Buffers

To clear conditions and logs in the global and filtered trace buffers, use the following commands:

```
Device# clear platform hardware chassis active qfp feature wireless trace-buffer ingress
all
Trace, clear all trace configuration & buffer.
```

```
Device# clear platform hardware chassis active qfp feature wireless trace-buffer ingress
conditions
Trace, clear trace configuration
```

```
Device# clear platform hardware chassis active qfp feature wireless trace-buffer ingress
filtered-trace
Trace, clear trace Q
```

```
Device# clear platform hardware chassis active qfp feature wireless trace-buffer ingress
global-trace
Trace, clear trace global Q
```





## CHAPTER 95

# Streaming Telemetry

- [Information About Streaming Telemetry](#) , on page 771
- [Gather Points](#), on page 771
- [Subscription](#), on page 772
- [Transport](#) , on page 773
- [Scale Considerations](#) , on page 773
- [Session](#), on page 773
- [Configuring Telemetry on a Cisco Catalyst 9800 Series Wireless Controller](#), on page 774
- [Troubleshooting Telemetry Support](#), on page 781

## Information About Streaming Telemetry

Streaming telemetry is a new paradigm in monitoring the health of a network. It provides a mechanism to efficiently stream configuration and operational data of interest from the Cisco Catalyst 9800 Series Wireless Controller. This streamed data is transmitted in a structured format to remote management stations for monitoring and troubleshooting purposes.

This topic explains how to enable the telemetry support the Wi-Fi and system health-related data. Not that telemetry support can be enhanced up to a scale of 1000 access points (APs) and 15000 clients. A single collector setup can be used to subscribe to the requested XPath. A telemetry feed can be used to subscribe to data elements to monitor APs and clients effectively. Data is provided through the native Cisco wireless models.

## Gather Points

Gather points are the top-level XPaths and act as the smallest unit of data exported by a target. Any subscription to an XPath raises to the level of the Gather point, and the target sends updates comprising of all the leaves defined under this Gather point. For example, when you subscribe to an XPath `/access-point-operdata/radio-oper-data/vap-oper-config/ssid`, which is part of the Gather point `/access-point-operdata/radio-oper-data/vap-oper-config`, the reply will comprise of all the attributes that are a part of the Gather point, in this case, AP-VAP-ID, SSID, and WLAN ID.

The following lists the supported Gather points for an XPaths.

Table 37: Supported Gather Points and Subscription Intervals

Supported Gather Point	Subscription Interval
<i>wireless-access-point-oper:access-point-oper-data/ethernet-mac-wtp-mac-map</i>	>=15 mins
<i>/wireless-access-point-oper:access-point-oper-data/capwap-data</i>	>=15 mins
<i>/wireless-access-point-oper:access-point-oper-data/cdp-cache-data/</i>	>=15 mins
<i>/wireless-access-point-oper:access-point-oper-data/radio-oper-stats</i>	>=60 secs
<i>/wireless-access-point-oper:access-point-oper-data/radio-oper-data</i>	>=180 secs
<i>/wireless-access-point-oper:access-point-oper-data/oper-data</i>	>=180 secs
<i>/wireless-rrm-oper:rrm-oper-data/rrm-measurement</i>	>=180 secs
<i>/wireless-client-oper:client-oper-data/dot11-oper-data</i>	>=180 secs
<i>/wireless-client-oper:client-oper-data/common-oper-data</i>	>=15 mins
<i>/wireless-client-oper:client-oper-data/policy-data</i>	>=60 secs
<i>/wireless-client-oper:client-oper-data/sisf-db-mac/ipv4-binding/ip-key/ip-addr</i>	>=15 mins
<i>/wireless-client-oper:client-oper-data/traffic-stats</i>	>=180 secs
<i>/lldp-ios-xe-oper:lldp-entries/lldp-state-details</i>	>=60 secs
<i>/device-hardware-xe-oper:device-hardware-data/device-hardware</i>	>=15 mins
<i>/wireless-mobility-oper:mobility-oper-data/mobility-node-data/ulink-status</i>	>=60 secs
<i>/process-cpu-ios-xe-oper:cpu-usage/cpu-utilization/one-minute</i>	>=60 secs
<i>/platform-sw-ios-xe-oper:cisco-platform-software/control-processes</i>	>=60 secs
<i>/environment-ios-xe-oper:environment-sensors/environment-sensor</i>	>=60 secs
<i>/lldp-ios-xe-oper:lldp-entries/lldp-intf-details</i>	>=60 secs
<i>/interfaces-ios-xe-oper:interfaces/interface</i>	>=60 secs
<i>/platform-ios-xe-oper:components/component</i>	>=60 secs
<i>/mdt-oper-v2:mdt-oper-v2-data</i>	>=60 secs
<i>/wireless-access-point-oper:access-point-oper-data/radio-oper-data/radio-band-info</i>	>=180 secs

## Subscription

A subscription binds one or more Gather points and destinations. A Multicast Default (MDT) streams data for each Gather point at the configured frequency (cadence-based streaming).

# Transport

The protocol that is used for the connection between a publisher and a receiver is known as the transport protocol, and this decides how data are transmitted. This protocol is independent of the management protocol for configured subscriptions. The supported transport protocols are gNMI and gRPC. The gNMI transport protocol supports JSON encoding of data, while gRPC supports Key-value Google Protocol Buffers (kvGPB) encoding.

## Scale Considerations

The following table provides the scale numbers that are applicable to the native model for an XPath set.

*Table 38: Scaling Considerations to the Native Model*

Attribute	Scale
AP	4000
Client	15000
SSID Per AP	6
BSSID per AP	12
Neighbors per AP	60 (30x2)
Number of Physical Neighbor APs	49
Number of Neighbor Records	60000 records

## Session

You can choose to initiate the subscription by establishing a telemetry session between the controller and the receiver. A telemetry session can be initiated using:

- gNMI Dial-In Mode
- gRPC Dial-Out Mode

### gNMI Dial-In-Mode

In a dial-in mode, a Model-Driven Telemetry (MDT) receiver dials in to the controller, and subscribes dynamically to one or more Gather points or subscriptions. The controller acts as the server, and the receiver as the client. The controller streams telemetry data through the same session. The dial-in mode of subscriptions is dynamic, which gets terminated when the receiver cancels the subscription or when the session is terminated.

## gRPC- Dial-Out-Mode

In a dial-out mode, the controller dials out to the receiver. Here the controller acts as a client and receiver acts as a server. In this mode, Gather points and destinations are configured and bound together into one or more subscriptions. The controller continually attempts to establish a session with each destination in the subscription, and streams data to the receiver. The dial-out mode of subscriptions is persistent.

**Figure 19: Telemetry Session**

The following figure explains the telemetry session:

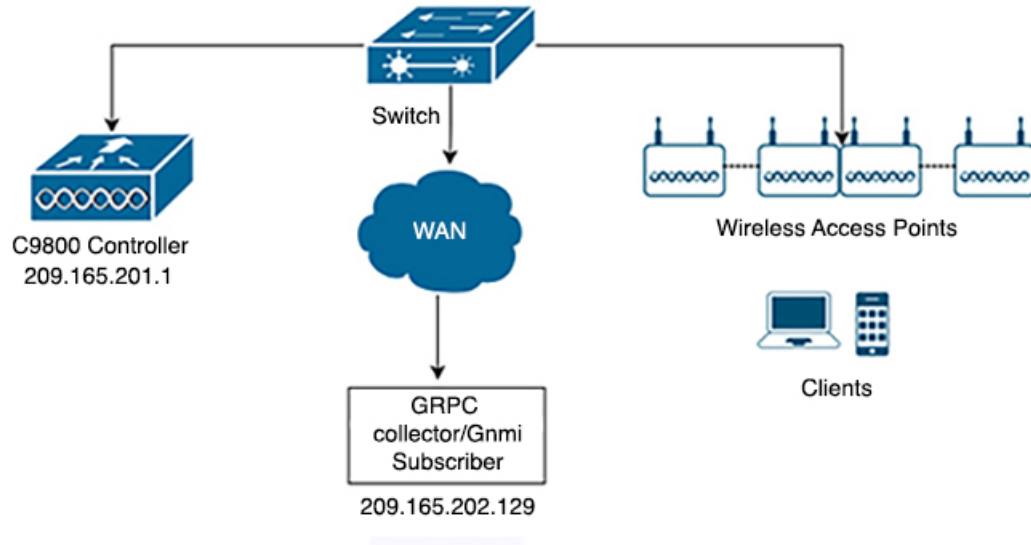

## Configuring Telemetry on a Cisco Catalyst 9800 Series Wireless Controller

To configure telemetry on a Cisco Catalyst 9800 Series Wireless Controller, perform the following:

1. Enable gNXI in an Insecure Mode
2. Enable gNXI in a Secure Mode
3. Verify the Status of the Subscription
4. Manage Configured Subscriptions

### Enabling gNXI in Insecure Mode (CLI)

#### Procedure

	Command or Action	Purpose
Step 1	enable	Enables privileged EXEC mode



	Command or Action	Purpose
	<b>Example:</b> Device# enable	Enter your password, if prompted.
<b>Step 2</b>	<b>configure terminal</b> <b>Example:</b> Device# configure terminal	Enters global configuration mode.
<b>Step 3</b>	<b>gnxi</b> <b>Example:</b> Device(config)# <b>gnxi</b>	Starts the gNXI process.
<b>Step 4</b>	<b>gnxi server</b> <b>Example:</b> Device(config)# gnxi server	Enables the gNXI server in insecure mode.
<b>Step 5</b>	<b>gnxi port <i>port-number</i></b> <b>Example:</b> Device(config)# <b>gnxi 50000</b>	Sets the gNXI port. The default insecure gNXI port is 9339.
<b>Step 6</b>	<b>end</b> <b>Example:</b> Device(config)# end	Returns to privileged EXEC mode.
<b>Step 7</b>	<b>show gnxi state</b> <b>Example:</b> Device# show gnxi state	Displays the status of gNXI server.

**Example**

The following is a sample output of the **show gnxi state** command:

```
Device# show gnxi state
State Status
-----
Enabled Up
```

## Enabling gNXI in Secure Mode (CLI)

**Procedure**

	Command or Action	Purpose
<b>Step 1</b>	<b>enable</b> <b>Example:</b> Device# enable	Enables privileged EXEC mode Enter your password, if prompted.

	Command or Action	Purpose
<b>Step 2</b>	<b>configure terminal</b> <b>Example:</b> Device# configure terminal	Enters global configuration mode.
<b>Step 3</b>	<b>gnxi</b> <b>Example:</b> Device(config)# gnxi	Starts the gNXI process.
<b>Step 4</b>	<b>gnxi secure-server</b> <b>Example:</b> Device(config)# gnxi secure-server	Enables the gNXI server in secure mode.
<b>Step 5</b>	<b>gnxi secure-trustpoint <i>trustpoint-name</i></b> <b>Example:</b> Device(config)# gnxi secure-trustpoint	Specifies the trustpoint and certificate set that gNXI uses for authentication.
<b>Step 6</b>	<b>gnxi secure-client-auth</b> <b>Example:</b> Device(config)# gnxi secure-client-auth	(Optional) The gNXI process authenticates the client certificate against the root certificate.
<b>Step 7</b>	<b>gnxi secure-port</b> <b>Example:</b> Device(config)# gnxi secure-port	(Optional) Sets the gNXI port. <ul style="list-style-type: none"> <li>The default insecure gNXI port is 9339.</li> </ul>
<b>Step 8</b>	<b>end</b> <b>Example:</b> Device(config)# end	Returns to privileged EXEC mode.
<b>Step 9</b>	<b>show gnxi state</b> <b>Example:</b> Device# show gnxi state	Displays the gNXI servers status.

### Example

The following is sample output from the **show gnxi state** command:

```
Device# show gnxi state
State Status
-----
Enabled Up
```

## Verifying the Status of a Telemetry Subscription on a Cisco Catalyst 9800 Series Wireless Controller

To verify the status of a subscription, use the following command:

```
Device# show telemetry ietf subscription all
Device# show telemetry ietf subscription 101
Device# show telemetry ietf subscription 101 detail
Device# show telemetry ietf subscription 101 receiver
Device# show telemetry internal connection
Device# show telemetry internal subscription all stats
Device# show telemetry receiver all
Device# show telemetry receiver name <receivers-name>
Device# show telemetry connection all
```

## Managing Configured Subscriptions on a Cisco Catalyst 9800 Series Wireless Controller

Use the `show platform software ndbman switch {switch-number | active| standby} models` command to display the list of YANG models that support on-change subscription.



**Note** Currently, you can only use the gRPC protocol for managing configured subscriptions.

### Procedure

	Command or Action	Purpose
<b>Step 1</b>	<b>enable</b> <b>Example:</b> Device# enable	Enables privileged EXEC mode Enter your password, if prompted.
<b>Step 2</b>	<b>configure terminal</b> <b>Example:</b> Device# configure terminal	Enters global configuration mode.
<b>Step 3</b>	<b>telemetry ietf subscription <i>id</i></b> <b>Example:</b> Device(config)# telemetry ietf subscription 112	Creates a telemetry subscription and enters telemetry-subscription mode.
<b>Step 4</b>	<b>encoding encode-kvgpb</b> <b>Example:</b> Device(config-mdt-subs)# encoding encode-kvgpb	Specifies the Key-value Google Protocol Buffers (kvGPB) encoding.

	Command or Action	Purpose
Step 5	<b>filter xpath</b> <i>path</i> <b>Example:</b> Device(config-mdt-sub)# <b>filter xpath</b> <del>/wireless-access-point-oper:access-point-oper-data/ospwep-data</del>	Specifies the XPath filter for the subscription.
Step 6	<b>source-address</b> { <i>A.B.C.D / X:X:X:X::X</i> } <b>Example:</b> Device(config-mdt-sub)# <b>source-address</b> <b>ip-address</b> 209.165.200.225   2001:DB8::1	Configures the source IP address on the telemetry subscription interface.
Step 7	<b>stream yang-push</b> <i>path</i> <b>Example:</b> Device(config-mdt-sub)# <b>stream</b> <b>yang-push</b>	Configures a stream for the subscription.
Step 8	<b>update-policy</b> { <b>on-change</b>   <b>periodic</b> } <i>period</i> <b>Example:</b> Device(config-mdt-sub)# <b>update-policy</b> <b>periodic</b> 3000	Configures a periodic update policy for the subscription.
Step 9	<b>receiver ip address</b> <i>ip-address receiver-port</i> <b>protocol</b> <i>protocol profile name</i> <b>Example:</b> Device(config-mdt-sub)# <b>receiver ip</b> <b>address</b> 209.165.201.1 <b>protocol</b> <b>grpc-tcp</b>	Configures a periodic update policy for the subscription.
Step 10	<b>end</b> <b>Example:</b> Device(config-mdt-sub)# <b>end</b>	Exits telemetry-subscription configuration mode and returns to privileged EXEC mode.

## Zero Trust Telemetry

To configure zero trust telemetry on a Cisco Catalyst 9800 Series Wireless Controller, perform the following:

1. Define a protocol
2. Define a named receiver
3. Configure telemetry subscription

## Define a Protocol

### Before you begin

Define crypto trustpoints (CAforMDTserver and IDforWLCclient) and certificates before the telemetry configuration.

### Procedure

	Command or Action	Purpose
<b>Step 1</b>	<b>configure terminal</b> <b>Example:</b> Device# <code>configure terminal</code>	Enters global configuration mode.
<b>Step 2</b>	<b>telemetry protocol grpc profile <i>profile-name</i></b> <b>Example:</b> Device(config)# <code>telemetry protocol grpc profile mtlsyang</code>	Configures the protocol gRPC profile and enters gRPC profile name.
<b>Step 3</b>	<b>ca-trustpoint <i>ca-for-mdt-server</i></b> <b>Example:</b> Device(config-mdt-protocol-grpc-profile)# <code>ca-trustpoint CAforMDTserver</code>	Adds the server CA trustpoint.
<b>Step 4</b>	<b>id-trustpoint <i>wlc-id-trustpoint</i></b> <b>Example:</b> Device(config-mdt-protocol-grpc-profile)# <code>id-trustpoint IDforWLCclient</code>	Adds the client ID trustpoint.

## Define a Named Receiver

This procedure defines:

- FQDN DNS name
- Crypto protocol definition

### Procedure

	Command or Action	Purpose
<b>Step 1</b>	<b>configure terminal</b> <b>Example:</b> Device# <code>configure terminal</code>	Enters global configuration mode.
<b>Step 2</b>	<b>telemetry receiver protocol <i>receiver-name</i></b> <b>Example:</b> Device(config)# <code>telemetry receiver protocol collector</code>	Configures the receiver name.

	Command or Action	Purpose
<b>Step 3</b>	<b>host name</b> <i>FQDN-receiver</i> <b>Example:</b> Device (config-mdt-protocol-receiver) # <b>host name collector-telemetry.cisco.com</b> <b>57500</b>	Adds FQDN DNS name of receiver.
<b>Step 4</b>	<b>protocol grpc-tls profile</b> <i>profile-name</i> <b>Example:</b> Device (config-mdt-protocol-receiver) # <b>protocol grpc-tls profile mtlsyang</b>	Defines the gRPC TLS profile named mtlsyang.

## Configure Telemetry Subscription

This procedure configures:

- Xpath
- Named receiver
- Protocol

### Procedure

	Command or Action	Purpose
<b>Step 1</b>	<b>enable</b> <b>Example:</b> Device# <b>enable</b>	Enables privileged EXEC mode Enter your password, if prompted.
<b>Step 2</b>	<b>configure terminal</b> <b>Example:</b> Device# <b>configure terminal</b>	Enters global configuration mode.
<b>Step 3</b>	<b>telemetry ietf subscription</b> <i>id</i> <b>Example:</b> Device (config) # <b>telemetry ietf</b> <b>subscription 113</b>	Creates a telemetry subscription and enters telemetry-subscription mode.
<b>Step 4</b>	<b>encoding encode-kvgpb</b> <b>Example:</b> Device (config-mdt-subs) # <b>encoding</b> <b>encode-kvgpb</b>	Specifies the Key-value Google Protocol Buffers (kvGPB) encoding.
<b>Step 5</b>	<b>filter xpath</b> <i>path</i> <b>Example:</b> Device (config-mdt-subs) # <b>filter xpath</b> <del>/wireless-ble-ltr-oper:ble-ltr-oper-data/ble-ltr-ap-streaming</del>	Specifies the XPath filter for the subscription.

	Command or Action	Purpose
<b>Step 6</b>	<b>source-address</b> { <i>A.B.C.D / X:X:X:X::X</i> } <b>Example:</b> Device (config-mdt-subs) # <b>source-address</b> <b>ip-address</b> 209.165.200.225   2001:DB8::1	Configures the source IP address on the telemetry subscription interface.
<b>Step 7</b>	<b>stream yang-push</b> <b>Example:</b> Device (config-mdt-subs) # <b>stream</b> <b>yang-push</b>	Configures a stream for the subscription.
<b>Step 8</b>	<b>update-policy {on-change   periodic} period</b> <b>Example:</b> Device (config-mdt-subs) # <b>update-policy</b> <b>periodic</b> 6000	Configures a periodic update policy for the subscription.
<b>Step 9</b>	<b>receiver-type protocol</b> <b>Example:</b> Device (config-mdt-subs) # <b>receiver-type</b> <b>protocol</b>	Configures type protocol for receiver.
<b>Step 10</b>	<b>receiver name</b> <i>receiver-name</i> <b>Example:</b> Device (config-mdt-subs) # <b>receiver name</b> <b>collector</b>	Specifies the receiver name.
<b>Step 11</b>	<b>end</b> <b>Example:</b> Device (config-mdt-subs) # <b>end</b>	Exits telemetry-subscription configuration mode and returns to privileged EXEC mode.

## Troubleshooting Telemetry Support

This document outlines a set of commands for gathering data from Cisco Catalyst 9800 Series Wireless Controller, specifically focused on addressing gRPC telemetry-related issues in support of TAC cases.

Here are a few factors to consider when conducting troubleshooting steps:

- Provide a clear problem description.
- What has changed in the network?
- What was the previous working day/time?
- What is the impact of this problem?



---

**Note** Run all the **show** commands with **show clock** or **terminal exec prompt timestamp** once to log timestamps automatically.

---

### General Guidelines

For every issue, run the following commands:

1. Device# terminal length 0
2. Device# show clock
3. Device# show tech-support wireless
4. Device# request platform software trace archive last 1

### Perform Basic Checks

1. Verify that the requisite processes (particularly pubd) are running using the following commands:

```
show platform software yang-management process
```

2. Capture and validate the telemetry-specific configuration using the following command:

```
show running-config | section telemetry
```

3. Check the validity of any subscriptions using the following command:

```
show telemetry ietf subscription all
```

4. Check the validity of any named receivers using the following command:

```
show telemetry receiver all
```

5. Verify the telemetry subscription states using the following command:

```
show telemetry internal subscription all stats
```

### Check Connectivity Issues

1. Check the state of the subscription receiver using the following commands:

```
show telemetry ietf subscription <id> receiver
```

2. Check the state of telemetry connections using the following command:

```
show telemetry connection all
```

3. Check which subscriptions use a particular connection using the following command:

```
show telemetry connection <index> subscription
```

### Capture Debug Logs

1. Enable the following debug options:

```
set platform software trace mdt-pubd chassis active r0 mdt-ctrl debug
set platform software trace mdt-pubd chassis active r0 pubd debug
set platform software trace mdt-pubd chassis active r0 green-be debug
set platform software trace mdt-pubd chassis active r0 green-fe debug
```



```
set platform software trace mdt-pubd chassis active r0 dbal debug
set platform software trace mdt-pubd chassis active r0 tdllib debug
set platform software trace ios chassis active r0 green-be debug
set platform software trace ios chassis active r0 dbal debug
set platform software trace ios chassis active r0 tdllib debug
```

2. Recreate the problem.

3. Collect debug logs:

```
request platform software trace archive last <days>
```

4. Disable debugging using the following commands:

```
set platform software trace mdt-pubd chassis active r0 mdt-ctrl notice
set platform software trace mdt-pubd chassis active r0 pubd notice
set platform software trace mdt-pubd chassis active r0 green-be notice
set platform software trace mdt-pubd chassis active r0 green-fe notice
set platform software trace mdt-pubd chassis active r0 dbal notice
set platform software trace mdt-pubd chassis active r0 tdllib notice
set platform software trace ios chassis active r0 green-be notice
set platform software trace ios chassis active r0 dbal notice
set platform software trace ios chassis active r0 tdllib notice
```

### General Telemetry Diagnostics

To capture general telemetry diagnostics, use the following command:

```
show telemetry internal diagnostics
```

### Generate a Core

Generate a core using the following commands:

1. `show clock`
2. `configure terminal`
3. `service internal`
4. `end`
5. `request platform software process core mdt-pubd chassis active r0`

### Disable Logging

Disable the logging using the following commands:

1. `configure terminal`
2. `no service internal`
3. `end`

### Capture CPU Memory

To capture CPU memory details use the following commands:

- `show processes cpu platform sorted | i pubd`

- `show processes memory platform sorted | s pubd`



# CHAPTER 96

## Wireless Clients Threshold Warning

- [Information About Wireless Clients Threshold Warning, on page 785](#)
- [Configuring a Warning Period, on page 785](#)
- [Configuring Client Threshold, on page 786](#)

### Information About Wireless Clients Threshold Warning

Cisco IOS XE Bengaluru 17.6.x introduces the Wireless Clients Threshold Warning feature, which allows you to configure a warning message when the number of simultaneous wireless clients on the controller breaches a set threshold. By default, the threshold is set to 75 percent of the total capacity. For example, Cisco Catalyst 9800-80 Wireless Controller supports up to 64,000 clients, and the threshold is set at 48,000 client. When the threshold is breached, the controller sends notifications to the corresponding user using syslog messages, SNMP traps, and NETCONF/Yang notifications.

The Wireless Clients Threshold Warning feature allows you to take note of the impending wireless client limit and act on it before reaching the maximum limit, or modify the number of wireless clients allowed on a controller, as required.

The Wireless Clients Threshold Warning feature is enabled by default. To disable the feature, use the **no wireless max-warning** command.

### Configuring a Warning Period

#### Procedure

	Command or Action	Purpose
<b>Step 1</b>	<b>configure terminal</b>  <b>Example:</b> Device# configure terminal	Enters global configuration mode.
<b>Step 2</b>	<b>wireless max-warning period <i>interval-in-mins</i></b>  <b>Example:</b> Device(config)# wireless max-warning period 20	Configures the periodicity of the wireless client check. Valid values range from 1 to 60 minutes.

	Command or Action	Purpose
<b>Step 3</b>	<b>end</b> <b>Example:</b> Device(config)# end	Returns to privileged EXEC mode.

## Configuring Client Threshold

### Procedure

	Command or Action	Purpose
<b>Step 1</b>	<b>configure terminal</b> <b>Example:</b> Device# configure terminal	Enters global configuration mode.
<b>Step 2</b>	<b>wireless max-warning threshold clients</b> <i>threshold_percentage</i> <b>Example:</b> Device(config)# wireless max-warning threshold clients 90	Configures the warning threshold percentage for the maximum number of wireless clients. Valid values range from 50 to 100 percent.
<b>Step 3</b>	<b>end</b> <b>Example:</b> Device(config)# end	Returns to privileged EXEC mode.



## PART VII

### Security

- [MAC Filtering](#), on page 789
- [Web-Based Authentication](#) , on page 795
- [Central Web Authentication](#), on page 845
- [Private Shared Key](#), on page 865
- [Multi-Preshared Key](#), on page 873
- [Multiple Authentications for a Client](#), on page 881
- [Wi-Fi Protected Access 3](#), on page 907
- [IP Source Guard](#), on page 923
- [802.11w](#), on page 925
- [Management Frame Protection](#), on page 933
- [IPv4 ACLs](#) , on page 937
- [DNS-Based Access Control Lists](#), on page 965
- [Allowed List of Specific URLs](#), on page 983
- [Cisco Umbrella WLAN](#), on page 987
- [RADIUS Server Load Balancing](#), on page 999
- [AAA Dead-Server Detection](#), on page 1003
- [ISE Simplification and Enhancements](#), on page 1007
- [RADIUS DTLS](#), on page 1021
- [Policy Enforcement and Usage Monitoring](#), on page 1033
- [Local Extensible Authentication Protocol](#), on page 1037
- [Authentication and Authorization Between Multiple RADIUS Servers](#), on page 1045
- [Secure LDAP](#), on page 1055
- [Network Access Server Identifier](#), on page 1063
- [Locally Significant Certificates](#), on page 1069

- [Certificate Management](#), on page 1099
- [Controller Self-Signed Certificate for Wireless AP Join](#), on page 1103
- [Managing Rogue Devices](#), on page 1111
- [Classifying Rogue Access Points](#), on page 1127
- [Advanced WIPS](#), on page 1137
- [Cisco TrustSec](#), on page 1147
- [SGT Inline Tagging and SXPv4](#), on page 1161
- [Multiple Cipher Support](#), on page 1167
- [Configuring Secure Shell](#) , on page 1171
- [Encrypted Traffic Analytics](#), on page 1179
- [FIPS](#), on page 1193
- [Internet Protocol Security](#), on page 1199
- [Transport Layer Security Tunnel Support](#), on page 1215
- [Disabling IP Learning in FlexConnect Mode](#), on page 1221



## CHAPTER 97

# MAC Filtering

- [MAC Filtering, on page 789](#)
- [Configuring MAC Filtering for Local Authentication \(CLI\), on page 791](#)
- [Configuring MAC Filtering \(GUI\), on page 792](#)
- [Configuring MAB for External Authentication \(CLI\), on page 792](#)

## MAC Filtering

You can configure the controller to authorize clients based on the client MAC address by using the MAC filtering feature.

When MAC filtering is enabled, the controller uses the MAC address as the client identity. The authentication server has a database of client MAC addresses that are allowed network access. The controller sends the authentication server a RADIUS-access/request frame with a username and password based on the client MAC address as soon as it gets the association request from the client. If authorization succeeds, the controller sends a successful association response to the client. If authorization fails, the controller rejects the client association.

Clients that were authorized with MAC filtering can be re-authenticated through the WLAN session timeout feature.

### MAC Filtering Configuration Guidelines

- MAC filtering authentication occurs at the 802.11 association phase and delays the association response until authentication is done. If you use a RADIUS server for MAC filtering, it is advised to keep a low latency between the controller and the RADIUS server. When latency is too high, the client might timeout while waiting for the association response.
- MAC filtering can be combined with other authentication methods such as 802.1X, Pre-Shared Key or it can be used alone.
- MAC addresses can be spoofed and MAC filtering does not consist in a security measure.
- Many clients can use a private MAC address to connect and change it at every session, therefore making it harder to identify devices through their MAC address.



**Note** If wlan-profile-name is configured for a user, guest user authentication is allowed only from that WLAN. If wlan-profile-name is not configured for a user, guest user authentication is allowed on any WLAN.

The AP fails to join the controller due to an authentication rejection on the RADIUS server. The failure occurs on the Cisco Catalyst 9800 controller, only when the RADIUS server is configured to authenticate the APs with method MAB as endpoints. The reason is that the RADIUS calling-station-id attribute is required for MAB authentication and is not present within the access request packet during the AP join. The workaround is to use a different AP authentication method than MAB as endpoints such as PAP-ASCII using a username and a password.

If you want the client to connect to SSID1, but not to SSID2 using mac-filtering, ensure that you configure **aaa-override** in the policy profile.

In the following example, when a client with MAC address 1122.3344.0001 tries to connect to a WLAN, the request is sent to the local RADIUS server, which checks the presence of the client MAC address in its attribute list (FILTER\_1 and FILTER\_2). If the client MAC address is listed in an attribute list (FILTER\_1), the client is allowed to join the WLAN (WLAN\_1) that is returned as *ssid attribute* from the RADIUS server. The client is rejected, if the client MAC address is not listed in the attribute list.

#### Local RADIUS Server Configuration

```
!Configures an attribute list as FILTER_2
aaa attribute list FILTER_2
!Defines an attribute type that is to be added to an attribute list.
attribute type ssid "WLAN_2"

!Username with the MAC address is added to the filter
username 1122.3344.0001 mac aaa attribute list FILTER_2

!
aaa attribute list FILTER_1
attribute type ssid "WLAN_1"
username 112233440001 aaa attribute list FILTER_1
```

#### Controller Configuration

```
! Sets authorization to the local radius server
aaa authorization network MLIST_MACFILTER local

!A WLAN with the SSID WLAN_2 is created and MAC filtering is set along with security
parameters.
wlan WLAN_2 2 WLAN_2
mac-filtering MLIST_MACFILTER
no security wpa
no security wpa wpa2 ciphers

!WLAN with the SSID WLAN_1 is created and MAC filtering is set along with security parameters.
wlan WLAN_1 1 WLAN_1
mac-filtering MLIST_MACFILTER
no security wpa
no security wpa wpa2 ciphers aes
no security wpa akm dot1x
security web-auth
security web-auth authentication-list WEBAUTH

! Policy profile to be associated with the above WLANs
wireless profile policy MAC_FILTER_POLICY
aaa-override
```



```
vlan 504
no shutdown
```

## Configuring MAC Filtering for Local Authentication (CLI)

Follow the procedure given below to configure MAB for local authentication.

### Before you begin

Configure AAA local authentication.

Configure the username for WLAN configuration (local authentication) using **username mac-address mac** command.



**Note** The mac-address must be in the following format: *abcdabcdabcd*

### Procedure

	Command or Action	Purpose
<b>Step 1</b>	<b>wlan profile-name wlan-id</b>  <b>Example:</b> wlan CR1_SSID_mab-local-default 1 CR1_SSID_mab-local-default	Specifies the WLAN name and ID.
<b>Step 2</b>	<b>mac-filtering default</b>  <b>Example:</b> Device(config-wlan)# mac-filtering default	Sets MAC filtering support for the WLAN.
<b>Step 3</b>	<b>no security wpa</b>  <b>Example:</b> Device(config-wlan)# no security wpa	Disables WPA security.
<b>Step 4</b>	<b>no security wpa akm dot1x</b>  <b>Example:</b> Device(config-wlan)# no security wpa akm dot1x	Disables security AKM for dot1x.
<b>Step 5</b>	<b>no security wpa wpa2</b>  <b>Example:</b> Device(config-wlan)# no security wpa wpa2	Disables WPA2 security.
<b>Step 6</b>	<b>no security wpa wpa2 ciphers aes</b>  <b>Example:</b> Device(config-wlan)# no security wpa wpa2 ciphers aes	Disables WPA2 ciphers for AES.

	Command or Action	Purpose
<b>Step 7</b>	<b>no shutdown</b>  <b>Example:</b> Device(config-wlan)# no shutdown	Enables the WLAN.

## Configuring MAC Filtering (GUI)

### Before you begin

Configure AAA external authentication.

### Procedure

- 
- Step 1** Choose **Configuration > Wireless > WLANs**.
  - Step 2** On the **Wireless Networks** page, click the name of the WLAN.
  - Step 3** In the **Edit WLAN** window, click the **Security** tab.
  - Step 4** In the **Layer2** tab, check the **MAC Filtering** check box to enable the feature.
  - Step 5** With MAC Filtering enabled, choose the **Authorization List** from the drop-down list.
  - Step 6** Save the configuration.
- 

## Configuring MAB for External Authentication (CLI)

Follow the procedure given below to configure MAB for external authentication.

### Before you begin

Configure AAA external authentication.

### Procedure

	Command or Action	Purpose
<b>Step 1</b>	<b>wlan wlan-name wlan-id ssid-name</b>  <b>Example:</b> wlan CR1_SSID_mab-ext-radius 3 CR1_SSID_mab-ext-radius	Specifies the WLAN name and ID.
<b>Step 2</b>	<b>mac-filtering list-name</b>  <b>Example:</b> Device(config-wlan)# mac-filtering ewlc-radius	Sets the MAC filtering parameters. Here, <i>ewlc-radius</i> is an example for the <i>list-name</i>

	Command or Action	Purpose
<b>Step 3</b>	<b>no security wpa</b> <b>Example:</b> Device(config-wlan)# no security wpa	Disables WPA security.
<b>Step 4</b>	<b>no security wpa akm dot1x</b> <b>Example:</b> Device(config-wlan)# no security wpa akm dot1x	Disables security AKM for dot1x.
<b>Step 5</b>	<b>no security wpa wpa2</b> <b>Example:</b> Device(config-wlan)# no security wpa wpa2	Disables WPA2 security.
<b>Step 6</b>	<b>mab request format attribute {1 groupsize size separator separator [lowercase   uppercase]   2 {0   7   LINE} LINE password   32 vlan access-vlan}</b> <b>Example:</b> Device(config)# mab request format attribute 1 groupsize 4 separator	Optional. Configures the delimiter while using MAC filtering in a WLAN. Here, <b>1-</b> Specifies the username format used for MAB requests. <b>groupsize size-</b> Specifies the number of hex digits per group. The valid values range from 1 to 12. <b>separator separator-</b> Specifies how to separate groups. The separators are comma, semicolon, and full stop. <b>lowercase-</b> Specifies the username in lowercase format. <b>uppercase-</b> Specifies the username in uppercase format. <b>2-</b> Specifies the global password used for all the MAB requests. <b>0-</b> Specifies the unencrypted password. <b>7-</b> Specifies the hidden password. <b>LINE-</b> Specifies the encrypted or unencrypted password. <i>password-</i> LINE password. <b>32-</b> Specifies the NAS-Identifier attribute. <b>vlan-</b> Specifies a VLAN. <b>access-vlan-</b> Specifies the configured access VLAN.

	<b>Command or Action</b>	<b>Purpose</b>
<b>Step 7</b>	<b>no security wpa wpa2 ciphers aes</b> <b>Example:</b> Device(config-wlan)# no security wpa wpa2 ciphers aes	Disables WPA2 ciphers for AES.
<b>Step 8</b>	<b>no shutdown</b> <b>Example:</b> Device(config-wlan)# no shutdown	Enables the WLAN.



## CHAPTER 98

# Web-Based Authentication

This chapter describes how to configure web-based authentication on the device. It contains these sections:

- [Local Web Authentication Overview, on page 795](#)
- [How to Configure Local Web Authentication, on page 803](#)
- [Configuration Examples for Local Web Authentication, on page 825](#)
- [External Web Authentication \(EWA\), on page 830](#)
- [Authentication for Sleeping Clients, on page 835](#)
- [Sleeping Clients with Multiple Authentications, on page 837](#)

## Local Web Authentication Overview

Web authentication is a Layer 3 security solution designed for providing easy and secure guest access to hosts on WLAN with open authentication or appropriate layer 2 security methods. Web authentication allows users to get authenticated through a web browser on a wireless client, with minimal configuration on the client side. It allows users to associate with an open SSID without having to set up a user profile. The host receives an IP address and DNS information from the DHCP server, however cannot access any of the network resources until they authenticate successfully. When the host connects to the guest network, the WLC redirects the host to an authentication web page where the user needs to enter valid credentials. The credentials are authenticated by the WLC or an external authentication server and if authenticated successfully is given full access to the network. Hosts can also be given limited access to particular network resources before authentication for which the pre-authentication ACL functionality needs to be configured.

The following are the different types of web authentication methods:

- **Local Web Authentication (LWA):** Configured as Layer 3 security on the controller, the web authentication page and the pre-authentication ACL are locally configured on the controller. The controller intercepts http(s) traffic and redirects the client to the internal web page for authentication. The credentials entered by the client on the login page is authenticated by the controller locally or through a RADIUS or LDAP server.
- **External Web Authentication (EWA):** Configured as Layer 3 security on the controller, the controller intercepts http(s) traffic and redirects the client to the login page hosted on the external web server. The credentials entered by the client on the login page is authenticated by the controller locally or through a RADIUS or LDAP server. The pre-authentication ACL is configured statically on the controller.
- **Central Web Authentication (CWA):** Configured mostly as Layer 2 security on the controller, the redirection URL and the pre-authentication ACL reside on ISE and are pushed during layer 2 authentication

to the controller. The controller redirects all web traffic from the client to the ISE login page. ISE validates the credentials entered by the client through HTTPS and authenticates the user.

Use the local web authentication feature, known as web authentication proxy, to authenticate end users on host systems that do not run the IEEE 802.1x supplicant.

When a client initiates an HTTP session, local web authentication intercepts ingress HTTP packets from the host and sends an HTML login page to the users. The users enter their credentials, which the local web authentication feature sends to the authentication, authorization, and accounting (AAA) server for authentication.

If authentication succeeds, local web authentication sends a Login-Successful HTML page to the host and applies the access policies returned by the AAA server.

If authentication fails, local web authentication forwards a Login-Fail HTML page to the user, prompting the user to retry the login. If the user exceeds the maximum number of attempts, local web authentication forwards a Login-Expired HTML page to the host, and the user is excluded with the exclusion reason as Web authentication failure.

When a client reaches maximum HTTP connections (maximum of 200 connections when configured), it will cause Transmission Control Protocol (TCP) resets and client exclusion.



---

**Note** You should use either global or named parameter-map under WLAN (for method-type, custom, and redirect) for using the same web authentication methods, such as consent, web consent, and webauth. Global parameter-map is applied by default, if none of the parameter-map is configured under WLAN.

---



---

**Note** The traceback that you receive when webauth client tries to do authentication does not have any performance or behavioral impact. It happens rarely when the context for which FFM replied back to EPM for ACL application is already dequeued (possibly due to timer expiry) and the session becomes 'unauthorized'.

---



---

**Note** When command authorization is enabled as a part of AAA Authorization configuration through TACACS and the corresponding method list is not configured as a part of the HTTP configuration, WebUI pages will not load any data. However, some wireless feature pages may work as they are privilege based and not command based.

---

Based on where the web pages are hosted, the local web authentication can be categorized as follows:

- *Internal*—The internal default HTML pages (Login, Success, Fail, and Expire) in the controller are used during the local web authentication.
- *Customized*—The customized web pages (Login, Success, Fail, and Expire) are downloaded onto the controller and used during the local web authentication.
- *External*—The customized web pages are hosted on the external web server instead of using the in-built or custom web pages.

Based on the various web authentication pages, the types of web authentication are as follows:

- *Webauth*—This is a basic web authentication. Herein, the controller presents a policy page with the user name and password. You need to enter the correct credentials to access the network.
- *Consent or web-passthrough*—Herein, the controller presents a policy page with the Accept or Deny buttons. You need to click the Accept button to access the network.
- *Webconsent*—This is a combination of webauth and consent web authentication types. Herein, the controller presents a policy page with Accept or Deny buttons along with user name or password. You need to enter the correct credentials and click the Accept button to access the network.

**Note**

- You can view the webauth parameter-map information using the **show running-config** command output.
- The wireless Web-Authentication feature does not support the bypass type.
- Change in web authentication parameter map redirect login URL does not occur until a AP rejoin happens. You must enable and disable the WLAN to apply the new URL redirection.

**Note**

We recommend that you follow the Cisco guidelines to create a customized web authentication login page. If you have upgraded to the latest versions of Google Chrome or Mozilla Firefox browsers, ensure that your webauth bundle has the following line in the *login.html* file:

```
<body onload="loadAction();">
```

## Device Roles

With local web authentication, the devices in the network have these specific roles:

- *Client*—The device (workstation) that requests access to the network and the controller and responds to requests from the controller. The workstation must be running an HTML browser with Java Script enabled.
- *Authentication server*—Authenticates the client. The authentication server validates the identity of the client and notifies the controller that the client is authorized to access the network and the controller services or that the client is denied.
- *Controller*—Controls the physical access to the network based on the authentication status of the client. The controller acts as an intermediary (proxy) between the client and the authentication server, requesting identity information from the client, verifying that information with the authentication server, and relaying a response to the client.

Figure 20: Local Web Authentication Device Roles

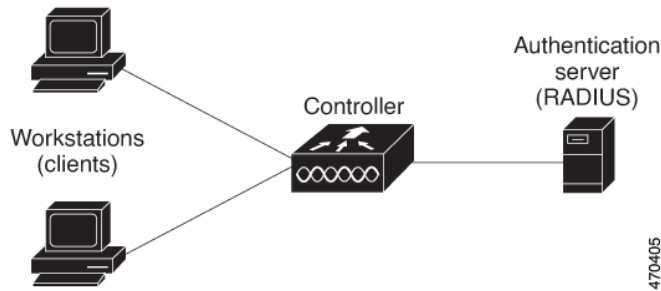

## Authentication Process

When the page is hosted on the controller, the controller uses its virtual IP (a non-routable IP like 192.0.2.1 typically) to serve the request. If the page is hosted externally, the web redirection sends the client first to the virtual IP, which then sends the user again to the external login page while it adds arguments to the URL, such as the location of the virtual IP. Even when the page is hosted externally, the user submits its credentials to the virtual IP.

When you enable local web authentication, these events occur:

- The user initiates an HTTP session.
- The HTTP traffic is intercepted, and authorization is initiated. The controller sends the login page to the user. The user enters a username and password, and the controller sends the entries to the authentication server.
- If the authentication succeeds, the controller downloads and activates the user's access policy from the authentication server. The login success page is sent to the user.
- If the authentication fails, the controller sends the login fail page. The user retries the login. If the maximum number of attempts fails, the controller sends the login expired page, and the host is placed in a watch list. After the watch list times out, the user can retry the authentication process.
- If authentication server is not available, after the web authentication retries, the client moves to the excluded state and the client receives an Authentication Server is Unavailable page.
- The controller reauthenticates a client when the host does not respond to an ARP probe on a Layer 2 interface, or when the host does not send any traffic within the idle timeout on a Layer 3 interface.
- Web authentication sessions can not apply new VLAN as part of the authorization policy, as the client already has been assigned an IP address and you will not be able to change the IP address in the client, in case the VLAN changes.
- If the terminate action is default, the session is dismantled, and the applied policy is removed.



---

**Note** Do not use semicolons (;) while configuring username for GUI access.

---



## Local Web Authentication Banner

With Web Authentication, you can create a default and customized web-browser banners that appears when you log in to the controller.

The banner appears on both the login page and the authentication-result pop-up pages. The default banner messages are as follows:

- *Authentication Successful*
- *Authentication Failed*
- *Authentication Expired*

The Local Web Authentication Banner can be configured as follows:

- Use the following global configuration command:

```
Device(config)# parameter map type webauth global
Device(config-params-parameter-map)# banner ?
file <file-name>
text <Banner text>
title <Banner title>
```

The default banner *Cisco Systems* and *Switch host-name Authentication* appear on the Login Page. *Cisco Systems* appears on the authentication result pop-up page.

**Figure 21: Authentication Successful Banner**

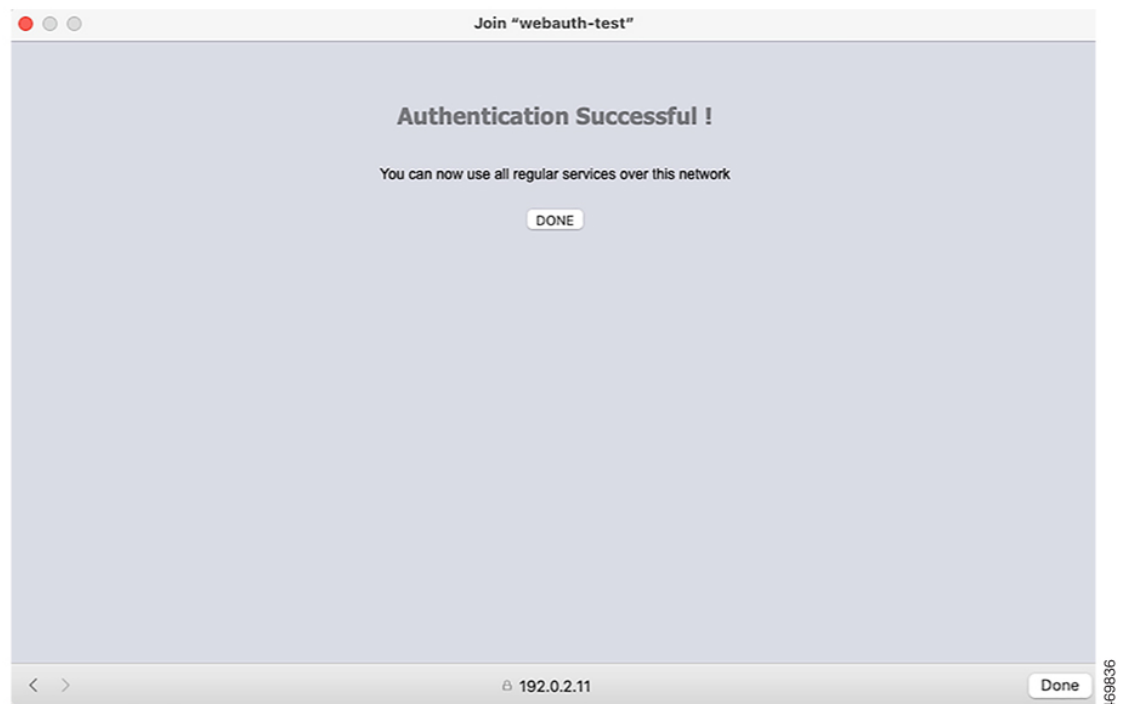

The banner can be customized as follows:

- Add a message, such as switch, router, or company name to the banner:

- New-style mode—Use the following global configuration command:

```
parameter-map type webauth global
```

```
banner text <text>
```

- Add a logo or text file to the banner:

- New-style mode—Use the following global configuration command:

```
parameter-map type webauth global
```

```
banner file <filepath>
```

*Figure 22: Customized Web Banner*



If you do not enable a banner, only the username and password dialog boxes appear in the web authentication login screen, and no banner appears when you log into the switch.

Figure 23: Login Screen With No Banner

Join "webauth-test"

**Login**

Welcome to the Cisco Web-Authentication network

Cisco is pleased to provide web-authentication infrastructure for your network. Please login.

User Name

Password

< > 192.0.2.11 Cancel 469838

## Customized Local Web Authentication

During the local web authentication process, the switch's internal HTTP server hosts four HTML pages to deliver to an authenticating client. The server uses these pages to notify you of these four authentication process states:

- Login: Your credentials are requested
- Success: The login was successful
- Fail: The login failed
- Expire: The login session has expired because of excessive login failures



---

**Note** Virtual IP address is mandatory to configure custom web authentication.

---

## Guidelines

- You can substitute your own HTML pages for the default internal HTML pages.
- You can use a logo or specify text in the *login*, *success*, *failure*, and *expire* web pages.
- On the banner page, you can specify text in the login page.
- The pages are in HTML.

- You must include an HTML redirect command in the success page to access a specific URL.
- The URL string must be a valid URL (for example, `http://www.cisco.com`). An incomplete URL might cause *page not found* or similar errors on a web browser.
- If you configure web pages for HTTP authentication, they must include the appropriate HTML commands (for example, to set the page time out, to set a hidden password, or to confirm that the same page is not submitted twice). The custom page samples in the webauth bundle are provided with the image and the details of what you can and cannot change.
- The CLI command to redirect users to a specific URL is not available when the configured login form is enabled. The administrator should ensure that the redirection is configured in the web page.
- If the CLI command redirecting users to specific URL after authentication occurs is entered and then the command configuring web pages is entered, the CLI command redirecting users to a specific URL does not take effect.
- Configured web pages can be copied to the switch boot flash or flash.
- The login page can be on one flash, and the success and failure pages can be another flash (for example, the flash on the active switch or a member switch).
- You must configure all four pages.
- All of the logo files (image, flash, audio, video, and so on) that are stored in the system directory (for example, flash, disk0, or disk) and that are displayed on the login page must use `web_auth_<filename>` as the file name.
- The configured authentication proxy feature supports both HTTP and SSL.

You can substitute your HTML pages for the default internal HTML pages. You can also specify a URL to which users are redirected after authentication occurs, which replaces the internal Success page.

**Figure 24: Customizable Authentication Page**

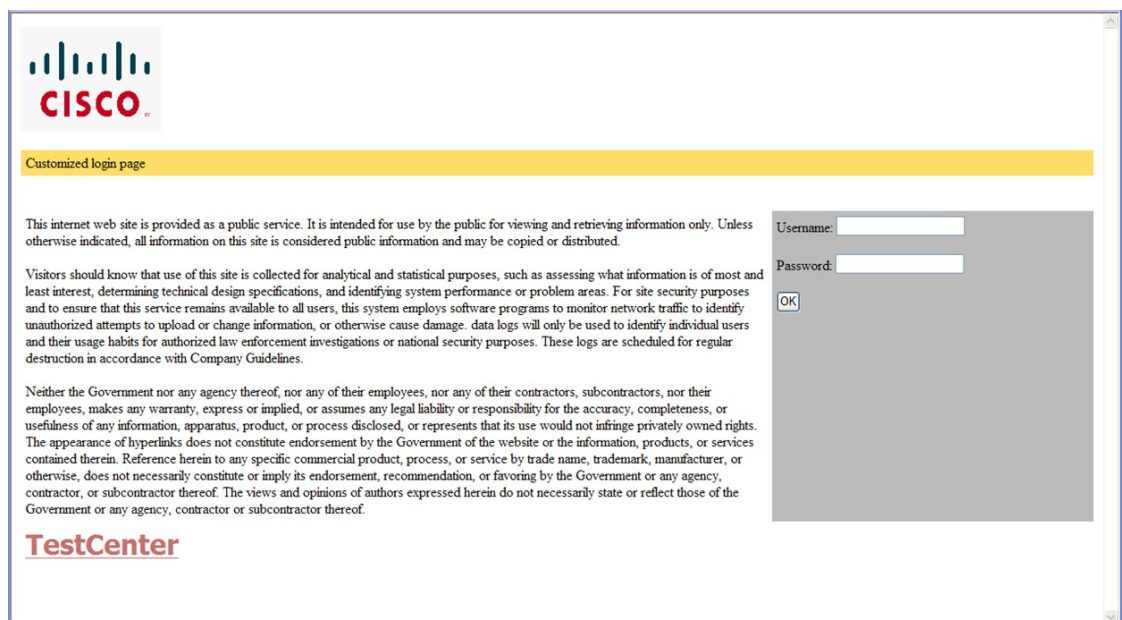

## Redirection URL for Successful Login Guidelines

When configuring a redirection URL for successful login, consider these guidelines:

- If the custom authentication proxy web pages feature is enabled, the redirection URL feature is disabled and is not available in the CLI. You can perform redirection in the custom-login success page.
- If the redirection URL feature is enabled, a configured auth-proxy-banner is not used
- To remove the specification of a redirection URL, use the **no** form of the command.
- If the redirection URL is required after the web-based authentication client is successfully authenticated, then the URL string must start with a valid URL (for example, http://) followed by the URL information. If only the URL is given without http://, then the redirection URL on successful authentication might cause page not found or similar errors on a web browser.

# How to Configure Local Web Authentication

## Configuring Default Local Web Authentication

The following table shows the default configurations required for local web authentication.

*Table 39: Default Local Web Authentication Configuration*

Feature	Default Setting
AAA	Disabled
RADIUS server <ul style="list-style-type: none"> <li>• IP address</li> <li>• UDP authentication port</li> <li>• Key</li> </ul>	<ul style="list-style-type: none"> <li>• None specified</li> </ul>
Default value of inactivity timeout	3600 seconds
Inactivity timeout	Disabled

## Information About the AAA Wizard

The AAA wizard helps you to add the authentication, authorization, and accounting details without having to access multiple windows.



**Note** When command authorization is enabled as a part of AAA Authorization configuration through TACACS and the corresponding method list is not configured as a part of the HTTP configuration, WebUI pages will not load any data. However, some wireless feature pages may work as they are privilege-based and not command based.



---

**Note** Note the following limitations for a TACACS+ user on the 9800 WebUI:

- Users with privilege level 1-10 can only view the **Monitor** tab.
  - Users with privilege level 15 have full access.
  - Users with privilege level 15 and a command set allowing specific commands only, is not supported.
- 



---

**Note** When you configure the AAA authentication and authorization attributes, the following format must be followed:

- protocol:attr=bla
- protocol:attr#0=bla
- protocol:attr#\*=bla
- attr=bla
- attr#0=bla
- attr#\*=bla

*attr* is mapped to the supported AAA attributes. If *attr* is an unknown or undefined attribute, a warning message *parse unknown cisco vsa* is displayed when you configure the **radius-server disallow unknown vendor-code** command. Otherwise, the transaction will be treated as a failure.

We recommend that you configure the command as per the format discussed above. Otherwise, the transaction fails. Whenever the passed attribute does not match any of the patterns mentioned, then AAA fails to decode that specific attribute and marks the request as a failure.

---

To edit the details entered using the wizard, use the respective screens.

### Procedure

---

**Step 1** Choose **Configuration > Security > AAA**.

**Step 2** Click + **AAA Wizard**.

The **Add Wizard** page is displayed.

**Step 3** Click **RADIUS** tab.

The RADIUS server option is enabled by default. You can switch between the **Basic** and **Advanced** options using the radio buttons.

- a) In the **Name** field, enter the name of the RADIUS server.
- b) In the **IPv4 / IPv6 Server Address** field, enter the IPv4 or IPv6 address, or hostname.
- c) Check the **PAC Key** check box to enable the Protected Access Credential (PAC) authentication key option.
- d) From the **Key Type** drop-down list, choose the authentication key type.

- e) In the **Key** field, enter the authentication key.
- f) In the **Confirm Key** field, re-enter the authentication key.
- g) Click the **Advanced** radio button.  
This enables the **Advanced** options.
- h) In the **Auth Port** field, enter the authorization port number.
- i) In the **Acct Port** field, enter the accounting port number.
- j) In the **Server Timeout** field, enter the timeout duration, in seconds.
- k) In the **Retry Count** field, enter the number of retries.
- l) Use the **Support for CoA** toggle button to enable or disable change of authorization (CoA).

**Step 4**

Check the **TACACS+** check box.

This enables the TACACS+ options. You can switch between the **Basic** and **Advanced** options using the radio buttons.

- a) In the **Name** field, enter the TACACS+ server name.
- b) In the **IPv4 / IPv6 Server Address** field, enter the IPv4 or IPv6 address, or hostname.
- c) In the **Key** field, enter the authentication key.
- d) In the **Confirm Key** field, re-enter the authentication key.
- e) Click the **Advanced** radio button.

This enables the **Advanced** options.

- f) In the **Port** field, enter the port number to use.
- g) In the **Server Timeout** field, enter the timeout duration, in seconds.

**Step 5**

Check the **LDAP** check box.

This enables the LDAP options. You can switch between the **Basic** and **Advanced** options using the radio buttons.

- a) In the Server Name field, enter the **LDAP** server name.
- b) In the **IPv4 / IPv6 Server Address** field, enter the IPv4 or IPv6 address, or hostname.
- c) In the **Port Number** field, enter the port number to use.
- d) From the **Simple Bind** drop-down list, choose the authentication key type.
- e) In the **User Base DN** field, enter the details.
- f) Click the **Advanced** radio button.

This enables the **Advanced** options.

- g) From the **User Attribute** drop-down list, choose the user attribute.
- h) In the **User Object Type** field, enter the object type details and click the + icon.

The objects that have been added are listed in the area below. Use the x mark adjacent to each object to remove it.

- i) In the **Server Timeout** field, enter the timeout duration, in seconds.
- j) Check the **Secure Mode** check box to enable secure mode.

Checking this enables the **Trustpoint Name** drop-down list.

- k) From the **Trustpoint Name** drop-down list, choose the trustpoint.
- l) Click **Next**.

This enables the **Server Group Association** page and the RADIUS tab is selected by default.

- Step 6** Perform the following actions under **RADIUS** tab.
- In the **Name** field, enter the name of the RADIUS server group.
  - From the **MAC-Delimiter** drop-down list, choose the delimiter to be used in the MAC addresses that are sent to the RADIUS servers.
  - From the **MAC Filtering** drop-down list, choose a value based on which to filter MAC addresses.
  - To configure the dead time for the server group and direct AAA traffic to alternative groups of servers that have different operational characteristics, in the **Dead-Time** field, enter the amount of time, in minutes, after which a server is assumed to be dead.
  - Choose the servers that you want to include in the server group from the **Available Servers** list and move them to the **Assigned Servers** list.
  - Click **Next**.

The **TACACS+** window is displayed, if you have selected **TACACS+** in server configuration.

- Step 7** Use the **TACACS+** window to enter the following details:
- In the **Name** field, enter the name of the TACACS+ server group.
  - From the **Available Servers** list, choose the servers that you want to include in the server group from the list and move them to the **Assigned Servers** list.
  - Click **Next**.

The **LDAP** window is displayed, if you have selected **LDAP** under server configuration.

- Step 8** Use the **LDAP** window to enter the following details:
- In the **Name** field, enter the name of the LDAP server group.
  - From the **Available Servers** list, choose the servers that you want to include in the server group from the list and move them to the **Assigned Servers** list.

- Step 9** Click **Next**.

The **MAP AAA** window is displayed.

Use the check boxes to enable the **Authentication**, **Authorization**, and **Accounting** tabs. You cannot unselect all the three options. At least one option has to be selected.

- Step 10** Use the **Authentication** tab to enter the authentication details:
- In the **Method List Name** field, enter the name of the method list.
  - From the **Type** drop-down list, choose the type of accounting that you want to perform before allowing access to the network.
  - From the **Group Type** drop-down list, choose a value depending on whether you want to assign a group of servers as your access server, or want to use a local server to authenticate access.

If you choose the local option, the **Fallback** to local option is removed.

- Check the **Fallback to local** check box to configure a local server to act as a fallback method when servers in the group are unavailable.
- From the **Available Server Groups** list, choose the server groups that you want to use to authenticate access to your network and click the > icon to move them to the **Assigned Server Groups** list.

- Step 11** Check the **Authorization** check box to configure the authorization details:

- In the **Method List Name** field, enter the name of the method list.
- From the **Type** drop-down list, choose the type of authorization you want to perform before allowing access to the network.



- c) From the **Group Type** drop-down list, choose a value depending on whether you want to assign a group of servers as your access server, or want to use a local server to authorize access.

If you choose the local option, the **Fallback** to local option is removed.

- d) Check the **Fallback to local** check box to configure a local server to act as a fallback method when the servers in the group are unavailable.
- e) From the **Available Server Groups** list, choose the server groups you want to use to authorize access to your network and click > icon to move them to the **Assigned Server Groups** list.

**Step 12** Check the **Accounting** check box to configure the accounting details:

- a) In the **Method List Name** field, enter the name of the method list.
- b) From the **Type** drop-down list, choose the type of accounting that you want to perform.
- c) From the **Available Server Groups** list, choose the server groups that you want to use to authorize access to your network and click the > icon to move them to the **Assigned Server Groups** list.

**Step 13** Click **Apply to Device**.

---

## Configuring AAA Authentication (GUI)



---

**Note** The WebUI does not support the ipv6 radius source-interface under AAA radius server group configuration.

---

### Procedure

---

- Step 1** Choose **Configuration > Security > AAA**.
  - Step 2** In the **Authentication** section, click **Add**.
  - Step 3** In the **Quick Setup: AAA Authentication** window that is displayed, enter a name for your method list.
  - Step 4** Choose the type of authentication you want to perform before allowing access to the network, in the **Type** drop-down list.
  - Step 5** Choose if you want to assign a group of servers as your access server, or if you want to use a local server to authenticate access, from the **Group Type** drop-down list.
  - Step 6** To configure a local server to act as a fallback method when servers in the group are unavailable, check the **Fallback to local** check box.
  - Step 7** Choose the server groups you want to use to authenticate access to your network, from the **Available Server Groups** list and click > icon to move them to the **Assigned Server Groups** list.
  - Step 8** Click **Save & Apply to Device**.
-

## Configuring AAA Authentication (CLI)

### Procedure

	Command or Action	Purpose
<b>Step 1</b>	<b>aaa new-model</b>  <b>Example:</b>  Device(config)# <b>aaa new-model</b>	Enables AAA functionality.
<b>Step 2</b>	<b>aaa authentication login {default   named_authentication_list} group AAA_group_name</b>  <b>Example:</b>  Device(config)# <b>aaa authentication login default group group1</b>	Defines the list of authentication methods at login.  <b>named_authentication_list</b> refers to any name that is not greater than 31 characters.  <b>AAA_group_name</b> refers to the server group name. You need to define the server-group <b>server_name</b> at the beginning itself.
<b>Step 3</b>	<b>aaa authorization network {default   named} group AAA_group_name</b>  <b>Example:</b>  Device(config)# <b>aaa authorization network default group group1</b>	Creates an authorization method list for web-based authorization.
<b>Step 4</b>	<b>tacacs server server-name</b>  <b>Example:</b>  Device(config)# <b>tacacs server yourserver</b>	Specifies an AAA server.
<b>Step 5</b>	<b>address {ipv4   ipv6}ip_address</b>  <b>Example:</b>  Device(config-server-tacacs)# <b>address ipv4 10.0.1.12</b>	Configures the IP address for the TACACS server.
<b>Step 6</b>	<b>single-connection</b>  <b>Example:</b>  Device(config-server-tacacs)# <b>single-connection</b>	Multiplexes all packets over a single TCP connection to TACACS server.
<b>Step 7</b>	<b>tacacs-server host {hostname   ip_address}</b>  <b>Example:</b>	Specifies a AAA server.

	Command or Action	Purpose
	Device(config)# <b>tacacs-server host</b> 10.1.1.1	

## Configuring the HTTP/HTTPS Server (GUI)

### Procedure

- 
- Step 1** Choose **Administration > Management > HTTP/HTTPS/Netconf**.
  - Step 2** In the **HTTP/HTTPS Access Configuration** section, enable HTTP Access and enter the port that will listen for HTTP requests. The default port is 80. Valid values are 80, and ports between 1025 and 65535.
  - Step 3** Enable **HTTPS Access** on the device and enter the designated port to listen for HTTPS requests. The default port is 1025. Valid values are 443, and ports between 1025 and 65535. On a secure HTTP connection, data to and from an HTTP server is encrypted before being sent over the Internet. HTTP with SSL encryption provides a secure connection to allow such functions as configuring a switch from a Web browser.
  - Step 4** Choose the **Personal Identity Verification** as enabled or disabled.
  - Step 5** In the **HTTP Trust Point Configuration** section, enable **Enable Trust Point** to use Certificate Authority servers as trustpoints.
  - Step 6** From the **Trust Points** drop-down list, choose a trust point.
  - Step 7** In the **Timeout Policy Configuration** section, enter the HTTP timeout policy in seconds. Valid values can range from 1 to 600 seconds.
  - Step 8** Enter the number of minutes of inactivity allowed before the session times out. Valid values can range from 180 to 1200 seconds.
  - Step 9** Enter the server life time in seconds. Valid values can range from 1 to 86400 seconds.
  - Step 10** Enter the maximum number of requests the device can accept. Valid values range from 1 to 86400 requests.
  - Step 11** Save the configuration.
- 

## Configuring the HTTP Server (CLI)

To use local web authentication, you must enable the HTTP server within the device. You can enable the server for either HTTP or HTTPS.



**Note** The Apple psuedo-browser will not open if you configure only the **ip http secure-server** command. You should also configure the **ip http server** command.

Follow the procedure given below to enable the server for either HTTP or HTTPS:

**Procedure**

	<b>Command or Action</b>	<b>Purpose</b>
<b>Step 1</b>	<b>configure terminal</b> <b>Example:</b> Device# <code>configure terminal</code>	Enters global configuration mode.
<b>Step 2</b>	<b>ip http server</b> <b>Example:</b> Device(config)# <code>ip http server</code>	Enables the HTTP server. The local web authentication feature uses the HTTP server to communicate with the hosts for user authentication.
<b>Step 3</b>	<b>ip http secure-server</b> <b>Example:</b> Device(config)# <code>ip http secure-server</code>	Enables HTTPS.  You can configure custom authentication proxy web pages or specify a redirection URL for successful login.  <b>Note</b> To ensure secure authentication when you enter the <b>ip http secure-server</b> command, the login page is always in HTTPS (secure HTTP) even if the user sends an HTTP request.
<b>Step 4</b>	<b>end</b> <b>Example:</b> Device(config)# <code>end</code>	Exits configuration mode.

## Configuring HTTP and HTTPS Requests for Web Authentication

### Information About Configuring HTTP and HTTPS Requests for Web Authentication

Using the Configuring HTTP and HTTPS Requests for Web Authentication feature, you can have HTTPS access to device management and HTTP access to web authentication. To control the HTTP and HTTPS requests being sent to the web authentication module, run the **secure-webauth-disable** and **webauth-http-enable** commands in the global parameter map mode.



**Note** The **secure-webauth-disable** and **webauth-http-enable** commands are not enabled by default; you must configure them explicitly.

The following table describes the various CLI combinations:

Table 40: CLI Combinations

Admin (Device Management)		WebAuthentication		Required Configurations	
HTTP Access	HTTPS Access	HTTP Access	HTTPS Access	Admin	Web Authentication
No	Yes	Yes	Yes	no ip http server ip http secure-server	no ip http server ip http secure-server parameter-map type webauth global webauth-http-enable
No	Yes	No	Yes	no ip http server ip http secure-server	no ip http server ip http secure-server
No	Yes	Yes	No	no ip http server ip http secure-server	no ip http server ip http secure-server parameter-map type webauth global webauth-http-enable secure-webauth-disable
No	Yes	No	No	no ip http server ip http secure-server	no ip http server ip http secure-server parameter-map type webauth global secure-webauth-disable
No	No	No	Yes	no ip http server no ip http secure-server	Not Supported
No	No	Yes	No	no ip http server no ip http secure-server	no ip http server no ip http secure-server parameter-map type webauth global webauth-http-enable
Yes	No	Yes	No	ip http server no ip http secure-server	ip http server no ip http secure-server

Admin (Device Management)		WebAuthentication		Required Configurations	
HTTP Access	HTTPS Access	HTTP Access	HTTPS Access	Admin	Web Authentication
Yes	Yes	Yes	No	ip http server ip http secure-server	ip http server ip http secure-server  parameter-map type webauth global  secure-webauth-disable

**Note**

- The **ip http server** and **ip http secure-server** commands allow access for HTTP and HTTPS, respectively. For example, in the first row of the table, for HTTP access to web authentication, you do not require the **ip http server** command. You can use the new **webauth-http-enable** command under the global parameter map, to allow HTTP access.
- For HTTPS access to webauth, the **ip http secure-server** command is required. Therefore, HTTPS access for both admin and web authentication are enabled in the first row. To disable HTTPS access for web authentication, configure the **secure-webauth-disable** command. For example, in the fourth row of the table, HTTPS access is disabled for web authentication because the **secure-webauth-disable** command is configured.

## Guidelines and Limitations

The following are the guidelines and limitations for configuring HTTP and HTTPS requests for web authentication:

- You cannot enable HTTPS web authentication without enabling HTTPS for device management.
- If the **secure-webauth-disable** command is configured, central web authentication cannot be performed, if the initial request from the client is `https://<>`.

## Configuring HTTP and HTTPS Requests for Web Authentication (CLI)

To configure the HTTP and HTTPS requests being sent to the webauth module, complete the steps given below:

### Procedure

	Command or Action	Purpose
<b>Step 1</b>	<b>enable</b>  <b>Example:</b> Device# enable	Enables privileged EXEC mode.  Enter your password if prompted.

	Command or Action	Purpose
<b>Step 2</b>	<b>configure terminal</b> <b>Example:</b> Device# configure terminal	Enters global configuration mode.
<b>Step 3</b>	<b>no ip http server</b> <b>Example:</b> Device(config)# no ip http server	Sets the HTTP server to its default.
<b>Step 4</b>	<b>ip http {server   secure-server}</b> <b>Example:</b> Device(config)# ip http server	Enables the HTTP server or the HTTP secure server.
<b>Step 5</b>	<b>parameter-map type webauth global</b> <b>Example:</b> Device(config)# parameter-map type webauth global	Enables the global parameter map mode.
<b>Step 6</b>	<b>secure-webauth-disable</b> <b>Example:</b> Device(config-params-parameter-map)# secure-webauth-disable	Disables HTTP secure server for web authentication.
<b>Step 7</b>	<b>webauth-http-enable</b> <b>Example:</b> Device(config-params-parameter-map)# webauth-http-enable	Enables HTTP server for web authentication.

## Creating a Parameter Map (GUI)

### Procedure

- 
- Step 1** Choose **Configuration > Security > Web Auth**.
  - Step 2** Click **Add**.
  - Step 3** Click **Policy Map**.
  - Step 4** Enter **Parameter Name**, **Maximum HTTP connections**, **Init-State Timeout(secs)** and choose **webauth** in the **Type** drop-down list.
  - Step 5** Click **Apply to Device**.
-

# Creating Parameter Maps

## Configuring Local Web Authentication (GUI)

### Procedure

---

- Step 1** Choose **Configuration > Security > Web Auth**.
- Step 2** On the **Web Auth** page, click **Add**.
- Step 3** In the **Create Web Auth Parameter** window that is displayed, enter a name for the parameter map.
- Step 4** In the **Maximum HTTP Connections** field, enter the maximum number of HTTP connections that you want to allow.
- Step 5** In the **Init-State Timeout** field, enter the time after which the init state timer should expire due to user's failure to enter valid credentials in the login page.
- Step 6** Choose the type of Web Auth parameter.
- Step 7** Click **Apply to Device**.
- Step 8** On the **Web Auth** page, click the name of the parameter map.
- Step 9** In the **Edit WebAuth Parameter** window that is displayed, choose the required **Banner Type**.
- If you choose **Banner Text**, enter the required banner text to be displayed.
  - If you choose **File Name**, specify the path of the file from which the banner text has to be picked up.
- Step 10** Enter the virtual IP addresses as required.
- Step 11** Set appropriate status of **WebAuth Intercept HTTPS**, **Captive Bypass Portal**.
- Step 12** Set appropriate status for **Disable Success Window**, **Disable Logout Window**, and **Login Auth Bypass for FQDN**.
- Step 13** Check the **Sleeping Client Status** check box to enable authentication of sleeping clients and then specify the **Sleeping Client Timeout** in minutes. Valid range is between 10 minutes and 43200 minutes.
- Step 14** Click the **Advanced** tab.
- Step 15** To configure external web authentication, perform these tasks:
- a) In the **Redirect for log-in** field, enter the name of the external server to send login request.
  - b) In the **Redirect On-Success** field, enter the name of the external server to redirect after a successful login.
  - c) In the **Redirect On-Failure** field, enter the name of the external server to redirect after a login failure.
  - d) (Optional) Under **Redirect to External Server** in the **Redirect Append for AP MAC Address** field, enter the AP MAC address.
  - e) (Optional) In the **Redirect Append for Client MAC Address** field, enter the client MAC address.
  - f) (Optional) In the **Redirect Append for WLAN SSID** field, enter the WLAN SSID.
  - g) In the **Portal IPV4 Address** field, enter the IPv4 address of the portal to send redirects.
  - h) In the **Portal IPV6 Address** field, enter the IPv6 address of the portal to send redirects, if IPv6 address is used.
- Step 16** To configure customized local web authentication, perform these tasks:
- a) Under **Customized Page**, specify the following pages:
    - **Login Failed Page**
    - **Login Page**



- Logout Page
- Login Successful Page

**Step 17** Click Update & Apply.

## Configuring the Internal Local Web Authentication (CLI)

Follow the procedure given below to configure the internal local web authentication:

### Procedure

	Command or Action	Purpose
<b>Step 1</b>	<b>configure terminal</b>  <b>Example:</b>  Device# <b>configure terminal</b>	Enters global configuration mode.
<b>Step 2</b>	<b>parameter-map type webauth</b> { <i>parameter-map-name</i>   <b>global</b> }  <b>Example:</b>  Device(config)# <b>parameter-map type</b> <b>webauth sample</b>	Creates the parameter map.  The <b>parameter-map-name</b> must not exceed 99 characters.
<b>Step 3</b>	<b>end</b>  <b>Example:</b>  Device(config-params-parameter-map)# <b>end</b>	Returns to privileged EXEC mode.

## Configuring the Customized Local Web Authentication (CLI)

Follow the procedure given below to configure the customized local web authentication:



**Note** Virtual IP address is mandatory for custom web authentication.

### Procedure

	Command or Action	Purpose
<b>Step 1</b>	<b>configure terminal</b>  <b>Example:</b>	Enters global configuration mode.

	Command or Action	Purpose
	Device# <code>configure terminal</code>	
<b>Step 2</b>	<p><b>parameter-map type webauth</b> <i>parameter-map-name</i></p> <p><b>Example:</b></p> <pre>Device(config)# parameter-map type webauth sample</pre>	<p>Configures the webauth type parameter.</p> <p><b>Note</b> You need to configure a virtual IP in the global parameter map to use the customized web authentication bundle.</p>
<b>Step 3</b>	<p><b>type {authbypass   consent   webauth   webconsent}</b></p> <p><b>Example:</b></p> <pre>Device(config-params-parameter-map)# type webauth</pre>	Configures webauth sub-types, such as passthru, consent, webauth, or webconsent.
<b>Step 4</b>	<p><b>custom-page login device</b> <i>html-filename</i></p> <p><b>Example:</b></p> <pre>Device(config-params-parameter-map)# custom-page login device bootflash:login.html</pre>	Configures the customized login page.
<b>Step 5</b>	<p><b>custom-page login expired device</b> <i>html-filename</i></p> <p><b>Example:</b></p> <pre>Device(config-params-parameter-map)# custom-page login expired device bootflash:loginexpired.html</pre>	Configures the customized login expiry page.
<b>Step 6</b>	<p><b>custom-page success device</b> <i>html-filename</i></p> <p><b>Example:</b></p> <pre>Device(config-params-parameter-map)# custom-page success device bootflash:loginsuccess.html</pre>	Configures the customized login success page.
<b>Step 7</b>	<p><b>custom-page failure device</b> <i>html-filename</i></p> <p><b>Example:</b></p> <pre>Device(config-params-parameter-map)# custom-page failure device bootflash:loginfail.html</pre>	Configures the customized login failure page.
<b>Step 8</b>	<p><b>end</b></p> <p><b>Example:</b></p>	Returns to privileged EXEC mode.

	Command or Action	Purpose
	Device (config-params-parameter-map) # <b>end</b>	

## Configuring the External Local Web Authentication (CLI)

Follow the procedure given below to configure the external local web authentication:

### Procedure

	Command or Action	Purpose
<b>Step 1</b>	<b>configure terminal</b> <b>Example:</b> Device# <b>configure terminal</b>	Enters global configuration mode.
<b>Step 2</b>	<b>parameter-map type webauth</b> <i>parameter-map-name</i> <b>Example:</b> Device (config) # <b>parameter-map type webauth sample</b>	Configures the webauth type parameter.
<b>Step 3</b>	<b>type {authbypass   consent   webauth   webconsent}</b> <b>Example:</b> Device (config-params-parameter-map) # <b>type webauth</b>	Configures the webauth sub-types, such as authbypass, consent, passthru, webauth, or webconsent.
<b>Step 4</b>	<b>redirect [for-login   on-failure   on-success]</b> <i>URL</i> <b>Example:</b> Device (config-params-parameter-map) # <b>redirect for-login http://www.cisco.com/login.html</b>	Configures the redirect URL for the login, failure, and success pages. <b>Note</b> In the redirect url, you need to press <i>Ctrl+v</i> and type <i>?</i> to configure the <i>?</i> character. The <i>?</i> character is commonly used in URL when ISE is configured as an external portal.
<b>Step 5</b>	<b>redirect portal {ipv4   ipv6} ip-address</b> <b>Example:</b>	Configures the external portal IPv4 address.

	Command or Action	Purpose
	Device(config-params-parameter-map)# <b>redirect portal ipv4 23.0.0.1</b>	<b>Note</b> The IP address should be one of the associated IP addresses of the domain and not a random IP address when using FQDN. It is recommended to use the FQDN URL here, if a given domain resolves to more than a single IP address.
<b>Step 6</b>	<b>end</b>  <b>Example:</b>  Device(config-params-parameter-map)# <b>end</b>	Returns to privileged EXEC mode.

## Configuring the Web Authentication WLANs

Follow the procedure given below to configure WLAN using web auth security and map the authentication list and parameter map:

### Procedure

	Command or Action	Purpose
<b>Step 1</b>	<b>configure terminal</b>  <b>Example:</b>  Device# <b>configure terminal</b>	Enters global configuration mode.
<b>Step 2</b>	<b>wlan profile-name wlan-id ssid-name</b>  <b>Example:</b>  Device(config)# <b>wlan mywlan 34 mywlan-ssid</b>	Specifies the WLAN name and ID.  <i>profile-name</i> is the WLAN name which can contain 32 alphanumeric characters.  <i>wlan-id</i> is the wireless LAN identifier. The valid range is from 1 to 512.  <i>ssid-name</i> is the SSID which can contain 32 alphanumeric characters.
<b>Step 3</b>	<b>no security wpa</b>  <b>Example:</b>  Device(config-wlan)# <b>no security wpa</b>	Disables the WPA security.
<b>Step 4</b>	<b>security web-auth</b>  <b>Example:</b>  Device(config-wlan)# <b>security web-auth</b>	Enables web authentication for WLAN.

	Command or Action	Purpose
<b>Step 5</b>	<p><b>security web-auth</b> {<b>authentication-list</b> <i>authentication-list-name</i>   <b>parameter-map</b> <i>parameter-map-name</i>}</p> <p><b>Example:</b></p> <pre>Device(config-wlan) # security web-auth authentication-list webauthlistlocal  Device(config-wlan) # security web-auth parameter-map sample</pre>	<p>Enables web authentication for WLAN.</p> <p>Here,</p> <ul style="list-style-type: none"> <li>• <b>authentication-list</b> <i>authentication-list-name</i>: Sets the authentication list for IEEE 802.1x.</li> <li>• <b>parameter-map</b> <i>parameter-map-name</i>: Configures the parameter map.</li> </ul> <p><b>Note</b> When <b>security web-auth</b> is enabled, you get to map the default <b>authentication-list</b> and global <b>parameter-map</b>. This is applicable for authentication-list and parameter-map that are not explicitly mentioned.</p>
<b>Step 6</b>	<p><b>end</b></p> <p><b>Example:</b></p> <pre>Device(config-wlan) # end</pre>	Returns to privileged EXEC mode.

## Configuring Pre-Auth Web Authentication ACL (GUI)

### Before you begin

Ensure that you have configured an access control list (ACL) and a WLAN.

### Procedure

- 
- Step 1** Choose **Configuration** > **Tags & Profiles** > **WLANs**.
  - Step 2** Click the name of the WLAN.
  - Step 3** In the **Edit WLAN** window, click the **Security** tab and then click the **Layer3** tab.
  - Step 4** Click **Show Advanced Settings**.
  - Step 5** In the **Preauthentication ACL** section, choose the appropriate ACL to be mapped to the WLAN.
  - Step 6** Click **Update & Apply to Device**.
- 

## Configuring Pre-Auth Web Authentication ACL (CLI)

Follow the procedure given below to configure pre-auth web authentication ACL:

## Procedure

	Command or Action	Purpose
<b>Step 1</b>	<b>configure terminal</b> <b>Example:</b> Device# <b>configure terminal</b>	Enters global configuration mode.
<b>Step 2</b>	<b>access-list <i>access-list-number</i> {deny   permit} <i>hostname source-wildcard-bits</i></b> <b>Example:</b> Device(config)# <b>access-list 2 deny your_host 10.1.1.1 log</b>	Creates an ACL list. The <i>access-list-number</i> is a decimal number from 1 to 99, 100 to 199, 300 to 399, 600 to 699, 1300 to 1999, 2000 to 2699, or 2700 to 2799. Enter <b>deny</b> or <b>permit</b> to specify whether to deny or permit if the conditions are matched. The <i>source</i> is the source address of the network or host from which the packet is being sent specified as: <ul style="list-style-type: none"> <li>• The 32-bit quantity in dotted-decimal format.</li> <li>• The keyword <b>any</b> as an abbreviation for <i>source</i> and <i>source-wildcard</i> of 0.0.0.0 255.255.255.255. You do not need to enter a source-wildcard.</li> <li>• The keyword <b>host</b> as an abbreviation for <i>source</i> and <i>source-wildcard</i> of source 0.0.0.0.</li> </ul> (Optional) The <i>source-wildcard</i> applies wildcard bits to the source.
<b>Step 3</b>	<b>wlan <i>profile-name wlan-id ssid-name</i></b> <b>Example:</b> Device(config)# <b>wlan mywlan 34 mywlan-ssid</b>	Creates the WLAN. <i>profile-name</i> is the WLAN name which can contain 32 alphanumeric characters. <i>wlan-id</i> is the wireless LAN identifier. The valid range is from 1 to 512. <i>ssid-name</i> is the SSID which can contain 32 alphanumeric characters.
<b>Step 4</b>	<b>ip access-group web <i>access-list-name</i></b> <b>Example:</b> Device(config-wlan)# <b>ip access-group web name</b>	Maps the ACL to the web auth WLAN. <i>access-list-name</i> is the IPv4 ACL name or ID.

	Command or Action	Purpose
<b>Step 5</b>	<b>end</b> <b>Example:</b> Device(config-wlan) # <b>end</b>	Returns to privileged EXEC mode.

## Configuring the Maximum Web Authentication Request Retries

Follow these steps to configure the maximum web authentication request retries:

### Procedure

	Command or Action	Purpose
<b>Step 1</b>	<b>configure terminal</b> <b>Example:</b> Device# <b>configure terminal</b>	Enters global configuration mode.
<b>Step 2</b>	<b>configure terminal</b> <b>Example:</b> Device# <b>configure terminal</b>	Enters global configuration mode.
<b>Step 3</b>	<b>wireless security web-auth retries <i>number</i></b> <b>Example:</b> Device(config) # <b>wireless security web-auth retries 2</b>	<i>number</i> is the maximum number of web auth request retries. The valid range is 0 to 20.
<b>Step 4</b>	<b>end</b> <b>Example:</b> Device(config) # <b>end</b>	Returns to privileged EXEC mode.

## Configuring a Local Banner in Web Authentication Page (GUI)

### Procedure

- 
- Step 1** Choose **Configuration > Security > Web Auth**.
- Step 2** In the **Webauth Parameter Map** tab, click the parameter map name. The **Edit WebAuth Parameter** window is displayed.

- Step 3** In the **General** tab and choose the required Banner Type:
- If you choose **Banner Text**, enter the required banner text to be displayed.
  - If you choose **File Name**, specify the path of the file from which the banner text has to be picked up.
- Step 4** Click **Update & Apply**.

## Configuring a Local Banner in Web Authentication Page (CLI)

Follow the procedure given below to configure a local banner in web authentication pages.

### Procedure

	Command or Action	Purpose
<b>Step 1</b>	<b>configure terminal</b>  <b>Example:</b> Device# <code>configure terminal</code>	Enters global configuration mode.
<b>Step 2</b>	<b>parameter-map type webauth <i>param-map</i></b>  <b>Example:</b> Device(config)# <code>parameter-map type webauth param-map</code>	Configures the web authentication parameters. Enters the parameter map configuration mode.
<b>Step 3</b>	<b>banner [ <i>file</i>   <i>banner-text</i>   <i>title</i> ]</b>  <b>Example:</b> Device(config-params-parameter-map)# <code>banner http C My Switch C</code>	Enables the local banner.  Create a custom banner by entering <i>C banner-text C</i> (where <i>C</i> is a delimiting character), or <i>file</i> that indicates a file (for example, a logo or text file) that appears in the banner, or <i>title</i> that indicates the title of the banner.
<b>Step 4</b>	<b>end</b>  <b>Example:</b> Device(config-params-parameter-map)# <code>end</code>	Returns to privileged EXEC mode.

## Configuring Type WebAuth, Consent, or Both

### Procedure

	Command or Action	Purpose
<b>Step 1</b>	<b>configure terminal</b>  <b>Example:</b> Device # <code>configure terminal</code>	Enters global configuration mode.



	Command or Action	Purpose
<b>Step 2</b>	<b>parameter-map type webauth</b> <i>parameter-map name</i>  <b>Example:</b> Device (config) # <b>parameter-map type webauth</b> webparalocal	Configures the webauth type parameter.
<b>Step 3</b>	<b>type consent</b>  <b>Example:</b> Device (config-params-parameter-map) # <b>type consent</b>	Configures webauth type as consent. You can configure the type as webauth, consent, or both (webconsent).
<b>Step 4</b>	<b>end</b>  <b>Example:</b> Device (config-params-parameter-map) # <b>end</b>	Returns to privileged EXEC mode.
<b>Step 5</b>	<b>show running-config   section parameter-map type webauth</b> <i>parameter-map</i>  <b>Example:</b> Device (config) # <b>show running-config   section parameter-map type webauth</b> test	Displays the configuration details.

## Configuring Preauthentication ACL

### Procedure

	Command or Action	Purpose
<b>Step 1</b>	<b>configure terminal</b>  <b>Example:</b> Device# <b>configure terminal</b>	Enters global configuration mode.
<b>Step 2</b>	<b>wlan</b> <i>wlan-name</i>  <b>Example:</b> Device (config)# <b>wlan</b> ramban	For <i>wlan-name</i> , enter the profile name.
<b>Step 3</b>	<b>shutdown</b>  <b>Example:</b> Device (config-wlan)# <b>shutdown</b>	Disables the WLAN.
<b>Step 4</b>	<b>ip access-group web</b> <i>preauthrule</i>  <b>Example:</b> Device (config-wlan)# <b>ip access-group web</b> preauthrule	Configures ACL that has to be applied before authentication.

	Command or Action	Purpose
<b>Step 5</b>	<b>no shutdown</b> <b>Example:</b> Device (config)# <b>no shutdown</b>	Enables the WLAN.
<b>Step 6</b>	<b>end</b> <b>Example:</b> Device (config-wlan)# <b>end</b>	Returns to privileged EXEC mode.
<b>Step 7</b>	<b>show wlan name wlan-name</b> <b>Example:</b> Device# <b>show wlan name ramban</b>	Displays the configuration details.

## Configuring TrustPoint for Local Web Authentication

### Before you begin

Ensure that a certificate is installed on your controller . Using trustpoint controller presents the domain specific certificate that client browser trusts when it gets redirected to \*.com portal.

### Procedure

	Command or Action	Purpose
<b>Step 1</b>	<b>configure terminal</b> <b>Example:</b> Device# <b>configure terminal</b>	Enters global configuration mode.
<b>Step 2</b>	<b>parameter-map type webauth global</b> <b>Example:</b> Device (config)# <b>parameter-map type webauth global</b>	Creates the parameter map.
<b>Step 3</b>	<b>trustpoint trustpoint-name</b> <b>Example:</b> Device (config-params-parameter-map)# <b>trustpoint trustpoint-name</b>	Configures trustpoint for local web authentication.
<b>Step 4</b>	<b>end</b> <b>Example:</b> Device (config-params-parameter-map)# <b>end</b>	Returns to privileged EXEC mode.

# Configuration Examples for Local Web Authentication

## Example: Obtaining Web Authentication Certificate

This example shows how to obtain web authentication certificate.

```
Device# configure terminal
Device(config)# crypto pki import cert pkcs12 tftp://9.1.0.100/ldapserver-cert.p12 cisco
Device(config)# end
Device# show crypto pki trustpoints cert
Trustpoint cert:
  Subject Name:
    e=rkannajr@cisco.com
    cn=sthaliya-lnx
    ou=WNBU
    o=Cisco
    l=SanJose
    st=California
    c=US
  Serial Number (hex): 00
  Certificate configured.
Device# show crypto pki certificates cert
Certificate
  Status: Available
  Certificate Serial Number (hex): 04
  Certificate Usage: General Purpose
  Issuer:
    e=rkannajr@cisco.com
    cn=sthaliya-lnx
    ou=WNBU
    o=Cisco
    l=SanJose
    st=California
    c=US
  Subject:
    Name: ldapserver
    e=rkannajr@cisco.com
    cn=ldapserver
    ou=WNBU
    o=Cisco
    st=California
    c=US
  Validity Date:
    start date: 07:35:23 UTC Jan 31 2012
    end date: 07:35:23 UTC Jan 28 2022
  Associated Trustpoints: cert ldap12
  Storage: nvram:rkannajrcisc#4.cer

CA Certificate
  Status: Available
  Certificate Serial Number (hex): 00
  Certificate Usage: General Purpose
  Issuer:
    e=rkannajr@cisco.com
    cn=sthaliya-lnx
    ou=WNBU
    o=Cisco
    l=SanJose
    st=California
```

```

c=US
Subject:
e=rkannajr@cisco.com
cn=sthaliya-lnx
ou=WNBU
o=Cisco
l=SanJose
st=California
c=US
Validity Date:
start date: 07:27:56 UTC Jan 31 2012
end date: 07:27:56 UTC Jan 28 2022
Associated Trustpoints: cert ldap12 ldap
Storage: nvram:rkannajrcisc#OCA.cer

```

## Example: Displaying a Web Authentication Certificate

This example shows how to display a web authentication certificate.

```

Device# show crypto ca certificate verb
Certificate
Status: Available
Version: 3
Certificate Serial Number (hex): 2A9636AC00000000858B
Certificate Usage: General Purpose
Issuer:
cn=Cisco Manufacturing CA
o=Cisco Systems
Subject:
Name: WS-C3780-6DS-S-2037064C0E80
Serial Number: PID:WS-C3780-6DS-S SN:FOC1534X12Q
cn=WS-C3780-6DS-S-2037064C0E80
serialNumber=PID:WS-C3780-6DS-S SN:FOC1534X12Q
CRL Distribution Points:
http://www.cisco.com/security/pki/crl/cmca.crl
Validity Date:
start date: 15:43:22 UTC Aug 21 2011
end date: 15:53:22 UTC Aug 21 2021
Subject Key Info:
Public Key Algorithm: rsaEncryption
RSA Public Key: (1024 bit)
Signature Algorithm: SHA1 with RSA Encryption
Fingerprint MD5: A310B856 A41565F1 1D9410B5 7284CB21
Fingerprint SHA1: 04F180F6 CA1A67AF 9D7F561A 2BB397A1 0F5EB3C9
X509v3 extensions:
X509v3 Key Usage: F0000000
Digital Signature
Non Repudiation
Key Encipherment
Data Encipherment
X509v3 Subject Key ID: B9EEB123 5A3764B4 5E9C54A7 46E6EECA 02D283F7
X509v3 Authority Key ID: DOC52226 AB4F4660 ECAE0591 C7DC5AD1 B047F76C
Authority Info Access:
Associated Trustpoints: CISCO_IDEVID_SUDI
Key Label: CISCO_IDEVID_SUDI

```

## Example: Choosing the Default Web Authentication Login Page

This example shows how to choose a default web authentication login page.

```

Device# configure terminal
Device(config)# parameter-map type webauth test
This operation will permanently convert all relevant authentication commands to their CPL
control-policy equivalents. As this conversion is irreversible and will
disable the conversion CLI 'authentication display [legacy|new-style]', you are strongly
advised to back up your current configuration before proceeding.
Do you wish to continue? [yes]: yes
Device(config)# wlan wlan50
Device(config-wlan)# shutdown
Device(config-wlan)# security web-auth authentication-list test
Device(config-wlan)# security web-auth parameter-map test
Device(config-wlan)# no shutdown
Device(config-wlan)# end
Device# show running-config | section wlan50
wlan wlan50 50 wlan50
  security wpa akm cckm
  security wpa wpa1
  security wpa wpa1 ciphers aes
  security wpa wpa1 ciphers tkip
  security web-auth authentication-list test
  security web-auth parameter-map test
  session-timeout 1800
  no shutdown

Device# show running-config | section parameter-map type webauth test
parameter-map type webauth test
  type webauth

```

## Example: Choosing a Customized Web Authentication Login Page from an IPv4 External Web Server

This example shows how to choose a customized web authentication login page from an IPv4 external web server.

```

Device# configure terminal
Device(config)# parameter-map type webauth global
Device(config-params-parameter-map)# virtual-ip ipv4 192.0.2.1.
Device(config-params-parameter-map)# parameter-map type webauth test
Device(config-params-parameter-map)# type webauth
Device(config-params-parameter-map)# redirect for-login http://9.1.0.100/login.html
Device(config-params-parameter-map)# redirect portal ipv4 9.1.0.100
Device(config-params-parameter-map)# end
Device# show running-config | section parameter-map
parameter-map type webauth global
virtual-ip ipv4 192.0.2.1.
parameter-map type webauth test
type webauth
redirect for-login http://9.1.0.100/login.html
redirect portal ipv4 9.1.0.100
security web-auth parameter-map rasagna-auth-map
security web-auth parameter-map test

```

## Example: Choosing a Customized Web Authentication Login Page from an IPv6 External Web Server

This example shows how to choose a customized web authentication login page from an IPv6 external web server.

```
Device# configure terminal
Device(config)# parameter-map type webauth global
Device(config-params-parameter-map)# virtual-ip ipv6 2001:DB8::/48
Device(config-params-parameter-map)# parameter-map type webauth test
Device(config-params-parameter-map)# type webauth
Device(config-params-parameter-map)# redirect for-login http://9:1:1::100/login.html
Device(config-params-parameter-map)# redirect portal ipv6 9:1:1::100
Device(config-params-parameter-map)# end
Device# show running-config | section parameter-map
parameter-map type webauth global
virtual-ip ipv6 2001:DB8::/48
parameter-map type webauth test
type webauth
redirect for-login http://9:1:1::100/login.html
redirect portal ipv6 9:1:1::100
security web-auth parameter-map rasagna-auth-map
security web-auth parameter-map test
```

## Example: Assigning Login, Login Failure, and Logout Pages per WLAN

This example shows how to assign login, login failure and logout pages per WLAN.

```
Device# configure terminal
Device(config)# parameter-map type webauth test
Device(config-params-parameter-map)# custom-page login device flash:loginsantosh.html
Device(config-params-parameter-map)# custom-page login expired device flash:loginexpire.html
Device(config-params-parameter-map)# custom-page failure device flash:loginfail.html
Device(config-params-parameter-map)# custom-page success device flash:loginsuccess.html
Device(config-params-parameter-map)# end
Device# show running-config | section parameter-map type webauth test
parameter-map type webauth test
type webauth
redirect for-login http://9.1.0.100/login.html
redirect portal ipv4 9.1.0.100
custom-page login device flash:loginsantosh.html
custom-page success device flash:loginsuccess.html
custom-page failure device flash:loginfail.html
custom-page login expired device flash:loginexpire.html
```

## Example: Configuring Preauthentication ACL

This example shows how to configure preauthentication ACL.

```
Device# configure terminal
Device(config)# wlan fff
Device(config-wlan)# shutdown
Device(config-wlan)# ip access-group web preauthrule
Device(config-wlan)# no shutdown
```

```
Device(config-wlan)# end
Device# show wlan name fff
```

## Example: Configuring Webpassthrough

This example shows how to configure webpassthrough.

```
Device# configure terminal
Device(config)# parameter-map type webauth webparalocal
Device(config-params-parameter-map)# type consent
Device(config-params-parameter-map)# end
Device# show running-config | section parameter-map type webauth test
parameter-map type webauth test
type webauth
redirect for-login http://9.1.0.100/login.html
redirect portal ipv4 9.1.0.100
```

## Verifying Web Authentication Type

To verify the web authentication type, run the following command:

```
Device# show parameter-map type webauth all
Type Name
-----
Global global
Named webauth
Named ext
Named redirect
Named abc
Named glbal
Named ewa-2

Device# show parameter-map type webauth global
Parameter Map Name : global
Banner:
Text : CisCo
Type : webauth
Auth-proxy Init State time : 120 sec
Webauth max-http connection : 100
Webauth logout-window : Enabled
Webauth success-window : Enabled
Consent Email : Disabled
Sleeping-Client : Enabled
Sleeping-Client timeout : 60 min
Virtual-ipv4 : 192.0.2.1.
Virtual-ipv4 hostname :
Webauth intercept https : Disabled
Webauth Captive Bypass : Disabled
Webauth bypass intercept ACL :
Trustpoint name :
HTTP Port : 80
Watch-list:
Enabled : no
Webauth login-auth-bypass:

Device# show parameter-map type webauth name global
Parameter Map Name : global
Type : webauth
Auth-proxy Init State time : 120 sec
Webauth max-http connection : 100
Webauth logout-window : Enabled
```

```

Webauth success-window : Enabled
Consent Email : Disabled
Sleeping-Client : Disabled
Webauth login-auth-bypass:

```

## External Web Authentication (EWA)

### Configuring EWA with Single WebAuth Server Address and Default Ports (80/443) (CLI)

#### Procedure

	Command or Action	Purpose
<b>Step 1</b>	<b>configure terminal</b> <b>Example:</b> Device# configure terminal	Enters global configuration mode.
<b>Step 2</b>	<b>aaa authentication login</b> <b>Example:</b> Device(config)# aaa authentication login WEBAUTH local	Defines the authentication method at login.
<b>Step 3</b>	<b>parameter-map type webauth</b> <i>parameter-map-name</i> <b>Example:</b> Device(config)# parameter-map type webauth ISE-Ext-Webauth_IP	Creates the parameter map.  The <i>parameter-map-name</i> must not exceed 99 characters.
<b>Step 4</b>	<b>type webauth</b> <b>Example:</b> Device(config-params-parameter-map)# type webauth	Configures the webauth type parameter.
<b>Step 5</b>	<b>redirect for-login</b> <i>URL-String</i> <b>Example:</b> Device(config-params-parameter-map)# redirect for-login <a href="https://192.168.0.98/portal/Registration.html">https://192.168.0.98/portal/Registration.html</a>	Configures the URL string for redirect during login.
<b>Step 6</b>	<b>redirect portal ipv4</b> <i>ip-address</i> <b>Example:</b> Device(config-params-parameter-map)# redirect portal ipv4 192.168.0.98	Configures the external portal IPv4 address.
<b>Step 7</b>	<b>exit</b> <b>Example:</b>	Returns to global configuration mode.



	Command or Action	Purpose
	Device(config-params-parameter-map)# exit	
<b>Step 8</b>	<b>wlan wlan-name wlan-id SSID-name</b>  <b>Example:</b> Device(config)# wlan EWLC3-GUEST 3 EWLC3-GUEST	Configures a WLAN.
<b>Step 9</b>	<b>no security ft adaptive</b>  <b>Example:</b> Device(config-wlan)# no security ft adaptive	Disables adaptive 11r.
<b>Step 10</b>	<b>no security wpa</b>  <b>Example:</b> Device(config-wlan)# no security wpa	Disables WPA security.
<b>Step 11</b>	<b>no security wpa wpa2</b>  <b>Example:</b> Device(config-wlan)# no security wpa wpa2	Disables WPA2 security.
<b>Step 12</b>	<b>no security wpa wpa2 ciphers aes</b>  <b>Example:</b> Device(config-wlan)# no security wpa wpa2 ciphers aes	Disables WPA2 ciphers for AES.
<b>Step 13</b>	<b>no security wpa akm dot1x</b>  <b>Example:</b> Device(config-wlan)# no security wpa akm dot1x	Disables security AKM for dot1x.
<b>Step 14</b>	<b>security web-auth</b>  <b>Example:</b> Device(config-wlan)# security web-auth	Enables web authentication for WLAN.
<b>Step 15</b>	<b>security web-auth authentication-list authenticate-list-name</b>  <b>Example:</b> Device(config-wlan)# security web-auth authentication-list WEBAUTH	Enables authentication list for dot1x security.
<b>Step 16</b>	<b>security web-auth parameter-map parameter-map-name</b>  <b>Example:</b> Device(config-wlan)# security web-auth parameter-map ISE-Ext-Webauth_IP	Configures the parameter map.  <b>Note</b> If parameter map is not associated with a WLAN, the configuration is considered from the global parameter map.

	Command or Action	Purpose
Step 17	<b>end</b> <b>Example:</b> Device(config-wlan)# end	Returns to privileged EXEC mode.

## Configuring EWA with Multiple Web Servers and/or Ports Different than Default (80/443)

### Procedure

	Command or Action	Purpose
Step 1	<b>configure terminal</b> <b>Example:</b> Device# configure terminal	Enters global configuration mode.
Step 2	<b>ip access-list extended name</b> <b>Example:</b> Device(config)# ip access-list extended preauth_ISE_Ext_WA	Defines an extended IPv4 access list using a name, and enters access-list configuration mode.
Step 3	<b>access-list-number permit tcp any host            external_web_server_ip_address1 eq            port-number</b> <b>Example:</b> Device(config)# 10 permit tcp any host 192.168.0.98 eq 8443	Permits access from any host to the external web server port number 8443.
Step 4	<b>access-list-number permit tcp any host            external_web_server_ip_address2 eq            port-number</b> <b>Example:</b> Device(config)# 10 permit tcp any host 192.168.0.99 eq 8443	Permits access from any host to the external web server port number 8443.
Step 5	<b>access-list-number permit udp any any eq            domain</b> <b>Example:</b> Device(config)# 20 permit udp any any eq domain	Permits DNS UDP traffic.
Step 6	<b>access-list-number permit udp any any eq            bootpc</b> <b>Example:</b> Device(config)# 30 permit udp any any eq bootpc	Permits DHCP traffic.

	<b>Command or Action</b>	<b>Purpose</b>
<b>Step 7</b>	<p><i>access-list-number</i> <b>permit udp any any eq bootps</b></p> <p><b>Example:</b></p> <pre>Device(config)# 40 permit udp any any eq bootps</pre>	Permits DHCP traffic.
<b>Step 8</b>	<p><i>access-list-number</i> <b>permit tcp host external_web_server_ip_address1 eq port_number any</b></p> <p><b>Example:</b></p> <pre>Device(config)# 50 permit tcp host 192.168.0.98 eq 8443 any</pre>	Permits the access from the external web server port 8443 to any host.
<b>Step 9</b>	<p><i>access-list-number</i> <b>permit tcp host external_web_server_ip_address2 eq port_number any</b></p> <p><b>Example:</b></p> <pre>Device(config)# 50 permit tcp host 192.168.0.99 eq 8443 any</pre>	Permits the access from the external web server port 8443 to any host.
<b>Step 10</b>	<p><i>access-list-number</i> <b>permit tcp any any eq domain</b></p> <p><b>Example:</b></p> <pre>Device(config)# 60 permit tcp any any eq domain</pre>	Permits the DNS TCP traffic.
<b>Step 11</b>	<p><i>access-list-number</i> <b>deny ip any any</b></p> <p><b>Example:</b></p> <pre>Device(config)# 70 deny ip any any</pre>	Denies all the other traffic.
<b>Step 12</b>	<p><b>wlan wlan-name wlan-id ssid</b></p> <p><b>Example:</b></p> <pre>Device(config)# wlan EWLC3-GUEST 3 EWLC3-GUEST</pre>	Creates the WLAN.
<b>Step 13</b>	<p><b>ip access-group web name</b></p> <p><b>Example:</b></p> <pre>Device(config-wlan)# ip access-group web preauth_ISE_Ext_WA</pre>	Configures the IPv4 WLAN web ACL. The variable <i>name</i> specifies the user-defined IPv4 ACL name.
<b>Step 14</b>	<p><b>end</b></p> <p><b>Example:</b></p> <pre>Device(config-wlan)# end</pre>	Returns to privileged EXEC mode.

## Configuring Wired Guest EWA with Multiple Web Servers and/or Ports Different than Default (80/443)

### Before you begin

You cannot assign a manual ACL to a wired guest LAN configuration. The workaround is to use the bypass ACL in the global parameter map.

### Procedure

	Command or Action	Purpose
<b>Step 1</b>	<b>configure terminal</b> <b>Example:</b> Device# configure terminal	Enters global configuration mode.
<b>Step 2</b>	<b>ip access-list extended name</b> <b>Example:</b> Device(config)# ip access-list extended BYPASS_ACL	Defines an extended IPv4 access list using a name, and enters access-list configuration mode.
<b>Step 3</b>	<b>access-list-number deny ip any host hostname</b> <b>Example:</b> Device(config)# 10 deny ip any host 192.168.0.45	Allows the traffic to switch centrally.
<b>Step 4</b>	<b>access-list-number deny ip any host hostname</b> <b>Example:</b> Device(config)# 20 deny ip any host 4.0.0.1	Allows the traffic to switch centrally.
<b>Step 5</b>	<b>parameter-map type webauth global</b> <b>Example:</b> Device(config)# parameter-map type webauth global	Creates a parameter map and enters parameter-map webauth configuration mode.
<b>Step 6</b>	<b>webauth-bypass-intercept name</b> <b>Example:</b> Device(config-params-parameter-map)# webauth-bypass-intercept BYPASS_ACL	Creates a WebAuth bypass intercept using the ACL name.  <b>Note</b> You cannot apply a manual ACL to the wired guest profile and configure an external web authentication with multiple IP addresses or different ports. The workaround is to use the bypass ACL for wired guest profile.
<b>Step 7</b>	<b>end</b> <b>Example:</b> Device(config-params-parameter-map)# end	Returns to privileged EXEC mode.

# Authentication for Sleeping Clients

## Information About Authenticating Sleeping Clients

Clients with guest access that have had successful web authentication are allowed to sleep and wake up without having to go through another authentication process through the login page. You can configure the duration for which sleeping clients should be remembered for before reauthentication becomes necessary. The valid range is 10 minutes to 43200 minutes, with the default being 720 minutes. You can also configure this duration on WebAuth parameter map that is mapped to a WLAN. Note that the sleeping client timer comes into effect due to instances such as idle timeout, session timeout, disabling of the WLAN, and the AP being nonoperational.

This feature is supported in the following FlexConnect scenario: local switching and central authentication.



---

**Caution** If the MAC address of a client that goes to sleep mode is spoofed, the fake device such as a laptop can be authenticated.

---

### Mobility Scenarios

Following are some guidelines in a mobility scenario:

- L2 roaming in the same subnet is supported.
- Anchor sleeping timer is applicable.
- The sleeping client information is shared between multiple autoanchors when a sleeping client moves from one anchor to another.

A sleeping client does not require reauthentication in the following scenarios:

- Suppose there are two controller s in a mobility group. A client that is associated with one controller goes to sleep and then wakes up and gets associated with the other controller .
- Suppose there are three controller s in a mobility group. A client that is associated with the second controller that is anchored to the first controller goes to sleep, wakes up, and gets associated with the third controller .
- A client sleeps, wakes up and gets associated with the same or different export foreign controller that is anchored to the export anchor.

## Restrictions on Authenticating Sleeping Clients

- The sleep client feature works only for WLAN configured with WebAuth security.
- You can configure the sleeping clients only on a per WebAuth parameter-map basis.
- The authentication of sleeping clients feature is supported only on WLANs that have Layer 3 security enabled.
- With Layer 3 security, the Authentication, Passthrough, and On MAC Filter failure web policies are supported. The Conditional Web Redirect and Splash Page Web Redirect web policies are not supported.

- The central web authentication of sleeping clients is not supported.
- The authentication of sleeping clients feature is not supported on guest LANs and remote LANs.
- A guest access sleeping client that has a local user policy is not supported. In this case, the WLAN-specific timer is applied.

## Configuring Authentication for Sleeping Clients (GUI)

### Procedure

- 
- Step 1** Choose **Configuration > Security > Web Auth**.
- Step 2** In the **Webauth Parameter Map** tab, click the parameter map name. The **Edit WebAuth Parameter** window is displayed.
- Step 3** Select **Sleeping Client Status** check box.
- Step 4** Click **Update & Apply to Device**.
- 

## Configuring Authentication for Sleeping Clients (CLI)

### Procedure

	Command or Action	Purpose
<b>Step 1</b>	<p><b>[no] parameter-map type webauth</b>  <code>{parameter-map-name   global}</code></p> <p><b>Example:</b></p> <pre>Device(config)# parameter-map type webauth global</pre>	Creates a parameter map and enters parameter-map webauth configuration mode.
<b>Step 2</b>	<p><b>sleeping-client [timeout time]</b></p> <p><b>Example:</b></p> <pre>Device(config-params-parameter-map)# sleeping-client timeout 100</pre>	<p>Configures the sleeping client timeout to 100 minutes. Valid range is between 10 minutes and 43200 minutes.</p> <p><b>Note</b> If you do not use the timeout keyword, the sleeping client is configured with the default timeout value of 720 minutes.</p>
<b>Step 3</b>	<b>end</b>	Exits parameter-map webauth configuration mode and returns to privileged EXEC mode.
<b>Step 4</b>	<p>(Optional) <b>show wireless client sleeping-client</b></p> <p><b>Example:</b></p> <pre>Device# show wireless client sleeping-client</pre>	Shows the MAC address of the clients and the time remaining in their respective sessions.

	Command or Action	Purpose
<b>Step 5</b>	(Optional) <b>clear wireless client sleeping-client</b> [ <b>mac-address</b> <i>mac-addr</i> ]  <b>Example:</b> <pre>Device# clear wireless client sleeping-client mac-address 00e1.e1e1.0001</pre>	<ul style="list-style-type: none"> <li>• <b>clear wireless client sleeping-client</b>—Deletes all sleeping client entries from the sleeping client cache.</li> <li>• <b>clear wireless client sleeping-client mac-address</b> <i>mac-addr</i>—Deletes the specific MAC entry from the sleeping client cache.</li> </ul>

## Sleeping Clients with Multiple Authentications

### Mobility Support for Sleeping Clients

From Release 17.1.1 onwards, mobility support for guest and nonguest sleeping clients.

### Supported Combinations of Multiple Authentications

Multiple authentication feature supports sleeping clients configured in the WLAN profile.

The following table outlines the supported combination of multiple authentications:

*Table 41: Supported Combinations of Multiple Authentications*

Layer 2	Layer 3	Supported
MAB	LWA	Yes
MAB Failure	LWA	Yes
Dot1x	LWA	Yes
PSK	LWA	Yes

## Configuring Sleeping Clients with Multiple Authentications

### Configuring WLAN for Dot1x and Local Web Authentication

#### Procedure

	Command or Action	Purpose
<b>Step 1</b>	<b>configure terminal</b>  <b>Example:</b>	Enters global configuration mode.

	Command or Action	Purpose
	Device# <code>configure terminal</code>	
<b>Step 2</b>	<p><b>wlan</b> <i>profile-name wlan-id SSID_name</i></p> <p><b>Example:</b></p> <pre>Device(config)# wlan wlan-test 3 ssid-test</pre>	<p>Enters WLAN configuration submenu.</p> <ul style="list-style-type: none"> <li>• <i>profile-name</i> - Profile name of the configured WLAN.</li> <li>• <i>wlan-id</i> - Wireless LAN identifier. Range is from 1 to 512.</li> <li>• <i>SSID_Name</i> - SSID, which can contain up to 32 alphanumeric characters.</li> </ul>
<b>Step 3</b>	<p><b>security dot1x authentication-list</b> <i>auth-list-name</i></p> <p><b>Example:</b></p> <pre>Device(config-wlan)# security dot1x authentication-list default</pre>	<p>Enables security authentication list for dot1x security. The configuration is similar for all dot1x security WLANs.</p>
<b>Step 4</b>	<p><b>security web-auth</b></p> <p><b>Example:</b></p> <pre>Device(config-wlan)# security web-auth</pre>	<p>Configures web authentication.</p>
<b>Step 5</b>	<p><b>security web-auth authentication-list</b> <i>authenticate-list-name</i></p> <p><b>Example:</b></p> <pre>Device(config-wlan)# security web-auth authentication-list default</pre>	<p>Enables authentication list for dot1x security.</p>
<b>Step 6</b>	<p><b>security web-auth parameter-map</b> <i>parameter-map-name</i></p> <p><b>Example:</b></p> <pre>Device(config-wlan)# security web-auth parameter-map global</pre>	<p>Maps the parameter map.</p> <p><b>Note:</b> If the parameter map is not associated with a WLAN, the configuration is considered from the global parameter map.</p>
<b>Step 7</b>	<p><b>no shutdown</b></p> <p><b>Example:</b></p> <pre>Device(config-wlan)# no shutdown</pre>	<p>Enables WLAN.</p>



## Configuring a WLAN for MAC Authentication Bypass and Local Web Authentication

### Procedure

	Command or Action	Purpose
<b>Step 1</b>	<b>configure terminal</b>  <b>Example:</b> Device# <b>configure terminal</b>	Enters global configuration mode.
<b>Step 2</b>	<b>wlan profile-name wlan-id SSID_name</b>  <b>Example:</b> Device(config)# <b>wlan wlan-test 3 ssid-test</b>	Enters WLAN configuration submode.  <ul style="list-style-type: none"> <li>• <i>profile-name</i> - Profile name of the configured WLAN.</li> <li>• <i>wlan-id</i> - Wireless LAN identifier. Range is from 1 to 512.</li> <li>• <i>SSID_Name</i> - SSID, which can contain up to 32 alphanumeric characters.</li> </ul>
<b>Step 3</b>	<b>mac-filtering list-name</b>  <b>Example:</b> Device(config-wlan)# <b>mac-filtering cat-radius</b>	Sets the MAC filtering parameters.
<b>Step 4</b>	<b>no security wpa akm dot1x</b>  <b>Example:</b> Device(config-wlan)# <b>no security wpa akm dot1x</b>	Disables security AKM for dot1x.
<b>Step 5</b>	<b>no security wpa wpa2 ciphers aes</b>  <b>Example:</b> Device(config-wlan)# <b>no security wpa wpa2 ciphers aes</b>	Disables the WPA2 cipher.  <b>aes</b> —Encryption type that specifies WPA/AES support.
<b>Step 6</b>	<b>security web-auth parameter-map parameter-map-name</b>  <b>Example:</b> Device(config-wlan)# <b>security web-auth parameter-map global</b>	Maps the parameter map.  <b>Note:</b> If parameter map is not associated with a WLAN, the configuration is considered from the global parameter map.
<b>Step 7</b>	<b>no shutdown</b>  <b>Example:</b> Device(config-wlan)# <b>no shutdown</b>	Enables WLAN.

## Configuring a WLAN for Local Web Authentication and MAC Filtering

### Procedure

	Command or Action	Purpose
<b>Step 1</b>	<b>configure terminal</b> <b>Example:</b> Device# <b>configure terminal</b>	Enters global configuration mode.
<b>Step 2</b>	<b>wlan profile-name wlan-id SSID_name</b> <b>Example:</b> Device(config)# <b>wlan wlan-test 3 ssid-test</b>	Enters WLAN configuration submode. <ul style="list-style-type: none"> <li>• <i>profile-name</i> - Profile name of the configured WLAN.</li> <li>• <i>wlan-id</i> - Wireless LAN identifier. Range is from 1 to 512.</li> <li>• <i>SSID_Name</i> - SSID, which can contain up to 32 alphanumeric characters.</li> </ul>
<b>Step 3</b>	<b>mac-filtering list-name</b> <b>Example:</b> Device(config-wlan)# <b>mac-filtering cat-radius</b>	Sets the MAC filtering parameters.
<b>Step 4</b>	<b>no security wpa akm dot1x</b> <b>Example:</b> Device(config-wlan)# <b>no security wpa akm dot1x</b>	Disables security Authenticated Key Management (AKM) for dot1x.
<b>Step 5</b>	<b>no security wpa wpa2 ciphers aes</b> <b>Example:</b> Device(config-wlan)# <b>no security wpa wpa2 ciphers aes</b>	Disables the WPA2 cipher. <b>aes:</b> Exryption type that specifies WPA/AES support.
<b>Step 6</b>	<b>security web-auth on-macfilter-failure</b> <b>Example:</b> Device(config-wlan)# <b>security web-auth on-macfilter-failure wlan-id</b>	Configures the fallback policy with MAC filtering and web authentication.
<b>Step 7</b>	<b>security web-auth parameter-map parameter-map-name</b> <b>Example:</b> Device(config-wlan)# <b>security web-auth parameter-map global</b>	Maps the parameter map. <b>Note:</b> If the parameter map is not associated with a WLAN, the configuration is considered from the global parameter map.

	Command or Action	Purpose
<b>Step 8</b>	<b>no shutdown</b> <b>Example:</b> Device(config-wlan) # <b>no shutdown</b>	Enables WLAN.

## Configuring a PSK + LWA in a WLAN

### Procedure

	Command or Action	Purpose
<b>Step 1</b>	<b>configure terminal</b> <b>Example:</b> Device# <b>configure terminal</b>	Enters global configuration mode.
<b>Step 2</b>	<b>wlan profile-name wlan-id SSID_name</b> <b>Example:</b> Device(config) # <b>wlan wlan-test 3 ssid-test</b>	Enters WLAN configuration submode. <ul style="list-style-type: none"> <li>• <i>profile-name</i> - Profile name of the configured WLAN.</li> <li>• <i>wlan-id</i> - Wireless LAN identifier. Range is from 1 to 512.</li> <li>• <i>SSID_Name</i> - SSID, which can contain up to 32 alphanumeric characters.</li> </ul>
<b>Step 3</b>	<b>no security wpa akm dot1x</b> <b>Example:</b> Device(config-wlan) # <b>no security wpa akm dot1x</b>	Disables security AKM for dot1x.
<b>Step 4</b>	<b>security web-auth</b> <b>Example:</b> Device(config-wlan) # <b>security web-auth</b>	Enables web authentication for a WLAN.
<b>Step 5</b>	<b>no security wpa wpa2 ciphers aes</b> <b>Example:</b> Device(config-wlan) # <b>no security wpa wpa2 ciphers aes</b>	Disables the WPA2 cipher. <b>aes:</b> Excrption type that specifies WPA/AES support.
<b>Step 6</b>	<b>security wpa psk set-key ascii ascii/hex key</b> <b>Example:</b> Device(config-wlan) # <b>security wpa psk set-key ascii 0 1234567</b>	Configures the preshared key on a WLAN.
<b>Step 7</b>	<b>security wpa akm psk</b> <b>Example:</b>	Configures PSK support.

	Command or Action	Purpose
	Device(config-wlan)# <b>security wpa akm psk</b>	
<b>Step 8</b>	<b>security web-auth authentication-list</b> <i>authenticate-list-name</i>  <b>Example:</b> Device(config-wlan)# <b>security web-auth authentication-list default</b>	Enables the authentication list for dot1x security.
<b>Step 9</b>	<b>security web-auth parameter-map</b> <i>parameter-map-name</i>  <b>Example:</b> Device(config-wlan)# <b>security web-auth parameter-map global</b>	Maps the parameter map.  <b>Note:</b> If the parameter map is not associated with a WLAN, the configuration is considered from the global parameter map.

## Configuring a Sleeping Client

### Procedure

	Command or Action	Purpose
<b>Step 1</b>	<b>configure terminal</b>  <b>Example:</b> Device# <b>configure terminal</b>	Enters global configuration mode.
<b>Step 2</b>	<b>parameter-map type webauth</b> <i>{parameter-map-name   global}</i>  <b>Example:</b> Device(config)# <b>parameter-map type webauth MAP-2</b>	Creates a parameter map and enters <i>parameter-map-name</i> configuration mode.  The specific configuration commands supported for a <b>global</b> parameter map defined with the global keyword differ from the commands supported for a named parameter map defined with the <i>parameter-map-name</i> argument.
<b>Step 3</b>	<b>sleeping client [timeout time]</b>  <b>Example:</b> Device(config-params-parameter-map)# <b>sleeping-client timeout 60</b>	Configures the sleeping client timeout, in minutes. The available range for the <i>time</i> argument is from 10 to 43200.  <b>Note:</b> If you do not use the <b>timeout</b> keyword, the sleeping client is configured with the default timeout value of 720 minutes.

## Verifying a Sleeping Client Configuration

To verify a sleeping client configuration, use the following command:

```
Device# show wireless client sleeping-client
Total number of sleeping-client entries: 1

MAC Address                               Remaining time (mm:ss)
-----
2477.031b.aa18                             59:56
```





## CHAPTER 99

# Central Web Authentication

- [Information About Central Web Authentication, on page 845](#)
- [How to Configure ISE, on page 846](#)
- [How to Configure Central Web Authentication on the Controller, on page 848](#)
- [Authentication for Sleeping Clients, on page 856](#)
- [Sleeping Clients with Multiple Authentications, on page 858](#)

## Information About Central Web Authentication

Central web authentication offers the possibility to have a central device that acts as a web portal (in this example, the ISE). The major difference compared to the usual local web authentication is that it is shifted to Layer 2 along with MAC filtering or dot1x authentication. The concept also differs in that the radius server (ISE in this example) returns special attributes that indicate to the switch that a web redirection must occur. This solution eliminates any delay to start the web authentication.

The following are the different types of web authentication methods:

- **Local Web Authentication (LWA):** Configured as Layer 3 security on the controller, the web authentication page and the pre-authentication ACL are locally configured on the controller. The controller intercepts http(s) traffic and redirects the client to the internal web page for authentication. The credentials entered by the client on the login page is authenticated by the controller locally or through a RADIUS or LDAP server.
- **External Web Authentication (EWA):** Configured as Layer 3 security on the controller, the controller intercepts http(s) traffic and redirects the client to the login page hosted on the external web server. The credentials entered by the client on the login page is authenticated by the controller locally or through a RADIUS or LDAP server. The pre-authentication ACL is configured statically on the controller.
- **Central Web Authentication (CWA):** Configured mostly as Layer 2 security on the controller, the redirection URL and the pre-authentication ACL reside on ISE and are pushed during layer 2 authentication to the controller. The controller redirects all web traffic from the client to the ISE login page. ISE validates the credentials entered by the client through HTTPS and authenticates the user.

Globally, if the MAC address of the client station is not known by the radius server (but other criteria can also be used), the server returns the redirection attributes, and the controller authorizes the station (using the MAC filtering) but places an access list to redirect the web traffic to the portal.

Once the user logs into the guest portal, it is possible to re-authenticate the client so that a new Layer 2 MAC filtering occurs using the Change of Authorization (CoA). This way, the ISE remembers that it was a webauth user and pushes the necessary authorization attributes to the controller for accessing the network.

**Note**

- In Central Web Authentication (CWA) with dual VLAN posture scenario, Cisco AireOS and IOS-XE controller performs 2 and 3 EAPOL handshakes respectively. If a client is stuck in a quarantine VLAN because of any break in EAPOL handshake due to client or network issue, you need to analyze the client or network issue.
- However, you can manually disconnect or reconnect the client to come out of the quarantine loop (or) click the Scan Again on AnyConnect (Or) enable posture lease (Or) use the ISE posture sync feature.
- If the controller has no switch virtual interface (SVI) in the client subnet or VLAN, the controller has to use any of the other SVIs and send traffic as defined in the routing table. This means that the traffic is sent to another gateway in the core of the network; this traffic then reaches the client subnet. Firewalls typically block traffic from and to the same switch, as seen in this scenario, so redirection might not work properly. Workarounds are to allow this behavior on the firewall.

## Prerequisites for Central Web Authentication

- Cisco Identity Services Engine (ISE)

## How to Configure ISE

To configure ISE, proceed as follows:

1. Create an authorization profile.
2. Create an authentication rule.
3. Create an authorization rule.

## Creating an Authorization Profile

### Procedure

- 
- Step 1** Click **Policy**, and click **Policy Elements**.
  - Step 2** Click **Results**.
  - Step 3** Expand **Authorization**, and click **Authorization Profiles**.
  - Step 4** Click **Add** to create a new authorization profile for central webauth.
  - Step 5** In the **Name** field, enter a name for the profile. For example, CentralWebauth.
  - Step 6** Choose **ACCESS\_ACCEPT** from the Access Type drop-down list.



- Step 7** Check the **Web Redirection (CWA, MDM, NSP, CPP)** check box, and choose **Centralized Web Auth** from the drop-down list.
- Step 8** In the **ACL** field, enter the name of the ACL that defines the traffic to be redirected. For example, redirect.
- Step 9** In the **Value** field, choose the default or customized values.  
The Value attribute defines whether the ISE sees the default or a custom web portal that the ISE admin created.
- Step 10** Click **Save**.
- 

## Creating an Authentication Rule

Follow the procedure given below to use the authentication profile and create the authentication rule:

### Procedure

---

- Step 1** In the **Policy > Authentication** page, click **Authentication**.
- Step 2** Enter a name for your authentication rule. For example, MAB.
- Step 3** In the If condition field, select the plus (+) icon.
- Step 4** Choose **Compound condition**, and choose **Wireless\_MAB**.
- Step 5** Click the arrow located next to **and ...** in order to expand the rule further.
- Step 6** Click the + icon in the Identity Source field, and choose **Internal endpoints**.
- Step 7** Choose **Continue** from the 'If user not found' drop-down list.  
This option allows a device to be authenticated even if its MAC address is not known.
- Step 8** Click **Save**.
- 

## Creating an Authorization Rule

You can configure many rules in the authorization policy. The *MAC not known* rule is configured in this section:

### Procedure

---

- Step 1** Click **Policy > Authorization**.
- Step 2** In the Rule Name field, enter a name. For example: *Mac not known*.
- Step 3** In the Conditions field, click the plus (+) icon.
- Step 4** Choose **Compound Conditions**, and choose **Wireless\_MAB**.
- Step 5** From the settings icon, select **Add Attribute/Value** from the options.
- Step 6** In the Description field, choose **Network Access > AuthenticationStatus** as the attribute from the drop-down list.
- Step 7** Choose the **Equals** operator.

- Step 8** From the right-hand field, choose **UnknownUser**.
- Step 9** In the Permissions field, choose the authorization profile name that you had created earlier.
- The ISE continues even though the user (or MAC) is not known.
- Unknown users are now presented with the Login page. However, once they enter their credentials, they are presented again with an authentication request on the ISE; therefore, another rule must be configured with a condition that is met if the user is a guest user. For example, if `UseridentityGroup Equals Guest` is used then it is assumed that all guests belong to this group.
- Step 10** In the Conditions field, click the plus (+) icon.
- Step 11** Choose **Compound Conditions**, and choose to create a new condition.
- The new rule must come before the *MAC not known* rule.
- Step 12** From the settings icon, select **Add Attribute/Value** from the options.
- Step 13** In the Description field, choose **Network Access > UseCase** as the attribute from the drop-down list.
- Step 14** Choose the **Equals** operator.
- Step 15** From the right-hand field, choose **GuestFlow**.
- Step 16** In the Permissions field, click the plus (+) icon to select a result for your rule.
- You can choose **Standard > PermitAccess** option or create a custom profile to return the attributes that you like.
- When the user is authorized on the login page, the ISE triggers a COA that results in the restart of Layer 2 authentication. When the user is identified as a guest user, the user is authorized.
- 

## How to Configure Central Web Authentication on the Controller

To configure central web authentication on the controller, proceed as follows:

1. Configure WLAN.
2. Configure policy profile.
3. Configure redirect ACL.
4. Configure AAA for central web authentication.
5. Configure redirect ACL in Flex profile.

### Configuring WLAN (GUI)

#### Before you begin

You need to enable MAC filtering for Layer 2 authentication to download the redirect URL and ACL.

## Procedure

---

- Step 1** Choose **Configuration > Tags & Profiles > WLANs**.
- Step 2** In the **WLANs** window, click the name of the **WLAN** or click **Add** to create a new one.
- Step 3** In the **Add/Edit WLAN** window that is displayed, click the **General** tab to configure the following parameters.
- In the **Profile Name** field, enter or edit the name of the profile.
  - In the **SSID** field, enter or edit the SSID name.  
The SSID name can be alphanumeric, and up to 32 characters in length.
  - In the **WLAN ID** field, enter or edit the ID number. The valid range is between 1 and 512.
  - From the **Radio Policy** drop-down list, choose the **802.11** radio band.
  - Using the **Broadcast SSID** toggle button, change the status to either **Enabled** or **Disabled** .
  - Using the **Status** toggle button, change the status to either **Enabled** or **Disabled** .
- Step 4** Click the **Security** tab, and then **Layer 2** tab to configure the following parameters:
- From the **Layer 2 Security Mode** drop-down list, choose **None** . This setting disables Layer 2 security.
  - Enter the **Reassociation Timeout** value, in seconds. This is the time after which a fast transition reassociation times out.
  - Check the **Over the DS** check box to enable Fast Transition over a distributed system.
  - Choose OWE, Opportunistic Wireless Encryption (OWE) provides data confidentiality with encryption over the air between an AP radio and a wireless client. OWE Transition Mode is meant to provide a sort of backwards compatibility.
  - Choose Fast Transition, 802.11r which is the IEEE standard for fast roaming, introduces a new concept of roaming where the initial handshake with a new AP is done even before the corresponding client roams to the target access point. This concept is called Fast Transition.
  - Check the check box to enable MAC filtering in the WLAN.
  - Check the **Lobby Admin Access** check box to enable Lobby Admin access.
- Step 5** Click **Save & Apply to Device**.
- 

## Configuring WLAN (CLI)

Configure WLAN using commands.



**Note** You need to enable MAC filtering for Layer 2 authentication to download the redirect URL and ACL. After completing the WLAN configuration, if the changes are not pushed to all the APs, the following syslog message appears:

*2021/01/06 16:20:00.597927186 {wncd\_x\_R0-4}{1}: [wlanmgr-db] [20583]: UUID: 0, ra: 0, TID: 0 (note): Unable to push WLAN config changes to all APs, cleanup required for WlanId: 2, profile: wlan1 state: Delete pending*

If the above mentioned syslog message appears for more than six minutes, reload the controller.

If the controller does not reload and still the syslog message appears, then collect the archive logs, wncd core file, and raise a case by clicking the following link: [Support Case Manager](#).

**Procedure**

	Command or Action	Purpose
<b>Step 1</b>	<p><b>wlan wlan-name wlan-id SSID-name</b></p> <p><b>Example:</b></p> <pre>Device(config)# wlan wlanProfileName 1 ngwcSSID</pre>	<p>Enters the WLAN configuration sub-mode.</p> <p><b>wlan-name</b> is the name of the configured WLAN.</p> <p><b>wlan-id</b> is the wireless LAN identifier. The range is 1 to 512.</p> <p><b>SSID-name</b> is the SSID name which can contain 32 alphanumeric characters.</p> <p><b>Note</b> If you have already configured this command, enter <b>wlan wlan-name</b> command.</p>
<b>Step 2</b>	<p><b>mac-filtering [name]</b></p> <p><b>Example:</b></p> <pre>Device(config-wlan)# mac-filtering name</pre>	<p>Enables MAC filtering on a WLAN.</p> <p><b>Note</b> While configuring mac-filtering the default authentication list is considered, if the authentication list is not configured earlier.</p>
<b>Step 3</b>	<p><b>no security wpa</b></p> <p><b>Example:</b></p> <pre>Device(config-wlan)# no security wpa</pre>	<p>Disable WPA security.</p>
<b>Step 4</b>	<p><b>no shutdown</b></p> <p><b>Example:</b></p> <pre>Device(config-wlan)# no shutdown</pre>	<p>Enables the WLAN.</p>
<b>Step 5</b>	<p><b>end</b></p> <p><b>Example:</b></p> <pre>Device(config-wlan)# end</pre>	<p>Returns to privileged EXEC mode.</p>

**Example**

```

Device# config terminal
Device(config)# wlan wlanProfileName 1 ngwcSSID
Device(config-wlan)# mac-filtering default
Device(config-wlan)# no security wpa
Device(config-wlan)# no shutdown
Device(config-wlan)# end

```

## Configuring Policy Profile (CLI)

Configure Policy Profile using commands.



- Note** You need a AAA override to apply policies coming from the AAA or ISE servers. When a redirect URL and redirect ACL is received from the ISE server, NAC is used to trigger the Central Web Authentication (CWA). Both NAC and AAA override must be available in the policy profile to which the client is being associated. The default policy profile is associated to an AP, if the AP is not associated to any other policy profiles.

**Procedure**

	Command or Action	Purpose
<b>Step 1</b>	<b>wireless profile policy default-policy-profile</b> <b>Example:</b> Device(config)# wireless profile policy default-policy-profile	Sets the policy profile.
<b>Step 2</b>	<b>vlan vlan-id</b> <b>Example:</b> Device(config-wireless-policy)# vlan 41	Maps the VLAN to a policy profile. If vlan-id is not specified, the default native vlan 1 is applied. The valid range for vlan-id is 1 to 4096. Management VLAN is applied if no VLAN is configured on the policy profile.
<b>Step 3</b>	<b>aaa-override</b> <b>Example:</b> Device(config-wireless-policy)# aaa-override	Configures AAA override to apply policies coming from the AAA or ISE servers.
<b>Step 4</b>	<b>nac</b> <b>Example:</b> Device(config-wireless-policy)# nac	Configures Network Access Control in the policy profile. NAC is used to trigger the Central Web Authentication (CWA).
<b>Step 5</b>	<b>no shutdown</b> <b>Example:</b> Device(config-wireless-policy)# no shutdown	Enables the WLAN.

	Command or Action	Purpose
<b>Step 6</b>	<b>end</b>  <b>Example:</b> Device(config-wireless-policy)# end	Returns to privileged EXEC mode.

### Example

```
Device# configure terminal
Device(config)# wireless profile policy default-policy-profile
Device(config-wireless-policy)# vlan 41
Device(config-wireless-policy)# aaa-override
Device(config-wireless-policy)# nac
Device(config-wireless-policy)# no shutdown
Device(config-wireless-policy)# end
```

## Configuring a Policy Profile (GUI)

### Procedure

- 
- Step 1** Choose **Configuration > Tags & Profiles > Policy**.
- Step 2** On the **Policy Profile** page, click **Add**.
- Step 3** In the **Add Policy Profile** window, in **General Tab**, enter a name and description for the policy profile.
- Step 4** To enable the policy profile, set **Status** as **Enabled**.
- Step 5** Use the slider to enable or disable **Passive Client** and **Encrypted Traffic Analytics**.
- Step 6** (Optional) In the **CTS Policy** section, choose the appropriate status for the following:
- **Inline Tagging**—a transport mechanism using which a controller embedded wireless controller or access point understands the source SGT.
  - **SGACL Enforcement**
- Step 7** Specify a default **SGT**. The valid range is from 2 to 65519.
- Step 8** In the **WLAN Switching Policy** section, choose the following, as required:
- **Central Switching**
  - **Central Authentication**
  - **Central DHCP**
  - **Central Association Enable**
  - **Flex NAT/PAT**
- Step 9** Click **Save & Apply to Device**.
-

## Creating Redirect ACL

The redirect ACL is a punt ACL that needs to be predefined on the controller (or the AP in case of FlexConnect local switching): the AAA server returns the name of the ACL and not its definition. The redirect ACL defines traffic (matching “deny” statements, as it denies redirection for it) that will be allowed through on the data plane and traffic (matching “permit” statements) that will be sent to the control plane towards the CPU for further processing (that is, the web interception and redirection in this case). The ACL has implicit (that is, the invisible) statements allowing DHCP and DNS traffic towards all IPs, just like it is the case with LWA. It also ends with a statement that a security ACL implicit deny.

### Procedure

	Command or Action	Purpose
<b>Step 1</b>	<b>ip access-list extended redirect</b> <b>Example:</b> Device(config)# ip access-list extended redirect	The HTTP and HTTPS browsing does not work without authentication (per the other ACL) as ISE is configured to use a redirect ACL (named <b>redirect</b> ).
<b>Step 2</b>	<b>deny ip any host ISE-IP-add</b> <b>Example:</b> Device(config)# deny ip any host 123.123.134.112	Allows traffic to ISE and all other traffic is blocked.
<b>Step 3</b>	<b>deny ip host ISE-IP-add any</b> <b>Example:</b> Device(config)# deny ip host 123.123.134.112 any	Allows traffic to ISE and all other traffic is blocked.  <b>Note</b> This ACL is applicable for both local and flex mode.
<b>Step 4</b>	<b>permit TCP any any eq web address/port-number</b> <b>Example:</b> In case of HTTP: Device(config)# permit TCP any any eq www Device(config)# permit TCP any any eq 80 <b>Example:</b> In case of HTTPS: Device(config)# permit TCP any any eq 443	Redirects all HTTP or HTTPS access to the ISE login page. port-number 80 is used for HTTP and port-number 443 is used for HTTPS.  For the ACE to allow traffic to ISE, ISE should be configured above the HTTP/HTTPS ACE.
<b>Step 5</b>	<b>end</b> <b>Example:</b> Device(config)# end	Returns to privileged EXEC mode.

## Configuring AAA for Central Web Authentication

### Procedure

	Command or Action	Purpose
<b>Step 1</b>	<b>aaa server radius dynamic-author</b>  <b>Example:</b> Device(config)# aaa server radius dynamic-author	Configures the Change of Authorization (CoA) on the controller.
<b>Step 2</b>	<b>client ISE-IP-add server-key radius-shared-secret</b>  <b>Example:</b> Device(config-locsvr-da-radius)# client 123.123.134.112 server-key 0 SECRET	Specifies a RADIUS client and the RADIUS key to be shared between a device and a RADIUS client.  <b>ISE-IP-add</b> is the IP address of the RADIUS client.  <b>server-key</b> is the radius client server-key.  <b>radius-shared-secret</b> covers the following: <ul style="list-style-type: none"> <li>• <b>0</b>—Specifies unencrypted key.</li> <li>• <b>6</b>—Specifies encrypted key.</li> <li>• <b>7</b>—Specifies HIDDEN key.</li> <li>• <b>Word</b>—Unencrypted (cleartext) server key.</li> </ul> The RADIUS shared secret should not exceed 240 characters while configuring WSMA data in GUI.  <b>Note</b> All these steps work only if the AAA configuration is in place. See the <i>Configuring AAA Authentication</i> for details.

### Example

```
Device# config terminal
Device(config)# aaa server radius dynamic-author
Device(config-locsvr-da-radius)# client 123.123.134.112 server-key 0 SECRET
Device(config-locsvr-da-radius)# end
```

## Configuring Redirect ACL in Flex Profile (GUI)

The redirect ACL definition must be sent to the access point in the FlexConnect profile. For this, the redirect ACL associated with an AP must be configured in the FlexConnect profile where the client is hosted. If an



access point is not configured with any of the FlexConnect profiles, the default FlexConnect profile is associated with it.

### Procedure

- 
- Step 1** Choose **Configuration > Tags & Profiles > Flex**.
  - Step 2** On the **Flex Profile** page, click the name of the FlexConnect profile or click **Add** to create a new FlexConnect profile.
  - Step 3** In the **Add/Edit Flex Profile** window that is displayed, click the **Policy ACL** tab.
  - Step 4** Click **Add** to map an ACL to the FlexConnect profile.
  - Step 5** Choose the ACL name, enable central web authentication, and specify the preauthentication URL filter.
  - Step 6** Click **Save**.
  - Step 7** Click **Update & Apply to Device**.
- 

## Configuring Redirect ACL in Flex Profile (CLI)

The redirect ACL definition must be sent to the access point in the Flex profile. For this, the redirect ACL associated to an AP must be configured in the Flex profile where the client is being hosted. If an access point is not configured with any of the Flex profiles, the default Flex profile is associated with it.



**Note** When the ACL is pushed down to the APs, the permission must change from **deny** to **permit** or vice-versa. This change does not occur if the ACL contains an object group, causing the ACL not to be fully translated, which may cause the redirection to fail.

### Procedure

	Command or Action	Purpose
<b>Step 1</b>	<b>wireless profile flex default-flex-profile</b> <b>Example:</b> Device(config)# wireless profile flex default-flex-profile	Creates a new flex policy. The default flex profile name is <b>default-flex-profile</b> .
<b>Step 2</b>	<b>acl-policy acl policy name</b> <b>Example:</b> Device(config-wireless-flex-profile)# acl-policy acl1	Configures ACL policy.
<b>Step 3</b>	<b>central-webauth</b> <b>Example:</b> Device(config-wireless-flex-profile-acl)# central-webauth	Configures central web authentication.

	Command or Action	Purpose
<b>Step 4</b>	<b>end</b>  <b>Example:</b> Device (config-wireless-flex-profile-acl) # end	Returns to privileged EXEC mode.

## Troubleshooting Central Web Authentication

Init-State timer running out

**Problem Issue:** The client devices are deauthenticated by the controller if users fail to enter their credentials in a limited time interval. The clients are deauthenticated after three times the time configured for the init-state timeout in the controller.

**Problem Explanation:** This is the expected functionality as the init-state timeout is not directly applicable for central web authentication; instead, it is the reap timer's value which is three times the init-state time plus five seconds ( $3 * \text{init-state timeout} + 5$ ) that determines the time interval in seconds for client deauthentication. For example, if you have configured the init-state timeout as 10 seconds, then the client devices are deauthenticated if users fail to enter their credentials after 35 seconds; that is  $(3 * 10 + 5) = 35$  seconds.

## Authentication for Sleeping Clients

### Information About Authenticating Sleeping Clients

Clients with guest access that have had successful web authentication are allowed to sleep and wake up without having to go through another authentication process through the login page. You can configure the duration for which sleeping clients should be remembered for before reauthentication becomes necessary. The valid range is 10 minutes to 43200 minutes, with the default being 720 minutes. You can also configure this duration on WebAuth parameter map that is mapped to a WLAN. Note that the sleeping client timer comes into effect due to instances such as idle timeout, session timeout, disabling of the WLAN, and the AP being nonoperational.

This feature is supported in the following FlexConnect scenario: local switching and central authentication.



---

**Caution** If the MAC address of a client that goes to sleep mode is spoofed, the fake device such as a laptop can be authenticated.

---

#### Mobility Scenarios

Following are some guidelines in a mobility scenario:

- L2 roaming in the same subnet is supported.
- Anchor sleeping timer is applicable.
- The sleeping client information is shared between multiple autoanchors when a sleeping client moves from one anchor to another.

A sleeping client does not require reauthentication in the following scenarios:

- Suppose there are two controller s in a mobility group. A client that is associated with one controller goes to sleep and then wakes up and gets associated with the other controller .
- Suppose there are three controller s in a mobility group. A client that is associated with the second controller that is anchored to the first controller goes to sleep, wakes up, and gets associated with the third controller .
- A client sleeps, wakes up and gets associated with the same or different export foreign controller that is anchored to the export anchor.

## Restrictions on Authenticating Sleeping Clients

- The sleep client feature works only for WLAN configured with WebAuth security.
- You can configure the sleeping clients only on a per WebAuth parameter-map basis.
- The authentication of sleeping clients feature is supported only on WLANs that have Layer 3 security enabled.
- With Layer 3 security, the Authentication, Passthrough, and On MAC Filter failure web policies are supported. The Conditional Web Redirect and Splash Page Web Redirect web policies are not supported.
- The central web authentication of sleeping clients is not supported.
- The authentication of sleeping clients feature is not supported on guest LANs and remote LANs.
- A guest access sleeping client that has a local user policy is not supported. In this case, the WLAN-specific timer is applied.

## Configuring Authentication for Sleeping Clients (GUI)

### Procedure

---

- Step 1** Choose **Configuration > Security > Web Auth**.
  - Step 2** In the **Webauth Parameter Map** tab, click the parameter map name. The **Edit WebAuth Parameter** window is displayed.
  - Step 3** Select **Sleeping Client Status** check box.
  - Step 4** Click **Update & Apply to Device**.
-

## Configuring Authentication for Sleeping Clients (CLI)

### Procedure

	Command or Action	Purpose
<b>Step 1</b>	<p>[no] <b>parameter-map type webauth</b> {<i>parameter-map-name</i>   <b>global</b>}</p> <p><b>Example:</b></p> <pre>Device(config)# parameter-map type webauth global</pre>	Creates a parameter map and enters parameter-map webauth configuration mode.
<b>Step 2</b>	<p><b>sleeping-client</b> [<b>timeout</b> <i>time</i>]</p> <p><b>Example:</b></p> <pre>Device(config-params-parameter-map)# sleeping-client timeout 100</pre>	<p>Configures the sleeping client timeout to 100 minutes. Valid range is between 10 minutes and 43200 minutes.</p> <p><b>Note</b> If you do not use the timeout keyword, the sleeping client is configured with the default timeout value of 720 minutes.</p>
<b>Step 3</b>	<b>end</b>	Exits parameter-map webauth configuration mode and returns to privileged EXEC mode.
<b>Step 4</b>	<p>(Optional) <b>show wireless client sleeping-client</b></p> <p><b>Example:</b></p> <pre>Device# show wireless client sleeping-client</pre>	Shows the MAC address of the clients and the time remaining in their respective sessions.
<b>Step 5</b>	<p>(Optional) <b>clear wireless client sleeping-client</b> [<b>mac-address</b> <i>mac-addr</i>]</p> <p><b>Example:</b></p> <pre>Device# clear wireless client sleeping-client mac-address 00e1.e1e1.0001</pre>	<ul style="list-style-type: none"> <li>• <b>clear wireless client sleeping-client</b>—Deletes all sleeping client entries from the sleeping client cache.</li> <li>• <b>clear wireless client sleeping-client mac-address</b> <i>mac-addr</i>—Deletes the specific MAC entry from the sleeping client cache.</li> </ul>

## Sleeping Clients with Multiple Authentications

### Mobility Support for Sleeping Clients

From Release 17.1.1 onwards, mobility support for guest and nonguest sleeping clients.

### Supported Combinations of Multiple Authentications

Multiple authentication feature supports sleeping clients configured in the WLAN profile.

The following table outlines the supported combination of multiple authentications:

**Table 42: Supported Combinations of Multiple Authentications**

Layer 2	Layer 3	Supported
MAB	LWA	Yes
MAB Failure	LWA	Yes
Dot1x	LWA	Yes
PSK	LWA	Yes

## Configuring Sleeping Clients with Multiple Authentications

### Configuring WLAN for Dot1x and Local Web Authentication

#### Procedure

	Command or Action	Purpose
<b>Step 1</b>	<b>configure terminal</b> <b>Example:</b> Device# <code>configure terminal</code>	Enters global configuration mode.
<b>Step 2</b>	<b>wlan profile-name wlan-id SSID_name</b> <b>Example:</b> Device(config)# <code>wlan wlan-test 3 ssid-test</code>	Enters WLAN configuration submode. <ul style="list-style-type: none"> <li>• <i>profile-name</i> - Profile name of the configured WLAN.</li> <li>• <i>wlan-id</i> - Wireless LAN identifier. Range is from 1 to 512.</li> <li>• <i>SSID_Name</i> - SSID, which can contain up to 32 alphanumeric characters.</li> </ul>
<b>Step 3</b>	<b>security dot1x authentication-list auth-list-name</b> <b>Example:</b> Device(config-wlan)# <code>security dot1x authentication-list default</code>	Enables security authentication list for dot1x security. The configuration is similar for all dot1x security WLANs.
<b>Step 4</b>	<b>security web-auth</b> <b>Example:</b> Device(config-wlan)# <code>security web-auth</code>	Configures web authentication.

	Command or Action	Purpose
<b>Step 5</b>	<b>security web-auth authentication-list</b> <i>authenticate-list-name</i>  <b>Example:</b> Device(config-wlan)# <b>security web-auth authentication-list default</b>	Enables authentication list for dot1x security.
<b>Step 6</b>	<b>security web-auth parameter-map</b> <i>parameter-map-name</i>  <b>Example:</b> Device(config-wlan)# <b>security web-auth parameter-map global</b>	Maps the parameter map.  <b>Note:</b> If the parameter map is not associated with a WLAN, the configuration is considered from the global parameter map.
<b>Step 7</b>	<b>no shutdown</b>  <b>Example:</b> Device(config-wlan)# <b>no shutdown</b>	Enables WLAN.

## Configuring a WLAN for MAC Authentication Bypass and Local Web Authentication

### Procedure

	Command or Action	Purpose
<b>Step 1</b>	<b>configure terminal</b>  <b>Example:</b> Device# <b>configure terminal</b>	Enters global configuration mode.
<b>Step 2</b>	<b>wlan profile-name wlan-id SSID_name</b>  <b>Example:</b> Device(config)# <b>wlan wlan-test 3 ssid-test</b>	Enters WLAN configuration submenu. <ul style="list-style-type: none"> <li>• <i>profile-name</i> - Profile name of the configured WLAN.</li> <li>• <i>wlan-id</i> - Wireless LAN identifier. Range is from 1 to 512.</li> <li>• <i>SSID_Name</i> - SSID, which can contain up to 32 alphanumeric characters.</li> </ul>
<b>Step 3</b>	<b>mac-filtering list-name</b>  <b>Example:</b> Device(config-wlan)# <b>mac-filtering cat-radius</b>	Sets the MAC filtering parameters.
<b>Step 4</b>	<b>no security wpa akm dot1x</b>  <b>Example:</b>	Disables security AKM for dot1x.

	Command or Action	Purpose
	Device(config-wlan) # <b>no security wpa akm dot1x</b>	
<b>Step 5</b>	<b>no security wpa wpa2 ciphers aes</b>  <b>Example:</b> Device(config-wlan) # <b>no security wpa wpa2 ciphers aes</b>	Disables the WPA2 cipher.  <b>aes</b> —Encryption type that specifies WPA/AES support.
<b>Step 6</b>	<b>security web-auth parameter-map parameter-map-name</b>  <b>Example:</b> Device(config-wlan) # <b>security web-auth parameter-map global</b>	Maps the parameter map.  <b>Note:</b> If parameter map is not associated with a WLAN, the configuration is considered from the global parameter map.
<b>Step 7</b>	<b>no shutdown</b>  <b>Example:</b> Device(config-wlan) # <b>no shutdown</b>	Enables WLAN.

## Configuring a WLAN for Local Web Authentication and MAC Filtering

### Procedure

	Command or Action	Purpose
<b>Step 1</b>	<b>configure terminal</b>  <b>Example:</b> Device# <b>configure terminal</b>	Enters global configuration mode.
<b>Step 2</b>	<b>wlan profile-name wlan-id SSID_name</b>  <b>Example:</b> Device(config) # <b>wlan wlan-test 3 ssid-test</b>	Enters WLAN configuration submode. <ul style="list-style-type: none"> <li>• <i>profile-name</i> - Profile name of the configured WLAN.</li> <li>• <i>wlan-id</i> - Wireless LAN identifier. Range is from 1 to 512.</li> <li>• <i>SSID_Name</i> - SSID, which can contain up to 32 alphanumeric characters.</li> </ul>
<b>Step 3</b>	<b>mac-filtering list-name</b>  <b>Example:</b> Device(config-wlan) # <b>mac-filtering cat-radius</b>	Sets the MAC filtering parameters.
<b>Step 4</b>	<b>no security wpa akm dot1x</b>  <b>Example:</b>	Disables security Authenticated Key Management (AKM) for dot1x.

	Command or Action	Purpose
	Device(config-wlan)# <b>no security wpa akm dot1x</b>	
<b>Step 5</b>	<b>no security wpa wpa2 ciphers aes</b> <b>Example:</b> Device(config-wlan)# <b>no security wpa wpa2 ciphers aes</b>	Disables the WPA2 cipher. <b>aes:</b> Excrption type that specifies WPA/AES support.
<b>Step 6</b>	<b>security web-auth on-macfilter-failure</b> <b>Example:</b> Device(config-wlan)# <b>security web-auth on-macfilter-failure wlan-id</b>	Configures the fallback policy with MAC filtering and web authentication.
<b>Step 7</b>	<b>security web-auth parameter-map parameter-map-name</b> <b>Example:</b> Device(config-wlan)# <b>security web-auth parameter-map global</b>	Maps the parameter map. <b>Note:</b> If the parameter map is not associated with a WLAN, the configuration is considered from the global parameter map.
<b>Step 8</b>	<b>no shutdown</b> <b>Example:</b> Device(config-wlan)# <b>no shutdown</b>	Enables WLAN.

## Configuring a PSK + LWA in a WLAN

### Procedure

	Command or Action	Purpose
<b>Step 1</b>	<b>configure terminal</b> <b>Example:</b> Device# <b>configure terminal</b>	Enters global configuration mode.
<b>Step 2</b>	<b>wlan profile-name wlan-id SSID_name</b> <b>Example:</b> Device(config)# <b>wlan wlan-test 3 ssid-test</b>	Enters WLAN configuration submode. <ul style="list-style-type: none"> <li>• <i>profile-name</i> - Profile name of the configured WLAN.</li> <li>• <i>wlan-id</i> - Wireless LAN identifier. Range is from 1 to 512.</li> <li>• <i>SSID_Name</i> - SSID, which can contain up to 32 alphanumeric characters.</li> </ul>
<b>Step 3</b>	<b>no security wpa akm dot1x</b> <b>Example:</b> Device(config-wlan)# <b>no security wpa akm dot1x</b>	Disables security AKM for dot1x.



	Command or Action	Purpose
<b>Step 4</b>	<b>security web-auth</b> <b>Example:</b> Device(config-wlan)# <b>security web-auth</b>	Enables web authentication for a WLAN.
<b>Step 5</b>	<b>no security wpa wpa2 ciphers aes</b> <b>Example:</b> Device(config-wlan)# <b>no security wpa wpa2 ciphers aes</b>	Disables the WPA2 cipher. <b>aes:</b> Exryption type that specifies WPA/AES support.
<b>Step 6</b>	<b>security wpa psk set-key ascii <i>ascii/hex key</i></b> <b>Example:</b> Device(config-wlan)# <b>security wpa psk set-key ascii 0 1234567</b>	Configures the preshared key on a WLAN.
<b>Step 7</b>	<b>security wpa akm psk</b> <b>Example:</b> Device(config-wlan)# <b>security wpa akm psk</b>	Configures PSK support.
<b>Step 8</b>	<b>security web-auth authentication-list <i>authenticate-list-name</i></b> <b>Example:</b> Device(config-wlan)# <b>security web-auth authentication-list default</b>	Enables the authentication list for dot1x security.
<b>Step 9</b>	<b>security web-auth parameter-map <i>parameter-map-name</i></b> <b>Example:</b> Device(config-wlan)# <b>security web-auth parameter-map global</b>	Maps the parameter map. <b>Note:</b> If the parameter map is not associated with a WLAN, the configuration is considered from the global parameter map.

## Configuring a Sleeping Client

### Procedure

	Command or Action	Purpose
<b>Step 1</b>	<b>configure terminal</b> <b>Example:</b> Device# <b>configure terminal</b>	Enters global configuration mode.
<b>Step 2</b>	<b>parameter-map type webauth <i>{parameter-map-name   global}</i></b> <b>Example:</b>	Creates a parameter map and enters <i>parameter-map-name</i> configuration mode.

	Command or Action	Purpose
	Device(config)# <b>parameter-map type</b> <b>webauth MAP-2</b>	The specific configuration commands supported for a <b>global</b> parameter map defined with the global keyword differ from the commands supported for a named parameter map defined with the <i>parameter-map-name</i> argument.
<b>Step 3</b>	<b>sleeping client [timeout time]</b>  <b>Example:</b> Device(config-params-parameter-map)# <b>sleeping-client timeout 60</b>	Configures the sleeping client timeout, in minutes. The available range for the <i>time</i> argument is from 10 to 43200.  <b>Note:</b> If you do not use the <b>timeout</b> keyword, the sleeping client is configured with the default timeout value of 720 minutes.

## Verifying a Sleeping Client Configuration

To verify a sleeping client configuration, use the following command:

```
Device# show wireless client sleeping-client
Total number of sleeping-client entries: 1

MAC Address                               Remaining time (mm:ss)
-----
2477.031b.aa18                             59:56
```



## CHAPTER 100

# Private Shared Key

---

- [Information About Private Preshared Key, on page 865](#)
- [Configuring a PSK in a WLAN \(CLI\), on page 866](#)
- [Configuring a PSK in a WLAN \(GUI\), on page 867](#)
- [Applying a Policy Profile to a WLAN \(GUI\), on page 868](#)
- [Applying a Policy Profile to a WLAN \(CLI\), on page 868](#)
- [Verifying a Private PSK, on page 869](#)

## Information About Private Preshared Key

With the advent of Internet of Things (IoT), the number of devices that connect to the internet has increased manifold. Not all of these devices support the 802.1x supplicant and need an alternate mechanism to connect to the internet. One of the security mechanisms, WPA-PSK, could be considered as an alternative. With the current configuration, the PSK is the same for all the clients that connect to the same WLAN. In certain deployments, such as educational institutions, this results in the key being shared to unauthorized users leading to security breach. This necessitates the need to provision unique PSKs for different clients on a large scale.

Identity PSKs are unique PSKs created for individuals or groups of users on the same SSID. No complex configuration is required for the clients. It provides the same simplicity of PSK, making it ideal for IoT, Bring your own device (BYOD), and guest deployments.

Identity PSKs are supported on most devices, in which 802.1X is not, enabling stronger security for IoT. It is possible to easily revoke access, for a single device or individual without affecting everyone else. Thousands of keys can easily be managed and distributed through the AAA server.



---

**Note** Special characters, such as '<' and '>' are not supported in SSID Preshared key.

---



---

**Note** PSK supports whitespace in passwords (before or after or in-between) within double quotes only; single quotes for whitespaces are not supported.

---

### IPSK Solution

During client authentication, the AAA server authorizes the client MAC address and sends the passphrase (if configured) as part of the Cisco-AV pair list. The Cisco Wireless Controller (WLC) receives this as part of the RADIUS response and processes this further for the computation of PSKs.

When a client sends an association request to the SSID broadcast by the corresponding access point, the controller forms the RADIUS request packet with the particular mac address of the client and relays to the RADIUS server.

The RADIUS server performs the authentication and checks whether the client is allowed or not and sends either ACCESS-ACCEPT or ACCESS-REJECT as response to the WLC.

To support Identity PSKs, in addition to sending the authentication response, the authentication server also provides the AV pair passphrase for this specific client. This is used for the computation of the PMK.

The RADIUS server might also provide additional parameters, such as username, VLAN, Quality of Service (QoS), and so on, in the response, that is specific to this client. For multiple devices owned by a single user, the passphrase can remain the same.



**Note** When the PSK length is less than 15 characters in Federal Information Processing Standard (FIPS), the controller allows the WLAN configuration but displays the following error message on the console:

**"AP is allowed to join but corresponding WLAN will not be pushed to the access point"**

## Configuring a PSK in a WLAN (CLI)

Follow the procedure given below to configure a PSK in a WLAN:

### Before you begin

- Security should be configured for a pre-shared key (PSK) in a WLAN.
- If there is no override from the AAA server, the value on the corresponding WLAN is considered for authentication.
- In Federal Information Processing Standard (FIPS) and common criteria mode, ensure that the PSK WLAN has a minimum of 15 ASCII characters, else APs won't join the controller.

### Procedure

	Command or Action	Purpose
<b>Step 1</b>	<b>configure terminal</b>  <b>Example:</b> Device# configure terminal	Enters global configuration mode.
<b>Step 2</b>	<b>wlan wlan-name wlan-id ssid</b>  <b>Example:</b> Device(config)# wlan test-profile 4 abc	Configures the WLAN and SSID.

	Command or Action	Purpose
<b>Step 3</b>	<b>no security wpa akm dot1x</b> <b>Example:</b> Device(config-wlan)# no security wpa akm dot1x	Disables security AKM for dot1x.
<b>Step 4</b>	<b>security wpa akm psk</b> <b>Example:</b> Device(config-wlan)# security wpa akm psk	Configures the security type PSK.
<b>Step 5</b>	<b>security wpa akm psk set-key ascii/hex key</b> <b>Example:</b> Device(config-wlan)# security wpa akm psk set-key ascii 0	Configures the PSK authenticated key management (AKM) shared key. <b>Note</b> You must set the <b>psk set-key</b> before configuring AKM PSK.
<b>Step 6</b>	<b>security wpa akm psk</b> <b>Example:</b> Device(config-wlan)# security wpa akm psk	Configures PSK support.
<b>Step 7</b>	<b>security wpa wpa2 mpsk</b> <b>Example:</b> Device(config-wlan)# security wpa wpa2 mpsk	Configures multi-preshared key (MPSK) support. <b>Note</b> AKM PSK should be enabled for MPSK to work.
<b>Step 8</b>	<b>mac-filtering auth-list-name</b> <b>Example:</b> Device(config-wlan)# mac-filtering test1	Specifies MAC filtering in a WLAN.

## Configuring a PSK in a WLAN (GUI)

### Procedure

- 
- Step 1** Choose **Configuration > Tags & Profiles > WLANs**.
- Step 2** On the **Wireless Networks** page, click **Security** tab.
- Step 3** In the **Layer 2** window that is displayed, go to the **WPA Parameters** section.
- Step 4** From the **Auth Key Mgmt** drop-down, select the PSK format and type.
- Step 5** Enter the Pre-Shared Key in hexadecimal characters.
- If you selected the PSK format as HEX, the key length must be exactly 64 characters.
  - If you selected the PSK format as ASCII, the key length must be in the range of 8-63 characters.

Note that once you have configured the key, these details are not visible even if you click on the eye icon next to the preshared key box, due to security reasons.

**Step 6** Click **Save & Apply to Device**.

## Applying a Policy Profile to a WLAN (GUI)

### Procedure

- Step 1** Choose **Configuration > Tags & Profiles > Tags**.
- Step 2** On the **Manage Tags** page, click **Policy** tab.
- Step 3** Click **Add** to view the **Add Policy Tag** window.
- Step 4** Enter a name and description for the policy tag.
- Step 5** Click **Add** to map WLAN and policy.
- Step 6** Choose the WLAN profile to map with the appropriate policy profile, and click the tick icon.
- Step 7** Click **Save & Apply to Device**.

## Applying a Policy Profile to a WLAN (CLI)

Follow the procedure given below to apply policy profile to a WLAN:

### Procedure

	Command or Action	Purpose
<b>Step 1</b>	<b>configure terminal</b>  <b>Example:</b> Device# configure terminal	Enters global configuration mode.
<b>Step 2</b>	<b>wireless profile policy <i>policy-profile-name</i></b>  <b>Example:</b> Device(config)# wireless profile policy policy-iot	Configures the default policy profile.
<b>Step 3</b>	<b>aaa-override</b>  <b>Example:</b> Device(config-wireless-policy)# aaa-override	Configures AAA override to apply policies coming from the AAA server or ISE the Cisco Identify Services Engine (ISE) server.

## Verifying a Private PSK

Use the following **show** commands to verify the configuration of a WLAN and a client:

```
Device# show wlan id 2
```

```
WLAN Profile Name      : test_ppsk
=====
Identifier              : 2
Network Name (SSID)    : test_ppsk
Status                  : Enabled
Broadcast SSID         : Enabled
Universal AP Admin     : Disabled
Max Associated Clients per WLAN : 0
Max Associated Clients per AP per WLAN : 0
Max Associated Clients per AP Radio per WLAN : 0
Number of Active Clients : 0
Exclusionlist Timeout  : 60
CHD per WLAN          : Enabled
Interface              : default
Multicast Interface    : Unconfigured
WMM                    : Allowed
WifiDirect             : Invalid
Channel Scan Defer Priority:
  Priority (default)   : 4
  Priority (default)   : 5
  Priority (default)   : 6
Scan Defer Time (msecs) : 100
Media Stream Multicast-direct : Disabled
CCX - AironetIe Support : Enabled
CCX - Diagnostics Channel Capability : Disabled
Peer-to-Peer Blocking Action : Disabled
Radio Policy           : All
DTIM period for 802.11a radio : 1
DTIM period for 802.11b radio : 1
Local EAP Authentication : Disabled
Mac Filter Authorization list name : test1
Accounting list name   : Disabled
802.1x authentication list name : Disabled
Security
  802.11 Authentication : Open System
  Static WEP Keys       : Disabled
  802.1X                : Disabled
  Wi-Fi Protected Access (WPA/WPA2) : Enabled
    WPA (SSN IE)        : Disabled
    WPA2 (RSN IE)       : Enabled
      TKIP Cipher       : Disabled
      AES Cipher        : Enabled
    Auth Key Management
      802.1x            : Disabled
      PSK              : Enabled
      CCKM              : Disabled
      FT dot1x          : Disabled
      FT PSK            : Disabled
      PMF dot1x        : Disabled
      PMF PSK          : Disabled
    CCKM TSF Tolerance : 1000
    FT Support          : Disabled
      FT Reassociation Timeout : 20
      FT Over-The-DS mode : Enabled
    PMF Support        : Disabled
```

```

        PMF Association Comeback Timeout      : 1
        PMF SA Query Time                    : 200
        Web Based Authentication              : Disabled
        Conditional Web Redirect              : Disabled
        Splash-Page Web Redirect             : Disabled
        Webauth On-mac-filter Failure         : Disabled
        Webauth Authentication List Name     : Disabled
        Webauth Parameter Map                : Disabled
        Tkip MIC Countermeasure Hold-down Timer : 60
    Call Snooping                            : Disabled
    Passive Client                           : Disabled
    Non Cisco WGB                            : Disabled
    Band Select                              : Disabled
    Load Balancing                           : Disabled
    Multicast Buffer                          : Disabled
    Multicast Buffer Size                     : 0
    IP Source Guard                          : Disabled
    Assisted-Roaming
        Neighbor List                        : Disabled
        Prediction List                      : Disabled
        Dual Band Support                    : Disabled
    IEEE 802.11v parameters
        Directed Multicast Service           : Disabled
        BSS Max Idle
            Protected Mode                   : Disabled
        Traffic Filtering Service            : Disabled
        BSS Transition                       : Enabled
            Disassociation Imminent          : Disabled
                Optimised Roaming Timer    : 40
                Timer                       : 200
        WNM Sleep Mode                       : Disabled
    802.11ac MU-MIMO                          : Disabled

```

Device# **show wireless client mac-address a886.adb2.05f9 detail**

```

Client MAC Address : a886.adb2.05f9
Client IPv4 Address : 9.9.58.246
Client Username : A8-86-AD-B2-05-F9
AP MAC Address : c025.5c55.e400
AP Name: saurabh-3600
AP slot : 1
Client State : Associated
Policy Profile : default-policy-profile
Flex Profile : default-flex-profile
Wireless LAN Id : 6
Wireless LAN Name: SSS_PPSK
BSSID : c025.5c55.e40f
Connected For : 280 seconds
Protocol : 802.11n - 5 GHz
Channel : 60
Client IIF-ID : 0xa0000001
Association Id : 1
Authentication Algorithm : Open System
Client CCX version : No CCX support
Session Timeout : 320 sec (Remaining time: 40 sec)
Input Policy Name :
Input Policy State : None
Input Policy Source : None
Output Policy Name :
Output Policy State : None
Output Policy Source : None
WMM Support : Enabled
U-APSD Support : Enabled

```



```

U-APSD value : 0
APSD ACs      : BK, BE, VI, VO
Fastlane Support : Disabled
Power Save    : OFF
Current Rate  : m22
Supported Rates : 9.0,18.0,36.0,48.0,54.0
Mobility:
  Move Count           : 0
  Mobility Role        : Local
  Mobility Roam Type    : None
  Mobility Complete Timestamp : 09/27/2017 16:32:25 IST
Policy Manager State: Run
NPU Fast Fast Notified : No
Last Policy Manager State : IP Learn Complete
Client Entry Create Time : 280 seconds
Policy Type : WPA2
Encryption Cipher : CCMP (AES)
Authentication Key Management : PSK
AAA override passphrase: Yes
Management Frame Protection : No
Protected Management Frame - 802.11w : No
EAP Type : Not Applicable
VLAN : 58
Access VLAN : 58
Anchor VLAN : 0
WFD capable : No
Manged WFD capable : No
Cross Connection capable : No
Support Concurrent Operation : No
Session Manager:
  Interface      : capwap_90000005
  IIF ID         : 0x90000005
  Device Type    : Apple-Device
  Protocol Map   : 0x000001
  Authorized     : TRUE
  Session timeout : 320
  Common Session ID: 1F3809090000005DC30088EA
  Acct Session ID : 0x00000000
  Auth Method Status List
    Method : MAB
      SM State      : TERMINATE
      Authen Status : Success
  Local Policies:
    Service Template : wlan_svc_default-policy-profile (priority 254)
    Absolute-Timer   : 320
    VLAN              : 58
  Server Policies:
  Resultant Policies:
    VLAN              : 58
    Absolute-Timer    : 320
Client Capabilities
  CF Pollable : Not implemented
  CF Poll Request : Not implemented
  Short Preamble : Not implemented
  PECC : Not implemented
  Channel Agility : Not implemented
  Listen Interval : 0
Fast BSS Transition Details :
  Reassociation Timeout : 0
11v BSS Transition : Not implemented
FlexConnect Data Switching : Local
FlexConnect Dhcp Status : Local
FlexConnect Authentication : Central
FlexConnect Central Association : No

```

```
Client Statistics:
  Number of Bytes Received : 59795
  Number of Bytes Sent : 21404
  Number of Packets Received : 518
  Number of Packets Sent : 274
  Number of EAP Id Request Msg Timeouts :
  Number of EAP Request Msg Timeouts :
  Number of EAP Key Msg Timeouts :
  Number of Policy Errors : 0
  Radio Signal Strength Indicator : -32 dBm
  Signal to Noise Ratio : 58 dB
Fabric status : Disabled
```



# CHAPTER 101

## Multi-Preshared Key

- [Information About Multi-Preshared Key, on page 873](#)
- [Restrictions on Multi-PSK, on page 874](#)
- [Configuring Multi-Preshared Key \(GUI\), on page 874](#)
- [Configuring Multi-Preshared Key \(CLI\), on page 877](#)
- [Verifying Multi-PSK Configurations, on page 878](#)

### Information About Multi-Preshared Key

Multi-PSK feature supports multiple PSKs simultaneously on a single SSID. You can use any of the configured PSKs to join the network. This is different from the Identity PSK (iPSK), wherein unique PSKs are created for individuals or groups of users on the same SSID.

From 16.10 onwards, each SSID supports five PSKs, which can be extended

In a traditional PSK, all the clients joining the network use the same password as shown in the below figure.

**Figure 25: Traditional PSK**

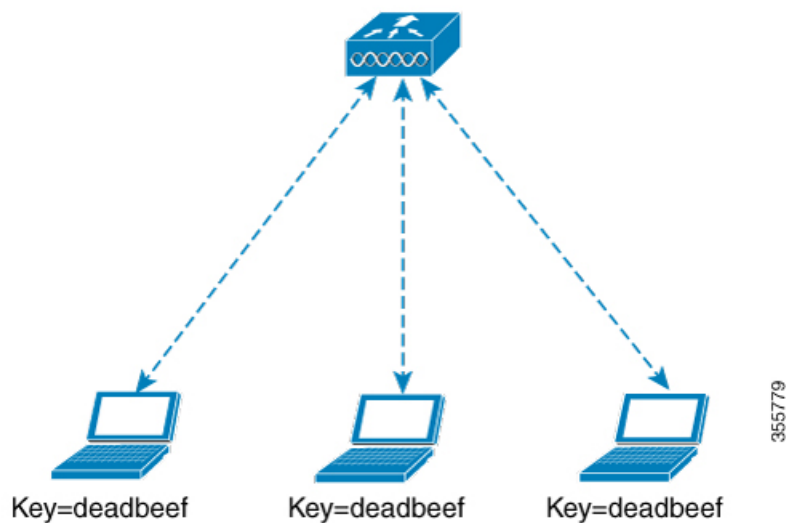

But with multi-PSK, client can use any of the configured pre-shared keys to connect to the network as shown in the below figure.

Figure 26: Multi-PSK

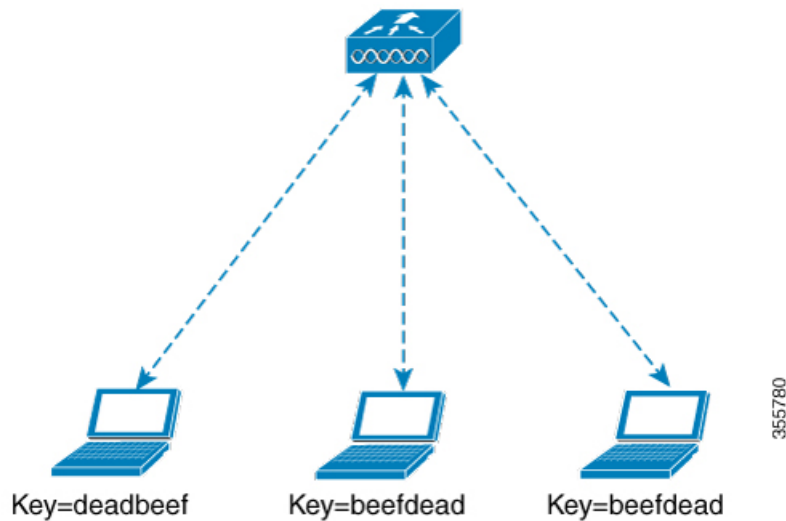

In Multi-PSK, two passwords are configured (deadbeef and beefdead) for the same SSID. In this scenario, clients can connect to the network using either of the passwords.

## Restrictions on Multi-PSK

- Central authentication is supported in local, flex, and fabric modes only.
- In central authentication flex mode, the standalone AP allows client join with the highest priority PSK (*priority 0* key). New clients that do not use the highest priority PSK are rejected during the standalone mode.
- Multi-PSK does not support local authentication.
- Multi-PSK is different from iPSK. In iPSK, the PSK password comes from ISE authorization policy, so MAB is required. MPSK uses a pool of passwords locally configured in WLAN, so ISE is not used.

## Configuring Multi-Preshared Key (GUI)

### Procedure

- 
- Step 1** Choose **Configuration** > **Tags & Profiles** > **WLANs**.
  - Step 2** On the **Wireless Networks** page, click the name of the WLAN.
  - Step 3** In the **Edit WLAN** window, click the **Security** tab.
  - Step 4** In the **Layer2** tab, choose the **Layer2 Security Mode** from the following options:
    - None: No Layer 2 security
    - 802.1X: WEP 802.1X data encryption type

- WPA + WPA2: Wi-Fi Protected Access
- Static WEP: Static WEP encryption parameters
- Static WEP+802.1X: Both Static WEP and 802.1X parameters

Parameters	Description
<b>802.1X</b>	
WEP Key Size	Choose the key size. The available values are <i>None</i> , <i>40 bits</i> , and <i>104 bits</i> .
<b>WPA + WPA2</b>	
Protected Management Frame	Choose from the following options: <ul style="list-style-type: none"> <li>• Disabled</li> <li>• Optional</li> <li>• Required</li> </ul>
WPA Policy	Check the check box to enable WPA policy.
WPA Encryption	Choose the WPA encryption standard. A WPA encryption standard must be specified if you have enabled WPA policy.
WPA2 Policy	Check the check box to enable WPA2 policy.
WPA2 Encryption	Choose the WPA2 encryption standard. A WPA encryption standard must be specified if you have enabled WPA policy.
Auth Key Mgmt	Choose the rekeying mechanism from the following options: <ul style="list-style-type: none"> <li>• 802.1X</li> <li>• FT + 802.1X</li> <li>• PSK: You must specify the PSK format and a preshared key</li> <li>• Cisco Centralized Key Management: You must specify a Cisco Centralized Key Management Timestamp Tolerance value</li> <li>• 802.1X + Cisco Centralized Key Management: You must specify a Cisco Centralized Key Management Timestamp Tolerance value</li> <li>• FT + 802.1X + Cisco Centralized Key Management: You must specify a Cisco Centralized Key Management Timestamp Tolerance value</li> </ul>

Parameters	Description
<b>Static WEP</b>	
Key Size	Choose the key size from the following options: <ul style="list-style-type: none"> <li>• 40 bits</li> <li>• 104 bits</li> </ul>
Key Index	Choose a key index from 1 to 4. One unique WEP key index can be applied to each WLAN. As there are only four WEP key indexes, only four WLANs can be configured for static WEP Layer2 encryption.
Key Format	Choose the encryption key format as either ASCII or HEX.
Encryption Key	Enter an encryption key that is 13 characters long.
<b>Static WEP + 802.1X</b>	
Key Size	Choose the key size from the following options: <ul style="list-style-type: none"> <li>• 40 bits</li> <li>• 104 bits</li> </ul>
Key Index	Choose a key index from 1 to 4. One unique WEP key index can be applied to each WLAN. As there are only four WEP key indexes, only four WLANs can be configured for static WEP Layer2 encryption.
Key Format	Choose the encryption key format as either ASCII or HEX.
Encryption Key	Enter an encryption key that is 13 characters long.
WEP Key Size	Choose from the following options: <ul style="list-style-type: none"> <li>• None</li> <li>• 40 bits</li> <li>• 104 bits</li> </ul>

**Step 5** Click **Save & Apply to Device**.

---

## Configuring Multi-Preshared Key (CLI)

### Procedure

	Command or Action	Purpose
<b>Step 1</b>	<b>configure terminal</b> <b>Example:</b> Device# <code>configure terminal</code>	Enters global configuration mode.
<b>Step 2</b>	<b>wlan wlan-name wlan-id ssid</b> <b>Example:</b> Device(config)# <code>wlan mywlan 1 SSID_name</code>	Configures WLAN and SSID.
<b>Step 3</b>	<b>no security wpa akm dot1x</b> <b>Example:</b> Device(config-wlan)# <code>no security wpa akm dot1x</code>	Disables security AKM for dot1x.
<b>Step 4</b>	<b>security wpa akm psk</b> <b>Example:</b> Device(config-wlan)# <code>security wpa akm psk</code>	Configures PSK.
<b>Step 5</b>	<b>security wpa wpa2 mpsk</b> <b>Example:</b> Device(config-wlan)# <code>security wpa wpa2 mpsk</code>	Configures multi-PSK.
<b>Step 6</b>	<b>priority priority_value set-key {ascii [0   8] pre-shared-key   hex [0   8] pre-shared-key}</b> <b>Example:</b> Device(config-mpsk)# <code>priority 0 set-key ascii 0 deadbeef</code>	Configures PSK priority and all its related passwords. The <i>priority_value</i> ranges from 0 to 4. <b>Note</b> You need to configure <b>priority 0</b> key for multi-PSK.
<b>Step 7</b>	<b>no shutdown</b> <b>Example:</b> Device(config-mpsk)# <code>no shutdown</code>	Enables WLAN.
<b>Step 8</b>	<b>exit</b> <b>Example:</b> Device(config-wlan)# <code>exit</code>	Exits WLAN configuration mode and returns to configuration mode.

	Command or Action	Purpose
<b>Step 9</b>	<b>end</b>  <b>Example:</b> Device(config)# <b>end</b>	Returns to privileged EXEC mode. Alternatively, you can also press <b>Ctrl-Z</b> to exit global configuration mode.

## Verifying Multi-PSK Configurations

To verify the configuration of a WLAN and a client, use the following command:

```
Device# show wlan id 8
WLAN Profile Name      : wlan_8
=====
Identifier              : 8
Network Name (SSID)    : ssid_8
Status                  : Enabled
Broadcast SSID         : Enabled
Universal AP Admin     : Disabled
Max Associated Clients per WLAN : 0
Max Associated Clients per AP per WLAN : 0
Max Associated Clients per AP Radio per WLAN : 200
Number of Active Clients : 0
CHD per WLAN           : Enabled
Multicast Interface    : Unconfigured
WMM                     : Allowed
WifiDirect              : Invalid
Channel Scan Defer Priority:
  Priority (default)    : 5
  Priority (default)    : 6
Scan Defer Time (msecs) : 100
Media Stream Multicast-direct : Disabled
CCX - AironetIe Support : Enabled
CCX - Diagnostics Channel Capability : Disabled
Peer-to-Peer Blocking Action : Disabled
Radio Policy           : All
DTIM period for 802.11a radio : 1
DTIM period for 802.11b radio : 1
Local EAP Authentication : Disabled
Mac Filter Authorization list name : Disabled
Mac Filter Override Authorization list name : Disabled
Accounting list name   :
802.1x authentication list name : Disabled
802.1x authorization list name : Disabled
Security
  802.11 Authentication : Open System
  Static WEP Keys       : Disabled
  802.1X                 : Disabled
  Wi-Fi Protected Access (WPA/WPA2/WPA3) : Enabled
    WPA (SSN IE)        : Disabled
    WPA2 (RSN IE)       : Enabled
      MP SK              : Enabled
      AES Cipher        : Enabled
      CCMP256 Cipher    : Disabled
      GCMP128 Cipher    : Disabled
      GCMP256 Cipher    : Disabled
    WPA3 (WPA3 IE)     : Disabled
  Auth Key Management
    802.1x               : Disabled
    PSK                  : Enabled
```



```

CCKM : Disabled
FT dot1x : Disabled
FT PSK : Disabled
FT SAE : Disabled
PMF dot1x : Disabled
PMF PSK : Disabled
SAE : Disabled
OWE : Disabled
SUITEB-1X : Disabled
SUITEB192-1X : Disabled
CCKM TSF Tolerance : 1000
FT Support : Adaptive
  FT Reassociation Timeout : 20
  FT Over-The-DS mode : Enabled
PMF Support : Disabled
  PMF Association Comeback Timeout : 1
  PMF SA Query Time : 200
Web Based Authentication : Disabled
Conditional Web Redirect : Disabled
Splash-Page Web Redirect : Disabled
Webauth On-mac-filter Failure : Disabled
Webauth Authentication List Name : Disabled
Webauth Authorization List Name : Disabled
Webauth Parameter Map : Disabled
Tkip MIC Countermeasure Hold-down Timer : 60
Non Cisco WGB : Disabled
Band Select : Enabled
Load Balancing : Disabled
Multicast Buffer : Disabled
Multicast Buffer Size : 0
IP Source Guard : Disabled
Assisted-Roaming
  Neighbor List : Disabled
  Prediction List : Disabled
  Dual Band Support : Disabled
IEEE 802.11v parameters
  Directed Multicast Service : Disabled
  BSS Max Idle : Disabled
  Protected Mode : Disabled
  Traffic Filtering Service : Disabled
  BSS Transition : Enabled
  Disassociation Imminent : Disabled
  Optimised Roaming Timer : 40
  Timer : 200
  WNM Sleep Mode : Disabled
802.11ac MU-MIMO : Disabled
802.11ax paramters
  OFDMA Downlink : unknown
  OFDMA Uplink : unknown
  MU-MIMO Downlink : unknown
  MU-MIMO Uplink : unknown
  BSS Color : unknown
  Partial BSS Color : unknown
  BSS Color Code :

```

To view the WLAN details, use the following command:

```

Device# show run wlan
wlan wlan_8 8 ssid_8
  security wpa psk set-key ascii 0 deadbeef
  no security wpa akm dot1x
  security wpa akm psk
  security wpa wpa2 mpsk
  priority 0 set-key ascii 0 deadbeef
  priority 1 set-key ascii 0 deaddead

```

```
priority 2 set-key ascii 0 d123d123
priority 3 set-key hex 0 023456789012345678901234567890123456789012345678901234
priority 4 set-key hex 0 1234567890123456789012345678901234567890123456789012345678901234
no shutdown
```



## CHAPTER 102

# Multiple Authentications for a Client

- [Information About Multiple Authentications for a Client](#), on page 881
- [Configuring Multiple Authentications for a Client](#), on page 883
- [Configure WLAN for Web Authentication on MAC Authentication Bypass Failure with Pre-Shared Key \(CLI\)](#), on page 889
- [Configure WLAN for Web Authentication on MAC Authentication Bypass Failure with OWE \(CLI\)](#), on page 891
- [Configure WLAN for Web Authentication on MAC Authentication Bypass Failure with Secure Agile Exchange \(CLI\)](#), on page 893
- [Configuring 802.1x and Central Web Authentication on Controller \(CLIs\)](#), on page 894
- [Configuring ISE for Central Web Authentication with Dot1x \(GUI\)](#), on page 901
- [Verifying Multiple Authentication Configurations](#), on page 903

## Information About Multiple Authentications for a Client

Multiple Authentication feature is an extension of Layer 2 and Layer 3 security types supported for client join.



**Note** You can enable both L2 and L3 authentication for a given SSID.



**Note** The Multiple Authentication feature is applicable for regular clients only.

## Information About Supported Combination of Authentications for a Client

The Multiple Authentications for a Client feature supports multiple combination of authentications for a given client configured in the WLAN profile.

The following table outlines the supported combination of authentications:

Layer 2	Layer 3	Supported
MAB	CWA	Yes

MAB	LWA	Yes
MAB + PSK	-	Yes
MAB + 802.1X	-	Yes
MAB Failure	LWA	Yes
802.1X	CWA	Yes
802.1X	LWA	Yes
PSK	-	Yes
PSK	LWA	Yes
PSK	CWA	Yes
iPSK	-	Yes
iPSK	CWA	Yes
iPSK + MAB	CWA	Yes
iPSK	LWA	No
MAB Failure + PSK	LWA	Yes
MAB Failure + PSK	CWA	No
MAB Failure + OWE	LWA	Yes
MAB Failure + SAE	LWA	Yes

From 16.10.1 onwards, 802.1X configurations on WLAN support web authentication configurations with WPA or WPA2 configuration.

The feature also supports the following AP modes:

- Local
- FlexConnect
- Fabric

## Combination of Authentications on MAC Failure Not Supported on a Client

The following table outlines the combination of authentications on MAC failure that are not supported on a given client:

Authentication Types	Foreign	Anchor	Supported
WPA3-OWE+LWA	Cisco AireOS	Cisco Catalyst 9800 Controller	No

Authentication Types	Foreign	Anchor	Supported
WPA3-SAE+LWA	Cisco AireOS	Cisco Catalyst 9800 Controller	No

## Configuring Multiple Authentications for a Client

### Configuring WLAN for 802.1X and Local Web Authentication (GUI)

#### Procedure

- 
- Step 1** Choose **Configuration > Tags & Profiles > WLANs**.
- Step 2** Select the required WLAN from the list of WLANs displayed.
- Step 3** Choose **Security > Layer2** tab.
- Step 4** Select the security method from the **Layer 2 Security Mode** drop-down list.
- Step 5** In the **Auth Key Mgmt**, check the **802.1x** check box.
- Step 6** Check the **MAC Filtering** check box to enable the feature.
- Step 7** After MAC Filtering is enabled, from the **Authorization List** drop-down list, choose an option.
- Step 8** Choose **Security > Layer3** tab.
- Step 9** Check the **Web Policy** check box to enable web authentication policy.
- Step 10** From the **Web Auth Parameter Map** and the **Authentication List** drop-down lists, choose an option.
- Step 11** Click **Update & Apply to Device**.
- 

### Configuring WLAN for 802.1X and Local Web Authentication (CLI)

#### Procedure

	Command or Action	Purpose
<b>Step 1</b>	<b>configure terminal</b>  <b>Example:</b> Device# <code>configure terminal</code>	Enters global configuration mode.
<b>Step 2</b>	<b>wlan profile-name wlan-id SSID_Name</b>  <b>Example:</b> Device(config)# <code>wlan wlan-test 3 ssid-test</code>	Enters WLAN configuration sub-mode.  <ul style="list-style-type: none"> <li>• <i>profile-name</i>: Profile name of the configured WLAN.</li> <li>• <i>wlan-id</i>: Wireless LAN identifier. Range is from 1 to 512.</li> </ul>

	Command or Action	Purpose
		<ul style="list-style-type: none"> <li>• <i>SSID_Name</i>: SSID that can contain 32 alphanumeric characters.</li> </ul> <p><b>Note</b> If you have already configured this command, enter the <code>wlan profile-name</code> command.</p>
<b>Step 3</b>	<b>security dot1x authentication-list</b> <i>auth-list-name</i>  <b>Example:</b> <pre>Device(config-wlan)# security dot1x authentication-list default</pre>	Enables security authentication list for dot1x security.  The configuration is similar for all dot1x security WLANs.
<b>Step 4</b>	<b>security web-auth</b>  <b>Example:</b> <pre>Device(config-wlan)# security web-auth</pre>	Enables web authentication.
<b>Step 5</b>	<b>security web-auth authentication-list</b> <i>authenticate-list-name</i>  <b>Example:</b> <pre>Device(config-wlan)# security web-auth authentication-list default</pre>	Enables authentication list for dot1x security.
<b>Step 6</b>	<b>security web-auth parameter-map</b> <i>parameter-map-name</i>  <b>Example:</b> <pre>Device(config-wlan)# security web-auth parameter-map WLAN1_MAP</pre>	Maps the parameter map.  <p><b>Note</b> If a parameter map is not associated with a WLAN, the configuration is considered from the global parameter map.</p>
<b>Step 7</b>	<b>no shutdown</b>  <b>Example:</b> <pre>Device(config-wlan)# no shutdown</pre>	Enables the WLAN.

### Example

```
wlan wlan-test 3 ssid-test
 security dot1x authentication-list default
 security web-auth
 security web-auth authentication-list default
 security web-auth parameter-map WLAN1_MAP
 no shutdown
```

## Configuring WLAN for Preshared Key (PSK) and Local Web Authentication (GUI)

### Procedure

- 
- Step 1** Choose **Configuration > Tags & Profiles > WLANs**.
- Step 2** Select the required WLAN.
- Step 3** Choose **Security > Layer2** tab.
- Step 4** Select the security method from the **Layer 2 Security Mode** drop-down list.
- Step 5** In the Auth Key Mgmt, uncheck the **802.1x** check box.
- Step 6** Check the **PSK** check box.
- Step 7** Enter the **Pre-Shared Key** and choose the PSK Format from the **PSK Format** drop-down list and the PSK Type from the **PSK Type** drop-down list.
- Step 8** Choose **Security > Layer3** tab.
- Step 9** Check the **Web Policy** checkbox to enable web authentication policy.
- Step 10** Choose the Web Auth Parameter Map from the **Web Auth Parameter Map** drop-down list and the authentication list from the **Authentication List** drop-down list.
- Step 11** Click **Update & Apply to Device**.
- 

## Configuring WLAN for Preshared Key (PSK) and Local Web Authentication

### Procedure

	Command or Action	Purpose
<b>Step 1</b>	<b>configure terminal</b> <b>Example:</b> Device# <code>configure terminal</code>	Enters global configuration mode.
<b>Step 2</b>	<b>wlan profile-name wlan-id SSID_Name</b> <b>Example:</b> Device(config)# <code>wlan wlan-test 3 ssid-test</code>	Enters WLAN configuration sub-mode. <ul style="list-style-type: none"> <li>• <i>profile-name</i> - Is the profile name of the configured WLAN.</li> <li>• <i>wlan-id</i> - Is the wireless LAN identifier. Range is from 1 to 512.</li> <li>• <i>SSID_Name</i> - Is the SSID which can contain 32 alphanumeric characters.</li> </ul> <p><b>Note</b> If you have already configured this command, enter <code>wlan profile-name</code> command.</p>

	Command or Action	Purpose
<b>Step 3</b>	<b>security wpa psk set-key <i>ascii/hex key password</i></b>  <b>Example:</b> Device(config-wlan)# <b>security wpa psk set-key ascii 0 PASSWORD</b>	Configures the PSK shared key.
<b>Step 4</b>	<b>no security wpa akm dot1x</b>  <b>Example:</b> Device(config-wlan)# <b>no security wpa akm dot1x</b>	Disables security AKM for dot1x.
<b>Step 5</b>	<b>security wpa akm psk</b>  <b>Example:</b> Device(config-wlan)# <b>security wpa akm psk</b>	Configures the PSK support.
<b>Step 6</b>	<b>security web-auth</b>  <b>Example:</b> Device(config-wlan)# <b>security web-auth</b>	Enables web authentication for WLAN.
<b>Step 7</b>	<b>security web-auth authentication-list <i>authenticate-list-name</i></b>  <b>Example:</b> Device(config-wlan)# <b>security web-auth authentication-list webauth</b>	Enables authentication list for dot1x security.
<b>Step 8</b>	<b>security web-auth parameter-map <i>parameter-map-name</i></b>  <b>Example:</b> (config-wlan)# <b>security web-auth parameter-map WLAN1_MAP</b>	Configures the parameter map.  <b>Note</b> If parameter map is not associated with a WLAN, the configuration is considered from the global parameter map.

### Example

```
wlan wlan-test 3 ssid-test
 security wpa psk set-key ascii 0 PASSWORD
 no security wpa akm dot1x
 security wpa akm psk
 security web-auth
 security web-auth authentication-list webauth
 security web-auth parameter-map WLAN1_MAP
```



## Configuring WLAN for PSK or Identity Preshared Key (iPSK) and Central Web Authentication (GUI)

### Procedure

- 
- Step 1** Choose **Configuration > Tags & Profiles > WLANs**.
- Step 2** Select the required WLAN.
- Step 3** Choose **Security > Layer2** tab.
- Step 4** Select the security method from the **Layer 2 Security Mode** drop-down list.
- Step 5** In the **Auth Key Mgmt**, uncheck the **802.1x** check box.
- Step 6** Check the **PSK** check box.
- Step 7** Enter the **Pre-Shared Key** and choose the PSK Format from the **PSK Format** drop-down list and the PSK Type from the **PSK Type** drop-down list.
- Step 8** Check the **MAC Filtering** check box to enable the feature.
- Step 9** With MAC Filtering enabled, choose the Authorization List from the **Authorization List** drop-down list.
- Step 10** Choose **Security > Layer3** tab.
- Step 11** Check the **Web Policy** checkbox to enable web authentication policy.
- Step 12** Choose the Web Auth Parameter Map from the **Web Auth Parameter Map** drop-down list and the authentication list from the **Authentication List** drop-down list.
- Step 13** Click **Update & Apply to Device**.
- 

## Configuring WLAN for PSK or Identity Preshared Key (iPSK) and Central Web Authentication

### Configuring WLAN

#### Procedure

	Command or Action	Purpose
<b>Step 1</b>	<b>configure terminal</b>  <b>Example:</b> Device# <code>configure terminal</code>	Enters global configuration mode.
<b>Step 2</b>	<b>wlan profile-name wlan-id SSID_Name</b>  <b>Example:</b> Device(config)# <code>wlan wlan-test 3 ssid-test</code>	Enters WLAN configuration sub-mode.  <ul style="list-style-type: none"> <li>• <i>profile-name</i> - Is the profile name of the configured WLAN.</li> <li>• <i>wlan-id</i> - Is the wireless LAN identifier. Range is from 1 to 512.</li> </ul>

	Command or Action	Purpose
		<ul style="list-style-type: none"> <li>• <i>SSID_Name</i> - Is the SSID which can contain 32 alphanumeric characters.</li> </ul> <p><b>Note</b> If you have already configured this command, enter <code>wlan profile-name</code> command.</p>
<b>Step 3</b>	<b>no security wpa akm dot1x</b>  <b>Example:</b> Device(config-wlan)# <code>no security wpa akm dot1x</code>	Disables security AKM for dot1x.
<b>Step 4</b>	<b>security wpa psk set-key ascii/hex key password</b>  <b>Example:</b> Device(config-wlan)# <code>security wpa psk set-key ascii 0 PASSWORD</code>	Configures the PSK AKM shared key.
<b>Step 5</b>	<b>mac-filtering auth-list-name</b>  <b>Example:</b> Device(config-wlan)# <code>mac-filtering test-auth-list</code>	Sets the MAC filtering parameters.

**Example**

```
wlan wlan-test 3 ssid-test
no security wpa akm dot1x
security wpa psk set-key ascii 0 PASSWORD
mac-filtering test-auth-list
```

**Applying Policy Profile to a WLAN****Procedure**

	Command or Action	Purpose
<b>Step 1</b>	<b>configure terminal</b>  <b>Example:</b> Device# <code>configure terminal</code>	Enters global configuration mode.
<b>Step 2</b>	<b>wireless profile policy policy-profile-name</b>  <b>Example:</b> Device(config)# <code>wireless profile policy policy-iot</code>	Configures the default policy profile.

	Command or Action	Purpose
Step 3	<b>aaa-override</b> <b>Example:</b> Device(config-wireless-policy) # <b>aaa-override</b>	Configures AAA override to apply policies coming from the AAA or ISE servers.
Step 4	<b>nac</b> <b>Example:</b> Device(config-wireless-policy) # <b>nac</b>	Configures NAC in the policy profile.
Step 5	<b>no shutdown</b> <b>Example:</b> Device(config-wireless-policy) # <b>no shutdown</b>	Shutdown the WLAN.
Step 6	<b>end</b> <b>Example:</b> Device(config-wireless-policy) # <b>end</b>	Returns to privileged EXEC mode.

**Example**

```
wireless profile policy policy-iot
aaa-override
nac
no shutdown
```

## Configure WLAN for Web Authentication on MAC Authentication Bypass Failure with Pre-Shared Key (CLI)

**Procedure**

	Command or Action	Purpose
Step 1	<b>configure terminal</b> <b>Example:</b> Device# <b>configure terminal</b>	Enters global configuration mode.
Step 2	<b>wlan <i>profile-name</i> <i>wlan-id</i> <i>SSID_Name</i></b> <b>Example:</b> Device(config)# <b>wlan wlan-test 3 ssid-test</b>	Enters WLAN configuration submenu. <ul style="list-style-type: none"> <li>• <i>profile-name</i>: Profile name of the configured WLAN.</li> <li>• <i>wlan-id</i>: Wireless LAN identifier. Range is from 1 to 512.</li> </ul>

	Command or Action	Purpose
		<ul style="list-style-type: none"> <li>• <i>SSID_Name</i>: SSID that can contain 32 alphanumeric characters.</li> </ul> <p><b>Note</b> If you have already configured this command, enter the <b>wlan profile-name</b> command.</p>
<b>Step 3</b>	<b>mac-filtering</b> <i>auth-list-name</i> <b>Example:</b> Device(config-wlan)# <b>mac-filtering test-auth-list</b>	Sets the MAC filtering parameters.
<b>Step 4</b>	<b>security wpa psk set-key</b> <i>ascii/hex key password</i> <b>Example:</b> Device(config-wlan)# <b>security wpa psk set-key ascii 0 PASSWORD</b>	Configures the PSK AKM shared key.
<b>Step 5</b>	<b>no security wpa akm dot1x</b> <b>Example:</b> Device(config-wlan)# <b>no security wpa akm dot1x</b>	Disables security AKM for dot1x.
<b>Step 6</b>	<b>security wpa akm psk</b> <b>Example:</b> Device(config-wlan)# <b>security wpa akm psk</b>	Configures PSK support.
<b>Step 7</b>	<b>security web-auth authentication-list</b> <i>authenticate-list-name</i> <b>Example:</b> Device(config-wlan)# <b>security web-auth authentication-list default</b>	Enables authentication list for dot1x security.
<b>Step 8</b>	<b>security web-auth authorization-list</b> <i>authorize-list-name</i> <b>Example:</b> Device(config-wlan)# <b>security web-auth authorization-list default</b>	Enables authorization list for dot1x security.
<b>Step 9</b>	<b>security web-auth on-macfilter-failure</b> <b>Example:</b> Device(config-wlan)# <b>security web-auth on-macfilter-failure</b>	Enables web authentication on MAC filter failure.
<b>Step 10</b>	<b>security web-auth parameter-map</b> <i>parameter-map-name</i>	Configures the parameter map.

	Command or Action	Purpose
	<b>Example:</b> Device(config-wlan)# <b>security web-auth parameter-map WLAN1_MAP</b>	<b>Note</b> If a parameter map is not associated with a WLAN, the configuration is considered from the global parameter map.
<b>Step 11</b>	<b>no shutdown</b>  <b>Example:</b> Device(config-wlan)# <b>no shutdown</b>	Enables the WLAN.

## Configure WLAN for Web Authentication on MAC Authentication Bypass Failure with OWE (CLI)

### Procedure

	Command or Action	Purpose
<b>Step 1</b>	<b>configure terminal</b>  <b>Example:</b> Device# <b>configure terminal</b>	Enters global configuration mode.
<b>Step 2</b>	<b>wlan profile-name wlan-id SSID_Name</b>  <b>Example:</b> Device(config)# <b>wlan wlan-test 3 ssid-test</b>	Enters WLAN configuration submode. <ul style="list-style-type: none"> <li>• <i>profile-name</i>: Profile name of the configured WLAN.</li> <li>• <i>wlan-id</i>: Wireless LAN identifier. Range is from 1 to 512.</li> <li>• <i>SSID_Name</i>: SSID that can contain 32 alphanumeric characters.</li> </ul> <b>Note</b> If you have already configured this command, enter the <b>wlan profile-name</b> command.
<b>Step 3</b>	<b>mac-filtering auth-list-name</b>  <b>Example:</b> Device(config-wlan)# <b>mac-filtering test-auth-list</b>	Sets the MAC filtering parameters.
<b>Step 4</b>	<b>no security wpa akm dot1x</b>  <b>Example:</b> Device(config-wlan)# <b>no security wpa akm dot1x</b>	Disables security AKM for dot1x.

	Command or Action	Purpose
<b>Step 5</b>	<b>security wpa wpa3</b> <b>Example:</b> Device(config-wlan)# security wpa wpa3	Enables WPA3 support.
<b>Step 6</b>	<b>security wpa akm owe</b> <b>Example:</b> Device(config-wlan)# security wpa akm owe	Enables WPA3 OWE support.
<b>Step 7</b>	<b>security web-auth authentication-list</b> <i>authenticate-list-name</i> <b>Example:</b> Device(config-wlan)# security web-auth authentication-list default	Enables authentication list for dot1x security.
<b>Step 8</b>	<b>security web-auth authorization-list</b> <i>authorize-list-name</i> <b>Example:</b> Device(config-wlan)# security web-auth authorization-list default	Enables authorization list for dot1x security.
<b>Step 9</b>	<b>security web-auth on-macfilter-failure</b> <b>Example:</b> Device(config-wlan)# security web-auth on-macfilter-failure	Enables web authentication on MAC filter failure.
<b>Step 10</b>	<b>security web-auth parameter-map</b> <i>parameter-map-name</i> <b>Example:</b> Device(config-wlan)# security web-auth parameter-map WLAN1_MAP	Configures the parameter map.  <b>Note</b> If a parameter map is not associated with a WLAN, the configuration is considered from the global parameter map.
<b>Step 11</b>	<b>no shutdown</b> <b>Example:</b> Device(config-wlan)# no shutdown	Enables the WLAN.

# Configure WLAN for Web Authentication on MAC Authentication Bypass Failure with Secure Agile Exchange (CLI)

## Procedure

	Command or Action	Purpose
<b>Step 1</b>	<b>configure terminal</b> <b>Example:</b> Device# <b>configure terminal</b>	Enters global configuration mode.
<b>Step 2</b>	<b>wlan profile-name wlan-id SSID_Name</b> <b>Example:</b> Device(config)# <b>wlan wlan-test 3 ssid-test</b>	Enters WLAN configuration submode.  <ul style="list-style-type: none"> <li>• <i>profile-name</i>: Profile name of the configured WLAN.</li> <li>• <i>wlan-id</i>: Wireless LAN identifier. Range is from 1 to 512.</li> <li>• <i>SSID_Name</i>: SSID that can contain 32 alphanumeric characters.</li> </ul> <p><b>Note</b> If you have already configured this command, enter the <b>wlan profile-name</b> command.</p>
<b>Step 3</b>	<b>mac-filtering auth-list-name</b> <b>Example:</b> Device(config-wlan)# <b>mac-filtering test-auth-list</b>	Sets the MAC filtering parameters.
<b>Step 4</b>	<b>no security wpa akm dot1x</b> <b>Example:</b> Device(config-wlan)# <b>no security wpa akm dot1x</b>	Disables security AKM for dot1x.
<b>Step 5</b>	<b>security wpa wpa3</b> <b>Example:</b> Device(config-wlan)# <b>security wpa wpa3</b>	Enables WPA3 support.
<b>Step 6</b>	<b>security wpa akm sae</b> <b>Example:</b> Device(config-wlan)# <b>security wpa akm sae</b>	Enables AKM SAE support.
<b>Step 7</b>	<b>security web-auth authentication-list authenticate-list-name</b>	Enables authentication list for dot1x security.

	Command or Action	Purpose
	<b>Example:</b> Device(config-wlan)# <b>security web-auth authentication-list default</b>	
<b>Step 8</b>	<b>security web-auth authorization-list authorize-list-name</b>  <b>Example:</b> Device(config-wlan)# <b>security web-auth authorization-list default</b>	Enables authorization list for dot1x security.
<b>Step 9</b>	<b>security web-auth on-macfilter-failure</b>  <b>Example:</b> Device(config-wlan)# <b>security web-auth on-macfilter-failure</b>	Enables web authentication on MAC filter failure.
<b>Step 10</b>	<b>security web-auth parameter-map parameter-map-name</b>  <b>Example:</b> Device(config-wlan)# <b>security web-auth parameter-map WLAN1_MAP</b>	Configures the parameter map.  <b>Note</b> If a parameter map is not associated with a WLAN, the configuration is considered from the global parameter map.
<b>Step 11</b>	<b>no shutdown</b>  <b>Example:</b> Device(config-wlan)# <b>no shutdown</b>	Enables the WLAN.

## Configuring 802.1x and Central Web Authentication on Controller (CLIs)

### Creating AAA Authentication

#### Procedure

	Command or Action	Purpose
<b>Step 1</b>	<b>configure terminal</b>  <b>Example:</b> Device# <b>configure terminal</b>	Enters global configuration mode.
<b>Step 2</b>	<b>aaa new-model</b>  <b>Example:</b> Device(config)# <b>aaa new-model</b>	Creates a AAA authentication model.



## Configuring AAA Server for External Authentication

### Procedure

	Command or Action	Purpose
<b>Step 1</b>	<b>configure terminal</b> <b>Example:</b> Device# configure terminal	Enters global configuration mode.
<b>Step 2</b>	<b>radius-server attribute wireless authentication call-station-id ap-name-ssid</b> <b>Example:</b> Device(config)# radius-server attribute wireless authentication call-station-id ap-name-ssid	Configures a call station identifier sent in the RADIUS authentication messages.
<b>Step 3</b>	<b>radius server <i>server-name</i></b> <b>Example:</b> Device(config)# radius server ISE2	Sets the RADIUS server.
<b>Step 4</b>	<b>address ipv4 <i>radius-server-ip-address</i></b> <b>Example:</b> Device(config-radius-server)# address ipv4 111.111.111.111	Specifies the RADIUS server address.
<b>Step 5</b>	<b>timeout <i>seconds</i></b> <b>Example:</b> Device(config-radius-server)# timeout 10	Specify the time-out value in seconds. The range is between 10 and 1000 seconds.
<b>Step 6</b>	<b>retransmit <i>number-of-retries</i></b> <b>Example:</b> Device(config-radius-server)# retransmit 10	Specify the number of retries to the server. The range is between 0 and 100.
<b>Step 7</b>	<b>key <i>key</i></b> <b>Example:</b> Device(config-radius-server)# key cisco	Specifies the authentication and encryption key used between the device and the key string RADIUS daemon running on the RADIUS server.  <i>key</i> covers the following: <ul style="list-style-type: none"> <li>• 0—Specifies unencrypted key.</li> <li>• 6—Specifies encrypted key.</li> <li>• 7—Specifies HIDDEN key.</li> <li>• Word—Unencrypted (cleartext) server key.</li> </ul>

	Command or Action	Purpose
<b>Step 8</b>	<b>exit</b> <b>Example:</b> Device(config-radius-server)# exit	Returns to the configuration mode.
<b>Step 9</b>	<b>aaa group server radius server-group</b> <b>Example:</b> Device(config)# aaa group server radius ISE2	Creates a RADIUS server-group identification.
<b>Step 10</b>	<b>server name server-name</b> <b>Example:</b> Device(config)# server name ISE2	Configures the server name.
<b>Step 11</b>	<b>radius-server deadtime time-in-minutes</b> <b>Example:</b> Device(config)# radius-server deadtime 5	<p>Defines the time in minutes when a server marked as DEAD is held in that state. Once the deadtime expires, the controller marks the server as UP (ALIVE) and notifies the registered clients about the state change. If the server is still unreachable after the state is marked as UP and if the DEAD criteria is met, then server is marked as DEAD again for the deadtime interval.</p> <p><i>time-in-mins</i>—Valid values range from 1 to 1440 minutes. Default value is zero. To return to the default value, use the <b>no radius-server deadtime</b> command.</p> <p>The <b>radius-server deadtime</b> command can be configured globally or per aaa group server level.</p> <p>You can use the <b>show aaa dead-criteria</b> or <b>show aaa servers</b> command to check for dead-server detection. If the default value is zero, deadtime is not configured.</p>

## Configuring AAA for Authentication

### Before you begin

Configure the RADIUS server and AAA group server.

**Procedure**

	Command or Action	Purpose
<b>Step 1</b>	<b>aaa authentication login</b> <b>Example:</b> Device# aaa authentication login ISE_GROUP group ISE2 local	Defines the authentication method at login.
<b>Step 2</b>	<b>aaa authentication dot1x</b> <b>Example:</b> Device(config)# aaa authentication network ISE_GROUP group ISE2 local	Defines the authentication method at dot1x.

## Configuring Accounting Identity List

**Before you begin**

Configure the RADIUS server and AAA group server.

**Procedure**

	Command or Action	Purpose
<b>Step 1</b>	<b>aaa accounting identity <i>named-list</i> start-stop group <i>server-group-name</i></b> <b>Example:</b> Device# aaa accounting identity ISE start-stop group ISE2	Enables accounting to send a start-record accounting notice when a client is authorized and a stop-record at the end.  <b>Note</b> You can also use the default list instead of the named list.

## Configuring AAA for Central Web Authentication

**Before you begin**

Configure the RADIUS server and AAA group server.

**Procedure**

	Command or Action	Purpose
<b>Step 1</b>	<b>aaa server radius dynamic-author</b> <b>Example:</b> Device# aaa server radius dynamic-author	Configures the Change of Authorization (CoA) on the controller.
<b>Step 2</b>	<b>client <i>client-ip-addr</i> server-key <i>key</i></b> <b>Example:</b>	Configures a server key for a RADIUS client.

	Command or Action	Purpose
	Device(config-locsvr-da-radius)# client 111.111.111.111 server-key ciscokey	

## Defining an Access Control List for Radius Server

### Procedure

	Command or Action	Purpose
<b>Step 1</b>	<b>configure terminal</b> <b>Example:</b> Device# configure terminal	Enters global configuration mode.
<b>Step 2</b>	<b>ip access-list extended redirect</b> <b>Example:</b> Device(config)# ip access-list extended redirect	The HTTP and HTTPS browsing does not work without authentication (per the other ACL) as ISE is configured to use a redirect ACL (named <b>redirect</b> ).
<b>Step 3</b>	<b>sequence-number deny icmp any</b> <b>Example:</b> Device(config-ext-nacl)# 10 deny icmp any	Specifies packets to reject according to the sequence number.  <b>Note</b> You must have the DHCP, DNS, and ISE servers in the reject sequences. Refer to <a href="#">Configuration Example to Define an Access Control List for Radius Server</a> , wherein the <i>111.111.111.111</i> refers to the IP address of the ISE server.
<b>Step 4</b>	<b>permit TCP any any eq web-address</b> <b>Example:</b> Device(config-ext-nacl)# permit TCP any any eq www	Redirects all HTTP or HTTPS access to the Cisco ISE login page.

## Configuration Example to Define an Access Control List for Radius Server

This example shows how to define an access control list for RADIUS server:

```
Device# configure terminal
Device(config-ext-nacl) # 10 deny icmp any
Device(config-ext-nacl) # 20 deny udp any any eq bootps
Device(config-ext-nacl) # 30 deny udp any any eq bootpc
Device(config-ext-nacl) # 40 deny udp any any eq domain
Device(config-ext-nacl) # 50 deny tcp any host 111.111.111.111 eq 8443
Device(config-ext-nacl) # 55 deny tcp host 111.111.111.111 eq 8443 any
Device(config-ext-nacl) # 40 deny udp any any eq domain
Device(config-ext-nacl) # end
```

## Configuring WLAN

### Procedure

	Command or Action	Purpose
<b>Step 1</b>	<b>configure terminal</b> <b>Example:</b> Device# configure terminal	Enters global configuration mode.
<b>Step 2</b>	<b>wlan wlan-name</b> <b>Example:</b> Device(config)# wlan wlan30	Enters WLAN configuration mode.
<b>Step 3</b>	<b>security dot1x authentication-list ISE_GROUP</b> <b>Example:</b> Device(config-wlan)# security dot1x authentication-list ISE_GROUP	Configures 802.1X for a WLAN.
<b>Step 4</b>	<b>no shutdown</b> <b>Example:</b> Device(config-wlan)# no shutdown	Enables the WLAN.

## Configuring Policy Profile

### Procedure

	Command or Action	Purpose
<b>Step 1</b>	<b>configure terminal</b> <b>Example:</b> Device# configure terminal	Enters global configuration mode.
<b>Step 2</b>	<b>wireless profile policy profile-name</b> <b>Example:</b> Device(config)# wireless profile policy wireless-profile1	Configures policy profile.
<b>Step 3</b>	<b>aaa-override</b> <b>Example:</b> Device(config-wireless-policy)# aaa-override	Configures AAA override to apply policies coming from the AAA or Cisco Identify Services Engine (ISE) server.
<b>Step 4</b>	<b>accounting-list list-name</b> <b>Example:</b>	Sets the accounting list for IEEE 802.1x.

	Command or Action	Purpose
	Device(config-wireless-policy)# accounting-list ISE	
<b>Step 5</b>	<b>ipv4 dhcp required</b>  <b>Example:</b> Device(config-wireless-policy)# ipv4 dhcp required	Configures DHCP parameters for WLAN.
<b>Step 6</b>	<b>nac</b>  <b>Example:</b> Device(config-wireless-policy)# nac	Configures Network Access Control (NAC) in the policy profile. NAC is used to trigger the Central Web Authentication (CWA).
<b>Step 7</b>	<b>vlan 25</b>  <b>Example:</b> Device(config-wireless-policy)# vlan 25	Configures guest VLAN profile.
<b>Step 8</b>	<b>no shutdown</b>  <b>Example:</b> Device(config-wireless-policy)# no shutdown	Enables policy profile.

## Mapping WLAN and Policy Profile to Policy Tag

### Procedure

	Command or Action	Purpose
<b>Step 1</b>	<b>configure terminal</b>  <b>Example:</b> Device# configure terminal	Enters global configuration mode.
<b>Step 2</b>	<b>wireless tag policy <i>policy-tag-name</i></b>  <b>Example:</b> Device(config-policy-tag)# wireless tag policy xx-xre-policy-tag	Configures policy tag and enters policy tag configuration mode.
<b>Step 3</b>	<b>wlan <i>wlan-name</i> policy <i>profile-policy-name</i></b>  <b>Example:</b> Device(config-policy-tag)# wlan wlan30 policy wireless-profile1	Maps a policy profile to a WLAN profile.
<b>Step 4</b>	<b>end</b>  <b>Example:</b> Device(config-policy-tag)# end	Saves the configuration and exits the configuration mode and returns to privileged EXEC mode.

# Configuring ISE for Central Web Authentication with Dot1x (GUI)

## Defining Guest Portal

### Before you begin

Define the guest portal or use the default guest portal.

### Procedure

---

- Step 1** Login to the Cisco Identity Services Engine (ISE).
  - Step 2** Choose **Work Centers > Guest Access > Portals & Components**.
  - Step 3** Click **Guest Portal**.
- 

## Defining Authorization Profile for a Client

### Before you begin

You can define the authorization profile to use guest portal and other additional parameters as per the requirement. Authorization profile redirects the client to the authentication portal. In the latest Cisco ISE version, Cisco\_Webauth authorization results exist already, and you can edit the same to modify the redirection ACL name to match the configuration in the controller.

### Procedure

---

- Step 1** Login to the Cisco Identity Services Engine (ISE).
  - Step 2** Choose **Policy > Policy Elements > Authorization > Authorization Profiles**.
  - Step 3** Click **Add** to create your own custom or edit the Cisco\_Webauth default result.
- 

## Defining Authentication Rule

### Procedure

---

- Step 1** Login to the Cisco Identity Services Engine (ISE).
- Step 2** Choose **Policy > Policy Sets** and click on the appropriate policy set.
- Step 3** Expand **Authentication** policy.

**Step 4** Expand **Options** and choose an appropriate **User ID**.

## Defining Authorization Rule

### Procedure

**Step 1** Login to the Cisco Identity Services Engine (ISE).

**Step 2** Choose **Policy > Policy Sets > Authorization Policy**.

**Step 3** Create a rule that matches the condition for 802.1x with a specific SSID (using Radius-Called-Station-ID).

**Note** You get to view the CWA redirect attribute.

**Step 4** Choose the already created authorization profile.

**Step 5** From the **Result/Profile** column, choose the already created authorization profile.

**Step 6** Click **Save**.

**Note** The following image depicts the working configuration sample for your reference.

**Figure 27: Working Configuration Sample**

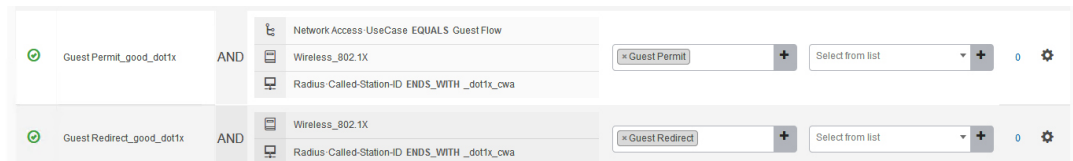

## Creating Rules to Match Guest Flow Condition

### Before you begin

You must create a second rule that matches the guest flow condition and returns to network access details once the user completes authentication in the portal.

### Procedure

**Step 1** Login to the Cisco Identity Services Engine (ISE).

**Step 2** Choose **Policy > Policy Sets > Authorization Policy**.

**Step 3** Create a rule that matches the condition for 802.1x with, Network Access-UseCase EQUALS Guest, and a specific SSID (using Radius-Called-Station-ID).

**Note** You get to view the Permit Access.

**Step 4** From the **Result/Profile** column, choose the already created authorization profile.



- Step 5** Choose the default or customized Permit Access.  
**Step 6** Click Save.

## Verifying Multiple Authentication Configurations

### Layer 2 Authentication

After L2 authentication (Dot1x) is complete, the client is moved to *Webauth Pending* state.

To verify the client state after L2 authentication, use the following commands:

```
Device# show wireless client summary
Number of Local Clients: 1
MAC Address  AP Name  WLAN  State  Protocol  Method  Role
-----
58ef.68b6.aa60  ewlc1_ap_1  3  Webauth Pending  11n(5)  Dot1x  Local
Number of Excluded Clients: 0

Device# show wireless client mac-address <mac_address> detail

Auth Method Status List

Method: Dot1x
Webauth State: Init
Webauth Method: Webauth
Local Policies:
Service Template: IP-Adm-V6-Int-ACL-global (priority 100)
URL Redirect ACL: IP-Adm-V6-Int-ACL-global
Service Template: IP-Adm-V4-Int-ACL-global (priority 100)
URL Redirect ACL: IP-Adm-V4-Int-ACL-global
Service Template: wlan_svc_default-policy-profile_local (priority 254)
Absolute-Timer: 1800
VLAN: 50

Device# show platform software wireless-client chassis active R0

      ID  MAC Address      WLAN  Client      State
-----
0xa0000003  58ef.68b6.aa60  3      L3      Authentication

Device# show platform software wireless-client chassis active F0

      ID      MAC Address      WLAN  Client      State  AOM ID      Status
-----
0xa0000003  58ef.68b6.aa60  3      L3      Authentication.      730.
Done

Device# show platform hardware chassis active qfp feature wireless wlclient cpp-client
summary

Client Type Abbreviations:
RG - REGULAR  BLE - BLE
HL - HALO     LI - LWFL INT

Auth State Abbreviations:
UK - UNKNOWN  IP - LEARN  IP IV - INVALID
L3 - L3 AUTH RN - RUN

Mobility State Abbreviations:
```

```

UK - UNKNOWN          IN - INIT
LC - LOCAL            AN - ANCHOR
FR - FOREIGN          MT - MTE
IV - INVALID

```

```

EoGRE Abbreviations:
N - NON EOGRE Y - EOGRE

```

```

CPP IF_H   DP IDX       MAC Address      VLAN   CT   MCVL AS MS E   WLAN      POA
-----
0X49      0XA0000003    58ef.68b6.aa60    50    RG    0   L3 LC N wlan-test 0x90000003

```

```

Device# show platform hardware chassis active qfp feature wireless wlclient datapath summary
Vlan  DP IDX       MAC Address      VLAN   CT   MCVL AS MS E   WLAN      POA
-----
0X49  0xa0000003    58ef.68b6.aa60    50    RG    0   L3 LC N wlan-test 0x90000003

```

### Layer 3 Authentication

Once L3 authentication is successful, the client is moved to *Run* state.

To verify the client state after L3 authentication, use the following commands:

```
Device# show wireless client summary
```

```

Number of Local Clients: 1
MAC Address  AP Name  WLAN  State  Protocol  Method  Role
-----
58ef.68b6.aa60  ewlcl_ap_1  3    Run    11n(5)   Web Auth  Local
Number of Excluded Clients: 0

```

```
Device# show wireless client mac-address 58ef.68b6.aa60 detail
```

```
Auth Method Status List
```

```

Method: Web Auth
Webauth State: Authz
Webauth Method: Webauth
Local Policies:
Service Template: wlan_svc_default-policy-profile_local (priority 254)
Absolute-Timer: 1800
VLAN: 50

```

```
Server Policies:
```

```

Resultant Policies:
VLAN: 50
Absolute-Timer: 1800

```

```
Device# show platform software wireless-client chassis active R0
```

```

ID          MAC Address      WLAN  Client State
-----
0xa0000001 58ef.68b6.aa60    3      Run

```

```
Device# show platform software wireless-client chassis active f0
```

```

ID          MAC Address      WLAN  Client State  AOM ID.  Status
-----
0xa0000001 58ef.68b6.aa60.  3      Run            11633    Done

```

```
Device# show platform hardware chassis active qfp feature wireless wlclient cpp-client
summary
```

Client Type Abbreviations:  
 RG - REGULAR BLE - BLE  
 HL - HALO LI - LWFL INT

Auth State Abbreviations:  
 UK - UNKNOWN IP - LEARN IP IV - INVALID  
 L3 - L3 AUTH RN - RUN

Mobility State Abbreviations:  
 UK - UNKNOWN IN - INIT  
 LC - LOCAL AN - ANCHOR  
 FR - FOREIGN MT - MTE  
 IV - INVALID

EOGRE Abbreviations:  
 N - NON EOGRE Y - EOGRE

CPP	IF_H	DP	IDX	MAC Address	VLAN	CT	MCVL	AS	MS	E	WLAN	POA
0X49		0XA0000003		58ef.68b6.aa60	50	RG	0	RN	LC	N	wlan-test	0x90000003

Device# show platform hardware chassis active qfp feature wireless wlclient datapath summary

Vlan	pal_if_hdl	mac	Input Uidb	Output Uidb
50	0xa0000003	58ef.68b6.aa60	95929	95927

### Verifying PSK+Webauth Configuration

Device# show wlan summary

Load for five secs: 0%/0%; one minute: 0%; five minutes: 0%  
 Time source is NTP, 12:08:32.941 CEST Tue Oct 6 2020

Number of WLANs: 1

ID Profile Name SSID Status Security

---

23 Gladius1-PSKWEBAUTH Gladius1-PSKWEBAUTH UP [WPA2] [PSK] [AES], [Web Auth]





## CHAPTER 103

# Wi-Fi Protected Access 3

- [Simultaneous Authentication of Equals, on page 907](#)
- [Opportunistic Wireless Encryption, on page 908](#)
- [Configuring SAE \(WPA3+WPA2 Mixed Mode\), on page 908](#)
- [Configuring WPA3 Enterprise \(GUI\), on page 909](#)
- [Configuring WPA3 Enterprise, on page 910](#)
- [Configuring the WPA3 OWE, on page 911](#)
- [Configuring WPA3 OWE Transition Mode \(GUI\), on page 912](#)
- [Configuring WPA3 OWE Transition Mode, on page 912](#)
- [Configuring WPA3 SAE \(GUI\), on page 914](#)
- [Configuring WPA3 SAE, on page 915](#)
- [Configuring Anti-Clogging and SAE Retransmission \(GUI\), on page 916](#)
- [Configuring Anti-Clogging and SAE Retransmission, on page 917](#)
- [Verifying WPA3 SAE and OWE, on page 918](#)

## Simultaneous Authentication of Equals

WPA3 is the latest version of Wi-Fi Protected Access (WPA), which is a suite of protocols and technologies that provide authentication and encryption for Wi-Fi networks.

WPA3 leverages Simultaneous Authentication of Equals (SAE) to provide stronger protections for users against password guessing attempts by third parties. SAE employs a discrete logarithm cryptography to perform an efficient exchange in a way that performs mutual authentication using a password that is probably resistant to an offline dictionary attack. An offline dictionary attack is where an adversary attempts to determine a network password by trying possible passwords without further network interaction.

WPA3-Personal brings better protection to individual users by providing more robust password-based authentication making the brute-force dictionary attack much more difficult and time-consuming, while WPA3-Enterprise provides higher grade security protocols for sensitive data networks.

When the client connects to the access point, they perform an SAE exchange. If successful, they will each create a cryptographically strong key, from which the session key will be derived. Basically a client and access point goes into phases of commit and then confirm. Once there is a commitment, the client and access point can then go into the confirm states each time there is a session key to be generated. The method uses forward secrecy, where an intruder could crack a single key, but not all of the other keys.

## Opportunistic Wireless Encryption

Opportunistic Wireless Encryption (OWE) is an extension to IEEE 802.11 that provides encryption of the wireless medium. The purpose of OWE based authentication is avoid open unsecured wireless connectivity between the AP's and clients. The OWE uses the Diffie-Hellman algorithms based Cryptography to setup the wireless encryption. With OWE, the client and AP perform a Diffie-Hellman key exchange during the access procedure and use the resulting pairwise secret with the 4-way handshake. The use of OWE enhances wireless network security for deployments where Open or shared PSK based networks are deployed.

## Configuring SAE (WPA3+WPA2 Mixed Mode)

Follow the procedure given below to configure WPA3+WPA2 mixed mode for SAE.

### Procedure

	Command or Action	Purpose
<b>Step 1</b>	<b>configure terminal</b> <b>Example:</b> Device# configure terminal	Enters global configuration mode.
<b>Step 2</b>	<b>wlan wlan-name wlan-id SSID-name</b> <b>Example:</b> Device(config)# wlan WPA3 1 WPA3	Enters the WLAN configuration sub-mode.
<b>Step 3</b>	<b>no security wpa akm dot1x</b> <b>Example:</b> Device(config-wlan)# no security wpa akm dot1x	Disables security AKM for dot1x.
<b>Step 4</b>	<b>no security ft over-the-ds</b> <b>Example:</b> Device(config-wlan)# no security ft over-the-ds	Disables fast transition over the data source on the WLAN.
<b>Step 5</b>	<b>no security ft</b> <b>Example:</b> Device(config-wlan)# no security ft	Disables 802.11r fast transition on the WLAN.
<b>Step 6</b>	<b>security wpa wpa2 ciphers aes</b> <b>Example:</b> Device(config-wlan)# security wpa wpa2 ciphers aes	Configures WPA2 cipher. <b>Note</b> You can check whether cipher is configured using <b>no security wpa wpa2 ciphers aes</b> command. If cipher is not reset, configure the cipher.

	Command or Action	Purpose
<b>Step 7</b>	<b>security wpa psk set-key ascii <i>value</i></b> <i>pre-shared-key</i>  <b>Example:</b> <pre>Device(config-wlan)# security wpa psk set-key ascii 0 Cisco123</pre>	Specifies a preshared key.
<b>Step 8</b>	<b>security wpa wpa3</b>  <b>Example:</b> <pre>Device(config-wlan)# security wpa wpa3</pre>	Enables WPA3 support.  <b>Note</b> If both WPA2 and WPA3 are supported (SAE and PSK together), it is optional to configure PMF. However, you cannot disable PMF. For WPA3, PMF is mandatory.
<b>Step 9</b>	<b>security wpa akm sae</b>  <b>Example:</b> <pre>Device(config-wlan)# security wpa akm sae</pre>	Enables AKM SAE support.
<b>Step 10</b>	<b>security wpa akm psk</b>  <b>Example:</b> <pre>Device(config-wlan)# security wpa akm psk</pre>	Enables AKM PSK support.
<b>Step 11</b>	<b>no shutdown</b>  <b>Example:</b> <pre>Device(config-wlan)# no shutdown</pre>	Enables the WLAN.
<b>Step 12</b>	<b>end</b>  <b>Example:</b> <pre>Device(config-wlan)# end</pre>	Returns to the privileged EXEC mode.

## Configuring WPA3 Enterprise (GUI)

### Procedure

- Step 1** Choose **Configuration > Tags & Profiles > WLANs**.
- Step 2** Click **Add**.
- Step 3** In the **General** tab, enter the **Profile Name**, the **SSID** and the **WLAN ID**.
- Step 4** Choose **Security > Layer2** tab. Choose **WPA2+WPA3** in **Layer 2 Security Mode** drop-down list.
- Step 5** Uncheck the **WPA2 Policy** and **802.1x** check boxes. Check the **WPA3 Policy** and **802.1x-SHA256** check boxes.
- Step 6** Choose **Security > AAA** tab, choose the Authentication List from the **Authentication List** drop-down list.

## Step 7 Click Apply to Device.

# Configuring WPA3 Enterprise

Follow the procedure given below to configure WPA3 enterprise.

### Procedure

	Command or Action	Purpose
<b>Step 1</b>	<b>configure terminal</b> <b>Example:</b> Device# configure terminal	Enters global configuration mode.
<b>Step 2</b>	<b>wlan wlan-name wlan-id SSID-name</b> <b>Example:</b> Device(config)# wlan wl-dot1x 4 wl-dot1x	Enters the WLAN configuration sub-mode.
<b>Step 3</b>	<b>no security wpa akm dot1x</b> <b>Example:</b> Device(config-wlan)# no security wpa akm dot1x	Disables security AKM for dot1x.
<b>Step 4</b>	<b>no security wpa wpa2</b> <b>Example:</b> Device(config-wlan)# no security wpa wpa2	Disables WPA2 security.
<b>Step 5</b>	<b>security wpa akm dot1x-sha256</b> <b>Example:</b> Device(config-wlan)# security wpa akm dot1x-sha256	Configures 802.1x support.
<b>Step 6</b>	<b>security wpa wpa3</b> <b>Example:</b> Device(config-wlan)# security wpa wpa3	Enables WPA3 support.
<b>Step 7</b>	<b>security dot1x authentication-list list-name</b> <b>Example:</b> Device(config-wlan)# security dot1x authentication-list ipv6_ircm_aaa_list	Configures security authentication list for dot1x security.
<b>Step 8</b>	<b>no shutdown</b> <b>Example:</b> Device(config-wlan)# no shutdown	Enables the WLAN.
<b>Step 9</b>	<b>end</b>	Returns to the privileged EXEC mode.



	Command or Action	Purpose
	<b>Example:</b> Device(config-wlan)# end	<b>Note</b> A WLAN configured with WPA3 enterprise (SUITEB192-1X) is not supported on C9115/C9120 APs.

## Configuring the WPA3 OWE

Follow the procedure given below to configure WPA3 OWE.

### Before you begin

Configure PMF internally. The associated ciphers configuration can use the WPA2 ciphers.

### Procedure

	Command or Action	Purpose
<b>Step 1</b>	<b>configure terminal</b> <b>Example:</b> Device# configure terminal	Enters global configuration mode.
<b>Step 2</b>	<b>wlan wlan-name wlan-id SSID-name</b> <b>Example:</b> Device(config)# wlan WPA3 1 WPA3	Enters the WLAN configuration sub-mode.
<b>Step 3</b>	<b>no security ft over-the-ds</b> <b>Example:</b> Device(config-wlan)# no security ft over-the-ds	Disables fast transition over the data source on the WLAN.
<b>Step 4</b>	<b>no security ft</b> <b>Example:</b> Device(config-wlan)# no security ft	Disables 802.11r fast transition on the WLAN.
<b>Step 5</b>	<b>no security wpa akm dot1x</b> <b>Example:</b> Device(config-wlan)# no security wpa akm dot1x	Disables security AKM for dot1x.
<b>Step 6</b>	<b>no security wpa wpa2</b> <b>Example:</b> Device(config-wlan)# no security wpa wpa2	Disables WPA2 security. PMF is disabled now.
<b>Step 7</b>	<b>security wpa wpa2 ciphers aes</b> <b>Example:</b>	Enables WPA2 ciphers for AES.

	Command or Action	Purpose
	Device (config-wlan) # security wpa wpa2 ciphers aes	<b>Note</b> The ciphers for WPA2 and WPA3 are common.
<b>Step 8</b>	<b>security wpa wpa3</b>  <b>Example:</b> Device (config-wlan) # security wpa wpa3	Enables WPA3 support.
<b>Step 9</b>	<b>security wpa akm owe</b>  <b>Example:</b> Device (config-wlan) # security wpa akm owe	Enables WPA3 OWE support.
<b>Step 10</b>	<b>no shutdown</b>  <b>Example:</b> Device (config-wlan) # no shutdown	Enables the WLAN.
<b>Step 11</b>	<b>end</b>  <b>Example:</b> Device (config-wlan) # end	Returns to the privileged EXEC mode.

## Configuring WPA3 OWE Transition Mode (GUI)

### Procedure

- 
- Step 1** Choose **Configuration > Tags & Profiles > WLANs**.
  - Step 2** Click **Add**.
  - Step 3** In the **General** tab, enter the **Profile Name**, the **SSID** and the **WLAN ID**.
  - Step 4** Choose **Security > Layer2** tab. Choose **WPA2+WPA3** in **Layer 2 Security Mode** drop-down list.
  - Step 5** Uncheck the **WPA2 Policy, 802.1x, Over the DS, FT + 802.1x** and **FT + PSK** check boxes. Check the **WPA3 Policy, AES** and **OWE** check boxes.
  - Step 6** Enter the **Transition Mode WLAN ID**.
  - Step 7** Click **Apply to Device**.
- 

## Configuring WPA3 OWE Transition Mode

Follow the procedure given below to configure the WPA3 OWE transition mode.



**Note** Policy validation is not done between open WLAN and OWE WLAN. The operator is expected to configure them appropriately.

### Procedure

	Command or Action	Purpose
<b>Step 1</b>	<b>configure terminal</b> <b>Example:</b> Device# configure terminal	Enters global configuration mode.
<b>Step 2</b>	<b>wlan wlan-name wlan-id SSID-name</b> <b>Example:</b> Device(config)# wlan WPA3 1 WPA3	Enters the WLAN configuration sub-mode.
<b>Step 3</b>	<b>no security wpa akm dot1x</b> <b>Example:</b> Device(config-wlan)# no security wpa akm dot1x	Disables security AKM for dot1x.
<b>Step 4</b>	<b>no security ft over-the-ds</b> <b>Example:</b> Device(config-wlan)# no security ft over-the-ds	Disables fast transition over the data source on the WLAN.
<b>Step 5</b>	<b>no security ft</b> <b>Example:</b> Device(config-wlan)# no security ft	Disables 802.11r fast transition on the WLAN.
<b>Step 6</b>	<b>no security wpa wpa2</b> <b>Example:</b> Device(config-wlan)# no security wpa wpa2	Disables WPA2 security. PMF is disabled now.
<b>Step 7</b>	<b>security wpa wpa2 ciphers aes</b> <b>Example:</b> Device(config-wlan)# security wpa wpa2 ciphers aes	Enables WPA2 ciphers for AES.
<b>Step 8</b>	<b>security wpa wpa3</b> <b>Example:</b> Device(config-wlan)# security wpa wpa3	Enables WPA3 support.
<b>Step 9</b>	<b>security wpa akm owe</b> <b>Example:</b>	Enables WPA3 OWE support.

	Command or Action	Purpose
	Device(config-wlan)# security wpa akm owe	
<b>Step 10</b>	<b>security wpa transition-mode-wlan-id</b> <i>wlan-id</i>  <b>Example:</b> Device(config-wlan)# security wpa transition-mode-wlan-id 1	Configures the open or OWE transition mode WLAN ID.  <b>Note</b> Validation is not performed on the transition mode WLAN. The operator is expected to configure it correctly with OWE WLAN having open WLAN identifier and the opposite way.  You should configure OWE WLAN ID as transition mode WLAN in open WLAN. Similarly, open WLAN should be configured as transition mode WLAN in OWE WLAN configuration.
<b>Step 11</b>	<b>no shutdown</b>  <b>Example:</b> Device(config-wlan)# no shutdown	Enables the WLAN.
<b>Step 12</b>	<b>end</b>  <b>Example:</b> Device(config-wlan)# end	Returns to the privileged EXEC mode.

## Configuring WPA3 SAE (GUI)

### Procedure

- 
- Step 1** Choose **Configuration > Tags & Profiles > WLANs**.
  - Step 2** Click **Add**.
  - Step 3** In the **General** tab, enter the **Profile Name**, the **SSID** and the **WLAN ID**.
  - Step 4** Choose **Security > Layer2** tab. Choose **WPA2+WPA3** in **Layer 2 Security Mode** drop-down list.
  - Step 5** Uncheck the **WPAPolicy**, **802.1x**, **Over the DS**, **FT + 802.1x** and **FT + PSK** check boxes. Check the **WPA3 Policy**, **AES** and **PSK** check boxes. Enter the **Pre-Shared Key** and choose the PSK Format from the **PSK Format** drop-down list and the PSK Type from the **PSK Type** drop-down list.
  - Step 6** Click **Apply to Device**.
-

# Configuring WPA3 SAE

Follow the procedure given below to configure WPA3 SAE.

## Before you begin

Configure PMF internally. The associated ciphers configuration can use the WPA2 ciphers.

## Procedure

	Command or Action	Purpose
<b>Step 1</b>	<b>configure terminal</b> <b>Example:</b> Device# configure terminal	Enters global configuration mode.
<b>Step 2</b>	<b>wlan wlan-name wlan-id SSID-name</b> <b>Example:</b> Device(config)# wlan WPA3 1 WPA3	Enters the WLAN configuration sub-mode.
<b>Step 3</b>	<b>no security wpa akm dot1x</b> <b>Example:</b> Device(config-wlan)# no security wpa akm dot1x	Disables security AKM for dot1x.
<b>Step 4</b>	<b>no security ft over-the-ds</b> <b>Example:</b> Device(config-wlan)# no security ft over-the-ds	Disables fast transition over the data source on the WLAN.
<b>Step 5</b>	<b>no security ft</b> <b>Example:</b> Device(config-wlan)# no security ft	Disables 802.11r fast transition on the WLAN.
<b>Step 6</b>	<b>no security wpa wpa2</b> <b>Example:</b> Device(config-wlan)# no security wpa wpa2	Disables WPA2 security. PMF is disabled now.
<b>Step 7</b>	<b>security wpa wpa2 ciphers aes</b> <b>Example:</b> Device(config-wlan)# security wpa wpa2 ciphers aes	Configures WPA2 cipher. <b>Note</b> You can check whether cipher is configured using <b>no security wpa wpa2 ciphers aes</b> command. If cipher is not reset, configure the cipher.
<b>Step 8</b>	<b>security wpa psk set-key ascii value</b> <i>preshared-key</i>	Specifies a preshared key.

	Command or Action	Purpose
	<b>Example:</b> Device(config-wlan)# security wpa psk set-key ascii 0 Cisco123	
<b>Step 9</b>	<b>security wpa wpa3</b>  <b>Example:</b> Device(config-wlan)# security wpa wpa3	Enables WPA3 support.  <b>Note</b> If both WPA2 and WPA3 are supported (SAE and PSK together), it is optional to configure PMF. However, you cannot disable PMF. For WPA3, PMF is mandatory.
<b>Step 10</b>	<b>security wpa akm sae</b>  <b>Example:</b> Device(config-wlan)# security wpa akm sae	Enables AKM SAE support.
<b>Step 11</b>	<b>no shutdown</b>  <b>Example:</b> Device(config-wlan)# no shutdown	Enables the WLAN.
<b>Step 12</b>	<b>end</b>  <b>Example:</b> Device(config-wlan)# end	Returns to the privileged EXEC mode.

## Configuring Anti-Clogging and SAE Retransmission (GUI)

### Procedure

- 
- Step 1** Choose **Configuration > Tags & Profiles > WLANs**.
  - Step 2** Click **Add**.
  - Step 3** In the **General** tab, enter the **Profile Name**, the **SSID** and the **WLAN ID**.
  - Step 4** Enable or disable **Status** and **Broadcast SSID** toggle buttons.
  - Step 5** From the **Radio Policy** drop-down list, choose a policy.
  - Step 6** Choose **Security > Layer2** tab. Check the **SAE** check box.
  - Step 7** Enter the **Anti Clogging Threshold**, **Max Retries** and **Retransmit Timeout**.
  - Step 8** Click **Apply to Device**.
-

# Configuring Anti-Clogging and SAE Retransmission

Follow the procedure given below to configure anti-clogging and SAE retransmission.



**Note** If the simultaneous SAE ongoing sessions are more than the configured anti-clogging threshold, then anti-clogging mechanism is triggered.

## Before you begin

Ensure that SAE WLAN configuration is in place, as the steps given below are incremental in nature, in addition to the SAE WLAN configuration.

## Procedure

	Command or Action	Purpose
<b>Step 1</b>	<b>configure terminal</b> <b>Example:</b> Device# configure terminal	Enters global configuration mode.
<b>Step 2</b>	<b>wlan wlan-name wlan-id SSID-name</b> <b>Example:</b> Device(config)# wlan WPA3 1 WPA3	Enters the WLAN configuration sub-mode.
<b>Step 3</b>	<b>shutdown</b> <b>Example:</b> Device(config-wlan)# no shutdown	Disables the WLAN.
<b>Step 4</b>	<b>security wpa akm sae</b> <b>Example:</b> Device(config-wlan)# security wpa akm sae	Enables simultaneous authentication of equals as a security protocol.
<b>Step 5</b>	<b>security wpa akm sae anti-clogging-threshold threshold</b> <b>Example:</b> Device(config-wlan)# security wpa akm sae anti-clogging-threshold 2000	Configures threshold on the number of open sessions to trigger the anti-clogging procedure for new sessions.
<b>Step 6</b>	<b>security wpa akm sae max-retries retry-limit</b> <b>Example:</b> Device(config-wlan)# security wpa akm sae max-retries 10	Configures the maximum number of retransmissions.

	Command or Action	Purpose
<b>Step 7</b>	<b>security wpa akm sae retransmit-timeout</b> <i>retransmit-timeout-limit</i>  <b>Example:</b> Device(config-wlan)# security wpa akm sae retransmit-timeout 500	Configures SAE message retransmission timeout value.
<b>Step 8</b>	<b>no shutdown</b>  <b>Example:</b> Device(config-wlan)# no shutdown	Enables the WLAN.
<b>Step 9</b>	<b>end</b>  <b>Example:</b> Device(config-wlan)# end	Returns to the privileged EXEC mode.

## Verifying WPA3 SAE and OWE

To view the system level statistics for the client that has undergone successful SAE authentication, SAE authentication failures, SAE ongoing sessions, SAE commit and confirm message exchanges, use the following show command:

```
Device# show wireless stats client detail
```

```
Total Number of Clients : 0
```

```
client global statistics:
```

```
-----
Total association requests received      : 0
Total association attempts                : 0
Total FT/LocalAuth requests              : 0
Total association failures                : 0
Total association response accepts        : 0
Total association response rejects        : 0
Total association response errors         : 0
Total association failures due to blacklist : 0
Total association drops due to multicast mac : 0
Total association drops due to throttling : 0
Total association drops due to unknown bssid : 0
Total association drops due to parse failure : 0
Total association drops due to other reasons : 0
Total association requests wired clients  : 0
Total association drops wired clients     : 0
Total association success wired clients   : 0
Total peer association requests wired clients : 0
Total peer association drops wired clients : 0
Total peer association success wired clients : 0
Total 11r ft authentication requests received : 0
Total 11r ft authentication response success : 0
Total 11r ft authentication response failure : 0
Total 11r ft action requests received     : 0
Total 11r ft action response success      : 0
Total 11r ft action response failure      : 0
Total AID allocation failures             : 0
Total AID free failures                   : 0
```



```

Total roam attempts : 0
  Total CCKM roam attempts : 0
  Total 11r roam attempts : 0
  Total 11i fast roam attempts : 0
  Total 11i slow roam attempts : 0
  Total other roam type attempts : 0
Total roam failures in dot11 : 0

Total WPA3 SAE attempts : 0
Total WPA3 SAE successful authentications : 0
Total WPA3 SAE authentication failures : 0
  Total incomplete protocol failures : 0
Total WPA3 SAE commit messages received : 0
Total WPA3 SAE commit messages rejected : 0
  Total unsupported group rejections : 0
Total WPA3 SAE commit messages sent : 0
Total WPA3 SAE confirm messages received : 0
Total WPA3 SAE confirm messages rejected : 0
  Total WPA3 SAE confirm message field mismatch : 0
  Total WPA3 SAE confirm message invalid length : 0
Total WPA3 SAE confirm messages sent : 0
Total WPA3 SAE Open Sessions : 0
Total SAE Message drops due to throttling : 0

Total Flexconnect local-auth roam attempts : 0
  Total AP 11i fast roam attempts : 0
  Total 11i slow roam attempts : 0

Total client state starts : 0
Total client state associated : 0
Total client state l2auth success : 0
Total client state l2auth failures : 0
Total blacklisted clients on dot1xauth failure : 0
Total client state mab attempts : 0
Total client state mab failed : 0
Total client state ip learn attempts : 0
Total client state ip learn failed : 0
Total client state l3 auth attempts : 0
Total client state l3 auth failed : 0
Total client state session push attempts : 0
Total client state session push failed : 0
Total client state run : 0
Total client deleted : 0

```

To view the WLAN summary details, use the following command.

```
Device# show wlan summary
```

```
Number of WLANs: 3
```

ID	Profile Name	SSID	Status	Security
1	wlan-demo	ssid-demo	DOWN	[WPA3] [SAE] [AES]
3	CR1_SSID_mab-ext-radius [WPA2] [802.1x] [AES]	CR1_SSID_mab-ext-radius	DOWN	
109	guest-wlan1 [WPA2] [802.1x] [AES], [Web Auth]	docssid	DOWN	

To view the WLAN properties (WPA2 and WPA3 mode) based on the WLAN ID, use the following command.

```
Device# show wlan id 1

WLAN Profile Name      : wlan-demo
=====
Identifier              : 1

!
!
!
Security
  802.11 Authentication      : Open System
  Static WEP Keys           : Disabled
  Wi-Fi Protected Access (WPA/WPA2/WPA3) : Enabled
    WPA (SSN IE)            : Disabled
    WPA2 (RSN IE)           : Disabled
    WPA3 (WPA3 IE)         : Enabled
      AES Cipher            : Enabled
      CCMP256 Cipher        : Disabled
      GCMP128 Cipher        : Disabled
      GCMP256 Cipher        : Disabled
  Auth Key Management
    802.1x                   : Disabled
    PSK                      : Disabled
    CCKM                     : Disabled
    FT dot1x                 : Disabled
    FT PSK                   : Disabled
    Dot1x-SHA256             : Disabled
    PSK-SHA256               : Disabled
    SAE                      : Enabled
    OWE                      : Disabled
    SUITEB-1X                : Disabled
    SUITEB192-1X            : Disabled
  CCKM TSF Tolerance        : 1000
  OSEN                      : Disabled
  FT Support                : Adaptive
    FT Reassociation Timeout : 20
    FT Over-The-DS mode      : Enabled
  PMF Support               : Required
    PMF Association Comeback Timeout : 1
    PMF SA Query Time        : 200
  Web Based Authentication  : Disabled
  Conditional Web Redirect  : Disabled
  Splash-Page Web Redirect  : Disabled
  Webauth On-mac-filter Failure : Disabled
  Webauth Authentication List Name : Disabled
  Webauth Authorization List Name : Disabled
  Webauth Parameter Map     : Disabled

!
!
!
```

To view the correct AKM for the client that has undergone SAE authentication, use the following command.

```
Device# show wireless client mac-address <e0ca.94c9.6be0> detail

Client MAC Address : e0ca.94c9.6be0
!
!
!
Wireless LAN Name: WPA3

!
```

```
!  
!  
Policy Type : WPA3  
Encryption Cipher : CCMP (AES)  
Authentication Key Management : SAE  
!  
!  
!
```

To view the correct AKM for the client that has undergone OWE authentication, use the following command.

```
Device# show wireless client mac-address <e0ca.94c9.6be0> detail
```

```
Client MAC Address : e0ca.94c9.6be0  
!  
!  
!  
Wireless LAN Name: WPA3
```

```
!  
!  
!  
Policy Type : WPA3  
Encryption Cipher : CCMP (AES)  
Authentication Key Management : OWE  
!  
!  
!
```

To view the list of PMK cache stored locally, use the following command.

```
Device# show wireless pmk-cache
```

```
Number of PMK caches in total : 0
```

Type	Station	Entry Lifetime	VLAN Override	IP Override
Audit-Session-Id		Username		





## CHAPTER 104

# IP Source Guard

---

- [Information About IP Source Guard, on page 923](#)
- [Configuring IP Source Guard \(GUI\), on page 923](#)
- [Configuring IP Source Guard, on page 924](#)

## Information About IP Source Guard

IP Source Guard (IPSG) is a Layer 2 security feature in the Cisco Catalyst 9800 Series Wireless Controller . It supports both IPv4 and IPv6 wireless clients.

The IPSG feature prevents the wireless controller from forwarding the packets, with the source IP addresses that are not known to it. This security feature is not enabled by default and has to be explicitly configured. It is enabled on a per WLAN basis, and all the wireless clients joining that WLAN inherits this feature.

The wireless controller maintains an IP/MAC pair binding table for the IPSG feature. Using this table, the wireless controller keeps track of IP and MAC address combination (binding) information for all the wireless clients. This binding information is captured as part of the IP learning process. When the feature is enabled on a WLAN, the wireless controller forwards the incoming packets (from the wireless clients) only if it finds a matching binding table entry corresponding to the source IP and MAC address combination of those packets. Otherwise, the packets are dropped.

## Configuring IP Source Guard (GUI)

### Procedure

---

- Step 1** Choose **Configuration > Tags & Profiles > WLANs**.
  - Step 2** Click the WLAN.
  - Step 3** In the **Advanced** tab, check the **IP Source Guard** checkbox.
  - Step 4** Click **Update & Apply to Device**.
-

# Configuring IP Source Guard

Follow the procedure given below to configure IPSG:

## Before you begin

Cisco Catalyst 9800 Series Wireless Controller supports only one IPv4 address for a client and up to 8 IPv6 addresses (including link local addresses) per client.

## Procedure

	Command or Action	Purpose
<b>Step 1</b>	<b>wlan profile-name wlan-id ssid</b>  <b>Example:</b> Device(config)# wlan mywlan 34 mywlan-ssid	Specifies the WLAN name and ID to use.  <b>Note</b> If a WLAN is not already configured, this step creates the WLAN.
<b>Step 2</b>	<b>shutdown</b>  <b>Example:</b> Device(config-wlan)# shutdown	Disables the WLAN.
<b>Step 3</b>	<b>ip verify source mac-check</b>  <b>Example:</b> Device(config-wlan)# ip verify source mac-check	Enables the IP Source Guard feature.
<b>Step 4</b>	<b>no shutdown</b>  <b>Example:</b> Device(config-wlan)# no shutdown	Enables the WLAN.



## CHAPTER 105

### 802.11w

---

- [Information About 802.11w, on page 925](#)
- [Prerequisites for 802.11w, on page 928](#)
- [Restrictions for 802.11w, on page 928](#)
- [How to Configure 802.11w, on page 929](#)
- [Disabling 802.11w, on page 930](#)
- [Monitoring 802.11w, on page 931](#)

### Information About 802.11w

Wi-Fi is a broadcast medium that enables any device to eavesdrop and participate either as a legitimate or rogue device. Management frames such as authentication, de-authentication, association, disassociation, beacons, and probes are used by wireless clients to initiate and tear down sessions for network services. Unlike data traffic, which can be encrypted to provide a level of confidentiality, these frames must be heard and understood by all clients and therefore must be transmitted as open or unencrypted. While these frames cannot be encrypted, they must be protected from forgery to protect the wireless medium from attacks. For example, an attacker could spoof management frames from an AP to attack a client associated with the AP.

The 802.11w protocol applies only to a set of robust management frames that are protected by the Protected Management Frames (PMF) service. These include Disassociation, De-authentication, and Robust Action frames.

Management frames that are considered as robust action and therefore protected are the following:

- Spectrum Management
- QoS
- DLS
- Block Ack
- Radio Measurement
- Fast BSS Transition
- SA Query
- Protected Dual of Public Action
- Vendor-specific Protected

When 802.11w is implemented in the wireless medium, the following occur:

- Client protection is added by the AP adding cryptographic protection to de-authentication and disassociation frames preventing them from being spoofed in a DOS attack.
- Infrastructure protection is added by adding a Security Association (SA) tear down protection mechanism consisting of an Association Comeback Time and an SA-Query procedure preventing spoofed association request from disconnecting an already connected client.

802.11w has introduced a new IGTK Key, which is used to protect broadcast/multicast robust management frames:

- IGTK is a random value assigned by the authenticator STA (WLC) and used to protect MAC management protocol data units (MMPDUs) from that source STA.

When Management Frame Protection is negotiated, the AP encrypts the GTK and IGTK values in the EAPOL-Key frame, which is delivered in Message 3 of 4-way handshake.

**Figure 28: IGTK Exchange in 4-way Handshake**

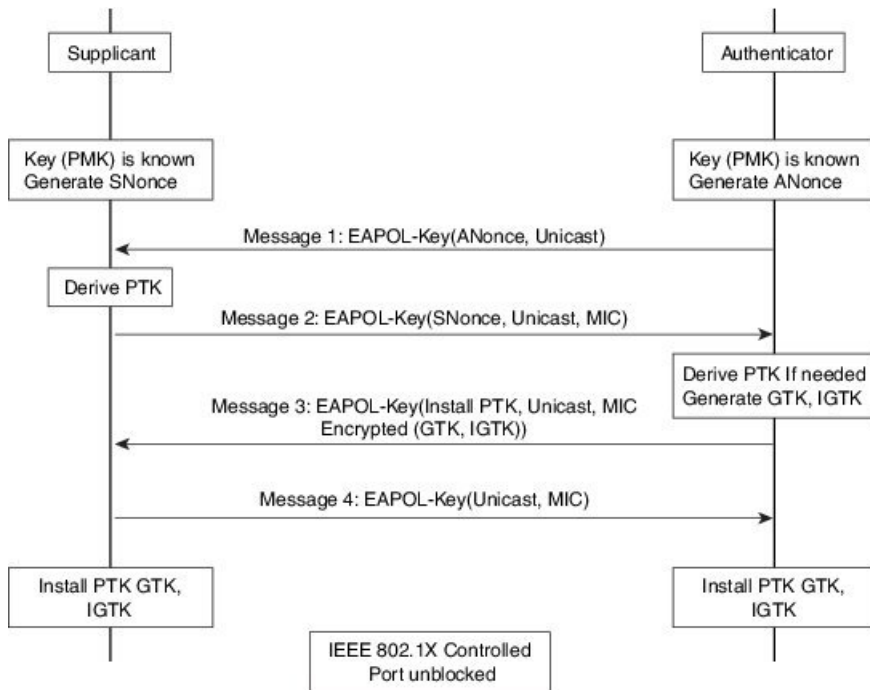

- If the AP later changes the GTK, it sends the new GTK and IGTK to the client using the Group Key Handshake .

802.11w defines a new Broadcast/Multicast Integrity Protocol (BIP) that provides data integrity and replay protection for broadcast/multicast robust management frames after successful establishment of an IGTKSA - It adds a MIC that is calculated using the shared IGTK key.



### 802.11w Information Elements (IEs)

Figure 29: 802.11w Information Elements

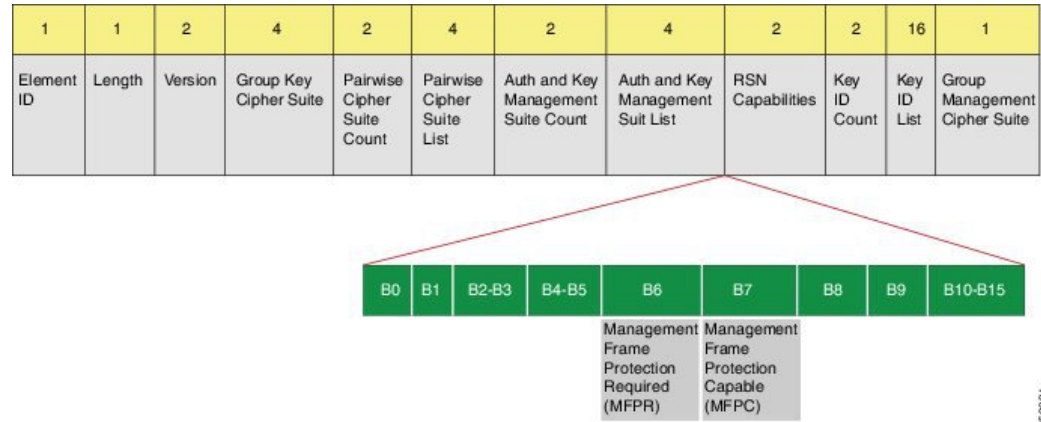

1. Modifications made in the RSN capabilities field of RSNIE.
  - a. Bit 6: Management Frame Protection Required (MFPR)
  - b. Bit 7: Management Frame Protection Capable (MFPC)
2. Two new AKM Suites, 5 and 6 are added for AKM Suite Selectors.
3. New Cipher Suite with type 6 is added to accommodate BIP.

The WLC adds this modified RSNIE in association and re-association responses and the APs add this modified RSNIE in beacons and probe responses.

The following Wireshark captures shows the RSNIE capabilities and the Group Management Cipher Suite elements.

Figure 30: 802.11w Information Elements

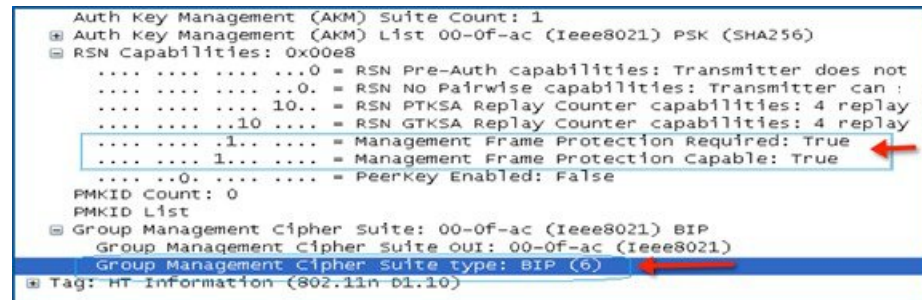

### Security Association (SA) Teardown Protection

SA teardown protection is a mechanism to prevent replay attacks from tearing down the session of an existing client. It consists of an Association Comeback Time and an SA-Query procedure preventing spoofed association requests from disconnecting an already connected client.

If a client has a valid security association, and has negotiated 802.11w, the AP shall reject another Association Request with status code 30. This status code stands for "Association request rejected temporarily; Try again later". The AP should not tear down or otherwise modify the state of the existing association until the SA-Query

procedure determines that the original SA is invalid and shall include in the Association Response an Association Comeback Time information element, specifying a comeback time when the AP would be ready to accept an association with this client.

The following capture shows the Association Reject message with status code 0x1e (30) and the Association comeback time set to 10 seconds.

**Figure 31: Association Reject with Comeback Time**

```

IEEE 802.11 wireless LAN management frame
  Fixed parameters (6 bytes)
    Capabilities Information: 0x0001
    status code: Association request rejected temporarily; try again later (0x001e)
    ..00 0000 0000 0000 = Association ID: 0x0000
  Tagged parameters (95 bytes)
    Tag: Supported Rates 6(B), 9, 12(B), 18, 24(B), 36, 48, 54, [Mbit/sec]
    Tag: HT Capabilities (802.11n D1.10)
    Tag: HT Information (802.11n D1.10)
    Tag: Vendor Specific: Microsoft: WMM/WME: Parameter Element
    Tag: Timeout Interval
      Tag Number: Timeout Interval (56)
      Tag length: 5
      Timeout Interval Type: Association Comeback time (TUS) (3)
      Timeout Interval value: 10000
  
```

Following this, if the AP is not already engaged in an SA Query with the client, the AP shall issue an SA Query until a matching SA Query response is received or the Association Comeback time expires. An AP may interpret reception of a valid protected frame as an indication of a successfully completed SA Query.

If a SA QUERY response with a matching transaction identifier within the time period, the AP shall allow the association process to be started without starting additional SA Query procedures.

## Prerequisites for 802.11w

- To configure 802.11w feature for optional and mandatory, you must have WPA and AKM configured.



**Note** The RNS (Robust Secure Network) IE must be enabled with an AES Cipher.

## Restrictions for 802.11w

- 802.11w cannot be applied on an open WLAN, WEP-encrypted WLAN, or a TKIP-encrypted WLAN.
- Cisco Catalyst 9800 Series Wireless Controller supports 802.11w + PMF combination for non-Apple clients. But Apple iOS version 11 and earlier require fix from the Apple iOS side to resolve the association issues.
- The controller will ignore disassociation or deauthentication frames sent by the clients if they are not using 802.11w PMF. The client entry will only get deleted immediately upon reception of such a frame if the client uses PMF. This is to avoid denial of service by malicious device since there is no security on those frames without PMF.

# How to Configure 802.11w

## Configuring 802.11w (GUI)

### Before you begin

WPA and AKM must be configured.

### Procedure

- 
- Step 1** Choose **Configuration > Tags & Profiles > WLANs**.
- Step 2** Click **Add** to create WLANs.  
The **Add WLAN** page is displayed.
- Step 3** In the **Security > Layer2** tab, navigate to the **Protected Management Frame** section.
- Step 4** Choose **PMF** as *Disabled*, *Optional*, or *Required*. By default, the PMF is *disabled*.  
If you choose **PMF** as *Optional* or *Required*, you get to view the following fields:
- **Association Comeback Timer**—Enter a value between 1 and 10 seconds to configure 802.11w association comeback time.
  - **SA Query Time**—Enter a value between 100 to 500 (milliseconds). This is required for clients to negotiate 802.11w PMF protection on a WLAN.
- Step 5** Click **Save & Apply to Device**.
- 

## Configuring 802.11w (CLI)

### Before you begin

WPA and AKM must be configured.

### Procedure

	Command or Action	Purpose
<b>Step 1</b>	<b>configure terminal</b> <b>Example:</b> Device# configure terminal	Enters global configuration mode.
<b>Step 2</b>	<b>wlan profile-name wlan-id ssid</b> <b>Example:</b> Device(config)# wlan wlan-test 12 alpha	Configures a WLAN and enters configuration mode.

	Command or Action	Purpose
<b>Step 3</b>	<b>security wpa akm dot1x-sha256</b> <b>Example:</b> Device(config-wlan)#security wpa akm dot1x-sha256	Configures 802.1x support.
<b>Step 4</b>	<b>security pmf association-comeback comeback-interval</b> <b>Example:</b> Device(config-wlan)# security pmf association-comeback 10	Configures the 802.11w association comeback time.
<b>Step 5</b>	<b>security pmf mandatory</b> <b>Example:</b> Device(config-wlan)# security pmf mandatory	Requires clients to negotiate 802.11w PMF protection on a WLAN.
<b>Step 6</b>	<b>security pmf saquery-retry-time timeout</b> <b>Example:</b> Device(config-wlan)# security pmf saquery-retry-time 100	Time interval identified in milliseconds before which the SA query response is expected. If the device does not get a response, another SQ query is tried.

## Disabling 802.11w

### Procedure

	Command or Action	Purpose
<b>Step 1</b>	<b>configure terminal</b> <b>Example:</b> Device# configure terminal	Enters global configuration mode.
<b>Step 2</b>	<b>wlan profile-name wlan-id ssid</b> <b>Example:</b> Device(config)# wlan wlan-test 12 alpha	Configures a WLAN and enters configuration mode.
<b>Step 3</b>	<b>no security wpa akm dot1x-sha256</b> <b>Example:</b> Device(config-wlan)# no security wpa akm dot1x-sha256	Disables 802.1x support.
<b>Step 4</b>	<b>no security pmf association-comeback comeback-interval</b> <b>Example:</b> Device(config-wlan)# no security pmf association-comeback 10	Disables the 802.11w association comeback time.

	Command or Action	Purpose
<b>Step 5</b>	<b>no security pmf mandatory</b> <b>Example:</b> Device(config-wlan)# no security pmf mandatory	Disables client negotiation of 802.11w PMF protection on a WLAN.
<b>Step 6</b>	<b>no security pmf saquery-retry-time timeout</b> <b>Example:</b> Device(config-wlan)# no security pmf saquery-retry-time 100	Disables SQ query retry.

## Monitoring 802.11w

Use the following commands to monitor 802.11w.

### Procedure

#### Step 1 **show wlan name** *wlan-name*

Displays the WLAN parameters on the WLAN. The PMF parameters are displayed.

```

. . . . .
. . . . .
Auth Key Management
    802.1x : Disabled
    PSK : Disabled
    CCKM : Disabled
    FT dot1x : Disabled
    FT PSK : Disabled
    FT SAE : Disabled
    Dot1x-SHA256 : Enabled
    PSK-SHA256 : Disabled
    SAE : Disabled
    OWE : Disabled
    SUITEB-1X : Disabled
    SUITEB192-1X : Disabled
CCKM TSF Tolerance : 1000
FT Support : Adaptive
    FT Reassociation Timeout : 20
    FT Over-The-DS mode : Enabled
PMF Support : Required
    PMF Association Comeback Timeout : 1
    PMF SA Query Time : 500
. . . . .
. . . . .

```

#### Step 2 **show wireless client mac-address** *mac-address detail*

Displays the summary of the 802.11w authentication key management configuration on a client.

```

. . . . .
. . . . .
Policy Manager State: Run

```

```
NPU Fast Fast Notified : No
Last Policy Manager State : IP Learn Complete
Client Entry Create Time : 497 seconds
Policy Type : WPA2
Encryption Cipher : CCMP (AES)
Authentication Key Management : 802.1x-SHA256
Encrypted Traffic Analytics : No
Management Frame Protection : No
Protected Management Frame - 802.11w : Yes
EAP Type : LEAP
VLAN : 39
Multicast VLAN : 0
Access VLAN : 39
Anchor VLAN : 0
WFD capable : No
Manged WFD capable : No
. . . .
. . . .
```

---



## CHAPTER 106

# Management Frame Protection

- [Information About Management Frame Protection](#), on page 933
- [Restrictions for Management Frame Protection](#), on page 934
- [Configuring Management Frame Protection \(CLI\)](#), on page 935
- [Verifying Management Frame Protection Settings](#), on page 935

## Information About Management Frame Protection

By default, 802.11 management frames are unauthenticated and hence not protected against spoofing. Infrastructure management frame protection (MFP) and 802.11w protected management frames (PMF) provide protection against such attacks.

### Infrastructure MFP

Infrastructure MFP protects management frames by detecting adversaries that are invoking denial-of-service attacks, flooding the network with associations and probes, interjecting as rogue APs, and affecting network performance by attacking the QoS and radio measurement frames. Infrastructure MFP is a global setting that provides a quick and effective means to detect and report phishing incidents.

Specifically, infrastructure MFP protects 802.11 session management functions by adding message integrity check information elements (MIC IEs) to the management frames emitted by APs (and not those emitted by clients), which are then validated by other APs in the network. Infrastructure MFP is passive, can detect and report intrusions but has no means to stop them.

Infrastructure MFP consists of three main components:

- **Management frame protection:** The AP protects the management frames it transmits by adding a MIC IE to each frame. Any attempt to copy, alter, or replay the frame invalidates the MIC, causing any receiving AP configured to detect MFP frames to report the discrepancy. MFP is supported for use with Cisco Aironet lightweight APs.
- **Management frame validation:** In infrastructure MFP, the AP validates every management frame that it receives from other APs in the network. It ensures that the MIC IE is present (when the originator is configured to transmit MFP frames) and matches the content of the management frame. If it receives any frame that does not contain a valid MIC IE from a BSSID belonging to an AP that is configured to transmit MFP frames, it reports the discrepancy to the network management system. In order for the timestamps to operate properly, all controllers must be Network Time Protocol (NTP) synchronized.

- **Event reporting:** The AP notifies the controller when it detects an anomaly, and the controller aggregates the received anomaly events and can report the results through SNMP traps to the network management system.

Infrastructure MFP is disabled by default, and you can enable it globally. When you upgrade from a previous software release, infrastructure MFP is disabled globally if you have enabled AP authentication because the two features are mutually exclusive. When you enable infrastructure MFP globally, signature generation (adding MICs to outbound frames) can be disabled for selected WLANs, and validation can be disabled for selected APs.



---

**Note** CCXv5 client MFP is no longer supported. Client MFP is enabled as optional by default on WLANs that are configured for WPA2. However, client MFP is not supported on Wave 2 APs or 802.11ax Wi-Fi6 APs, and there exist no clients that support CCXv5.

---

### Supported Access Point Models

Cisco MFP is supported on the following AP models:

- Cisco Aironet 2802, 3802, and 4802 series access points
- Cisco Aironet 2800, 3800, 4800, and 1560 series access points

### Unsupported Access Point Models

Cisco MFP is not supported on the following AP models:

- Cisco Aironet 1800 series access points
- Cisco 802.11ax access points
- All Cisco IOS access points

## Restrictions for Management Frame Protection

- Lightweight access points support infrastructure MFP in local and monitor modes and in FlexConnect mode when the access point is connected to a controller.
- Client MFP is supported for use only with CCXv5 clients using WPA2 with TKIP or AES-CCMP.
- Client MFP is not supported on Cisco Wave 1 APs and Cisco Wave 2 APs.
- 802.11ax access points do not support MFP.
- Non-CCXv5 clients may associate to a WLAN, if client MFP is disabled or optional.
- Error reports generated on a FlexConnect access point in standalone mode cannot be forwarded to the controller and are dropped.
- Keys are generated using random number generator but you can improve the keys by changing to SHA.
- MFP key for each BSSID is not supported.



## Configuring Management Frame Protection (CLI)

### Procedure

	Command or Action	Purpose
<b>Step 1</b>	<b>configure terminal</b>  <b>Example:</b> Device# configure terminal	Enters global configuration mode.
<b>Step 2</b>	<b>wireless wps mfp</b>  <b>Example:</b> Device(config)# wireless wps mfp	Configures a management frame protection.
<b>Step 3</b>	<b>wireless wps mfp {ap-impersonation   key-refresh-interval}</b>  <b>Example:</b> Device(config)# wireless wps mfp ap-impersonation  Device(config)# wireless wps mfp key-refresh-interval	Configures ap impersonation detection (or) MFP key refresh interval in hours.  key-refresh-interval—Refers to the MFP key refresh interval in hours. The valid range is from 1 to 24. Default value is 24.
<b>Step 4</b>	<b>end</b>  <b>Example:</b> Device(config)# end	Saves the configuration and exits configuration mode and returns to privileged EXEC mode.

## Verifying Management Frame Protection Settings

To verify if the Management Frame Protection (MFP) feature is enabled or not, use the following command:

```
Device# show wireless wps summary
Client Exclusion Policy
  Excessive 802.11-association failures : unknown
  Excessive 802.11-authentication failures: unknown
  Excessive 802.1x-authentication      : unknown
  IP-theft                             : unknown
  Excessive Web authentication failure  : unknown
  Failed Qos Policy                    : unknown

Management Frame Protection
  Global Infrastructure MFP state : Enabled
  AP Impersonation detection     : Disabled
  Key refresh interval           : 15
```

To view the MFP details, use the following command:

```
Device# show wireless wps mfp summary
Management Frame Protection
  Global Infrastructure MFP state : Enabled
```

```

AP Impersonation detection      : Disabled
Key refresh interval           : 15

```

To view the MFP statistics details, use the following command:

```

Device# show wireless wps mfp statistics
BSSID          Radio DetectorAP      LastSourceAddr Error          Count
  FrameTypes
aabb.ccdd.eeff a      AP3800          aabb.ccdd.eeff Invalid MIC    10
  Beacon, Probe Response
                                     Invalid MIC    20
  Beacon, Probe Response

```

To verify if access points support MFP validation and protection, use the following command:

```

Device# show wireless wps mfp ap summary
AP Name          Radio MAC          Validation          Protection
-----
AP002A.1087.CBF4 00a2.eefd.bdc0    Enabled            Enabled
AP58AC.78DE.9946 00a2.eeb8.4ae0    Enabled            Enabled
APb4de.3196.caac 4c77.6d83.6b90    Enabled            Enabled

```



## CHAPTER 107

# IPv4 ACLs

---

- [Information about Network Security with ACLs, on page 937](#)
- [Restrictions for Configuring IPv4 Access Control Lists, on page 945](#)
- [How to Configure ACLs, on page 946](#)
- [Configuration Examples for ACLs, on page 959](#)
- [Monitoring IPv4 ACLs, on page 963](#)

## Information about Network Security with ACLs

This chapter describes how to configure network security on the switch by using access control lists (ACLs), which in commands and tables are also referred to as access lists.

### ACL Overview

Packet filtering can help limit network traffic and restrict network use by certain users or devices. ACLs filter traffic as it passes through a controller and permit or deny packets crossing specified interfaces. An ACL is a sequential collection of permit and deny conditions that apply to packets. When a packet is received on an interface, the switch compares the fields in the packet against any applied ACLs to verify that the packet has the required permissions to be forwarded, based on the criteria specified in the access lists. One by one, it tests packets against the conditions in an access list. The first match decides whether the controller accepts or rejects the packets. Because the controller stops testing after the first match, the order of conditions in the list is critical. If no conditions match, the controller rejects the packet. If there are no restrictions, the controller forwards the packet; otherwise, the controller drops the packet. The controller can use ACLs on all packets it forwards. There is implicit any host deny deny rule.

You configure access lists on a controller to provide basic security for your network. If you do not configure ACLs, all packets passing through the switch could be allowed onto all parts of the network. You can use ACLs to control which hosts can access different parts of a network or to decide which types of traffic are forwarded or blocked at router interfaces. For example, you can allow e-mail traffic to be forwarded but not Telnet traffic.

### Access Control Entries

An ACL contains an ordered list of access control entries (ACEs). Each ACE specifies *permit* or *deny* and a set of conditions the packet must satisfy in order to match the ACE. The meaning of *permit* or *deny* depends on the context in which the ACL is used.



---

**Note** The maximum number of ACEs that can be applied under an access policy (ACL) for central switching is 256 ACEs. The maximum number of ACEs applicable for Flex Mode or Local Switching is 64 ACEs.

---

## ACL Supported Types

The switch supports IP ACLs and Ethernet (MAC) ACLs:

- IP ACLs filter IPv4 traffic, including TCP, User Datagram Protocol (UDP), Internet Group Management Protocol (IGMP), and Internet Control Message Protocol (ICMP).
- Ethernet ACLs filter non-IP traffic.

This switch also supports quality of service (QoS) classification ACLs.

## Supported ACLs

The controller supports three types of ACLs to filter traffic:

- Port ACLs access-control traffic entering a Layer 2 interface. You can apply port ACLs to a Layer 2 interface in each direction to each access list type — IPv4 and MAC.
- Router ACLs access-control routed traffic between VLANs and are applied to Layer 3 interfaces in a specific direction (inbound or outbound).
- FQDN ACL: FQDN ACL is encoded along with IPv6 ACL and sent to AP. FQDN ACL is always a custom ACL. AP does DNS snooping and sends the IPv4 and IPv6 addresses to the controller.

## ACL Precedence

When Port ACLs, and router ACLs are configured on the same switch, the filtering precedence, from greatest to least for ingress traffic is port ACL, and then router ACL. For egress traffic, the filtering precedence is router ACL, and then port ACL.

The following examples describe simple use cases:

- When an input router ACL and input port ACL exist in a switch virtual interface (SVI), incoming packets received on ports to which a port ACL is applied are filtered by the port ACL. Incoming routed IP packets received on ports are filtered by the router ACL. Other packets are not filtered.
- When an output router ACL and input port ACL exist in an SVI, incoming packets received on the ports to which a port ACL is applied are filtered by the port ACL. Outgoing routed IP packets are filtered by the router ACL. Other packets are not filtered.

## Port ACLs

- Standard IP access lists using source addresses
- Extended IP access lists using source and destination addresses and optional protocol type information
- MAC extended access lists using source and destination MAC addresses and optional protocol type information

The switch examines ACLs on an interface and permits or denies packet forwarding based on how the packet matches the entries in the ACL. In this way, ACLs control access to a network or to part of a network.

**Figure 32: Using ACLs to Control Traffic in a Network**

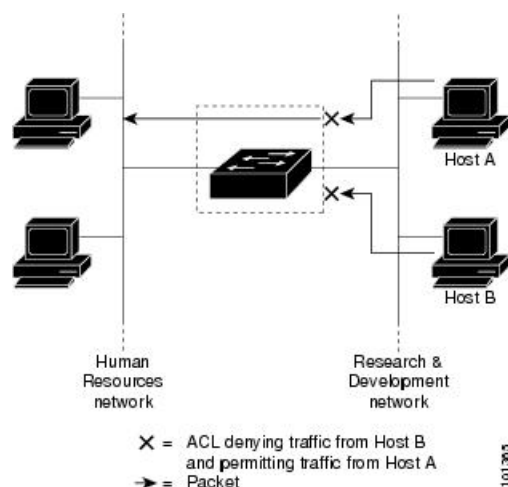

This is an example of using port ACLs to control access to a network when all workstations are in the same VLAN. ACLs applied at the Layer 2 input would allow Host A to access the Human Resources network, but prevent Host B from accessing the same network. Port ACLs can only be applied to Layer 2 interfaces in the inbound direction.

When you apply a port ACL to a trunk port, the ACL filters traffic on all VLANs present on the trunk port. When you apply a port ACL to a port with voice VLAN, the ACL filters traffic on both data and voice VLANs.

With port ACLs, you can filter IP traffic by using IP access lists and non-IP traffic by using MAC addresses. You can filter both IP and non-IP traffic on the same Layer 2 interface by applying both an IP access list and a MAC access list to the interface.



**Note** You can't apply more than one IP access list and one MAC access list to a Layer 2 interface. If an IP access list or MAC access list is already configured on a Layer 2 interface and you apply a new IP access list or MAC access list to the interface, the new ACL replaces the previously configured one.

## Router ACLs

You can apply router ACLs on switch virtual interfaces (SVIs), which are Layer 3 interfaces to VLANs; on physical Layer 3 interfaces; and on Layer 3 EtherChannel interfaces. You apply router ACLs on interfaces for specific directions (inbound or outbound). You can apply one router ACL in each direction on an interface.

The switch supports these access lists for IPv4 traffic:

- Standard IP access lists use source addresses for matching operations.
- Extended IP access lists use source and destination addresses and optional protocol type information for matching operations.

As with port ACLs, the switch examines ACLs associated with features configured on a given interface. As packets enter the switch on an interface, ACLs associated with all inbound features configured on that interface are examined. After packets are routed and before they are forwarded to the next hop, all ACLs associated with outbound features configured on the egress interface are examined.

ACLs permit or deny packet forwarding based on how the packet matches the entries in the ACL, and can be used to control access to a network or to part of a network.

## ACEs and Fragmented and Unfragmented Traffic

IP packets can be fragmented as they cross the network. When this happens, only the fragment containing the beginning of the packet contains the Layer 4 information, such as TCP or UDP port numbers, ICMP type and code, and so on. All other fragments are missing this information.

Some access control entries (ACEs) do not check Layer 4 information and therefore can be applied to all packet fragments. ACEs that do test Layer 4 information cannot be applied in the standard manner to most of the fragments in a fragmented IP packet. When the fragment contains no Layer 4 information and the ACE tests some Layer 4 information, the matching rules are modified:

- Permit ACEs that check the Layer 3 information in the fragment (including protocol type, such as TCP, UDP, and so on) are considered to match the fragment regardless of what the missing Layer 4 information might have been.



---

**Note** For TCP ACEs with L4 Ops, the fragmented packets will be dropped per RFC 1858.

---

- Deny ACEs that check Layer 4 information never match a fragment unless the fragment contains Layer 4 information.

## ACEs and Fragmented and Unfragmented Traffic Examples

Consider access list 102, configured with these commands, applied to three fragmented packets:

```
Device(config)# access-list 102 permit tcp any host 10.1.1.1 eq smtp
Device(config)# access-list 102 deny tcp any host 10.1.1.2 eq telnet
Device(config)# access-list 102 permit tcp any host 10.1.1.2
Device(config)# access-list 102 deny tcp any any
```



---

**Note** In the first and second ACEs in the examples, the *eq* keyword after the destination address means to test for the TCP-destination-port well-known numbers equaling Simple Mail Transfer Protocol (SMTP) and Telnet, respectively.

---

- Packet A is a TCP packet from host 10.2.2.2., port 65000, going to host 10.1.1.1 on the SMTP port. If this packet is fragmented, the first fragment matches the first ACE (a permit) as if it were a complete packet because all Layer 4 information is present. The remaining fragments also match the first ACE, even though they do not contain the SMTP port information, because the first ACE only checks Layer 3 information when applied to fragments. The information in this example is that the packet is TCP and that the destination is 10.1.1.1.

- Packet B is from host 10.2.2.2, port 65001, going to host 10.1.1.2 on the Telnet port. If this packet is fragmented, the first fragment matches the second ACE (a deny) because all Layer 3 and Layer 4 information is present. The remaining fragments in the packet do not match the second ACE because they are missing Layer 4 information. Instead, they match the third ACE (a permit).

Because the first fragment was denied, host 10.1.1.2 cannot reassemble a complete packet, so packet B is effectively denied. However, the later fragments that are permitted will consume bandwidth on the network and resources of host 10.1.1.2 as it tries to reassemble the packet.

- Fragmented packet C is from host 10.2.2.2, port 65001, going to host 10.1.1.3, port ftp. If this packet is fragmented, the first fragment matches the fourth ACE (a deny). All other fragments also match the fourth ACE because that ACE does not check any Layer 4 information and because Layer 3 information in all fragments shows that they are being sent to host 10.1.1.3, and the earlier permit ACEs were checking different hosts.

## Standard and Extended IPv4 ACLs

This section describes IP ACLs.

An ACL is a sequential collection of permit and deny conditions. One by one, the switch tests packets against the conditions in an access list. The first match determines whether the switch accepts or rejects the packet. Because the switch stops testing after the first match, the order of the conditions is critical. If no conditions match, the switch denies the packet.

The software supports these types of ACLs or access lists for IPv4:

- Standard IP access lists use source addresses for matching operations.
- Extended IP access lists use source and destination addresses for matching operations and optional protocol-type information for finer granularity of control.



---

**Note** Only extended ACLs are supported while the standard ACLs are not supported.

---

## IPv4 ACL Switch Unsupported Features

Configuring IPv4 ACLs on the switch is the same as configuring IPv4 ACLs on other Cisco switches and routers.

The following ACL-related features are not supported:

- Non-IP protocol ACLs
- IP accounting
- Reflexive ACLs, URL Redirect ACLs and Dynamic ACLs are not supported.

## Access List Numbers

The number you use to denote your ACL shows the type of access list that you are creating.

This lists the access-list number and corresponding access list type and shows whether or not they are supported in the switch. The switch supports IPv4 standard and extended access lists, numbers 1 to 199 and 1300 to 2699.

**Table 43: Access List Numbers**

Access List Number	Type	Supported
1–99	IP standard access list	Yes
100–199	IP extended access list	Yes
200–299	Protocol type-code access list	No
300–399	DECnet access list	No
400–499	XNS standard access list	No
500–599	XNS extended access list	No
600–699	AppleTalk access list	No
700–799	48-bit MAC address access list	No
800–899	IPX standard access list	No
900–999	IPX extended access list	No
1000–1099	IPX SAP access list	No
1100–1199	Extended 48-bit MAC address access list	No
1200–1299	IPX summary address access list	No
1300–1999	IP standard access list (expanded range)	Yes
2000–2699	IP extended access list (expanded range)	Yes

In addition to numbered standard and extended ACLs, you can also create standard and extended named IP ACLs by using the supported numbers. That is, the name of a standard IP ACL can be 1 to 99; the name of an extended IP ACL can be 100 to 199. The advantage of using named ACLs instead of numbered lists is that you can delete individual entries from a named list.

## Numbered Standard IPv4 ACLs

When creating an ACL, remember that, by default, the end of the ACL contains an implicit deny statement for all packets that it did not find a match for before reaching the end. With standard access lists, if you omit the mask from an associated IP host address ACL specification, 0.0.0.0 is assumed to be the mask.

The switch always rewrites the order of standard access lists so that entries with **host** matches and entries with matches having a *don't care* mask of 0.0.0.0 are moved to the top of the list, above any entries with non-zero *don't care* masks. Therefore, in **show** command output and in the configuration file, the ACEs do not necessarily appear in the order in which they were entered.

After creating a numbered standard IPv4 ACL, you can apply it to terminal lines (virtual teletype (VTY) lines), or to interfaces.



## Numbered Extended IPv4 ACLs

Although standard ACLs use only source addresses for matching, you can use extended ACL source and destination addresses for matching operations and optional protocol type information for finer granularity of control. When you are creating ACEs in numbered extended access lists, remember that after you create the ACL, any additions are placed at the end of the list. You cannot reorder the list or selectively add or remove ACEs from a numbered list.

The switch does not support dynamic or reflexive access lists. It also does not support filtering based on the type of service (ToS) minimize-monetary-cost bit.

Some protocols also have specific parameters and keywords that apply to that protocol.

You can define an extended TCP, UDP, ICMP, IGMP, or other IP ACL. The switch also supports these IP protocols:

These IP protocols are supported:

- Authentication Header Protocol (**ahp**)
- Encapsulation Security Payload (**esp**)
- Enhanced Interior Gateway Routing Protocol (**eigrp**)
- generic routing encapsulation (**gre**)
- Internet Control Message Protocol (**icmp**)
- Internet Group Management Protocol (**igmp**)
- any Interior Protocol (**ip**)
- IP in IP tunneling (**ipinip**)
- KA9Q NOS-compatible IP over IP tunneling (**nos**)
- Open Shortest Path First routing (**ospf**)
- Payload Compression Protocol (**pcp**)
- Protocol-Independent Multicast (**pim**)
- Transmission Control Protocol (**tcp**)
- User Datagram Protocol (**udp**)

## Named IPv4 ACLs

You can identify IPv4 ACLs with an alphanumeric string (a name) rather than a number. You can use named ACLs to configure more IPv4 access lists in a router than if you were to use numbered access lists. If you identify your access list with a name rather than a number, the mode and command syntax are slightly different. However, at times, not all commands that use IP access lists accept a named access list.



---

**Note** The name you give to a standard or extended ACL can also be a number in the supported range of access list numbers. That is, the name of a standard IP ACL can be 1 to 99 and . The advantage of using named ACLs instead of numbered lists is that you can delete individual entries from a named list.

---

Consider these guidelines before configuring named ACLs:

- Numbered ACLs are also available.
- A standard ACL and an extended ACL cannot have the same name.

## ACL Logging

The controller software can provide logging messages about packets permitted or denied by a standard IP access list. That is, any packet that matches the ACL causes an informational logging message about the packet to be sent to the console. The level of messages logged to the console is controlled by the **logging console** commands controlling the syslog messages.



---

**Note** Because routing is done in hardware and logging is done in software, if a large number of packets match a *permit* or *deny* ACE containing a **log** keyword, the software might not be able to match the hardware processing rate, and not all packets will be logged.

---

The first packet that triggers the ACL causes a logging message right away, and subsequent packets are collected over 5-minute intervals before they appear or logged. The logging message includes the access list number, whether the packet was permitted or denied, the source IP address of the packet, and the number of packets from that source permitted or denied in the prior 5-minute interval.



---

**Note** The logging facility might drop some logging message packets if there are too many to be handled or if there is more than one logging message to be handled in 1 second. This behavior prevents the router from crashing due to too many logging packets. Therefore, the logging facility should not be used as a billing tool or an accurate source of the number of matches to an access list.

---

## Hardware and Software Treatment of IP ACLs

ACL processing is performed in hardware. If the hardware reaches its capacity to store ACL configurations, all packets on that interface are dropped.

The ACL scale for controllers is as follows:

- Cisco Catalyst 9800-40 Wireless Controller, Cisco Catalyst 9800-L Wireless Controller, Cisco Catalyst 9800-CL Wireless Controller (small and medium) support 128 ACLs with 128 Access List Entries (ACEs).
- Cisco Catalyst 9800-80 Wireless Controller and Cisco Catalyst 9800-CL Wireless Controller (large) support 256 ACLs and 256 ACEs.
- FlexConnect and Fabric mode APs support 96 ACLs.



---

**Note** If an ACL configuration cannot be implemented in the hardware due to an out-of-resource condition on the controller, then only the traffic in that VLAN arriving on that controller is affected.

---

When you enter the **show ip access-lists** privileged EXEC command, the match count displayed does not account for packets that are access controlled in hardware. Use the `show ip access-lists hardware` privileged EXEC command to obtain some basic hardware ACL statistics for switched and routed packets.

## IPv4 ACL Interface Considerations

For inbound ACLs, after receiving a packet, the controller checks the packet against the ACL. If the ACL permits the packet, the controller continues to process the packet. If the ACL rejects the packet, the controller discards the packet.

For outbound ACLs, after receiving and routing a packet to a controlled interface, the controller checks the packet against the ACL. If the ACL permits the packet, the controller sends the packet. If the ACL rejects the packet, the controller discards the packet.

If an undefined ACL has nothing listed in it, it is an empty access list.

## Restrictions for Configuring IPv4 Access Control Lists

The following are restrictions for configuring network security with ACLs:

### General Network Security

The following are restrictions for configuring network security with ACLs:

- A standard ACL and an extended ACL cannot have the same name.
- Though visible in the command-line help strings, **AppleTalk** is not supported as a matching condition for the **deny** and **permit** MAC access-list configuration mode commands.
- DNS traffic is permitted by default with or without ACL entries for clients that are awaiting web authentication.

### IPv4 ACL Network Interfaces

The following restrictions apply to IPv4 ACLs to network interfaces:

- When controlling access to an interface, you can use a named or numbered ACL.
- You do not have to enable routing to apply ACLs to Layer 2 interfaces.

### MAC ACLs on a Layer 2 Interface

After you create a MAC ACL, you can apply it to a Layer 2 interface to filter non-IP traffic coming in that interface. When you apply the MAC ACL, consider these guidelines:

- You can apply no more than one IP access list and one MAC access list to the same Layer 2 interface. The IP access list filters only IP packets, and the MAC access list filters non-IP packets.
- A Layer 2 interface can have only one MAC access list. If you apply a MAC access list to a Layer 2 interface that has a MAC ACL configured, the new ACL replaces the previously configured one.



---

**Note** The **mac access-group** interface configuration command is only valid when applied to a physical Layer 2 interface. You cannot use the command on EtherChannel port channels.

---

#### IP Access List Entry Sequence Numbering

- This feature does not support dynamic, reflexive, or firewall access lists.

## How to Configure ACLs

### Configuring IPv4 ACLs (GUI)

#### Procedure

---

- Step 1** Choose **Configuration > Security > ACL**.
- Step 2** Click **Add**.
- Step 3** In the **Add ACL Setup** dialog box, enter the following parameters.
- **ACL Name:** Enter the name for the ACL.
  - **ACL Type:** IPv4 Standard.
  - **Sequence:** Enter the sequence number.
  - **Action:** Choose **Permit** or **Deny** the packet flow from the drop-down list.
  - **Source Type:** Choose **any**, **Host** or **Network** from which the packet is sent.
  - **Log:** Enable or disable logging.
- Step 4** Click **Add**.
- Step 5** Add the rest of the rules and click **Apply to Device**.
- 

### Configuring IPv4 ACLs

Follow the procedure given below to use IP ACLs on the switch:

#### Procedure

---

- Step 1** Create an ACL by specifying an access list number or name and the access conditions.
- Step 2** Apply the ACL to interfaces or terminal lines.
-

## Creating a Numbered Standard ACL (GUI)

### Procedure

- 
- Step 1** Choose **Configuration > Security > ACL**.
- Step 2** On the **ACL** page, click **Add**.
- Step 3** In the **Add ACL Setup** window, enter the following parameters.
- **ACL Name:** Enter the name for the ACL.
  - **ACL Type:** IPv4 Standard.
  - **Sequence:** Enter the sequence number.
  - **Action:** Choose **Permit** or **Deny** access from the drop-down list.
  - **Source Type:** Choose **any**, **Host** or **Network**
  - **Log:** Enable or disable logging, this is limited to ACLs associated to Layer 3 interface only.
- Step 4** Click **Add**.
- Step 5** Click **Save & Apply to Device**.
- 

## Creating a Numbered Standard ACL (CLI)

Follow the procedure given below to create a numbered standard ACL:

### Procedure

	Command or Action	Purpose
<b>Step 1</b>	<b>enable</b> <b>Example:</b> Device> <b>enable</b>	Enables privileged EXEC mode. Enter your password if prompted.
<b>Step 2</b>	<b>configure terminal</b> <b>Example:</b> Device# <b>configure terminal</b>	Enters global configuration mode.
<b>Step 3</b>	<b>access-list <i>access-list-number</i> {deny   permit} <i>source source-wildcard</i> ]</b> <b>Example:</b> Device(config)# <b>access-list 2 deny</b>	Defines a standard IPv4 access list by using a source address and wildcard. The <i>access-list-number</i> is a decimal number from 1 to 99 or 1300 to 1999.

	Command or Action	Purpose
	<code>your_host</code>	<p>Enter <b>deny</b> or <b>permit</b> to specify whether to deny or permit access if conditions are matched.</p> <p>The <i>source</i> is the source address of the network or host from which the packet is being sent specified as:</p> <ul style="list-style-type: none"> <li>• The 32-bit quantity in dotted-decimal format.</li> <li>• The keyword <b>any</b> as an abbreviation for <i>source</i> and <i>source-wildcard</i> of 0.0.0.0 255.255.255.255. You do not need to enter a source-wildcard.</li> <li>• The keyword <b>host</b> as an abbreviation for <i>source</i> and <i>source-wildcard</i> of <i>source</i> 0.0.0.0.</li> </ul> <p>(Optional) The <i>source-wildcard</i> applies wildcard bits to the source.</p> <p><b>Note</b> Logging is supported only on ACLs attached to Layer 3 interfaces.</p>
<b>Step 4</b>	<p><b>end</b></p> <p><b>Example:</b></p> <pre>Device(config)# end</pre>	Returns to privileged EXEC mode.
<b>Step 5</b>	<p><b>show running-config</b></p> <p><b>Example:</b></p> <pre>Device# show running-config</pre>	Verifies your entries.
<b>Step 6</b>	<p><b>copy running-config startup-config</b></p> <p><b>Example:</b></p> <pre>Device# copy running-config startup-config</pre>	(Optional) Saves your entries in the configuration file.

## Creating a Numbered Extended ACL (GUI)

### Procedure

**Step 1** Choose **Configuration > Security > ACL**.

- Step 2** On the **ACL** page, click **Add**.
- Step 3** In the **Add ACL Setup** window, enter the following parameters.
- **ACL Name:** Enter the name for the ACL.
  - **ACL Type:** IPv4 Extended.
  - **Sequence:** Enter the sequence number.
  - **Action:** Choose **Permit** or **Deny** the packet flow from the drop-down list.
  - **Source Type:** Choose **any**, **Host** or **Network** from which the packet is sent.
  - **Destination Type:** Choose **any**, **Host** or **Network** to which the packet is sent.
  - **Protocol:** Choose a protocol from the drop-down list.
  - **Log:** Enable or disable logging.
  - **DSCP:** Enter to match packets with the DSCP value
- Step 4** Click **Add**.
- Step 5** Click **Save & Apply to Device**.

## Creating a Numbered Extended ACL (CLI)

Follow the procedure given below to create a numbered extended ACL:

### Procedure

	Command or Action	Purpose
<b>Step 1</b>	<b>configure terminal</b> <b>Example:</b> Device# <b>configure terminal</b>	Enters global configuration mode.
<b>Step 2</b>	<b>access-list</b> <i>access-list-number</i> {deny   permit} <i>protocol source source-wildcard destination</i> <i>destination-wildcard [precedence precedence]</i> <i>[tos tos] [fragments] [time-range</i> <i>time-range-name] [dscp dscp]</i> <b>Example:</b> Device(config)# <b>access-list 101 permit</b> <b>ip host 10.1.1.2 any precedence 0 tos 0</b> <b>log</b>	Defines an extended IPv4 access list and the access conditions. The <i>access-list-number</i> is a decimal number from 100 to 199 or 2000 to 2699. Enter <b>deny</b> or <b>permit</b> to specify whether to deny or permit the packet if conditions are matched. For <i>protocol</i> , enter the name or number of an P protocol: <b>ahp</b> , <b>eigrp</b> , <b>esp</b> , <b>gre</b> , <b>icmp</b> , <b>igmp</b> , <b>igrp</b> , <b>ip</b> , <b>ipinip</b> , <b>nos</b> , <b>ospf</b> , <b>pcp</b> , <b>pim</b> , <b>tcp</b> , or <b>udp</b> , or an integer in the range 0 to 255 representing an IP protocol number. To match

	Command or Action	Purpose
		<p>any Internet protocol (including ICMP, TCP, and UDP), use the keyword <b>ip</b>.</p> <p><b>Note</b> This step includes options for most IP protocols. For additional specific parameters for TCP, UDP, ICMP, and IGMP, see the following steps.</p> <p>The <i>source</i> is the number of the network or host from which the packet is sent.</p> <p>The <i>source-wildcard</i> applies wildcard bits to the source.</p> <p>The <i>destination</i> is the network or host number to which the packet is sent.</p> <p>The <i>destination-wildcard</i> applies wildcard bits to the destination.</p> <p>Source, source-wildcard, destination, and destination-wildcard can be specified as:</p> <ul style="list-style-type: none"> <li>• The 32-bit quantity in dotted-decimal format.</li> <li>• The keyword <b>any</b> for 0.0.0.0 255.255.255.255 (any host).</li> <li>• The keyword <b>host</b> for a single host 0.0.0.0.</li> </ul> <p>The other keywords are optional and have these meanings:</p> <ul style="list-style-type: none"> <li>• <b>precedence</b>—Enter to match packets with a precedence level specified as a number from 0 to 7 or by name: <b>routine</b> (0), <b>priority</b> (1), <b>immediate</b> (2), <b>flash</b> (3), <b>flash-override</b> (4), <b>critical</b> (5), <b>internet</b> (6), <b>network</b> (7).</li> <li>• <b>fragments</b>—Enter to check non-initial fragments.</li> <li>• <b>tos</b>—Enter to match by type of service level, specified by a number from 0 to 15 or a name: <b>normal</b> (0), <b>max-reliability</b> (2), <b>max-throughput</b> (4), <b>min-delay</b> (8).</li> <li>• <b>time-range</b>—Specify the time-range name.</li> <li>• <b>dscp</b>—Enter to match packets with the DSCP value specified by a number from 0 to 63, or use the question mark (?) to see a list of available values.</li> </ul>



	Command or Action	Purpose
		<p><b>Note</b> Your controller must support the ability to:</p> <ul style="list-style-type: none"> <li>• Mark DCSP</li> <li>• Mark UP</li> <li>• Map DSCP and UP</li> </ul> <p>For more information on <b>DSCP-to-UP Mapping</b>, see: <a href="https://tools.ietf.org/html/draft-ietf-tsvwg-ieee-802-11-01">https://tools.ietf.org/html/draft-ietf-tsvwg-ieee-802-11-01</a></p> <p><b>Note</b> If you enter a <b>dscp</b> value, you cannot enter <b>tos</b> or <b>precedence</b>. You can enter both a <b>tos</b> and a <b>precedence</b> value with no <b>dscp</b>.</p>
<b>Step 3</b>	<p><b>access-list</b> <i>access-list-number</i> {<b>deny</b>   <b>permit</b>}  <b>tcp</b> <i>source source-wildcard</i> [<i>operator port</i>]  <i>destination destination-wildcard</i> [<i>operator port</i>]  [<b>precedence</b> <i>precedence</i>] [<b>tos</b> <i>tos</i>] [<b>fragments</b>]  [<b>time-range</b> <i>time-range-name</i>] [<b>dscp</b> <i>dscp</i>]  [<i>flag</i>]</p> <p><b>Example:</b></p> <pre>Device(config)# access-list 101 permit tcp any any eq 500</pre>	<p>Defines an extended TCP access list and the access conditions.</p> <p>The parameters are the same as those described for an extended IPv4 ACL, with these exceptions:</p> <p>(Optional) Enter an <i>operator</i> and <i>port</i> to compare source (if positioned after <i>source source-wildcard</i>) or destination (if positioned after <i>destination destination-wildcard</i>) port. Possible operators include <b>eq</b> (equal), <b>gt</b> (greater than), <b>lt</b> (less than), <b>neq</b> (not equal), and <b>range</b> (inclusive range). Operators require a port number (range requires two port numbers separated by a space).</p> <p>Enter the <i>port</i> number as a decimal number (from 0 to 65535) or the name of a TCP port. Use only TCP port numbers or names when filtering TCP.</p> <p>The other optional keywords have these meanings:</p> <ul style="list-style-type: none"> <li>• <i>flag</i>—Enter one of these flags to match by the specified TCP header bits: <b>ack</b> (acknowledge), <b>fin</b> (finish), <b>psh</b> (push), <b>rst</b> (reset), <b>syn</b> (synchronize), or <b>urg</b> (urgent).</li> </ul>
<b>Step 4</b>	<p><b>access-list</b> <i>access-list-number</i> {<b>deny</b>   <b>permit</b>}  <b>udp</b> <i>source source-wildcard</i> [<i>operator port</i>]</p>	<p>(Optional) Defines an extended UDP access list and the access conditions.</p>

	Command or Action	Purpose
	<p><i>destination destination-wildcard</i> [<i>operator port</i>]  <pre>[precedence precedence] [tos tos] [fragments] [time-range time-range-name] [dscp dscp]</pre></p> <p><b>Example:</b></p> <pre>Device(config)# access-list 101 permit udp any any eq 100</pre>	<p>The UDP parameters are the same as those described for TCP except that the [<i>operator port</i>] port number or name must be a UDP port number or name, and the <b>flag</b> not valid for UDP.</p>
<b>Step 5</b>	<p><b>access-list</b> <i>access-list-number</i> {<b>deny</b>   <b>permit</b>}  <b>icmp</b> <i>source source-wildcard destination destination-wildcard</i> [<i>icmp-type</i>   [<i>icmp-type icmp-code</i>]   [<i>icmp-message</i>]] [<b>precedence precedence</b>] [<b>tos tos</b>] [<b>fragments</b>] [<b>time-range time-range-name</b>] [<b>dscp dscp</b>]</p> <p><b>Example:</b></p> <pre>Device(config)# access-list 101 permit icmp any any 200</pre>	<p>Defines an extended ICMP access list and the access conditions.</p> <p>The ICMP parameters are the same as those described for most IP protocols in an extended IPv4 ACL, with the addition of the ICMP message type and code parameters. These optional keywords have these meanings:</p> <ul style="list-style-type: none"> <li>• <i>icmp-type</i>—Enter to filter by ICMP message type, a number from 0 to 255.</li> <li>• <i>icmp-code</i>—Enter to filter ICMP packets that are filtered by the ICMP message code type, a number from 0 to 255.</li> <li>• <i>icmp-message</i>—Enter to filter ICMP packets by the ICMP message type name or the ICMP message type and code name.</li> </ul>
<b>Step 6</b>	<p><b>access-list</b> <i>access-list-number</i> {<b>deny</b>   <b>permit</b>}  <b>igmp</b> <i>source source-wildcard destination destination-wildcard</i> [<i>igmp-type</i>] [<b>precedence precedence</b>] [<b>tos tos</b>] [<b>fragments</b>] [<b>time-range time-range-name</b>] [<b>dscp dscp</b>]</p> <p><b>Example:</b></p> <pre>Device(config)# access-list 101 permit igmp any any 14</pre>	<p>(Optional) Defines an extended IGMP access list and the access conditions.</p> <p>The IGMP parameters are the same as those described for most IP protocols in an extended IPv4 ACL, with this optional parameter.</p> <p><i>igmp-type</i>—To match IGMP message type, enter a number from 0 to 15, or enter the message name: <b>dvmp</b>, <b>host-query</b>, <b>host-report</b>, <b>pim</b>, or <b>trace</b>.</p>
<b>Step 7</b>	<p><b>end</b></p> <p><b>Example:</b></p> <pre>Device(config)# end</pre>	<p>Returns to privileged EXEC mode.</p>

## Creating Named Standard ACLs (GUI)

### Procedure

- 
- Step 1** Click **Configuration > Security > ACL**.
- Step 2** Click **Add** to create a new ACL setup.
- Step 3** In the **Add ACL Setup** window, enter the following parameters.
- **ACL Name:** Enter the name for the ACL
  - **ACL Type:** IPv4 Standard
  - **Sequence:** The valid range is between 1 and 99 or 1300 and 1999
  - **Action:** Choose **Permit** or **Deny** access from the drop-down list.
  - **Source Type:** Choose **any**, **Host** or **Network**
  - **Log:** Enable or disable logging, this is limited to ACLs associated to Layer 3 interface only.
- Step 4** Click **Add** to add the rule.
- Step 5** Click **Save & Apply to Device**.
- 

## Creating Named Standard ACLs

Follow the procedure given below to create a standard ACL using names:

### Procedure

	Command or Action	Purpose
<b>Step 1</b>	<b>enable</b> <b>Example:</b> Device> <b>enable</b>	Enables privileged EXEC mode. Enter your password if prompted.
<b>Step 2</b>	<b>configure terminal</b> <b>Example:</b> Device# <b>configure terminal</b>	Enters global configuration mode.
<b>Step 3</b>	<b>ip access-list standard <i>name</i></b> <b>Example:</b> Device(config)# <b>ip access-list standard</b> <b>20</b>	Defines a standard IPv4 access list using a name, and enter access-list configuration mode. The name can be a number from 1 to 99.

	Command or Action	Purpose
<b>Step 4</b>	<p>Use one of the following:</p> <ul style="list-style-type: none"> <li>• <b>deny</b> {<i>source</i> [<i>source-wildcard</i>]   <b>host</b> <i>source</i>   <b>any</b>} [<b>log</b>]</li> <li>• <b>permit</b> {<i>source</i> [<i>source-wildcard</i>]   <b>host</b> <i>source</i>   <b>any</b>} [<b>log</b>]</li> </ul> <p><b>Example:</b></p> <pre>Device(config-std-nacl)# deny 192.168.0.0 0.0.255.255 255.255.0.0 0.0.255.255</pre> <p>or</p> <pre>Device(config-std-nacl)# permit 10.108.0.0 0.0.0.0 255.255.255.0 0.0.0.0</pre>	<p>In access-list configuration mode, specify one or more conditions denied or permitted to decide if the packet is forwarded or dropped.</p> <ul style="list-style-type: none"> <li>• <b>host</b> <i>source</i>—A source and source wildcard of <i>source</i> 0.0.0.0.</li> <li>• <b>any</b>—A source and source wildcard of 0.0.0.0 255.255.255.255.</li> </ul>
<b>Step 5</b>	<p><b>end</b></p> <p><b>Example:</b></p> <pre>Device(config-std-nacl)# end</pre>	Returns to privileged EXEC mode.
<b>Step 6</b>	<p><b>show running-config</b></p> <p><b>Example:</b></p> <pre>Device# show running-config</pre>	Verifies your entries.
<b>Step 7</b>	<p><b>copy running-config startup-config</b></p> <p><b>Example:</b></p> <pre>Device# copy running-config startup-config</pre>	(Optional) Saves your entries in the configuration file.

## Creating Extended Named ACLs (GUI)

### Procedure

- 
- Step 1** Choose **Configuration > Security > ACL**.
- Step 2** Click **Add**.
- Step 3** In the **Add ACL Setup** window, enter the following parameters.
- **ACL Name:** Enter the name for the ACL.

- **ACL Type:** IPv4 Extended.
- **Sequence:** Enter the sequence number.
- **Action:** Choose **Permit** or **Deny** the packet flow from the drop-down list.
- **Source Type:** Choose **any**, **Host** or **Network** from which the packet is sent.
- **Destination Type:** Choose **any**, **Host** or **Network** to which the packet is sent.
- **Protocol:** Choose a protocol from the drop-down list.
- **Log:** Enable or disable logging.
- **DSCP:** Enter to match packets with the DSCP value

**Step 4** Click **Add**.

**Step 5** Add the rest of the rules and click **Apply to Device**.

## Creating Extended Named ACLs

Follow the procedure given below to create an extended ACL using names:

### Procedure

	Command or Action	Purpose
<b>Step 1</b>	<b>enable</b> <b>Example:</b> Device> <b>enable</b>	Enables privileged EXEC mode. Enter your password if prompted.
<b>Step 2</b>	<b>configure terminal</b> <b>Example:</b> Device# <b>configure terminal</b>	Enters global configuration mode.
<b>Step 3</b>	<b>ip access-list extended</b> <i>name</i> <b>Example:</b> Device(config)# <b>ip access-list extended</b> <b>150</b>	Defines an extended IPv4 access list using a name, and enter access-list configuration mode.  The name can be a number from 100 to 199.
<b>Step 4</b>	<b>{deny   permit} protocol {source</b> <b>[source-wildcard]   host source   any}</b> <b>{destination [destination-wildcard]   host</b> <b>destination   any} [precedence precedence]</b> <b>[tos tos] [log] [time-range time-range-name]</b>	In access-list configuration mode, specify the conditions allowed or denied. Use the <b>log</b> keyword to get access list logging messages, including violations.

	Command or Action	Purpose
	<p><b>Example:</b></p> <pre>Device(config-ext-nacl)# permit 0 any any</pre>	<ul style="list-style-type: none"> <li>• <b>host source</b>—A source and source wildcard of <i>source</i> 0.0.0.0.</li> <li>• <b>host destination</b>—A destination and destination wildcard of <i>destination</i> 0.0.0.0.</li> <li>• <b>any</b>—A source and source wildcard or destination and destination wildcard of 0.0.0.0 255.255.255.255.</li> </ul>
<b>Step 5</b>	<p><b>end</b></p> <p><b>Example:</b></p> <pre>Device(config-ext-nacl)# end</pre>	Returns to privileged EXEC mode.
<b>Step 6</b>	<p><b>show running-config</b></p> <p><b>Example:</b></p> <pre>Device# show running-config</pre>	Verifies your entries.
<b>Step 7</b>	<p><b>copy running-config startup-config</b></p> <p><b>Example:</b></p> <pre>Device# copy running-config startup-config</pre>	(Optional) Saves your entries in the configuration file.

When you are creating extended ACLs, remember that, by default, the end of the ACL contains an implicit deny statement for everything if it did not find a match before reaching the end. For standard ACLs, if you omit the mask from an associated IP host address access list specification, 0.0.0.0 is assumed to be the mask.

After you create an ACL, any additions are placed at the end of the list. You cannot selectively add ACL entries to a specific ACL. However, you can use **no permit** and **no deny** access-list configuration mode commands to remove entries from a named ACL.

Being able to selectively remove lines from a named ACL is one reason you might use named ACLs instead of numbered ACLs.

### What to do next

After creating a named ACL, you can apply it to interfaces or to VLANs.

## Applying an IPv4 ACL to an Interface (GUI)

### Procedure

- 
- Step 1** Choose **Configuration > Security > ACL**.
  - Step 2** Click **Associating Interfaces**.
  - Step 3** Choose the interface from the **Available Interfaces** list to view its ACL details on the right-hand side. You can change the ACL details, if required.
  - Step 4** Click **Save & Apply to Device**.
- 

## Applying an IPv4 ACL to an Interface (CLI)

This section describes how to apply IPv4 ACLs to network interfaces.

Beginning in privileged EXEC mode, follow the procedure given below to control access to an interface:

### Procedure

	Command or Action	Purpose
<b>Step 1</b>	<b>configure terminal</b>  <b>Example:</b>  Device# <code>configure terminal</code>	Enters global configuration mode.
<b>Step 2</b>	<b>interface <i>interface-id</i></b>  <b>Example:</b>  Device(config)#	Identifies a specific interface for configuration, and enter interface configuration mode.  The interface can be a Layer 2 interface (port ACL), or a Layer 3 interface (router ACL).
<b>Step 3</b>	<b>ip access-group {<i>access-list-number</i>   <i>name</i>} {in   out}</b>  <b>Example:</b>  Device(config-if)# <code>ip access-group 2 in</code>	Controls access to the specified interface.
<b>Step 4</b>	<b>end</b>  <b>Example:</b>  Device(config-if)# <code>end</code>	Returns to privileged EXEC mode.
<b>Step 5</b>	<b>show running-config</b>  <b>Example:</b>	Displays the access list configuration.

	Command or Action	Purpose
	Device# <code>show running-config</code>	
<b>Step 6</b>	<b>copy running-config startup-config</b> <b>Example:</b> Device# <code>copy running-config startup-config</code>	(Optional) Saves your entries in the configuration file.

## Applying ACL to Policy Profile (GUI)

### Procedure

- 
- Step 1** Choose **Configuration > Tags & Profiles > Policy**.
  - Step 2** On the **Policy Profile** page, click **Add**.
  - Step 3** In the **Add Policy Profile** window, click **Access Policies** tab.
  - Step 4** In the **WLAN ACL** area, choose the IPv4 ACL from the **IPv4 ACL** drop-down list.
  - Step 5** Click **Apply to Device**.
- 

## Applying ACL to Policy Profile

### Procedure

	Command or Action	Purpose
<b>Step 1</b>	<b>configure terminal</b> <b>Example:</b> Device# <code>configure terminal</code>	Enters global configuration mode.
<b>Step 2</b>	<b>wireless profile policy <i>profile-policy</i></b> <b>Example:</b> Device(config)# <code>wireless profile policy profile-policy</code>	Configures a WLAN policy profile and enters wireless policy configuration mode.
<b>Step 3</b>	<b>ipv4 acl <i>acl-name</i></b> <b>Example:</b> Device(config-wireless-policy)# <code>ipv4 acl test-acl</code>	Configures an IPv4 ACL.



	Command or Action	Purpose
Step 4	<b>end</b> <b>Example:</b> Device(config-wireless-policy)# end	Returns to privileged EXEC mode. Alternatively, you can also press <b>Ctrl-Z</b> to exit global configuration mode.

## Configuration Examples for ACLs

### Examples: Including Comments in ACLs

You can use the **remark** keyword to include comments (remarks) about entries in any IP standard or extended ACL. The remarks make the ACL easier for you to understand and scan. Each remark line is limited to 100 characters.

The remark can go before or after a permit or deny statement. You should be consistent about where you put the remark so that it is clear which remark describes which permit or deny statement. For example, it would be confusing to have some remarks before the associated permit or deny statements and some remarks after the associated statements.

To include a comment for IP numbered standard or extended ACLs, use the **access-list access-list number remark remark** global configuration command. To remove the remark, use the **no** form of this command.

In this example, the workstation that belongs to Jones is allowed access, and the workstation that belongs to Smith is not allowed access:

```
Device(config)# access-list 1 remark Permit only Jones workstation through
Device(config)# access-list 1 permit 171.69.2.88
Device(config)# access-list 1 remark Do not allow Smith through
Device(config)# access-list 1 deny 171.69.3.13
```

For an entry in a named IP ACL, use the **remark access-list** configuration command. To remove the remark, use the **no** form of this command.

In this example, the Jones subnet is not allowed to use outbound Telnet:

```
Device(config)# ip access-list extended telnetting
Device(config-ext-nacl)# remark Do not allow Jones subnet to telnet out
Device(config-ext-nacl)# deny tcp host 171.69.2.88 any eq telnet
```

### Examples: Applying an IPv4 ACL to a Policy Profile in a Wireless Environment

This example shows how to apply an IPv4 ACL to a Policy Profile in a Wireless environment.



**Note** All IPv4 ACLs must be associated to a policy profile.

This example uses extended ACLs to permit TCP traffic.

### 1. Creating an IPv4 ACL.

```
Device(config)# ip access-list extended <acl-name>
Device(config-ext-nacl)# 10 permit ip any 10.193.48.224 0.0.0.31
Device (config-ext-nacl)# 20 permit ip any any
```

### 2. Applying the IPv4 ACL to a policy profile.

```
Device(config)# wireless profile policy <policy-profile-name>
Device(config-wireless-policy)# shutdown
Device(config-wireless-policy)# ipv4 acl <acl-name>
Device(config-wireless-policy)# no shutdown
```

## IPv4 ACL Configuration Examples

This section provides examples of configuring and applying IPv4 ACLs. For detailed information about compiling ACLs, see the *Cisco IOS Security Configuration Guide, Release 12.4* and to the Configuring IP Services” section in the “IP Addressing and Services” chapter of the *Cisco IOS IP Configuration Guide, Release 12.4*.

### ACLs in a Small Networked Office

Figure 33: Using Router ACLs to Control Traffic

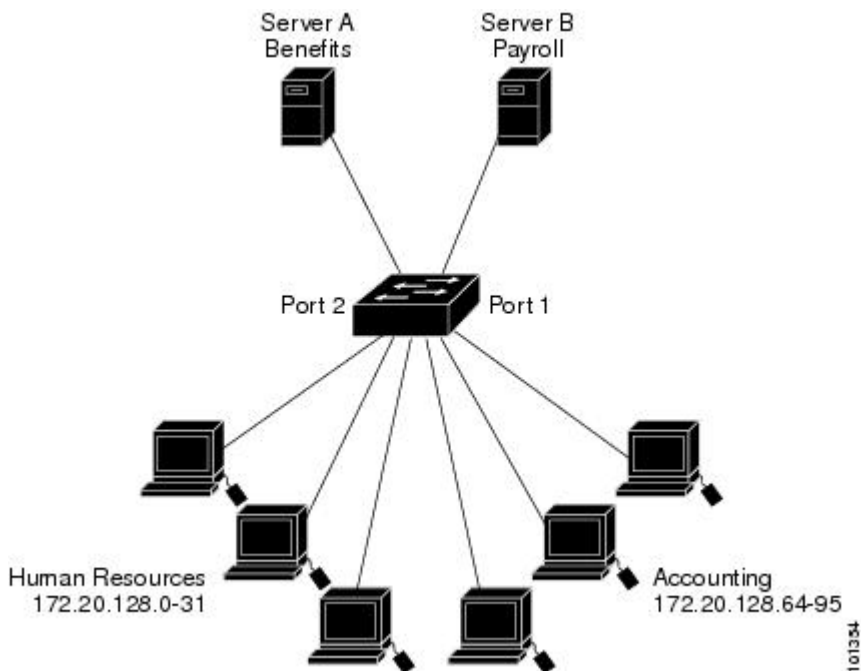

This shows a small networked office environment with routed Port 2 connected to Server A, containing benefits and other information that all employees can access, and routed Port 1 connected to Server B, containing confidential payroll data. All users can access Server A, but Server B has restricted access.

Use router ACLs to do this in one of two ways:

- Create a standard ACL, and filter traffic coming to the server from Port 1.
- Create an extended ACL, and filter traffic coming from the server into Port 1.

## Examples: ACLs in a Small Networked Office

This example uses a standard ACL to filter traffic coming into Server B from a port, permitting traffic only from Accounting's source addresses 172.20.128.64 to 172.20.128.95. The ACL is applied to traffic coming out of routed Port 1 from the specified source address.

```
Device(config)# access-list 6 permit 172.20.128.64 0.0.0.31
Device(config)# end
Device# show access-lists
Standard IP access list 6
    10 permit 172.20.128.64, wildcard bits 0.0.0.31
Device(config)# interface gigabitethernet1/0/1
Device(config-if)# ip access-group 6 out
```

This example uses an extended ACL to filter traffic coming from Server B into a port, permitting traffic from any source address (in this case Server B) to only the Accounting destination addresses 172.20.128.64 to 172.20.128.95. The ACL is applied to traffic going into routed Port 1, permitting it to go only to the specified destination addresses. Note that with extended ACLs, you must enter the protocol (IP) before the source and destination information.

```
Device(config)# access-list 106 permit ip any 172.20.128.64 0.0.0.31
Device(config)# end
Device# show access-lists
Extended IP access list 106
    10 permit ip any 172.20.128.64 0.0.0.31
Device(config)# interface gigabitethernet1/0/1
Device(config-if)# ip access-group 106 in
```

## Example: Numbered ACLs

In this example, network 10.0.0.0 is a Class A network whose second octet specifies a subnet; that is, its subnet mask is 255.255.0.0. The third and fourth octets of a network 10.0.0.0 address specify a particular host. Using access list 2, the switch accepts one address on subnet 48 and reject all others on that subnet. The last line of the list shows that the switch accepts addresses on all other network 10.0.0.0 subnets. The ACL is applied to packets entering a port.

```
Device(config)# access-list 2 permit 10.48.0.3
Device(config)# access-list 2 deny 10.48.0.0 0.0.255.255
Device(config)# access-list 2 permit 10.0.0.0 0.255.255.255
Device(config)#
Device(config-if)# ip access-group 2 in
```

## Examples: Extended ACLs

In this example, the first line permits any incoming TCP connections with destination ports greater than 1023. The second line permits incoming TCP connections to the Simple Mail Transfer Protocol (SMTP) port of host 128.88.1.2. The third line permits incoming ICMP messages for error feedback.

```
Device(config)# access-list 102 permit tcp any 128.88.0.0 0.0.255.255 gt 1023
Device(config)# access-list 102 permit tcp any host 128.88.1.2 eq 25
Device(config)# access-list 102 permit icmp any any
Device(config)#
```

```
Device(config-if)# ip access-group 102 in
```

In this example, suppose that you have a network connected to the Internet, and you want any host on the network to be able to form TCP connections to any host on the Internet. However, you do not want IP hosts to be able to form TCP connections to hosts on your network, except to the mail (SMTP) port of a dedicated mail host.

SMTP uses TCP port 25 on one end of the connection and a random port number on the other end. The same port numbers are used throughout the life of the connection. Mail packets coming in from the Internet have a destination port of 25. Because the secure system of the network always accepts mail connections on port 25, the incoming are separately controlled.

```
Device(config)# access-list 102 permit tcp any 128.88.0.0 0.0.255.255 eq 23
Device(config)# access-list 102 permit tcp any 128.88.0.0 0.0.255.255 eq 25
Device(config)#
Device(config-if)# ip access-group 102 in
```

## Examples: Named ACLs

### Creating named standard and extended ACLs

This example creates a standard ACL named *internet\_filter* and an extended ACL named *marketing\_group*. The *internet\_filter* ACL allows all traffic from the source address 1.2.3.4.

```
Device(config)# ip access-list standard Internet_filter
Device(config-ext-nacl)# permit 1.2.3.4
Device(config-ext-nacl)# exit
```

The *marketing\_group* ACL allows any TCP Telnet traffic to the destination address and wildcard 171.69.0.0 0.0.255.255 and denies any other TCP traffic. It permits ICMP traffic, denies UDP traffic from any source to the destination address range 171.69.0.0 through 179.69.255.255 with a destination port less than 1024, denies any other IP traffic, and provides a log of the result.

```
Device(config)# ip access-list extended marketing_group
Device(config-ext-nacl)# permit tcp any 171.69.0.0 0.0.255.255 eq telnet
Device(config-ext-nacl)# deny tcp any any
Device(config-ext-nacl)# permit icmp any any
Device(config-ext-nacl)# deny udp any 171.69.0.0 0.0.255.255 lt 1024
Device(config-ext-nacl)# deny ip any any log
Device(config-ext-nacl)# exit
```

The *Internet\_filter* ACL is applied to outgoing traffic and the *marketing\_group* ACL is applied to incoming traffic on a Layer 3 port.

```
Device(config)# interface gigabitethernet3/0/1

Device(config-if)# ip address 2.0.5.1 255.255.255.0
Device(config-if)# ip access-group Internet_filter out
Device(config-if)# ip access-group marketing_group in
```

### Deleting individual ACEs from named ACLs

This example shows how you can delete individual ACEs from the named access list *border-list*:

```
Device(config)# ip access-list extended border-list
Device(config-ext-nacl)# no permit ip host 10.1.1.3 any
```

## Monitoring IPv4 ACLs

You can monitor IPv4 ACLs by displaying the ACLs that are configured on the switch, and displaying the ACLs that have been applied to interfaces and VLANs.

When you use the **ip access-group** interface configuration command to apply ACLs to a Layer 2 or 3 interface, you can display the access groups on the interface. You can also display the MAC ACLs applied to a Layer 2 interface. You can use the privileged EXEC commands as described in this table to display this information.

**Table 44: Commands for Displaying Access Lists and Access Groups**

Command	Purpose
<b>show access-lists</b> [ <i>number</i>   <i>name</i> ]	Displays the contents of one or all current IP and MAC address access lists on the switch. If you specify a specific access list (numbered or named).
<b>show ip access-lists</b> [ <i>number</i>   <i>name</i> ]	Displays the contents of all current IP access lists or a specific IP access list (numbered or named).
<b>show ip interface</b> <i>interface-id</i>	Displays detailed configuration and status of an interface. If IP access lists and ACLs have been applied by using the <b>ip access-group</b> configuration command, the access groups are included in the display.
<b>show running-config</b> [ <b>interface</b> <i>interface-id</i> ]	Displays the contents of the configuration file for the switch or interface, including all configured MAC and IP access lists and access groups applied to an interface.





## CHAPTER 108

# DNS-Based Access Control Lists

- [Information About DNS-Based Access Control Lists, on page 965](#)
- [Restrictions on DNS-Based Access Control Lists, on page 968](#)
- [Flex Mode, on page 969](#)
- [Local Mode, on page 971](#)
- [Viewing DNS-Based Access Control Lists, on page 975](#)
- [Configuration Examples for DNS-Based Access Control Lists, on page 975](#)
- [Verifying DNS Snoop Agent \(DSA\), on page 976](#)
- [Information About Flex Client IPv6 Support with WebAuth Pre and Post ACL, on page 977](#)
- [Enabling Pre-Authentication ACL for LWA and EWA \(GUI\), on page 978](#)
- [Enabling Pre-Authentication ACL for LWA and EWA, on page 979](#)
- [Enabling Post-Authentication ACL for LWA and EWA \(GUI\), on page 980](#)
- [Enabling Post-Authentication ACL for LWA and EWA, on page 981](#)
- [Enabling DNS ACL for LWA and EWA \(GUI\), on page 981](#)
- [Enabling DNS ACL for LWA and EWA, on page 981](#)
- [Verifying Flex Client IPv6 Support with WebAuth Pre and Post ACL, on page 982](#)

## Information About DNS-Based Access Control Lists

The DNS-based ACLs are used for wireless client devices. When using these devices, you can set pre-authentication ACLs on the Cisco Catalyst 9800 Series Wireless Controller to determine the data requests that are allowed or blocked.

To enable DNS-based ACLs on the controller, you need to configure the allowed URLs or denied URLs for the ACLs. The URLs need to be pre-configured on the ACL.

With DNS-based ACLs, the client when in registration phase is allowed to connect to the configured URLs. The controller is configured with the ACL name that is returned by the AAA server. If the ACL name is returned by the AAA server, then the ACL is applied to the client for web-redirection.

At the client authentication phase, the AAA server returns the pre-authentication ACL (url-redirect-acl, which is the attribute name given to the AAA server). The DNS snooping is performed on the AP for each client until the registration is complete and the client is in SUPPLICANT PROVISIONING state. When the ACL configured with the URLs is received on the controller, the CAPWAP payload is sent to the AP enabling DNS snooping for the URLs to be snooped.

With URL snooping in place, the AP learns the IP address of the resolved domain name in the DNS response. If the domain name matches the configured URL, then the DNS response is parsed for the IP address, and the IP address is sent to the controller as a CAPWAP payload. The controller adds the IP address to the allowed list of IP addresses and thus the client can access the URLs configured.

URL filtering allows access to the IP address for DNS ports 80 or 443.

During pre-authentication or post-authentication, DNS ACL is applied to the client in the access point. If the client roams from one AP to another AP, the DNS learned IP addresses on the old AP is valid on the new AP as well.



---

**Note** Standard URL filtering is used for local mode, whereas enhanced URL filtering is used for flex mode local switching.

---



---

**Note** URL filter needs to be attached to a policy profile in case of the local mode. In the flex mode, the URL filter is attached to the flex profile and it is not need to be attached to a policy profile.

---



---

**Note** DNS based URLs work with active DNS query from the client. Hence, for URL filtering, the DNS should be setup correctly.

---



---

**Note** URL filter takes precedence over punt or redirect ACL, and over custom or static pre-auth ACL.s

---

## Defining ACLs

Extended ACLs are like standard ACLs but identifies the traffic more precisely.

The following CLI allows you to define ACLs by name or by an identification number.

```
Device(config)#ip access-list extended ?
<100-199> Extended IP access-list number
<2000-2699> Extended IP access-list number (expanded range)
WORD Access-list name
```

The following is the structure of a CLI ACL statement:

```
<sequence number> [permit/deny] <protocol> <address or any> eq <port number> <subnet>
<wildcard>
```

For example:

```
1 permit tcp any eq www 192.168.1.0 0.0.0.255
```

The sequence number specifies where to insert the Access Control list Entry (ACE) in the ACL order of ACEs. You can define your statements with sequences of 10, 20, 30, 40, and so on.

The controller GUI allows you to write a complete ACL going to the **Configuration > Security > ACL** page. You can view a list of protocols to pick from, and make changes to an existing ACL.



## Applying ACLs

The following are the ways to apply ACLs:

- **Security ACL:** A security ACL defines the type of traffic that should be allowed through the device and that which should be blocked or dropped.

A security ACL is applied:

- **On SVI interfaces:** The ACL will only be evaluated against the traffic that is routed through the interface.

```
Device(config)# interface Vlan<number>  
Device(config-if)# ip access-group myACL in/out
```

- **On a physical interface of the controller:** The ACL will be evaluated against all traffic that passes through the interface. Along with applying ACLs on SVI, this is another option for restricting traffic on the controller management plane.

```
Device(config)#interface GigabitEthernet1  
Device(config-if)#ip access-group myACL in/out
```

- **In the wireless policy profile or WLAN:** This option includes several places where you can configure an ACL that will be applied to the wireless client traffic, in case of central switching or local switching of traffic. Such ACLs are only supported in the inbound direction.
- **On the AP:** In case of FlexConnect local switching, the ACL is configured and applied from the policy profile on the controller. This ACL has to be downloaded on to the AP through the Flex profile. ACLs must be downloaded to the AP before they can be applied. As an exception, fabric mode APs (in case of Software Defined Access) also use Flex ACLs even though the AP is not operating in Flex mode.
- **Punt ACL or Redirect ACL:** Punt ACL or redirect ACL refers to an ACL that specifies as to which traffic will be sent to the CPU (instead of its normal expected handling by the dataplane) for further processing. For example, the Central Web Authentication (CWA) redirect ACL defines as to which traffic is intercepted and redirected to the web login portal. The ACL does not define any traffic to be dropped or allowed, but follows the regular processing or forwarding rules, and what will be sent to the CPU for interception.

A redirect ACL has an invisible last statement which is an implicit deny. This implicit deny is applied as a security access list entry (and therefore drops traffic that is not explicitly allowed through or sent to the CPU).

## Types of URL Filters

The following are the two types of URL filters:

- **Standard:** Standard URL filters can be applied before client authentication (pre-auth) or after a successful client authentication (post-auth). Pre-auth filters are extremely useful in the case of external web authentication to allow access to the external login page, as well as, some internal websites before authentication takes place. Post-auth, they can work to block specific websites or allow only specific websites while all the rest is blocked by default. This type of URL filtering post-auth is better handled by using Cisco DNS Layer Security (formerly known as Umbrella) for more flexibility. The standard URL filters apply the same action (permit or deny) for the whole list of URLs. It is either all permit or all deny. Standard URL filter work on local mode APs only.

- **Enhanced:** Enhanced URL filters allow specification of a different action (deny or permit) for each URL inside the list and have per-URL hit counters. Enhanced URL filter work on FlexConnect mode APs only.

In both types of URL filters, you can use a wildcard sub-domain such as `*.cisco.com`. URL filters are standalone but always applied along with an IP-based ACL. A maximum of 20 URLs are supported in a given URL filter. Considering one URL can resolve multiple IP addresses, only up to 40 resolved IP addresses can be tracked for each client. Only DNS records are tracked by URL filters. The controller or APs do not track the resolved IP address of a URL if the DNS answer uses a CNAME alias record.



---

**Note** In a scenario where you have a URL filter of type POST and an ACL applied to a policy profile, traffic to the URL is blocked by the ACL if there are no permit statements regarding the URLs. This can occur if the URL filter is POST with permit statement and within the ACL there is no permit statement for the URLs. Therefore, we recommend that you create permit statements within the ACL, regarding the IP address of the URLs, instead of using the POST URL filter.

---

## Restrictions on DNS-Based Access Control Lists

The restriction for DNS-based ACLs is as follows:

- Pre-authentication and Post-authentication filters are supported in local modes. Only Pre-authentication filter is supported in Flex (Fabric) mode.
- ACL override pushed from ISE is not supported.
- FlexConnect Local Switching with External Web authentication using URL filtering is not supported until Cisco IOS XE Gibraltar 16.12.x.
- Fully qualified domain name (FQDN) or DNS based ACLs are not supported on Cisco Wave 1 Access Points.
- The URL filter considers only the first 20 URLs, though you can add more.
- The URL filter employs regular regex patterns and permits wildcard characters only at the beginning or at the end of an URL.
- The URL ACLs are defined and added to the FlexConnect policy profile in which they associate with a WLAN. The URL ACL creation follows a similar mechanism as that of local mode URL ACLs.
- In FlexConnect mode, the URL domain ACL works only if they are connected to a FlexConnect policy profile.
- The ACL can be attached to a WLAN by associating a policy profile with a WLAN or local policies. However, you can override it using "url-redirect-acl".
- For the Cisco AV pair received from ISE, the policy that needs to be applied for a particular client is pushed as part of ADD MOBILE message.
- When an AP joins or when an existing URL ACL is modified and applied on FlexConnect profile, the ACL definition along with mapped URL filter list is pushed to the AP.

- The AP stores the URL ACL definition with mapped ACL name and snoops the DNS packets for learning the first IP address for each URL in the ACL. When the AP learns the IP addresses, it updates the controller of the URL and IP bindings. The controller records this information in the client database for future use.
- When a client roams to another AP during the pre-authentication state, the learned IP addresses are pushed to a new AP. Otherwise, these learned IP addresses are purged when a client moves to a post-authentication state or when the TTL for the learned IP address expires.

### Restrictions on Wildcard Support in URLs

- The generic wildcard URL, such as \*.\* is not allowed.
- Wildcard between the domain names, such as \*a.cisco.com, a.cisco\*.com, a.b.c.test\*.apply.play are not allowed.
- Multiple wildcard, such as test.\*.cisco\*.com is not allowed in a URL.
- The wildcard such as \*.cisco.com is allowed in the URL.
- The wildcard with a suffix such as wpr.cisco.\* is a valid configuration.
- A maximum of 16 wildcard-based URLs must be configured for a given ACL.

## Flex Mode

### Defining URL Filter List

#### Procedure

	Command or Action	Purpose
<b>Step 1</b>	<b>configure terminal</b>  <b>Example:</b> Device# configure terminal	Enters global configuration mode.
<b>Step 2</b>	<b>urlfilter enhanced-list list-name</b>  <b>Example:</b> Device(config)# urlfilter enhanced-list urllist_flex_preauth	Configures the URL filter enhanced list.  Here, <i>list-name</i> refers to the URL filter list name. The list name must not exceed 32 alphanumeric characters.
<b>Step 3</b>	<b>url url-name preference 0-65535 action { deny   permit }</b>  <b>Example:</b> Device(config-urlfilter-enhanced-params)# url url-name preference 1 action permit	Configures the action: permit (allowed list) or deny (blocked list).
<b>Step 4</b>	<b>end</b>  <b>Example:</b>	Returns to privileged EXEC mode.

	Command or Action	Purpose
	Device (config-urlfilter-params) # <b>end</b>	

## Applying URL Filter List to Flex Profile

### Procedure

	Command or Action	Purpose
<b>Step 1</b>	<b>configure terminal</b>  <b>Example:</b> Device# <code>configure terminal</code>	Enters global configuration mode.
<b>Step 2</b>	<b>wireless profile flex</b> <i>default-flex-profile</i>  <b>Example:</b> Device (config) # <b>wireless profile flex default-flex-profile</b>	Creates a new flex policy.  The default flex profile name is <i>default-flex-profile</i> .
<b>Step 3</b>	<b>acl-policy</b> <i>acl policy name</i>  <b>Example:</b> Device (config-wireless-flex-profile) # <b>acl-policy acl_name</b>	Configures ACL policy.
<b>Step 4</b>	<b>urlfilter list</b> <i>name</i>  <b>Example:</b> Device (config-wireless-flex-profile-acl) # <b>urlfilter list</b> <b>urllist_flex_preauth</b>	Applies the URL list to the Flex profile.
<b>Step 5</b>	<b>end</b>  <b>Example:</b> Device (config-wireless-flex-profile-acl) # <b>end</b>	Returns to privileged EXEC mode.

## Configuring ISE for Central Web Authentication (GUI)

Perform the following steps to configure ISE for Central Web Authentication.

### Procedure

- 
- Step 1** Login to the Cisco Identity Services Engine (ISE).
  - Step 2** Click **Policy** and then click **Policy Elements**.
  - Step 3** Click **Results**.
  - Step 4** Expand **Authorization** and click **Authorization Profiles**.
  - Step 5** Click **Add** to create a new authorization profile for URL filter.

- Step 6** Enter a name for the profile in the **Name** field. For example, CentralWebauth.
- Step 7** Choose **ACCESS\_ACCEPT** option from the **Access Type** drop-down list.
- Step 8** Alternatively, in the **Common Tasks** section, check **Web Redirection**.
- Step 9** Choose the **Centralized Web Auth** option from the drop-down list.
- Step 10** Specify the ACL and choose the ACL value from the drop-down list.
- Step 11** In the **Advanced Attributes Setting** section, choose **Cisco:cisco-av-pair** from the drop-down list.

**Note** Multiple ACL can be applied on the controller based on priority. In L2 Auth + webauth multi-auth scenario, if the ISE returns ACL during L2 Auth then ISE ACL takes precedence over the default webauth redirect ACL. This leads to traffic running in webauth pending state, if ISE ACL has permit rule. To avoid this scenario, you need to set the precedence for L2 Auth ISE returned ACL. The default webauth redirect ACL priority is 100. To avoid traffic issue, you need to configure the redirect ACL priority above 100 for ACL returned by ISE.

- Step 12** Enter the following one by one and click (+) icon after each of them:

- url-redirect-acl=<sample\_name>
- url-redirect=<sample\_redirect\_URL>

For example,

```
Cisco:cisco-av-pair = priv-lvl=15
Cisco:cisco-av-pair = url-redirect-acl=ACL-REDIRECT2
Cisco:cisco-av-pair = url-redirect=
https://9.10.8.247:port/portal/gateway?
sessionId=SessionIdValue&portal=0ce17ad0-6d90-11e5-978e-005056bf2f0a&daysToExpiry=value&action=cwa
```

- Step 13** Verify contents in the **Attributes Details** section and click **Save**.

## Local Mode

### Defining URL Filter List

#### Procedure

	Command or Action	Purpose
<b>Step 1</b>	<b>configure terminal</b>  <b>Example:</b> Device# configure terminal	Enters global configuration mode.
<b>Step 2</b>	<b>urlfilter list list-name</b>  <b>Example:</b> Device(config)# urlfilter list urllist_local_preauth	Configures the URL filter list.  Here, <i>list-name</i> refers to the URL filter list name. The list name must not exceed 32 alphanumeric characters.

	Command or Action	Purpose
<b>Step 3</b>	<b>action permit</b> <b>Example:</b> Device(config-urlfilter-params)# action permit	Configures the action: permit (allowed list) or deny (blocked list).
<b>Step 4</b>	<b>filter-type post-authentication</b> <b>Example:</b> Device(config-urlfilter-params)# filter-type post-authentication	<b>Note</b> This step is applicable while configuring post-authentication URL filter only.  Configures the URL list as post-authentication filter.
<b>Step 5</b>	<b>redirect-server-ip4 IPv4-address</b> <b>Example:</b> Device(config-urlfilter-params)# redirect-server-ipv4 9.1.0.101	Configures the IPv4 redirect server for the URL list.  Here, <i>IPv4-address</i> refers to the IPv4 address.
<b>Step 6</b>	<b>redirect-server-ip6 IPv6-address</b> <b>Example:</b> Device(config-urlfilter-params)# redirect-server-ipv6 2001:300:8::82	Configures the IPv6 redirect server for the URL list.  Here, <i>IPv6-address</i> refers to the IPv6 address.
<b>Step 7</b>	<b>url url</b> <b>Example:</b> Device(config-urlfilter-params)# url url1.dns.com	Configures an URL.  Here, <i>url</i> refers to the name of the URL.
<b>Step 8</b>	<b>end</b> <b>Example:</b> Device(config-urlfilter-params)# end	Returns to privileged EXEC mode.

## Applying URL Filter List to Policy Profile (GUI)

### Procedure

- 
- Step 1** Choose **Configuration > Tags & Profiles > Policy**.
  - Step 2** Click on the **Policy Name**.
  - Step 3** Go to **Access Policies** tab.
  - Step 4** In the **URL Filters** section, choose the filters from the **Pre Auth** and **Post Auth** drop-down lists.
  - Step 5** Click **Update & Apply to Device**.
-

## Applying URL Filter List to Policy Profile

### Procedure

	Command or Action	Purpose
<b>Step 1</b>	<b>configure terminal</b> <b>Example:</b> Device# configure terminal	Enters global configuration mode.
<b>Step 2</b>	<b>wireless profile policy <i>profile-policy</i></b> <b>Example:</b> Device(config)# wireless profile policy default-policy-profile	Configures wireless policy profile.  Here, <i>profile-policy</i> refers to the name of the WLAN policy profile.
<b>Step 3</b>	<b>urlfilter list {pre-auth-filter <i>name</i>   post-auth-filter <i>name</i>}</b> <b>Example:</b> Device(config-wireless-policy)# urlfilter list pre-auth-filter urllist_local_preauth Device(config-wireless-policy)# urlfilter list post-auth-filter urllist_local_postauth	Applies the URL list to the policy profile.  Here, <i>name</i> refers to the name of the pre-authentication or post-authentication URL filter list configured earlier.  <b>Note</b> During the client join, the URL filter configured on the policy will be applied.
<b>Step 4</b>	<b>end</b> <b>Example:</b> Device(config-wireless-policy)# end	Returns to privileged EXEC mode.

## Configuring ISE for Central Web Authentication

### Creating Authorization Profiles

#### Procedure

- Step 1** Login to the Cisco Identity Services Engine (ISE).
- Step 2** Click **Policy**, and click **Policy Elements**.
- Step 3** Click **Results**.
- Step 4** Expand **Authorization**, and click **Authorization Profiles**.
- Step 5** Click **Add** to create a new authorization profile for URL filter.
- Step 6** In the Name field, enter a name for the profile. For example, *CentralWebauth*.
- Step 7** Choose **ACCESS\_ACCEPT** from the Access Type drop-down list.
- Step 8** In the Advanced Attributes Setting section, choose **Cisco:cisco-av-pair** from the drop-down list.
- Step 9** Enter the following one by one and click (+) icon after each of them:

- url-filter-preauth=<preauth\_filter\_name>
- url-filter-postauth=<postauth\_filter\_name>

For example,

```
Cisco:cisco-av-pair = url-filter-preauth=urllist_pre_cwa
Cisco:cisco-av-pair = url-filter-postauth=urllist_post_cwa
```

- Step 10** Verify contents in the Attributes Details section and click **Save**.
- 

## Mapping Authorization Profiles to Authentication Rule

### Procedure

---

- Step 1** In the **Policy > Authentication** page, click **Authentication**.
- Step 2** Enter a name for your authentication rule.  
For example, *MAB*.
- Step 3** In the If condition field, select the plus (+) icon.
- Step 4** Choose **Compound condition**, and choose **WLC\_Web\_Authentication**.
- Step 5** Click the arrow located next to **and ...** in order to expand the rule further.
- Step 6** Click the + icon in the Identity Source field, and choose **Internal endpoints**.
- Step 7** Choose **Continue** from the 'If user not found' drop-down list.  
This option allows a device to be authenticated even if its MAC address is not known.
- Step 8** Click **Save**.
- 

## Mapping Authorization Profiles to Authorization Rule

### Procedure

---

- Step 1** Click **Policy > Authorization**.
- Step 2** In the Rule Name field, enter a name.  
For example, *CWA Post Auth*.
- Step 3** In the Conditions field, select the plus (+) icon.
- Step 4** Click the drop-down list to view the Identity Groups area.
- Step 5** Choose **User Identity Groups > user\_group**.
- Step 6** Click the plus (+) sign located next to **and ...** in order to expand the rule further.
- Step 7** In the Conditions field, select the plus (+) icon.
- Step 8** Choose **Compound Conditions**, and choose to create a new condition.



- Step 9** From the settings icon, select **Add Attribute/Value** from the options.
- Step 10** In the Description field, choose **Network Access > UseCase** as the attribute from the drop-down list.
- Step 11** Choose the **Equals** operator.
- Step 12** From the right-hand field, choose **GuestFlow**.
- Step 13** In the Permissions field, select the plus (+) icon to select a result for your rule.
- You can choose **Standard > PermitAccess** option or create a custom profile to return the attributes that you like.
- 

## Viewing DNS-Based Access Control Lists

To view details of a specified wireless URL filter, use the following command:

```
Device# show wireless urlfilter details <urllist_flex_preauth>
```

To view the summary of all wireless URL filters, use the following command:

```
Device# show wireless urlfilter summary
```

To view the URL filter applied to the client in the resultant policy section, use the following command:

```
Device# show wireless client mac-address <MAC_addr> detail
```

## Configuration Examples for DNS-Based Access Control Lists

### Flex Mode

*Example: Defining URL Filter List*

This example shows how to define URL list in Flex mode:

```
Device# configure terminal
Device(config)# urlfilter enhanced-list urllist_flex_pre
Device(config-urlfilter-params)# url www.dns.com preference 1 action permit
Device(config-urlfilter-params)# end
```

*Example: Applying URL Filter List to Flex Profile*

This example shows how to apply an URL list to the Flex profile in Flex mode:

```
Device# configure terminal
Device(config)# wireless profile flex default-flex-profile
Device(config-wireless-flex-profile)# acl-policy acl_name
Device(config-wireless-flex-profile-acl)# urlfilter list urllist_flex_preauth
Device(config-wireless-flex-profile-acl)# end
```

### Local Mode

*Example: Defining Preauth URL Filter List*

This example shows how to define URL filter list (pre-authentication):

```

Device# configure terminal
Device(config)# urlfilter list urllist_local_preauth
Device(config-urlfilter-params)# action permit
Device(config-urlfilter-params)# redirect-server-ipv4 9.1.0.101
Device(config-urlfilter-params)# redirect-server-ipv6 2001:300:8::82
Device(config-urlfilter-params)# url url1.dns.com
Device(config-urlfilter-params)# end

```

*Example: Defining Postauth URL Filter List*

This example shows how to define URL filter list (post-authentication):

```

Device# configure terminal
Device(config)# urlfilter list urllist_local_postauth
Device(config-urlfilter-params)# action permit
Device(config-urlfilter-params)# filter-type post-authentication
Device(config-urlfilter-params)# redirect-server-ipv4 9.1.0.101
Device(config-urlfilter-params)# redirect-server-ipv6 2001:300:8::82
Device(config-urlfilter-params)# url url1.dns.com
Device(config-urlfilter-params)# end

```

*Example: Applying URL Filter List to Policy Profile*

This example shows how to apply an URL list to the policy profile in local mode:

```

Device# configure terminal
Device(config)# wireless profile policy default-policy-profile
Device(config-wireless-policy)# urlfilter list pre-auth-filter urllist_local_preauth
Device(config-wireless-policy)# urlfilter list post-auth-filter urllist_local_postauth
Device(config-wireless-policy)# end

```

## Verifying DNS Snoop Agent (DSA)

To view details of the DNS snooping agent client, use the following command:

```
Device# show platform hardware chassis active qfp feature dns-snoop-agent client
```

To view details of the DSA enabled interface, use the following command:

```
Device# show platform hardware chassis active qfp feature dns-snoop-agent client enabled-intf
```

To view the pattern list in uCode memory, use the following command:

```
Device# show platform hardware chassis active qfp feature dns-snoop-agent client
hw-pattern-list
```

To view the OpenDNS string for the pattern list, use the following command:

```
Device# show platform hardware chassis active qfp feature dns-snoop-agent client
hw-pattern-list odns_string
```

To view the FQDN filter for the pattern list, use the following command:

```
Device#
show platform hardware chassis active qfp feature dns-snoop-agent client hw-pattern-list
fqdn-filter <fqdn_filter_ID>
```



**Note** The valid range of *fqdn\_filter\_ID* is from 1 to 16.

To view details of the DSA client, use the following command:

```
Device# show platform hardware chassis active qfp feature dns-snoop-agent client info
```

To view the pattern list in CPP client, use the following command:

```
Device# show platform hardware chassis active qfp feature dns-snoop-agent client pattern-list
```

To view the OpenDNS string for the pattern list, use the following command:

```
Device# show platform hardware chassis active qfp feature dns-snoop-agent client pattern-list  
odns_string
```

To view the FQDN filter for the pattern list, use the following command:

```
Device# show platform hardware chassis active qfp feature dns-snoop-agent client pattern-list  
fqdn-filter <fqdn_filter_ID>
```



---

**Note** The valid range of *fqdn\_filter\_ID* is from 1 to 16.

---

To view details of the DSA datapath, use the following command:

```
Device# show platform hardware chassis active qfp feature dns-snoop-agent datapath
```

To view details of the DSA IP cache table, use the following command:

```
Device# show platform hardware chassis active qfp feature dns-snoop-agent datapath ip-cache
```

To view details of the DSA address entry, use the following command:

```
Device# show platform hardware chassis active qfp feature dns-snoop-agent datapath ip-cache  
address {ipv4 <IPv4_addr> | ipv6 <IPv6_addr>}
```

To view details of all the DSA IP cache address, use the following command:

```
Device# show platform hardware chassis active qfp feature dns-snoop-agent datapath ip-cache  
all
```

To view details of the DSA IP cache pattern, use the following command:

```
Device# show platform hardware chassis active qfp feature dns-snoop-agent datapath ip-cache  
pattern <pattern>
```

To view details of the DSA datapath memory, use the following command:

```
Device# show platform hardware chassis active qfp feature dns-snoop-agent datapath memory
```

To view the DSA regular expression table, use the following command:

```
Device# show platform hardware chassis active qfp feature dns-snoop-agent datapath  
regexp-table
```

To view the DSA statistics, use the following command:

```
Device# show platform hardware chassis active qfp feature dns-snoop-agent datapath stats
```

## Information About Flex Client IPv6 Support with WebAuth Pre and Post ACL

IOS IPv6 ACLs is used to send webauth ACL to an AP. A change in the ACL policies of the Flex profile (new ACL, deleted ACL or modified ACL).

ACL definitions are pushed to AP in the following events:

- AP join.
- New ACL mapping in a new Flex profile.
- Configuring IPv6 ACL definition in Flex profile.

#### Default Local Web Authentication ACLs

The pre-defined default LWA IPv6 ACL is pushed to AP and plumbed to data plane.

#### Default External Web Authentication ACL

The default EWA ACLs are derived from the redirect portal address configured in the parameter map.

The following list covers the types of default EWA ACLs:

- Security ACL—Pushed and plumbed to AP.
- Intercept ACL—Pushed and plumbed to data plane.

#### FQDN ACL

- FQDN ACL is encoded along with IPv6 ACL and sent to AP.
- FQDN ACL is always a custom ACL.

The following applies to Flex and Local mode:

- If you are migrating from AireOS, you would explicitly need to execute the following commands:
 

```
redirect append ap-mac tag ap_mac
redirect append wlan-ssid tag wlan
redirect append client-mac tag client_mac
```
- If the login page has any resource that needs to be fetched from the server, you will need to include those resource URLs in URL filtering.
- If you are trying to access IPv6 URL and you have an IPv4 web server, the controller redirects the client to an internal page as domain redirection is not supported. It is recommended to have a dual-stack web server and configure virtual IPv6 address in the global parameter map.

## Enabling Pre-Authentication ACL for LWA and EWA (GUI)

### Procedure

- 
- Step 1** Choose **Configuration > Tags & Profiles > WLANs**.
  - Step 2** Click **Add**.
  - Step 3** In the **General** tab, enter the **Profile Name**, the **SSID** and the **WLAN ID**.
  - Step 4** Choose **Security > Layer2** tab. Uncheck the **WPAPolicy**, **AES** and **802.1x** check boxes.

- Step 5** Choose **Security > Layer3** tab. Choose the Web Auth Parameter Map from the **Web Auth Parameter Map** drop-down list and authentication list from the **Authentication List** drop-down list. Click **Show Advanced Settings** and under the **Preauthenticated ACL** settings, choose the IPv6 ACL from the **IPv6** drop-down list.
- Step 6** Choose **Security > AAA** tab. Choose the authentication list from the **Authentication List** drop-down list.
- Step 7** Click **Apply to Device**.

## Enabling Pre-Authentication ACL for LWA and EWA

### Procedure

	Command or Action	Purpose
<b>Step 1</b>	<b>configure terminal</b> <b>Example:</b> Device# configure terminal	Enters global configuration mode.
<b>Step 2</b>	<b>wlan wlan-name wlan-id SSID-name</b> <b>Example:</b> Device(config)# wlan wlan-demo 1 ssid-demo	Enters the WLAN configuration sub-mode. <ul style="list-style-type: none"> <li>• <i>wlan-name</i>—Enter the profile name. The range is from 1 to 32 alphanumeric characters.</li> <li>• <i>wlan-id</i>—Enter the WLAN ID. The range is from 1 to 512.</li> <li>• <i>SSID-name</i>—Enter the Service Set Identifier (SSID) for this WLAN. If the SSID is not specified, the WLAN profile name is set as the SSID.</li> </ul> <p><b>Note</b> If you have already configured WLAN, enter <b>wlan wlan-name</b> command.</p>
<b>Step 3</b>	<b>ipv6 traffic-filter web acl_name-preauth</b> <b>Example:</b> Device(config-wlan)# ipv6 traffic-filter web preauth_v6_acl	Creates a pre-authentication ACL for web authentication.
<b>Step 4</b>	<b>no security wpa</b> <b>Example:</b> Device(config-wlan)# no security wpa	Disables the WPA security.
<b>Step 5</b>	<b>no security wpa wpa2 ciphers aes</b> <b>Example:</b> Device(config-wlan)#no security wpa wpa2 ciphers aes	Disables WPA2 ciphers for AES.

	Command or Action	Purpose
<b>Step 6</b>	<b>no security wpa akm dot1x</b> <b>Example:</b> Device(config-wlan)#no security wpa akm dot1x	Disables security AKM for dot1x.
<b>Step 7</b>	<b>security web-auth</b> <b>Example:</b> Device(config-wlan)# security web-auth	Configures web authentication.
<b>Step 8</b>	<b>security web-auth authentication-list authenticate-list-name</b> <b>Example:</b> Device(config-wlan)# security web-auth authentication-list wcm_dot1x	Enables authentication list for WLAN.
<b>Step 9</b>	<b>security web-auth parameter-map parameter-map-name</b> <b>Example:</b> Device(config-wlan)# security web-auth parameter-map param-custom-webconsent	Maps the parameter map.
<b>Step 10</b>	<b>no shutdown</b> <b>Example:</b> Device(config-wlan)# no shutdown	Shutdown the WLAN.

## Enabling Post-Authentication ACL for LWA and EWA (GUI)

### Procedure

- 
- Step 1** Choose **Configuration > Tags & Profiles > WLANs**.
  - Step 2** Click **Add**.
  - Step 3** In the **General** tab, enter the **Profile Name**. The **Profile Name** is the profile name of the policy profile.
  - Step 4** Enter the **SSID** and the **WLAN ID**.
  - Step 5** Click **Apply to Device**.
-

## Enabling Post-Authentication ACL for LWA and EWA

### Procedure

	Command or Action	Purpose
<b>Step 1</b>	<b>configure terminal</b> <b>Example:</b> Device# configure terminal	Enters global configuration mode.
<b>Step 2</b>	<b>wireless profile policy <i>profile-name</i></b> <b>Example:</b> Device(config)# wireless profile policy test1	Creates policy profile for the WLAN. The <i>profile-name</i> is the profile name of the policy profile.
<b>Step 3</b>	<b>ipv6 acl <i>acl_name</i></b> <b>Example:</b> Device(config-wireless-policy)# ipv6 acl testacl	Creates a named WLAN ACL.
<b>Step 4</b>	<b>end</b> <b>Example:</b> Device(config-wireless-policy)# end	Returns to privileged EXEC mode. Alternatively, you can also press <b>Ctrl-Z</b> to exit global configuration mode.

## Enabling DNS ACL for LWA and EWA (GUI)

### Procedure

- 
- Step 1** Choose **Configuration > Tags & Profiles > WLANs**.
  - Step 2** Click **Add**.
  - Step 3** In the **General** tab, enter the **Profile Name**. The **Profile Name** is the profile name of the policy profile.
  - Step 4** Enter the **SSID** and the **WLAN ID**.
  - Step 5** Click **Apply to Device**.
- 

## Enabling DNS ACL for LWA and EWA



**Note** Post-authentication DNS ACL is not supported.

**Procedure**

	<b>Command or Action</b>	<b>Purpose</b>
<b>Step 1</b>	<b>configure terminal</b> <b>Example:</b> Device# configure terminal	Enters global configuration mode.
<b>Step 2</b>	<b>wireless profile policy <i>profile-name</i></b> <b>Example:</b> Device(config)# wireless profile policy test1	Creates policy profile for the WLAN.  The <i>profile-name</i> is the profile name of the policy profile.
<b>Step 3</b>	<b>end</b> <b>Example:</b> Device(config)# end	Returns to privileged EXEC mode. Alternatively, you can also press <b>Ctrl-Z</b> to exit global configuration mode.

## Verifying Flex Client IPv6 Support with WebAuth Pre and Post ACL

To verify the client state after L2 authentication, use the following command:

```
Device# show wireless client summary
Number of Local Clients: 1
```

MAC Address	AP Name	WLAN	State	Protocol	Method
1491.82b8.f8c1	AP4001.7A03.544C	4	Webauth Pending	11n(5)	None
-----					
Local					

```
Number of Excluded Clients: 0
```

To verify the IP state, discovery, and MAC, use the following command:

```
Device# show wireless dev da ip
IP STATE DISCOVERY MAC
-----
15.30.0.4 Reachable ARP 1491.82b8.f8c1
2001:15:30:0:d1d7:ecf3:7940:af60 Reachable IPv6 Packet 1491.82b8.f8c1
fe80::595e:7c29:d7c:3c84 Reachable IPv6 Packet 1491.82b8.f8c1
```





## CHAPTER 109

# Allowed List of Specific URLs

- [Allowed List of Specific URLs, on page 983](#)
- [Adding URL to Allowed List, on page 983](#)
- [Verifying URLs on the Allowed List, on page 985](#)

## Allowed List of Specific URLs

This feature helps you to add specific URLs to allowed list on the controller or the AP so that those specific URLs are available for use, even when there is no connectivity to the internet. You can add URLs to allowed list for web authentication of captive portal and walled garden. Authentication is not required to access the allowed list of URLs. When you try to access sites that are not in allowed list, you are redirected to the Login page.

## Adding URL to Allowed List

### Procedure

	Command or Action	Purpose
<b>Step 1</b>	<b>configure terminal</b> <b>Example:</b> Device# configure terminal	Enters global configuration mode.
<b>Step 2</b>	<b>urlfilter list &lt;urlfilter-name&gt;</b> <b>Example:</b> Device(config)# urlfilter list url-allowedlist-nbn	Configures the URL filter profile.
<b>Step 3</b>	<b>action [deny   permit]</b> <b>Example:</b> Device(config-urlfilter-params)# action permit	Configures the list as allowed list. The <b>permit</b> command configures the list as allowed list and the <b>deny</b> command configures the list as blocked list.

	Command or Action	Purpose
<b>Step 4</b>	<b>{ redirect-server-ipv4   redirect-server-ipv6 }</b> <b>Example:</b> Device(config-urlfilter-params)# redirect-server-ipv4 X.X.X.X	Configures the IP address of the redirect servers to which the user requests will be redirected in case of denied requests.
<b>Step 5</b>	<b>url url-to-be-allowed</b> <b>Example:</b> Device(config-urlfilter-params)# url www.cisco.com	Configures the URL to be allowed.



**Note** The controller uses two IP addresses and the mechanism only allows for one portal IP to be allowed. To allow pre-authentication access to more HTTP resources, you need to use URL filters which will dynamically make holes in the intercept (redirect) and security (preauth) ACLs for the IPs related to the website whose URL you enter in the URL filter. DNS requests will be dynamically snooped for the controller to learn the IP address of those URLs and add it to the ACLs dynamically.



**Note** **redirect-server-ipv4** and **redirect-server-ipv6** is applicable only in the local mode, specifically in post-authentication. For any further tracking or displaying any warning messages, the denied user request is redirected to the configured server.

But the **redirect-server-ipv4** and **redirect-server-ipv6** configurations do not apply to pre-authentication scenario as you will be redirected to the controller for the redirect login URL for any denied access.

You can associate the allowed URL with the ACL policy in flex profile.

### Example

Associating the allowed URL with the ACL policy in flex profile:

```
Device(config)# wireless profile flex default-flex-profile
Device(config-wireless-flex-profile)# acl-policy user_v4_acl
Device(config-wireless-flex-profile-acl)# urlfilter list url_allowedlist_nbn
Device(config-wireless-flex-profile-acl)# exit
Device(config-wireless-flex-profile)# description "default flex profile"

Device(config)# urlfilter enhanced-list urllist_pre_cwa
Device(config-urlfilter-enhanced-params)# url url1.dns.com preference 1 action permit
Device(config-urlfilter-enhanced-params)# url url2.dns.com preference 2 action deny
Device(config-urlfilter-enhanced-params)# url url3.dns.com preference 3 action permit

Device(config)# wlan wlan5 5 wlan5
Device(config-wlan)#ip access-group web user_v4_acl
Device(config-wlan)#no security wpa
Device(config-wlan)#no security wpa
Device(config-wlan)#no security wpa wpa2 ciphers aes
Device(config-wlan)#no security wpa akm dot1x
Device(config-wlan)#security web-auth
Device(config-wlan)#security web-auth authentication-list default
```

```
Device(config-wlan)#security web-auth parameter-map global
Device(config-wlan)#no shutdown
```

## Verifying URLs on the Allowed List

Verify URLs on the Allowed List.

```
Device# show wireless urlfilter summary
Black-list      - DENY
White-list      - PERMIT
Filter-Type     - Specific to Local Mode
```

URL-List	ID	Filter-Type	Action	Redirect-ipv4	Redirect-ipv6
url-whitelist	1	PRE-AUTH	PERMIT	1.1.1.1	

Device#

```
Device# show wireless urlfilter details url-whitelist
List Name..... : url-whitelist
Filter ID.....  : 1
Filter Type..... : PRE-AUTH
Action.....     : PERMIT
Redirect server ipv4..... : 1.1.1.1
Redirect server ipv6..... :
Configured List of URLs
URL.....        : www.cisco.com
```





## CHAPTER 110

# Cisco Umbrella WLAN

- [Information About Cisco Umbrella WLAN, on page 987](#)
- [Registering Controller to Cisco Umbrella Account, on page 988](#)
- [Configuring Cisco Umbrella WLAN, on page 989](#)
- [Configuring the Umbrella Flex Profile, on page 995](#)
- [Configuring the Umbrella Flex Profile \(GUI\), on page 995](#)
- [Configuring Umbrella Flex Parameters, on page 996](#)
- [Configuring the Umbrella Flex Policy Profile \(GUI\), on page 996](#)
- [Verifying the Cisco Umbrella Configuration, on page 997](#)

## Information About Cisco Umbrella WLAN

The Cisco Umbrella WLAN provides a cloud-delivered network security service at the Domain Name System (DNS) level, with automatic detection of both known and emergent threats.

This feature allows you to block sites that host malware, bot networks, and phishing before they actually become malicious.

Cisco Umbrella WLAN provides the following:

- Policy configuration per user group at a single point.
- Policy configuration per network, group, user, device, or IP address.

The following is the policy priority order:

1. Local policy
2. AP group
3. WLAN

- Visual security activity dashboard in real time with aggregated reports.
- Schedule and send reports through email.
- Support up to 60 content categories, with a provision to add custom allowed list and blocked list entries.
- Supports custom parameter-type Umbrella profiles. One Global profile and 15 custom profiles are supported.

- Although IPv6 is supported, device registration will always be over IPv4. There is no support of device registration over IPv6.
- The communication from device to the Umbrella Cloud can be done over IPv6 also.
- In the Flexconnect mode, DNS handling takes place in the AP instead of the controller. Multiple profiles are supported in the Flex mode.

This feature does not work in the following scenarios:

- If an application or host use an IP address directly, instead of using DNS to query domain names.
- If a client is connected to a web proxy and does not send a DNS query to resolve the server address.

## Registering Controller to Cisco Umbrella Account

### Before you Begin

- You should have an account with Cisco Umbrella.
- You should have an API token from Cisco Umbrella.

This section describes the process followed to register the controller to the Cisco Umbrella account.

The controller is registered to Cisco Umbrella server using the Umbrella parameter map. Each of the Umbrella parameter map must have an API token. The Cisco Umbrella responds with the device ID for the controller. The device ID has a 1:1 mapping with the Umbrella parameter map name.

### Fetching API token for Controller from Cisco Umbrella Dashboard

From Cisco Umbrella dashboard, verify that your controller shows up under Device Name, along with their identities.

### Applying the API Token on Controller

Registers the Cisco Umbrella API token on the network.

### DNS Query and Response

Once the device is registered and Umbrella parameter map is configured on WLAN, the DNS queries from clients joining the WLAN are redirected to the Umbrella DNS resolver.



---

**Note** This is applicable for all domains not configured in the local domain RegEx parameter map.

---

The queries and responses are encrypted based on the DNSCrypt option in the Umbrella parameter map.

For more information on the Cisco Umbrella configurations, see the [Integration for ISR 4K and ISR 1100 – Security Configuration Guide](#).

### Limitations and Considerations

The limitations and considerations for this feature are as follows:

- You will be able to apply the wireless Cisco Umbrella profiles to wireless entities, such as, WLAN or AP groups, if the device registration is successful.
- In case of L3 mobility, the Cisco Umbrella must be applied on the anchor controller always.
- When two DNS servers are configured under DHCP, two Cisco Umbrella server IPs are sent to the client from DHCP option 6. If only one DNS server is present under DHCP, only one Cisco Umbrella server IP is sent as part of DHCP option 6.

## Configuring Cisco Umbrella WLAN

To configure Cisco Umbrella on the controller, perform the following:

- You must have the API token from the Cisco Umbrella dashboard.
- You must have the root certificate to establish HTTPS connection with the Cisco Umbrella registration server: [api.opendns.com](https://api.opendns.com). You must import the root certificate from **digicert.com** to the controller using the **crypto pki trustpool import terminal** command.

## Importing CA Certificate to the Trust Pool

### Before you begin

The following section covers details about how to fetch the root certificate and establish HTTPS connection with the Cisco Umbrella registration server:

### Procedure

	Command or Action	Purpose
<b>Step 1</b>	<b>configure terminal</b> <b>Example:</b> Device# configure terminal	Enters global configuration mode.
<b>Step 2</b>	Perform either of the following tasks: <ul style="list-style-type: none"> <li>• <b>crypto pki trustpool import url url</b></li> </ul> <pre>Device(config)# crypto pki trustpool import url http://www.cisco.com/security/pki/trs/ios.p7b</pre> Imports the root certificate directly from the Cisco website.	

	Command or Action	Purpose
	<p><b>Note</b> The Trustpool bundle contains the root certificate of <i>digicert.com</i> together with other CA certificates.</p> <ul style="list-style-type: none"> <li><b>crypto pki trustpool import terminal</b></li> </ul> <pre>Device(config)# crypto pki trustpool import terminal</pre> <p>Imports the root certificate by executing the import terminal command.</p> <ul style="list-style-type: none"> <li>Enter PEM-formatted CA certificate from the following location: See the Related Information section to download the CA certificate.</li> </ul> <pre>-----BEGIN CERTIFICATE----- MIHjCAQwBgcqCjUIMwKFKlVA3DNEjchk9QABFHMbcCQDQF EwUeRMBGALIKMRGraNrcQ5fHwWMDQEBBnzZGanLrQJ29Mw HjDQfcdvq2VdHfG2Wgjr9dHBTafQMDBJOMAMB50ND9Mj MzNlNzBSCABNzVAMVRGEMQEBFavQ2VdEhMKFAzBNEMTfP Z2IXX0IHRUyB0rj0BjZ2LWp9QEMIEFANejchk9QABFROAQMIB GjCAQwAIZGwNIPNsCZULFRNtjprB5z4BUI3N5C03E0Gac0tpj EhBf9wIHIQHEGAT5M55HJLlE55NOE9K0w0ng9f0hTCRf80ND VfR0L9gUthbf0UNwTRALE/1p0hJhWakTnR65z6CzDhN2LlY8T mz49jRk5JhER6U9TQjG557K74hyFR3Uq83Nco06wVh5j40 K678jB08Lz2heocicp7CRITtHkcf9QDRA4BjCAoHMDR0BB Eldcupp8eef2y85W0rMBALHQMzFA8LWUj7dC48b09PTM4G AllDEE/CAwBjRzNzBzFjURgRjRQZQIKWEDHawRjDFOUQjH3y EjEjwEAE8gRjE8QrQyFVKWEDHAGCGH8j9A2NwR2Zj2X0 InK5E8gRjE8QrQyFVKWEDHAGCGH8j9A2NwR2Zj2X0R2v YBSj9dNEMjEBNVRGEMQEBFANejchk9QABFROAQMIB54q32yd5j2V RCraNrcH69W829QRB3BMEgFAhrcR08X3BC5aQ2yd5j2V RCraNrcH69W829QRB3BMDALHQMCoBwZEMAEACZ4MAQDMAg BwEACjYBj0PQWQKZlvAQELAgBhct3rE69GjloHFRWEX 35HfG7UgApwE8H0rCjRUSGQj0B5kcdEHqhinTEBch4Gw0t2 v2HRQVlBopB2380HMLkxYBQZMGAwBwCwRj7/InCR245Sre 50f668sKRMgDg0AHCCYm6VkiPPIRMlcwCjZ0Cj79z4Cj42x YRhs6wAp39zZfngqCj0zXp5fZUACB8Utw0E2B5S1E8 SaZMkE4f97Q= -----END CERTIFICATE-----</pre> <p>Imports the root certificate by pasting the CA certificate from the <b>digicert.com</b>.</p>	
<b>Step 3</b>	<p><b>quit</b></p> <p><b>Example:</b></p> <pre>Device(config)# quit</pre>	<p>Imports the root certificate by entering the <b>quit</b> command.</p> <p><b>Note</b> You will receive a message after the certificate has been imported.</p>



## Creating a Local Domain RegEx Parameter Map

### Procedure

	Command or Action	Purpose
<b>Step 1</b>	<b>configure terminal</b> <b>Example:</b> Device# <code>configure terminal</code>	Enters global configuration mode.
<b>Step 2</b>	<b>parameter-map type regex</b> <i>parameter-map-name</i> <b>Example:</b> Device(config)# <code>parameter-map type regex</code> <code>dns_wl</code>	Creates a regex parameter map.
<b>Step 3</b>	<b>pattern</b> <i>regex-pattern</i> <b>Example:</b> Device(config-profile)# <code>pattern</code> <code>www.google.com</code>	Configures the regex pattern to match. <b>Note</b> The following patterns are supported: <ul style="list-style-type: none"> <li>• Begins with <code>.*</code>. For example: <code>.*facebook.com</code></li> <li>• Begins with <code>.*</code> and ends with <code>*</code>. For example: <code>.*google*</code></li> <li>• Ends with <code>*</code>. For example: <code>www.facebook*</code></li> <li>• No special character. For example: <code>www.facebook.com</code></li> </ul>
<b>Step 4</b>	<b>end</b> <b>Example:</b> Device(config-profile)# <code>end</code>	Returns to privileged EXEC mode.

## Configuring Parameter Map Name in WLAN (GUI)

### Procedure

- Step 1** Choose **Configuration > Tags & Profiles > Policy**.
- Step 2** Click on the Policy Profile Name. The **Edit Policy Profile** window is displayed.
- Step 3** Choose the **Advanced** tab.
- Step 4** In the **Umbrella** settings, from the **Umbrella Parameter Map** drop-down list, choose the parameter map.
- Step 5** Enable or disable **Flex DHCP Option for DNS** and **DNS Traffic Redirect** toggle buttons.

**Step 6** Click **Update & Apply to Device**.

## Configuring the Umbrella Parameter Map

### Procedure

	Command or Action	Purpose
<b>Step 1</b>	<b>configure terminal</b>  <b>Example:</b> Device# <code>configure terminal</code>	Enters global configuration mode.
<b>Step 2</b>	<b>parameter-map type umbrella global / parameter-map-name</b>  <b>Example:</b> Device(config)# <code>parameter-map type umbrella custom_pmap</code>	Creates an umbrella global or customized parameter map.
<b>Step 3</b>	<b>token token-value</b>  <b>Example:</b> Device(config-profile)# <code>token 5XX</code>	Configures an umbrella token.
<b>Step 4</b>	<b>local-domain regex-parameter-map-name</b>  <b>Example:</b> Device(config-profile)# <code>local-domain dns_w1</code>	Configures local domain RegEx parameter map.
<b>Step 5</b>	<b>resolver {IPv4 X.X.X.X   IPv6 X:X:X:X::X}</b>  <b>Example:</b> Device(config-profile)# <code>resolver IPv6 10:1:1:1::10</code>	Configures the Anycast address. The default address is applied when there is no specific address configured.
<b>Step 6</b>	<b>end</b>  <b>Example:</b> Device(config-profile)# <code>end</code>	Returns to privileged EXEC mode.

## Enabling or Disabling DNSCrypt (GUI)

### Procedure

**Step 1** Choose **Configuration > Security > Threat Defence > Umbrella**.

**Step 2** Enter the **Registration Token** received from Umbrella. Alternatively, you can click on **Click here to get your Token** to get the token from Umbrella.

- Step 3** Enter the **Whitelist Domains** that you want to exclude from filtering.
- Step 4** Check or uncheck the **Enable DNS Packets Encryption** check box to encrypt or decrypt the DNS packets.
- Step 5** Click **Apply**.

## Enabling or Disabling DNScrypt

### Procedure

	Command or Action	Purpose
<b>Step 1</b>	<b>configure terminal</b> <b>Example:</b> Device# configure terminal	Enters global configuration mode.
<b>Step 2</b>	<b>parameter-map type umbrella global</b> <b>Example:</b> Device(config)# parameter-map type umbrella global	Creates an umbrella global parameter map.
<b>Step 3</b>	<b>[no] dnsencrypt</b> <b>Example:</b> Device(config-profile)# no dnsencrypt	Enables or disables DNScrypt. By default, the DNScrypt option is enabled. <b>Note</b> Cisco Umbrella DNScrypt is not supported when DNS-encrypted responses are sent in the data-DTLS encrypted tunnel (either mobility tunnel or AP CAPWAP tunnel).
<b>Step 4</b>	<b>end</b> <b>Example:</b> Device(config-profile)# end	Returns to privileged EXEC mode.

## Configuring Timeout for UDP Sessions

### Procedure

	Command or Action	Purpose
<b>Step 1</b>	<b>configure terminal</b> <b>Example:</b> Device# configure terminal	Enters global configuration mode.
<b>Step 2</b>	<b>parameter-map type umbrella global</b> <b>Example:</b> Device(config)# parameter-map type umbrella global	Creates an umbrella global parameter map.

	Command or Action	Purpose
<b>Step 3</b>	<b>udp-timeout</b> <i>timeout_value</i> <b>Example:</b> Device(config-profile)# <b>udp-timeout</b> 2	Configures timeout value for UDP sessions. The <i>timeout_value</i> ranges from 1 to 30 seconds. <b>Note</b> The <b>public-key</b> and <b>resolver</b> parameter-map options are automatically populated with the default values. So, you need not change them.
<b>Step 4</b>	<b>end</b> <b>Example:</b> Device(config-profile)# <b>end</b>	Returns to privileged EXEC mode.

## Configuring Parameter Map Name in WLAN (GUI)

### Procedure

- 
- Step 1** Choose **Configuration > Tags & Profiles > Policy**.
  - Step 2** Click on the Policy Profile Name. The **Edit Policy Profile** window is displayed.
  - Step 3** Choose the **Advanced** tab.
  - Step 4** In the **Umbrella** settings, from the **Umbrella Parameter Map** drop-down list, choose the parameter map.
  - Step 5** Enable or disable **Flex DHCP Option for DNS** and **DNS Traffic Redirect** toggle buttons.
  - Step 6** Click **Update & Apply to Device**.
- 

## Configuring Parameter Map Name in WLAN

### Procedure

	Command or Action	Purpose
<b>Step 1</b>	<b>configure terminal</b> <b>Example:</b> Device# <b>configure terminal</b>	Enters global configuration mode.
<b>Step 2</b>	<b>wireless profile policy</b> <i>profile-name</i> <b>Example:</b> Device(config)# <b>wireless profile policy</b> <b>default-policy-profile</b>	Creates policy profile for the WLAN. The <i>profile-name</i> is the profile name of the policy profile.
<b>Step 3</b>	<b>umbrella-param-map</b> <i>umbrella-name</i> <b>Example:</b>	Configures the Umbrella OpenDNS feature for the WLAN.

	Command or Action	Purpose
	Device(config-wireless-policy) # umbrella-param-map global	
<b>Step 4</b>	<b>end</b> <b>Example:</b> Device(config-wireless-policy) # <b>end</b>	Returns to privileged EXEC mode. Alternatively, you can also press <b>Ctrl-Z</b> to exit global configuration mode.

## Configuring the Umbrella Flex Profile

### Procedure

	Command or Action	Purpose
<b>Step 1</b>	<b>configure terminal</b> <b>Example:</b> Device# configure terminal	Enters global configuration mode.
<b>Step 2</b>	<b>wireless profile flex <i>flex-profile-name</i></b> <b>Example:</b> Device(config) # <b>wireless profile flex default-flex-profile</b>	Creates a new flex policy. Enters the flex profile configuration mode.  The <i>flex-profile-name</i> is the flex profile name.
<b>Step 3</b>	<b>umbrella-profile <i>umbrella-profile-name</i></b> <b>Example:</b> Device(config-wireless-flex-profile) # <b>umbrella-profile global</b>	Configures the Umbrella flex feature. Use the <b>no</b> form of this command to negate the command or to set the command to its default.
<b>Step 4</b>	<b>end</b> <b>Example:</b> Device(config-wireless-policy) # <b>end</b>	Returns to privileged EXEC mode. Alternatively, you can also press <b>Ctrl-Z</b> to exit global configuration mode.

## Configuring the Umbrella Flex Profile (GUI)

### Procedure

- 
- Step 1** Choose **Configuration > Tags & Profiles > Flex**.
  - Step 2** Click a **Flex Profile Name**. The **Edit Flex Profile** dialog box appears.
  - Step 3** Under the **Umbrella** tab, click the **Add** button.
  - Step 4** Select a name for the parameter map from the **Parameter Map Name** drop-down list and click **Save**.
  - Step 5** Click the **Update & Apply to Device** button. The configuration changes are successfully applied.
-

## Configuring Umbrella Flex Parameters

### Procedure

	Command or Action	Purpose
<b>Step 1</b>	<b>configure terminal</b>  <b>Example:</b> Device# <code>configure terminal</code>	Enters global configuration mode.
<b>Step 2</b>	<b>wireless profile policy <i>profile-policy-name</i></b>  <b>Example:</b> Device(config)# <code>wireless profile policy default-policy-profile</code>	Configures the WLAN policy profile. Enters the wireless policy profile configuration mode.  The <i>policy-profile-name</i> is the WLAN policy profile name.
<b>Step 3</b>	<b>flex umbrella dhcp-dns-option</b>  <b>Example:</b> Device(config-wireless-policy-profile)# <code>[no] flex umbrella dhcp-dns-option</code>	Configures the Umbrella DHCP option for DNS. By default the option is enabled.
<b>Step 4</b>	<b>flex umbrella mode {force   ignore}</b>  <b>Example:</b> Device(config-wireless-policy-profile)# <code>[no] flex umbrella mode force</code>	Configures the DNS traffic to be redirected to Umbrella. You can either forcefully redirect the traffic or choose to ignore the redirected traffic to Umbrella. The default mode is <b>ignore</b> .
<b>Step 5</b>	<b>end</b>  <b>Example:</b> Device(config-wireless-policy)# <code>end</code>	Returns to privileged EXEC mode. Alternatively, you can also press <b>Ctrl-Z</b> to exit global configuration mode.

## Configuring the Umbrella Flex Policy Profile (GUI)

### Procedure

- 
- Step 1** Choose **Configuration > Tags & Profiles > Policy**.
- Step 2** Click the **Add** button. The **Add Policy Profile** dialog box appears.
- Step 3** In the **Advanced** tab, and under the **Umbrella** section, complete the following:
- Select the parameter map from the **Umbrella Parameter Map** drop-down list. Click the **Clear** hyperlink to clear the selection.
  - Click the field adjacent to **Flex DHCP Option for DNS** to **Disable** the option. By default it is **Enabled**.
  - Click the field adjacent to **DNS Traffic Redirect** to set the option to **Force**. By default it is set to **Ignore**.
- Step 4** Click the **Apply to Device** button.
-

# Verifying the Cisco Umbrella Configuration

To view the Umbrella configuration details, use the following command:

```
Device# show umbrella config
Umbrella Configuration
=====
Token: 5XXXXXXXXABXXXXXFXXXXXXXXXDXXXXXXXXXXABXX
API-KEY: NONE
OrganizationID: xxxxxxxx
Local Domain Regex parameter-map name: dns_bypass
DNSEncrypt: Not enabled
Public-key: NONE
UDP Timeout: 5 seconds
Resolver address:
1. 10.1.1.1
2. 5.5.5.5
3. XXXX:120:50::50
4. XXXX:120:30::30
```

To view the device registration details, use the following command:

```
Device# show umbrella deviceid
Device registration details
Param-Map Name          Status      Device-id
global                  200 SUCCESS 010aa4eXXXXXXXX8d
vj-1                    200 SUCCESS 01XXXXXXXXf4541e1
GUEST                   200 SUCCESS 010a4f6XXXXXXXX42
EMP                     200 SUCCESS 0XXXXXXXXd106ecd
```

To view the detailed description for the Umbrella device ID, use the following command:

```
Device# show umbrella deviceid detailed
Device registration details

1.global
  Tag          : global
  Device-id    : 010aa4eXXXXXXXX8d
  Description  : Device Id recieved successfully
  WAN interface : None
2.vj-1
  Tag          : vj-1
  Device-id    : 01XXXXXXXXf4541e1
  Description  : Device Id recieved successfully
  WAN interface : None
```

To view the Umbrella DNSEncrypt details, use the following command:

```
Device# show umbrella dnscrypt
DNSEncrypt: Enabled
Public-key: B111:XXXX:XXXX:XXXX:3E2B:XXXX:XXXX:XXxE:XXX3:3XXX:DXXX:XXXX:BXXX:XXXB:XXXX:FXXX

Certificate Update Status: In Progress
```

To view the Umbrella global parameter map details, use the following command:

```
Device# show parameter-map type umbrella global
```

To view the regex parameter map details, use the following command:

```
Device# show parameter-map type regex <parameter-map-name>
```

To view the Umbrella statistical information, use the following command:

```
Device# show platform hardware chassis active qfp feature umbrella datapath stats
```

To view the wireless policy profile Umbrella configuration, use the following command:

```
Device#show wireless profile policy detailed vj-pol-profile | s Umbrella
Umbrella information
Cisco Umbrella Parameter Map : vj-2
DHCP DNS Option : ENABLED
Mode : force
```

To view the wireless flex profile Umbrella configuration, use the following command:

```
Device#show wireless profile flex detailed vj-flex-profile | s Umbrella
Umbrella Profiles :
vj-1
vj-2
global
```

To view the Umbrella details on the AP, use the following command:

```
AP#show client.opendns.summary
Server-IP role
208.67.220.220 Primary
208.67.222.222 Secondary

Server-IP role
2620:119:53::53 Primary
2620:119:35::35 Secondary

Wlan Id DHCP OpenDNS Override Force Mode
0 true false
1 false false
...

15 false false
Profile-name Profile-id
vj-1 010a29b176b34108
global 010a57bf502c85d4
vj-2 010ae385ce6c1256
AP0010.10A7.1000#

Client to profile command

AP#show client.opendns.address 50:3e:aa:ce:50:17
Client-mac Profile-name
50:3E:AA:CE:50:17 vj-1
AP0010.10A7.1000#
```





## CHAPTER 111

# RADIUS Server Load Balancing

- [Information About RADIUS Server Load Balancing, on page 999](#)
- [Prerequisites for RADIUS Server Load Balancing, on page 1001](#)
- [Restrictions for RADIUS Server Load Balancing, on page 1001](#)
- [Enabling Load Balancing for a Named RADIUS Server Group \(CLI\), on page 1001](#)

## Information About RADIUS Server Load Balancing

### RADIUS Server Load Balancing Overview

By default, if two RADIUS servers are configured in a server group, only one is used. The other server acts as standby, if the primary server is declared as dead, the secondary server receives all the load.

If you need both servers to perform transactions actively, you need to enable Load Balancing.



---

**Note** By default, load balancing is not enabled on the RADIUS server group.

---

If you enable load balancing in a RADIUS server group with two or more RADIUS servers, the Server A and Server B receives a AAA transaction. The transaction queues are checked in Server A and Server B. The server with less number of outstanding transactions are assigned the next batch of AAA transaction.

Load balancing distributes batches of transactions to RADIUS servers in a server group. Load balancing assigns each batch of transactions to the server with the lowest number of outstanding transactions in its queue. The process of assigning a batch of transactions is as follows:

1. The first transaction is received for a new batch.
2. All server transaction queues are checked.
3. The server with the lowest number of outstanding transactions is identified.
4. The identified server is assigned the next batch of transactions.

The batch size is a user-configured parameter. Changes in the batch size may impact CPU load and network throughput. As batch size increases, CPU load decreases, and network throughput increases. However, if a large batch size is used, all available server resources may not be fully utilized. As batch size decreases, CPU load increases and network throughput decreases.



---

**Note** There is no set number for large or small batch sizes. A batch with more than 50 transactions is considered large and a batch with fewer than 25 transactions is considered small.

---



---

**Note** If a server group contains ten or more servers, we recommend that you set a high batch size to reduce CPU load.

---

### Transaction Load Balancing Across RADIUS Server Groups

You can configure load balancing either per-named RADIUS server group or for the global RADIUS server group. The load balancing server group must be referred to as “radius” in the authentication, authorization, and accounting (AAA) method lists. All public servers that are part of the RADIUS server group are then load balanced.

You can configure authentication and accounting to use the same RADIUS server or different servers. In some cases, the same server can be used for preauthentication, authentication, or accounting transactions for a session. The preferred server, which is an internal setting and is set as the default, informs AAA to use the same server for the start and stop record for a session regardless of the server cost. When using the preferred server setting, ensure that the server that is used for the initial transaction (for example, authentication), the preferred server, is part of any other server group that is used for a subsequent transaction (for example, accounting).

The preferred server is not used if one of the following criteria is true:

- The **load-balance method least-outstanding ignore-preferred-server** command is used.
- The preferred server is dead.
- The preferred server is in quarantine.
- The want server flag has been set, overriding the preferred server setting.

The want server flag, an internal setting, is used when the same server must be used for all stages of a multistage transaction regardless of the server cost. If the want server is not available, the transaction fails.

You can use the **load-balance method least-outstanding ignore-preferred-server** command if you have either of the following configurations:

- Dedicated authentication server and a separate dedicated accounting server
- Network where you can track all call record statistics and call record details, including start and stop records and records that are stored on separate servers

If you have a configuration where authentication servers are a superset of accounting servers, the preferred server is not used.



**Note** If a third-party RADIUS load balancer is used and RADIUS packets are routed based on the NAS source port, it is recommended to move to any other rule based on the following Attribute-Value Pairs (AVPs):

- If the load balancer uses NAS source port in the Access-Request to load balance, rules may not work as expected as the source port in NAS might change during transaction.
- If the load balancer compares AVPs between Access-Challenge and Access-Request to route packets, you will need to use the AVP value of t-State.
- If the load balancer compares AVPs in Access-Request from NAS, you will need to use one or a combination of the following AVPs:
  - t-State value
  - Calling-Station-ID and NAS IP or Identifier

## Prerequisites for RADIUS Server Load Balancing

- Authentication, Authorization, and Accounting (AAA) must be configured on the RADIUS server.
- AAA RADIUS server groups must be configured.
- RADIUS must be configured for functions such as authentication, accounting, or static route download.

## Restrictions for RADIUS Server Load Balancing

- Incoming RADIUS requests, such as Packet of Disconnect (POD) requests are not supported.
- Load balancing is not supported on proxy RADIUS servers and private server groups.
- Load balancing is not supported on Central Web Authentication (CWA).

## Enabling Load Balancing for a Named RADIUS Server Group (CLI)

### Procedure

	Command or Action	Purpose
<b>Step 1</b>	<b>configure terminal</b>  <b>Example:</b> Device# <code>configure terminal</code>	Enters global configuration mode.

	Command or Action	Purpose
<b>Step 2</b>	<b>aaa group server radius</b> <i>group-name</i> <b>Example:</b> <pre>Device(config)# aaa group server radius rad-sg</pre>	Enters server group configuration mode.
<b>Step 3</b>	<b>server ip-address [auth-port port-number]</b> <b>[acct-port port-number]</b> <b>Example:</b> <pre>Device(config-sg-radius)# server 192.0.2.238 auth-port 2095 acct-port 2096</pre>	Configures the IP address of the RADIUS server for the group server.
<b>Step 4</b>	<b>load-balance method least-outstanding</b> <b>[batch-size number] [ignore-preferred-server]</b> <b>Example:</b> <pre>Device(config-sg-radius)# load-balance method least-outstanding batch-size 30</pre>	<p>Enables the least-outstanding load balancing for a named server group.</p> <p><b>Note</b> The session ownership change occurs multiple times when RADIUS server load balancing feature is configured with 802.1x authentication in Cisco ISE. This is because the RADIUS server load balancing feature distributes transactions of the same session in different RADIUS servers.</p> <p>Therefore, when the <b>Endpoint Owner Directory</b> is enabled in Cisco ISE, the RADIUS server load balancing feature is enabled in the controller and there is a high rate of 802.1x authentication or accounting requests resulting in the following:</p> <ul style="list-style-type: none"> <li>• High Authentication Latency for sessions in ISE.</li> <li>• Full RMQ queue (with size of 50000 endpoint profiler forwarder events).</li> <li>• Drop new endpoints sessions.</li> </ul>
<b>Step 5</b>	<b>end</b> <b>Example:</b> <pre>Device(config-sg)# end</pre>	Exits server group configuration mode and enters privileged EXEC mode.



## CHAPTER 112

# AAA Dead-Server Detection

- [Information About AAA Dead-Server Detection, on page 1003](#)
- [Prerequisites for AAA Dead-Server Detection, on page 1004](#)
- [Restrictions for AAA Dead-Server Detection, on page 1004](#)
- [Configuring AAA Dead-Server Detection \(CLI\), on page 1004](#)
- [Verifying AAA Dead-Server Detection, on page 1005](#)

## Information About AAA Dead-Server Detection

The AAA Dead-Server Detection feature allows you to configure the criteria to be used to mark a RADIUS server as dead.

If you have more than one RADIUS server, the following concepts come into picture:

- **Deadtime**—Defines the time in minutes a server marked as DEAD is held in that state. Once the deadtime expires, the controller marks the server as UP (ALIVE) and notifies the registered clients about the state change. If the server is still unreachable after the state is marked as UP and if the DEAD criteria is met, then server is marked as DEAD again for the deadtime interval.



---

**Note** You can configure deadtime for each server group or on a global level.

---

- **Dead-criteria**—To declare a server as DEAD, you need to configure **dead-criteria** and configure the conditions that determine when a RADIUS server is considered unavailable or dead.

Using this feature will result in less deadtime and quicker packet processing.

### Criteria for Marking a RADIUS Server As Dead

The AAA Dead-Server Detection feature allows you to determine the criteria that are used to mark a RADIUS server as dead. That is, you can configure the minimum amount of time, in seconds, that must elapse from the time that the controller last received a valid packet from the RADIUS server to the time the server is marked as dead. If a packet has not been received since the controller booted, and there is a timeout, the time criterion will be treated as though it has been met.

In addition, you can configure the number of consecutive timeouts that must occur on the controller before the RADIUS server is marked as dead. If the server performs both authentication and accounting, both types

of packets are included in the number. Improperly constructed packets are counted as though they are timeouts. Both initial packet transmission and retransmissions are counted. (Each timeout causes one retransmission to be sent.)



**Note** Both the time criterion and tries criterion must be met for the server to be marked as dead.

The RADIUS dead-server detection configuration will result in the prompt detection of RADIUS servers that have stopped responding. This configuration will also result in the avoidance of servers being improperly marked as dead when they are “swamped” (responding slowly) and the avoidance of the state of servers being rapidly changed from dead to live to dead again. This prompt detection of non-responding RADIUS servers and the avoidance of swamped and dead-to-live-to-dead-again servers will result in less downtime and quicker packet processing.

## Prerequisites for AAA Dead-Server Detection

- You must have access to a RADIUS server.
- You should be familiar with configuring a RADIUS server.
- You should be familiar with configuring Authentication, Authorization, and Accounting (AAA).
- Before a server can be marked as dead, you must configure **radius-server dead-criteria time** *time-in-seconds* **tries** *number-of-tries* to mark the server as DOWN.

Also, you must configure the **radius-server deadtime** *time-in-mins* to retain the server in DEAD status.

## Restrictions for AAA Dead-Server Detection

- Original transmissions are not counted in the number of consecutive timeouts that must occur on the controller before the server is marked as dead--only the number of retransmissions are counted.

## Configuring AAA Dead-Server Detection (CLI)

### Procedure

	Command or Action	Purpose
<b>Step 1</b>	<b>configure terminal</b>  <b>Example:</b> Device# configure terminal	Enters global configuration mode.
<b>Step 2</b>	<b>aaa new-model</b>  <b>Example:</b> Device(config)# aaa new-model	Enables the AAA access control model.

	Command or Action	Purpose
<b>Step 3</b>	<b>radius-server deadtime</b> <i>time-in-mins</i> <b>Example:</b> <pre>Device(config)# radius-server deadtime 5</pre>	<p>Defines the time in minutes when a server marked as DEAD is held in that state. Once the deadtime expires, the controller marks the server as UP (ALIVE) and notifies the registered clients about the state change. If the server is still unreachable after the state is marked as UP and if the DEAD criteria is met, then server is marked as DEAD again for the deadtime interval.</p> <p><i>time-in-mins</i>—Valid values range from 1 to 1440 minutes. Default value is zero. To return to the default value, use the <b>no radius-server deadtime</b> command.</p> <p>The <b>radius-server deadtime</b> command can be configured globally or per aaa group server level.</p> <p>You can use the <b>show aaa dead-criteria</b> or <b>show aaa servers</b> command to check for dead-server detection. If the default value is zero, deadtime is not configured.</p>
<b>Step 4</b>	<b>radius-server dead-criteria</b> [ <b>time</b> <i>time-in-seconds</i> ][ <b>tries</b> <i>number-of-tries</i> ] <b>Example:</b> <pre>Device(config)# radius-server dead-criteria time 5 tries 4</pre>	<p>Declares a server as DEAD and configures the conditions that determine when a RADIUS server is considered unavailable or dead.</p> <p><i>time-in-seconds</i>—Time in seconds during which no response is received from the RADIUS server to consider it as dead. Valid values range from 1 to 120 seconds.</p> <p><i>number-of-tries</i>—Number of transmits to RADIUS server without responses before marking the server as dead. Valid values range from 1 to 100.</p>
<b>Step 5</b>	<b>end</b> <b>Example:</b> <pre>Device(config)# end</pre>	<p>Exits configuration mode and enters privileged EXEC mode.</p>

## Verifying AAA Dead-Server Detection

To verify dead-criteria, use the following command:

```
Device# show run | s dead-criteria

radius-server dead-criteria time 20 tries 20
```

To verify the dead-criteria details, use the following command:

```
Device# sh aaa dead-criteria radius <server>

sh aaa dead-criteria radius 8.109.0.55
RADIUS Server Dead Criteria:
Server Details:
Address : 8.109.0.55
Auth Port : 1645
Acct Port : 1646
Server Group : radius
Dead Criteria Details:
Configured Retransmits : 3
Configured Timeout : 5
Estimated Outstanding Access Transactions: 2
Estimated Outstanding Accounting Transactions: 0
Dead Detect Time : 30s
Computed Retransmit Tries: 6
Statistics Gathered Since Last Successful Transaction
Max Computed Outstanding Transactions: 3
Max Computed Dead Detect Time: 90s
Max Computed Retransmits : 18
```

To verify the state of servers, number of requests being processed, and so on, use the following command:

```
Device# show aaa servers | s WNCN

Platform State from WNCN (1) : current UP
Platform State from WNCN (2) : current UP
Platform State from WNCN (3) : current UP
Platform State from WNCN (4) : current UP
Platform State from WNCN (5) : current UP, duration 773s, previous duration 0s
Platform Dead: total time 0s, count 0
Quarantined: No
```





## CHAPTER 113

# ISE Simplification and Enhancements

- [Utilities for Configuring Security, on page 1007](#)
- [Configuring Captive Portal Bypassing for Local and Central Web Authentication, on page 1009](#)
- [Sending DHCP Options 55 and 77 to ISE, on page 1012](#)
- [Captive Portal, on page 1015](#)

## Utilities for Configuring Security

This chapter describes how to configure all the RADIUS server side configuration using the following command:

**wireless-default radius server *ip key secret***

This simplified configuration option provides the following:

- Configures AAA authorization for network services, authentication for web auth and Dot1x.
- Enables local authentication with default authorization.
- Configures the default redirect ACL for CWA.
- Creates global parameter map with virtual IP and enables captive bypass portal.
- Configures all the AAA configuration for a default case while configuring the RADIUS server.
- The method-list configuration is assumed by default on the WLAN.
- Enables the radius accounting by default.
- Disables the radius aggressive failovers by default.
- Sets the radius request timeouts to 5 seconds by default.
- Enables captive bypass portal.

This command configures the following in the background:

```
aaa new-model
aaa authentication webauth default group radius
aaa authentication dot1x default group radius
aaa authorization network default group radius
aaa accounting identity default start-stop group radius
!
aaa server radius dynamic-author
```

```

client <IP> server-key cisco123
!
radius server RAD_SRV_DEF_<IP>
description Configured by wireless-default
address ipv4 <IP> auth-port 1812 acct-port 1813
key <key>
!
aaa local authentication default authorization default
aaa session-id common
!
ip access-list extended CISCO-CWA-URL-REDIRECT-ACL-DEFAULT
remark " CWA ACL to be referenced from ISE "
deny udp any any eq domain
deny tcp any any eq domain
deny udp any any eq bootps any
deny udp any any eq bootpc
deny udp any eq bootpc any
deny ip any host <IP>
permit tcp any any eq www
!
parameter-map type webauth global
captive-bypass-portal
virtual-ip ipv4 192.0.2.1
virtual-ip ipv6 1001::1
!
wireless profile policy default-policy-profile
aaa-override
local-http-profiling
local-dhcp-profiling
accounting

```

Thus, you need not go through the entire Configuration Guide to configure wireless controller for a simple configuration requirement.

## Configuring Multiple Radius Servers

Use the following procedure to configure a RADIUS server.

### Procedure

	Command or Action	Purpose
<b>Step 1</b>	<b>configure terminal</b>  <b>Example:</b> Device# configure terminal	Enters global configuration mode.
<b>Step 2</b>	<b>wireless-default radius server ip key secret</b>  <b>Example:</b> Device(config)# wireless-default radius server 9.2.58.90 key cisco123	Configures a radius server.  <b>Note</b> You can configure up to ten RADIUS servers.
<b>Step 3</b>	<b>end</b>  <b>Example:</b> Device(config)# end	Returns to privileged EXEC mode. Alternatively, you can also press <b>Ctrl-Z</b> to exit global configuration mode.

## Verifying AAA and Radius Server Configurations

To view details of AAA server, use the following command:

```
Device# show run aaa
!
aaa new-model
aaa authentication webauth default group radius
aaa authentication dot1x default group radius
aaa authorization network default group radius
aaa accounting Identity default start-stop group radius
!
aaa server radius dynamic-author
  client 9.2.58.90 server-key cisco123
!
radius server RAD_SRV_DEF_9.2.58.90
  description Configured by wireless-default
  address ipv4 9.2.58.90 auth-port 1812 acct-port 1813
  key cisco123
!
aaa local authentication default authorization default
aaa session-id common
!
!
ip access-list extended CISCO-CWA-URL-REDIRECT-ACL-DEFAULT
remark " CWA ACL to be referenced from ISE "
deny udp any any eq domain
deny tcp any any eq domain
deny udp any eq bootps any
deny udp any any eq bootpc
deny udp any eq bootpc any
deny ip any host 9.2.58.90
permit tcp any any eq www
!
parameter-map type webauth global
  captive-bypass-portal
  virtual-ip ipv4 192.0.2.1
  virtual-ip ipv6 1001::1
!
wireless profile policy default-policy-profile
  aaa-override
  local-http-profiling
  local-dhcp-profiling
  accounting
```



---

**Note** The `show run aaa` output may change when new commands are added to this utility.

---

## Configuring Captive Portal Bypassing for Local and Central Web Authentication

### Information About Captive Bypassing

WISPr is a draft protocol that enables users to roam between different wireless service providers. Some devices (For example, Apple iOS devices) have a mechanism using which they can determine if the device is connected

to Internet, based on an HTTP WISPr request made to a designated URL. This mechanism is used for the device to automatically open a web browser when a direct connection to the internet is not possible. This enables the user to provide his credentials to access the internet. The actual authentication is done in the background every time the device connects to a new SSID.

The client device (Apple iOS device) sends a WISPr request to the controller, which checks for the user agent details and then triggers an HTTP request with a web authentication interception in the controller. After verification of the iOS version and the browser details provided by the user agent, the controller allows the client to bypass the captive portal settings and provides access to the Internet.

This HTTP request triggers a web authentication interception in the controller as any other page requests are performed by a wireless client. This interception leads to a web authentication process, which will be completed normally. If the web authentication is being used with any of the controller splash page features (URL provided by a configured RADIUS server), the splash page may never be displayed because the WISPr requests are made at very short intervals, and as soon as one of the queries is able to reach the designated server, any web redirection or splash page display process that is performed in the background is cancelled, and the device processes the page request, thus breaking the splash page functionality.

For example, Apple introduced an iOS feature to facilitate network access when captive portals are present. This feature detects the presence of a captive portal by sending a web request on connecting to a wireless network. This request is directed to <http://www.apple.com/library/test/success.html> for Apple iOS version 6 and older, and to several possible target URLs for Apple iOS version 7 and later. If a response is received, then the Internet access is assumed to be available and no further interaction is required. If no response is received, then the Internet access is assumed to be blocked by the captive portal and Apple's Captive Network Assistant (CNA) auto-launches the pseudo-browser to request portal login in a controlled window. The CNA may break when redirecting to an ISE captive portal. The controller prevents this pseudo-browser from popping up.

You can now configure the controller to bypass WISPr detection process, so the web authentication interception is only done when a user requests a web page leading to splash page load in user context, without the WISPr detection being performed in the background.

## Configuring Captive Bypassing for WLAN in LWA and CWA (GUI)

### Procedure

---

- Step 1** Choose **Configuration > Security > Web Auth**.
  - Step 2** In the **Webauth Parameter Map** tab, click the parameter map name. The **Edit WebAuth Parameter** window is displayed.
  - Step 3** Select **Captive Bypass Portal** check box.
  - Step 4** Click **Update & Apply to Device**.
-

## Configuring Captive Bypassing for WLAN in LWA and CWA (CLI)

### Procedure

	Command or Action	Purpose
<b>Step 1</b>	<b>configure terminal</b> <b>Example:</b> Device# configure terminal	Enters global configuration mode.
<b>Step 2</b>	<b>parameter-map type webauth</b> <i>parameter-map-name</i> <b>Example:</b> Device(config)# parameter-map type webauth WLAN1_MAP	Creates the parameter map.  The <i>parameter-map-name</i> must not exceed 99 characters.
<b>Step 3</b>	<b>captive-bypass-portal</b> <b>Example:</b> Device(config)# captive-bypass-portal	Configures captive bypassing.
<b>Step 4</b>	<b>wlan profile-name wlan-id ssid-name</b> <b>Example:</b> Device(config)# wlan WLAN1_NAME 4 WLAN1_NAME	Specifies the WLAN name and ID. <ul style="list-style-type: none"> <li>• <i>profile-name</i> is the WLAN name which can contain 32 alphanumeric characters.</li> <li>• <i>wlan-id</i> is the wireless LAN identifier. The valid range is from 1 to 512.</li> <li>• <i>ssid-name</i> is the SSID which can contain 32 alphanumeric characters.</li> </ul>
<b>Step 5</b>	<b>security web-auth</b> <b>Example:</b> Device(config-wlan)# security web-auth	Enables the web authentication for the WLAN.
<b>Step 6</b>	<b>security web-auth parameter-map</b> <i>parameter-map-name</i> <b>Example:</b> Device(config-wlan)# security web-auth parameter-map WLAN1_MAP	Maps the parameter map.  <b>Note</b> If parameter map is not associated with a WLAN, the configuration is considered from the global parameter map.
<b>Step 7</b>	<b>end</b> <b>Example:</b> Device(config-wlan)# end	Returns to privileged EXEC mode. Alternatively, you can also press <b>Ctrl-Z</b> to exit global configuration mode.

# Sending DHCP Options 55 and 77 to ISE

## Information about DHCP Option 55 and 77

The DHCP sensors use the following DHCP options on the ISE for native and remote profiling:

- **Option 12:** Hostname
- **Option 6:** Class Identifier

Along with this, the following options needs to be sent to the ISE for profiling:

- **Option 55:** Parameter Request List
- **Option 77:** User Class

## Configuration to Send DHCP Options 55 and 77 to ISE (GUI)

### Procedure

- 
- Step 1** Choose **Configuration > Tags & Profiles > Policy**.
  - Step 2** On the **Policy Profile** page, click **Add** to view the **Add Policy Profile** window.
  - Step 3** Click **Access Policies** tab, choose the **RADIUS Profiling** and **DHCP TLV Caching** check boxes to configure radius profiling and DHCP TLV Caching on a WLAN.
  - Step 4** Click **Save & Apply to Device**.
- 

## Configuration to Send DHCP Options 55 and 77 to ISE (CLI)

### Procedure

	Command or Action	Purpose
<b>Step 1</b>	<b>configure terminal</b>  <b>Example:</b> Device# configure terminal	Enters global configuration mode.
<b>Step 2</b>	<b>wireless profile policy <i>profile-policy</i></b>  <b>Example:</b> Device(config)# wireless profile policy rr-xyz-policy-1	Configures WLAN policy profile and enters the wireless policy configuration mode.
<b>Step 3</b>	<b>dhcp-tlv-caching</b>  <b>Example:</b>	Configures DHCP TLV caching on a WLAN.

	Command or Action	Purpose
	Device(config-wireless-policy) # dhcp-tlv-caching	
<b>Step 4</b>	<b>radius-profiling</b>  <b>Example:</b> Device(config-wireless-policy) # radius-profiling	Configures client radius profiling on a WLAN.
<b>Step 5</b>	<b>end</b>  <b>Example:</b> Device(config-wireless-policy) # end	Returns to privileged EXEC mode. Alternatively, you can also press <b>Ctrl-Z</b> to exit global configuration mode.

## Configuring EAP Request Timeout (GUI)

Follow the steps given below to configure the EAP Request Timeout through the GUI:

### Procedure

- 
- Step 1** Choose **Configuration > Security > Advanced EAP**.
- Step 2** In the **EAP-Identity-Request Timeout** field, specify the amount of time (in seconds) in which the device attempts to send an EAP identity request to wireless clients using local EAP.
- Step 3** In the **EAP-Identity-Request Max Retries** field, specify the maximum number of times that the device attempts to retransmit the EAP identity request to wireless clients using local EAP.
- Step 4** Set **EAP Max-Login Ignore Identity Response** to **Enabled** state to limit the number of clients that can be connected to the device with the same username. You can log in up to eight times from different clients (PDA, laptop, IP phone, and so on) on the same device. The default state is **Disabled**.
- Step 5** In the **EAP-Request Timeout** field, specify the amount of time (in seconds) in which the device attempts to send an EAP request to wireless clients using local EAP.
- Step 6** In the **EAP-Request Max Retries** field, specify the maximum number of times that the device attempts to retransmit the EAP request to wireless clients using local EAP.
- Step 7** In the **EAPOL-Key Timeout** field, specify the amount of time (in seconds) in which the device attempts to send an EAP key over the LAN to wireless clients using local EAP.
- Step 8** In the **EAPOL-Key Max Retries** field, specify the maximum number of times that the device attempts to send an EAP key over the LAN to wireless clients using local EAP.
- Step 9** In the **EAP-Broadcast Key Interval** field, specify the time interval between rotations of the broadcast encryption key used for clients and click **Apply**.

**Note** After configuring the EAP-Broadcast key interval to a new time period, you must shut down or restart the WLAN for the changes to take effect. Once the WLAN is shut down or restarted, the M5 and M6 packets are exchanged when the configured timer value expires.

## Configuring EAP Request Timeout

### Procedure

	Command or Action	Purpose
<b>Step 1</b>	<b>configure terminal</b>  <b>Example:</b> Device# configure terminal	Enters global configuration mode.
<b>Step 2</b>	<b>wireless wps client-exclusion dot1x-timeout</b>  <b>Example:</b> Device(config)# wireless wps client-exclusion dot1x-timeout	Enables exclusion on timeout and no response.  By default, this feature is enabled.  To disable, append a <b>no</b> at the beginning of the command.
<b>Step 3</b>	<b>end</b>  <b>Example:</b> Device(config)# end	Returns to privileged EXEC mode. Alternatively, you can also press <b>Ctrl-Z</b> to exit global configuration mode.

## Configuring EAP Request Timeout in Wireless Security (CLI)

### Procedure

	Command or Action	Purpose
<b>Step 1</b>	<b>configure terminal</b>  <b>Example:</b> Device# configure terminal	Enters global configuration mode.
<b>Step 2</b>	<b>wireless security dot1x request {retries 0 - 20   timeout 1 - 120}</b>  <b>Example:</b> Device(config)# wireless security dot1x request timeout 60	Configures the EAP request retransmission timeout value in seconds.
<b>Step 3</b>	<b>end</b>  <b>Example:</b> Device(config)# end	Returns to privileged EXEC mode. Alternatively, you can also press <b>Ctrl-Z</b> to exit global configuration mode.



# Captive Portal

## Captive Portal Configuration

This feature enables you to configure multiple web authentication URLs (including external captive URLs) for the same SSID based on an AP. The default setting is to use the Global URL for authentication. The override option is available at WLAN and AP level.

The order of precedence is:

- AP
- WLAN
- Global configuration

### Restrictions for Captive Portal Configuration

- This configuration is supported in a standalone controller only.
- Export-Anchor configuration is not supported.

## Configuring Captive Portal (GUI)

### Procedure

---

- Step 1** Choose **Configuration > Tags & Profiles > WLANs**.
- Step 2** Click **Add**.
- Step 3** In the **General** tab, enter the **Profile Name**, the **SSID**, and the **WLAN ID**.
- Step 4** In the **Security > Layer2** tab, uncheck the **WPA Policy**, **AES** and **802.1x** check boxes.
- Step 5** In the **Security > Layer3** tab, choose the parameter map from the **Web Auth Parameter Map** drop-down list and authentication list from the **Authentication List** drop-down list.
- Step 6** In the **Security > AAA** tab, choose the Authentication list from the **Authentication List** drop-down list.
- Step 7** Click **Apply to Device**.
- Step 8** Choose **Configuration > Security > Web Auth**.
- Step 9** Choose a **Web Auth Parameter Map**.
- Step 10** In the **General** tab, enter the **Maximum HTTP connections**, **Init-State Timeout(secs)** and choose **webauth** from the **Type** drop-down list.
- Step 11** In the **Advanced** tab, under the **Redirect to external server** settings, enter the **Redirect for log-in** server.
- Step 12** Click **Update & Apply**.
-

## Configuring Captive Portal

### Procedure

	Command or Action	Purpose
<b>Step 1</b>	<b>configure terminal</b> <b>Example:</b> Device# configure terminal	Enters global configuration mode.
<b>Step 2</b>	<b>wlan</b> { <i>profile-name</i>   <b>shutdown</b> } <i>network-name</i> <b>Example:</b> Device(config)# wlan edc6 6 edc	Configures the WLAN profile. Enables or Disables all WLANs and creates the WLAN identifier. The profile-name and the SSID network name should be up to 32 alphanumeric characters.
<b>Step 3</b>	<b>ip</b> { <b>access-group</b>   <b>verify</b> } <b>web</b> <i>IPv4-ACL-Name</i> <b>Example:</b> Device(config-wlan)# ip access-group web CPWebauth	Configures the WLAN web ACL. <b>Note</b> WLAN needs to be disabled before performing this operation.
<b>Step 4</b>	<b>no security wpa</b> <b>Example:</b> Device(config-wlan)# no security wpa	Disables WPA security.
<b>Step 5</b>	<b>no security wpa akm dot1x</b> <b>Example:</b> Device(config-wlan)# no security wpa akm dot1x	Disables security AKM for dot1x.
<b>Step 6</b>	<b>no security wpa wpa2 ciphers aes</b> <b>Example:</b> Device(config-wlan)# no security wpa wpa2 ciphers aes	Disables WPA2 ciphers for AES.
<b>Step 7</b>	<b>security web-auth</b> { <b>authentication-list</b> <i>authentication-list-name</i>   <b>authorization-list</b> <i>authorization-list-name</i>   <b>on-macfilter-failure</b>   <b>parameter-map</b> <i>parameter-map-name</i> } <b>Example:</b> Device(config-wlan)# security web-auth authentication-list cp-webauth Device(config-wlan)# security web-auth parameter-map parMap6	Enables web authentication for WLAN. Here, <ul style="list-style-type: none"> <li>• <b>authentication-list</b> <i>authentication-list-name</i>: Sets the authentication list for IEEE 802.1x.</li> <li>• <b>authorization-list</b> <i>authorization-list-name</i>: Sets the override-authorization list for IEEE 802.1x.</li> <li>• <b>on-macfilter-failure</b>: Enables Web authentication on MAC filter failure.</li> </ul>

	Command or Action	Purpose
		<ul style="list-style-type: none"> <li><b>parameter-map</b> <i>parameter-map-name</i>: Configures the parameter map.</li> </ul> <p><b>Note</b> When <b>security web-auth</b> is enabled, you get to map the default <b>authentication-list</b> and global <b>parameter-map</b>. This is applicable for authentication-list and parameter-map that are not explicitly mentioned.</p>
<b>Step 8</b>	<b>no shutdown</b> <b>Example:</b> Device(config-wlan)# no shutdown	Enables the WLAN.
<b>Step 9</b>	<b>exit</b> <b>Example:</b> Device(config-wlan)# exit	Exits from the WLAN configuration.
<b>Step 10</b>	<b>parameter-map type webauth</b> <i>parameter-map-name</i> <b>Example:</b> Device(config)# parameter-map type webauth parMap6	Creates a parameter map and enters parameter-map webauth configuration mode.
<b>Step 11</b>	<b>parameter-map type webauth</b> <i>parameter-map-name</i> <b>Example:</b> Device(config)# parameter-map type webauth parMap6	Creates a parameter map and enters parameter-map webauth configuration mode.
<b>Step 12</b>	<b>type webauth</b> <b>Example:</b> Device(config-params-parameter-map)# type webauth	Configures the webauth type parameter.
<b>Step 13</b>	<b>timeout init-state sec &lt;timeout-seconds&gt;</b> <b>Example:</b> Device(config-params-parameter-map)# timeout inti-state sec 3600	Configures the WEBAUTH timeout in seconds. Valid range for the time in sec parameter is 60 seconds to 3932100 seconds.
<b>Step 14</b>	<b>redirect for-login &lt;URL-String&gt;</b> <b>Example:</b> Device(config-params-parameter-map)# redirect for-login https://172.16.100.157/portal/login.html	Configures the URL string for redirect during login.

	Command or Action	Purpose
<b>Step 15</b>	<b>exit</b> <b>Example:</b> Device(config-params-parameter-map)# exit	Exits the parameters configuration.
<b>Step 16</b>	<b>wireless tag policy <i>policy-tag-name</i></b> <b>Example:</b> Device(config)# wireless tag policy policy_tag_edc6	Configures policy tag and enters policy tag configuration mode.
<b>Step 17</b>	<b>wlan <i>wlan-profile-name</i> policy <i>policy-profile-name</i></b> <b>Example:</b> Device(config-policy-tag)# wlan edc6 policy policy_profile_flex	Attaches a policy profile to a WLAN profile.
<b>Step 18</b>	<b>end</b> <b>Example:</b> Device(config-policy-tag)# end	Saves the configuration and exits configuration mode and returns to privileged EXEC mode.

## Captive Portal Configuration - Example

The following example shows how you can have APs at different locations, broadcasting the same SSID but redirecting clients to different redirect portals:

Configuring multiple parameter maps pointing to different redirect portal:

```
parameter-map type webauth parMap1
type webauth
timeout init-state sec 21600
redirect for-login
https://172.16.12.3:8080/portal/PortalSetup.action?portal=cfdbce00-2ce2-11e8-b83c-005056a06b27
redirect portal ipv4 172.16.12.3
!
!
parameter-map type webauth parMap11
type webauth
timeout init-state sec 21600
redirect for-login
https://172.16.12.4:8443/portal/PortalSetup.action?portal=094e7270-3808-11e8-9797-02421e4cae0c
redirect portal ipv4 172.16.12.4
!
```

Associating these parameter maps to different WLANs:

```
wlan edc1 1 edc
ip access-group web CPWebauth
no security wpa
no security wpa akm dot1x
no security wpa wpa2 ciphers aes
security web-auth
security web-auth authentication-list cp-webauth
security web-auth parameter-map parMap11
```

```
no shutdown
wlan edc2 2 edc
ip access-group web CPWebauth
no security wpa
no security wpa akm dot1x
no security wpa wpa2 ciphers aes
security web-auth
security web-auth authentication-list cp-webauth
security web-auth parameter-map parMap1
no shutdown
```



---

**Note** All WLANs have identical SSIDs.

---

Associating WLANs to different policy tags:

```
wireless tag policy policy_tag_edc1
wlan edc1 policy policy_profile_flex
wireless tag policy policy_tag_edc2
wlan edc2 policy policy_profile_flex
```

Assigning these policy tags to the desired APs:

```
ap E4AA.5D13.14DC
policy-tag policy_tag_edc1
site-tag site_tag_flex
ap E4AA.5D2C.3CAC
policy-tag policy_tag_edc2
site-tag site_tag_flex
```





## CHAPTER 114

# RADIUS DTLS

- [Information About RADIUS DTLS, on page 1021](#)
- [Prerequisites, on page 1023](#)
- [Configuring RADIUS DTLS Server, on page 1023](#)
- [Configuring DTLS Dynamic Author, on page 1028](#)
- [Enabling DTLS for Client, on page 1029](#)
- [Verifying the RADIUS DTLS Server Configuration, on page 1031](#)
- [Clearing RADIUS DTLS Specific Statistics, on page 1031](#)

## Information About RADIUS DTLS

The Remote Authentication Dial-In User Service (RADIUS) is a client or server protocol that provides centralized security for users attempting to gain management access to a network. The RADIUS protocol is a widely deployed authentication and authorization protocol that delivers a complete Authentication, Authorization, and Accounting (AAA) solution.

### RADIUS DTLS Port

The RADIUS port (DTLS server) is used for authentication and accounting. The default DTLS server port is 2083.

You can change the RADIUS DTLS port number using `dtls port port_number`. For more information, see the [Configuring RADIUS DTLS Port Number](#) section.

### Shared Secret

You can use `radius/dtls` as the shared secret, if you have enabled DTLS for a specific server.

### Handling PAC for CTS Communication

You can download PAC from ISE for CTS communication. Once the PAC is downloaded, you need to encrypt all the CTS attributes with the PAC key instead of the shared secret.

The ISE then decrypts these attributes using PAC.

### Session Management

The RADIUS client purely depends on the response from the DTLS server. If the session is ideal for ideal timeout, then the session must be closed.

In case of invalid responses, the sessions must be deleted.

If you need to send the radius packets over DTLS, the DTLS session needs to be re-established with the specific server.

### Load Balancing

Multiple DTLS servers and load balancing methods are configured.

You need to select the AAA server to which the request needs to be sent. Then use the DTLS context of the specific server to encrypt the RADIUS packet and send it back.

### Connection Timeout

After the encrypted RADIUS packet is sent, you need to start the retransmission timer. If you do not get a response before the retransmission timer expires, the packet is re-encrypted and re-transmitted.

You can continue for number of times as per the **dtls retries** configuration or till the default value. Once the number of tries exceeds the limit, the server becomes unavailable and responses are sent back to the AAA clients.



---

**Note** The default connection timeout is 5 seconds.

---

### Connection Retries

As the RADIUS DTLS is UDP based, you need to retry the connection after a specific timeout interval for a specific number of retries.

After all retries are exhausted, the DTLS connection performs the following:

- Is marked as unsuccessful.
- Looks up for the next available server for processing the RADIUS requests.



---

**Note** The default connection retries is 5.

---

### Idle Timeout

When the idle timer expires and no transactions exists since the last idle timeout, the DTLS session remains closed.

After you establish the DTLS session, you can start the idle timer. If you start the idle timer for 30 seconds and one of the RADIUS DTLS packet is sent, then after 30 seconds, the idle timer expires and checks for number of RADIUS DTLS transactions.

If the idle timer value exceeds zero, the idle timer resets the transaction counter and restarts the timer.





---

**Note** The default idle timeout is 60 seconds.

---

### Handling Server and Server Group Failover

You can configure RADIUS servers with and without DTLS. It is recommended to create AAA server groups with DTLS enabled servers and non-DTLS servers. However, you will not find any such restriction while configuring AAA server groups.

Suppose you choose a DTLS server, the DTLS server establishes connection and RADIUS request packet is sent to the DTLS server. If the DTLS server does not respond after all RADIUS retries, it would fall over to the next configured server in the same server group. If the next server is a DTLS server, the processing of the RADIUS request packet continues with the next server. If the next server is a non-DTLS server, the processing of RADIUS request packet does not happen in that server group. Then the server group failover occurs and the same sequence continues with the next server group, if the next server group is available.



---

**Note** You need to use either only DTLS or non-DTLS servers in a server group.

---

## Prerequisites

### Support for IOS and BINOS AAA

The AAA server runs in IOS and BINOS platforms. Once you complete the RADIUS DTLS support in IOS, the same needs to be ported to BINOS.

## Configuring RADIUS DTLS Server

### Procedure

	Command or Action	Purpose
<b>Step 1</b>	<b>enable</b>  <b>Example:</b> Device# enable	Enters privileged EXEC mode.
<b>Step 2</b>	<b>configure terminal</b>  <b>Example:</b> Device# configure terminal	Enters global configuration mode.
<b>Step 3</b>	<b>radius server</b> <i>server-name</i>  <b>Example:</b> Device(config)# radius server R1	Specifies the RADIUS server name.

	Command or Action	Purpose
<b>Step 4</b>	<b>dtls</b> <b>Example:</b> Device(config-radius-server) # <b>dtls</b>	Configures DTLS parameters.
<b>Step 5</b>	<b>end</b> <b>Example:</b> Device(config-radius-server) # <b>end</b>	Returns to privileged EXEC mode. Alternatively, you can also press <b>Ctrl-Z</b> to exit global configuration mode.

## Configuring RADIUS DTLS Connection Timeout

### Procedure

	Command or Action	Purpose
<b>Step 1</b>	<b>enable</b> <b>Example:</b> Device# <b>enable</b>	Enters privileged EXEC mode.
<b>Step 2</b>	<b>configure terminal</b> <b>Example:</b> Device# <b>configure terminal</b>	Enters global configuration mode.
<b>Step 3</b>	<b>radius server</b> <i>server-name</i> <b>Example:</b> Device(config) # <b>radius server R1</b>	Specifies the RADIUS server name.
<b>Step 4</b>	<b>dtls connectiontimeout</b> <i>timeout</i> <b>Example:</b> Device(config-radius-server) # <b>dtls connectiontimeout 1</b>	Configures RADIUS DTLS connection timeout. Here, <i>timeout</i> refers to the DTLS connection timeout value. The valid range is from 1 to 65535.
<b>Step 5</b>	<b>end</b> <b>Example:</b> Device(config-radius-server) # <b>end</b>	Returns to privileged EXEC mode. Alternatively, you can also press <b>Ctrl-Z</b> to exit global configuration mode.

## Configuring RADIUS DTLS Idle Timeout

### Procedure

	Command or Action	Purpose
<b>Step 1</b>	<b>enable</b> <b>Example:</b>	Enters privileged EXEC mode.

	Command or Action	Purpose
	Device# enable	
<b>Step 2</b>	<b>configure terminal</b> <b>Example:</b> Device# configure terminal	Enters global configuration mode.
<b>Step 3</b>	<b>radius server</b> <i>server-name</i> <b>Example:</b> Device(config)# <b>radius server</b> R1	Specifies the RADIUS server name.
<b>Step 4</b>	<b>dtls idletimeout</b> <i>idle_timeout</i> <b>Example:</b> Device(config-radius-server)# <b>dtls idletimeout</b> 2	Configures RADIUS DTLS idle timeout. Here, <i>idle_timeout</i> refers to the DTLS idle timeout value. The valid range is from 1 to 65535.
<b>Step 5</b>	<b>end</b> <b>Example:</b> Device(config-radius-server)# <b>end</b>	Returns to privileged EXEC mode. Alternatively, you can also press <b>Ctrl-Z</b> to exit global configuration mode.

## Configuring Source Interface for RADIUS DTLS Server

### Procedure

	Command or Action	Purpose
<b>Step 1</b>	<b>enable</b> <b>Example:</b> Device# enable	Enters privileged EXEC mode.
<b>Step 2</b>	<b>configure terminal</b> <b>Example:</b> Device# configure terminal	Enters global configuration mode.
<b>Step 3</b>	<b>radius server</b> <i>server-name</i> <b>Example:</b> Device(config)# <b>radius server</b> R1	Specifies the RADIUS server name.
<b>Step 4</b>	<b>dtls ip</b> { <b>radius source-interface</b> <i>Ethernet-Internal interface_number</i> <b>Example:</b> Device(config-radius-server)# <b>dtls ip radius source-interface</b> <b>Ethernet-Internal</b> 0	Configures source interface for RADIUS DTLS server. Here, <ul style="list-style-type: none"> <li><i>interface_number</i> refers to the Ethernet-Internal interface number. The default value is 0.</li> </ul>

	Command or Action	Purpose
<b>Step 5</b>	<b>end</b>  <b>Example:</b> Device(config-radius-server) # <b>end</b>	Returns to privileged EXEC mode. Alternatively, you can also press <b>Ctrl-Z</b> to exit global configuration mode.

## Configuring RADIUS DTLS Port Number

### Procedure

	Command or Action	Purpose
<b>Step 1</b>	<b>enable</b>  <b>Example:</b> Device# <b>enable</b>	Enters privileged EXEC mode.
<b>Step 2</b>	<b>configure terminal</b>  <b>Example:</b> Device# <b>configure terminal</b>	Enters global configuration mode.
<b>Step 3</b>	<b>radius server</b> <i>server-name</i>  <b>Example:</b> Device(config)# <b>radius server R1</b>	Specifies the RADIUS server name.
<b>Step 4</b>	<b>dtls port</b> <i>port_number</i>  <b>Example:</b> Device(config-radius-server) # <b>dtls port</b> <b>2</b>	Configures RADIUS DTLS port number. Here, <i>port_number</i> refers to the DTLS port number.
<b>Step 5</b>	<b>end</b>  <b>Example:</b> Device(config-radius-server) # <b>end</b>	Returns to privileged EXEC mode. Alternatively, you can also press <b>Ctrl-Z</b> to exit global configuration mode.

## Configuring RADIUS DTLS Connection Retries

### Procedure

	Command or Action	Purpose
<b>Step 1</b>	<b>enable</b>  <b>Example:</b> Device# <b>enable</b>	Enters privileged EXEC mode.
<b>Step 2</b>	<b>configure terminal</b>  <b>Example:</b>	Enters global configuration mode.

	Command or Action	Purpose
	Device# configure terminal	
<b>Step 3</b>	<b>radius server</b> <i>server-name</i> <b>Example:</b> Device(config)# <b>radius server R1</b>	Specifies the RADIUS server name.
<b>Step 4</b>	<b>dtls retries</b> <i>retry_number</i> <b>Example:</b> Device(config-radius-server)# <b>dtls retries 3</b>	Configures RADIUS connection retries. Here, <i>retry_number</i> refers to the DTLS connection retries. The valid range is from 1 to 65535.
<b>Step 5</b>	<b>end</b> <b>Example:</b> Device(config-radius-server)# <b>end</b>	Returns to privileged EXEC mode. Alternatively, you can also press <b>Ctrl-Z</b> to exit global configuration mode.

## Configuring RADIUS DTLS Trustpoint

### Procedure

	Command or Action	Purpose
<b>Step 1</b>	<b>enable</b> <b>Example:</b> Device# enable	Enters privileged EXEC mode.
<b>Step 2</b>	<b>configure terminal</b> <b>Example:</b> Device# configure terminal	Enters global configuration mode.
<b>Step 3</b>	<b>radius server</b> <i>server-name</i> <b>Example:</b> Device(config)# <b>radius server R1</b>	Specifies the RADIUS server name.
<b>Step 4</b>	<b>dtls trustpoint</b> { <b>client</b> <i>LINE dtls</i>   <b>server</b> <i>LINE dtls</i> } <b>Example:</b> Device(config-radius-server)# <b>dtls trustpoint client client1 dtls</b> Device(config-radius-server)# <b>dtls trustpoint server server1 dtls</b>	Configures trustpoint for client and server.
<b>Step 5</b>	<b>end</b> <b>Example:</b> Device(config-radius-server)# <b>end</b>	Returns to privileged EXEC mode. Alternatively, you can also press <b>Ctrl-Z</b> to exit global configuration mode.

## Configuring RADIUS DTLS Match-Server-Identity

### Procedure

	Command or Action	Purpose
<b>Step 1</b>	<b>enable</b> <b>Example:</b> dtls match-server-identity hostname <name>	Configure the RADSEC certification validation parameters.
<b>Step 2</b>	<b>enable</b> <b>Example:</b> dtls match-server-identity ip-address <IPv4 or IPv6>	Configure the RADSEC certification validation parameters.

## Configuring DTLS Dynamic Author

### Procedure

	Command or Action	Purpose
<b>Step 1</b>	<b>enable</b> <b>Example:</b> Device# enable	Enters privileged EXEC mode.
<b>Step 2</b>	<b>configure terminal</b> <b>Example:</b> Device# configure terminal	Enters global configuration mode.
<b>Step 3</b>	<b>aaa server radius dynamic-author</b> <b>Example:</b> Device(config)# <b>aaa server radius dynamic-author</b>	Configures local server profile for RFC 3576 support.
<b>Step 4</b>	<b>dtls</b> <b>Example:</b> Device(config-locsvr-da-radius)# <b>dtls</b>	Configures DTLS source parameters.
<b>Step 5</b>	<b>end</b> <b>Example:</b> Device(config-locsvr-da-radius)# <b>end</b>	Returns to privileged EXEC mode. Alternatively, you can also press <b>Ctrl-Z</b> to exit global configuration mode.

## Enabling DTLS for Client

### Procedure

	Command or Action	Purpose
<b>Step 1</b>	<b>enable</b> <b>Example:</b> Device# enable	Enters privileged EXEC mode.
<b>Step 2</b>	<b>configure terminal</b> <b>Example:</b> Device# configure terminal	Enters global configuration mode.
<b>Step 3</b>	<b>aaa server radius dynamic-author</b> <b>Example:</b> Device(config)# <b>aaa server radius dynamic-author</b>	Configures local server profile for RFC 3576 support.
<b>Step 4</b>	<b>client IP_addr dtls</b> <b>Example:</b> Device(config-locsvr-da-radius)# <b>client 10.104.49.14 dtls</b>	Enables DTLS for the client.
<b>Step 5</b>	<b>end</b> <b>Example:</b> Device(config-locsvr-da-radius)# <b>end</b>	Returns to privileged EXEC mode. Alternatively, you can also press <b>Ctrl-Z</b> to exit global configuration mode.

## Configuring Client Trustpoint for DTLS

### Procedure

	Command or Action	Purpose
<b>Step 1</b>	<b>enable</b> <b>Example:</b> Device# enable	Enters privileged EXEC mode.
<b>Step 2</b>	<b>configure terminal</b> <b>Example:</b> Device# configure terminal	Enters global configuration mode.
<b>Step 3</b>	<b>aaa server radius dynamic-author</b> <b>Example:</b>	Configures local server profile for RFC 3576 support.

	Command or Action	Purpose
	Device(config)# <b>aaa server radius dynamic-author</b>	
<b>Step 4</b>	<b>client <i>IP_addr</i> dtls {client-tp <i>client-tp-name</i>   server-tp <i>server-tp-name</i>}</b>  <b>Example:</b> Device(config-locsvr-da-radius)# <b>client 10.104.49.14 dtls client-tp client_tp_name</b>	Configures client trustpoint for DTLS.
<b>Step 5</b>	<b>end</b>  <b>Example:</b> Device(config-locsvr-da-radius)# <b>end</b>	Returns to privileged EXEC mode. Alternatively, you can also press <b>Ctrl-Z</b> to exit global configuration mode.

## Configuring DTLS Idle Timeout

### Procedure

	Command or Action	Purpose
<b>Step 1</b>	<b>enable</b>  <b>Example:</b> Device# <b>enable</b>	Enters privileged EXEC mode.
<b>Step 2</b>	<b>configure terminal</b>  <b>Example:</b> Device# <b>configure terminal</b>	Enters global configuration mode.
<b>Step 3</b>	<b>aaa server radius dynamic-author</b>  <b>Example:</b> Device(config)# <b>aaa server radius dynamic-author</b>	Configures local server profile for RFC 3576 support.
<b>Step 4</b>	<b>client <i>IP_addr</i> dtls idletimeout timeout-interval {client-tp <i>client_tp_name</i>   server-tp <i>server_tp_name</i>}</b>  <b>Example:</b> Device(config-locsvr-da-radius)# <b>client 10.104.49.14 dtls idletimeout 62 client-tp dtls_ise</b>	Configures DTLS idle time.  Here, <i>timeout-interval</i> refers to the idle timeout interval. The valid range is from 60 to 600.
<b>Step 5</b>	<b>end</b>  <b>Example:</b> Device(config-locsvr-da-radius)# <b>end</b>	Returns to privileged EXEC mode. Alternatively, you can also press <b>Ctrl-Z</b> to exit global configuration mode.



## Configuring Server Trustpoint for DTLS

### Procedure

	Command or Action	Purpose
<b>Step 1</b>	<b>enable</b> <b>Example:</b> Device# enable	Enters privileged EXEC mode.
<b>Step 2</b>	<b>configure terminal</b> <b>Example:</b> Device# configure terminal	Enters global configuration mode.
<b>Step 3</b>	<b>aaa server radius dynamic-author</b> <b>Example:</b> Device(config)# aaa server radius dynamic-author	Configures local server profile for RFC 3576 support.
<b>Step 4</b>	<b>client IP_addr dtls server-tp server_tp_name</b> <b>Example:</b> Device(config-locsvr-da-radius)# client 10.104.49.14 dtls server-tp dtls_client	Configures server trust point.
<b>Step 5</b>	<b>end</b> <b>Example:</b> Device(config-locsvr-da-radius)# end	Returns to privileged EXEC mode. Alternatively, you can also press <b>Ctrl-Z</b> to exit global configuration mode.

## Verifying the RADIUS DTLS Server Configuration

To view information about the DTLS enabled servers, use the following command:

```
Device# show aaa servers
DTLS: Packet count since last idletimeout 1,
Send handshake count 3,
Handshake Success 1,
Total Packets Transmitted 1,
Total Packets Received 1,
Total Connection Resets 2,
Connection Reset due to idle timeout 0,
Connection Reset due to No Response 2,
Connection Reset due to Malformed packet 0,
```

## Clearing RADIUS DTLS Specific Statistics

To clear the radius DTLS specific statistics, use the following command:

```
Device# clear aaa counters servers radius {<server-id> | all}
```



---

**Note** Here, *server-id* refers to the server ID displayed by **show aaa servers**. The valid range is from 0 to 2147483647.

---



## CHAPTER 115

# Policy Enforcement and Usage Monitoring

- [Policy Enforcement and Usage Monitoring, on page 1033](#)
- [Configuring Policy Enforcement and Enabling Change-of-Authorization \(CLI\), on page 1033](#)
- [Example: Configuring Policy Enforcement and Usage Monitoring, on page 1034](#)
- [Verifying Policy Usage and Enforcement, on page 1035](#)

## Policy Enforcement and Usage Monitoring

You can enforce dynamic QoS policies and upstream and downstream TCP or UDP data rates on 802.11 clients seamlessly without disrupting the client's ongoing sessions. The feature ensures that clients do not have to get dissociated from the network. All the authentication methods: 802.1X, PSK, web authentication, and so on, are supported.

The APs periodically send client statistics including bandwidth usage to the Controller. The AAA server receives Accounting-Interim messages which include the clients data utilization at the configured intervals. The AAA server accumulates information about data consumption for each client and when the client exhausts the data limit, the AAA server sends a change-of-authorization (CoA) message to the Controllers. Upon successful CoA handshakes, the Controllers apply and send new policies to the APs.

### Restrictions on Policy Enforcement and Usage Monitoring

- Only FlexConnect local switching mode is supported.

## Configuring Policy Enforcement and Enabling Change-of-Authorization (CLI)

For more information, follow the utility specified in Utilities for configuring Security section of this guide.

### Procedure

	Command or Action	Purpose
Step 1	<code>configure terminal</code> Example:	Enters global configuration mode.

	Command or Action	Purpose
	Device# configure terminal	
<b>Step 2</b>	<b>aaa server radius dynamic-author</b> <b>Example:</b> Device(config)# aaa server radius dynamic-author	Creates a local server RADIUS profile in the controller.
<b>Step 3</b>	<b>client client-ip-addr server-key key</b> <b>Example:</b> Device(config-locsvr-da-radius)# client 3.2.4.3 server-key testpwd	Configures a server key for a RADIUS client.
<b>Step 4</b>	<b>[Optional] show aaa command handler</b> <b>Example:</b> Device#show aaa command handler	Displays the AAA CoA packet statistics.

## Example: Configuring Policy Enforcement and Usage Monitoring

Policy enforcement and usage monitoring is applied on a group where a class-map is created for QoS policies. This is done via CoA.

Given below is a sample configuration for policy enforcement and usage monitoring:

```

aaa new-model
 radius server radius_free
 address ipv4 10.0.0.1 auth-port 1812 acct-port 1813
 key cisco123
 exit

aaa new-model
 aaa server radius dynamic-author
 client 10.0.0.1 server-key cisco123
aaa new-model
 aaa group server radius rad_eap
 server name radius_free
 exit
aaa new-model
 dot1x system-auth-control
 aaa authentication dot1x eap_methods group rad_eap
 dot1x system-auth-control
class-map client_dscp_clsmapout
match dscp af13
exit
class-map client_dscp_clsmapin
match dscp af13
exit
policy-map qos_new
 class client_dscp_clsmapout
 police 512000 conform-action transmit exceed-action drop
 policy-map qos_nbn
 class client_dscp_clsmapin
 police 1600000 conform-action transmit exceed-action drop
 wlan test1 3 test2

```

```
broadcast-ssid
security wpa wpa2 ciphers aes
security dot1x authentication-list eap_methods
no shutdown
exit
wireless profile policy named-policy-profile
shutdown
vlan 10
aaa-override
no central association
no central dhcp
no central switching
no shutdown
wireless tag policy named-policy-tag
wlan test1 policy named-policy-profile
wireless profile flex FP_name_001
native-vlan-id 10
wireless tag site ST_name_001
no local-site
flex-profile FP_name_001
exit
ap test-ap
policy-tag named-policy-tag
site-tag ST_name_001
exit
aaa authorization network default group radius
exit
```

## Verifying Policy Usage and Enforcement

To view the detailed information about the policies applied to a specific client, use the following command:

```
Device# show wireless client mac-address mac-address detail
```

To view client-level mobility statistics, use the following command:

```
Device# show wireless client mac-address mac-address mobility statistics
```

To view client-level roaming history for an active client in a sub-domain, use the following command:

```
Device# show wireless client mac-address mac-address mobility history
```

To view detailed parameters of a given profile policy, use the following command:

```
Device# show wireless profile policy detailed policy-name
```





## CHAPTER 116

# Local Extensible Authentication Protocol

- [Information About Local EAP, on page 1037](#)
- [Restrictions for Local EAP, on page 1038](#)
- [Configuring Local EAP Profile \(CLI\), on page 1038](#)
- [Configuring Local EAP profile \(GUI\), on page 1039](#)
- [Configuring AAA Authentication \(GUI\), on page 1039](#)
- [Configuring AAA Authorization Method \(GUI\), on page 1039](#)
- [Configuring AAA Authorization Method \(CLI\), on page 1040](#)
- [Configuring Local Advanced Methods \(GUI\), on page 1041](#)
- [Configuring WLAN \(GUI\), on page 1041](#)
- [Configuring WLAN \(CLI\), on page 1042](#)
- [Creating a User Account \(CLI\), on page 1042](#)
- [Attaching a Policy Profile to a WLAN Interface \(GUI\), on page 1043](#)
- [Deploy Policy Tag to Access Points \(GUI\), on page 1044](#)

## Information About Local EAP

Local Extensible Authentication Protocol (EAP) feature refers to the controller that acts as authenticator and authentication server. Local EAP allows 802.1x authentication on WPA Enterprise wireless clients without the use of any RADIUS server. The Local EAP refers to the EAP authentication server activity and not necessarily tied to the user credentials validation (for example) that can be delegated to an external LDAP database.

### Feature Scenarios

Local EAP is designed to allow administrators to use Enterprise-grade 802.1x authentication for a limited number of users in situations and branches where an external dedicated RADIUS server may not be available. It can also work as an emergency backup in case the RADIUS server is not available.

### Use Cases

You can implement Local EAP either with users local to the controller or use an external LDAP database to store the user credentials.

## Restrictions for Local EAP

- It is not possible to configure AAA attributes, such as per-user ACL or per-user session timeout using local EAP.
- Local EAP only allows user database either locally on the controller or on an external LDAP database.
- Local EAP supports TLS 1.2 as of 17.1 and later software release.
- Local EAP uses the trustpoint of your choice on the controller. You will either need to install a publicly trusted certificate on the controller or import it on the clients for the EAP session to be trusted by the client.
- Local EAP supports *EAP-FAST*, *EAP-TLS*, and *PEAP* as EAP authentication methods.



**Note** *PEAP-mschapv2* does not work when using certain external LDAP databases that only support clear text passwords.

## Configuring Local EAP Profile (CLI)

### Procedure

	Command or Action	Purpose
<b>Step 1</b>	<b>configure terminal</b> <b>Example:</b> Device# configure terminal	Enters global configuration mode.
<b>Step 2</b>	<b>eap profile name</b> <b>Example:</b> Device(config)# eap profile mylocapeap	Creates an EAP profile.
<b>Step 3</b>	<b>method peap</b> <b>Example:</b> Device(config-eap-profile)# method peap	Configures the PEAP method on the profile.
<b>Step 4</b>	<b>pki-trustpoint name</b> <b>Example:</b> Device(config-eap-profile)# pki-trustpoint admincert	Configures the PKI trustpoint on the profile.



## Configuring Local EAP profile (GUI)

### Procedure

---

- Step 1** Choose **Configuration > Security > Local EAP**.
- Step 2** Click **Add**.
- Step 3** In the **Create Local EAP Profiles** page, enter a profile name.

**Note** It is not advised to use LEAP EAP method due to its weak security. You can use any of the following EAP methods to configure a trustpoint:

- EAP-FAST
- EAP-TLS
- PEAP

Clients do not trust the default controller certificate, so you need to deactivate the server certificate validation on the client side or install a certificate trustpoint on the controller.

- Step 4** Click **Apply to Device**.
- 

## Configuring AAA Authentication (GUI)

### Procedure

---

- Step 1** Choose **Configuration > Security > AAA**, and navigate to the **AAA Method List > Authentication** tabs.
- Step 2** Click **Add**.
- Step 3** Choose **dot1x** as the **Type** and **local** as the **Group Type**.
- Step 4** Click **Apply to Device**.
- 

## Configuring AAA Authorization Method (GUI)

### Procedure

---

- Step 1** Navigate to **Authorization** sub-tab.
- Step 2** Create a new method for **credential-download** type and point it to local.

**Note** Perform the same for **network** authorization type.

## Configuring AAA Authorization Method (CLI)

### Procedure

	Command or Action	Purpose
<b>Step 1</b>	<b>configure terminal</b> <b>Example:</b> Device# configure terminal	Enters global configuration mode.
<b>Step 2</b>	<b>aaa new-model</b> <b>Example:</b> Device(config)# aaa new-model	Creates a AAA authentication model.
<b>Step 3</b>	<b>aaa authentication dot1x default local</b> <b>Example:</b> Device(config)# aaa authentication dot1x default local	Configures the default local RADIUS server.
<b>Step 4</b>	<b>aaa authorization credential-download default local</b> <b>Example:</b> Device(config)# aaa authorization credential-download default local	Configures default database to download credentials from local server.
<b>Step 5</b>	<b>aaa local authentication default authorization default</b> <b>Example:</b> Device(config)# aaa local authentication default authorization default	Configures the local authentication method list.
<b>Step 6</b>	<b>aaa authorization network default local</b> <b>Example:</b> Device(config)# aaa authorization network default local	Configures authorization for network services.

## Configuring Local Advanced Methods (GUI)

### Procedure

---

- Step 1** In the **Configuration > Security > AAA** window, perform the following:
- Navigate to **AAA Advanced** tab.
  - From the **Local Authentication** drop-down list, choose a default local authentication.
  - From the **Local Authorization** drop-down list, choose a default local authorization.
- Step 2** Click **Apply**.
- 

## Configuring WLAN (GUI)

### Procedure

---

- Step 1** Choose **Configuration > Tags & Profiles > WLANs**.
- Step 2** In the **WLANs** window, click the name of the **WLAN** or click **Add** to create a new one.
- Step 3** In the **Add/Edit WLAN** window that is displayed, click the **General** tab to configure the following parameters.
- In the **Profile Name** field, enter or edit the name of the profile.
  - In the **SSID** field, enter or edit the SSID name.  
The SSID name can be alphanumeric, and up to 32 characters in length.
  - In the **WLAN ID** field, enter or edit the ID number. The valid range is between 1 and 512.
  - From the **Radio Policy** drop-down list, choose the **802.11** radio band.
  - Using the **Broadcast SSID** toggle button, change the status to either **Enabled** or **Disabled**.
  - Using the **Status** toggle button, change the status to either **Enabled** or **Disabled**.
- Step 4** In the **AAA** tab, you can configure the following:
- Choose an authentication list from the drop-down.
  - Check the **Local EAP Authentication** check box to enable local EAP authentication on the WLAN. Also, choose the required **EAP Profile Name** from the drop-down list.
- Step 5** Click **Save & Apply to Device**.
-

## Configuring WLAN (CLI)

### Procedure

	Command or Action	Purpose
<b>Step 1</b>	<b>configure terminal</b>  <b>Example:</b> Device# configure terminal	Enters global configuration mode.
<b>Step 2</b>	<b>wlan wlan-name wlan-id SSID-name</b>  <b>Example:</b> Device(config)# wlan localpeapssid 1 localpeapssid	Enters the WLAN configuration sub-mode.  <i>wlan-name</i> —Is the name of the configured WLAN.  <i>wlan-id</i> —Is the wireless LAN identifier. The range is 1 to 512.  <i>SSID-name</i> —Is the SSID name which can contain 32 alphanumeric characters.  <b>Note</b> If you have already configured this command, enter <b>wlan wlan-name</b> command.
<b>Step 3</b>	<b>security dot1x authentication-list auth-list-name</b>  <b>Example:</b> Device(config-wlan)# security dot1x authentication-list default	Enables security authentication list for dot1x security. The configuration is similar for all dot1x security WLANs.
<b>Step 4</b>	<b>local-auth profile name</b>  <b>Example:</b> Device(config-wlan)# local-auth mylocaleap	Sets EAP Profile on an WLAN.  <i>profile name</i> —Is the EAP profile on an WLAN.

## Creating a User Account (CLI)

### Procedure

	Command or Action	Purpose
<b>Step 1</b>	<b>configure terminal</b>  <b>Example:</b> Device# configure terminal	Enters global configuration mode.

	Command or Action	Purpose
<b>Step 2</b>	<b>user-name</b> <i>user-name</i> <b>Example:</b> Device(config)# user-name lxuser	Creates a user account.
<b>Step 3</b>	<b>creation-time</b> <i>time</i> <b>Example:</b> Device(config)# creation-time 1572730075	Creation time of the user account.
<b>Step 4</b>	<b>description</b> <i>user-name</i> <b>Example:</b> Device(config)# description lxuser	Adds a user-defined description to the new user account.
<b>Step 5</b>	<b>password 0</b> <i>password</i> <b>Example:</b> Device(config)# password 0 Cisco123	Creates a password for the user account.
<b>Step 6</b>	<b>type network-user description</b> <i>user-name</i> <b>Example:</b> Device(config)# type network-user description lxuser	Specifies the type of user account.

## Attaching a Policy Profile to a WLAN Interface (GUI)

### Procedure

- 
- Step 1** Choose **Configuration > Tags & Profiles > Tags**.
  - Step 2** On the **Manage Tags** page, click **Policy** tab.
  - Step 3** Click **Add** to view the **Add Policy Tag** window.
  - Step 4** Enter a name and description for the policy tag.
  - Step 5** Click **Add** to map the WLAN and policy.
  - Step 6** Choose the WLAN profile to map with the appropriate policy profile, and click the tick icon.
  - Step 7** Click **Save & Apply to Device**.
-

# Deploy Policy Tag to Access Points (GUI)

## Procedure

---

- Step 1** Choose **Configuration > Wireless > Access Points**.
- Step 2** On the **All Access Points** page, click the access point you want to configure.  
Make sure that the tags assigned are the ones you configured.
- Step 3** Click **Apply**.
-



## CHAPTER 117

# Authentication and Authorization Between Multiple RADIUS Servers

---

- [Information About Authentication and Authorization Between Multiple RADIUS Servers](#), on page 1045
- [Configuring 802.1X Security for WLAN with Split Authentication and Authorization Servers](#), on page 1046
- [Configuring Web Authentication for WLAN with Split Authentication and Authorization Servers](#), on page 1051
- [Verifying Split Authentication and Authorization Configuration](#), on page 1053
- [Configuration Examples](#), on page 1054

## Information About Authentication and Authorization Between Multiple RADIUS Servers

Cisco Catalyst 9800 Series Wireless Controller uses the approach of request and response transaction with a single RADIUS server that combines both authentication and authorization. You can split the authentication and authorization on the controller between multiple RADIUS servers.

A RADIUS sever can assume the role of either an authentication server, authorization server, or both. In cases where there are disparate RADIUS servers for authentication and authorization, the Session Aware Networking (SANet) component on the controller now allows authentication on one server and authorization on another when a client joins the controller .

Authentication can be done using the Cisco ISE, Cisco Catalyst Center, Free RADIUS, or any third-party RADIUS Server. After successful authentication from an authentication server, the controller relays attributes received from the authentication server to another RADIUS sever designated as authorization server.

The authorization server then performs the following:

- Processes received attributes with the other policies or rules defined on the server.
- Derives attributes as part of the authorization response and returns it to the controller .



### Note

In a split authentication and authorization configuration, both servers must be available and must successfully authenticate and authorize with an ACCESS-ACCEPT for a session to be accepted by the controller .

---



**Note** A maximum of 100 entries is supported in the Authentication/Authorization list created through Cisco Catalyst Center provisioning. The entries beyond 100 do not work even though they can be created.

# Configuring 802.1X Security for WLAN with Split Authentication and Authorization Servers

## Configuring Explicit Authentication and Authorization Server List (GUI)

### Procedure

- 
- Step 1** Choose **Configuration > Security > AAA**.
- Step 2** On the **Authentication Authorization and Accounting** page, click the **Servers/Groups** tab.
- Step 3** Click the type of AAA server you want to configure from the following options:
- RADIUS
  - TACACS+
  - LDAP
- In this procedure, the RADIUS server configuration is described.
- Step 4** With the **RADIUS** option selected, click **Add**.
- Step 5** Enter a name for the RADIUS server and the IPv4 or IPV6 address of the server.
- Step 6** Enter the authentication and encryption key to be used between the device and the key string RADIUS daemon running on the RADIUS server. You can choose to use either a PAC key or a non-PAC key.
- Step 7** Enter the server timeout value; valid range is 1 to 1000 seconds.
- Step 8** Enter a retry count; valid range is 0 to 100.
- Step 9** Leave the **Support for CoA** field in **Enabled** state.
- Step 10** Click **Save & Apply to Device**.
- Step 11** On the **Authentication Authorization and Accounting** page, with **RADIUS** option selected, click the **Server Groups** tab.
- Step 12** Click **Add**.
- Step 13** In the **Create AAA RADIUS Server Group** window that is displayed, enter a name for the RADIUS server group.
- Step 14** From the **MAC-Delimiter** drop-down list, choose the delimiter to be used in the MAC addresses that are sent to the RADIUS servers.
- Step 15** From the **MAC Filtering** drop-down list, choose a value based on which to filter MAC addresses.
- Step 16** To configure dead time for the server group and direct AAA traffic to alternative groups of servers that have different operational characteristics, in the **Dead-Time** field, enter the amount of time, in minutes, after which a server is assumed to be dead.



- Step 17** Choose the servers that you want to include in the server group from the **Available Servers** list and move them to the **Assigned Servers** list.
- Step 18** Click **Save & Apply to Device**.

## Configuring Explicit Authentication Server List (GUI)

### Procedure

- Step 1** Choose **Configuration > Security > AAA > Servers/Groups**.
- Step 2** Choose **RADIUS > Servers** tab.
- Step 3** Click **Add** to add a new server or click an existing server.
- Step 4** Enter the **Name**, the **Server Address**, **Key**, **Confirm Key**, **Auth Port** and **Acct Port**. Check the **PAC Key** checkbox and enter the **PAC key** and **Confirm PAC Key**.
- Step 5** Click **Apply to Device**.
- Step 6** Choose **RADIUS > Server Groups** and click **Add** to add a new server group or click an existing server group.
- Step 7** Enter the **Name** of the server group and choose the servers that you want to include in the server group, from the **Available Servers** list and move them to the **Assigned Servers** list.
- Step 8** Click **Apply to Device**.

## Configuring Explicit Authentication Server List (CLI)

### Procedure

	Command or Action	Purpose
<b>Step 1</b>	<b>enable</b>  <b>Example:</b> Device> enable	Enables privileged EXEC mode.  Enter your password if prompted.
<b>Step 2</b>	<b>configure terminal</b>  <b>Example:</b> Device# configure terminal	Enters global configuration mode.
<b>Step 3</b>	<b>radius server</b> <i>server-name</i>  <b>Example:</b> Device(config)# <b>radius server</b> <b>free-radius-authc-server</b>	Specifies the RADIUS server name.
<b>Step 4</b>	<b>address ipv4</b> <i>address</i> <b>auth-port</b> <i>auth_port_number</i> <b>acct-port</b> <i>acct_port_number</i>  <b>Example:</b>	Specifies the RADIUS server parameters.

	Command or Action	Purpose
	Device(config-radius-server)# <b>address</b> ipv4 9.2.62.56 auth-port 1812 acct-port 1813	
<b>Step 5</b>	[pac] <b>key</b> <i>key</i> <b>Example:</b> Device(config-radius-server)# <b>key</b> cisco	Specify the authentication and encryption key used between the Device and the key string RADIUS daemon running on the RADIUS server.
<b>Step 6</b>	<b>exit</b> <b>Example:</b> Device(config-radius-server)# <b>exit</b>	Returns to the configuration mode.
<b>Step 7</b>	<b>aaa group server radius</b> <i>server-group</i> <b>Example:</b> Device(config)# <b>aaa group server radius</b> <b>authc-server-group</b>	Creates a radius server-group identification.  <i>server-group</i> refers to the server group name. The valid range is from 1 to 32 alphanumeric characters.  If the IP address of the RADIUS server is not added to the routes defined for the controller, the default route is used. We recommend that you define a specific route to source the traffic from the defined SVI in the AAA server group.
<b>Step 8</b>	<b>server name</b> <i>server-name</i> <b>Example:</b> Device(config)# <b>server name</b> <b>free-radius-authc-server</b>	Configures the server name.
<b>Step 9</b>	<b>end</b> <b>Example:</b> Device(config)# <b>end</b>	Returns to privileged EXEC mode. Alternatively, you can also press <b>Ctrl-Z</b> to exit global configuration mode.  For more information, see <b>Configuring AAA for External Authentication</b> .

## Configuring Explicit Authorization Server List (GUI)

### Procedure

- 
- Step 1** Choose **Configuration > Security > AAA > Servers/Groups**.
  - Step 2** Choose **RADIUS > Servers** tab.
  - Step 3** Click **Add** to add a new server or click an existing server.
  - Step 4** Enter the **Name**, the **Server Address**, **Key**, **Confirm Key**, **Auth Port** and **Acct Port**. Check the **PAC Key** checkbox and enter the **PAC key** and **Confirm PAC Key**.
  - Step 5** Click **Apply to Device**.

- Step 6** Choose **RADIUS > Server Groups** and click **Add** to add a new server group or click an existing server group.
- Step 7** Enter the **Name** of the server group and choose the servers that you want to include in the server group, from the **Available Servers** list and move them to the **Assigned Servers** list.
- Step 8** Click **Apply to Device**.

## Configuring Explicit Authorization Server List (CLI)

### Procedure

	Command or Action	Purpose
<b>Step 1</b>	<b>enable</b> <b>Example:</b> Device> enable	Enables privileged EXEC mode. Enter your password if prompted.
<b>Step 2</b>	<b>configure terminal</b> <b>Example:</b> Device# configure terminal	Enters global configuration mode.
<b>Step 3</b>	<b>radius server <i>server-name</i></b> <b>Example:</b> Device(config)# radius server cisco-catalyst-center-authz-server	Specifies the RADIUS server name.
<b>Step 4</b>	<b>address ipv4 <i>address</i> auth-port <i>auth_port_number</i> acct-port <i>acct_port_number</i></b> <b>Example:</b> Device(config-radius-server)# address ipv4 9.4.62.32 auth-port 1812 acct-port 1813	Specifies the RADIUS server parameters.
<b>Step 5</b>	<b>[pac] key <i>key</i></b> <b>Example:</b> Device(config-radius-server)# pac key cisco	Specify the authorization and encryption key used between the Device and the key string RADIUS daemon running on the RADIUS server.
<b>Step 6</b>	<b>exit</b> <b>Example:</b> Device(config-radius-server)# exit	Returns to the configuration mode.
<b>Step 7</b>	<b>aaa group server radius <i>server-group</i></b> <b>Example:</b> Device(config)# aaa group server radius authz-server-group	Creates a radius server-group identification. <b>Note</b> <i>server-group</i> refers to the server group name. The valid range is from 1 to 32 alphanumeric characters.
<b>Step 8</b>	<b>server name <i>server-name</i></b>	

	Command or Action	Purpose
	<b>Example:</b> Device(config)# <b>server name</b> <b>cisco-catalyst-center-authz-server</b>	
<b>Step 9</b>	<b>end</b> <b>Example:</b> Device(config)# <b>end</b>	Returns to privileged EXEC mode. Alternatively, you can also press <b>Ctrl-Z</b> to exit global configuration mode.

## Configuring Authentication and Authorization List for 802.1X Security (GUI)

### Procedure

- 
- Step 1** Choose **Configuration > Tags & Profiles > WLANs**.
- Step 2** Click **Add**.
- Step 3** In the **General** tab, enter the **Profile Name**, the **SSID**, and the **WLAN ID**.
- Step 4** In the **Security > AAA** tab, choose the Authentication list from the **Authentication List** drop-down list.
- Step 5** Click **Apply to Device**.
- 

## Configuring Authentication and Authorization List for 802.1X Security

### Procedure

	Command or Action	Purpose
<b>Step 1</b>	<b>enable</b> <b>Example:</b> Device> <b>enable</b>	Enables privileged EXEC mode. Enter your password if prompted.
<b>Step 2</b>	<b>configure terminal</b> <b>Example:</b> Device# <b>configure terminal</b>	Enters global configuration mode.
<b>Step 3</b>	<b>wlan wlan-name wlan-id SSID-name</b> <b>Example:</b> Device(config)# <b>wlan wlan-foo 222</b> <b>foo-ssid</b>	Enters WLAN configuration sub-mode. <ul style="list-style-type: none"> <li>• <i>wlan-name</i>: Is the name of the configured WLAN.</li> <li>• <i>wlan-id</i>: Is the wireless LAN identifier. Range is from 1 to 512.</li> <li>• <i>SSID-name</i>: Is the SSID name which can contain 32 alphanumeric characters.</li> </ul>

	Command or Action	Purpose
		<b>Note</b> If you have already configured this command, enter <code>wlan wlan-name</code> command.
<b>Step 4</b>	<b>security dot1x authentication-list</b> <i>authenticate-list-name</i>  <b>Example:</b> Device(config-wlan) # <b>security dot1x authentication-list authc-server-group</b>	Enables authentication list for dot1x security.
<b>Step 5</b>	<b>security dot1x authorization-list</b> <i>authorize-list-name</i>  <b>Example:</b> Device(config-wlan) # <b>security dot1x authorization-list authz-server-group</b>	Specifies authorization list for dot1x security.  For more information on the <b>Cisco Catalyst Center</b> , see the <b>Cisco Catalyst Center documentation</b> .
<b>Step 6</b>	<b>end</b>  <b>Example:</b> Device(config-wlan) # <b>end</b>	Returns to privileged EXEC mode. Alternatively, you can also press <b>Ctrl-Z</b> to exit global configuration mode.

## Configuring Web Authentication for WLAN with Split Authentication and Authorization Servers

### Configuring Authentication and Authorization List for Web Authentication (GUI)

#### Procedure

- 
- Step 1** Choose **Configuration > Tags & Profiles > WLANs**.
  - Step 2** Click **Add**.
  - Step 3** In the **General** tab, enter the **Profile Name**, the **SSID**, and the **WLAN ID**.
  - Step 4** In the **Security > Layer2** tab, uncheck the **WPAPolicy**, **AES** and **802.1x** check boxes.
  - Step 5** Check the **MAC Filtering** check box to enable the feature. With MAC Filtering enabled, choose the Authorization list from the **Authorization List** drop-down list.
  - Step 6** In the **Security > AAA** tab, choose the Authentication list from the **Authentication List** drop-down list.
  - Step 7** Click **Apply to Device**.
-

## Configuring Authentication and Authorization List for Web Authentication

### Procedure

	Command or Action	Purpose
<b>Step 1</b>	<b>enable</b> <b>Example:</b> Device> enable	Enables privileged EXEC mode. Enter your password if prompted.
<b>Step 2</b>	<b>configure terminal</b> <b>Example:</b> Device# configure terminal	Enters global configuration mode.
<b>Step 3</b>	<b>wlan wlan-name wlan-id SSID-name</b> <b>Example:</b> Device(config)# wlan wlan-bar 1 bar-ssid	Enters WLAN configuration sub-mode. <ul style="list-style-type: none"> <li>• <i>wlan-name</i>: Is the name of the configured WLAN.</li> <li>• <i>wlan-id</i>: Is the wireless LAN identifier.</li> <li>• <i>SSID-name</i>: Is the SSID name which can contain 32 alphanumeric characters.</li> </ul> <b>Note</b> If you have already configured this command, enter <b>wlan wlan-name</b> command.
<b>Step 4</b>	<b>no security wpa</b> <b>Example:</b> Device(config-wlan)# no security wpa	Disables WPA security.
<b>Step 5</b>	<b>no security wpa akm dot1x</b> <b>Example:</b> Device(config-wlan)# no security wpa akm dot1x	Disables security AKM for dot1x.
<b>Step 6</b>	<b>no security wpa wpa2</b> <b>Example:</b> Device(config-wlan)# no security wpa wpa2	Disables WPA2 security.
<b>Step 7</b>	<b>security web-auth {authentication-list authenticate-list-name   authorization-list authorize-list-name}</b> <b>Example:</b> Device(config-wlan)# security web-auth authentication-list authc-server-group	Enables authentication or authorization list for dot1x security.  <b>Note</b> You get to view the following error, if you do not disable WPA security, AKM for dot1x, and WPA2 security: <i>% switch-1:dbm:wireless:web-auth cannot be enabled. Invalid WPA/WPA2 settings.</i>

	Command or Action	Purpose
<b>Step 8</b>	<b>end</b> <b>Example:</b> Device(config-wlan) # <b>end</b>	Returns to privileged EXEC mode. Alternatively, you can also press <b>Ctrl-Z</b> to exit global configuration mode.

## Verifying Split Authentication and Authorization Configuration

To view the WLAN details, use the following command:

```
Device# show run wlan
wlan wlan-foo 2 foo-ssid
security dot1x authentication-list authc-server-group
security dot1x authorization-list authz-server-group

wlan wlan-bar 3 bar-ssid
security web-auth authentication-list authc-server-group
security web-auth authorization-list authz-server-group
```

To view the AAA authentication and server details, use the following command:

```
Device# show run aaa
!
aaa authentication dot1x default group radius
username cisco privilege 15 password 0 cisco
!
!
radius server free-radius-authc-server
  address ipv4 9.2.62.56 auth-port 1812 acct-port 1813
  key cisco
!
radius server cisco-catalyst-center-authz-server
  address ipv4 9.4.62.32 auth-port 1812 acct-port 1813
  pac key cisco
!
!
aaa new-model
aaa session-id common
!
```

To view the authentication and authorization list for 802.1X security, use the following command:

```
Device# show wlan name wlan-foo | sec 802.1x
802.1x authentication list name      : authc-server-group
802.1x authorization list name     : authz-server-group
           802.1x                   : Enabled
```

To view the authentication and authorization list for web authentication, use the following command:

```
Device# show wlan name wlan-bar | sec Webauth
Webauth On-mac-filter Failure      : Disabled
Webauth Authentication List Name   : authc-server-group
Webauth Authorization List Name    : authz-server-group
Webauth Parameter Map              : Disabled
```

# Configuration Examples

## Configuring Cisco Catalyst 9800 Series Wireless Controller for Authentication with a Third-Party RADIUS Server: Example

This example shows how to configure Cisco Catalyst 9800 Series Wireless Controller for authentication with a third-party RADIUS server:

```
Device(config)# radius server free-radius-authc-server
Device(config-radius-server)# address ipv4 9.2.62.56 auth-port 1812 acct-port 1813
Device(config-radius-server)# key cisco
Device(config-radius-server)# exit
Device(config)# aaa group server radius authc-server-group
Device(config)# server name free-radius-authc-server
Device(config)# end
```

## Configuring Cisco Catalyst 9800 Series Wireless Controller for Authorization with Cisco ISE or Cisco Catalyst Center: Example

This example shows how to configure Cisco Catalyst 9800 Series Wireless Controller for authorization with Cisco ISE or Cisco Catalyst Center:

```
Device(config)# radius server cisco-catalyst-center-authz-server
Device (config-radius-server)# address ipv4 9.4.62.32 auth-port 1812 acct-port 1813
Device (config-radius-server)# pac key cisco
Device (config-radius-server)# exit
Device(config)# aaa group server radius authz-server-group
Device(config)# server name cisco-catalyst-center-authz-server
Device(config)# end
```





## CHAPTER 118

# Secure LDAP

---

- [Information About SLDAP, on page 1055](#)
- [Prerequisite for Configuring SLDAP, on page 1057](#)
- [Restrictions for Configuring SLDAP, on page 1057](#)
- [Configuring SLDAP, on page 1057](#)
- [Configuring an AAA Server Group \(GUI\), on page 1058](#)
- [Configuring a AAA Server Group, on page 1059](#)
- [Configuring Search and Bind Operations for an Authentication Request, on page 1060](#)
- [Configuring a Dynamic Attribute Map on an SLDAP Server, on page 1061](#)
- [Verifying the SLDAP Configuration, on page 1061](#)

## Information About SLDAP

### Transport Layer Security (TLS)

The Transport Layer Security (TLS) is an application-level protocol that enables secure transactions of data through privacy, authentication, and data integrity. TLS relies upon certificates, public keys, and private keys to prove the identity of clients.

The certificates are issued by the Certificate Authorities (CAs).

Each certificate includes the following:

- The name of the authority that issued it.
- The name of the entity to which the certificate was issued.
- The public key of the entity.
- The timestamps of the entity that indicate the expiration date of the certificate.

You can find the TLS support for LDAP in the RFC2830 which is an extension to the LDAP protocol.

### LDAP Operations

*Bind*

The bind operation is used to authenticate a user to the server. It is used to start a connection with the LDAP server. LDAP is a connection-oriented protocol. The client specifies the protocol version and authentication information.

LDAP supports the following binds:

- **Authenticated bind**—An authenticated bind is performed when a root Distinguished Name (DN) and password are available.
- **Anonymous bind**—In the absence of a root DN and password, an anonymous bind is performed.

In LDAP deployments, the search operation is performed first and the bind operation later. This is because, if a password attribute is returned as part of the search operation, the password verification can be done locally on an LDAP client. Thus, there is no need to perform an extra bind operation. If a password attribute is not returned, the bind operation can be performed later. Another advantage of performing a search operation first and a bind operation later is that the DN received in the search result can be used as the user DN instead of forming a DN by prefixing the username (cn attribute) with the base DN. All entries stored in an LDAP server have a unique DN.

The DN consists of two parts:

- **Relative Distinguished Name (RDN)**
- **Location in the LDAP server where the record resides.**

Most of the entries that you store in an LDAP server will have a name, and the name is frequently stored in the Common Name (cn) attribute. Because every object has a name, most objects you store in an LDAP will use their cn value as the basis for their RDN.

### *Search*

A search operation is used to search the LDAP server. The client specifies the starting point (base DN) of the search, the search scope (either the object, its children, or the subtree rooted at the object), and a search filter.

For authorization requests, the search operation is directly performed without a bind operation. The LDAP server can be configured with certain privileges for the search operation to succeed. This privilege level is established with the bind operation.

An LDAP search operation can return multiple user entries for a specific user. In such cases, the LDAP client returns an appropriate error code to AAA. To avoid these errors, you must configure appropriate search filters to match a single entry.

### *Compare*

The compare operation is used to replace a bind request with a compare request for an authentication. The compare operation helps to maintain the initial bind parameters for the connection.

## **LDAP Dynamic Attribute Mapping**

The Lightweight Directory Access Protocol (LDAP) is a powerful and flexible protocol for communication with AAA servers. LDAP attribute maps provide a method to cross-reference the attributes retrieved from a server to Cisco attributes supported by the security appliances.

When a user authenticates a security appliance, the security appliance, in turn, authenticates the server and uses the LDAP protocol to retrieve the record for that user. The record consists of LDAP attributes associated with fields displayed on the user interface of the server. Each attribute retrieved includes a value that was entered by the administrator who updates the user records.

## Prerequisite for Configuring SLDAP

If you are using a secure Transport Layer Security (TLS) secure connection, you must configure the X.509 certificates.

## Restrictions for Configuring SLDAP

- LDAP referrals are not supported.
- Unsolicited messages or notifications from the LDAP server are not handled.
- LDAP authentication is not supported for interactive (terminal) sessions.

## Configuring SLDAP

### Procedure

	Command or Action	Purpose
<b>Step 1</b>	<b>enable</b> <b>Example:</b> Device# enable	Enables privileged EXEC mode. Enter your password if prompted.
<b>Step 2</b>	<b>configure terminal</b> <b>Example:</b> Device# configure terminal	Enters global configuration mode.
<b>Step 3</b>	<b>ldap server <i>name</i></b> <b>Example:</b> Device(config)# ldap server server1	Defines a Lightweight Directory Access Protocol (LDAP) server and enters LDAP server configuration mode.
<b>Step 4</b>	<b>ipv4 <i>ipv4-address</i></b> <b>Example:</b> Device(config-ldap-server)# ipv4 9.4.109.20	Specifies the LDAP server IP address using IPv4.
<b>Step 5</b>	<b>timeout retransmit <i>seconds</i></b> <b>Example:</b> Device(config-ldap-server)# timeout retransmit 20	Specifies the number of seconds the Cisco Catalyst 9800 Series Wireless Controller embedded wireless controller waits for a reply to an LDAP request before retransmitting the request.
<b>Step 6</b>	<b>bind authenticate root-dn password [0 <i>string</i>   7 <i>string</i>] <i>string</i></b>	Specifies a shared secret text string used between the Cisco Catalyst 9800 Series

	Command or Action	Purpose
	<b>Example:</b> <pre>Device(config-ldap-server)# bind authenticate root-dn CN=ldapipv6user,CN=Users,DC=ca,DC=ssh2,DC=com password Cisco12345</pre>	Wireless Controller embedded wireless controller and an LDAP server.  Use the <b>0</b> line option to configure an unencrypted shared secret.  Use the <b>7</b> line option to configure an encrypted shared secret.
<b>Step 7</b>	<b>base-dn</b> <i>string</i>  <b>Example:</b> <pre>Device(config-ldap-server)# base-dn CN=Users,DC=ca,DC=ssh2,DC=com</pre>	Specifies the base Distinguished Name (DN) of the search.
<b>Step 8</b>	<b>mode secure</b> [ <b>no- negotiation</b> ]  <b>Example:</b> <pre>Device(config-ldap-server)# mode secure no- negotiation</pre>	Configures LDAP to initiate the TLS connection and specifies the secure mode.
<b>Step 9</b>	<b>end</b>  <b>Example:</b> <pre>Device(config-ldap-server)# end</pre>	Returns to privileged EXEC mode. Alternatively, you can also press <b>Ctrl-Z</b> to exit global configuration mode.

## Configuring an AAA Server Group (GUI)

Configuring a device to use AAA server groups helps you to group existing server hosts, select a subset of the configured server hosts and use them for a particular service. A server group is used with a global server-host list. The server group lists the IP addresses of the selected server hosts.

You can create the following server groups:

### Procedure

#### Step 1

#### RADIUS

- Choose **Services > Security > AAA > Server Groups > RADIUS**.
- Click the **Add** button. The **Create AAA Radius Server Group** dialog box appears.
- Enter a name for the RADIUS server group in the **Name** field.
- Choose a desired delimiter from the **MAC-Delimiter** drop-down list. The available options are colon, hyphen, and single-hyphen.
- Choose a desired filter from the **MAC-Filtering** drop-down list. The available options are mac and Key.
- Enter a value in the **Dead-Time (mins)** field to make a server non-operational. You must specify a value between 1 and 1440.
- Choose any of the available servers from the **Available Servers** list and move them to the **Assigned Servers** list by clicking the **>** button.
- Click the **Save & Apply to Device** button.

**Step 2** TACACS+

- a) Choose **Services > Security > AAA > Server Groups > TACACS+**.
- b) Click the **Add** button. The **Create AAA Tacacs Server Group** dialog box appears.
- c) Enter a name for the TACACS server group in the **Name** field.
- d) Choose any of the available servers from the **Available Servers** list and move them to the **Assigned Servers** list by clicking the **>** button.
- e) Click the **Save & Apply to Device** button.

**Step 3** LDAP

- a) Choose **Services > Security > AAA > Server Groups > LDAP**.
- b) Click the **Add** button. The **Create AAA Ldap Server Group** dialog box appears.
- c) Enter a name for the LDAP server group in the **Name** field.
- d) Choose any of the available servers from the **Available Servers** list and move them to the **Assigned Servers** list by clicking the **>** button.
- e) Click the **Save & Apply to Device** button.

## Configuring a AAA Server Group

### Procedure

	Command or Action	Purpose
<b>Step 1</b>	<b>enable</b> <b>Example:</b> Device# enable	Enables privileged EXEC mode. Enter your password if prompted.
<b>Step 2</b>	<b>configure terminal</b> <b>Example:</b> Device# configure terminal	Enters global configuration mode.
<b>Step 3</b>	<b>aaa new-model</b> <b>Example:</b> Device(config)# aaa new-model	Enables AAA.
<b>Step 4</b>	<b>aaa group server ldap <i>group-name</i></b> <b>Example:</b> Device(config)# aaa group server ldap name1	Defines the AAA server group with a group name and enters LDAP server group configuration mode. All members of a group must be of the same type, that is, RADIUS, LDAP, or TACACS+.
<b>Step 5</b>	<b>server <i>name</i></b> <b>Example:</b> Device(config-ldap-sg)# server server1	Associates a particular LDAP server with the defined server group. Each security server is identified by its IP address and UDP port number.

	Command or Action	Purpose
<b>Step 6</b>	<b>exit</b> <b>Example:</b> Device(config-ldap-sg) # <b>exit</b>	Exits LDAP server group configuration mode.

## Configuring Search and Bind Operations for an Authentication Request

### Procedure

	Command or Action	Purpose
<b>Step 1</b>	<b>enable</b> <b>Example:</b> Device# <b>enable</b>	Enables privileged EXEC mode. Enter your password if prompted.
<b>Step 2</b>	<b>configure terminal</b> <b>Example:</b> Device# <b>configure terminal</b>	Enters global configuration mode.
<b>Step 3</b>	<b>aaa new-model</b> <b>Example:</b> Device(config) # <b>aaa new-model</b>	Enables AAA.
<b>Step 4</b>	<b>ldap server <i>name</i></b> <b>Example:</b> Device(config) # <b>ldap server server1</b>	Defines a Lightweight Directory Access Protocol (LDAP) server and enters LDAP server configuration mode.
<b>Step 5</b>	<b>authentication bind-first</b> <b>Example:</b> Device(config-ldap-server) # <b>authentication bind-first</b>	Configures the sequence of search and bind operations for an authentication request.
<b>Step 6</b>	<b>authentication compare</b> <b>Example:</b> Device(config-ldap-server) # <b>authentication compare</b>	Replaces the bind request with the compare request for authentication.
<b>Step 7</b>	<b>exit</b> <b>Example:</b> Device(config-ldap-server) # <b>exit</b>	Exits LDAP server group configuration mode.

## Configuring a Dynamic Attribute Map on an SLDAP Server

You must create LDAP attribute maps that map your existing user-defined attribute names and values to Cisco attribute names and values that are compatible with the security appliance. You can then bind these attribute maps to LDAP servers or remove them as required.



**Note** To use the attribute mapping features correctly, you need to understand the Cisco LDAP and user-defined attribute names and values.

### Procedure

	Command or Action	Purpose
<b>Step 1</b>	<b>enable</b> <b>Example:</b> Device# enable	Enables privileged EXEC mode. Enter your password if prompted.
<b>Step 2</b>	<b>configure terminal</b> <b>Example:</b> Device# configure terminal	Enters global configuration mode.
<b>Step 3</b>	<b>ldap attribute-map <i>map-name</i></b> <b>Example:</b> Device(config)# ldap attribute-map map1	Configures a dynamic LDAP attribute map and enters attribute-map configuration mode.
<b>Step 4</b>	<b>map type <i>ldap-attr-type aaa-attr-type</i></b> <b>Example:</b> Device(config-attr-map)# map type department supplicant-group	Defines an attribute map.
<b>Step 5</b>	<b>exit</b> <b>Example:</b> Device(config-attr-map)# exit	Exits attribute-map configuration mode.

## Verifying the SLDAP Configuration

To view details about the default LDAP attribute mapping, use the following command:

```
Device# show ldap attributes
```

To view the LDAP server state information and various other counters for the server, use the following command:

```
Device# show ldap server
```







## CHAPTER 119

# Network Access Server Identifier

---

- [Information About Network Access Server Identifier, on page 1063](#)
- [Creating a NAS ID Policy\(GUI\), on page 1064](#)
- [Creating a NAS ID Policy, on page 1064](#)
- [Attaching a Policy to a Tag \(GUI\), on page 1065](#)
- [Attaching a Policy to a Tag \(CLI\), on page 1065](#)
- [Verifying the NAS ID Configuration, on page 1066](#)

## Information About Network Access Server Identifier

Network access server identifier (NAS-ID) is used to notify the source of a RADIUS access request, which enables the RADIUS server to choose a policy for that request. You can configure one on each WLAN profile, VLAN interface, or access point group. The NAS-ID is sent to the RADIUS server by the controller through an authentication request to classify users to different groups. This enables the RADIUS server to send a customized authentication response.



---

**Note** The acct-session-id is sent with the RADIUS access request only when accounting is enabled on the policy profile.

---

If you configure a NAS-ID for an AP group, it overrides the NAS-ID that is configured for a WLAN profile or the VLAN interface. Similarly, if you configure a NAS-ID for a WLAN profile, it overrides the NAS-ID that is configured for the VLAN interface.

The following options can be configured for a NAS ID:

- sys-name (System Name)
- sys-ip (System IP Address)
- sys-mac (System MAC Address)
- ap-ip (AP's IP address)
- ap-name (AP's Name)
- ap-mac (AP's MAC Address)
- ap-eth-mac (AP's Ethernet MAC Address)

- ap-policy-tag (AP's policy tag name)
- ap-site-tag (AP's site tag name)
- ssid (SSID Name)
- ap-location (AP's Location)

## Creating a NAS ID Policy(GUI)

### Procedure

- 
- Step 1** Choose **Configuration > Security > Wireless AAA Policy**.
- Step 2** On the **Wireless AAA Policy** page, click the name of the **Policy** or click **Add** to create a new one.
- Step 3** In the **Add/Edit Wireless AAA Policy** window that is displayed, enter the name of the policy in the **Policy Name** field.
- Step 4** Choose from one of the NAS ID options from the **Option 1** drop-down list.
- Step 5** Choose from one of the NAS ID options from the **Option 2** drop-down list.
- Step 6** Choose from one of the NAS ID options from the **Option 3** drop-down list.
- Step 7** Save the configuration.
- 

## Creating a NAS ID Policy

Follow the procedure given below to create NAS ID policy:

### Before you begin

- NAS ID can be a combination of multiple NAS ID options; the maximum options are limited to 3.
- The maximum length of the NAS ID attribute is 253. Before adding a new attribute, the attribute buffer is checked, and if there is no sufficient space, the new attribute is ignored.
- By default, a wireless aaa policy (default-aaa-policy) is created with the default configuration (sys-name). You can update this policy with various NAS ID options. However, the default-aaa-policy cannot be deleted.
- If a NAS ID is not configured, the default sys-name is considered as the NAS ID for all wireless-specific RADIUS packets (authentication and accounting) from the controller .

### Procedure

	Command or Action	Purpose
<b>Step 1</b>	<b>configure terminal</b>  <b>Example:</b>	Enters global configuration mode.

	Command or Action	Purpose
	Device# configure terminal	
<b>Step 2</b>	<b>wireless aaa policy <i>policy-name</i></b> <b>Example:</b> Device(config)# wireless aaa policy test	Configures a new AAA policy.
<b>Step 3</b>	<b>nas-id option1 sys-name</b> <b>Example:</b> Device(config-aaa-policy)# nas-id option1 sys-name	Configures NAS ID for option1.
<b>Step 4</b>	<b>nas-id option2 sys-ip</b> <b>Example:</b> Device(config-aaa-policy)# nas-id option2 sys-ip	Configures NAS ID for option2.
<b>Step 5</b>	<b>nas-id option3 sys-mac</b> <b>Example:</b> Device(config-aaa-policy)# nas-id option3 sys-mac	Configures NAS ID for option3.

## Attaching a Policy to a Tag (GUI)

### Procedure

- 
- Step 1** Choose **Configuration > Tags & Profiles > Tags** page, click **Policy** tab.
  - Step 2** Click **Add** to view the **Add Policy Tag** window.
  - Step 3** Enter a name and description for the policy tag.
  - Step 4** Click **Add** to map WLAN profile and Policy profile.
  - Step 5** Choose the **WLAN Profile** to map with the appropriate **Policy Profile**, and click the tick icon.
  - Step 6** Click **Save & Apply to Device**.
- 

## Attaching a Policy to a Tag (CLI)

Follow the procedure given below to attach a NAS ID policy to a tag:

**Procedure**

	<b>Command or Action</b>	<b>Purpose</b>
<b>Step 1</b>	<b>configure terminal</b> <b>Example:</b> Device# configure terminal	Enters global configuration mode.
<b>Step 2</b>	<b>wireless profile policy <i>policy-name</i></b> <b>Example:</b> Device(config)# wireless profile policy test1	Configures a WLAN policy profile.
<b>Step 3</b>	<b>aaa-policy <i>aaa-policy-name</i></b> <b>Example:</b> Device(config-wireless-policy)# aaa-policy policy-aaa	Configures a AAA policy profile.
<b>Step 4</b>	<b>exit</b> <b>Example:</b> Device(config-wireless-policy)# exit	Returns to global configuration mode.
<b>Step 5</b>	<b>wireless tag policy <i>policy-tag</i></b> <b>Example:</b> Device(config)# wireless tag policy policy-tag1	Configures a wireless policy tag.
<b>Step 6</b>	<b>wlan wlan1 policy <i>policy-name</i></b> <b>Example:</b> Device(config)# wlan wlan1 policy test1	Maps a WLAN profile to a policy profile.  <b>Note</b> You can also use the <b>ap-tag</b> option to configure a NAS ID for an AP group, which will override the NAS ID that is configured for a WLAN profile or the VLAN interface.

## Verifying the NAS ID Configuration

Use the following **show** command to verify the NAS ID configuration:

```
Device# show wireless profile policy detailed test1
```

```
Policy Profile Name      : test1
Description              :
Status                   : ENABLED
VLAN                     : 1
Client count             : 0

:
:
AAA Policy Params
  AAA Override           : DISABLED
```

```
NAC : DISABLED
AAA Policy name : test
```





## CHAPTER 120

# Locally Significant Certificates

- [Information About Locally Significant Certificates, on page 1069](#)
- [Restrictions for Locally Significant Certificates, on page 1071](#)
- [Provisioning Locally Significant Certificates, on page 1071](#)
- [Verifying LSC Configuration, on page 1083](#)
- [Configuring Management Trustpoint to LSC \(GUI\), on page 1083](#)
- [Configuring Management Trustpoint to LSC \(CLI\), on page 1084](#)
- [Information About MIC and LSC Access Points Joining the Controller, on page 1084](#)
- [LSC Fallback Access Points, on page 1089](#)
- [Configuring Controller Self-Signed Certificate for Wireless AP Join, on page 1090](#)

## Information About Locally Significant Certificates

This module explains how to configure the Cisco Catalyst 9800 Series Wireless Controller and Lightweight Access Points (LAPs) to use the Locally Significant Certificate (LSC). If you choose the Public Key Infrastructure (PKI) with LSC, you can generate the LSC on the APs and controllers. You can then use the certificates to mutually authenticate the controllers and the APs.

In Cisco controllers, you can configure the controller to use an LSC. Use an LSC if you want your own PKI to provide better security, have control of your Certificate Authority (CA), and define policies, restrictions, and usages on the generated certificates.

You need to provision the new LSC certificate on the controller and then the Lightweight Access Point (LAP) from the CA Server.

The LAP communicates with the controller using the CAPWAP protocol. Any request to sign the certificate and issue the CA certificates for LAP and controller itself must be initiated from the controller. The LAP does not communicate directly with the CA server. The CA server details must be configured on the controller and must be accessible.

The controller makes use of the Simple Certificate Enrollment Protocol (SCEP) to forward certReqs generated on the devices to the CA and makes use of SCEP again to get the signed certificates from the CA.

The SCEP is a certificate management protocol that the PKI clients and CA servers use to support certificate enrollment and revocation. It is widely used in Cisco and supported by many CA servers. In SCEP, HTTP is used as the transport protocol for the PKI messages. The primary goal of SCEP is the secure issuance of certificates to network devices. SCEP is capable of many operations, but for our release, SCEP is utilized for the following operations:

- CA and Router Advertisement (RA) Public Key Distribution
- Certificate Enrollment

## Certificate Provisioning in Controllers

The new LSC certificates, both CA and device certificates, must be installed on the controller.

With the help of SCEP, CA certificates are received from the CA server. During this point, there are no certificates in the controller. After the **get** operation of obtaining the CA certificates, are installed on the controller. The same CA certificates are also pushed to the APs when the APs are provisioned with LSCs.



---

**Note** We recommend that you use a new RSA keypair name for the newly configured PKI certificate. If you want to reuse an existing RSA keypair name (that is associated with an old certificate) for a new PKI certificate, do either of the following:

- Do not regenerate a new RSA keypair with an existing RSA keypair name, reuse the existing RSA keypair name. Regenerating a new RSA keypair with an existing RSA keypair name will make all the certificates associated with the existing RSA keypair invalid.
  - Manually remove the old PKI certificate configurations first, before reusing the existing RSA keypair name for the new PKI certificate.
- 

## Device Certificate Enrollment Operation

For both the LAP and the controller that request a CA-signed certificate, the certRequest is sent as a PKCS#10 message. The certRequest contains the Subject Name, Public Key, and other attributes to be included in the X.509 certificate, and must be digitally signed by the Private Key of the requester. These are then sent to the CA, which transforms the certRequest into an X.509 certificate.

The CA that receives a PKCS#10 certRequest requires additional information to authenticate the requester's identity and verify if the request is unaltered. (Sometimes, PKCS#10 is combined with other approaches, such as PKCS#7 to send and receive the certificate request or response.)

The PKCS#10 is wrapped in a PKCS#7 Signed Data message type. This is supported as part of the SCEP client functionality, while the PKCSReq message is sent to the controller. Upon successful enrollment operation, both the CA and device certificates are available on the controller.

## Certificate Provisioning on Lightweight Access Point

In order to provision a new certificate on LAP, while in CAPWAP mode, the LAP must be able to get the new signed X.509 certificate. In order to do this, it sends a certRequest to the controller, which acts as a CA proxy and helps obtain the certRequest signed by the CA for the LAP.

The certReq and the certResponses are sent to the LAP with the LWAPP payloads.

Both the LSC CA and the LAP device certificates are installed in the LAP, and the system reboots automatically. The next time when the system comes up, because it is configured to use LSCs, the AP sends the LSC device certificate to the controller as part of the JOIN Request. As part of the JOIN Response, the controller sends the new device certificate and also validates the inbound LAP certificate with the new CA root certificate.



**What to Do Next**

To configure, authorize, and manage certificate enrollment with the existing PKI infrastructure for controller and AP, you need to use the LSC provisioning functionality.

## Restrictions for Locally Significant Certificates

- LSC workflow is different in FIPS+WLANCC mode. CA server must support Enrollment over Secure Transport (EST) protocol and should be capable of issuing EC certificates in FIPS+WLANCC mode.
- Elliptic Curve Digital Signature Algorithm (ECDSA) cipher works only if both AP and controller are having EC certificates, provisioned with LSC.
- EC certificates (LSC-EC) can be provisioned only if CA server supports EST (and not SCEP).
- FIPS + CC security modes is required to be configured in order to provision EC certificate.

## Provisioning Locally Significant Certificates

### Configuring RSA Key for PKI Trustpoint

**Procedure**

	Command or Action	Purpose
<b>Step 1</b>	<b>configure terminal</b>  <b>Example:</b> Device# configure terminal	Enters global configuration mode.
<b>Step 2</b>	<b>crypto key generate rsa [exportable]</b> <b>general-keys modulus <i>key_size</i> label <i>RSA_key</i></b>  <b>Example:</b> Device(config)# <b>crypto key generate rsa</b> <b>exportable</b> <b>general-keys modulus 2048 label lsc-tp</b>	Configures RSA key for PKI trustpoint.  <b>exportable</b> is an optional keyword. You may or may not want to configure an exportable-key. If selected, you can export the key out of the box, if required  <ul style="list-style-type: none"> <li>• <i>key_size</i>: Size of the key modulus. The valid range is from 2048 to 4096.</li> <li>• <i>RSA_key</i>: RSA key pair label.</li> </ul>
<b>Step 3</b>	<b>end</b>  <b>Example:</b> Device(config)# <b>end</b>	Returns to privileged EXEC mode.

## Configuring PKI Trustpoint Parameters

### Procedure

	Command or Action	Purpose
<b>Step 1</b>	<b>configure terminal</b>  <b>Example:</b> Device# <code>configure terminal</code>	Enters global configuration mode.
<b>Step 2</b>	<b>crypto pki trustpoint <i>trustpoint_name</i></b>  <b>Example:</b> Device(config)# <code>crypto pki trustpoint microsoft-ca</code>	Creates a new trustpoint for an external CA server. Here, <i>trustpoint_name</i> refers to the trustpoint name.
<b>Step 3</b>	<b>enrollment url <i>HTTP_URL</i></b>  <b>Example:</b> Device(ca-trustpoint)# <code>enrollment url http://CA_server/certsrv/mscep/mscep.dll</code>	Specifies the URL of the CA on which your router should send certificate requests.  <b>url url:</b> URL of the file system where your router should send certificate requests. An IPv6 address can be added in the URL enclosed in brackets. For example: <code>http://[2001:DB8:1:1::1]:80</code> . For more enrollment method options, see the enrollment url (ca-trustpoint) command page.
<b>Step 4</b>	<b>subject-name <i>subject_name</i></b>  <b>Example:</b> Device(ca-trustpoint)# <code>subject-name C=IN, ST=KA, L=Bengaluru, O=Cisco, CN=eagle-eye/emailAddress=support@abc.com</code>	Creates subject name parameters for the trustpoint.
<b>Step 5</b>	<b>rsakeypair <i>RSA_key key_size</i></b>  <b>Example:</b> Device(ca-trustpoint)# <code>rsakeypair ewlc-tp1</code>	Maps RSA key with that of the trustpoint.  <ul style="list-style-type: none"> <li>• <i>RSA_key</i>: RSA key pair label.</li> <li>• <i>key_size</i>: Signature key length. Range is from 360 to 4096.</li> </ul>
<b>Step 6</b>	<b>revocation {crl   none   ocsp}</b>  <b>Example:</b> Device(ca-trustpoint)# <code>revocation none</code>	Checks revocation.
<b>Step 7</b>	<b>end</b>  <b>Example:</b> Device(ca-trustpoint)# <code>end</code>	Returns to privileged EXEC mode.

## Authenticating and Enrolling a PKI Trustpoint (GUI)

### Procedure

- 
- Step 1** Choose **Configuration > Security > PKI Management**.
- Step 2** In the **PKI Management** window, click the **Trustpoints** tab.
- Step 3** In the **Add Trustpoint** dialog box, provide the following information:
- In the **Label** field, enter the RSA key label.
  - In the **Enrollment URL** field, enter the enrollment URL.
  - Check the **Authenticate** check box to authenticate the Public Certificate from the enrollment URL.
  - In the **Subject Name** section, enter the **Country Code, State, Location, Organization, Domain Name, and Email Address**.
  - Check the **Key Generated** check box to view the available RSA keypairs. Choose an option from the **Available RSA Keypairs** drop-down list.
  - Check the **Enroll Trustpoint** check box.
  - In the **Password** field, enter the password.
  - In the **Re-Enter Password** field, confirm the password.
  - Click **Apply to Device**.
- The new trustpoint is added to the trustpoint name list.
- 

## Authenticating and Enrolling the PKI Trustpoint with CA Server (CLI)

### Procedure

	Command or Action	Purpose
<b>Step 1</b>	<b>configure terminal</b>  <b>Example:</b> Device# configure terminal	Enters global configuration mode.
<b>Step 2</b>	<b>crypto pki authenticate trustpoint_name</b>  <b>Example:</b> Device(config)# <b>crypto pki authenticate microsoft-ca</b>	Fetches the CA certificate.
<b>Step 3</b>	<b>yes</b>  <b>Example:</b> Device(config)# % Do you accept this certificate? [yes/no]: yes Trustpoint CA certificate accepted.	
<b>Step 4</b>	<b>crypto pki enroll trustpoint_name</b>  <b>Example:</b>	Enrolls the client certificate.

	Command or Action	Purpose
	<pre>Device(config)# crypto pki enroll microsoft-ca % % Start certificate enrollment .. % Create a challenge password. You will need to verbally provide this password to the CA Administrator in order to revoke your certificate. For security reasons your password will not be saved in the configuration. Please make a note of it.</pre>	
<b>Step 5</b>	<pre>password Example: Device(config)# abcd123</pre>	Enters a challenge password to the CA server.
<b>Step 6</b>	<pre>password Example: Device(config)# abcd123</pre>	Re-enters a challenge password to the CA server.
<b>Step 7</b>	<pre>yes Example: Device(config)# % Include the router serial number in the subject name? [yes/no]: yes</pre>	
<b>Step 8</b>	<pre>no Example: Device(config)# % Include an IP address in the subject name? [no]: no</pre>	
<b>Step 9</b>	<pre>yes Example: Device(config)# Request certificate from CA? [yes/no]: yes % Certificate request sent to Certificate Authority % The 'show crypto pki certificate verbose client' command will show the fingerprint.</pre>	
<b>Step 10</b>	<pre>end Example: Device(config)# end</pre>	Returns to privileged EXEC mode.

## Configuring AP Join Attempts with LSC Certificate (GUI)

### Procedure

- 
- Step 1** Choose **Configuration > Wireless > Access Points**.
- Step 2** In the **All Access Points** window, click the LSC Provision name.
- Step 3** From the **Status** drop-down list, choose a status to enable LSC.
- Step 4** From the **Trustpoint Name** drop-down list, choose the trustpoint.
- Step 5** In the **Number of Join Attempts** field, enter the number of retry attempts that will be permitted.
- Step 6** Click **Apply**.
- 

## Configuring AP Join Attempts with LSC Certificate (CLI)

### Procedure

	Command or Action	Purpose
<b>Step 1</b>	<b>configure terminal</b>  <b>Example:</b> Device# <code>configure terminal</code>	Enters global configuration mode.
<b>Step 2</b>	<b>ap lsc-provision join-attempt</b> <i>number_of_attempts</i>  <b>Example:</b> Device(config)# <code>ap lsc-provision</code> <code>join-attempt 10</code>	Specifies the maximum number of AP join failure attempts with the newly provisioned LSC certificate.  When the number of AP joins exceed the specified limit, AP joins back with the Manufacturer Installed Certificate (MIC).
<b>Step 3</b>	<b>end</b>  <b>Example:</b> Device(config)# <code>end</code>	Returns to privileged EXEC mode. Alternatively, you can also press <b>Ctrl-Z</b> to exit global configuration mode.

## Configuring Subject-Name Parameters in LSC Certificate

### Procedure

	Command or Action	Purpose
<b>Step 1</b>	<b>configure terminal</b>  <b>Example:</b> Device# <code>configure terminal</code>	Enters global configuration mode.

	Command or Action	Purpose
<b>Step 2</b>	<b>ap lsc-provision subject-name-parameter</b> <b>country</b> <i>country-str</i> <b>state</b> <i>state-str</i> <b>city</b> <i>city-str</i> <b>domain</b> <i>domain-str</i> <b>org</b> <i>org-str</i> <b>email-address</b> <i>email-addr-str</i>  <b>Example:</b> <pre>Device(config)# ap lsc-provision subject-name-parameter country India state Karnataka city Bangalore domain domain1 org Right email-address adc@gfe.com</pre>	Specifies the attributes to be included in the subject-name parameter of the certificate request generated by an AP.
<b>Step 3</b>	<b>end</b>  <b>Example:</b> <pre>Device(config)# end</pre>	Returns to privileged EXEC mode.

## Configuring Key Size for LSC Certificate

### Procedure

	Command or Action	Purpose
<b>Step 1</b>	<b>configure terminal</b>  <b>Example:</b> <pre>Device# configure terminal</pre>	Enters global configuration mode.
<b>Step 2</b>	<b>ap lsc-provision key-size { 2048   3072   4096 }</b>  <b>Example:</b> <pre>Device(config)# ap lsc-provision key-size 2048</pre>	Specifies the size of keys to be generated for the LSC on AP.
<b>Step 3</b>	<b>end</b>  <b>Example:</b> <pre>Device(config)# end</pre>	Returns to privileged EXEC mode. Alternatively, you can also press <b>Ctrl-Z</b> to exit global configuration mode.

## Configuring Trustpoint for LSC Provisioning on an Access Point

### Procedure

	Command or Action	Purpose
<b>Step 1</b>	<b>configure terminal</b>  <b>Example:</b> <pre>Device# configure terminal</pre>	Enters global configuration mode.

	Command or Action	Purpose
<b>Step 2</b>	<b>ap lsc-provision trustpoint <i>tp-name</i></b> <b>Example:</b> Device(config)# <b>ap lsc-provision trustpoint microsoft-ca</b>	Specifies the trustpoint with which the LCS is provisioned to an AP.  <i>tp-name</i> : The trustpoint name.
<b>Step 3</b>	<b>end</b> <b>Example:</b> Device(config)# <b>end</b>	Returns to privileged EXEC mode.

## Configuring an AP LSC Provision List (GUI)

### Procedure

- 
- Step 1** Choose **Configuration > Wireless > Access Points**.
- Step 2** In the **All Access Points** window, click the corresponding LSC Provision name.
- Step 3** From the **Status** drop-down list, choose a status to enable LSC.
- Step 4** From the **Trustpoint Name** drop-down list, choose a trustpoint.
- Step 5** In the **Number of Join Attempts** field, enter the number of retry attempts that are allowed.
- Step 6** From the **Key Size** drop-down list, choose a key.
- Step 7** In the **Edit AP Join Profile** window, click the **CAPWAP** tab.
- Step 8** In the **Add APs to LSC Provision List** section, click **Select File** to upload the CSV file that contains AP details.
- Step 9** Click **Upload File**.
- Step 10** In the **AP MAC Address** field, enter the AP MAC address. and add them. (The APs added to the provision list are displayed in the **APs in provision List** .)
- Step 11** In the **Subject Name Parameters** section, enter the following details:
- **Country**
  - **State**
  - **City**
  - **Organization**
  - **Department**
  - **Email Address**
- Step 12** Click **Apply**.
-

## Configuring an AP LSC Provision List (CLI)

### Procedure

	Command or Action	Purpose
<b>Step 1</b>	<b>configure terminal</b>  <b>Example:</b> Device# configure terminal	Enters global configuration mode.
<b>Step 2</b>	<b>ap lsc-provision mac-address mac-addr</b>  <b>Example:</b> Device(config)# ap lsc-provision mac-address 001b.3400.02f0	Adds the AP to the LSC provision list.  <b>Note</b> You can provision a list of APs using the <b>ap lsc-provision provision-list</b> command.  (Or)  You can provision all the APs using the <b>ap lsc-provision</b> command.
<b>Step 3</b>	<b>end</b>  <b>Example:</b> Device(config)# end	Returns to privileged EXEC mode.

## Configuring LSC Provisioning for all the APs (GUI)

### Procedure

**Step 1** Choose **Configuration > Wireless > Access Points**.

**Step 2** In the **Access Points** window, expand the **LSC Provision** section.

**Step 3** Set **Status** to **Enabled** state.

**Note** If you set **Status** to **Provision List**, LSC provisioning will be configured only for APs that are a part of the provision list.

**Step 4** From the **Trustpoint Name** drop-down list, choose the appropriate trustpoint for all APs.

**Step 5** In the **Number of Join Attempts** field, enter the number of retry attempts that the APs can make to join the controller.

**Step 6** From the **Key Size** drop-down list, choose the appropriate key size of the certificate:

- 2048
- 3072
- 4096

**Step 7** In the **Add APs to LSC Provision List** section, click **Select File** to upload the CSV file that contains the AP details.

**Step 8** Click **Upload File**.



- Step 9** In the **AP MAC Address** field, enter the AP MAC address. (The APs that are added to the provision list are displayed in the **APs in Provision List** section.)
- Step 10** In the **Subject Name Parameters** section, enter the following details:
- a. **Country**
  - b. **State**
  - c. **City**
  - d. **Organization**
  - e. **Department**
  - f. **Email Address**
- Step 11** Click **Apply**.

## Configuring LSC Provisioning for All APs (CLI)

### Procedure

	Command or Action	Purpose
<b>Step 1</b>	<b>configure terminal</b> <b>Example:</b> Device# configure terminal	Enters global configuration mode.
<b>Step 2</b>	<b>ap lsc-provision</b> <b>Example:</b> Device(config)# ap lsc-provision	Enables LSC provisioning for all APs. By default, LSC provisioning is disabled for all APs.
<b>Step 3</b>	<b>end</b> <b>Example:</b> Device(config)# end	Returns to privileged EXEC mode.

## Configuring LSC Provisioning for the APs in the Provision List

### Procedure

	Command or Action	Purpose
<b>Step 1</b>	<b>configure terminal</b> <b>Example:</b> Device# configure terminal	Enters global configuration mode.

	Command or Action	Purpose
<b>Step 2</b>	<b>ap lsc-provision provision-list</b> <b>Example:</b> Device(config)# <b>ap lsc-provision provision-list</b>	Enables LSC provisioning for a set of APs configured in the provision list.
<b>Step 3</b>	<b>end</b> <b>Example:</b> Device(config)# <b>end</b>	Returns to privileged EXEC mode. Alternatively, you can also press <b>Ctrl-Z</b> to exit global configuration mode.

## Importing a CA Certificate to the Trustpool (GUI)

PKI Trustpool Management is used to store a list of trusted certificates (either downloaded or built in) used by the different services on the controller. This is also used to authenticate a multilevel CA certificate. The built in CA certificate bundle in the PKI trustpool receives automatic updates from Cisco if they are not current, are corrupt, or if certain certificates need to be updated.

Perform this task to manually update the CA certificates in the PKI trustpool.



**Note** If your LSC has been issued by an intermediate CA, you must import the complete chain of CA certificates into the trustpool. Otherwise, you will not be able to provision the APs without the complete chain being present on the controller. The import step is not required if the certificate has been issued by a root CA.

### Procedure

- 
- Step 1** Choose **Configuration > Security > PKI Management**.
  - Step 2** In the **PKI Management** window, click the **Trustpool** tab.
  - Step 3** Click **Import**.
  - Step 4** In the **CA Certificate** field, copy and paste the CA certificate. Link together the multiple CA certificates in **.pem** format.
  - Step 5** Click **Apply to Device**.
- 

## Importing a CA Certificate to the Trustpool (CLI)

### Procedure

	Command or Action	Purpose
<b>Step 1</b>	<b>configure terminal</b> <b>Example:</b> Device# <b>configure terminal</b>	Enters global configuration mode.

	Command or Action	Purpose
<b>Step 2</b>	<b>crypto pki trust pool import terminal</b> <b>Example:</b> <pre>Device(config)# crypto pki trust pool import terminal % Enter PEM-formatted CA certificate. % End with a blank line or "quit" on a line by itself. -----BEGIN CERTIFICATE----- -----END CERTIFICATE----- -----BEGIN CERTIFICATE----- -----END CERTIFICATE----- -----BEGIN CERTIFICATE----- -----END CERTIFICATE----- Aug 23 02:47:33.450: %PKI-6-TRUSTPOOL_DOWNLOAD_SUCCESS: Trustpool Download is successful</pre>	Imports the root certificate. For this, you need to paste the CA certificate from the <b>digicert.com</b> .
<b>Step 3</b>	<b>end</b> <b>Example:</b> <pre>Device(config)# end</pre>	Returns to privileged EXEC mode.

## Cleaning the CA Certificates Imported in Trustpool (GUI)

### Procedure

**Step 1** Choose **Configuration > Security > PKI Management**.

**Step 2** In the **PKI Management** window, click the **Trustpool** tab.

**Step 3** Click **Clean**.

**Note** This erases the downloaded CA certificate bundles. However, it does not erase the built-in CA certificate bundles.

**Step 4** Click **Yes**.

## Cleaning CA Certificates Imported in Trustpool (CLI)

You cannot delete a specific CA certificate from the trustpool. However, you can clear all the CA certificates that are imported to the Trustpool.

### Procedure

	Command or Action	Purpose
<b>Step 1</b>	<b>configure terminal</b> <b>Example:</b>	Enters global configuration mode.

	Command or Action	Purpose
	Device# <code>configure terminal</code>	
<b>Step 2</b>	<b>crypto pki trustpool clean</b> <b>Example:</b> Device(config)# <code>crypto pki trustpool clean</code>	Erases the downloaded CA certificate bundles. However, it does not erase the built-in CA certificate bundles.
<b>Step 3</b>	<b>end</b> <b>Example:</b> Device(config)# <code>end</code>	Returns to privileged EXEC mode. Alternatively, you can also press <b>Ctrl-Z</b> to exit global configuration mode.

## Creating a New Trustpoint Dedicated to a Single CA Certificate

### Procedure

	Command or Action	Purpose
<b>Step 1</b>	<b>configure terminal</b> <b>Example:</b> Device# <code>configure terminal</code>	Enters global configuration mode.
<b>Step 2</b>	<b>crypto pki trustpoint <i>tp-name</i></b> <b>Example:</b> Device(config)# <code>crypto pki trustpoint tp_name</code>	Creates a trustpoint.
<b>Step 3</b>	<b>enrollment terminal</b> <b>Example:</b> Device(ca-trustpoint)# <code>enrollment terminal</code>	Creates an enrollment terminal for the trustpoint.
<b>Step 4</b>	<b>exit</b> <b>Example:</b> Device(ca-trustpoint)# <code>exit</code>	Exits from the trustpoint configuration.
<b>Step 5</b>	<b>crypto pki authenticate <i>tp-name</i></b> <b>Example:</b> Device(config)# <code>crypto pki authenticate tp_name</code> <<< PASTE CA-CERT in PEM format followed by quit >>>	Authenticates the trustpoint.

## Verifying LSC Configuration

To view the details of the wireless management trustpoint, use the following command:

```
Device# show wireless management trustpoint

Trustpoint Name : microsoft-ca
Certificate Info : Available
Certificate Type : LSC
Certificate Hash : 9e5623adba5307facf778e6ea2f5082877ea4beb
Private key Info : Available
```

To view the LSC provision-related configuration details for an AP, use the following command:

```
Device# show ap lsc-provision summary

AP LSC-provisioning : Disabled
Trustpoint used for LSC-provisioning : lsc-root-tp
Certificate chain status : Available
Number of certs on chain : 2
Certificate hash : 7f9d05183deecac4e5a79db65d538245685e8e30
LSC Revert Count in AP reboots : 1

AP LSC Parameters :
Country : IN
State : KA
City : BLR
Orgn : ABC
Dept : ABC
Email : support@abc.com
Key Size : 2048
EC Key Size : 384 bit

AP LSC-provision List :

Total number of APs in provision list: 2

Mac Addresses :
-----
1880.90f5.1540
2c5a.0f70.84dc
```

## Configuring Management Trustpoint to LSC (GUI)

### Procedure

- 
- Step 1** Choose **Administration > Management > HTTP/HTTPS**.
  - Step 2** In the **HTTP Trust Point Configuration** section, set **Enable Trust Point** to the **Enabled** state.
  - Step 3** From the **Trust Points** drop-down list, choose the appropriate trustpoint.
  - Step 4** Save the configuration.
-

## Configuring Management Trustpoint to LSC (CLI)

After LSC provisioning, the APs will automatically reboot and join at the LSC mode after bootup. Similarly, if you remove the AP LSC provisioning, the APs reboot and join at non-LSC mode.

### Procedure

	Command or Action	Purpose
<b>Step 1</b>	<b>configure terminal</b> <b>Example:</b> Device# <code>configure terminal</code>	Enters global configuration mode.
<b>Step 2</b>	<b>wireless management trustpoint</b> <i>trustpoint_name</i> <b>Example:</b> Device(config)# <code>wireless management trustpoint microsoft-ca</code>	Configures the management trustpoint to LSC.
<b>Step 3</b>	<b>end</b> <b>Example:</b> Device(config)# <code>end</code>	Returns to privileged EXEC mode. Alternatively, you can also press <b>Ctrl-Z</b> to exit global configuration mode.

## Information About MIC and LSC Access Points Joining the Controller

### Overview of Support for MIC and LSC Access Points Joining the Controller

In Cisco IOS XE Bengaluru 17.4.1 and earlier releases, APs with a default certificate (Manufacturing Installed Certificates [MIC]) or Secure Unique Device Identifier [SUDI]) fail to join a Locally Significant Certificate-deployed (LSC-deployed) controller, where the management certificate of the controller is an LSC. To resolve this issue, you must provision LSC on these APs using the provisioning controller before moving them to the LSC-deployed controller.

From Cisco IOS XE Bengaluru 17.5.1 onwards, the new authorization policy configuration allows MIC APs to join the LSC-deployed controller, so that the LSC and MIC APs can coexist in the controller at the same time.

### Recommendations and Limitations

- When the CA server is configured with manual enrollment (manual intervention) to accept Certificate Signing Request (CSR), the controller waits for the CA server to send the pending response. If there is no response from the CA server for 10 minutes, the fallback mode comes into effect.
  - Cisco Wave 2 APs regenerate CSR, and a fresh CSR is sent to the CA server.

- Cisco IOS APs restart, and then Cisco IOS APs send a fresh CSR, which is in turn sent to the CA server.
- Locally significant certificate (LSC) on the controller does not work on the password challenge. Therefore, for LSC to work, you must disable password challenge on the CA server.
- If you are using Microsoft CA, we recommend that you use Windows Server 2012 or later as the CA server.

## Configuration Workflow

1. [#unique\\_1423](#)
2. [#unique\\_1424](#)
3. [#unique\\_1425](#)
4. [#unique\\_1426](#)

## Configuring LSC on the Controller (CLI)

The server certificate used by the controller for CAPWAP-DTLS is based on the following configuration.

### Before you begin

- Ensure that you enable LSC by setting the appropriate trustpoints for the following wireless management services:
  - AP join process: CAPWAP DTLS server certificate
  - Mobility connections: Mobility DTLS certificate
  - NMSP and CMX connections: NMSP TLS certificate

### Procedure

	Command or Action	Purpose
<b>Step 1</b>	<b>configure terminal</b> <b>Example:</b> Device# configure terminal	Enters global configuration mode.
<b>Step 2</b>	<b>[no] wireless management trustpoint</b> <i>trustpoint-name</i> <b>Example:</b> Device(config)# wireless management trustpoint <i>trustpoint-name</i>	Configures the LSC trustpoint in the LSC-deployed controller.

## Enabling the AP Certificate Policy on the APs (CLI)

- If the management trustpoint is an LSC, by default, MIC APs fail to join the controller. This configuration acts as an enable or disable configuration knob that allows MIC APs to join the controller.
- This configuration is a controller authorization to allow APs to join MIC at the time of DTLS handshake.

To prevent manufacturing installed certificate (MIC) expiry failures, ensure that you configure a policy, as shown here:

- Create a certificate map and add the rules:

```
configure terminal
crypto pki certificate map map1 1
issuer-name co Cisco Manufacturing CA
```



**Note** You can add multiple rules and filters under the same map. The rule mentioned in the example above specifies that any certificate whose issuer-name contains *Cisco Manufacturing CA* (case insensitive) is selected under this map.

- Use the certificate map under the trustpool policy:

```
configure terminal
crypto pki trustpool policy
match certificate map1 allow expired-certificate
```

### Procedure

	Command or Action	Purpose
<b>Step 1</b>	<b>configure terminal</b>  <b>Example:</b> Device# configure terminal	Enters global configuration mode.
<b>Step 2</b>	<b>ap auth-list ap-cert-policy allow-mic-ap trustpoint trustpoint-name</b>  <b>Example:</b> Device(config)# ap auth-list ap-cert-policy allow-mic-ap trustpoint trustpoint-name	Configures the trustpoint name for the controller certificate chain.  <b>Note</b> The <b>allow-mic-ap trustpoint</b> command is required only for the virtual controller (Cisco Catalyst 9800-CL Wireless Controller for Cloud). In all the other appliance controller platforms, the default certificate is selected. This default certificate is manufacturer-installed SUDI.
<b>Step 3</b>	<b>ap auth-list ap-cert-policy allow-mic-ap</b>  <b>Example:</b> Device(config)# ap auth-list ap-cert-policy allow-mic-ap	Enables the AP certificate policy during CAPWAP-DTLS handshake.



	Command or Action	Purpose
<b>Step 4</b>	<p><b>ap auth-list ap-cert-policy {mac-address H.H.H   serial-number serial-number-ap} policy-type mic</b></p> <p><b>Example:</b></p> <pre>Device(config)# ap auth-list ap-cert-policy mac-address 1111.1111.1111 policy-type mic</pre>	Enables the AP certificate policy as MIC.

## Configuring the AP Policy Certificate (GUI)

### Procedure

- 
- Step 1** Choose **Configuration > Wireless > Access Points**
- Step 2** In the **All Access Points** window, click **AP Certificate Policy**.
- Step 3** In the **AP Policy Certificate** window, complete the following actions:
- Click the **Authorize APs joining with MIC** toggle button to enable AP authorization.
  - From the **Trustpoint Name** drop-down list, choose the required trustpoint.
  - Click **Add MAC or Serial Number** to add a MAC address or a serial number manually or through a .csv file.  
The **Add MAC or Serial Number** window is displayed.
  - Click the **AP Authlist Type** and enter the MAC address or the serial number. Upload the .csv file or enter the MAC address in the list box.  
The newly added MAC address and serial numbers are displayed under **List of MAC Address and Serial Numbers**.
  - Click **Apply**.
- The AP certificate policy is added to the **AP Inventory** window.
- Note** To add a new AP with MIC, perform Step 1 to Step 3 described in [Configuring the AP Policy Certificate \(GUI\)](#) section. To add a new AP with LSC, perform the procedure described in the [Configuring AP LSC Provision List \(GUI\)](#) and Step 1 to Step 3 in the [Configuring the AP Policy Certificate \(GUI\)](#) section.
- 

## Configuring the Allowed List of APs to Join the Controller (CLI)

The allowed list of APs can either be populated based on the Ethernet MAC address or based on the serial number of the APs.

**Procedure**

	<b>Command or Action</b>	<b>Purpose</b>
<b>Step 1</b>	<b>configure terminal</b>  <b>Example:</b> Device# configure terminal	Enters global configuration mode.
<b>Step 2</b>	<b>ap auth-list ap-cert-policy {mac-address AP-Ethernet-MAC-address   serial-number AP-serial-number} policy-type mic</b>  <b>Example:</b> Device# ap auth-list ap-cert-policy mac-address 00b0.e192.0d98 policy-type mic	Configures the AP certificate policy based on the Ethernet MAC address or based on the assembly serial number of the AP.

**Verifying the Configuration Status**

To verify if the APs have been authorized by the AP certificate policy, use the following command:

```
Device# show ap auth-list ap-cert-policy
Authorize APs joining with MIC : ENABLED
MIC AP policy trustpoint
Name : CISCO_IDEVID_SUDI
Certificate status : Available
Certificate Type : MIC
Certificate Hash : xxxxxxxxxxxxxxxxxxxxxxxxxxxxxxxxxxxxxxxxxxxxxxxxxxxxxxxxxxxxxxx
```

To verify the AP certificate policy on the MAC address and the serial number of the AP, use the following commands:

```
Device# show ap auth-list ap-cert-policy mac-address
MAC address      AP cert policy
-----
1111.2222.3333   MIC

Device# show ap auth-list ap-cert-policy serial-number
Serial number    AP cert policy
-----
F1234567890     MIC
```



**Note** If you set an invalid trustpoint (not SSC), the **allow-mic-ap policy** is not enabled. If you set an invalid trustpoint, the following error is displayed on the console:

```
Device(config)# ap auth-list ap-cert-policy allow-mic-ap trustpoint lsc-root-tp
Dec 18 07:38:29.944: %CERT_MGR_ERRMSG-3-CERT_MGR_GENERAL_ERR: Chassis 1 R0/0: wncd: General
error: MIC AP Policy trustpoint: 'lsc-root-tp' cert-chain type is LSC, It must be either
MIC or vWLC-SSC
```

# LSC Fallback Access Points

## Information About LSC Fallback APs

When an AP is configured with LSC for CAPWAP but fails to establish DTLS connection, the AP reboots and retries for certain number of times. For information on how an AP configures with LSC, see [Configuring AP Join Attempts with LSC Certificate \(CLI\)](#), on page 1075.

The AP falls back to its default certificate (MIC) for CAPWAP after maximum number of failures. This state is referred to as the LSC fallback.



---

**Note** MIC is also known as SUDI certificate.

---

## Troubleshooting LSC Fallback State

When an AP in **LSC fallback** state joins the controller, the following syslog is generated:

```
Jun 15 23:24:14.836: %APMGR_TRACE_MESSAGE-3-WLC_GEN_ERR: Chassis 1 R0/0: wncd: Error
in AP: 'AP2c5a.0f70.84dc' with address 70db.9888.cc20 is joined with MIC, while configuration
requires LSC. No WLANs will be pushed.
```

The controller allows such an AP to be joined with MIC (when AP certificate policy allows it) and AP is held in misconfigured state.



---

**Note** The AP does not broadcast WLAN or SSID configurations in such state. This permits the admin to examine the reason for previous failures and recover APs.

---

You can identify the **LSC fallback** APs using **show wireless summary** as follows:

```
Device# show wireless summary
...
Access Point Summary
...
DTLS LSC fallback APs      20 (No WLANs will be pushed to these APs)
...
For more information on DTLS LSC fallback APs,
execute 'wireless config validate' and look for reported errors in
'show wireless config validation status' CLI output.

Use 'show ap config general | inc AP Name | LSC fallback' to list DTLS LSC fallback APs.
Examine LSC fallback reasons / DTLS handshake failures with LSC then
issue 'ap lsc dtls-fallback clear-certificate / clear-flag' to recover APs
```

## Recovery Steps

- Use the **ap lsc dtls-fallback clear-flag** to clear the LSC fallback flag on AP and instruct AP to reload.



---

**Note** The AP reuses the LSC for CAPWAP DTLS connection post the reload.

---

- Use the **ap lsc dtls-fallback clear-certificate** to clear LSC and instruct AP to reload.



---

**Note** The AP uses MIC for CAPWAP-DTLS post the reload. If LSC is used for Dot1x port authentication then further recovery is needed on switch port for AP authentication.

---



- 
- Note**
- The **ap lsc dtls-fallback clear-flag** command is sufficient to retain LSC on AP. Both **ap lsc dtls-fallback clear-flag** and **ap lsc dtls-fallback clear-certificate** commands are not required at the same time.
  - APs must be in connected state when issuing the recovery command. You will need to reissue the command, if any **LSC fallback** AP joins afterwards.
- 

# Configuring Controller Self-Signed Certificate for Wireless AP Join

## Use Cases

### Use Case-1

Cisco Catalyst 9800-CL platform does not contain manufacturer installed SUDI certificates. You will need to configure Self-Signed Certificates on your controller.

### Use Case-2

APs running on earlier versions and having Manufacturer Installed Certificate (MIC) issued by a SHA1 Cisco Trusted CA cannot join the controller with SHA2 SUDI certificate. During CAPWAP join process, the AP displays a bad certificate error and tears down the DTLS handshake.

**Workaround:** To upgrade APs, configure controller Self-Signed certificates. Once done, you can delete the Self-Signed certificates and revert back to the SUDI certificate.



---

**Note** This workaround does not apply to the Embedded Wireless Controller running Catalyst 9k switches. But applies to other hardware appliance controllers, such as Cisco Catalyst 9800-40, Cisco Catalyst 9800-80, and Cisco Catalyst 9800-L.

---



---

**Note** Certificate used in DTLS connections (AP and mobility) must use RSA key of size equal or more than 2048 bits. Otherwise, the APs and mobility connections will fail after reload. Run the **show crypto pki certificate verbose \_tp-name\_** command to display the key size of the device certificate.

---

## Prerequisites

- Ensure that the VLAN interface is up and it's IP is reachable.
- Ensure that the **ip http server** is enabled. For more information, see [Enabling HTTP Server](#).
- Set the **clock calendar-valid** command appropriately. For more information, see [#unique\\_1441](#).
- Check if the PKI CA server is already configured or not. If configured, you will need to delete the existing CA server configuration.



---

**Note** The **show crypto pki server** command output should not display anything.

---

## Configuring Clock Calendar (CLI)

### Procedure

	Command or Action	Purpose
<b>Step 1</b>	<b>configure terminal</b> <b>Example:</b> Device# <b>configure terminal</b>	Enters global configuration mode.
<b>Step 2</b>	<b>clock calendar-valid</b> <b>Example:</b> Device(config)# <b>clock calendar-valid</b>	Enables clock calendar.
<b>Step 3</b>	<b>exit</b> <b>Example:</b> Device(config)# <b>exit</b>	Exits configuration mode.

## Enabling HTTP Server (CLI)

### Procedure

	Command or Action	Purpose
<b>Step 1</b>	<b>configure terminal</b> <b>Example:</b> Device# <code>configure terminal</code>	Enters global configuration mode.
<b>Step 2</b>	<b>ip http server</b> <b>Example:</b> Device(config)# <code>ip http server</code>	Enables the HTTP server on your IP or IPv6 system, including a Cisco web browser user interface. By default, the HTTP server uses the standard port 80.
<b>Step 3</b>	<b>ip http secure-server</b> <b>Example:</b> Device(config)# <code>ip http secure-server</code>	Enables the HTTP server on your IP or IPv6 system, including a Cisco web browser user interface. By default, the HTTP server uses the standard port 80.
<b>Step 4</b>	<b>exit</b> <b>Example:</b> Device(config)# <code>exit</code>	Exits configuration mode.

## Configuring CA Server (CLI)

### Procedure

	Command or Action	Purpose
<b>Step 1</b>	<b>configure terminal</b> <b>Example:</b> Device# <code>configure terminal</code>	Enters global configuration mode.
<b>Step 2</b>	<b>crypto key generate rsa general-keys modulus <i>size_of_key_module</i> label <i>keypair_name</i></b> <b>Example:</b> Device(config)# <code>crypto key generate rsa general-keys modulus 2048 label WLC_CA</code>	Configures a certificate for the controller. When you generate RSA keys, you are prompted to enter a modulus length. A longer modulus length might be more secure, but it takes longer to generate and to use. <b>Note</b> The recommended key-pair name is <i>WLC_CA</i> and key modulus is <i>2048</i> bits.
<b>Step 3</b>	<b>crypto pki server <i>certificate_server_name</i></b> <b>Example:</b> Device(config)# <code>crypto pki server WLC_CA</code>	Enables IOS certificate server. <b>Note</b> The <i>certificate_server_name</i> must be the same name as the <i>keypair_name</i> .

	Command or Action	Purpose
<b>Step 4</b>	<b>issuer-name</b> <b>Example:</b> <pre>Device(config)# issuer-name O=Cisco Virtual Wireless LAN Controller, CN=CA-vWLC</pre>	Configures X.509 distinguished name for the issuer CA certificate.  <b>Note</b> You need to configure the same <b>issuer-name</b> as suggested for AP join.
<b>Step 5</b>	<b>grant auto</b> <b>Example:</b> <pre>Device(config)# grant auto</pre>	Grants certificate requests automatically.
<b>Step 6</b>	<b>hash sha256</b> <b>Example:</b> <pre>Device(config)# hash sha256</pre>	(Optional) Specifies the hash function for the signature used in the granted certificates.
<b>Step 7</b>	<b>lifetime ca-certificate <i>time-interval</i></b> <b>Example:</b> <pre>Device(config)# lifetime ca-certificate 3650</pre>	(Optional) Specifies the lifetime in days of a CA certificate.
<b>Step 8</b>	<b>lifetime certificate <i>time-interval</i></b> <b>Example:</b> <pre>Device(config)# lifetime certificate 3650</pre>	(Optional) Specifies the lifetime in days of a granted certificate.
<b>Step 9</b>	<b>database archive pkcs12 password <i>password</i></b> <b>Example:</b> <pre>Device(config)# database archive pkcs12 password 0 cisco123</pre>	Sets the CA key and CA certificate archive format and password to encrypt the file.
<b>Step 10</b>	<b>no shutdown</b> <b>Example:</b> <pre>Device(config)# no shutdown</pre>	Enables the certificate server.  <b>Note</b> Issue this command only after you have completely configured your certificate server.
<b>Step 11</b>	<b>end</b> <b>Example:</b> <pre>Device(config)# end</pre>	Returns to privileged EXEC mode. Alternatively, you can also press <b>Ctrl-Z</b> to exit global configuration mode.

## Configuring Trustpoint (CLI)

### Procedure

	Command or Action	Purpose
<b>Step 1</b>	<b>configure terminal</b> <b>Example:</b> Device# <b>configure terminal</b>	Enters global configuration mode.
<b>Step 2</b>	<b>crypto key generate rsa exportable general-keys modulus size-of-the-key-modulus label label</b> <b>Example:</b> Device (config)# <b>crypto key generate rsa exportable general-keys modulus 2048 label ewlc-tp1</b>	When you generate RSA keys, you are prompted to enter a modulus length. A longer modulus length might be more secure, but it takes longer to generate and to use.
<b>Step 3</b>	<b>crypto pki trustpoint trustpoint_name</b> <b>Example:</b> Device (config)# <b>crypto pki trustpoint ewlc-tp1</b>	Creates a new trust point for an external CA server. Here, <i>trustpoint_name</i> refers to the trustpoint name. <b>Note</b> Ensure that same names are used for key-pair ( <i>label</i> ) and <i>trustpoint_name</i> .
<b>Step 4</b>	<b>rsakeypair RSA_key key_size</b> <b>Example:</b> Device (ca-trustpoint)# <b>rsakeypair ewlc-tp1</b>	Maps RSA key with that of the trustpoint. <ul style="list-style-type: none"><li>• <i>RSA_key</i>—Refers to the RSA key pair label.</li><li>• <i>key_size</i>—Refers to the signature key length. The value ranges from 360 to 4096.</li></ul>
<b>Step 5</b>	<b>subject-name subject_name</b> <b>Example:</b> Device (ca-trustpoint)# <b>subject-name O=Cisco Virtual Wireless LAN Controller, CN=DEVICE-vWLC</b>	Creates subject name parameters for the trustpoint.
<b>Step 6</b>	<b>revocation-check none</b> <b>Example:</b> Device (ca-trustpoint)# <b>revocation-check none</b>	Checks revocation.
<b>Step 7</b>	<b>hash sha256</b> <b>Example:</b> Device (ca-trustpoint)# <b>hash sha256</b>	Specifies the hash algorithm.



	Command or Action	Purpose
<b>Step 8</b>	<b>serial-number</b> <b>Example:</b> Device(ca-trustpoint)# <b>serial-number</b>	Specifies the serial number.
<b>Step 9</b>	<b>eku request server-auth client-auth</b> <b>Example:</b> Device(ca-trustpoint)# <b>eku request server-auth client-auth</b>	(Optional) Sets certificate key-usage purpose.
<b>Step 10</b>	<b>password password</b> <b>Example:</b> Device(config)# <b>password 0 cisco123</b>	Enables password.
<b>Step 11</b>	<b>enrollment url url</b> <b>Example:</b> Device(config)# <b>enrollment url http://&lt;management-IPv4&gt;:80</b>	Enrolls the URL. <b>Note</b> Replace the dummy IP with management VLAN interface IP of the controller where CA server is configured.
<b>Step 12</b>	<b>exit</b> <b>Example:</b> Device(config)# <b>exit</b>	Exits the configuration.

## Authenticating and Enrolling the PKI TrustPoint with CA Server (CLI)

### Procedure

	Command or Action	Purpose
<b>Step 1</b>	<b>configure terminal</b> <b>Example:</b> Device# <b>configure terminal</b>	Enters global configuration mode.
<b>Step 2</b>	<b>crypto pki authenticate trustpoint_name</b> <b>Example:</b> Device(config)# <b>crypto pki authenticate ewlc-tp1</b> Certificate has the following attributes: Fingerprint MD5: 64C5FC9A C581D827 C25FC3CF 1A7F42AC Fingerprint SHA1: 6FAFF812 7C552783 6A8FB566 52D95849 CC2FC050 % Do you accept this certificate? [yes/no]: yes Trustpoint CA certificate accepted.	Fetches the CA certificate.

	Command or Action	Purpose
<b>Step 3</b>	<b>crypto pki enroll</b> <i>trustpoint_name</i> <b>Example:</b> Device(config)# <b>crypto pki enroll ewlc-tp1</b> Enter following answers for UI interaction: % Include an IP address in the subject name? [no]: no Request certificate from CA? [yes/no]: yes	Enrolls for client certificate.
<b>Step 4</b>	<b>end</b> <b>Example:</b> Device(config)# <b>end</b>	Returns to privileged EXEC mode. Alternatively, you can also press <b>Ctrl-Z</b> to exit global configuration mode.

## Tagging Wireless Management TrustPoint Name (CLI)

### Procedure

	Command or Action	Purpose
<b>Step 1</b>	<b>configure terminal</b> <b>Example:</b> Device# <b>configure terminal</b>	Enters global configuration mode.
<b>Step 2</b>	<b>wireless management trustpoint</b> <i>trustpoint_name</i> <b>Example:</b> Device(config)# <b>wireless management trustpoint ewlc-tp1</b>	Tags the wireless management trustpoint name.
<b>Step 3</b>	<b>end</b> <b>Example:</b> Device(config)# <b>end</b>	Returns to privileged EXEC mode. Alternatively, you can also press <b>Ctrl-Z</b> to exit global configuration mode.

## Verifying Controller Certificates for Wireless AP Join

To view the CA server details, use the following command:

```
Device# show crypto pki server
Certificate Server WLC_CA:
Status: enabled
State: enabled
Server's configuration is locked (enter "shut" to unlock it)
Issuer name: O=Cisco Virtual Wireless LAN Controller, CN=CA-vWLC
CA cert fingerprint: 79A3DBD5 59A7E384 73ABD152 C133F4E2
Granting mode is: auto
```

```
Last certificate issued serial number (hex): 1
CA certificate expiration timer: 12:04:00 UTC Mar 8 2029
CRL NextUpdate timer: 18:04:00 UTC Mar 11 2019
Current primary storage dir: nvram:
Database Level: Minimum - no cert data written to storage
```

To view the trustpoint details, use the following command:

```
Device# show crypto pki trustpoint ewlc-tp1 status
Trustpoint ewlc-tp1:
...
State:
Keys generated ..... Yes (General Purpose, exportable)
Issuing CA authenticated ..... Yes
Certificate request(s) ..... Yes
```

To view the wireless management trustpoint details, use the following command:

```
Device# do show wireless management trustpoint
Trustpoint Name : ewlc-tp1
Certificate Info : Available
Certificate Type : SSC
Certificate Hash : 4a5d777c5b2071c17faef376feb08398702184e
Private key Info : Available
FIPS suitability : Not Applicable
```

To view the HTTP server status, use the following command:

```
Device# show ip http server status | include server status
HTTP server status: Enabled
HTTP secure server status: Enabled
```





## CHAPTER 121

# Certificate Management

---

- [About Public Key Infrastructure Management \(GUI\), on page 1099](#)
- [Authenticating and Enrolling a PKI Trustpoint \(GUI\), on page 1099](#)
- [Adding the Certificate Authority Server \(GUI\), on page 1100](#)
- [Adding an RSA or EC Key for PKI Trustpoint \(GUI\), on page 1101](#)
- [Adding and Managing Certificates , on page 1101](#)

## About Public Key Infrastructure Management (GUI)

The Public Key Infrastructure (PKI) Management page displays the following tabs:

**Trustpoints** tab: Used to add, create or enroll a new trustpoint. This page also displays the current trustpoints configured on the controller and other details of the trustpoint. You can also view if the trustpoint is in use for any of the features. For example, Webadmin or AP join (Wireless Management Interface ), and others.

**CA Server** tab: Used to enable or disable the Certificate Authority (CA) server functionality on the controller. The CA server functionality should be enabled for the controller to generate a Self Signed Certificate (SSC).

**Key Pair Generation** tab: Used to generate key pairs.

**Certificate Management** tab: Used to generate and manage certificates, and perform all certificate related operations, on the controller.

## Authenticating and Enrolling a PKI Trustpoint (GUI)

### Procedure

---

- Step 1** Choose **Configuration > Security > PKI Management**.
- Step 2** In the **PKI Management** window, click the **Trustpoints** tab.
- Step 3** In the **Add Trustpoint** dialog box, provide the following information:
- a) In the **Label** field, enter the RSA key label.
  - b) In the **Enrollment URL** field, enter the enrollment URL.
  - c) Check the **Authenticate** check box to authenticate the Public Certificate from the enrollment URL.

- d) In the **Subject Name** section, enter the **Country Code, State, Location, Organization, Domain Name, and Email Address**.
- e) Check the **Key Generated** check box to view the available RSA keypairs. Choose an option from the **Available RSA Keypairs** drop-down list.
- f) Check the **Enroll Trustpoint** check box.
- g) In the **Password** field, enter the password.
- h) In the **Re-Enter Password** field, confirm the password.
- i) Click **Apply to Device**.

The new trustpoint is added to the trustpoint name list.

## Generating an AP Self-Signed Certificate (GUI)



**Note** This section is valid only for virtual controllers (Cisco Catalyst 9800-CL Wireless Controller for Cloud) and not applicable for appliance based controllers (Cisco Catalyst 9800-40 Wireless Controller, Cisco Catalyst 9800-80 Wireless Controller, Cisco Catalyst 9800-L Wireless Controller (Copper Uplink), and Cisco Catalyst 9800-L Wireless Controller (Fiber Uplink)).

### Procedure

- Step 1** Choose **Configuration > Security > PKI Management**.
- Step 2** In the **AP SSC Trustpoint** area, click **Generate** to generate an AP SSC trustpoint.
- Step 3** From the **RSA Key-Size** drop-down list, choose a key size.
- Step 4** From the **Signature Algorithm** drop-down list, choose an option.
- Step 5** From the **Password Type** drop-down list, choose a password type.
- Step 6** In the **Password** field, enter a password. The valid range is between 8 and 32 characters.
- Step 7** Click **Apply to Device**.

## Adding the Certificate Authority Server (GUI)

### Procedure

- Step 1** Choose **Configuration > Security > PKI Management**.
- Step 2** In the **PKI Management** window, click the **CA Server** tab.
- Step 3** In the **CA Server** section, click the **Shutdown Status** toggle button, to enable the status. If you choose the shutdown status as **Enabled**, you must enter the password and confirm the same.
- Step 4** If you choose the shutdown status as **Disabled**, you must enter the **Country Code, State, Location, Organization, Domain Name, and Email Address**.

- Step 5** Click **Apply** to add the CA server.
- Step 6** Click **Remove CA Server** to delete the CA server.
- 

## Adding an RSA or EC Key for PKI Trustpoint (GUI)

### Procedure

---

- Step 1** Choose **Configuration > Security > PKI Management**.
- Step 2** In the **PKI Management** window, click the **Key Pair Generation** tab.
- Step 3** In the **Key Pair Generation** section, click **Add**.
- Step 4** In the dialog box that is displayed, provide the following information:
- In the **Key Name** field, enter the key name.
  - In the **Key Type** options, select either **RSA Key** or **EC Key**.
  - In the **Modulus Size** field, enter the modulus value for the RSA key or the EC key. The default modulus size for the RSA key is 4096 and the default value for the EC key is 521.
  - Check the **Key Exportable** check box to export the key. By default, this is checked.
  - Click **Generate**.
- 

## Adding and Managing Certificates

To add and manage certificates, use one of the following methods:



**Note** While configuring a password for the .pfx file, do not use the following ASCII characters: "\*", "^", "()", "[", "\\", " ", and "+"

Using these ASCII characters results in error with bad configuration and does not import the certificate to the controller.

---

### Method 1

#### Procedure

---

- Step 1** Choose **Configuration > Security > PKI Management > Add Certificate**.
- Step 2** Click **Generate Certificate Signing Request**.
- In the **Certificate Name** field, enter the certificate name.
  - From the **Key Name** drop-down list, choose an RSA key pair. (Click the plus (+) icon under the **Key Pair Generation** tab to create new RSA key pairs.)

- c) Enter values the **Country Code**, **Location**, **Organization**, **State**, **Organizational Unit**, and the **Domain Name** fields.
- d) Click **Generate**.  
The generated Certificate Signing Request (CSR) is displayed on the right. Click **Copy** to copy and save a local copy. Click **Save to Device** to save the generated CSR to the /bootflash/csr directory.

**Step 3** Click **Authenticate Root CA** .

- a) From the **Trustpoint** drop-down list, choose the trustpoint label generated in Step 2, or any other trustpoint label that you want to authenticate.
- b) In the **Root CA Certificate (.pem)** field, copy and paste the certificate that you have received from the CA.

**Note** Ensure that you copy and paste the PEM Base64 certificate of the issuing CA of the device certificate.

- c) Click **Authenticate**.

**Step 4** Click **Import Device Certificate** .

- a) From the **Trustpoint** drop-down list, choose the trustpoint label that was generated in Step 2, or any other trustpoint label that you want to authenticate.
- b) In the **Signed Certificate (.pem)** field, copy and paste the signed certificate that you received, from your CA.
- c) Click **Import**.

This completes the device certificate import process and the certificate can now be assigned to features.

## Method 2

### Procedure

Click **Import PKCS12 Certificate** .

**Note** You can import an entire certificate chain in the PKCS12 format using different transport types.

- a) From the **Transport Type** drop-down list, choose either **FTP**, **SFTP**, **TFTP**, **SCP**, or **Desktop (HTTPS)**.

For **FTP**, **SFTP**, and **SCP**, enter values in the **Server IP Address (IPv4/IPv6)**, **Username**, **Password**, **Certificate File Path**, **Certificate Destination File Name**, and **Certificate Password** fields.

For **TFTP**, enter values in the **Server IP Address (IPv4/IPv6)**, **Certificate File Path**, **Certificate Destination File Name**, and **Certificate Password** fields.

For **Desktop (HTTPS)**, enter values in the **Source File Path** and **Certificate Password** fields.

- b) Click **Import**.



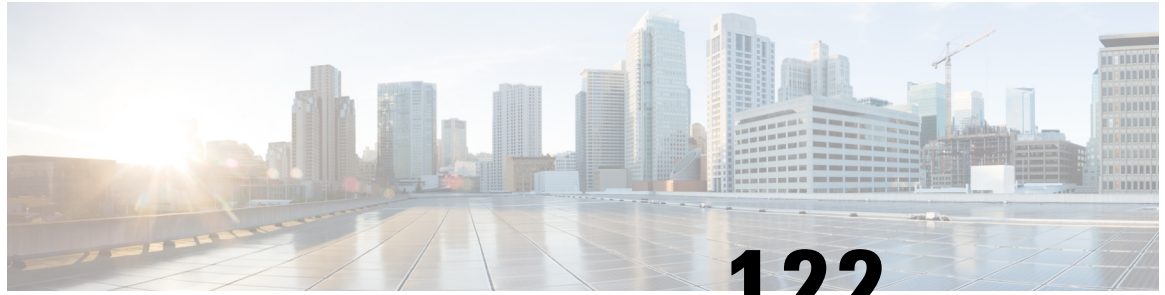

## CHAPTER 122

# Controller Self-Signed Certificate for Wireless AP Join

---

- [Use Cases, on page 1103](#)
- [Prerequisites, on page 1104](#)
- [Configuring Clock Calendar \(CLI\), on page 1104](#)
- [Enabling HTTP Server \(CLI\), on page 1105](#)
- [Configuring CA Server \(CLI\), on page 1105](#)
- [Configuring Trustpoint \(CLI\), on page 1107](#)
- [Authenticating and Enrolling the PKI TrustPoint with CA Server \(CLI\), on page 1108](#)
- [Tagging Wireless Management TrustPoint Name \(CLI\), on page 1109](#)
- [Verifying Controller Certificates for Wireless AP Join, on page 1109](#)

## Use Cases

### Use Case-1

Cisco Catalyst 9800-CL platform does not contain manufacturer installed SUDI certificates. You will need to configure Self-Signed Certificates on your controller.

### Use Case-2

APs running on earlier versions and having Manufacturer Installed Certificate (MIC) issued by a SHA1 Cisco Trusted CA cannot join the controller with SHA2 SUDI certificate. During CAPWAP join process, the AP displays a bad certificate error and tears down the DTLS handshake.

**Workaround:** To upgrade APs, configure controller Self-Signed certificates. Once done, you can delete the Self-Signed certificates and revert back to the SUDI certificate.



---

**Note** This workaround does not apply to the Embedded Wireless Controller running Catalyst 9k switches. But applies to other hardware appliance controllers, such as Cisco Catalyst 9800-40, Cisco Catalyst 9800-80, and Cisco Catalyst 9800-L.

---



---

**Note** Certificate used in DTLS connections (AP and mobility) must use RSA key of size equal or more than 2048 bits. Otherwise, the APs and mobility connections will fail after reload. Run the **show crypto pki certificate verbose \_tp-name\_** command to display the key size of the device certificate.

---

## Prerequisites

- Ensure that the VLAN interface is up and it's IP is reachable.
- Ensure that the **ip http server** is enabled. For more information, see [Enabling HTTP Server](#).
- Set the **clock calendar-valid** command appropriately. For more information, see [#unique\\_1441](#).
- Check if the PKI CA server is already configured or not. If configured, you will need to delete the existing CA server configuration.



---

**Note** The **show crypto pki server** command output should not display anything.

---

## Configuring Clock Calendar (CLI)

### Procedure

	Command or Action	Purpose
<b>Step 1</b>	<b>configure terminal</b>  <b>Example:</b> Device# <b>configure terminal</b>	Enters global configuration mode.
<b>Step 2</b>	<b>clock calendar-valid</b>  <b>Example:</b> Device(config)# <b>clock calendar-valid</b>	Enables clock calendar.
<b>Step 3</b>	<b>exit</b>  <b>Example:</b> Device(config)# <b>exit</b>	Exits configuration mode.

## Enabling HTTP Server (CLI)

### Procedure

	Command or Action	Purpose
<b>Step 1</b>	<b>configure terminal</b> <b>Example:</b> Device# <code>configure terminal</code>	Enters global configuration mode.
<b>Step 2</b>	<b>ip http server</b> <b>Example:</b> Device(config)# <code>ip http server</code>	Enables the HTTP server on your IP or IPv6 system, including a Cisco web browser user interface. By default, the HTTP server uses the standard port 80.
<b>Step 3</b>	<b>ip http secure-server</b> <b>Example:</b> Device(config)# <code>ip http secure-server</code>	Enables the HTTP server on your IP or IPv6 system, including a Cisco web browser user interface. By default, the HTTP server uses the standard port 80.
<b>Step 4</b>	<b>exit</b> <b>Example:</b> Device(config)# <code>exit</code>	Exits configuration mode.

## Configuring CA Server (CLI)

### Procedure

	Command or Action	Purpose
<b>Step 1</b>	<b>configure terminal</b> <b>Example:</b> Device# <code>configure terminal</code>	Enters global configuration mode.
<b>Step 2</b>	<b>crypto key generate rsa general-keys modulus <i>size_of_key_module</i> label <i>keypair_name</i></b> <b>Example:</b> Device(config)# <code>crypto key generate rsa general-keys modulus 2048 label WLC_CA</code>	Configures a certificate for the controller.  When you generate RSA keys, you are prompted to enter a modulus length. A longer modulus length might be more secure, but it takes longer to generate and to use.  <b>Note</b> The recommended key-pair name is <code>WLC_CA</code> and key modulus is <code>2048</code> bits.
<b>Step 3</b>	<b>crypto pki server <i>certificate_server_name</i></b> <b>Example:</b>	Enables IOS certificate server.

	Command or Action	Purpose
	Device (config) # <code>crypto pki server WLC_CA</code>	<b>Note</b> The <i>certificate_server_name</i> must be the same name as the <i>keypair_name</i> .
<b>Step 4</b>	<b>issuer-name</b> <b>Example:</b> Device (config) # <code>issuer-name O=Cisco Virtual Wireless LAN Controller, CN=CA-vWLC</code>	Configures X.509 distinguished name for the issuer CA certificate.  <b>Note</b> You need to configure the same <b>issuer-name</b> as suggested for AP join.
<b>Step 5</b>	<b>grant auto</b> <b>Example:</b> Device (config) # <code>grant auto</code>	Grants certificate requests automatically.
<b>Step 6</b>	<b>hash sha256</b> <b>Example:</b> Device (config) # <code>hash sha256</code>	(Optional) Specifies the hash function for the signature used in the granted certificates.
<b>Step 7</b>	<b>lifetime ca-certificate <i>time-interval</i></b> <b>Example:</b> Device (config) # <code>lifetime ca-certificate 3650</code>	(Optional) Specifies the lifetime in days of a CA certificate.
<b>Step 8</b>	<b>lifetime certificate <i>time-interval</i></b> <b>Example:</b> Device (config) # <code>lifetime certificate 3650</code>	(Optional) Specifies the lifetime in days of a granted certificate.
<b>Step 9</b>	<b>database archive pkcs12 password <i>password</i></b> <b>Example:</b> Device (config) # <code>database archive pkcs12 password 0 cisco123</code>	Sets the CA key and CA certificate archive format and password to encrypt the file.
<b>Step 10</b>	<b>no shutdown</b> <b>Example:</b> Device (config) # <code>no shutdown</code>	Enables the certificate server.  <b>Note</b> Issue this command only after you have completely configured your certificate server.
<b>Step 11</b>	<b>end</b> <b>Example:</b> Device (config) # <code>end</code>	Returns to privileged EXEC mode. Alternatively, you can also press <b>Ctrl-Z</b> to exit global configuration mode.

# Configuring Trustpoint (CLI)

## Procedure

	Command or Action	Purpose
<b>Step 1</b>	<b>configure terminal</b>  <b>Example:</b> Device# <code>configure terminal</code>	Enters global configuration mode.
<b>Step 2</b>	<b>crypto key generate rsa exportable general-keys modulus size-of-the-key-modulus label label</b>  <b>Example:</b> Device(config)# <code>crypto key generate rsa exportable general-keys modulus 2048 label ewlc-tp1</code>	When you generate RSA keys, you are prompted to enter a modulus length. A longer modulus length might be more secure, but it takes longer to generate and to use.
<b>Step 3</b>	<b>crypto pki trustpoint trustpoint_name</b>  <b>Example:</b> Device(config)# <code>crypto pki trustpoint ewlc-tp1</code>	Creates a new trust point for an external CA server. Here, <i>trustpoint_name</i> refers to the trustpoint name.  <b>Note</b> Ensure that same names are used for key-pair ( <i>label</i> ) and <i>trustpoint_name</i> .
<b>Step 4</b>	<b>rsakeypair RSA_key key_size</b>  <b>Example:</b> Device(ca-trustpoint)# <code>rsakeypair ewlc-tp1</code>	Maps RSA key with that of the trustpoint.  <ul style="list-style-type: none"> <li>• <i>RSA_key</i>—Refers to the RSA key pair label.</li> <li>• <i>key_size</i>—Refers to the signature key length. The value ranges from 360 to 4096.</li> </ul>
<b>Step 5</b>	<b>subject-name subject_name</b>  <b>Example:</b> Device(ca-trustpoint)# <code>subject-name O=Cisco Virtual Wireless LAN Controller, CN=DEVICE-vWLC</code>	Creates subject name parameters for the trustpoint.
<b>Step 6</b>	<b>revocation-check none</b>  <b>Example:</b> Device(ca-trustpoint)# <code>revocation-check none</code>	Checks revocation.
<b>Step 7</b>	<b>hash sha256</b>  <b>Example:</b> Device(ca-trustpoint)# <code>hash sha256</code>	Specifies the hash algorithm.

	Command or Action	Purpose
<b>Step 8</b>	<b>serial-number</b> <b>Example:</b> Device(ca-trustpoint)# <b>serial-number</b>	Specifies the serial number.
<b>Step 9</b>	<b>eku request server-auth client-auth</b> <b>Example:</b> Device(ca-trustpoint)# <b>eku request server-auth client-auth</b>	(Optional) Sets certificate key-usage purpose.
<b>Step 10</b>	<b>password password</b> <b>Example:</b> Device(config)# <b>password 0 cisco123</b>	Enables password.
<b>Step 11</b>	<b>enrollment url url</b> <b>Example:</b> Device(config)# <b>enrollment url http://&lt;management-IPv4&gt;:80</b>	Enrolls the URL. <b>Note</b> Replace the dummy IP with management VLAN interface IP of the controller where CA server is configured.
<b>Step 12</b>	<b>exit</b> <b>Example:</b> Device(config)# <b>exit</b>	Exits the configuration.

## Authenticating and Enrolling the PKI TrustPoint with CA Server (CLI)

### Procedure

	Command or Action	Purpose
<b>Step 1</b>	<b>configure terminal</b> <b>Example:</b> Device# <b>configure terminal</b>	Enters global configuration mode.
<b>Step 2</b>	<b>crypto pki authenticate trustpoint_name</b> <b>Example:</b> Device(config)# <b>crypto pki authenticate ewlc-tp1</b> Certificate has the following attributes: Fingerprint MD5: 64C5FC9A C581D827 C25FC3CF 1A7F42AC Fingerprint SHA1: 6FAFF812 7C552783 6A8FB566 52D95849 CC2FC050 % Do you accept this certificate?	Fetches the CA certificate.

	Command or Action	Purpose
	<pre>[yes/no]: yes Trustpoint CA certificate accepted.</pre>	
<b>Step 3</b>	<b>crypto pki enroll</b> <i>trustpoint_name</i> <b>Example:</b> Device(config)# <b>crypto pki enroll ewlc-tp1</b> Enter following answers for UI interaction: % Include an IP address in the subject name? [no]: no Request certificate from CA? [yes/no]: yes	Enrolls for client certificate.
<b>Step 4</b>	<b>end</b> <b>Example:</b> Device(config)# <b>end</b>	Returns to privileged EXEC mode. Alternatively, you can also press <b>Ctrl-Z</b> to exit global configuration mode.

## Tagging Wireless Management TrustPoint Name (CLI)

### Procedure

	Command or Action	Purpose
<b>Step 1</b>	<b>configure terminal</b> <b>Example:</b> Device# <b>configure terminal</b>	Enters global configuration mode.
<b>Step 2</b>	<b>wireless management trustpoint</b> <i>trustpoint_name</i> <b>Example:</b> Device(config)# <b>wireless management trustpoint ewlc-tp1</b>	Tags the wireless management trustpoint name.
<b>Step 3</b>	<b>end</b> <b>Example:</b> Device(config)# <b>end</b>	Returns to privileged EXEC mode. Alternatively, you can also press <b>Ctrl-Z</b> to exit global configuration mode.

## Verifying Controller Certificates for Wireless AP Join

To view the CA server details, use the following command:

```
Device# show crypto pki server
Certificate Server WLC_CA:
Status: enabled
```

```
State: enabled
Server's configuration is locked (enter "shut" to unlock it)
Issuer name: O=Cisco Virtual Wireless LAN Controller, CN=CA-vWLC
CA cert fingerprint: 79A3DBD5 59A7E384 73ABD152 C133F4E2
Granting mode is: auto
Last certificate issued serial number (hex): 1
CA certificate expiration timer: 12:04:00 UTC Mar 8 2029
CRL NextUpdate timer: 18:04:00 UTC Mar 11 2019
Current primary storage dir: nvram:
Database Level: Minimum - no cert data written to storage
```

To view the trustpoint details, use the following command:

```
Device# show crypto pki trustpoint ewlc-tp1 status
Trustpoint ewlc-tp1:
...
State:
Keys generated ..... Yes (General Purpose, exportable)
Issuing CA authenticated ..... Yes
Certificate request(s) ..... Yes
```

To view the wireless management trustpoint details, use the following command:

```
Device# do show wireless management trustpoint
Trustpoint Name : ewlc-tp1
Certificate Info : Available
Certificate Type : SSC
Certificate Hash : 4a5d777c5b2071c17faef376feb08398702184e
Private key Info : Available
FIPS suitability : Not Applicable
```

To view the HTTP server status, use the following command:

```
Device# show ip http server status | include server status
HTTP server status: Enabled
HTTP secure server status: Enabled
```





## CHAPTER 123

# Managing Rogue Devices

- [Rogue Detection, on page 1111](#)
- [Rogue Detection Security Level, on page 1123](#)
- [Setting Rogue Detection Security-level , on page 1124](#)
- [Wireless Service Assurance Rogue Events, on page 1125](#)

## Rogue Detection

### Rogue Devices

Rogue access points can disrupt wireless LAN operations by hijacking legitimate clients and using plain-text or other denial-of-service or man-in-the-middle attacks. That is, a hacker can use a rogue access point to capture sensitive information, such as usernames and passwords. The hacker can then transmit a series of Clear to Send (CTS) frames. This action mimics an access point, informing a particular client to transmit, and instructing all the other clients to wait, which results in legitimate clients being unable to access network resources. Wireless LAN service providers have a strong interest in banning rogue access points from the air space.

Because rogue access points are inexpensive and readily available, employees sometimes plug unauthorized rogue access points into existing LANs and build ad hoc wireless networks without their IT department's knowledge or consent. These rogue access points can be a serious breach of network security because they can be plugged into a network port behind the corporate firewall. Because employees generally do not enable any security settings on the rogue access point, it is easy for unauthorized users to use the access point to intercept network traffic and hijack client sessions. There is an increased chance of enterprise security breach when wireless users connect to access points in the enterprise network.

The following are some guidelines to manage rogue devices:

- The access points are designed to serve associated clients. These access points spend relatively less time performing off-channel scanning: about 50 milliseconds on each channel. If you want to detect a large number of rogue APs and clients with high sensitivity, a monitor mode access point must be used. Alternatively, you can reduce the scan intervals from 180 seconds to a lesser value, for example, 120 or 60 seconds, ensuring that the radio goes off-channel more frequently, which improves the chances of rogue detection. However, the access point continues to spend about 50 milliseconds on each channel.
- Rogue detection is disabled by default for OfficeExtend access points because these access points, which are deployed in a home environment, are likely to detect many rogue devices.

- Client card implementation might mitigate the effectiveness of containment. This normally happens when a client might quickly reconnect to the network after receiving a "de-association/de-authentication" frame, so it might still be able to pass some traffic. However, the browsing experience of the rogue client would be badly affected when it is contained.
- It is possible to classify and report rogue access points by using rogue states and user-defined classification rules that enable rogues to automatically move between states.
- Each controller limits the number of rogue containments to three and six per radio for access points in the monitor mode.
- When manual containment is performed using configuration, the rogue entry is retained even after the rogue entry expires.
- When a rogue entry expires, the managed access points are instructed to stop any active containment on it.
- When Validate Rogue AP Against AAA is enabled, the controller requests the AAA server for rogue AP classification with the configured interval.
- To validate a Rogue AP against AAA, add the rogue AP MAC to the AAA user-database with relevant delimiter, username, and password being the MAC address with relevant delimiter. The Access-Accept contains the Cisco-AV-pair with one of the following keywords:

- **rogue-ap-state**=*state*



---

**Note** Here, **state** can be either of the types, namely: alert, contain, internal, external, or threat.

---

- **rogue-ap-class**=*class*



---

**Note** Here, **class** can be either of the types, namely: unclassified, malicious, or friendly.

---

The following are the allowed combinations of class or state:

- **unclassified**: alert, contain, or threat.
- **malicious**: alert, contain, or threat.
- **friendly**: alert, internal, or external.

The Radius Access-Reject for rogue AP AAA validation is ignored.

- When Validate Rogue Clients Against AAA is enabled, the controller requests the AAA server for rogue client validation only once. As a result, if rogue client validation fails on the first attempt then the rogue client will not be detected as a threat any more. To avoid this, add the valid client entries in the authentication server before enabling Validate Rogue Clients Against AAA.

### Restrictions on Rogue Detection

- Rogue containment is not supported on DFS channels.

A rogue access point is moved to a contained state either automatically or manually. The controller selects the best available access point for containment and pushes the information to the access point. The access point stores the list of containments per radio. For auto containment, you can configure the controller to use only the monitor mode access point. The containment operation occurs in the following two ways:

- The container access point goes through the list of containments periodically and sends unicast containment frames. For rogue access point containment, the frames are sent only if a rogue client is associated.
- Whenever a contained rogue activity is detected, containment frames are transmitted.

Individual rogue containment involves sending a sequence of unicast disassociation and deauthentication frames.

### Cisco Prime Infrastructure Interaction and Rogue Detection

Cisco Prime Infrastructure supports rule-based classification and uses the classification rules configured on the controller. The controller sends traps to Cisco Prime Infrastructure after the following events:

- If an unknown access point moves to the Friendly state for the first time, the controller sends a trap to Cisco Prime Infrastructure only if the rogue state is Alert. It does not send a trap if the rogue state is Internal or External.
- If a rogue entry is removed after the timeout expires, the controller sends a trap to Cisco Prime Infrastructure for rogue access points that are categorized as Malicious (Alert, Threat) or Unclassified (Alert). The controller does not remove rogue entries with the following rogue states: Contained, Contained Pending, Internal, and External.

## Information About Rogue Containment (Protected Management Frames (PMF) Enabled)

From Cisco IOS XE Amsterdam, 17.3.1 onwards, rogue devices that are enabled with 802.11w Protected Management Frames (PMF) are not contained. Instead, the rogue device is marked as *Contained Pending*, and a WSA alarm is raised to inform about the Contained Pending event. Because the device containment is not performed, access point (AP) resources are not consumed unnecessarily.



---

**Note** This feature is supported only on the Wave 2 APs.

---

Run the **show wireless wps rogue ap detailed** command to verify the device containment, when PMF is enabled on a rogue device.

## AP Impersonation Detection

The various methods to detect AP impersonation are:

- AP impersonation can be detected if a managed AP reports itself as Rogue. This method is always enabled and no configuration is required.
- AP impersonation detection is based on MFP.
- AP impersonation detection based on AP authentication.

Infrastructure MFP protects 802.11 session management functions by adding message integrity check (MIC) information elements, to the management frames sent by APs (and not those sent by clients), which are then validated by other APs in the network. If infrastructure MFP is enabled, the managed APs check if the MIC

information elements are present and if MIC information elements are as expected. If either of these conditions is not fulfilled, the managed AP sends rogue AP reports with updated AP authentication failure counter.

The AP Authentication functionality allows you to detect AP impersonation. When you enable this functionality, the controller creates an AP domain secret and shares it with other APs in the same network. This allows the APs to authenticate each other.

An AP Authentication information element is attached to beacon and probe response frames. If the AP Authentication information element has an incorrect Signature field, or the timestamp is off, or if the AP Authentication information element is missing, then the AP that has detected such a condition increments the **AP authentication failure count** field. An impersonation alarm is raised after the **AP authentication failure count** field breaches its threshold. The rogue AP is classified as **Malicious** with state **Threat**.

Run the **show wireless wps rogue ap detail** command to see when the impersonation is detected due to authentication errors.



---

**Note** Ensure that the **ccx aironet-iesupport** command is run in all the WLAN procedures, else the BSSID will be detected as a rogue.

For AP impersonation detection, Network Time Protocol (NTP) must be enabled instead of CAPWAP based time, under the AP profile.

---

## Configuring Rogue Detection (GUI)

### Procedure

---

- Step 1** Choose **Configuration > Tags & Profiles > AP Join**.
  - Step 2** Click the **AP Join Profile Name** to edit the AP join profile properties.
  - Step 3** In the **Edit AP Join Profile** window, click the **Rogue AP** tab.
  - Step 4** Check the **Rogue Detection** check box to enable rogue detection.
  - Step 5** In the **Rogue Detection Minimum RSSI** field, enter the RSSI value.
  - Step 6** In the **Rogue Detection Transient Interval** field, enter the interval in seconds.
  - Step 7** In the **Rogue Detection Report Interval** field, enter the report interval value in seconds.
  - Step 8** In the **Rogue Detection Client Number Threshold** field, enter the threshold for rogue client detection.
  - Step 9** Check the **Auto Containment on FlexConnect Standalone** check box to enable auto containment.
  - Step 10** Click **Update & Apply to Device**.
-

## Configuring Rogue Detection (CLI)

### Procedure

	Command or Action	Purpose
<b>Step 1</b>	<b>configure terminal</b> <b>Example:</b> Device# <b>configure terminal</b>	Enters global configuration mode.
<b>Step 2</b>	<b>ap profile <i>profile-name</i> rogue detection min-rssi <i>rsssi in dBm</i></b> <b>Example:</b> Device(config)# <b>ap profile profile1</b> Device(config)# <b>rogue detection min-rssi -100</b>	Specify the minimum RSSI value that rogues should have for APs to detect and for rogue entry to be created in the device.  Valid range for the rssi in dBm parameter is -128 dBm to -70 dBm, and the default value is -128 dBm.  <b>Note</b> This feature is applicable to all the AP modes. There can be many rogues with very weak RSSI values that do not provide any valuable information in rogue analysis. Therefore, you can use this option to filter rogues by specifying the minimum RSSI value at which APs should detect rogues.
<b>Step 3</b>	<b>ap profile <i>profile-name</i> rogue detection containment {<i>auto-rate</i>   <i>flex-rate</i>}</b> <b>Example:</b> Device(config)# <b>ap profile profile1</b> Device(config)# <b>rogue detection containment flex-rate</b>	Specifies the rogue containment options. The <b>auto-rate</b> option enables auto-rate for containment of rogues. The <b>flex-rate</b> option enables rogue containment of standalone FlexConnect APs.
<b>Step 4</b>	<b>ap profile <i>profile-name</i> rogue detection enable</b> <b>Example:</b> Device(config)# <b>ap profile profile1</b> Device(config)# <b>rogue detection enable</b>	Enables rogue detection on all APs.
<b>Step 5</b>	<b>ap profile <i>profile-name</i> rogue detection report-interval <i>time in seconds</i></b> <b>Example:</b> Device(config)# <b>ap profile profile1</b> Device(config)# <b>rogue detection report-interval 120</b>	Configures rogue report interval for monitor mode Cisco APs.  The valid range for reporting the interval in seconds is 10 seconds to 300 seconds.

## Configuring RSSI Deviation Notification Threshold for Rogue APs (CLI)

### Procedure

	Command or Action	Purpose
<b>Step 1</b>	<b>configure terminal</b>  <b>Example:</b> Device# <code>configure terminal</code>	Enters global configuration mode.
<b>Step 2</b>	<b>wireless wps rogue ap notify-rssi-deviation</b>  <b>Example:</b> Device(config)# <code>wireless wps rogue ap notify-rssi-deviation</code>	Configures RSSI deviation notification threshold for Rogue APs.
<b>Step 3</b>	<b>end</b>  <b>Example:</b> Device(config)# <code>end</code>	Returns to privileged EXEC mode. Alternatively, you can also press <b>Ctrl-Z</b> to exit global configuration mode.

## Configuring Management Frame Protection (GUI)

### Procedure

- 
- Step 1** Choose **Configuration > Security > Wireless Protection Policies**.
- Step 2** In the **Rogue Policy** tab, under the **MFP Configuration** section, check the **Global MFP State** check box and the **AP Impersonation Detection** check box to enable the global MFP state and the AP impersonation detection, respectively.
- Step 3** In the **MFP Key Refresh Interval** field, specify the refresh interval in hours.
- Step 4** Click **Apply**.
- 

## Configuring Management Frame Protection (CLI)

### Procedure

	Command or Action	Purpose
<b>Step 1</b>	<b>configure terminal</b>  <b>Example:</b> Device# <code>configure terminal</code>	Enters global configuration mode.
<b>Step 2</b>	<b>wireless wps mfp</b>  <b>Example:</b> Device(config)# <code>wireless wps mfp</code>	Configures a management frame protection.

	Command or Action	Purpose
<b>Step 3</b>	<b>wireless wps mfp {ap-impersonation   key-refresh-interval}</b>  <b>Example:</b> Device(config)# wireless wps mfp ap-impersonation  Device(config)# wireless wps mfp key-refresh-interval	Configures ap impersonation detection (or) MFP key refresh interval in hours.  key-refresh-interval—Refers to the MFP key refresh interval in hours. The valid range is from 1 to 24. Default value is 24.
<b>Step 4</b>	<b>end</b>  <b>Example:</b> Device(config)# end	Saves the configuration and exits configuration mode and returns to privileged EXEC mode.

## Enabling Access Point Authentication

### Procedure

	Command or Action	Purpose
<b>Step 1</b>	<b>configure terminal</b>  <b>Example:</b> Device# configure terminal	Enters global configuration mode.
<b>Step 2</b>	<b>wireless wps ap-authentication</b>  <b>Example:</b> Device(config)# wireless wps ap-authentication	Configures the wireless WPS AP authentication.
<b>Step 3</b>	<b>wireless wps ap-authentication threshold threshold</b>  <b>Example:</b> Device(config)# wireless wps ap-authentication threshold 100	Configures AP neighbor authentication and sets the threshold for AP authentication failures.
<b>Step 4</b>	<b>wlan wlan-name wlan-id SSID-name</b>  <b>Example:</b> Device(config)# wlan wlan-demo 1 ssid-demo	Configures a WLAN.
<b>Step 5</b>	<b>ccx aironet-iesupport</b>  <b>Example:</b> Device(config-wlan)# ccx aironet-iesupport	Enables support for Aironet Information Elements on this WLAN.
<b>Step 6</b>	<b>end</b>  <b>Example:</b>	Returns to privileged EXEC mode.

	Command or Action	Purpose
	Device# end	

## Verifying Management Frame Protection

To verify if the Management Frame Protection (MFP) feature is enabled or not, use the following command:

```
Device# show wireless wps summary
Client Exclusion Policy
  Excessive 802.11-association failures : unknown
  Excessive 802.11-authentication failures: unknown
  Excessive 802.1x-authentication      : unknown
  IP-theft                             : unknown
  Excessive Web authentication failure  : unknown
  Failed Qos Policy                    : unknown

Management Frame Protection
  Global Infrastructure MFP state : Enabled
  AP Impersonation detection     : Disabled
  Key refresh interval          : 15
```

To view the MFP details, use the following command:

```
Device# show wireless wps mfp summary
Management Frame Protection
  Global Infrastructure MFP state : Enabled
  AP Impersonation detection     : Disabled
  Key refresh interval          : 15
```

## Verifying Rogue Events

To verify the rogue event history, run the **show wireless wps rogue ap detailed** command:

```
Device# show wireless wps rogue ap detailed d8b1.901c.3cfd

Rogue Event history

Timestamp          #Times Class/State Event                               Ctx
RC
-----
---
05/01/2020 08:37:03.55645 41616 Mal/CPend FSM_GOTO                               ContPending (NotContYet)
0x0
05/01/2020 08:37:03.55427 28163 Mal/CPend EXPIRE_TIMER_START                    1200s
0x0
05/01/2020 08:37:03.55380 28163 Mal/CPend RECV_REPORT                          38ed.18cf.83e0/1
0x0
05/01/2020 08:36:54.659136 7356 Mal/CPend NO_OP_UPDATE                          0x0
05/01/2020 08:36:33.347132 3185 Mal/CPend CHANNEL_CHANGE                      e4aa.5d44.fec0/2,36->40
0x0
05/01/2020 08:25:19.573720 247 Mal/CPend LRAD_EXPIRE                           7c21.0e41.0700/0
0x0
04/30/2020 07:55:37.977450 2 Mal/CPend PMF_CONTAINMENT ContPending (PMFDetected) 0x0
04/30/2020 07:55:37.977242 1 Unc/Alert INIT_TIMER_DONE                       0xab9800439e00024f
0x0
04/30/2020 07:52:33.600332 1 Unk/Init INIT_TIMER_START                       180s
0x0
04/30/2020 07:52:33.600326 1 Unk/Init CREATE
```



0x0

To verify the impersonations detected due to authentication errors, use the following command:

```
Device# show wireless wps rogue ap detailed

Rogue BSSID                               : 0062.ecf3.8d30
Last heard Rogue SSID                     : rogueA
802.11w PMF required                       : No
Is Rogue an impersonator                   : Yes
Is Rogue on Wired Network                  : No
Classification                           : Malicious
Manually Contained                         : No
State                                     : Threat
First Time Rogue was Reported              : 01/07/2020 15:51:01
Last Time Rogue was Reported               : 01/08/2020 08:08:35

Number of clients                          : 0

Reported By
  AP Name : AP38ED.18CE.45E0
  MAC Address           : 38ed.18cf.83e0
  Detecting slot ID     : 0
  Radio Type            : dot11g, dot11n - 2.4 GHz
  SSID                  : rogueA
  Channel               : 6 (From DS)
  Channel Width         : 20 MHz
  RSSI                  : -33 dBm
  SNR                   : 52 dB
  ShortPreamble         : Disabled
  Security Policy       : WPA2/WPA/FT
  Last reported by this AP : 01/08/2020 08:02:53
  Authentication Failure Count           : 237
```

## Verifying Rogue Detection

This section describes the new command for rogue detection.

The following command can be used to verify rogue detection on the device.

**Table 45: Verifying Adhoc Rogues Information**

Command	Purpose
<code>show wireless wps rogue adhoc detailed mac_address</code>	Displays the detailed information for an Adhoc rogue.
<code>show wireless wps rogue adhoc summary</code>	Displays a list of all Adhoc rogues.

**Table 46: Verifying Rogue AP Information**

Command	Purpose
<code>show wireless wps rogue ap clients mac_address</code>	Displays the list of all rogue clients associated with a rogue.

<b>show wireless wps rogue ap custom summary</b>	Displays the custom rogue AP information.
<b>show wireless wps rogue ap detailed <i>mac_address</i></b>	Displays the detailed information for a rogue AP.
<b>show wireless wps rogue ap friendly summary</b>	Displays the friendly rogue AP information.
<b>show wireless wps rogue ap list <i>mac_address</i></b>	Displays the list of rogue APs detected by a given AP.
<b>show wireless wps rogue ap malicious summary</b>	Displays the malicious rogue AP information.
<b>show wireless wps rogue ap summary</b>	Displays a list of all Rogue APs.
<b>show wireless wps rogue ap unclassified summary</b>	Displays the unclassified rogue AP information.

Table 47: Verifying Rogue Auto-Containment Information

Command	Purpose
<b>show wireless wps rogue auto-contain</b>	Displays the rogue auto-containment information.

Table 48: Verifying Classification Rule Information

Command	Purpose
<b>show wireless wps rogue rule detailed <i>rule_name</i></b>	Displays the detailed information for a classification rule.
<b>show wireless wps rogue rule summary</b>	Displays the list of all rogue rules.

Table 49: Verifying Rogue Statistics

Command	Purpose
<b>show wireless wps rogue stats</b>	Displays the rogue statistics.

Table 50: Verifying Rogue Client Information

Command	Purpose
<b>show wireless wps rogue client detailed <i>mac_address</i></b>	Displays detailed information for a Rogue client.
<b>show wireless wps rogue client summary</b>	Displays a list of all the Rogue clients.

Table 51: Verifying Rogue Ignore List

Command	Purpose
<b>show wireless wps rogue ignore-list</b>	Displays the rogue ignore list.

## Examples: Rogue Detection Configuration

This example shows how to configure the minimum RSSI that a detected rogue AP needs to be at, to have an entry created in the device:

```
Device# configure terminal
Device(config)# ap profile profile1
Device(config)# rogue detection min-rssi -100
Device(config)# end
Device# show wireless wps rogue client summary/show wireless wps rogue ap summary
```

This example shows how to configure the classification interval:

```
Device# configure terminal
Device(config)# ap profile profile1
Device(config)# rogue detection min-transient-time 500
Device(config)# end
Device# show wireless wps rogue client summary/show wireless wps rogue ap summary
```

## Configuring Rogue Policies (GUI)

### Procedure

---

- Step 1** Choose **Configuration > Security > Wireless Protection Policies**.
  - Step 2** In the **Rogue Policies** tab, use the **Rogue Detection Security Level** drop-down to select the security level.
  - Step 3** In the **Expiration timeout for Rogue APs (seconds)** field, enter the timeout value.
  - Step 4** Select the **Validate Rogue Clients against AAA** check box to validate rogue clients against AAA server.
  - Step 5** Select the **Validate Rogue APs against AAA** check box to validate rogue access points against AAA server.
  - Step 6** In the **Rogue Polling Interval (seconds)** field, enter the interval to poll the AAA server for rogue information.
  - Step 7** Select the **Detect and Report Adhoc Networks** check box to enable detection of rogue adhoc networks.
  - Step 8** In the **Rogue Detection Client Number Threshold** field, enter the threshold to generate SNMP trap.
  - Step 9** In the **Auto Contain** section, enter the following details.
  - Step 10** Use the **Auto Containment Level** drop-down to select the level.
  - Step 11** Select the **Auto Containment only for Monitor Mode APs** check box to limit the auto-containment only to monitor mode APs.
  - Step 12** Select the **Rogue on Wire** check box to limit the auto-containment only to rogue APs on wire.
  - Step 13** Select the **Using our SSID** check box to limit the auto-containment only to rogue APs using one of the SSID configured on the controller.
  - Step 14** Select the **Adhoc Rogue AP** check box to limit the auto-containment only to adhoc rogue APs.
  - Step 15** Click **Apply**.
-

## Configuring Rogue Policies (CLI)

### Procedure

	Command or Action	Purpose
<b>Step 1</b>	<b>configure terminal</b>  <b>Example:</b> Device# <code>configure terminal</code>	Enters global configuration mode.
<b>Step 2</b>	<b>Example:</b> Device (config)# <code>wireless wps rogue security-level custom</code>	Configures the rogue detection security level. You can select <b>critical</b> for highly sensitive deployments, <b>custom</b> for customizable security level, <b>high</b> for medium-scale deployments, and <b>low</b> for small-scale deployments.
<b>Step 3</b>	<b>wireless wps rogue ap timeout</b> <i>number of seconds</i>  <b>Example:</b> Device (config)# <code>wireless wps rogue ap timeout 250</code>	Configures the expiration time for rogue entries, in seconds. Valid range for the time in seconds 240 seconds to 3600 seconds.
<b>Step 4</b>	<b>Example:</b> Device (config)# <code>wireless wps rogue client aaa</code>	Configures the use of AAA or local database to detect valid MAC addresses.
<b>Step 5</b>	<b>Example:</b> Device (config)# <code>wireless wps rogue client mse</code>	Configures the use of MSE to detect valid MAC addresses.
<b>Step 6</b>	<b>wireless wps rogue client notify-min-rssi</b> <i>RSSI threshold</i>  <b>Example:</b> Device (config)# <code>wireless wps rogue client notify-min-rssi -128</code>	Configures the minimum RSSI notification threshold for rogue clients. Valid range for the RSSI threshold in dB is -128 - dB to -70 dB.
<b>Step 7</b>	<b>wireless wps rogue client notify-min-deviation</b> <i>RSSI threshold</i>  <b>Example:</b> Device (config)# <code>wireless wps rogue client notify-min-deviation 4</code>	Configures the RSSI deviation notification threshold for rogue clients. Valid range for the RSSI threshold in dB is 0 dB to 10 dB.
<b>Step 8</b>	<b>wireless wps rogue ap aaa</b>  <b>Example:</b> Device (config)# <code>wireless wps rogue ap aaa</code>	Configures the use of AAA or local database to classify rogue AP based on rogue AP MAC addresses.

	Command or Action	Purpose
Step 9	<b>wireless wps rogue ap aaa polling-interval</b> <i>AP AAA Interval</i> <b>Example:</b> Device (config) # <b>wireless wps rogue ap</b> <b>aaa polling-interval 120</b>	Configures rogue AP AAA validation interval. The valid range for the AP AAA interval in seconds is 60 seconds to 86400 seconds.
Step 10	<b>wireless wps rogue adhoc</b> <b>Example:</b> Device (config) # <b>wireless wps rogue adhoc</b>	Enables detecting and reporting adhoc rogue (IBSS).
Step 11	<b>wireless wps rogue client client-threshold</b> <i>threshold</i> <b>Example:</b> Device (config) # <b>wireless wps rogue</b> <b>client client-threshold 100</b>	Configures the rogue client per a rogue AP SNMP trap threshold. The valid range for the threshold is 0 to 256.
Step 12	<b>wireless wps rogue ap init-timer</b> <b>Example:</b> Device (config) # <b>wireless wps rogue ap</b> <b>init-timer 180</b>	Configures the init timer for rogue APs. The default timer value is set to 180 seconds. <b>Note</b> When a rogue AP is detected, an init timer is started and the rules are applied when this timer expires. This allows for rogue AP information to stabilize before applying any rules. However, you can change the value of this timer using this command. For instance, the init timer can be set to 0, if the rules need to be applied as soon as a new rogue AP is detected.

## Rogue Detection Security Level

The rogue detection security level configuration allows you to set rogue detection parameters.

The available security levels are:

- Critical: Basic rogue detection for highly sensitive deployments.
- High: Basic rogue detection for medium-scale deployments.
- Low: Basic rogue detection for small-scale deployments.
- Custom: Default security-level, where all detection parameters are configurable.



**Note** When in Critical, High or Low, some rogue parameters are fixed and cannot be configured.

The following table shows parameter details for the three predefined levels:

**Table 52: Rogue Detection: Predefined Levels**

Parameter	Critical	High	Low
Cleanup Timer	3600	1200	240
AAA Validate Clients	Disabled	Disabled	Disabled
AAA Validate AP	Disabled	Disabled	Disabled
Adhoc Reporting	Enabled	Enabled	Enabled
Monitor-Mode Report Interval	10 seconds	30 seconds	60 seconds
Minimum RSSI	-128 dBm	-80 dBm	-80 dBm
Transient Interval	600 seconds	300 seconds	120 seconds
Auto Contain Works only on Monitor Mode APs.	Disabled	Disabled	Disabled
Auto Contain Level	1	1	1
Auto Contain Same-SSID	Disabled	Disabled	Disabled
Auto Contain Valid Clients on Rogue AP	Disabled	Disabled	Disabled
Auto Contain Adhoc	Disabled	Disabled	Disabled
Containment Auto-Rate	Enabled	Enabled	Enabled
Validate Clients with CMX	Enabled	Enabled	Enabled
Containment FlexConnect	Enabled	Enabled	Enabled

## Setting Rogue Detection Security-level

Follow the procedure given below to set the rogue detection security-level:

### Procedure

	Command or Action	Purpose
<b>Step 1</b>	<b>configure terminal</b>  <b>Example:</b> Device# configure terminal	Enters the global configuration mode.

	Command or Action	Purpose
<b>Step 2</b>	<b>wireless wps rogue security-level custom</b> <b>Example:</b> Device(config)# wireless wps rogue security-level custom	Configures rogue detection security level as custom.
<b>Step 3</b>	<b>wireless wps rogue security-level low</b> <b>Example:</b> Device(config)# wireless wps rogue security-level low	Configures rogue detection security level for basic rogue detection setup for small-scale deployments.
<b>Step 4</b>	<b>wireless wps rogue security-level high</b> <b>Example:</b> Device(config)# wireless wps rogue security-level high	Configures rogue detection security level for rogue detection setup for medium-scale deployments.
<b>Step 5</b>	<b>wireless wps rogue security-level critical</b> <b>Example:</b> Device(config)# wireless wps rogue security-level critical	Configures rogue detection security level for rogue detection setup for highly sensitive deployments.

## Wireless Service Assurance Rogue Events

Wireless Service Assurance (WSA) rogue events, supported in Release 16.12.x and later releases, consist of telemetry notifications for a subset of SNMP traps. WSA rogue events replicate the same information that is part of the corresponding SNMP trap.

For all the exported events, the following details are provided to the wireless service assurance (WSA) infrastructure:

- MAC address of the rogue AP
- Details of the managed AP and the radio that detected the rogue AP with strongest RSSI
- Event-specific data such as SSID, channel for potential honeypot event, and MAC address of the impersonating AP for impersonation event

The WSA rogue events feature can scale up to four times the maximum number of supported APs and half of the maximum number of supported clients.

The WSA rogue events feature is supported on Cisco Catalyst Center and other third-party infrastructure.

### Procedure

	Command or Action	Purpose
<b>Step 1</b>	<b>configure terminal</b> <b>Example:</b> Device# configure terminal	Enters global configuration mode.

	Command or Action	Purpose
<b>Step 2</b>	<b>network-assurance enable</b>  <b>Example:</b> Device# network-assurance enable	Enables wireless service assurance.
<b>Step 3</b>	<b>wireless wps rogue network-assurance enable</b>  <b>Example:</b> Device# wireless wps rogue network-assurance enable	Enables wireless service assurance for rogue devices. This ensures that the WSA rogue events are sent to the event queue.

## Monitoring Wireless Service Assurance Rogue Events

### Procedure

- **show wireless wps rogue stats**

#### Example:

```
Device# show wireless wps rogue stats
```

```
WSA Events
  Total WSA Events Triggered           : 9
    ROGUE_POTENTIAL_HONEYPOT_DETECTED : 2
    ROGUE_POTENTIAL_HONEYPOT_CLEARED  : 3
    ROGUE_AP_IMPERSONATION_DETECTED   : 4
  Total WSA Events Enqueued           : 6
    ROGUE_POTENTIAL_HONEYPOT_DETECTED : 1
    ROGUE_POTENTIAL_HONEYPOT_CLEARED  : 2
    ROGUE_AP_IMPERSONATION_DETECTED   : 3
```

In this example, nine events have been triggered, but only six of them have been enqueued. This is because three events were triggered before the WSA rogue feature was enabled.

- **show wireless wps rogue stats internal**

**show wireless wps rogue ap detailed** *rogue-ap-mac-addr*

These commands show information related to WSA events into the event history.





## CHAPTER 124

# Classifying Rogue Access Points

- [Information About Classifying Rogue Access Points, on page 1127](#)
- [Guidelines and Restrictions for Classifying Rogue Access Points, on page 1129](#)
- [How to Classify Rogue Access Points, on page 1129](#)
- [Monitoring Rogue Classification Rules, on page 1135](#)
- [Examples: Classifying Rogue Access Points, on page 1135](#)

## Information About Classifying Rogue Access Points

The controller software enables you to create rules that can organize and display rogue access points as Friendly, Malicious, Custom, or Unclassified.

By default, none of the classification rules are used. You need to enable them. Therefore, all unknown access points are categorized as Unclassified. When you create or change a rule, configure conditions, and enable it, all rogue access points are then reclassified. Whenever you change a rule, it is applied to all the access points (friendly, malicious, and unclassified).



### Note

- Rule-based rogue classification does not apply to ad hoc rogues and rogue clients.
- You can configure up to 64 rogue classification rules per controller .

When the controller receives a rogue report from one of its managed access points, it responds as follows:

- If the unknown access point is in the friendly MAC address list, the controller classifies the access point as Friendly.
- If the unknown access point is not in the friendly MAC address list, the controller starts applying the rogue classification rules to the access point.
- If the rogue access point is manually classified, rogue rules are not applied to it.
- If the rogue access point matches the configured rules criteria, the controller classifies the rogue based on the classification type configured for that rule.
- If the rogue access point does not match any of the configured rules, the rogue remains unclassified.

The controller repeats the previous steps for all the rogue access points.

- If the rogue access point is detected on the same wired network, the controller marks the rogue state as Threat and classifies it as Malicious automatically, even if there are no configured rules. You can then manually contain the rogue to change the rogue state to Contained. If the rogue access point is not available on the network, the controller marks the rogue state as Alert. You can then manually contain the rogue.
- If desired, you can manually move the access point to a different classification type and rogue state.
- Before performing any classification, the rogue access points are temporarily marked as Pending.

Table 53: Classification Mapping

Rule-Based Classification Type	Rogue State
Custom	<ul style="list-style-type: none"> <li>• Alert—No action is taken other than notifying the management station. The management station in the controller manages the controller and wired networks.</li> <li>• Contained—The unknown access point is contained. If none of the managed access points are available for containment, the rogue is in Contained Pending state.</li> </ul>
Delete	Deletes the rogue access point.
Friendly	<ul style="list-style-type: none"> <li>• Internal—If the unknown access point poses no threat to WLAN security, you can manually configure it as Friendly, Internal. An example of this would be the access points in your lab network.</li> <li>• External—If the unknown access point is outside the network and poses no threat to WLAN security, you can manually configure it as Friendly, External. An example of this would be the access point in your neighboring coffee shop.</li> <li>• Alert—No action is taken other than notifying the management station. The management station manages the controller and wired networks.</li> </ul>
Malicious	<ul style="list-style-type: none"> <li>• Alert—No action is taken other than notifying the management station. The management station manages the controller and wired networks.</li> <li>• Threat—The unknown access point is found to be on the network and poses a threat to WLAN security.</li> <li>• Contained—The unknown access point is contained. If none of the managed access points are available for containment, the rogue is in Contained Pending state.</li> </ul>
Unclassified	<ul style="list-style-type: none"> <li>• Alert— No action is taken other than notifying the management station. The management station manages the controller and wired networks.</li> <li>• Contained—The unknown access point is contained. If none of the managed access points are available for containment, the rogue is in contained pending state.</li> </ul>

As mentioned earlier, the controller can automatically change the classification type and rogue state of an unknown access point based on user-defined rules. Alternatively, you can manually move the unknown access point to a different classification type and rogue state.

## Guidelines and Restrictions for Classifying Rogue Access Points

- Classifying Custom type rogues is tied to rogue rules. Therefore, it is not possible to manually classify a rogue as Custom. Custom class change can occur only when rogue rules are used.
- Some SNMP traps are sent for containment by rule and every 30 minutes for rogue classification change.
- Rogue rules are applied on every incoming new rogue report in the controller in the order of their priority.
- After a rogue satisfies a rule and is classified, it does not move down the priority list for the same report.
- The rogue classification rules are re-evaluated at every report received by the managed access points. Hence, a rogue access point can move from one state to another, if a different rule matches the last report.
- If a rogue AP is classified as friendly or ignored, all rogue clients associated with it are not tracked.
- Until the controller discovers all the APs through neighbor reports from APs, the rogue APs are kept in unconfigured state for three minutes after they are detected. After 3 minutes, the rogue policy is applied on the rogue APs and the APs are moved to unclassified, friendly, malicious, or custom class. Rogue APs kept in unconfigured state means that no rogue policy has yet been applied on them.
- When a rogue BSSID is submitted for a containment on Cisco Catalyst 9800 Series Wireless Controller, if the controller has enough resources, it will contain. The APs that detect the particular contained rogue AP starts broadcasting the DEAUTH packets.

Wireless client connected to the contained rogue BSSID will disconnect once DEAUTH packets are received. However, when the client assumes being in a connected state, repeatedly tries to reconnect and the wireless client's user browsing experience would be badly affected.

Also, in a high RF environment like that of a stadium, though DEAUTH packets are broadcasted, client does not receive all of them because of RF disturbance. In this scenario, the client may not be fully disconnected but will be affected badly.

- The rogue AP manual classification limit has been enhanced from 625 to 10,000 configurations at a time. The rogue client manual classification limit has been enhanced from 625 to 10,000 configurations at a time.

## How to Classify Rogue Access Points

### Classifying Rogue Access Points and Clients Manually (GUI)

#### Procedure

- Step 1** Choose **Monitoring > Wireless > Rogues**.
- Step 2** In the **Unclassified** tab, select an AP to view the detail in the lower pane.

**Step 3** Use the **Class Type** drop-down to set the status.

**Step 4** Click **Apply**.

## Classifying Rogue Access Points and Clients Manually (CLI)

### Procedure

	Command or Action	Purpose
<b>Step 1</b>	<b>configure terminal</b> <b>Example:</b> Device# <code>configure terminal</code>	Enters global configuration mode.
<b>Step 2</b>	<b>wireless wps rogue adhoc {alert mac-addr   auto-contain   contain mac-addr containment-level   internal mac-addr   external mac-addr}</b> <b>Example:</b> Device(config)# <code>wireless wps rogue adhoc alert 74a0.2f45.c520</code>	Detects and reports the ad hoc rogue. Enter one of these options after you enter the <b>adhoc</b> keyword: <ul style="list-style-type: none"> <li>• <b>alert</b>—Sets the ad hoc rogue access point to alert mode. If you choose this option, enter the MAC address for the <i>mac-addr</i> parameter.</li> <li>• <b>auto-contain</b>—Sets the automatically containing ad hoc rogue to auto-contain mode.</li> <li>• <b>contain</b>—Sets the containing ad hoc rogue access point to contain mode. If you choose this option, enter the MAC address for the <i>mac-addr</i> parameter and containment level for the <i>containment-level</i> parameter. The valid range for <i>containment-level</i> is from 1 to 4.</li> <li>• <b>external</b>—Sets the ad hoc rogue access point as <b>external</b>. If you choose this option, enter the MAC address for the <i>mac-addr</i> parameter.</li> <li>• <b>internal</b>—Sets the ad hoc rogue access point as <b>internal</b>. If you choose this option, enter the MAC address for the <i>mac-addr</i> parameter.</li> </ul>
<b>Step 3</b>	<b>wireless wps rogue ap {friendly mac-addr state [external   internal]   malicious mac-addr state [alert   contain containment-level]}</b> <b>Example:</b>	Configures the rogue access points. Enter one of the following options after the <b>ap</b> keyword:

	Command or Action	Purpose
	<pre>Device(config)# wireless wps rogue ap malicious 74a0.2f45.c520 state contain 3</pre>	<ul style="list-style-type: none"> <li>• <b>friendly</b>—Configures the friendly rogue access points. If you choose this option, enter the MAC address for the <i>mac-addr</i> parameter. After that enter the <b>state</b> keyword followed by either of these options: <b>internal</b> or <b>external</b>. If you select an <b>internal</b> option, it indicates that you trust a foreign access point. If you select an <b>external</b> option, it indicates that you acknowledge the presence of a rogue access point.</li> <li>• <b>malicious</b>—Configures the malicious rogue access points. If you choose this option, enter the MAC address for the <i>mac-addr</i> parameter. After that enter the <b>state</b> keyword followed by either of these options: <b>alert</b> or <b>contain</b>.</li> <li>• <b>alert</b>—Sets the malicious rogue access point to <b>alert</b> mode.</li> <li>• <b>contain</b>—Sets the malicious rogue access point to <b>contain</b> mode. If you choose this option, enter the containment level for the <i>containment-level</i> parameter. The valid range is from 1 to 4.</li> </ul>
<b>Step 4</b>	<pre>wireless wps rogue client {contain mac-addr containment-level}  <b>Example:</b>  Device(config)# wireless wps rogue client contain 74a0.2f45.c520 2</pre>	<p>Configures the rogue clients.</p> <p>Enter the following option after you enter the <b>client</b> keyword:</p> <ul style="list-style-type: none"> <li>• <b>contain</b>—Contains the rogue client. After you choose this option, enter the MAC address for the <i>mac-addr</i> parameter and the containment level for <i>containment-level</i> parameter. The valid range for <i>containment-level</i> is from 1 to 4.</li> </ul>
<b>Step 5</b>	<pre><b>end</b>  <b>Example:</b>  Device(config)# <b>end</b></pre>	<p>Returns to privileged EXEC mode.</p> <p>Alternatively, you can also press <b>Ctrl-Z</b> to exit global configuration mode.</p>

## Configuring Rogue Classification Rules (GUI)

### Procedure

- Step 1** Choose **Configuration > Security > Wireless Protection Policies**.

- Step 2** In the **Wireless Protection Policies** page, choose **Rogue AP Rules** tab.
- Step 3** On the **Rogue AP Rules** page, click the name of the **Rule** or click **Add** to create a new one.
- Step 4** In the **Add/Edit Rogue AP Rule** window that is displayed, enter the name of the rule in the **Rule Name** field.
- Step 5** Choose the rule type from the following **Rule Type** drop-down list options:
- Friendly
  - Malicious
  - Unclassified
  - Custom

## Configuring Rogue Classification Rules (CLI)

### Procedure

	Command or Action	Purpose
<b>Step 1</b>	<b>configure terminal</b> <b>Example:</b> Device# <b>configure terminal</b>	Enters global configuration mode.
<b>Step 2</b>	<b>wireless wps rogue rule rule-name priority priority</b> <b>Example:</b> Device(config)# <b>wireless wps rogue rule rule_3 priority 3</b>	Creates or enables a rule. While creating a rule, you must enter the priority for the rule. <b>Note</b> After creating a rule, you can edit the rule and change the priority only for the rogue rules that are disabled. You cannot change the priority for the rogue rules that are enabled. While editing, changing the priority for a rogue rule is optional.
<b>Step 3</b>	<b>classify {friendly state {alert   external   internal}   malicious state {alert   contained} }</b> <b>Example:</b> Device(config)# <b>wireless wps rogue rule rule_3 priority 3</b> Device(config-rule)# <b>classify friendly</b>	Specifies the classification that needs to be applied to the rogue access points matching this rule. <ul style="list-style-type: none"> <li>• <b>friendly</b>—Configures the friendly rogue access points. After that enter the <b>state</b> keyword followed by either of these options: <b>alert</b>, <b>internal</b>, or <b>external</b>. If you select an <b>internal</b> option, it indicates that you trust a foreign access point. If you select an <b>external</b> option, it indicates that you acknowledge the presence of a rogue access point.</li> <li>• <b>malicious</b>—Configures the malicious rogue access points. After that enter the</li> </ul>

	Command or Action	Purpose
		<p>state keyword followed by either of these options: alert or contained.</p> <ul style="list-style-type: none"> <li>• <b>alert</b>—Sets the malicious rogue access point to alert mode.</li> <li>• <b>contained</b>—Sets the malicious rogue access point to contained mode.</li> </ul>
<b>Step 4</b>	<p><b>condition</b> {<b>client-count</b> <i>value</i>   <b>duration</b> <i>duration_value</i>   <b>encryption</b>   <b>infrastructure</b>   <b>rsi</b>   <b>ssid</b> <i>ssid_name</i>   <b>wildcard-ssid</b>}</p> <p><b>Example:</b></p> <pre>Device(config)# wireless wps rogue rule rule_3 priority 3  Device(config-rule)# condition client-count 5</pre>	<p>Adds the following conditions to a rule, which the rogue access point must meet:</p> <ul style="list-style-type: none"> <li>• <b>client-count</b>—Requires that a minimum number of clients be associated to the rogue access point. For example, if the number of clients associated to the rogue access point is greater than or equal to the configured value, the access point could be classified as Malicious. If you choose this option, enter the minimum number of clients to be associated to the rogue access point for the <i>value</i> parameter. The valid range is from 1 to 10 (inclusive), and the default value is 0.</li> <li>• <b>duration</b>—Requires that the rogue access point be detected for a minimum period of time. If you choose this option, enter a value for the minimum detection period for the <i>duration_value</i> parameter. The valid range is from 0 to 3600 seconds (inclusive), and the default value is 0 seconds.</li> <li>• <b>encryption</b>—Requires that the advertised WLAN does not have encryption enabled. You can choose <b>any</b> for any type of encryption, <b>off</b> for no encryption, <b>wpa1</b> for WPA encryption, <b>wpa2</b> for WPA2 encryption, <b>wpa3-owe</b> for WPA3 OWE encryption, or <b>wpa3-sae</b> for WPA3 SAE encryption.</li> <li>• <b>infrastructure</b>—Requires the SSID to be known to the controller.</li> <li>• <b>rsi</b>—Requires the rogue access point to be detected with a minimum RSSI value. If the classification is Friendly, the condition requires the rogue access point to be detected with a maximum RSSI</li> </ul>

	Command or Action	Purpose
		<p>value. The valid range is from -95 to -50 dBm (inclusive).</p> <ul style="list-style-type: none"> <li>• <b>ssid</b>—Requires the rogue access point to have a specific SSID. You could specify up to 25 different SSIDs. You should specify an SSID that is not managed by the controller. If you choose this option, enter the SSID for the <i>ssid_name</i> parameter. The SSID is added to the configured SSID list you just created.</li> <li>• <b>wildcard-ssid</b>—Allows you to specify an expression that could match an SSID string. You can specify up to 25 of these SSIDs.</li> </ul>
<b>Step 5</b>	<p><b>match {all   any}</b></p> <p><b>Example:</b></p> <pre>Device(config)# wireless wps rogue rule rule_3 priority 3 Device(config-rule)# match all</pre>	Specifies whether a detected rogue access point must meet all or any of the conditions specified by the rule for the rule to be matched and the rogue access point to adopt the classification type of the rule.
<b>Step 6</b>	<p><b>default</b></p> <p><b>Example:</b></p> <pre>Device(config)# wireless wps rogue rule rule_3 priority 3 Device(config-rule)# default</pre>	Sets a command to its default.
<b>Step 7</b>	<p><b>exit</b></p> <p><b>Example:</b></p> <pre>Device(config)# wireless wps rogue rule rule_3 priority 3 Device(config-rule)# exit Device(config)#</pre>	Exits the sub-mode.
<b>Step 8</b>	<p><b>shutdown</b></p> <p><b>Example:</b></p> <pre>Device(config)# wireless wps rogue rule rule_3 priority 3 Device(config-rule)# shutdown</pre>	Disables a particular rogue rule. In this example, the rule <b>rule_3</b> is disabled.
<b>Step 9</b>	<p><b>end</b></p> <p><b>Example:</b></p> <pre>Device(config)# end</pre>	Returns to privileged EXEC mode. Alternatively, you can also press <b>Ctrl-Z</b> to exit global configuration mode.



	Command or Action	Purpose
Step 10	<b>configure terminal</b> <b>Example:</b> Device# <code>configure terminal</code>	Enters global configuration mode.
Step 11	<b>wireless wps rogue rule shutdown</b> <b>Example:</b> Device (config)# <code>wireless wps rogue rule shutdown</code>	Disables all the rogue rules.
Step 12	<b>end</b> <b>Example:</b> Device (config)# <code>end</code>	Returns to privileged EXEC mode. Alternatively, you can also press <b>Ctrl-Z</b> to exit global configuration mode.

## Monitoring Rogue Classification Rules

You can monitor the rogue classification rules using the following commands:

*Table 54: Commands for Monitoring Rogue Classification Rules*

Command	Purpose
<code>show wireless wps rogue rule detailed</code>	Displays detailed information of a classification rule.
<code>show wireless wps rogue rule summary</code>	Displays a summary of the classification rules.

## Examples: Classifying Rogue Access Points

This example shows how to classify a rogue AP with MAC address 00:11:22:33:44:55 as malicious and mark it for being contained by 2 managed APs:

```
Device# configure terminal
Device(config)# wireless wps rogue ap malicious 0011.2233.4455 state contain 2
```

This example shows how to create a rule that can categorize a rogue AP that is using SSID **my-friendly-ssid**, and it is seen for at least for 1000 seconds as friendly internal:

```
Device# configure terminal
Device(config)# wireless wps rogue rule ap1 priority 1
Device(config-rule)# condition ssid my-friendly-ssid
Device(config-rule)# condition duration 1000
Device(config-rule)# match all
Device(config-rule)# classify friendly state internal
Device(config-rule)# no shutdown
```

This example shows how to apply a condition that a rogue access point must meet:

```
Device# configure terminal
```

```
Device(config)# wireless wps rogue rule ap1 priority 1
Device(config-rule)# condition client-count 5
Device(config-rule)# condition duration 1000
Device(config-rule)# no shutdown
Device(config-rule)# end
```

This example shows a condition to classify rogue devices with the controller SSIDs as malicious:

```
Device# configure terminal
Device(config)# wireless wps rogue rule ap1 priority 1
Device(config-rule)# classify malicious state alert
Device(config-rule)# condition duration 30
Device(config-rule)# condition infrastructure ssid
Device(config-rule)# match all
Device(config-rule)# no shutdown
Device(config-rule)# end
```



# CHAPTER 125

## Advanced WIPS

- [Feature History for Advanced WIPS, on page 1137](#)
- [Information About Advanced WIPS, on page 1138](#)
- [Enabling Advanced WIPS, on page 1141](#)
- [Syslog Support for Advanced WIPS, on page 1141](#)
- [Advanced WIPS Solution Components, on page 1142](#)
- [Supported Modes and Platforms, on page 1142](#)
- [Enabling Advanced WIPS\(GUI\), on page 1143](#)
- [Enabling Advanced WIPS \(CLI\), on page 1143](#)
- [Configuring Syslog Threshold for Advanced WIPS \(CLI\), on page 1144](#)
- [Viewing Advanced WIPS Alarms \(GUI\), on page 1144](#)
- [Verifying Advanced WIPS, on page 1145](#)
- [Verifying Syslog Configuration for Advanced WIPS, on page 1146](#)

## Feature History for Advanced WIPS

This table provides release and related information for the features explained in this module.

These features are available on all releases subsequent to the one they were introduced in, unless noted otherwise.

**Table 55: Feature History for Advanced WIPS**

Release	Feature Name	Feature Information
Cisco IOS XE Bengaluru 17.5.1	Advanced WIPS Signatures	Up to 15 additional signatures are supported.
Cisco IOS XE Bengaluru 17.6.1	Syslog Support for Advanced WIPs	From 17.6.1 release onwards: <ul style="list-style-type: none"> <li>• Two additional signatures are supported.</li> <li>• Syslog support has been added to the controller for advanced WIPS.</li> </ul>

## Information About Advanced WIPS

The Cisco Advanced Wireless Intrusion Prevention System (aWIPS) is a wireless intrusion threat detection and mitigation mechanism. The aWIPS uses an advanced approach to wireless threat detection and performance management. The AP detects threats and generates alarms. It combines network traffic analysis, network device and topology information, signature-based techniques, and anomaly detection to deliver highly accurate and complete wireless threat prevention.

With a fully infrastructure-integrated solution, you can continually monitor wireless traffic on both wired and wireless networks and use that network intelligence to analyze attacks from multiple sources to accurately pinpoint and proactively prevent attacks, rather than wait until damage or exposure has occurred.

The following table shows the alarms introduced from Cisco IOS XE Bengaluru 17.5.1 onwards:

**Table 56: Advanced WIPS Signatures and Definitions: From Cisco IOS XE Bengaluru 17.5.1 Onwards**

Advanced WIPS Signature	Definition
RTS Virtual Carrier Sense Attack	This is an addition to the existing RTS Flood alarm introduced in Cisco IOS XE Bengaluru 17.4.x. The alarm is triggered when an RTS with a large duration is detected. An attacker can use these frames to exhaust air time and disrupt wireless client service.
CTS Virtual Carrier Sense Attack	This is an addition to the existing CTS Flood alarm introduced in Cisco IOS XE Bengaluru 17.4.x. The alarm is triggered when a CTS with large duration is detected. An attacker can use these frames to exhaust air time and disrupt wireless client service.
Deauthentication Flood by Pair	In the enhanced context of threat, both the source (attacker) and the destination (victim) of attacks (Track by Pair) have visibility.
Fuzzed Beacon	Fuzzed beacon is when invalid, unexpected, or random data is introduced into the beacon and replays those modified frames into the air. This causes unexpected behavior on the destination device, including driver crashes, operating system crashes, and stack-based overflows. This in turn allows the execution of the arbitrary code of the affected system.
Fuzzed Probe Request	Fuzzed probe request is when invalid, unexpected, or random data is introduced into a probe request and replays those modified frames into the air.
Fuzzed Probe Response	Fuzzed probe response is when invalid, unexpected, or random data is introduced into a probe response and replays those modified frames into the air.

Advanced WIPS Signature	Definition
PS Poll Flood by Signature	PS poll flood is when a potential hacker spoofs a MAC address of a wireless client and sends out a flood of PS poll frames. The AP sends out buffered data frames to the wireless client. This results in the client missing the data frames because it could be in the power safe mode.
Eapol Start V1 Flood by Signature	Extensible Authentication Protocol over LAN (EAPOL) start flood is when an attacker attempts to bring down the AP by flooding the AP with EAPOL-start frames to exhaust the AP's internal resources.
Reassociation Request Flood by Destination	Reassociation request flood is when a specific device tries to flood the AP with a large number of emulated and spoofed client reassociations to exhaust the AP's resources, particularly the client association table. When the client association table overflows, legitimate clients are not able to associate, causing a DoS attack.
Beacon Flood by Signature	Beacon flood is when stations actively search for a network that is bombarded with beacons from the networks that are generated using different MAC addresses and SSIDs. This flood prevents a valid client from detecting the beacons sent by corporate APs, which in turn initiates a DoS attack.
Probe Response Flood by Destination	Probe response flood is when a device tries to flood clients with a large number of spoofed probe responses from the AP. This prevents clients from detecting the valid probe responses sent by the corporate APs.
Block Ack Flood by Signature	Block ack flood is when an attacker transmits an invalid Add Block Acknowledgement (ADDDBA) frame to the AP while spoofing the MAC address of the valid client. This process causes the AP to ignore any valid traffic transmitted from the client until it reaches the invalid frame range.
Airdrop Session	Airdrop session refers to the Apple feature called AirDrop. AirDrop is used to set up a peer-to-peer link for file sharing. This might create a security risk because of unauthorized peer-to-peer networks created dynamically in your WLAN environment.
Malformed Association Request	Malformed association request is when an attacker sends a malformed association request to trigger bugs in the AP. This results in a DoS attack.

Advanced WIPS Signature	Definition
Authentication Failure Flood by Signature	Authentication failure flood is when a specific device tries to flood the AP with invalid authentication requests spoofed from a valid client. This results in disconnection.
Invalid MAC OUI by Signature	Invalid MAC OUI is when a spoofed MAC address that does not have a valid OUI is used.
Malformed Authentication	Malformed authentication is when an attacker sends malformed authentication frames that can expose vulnerabilities in some drivers.

The following table shows the alarms introduced prior to Cisco IOS XE Bengaluru 17.5.1:

**Table 57: Advanced WIPS Signatures: Prior Cisco IOS XE Bengaluru 17.5.1**

Advanced WIPS Signatures
Authentication Flood Alarm
Association Flood Alarm
Broadcast Probe Flood Alarm
Disassociation Flood Alarm
Broadcast Dis-Association Flood Alarm
De-Authentication Flood Alarm
Broadcast De-Authentication Flood Alarm
EAPOL-Logoff Flood Alarm
CTS Flood Alarm
RTS Flood Alarm

## Guidelines and Restrictions

- In the aWIPS profile, Cisco Aironet 1850 Series Access Points, Cisco Catalyst 9117 Series Access Points, and Cisco Catalyst 9130AX Series Access Points can detect EAPOL logoff attack and raise alarms accordingly, only on off-channel. They can not detect EAPOL logoff attack and raise alarms on on-channel.
- aWIPS profile download is not supported when Cisco Catalyst Center is configured using the fully qualified domain name (FQDN).

## Enabling Advanced WIPS

From Cisco IOS XE Release 17.5.1 onwards, aWIPS security gets a higher priority over Hyperlocation/Fastlocate. The following are the possible scenarios.

All Catalyst APs supporting Fastlocate can be used together with aWIPS depending on the configuration and regardless of the AP mode.

In modes other than the Monitor mode for Cisco Aironet 4800 AP, if both aWIPS and Hyperlocation are enabled, only aWIPS is available.

Hyperlocation/Fastlocate	Advanced WIPS	Cisco Aironet 4800 AP Mode	Cisco Aironet 4800 AP Effective Feature
Enable	Enable	Any Non-Monitor	aWIPS <sup>7</sup>
Enable	Disable	Any Non-Monitor	Hyperlocation/Fastlocate
Disable	Disable	Any Non-Monitor	Hyperlocation/Fastlocate and aWIPS are disabled.
Disable	Enable	Any Non-Monitor	aWIPS
Enable	Enable	Monitor	aWIPS and Hyperlocation <sup>8</sup>
Disable	Enable	Monitor	aWIPS <sup>9</sup>
Enable	Disable	Monitor	Hyperlocation/Fastlocate
Disable	Disable	Monitor	Hyperlocation/Fastlocate and aWIPS are disabled.

<sup>7</sup> In modes other than the Monitor mode, if both aWIPS and Hyperlocation/Fastlocate are enabled, only aWIPS is available.

<sup>8</sup> In Monitor mode, if both aWIPS and Hyperlocation/Fastlocate are enabled, both aWIPS and Hyperlocation/Fastlocate are available.

<sup>9</sup> To monitor the status of aWIPS and Hyperlocation/Fastlocate simultaneously on AP, use the **show capwap client rcb** command.

## Syslog Support for Advanced WIPS

This feature adds syslog support to the controller for Advanced WIPS.

The controller raises syslog messages when it receives alarms from an AP. The syslog messages go through throttling. If the same signature is detected from the same AP in a configured throttling interval, you must generate the syslog message for that alarm. For instance, if there were 100 occurrences of the same signature from the same AP within the throttling interval, say, 1 minute, you get to view only one syslog message in the controller in that 1-minute period instead of 100 messages.

### Sample Syslog Format

The following is a sample syslog format:

```
Nov 18 20:45:23.746: %APMGR_AWIPS_SYSLOG-6-APMGR_AWIPS_MESSAGE: Chassis 1 R0/0: wncd: AWIPS
alarm:(AP00B0.E19A.5720) 00b0.e19a.5720 Radio MAC 00b0.e19b.c300 detected Probe Response
Flood by Destination (10019)
```

The format covers the AP name, AP Ethernet MAC address, AP Radio MAC address, description (signature ID).



---

**Note** The syslog messages do not display any client information or context.

---

## Advanced WIPS Solution Components

The aWIPS solution comprises the following components:

- Cisco Catalyst 9800 Series Wireless Controller
- Cisco Aironet Wave 2 APs
- Cisco Catalyst Center

Because the aWIPS functionality is integrated into Cisco Catalyst Center, the aWIPS can configure and monitor WIPS policies and alarms and report threats.

aWIPS supports the following capabilities:

- Static signatures
  - From Cisco IOS XE, 17.4.1 onwards Cisco Catalyst Center can change threshold values and push new signature files to the AP.
- Enable or disable signature forensic capture from Cisco Catalyst Center.
- Standalone signature detection only
- Alarms only
- GUI support
- CLIs to view alarms
- Static signature file packaged with controller and AP image
- Export alarms to Cisco Catalyst Center through WSA channel



---

**Note** aWIPS alarm details such as the AP MAC address, alarm ID, alarm string, and signature ID are displayed on the Cisco Catalyst 9800 series wireless controller GUI.

---

## Supported Modes and Platforms

aWIPS is supported on the following controllers:



- Cisco Catalyst 9800 Series Wireless Controllers
- Cisco Embedded Wireless Controller on Catalyst Access Points



**Note** aWIPS is not supported on Cisco IOS APs.

## Enabling Advanced WIPS(GUI)

### Procedure

- 
- Step 1** Choose **Configuration > Tags & Profiles > AP Join**.
- Step 2** Click **Add**. The **Add AP Join Profile** window is displayed.
- Step 3** In the **Add AP Join Profile** window, click the **Security** tab.
- Step 4** Under the **aWIPS** section, check the **aWIPS Enable** check box.
- Step 5** Click **Apply to Device**. You will go back the to **General** tab.
- Step 6** Click the **Security** tab.
- Step 7** Under the **aWIPS** section, check the **Forensic Enable** check box.
- Step 8** Click **Apply to Device**.
- 

## Enabling Advanced WIPS (CLI)

To enable aWIPS from the controller and ensure that aWIPS has higher priority than Hyperlocation/Fastlocate, perform the following:

### Procedure

	Command or Action	Purpose
<b>Step 1</b>	<b>configure terminal</b>  <b>Example:</b> Device# configure terminal	Enters global configuration mode.
<b>Step 2</b>	<b>ap profile profile-name</b>  <b>Example:</b> Device(config)# ap profile ap-profile-name	Configures the default AP profile.
<b>Step 3</b>	<b>awips</b>  <b>Example:</b> Device(config-ap-profile)# awips	Enables aWIPS.  <b>Note</b> aWIPS is disabled by default on the controller.

	Command or Action	Purpose
<b>Step 4</b>	<b>awips forensic</b> <b>Example:</b> Device(conf-ap-profile)# awips forensic	Enables forensics for aWIPS alarms.
<b>Step 5</b>	<b>hyperlocation</b> <b>Example:</b> Device(config-ap-profile)# hyperlocation	Enables Hyperlocation/Fastlocate on all the supported APs that are associated with this AP profile.
<b>Step 6</b>	<b>end</b> <b>Example:</b> Device(config-ap-profile)# end	Returns to privileged EXEC mode.

## Configuring Syslog Threshold for Advanced WIPS (CLI)

### Procedure

	Command or Action	Purpose
<b>Step 1</b>	<b>configure terminal</b> <b>Example:</b> Device# <b>configure terminal</b>	Enters global configuration mode.
<b>Step 2</b>	<b>awips-syslog throttle period</b> <i>syslog-throttle-interval</i> <b>Example:</b> Device(config)# <b>awips-syslog throttle period 38</b>	Configures the syslog threshold for aWIPS. <i>syslog-throttle-interval</i> : Enter the syslog throttle interval, in seconds. The range is from 30 to 600. <b>Note</b> The default throttling interval is 60 seconds.
<b>Step 3</b>	<b>end</b> <b>Example:</b> Device(config)# <b>end</b>	Returns to privileged EXEC mode.

## Viewing Advanced WIPS Alarms (GUI)

### Procedure

- 
- Step 1** Navigate to **Monitoring > Security > aWIPS**.
- Step 2** To view the details of the alarms in the last 5 minutes, click the **Current Alarms** tab.

**Step 3** To view the alarm count over an extended period of time, either hourly, for a day (24 hours) or more, click the **Historical Statistics** tab.

**Step 4** Sort or filter the alarms based on the following parameters:

- **AP Radio MAC address**
- **Alarm ID**
- **Time Stamp**
- **Signature ID**
- **Alarm Description**
- **Alarm Message Index**

## Verifying Advanced WIPS

To view the aWIPS status, use the **show awips status** *radio\_mac* command:

```
Device# show awips status 0xx7.8xx8.2xx0

AP Radio MAC  AWIPS Status  Forensic Capture Status  Alarm Message Count
-----
0xx7.8xx8.2xx0      ENABLED          CONFIG_NOT_ENABLED      14691
```

The various aWIPS status indicators are:

- **ENABLED:** aWIPS enabled.
- **NOT\_SUPPORTED:** The AP does not support AWIPS.
- **CONFIG\_NOT\_ENABLED:** aWIPS is not enabled on the AP.

To view details of specific alarm signatures, use the **show awips alarm signature** *signature\_id* command:

```
Device# show awips alarm signature 10001

AP Radio MAC      AlarmID  Timestamp                SignatureID  Alarm Description  Message
Index
-----
0xx7.8xx8.2f80   1714    11/02/2020 13:02:19   10001      Authentication Flood  3966
```

To view alarm message statistics, use the **show awips alarm statistics** command:

```
Device# show awips alarm statistics
```

To view a list of alarms since the last clear, use the **show awips alarm ap** *ap\_mac* **detailed** command:

```
Device# show awips alarm ap 0xx7.8xx8.2f80 detailed

AP Radio MAC      AlarmID  Timestamp                SignatureID  Alarm Description
-----
0xx7.8xx8.2f80   2491    08/02/2022 17:44:40   10009      RTS Flood
```

To view detailed alarm information, use the **show awips alarm detailed** command:

```
Device# show awips alarm detailed
```

AP Radio MAC	AlarmID	Timestamp	SignatureID	Alarm Description
7xx3.5xxd.d360	1	10/29/2020	23:21:27	10001 Authentication Flood by Source
dxxc.3xx5.9460	71	10/29/2020	23:21:27	10001 Authentication Flood by Source
7xx3.5xxd.d360	2	10/29/2020	23:21:28	10002 Association Request Flood by Destination
dxxc.3xx5.9460	72	10/29/2020	23:21:28	10002 Association Request Flood by Destination

To view the alarms on a specific AP, use the **show awips alarm ap *radio\_mac* detailed** command:

## Verifying Syslog Configuration for Advanced WIPS

To verify the syslog configuration for a WIPS, use the following command:

```
Device# show awips syslog throttle
```

```
Syslog Throttle Interval (seconds)
```

```
-----
```

```
38
```



## CHAPTER 126

# Cisco TrustSec

---

- [Information about Cisco TrustSec, on page 1147](#)
- [Cisco TrustSec Features, on page 1148](#)
- [Security Group Access Control List, on page 1149](#)
- [Inline Tagging, on page 1151](#)
- [Policy Enforcement, on page 1151](#)
- [SGACL Support for Wireless Guest Access, on page 1152](#)
- [Enabling SGACL on the AP \(GUI\), on page 1153](#)
- [Enabling SGACL on the AP, on page 1153](#)
- [Enabling SGACL Policy Enforcement Globally \(CLI\), on page 1155](#)
- [Enabling SGACL Policy Enforcement Per Interface \(CLI\), on page 1155](#)
- [Manually Configure a Device SGT \(CLI\), on page 1156](#)
- [Configuring SGACL, Inline Tagging, and SGT in Local Mode \(GUI\), on page 1156](#)
- [Configuring SGACL, Inline Tagging, and SGT in Local Mode, on page 1157](#)
- [Configuring ISE for TrustSec, on page 1157](#)
- [Verifying Cisco TrustSec Configuration, on page 1159](#)

## Information about Cisco TrustSec

Cisco TrustSec provides security improvements to Cisco network devices based on the capability to strongly identify users, hosts, and network devices within a network. TrustSec provides topology-independent and scalable access controls by uniquely classifying data traffic for a particular role. TrustSec ensures data confidentiality and integrity by establishing trust among authenticated peers and encrypting links with those peers.

The key component of Cisco TrustSec is the Cisco Identity Services Engine (ISE). Cisco ISE can provision switches with TrustSec Identities and Security Group ACLs (SGACLs), though these may be configured manually on the switch.



---

**Note** You should manually clear the CTS environment data using the **clear cts environment-data** command before changing CTS server to a new one. This ensures that you get the updated data while running **show cts environment-data** command.

---

## Cisco TrustSec Features

The table below lists the TrustSec features to be eventually implemented on TrustSec-enabled Cisco switches. Successive general availability releases of TrustSec will expand the number of switches supported and the number of TrustSec features supported per switch.

Cisco TrustSec Feature	Description
802.1AE Tagging (MACsec)	<p>Protocol for IEEE 802.1AE-based wire-rate hop-to-hop Layer 2 encryption.</p> <p>Between MACsec-capable devices, packets are encrypted on egress from the transmitting device, decrypted on ingress to the receiving device, and in the clear within the devices.</p> <p>This feature is only available between TrustSec hardware-capable devices.</p>
Endpoint Admission Control (EAC)	<p>EAC is an authentication process for an endpoint user or a device connecting to the TrustSec domain. Usually EAC takes place at the access level switch. Successful authentication and authorization in the EAC process results in Security Group Tag assignment for the user or device. Currently EAC can be 802.1X, MAC Authentication Bypass (MAB), and Web Authentication Proxy (WebAuth).</p>
Network Device Admission Control (NDAC)	<p>NDAC is an authentication process where each network device in the TrustSec domain can verify the credentials and trustworthiness of its peer device. NDAC utilizes an authentication framework based on IEEE 802.1X port-based authentication and uses EAP-FAST as its EAP method. Successful authentication and authorization in NDAC process results in Security Association Protocol negotiation for IEEE 802.1AE encryption.</p>
Security Group Access Control List (SGACL)	<p>A Security Group Access Control List (SGACL) associates a Security Group Tag with a policy. The policy is enforced upon SGT-tagged traffic egressing the TrustSec domain.</p>
Security Association Protocol (SAP)	<p>After NDAC authentication, the Security Association Protocol (SAP) automatically negotiates keys and the cipher suite for subsequent MACSec link encryption between TrustSec peers. SAP is defined in IEEE 802.11i.</p>
Security Group Tag (SGT)	<p>An SGT is a 16-bit single label indicating the security classification of a source in the TrustSec domain. It is appended to an Ethernet frame or an IP packet.</p>

Cisco TrustSec Feature	Description
SGT Exchange Protocol (SXP)	Security Group Tag Exchange Protocol (SXP). With SXP, devices that are not TrustSec-hardware-capable can receive SGT attributes for authenticated users and devices from the Cisco Identity Services Engine (ISE) or the Cisco Secure Access Control System (ACS). The devices can then forward a sourceIP-to-SGT binding to a TrustSec-hardware-capable device will tag the source traffic for SGACL enforcement.

When both ends of a link support 802.1AE MACsec, SAP negotiation occurs. An EAPOL-key exchange occurs between the supplicant and the authenticator to negotiate a cipher suite, exchange security parameters, and manage keys. Successful completion of these tasks results in the establishment of a security association (SA).

Depending on your software version and licensing and link hardware support, SAP negotiation can use one of these modes of operation:

- Galois Counter Mode (GCM)—authentication and encryption
- GCM authentication (GMAC)— GCM authentication, no encryption
- No Encapsulation—no encapsulation (clear text)
- Null—encapsulation, no authentication or encryption

## Security Group Access Control List

A security group is a group of users, end-point devices, and resources that share access control policies. Security groups are defined by the administrator in Cisco Identity Services Engine (ISE). As new users and devices are added to the Cisco TrustSec domain, the authentication server assigns these new entities to the appropriate security groups. Cisco TrustSec assigns each of the security group a unique 16-bit number whose scope is global in a Cisco TrustSec domain. The number of security groups in a wireless device is limited to the number of authenticated network entities. You do not have to manually configure the security group numbers.

After a device is authenticated, Cisco TrustSec tags any packet that originates from that device with an SGT that contains the security group number of the device. The packet carries this SGT everywhere in the network, in the Cisco TrustSec header.

As the SGT contains the security group of the source, the tag can be referred to as the source SGT (S-SGT). The destination device is also assigned to a security group (destination SG) that can be referred to as the destination SGT (D-SGT), even though the Cisco TrustSec packet does not contain the security group number of the destination device.

You can control the operations that users can perform based on the security group assignments of users and destination resources, using the Security Group Access Control Lists (SGACLs). Policy enforcement in a Cisco TrustSec domain is represented by a permission matrix, with the source security group numbers on one axis and the destination security group numbers on the other axis. Each cell in the matrix body contains an ordered list of SGACLs, which specify the permissions that must be applied to packets originating from the source security group and destined for the destination security group. When a wireless client is authenticated, the controller downloads all the SGACLs in the matrix cells.

When a wireless client connects to the network, the client pushes all the ACLs to the controller .

Cisco TrustSec achieves role-based topology-independent access control in a network by assigning users and devices in the network to security groups and applying access control between the security groups. The SGACLs define access control policies based on the device identities. As long as the roles and permissions remain the same, changes to the network topology do not change the security policy. When a user is added to the wireless group, you simply assign the user to an appropriate security group; the user immediately receives permissions to that group.

The size of ACLs are reduced and their maintenance is simplified with the use of role-based permissions. With Cisco TrustSec, the number of Access Control Entities (ACEs) that are configured is determined by the number of permissions specified, resulting in a much smaller number of ACEs.

To know the list of Cisco APs that support SGACL, see the release notes: <https://www.cisco.com/c/en/us/support/wireless/catalyst-9800-series-wireless-controllers/products-release-notes-list.html>



---

**Note** Clients receive zero SGT value and DHCP clients receive an Automatic Private IP Addressing (APIPA) address when TrustSec policy “unknown to unknown” is denied in TrustSec matrix.

Clients receive correct SGT values and DHCP clients receive an IP address when TrustSec policy “unknown to unknown” is permitted in TrustSec matrix.

---

The scenarios supported for SGACLs on the Cisco Catalyst 9800 Series Wireless Controller are:

- Wireless-to-wireless (within Enterprise network):
  - Flex mode with local switching—SGACL enforcement is done on the egress AP when a packet leaves from a source wireless network to a destination wireless network.
  - Flex mode with central switching—SGACL enforcement is done on the egress AP. To achieve this, controller should export IP address to security group tag (IP-SGT) binding over SGT Exchange Protocol (SXP).
- Wired-to-wireless (DC-to-Enterprise network)—Enforcement takes place when a packet reaches the destination AP.
- Wireless-to-wired (Enterprise network-to-DC)—Enforcement takes place on the uplink switch when a packet reaches the ingress of the wired network.

### Guidelines and Restrictions

- SGACL enforcement is carried out on the controller for local mode.
- SGACL enforcement is carried out on an AP for flex-mode APs performing local switching.
- SGACL enforcement for wireless clients is carried out either on the upstream switch or on the border gateway in a Branch-to-DC scenario.
- SGACL enforcement is not supported for non-IP or IP broadcast or multicast traffic.
- Per-WLAN SGT assignment is not supported.
- SGACL enforcement is not carried out for control-plane traffic between an AP and the wireless controller (for upstream or from upstream traffic).



- Non-static SGACL configurations are supported only for dynamic SGACL policies received from ISE.
- Static SGACL configuration on an AP is not supported.
- In case of Allow List model, you need to explicitly allow DHCP protocol for the client devices to get the DHCP IP address and then request the controller for SGACL policies.

## Inline Tagging

Inline tagging is a transport mechanism using which a controller or AP understands the source SGT.

Transport mechanism is of two types:

- Central switching—For centrally switched packets, the controller performs inline tagging of all the packets sourced from wireless clients that are associated with the controller, by tagging it with the Cisco Meta Data (CMD) tag. For packets that are inbound from the distribution system, inline tagging also involves the controller stripping off the CMD header from the packet to learn the S-SGT tag. Thereafter, the controller forwards the packet including the S-SGT, for SGACL enforcement.
- Local switching—To transmit locally switched traffic, an AP performs inline tagging for packets that are associated with the AP and sourced from clients. To receive traffic, the AP handles both locally switched packets and centrally switched packets, uses the S-SGT tag for packets, and applies the SGACL policy.

With wireless Cisco TrustSec enabled on the controller, the choice of enabling and configuring SXP to exchange tags with the switches is optional. Both wireless Cisco TrustSec and SXP modes are supported; however, there is no use case to have both wireless Cisco TrustSec (on an AP) and SXP to be in the enabled state concurrently.

### Consideration and Restriction for Inline Tagging over Port-Channel

- Configure the **cts manual** command on port-channel and its member interfaces to send or receive a tagged packet.
- If you downgrade to Cisco IOS XE releases that do not support inline tagging over port-channel, the port-channel may be suspended.



---

**Note** The inline tagging over port-channel is supported in Cisco IOS XE 17.3.517.6.3 release.

---

## Policy Enforcement

Cisco TrustSec access control is implemented using ingress tagging and egress enforcement. At the ingress point to the Cisco TrustSec domain, the traffic from the source is tagged with an SGT containing the security group number of the source entity. The SGT is propagated across the domain with the traffic. At the egress point of the Cisco TrustSec domain, an egress device uses the source SGT (S-SGT) and the security group of the destination entity (D-SGT) to determine the access policy to apply from the SGACL policy matrix.

Policy Enforcement Cisco TrustSec access control is implemented using ingress tagging and egress enforcement. At the ingress point to the Cisco TrustSec domain, the traffic from the source is tagged with an SGT containing the security group number of the source entity. The SGT is propagated across the domain with the traffic. At the egress point of the Cisco TrustSec domain, an egress device uses the source SGT (S-SGT) and the security group of the destination entity (D-SGT) to determine the access policy to apply from the SGACL policy matrix. Policy enforcement can be applied to both central and local switched traffic on an AP. If wired clients communicate with wireless clients, the AP enforces the downstream traffic. If wireless clients communicate with wired clients, the AP enforces the upstream traffic. This way, the AP enforces traffic in both downstream and wireless-to-wireless traffic. You require S-SGT, D-SGT, and ACLs for the enforcement to work. APs get the SGT information for all the wireless clients from the information available on the Cisco ISE server.



---

**Note** A Cisco AP must be in either Listener or Both (Listener and Speaker) mode to enforce traffic because the Listener mode maintains the complete set of IP-SGT bindings. After you enable the enforcement on a an AP, the corresponding policies are downloaded and pushed to the AP.

---

## SGACL Support for Wireless Guest Access

When a client joins the wireless network (WLAN), its session is managed by the Cisco Catalyst 9800 Series Wireless LAN Controller (WLC) that the AP is connected to is the foreign controller. Auto-Anchor Mobility allows a specific WLAN (for example, Guest WLAN) to be anchored to a particular controller, regardless of the client's entry point into the network. Auto-Anchor Mobility is the wireless Guest service where all guest traffic tunnels back to the DMZ controller irrespective of where they associate with the network.

In case of Auto-Anchor mobility, the following apply to Cisco TrustSec support:

- **Classification:** Occurs during authentication and hence on Foreign for Layer 2 security WLANs and on Anchor for Layer 3 security cases.
- **Propagation:** Always occurs at the Anchor where the client traffic enters the wired network.
- **Enforcement:** SGACL download and enforcement occurs on Anchor; the Anchor controller must have the connectivity to Cisco Identity Services Engine (ISE) and be registered as Network Access Server (NAS). Enforcement is not supported on foreign controller even when the enforcement CLI is configured on foreign controller.

This feature is supported in local mode and in Flex Central Switching of the controller. Flex mode with local switching and Fabric mode are not supported in guest scenarios as traffic does not go through the controller.

Roaming of a guest client occurs only at Guest Foreign controller and the Guest Anchor remains fixed. The different types of supported roam are Inter-Controller roaming and Intra-Controller roaming. Roaming under WebAuth pending is a special case which is also supported for Central Web Authentication (CWA) and Local Web Authentication (LWA).

## Enabling SGACL on the AP (GUI)

### Procedure

- 
- Step 1** Choose **Configuration > Tags & Profiles > Flex**.
- Step 2** Click **Add**.
- Step 3** In the **General** tab, check **Inline Tagging** and **SGACL Enforcement** check boxes and choose the CTS Profile Name from the **CTS Profile Name** drop-down list.
- Step 4** Click **Apply to Device**.
- 

## Enabling SGACL on the AP



**Note** Use the **no** form of the commands given below to disable the configuration. For example, **cts role-based enforcement** disables role-based access control enforcement for APs.

---

### Before you begin

- Security Group Access Control List (SGACL) on an AP can be enabled only when the wireless controller is in FlexConnect mode.
- Configure the **cts manual** command on the uplink port to send or receive a tagged packet.

### Procedure

	Command or Action	Purpose
<b>Step 1</b>	<b>configure terminal</b> <b>Example:</b> Device# configure terminal	Enters global configuration mode.
<b>Step 2</b>	<b>wireless profile flex <i>flex-profile</i></b> <b>Example:</b> Device(config)# wireless profile flex xyz-flex-profile	Configures an RF profile and enters RF profile configuration mode.
<b>Step 3</b>	<b>cts role-based enforcement</b> <b>Example:</b> Device(config-wireless-flex-profile)# cts role-based enforcement	Enables role-based access control enforcement for the AP.

	Command or Action	Purpose
<b>Step 4</b>	<b>cts inline-tagging</b>  <b>Example:</b> Device(config-wireless-flex-profile)# cts inline-tagging	Enables inline tagging on the AP.
<b>Step 5</b>	<b>cts profile <i>profile-name</i></b>  <b>Example:</b> Device(config-wireless-flex-profile)# cts profile xyz-profile	Enables the CTS profile name.
<b>Step 6</b>	<b>exit</b>  <b>Example:</b> Device(config-wireless-flex-profile)# exit	Returns to global configuration mode.
<b>Step 7</b>	<b>wireless tag site <i>site-name</i></b>  <b>Example:</b> Device(config)# wireless tag site xyz-site	Configures a site tag and enters site tag configuration mode.
<b>Step 8</b>	<b>flex-profile <i>flex-profile-name</i></b>  <b>Example:</b> Device(config-site-tag)# flex-profile xyz-flex-profile	Configures a flex profile.
<b>Step 9</b>	<b>exit</b>  <b>Example:</b> Device(config-site-tag)# exit	Returns to global configuration mode.
<b>Step 10</b>	<b>ap <i>mac-address</i></b>  <b>Example:</b> Device(config)# ap F866.F267.7DFB	Configures an AP and enters AP profile configuration mode.
<b>Step 11</b>	<b>site-tag <i>site-tag-name</i></b>  <b>Example:</b> Device(config-ap-tag)# site-tag xyz-site	Maps a site tag to an AP.

**What to do next**

Use the **show cts ap sgt-info *ap-name*** command to verify the SGACL configuration on the AP.

## Enabling SGACL Policy Enforcement Globally (CLI)

You must enable SGACL policy enforcement globally on Cisco Catalyst 9800 Series Wireless Controller. The same configuration commands that are used for enforcement of IPv4 traffic apply for IPv6 traffic as well.

### Procedure

	Command or Action	Purpose
<b>Step 1</b>	<b>configure terminal</b>  <b>Example:</b> Device# <code>configure terminal</code>	Enters global configuration mode.
<b>Step 2</b>	<b>cts role-based enforcement</b>  <b>Example:</b> Device(config)# <code>cts role-based enforcement</code>	Enables Cisco TrustSec SGACL policy enforcement on routed interfaces.

## Enabling SGACL Policy Enforcement Per Interface (CLI)

After enabling the SGACL policy enforcement globally, you will have to enable Cisco TrustSec-on the uplink interfaces.

### Procedure

	Command or Action	Purpose
<b>Step 1</b>	<b>configure terminal</b>  <b>Example:</b> Device# <code>configure terminal</code>	Enters global configuration mode.
<b>Step 2</b>	<b>interface gigabitethernet <i>interface number</i></b>  <b>Example:</b> Device(config)# <code>interface gigabitethernet 1</code>	Specifies interface on which to enable or disable SGACL enforcement.
<b>Step 3</b>	<b>cts role-based enforcement</b>  <b>Example:</b> Device(config-if)# <code>cts role-based enforcement</code>	Enables Cisco TrustSec SGACL policy enforcement on routed interfaces.
<b>Step 4</b>	<b>do show cts interface</b>  <b>Example:</b> Device(config-if)# <code>do show cts interface</code>	Verifies that SGACL enforcement is enabled.

## Manually Configure a Device SGT (CLI)

In normal Cisco TrustSec operation, the authentication server assigns an SGT to the device for packets originating from the device. You can manually configure an SGT to be used if the authentication server is not accessible, but an authentication server-assigned SGT will take precedence over a manually-assigned SGT.

### Procedure

	Command or Action	Purpose
<b>Step 1</b>	<b>configure terminal</b>  <b>Example:</b> Device# <code>configure terminal</code>	Enters global configuration mode.
<b>Step 2</b>	<b>wireless profile policy <i>profile-policy</i></b>  <b>Example:</b> Device(config)# <code>wireless profile policy rr-xyz-policy-1</code>	Configures a WLAN policy profile and enters wireless policy configuration mode.
<b>Step 3</b>	<b>cts sgt <i>sgt-value</i></b>  <b>Example:</b> Device(config-wireless-policy)# <code>cts stg 200</code>	Specifies the Security Group Tag (SGT) number. Valid values are from 0 to 65,535.
<b>Step 4</b>	<b>exit</b>  <b>Example:</b> Device(config-wireless-policy)# <code>exit</code>	Returns to global configuration mode.

## Configuring SGACL, Inline Tagging, and SGT in Local Mode (GUI)

### Procedure

- 
- Step 1** Choose **Configuration > Tags & Profiles > Policy**.
  - Step 2** Click the Policy Profile Name. The **Edit Policy Profile** is displayed.
  - Step 3** Choose **General** tab.
  - Step 4** In the **CTS Policy** settings, check or uncheck the **Inline Tagging** and **SGACL Enforcement** check boxes, and enter the **Default SGT** value.
  - Step 5** Click **Update & Apply to Device**.
-

## Configuring SGACL, Inline Tagging, and SGT in Local Mode

### Procedure

	Command or Action	Purpose
<b>Step 1</b>	<b>configure terminal</b> <b>Example:</b> Device# configure terminal	Enters global configuration mode.
<b>Step 2</b>	<b>wireless profile policy <i>profile-name</i></b> <b>Example:</b> Device(config)# wireless profile policy xyz-policy-profile	Creates a policy profile for the WLAN.
<b>Step 3</b>	<b>cts inline-tagging</b> <b>Example:</b> Device(config-wireless-policy)# cts inline-tagging	Enables CTS inline tagging. <b>Note</b> You will also need to configure the <b>cts manual</b> in the physical interface. If the <b>cts manual</b> is configured in the physical interface and <b>cts inline-tagging</b> is skipped, the packets will still remain tagged at egress in the controller.
<b>Step 4</b>	<b>cts role-based enforcement</b> <b>Example:</b> Device(config-wireless-policy)# cts role-based enforcement	Enables CTS SGACL enforcement.
<b>Step 5</b>	<b>cts sgt <i>sgt-value</i></b> <b>Example:</b> Device(config-wireless-policy)# cts sgt 100	(Optional) Sets the default Security Group Tag (SGT). <b>Note</b> SGT is required for a user session only when the client uses open authentication, and not the ISE server.

## Configuring ISE for TrustSec

### Procedure

	Command or Action	Purpose
<b>Step 1</b>	<b>configure terminal</b> <b>Example:</b> Device# configure terminal	Enters global configuration mode.

	Command or Action	Purpose
<b>Step 2</b>	<b>radius server</b> <i>server-name</i> <b>Example:</b> Device(config)# radius server Test-SERVER1	Specifies the RADIUS server name.
<b>Step 3</b>	<b>address ipv4</b> <i>ip address</i> <b>Example:</b> Device(config-radius-server)# address ipv4 124.3.50.62	Specifies the primary RADIUS server parameters.
<b>Step 4</b>	<b>pac key</b> <i>key</i> <b>Example:</b> Device(config-radius-server)# pac key cisco	Specify the authentication and encryption key used between the Device and the key string RADIUS daemon running on the RADIUS server.
<b>Step 5</b>	<b>exit</b> <b>Example:</b> Device(config-radius-server)# exit	Returns to the configuration mode.
<b>Step 6</b>	<b>aaa group server radius</b> <i>server-group</i> <b>Example:</b> Device(config)# aaa group server radius authc-server-group	Creates a radius server-group identification. <b>Note</b> <i>server-group</i> refers to the server group name. The valid range is from 1 to 32 alphanumeric characters.
<b>Step 7</b>	<b>cts authorization list</b> <i>mlist-name</i> <b>Example:</b> Device(config)# cts authorization list authc-list	Creates a CTS authorization list.
<b>Step 8</b>	<b>aaa authorization network</b> <i>mlist-name group name</i> <b>Example:</b> Device(config)# aaa authorization network default group group1	Creates an authorization method list for web-based authorization. <b>Note</b> Ensure that the ISE IP address configured on your controller is the same as the IP address configured on ISE ( <b>Work Center &gt; TrustSec &gt; Components &gt; Trustsec AAA Servers</b> ) <b>Note</b> If the ISE version is 002.005(000.239), 002.004(000.357), 002.003(000.298), 002.002(000.470), 002.001(000.474), 002.000(001.130), or 002.000(000.306), use the <b>access-session tls-version 1.0</b> command to download PAC from ISE. For other ISE versions, the above command is not required.



## Verifying Cisco TrustSec Configuration

To display the wireless CTS SGACL configuration summary, use the following command:

```
Device# show wireless cts summary
```

```
Local Mode CTS Configuration
```

Policy Profile Name	SGACL Enforcement	Inline-Tagging	Default-Sgt
xyz-policy	DISABLED	ENABLED	0
wireless-policy1	DISABLED	DISABLED	0
w-policy-profile1	DISABLED	DISABLED	0
default-policy-profile	DISABLED	DISABLED	0

```
Flex Mode CTS Configuration
```

Flex Profile Name	SGACL Enforcement	Inline-Tagging
xyz-flex	DISABLED	ENABLED
demo-flex	DISABLED	DISABLED
flex-demo	DISABLED	DISABLED
xyz-flex-profile	DISABLED	DISABLED
default-flex-profile	DISABLED	DISABLED

To display CTS-specific configuration status for various wireless profiles, use the following command:

```
Device# show cts wireless profile policy xyz-policy
```

```
Policy Profile Name      : xyz-policy
CTS
  Role-based enforcement : ENABLED
  Inline-tagging         : ENABLED
  Default SGT           : 100

Policy Profile Name      : foo2
CTS
  Role-based enforcement : DISABLED
  Inline-tagging         : ENABLED
  Default SGT            : NOT-DEFINED

Policy Profile Name      : foo3
CTS
  Role-based enforcement : DISABLED
  Inline-tagging         : DISABLED
  Default SGT            : 65001
```

To display CTS configuration for a given wireless profile, use the following command:

```
Device# show wireless profile policy detailed xyz-policy
```

```
Policy Profile Name      : xyz-policy
Description              :
Status                   : DISABLED
VLAN                     : 1
Client count             : 0
Passive Client           : DISABLED
ET-Analytics             : DISABLED
StaticIP Mobility        : DISABLED
!
```

```
.
.
.WGB Policy Params
  Broadcast Tagging      : DISABLED
  Client VLAN           : DISABLED
Mobility Anchor List
  IP Address                Priority
CTS
  Role-based enforcement   : ENABLED
  Inline-tagging           : ENABLED
  Default SGT              : NOT-DEFINED
```



## CHAPTER 127

# SGT Inline Tagging and SXPv4

- Introduction to SGT Inline Tagging on AP and SXPv4, on page 1161
- Creating an SXP Profile, on page 1161
- Configuring SGT Inline Tagging on Access Points, on page 1162
- Configuring an SXP Connection (GUI), on page 1162
- Configuring an SXP Connection, on page 1163
- Verifying SGT Push to Access Points, on page 1164

## Introduction to SGT Inline Tagging on AP and SXPv4

The Cisco TrustSec (CTS) builds secure networks by establishing domains of trusted network devices. Each device in the domain is authenticated by its peers. Communication on the links between devices in the domain is secured with a combination of encryption, message integrity check, and data-path replay protection mechanisms.

The Scalable Group Tag (SGT) Exchange Protocol (SXP) is one of the several protocols that support CTS. CTS SXP version 4 (SXPv4) enhances the functionality of SXP by adding a loop detection mechanism to prevent stale binding in the network. In addition, Cisco TrustSec supports SGT inline tagging which allows propagation of SGT embedded in clear-text (unencrypted) ethernet packets.

When a wireless client is connected and is authenticated by ISE, the IP-SGT binding is generated on the controller. The same SGT is pushed to the AP along with the other client details.

For more details on SGT inline tagging on the AP and SXPv4, see the **Cisco TrustSec Configuration Guide** at: [https://www.cisco.com/c/en/us/td/docs/ios-xml/ios/sec\\_usr\\_cts/configuration/xs-3s/sec-usr-cts-xe-3s-book/sec-cts-sxpv4.html](https://www.cisco.com/c/en/us/td/docs/ios-xml/ios/sec_usr_cts/configuration/xs-3s/sec-usr-cts-xe-3s-book/sec-cts-sxpv4.html)

## Creating an SXP Profile

### Procedure

	Command or Action	Purpose
Step 1	<b>configure terminal</b>  <b>Example:</b> Device# <code>configure terminal</code>	Enters global configuration mode.

	Command or Action	Purpose
<b>Step 2</b>	<b>wireless cts-sxp profile</b> <i>profile-name</i> <b>Example:</b> Device(config)# wireless cts-sxp profile rr-profile	Configures a wireless CTS profile and enters cts-sxp profile configuration mode.
<b>Step 3</b>	<b>cts sxp enable</b> <b>Example:</b> Device(config-cts-sxp-profile)# cts sxp enable	Enables SXP for Cisco TrustSec.

## Configuring SGT Inline Tagging on Access Points

Follow the procedure given below to configure SGT inline tagging on APs:

### Before you begin

- The SGTs pushed to the AP for inline tagging will only be from dynamic SGT allocation through ISE authentication. It is not supported for static bindings configured on the controller .
- SGTs will be pushed to an AP only when it is operating in flex mode.

To know the list of Cisco APs that support SGT inline tagging, see the release notes: <https://www.cisco.com/c/en/us/support/wireless/catalyst-9800-series-wireless-controllers/products-release-notes-list.html>

### Procedure

	Command or Action	Purpose
<b>Step 1</b>	<b>configure terminal</b> <b>Example:</b> Device# configure terminal	Enters the global configuration mode.
<b>Step 2</b>	<b>wireless profile flex</b> <i>flex-profile</i> <b>Example:</b> Device(config)# wireless profile flex rr-xyz-flex-profile	Configures a wireless flex profile and enters the wireless flex profile configuration mode.
<b>Step 3</b>	<b>cts inline-tagging</b> <b>Example:</b> Device(config-wireless-flex-profile)# cts inline-tagging	Enables inline-tagging on the AP.

## Configuring an SXP Connection (GUI)

Perform the following steps to set SXP global configuration.

## Procedure

- 
- Step 1** In the **Global** section, select the **SXP Enabled** check box to enable SXP.
- Step 2** Enter an IP address in the **Default Source IP** field.
- Step 3** Enter a value in the **Reconciliation Period (sec)** field.
- Step 4** Enter a value in the **Retry Period (sec)** field.
- Step 5** Select the **Set New Default Password** check box. Selecting this check box displays the **Password Type** and **Enter Password** fields.
- Step 6** Choose any one of the available types from the **Password Type** drop-down list.
- Step 7** Enter a value in the **Enter Password** field.
- Step 8** Click the **Apply** button.
- Step 9** In the **Peer** section, click the **Add** button.
- Step 10** Enter an IP address in the **Peer IP** field.
- Step 11** Enter an IP address in the **Source IP** field.
- Step 12** Choose any one of the available types from the **Password** drop-down list.
- Step 13** Choose any one of the available types from the **Mode of Local Device** drop-down list.
- Step 14** Click the **Save & Apply to Device** button.
- Step 15** In the **AP** tab, click the **Add** button. The **Add SXP AP** dialog box appears.
- Step 16** Enter a name for the profile in the **Profile Name** field.
- Step 17** Set the **Status** field to **Enabled** to enable AP.
- Step 18** Enter a value in the **Default Password** field.
- Step 19** Enter a value (in seconds) for the **CTS Speaker Seconds**, **CTS Recon Period**, **CTS Retry Period**, **CTS Listener Maximum**, and **CTS Listener Minimum**.
- Step 20** In the **CTS SXP Profile Connections** section, click **Add**.
- Step 21** Enter an IP address in the **Peer IP** field.
- Step 22** Choose any one of the modes from the **Connection Mode** drop-down list. The available modes are **Both**, **Listener**, and **Speaker**.
- Step 23** From the **Password Type** drop-down list, choose either **None** or **Default**.
- Step 24** Click the **Add** button.
- Step 25** Click the **Save & Apply to Device** button.
- 

## Configuring an SXP Connection

Follow the procedure given below to configure an SXP connection:

### Procedure

	Command or Action	Purpose
<b>Step 1</b>	<b>configure terminal</b>  <b>Example:</b>	Enters global configuration mode.

	Command or Action	Purpose
	Device# configure terminal	
<b>Step 2</b>	<b>cts sxp enable</b> <b>Example:</b> Device(config)# cts sxp enable	Enables CTS SXP support.
<b>Step 3</b>	<b>cts sxp connection peer ipv4-address password none mode local speaker</b> <b>Example:</b> Device(config)# cts sxp connection peer 1.1.1.1 password none mode local speaker	Configures the CTS-SXP peer address connection.  <b>Note</b> The password need not be <i>none</i> always and the mode can either be Speaker or Listener, or Both.

### What to do next

Use the following command to verify the configuration:

```
Device# show running-config | inc sxp
```

## Verifying SGT Push to Access Points

When a wireless client is connected and authenticated by ISE, the IP-SGT binding is generated on the controller. This can be verified using the following commands:

```
Device# show cts role-based sgt-map all
```

```
Active IPv4-SGT Bindings Information

IP Address          SGT      Source
=====
1.1.1.1             100      CLI

IP-SGT Active Bindings Summary
=====
Total number of CLI      bindings = 1
Total number of active  bindings = 1
```

Use the following command to verify the SXP connections status:

```
Device# show cts sxp connections

SXP                : Enabled
Highest Version Supported: 4
Default Password  : Not Set
Default Source IP: Not Set
Connection retry open period: 120 secs
Reconcile period: 120 secs
Retry open timer is running
Peer-Sequence traverse limit for export: Not Set
Peer-Sequence traverse limit for import: Not Set
-----
Peer IP           : 40.1.1.1
Source IP         : 40.1.1.2
Conn status       : On
Conn version      : 4
```

```

Conn capability : IPv4-IPv6-Subnet
Conn hold time : 120 seconds
Local mode     : SXP Listener
Connection inst# : 1
TCP conn fd    : 1
TCP conn password: none
Hold timer is running
Duration since last state change: 0:00:00:06 (dd:hr:mm:sec)

```

Total num of SXP Connections = 1

Use the following command to see the bindings learnt over SXP connection:

```
Device# show cts role-based sgt-map all
```

Active IPv4-SGT Bindings Information

```

IP Address          SGT      Source
=====
1.1.1.1             100     CLI

```

IP-SGT Active Bindings Summary

```

=====
Total number of CLI      bindings = 1
Total number of active  bindings = 1

```

Use the following commands on the AP to check the status of inline tagging on the AP and its IP-SGT bindings:

```
AP# show capwap client rcb
```

```

AdminState           : ADMIN_ENABLED
OperationState       : UP
Name                 : AP2C33.1185.C4D0
SwVer                : 16.6.230.41
HwVer                : 1.0.0.0
MwarApMgrIp         : 9.3.72.38
MwarName             : mohit-ewlc
MwarHwVer            : 0.0.0.0
Location             : default location
ApMode               : FlexConnect
ApSubMode            : Not Configured
CAPWAP Path MTU     : 1485
CAPWAP UDP-Lite     : Enabled
IP Prefer-mode       : IPv4
AP Link DTLS Encryption : OFF
AP TCP MSS Adjust   : Disabled
LinkAuditing         : disabled
Efficient Upgrade State : Disabled
Flex Group Name      : anrt-flex
AP Group Name        : default-group
Cisco Trustsec Config
  AP Inline Tagging Mode      : Enabled
! The status can be Enabled or Disabled and is based on the tag that is pushed to the AP.
  AP Sgacl Enforcement        : Disabled
  AP Override Status          : Disabled

```

```
AP# show cts role-based sgt-map all
```

Active IPv4-SGT Bindings Information

```

IP SGT SOURCE
9.3.74.101 17 LOCAL

```

```
IP-SGT Active Bindings Summary
=====
Total number of LOCAL   bindings = 1
Total number of active  bindings = 1

Active IPv6-SGT Bindings Information
      IP SGT SOURCE
fe80::c1d5:3da2:dc96:757d 17 LOCAL

IP-SGT Active Bindings Summary
=====
Total number of LOCAL   bindings = 1
Total number of active  bindings = 1
```





# CHAPTER 128

## Multiple Cipher Support

- [Default Ciphersuites Supported for CAPWAP-DTLS, on page 1167](#)
- [Configuring Multiple Ciphersuites, on page 1168](#)
- [Setting Server Preference, on page 1169](#)
- [Verifying Operational Ciphersuites and Priority, on page 1169](#)

## Default Ciphersuites Supported for CAPWAP-DTLS

From Cisco IOS XE Bengaluru 17.5.1, Elliptic Curve Diffie-Hellman Ephemeral (ECDHE)/Galois Counter Mode (GCM) ciphersuite with perfect forward secrecy (PFS) capability is added in the default list along with the existing AES128-SHA ciphersuite. All Cisco access point (AP) models, except the Cisco IOS APs, will prioritize this PFS ciphersuite for CAPWAP-DTLS under default configuration.



**Note** If link encryption is enabled to secure data channel traffic, then the AP (DTLS client) will prioritize AES128-SHA over ECDHE/GCM ciphersuite.

During DTLS handshake, the preference order of the ciphersuites are important. This feature allows you to set the order of priority while configuring cipher suites.

When explicit ciphersuites are not configured, default ciphersuites that are listed in the table below are applied.

**Table 58: Default Ciphersuites**

Security Mode	Ciphersuite
FIPS and non-FIPS	<ul style="list-style-type: none"><li>• TLS_ECDHE_RSA_WITH_AES_128_GCM_SHA256</li><li>• TLS_ECDHE_ECDSA_WITH_AES_128_GCM_SHA256</li><li>• TLS_RSA_WITH_AES_128_CBC_SHA</li></ul>

Security Mode	Ciphersuite
WLANCC	<ul style="list-style-type: none"> <li>• TLS_DHE_RSA_WITH_AES_128_CBC_SHA</li> <li>• TLS_DHE_RSA_WITH_AES_256_CBC_SHA</li> <li>• TLS_DHE_RSA_WITH_AES_256_CBC_SHA256</li> <li>• TLS_ECDHE_ECDSA_WITH_AES_128_GCM_SHA256</li> <li>• TLS_ECDHE_ECDSA_WITH_AES_256_GCM_SHA384</li> <li>• TLS_ECDHE_RSA_WITH_AES_128_GCM_SHA256</li> </ul>

This feature is supported on all variants of the Cisco Catalyst 9800 Series Wireless Controllers and APs, except Cisco Industrial Wireless 3702 Access Point.

For a list of controllers and APs supported in a particular release, see the release notes available at: <https://www.cisco.com/c/en/us/support/wireless/catalyst-9800-series-wireless-controllers/products-release-notes-list.html>

## Configuring Multiple Ciphersuites



### Note

### Procedure

	Command or Action	Purpose
<b>Step 1</b>	<b>configure terminal</b>  <b>Example:</b> Device# configure terminal	Enters global configuration mode.
<b>Step 2</b>	<b>ap dtls-ciphersuite priority <i>priority-num</i> <i>ciphersuite</i></b>  <b>Example:</b> Device(config)# ap dtls-ciphersuite priority 2 TLS_DHE_RSA_WITH_AES_128_CBC_SHA	Sets priority for a particular cipher suite. Use zero (0) to set the highest priority.  <b>Note</b> Configuration changes, if any, will automatically disconnect the existing APs.
<b>Step 3</b>	<b>exit</b>  <b>Example:</b> Device(config)# exit	Returns to privileged EXEC mode.

## Setting Server Preference

Ciphersuite configuration enforces the priority order in a DTLS handshake. To give equal priority for all the configured ciphersuites, then use **no ciphersuite server-preference** command in the corresponding AP join profile. By default, server preference is enabled.

### Procedure

	Command or Action	Purpose
<b>Step 1</b>	<b>configure terminal</b>  <b>Example:</b> Device# configure terminal	Enters global configuration mode.
<b>Step 2</b>	<b>ap profile profile-name</b>  <b>Example:</b> Device(config)# ap profile xxy	Configures an AP profile and enters AP profile configuration mode.
<b>Step 3</b>	<b>[no] ciphersuite server-preference</b>  <b>Example:</b> Device(config-ap-profile)# [no] ciphersuite server-preference	Sets the cipher suite server preference.  Use the <b>no</b> form of this command to disable server preference. By default, server preference is enabled.
<b>Step 4</b>	<b>exit</b>  <b>Example:</b> Device(config)# exit	Returns to global configuration mode.

## Verifying Operational Ciphersuites and Priority

To view the operational ciphersuites and their priority, use the following command:

```
Device# show wireless certification config
```

```
WLANCC                : Not Configured
AP DTLS Version        : DTLS v1.0 - v1.2
```

```
AP DTLS Cipher Suite List:
```

```
Priority                Ciphersuite
-----
0                       AES128-SHA
1                       DHE-RSA-AES256-SHA256
```





## CHAPTER 129

# Configuring Secure Shell

- [Information About Configuring Secure Shell](#) , on page 1171
- [Prerequisites for Configuring Secure Shell](#), on page 1173
- [Restrictions for Configuring Secure Shell](#), on page 1174
- [How to Configure SSH](#), on page 1175
- [Monitoring the SSH Configuration and Status](#), on page 1177

## Information About Configuring Secure Shell

Secure Shell (SSH) is a protocol that provides a secure, remote connection to a device. SSH provides more security for remote connections than Telnet does by providing strong encryption when a device is authenticated. This software release supports SSH Version 1 (SSHv1) and SSH Version 2 (SSHv2).

### SSH and Device Access

Secure Shell (SSH) is a protocol that provides a secure, remote connection to a device. SSH provides more security for remote connections than Telnet does by providing strong encryption when a device is authenticated. This software release supports SSH Version 1 (SSHv1) and SSH Version 2 (SSHv2).

SSH functions the same in IPv6 as in IPv4. For IPv6, SSH supports IPv6 addresses and enables secure, encrypted connections with remote IPv6 nodes over an IPv6 transport.

### SSH Servers, Integrated Clients, and Supported Versions

The Secure Shell (SSH) Integrated Client feature is an application that runs over the SSH protocol to provide device authentication and encryption. The SSH client enables a Cisco device to make a secure, encrypted connection to another Cisco device or to any other device running the SSH server. This connection provides functionality similar to that of an outbound Telnet connection except that the connection is encrypted. With authentication and encryption, the SSH client allows for secure communication over an unsecured network.

The SSH server and SSH integrated client are applications that run on the switch. The SSH server works with the SSH client supported in this release and with non-Cisco SSH clients. The SSH client works with publicly and commercially available SSH servers. The SSH client supports the ciphers of Data Encryption Standard (DES), 3DES, and password authentication.

The switch supports an SSHv1 or an SSHv2 server.

The switch supports an SSHv1 client.



---

**Note** The SSH client functionality is available only when the SSH server is enabled.

---

User authentication is performed like that in the Telnet session to the device. SSH also supports the following user authentication methods:

- TACACS+
- RADIUS
- Local authentication and authorization

## SSH Configuration Guidelines

Follow these guidelines when configuring the switch as an SSH server or SSH client:

- An RSA key pair generated by a SSHv1 server can be used by an SSHv2 server, and the reverse.
- If the SSH server is running on an active switch and the active switch fails, the new active switch uses the RSA key pair generated by the previous active switch.
- If you get CLI error messages after entering the **crypto key generate rsa** global configuration command, an RSA key pair has not been generated. Reconfigure the hostname and domain, and then enter the **crypto key generate rsa** command.
- When generating the RSA key pair, the message No host name specified might appear. If it does, you must configure a hostname by using the **hostname** global configuration command.
- When generating the RSA key pair, the message No domain specified might appear. If it does, you must configure an IP domain name by using the **ip domain-name** global configuration command.
- When configuring the local authentication and authorization authentication method, make sure that AAA is disabled on the console.

## Secure Copy Protocol Overview

The Secure Copy Protocol (SCP) feature provides a secure and authenticated method for copying switch configurations or switch image files. SCP relies on Secure Shell (SSH), an application and a protocol that provides a secure replacement for the Berkeley r-tools.

For SSH to work, the switch needs an RSA public/private key pair. This is the same with SCP, which relies on SSH for its secure transport.

Because SSH also relies on AAA authentication, and SCP relies further on AAA authorization, correct configuration is necessary.

- Before enabling SCP, you must correctly configure SSH, authentication, and authorization on the switch.
- Because SCP relies on SSH for its secure transport, the router must have an Rivest, Shamir, and Adelman (RSA) key pair.



**Note** When using SCP, you cannot enter the password into the copy command. You must enter the password when prompted.

## Secure Copy Protocol

The Secure Copy Protocol (SCP) feature provides a secure and authenticated method for copying device configurations or switch image files. The behavior of SCP is similar to that of remote copy (rcp), which comes from the Berkeley r-tools suite, except that SCP relies on SSH for security. SCP also requires that authentication, authorization, and accounting (AAA) authorization be configured so the device can determine whether the user has the correct privilege level. To configure the Secure Copy feature, you should understand the SCP concepts.

## SFTP Support

SFTP client support is introduced from Cisco IOS XE Gibraltar 16.10.1 release onwards. SFTP client is enabled by default and no separate configuration required.

The SFTP procedures can be invoked using the **copy** command, which is similar to that of **scp** and **tftp** commands. A typical file download procedure using **sftp** command can be carried out as shown below:

```
copy sftp://user :password @server-ip/file-name flash0:// file-name
```

For more details on the **copy** command, see the following URL:

[https://www.cisco.com/c/m/en\\_us/techdoc/dc/reference/cli/nxos/commands/fund/copy.html](https://www.cisco.com/c/m/en_us/techdoc/dc/reference/cli/nxos/commands/fund/copy.html)

## Prerequisites for Configuring Secure Shell

The following are the prerequisites for configuring the switch for secure shell (SSH):

- For SSH to work, the switch needs an Rivest, Shamir, and Adleman (RSA) public/private key pair. This is the same with Secure Copy Protocol (SCP), which relies on SSH for its secure transport.
- Before enabling SCP, you must correctly configure SSH, authentication, and authorization on the switch.
- Because SCP relies on SSH for its secure transport, the router must have an Rivest, Shamir, and Adelman (RSA) key pair.
- SCP relies on SSH for security.
- SCP requires that authentication, authorization, and accounting (AAA) authorization be configured so the router can determine whether the user has the correct privilege level.
- A user must have appropriate authorization to use SCP.
- A user who has appropriate authorization can use SCP to copy any file in the Cisco IOS File System (IFS) to and from a switch by using the **copy** command. An authorized administrator can also do this from a workstation.
- The Secure Shell (SSH) server requires an IPsec (Data Encryption Standard [DES] or 3DES) encryption software image; the SSH client requires an IPsec (DES or 3DES) encryption software image.)

- Configure a hostname and host domain for your device by using the **hostname** and **ip domain-name** commands in global configuration mode.



**Note** While upgrading from 16.11 to a later version, if you encounter a host key change by SSH client, you need to know the following:

- Wave 2 AP now supports a third key type ED25519 along with the RSA and ECDSA keys.
- The RSA and ECDSA keys are used for normal operations.
- The ED25519 key is used for FIPS mode.

## Restrictions for Configuring Secure Shell

The following are restrictions for configuring the device for secure shell.

- From Cisco IOS XE Dublin 17.10.x, Key Exchange and MAC algorithms like diffie-hellman-group14-sha1, hmac-sha1, hmac-sha2-256, and hmac-sha2-512 are not supported by default and it may impact some SSH clients that only support these algorithms. However, you can add them manually if required. For information on manually adding these algorithms, see the **SSH Algorithms for Common Criteria Certification** document available at: [https://www.cisco.com/c/en/us/td/docs/routers/ios/config/17-x/sec-vpn/b-security-vpn/m\\_sec-secure-shell-algorithm-ccc.html](https://www.cisco.com/c/en/us/td/docs/routers/ios/config/17-x/sec-vpn/b-security-vpn/m_sec-secure-shell-algorithm-ccc.html)
- The switch supports Rivest, Shamir, and Adelman (RSA) authentication.
- SSH supports only the execution-shell application.
- The SSH server and the SSH client are supported only on Data Encryption Standard (DES) (56-bit) and 3DES (168-bit) data encryption software. In DES software images, DES is the only encryption algorithm available. In 3DES software images, both DES and 3DES encryption algorithms are available.
- The device supports the Advanced Encryption Standard (AES) encryption algorithm with a 128-bit key, 192-bit key, or 256-bit key. However, symmetric cipher AES to encrypt the keys is not supported.
- When using SCP, you cannot enter the password into the **copy** command. You must enter the password when prompted.
- The login banner is not supported in Secure Shell Version 1. It is supported in Secure Shell Version 2.
- The **-l** keyword and **userid : {number} {ip-address}** delimiter and arguments are mandatory when configuring the alternative method of Reverse SSH for console access.
- To authenticate clients with FreeRADIUS over RADSEC, you should generate an RSA key longer than 1024 bit. Use the **crypto key generate rsa general-keys exportable label label-name** command to achieve this.



# How to Configure SSH

## Setting Up the Device to Run SSH

Follow the procedure given below to set up your device to run SSH:

### Before you begin

Configure user authentication for local or remote access.

### Procedure

	Command or Action	Purpose
<b>Step 1</b>	<b>configure terminal</b> <b>Example:</b> Device# <b>Device# configure terminal</b>	Enters global configuration mode.
<b>Step 2</b>	<b>hostname <i>hostname</i></b> <b>Example:</b> Device(config)# <b>hostname your_hostname</b>	Configures a hostname and IP domain name for your device.  <b>Note</b> Follow this procedure only if you are configuring the device as an SSH server.
<b>Step 3</b>	<b>ip domain name <i>domain_name</i></b> <b>Example:</b> Device(config)# <b>ip domain name your_domain</b>	Configures a host domain for your device.
<b>Step 4</b>	<b>crypto key generate rsa</b> <b>Example:</b> Device(config)# <b>crypto key generate rsa</b>	Enables the SSH server for local and remote authentication on the device and generates an RSA key pair. Generating an RSA key pair for the device automatically enables SSH.  We recommend that a minimum modulus size of 1024 bits.  When you generate RSA keys, you are prompted to enter a modulus length. A longer modulus length might be more secure, but it takes longer to generate and to use.  <b>Note</b> Follow this procedure only if you are configuring the device as an SSH server.

	Command or Action	Purpose
<b>Step 5</b>	<b>end</b>  <b>Example:</b> Device(config)# <b>end</b>	Exits configuration mode.

## Configuring the SSH Server

Follow the procedure given below to configure the SSH server:



**Note** This procedure is only required if you are configuring the device as an SSH server.

### Procedure

	Command or Action	Purpose
<b>Step 1</b>	<b>configure terminal</b>  <b>Example:</b> Device# <b>configure terminal</b>	Enters global configuration mode.
<b>Step 2</b>	<b>ip ssh version [2]</b>  <b>Example:</b> Device(config)# <b>ip ssh version 2</b>	(Optional) Configures the device to run SSH Version 2.  If you do not enter this command or do not specify a keyword, the SSH server selects the latest SSH version supported by the SSH client.
<b>Step 3</b>	<b>ip ssh window-size</b>  <b>Example:</b> Device(config)# <b>ip ssh window-size</b>	Specifies the SSH window size. The recommended window size is 32K or lesser than that. The default window size is 8912.  Selecting <b>window-size</b> greater than 32K might have some impact on the CPU, until unless: <ul style="list-style-type: none"> <li>• The network bandwidth is good.</li> <li>• Client can accommodate this size.</li> <li>• No latency in network.</li> </ul> <b>Note</b> This CLI is recommended only for SCP operations and can be disabled once the copy is done.
<b>Step 4</b>	<b>ip ssh {timeout <i>seconds</i>   authentication-retries <i>number</i>}</b>  <b>Example:</b> Device(config)# <b>ip ssh timeout 90</b>	Configures the SSH control parameters: <ul style="list-style-type: none"> <li>• Specify the time-out value in seconds; the default is 120 seconds. The range is 0 to 120 seconds. This parameter applies to the SSH negotiation phase. After the</li> </ul>

	Command or Action	Purpose
	<code>authentication-retries 2</code>	<p>connection is established, the device uses the default time-out values of the CLI-based sessions.</p> <p>By default, up to five simultaneous, encrypted SSH connections for multiple CLI-based sessions over the network are available (session 0 to session 4). After the execution shell starts, the CLI-based session time-out value returns to the default of 10 minutes.</p> <ul style="list-style-type: none"> <li>Specify the number of times that a client can re-authenticate to the server. The default is 3; the range is 0 to 5.</li> </ul> <p>Repeat this step when configuring both parameters.</p>
<b>Step 5</b>	<p>Use one or both of the following:</p> <ul style="list-style-type: none"> <li><code>line vty line_number [ending_line_number]</code></li> <li><code>transport input ssh</code></li> </ul> <p><b>Example:</b></p> <p>Device(config)# <code>line vty 1 10</code></p> <p>or</p> <p>Device(config-line)# <code>transport input ssh</code></p>	<p>(Optional) Configures the virtual terminal line settings.</p> <ul style="list-style-type: none"> <li>Enters line configuration mode to configure the virtual terminal line settings. For <code>line_number</code> and <code>ending_line_number</code>, specify a pair of lines. The range is 0 to 15.</li> <li>Specifies that the device prevent non-SSH Telnet connections. This limits the router to only SSH connections.</li> </ul>
<b>Step 6</b>	<p><code>end</code></p> <p><b>Example:</b></p> <p>Device(config-line)# <code>end</code></p>	Returns to privileged EXEC mode.

## Monitoring the SSH Configuration and Status

This table displays the SSH server configuration and status.

*Table 59: Commands for Displaying the SSH Server Configuration and Status*

Command	Purpose
<code>show ip ssh</code>	Shows the version and configuration information for the SSH server.

Command	Purpose
show ssh	Shows the status of the SSH server.



## CHAPTER 130

# Encrypted Traffic Analytics

---

- [Information About Encrypted Traffic Analytics, on page 1179](#)
- [Exporting Records to IPv4 Flow Export Destination, on page 1180](#)
- [Exporting Records to IPv6 Flow Export Destination, on page 1181](#)
- [Exporting Records to IPv4 and IPv6 Destination over IPFIX, on page 1181](#)
- [Allowed List of Traffic, on page 1182](#)
- [Configuring Source Interface for Record Export, on page 1183](#)
- [Configuring Source Interface for Record Export Without IPFIX, on page 1184](#)
- [Configuring ETA Flow Export Destination \(GUI\), on page 1185](#)
- [Enabling In-Active Timer, on page 1185](#)
- [Enabling ETA on WLAN Policy Profile, on page 1186](#)
- [Attaching Policy Profile to VLAN \(GUI\), on page 1187](#)
- [Attaching Policy Profile to VLAN, on page 1187](#)
- [Verifying ETA Configuration, on page 1188](#)

## Information About Encrypted Traffic Analytics

The Encrypted Traffic Analytics (ETA) leverages Flexible NetFlow (FNF) technology to export useful information about the flow to the collectors and gain visibility into the network.

Figure 34: Encrypted Traffic Analytics Deployed on Cisco Catalyst 9800 Series Wireless Controller in Local Mode

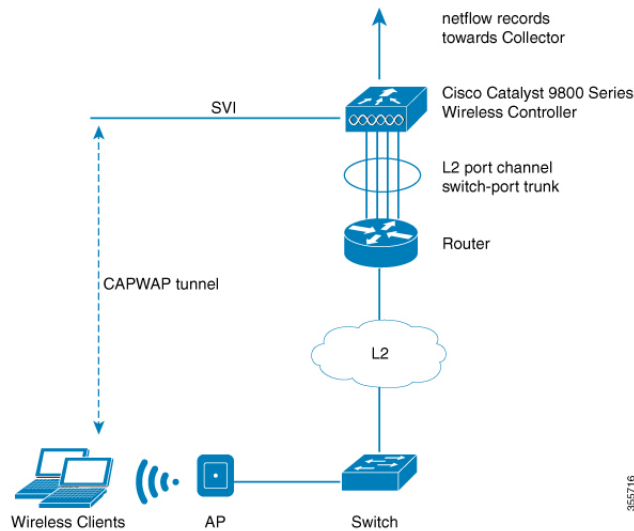

The wireless clients send data packets to the access point. The packets are then CAPWAP encapsulated and sent to the controller. This means that the actual client data is in the CAPWAP payload. To apply ETA on the client data, you need to strip the CAPWAP header before handing over the packet to the ETA module.

The ETA offers the following advantages:

- Enhanced telemetry based threat analytics.
- Analytics to identify malware.

Starting from Cisco IOS XE Amsterdam 17.1.1s, ETA inspection for IPv6 traffic is supported. ETA inspection for IPv6 traffic is enabled by default and no special configuration is required. This release also supports allowed list of IPv6 traffic, exporting ETA records to IPv4 or IPv6 export destination, exporting records over IPFIX (NetFlow v10), and configuring source interface for ETA exports. The records can be exported to IPv4 or IPv6 NetFlow collector.

## Exporting Records to IPv4 Flow Export Destination

Follow the procedure given below to enable encrypted traffic analytics and configure a flow export destination:

### Procedure

	Command or Action	Purpose
<b>Step 1</b>	<b>configure terminal</b> <b>Example:</b> Device# configure terminal	Enters the global configuration mode.
<b>Step 2</b>	<b>et-analytics</b> <b>Example:</b> Device(config)# et-analytics	Enables encrypted traffic analytics.

	Command or Action	Purpose
<b>Step 3</b>	<b>ip flow-export destination</b> <i>ip_address</i> <i>port_number</i> <b>Example:</b> Device(config-et-analytics)# ip flow-export destination 120.0.0.1 2055	Configures the NetFlow record export. Here, <i>port_number</i> ranges from 1 to 65535.
<b>Step 4</b>	<b>end</b> <b>Example:</b> Device(config-et-analytics)# end	Returns to privileged EXEC mode.

## Exporting Records to IPv6 Flow Export Destination

Follow the procedure given below to enable encrypted traffic analytics and configure an IPv6 flow export destination.

### Procedure

	Command or Action	Purpose
<b>Step 1</b>	<b>configure terminal</b> <b>Example:</b> Device# configure terminal	Enters the global configuration mode.
<b>Step 2</b>	<b>et-analytics</b> <b>Example:</b> Device(config)# et-analytics	Enables encrypted traffic analytics.
<b>Step 3</b>	<b>ipv6 flow-export destination</b> <i>ipv6-address</i> <i>port-number</i> <b>Example:</b> Device(config-et-analytics)# ipv6 flow-export destination 2001:181:181::1 2055	Specifies netflow record export destination IPv6 address and port. <b>Note</b> The maximum configurable limit for flow-export destinations is four (both IPv4 and IPv6 combined).
<b>Step 4</b>	<b>exit</b> <b>Example:</b> Device(config-et-analytics)# exit	Returns to global configuration mode.

## Exporting Records to IPv4 and IPv6 Destination over IPFIX

This procedure provides efficient bandwidth utilization by allowing variable len fields for smaller data packets and also reduces the overall bandwidth requirements for transmission.

**Procedure**

	<b>Command or Action</b>	<b>Purpose</b>
<b>Step 1</b>	<b>configure terminal</b> <b>Example:</b> Device# configure terminal	Enters the global configuration mode.
<b>Step 2</b>	<b>et-analytics</b> <b>Example:</b> Device(config)# et-analytics	Enables encrypted traffic analytics.
<b>Step 3</b>	<b>ip flow-export destination <i>ip-address</i>  <i>port-number</i> ipfix</b> <b>Example:</b> Device(config-et-analytics)# ip flow-export destination 192.168.19.2 2055 ipfix	Specifies NetFlow record export destination IP address, port and format.
<b>Step 4</b>	<b>ipv6 flow-export destination <i>ipv6-address</i>  <i>port-number</i> ipfix</b> <b>Example:</b> Device(config-et-analytics)# ipv6 flow-export destination 2001:181:181::1 2055 ipfix	Specifies NetFlow record export destination IPv6 address, port and format.  IPFIX allows you to collect flow information from network devices that support IPFIX protocol and analyze the traffic flow information by processing it through a netflow analyzer.  <b>Note</b> Maximum configurable limit for flow-export destinations is four (both IPv4 and IPv6 combined).
<b>Step 5</b>	<b>exit</b> <b>Example:</b> Device(config-et-analytics)# exit	Returns to global configuration mode.

## Allowed List of Traffic

You can add an allowed list of ACLs for both IPv4 and IPv6 traffic. Traffic from allowed list is skipped from ETA inspection and records are not generated for the matching traffic.

**Before you begin**

Configure an IPv4 or IPv6 access list.

- IPv4 ACL: **ip access-list standard *acl\_name***

```
Device(config)# ip access-list standard eta-whitelist_ipv4
```

- IPv6 ACL: **ipv6 access-list *acl\_name***

```
Device(config)# ipv6 access-list eta-whitelist_ipv6
```



## Procedure

	Command or Action	Purpose
<b>Step 1</b>	<b>configure terminal</b> <b>Example:</b> Device# configure terminal	Enters the global configuration mode.
<b>Step 2</b>	<b>et-analytics</b> <b>Example:</b> Device(config)# et-analytics	Enables encrypted traffic analytics.
<b>Step 3</b>	<b>whitelist acl <i>acl-name</i></b> <b>Example:</b> Device(config-et-analytics)# whitelist acl eta-whitelist	Configures an allowed list for IPv4 or IPv6. <b>Note</b> You cannot add both IPv4 and IPv6 client traffic simultaneously to an allowed list, as a single ACL cannot have both IPv4 and IPv6 terms.
<b>Step 4</b>	<b>exit</b> <b>Example:</b> Device(config-et-analytics)# exit	Returns to global configuration mode.
<b>Step 5</b>	<b>sequence <i>sequence-num</i> permit udp any any eq tftp</b> <b>Example:</b> Device(config-ipv6-acl)# sequence 10 permit udp any any eq tftp	(Optional) Configures a sequence number and the access conditions to add any IPv6 TFTP traffic to allowed list.

## Configuring Source Interface for Record Export

## Procedure

	Command or Action	Purpose
<b>Step 1</b>	<b>configure terminal</b> <b>Example:</b> Device# configure terminal	Enters the global configuration mode.
<b>Step 2</b>	<b>et-analytics</b> <b>Example:</b> Device(config)# et-analytics	Enables encrypted traffic analytics.
<b>Step 3</b>	<b>ip flow-export destination <i>ip-address</i></b> <b>source-interface <i>interface-name</i></b> <b><i>interface-number</i> ipfix</b> <b>Example:</b>	Specifies NetFlow record export destination IP address, source interface and format.  This allows the ETA export to use the IP address of the specified interface, as against

	Command or Action	Purpose
	<pre>Device(config-et-analytics)# ip flow-export destination 192.168.19.2 2055  source-interface loopback0 ipfix</pre>	<p>using the IP address of the egress interface as the source address.</p> <p>The source interface is applicable for both IPv4 and IPv6 export destinations.</p> <p><b>Note</b> Only one source interface can be specified and all exports use this source address.</p>
<b>Step 4</b>	<p><b>ipv6 flow-export destination</b> <i>ipv6-address</i>  <b>source-interface</b> <i>interface-name</i>  <i>interface-number</i> <b>ipfix</b></p> <p><b>Example:</b></p> <pre>Device(config-et-analytics)# ipv6 flow-export destination 2001:181:181::1 2055 source-interface Vlan160 ipfix</pre>	Specifies NetFlow record export destination IPv6 address, source interface and format.
<b>Step 5</b>	<p><b>exit</b></p> <p><b>Example:</b></p> <pre>Device(config-et-analytics)# exit</pre>	Returns to global configuration mode.

## Configuring Source Interface for Record Export Without IPFIX

### Procedure

	Command or Action	Purpose
<b>Step 1</b>	<p><b>configure terminal</b></p> <p><b>Example:</b></p> <pre>Device# configure terminal</pre>	Enters the global configuration mode.
<b>Step 2</b>	<p><b>et-analytics</b></p> <p><b>Example:</b></p> <pre>Device(config)# et-analytics</pre>	Enables encrypted traffic analytics.
<b>Step 3</b>	<p><b>ip flow-export destination</b> <i>ip-address</i>  <b>source-interface</b> <i>interface-name</i>  <i>interface-number</i></p> <p><b>Example:</b></p> <pre>Device(config-et-analytics)# ip flow-export destination 192.168.19.2 2055  source-interface loopback0 ipfix</pre>	Specifies NetFlow record export destination IP address, source interface and format.

	Command or Action	Purpose
<b>Step 4</b>	<b>ipv6 flow-export destination</b> <i>ipv6-address</i> <b>source-interface</b> <i>interface-name</i> <i>interface-number</i> <b>ipfix</b>  <b>Example:</b> <pre>Device(config-et-analytics)# ipv6 flow-export destination 2001:181:181::1 2055 source-interface Vlan160</pre>	Specifies NetFlow record export destination IPv6 address, source interface and format.
<b>Step 5</b>	<b>exit</b>  <b>Example:</b> <pre>Device(config-et-analytics)# exit</pre>	Returns to global configuration mode.

## Configuring ETA Flow Export Destination (GUI)

### Procedure

- 
- Step 1** Choose **Configuration > Services > NetFlow**.
- Step 2** Click the **Add** button. The **Create NetFlow** dialog box appears.
- Step 3** Choose any one of the available templates from the **NetFlow Template** drop-down list.
- Step 4** Enter an IPv4 or IPv6 address in the **Collector Address** field.
- Step 5** From the **Whitelist ACL** drop-down list, choose the desired option.
- Note** To use this option, ensure that you select **Encrypted Traffic Analytics** from the **NetFlow Template** drop-down list.
- Step 6** Enter a port number in the **Exporter Port** field. You must specify a value between 1 and 65535.
- Step 7** Choose the desired option from the **Export Interface IP** drop-down list.
- Step 8** Choose any one of the sampling methods from the **Sampling Method** drop-down list. The available options are **Deterministic**, **Random**, and **Full Netflow**.
- Step 9** Enter a range for the sample. You must specify a value between 32 and 1032.
- Step 10** Select the required interfaces/profile from the **Available** pane and move it to the **Selected** pane.
- Step 11** Click the **Save & Apply to Device** button.
- 

## Enabling In-Active Timer

Follow the procedure given below to enable in-active timer:

**Procedure**

	Command or Action	Purpose
<b>Step 1</b>	<b>configure terminal</b> <b>Example:</b> Device# configure terminal	Enters the global configuration mode.
<b>Step 2</b>	<b>et-analytics</b> <b>Example:</b> Device(config)# et-analytics	Configures the encrypted traffic analytics.
<b>Step 3</b>	<b>inactive-timeout <i>timeout-in-seconds</i></b> <b>Example:</b> Device(config-et-analytics)# inactive-timeout 15	Specifies the inactive flow timeout value.  Here, <i>timeout-in-seconds</i> ranges from 1 to 604800.
<b>Step 4</b>	<b>end</b> <b>Example:</b> Device(config-et-analytics)# end	Returns to privileged EXEC mode. Alternatively, you can also press Ctrl-Z to exit global configuration mode.

## Enabling ETA on WLAN Policy Profile

Follow the procedure given below to enable ETA on WLAN policy profile:

**Procedure**

	Command or Action	Purpose
<b>Step 1</b>	<b>configure terminal</b> <b>Example:</b> Device# configure terminal	Enters the global configuration mode.
<b>Step 2</b>	<b>wireless profile policy <i>profile-name</i></b> <b>Example:</b> Device(config)# wireless profile policy default-policy-profile	Creates policy profile for the WLAN.  The <i>profile-name</i> is the profile name of the policy profile.
<b>Step 3</b>	<b>et-analytics enable</b> <b>Example:</b> Device(config-wireless-policy)# et-analytics enable	Enables encrypted traffic analytics on the policy.
<b>Step 4</b>	<b>end</b> <b>Example:</b> Device(config-wireless-policy)# end	Returns to privileged EXEC mode. Alternatively, you can also press <b>Ctrl-Z</b> to exit global configuration mode.

## Attaching Policy Profile to VLAN (GUI)

Perform the following steps to attach a policy profile to VLAN.

### Procedure

- 
- Step 1** Check the **RADIUS Profiling** checkbox.
  - Step 2** From the **Local Subscriber Policy Name**, choose the required policy name.
  - Step 3** In the **WLAN Local Profiling** section, enable or disable the **Global State of Device Classification**, check the checkbox for **HTTP TLV Caching** and **DHCL TLV Caching**.
  - Step 4** In the **VLAN** section, choose the **VLAN/VLAN Group** from the drop-down list. Enter the Multicast VLAN.
  - Step 5** In the **WLAN ACL** section, choose the **IPv4 ACL** and **IPv6 ACL** from the drop-down list.
  - Step 6** In the **URL Filters** section, choose the **Pre Auth** and **Post Auth** from the drop-down list.
  - Step 7** Click **Save & Apply to Device**.
- 

## Attaching Policy Profile to VLAN

Follow the procedure given below to attach a policy profile to VLAN:

### Procedure

	Command or Action	Purpose
<b>Step 1</b>	<b>configure terminal</b>  <b>Example:</b> Device# configure terminal	Enters the global configuration mode.
<b>Step 2</b>	<b>wireless profile policy <i>profile-name</i></b>  <b>Example:</b> Device(config)# wireless profile policy default-policy-profile	Creates policy profile for the WLAN.  The <i>profile-name</i> is the profile name of the policy profile.
<b>Step 3</b>	<b>vlan <i>vlan-name</i></b>  <b>Example:</b> Device(config-wireless-policy)# vlan vlan-name	Assigns the policy profile to the VLANs.
<b>Step 4</b>	<b>no shutdown</b>  <b>Example:</b> Device(config-wireless-policy)# no shutdown	Enables the wireless policy profile.

# Verifying ETA Configuration

## Verifying ETA Globally

To view the ETA global and interface details, use the following command:

```
Device# show platform software utd chassis active F0 et-analytics global

ET Analytics Global Configuration
ID: 1
All Interfaces: Off
IP address and port and vrf: 192.168.5.2:2055:0
```

To view the ETA global configuration, use the following command:

```
Device# show platform software et-analytics global

ET-Analytics Global state
=====
All Interfaces      : Off
IP Flow-record Destination: 192.168.5.2 : 2055
Inactive timer: 15
```



---

**Note** The `show platform software et-analytics global` command does not display the ETA enabled wireless client interfaces.

---

To view the ETA global state in datapath, use the following command:

```
Device# show platform hardware chassis active qfp feature et-analytics datapath runtime

ET-Analytics run-time information:

Feature state: initialized (0x00000004)
Inactive timeout      : 15 secs (default 15 secs)
WhiteList information :
  flag: False
  cgacl w0 : n/a
  cgacl w1 : n/a
Flow CFG information  :
  instance ID        : 0x0
  feature ID         : 0x1
  feature object ID  : 0x1
  chunk ID          : 0xC
```

To view the ETA memory details, use the following command:

```
Device# show platform hardware chassis active qfp feature et-analytics datapath memory

ET-Analytics memory information:

Size of FO           : 3200 bytes
No. of FO allocs     : 0
No. of FO frees      : 0
```

To view the ETA flow export in datapath, use the following command:

```
Device# show platform hardware chassis active qfp feature et-analytics datapath stats export

ET-Analytics 192.168.5.2:2055 vrf 0 Stats:
```

```

Export statistics:
  Total records exported      : 5179231
  Total packets exported     : 3124873
  Total bytes exported       : 3783900196
  Total dropped records      : 0
  Total dropped packets      : 0
  Total dropped bytes        : 0
  Total IDP records exported :
    initiator->responder     : 1285146
    responder->initiator     : 979284
  Total SPLT records exported:
    initiator->responder     : 1285146
    responder->initiator     : 979284
  Total SALT records exported:
    initiator->responder     : 0
    responder->initiator     : 0
  Total BD records exported  :
    initiator->responder     : 0
    responder->initiator     : 0
  Total TLS records exported :
    initiator->responder     : 309937
    responder->initiator     : 329469

```

To view the ETA flow statistics, use the following command:

```
Device# show platform hardware chassis active qfp feature et-analytics datapath stats flow
```

```

ET-Analytics Stats:
  Flow statistics:
    feature object allocs : 0
    feature object frees  : 0
    flow create requests  : 0
    flow create matching  : 0
    flow create successful: 0
    flow create failed, CFT handle: 0
    flow create failed, getting FO: 0
    flow create failed, malloc FO : 0
    flow create failed, attach FO : 0
    flow create failed, match flow: 0
    flow create, aging already set: 0
    flow ageout requests   : 0
    flow ageout failed, freeing FO: 0
    flow ipv4 ageout requests : 0
    flow ipv6 ageout requests : 0
    flow whitelist traffic match : 0

```

### Verifying ETA on Wireless Client Interface

To view if a policy is configured with ETA, use the following command:

```
Device# show wireless profile policy detailed default-policy-profile
```

```

Policy Profile Name      : default-policy-profile
Description              : default policy profile
Status                   : ENABLED
VLAN                     : 160
Multicast VLAN          : 0
Passive Client           : DISABLED
ET-Analytics             : DISABLED
StaticIP Mobility        : DISABLED
WLAN Switching Policy
  Central Switching      : ENABLED
  Central Authentication : ENABLED
  Central DHCP           : ENABLED

```

```
Flex NAT PAT          : DISABLED
Central Assoc         : ENABLED
```

To view the ETA status in the wireless client detail, use the following command:

```
Device# show platform hardware chassis active qfp feature wireless wlclient datapath
<client_mac>
```

```
Wlclient Details for Client mac: 0026.c635.ebf8
```

```
-----
Input VlanId      : 160
Point of Presence : 0
Wlclient Input flags : 9
Instance ID      : 3
ETA enabled       : True
client_mac_addr   : 0026.c635.ebf8

bssid_mac_addr: 58ac.7843.037f
Point of Attachment : 65497
Output vlanId    : 160
wlan_output_uidb : -1
Wlclient Output flags : 9
Radio ID         : 1
cgacl w0         : 0x0
cgacl w1         : 0x0
IPv6 addr number : 0
IPv6 addr learning : 0
```

To view clients in the ETA pending wireless client tree, use the following command:

```
Device# show platform hardware chassis active qfp feature wireless et-analytics
eta-pending-client-tree
```

```
CPP IF_H      DPIDX      MAC Address      VLAN  AS  MS WLAN      POA
-----
0X2A         0XA0000001  2c33.7a5b.827b  160   RN  LC xyz_ssid   0x90000003
0X2B         0XA0000002  2c33.7a5b.80fb  160   RN  LC xyz_ssid   0x90000003
```

To view the QFP interface handle, use the following command:

```
Device#
show platform hardware chassis active qfp interface if-handle <qfp_interface_handle>
```

```
show platform hardware chassis active qfp interface if-handle 0X29
FIA handle - CP:0x27f3ce8 DP:0xd7142000
LAYER2_IPV4_INPUT_ARL_SANITY
WLCLIENT_INGRESS_IPV4_FWD
IPV4_TVI_INPUT_FIA      >>> ETA FIA Enabled
SWPORT_VLAN_BRIDGING
IPV4_INPUT_GOTO_OUTPUT_FEATURE (M)
Protocol 1 - ipv4_output
FIA handle - CP:0x27f3d30 DP:0xd7141780
IPV4_VFR_REFRAG (M)
IPV4_TVI_OUTPUT_FIA     >>> ETA FIA Enabled
WLCLIENT_EGRESS_IPV4_FWD
IPV4_OUTPUT_DROP_POLICY (M)
DEF_IF_DROP_FIA (M)
```



**Note** The *qfp\_interface\_handle* ranges from 1 to 4294967295.

To view the ETA pending wireless client tree statistics, use the following command:



```
Device# show platform hardware chassis active qfp feature wireless et-analytics statistics
```

```
Wireless ETA cpp-client plumbing statistics
```

```
Number of ETA pending clients : 2
```

```
Counter Value
```

```
-----
Enable ETA on wireless client called      0
Delete ETA on wireless client called      0
ETA global cfg init cb TVI FIA enable error 0
ETA global cfg init cb output SB read error 0
ETA global cfg init cb output SB write error 0
ETA global cfg init cb input SB read error 0
ETA global cfg init cb input SB write error 0
ETA global cfg init cb TVI FIA enable success 0
ETA global cfg uninit cb ingress feat disable 0
ETA global cfg uninit cb ingress cfg delete e 0
ETA global cfg uninit cb egress feat disable 0
ETA global cfg uninit cb egress cfg delete er 0
ETA pending list insert entry called      4
ETA pending list insert invalid arg error 0
ETA pending list insert entry exists error 0
ETA pending list insert no memory error   0
ETA pending list insert entry failed      0
ETA pending list insert entry success     4
ETA pending list delete entry called      2
ETA pending list delete invalid arg error 0
ETA pending list delete entry missing     0
ETA pending list delete entry remove error 0
ETA pending list delete entry success     2
```

To view the allowed list configuration, use the following commands:

```
Device# show platform software et-analytics global
```

```
ET-Analytics Global state
```

```
=====
```

```
All Interfaces      : Off
IP Flow-record Destination: 192.168.5.2 : 2055
Inactive timer: 15
whitelist acl eta-whitelist
```

```
Device# show platform hardware chassis active qfp feature et-analytics datapath runtime
```

```
ET-Analytics run-time information:
```

```
Feature state: initialized (0x00000004)
Inactive timeout      : 15 secs (default 15 secs)
```

```
WhiteList information :
```

```
flag: True
cgacl w0 : 0xd9ae9c80
cgacl w1 : 0x20000000
```

```
Flow CFG information :
instance ID      : 0x0
feature ID       : 0x0
feature object ID : 0x0
chunk ID        : 0x4
```

To view the ETA export statistics, use the following command:

```
Device# show platform hardware chassis active qfp feature et-analytics datapath stats export
```

```
ET-Analytics Stats:
```

```
Export statistics:
Total records exported      : 5179231
Total packets exported     : 3124873
Total bytes exported       : 3783900196
```

```

Total dropped records      : 0
Total dropped packets     : 0
Total dropped bytes       : 0
Total IDP records exported :
    initiator->responder : 1285146
    responder->initiator : 979284
Total SPLT records exported:
    initiator->responder : 1285146
    responder->initiator : 979284
Total SALT records exported:
    initiator->responder : 0
    responder->initiator : 0
Total BD records exported :
    initiator->responder : 0
    responder->initiator : 0
Total TLS records exported :
    initiator->responder : 309937
    responder->initiator : 329469

```

To view the ETA flow statistics, use the following command:

```
Device# show platform hardware chassis active qfp feature et-analytics datapath stats flow
```

```

ET-Analytics Stats:
  Flow statistics:
    feature object allocs : 0
    feature object frees  : 0
    flow create requests  : 0
    flow create matching  : 0
    flow create successful: 0
    flow create failed, CFT handle: 0
    flow create failed, getting FO: 0
    flow create failed, malloc FO : 0
    flow create failed, attach FO : 0
    flow create failed, match flow: 0
    flow create, aging already set: 0
    flow ageout requests   : 0
    flow ageout failed, freeing FO: 0
    flow ipv4 ageout requests : 0
    flow ipv6 ageout requests : 0
    flow whitelist traffic match : 0

```

To view the ETA datapath runtime detail, use the following command:

```
Device# show platform hardware chassis active qfp feature et-analytics datapath runtime
```

```

ET-Analytics run-time information:
  Feature state      : initialized (0x00000004)
  Inactive timeout   : 15 secs (default 15 secs)
  WhiteList information :
    flag             : True
    cgacl w0         : 0xd9ae1e10
    cgacl w1         : 0x20000000
  Flow CFG information :
    instance ID      : 0x0
    feature ID       : 0x0
    feature object ID : 0x0
    chunk ID         : 0x4

```



## CHAPTER 131

# FIPS

- [FIPS, on page 1193](#)
- [Guidelines and Restrictions for FIPS, on page 1194](#)
- [FIPS Self-Tests, on page 1194](#)
- [Configuring FIPS, on page 1195](#)
- [Configuring FIPS in HA Setup, on page 1196](#)
- [Verifying FIPS Configuration, on page 1197](#)

## FIPS

Federal Information Processing Standard (FIPS) 140-2 is a security standard used to validate cryptographic modules. The cryptographic modules are produced by the private sector for use by the U.S. government and other regulated industries (such as financial and healthcare institutions) that collect, store, transfer, share and disseminate sensitive but unclassified (SBU) information.



---

**Note** Cisco TrustSec (CTS) is not supported when the controller is in FIPS mode.

---

For more information about FIPS, see

<https://www.cisco.com/c/en/us/solutions/industries/government/global-government-certifications/fips-140.html>.

With FIPS in enabled state, some passwords and pre-shared keys must have the following minimum lengths:

- For Software-Defined Access Wireless, between the controller and map server, a pre-shared key (for example, the LISP authentication key) is used in authentication of all TCP messages between them. This pre-shared key must be at least 14 characters long.
- The ISAKMP key (for example, the Crypto ISAKMP key) must be at least 14 characters long.

### Limitations for FIPS

- The console of APs get disabled when the controller is operating in FIPS mode.
- The weak or legacy cipher like SHA1 is not supported in FIPS mode.
- APs would not reload immediately, if you change the FIPS status.



---

**Note** We recommend a minimum RSA key size of 2048 bits under RADSEC when operating in FIPS mode. Otherwise, the RADSEC fails.

---

## Guidelines and Restrictions for FIPS

- In the controller switches, a legacy key is used to support the legacy APs. However, in FIPS mode, the crypto engine detects the legacy key as a weak key and rejects it by showing the following error message: "% **Error in generating keys: could not generate test signature.**" We recommend that you ignore such error messages that are displayed during the bootup of the controller (when operating in FIPS mode).
- SSH clients using SHA1 will not be able to access the controller when you enable FIPS.



---

**Note** You need to use FIPS compliant SSH clients to access the controller.

---

- While configuring WLAN ensure that the PSK length must be minimum of 14 characters. If not, the APs will not be able to join the controller after changing tags.
- TrustSec is not supported.
- PAC key configuration is not supported.
- FIPS is not compatible with level-6 encrypted passwords. Additionally, 802.1X authentications will fail if the RADIUS shared secret uses a type-6 encryption key.

## FIPS Self-Tests

A cryptographic module must perform power-up self-tests and conditional self-tests to ensure that it is functional.

Power-up self-tests run automatically after the device powers up. A device goes into FIPS mode only after all self-tests are successfully completed. If any self-test fails, the device logs a system message and moves into an error state. Also, if the power-up self test fails, the device fails to boot.

Using a known-answer test (KAT), a cryptographic algorithm is run on data for which the correct output is already known, and then the calculated output is compared to the previously generated output. If the calculated output does not equal the known answer, the known-answer test fails.

Power-up self-tests include the following:

- Software integrity
- Algorithm tests

Conditional self-tests must be run when an applicable security function or operation is invoked. Unlike the power-up self-tests, conditional self-tests are executed each time their associated function is accessed.

The device uses a cryptographic algorithm known-answer test (KAT) to test FIPS mode for each FIPS 140-2-approved cryptographic function (encryption, decryption, authentication, and random number generation) implemented on the device. The device applies the algorithm to data for which the correct output is already known. It then compares the calculated output to the previously generated output. If the calculated output does not equal the known answer, the KAT fails.

Conditional self-tests run automatically when an applicable security function or operation is invoked. Unlike the power-up self-tests, conditional self-tests are executed each time their associated function is accessed.

Conditional self-tests include the following:

- Pair-wise consistency test—This test is run when a public or private key-pair is generated.
- Continuous random number generator test—This test is run when a random number is generated.
- Bypass
- Software load

## Configuring FIPS

Ensure that both the active and standby controllers have the same FIPS authorization key.

### Procedure

	Command or Action	Purpose
<b>Step 1</b>	<b>configure terminal</b>  <b>Example:</b> Device# <code>configure terminal</code>	Enters global configuration mode.
<b>Step 2</b>	<b>fips authorization-key key</b>  <b>Example:</b> Device(config)# <code>fips authorization-key 12345678901234567890123456789012</code>	Enables the FIPS mode. The key length should be of 32 hexadecimal characters.  <b>Note</b> When FIPS is enabled, you may need to trigger more than one factory reset using the reset button.  To disable FIPS mode on the device, use the <b>no</b> form of this command.
<b>Step 3</b>	<b>end</b>  <b>Example:</b> Device(config)# <code>end</code>	Returns to privileged EXEC mode. Alternatively, you can also press <b>Ctrl-Z</b> to exit global configuration mode.

### What to do next

You must reboot the controller whenever you enable or disable the FIPS mode.

## Configuring FIPS in HA Setup

While bringing up HA pair in FIPS mode, you need to configure both active and standby controllers with the same FIPS authorization key independently before forming HA pair.

If you configure FIPS authorization key after forming HA pair, the FIPS authorization key configuration will not be synced with the standby. Rebooting HA pair at this state causes reload loop. To avoid this, you need to perform the following:

- Break the HA pair.
- Configure the same FIPS authorization key independently on both the members.
- Pair up members.

To configure FIPS in HA setup, perform the following:

1. Power off both the members of the stack.
2. Power on only member1, and wait for the controller to come up and prompt for login from the console.
3. Login successfully with your valid credentials, and execute the following commands:

```
Show fips status
Show fips authorization-key
Show romvar
Show chassis
```



---

**Note** Keep the configured FIPS authorization key handy.

---

4. Configure the FIPS key, if you have not configured one earlier.

```
conf t
fips authorization-key <32 hex char>
```

5. Save and power off the member1.
6. Power on only member2 and wait for the controller to come up and prompt for login from the console.
7. Login successfully with your valid credentials, and execute the following commands:

```
Show fips status
Show fips authorization-key
Show romvar
Show chassis
```



---

**Note** Keep the configured FIPS authorization key handy.

---

8. Configure the FIPS key, if you have not configured one earlier.



---

**Note** The key value must be the same in both the members of the stack.

---

```
conf t
fips authorization-key <32 hex char>
```

9. Save and power off the member2.
10. Power on both the members together, and wait for the stack to form.
11. Monitor any crash or unexpected reload.



---

**Note** It is expected that members must not reload due to FIPS issue.

---

## Verifying FIPS Configuration

You can verify FIPS configuration using the following commands:

Use the following **show** command to display the installed authorization key:

```
Device# show fips authorization-key
FIPS: Stored key (16) : 12345678901234567890123456789012
```

Use the following **show** command to display the status of FIPS on the device:

```
Device# show fips status
Chassis is running in fips mode
```







## CHAPTER 132

# Internet Protocol Security

- [Information about Internet Protocol Security, on page 1199](#)
- [Internet Key Exchange Version 1 Transform Sets, on page 1200](#)
- [Configure IPsec Using Internet Key Exchange Version 1, on page 1201](#)
- [Internet Key Exchange Version 2 Transform Sets, on page 1203](#)
- [Configure IPsec Using Internet Key Exchange Version 2, on page 1204](#)
- [IPsec Transforms and Lifetimes, on page 1206](#)
- [Use of X.509 With Internet Key Exchange Version, on page 1207](#)
- [IPsec Session Interruption and Recovery, on page 1208](#)
- [Example: Configure IPsec Using ISAKMP, on page 1208](#)
- [Verifying IPsec Traffic, on page 1209](#)
- [Example: Configure IPsec Using Internet Key Exchange Version 2, on page 1210](#)
- [Verifying IPsec With Internet Key Exchange Version 2 Traffic , on page 1211](#)

## Information about Internet Protocol Security

Internet Protocol Security (IPsec) is a framework of open standards for ensuring secure private communications over the Internet. Based on standards developed by the Internet Engineering Task Force (IETF), IPsec ensures confidentiality, integrity, and authenticity of data communications across a public network. IPsec provides a necessary component of a standards-based, flexible solution for deploying a network-wide security policy.

Cisco Catalyst 9800 Series Wireless Controller supports IPsec configuration. The support for IPsec secures syslog traffic.

This section provides information about how to configure IPsec between Cisco Catalyst 9800 Series Wireless Controller and syslog (peer IP).

IPsec provides the following network security services:

- **Data confidentiality:** The IPsec sender can encrypt packets before transmitting them across a network.
- **Data integrity:** The IPsec receiver can authenticate packets sent by the IPsec sender to ensure that the data has not been altered during transmission.
- **Data origin authentication:** The IPsec receiver can authenticate the source of the sent IPsec packets. This service is dependent upon the data integrity service.
- **Anti-replay:** The IPsec receiver can detect and reject replayed packets.

IPsec provides secure *tunnels* between two peers, such as two devices. The administrator defines which packets are considered sensitive and should be sent through these secure tunnels and specifies the parameters that should be used to protect these sensitive packets by specifying the characteristics of these tunnels. When the IPsec peer recognizes a sensitive packet, the peer sets up the appropriate secure tunnel and sends the packet through the tunnel to the remote peer.

More accurately, these *tunnels* are sets of security associations (SAs) that are established between two IPsec peers. The SAs define the protocols and algorithms to be applied to sensitive packets and specify the keying material to be used by the two peers. SAs are unidirectional and are established per security protocol.

With IPsec, administrators can define the traffic that needs to be protected between two IPsec peers by configuring access lists and applying these access lists to interfaces using crypto map sets. Therefore, traffic may be selected on the basis of the source and destination address, and optionally the Layer 4 protocol and port. (The access lists used for IPsec are only used to determine the traffic that needs to be protected by IPsec, not the traffic that should be blocked or permitted through the interface. Separate access lists define blocking and permitting at the interface.)

A crypto map set can contain multiple entries, each with a different access list. The crypto map entries are searched in a sequence--the device attempts to match the packet to the access list specified in that entry.

When a packet matches a permit entry in a particular access list, and the corresponding crypto map entry is tagged as cisco, connections are established, if necessary. If the crypto map entry is tagged as ipsec-isakmp, IPsec is triggered. If there is no SA that the IPsec can use to protect this traffic to the peer, IPsec uses IKE to negotiate with the remote peer to set up the necessary IPsec SAs on behalf of the data flow. The negotiation uses information specified in the crypto map entry as well as the data flow information from the specific access list entry.

Once established, the set of SAs (outbound to the peer) is then applied to the triggering packet and to subsequent applicable packets as those packets exit the device. *Applicable* packets are packets that match the same access list criteria that the original packet matched. For example, all applicable packets could be encrypted before being forwarded to the remote peer. The corresponding inbound SAs are used when processing the incoming traffic from that peer.

Access lists associated with IPsec crypto map entries also represent the traffic that the device needs protected by IPsec. Inbound traffic is processed against crypto map entries--if an unprotected packet matches a permit entry in a particular access list associated with an IPsec crypto map entry, that packet is dropped because it was not sent as an IPsec-protected packet.

Crypto map entries also include transform sets. A transform set is an acceptable combination of security protocols, algorithms, and other settings that can be applied to IPsec-protected traffic. During the IPsec SA negotiation, the peers agree to use a particular transform set when protecting a particular data flow.

## Internet Key Exchange Version 1 Transform Sets

An Internet Key Exchange version 1 (IKEv1) transform set represents a certain combination of security protocols and algorithms. During the IPsec SA negotiation, the peers agree to use a particular transform set for protecting a particular data flow.

Privileged administrators can specify multiple transform sets and then specify one or more of these transform sets in a crypto map entry. The transform set defined in the crypto map entry is used in the IPsec SA negotiation to protect the data flows specified by that crypto map entry's access list.

During IPsec security association negotiations with IKE, peers search for a transform set that is the same at both peers. When such a transform set is found, it is selected and applied to the protected traffic as part of both peers' IPsec SAs.



**Note** If a transform set definition is changed during operation that the change is not applied to existing security associations, but is used in subsequent negotiations to establish new SAs. If you want the new settings to take effect sooner, you can clear all or part of the SA database by using the **clear crypto sa** command.

The following snippet helps to configure IPsec IKEv1 to use AES-CBC-128 for payload encryption. AES-CBC-256 can be selected with *encryption aes 256*:

```
device # conf t
device (config)#crypto isakmp policy 1
device (config-isakmp)# hash sha
device (config-isakmp)# encryption aes
```

## Configure IPsec Using Internet Key Exchange Version 1

Follow the procedure given below to configure IPsec IKEv1 to use AES-CBC-128 for payload encryption:

### Procedure

	Command or Action	Purpose
<b>Step 1</b>	<b>configure terminal</b> <b>Example:</b> Device# configure terminal	Enters global configuration mode.
<b>Step 2</b>	<b>crypto isakmp policy <i>priority</i></b> <b>Example:</b> Device(config)# crypto isakmp policy 1	Defines an Internet Key Exchange (IKE) policy and assigns a priority to the policy. <ul style="list-style-type: none"> <li>• <i>priority</i>: Uniquely identifies the IKE policy and assigns a priority to the policy. Valid values: 1 to 10,000; 1 is the highest priority.</li> </ul>
<b>Step 3</b>	<b>hash sha</b> <b>Example:</b> Device(config-isakmp)# hash sha	Specifies the hash algorithm.
<b>Step 4</b>	<b>encryption aes</b> <b>Example:</b> Device(config-isakmp)# encryption aes	Configures IPsec IKEv1 to use AES-CBC-128 for payload encryption. AES-CBC-256 can be selected with 'encryption aes 256'.

	Command or Action	Purpose
		<p><b>Note</b> The authorized administrator must ensure that the keysize for this setting is greater than or equal to the keysize selected for ESP in section <a href="#">IPsec Transforms and Lifetimes</a>. If AES 128 is selected here, then the highest keysize that can be selected on the device for ESP is AES 128 (either CBC or GCM).</p> <p>Both confidentiality and integrity are configured with the <b>hash sha</b> and <b>encryption aes</b> commands respectively. As a result, confidentiality-only mode is disabled.</p>
<b>Step 5</b>	<p><b>authentication pre-share</b></p> <p><b>Example:</b></p> <pre>Device(config-isakmp)# authentication pre-share</pre>	Configures IPsec to use the specified preshared keys as the authentication method. Preshared keys require that you separately configure these preshared keys.
<b>Step 6</b>	<p><b>exit</b></p> <p><b>Example:</b></p> <pre>Device(config-isakmp)# exit</pre>	Exits config-isakmp configuration mode.
<b>Step 7</b>	<p><b>crypto isakmp key <i>keystring</i> address <i>peer-address</i></b></p> <p><b>Example:</b></p> <pre>Device(config)# crypto isakmp key cisco123!cisco123!CISC address 192.0.2.1</pre>	<p>Configures a preshared authentication key.</p> <p><b>Note</b> To ensure a secure configuration, we recommend that you enter the pre-shared keys with at least 22 characters in length and can be composed of any combination of upper and lower case letters, numbers, and special characters (that include: “!”, “@”, “#”, “\$”, “%”, “^”, “&amp;”, “*”, “(”, and “”).</p> <p>The device supports pre-shared keys up to 127 characters in length. While longer keys increase the difficulty of brute-force attacks, longer keys increase processing time.</p>
<b>Step 8</b>	<p><b>group 14</b></p> <p><b>Example:</b></p> <pre>Device(config-isakmp)# group 14</pre>	Specifies the Diffie-Hellman (DH) group identifier as 2048-bit DH group 14 and selects DH Group 14 (2048-bit MODP) for IKE. However, 19 (256-bit Random ECP), 24 (2048-bit MODP with 256-bit POS), 20 (384-bit Random ECP), 15 (3072 bit MODP),

	Command or Action	Purpose
		and 16 (4096-bit MODP) are also allowed and supported.
<b>Step 9</b>	<b>lifetime seconds</b> <b>Example:</b> Device(config-isakmp)# lifetime 86400	Specifies the lifetime of the IKE SA. The default time value for Phase 1 SAs is 24 hours (86400 seconds), but this setting can be changed using the command above with different values. <ul style="list-style-type: none"> <li>• <i>seconds</i>: Time, in seconds, before each SA expires. Valid values: 60 to 86,400; default value: 86,400.</li> </ul> <b>Note</b> The shorter the lifetime (up to a point), the more secure your IKE negotiations will be. However, with longer lifetimes, future IPsec SAs can be set up more quickly.
<b>Step 10</b>	<b>crypto isakmp aggressive-mode disable</b> <b>Example:</b> Device(config-isakmp)# crypto isakmp aggressive-mode disable	Ensures all IKEv1 Phase 1 exchanges will be handled in the default main mode.
<b>Step 11</b>	<b>exit</b> <b>Example:</b> Device(config-isakmp)# exit	Exits config-isakmp configuration mode.

## Internet Key Exchange Version 2 Transform Sets

An Internet Key Exchange Version 2 (IKEv2) proposal is a set of transforms used in the negotiation of IKEv2 SA as part of the IKE\_SA\_INIT exchange. An IKEv2 proposal is regarded as complete only when it has at least an encryption algorithm, an integrity algorithm, and a Diffie-Hellman (DH) group configured. If no proposal is configured and attached to an IKEv2 policy, then the default proposal is used in the negotiation. The following snippet helps in configuring the IPsec with IKEv2 functionality for the device:

```

device # conf t
device(config)#crypto ikev2 proposal sample
device(config-ikev2-proposal)# integrity sha1
device (config-ikev2-proposal)# encryption aes-cbc-128
device(config-ikev2-proposal)# group 14
device(config-ikev2-proposal)# exit
device(config)# crypto ikev2 keyring keyring-1
device (config-ikev2-keyring)# peer peer1
device (config-ikev2-keyring-peer)# address 192.0.2.4 255.255.255.0
device (config-ikev2-keyring-peer)# pre-shared-key cisco123!cisco123!CISC
device (config-ikev2-keyring-peer)# exit
device(config)#crypto ikev2 keyring keyring-1

```

```

device (config-ikev2-keyring)# peer peer1
device (config-ikev2-keyring-peer)# address 192.0.2.4 255.255.255.0
device (config-ikev2-keyring-peer)# pre-shared-key cisco123!cisco123!CISC
device (config-ikev2-keyring-peer)# exit
device (config)#crypto logging ikev2

```

## Configure IPsec Using Internet Key Exchange Version 2

Follow the procedure given below to configure the IPsec with IKEv2:

### Procedure

	Command or Action	Purpose
<b>Step 1</b>	<b>configure terminal</b>  <b>Example:</b> Device# configure terminal	Enters global configuration mode.
<b>Step 2</b>	<b>crypto ikev2 proposal <i>name</i></b>  <b>Example:</b> Device (config)# crypto ikev2 proposal name	Defines an IKEv2 proposal name.
<b>Step 3</b>	<b>integrity sha1</b>  <b>Example:</b> Device (config-ikev2-proposal)# integrity sha1	Defines an IKEv2 proposal name.
<b>Step 4</b>	<b>encryption aes-cbc-128</b>  <b>Example:</b> Device (config-ikev2-proposal)# encryption aes-cbc-128	Configures IPsec IKEv2 to use AES-CBC-128 for payload encryption. AES-CBC-256 can be selected with encryption aes-cbc-256. AES-GCM-128 and AES-GCM-256 can also be selected similarly.  <b>Note</b> The authorized administrator must ensure that the keysize for this setting is greater than or equal to the keysize selected for ESP in section <a href="#">IPsec Transforms and Lifetimes</a> . If AES 128 is selected here, then the highest keysize that can be selected on the device for ESP is AES 128 (either CBC or GCM).  Both confidentiality and integrity are configured with the <b>hash sha</b> and <b>encryption aes</b> commands respectively. As a result, confidentiality-only mode is disabled.

	Command or Action	Purpose
<b>Step 5</b>	<b>group 14</b> <b>Example:</b> Device(config-ikev2-proposal)# group 14	Selects DH Group 14 (2048-bit MODP) for IKE. However, 19 (256-bit Random ECP), 24 (2048-bit MODP with 256-bit POS), 20 (384-bit Random ECP), 15 (3072 bit MODP), and 16 (4096-bit MODP) are also allowed and supported.
<b>Step 6</b>	<b>exit</b> <b>Example:</b> Device(config-ikev2-proposal)# exit	Exits IKEv2 proposal configuration mode.
<b>Step 7</b>	<b>crypto ikev2 keyring <i>keyring-name</i></b> <b>Example:</b> Device(config)# crypto ikev2 keyring keyring-1	Defines an IKEv2 keyring.
<b>Step 8</b>	<b>peer <i>peer-name</i></b> <b>Example:</b> Device(config-ikev2-keyring)# peer peer1	Defines the peer or peer group.
<b>Step 9</b>	<b>address {<i>ipv4-address</i> [<i>mask</i>]   <i>ipv6-address</i> <i>prefix</i>}</b> <b>Example:</b> Device(config-ikev2-keyring)# address 192.0.2.4 255.255.255.0	Specifies an IPv4 or IPv6 address or range for the peer.  <b>Note</b> This IP address is the IKE endpoint address and is independent of the identity address.
<b>Step 10</b>	<b>pre-shared-key <i>local</i></b> <b>Example:</b> Device(config-ikev2-keyring)# pre-shared-key cisco123!cisco123!CISC	Specifies the preshared key for the peer. You can enter the local or remote keyword to specify an asymmetric preshared key. By default, the preshared key is symmetric.

	Command or Action	Purpose
		<p><b>Note</b> To ensure a secure configuration, we recommend that you enter the pre-shared keys with at least 22 characters in length and can be composed of any combination of upper and lower case letters, numbers, and special characters (that include: “!”, “@”, “#”, “\$”, “%”, “^”, “&amp;”, “*”, “(”, and “”).</p> <p>The device supports pre-shared keys up to 127 characters in length. While longer keys increase the difficulty of brute-force attacks, longer keys increase processing time.</p> <p>HEX keys generated off system can also be input for IKEv2 using the following instead of the pre-shared-key command above: <i>pre-shared-key hex [hex key]</i>. For example: <i>pre-shared-key hex 0x6A6B6C</i>. This configures IPsec to use pre-shared keys.</p>
<b>Step 11</b>	<b>exit</b>  <b>Example:</b> Device(config-ikev2-keyring)# exit	Exits IKEv2 keyring peer configuration mode.
<b>Step 12</b>	<b>crypto logging ikev2</b>  <b>Example:</b> Device(config)# crypto logging ikev2	Enables IKEv2 syslog messages.  <b>Note</b> The configuration above is not a complete IKE v2 configuration, and that additional settings will be needed.

## IPsec Transforms and Lifetimes

Regardless of the IKE version selected, the device must be configured with the proper transform for IPsec ESP encryption and integrity as well as IPsec lifetimes.

```
device (config)# crypto ipsec transform-set example esp-aes 128 esp-sha-hmac
```

Note that this configures IPsec ESP to use HMAC-SHA-1 and AES-CBC-128. To change this to the other allowed algorithms the following options can replace **esp-aes 128** in the command above:

Encryption Algorithm	Command
AES-CBC-256	<b>esp-aes 256</b>
AES-GCM-128	<b>esp-gcm 128</b>



Encryption Algorithm	Command
AES-GCM-256	esp-gcm 256



**Note** The size of the key selected here must be less than or equal to the key size selected for the IKE encryption setting. If AES-CBC-128 was selected there for use with IKE encryption, then only AES-CBC-128 or AES-GCM-128 may be selected here.

```
device(config-crypto)# mode tunnel
```

This configures tunnel mode for IPsec. Tunnel is the default, but by explicitly specifying tunnel mode, the device will request tunnel mode and will accept only tunnel mode.

```
device(config-crypto)# mode transport
```

This configures transport mode for IPsec.

```
device(config)# crypto ipsec security-association lifetime seconds 28800
```

The default time value for Phase 2 SAs is 1 hour. There is no configuration required for this setting since the default is acceptable. However to change the setting to 8 hours as claimed in the Security Target the crypto ipsec security-association lifetime command can be used as specified above.

```
device(config)# crypto ipsec security-association lifetime kilobytes 100000
```

This configures a lifetime of 100 MB of traffic for Phase 2 SAs. The default amount for this setting is 2560KB, which is the minimum configurable value for this command. The maximum configurable value for this command is 4GB.

## Use of X.509 With Internet Key Exchange Version

Cisco Catalyst 9800 Series Wireless Controller supports RSA and ECDSA based certificates.

Once X.509v3 keys are installed on the device, they can be set for use with IKEv1 with the commands:

### Procedure

	Command or Action	Purpose
<b>Step 1</b>	<b>configure terminal</b> <b>Example:</b> Device# configure terminal	Enters global configuration mode.
<b>Step 2</b>	<b>crypto isakmp <i>policy-name</i></b> <b>Example:</b> Device(config)#crypto isakmp policy 1	Defines an Internet Key Exchange (IKE) policy and assigns a priority to the policy.
<b>Step 3</b>	<b>authentication [remote   local] rsa-sig</b> <b>Example:</b>	Uses RSA based certificates for IKEv1 authentication.

	Command or Action	Purpose
	Device (config-isakmp) #authentication rsa-sig	
<b>Step 4</b>	<b>authentication [remote   local] ecdsa-sig</b>  <b>Example:</b> Device (config-isakmp) #authentication ecdsa-sig	Uses ecdsa based certificates for IKEv1 authentication.

## For IKEv2 Commands

### Procedure

	Command or Action	Purpose
<b>Step 1</b>	<b>configure terminal</b>  <b>Example:</b> Device# configure terminal	Enters global configuration mode.
<b>Step 2</b>	<b>crypto ikev2 profile sample</b>  <b>Example:</b> Device (config) # crypto ikev2 profile sample	Defines an Internet Key Exchange (IKE) policy and assigns a profile.
<b>Step 3</b>	<b>authentication [remote   local] rsa-sig</b>  <b>Example:</b> Device (config-ikev2-profile) # authentication rsa-sig	Uses RSA based certificates for IKEv1 authentication.
<b>Step 4</b>	<b>authentication [remote   local] ecdsa-sig</b>  <b>Example:</b> Device (config-ikev2-profile) # authentication ecdsa-sig	Uses ecdsa based certificates for IKEv1 authentication.  Authentication fails if an invalid certificate is loaded.

## IPsec Session Interruption and Recovery

If an IPsec session with a peer is unexpectedly interrupted, the connection will be broken. In this scenario, no administrative interaction is required. The IPsec session will be reestablished (a new SA set up) once the peer is back online.

## Example: Configure IPsec Using ISAKMP

The following sample outputs display the IPsec **isakmp** configuration:

```
crypto isakmp policy 1
  encr aes 256
  hash sha256
```

```

authentication pre-share
group 14
lifetime 28800

crypto isakmp key 0 Cisco!123 address 192.0.2.4
crypto isakmp peer address 192.0.2.4

crypto ipsec transform-set aes-gcm-256 esp-gcm 256
mode tunnel

crypto map IPSEC_ewlc_to_syslog 1 ipsec-isakmp
set peer 192.0.2.4
set transform-set aes-gcm-256
match address acl_ewlc_to_syslog

interface Vlan15
crypto map IPSEC_ewlc_to_syslog
end

```

## Verifying IPsec Traffic

The following example shows how to verify the IPsec traffic configuration in isakmp configuration:

```

Device# show crypto map
Crypto Map IPv4 "IPSEC_ewlc_to_syslog" 1 ipsec-isakmp
  Peer = 192.0.2.4
  Extended IP access list acl_ewlc_to_syslog
    access-list acl_ewlc_to_syslog permit ip host 192.0.2.2 host 192.0.2.4
  Current peer: 192.0.2.4
  Security association lifetime: 4608000 kilobytes/3600 seconds
  Responder-Only (Y/N): N
  PFS (Y/N): N
  Mixed-mode : Disabled
  Transform sets={
    aes-gcm-256: { esp-gcm 256 } ,
  }
  Interfaces using crypto map IPSEC_ewlc_to_syslog:
    Vlan15

Device# show crypto isakmp sa
IPv4 Crypto ISAKMP SA
dst          src          state          conn-id status
192.0.2.5    192.0.2.4    QM_IDLE       1011 ACTIVE

IPv6 Crypto ISAKMP SA

Device# show crypto ipsec sa

interface: Vlan15
  Crypto map tag: IPSEC_ewlc_to_syslog, local addr 192.0.2.5

protected vrf: (none)
local  ident (addr/mask/prot/port): (192.0.2.5/255.255.255.255/0/0)
remote ident (addr/mask/prot/port): (192.0.2.4/255.255.255.255/0/0)
current_peer 192.0.2.4 port 500
  PERMIT, flags={origin_is_acl,}
#pkts encaps: 1626, #pkts encrypt: 1626, #pkts digest: 1626
#pkts decaps: 1625, #pkts decrypt: 1625, #pkts verify: 1625
#pkts compressed: 0, #pkts decompressed: 0
#pkts not compressed: 0, #pkts compr. failed: 0
#pkts not decompressed: 0, #pkts decompress failed: 0
#send errors 0, #recv errors 0

```

```

local crypto endpt.: 192.0.2.5, remote crypto endpt.: 192.0.2.4
plaintext mtu 1446, path mtu 1500, ip mtu 1500, ip mtu idb Vlan15
current outbound spi: 0x17FF2F4C(402599756)
PFS (Y/N): N, DH group: none

inbound esp sas:
  spi: 0x4B77AD78(1266134392)
    transform: esp-gcm 256 ,
    in use settings =(Tunnel, )
    conn id: 2041, flow_id: HW:41, sibling_flags FFFFFFFF80004048, crypto map:
IPSEC_ewlc_to_syslog
  sa timing: remaining key lifetime (k/sec): (4607904/1933)
  IV size: 8 bytes
  replay detection support: Y
  Status: ACTIVE(ACTIVE)

inbound ah sas:

inbound pcp sas:

outbound esp sas:
  spi: 0x17FF2F4C(402599756)
    transform: esp-gcm 256 ,
    in use settings =(Tunnel, )
    conn id: 2042, flow_id: HW:42, sibling_flags FFFFFFFF80004048, crypto map:
IPSEC_ewlc_to_syslog
  sa timing: remaining key lifetime (k/sec): (4607904/1933)
  IV size: 8 bytes
  replay detection support: Y
  Status: ACTIVE(ACTIVE)

outbound ah sas:
outbound pcp sas:

Device# show ip access-lists acl_ewlc_to_syslog
Extended IP access list acl_ewlc_to_syslog
  10 permit ip host 192.0.2.5 host 192.0.2.4 (17 matches)

```

## Example: Configure IPsec Using Internet Key Exchange Version 2

The following sample outputs display the IPsec **IKEv2** configuration:

```

topology : [192.0.2.6]DUT - (infra) - PEER[192.0.2.9]

ikev2 config in 192.0.2.6 (peer is 192.0.2.9)
hostname for 192.0.2.9: Edison-M1
hostname for 192.0.2.6: prsna-nyquist-192.0.2.6

ip access-list extended ikev2acl
  permit ip host 192.0.2.6 host 192.0.2.9

crypto ikev2 proposal PH1PROPOSAL
  encryption aes-cbc-256
  integrity sha256
  group 14
!
crypto ikev2 policy PH1POLICY
  proposal PH1PROPOSAL

crypto ikev2 keyring PH1KEY

```

```

peer Edison-M1
address 192.0.2.9
pre-shared-key Cisco!123Cisco!123Cisco!123

crypto ikev2 profile PH1PROFILE
match identity remote address 192.0.2.9 255.255.255.255
authentication remote pre-share
authentication local pre-share
keyring local PH1KEY

crypto ipsec transform-set aes256-shal esp-aes 256 esp-sha-hmac
mode tunnel

crypto map ikev2-cryptomap 1 ipsec-isakmp
set peer 192.0.2.9
set transform-set aes256-shal
set ikev2-profile PH1PROFILE
match address ikev2acl

interface Vlan15
ip address 192.0.2.6 255.255.255.0
crypto map ikev2-cryptomap

```

## Verifying IPsec With Internet Key Exchange Version 2 Traffic

The following example shows how to verify the IPsec traffic configuration in IKEv2 configuration:

```

Device# show ip access-lists
Extended IP access list ikev2acl
    10 permit ip host 192.0.2.6 host 192.0.2.9 (80 matches)

prnsa-nyquist-192.0.2.6#show crypto map
Crypto Map IPv4 "ikev2-cryptomap" 1 ipsec-isakmp
  Peer = 192.0.2.9
  IKEv2 Profile: PH1PROFILE
  Extended IP access list ikev2acl
    access-list ikev2acl permit ip host 192.0.2.6 host 192.0.2.9
  Current peer: 192.0.2.9
  Security association lifetime: 4608000 kilobytes/3600 seconds
  Responder-Only (Y/N): N
  PFS (Y/N): N
  Mixed-mode : Disabled
  Transform sets={
    aes256-shal: { esp-256-aes esp-sha-hmac } ,
  }
  Interfaces using crypto map ikev2-cryptomap:
    Vlan15
Device# show crypto ikev2 sa detailed
IPv4 Crypto IKEv2 SA

Tunnel-id Local Remote fvrf/ivrf Status
1 192.0.2.6/500 192.0.2.9/500 none/none READY
Encr: AES-CBC, keysize: 256, PRF: SHA256, Hash: SHA256, DH Grp:14, Auth sign: PSK,
Auth verify: PSK
Life/Active Time: 86400/1002 sec
CE id: 1089, Session-id: 2
Status Description: Negotiation done
Local spi: 271D20169FE91074 Remote spi: 13895472E3B910AF
Local id: 192.0.2.6
Remote id: 192.0.2.9
Local req msg id: 2 Remote req msg id: 0

```

```

Local next msg id: 2           Remote next msg id: 0
Local req queued: 2           Remote req queued: 0
Local window: 5               Remote window: 5
DPD configured for 0 seconds, retry 0
Fragmentation not configured.
Dynamic Route Update: disabled
Extended Authentication not configured.
NAT-T is not detected
Cisco Trust Security SGT is disabled
Initiator of SA : Yes
Device# show crypto ipsec sa detail

interface: Vlan15
  Crypto map tag: ikev2-cryptomap, local addr 192.0.2.6

protected vrf: (none)
local ident (addr/mask/prot/port): (192.0.2.6/255.255.255.255/0/0)
remote ident (addr/mask/prot/port): (192.0.2.9/255.255.255.255/0/0)
current_peer 192.0.2.9 port 500
  PERMIT, flags={origin_is_acl,}
  #pkts encaps: 80, #pkts encrypt:80, #pkts digest: 80
  #pkts decaps: 80, #pkts decrypt: 80, #pkts verify: 80
  #pkts compressed: 0, #pkts decompressed: 0
  #pkts not compressed: 0, #pkts compr. failed: 0
  #pkts not decompressed: 0, #pkts decompress failed: 0
  #pkts no sa (send) 0, #pkts invalid sa (rcv) 0
  #pkts encaps failed (send) 0, #pkts decaps failed (rcv) 0
  #pkts invalid prot (rcv) 0, #pkts verify failed: 0
  #pkts invalid identity (rcv) 0, #pkts invalid len (rcv) 0
  #pkts replay rollover (send): 0, #pkts replay rollover (rcv) 0
  ##pkts replay failed (rcv): 0
  #pkts tagged (send): 0, #pkts untagged (rcv): 0
  #pkts not tagged (send): 0, #pkts not untagged (rcv): 0
  #pkts internal err (send): 0, #pkts internal err (rcv) 0

  local crypto endpt.: 192.0.2.6, remote crypto endpt.: 192.0.2.9
  plaintext mtu 1438, path mtu 1500, ip mtu 1500, ip mtu idb Vlan15
  current outbound spi: 0xB546157A(3041269114)
  PFS (Y/N): N, DH group: none

inbound esp sas:
  spi: 0x350925BC(889791932)
    transform: esp-256-aes esp-sha-hmac ,
    in use settings ={Tunnel, }
    conn id: 838, flow_id: 838, sibling_flags FFFFFFFF80000040, crypto map:
ikev2-cryptomap
  sa timing: remaining key lifetime (k/sec): (4287660676/2560)
  IV size: 16 bytes
  replay detection support: Y
  Status: ACTIVE(ACTIVE)

inbound ah sas:

inbound pcp sas:

outbound esp sas:
  spi: 0xB546157A(3041269114)
    transform: esp-256-aes esp-sha-hmac ,
    in use settings ={Tunnel, }
    conn id: 837, flow_id: 837, sibling_flags FFFFFFFF80000040, crypto map:
ikev2-cryptomap
  sa timing: remaining key lifetime (k/sec): (4287660672/2560)
  IV size: 16 bytes
  replay detection support: Y

```

```
Status: ACTIVE (ACTIVE)
```

```
outbound ah sas:
```

```
outbound pcp sas:
```







## CHAPTER 133

# Transport Layer Security Tunnel Support

- [Information About Transport Layer Security Tunnel Support, on page 1215](#)
- [Configuring a Transport Layer Security Tunnel, on page 1216](#)
- [Verifying a Transport Layer Security Tunnel, on page 1217](#)

## Information About Transport Layer Security Tunnel Support

The Cisco Catalyst 9800 Series Wireless Controller requires direct access to a public cloud to implement the teleworker solution using Cisco OfficeExtend Access Points (OEAPs). With the introduction of Transport Layer Security (TLS) tunnel support from Cisco IOS XE Amsterdam 17.3.2 onwards, the controller can now reach a public cloud automatically. This helps Cisco Catalyst Center on Cloud to establish TLS communication channels with the controller to perform monitor and manage of wireless solutions.

The TLS connection ensures that the configuration and telemetry are reliably and securely communicated between the controller and the Digital Network Architecture (DNA) on Cloud. The TLS tunnel encrypts all the data that is sent over the TCP connection. The TLS tunnel provides a more secure protocol across the internet. After the controller discovery, the Cisco Catalyst Center on Cloud uses Cisco DNA Assurance and Automation features to manage the controller centrally.

### Cisco Plug and Play

The Cisco Plug and Play solution is a converged solution that provides a highly secure, scalable, seamless, and unified zero-touch deployment experience.

### Plug-n-Play Agent

The Cisco Plug and Play (PnP) agent is an embedded software component that is present in all the Cisco network devices that support simplified deployment architecture. The PnP agent understands and interacts only with a PnP server. The PnP agent, using DHCP, DNS, or other such methods, tries to acquire the IP address of the PnP server with which it wants to communicate. After a server is found and a connection is established, the agent communicates with the PnP server to perform deployment-related activities.

For more information on Cisco Plug and Play, see the [Cisco Plug and Play Feature Guide](#).

The Transport Layer Security Tunnel (TLS) over PnP feature is supported on the following controllers:

- Cisco Catalyst 9800-80 Wireless Controller
- Cisco Catalyst 9800-40 Wireless Controller
- Cisco Catalyst 9800-L Wireless Controller

# Configuring a Transport Layer Security Tunnel

## Procedure

	Command or Action	Purpose
<b>Step 1</b>	<b>configure terminal</b>  <b>Example:</b> Device# configure terminal	Enters global configuration mode.
<b>Step 2</b>	<b>crypto tls-tunnel <i>TLS-tunnel-name</i></b>  <b>Example:</b> Device(config)# crypto tls-tunnel cloud-primary	Configures a crypto TLS tunnel channel.
<b>Step 3</b>	<b>server {ipv4 &lt;A.B.C.D&gt; / ipv6 &lt;X.X.X.X::X&gt; / url &lt;url-name&gt;} port 443 &lt;1025-65535&gt;</b>  <b>Example:</b> Device(config-crypto-tls-tunnel)# server ipv4 172.31.255.255 port 4043	Specifies the server IPv4 address, IPv6 address, or URL name and the port number.
<b>Step 4</b>	<b>overlay interface <i>interface-name</i> <i>interface-num</i></b>  <b>Example:</b> Device(config-crypto-tls-tunnel)# overlay interface Loopback0	Specifies the overlay interface and interface number.  An overlay interface is a logical, multiaccess, multicast-capable interface. An overlay interface encapsulates Layer 2 frames in IP unicast or multicast headers.
<b>Step 5</b>	<b>local interface <i>interface-name</i> <i>interface-num</i> priority rank</b>  <b>Example:</b> Device(config-crypto-tls-tunnel)# local-interface vlan 1 priority 1	Specifies the LAN interface type, number, and the priority rank.  <b>Note</b> Currently, the tunnel supports only one WAN interface with priority 1 and does not support the list of WAN interfaces with multiple priorities.
<b>Step 6</b>	<b>psk id <i>identity</i> key options</b>  <b>Example:</b> Device(config-crypto-tls-tunnel)# psk id test key	Specifies a preshared key and password options.
<b>Step 7</b>	<b>pki trustpoint <i>trustpoint</i> <i>trustpoint-label</i> [sign   verify]</b>  <b>Example:</b> Device(config-crypto-tls-tunnel)# pki trustpoint tsp1 sign	Specifies the trustpoints for use with the RSA signature authentication method as follows: <ul style="list-style-type: none"> <li>• <b>sign:</b> Use the certificate from the trustpoint which is sent to the peer.</li> </ul>

	Command or Action	Purpose
		<ul style="list-style-type: none"> <li>• <b>verify</b>: Use the certificate from the trustpoint to verify the certificate received from the peer.</li> </ul> <p><b>Note</b></p> <ul style="list-style-type: none"> <li>• If the <b>sign</b> or <b>verify</b> keyword is not specified, the trustpoint is used for signing and verification.</li> <li>• In TLS Tunnel block, authentication can be done using either pre-shared key (PSK) or PKI (certificate based).</li> </ul>
<b>Step 8</b>	(Optional) <b>cc-mode</b> <b>Example:</b> Device(config-crypto-tls-tunnel)# cc-mode	Indicates a common criteria mode, which is a Federal Information Processing Standards (FIPS) mode.
<b>Step 9</b>	<b>no shutdown</b> <b>Example:</b> Device(config-crypto-tls-tunnel)# no shutdown	Enables the TLS tunnel.
<b>Step 10</b>	<b>end</b> <b>Example:</b> Device(config-crypto-tls-tunnel)# end	Returns to privileged EXEC mode.

## Verifying a Transport Layer Security Tunnel

The TLS client support includes BinOS processes using Linux Tun/Tap Interface. To verify the TLS client summary details, use the following command:

```
Device# show platform software tlsc client summary
TLS Client - Config Summary
```

Name	ID	Gateway	Port	Auth	Trustpoint	DPD Time	Rekey Time	Retry Time
fqdn	0		8443	PSK	N/A	60	300	20

To verify the TLS client session detail, session statistics, tunnel statistics, and DNS counters, use the following command:

```
Device# show platform software client detail <tls-name>
```

```
Session Name      : fqdn
FQDN resolved IP : 10.255.255.255
ID                : 0
Created           : 04/20/21 00:36:42
Updated          : 04/22/21 05:56:03
```

```

State           : Up (Rekey)
Up Time        : 04/21/21 20:30:21 (9 hours 25 minutes 45 seconds)
Down Time      : 04/21/21 20:30:01
Rekey Time     : 04/22/21 05:55:51 (15 seconds)

```

```

TLS Session Statistics
Up Notifications   : 3
Down Notifications : 2
Rekey Notifications : 636
DP State Updates  : 0
DPD Cleanups      : 0

```

Packets From	Packets To	Packet Errors To	Bytes From	Bytes To
BinOS	80	0	0	0
IOSd	0	0	0	0
TLS Client	0	0	0	0

#### TLS Tunnel Statistics

Type	Tx Packets	Rx Packets
Total	0	80
CSTP Ctrl	3836	3836
CSTP Data	80	0

Type	Requests	Responses
CSTP Cfg	639	639
CSTP DPD	3197	3197

```

Invalid CSTP Rx           : 0
Injected Packet Success  : 0
Injected Packet Failed    : 0
Consumed Packets         : 0

```

#### TLS Tunnel DNS Counters

```

DNS Resolve Request Success Count : 641
DNS Resolve Request Failure Count : 0
DNS Resolve Success Count         : 639
DNS Resolve Failure Count         : 2

```

To verify the TLS client global statistics, use the following command.

```

Device# show platform software tlsc statistics
TLS Client: Global Statistics

```

```

Session Statistics
Up / Down       : 5 / 2
Rekeys         : 636
DP Updates     : 0
DPD Cleanups   : 0

```

	Packets From	Packets To	Packet Errors To	Bytes From	Bytes To
BinOS	85	0			0
IOSd	0	0	0	0	0
TLS Client	0	0	0	0	0

#### Tunnel Statistics

```

SSL Handshake Init / Done : 641 / 641

```

```
TCP Connection Req / Done : 641 / 641
Tunnel Packets
Rx / Tx      : 85 / 0
Injected / Failed : 0 / 0
Consumed      : 0
```

```
CSTP Packets
Control Rx / Tx : 3839 / 3839
Data   Rx / Tx : 0 / 85
Config Req / Resp : 641 / 641
DPD   Req / Resp : 3198 / 3198
Invalid Rx      : 0
```

```
FQDN Counters
Req / Resp / Success : 0 / 0 / 0
```

```
NAT Counters
Transalte In / Out : 0 / 0
Ignore   In / Out : 0 / 0
Failed           : 0
Invalid          : 0
No Entry         : 0
Unsupported      : 0
```

Internal Counters

Type	Allocated	Freed
EV	1299	1295
Tunnel	5	4
Conn	643	642
Sess	3	2

```
Config Message Related Counters
Type      Success      Failed
-----
Create    3                0
Delete    2                0
```

To view the TLS client-session summary, use the following command.

```
Device# show platform software tlsc session summary
```

TLS Client - Session Summary

Name	ID	Created	State	Since	Elapsed
fqdn	0	04/20/21 00:36:42	Up	04/21/21 20:30:21	9 hours 26 minutes 44 seconds





## CHAPTER 134

# Disabling IP Learning in FlexConnect Mode

- [Information About Disabling IP Learning in FlexConnect Mode, on page 1221](#)
- [Restrictions for Disabling IP Learning in FlexConnect Mode, on page 1221](#)
- [Disabling IP Learning in FlexConnect Mode \(CLI\), on page 1222](#)
- [Verifying MAC Entries from Database, on page 1222](#)

## Information About Disabling IP Learning in FlexConnect Mode

In FlexConnect local switching scenarios, where clients from the same sites may share the same address range, there is a possibility of multiple clients being allocated or registered with the same IP address. The controller receives IP address information from the AP, and if more than one client attempts to use the same IP address, the controller discards the last device trying to register an already-used address as an IP theft event, potentially resulting in client exclusion.

The Disabling IP learning in FlexConnect mode feature utilizes the **no ip mac-binding** command to ensure that no device tracking is done for clients, thus preventing the IP theft error.



### Note

- This feature is applicable only for IPv4 addresses.
- Configuring **ip overlap** in FlexConnect Profile assists overlapping IP address support for clients across different sites in FlexConnect local switching.

## Restrictions for Disabling IP Learning in FlexConnect Mode

- The **wireless client ip deauthenticate** command works by referring to the IP table binding entries directly. It does not work for client whose IPs are not learnt.
- Overlapping IP addresses within a single site tag and across different site tags require different settings. Furthermore, if a single site tag contains overlapping IP addresses, L3 web authentication is necessary. However, L3 web authentication relies on IP addresses, and ensuring the uniqueness of IP addresses cannot be guaranteed, making this combination incorrect.
- When IP Source Guard (IPSG) is enabled and multiple binding information is sent with the same IP and preference level (such as DHCP, ARP, and so on) to CPP, the CPP starts to ignore the later bindings

after the first binding creation. Hence, you should not configure IPSG and disable IP MAC binding together. If IPSG and **no ip mac-binding** are configured together then IPSG does not work.

## Disabling IP Learning in FlexConnect Mode (CLI)

### Procedure

	Command or Action	Purpose
<b>Step 1</b>	<b>configure terminal</b> <b>Example:</b> Device# configure terminal	Enters global configuration mode.
<b>Step 2</b>	<b>wireless profile policy <i>profile-policy-name</i></b> <b>Example:</b> Device(config)# wireless profile policy test-profile-policy	Configures the wireless profile policy.
<b>Step 3</b>	<b>shutdown</b> <b>Example:</b> Device(config-wireless-policy)# shutdown	Disables the wireless policy profile. <b>Note</b> Disabling policy profile results in associated AP and client to rejoin.
<b>Step 4</b>	<b>no ip mac-binding</b> <b>Example:</b> Device(config-wireless-policy)# no ip mac-binding	Disables IP learning in FlexConnect mode.
<b>Step 5</b>	<b>no shutdown</b> <b>Example:</b> Device(config-wireless-policy)# no shutdown	Enables the wireless policy profile.
<b>Step 6</b>	<b>exit</b> <b>Example:</b> Device(config-wireless-policy)# exit	Returns to privileged EXEC mode.

## Verifying MAC Entries from Database

To verify the MAC details from database, use the following command:

```
Device# show wireless device-tracking database mac
MAC VLAN IF-HDL IP
-----
6c96.cff2.889a 64 0x90000008 9.9.64.175
```





## PART **VIII**

### **Mobility**

- [Mobility, on page 1225](#)
- [NAT Support on Mobility Groups, on page 1245](#)
- [Static IP Client Mobility, on page 1249](#)
- [Mobility Domain ID - Dot11i Roaming, on page 1253](#)
- [802.11r Support for Flex Local Authentication, on page 1255](#)
- [Opportunistic Key Caching, on page 1257](#)





## CHAPTER 135

# Mobility

---

- [Introduction to Mobility, on page 1225](#)
- [Guidelines and Restrictions, on page 1230](#)
- [Configuring Mobility \(GUI\), on page 1232](#)
- [Configuring Mobility \(CLI\), on page 1233](#)
- [Configuring Inter-Release Controller Mobility \(GUI\), on page 1235](#)
- [Configuring Inter-Release Controller Mobility, on page 1235](#)
- [Verifying Mobility, on page 1239](#)

## Introduction to Mobility

Mobility or roaming is a wireless LAN client's ability to maintain its association seamlessly from one access point to another access point securely and with as little latency as possible. This section explains how mobility works when controllers are included in a wireless network.

When a wireless client associates and authenticates to an access point, the access point's controller places an entry for that client in its client database. This entry includes the client's MAC and IP addresses, security context and associations, quality of service (QoS) contexts, the WLAN, and the associated access point. The controller uses this information to forward frames and manage traffic to and from a wireless client.

**Figure 35: Intracontroller Roaming**

This figure shows a wireless client that roams from one access point to another access point when both access points are joined to the same controller.

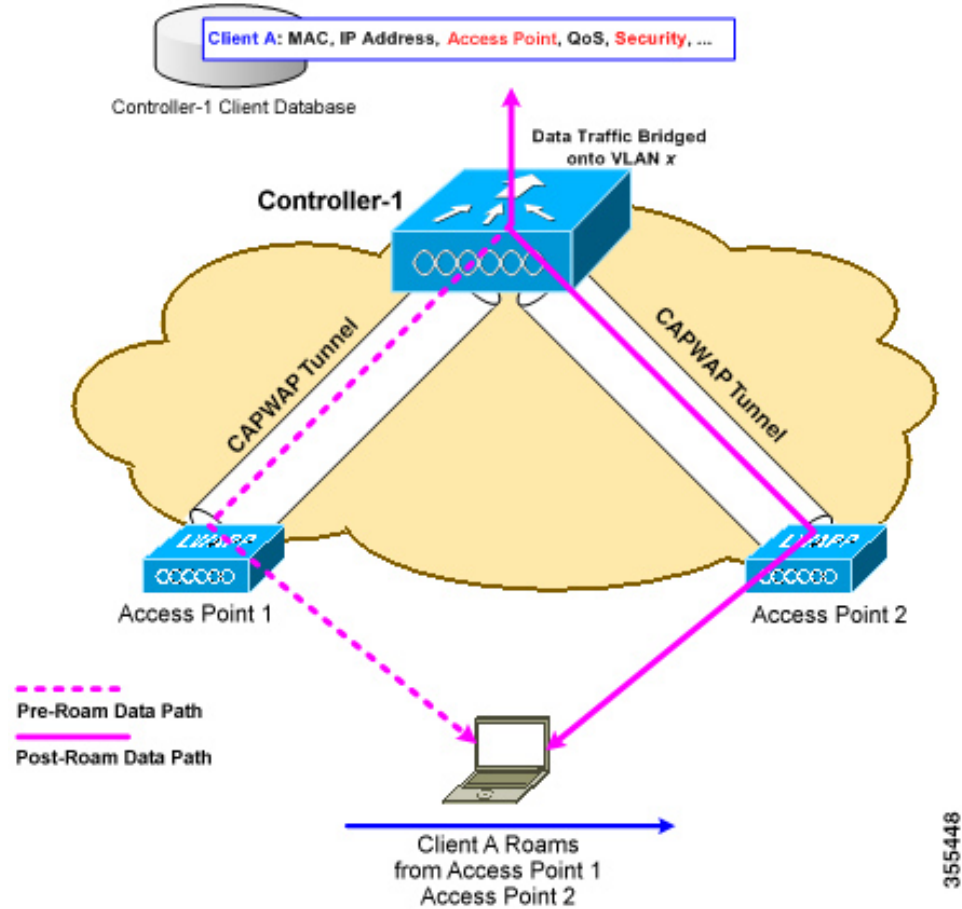

When a wireless client moves its association from one access point to another access point, the controller simply updates the client database with the newly associated access point. If necessary, new security context and associations are established as well.

The process becomes more complicated, however, when a client roams from an access point joined to one controller to an access point joined to a different controller. It also varies based on whether the controllers are operating on the same subnet.

**Figure 36: Intercontroller Roaming**

This figure shows intercontroller roaming, which occurs when the wireless LAN interfaces of controllers are on the same IP subnet.

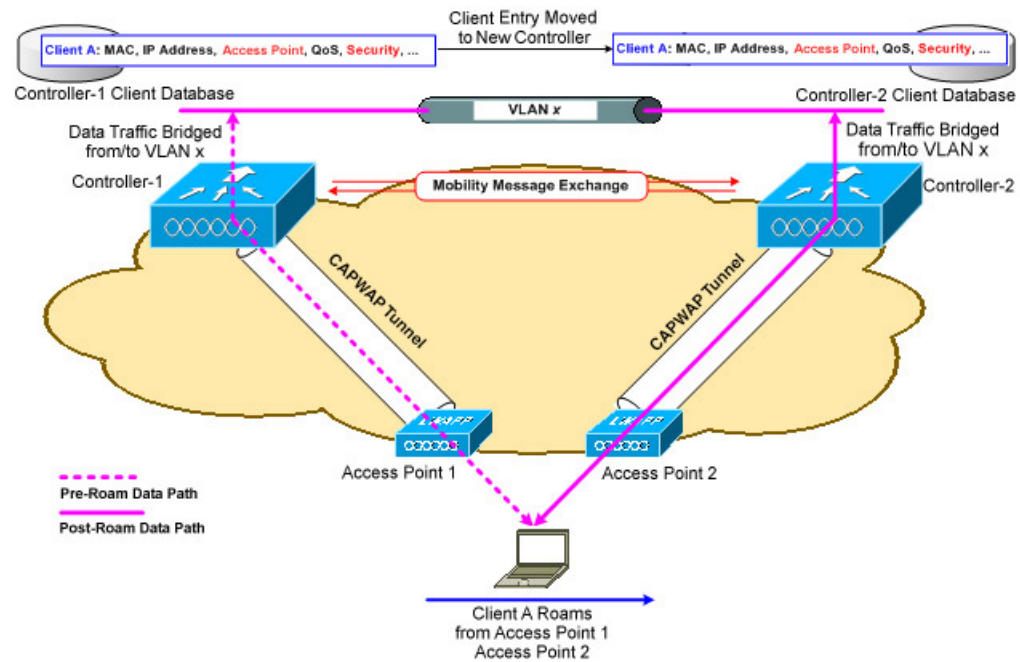

When a client joins an access point associated with a new controller, the new controller exchanges mobility messages with the original controller, and the client database entry is moved to the new controller. New security context and associations are established if necessary, and the client database entry is updated for the new access point. This process remains transparent to the user.



**Note** All clients configured with 802.1X/Wi-Fi Protected Access (WPA) security complete a full authentication in order to comply with the IEEE standard.



**Important** Intersubnet Roaming is not supported for SDA.

**Figure 37: Intersubnet Roaming**

This figure shows intersubnet roaming, which occurs when the wireless LAN interfaces of controllers are on different IP subnets.

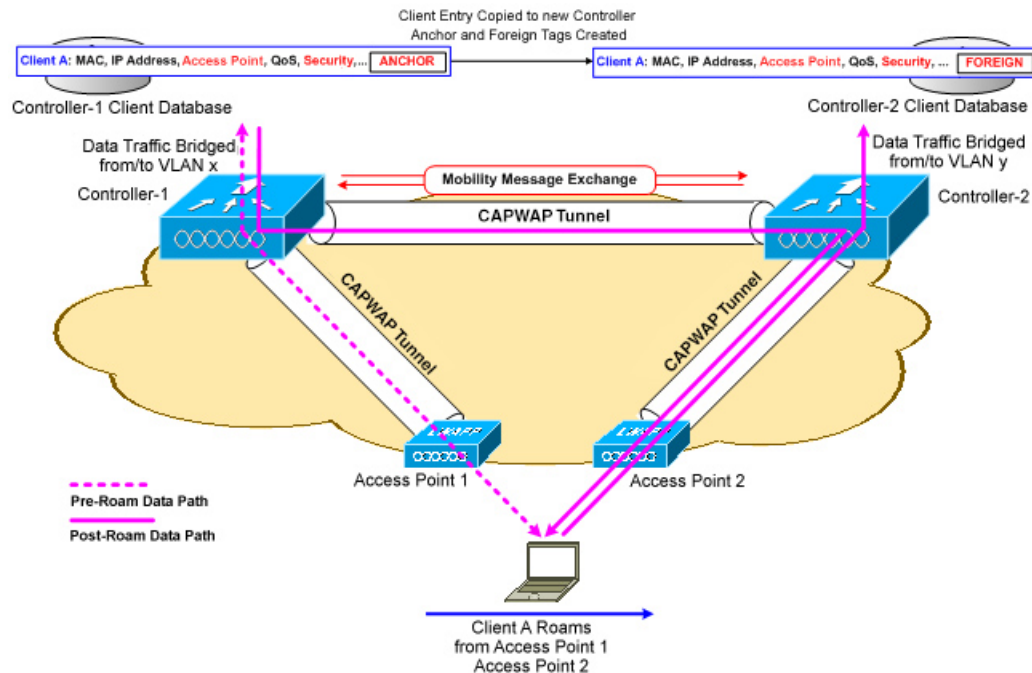

Intersubnet roaming is similar to intercontroller roaming in that, controllers exchange mobility messages on the client roam. However, instead of moving the client database entry to the new controller, the original controller marks the client with an *anchor* entry in its own client database. The database entry is copied to the new controller client database and marked with a *foreign* entry in the new controller. The roam remains transparent to the wireless client, and the client maintains its original IP address.

In intersubnet roaming, WLANs on both anchor and foreign controllers should have the same network access privileges, and no source-based routing or source-based firewalls in place. Otherwise, the clients may have network connectivity issues after the handoff.

In a static anchor setup using controllers and a RADIUS server, if AAA override is enabled to dynamically assign VLAN and QoS, the foreign controller updates the anchor controller with the right VLAN after a Layer 2 authentication (802.1x). For Layer 3 RADIUS authentication, the RADIUS requests for authentication are sent by the anchor controller.



**Note** The Cisco Catalyst 9800 Series Wireless Controller mobility tunnel is a CAPWAP tunnel with control path (UDP 16666) and data path (UDP 16667). The control path is DTLS encrypted by default. Data path DTLS can be enabled when you add the mobility peer.

## SDA Roaming

SDA supports two additional types of roaming, which are Intra-xTR and Inter-xTR. In SDA, xTR stands for an access-switch that is a fabric edge node. It serves both as an ingress tunnel router as well as an egress tunnel router.

When a client on a fabric enabled WLAN, roams from an access point to another access point on the same access-switch, it is called Intra-xTR. Here, the local client database and client history table are updated with the information of the newly associated access point.

When a client on a fabric enabled WLAN, roams from an access point to another access point on a different access-switch, it is called Inter-xTR. Here, the map server is also updated with the client location (RLOC) information. Also, the local client database is updated with the information of the newly associated access point.

**Figure 38: SDA Roaming**

This figure shows inter-xTR and intra-xTR roaming, which occurs when the client moves from one access point to another access point on the same switch or to a different switch in a Fabric topology.

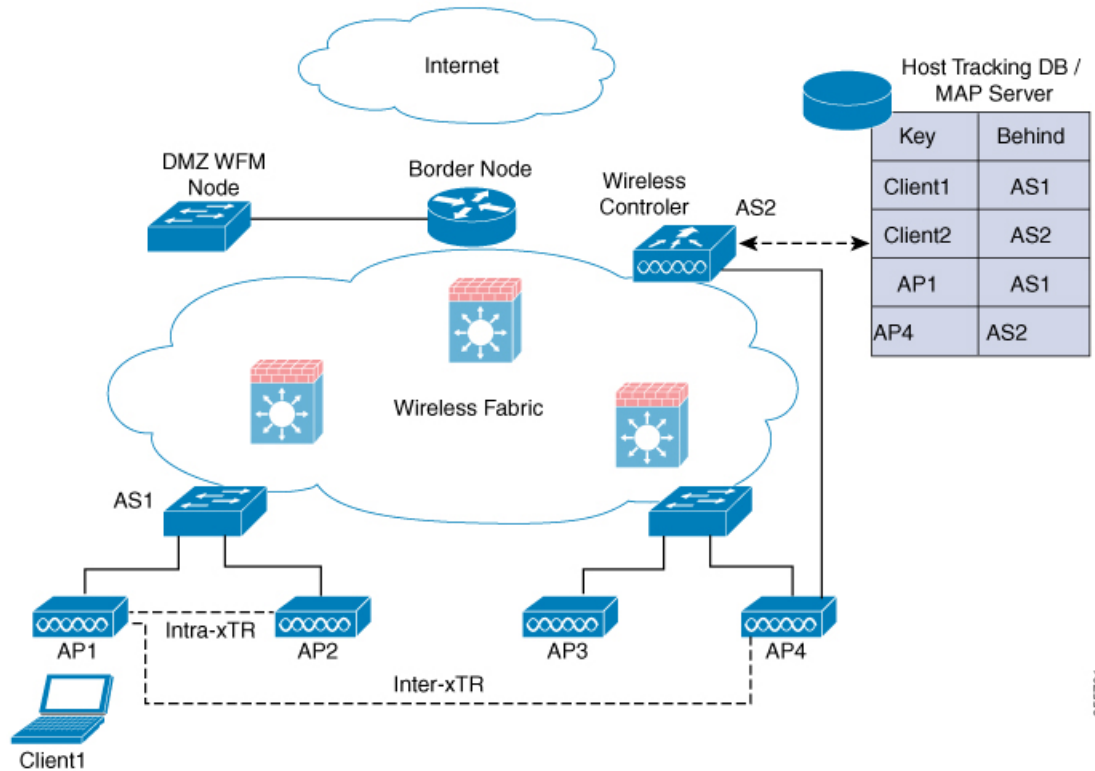

355781

## Definitions of Mobility-related Terms

- Point of Attachment—A station's point of attachment is where its data path is initially processed upon entry into the network.
- Point of Presence—A station's point of presence is the place in the network where the station is being advertised.
- Station—A user's device that connects to and requests service from a network.

## Mobility Groups

A mobility group is a set of controllers, identified by the same mobility group name, that defines the realm of seamless roaming for wireless clients. By creating a mobility group, you can enable multiple controllers

in a network to dynamically share information and forward data traffic when intercontroller or intersubnet roaming occurs. Controllers in the same mobility group can share the context and state of client devices as well as their list of access points so that they do not consider each other's access points as rogue devices. With this information, the network can support intercontroller wireless LAN roaming and controller redundancy.



**Note** While moving an AP from one controller to another (when both controllers are mobility peers), a client associated to controller-1 before the move might stay there even after the move. This is due to a timeout period on controller-1, where the client entry is maintained (for the purposes of roaming/re-association scenarios). To avoid the client being anchored in controller-1, remove the mobility peer configuration of the controller.

**Figure 39: Example of a Single Mobility Group**

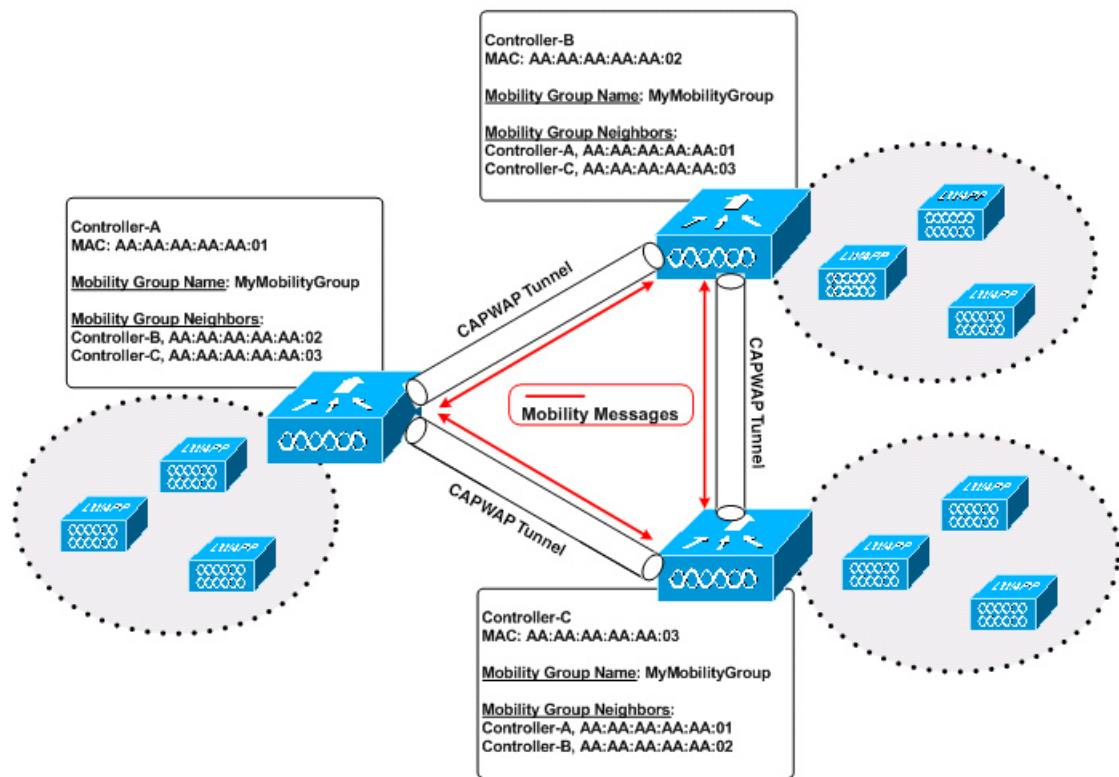

As shown in the figure above, each controller is configured with a list of the other members of the mobility group. Whenever a new client joins a controller, the controller sends out a unicast message (or multicast message if mobility multicast is configured) to all of the controllers in the mobility group. The controller to which the client was previously connected passes on the status of the client.

## Guidelines and Restrictions

The following AireOS and Cisco Catalyst 9800 Series Wireless Controller platforms are supported for SDA Inter-Controller Mobility (AireOS controller-to-Cisco Catalyst 9800 Series Wireless Controller):

- AireOS



- Cisco 3504
- Cisco 5520
- Cisco 8540
- **Cisco Catalyst 9800 Series Wireless Controller**
  - Cisco Catalyst 9800 Wireless Controller for Cloud
  - Cisco Catalyst 9800-80 Wireless Controller
  - Cisco Catalyst 9800-40 Wireless Controller
  - Cisco Catalyst 9800-L Wireless Controller

The following controller platforms are supported for SDA Inter-Controller Mobility:

- **Catalyst Switches**
    - Cisco 9300
  - **Cisco Catalyst 9800 Series Wireless Controller**
    - Cisco Catalyst 9800 Wireless Controller for Cloud
    - Cisco Catalyst 9800-40 Wireless Controller
- Ensure that the data DTLS configuration on the Cisco Catalyst 9800 Series Wireless Controller and AireOS are the same, as configuration mismatch is not supported on the Cisco Catalyst 9800 Series Wireless Controller and it causes the mobility data path to go down.
  - In intercontroller roaming scenarios, policy profiles having different VLANs is supported as a Layer 3 roaming.
  - In AireOS controller, L3 override is not supported in guest VLAN. Hence, the client does not trigger DHCP Discovery on the new VLAN automatically.
  - Policy profile name and client VLAN under policy profile can be different across the controllers with the same WLAN profile mapped.
  - In intracontroller roaming scenarios, client roaming is supported between same policy profiles, with WLAN mapped.

From Cisco IOS XE Amsterdam 17.3.x, The controller allows seamless roaming between same WLAN associated with different policy profile. For more information, see Client Roaming Policy Profile feature.
  - If a client roams in web authentication state, the client is considered as a new client on another controller instead of being identified as a mobile client.
  - Controllers that are mobility peers must use the same DHCP server to have an updated client mobility move count on intra-VLAN.
  - Data DTLS and SSC hash key must be same for mobility tunnels between members.
  - Mobility move count is updated under client detail only during inter-controller roaming. Intra-controller roaming can be verified under client stats and mobility history.

- Anchor VLAN in Cisco Catalyst 9800 Series Wireless Controller is represented as Access VLAN on the Cisco AireOS controller.
- When clients are roaming, their mobility role is shown as *Unknown*. This is because the roaming clients are in *IP learn* state, and in such a scenario, there are many client additions to the new instance and deletions in the old instance.
- In inter-controller roaming between 9800 and 9800/AireOS, client roaming is not supported, whenever there is a WLAN profile mismatch.
- Only IPv4 tunnel is supported between Cisco Catalyst 9800 Series Wireless Controller and Cisco AireOS controller.
- Ensure that you configure the mobility MAC address using the **wireless mobility mac-address** command for High-Availability to work.
- Mobility tunnel will not work if ECDSA based certificate or trustpoint is used for wireless management.
- If Anchor and Foreign controllers are put in the same Layer 2 network, it creates a loop topology (one path is Layer 3 mobility tunnel between Anchor and Foreign, another path is Layer 2 wired connection between Anchor and Foreign). In this topology, MAC\_CONFLICT warning message can be seen on both the Anchor and Foreign controllers. This MAC\_CONFLICT warning message is printed once every minute. However, it doesn't have any functionality and performance impact. As a best practice, do not use management VLAN as client VLAN.
- Mobility Tunnel will go down and come up if SSO is triggered due to gateway check failure.
- If the current AP has 5-GHz slot2 radio on L2 and L3 mobility 5-GHz slot2, the WLAN BSSID is only added to the 11k or 11v neighbor information. As a result, the AP does not have the information of radio properties of the APs belonging to the other controllers. Hence, it can be assumed that the radio properties of the APs belonging to the other controllers are similar to that of the current AP. If the current AP does not have slot2, the other APs cannot be added as a neighbor. In such a scenario, the validation fails and does not add this radio to the neighbor list.
- We recommend that you use the default keepalive count and interval values to reduce convergence time between the Cisco AireOS Wireless Controllers and Cisco Catalyst 9800 Series Wireless Controllers while setting up a mobility tunnel.
- A new client may take up to 3 seconds to join the network when the mobility tunnel is UP and mobility peers are configured. This is because the system sends three mobile messages (one second apart) to find out whether the client is already part of the network.

## Configuring Mobility (GUI)

### Procedure

---

- Step 1** Choose **Configuration > Wireless > Mobility**.  
The **Wireless Mobility** page is displayed on which you can perform global configuration and peer configuration.
- Step 2** In the **Global Configuration** section, perform the following tasks:
- a) Enter a name for the mobility group.
  - b) Enter the multicast IP address for the mobility group.

- c) In the **Keep Alive Interval** field, specify the number of times a ping request is sent to a mobility list member before the member is considered to be unreachable. The valid range is 3 to 20, and the default value is 3.
- d) Specify the **Mobility Keep Alive Count** amount of time (in seconds) between each ping request sent to a mobility list member. The valid range is 1 to 30 seconds.
- e) Enter the DSCP value for the mobility group.
- f) Enter the mobility MAC address.
- g) Click **Apply**.

**Step 3** In the **Peer Configuration** tab, perform the following tasks:

- a) In the **Mobility Peer Configuration** section, click **Add**.
- b) In the **Add Mobility Peer** window that is displayed, enter the MAC address and IP address for the mobility peer. The MAC address can be either in `xx:xx:xx:xx:xx:xx`, `xx-xx-xx-xx-xx-xx`, or `xxxx.xxxx.xxxx` format.
- c) Additionally, when NAT is used, enter the optional public IP address to enter the mobility peer's NATed address. When NAT is not used, the public IP address is not used and the device displays the mobility peer's direct IP address.
- d) Enter the mobility group to which you want to add the mobility peer.
- e) Select the required status for **Data Link Encryption**.
- f) Specify the **SSC Hash** as required.

SSC hash is required if the peer is a Cisco Catalyst 9800-CL Wireless Controller, which uses self-signed certificate and hence SSC hash is used as an additional validation. SSC hash is not required if peer is an appliance, which will have manufacturing installed certificates (MIC) or device certificates burned in the hardware.

- g) Click **Save & Apply to Device**.
- h) In the **Non-Local Mobility Group Multicast Configuration** section, click **Add**.
- i) Enter the mobility group name.
- j) Enter the multicast IP address for the mobility group.
- k) Click **Save**.

## Configuring Mobility (CLI)

### Procedure

	Command or Action	Purpose
<b>Step 1</b>	<b>wireless mobility group name</b> <i>group-name</i> <b>Example:</b> Device(config)# <b>wireless mobility group name</b> Mygroup	Creates a mobility group named <b>Mygroup</b> .
<b>Step 2</b>	<b>wireless mobility mac-address</b> <i>mac-addr</i> <b>Example:</b> Device(config)# <b>wireless mobility mac-address</b> 00:0d:ed:dd:25:82	Configures the MAC address to be used in mobility messages.

	Command or Action	Purpose
<b>Step 3</b>	<b>wireless mobility dscp</b> <i>value-0-to-63</i> <b>Example:</b> Device(config)# <b>wireless mobility dscp</b> <b>10</b>	(Optional) Configures mobility intercontroller DSCP value.
<b>Step 4</b>	<b>wireless mobility group keepalive interval</b> <i>time-in-seconds</i> <b>Example:</b> Device(config)# <b>wireless mobility group</b> <b>keepalive interval 5</b>	(Optional) Configures the interval between two keepalives sent to a mobility member. Valid range is between 1 and 30 seconds. <b>Note</b> For controllers connected through mobility tunnels, ensure that both controllers have the same keepalive interval value.
<b>Step 5</b>	<b>wireless mobility group keepalive count</b> <i>count</i> <b>Example:</b> Device(config)# <b>wireless mobility group</b> <b>keepalive count 3</b>	(Optional) Configures the keepalive retries before a member status is termed DOWN.
<b>Step 6</b>	Use the options given below to configure IPv4 or IPv6. <ul style="list-style-type: none"> <li>• <b>wireless mobility mac-address</b> <i>mac-address ip peer-ip-address group group-name data-link-encryption</i></li> <li>• <b>wireless mobility mac-address</b> <i>mac-address ip peer-ip-address public-ip public-ip-address group group-name</i></li> </ul> <b>Example:</b> Device(config)# wireless mobility mac-address 001E.BD0C.5AFF ip 9.12.32.10 group test-group data-link-encryption Device(config)# wireless mobility mac-address 001E.BD0C.5AFF ip fd09:9:2:49::55 public-ip fd09:9:2:49::55 group scalemobility	Adds a peer IPv4 or IPv6 address to a specific group. To remove the peer from the local group, use the <b>no</b> form of this command.
<b>Step 7</b>	<b>wireless mobility multicast</b> { <b>ipv4   ipv6</b> } <i>ip-address</i> or <b>wireless mobility group</b> <b>multicast-address</b> <i>group-name</i> { <b>ipv4   ipv6</b> } <i>ip-address</i> <b>Example:</b> Device(config)# <b>wireless mobility</b> <b>multicast ipv4 224.0.0.4</b> <b>Example:</b> Device(config)# <b>wireless mobility group</b> <b>multicast-address Mygroup ipv4 224.0.0.5</b>	(Optional) Configures a multicast IPv4 or IPv6 address for a local mobility group or a nonlocal mobility group. <b>Note</b> <b>Mobility Multicast</b> —The controller sends a multicast message instead of a unicast message to all the members in the mobility local group or a nonlocal group when a client joins or roams. Configures the multicast IPv4 address as 224.0.0.4 for a local mobility group.

	Command or Action	Purpose
		Configures the multicast IPv4 address as 224.0.0.5 for a nonlocal mobility group.

## Configuring Inter-Release Controller Mobility (GUI)

### Procedure

- 
- Step 1** Choose **Configuration > Wireless > Mobility > Global Configuration**.
- Step 2** Enter the **Mobility Group Name**, **Multicast IPv4 Address**, **Multicast IPv6 Address**, **Keep Alive Interval (sec)**, **Mobility Keep Alive Count**, **Mobility DSCP Value** and **Mobility MAC Address**.
- Step 3** Click **Apply**.
- 

## Configuring Inter-Release Controller Mobility

Inter-Release Controller Mobility (IRCM) is a set of features and functionality that enable interworking between controllers running different software releases. IRCM enables seamless mobility and wireless services across controllers running Cisco AireOS and Cisco IOS (for example, Cisco 8540 WLC to Cisco Catalyst 9800 Series Wireless Controller) for features such as Layer 2 and Layer 3 roaming and guest access or termination.



**Note** To configure IRCM for different combination of AireOS and Catalyst 9800 controllers, see the [Cisco Catalyst 9800 Wireless Controller-Aireos IRCM Deployment Guide](#).

Follow the procedure described to configure mobility peers on the controller:

### Before you begin

The Inter-Release Controller Mobility (IRCM) feature is supported by the following Cisco Wireless Controllers.

- For IRCM deployment, we recommended that you configure:
  - Both Cisco AireOS and Cisco Catalyst 9800 Series Controllers as static RF leaders to avoid RF grouping between them.
  - Configure the same RF network name on both the controllers.
- Cisco Catalyst 9800 Series Wireless Controller platforms running Cisco IOS XE Software version 16.10.1 or later.
- Supports the following Cisco AireOS Wireless Controllers running Cisco AireOS 8.5.14x.x IRCM image based on the 8.5 Maintenance Release software:
  - Cisco 3504 Wireless Controllers

- Cisco 5508 Wireless Controllers
  - Cisco 5520 Wireless Controllers
  - Cisco 8510 Wireless Controllers
  - Cisco 8540 Wireless Controllers
- By design, Cisco Catalyst 9800 Wireless Controllers does not have the Primary Mode configuration exposed that is to be sent in the Discovery Response. The controller always sends the Discovery Response with the Primary Mode enabled.
  - Supported Cisco AireOS Wireless Controllers running AireOS 8.8.111.0 and later. The following controllers are supported:
    - Cisco 3504 Wireless Controllers
    - Cisco 5520 Wireless Controllers
    - Cisco 8540 Wireless Controllers



**Note** If the peer Cisco Catalyst 9800 Series Wireless Controller is virtual, configure the hash using command:

```
config mobility group member hash 172.20.227.73
3f93a86cee2039e9c3aada1822ad74b89fea30c1
```

```
config mobility group member hash 172.20.227.73
3f93a86cee2039e9c3aada1822ad74b89fea30c1
```

Optionally enable data tunnel encryption using command:

```
config mobility group member data-dtls 00:0c:29:a8:d5:77
enable/disable
```

The hash configure above can be obtained by running the following command on the Cisco Catalyst 9800 Series Wireless Controller:

```
show wireless management trustpoint
Trustpoint Name : ewlc-tp1
Certificate Info : Available
Certificate Type : SSC
Certificate Hash : 3f93a86cee2039e9c3aada1822ad74b89fea30c1
Private key Info : Available
```

- The IRCM feature is not supported on the following Cisco AireOS Wireless Controllers:
  - Cisco 2504 Wireless Controllers
  - Cisco Flex 7510 Wireless Controllers
  - Cisco WiSM 2

- IPv6 is not supported for SDA IRCM for fabric client roaming. IPv6 is supported for IRCM for non-fabric client roaming.
- Ensure that you use AireOS controller that supports Encrypted Mobility feature.
- AVC is not supported for IRCM.
- In mixed deployments (Catalyst 9800 and AireOS Controllers), the WLAN profile name and the policy profile name must be the same. This is due to AireOS not knowing about the policy profile and therefore only sends or receives the WLAN name as both the policy profile and WLAN profile.
- Mobility group multicast is not supported because AireOS does not support mobility multicast in encrypted mobility.
- There could be instances where the total number of clients count shown may be more than those supported on the roaming scale. This inconsistency is observed when the client roaming rate is very high, as the system requires time to update the records. Here, the clients presented on multiple WNCds for a very short time are counted more than once. We recommend that you provide sufficient time for the process to obtain a consistent data before using one of the following methods: show CLIs, WebUI, Cisco Catalyst Center, or SNMP.
- Link Local bridging is not supported. Ensure that you disable it also on the peer AireOS controller.
- IRCM is not supported in FlexConnect and FlexConnect+Bridge modes.

The following client features support IPv6 client mobility between AireOS controllers and Cisco Catalyst 9800 Series Wireless Controller: Accounting, L3 Security (Webauth), Policy (ACL and QoS), IP address assignment and learning through SLAAC and DHCPv6, IPv6 Source Guard, multiple IPv6 address learning, IPv6 multicast, and SISF IPv6 features (RA Guard, RA Throttling, DHCPv6 Guard, and ND Suppress).β

The following IPv6 features are not supported on Cisco Catalyst 9800 Series Wireless Controller:

- Configurable IPv6 timers
- RA Guard enabled on AP
- Global IPv6 disable



- Note**
- IPv6 CWA is not supported for both AireOS controllers and Cisco Catalyst 9800 Series Wireless Controller.
  - Only eight IPv6 addresses are supported per client.

**Procedure**

	Command or Action	Purpose
<b>Step 1</b>	<b>configure terminal</b>  <b>Example:</b> Device# configure terminal	Enters global configuration mode.
<b>Step 2</b>	Use the options given below to configure IPv4 or IPv6.	Adds a peer IPv4 or IPv6 address to a specific group.

	Command or Action	Purpose
	<ul style="list-style-type: none"> <li>• <b>wireless mobility group member mac-address <i>mac-address</i> ip <i>peer-ip</i> group <i>group-name</i> data-link-encryption</b></li> <li>• <b>wireless mobility group member mac-address <i>mac-address</i> ip <i>peer-ip-address</i> public-ip <i>public-ip-address</i> group <i>group-name</i></b></li> </ul> <p><b>Example:</b></p> <pre>Device(config)# wireless mobility group member mac-address 001E.BD0C.5AFF ip 9.12.32.10 group test-group data-link-encryption  Device(config)# wireless mobility group member mac-address 001E.BD0C.5AFF ip fd09:9:2:49::55 public-ip fd09:9:2:49::55 group scalemobility</pre>	To remove the peer from the local group, use the <b>no</b> form of this command.
<b>Step 3</b>	<b>wireless mobility group name <i>group-name</i></b> <b>Example:</b> <pre>Device(config)# wireless mobility group name test-group</pre>	Adds a name for the local group. The default local group name is "default".
<b>Step 4</b>	<b>wireless mobility mac-address <i>mac-address</i></b> <b>Example:</b> <pre>Device(config)# wireless mobility mac-address 000d.bd5e.9f00</pre>	(Optional) Configures the MAC address to be used in mobility messages.
<b>Step 5</b>	<b>wireless mobility group member ip <i>peer-ip</i></b> <b>Example:</b> <pre>Device(config)# wireless mobility group member ip 9.12.32.15</pre>	Adds a peer in the local group.  To remove the peer from the local group, use the <b>no</b> form of this command.
<b>Step 6</b>	<b>wireless mobility dscp <i>dscp-value</i></b> <b>Example:</b> <pre>Device(config)# wireless mobility dscp 52</pre>	(Optional) Configures DSCP. The default value is 48.
<b>Step 7</b>	<b>wireless mobility group keepalive count <i>count</i></b> <b>Example:</b> <pre>Device(config)# wireless mobility group keepalive count 10</pre>	Configures the mobility control and data path keepalive count. The default value is 3.
<b>Step 8</b>	<b>wireless mobility group keepalive interval <i>interval</i></b> <b>Example:</b> <pre>Device(config)# wireless mobility group keepalive interval 30</pre>	Configures the mobility control and data path keepalive interval. The default value is 10.  <b>Note</b> For controllers connected through mobility tunnels, ensure that both controllers have the same keepalive interval value.



# Verifying Mobility

To display the summary of the mobility manager, use the following command:

```
Device# show wireless mobility summary
```

To display mobility peer information, use the following command:

```
Device# show wireless mobility peer ip 10.0.0.8
```

To display the list of access points known to the mobility group, use the following command:

```
Device# show wireless mobility ap-list
```

To display statistics for the mobility manager, use the following command:

```
Device# show wireless statistics mobility
Mobility event statistics:
  Joined as
    Local                : 0
    Foreign              : 0
    Export foreign       : 2793
    Export anchor        : 0
  Delete
    Local                : 2802
    Remote               : 0
  Role changes
    Local to anchor     : 0
    Anchor to local     : 0
  Roam stats
    L2 roam count       : 0
    L3 roam count       : 0
    Flex client roam count : 0
    Inter-WNCd roam count : 0
    Intra-WNCd roam count : 0
    Remote inter-cntrl roam count : 0
    Remote WebAuth pending roams : 0
  Anchor Request
    Sent                 : 0
    Grant received       : 0
    Deny received       : 0
  Received
    Grant sent           : 0
    Deny sent           : 0
  Handoff Status Received
    Success              : 0
    Group mismatch       : 0
    Client unknown       : 0
    Client blacklisted   : 14
    SSID mismatch        : 0
    Denied               : 0
  Handoff Status Sent
    Success              : 0
    Group mismatch       : 0
    Client unknown       : 0
    Client blacklisted   : 0
    SSID mismatch        : 0
    Denied               : 0
  Export Anchor
    Request Sent         : 2812
```

```

Response Received      :
  Ok                   : 2793
  Deny - generic       : 19
  Client blacklisted   : 0
  Client limit reached : 0
  Profile mismatch     : 0
  Deny - unknown reason : 0
Request Received      : 0
Response Sent         :
  Ok                   : 0
  Deny - generic       : 0
  Client blacklisted   : 0
  Client limit reached : 0
  Profile mismatch     : 0
MM mobility event statistics:
  Event data allocs    : 17083
  Event data frees     : 17083
  FSM set allocs       : 2826
  FSM set frees        : 2816
  Timer allocs         : 8421
  Timer frees          : 8421
  Timer starts         : 14045
  Timer stops          : 14045
  Invalid events       : 0
  Internal errors      : 0
  Delete internal errors : 0
  Roam internal errors : 0
    
```

```

MMIF mobility event statistics:
  Event data allocs    : 17088
  Event data frees     : 17088
  Invalid events       : 0
  Event schedule errors : 0
MMIF internal errors:
  IPC failure          : 0
  Database failure     : 0
  Invalid parameters   : 0
  Mobility message decode failure : 0
  FSM failure          : 0
  Client handoff success : 0
  Client handoff failure : 14
  Anchor Deny          : 0
  Remote delete        : 0
  Tunnel down delete   : 0
  MBSSID down         : 0
  Unknown failure     : 0
    
```

To display counters for all messages in mobility, use the following command:

Device# **show wireless stats mobility messages**

MM datagram message statistics:

Message Type	Built	Tx	Rx	Processed	Tx Error	Rx Error	Forwarded
Mobile Announce	0	0	0	0	0	0	25350
5624 0 2826 2826							
Mobile Announce Nak	0	0	0	0	0	0	0
0 0 0 0							
Static IP Mobile Annc	0	0	0	0	0	0	0
0 0 0 0							
Static IP Mobile Annc Rsp	0	0	0	0	0	0	0
0 0 0 0							

Handoff	0	0	14	14	0	0	0	0
0 0 42 42								
Handoff End	0	0	0	0	0	0	2783	
0 0 2783 2783								
Handoff End Ack	0	0	2783	2783	0	0	0	
0 0 8349 8349								
Anchor Req	0	0	0	0	0	0	0	
0 0 0 0								
Anchor Grant	0	0	0	0	0	0	0	
0 0 0 0								
Anchor Xfer	0	0	0	0	0	0	0	
0 0 0 0								
Anchor Xfer Ack	0	0	0	0	0	0	0	
0 0 0 0								
Export Anchor Req	0	0	0	0	0	0	2812	
0 0 2812 2812								
Export Anchor Rsp	0	0	2812	2812	0	0	0	
0 0 8436 8436								
AAA Handoff	0	0	0	0	0	0	0	
0 0 0 0								
AAA Handoff Ack	0	0	0	0	0	0	0	
0 0 0 0								
IPv4 Addr Update	0	0	2792	0	0	0	0	
0 0 2792 2792								
IPv4 Addr Update Ack	2792	2792	0	0	0	0	0	
0 0 2792 2792								
IPv6 ND Packet	0	0	0	0	0	0	0	
0 0 0 0								
IPv6 Addr Update	0	0	5587	0	0	0	0	
0 0 5587 5587								
IPv6 Addr Update Ack	5587	5587	0	0	0	0	0	
0 0 5587 5587								
Client Add	0	0	0	0	0	0	0	
0 0 0 0								
Client Delete	0	0	0	0	0	0	0	
0 0 0 0								
AP List Update	25585	25585	8512	8512	2	1	0	
0 0 34098 34098								
Client Device Profile Info	0	0	0	0	0	0	0	
0 0 0 0								
PMK Update	0	0	0	0	0	0	0	
0 0 0 0								
PMK Delete	0	0	0	0	0	0	0	
0 0 0 0								
PMK 11r Nonce Update	0	0	0	0	0	0	0	
0 0 0 0								
Device cache Update	0	0	0	0	0	0	0	
0 0 0 0								
HA SSO Announce	0	0	0	0	0	0	0	
0 0 0 0								
HA SSO Announce Resp	0	0	0	0	0	0	0	
0 0 0 0								
Mesh Roam Request	0	0	0	0	0	0	0	
0 0 0 0								
Mesh Roam Response	0	0	0	0	0	0	0	
0 0 0 0								
Mesh AP PMK Time Upd	0	0	0	0	0	0	0	
0 0 0 0								
Mesh AP PMK Time Upd Ack	0	0	0	0	0	0	0	
0 0 0 0								
Mesh AP Channel List	0	3	1	0	0	1	0	
0 0 2 2								
Mesh AP Channel List Resp	0	0	0	0	0	0	0	
0 0 0 0								

```

AP upgrade                0      0      0      0      0      0      0
0      0      0      0
Keepalive Ctrl Req        34080  34080  17031  17031  0      0      0
0      0      51111  51111
Keepalive Ctrl Resp       17031  17031  34067  34067  0      0      0
0      0      51098  51098
Keepalive Data Req/Resp   238527 238527 221451 221451 0      0      0
0      0      459978 459978

```

To display mobility information of the client, use the following command:

```
Device# show wireless client mac-address 00:0d:ed:dd:35:80 detail
```

To display roaming history of the active client in the subdomain, use the following command:

```
Device# show wireless client mac-address 00:0d:ed:dd:35:80 mobility history
```

To display client-specific statistics for the mobility manager, use the following command:

```
Device# show wireless client mac-address 00:0d:ed:dd:35:80 stats mobility
```

To verify whether intercontroller roam is successful, use the following commands:

- **show wireless client mac *mac-address* detail**: (on the roamed-to Controller) Displays the roam type as L2 and the roam count is incremented by 1.
- **show wireless client summary** : (on the roamed-from controller) The client entry will not be there in the output.

### Verifying SDA Mobility

To verify whether intracontroller, intra-xTR roam is successful, use the following commands:

- **show wireless client summary**: Displays the new AP if the client has roamed across the APs on the same xTR.
- **show wireless client mac *mac-address* detail**: Displays the same RLOC as before the roam.

To verify whether intracontroller, inter-xTR roam is successful, use the following commands:

- **show wireless fabric client summary**: Displays the new AP if the client has roamed across the APs on a different xTR.
- **show wireless client mac *mac-address* detail**: Displays the RLOC of the new xTR to which the client has roamed to.

To check client status before and after intracontroller roaming, perform the following steps:

1. Check if client is on the old AP, using **show wireless client summary** command on the controller.
2. Check whether the client MAC is listed against the old AP, using **show mac addr dyn** command on the xTR1.
3. Check whether the client IP is registered from current xTR1, and client MAC is registered from both current xTR1, and WLC1, using **show lisp site detail** command on the MAP server.
4. After the intra-WLC roam, check whether the client is on the new AP, using the **show wireless client summary** and **show mac addr dyn** commands on the WLC1 and xTR1.

5. After the Inter-xTR Roam (old and new APs on different xTRs), check whether the client is on the new AP (connected to the new xTR2), using the **show wireless client summary** and **show mac addr dyn** commands on the WLC1 and xTR2.
6. Check whether the client is registered from the new xTR2, using the **show lisp site detail** command on the MAP server.

### Verifying Roaming on MAP Server for SDA

To verify roaming information for SDA, use the following commands:

Run the following command on the MAP server, before and after the roam, to check whether the client IP is registered from current xTR, and client MAC is registered from both current xTR, and WLC.

```
Device# show lisp site detail
```





# CHAPTER 136

## NAT Support on Mobility Groups

- [Information About NAT Support on Mobility Groups, on page 1245](#)
- [Restrictions for NAT Support on Mobility Groups, on page 1246](#)
- [Functionalities Supported on Mobility NAT, on page 1246](#)
- [Configuring a Mobility Peer, on page 1247](#)
- [Verifying NAT Support on Mobility Groups , on page 1247](#)

### Information About NAT Support on Mobility Groups

The Network Address Translation (NAT) on Mobility Groups feature supports the establishment of mobility tunnels between peer controllers when one or both peers are behind a NAT. This is achieved by translating the public and private IP addresses of the peers (see figure below). Depending on the placement and number of NATs, translation might be required at one or both ends of the tunnel.

**Figure 40: Mobility NAT**

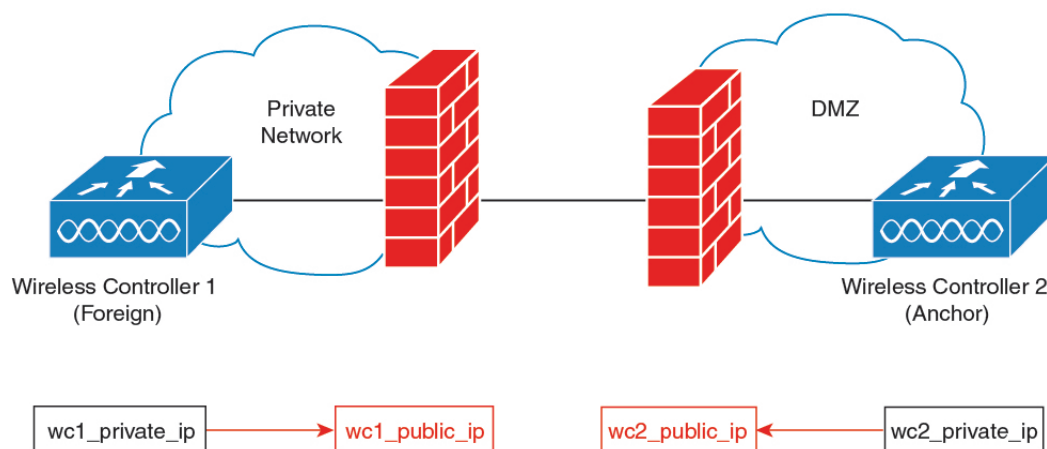

When configuring a NATed mobility peer, both the private IP address (address in the network before the NAT device) and the public IP address (address in the public network) have to be configured. Also, if you are using a firewall, ensure that the ports listed below can be accessed through the firewall:

- Port 16666 for mobility control messages

- Port 16667 for mobility data messages

## Restrictions for NAT Support on Mobility Groups

- Only 1:1 (static) NAT entries can exist for the controller peers that form the mobility tunnels.
- Configuring multiple peers with the same public IP address is not supported.
- Private IP addresses of the configured peers must be unique.
- Port Address Translation (PAT) is not supported.
- If peer controllers of different types, for example, Cisco AireOS and Cisco Catalyst 9800 Series) are placed behind NAT, Inter-Release Controller Mobility (IRCM) is not supported for client roaming.
- IPv6 address translation is not supported.

## Functionalities Supported on Mobility NAT

The following table lists the functionalities supported on mobility NAT:

**Table 60: Functionalities Supported on Mobility NAT**

Two controllers, with the foreign controller behind a NAT device (1to1 NAT only)	Yes
Two controllers, with the anchor controller behind a NAT device (1to1 NAT only)	Yes
Two controllers, with the anchor and foreign controller behind a NAT device (1to1 NAT only)	Yes
Multiple foreign and anchor controllers behind NATs (1to1 NAT only)	Yes
Supported Cisco Catalyst 9800 Series Wireless Controllers	<ul style="list-style-type: none"> <li>• Cisco Catalyst 9800-40 Wireless Controller</li> <li>• Cisco Catalyst 9800-80 Wireless Controller</li> <li>• Catalyst 9800 Wireless Controller for Cloud</li> <li>• Cisco Catalyst 9800-L Wireless Controller</li> </ul>
Number of peers supported	72
Manageability using SNMP, Yang, and web UI	Yes
IRCM support for mobility	Yes



SSO	Yes
Client roaming (Layer 2 and Layer 3) between Cisco Catalyst 9800 Series Wireless Controllers	Yes
Client roaming (Layer 2 and Layer 3) between Cisco Catalyst 9800 Series Wireless Controller and AireOS controller	No
Supported applications on the mobility tunnel	<ul style="list-style-type: none"> <li>• Native profiling</li> <li>• AP list</li> <li>• PMK cache</li> <li>• Mesh AP</li> </ul>

## Configuring a Mobility Peer

### Before you begin

Ensure that the private and public IP addresses of a mobility peer are of the same type, either IPv4 or IPv6.

### Procedure

	Command or Action	Purpose
<b>Step 1</b>	<b>configure terminal</b> <b>Example:</b> Device# configure terminal	Enters global configuration mode.
<b>Step 2</b>	<b>wireless mobility group member mac-address peer_mac ip peer_private_ip [public-ip peer_public_ip] group group_name</b> <b>Example:</b> Device(config)# wireless mobility group member mac-address 001e.494b.04ff ip 11.0.0.2 public-ip 4.0.0.112 group dom1	Adds a mobility peer to the list with an optional public IP address. <b>Note</b> You cannot configure multiple peers with the same private or public IP address.
<b>Step 3</b>	<b>exit</b> <b>Example:</b> Device(config)# exit	Returns to privileged EXEC mode.

## Verifying NAT Support on Mobility Groups

To display the mobility information of a client, use the following command:

```
Device# show wireless client mac-address 000a.bd15.0010 detail
```

```
Client MAC Address : 000a.bd15.0010
Client IPv4 Address : 100.100.0.2
Client Username: N/A
AP MAC Address : 000a.ad00.0800
AP Name: SIM-AP-7
AP slot : 1
.
.
.
```

To display mobility peer information using a private peer IP address, use the following command:

```
Device# show wireless mobility peer ip 21.0.0.2
```

```
Mobility Peer Info
=====
Ip Address : 21.0.0.2
Public Ip Address : 3.0.0.22
MAC Address : cc70.ed02.c3b0
Group Name : dom1
.
.
.
```



## CHAPTER 137

# Static IP Client Mobility

---

- [Information About Static IP Client Mobility, on page 1249](#)
- [Restrictions, on page 1249](#)
- [Configuring Static IP Client Mobility \(GUI\), on page 1250](#)
- [Configuring Static IP Client Mobility \(CLI\), on page 1250](#)
- [Verifying Static IP Client Mobility, on page 1251](#)

## Information About Static IP Client Mobility

At times, you may want to configure static IP addresses for wireless clients. When these wireless clients move about in a network, they might try associating with other controllers.

If the clients try to associate with a controller that does not support the same subnet as the static IP address, the clients fail to connect to the network. The controller inspects the ARP requests sent by the clients to determine if the clients are using static IP addresses or IP addresses that were previously assigned by DHCP. If the ARP requests contain IP addresses that do not exist on any of the controller's Switched Virtual Interfaces (SVIs), the clients are disconnected due to a "VLAN\_FAIL" error, resulting in client traffic backhauled without explicit disconnection.

The disconnection due to VLAN mismatch is a change in functionality introduced in the 17.9.1 release.

Static IP clients with static IP addresses can be associated with other controllers in which the client's subnet is supported by tunneling the traffic to another controller in the same mobility group. This feature enables you to configure your WLAN so that the network is serviced even though the clients use static IP addresses.

## Restrictions

- This feature is not supported on the Fabric and Cisco Catalyst 9800 Wireless Controller for Switch platforms.
- IPv6 is not supported.
- FlexConnect mode is not supported.
- WebAuth (LWA and CWA) is not supported.
- Supported only Open, Dot1x, and PSK authentication mechanisms.

- Supports only on the WLANs that are exclusive of the mobility anchor configuration. If the mobility anchor is already configured on a WLAN, and if static IP mobility is enabled, the feature is not supported.
- Supported only when all the peers are configured for the static IP mobility that is enabled.
- IRCM is not supported.

## Configuring Static IP Client Mobility (GUI)

### Procedure

- 
- Step 1** Choose **Configuration** > **Tags & Profiles** > **Policy**.
- Step 2** On the **Policy** page, click the policy profile name or click **Add** to create a new one.
- Step 3** Click the **Mobility** tab.
- Step 4** Set the **Static IP Mobility** field to **Enabled** state.
- Step 5** Click **Update & Apply to Device**.
- 

## Configuring Static IP Client Mobility (CLI)

Follow the procedure given below to configure static IP client mobility:

### Before you begin

- Configure the SVI interface (L3 VLAN interface) to service the static IP client on at least one of the peer controllers in the network.
- For clients to join a controller, the VLAN (based on the VLAN number in the policy profile configuration) should be configured on the device.

### Procedure

	Command or Action	Purpose
<b>Step 1</b>	<b>configure terminal</b>  <b>Example:</b> Device# configure terminal	Enters global configuration mode.
<b>Step 2</b>	<b>wireless profile policy</b> <i>profile-policy-name</i>  <b>Example:</b> Device(config)# wireless profile policy static-ip-policy	Configures a WLAN policy profile and enters wireless policy configuration mode.
<b>Step 3</b>	<b>static-ip-mobility</b>  <b>Example:</b>	Enables static IP mobility.

	Command or Action	Purpose
	Device(config-wireless-policy)# static-ip-mobility	

## Verifying Static IP Client Mobility

Use the following commands to verify the static IP client mobility configuration:

```
Device# show wireless profile policy detailed static-ip-policy
```

```

Policy Profile Name      : static-ip-policy
Description              :
Status                  : DISABLED
VLAN                    : 1
Wireless management interface VLAN      : 34
Passive Client          : DISABLED
ET-Analytics           : DISABLED
StaticIP Mobility      : DISABLED
WLAN Switching Policy
  Central Switching    : ENABLED
  Central Authentication : ENABLED
  Central DHCP         : DISABLED
  Flex NAT PAT         : DISABLED
  Central Assoc        : DISABLED
WLAN Flex Policy
  VLAN based Central Switching          : DISABLED
WLAN ACL
  IPv4 ACL                          : Not Configured
  IPv6 ACL                          : Not Configured
  Layer2 ACL                        : Not Configured
  Preauth urlfilter list            : Not Configured
  Postauth urlfilter list           : Not Configured
WLAN Timeout
  Session Timeout                   : 1800
  Idle Timeout                      : 300
  Idle Threshold                    : 0
WLAN Local Profiling
  Subscriber Policy Name            : Not Configured
  RADIUS Profiling                 : DISABLED
  HTTP TLV caching                 : DISABLED
  DHCP TLV caching                 : DISABLED
WLAN Mobility
  Anchor                           : DISABLED
AVC VISIBILITY
  Disabled
Flow Monitor IPv4
  Flow Monitor Ingress Name        : Not Configured
  Flow Monitor Egress Name         : Not Configured
Flow Monitor IPv6
  Flow Monitor Ingress Name        : Not Configured
  Flow Monitor Egress Name         : Not Configured
NBAR Protocol Discovery            : Disabled
Reanchoring                       : Disabled
Classmap name for Reanchoring
  Reanchoring Classmap Name        : Not Configured
QOS per SSID
  Ingress Service Name             : Not Configured
  Egress Service Name              : Not Configured
QOS per Client
  Ingress Service Name             : Not Configured

```

```

Egress Service Name          : Not Configured
Umbrella information
Cisco Umbrella Parameter Map : Not Configured
Autoqos Mode                 : None
Call Snooping                : Disabled
Fabric Profile
Profile Name                 : Not Configured
Accounting list
Accounting List              : Not Configured
DHCP
required                     : DISABLED
server address               : 0.0.0.0
Opt82
DhcpOpt82Enable              : DISABLED
DhcpOpt82Ascii               : DISABLED
DhcpOpt82Rid                 : DISABLED
APMAC                        : DISABLED
SSID                         : DISABLED
AP_ETHMAC                    : DISABLED
APNAME                       : DISABLED
POLICY TAG                   : DISABLED
AP_LOCATION                  : DISABLED
VLAN_ID                      : DISABLED
Exclusionlist Params
Exclusionlist                 : ENABLED
Exclusion Timeout             : 60
AAA Policy Params
AAA Override                  : DISABLED
NAC                           : DISABLED
AAA Policy name               : default-aaa-policy
WGB Policy Params
Broadcast Tagging            : DISABLED
Client VLAN                  : DISABLED
Mobility Anchor List
IP Address                    Priority
-----

```

```
Device# show run | section profile policy
```

```

wireless profile policy default-policy-profile
central switching
description "default policy profile"
static-ip-mobility
vlan 50
no shutdown

```



## CHAPTER 138

# Mobility Domain ID - Dot11i Roaming

- [Information about Mobility Domain ID - 802.11i Roaming, on page 1253](#)
- [Verifying Mobility Domain ID - 802.11i Roaming, on page 1254](#)

## Information about Mobility Domain ID - 802.11i Roaming

A mobility domain is a cluster of APs forming a continuous radio frequency space, where the Pairwise Master Key (PMK) can be synchronized, and fast roaming can be enabled for 802.11r (Fast Transition) or 802.11i (WPA).

In the releases prior to Cisco IOS XE 17.2.1, the PMK cache was shared across the FlexConnect APs using the AP site tag. All the APs that are a part of a site tag share the PMK cache. This is applicable only for central authentication.

From Cisco IOS XE 17.2.1, you can create a Mobility Domain ID (MDID) for each of the APs. All the APs with the same MDID share the PMK cache keys even if they are in different site tags. When MDID is configured for APs, the PMK cache keys are not shared with the APs that are not a part of the same MDID, even if they are a part of the same site tag. MDID supports PMK cache distribution for both central authentication and local authentication.



### Note

- The Mobility Domain ID - 802.11i Roaming feature does not work when the Flex APs are in standalone mode because the feature depends on the controller to share the keys.
- MDID is configured only through the open configuration model. There is no CLI or GUI support.
- In Cisco IOS XE Amsterdam 17.2.1, 100 APs per site-tag or per MDID are supported, and 1000 PMK entries are supported per AP.

The mobility domain can either be defined as a static configuration of clustered APs, all under a commonly configured MDID, or dynamically computed. You can implement a spatial clustering algorithm based on neighbor associations of APs. Each AP can only be a part of one roaming domain.

An MDID is used by 802.11r to define a network in which an 802.11r fast roam is supported. PMKs should be shared within mobility domains, allowing clients to support fast roaming. If defined, MDID takes precedence over a site tag.

MDID configurations are exercised only from open configuration models. For more information about open configuration models, see the [https://www.cisco.com/c/en/us/td/docs/ios-xml/ios/prog/configuration/172/b\\_172\\_programmability\\_cg.html](https://www.cisco.com/c/en/us/td/docs/ios-xml/ios/prog/configuration/172/b_172_programmability_cg.html).

## Verifying Mobility Domain ID - 802.11i Roaming

The following examples shows how to view and verify the 802.11i Roaming configuration:

```
Device# show running-config | section specific-config
ap specific-config 58ac.70dc.xxxx hostname AP58AC.70DC.XXXX
   roaming-domain roaming_domain_2
ap specific-config 78xc.f09d.xxxx hostname AP78XC.F09D.XXXX
   roaming-domain roaming_domain_3
```





## CHAPTER 139

# 802.11r Support for Flex Local Authentication

- [Information About 802.11r Support for FlexConnect Local Authentication, on page 1255](#)
- [Verifying 802.11r Support for Flex Local Authentication , on page 1256](#)

## Information About 802.11r Support for FlexConnect Local Authentication

In releases prior to Cisco IOS XE Amsterdam 17.2.1, the FlexConnect mode fast transition was supported only in centrally authenticated clients. This was achieved by sharing the Pairwise Master Key (PMK) to all the FlexConnect APs in the same site tag. From Cisco IOS XE Amsterdam 17.2.1, fast transition is supported even for locally authenticated clients.

The client PMK cache entries are shared and distributed to all the APs in the same site tag. From Cisco IOS XE Amsterdam 17.2.1, another grouping called Mobility Domain ID (MDID) is introduced, for sharing the PMK cache entries. MDID can be configured for APs using the open configuration model only. There is no CLI or GUI support.

The PMK cache distribution in a FlexConnect local site (using either the site tag or MDID) is restricted to 100 APs per group, with a maximum support for 1000 PMK entries per AP.

### Support Guidelines

The following are the 802.11r support guidelines:

- Supports 802.11r on FlexConnect local authentication only with Over-the-Air method of roaming. Over-the-DS (Distribution System) is not supported.
- Supports adaptive 11r for Apple clients.
- Supports both Fast Transition + 802.1x and Fast Transition + PSK.



---

**Note** This is supported only when clients join the standalone mode AP.

---

## Verifying 802.11r Support for Flex Local Authentication

To verify the number of PMK caches, use the **show wireless pmk-cache** command:

```
Device# show wireless pmk-cache
Number of PMK caches in total : 1
```

Type	Station	Entry Lifetime	VLAN Override	IP Override
Audit-Session-Id		Username		
DOT11R	74xx.bx5a.07xx	87	NA	
0000000000000000FF3562B5D		jey		

To verify the 802.11r flex roam attempts, use the **show wireless client mac-address 74xx.bx5a.07xx mobility history** command:

```
Device# show wireless client mac-address 74xx.bx5a.07xx mobility history
Recent association history (most recent on top):
```

AP Name	Instance	Mobility Role	Run Latency (ms)	BSSID	AP Slot	Assoc Time
				Dot11	Roam Type	
APM-9120-1-GCP	1	Local	2	d4xx.80xx.8fxx	1	12/11/2019 18:44:37
				802.11R		
APM-4800-3	1	Local	17547	f4xx.e6xx.08xx	1	12/11/2019 18:43:02
				N/A		

```
show wireless stats client detail | sec roam
Total 11r flex roam attempts : 1
```



## CHAPTER 140

# Opportunistic Key Caching

- [Information about Opportunistic Key Caching, on page 1257](#)
- [Enabling Opportunistic Key Caching, on page 1258](#)
- [Enabling Opportunistic Key Caching \(GUI\), on page 1258](#)
- [Verifying Opportunistic Key Caching, on page 1258](#)

## Information about Opportunistic Key Caching

Opportunistic Key Caching (OKC) is an enhancement of the WPA2 Pairwise Master Key ID (PMKID) caching method, which is why it is also named Proactive or Opportunistic PMKID Caching. Just like PMKID caching, OKC works with WPA2-EAP.

The OKC technique allows wireless clients and the WLAN infrastructure to cache only one PMK for client association with a WLAN, even when roaming between multiple APs because they all share the original PMK that is used for the WPA2 4-way handshake. This is required to generate new encryption keys every time a client reassociates with APs. For APs to share the original PMK from a client session, they must all be under a centralized device that caches and distributes the original PMK to all the APs.

Just as in PMKID caching, the initial association to an AP is a regular first-time authentication to the corresponding WLAN, where you must complete the entire 802.1X/EAP authentication for the authentication server, and the 4-way handshake for key generation, before sending data frames.

OKC is a fast roaming technique supported by Microsoft and some Android clients. Another fast roaming method is the use of 802.11r, which is supported by Apple and few Android clients. OKC is enabled by default on a WLAN. This configuration enables the control of OKC on a WLAN. Disabling OKC on a WLAN disables the OKC even for the OKC-supported clients.

A new configuration is introduced for each WLAN in the controller in Cisco IOS XE Amsterdam 17.2.1, to disable or enable fast and secure roaming with OKC at the corresponding AP.

## Enabling Opportunistic Key Caching

### Procedure

	Command or Action	Purpose
<b>Step 1</b>	<b>configure terminal</b>  <b>Example:</b> Device# configure terminal	Enters global configuration mode.
<b>Step 2</b>	<b>wlan profile-name wlan-identifier &lt;1-4096&gt; ssid-network-name</b>  <b>Example:</b> Device(config)# wlan wlan-profile-name 18 san-ssid	Enters WLAN configuration submode. <i>wlan-profile-name</i> : Profile name of the configured WLAN.
<b>Step 3</b>	<b>okc</b>  <b>Example:</b> Device(config-wlan)# okc	Enables Opportunistic Key Caching, if not enabled. By default, the OKC feature is enabled. (Use the <b>no</b> form of this command to disable the OKC feature.)

## Enabling Opportunistic Key Caching (GUI)

### Procedure

- 
- Step 1** Choose **Configuration > Tags & Profiles > WLANs**.
- Step 2** Click **Add**.  
The **Add WLAN** dialog box is displayed.
- Step 3** In the **Add WLAN** dialog box, click the **Advanced** tab and complete the following procedure:
- In the **11ax** section, check the **OKC** check box to disable or enable the feature. By default this feature is enabled.
  - Click **Update & Apply to Device**.
- 

## Verifying Opportunistic Key Caching

The following example shows how to verify whether OKC is disabled for a WLAN profile.

```

• Device# show wlan id 18
WLAN Profile Name      : 18%wlanprofile
=====
Identifier              : 18

```

```

Description                               :
Network Name (SSID)                       : san-ssid
Status                                     : Disabled
Broadcast SSID                             : Enabled
Advertise-Apname                           : Disabled
Universal AP Admin                         : Disabled
Max Associated Clients per WLAN             : 0
Max Associated Clients per AP per WLAN     : 0
Max Associated Clients per AP Radio per WLAN : 200
OKC                                         : Disabled
Number of Active Clients                   : 0
CHD per WLAN                               : Enabled
WMM                                         : Allowed
Channel Scan Defer Priority:
  Priority (default)                       : 5
  Priority (default)                       : 6
Scan Defer Time (msecs)                   : 100
Media Stream Multicast-direct              : Disabled
CCX - AironetIe Support                    : Disabled
Peer-to-Peer Blocking Action               : Disabled
Radio Policy                               : All

```

• Device# **show run wlan**

```

wlan name 2 ssid-name
wlan test 24 test
wlan test2 15 test2
wlan test4 12 testssid
  radio dot11a
wlan wlan1 234 wlan1
wlan wlan2 14 wlan-aaa
  security dot1x authentication-list realm
wlan wlan7 27 wlan7
wlan test23 17 test23
wlan wlan_1 4 ssid_name
  security dot1x authentication-list authenticate_list_name
wlan wlan_3 5 ssid_3
  security wpa wpa1
  security wpa wpa1 ciphers aes
wlan wlan_8 9 ssid_name
  no security wpa
  no security wpa wpa2
  no security wpa wpa2 ciphers aes
  no security wpa akm dot1x
  security web-auth
wlan test-wlan 23 test-wlan
wlan wlan-test 1 wlan2
  mac-filtering default
wlan 18%wlanprofile 18 san-ssid
  no okc

```





## PART **IX**

# High Availability

- [High Availability](#), on page 1263







## CHAPTER 141

# High Availability

---

- [Feature History for High Availability, on page 1264](#)
- [Information About High Availability, on page 1264](#)
- [Prerequisites for High Availability, on page 1265](#)
- [Restrictions on High Availability, on page 1266](#)
- [Configuring High Availability \(CLI\), on page 1268](#)
- [Disabling High Availability, on page 1269](#)
- [Copying a WebAuth Tar Bundle to the Standby Controller, on page 1270](#)
- [System and Network Fault Handling, on page 1271](#)
- [Handling Recovery Mechanism, on page 1277](#)
- [Verifying High Availability Configurations, on page 1278](#)
- [Verifying AP or Client SSO Statistics, on page 1278](#)
- [Verifying High Availability, on page 1280](#)
- [Configuring a Switchover, on page 1283](#)
- [Information About Redundancy Management Interface, on page 1284](#)
- [Configuring Redundancy Management Interface \(GUI\), on page 1288](#)
- [Configuring Redundancy Management Interface \(CLI\), on page 1289](#)
- [Configuring Gateway Monitoring \(CLI\), on page 1291](#)
- [Configuring Gateway Monitoring Interval \(CLI\), on page 1291](#)
- [Gateway Reachability Detection, on page 1292](#)
- [Monitoring the Health of the Standby Controller, on page 1293](#)
- [Monitoring the Health of Standby Parameters Using SNMP, on page 1294](#)
- [Monitoring the Health of Standby Controller Using Programmatic Interfaces, on page 1296](#)
- [Monitoring the Health of Standby Controller Using CLI, on page 1297](#)
- [Verifying the Gateway-Monitoring Configuration, on page 1300](#)
- [Verifying the RMI IPv4 Configuration, on page 1301](#)
- [Verifying the RMI IPv6 Configuration, on page 1302](#)
- [Verifying Redundancy Port Interface Configuration, on page 1302](#)
- [Information About Auto-Upgrade, on page 1305](#)
- [Configuration Workflow, on page 1306](#)
- [Configuring Auto-Upgrade \(CLI\), on page 1306](#)

## Feature History for High Availability

This table provides release and related information for the features explained in this module.

These features are available in all the releases subsequent to the one they were introduced in, unless noted otherwise.

**Table 61: Feature History for High Availability**

Release	Feature	Feature Information
Cisco IOS XE Amsterdam 17.1.1s	Redundant Management Interface	The Redundancy Management Interface (RMI) is used as a secondary link between the active and standby controllers. This interface is the same as the Wireless Management Interface and the IP address on this interface is configured in the same subnet as the Wireless Management Interface.
Cisco IOS XE Bengaluru 17.4.1	Gateway Reachability Detection	Gateway reachability feature minimizes the downtime on APs and clients when the gateway reachability is lost on the active controller.
Cisco IOS XE Bengaluru 17.5.1	Standby Monitoring Enhancements	The Standby Monitoring Enhancements feature monitors the standby CPU or memory information from the active controller. Also, this feature independently monitors the standby controller using SNMP for the interface MIB.  The cLHaPeerHotStandbyEvent and cLHaPeerHotStandbyEvent MIB objects in CISCO-HA-MIB are used to monitor the standby HA status.
Cisco IOS XE Bengaluru 17.5.1	Auto-Upgrade	The auto-upgrade feature enables the standby controller to upgrade to active controller's software image, so that both controllers can form an high availability (HA) pair.
Cisco IOS XE Bengaluru 17.6.1	Standby Interface Status using Active SNMP	This feature allows the standby controller interface status to be queried at the active using SNMP.

## Information About High Availability

High Availability (HA) allows you to reduce the downtime of wireless networks that occurs due to the failover of controllers. The HA Stateful Switch Over (SSO) capability on the controller allows AP to establish a CAPWAP tunnel with the active controller. The active controller shares a mirror copy of the AP and client database with the standby controller. The APs won't go into the discovery state and clients don't disconnect when the active controller fails. The standby controller takes over the network as the active controller. Only one CAPWAP tunnel is maintained between the APs and the controller that is in an active state.

HA supports full AP and client SSO. Client SSO is supported only for clients that have completed the authentication and DHCP phase, and have started passing traffic. With Client SSO, the client information is synced to the standby controller when the client associates to the controller or when the client parameters

change. Fully authenticated clients, for example, the ones in RUN state, are synced to the standby. Thus, client reassociation is avoided on switchover making the failover seamless for the APs and clients, resulting in zero client service downtime and zero SSID outage. This feature reduces major downtime in wireless networks due to failure conditions such as box failover, network failover, or power outage on the primary site.



- 
- Note**
- In HA mode, the RP port shut or no shut should not be performed during the controller bootup.
  - If the RP communication is lost between active and standby controller during HA sync, the standby controller crashes as the IPC communication fails. The crash is intentional.
- If RP link is restored, the standby controller gracefully reloads and forms an HA pair.
- 



- 
- Note** When the controller works as a host for spanning tree, ensure that you configure portfast trunk, using **spanning-tree port type edge trunk** or **spanning-tree portfast trunk** commands, in the uplink switch to ensure faster convergence.
- 



- 
- Note** You can configure FIPS in HA setup. For information, see the [Configuring FIPS in HA Setup](#).
- 



- 
- Note** The IPv4 secondary address is used internally for RMI purpose. So, it is not recommended to configure the secondary IPv4 address.
- In case of IPv6, only one management IPv6 is allowed, secondary address is configured for RMI-IPv6 purpose. It is not recommended to have more than one IPv6 management on the Wireless Management Interface (WMI).
- More than one management IPv4 and IPv6 addresses on WMI can result in unpredictable behavior.
- 

## Prerequisites for High Availability

### External Interfaces and IPs

Because all the interfaces are configured only on the Active box, but are synchronized with the Standby box, the same set of interfaces are configured on both controllers. From external nodes, the interfaces connect to the same IP addresses, irrespective of the controllers they are connected to.

For this purpose, the APs, clients, DHCP, Cisco Prime Infrastructure, Cisco Catalyst Centre, and Cisco Identity Services Engine (ISE) servers, and other controller members in the mobility group always connect to the same IP address. The SSO switchover is transparent to them. But if there are TCP connections from external nodes to the controller, the TCP connections need to be reset and reestablished.

### HA Interfaces

The HA interface serves the following purposes:

- Provides connectivity between the controller pair before an IOSd comes up.
- Provides IPC transport across the controller pair.
- Enables redundancy across control messages exchanged between the controller pair. The control messages can be HA role resolution, keepalives, notifications, HA statistics, and so on.

You can select either SFP or RJ-45 connection for HA port. Supported Cisco SFPs are:

- GLC-SX-MMD
- GLC-LH-SMD

When either SFP or RJ-45 connection is present, HA works between the two controllers. The SFP HA connectivity takes priority over RJ-45 HA connectivity. If SFP is connected when RJ-45 HA is up and running, the HA pair reloads. The reload occurs even if the link between the SFPs isn't connected.



---

**Note**

- It is recommended to have a dedicated physical NIC and Switch for RP when the HA pair is deployed across two host machines. This avoids any keep-alive loses and false HA switchovers or alarms.
  - Disable security scans on VMware virtual instances.
- 

## Restrictions on High Availability

- For a fail-safe SSO, wait till you receive the switchover event after completing configuration synchronization on the standby controller. If the standby controller has just been booted up, we recommend that you wait  $x$  minutes before the controller can handle switchover events without any problem. The value of  $x$  can change based on the platform. For example, a Cisco 9800-80 Series Controller running to its maximum capacity can take up to 24 minutes to complete the configuration synchronization before being ready for SSO. You can use the **show wireless stats redundancy config database** command to view the database-related statistics.
- The flow states of the NBAR engine are lost during a switchover in an HA scenario in local mode. Because of this, the classification of flows will restart, leading to incorrect packet classification as the first packet of the flow is missed.
- The HA connection supports only IPv4.
- Switchover and an active reload and forces a high availability link down from the new primary.
- Hyper threading is not supported and if enabled HA keepalives will be lost in case of an HA system that results in stack merge.
- Standby RMI interface does not support Web UI access.
- Two HA interfaces (RMI and RP) must be configured on the same subnet, and the subnet cannot be shared with any other interfaces on the device.
- It is not possible to synchronize a TCP session state because a TCP session cannot survive after a switchover, and needs to be reestablished.

- The Client SSO does not address clients that have not reached the RUN state because they are removed after a switchover.
- Statistics tables are not synced from active to standby controller.
- Machine snapshot of a VM hosting controller HA interfaces is not supported. It may lead to a crash in the HA controller.
- Mobility-side restriction: Clients which are not in RUN state will be forcefully reauthenticated after switchover.
- The following application classification may not be retained after the SSO:
  - AVC limitation—After a switchover, the context transfer or synchronization to the Standby box does not occur and the new active flow needs to be relearned. The AVC QoS does not take effect during classification failure.
  - A voice call cannot be recognized after a switchover because a voice policy is based on RTP or RTCP protocol.
  - Auto QoS is not effective because of AVC limitation.
- The active controller and the standby controller must be paired with the same interface for virtual platforms. For hardware appliance, there is a dedicated HA port.
- Static IP addressing can sync to standby, but the IP address cannot be used from the standby controller.
- You can map a dedicated HA port to a 1 GB interface only.
- To use EtherChannels in HA mode in releases until, and including, Cisco IOS XE Gibraltar 16.12.x, ensure that the channel mode is set to On.
- EtherChannel Auto-mode is not supported in HA mode in releases until, and including, Cisco IOS XE Gibraltar 16.12.x.
- LACP and PAGP is not supported in HA mode in releases until, and including, Cisco IOS XE Gibraltar 16.12.x.
- When the controller works as a host for spanning tree, ensure that you configure portfast trunk in the uplink switch using **spanning-tree port type edge trunk** or **spanning-tree portfast trunk** command to ensure faster convergence.
- The **clear chassis redundancy** and **write erase** commands will not reset the chassis priority to the default value.
- While configuring devices in HA, the members must not have wireless trustpoint with the same name and different keys. In such a scenario, if you form an HA pair between the two standalone controllers, the wireless trustpoint does not come up after a subsequent SSO. The reason being the *rsa keypair* file exists but it is incorrect as the *nvrाम:private-config* file is not synced with the actual *WLC\_WLC\_TP* key pair.

As a best practice, before forming an HA, it is recommended to delete the existing certificates and keys in each of the controllers which were previously deployed as standalone.
- After a switchover, when the recovery is in progress, do not configure the WLAN or WLAN policy. In case you configure, the controller can crash.

- After a switchover, clients that are not in RUN state and not connected to an AP are deleted after 300 seconds.

## Configuring High Availability (CLI)

### Before you begin

The active and standby controller should be in the same mode, either Install mode or Bundle mode, with same image version. We recommend that you use Install mode.

### Procedure

	Command or Action	Purpose
<b>Step 1</b>	<p><b>chassis</b> <i>chassis-num</i> <b>priority</b> <i>chassis-priority</i></p> <p><b>Example:</b></p> <pre>Device# chassis 1 priority 1</pre>	<p>(Optional) Configures the priority of the specified device.</p> <p><b>Note</b> From Cisco IOS XE Gibraltar 16.12.x onwards, device reload is not required for the chassis priority to become effective.</p> <ul style="list-style-type: none"> <li>• <i>chassis-num</i>—Enter the chassis number. The range is from 1 to 2.</li> <li>• <i>chassis-priority</i>—Enter the chassis priority. The range is from 1 to 2. The default value is 1.</li> </ul> <p><b>Note</b> When both the devices boot up at the same time, the device with higher priority(2) becomes active, and the other one becomes standby. If both the devices are configured with the same priority value, the one with the smaller MAC address acts as active and its peer acts as standby.</p>
<b>Step 2</b>	<p><b>chassis redundancy ha-interface</b> <b>GigabitEthernet</b> <i>num</i><b>local-ip</b> <i>local-chassis-ip-addr network-mask</i> <b>remote-ip</b> <i>remote-chassis-ip-addr</i></p> <p><b>Example:</b></p> <pre>Device# chassis redundancy ha-interface GigabitEthernet 2 local-ip 4.4.4.1 /24 remote-ip 4.4.4.2</pre>	<p>Configures the chassis high availability parameters.</p> <ul style="list-style-type: none"> <li>• <i>num</i>—GigabitEthernet interface number. The range is from 0 to 32.</li> <li>• <i>local-chassis-ip-addr</i>—Enter the IP address of the local chassis HA interface.</li> <li>• <i>network-mask</i>—Enter the network mask or prefix length in the <i>/nn</i> or <i>A.B.C.D</i> format.</li> </ul>

	Command or Action	Purpose
		<ul style="list-style-type: none"> <li><i>remote-chassis-ip-addr</i>—Enter the remote chassis IP address.</li> </ul>
<b>Step 3</b>	<b>chassis redundancy keep-alive timer <i>timer</i></b>  <b>Example:</b> Device# chassis redundancy keep-alive timer 6	Configures the peer keepalive timeout value. Time interval is set in multiple of 100 ms (enter 1 for default).
<b>Step 4</b>	<b>chassis redundancy keep-alive retries <i>retry-value</i></b>  <b>Example:</b> Device# chassis redundancy keep-alive retries 8	Configures the peer keepalive retry value before claiming peer is down. Default value is 5.

## Disabling High Availability

If the controller is configured using RP method of SSO configuration, use the following command to clear all the HA-related parameters, such as local IP, remote IP, HA interface, mask, timeout, and priority:

**clear chassis redundancy**

If the controller is configured using RMI method, use the following command:

**no redun-management interface vlan chassis**



**Note** Reload the devices for the changes to take effect.

After the HA unpairing, the standby controller startup configuration and the HA configuration will be cleared and standby will go to Day 0.

Before the command is executed, the user is prompted with the following warning on the active controller:

```
Device# clear chassis redundancy
```

```
WARNING: Clearing the chassis HA configuration will result in both the chassis move into Stand Alone mode. This involves reloading the standby chassis after clearing its HA configuration and startup configuration which results in standby chassis coming up as a totally clean after reboot. Do you wish to continue? [y/n]? [yes]:
```

```
*Apr 3 23:42:22.985: received clear chassis.. ha_supported:lyes
WLC#
```

```
*Apr 3 23:42:25.042: clearing peer startup config
```

```
*Apr 3 23:42:25.042: chkpt send: sent msg type 2 to peer..
```

```
*Apr 3 23:42:25.043: chkpt send: sent msg type 1 to peer..
```

```
*Apr 3 23:42:25.043: Clearing HA configurations
```

```
*Apr 3 23:42:26.183: Successfully sent Set chassis mode msg for chassis 1.chasfs file updated
```

```
*Apr 3 23:42:26.359: %IOSXE_REDUNDANCY-6-PEER_LOST: Active detected chassis 2 is no longer standby
```

On the standby controller, the following messages indicate that the configuration is being cleared:

```
Device-stby#
*Apr 3 23:40:40.537: mcprp_handle_spa_oir_tsm_event: subslot 0/0 event=2
*Apr 3 23:40:40.537: spa_oir_tsm subslot 0/0 TSM: during state ready, got event 3(ready)
*Apr 3 23:40:40.537: @@@ spa_oir_tsm subslot 0/0 TSM: ready -> ready
*Apr 3 23:42:25.041: Removing the startup config file on standby

!Standby controller is reloaded after clearing the chassis.
```

## Copying a WebAuth Tar Bundle to the Standby Controller

Use the following procedure to copy a WebAuth tar bundle to the standby controller, in a high-availability configuration.

### Procedure

- 
- Step 1** Choose **Administration > Management > Backup & Restore**.
  - Step 2** From the **Copy** drop-down list, choose **To Device**.
  - Step 3** From the **File Type** drop-down list, choose **WebAuth Bundle**.
  - Step 4** From the **Transfer Mode** drop-down list, choose **TFTP, SFTP, FTP, or HTTP**.

The **Server Details** options change based on the file transfer option selected.

- **TFTP**

- **IP Address (IPv4/IPv6):** Enter the server IP address (IPv4 or IPv6) of the TFTP server that you want to use.
- **File Path:** Enter the file path. The file path should start with slash a (*/path*).
- **File Name:** Enter a file name.

The file name should not contain spaces. Underscores ( `_` ) and hyphen ( `-` ) are the only special characters that are supported. Ensure that file name ends with `.tar`, for example, `webauthbundle.tar`.

- **SFTP**

- **IP Address (IPv4/IPv6):** Enter the server IP address (IPv4 or IPv6) of the SFTP server that you want to use.
  - **File Path:** Enter the file path. The file path should start with slash a (*/path*).
  - **File Name:** Enter a file name.
- The file name should not contain spaces. Underscores ( `_` ) and hyphen ( `-` ) are the only special characters that are supported. Ensure that file name ends with `.tar`, for example, `webauthbundle.tar`.
- **Server Login UserName:** Enter the SFTP server login user name.
  - **Server Login Password:** Enter the SFTP server login passphrase.

- **FTP**



- **IP Address (IPv4/IPv6):** Enter the server IP address (IPv4 or IPv6) of the TFTP server that you want to use.
- **File Path:** Enter the file path. The file path should start with slash a (*/path*).
- **File Name:** Enter a file name.  
The file name should not contain spaces. Underscores (\_) and hyphen (-) are the only special characters that are supported. Ensure that file name ends with .tar, for example, webauthbundle.tar.
- **Logon Type:** Choose the login type as either **Anonymous** or **Authenticated**. If you choose **Authenticated**, the following fields are activated:
  - **Server Login UserName:** Enter the FTP server login user name.
  - **Server Login Password:** Enter the FTP server login passphrase.
- **HTTP**
  - **Source File Path:** Click **Select File** to select the configuration file, and click **Open**.

- Step 5** Click the **Yes** or **No** radio button to back up the existing startup configuration to Flash.  
Save the configuration to Flash to propagate the WebAuth bundle to other members, including the standby controller. If you do not save the configuration to Flash, the WebAuth bundle will not be propagated to other members, including the standby controller.
- Step 6** Click **Download File**.

## System and Network Fault Handling

If the standby controller crashes, it reboots and comes up as the standby controller. Bulk sync follows causing the standby to become hot. If the active controller crashes, the standby becomes active. The new active controller assumes the role of primary and tries to detect a dual active.

The following matrices provide a clear picture of the conditions the controller switchover would trigger:

**Table 62: System and Network Fault Handling**

System Issues				
Trigger	RP Link Status	Peer Reachability through RMI	Switchover	Result
Critical process crash	Up	Reachable	Yes	Switchover happens
Forced switchover	Up	Reachable	Yes	Switchover happens
Critical process crash	Up	Unreachable	Yes	Switchover happens

<b>System Issues</b>				
<b>Trigger</b>	<b>RP Link Status</b>	<b>Peer Reachability through RMI</b>	<b>Switchover</b>	<b>Result</b>
Forced switchover	Up	Unreachable	Yes	Switchover happens
Critical process crash	Down	Reachable	No	No action. One controller in recovery mode.
Forced switchover	Down	Reachable	N/A	No action. One controller in recovery mode.
Critical process crash	Down	Unreachable	No	Double fault – as mentioned in Network Error handling
Forced switchover	Down	Unreachable	N/A	Double fault – as mentioned in Network Error handling

<b>RP Link</b>	<b>Peer Reachability Through RMI</b>	<b>Gateway From Active</b>	<b>Gateway From Standby</b>	<b>Switchover</b>	<b>Result</b>
Up	Reachable	Reachable	Reachable	No SSO	No action
Up	Reachable	Reachable	Unreachable	No SSO	No action. Standby is not ready for SSO in this state, as it does not have gateway reachability. The standby is shown to be in standby-recovery mode. If the RP goes down, standby (in recovery mode) becomes active.

RP Link	Peer Reachability Through RMI	Gateway From Active	Gateway From Standby	Switchover	Result
Up	Reachable	Unreachable	Reachable	SSO	Gateway reachability message is exchanged over the RMI + RP links. Active reboots so that the standby becomes active.
Up	Reachable	Unreachable	Unreachable	No SSO	With this, when the active SVI goes down, the standby SVI also goes down. A switchover is then triggered. If the new active discovers its gateway to be reachable, the system stabilizes in the Active - Standby Recovery mode. Otherwise, switchovers happen in a ping-pong fashion.
Up	Unreachable	Reachable	Reachable	No SSO	No action
Up	Unreachable	Reachable	Unreachable	No SSO	Standby is not ready for SSO in this state as it does not have gateway reachability. Standby moves in to recovery mode as LMP messages are exchanged over the RP link.

RP Link	Peer Reachability Through RMI	Gateway From Active	Gateway From Standby	Switchover	Result
Up	Unreachable	Unreachable	Reachable	SSO	Gateway reachability message is exchanged over RP link. Active reboots so that standby becomes active.
Up	Unreachable	Unreachable	Unreachable	No SSO	With this, when the active SVI goes down, the standby SVI also goes down. A switchover is then triggered. If the new active discovers its gateway to be reachable, the system stabilizes in Active - Standby Recovery mode. Otherwise, switchovers happen in a ping-pong fashion.

RP Link	Peer Reachability Through RMI	Gateway From Active	Gateway From Standby	Switchover	Result
Down	Reachable	Reachable	Reachable	No SSO	Standby detects the presence of the Active over the RMI link and avoids switchover when the RP link goes down. In such a case, the standby goes to recovery mode. This mode is represented through suffix <b>rp-rec-mode</b> in the hostname. The standby in recovery mode reloads when the RP link comes up. Single faults are gracefully handled in the system.
Down	Reachable	Reachable	Unreachable	No SSO	Same as above.

RP Link	Peer Reachability Through RMI	Gateway From Active	Gateway From Standby	Switchover	Result
Down	Reachable	Unreachable	Reachable	RP link down, then active loses GW, then there won't be any SSO. GW down, within 8 seconds, RP link goes down, then there would be a SSO.	Gateway reachability message is exchanged over RP+RMI links. Old-Active goes to active-recovery mode. The configuration mode is disabled in active-recovery mode. All interfaces will be ADMIN DOWN with the wireless management interface having RMI IP. The controller in active-recovery will reload to become standby (or standby-recovery if gateway reachability is still not available) when the RP link comes up.
Down	Reachable	Unreachable	Unreachable	No SSO	Standby goes to standby-recovery.

RP Link	Peer Reachability Through RMI	Gateway From Active	Gateway From Standby	Switchover	Result
Down	Unreachable	Reachable	Reachable	SSO	Double fault – this may result in a network conflict as there will be two active controllers. Standby becomes active. Old active also exists. Role negotiation has to happen once the connectivity is restored and keep the active that came up last.
Down	Unreachable	Reachable	Unreachable	SSO	Same as above.
Down	Unreachable	Unreachable	Reachable	SSO	Same as above.
Down	Unreachable	Unreachable	Unreachable	SSO	Same as above.

## Handling Recovery Mechanism

### Active to Active Recovery

- When RP is down and RMI is up at boot up, the Active Recovery occurs.
- When HA is stable (active - standby), if RMI is down first and then RP goes down next, and later if RMI comes up before RP comes up, the Active to Active Recovery occurs. Once the RP is up, the Active Recovery reloads and HA is formed.

### Standby to Standby Recovery

- When Standby goes to Standby Recovery for Gateway alone, once the Gateway is up, the HA comes up without any reboot.
- When Standby goes to Standby Recovery for RP down, once the RP is up, the standby recovery reboots automatically and HA is formed.

## Verifying High Availability Configurations

To view the HA configuration details, use the following command:

```
Device# show romvar
ROMMON variables:
LICENSE_BOOT_LEVEL =
MCP_STARTUP_TRACEFLAGS = 00000000:00000000
BOOTLDR =
CRASHINFO = bootflash:crashinfo_RP_00_00_20180202-034353-UTC
STACK_1_1 = 0_0
CONFIG_FILE =
BOOT =
bootflash:boot_image_test,1;bootflash:boot_image_good,1;bootflash:rp_super_universalk9.vwlc.bin,1;

RET_2_RTS =
SWITCH_NUMBER = 1
CHASSIS_HA_REMOTE_IP = 10.0.1.9
CHASSIS_HA_LOCAL_IP = 10.0.1.10
CHASSIS_HA_LOCAL_MASK = 255.255.255.0
CHASSIS_HA_IFNAME = GigabitEthernet2
CHASSIS_HA_IFMAC = 00:0C:29:C9:12:0B
RET_2_RCALTS =
BSI = 0
RANDOM_NUM = 647419395
```

## Verifying AP or Client SSO Statistics

To view the AP SSO statistics, use the following command:

```
Device# show wireless stat redundancy statistics ap-recovery wnc all
AP SSO Statistics
```

Inst	Timestamp	Dura (ms)	#APs	#Succ	#Fail	Avg (ms)	Min (ms)	Max (ms)
0	00:06:29.042	98	34	34	0	2	1	35
1	00:06:29.057	56	33	30	3	1	1	15
2	00:06:29.070	82	33	33	0	2	1	13

Statistics:

```
WNCD Instance : 0
No. of AP radio recovery failures : 0
No. of AP BSSID recovery failures : 0
No. of CAPWAP recovery failures : 0
No. of DTLS recovery failures : 0
No. of reconcile message send failed : 0
No. of reconcile message successfully sent : 34
No. of Mesh BSSID recovery failures: 0
No. of Partial delete cleanup done : 0
.
.
.
```

To view the Client SSO statistics, use the following command:

```
Device# show wireless stat redundancy client-recovery wncd all
Client SSO statistics
-----
```



```

WNCD instance      : 1
Reconcile messages received from AP      : 1
Reconcile clients received from AP       : 1
Recreate attempted post switchover       : 1
Recreate attempted by SANET Lib          : 0
Recreate attempted by DOT1x Lib         : 0
Recreate attempted by SISF Lib          : 0
Recreate attempted by SVC CO Lib        : 1
Recreate attempted by Unknown Lib       : 0
Recreate succeeded post switchover       : 1
Recreate Failed post switchover         : 0
Stale client entries purged post switchover : 0

Partial delete during heap recreate      : 0
Partial delete during force purge       : 0
Partial delete post restart              : 0
Partial delete due to AP recovery failure : 0
Partial delete during reconciliation     : 0

Client entries in shadow list during SSO : 0
Client entries in shadow default state during SSO : 0
Client entries in poison list during SSO  : 0

Invalid bssid during heap recreate      : 0
Invalid bssid during force purge       : 0
BSSID mismatch with shadow rec during reconciliation : 0
BSSID mismatch with shadow rec reconciliation(WGB client): 0
BSSID mismatch with dot11 rec during heap recreate : 0

AID mismatch with dot11 rec during force purge : 0
AP slotid mismatch during reconciliation : 0
Zero aid during heap recreate          : 0
AID mismatch with shadow rec during reconciliation : 0
AP slotid mismatch shadow rec during reconciliation : 0
Client shadow record not present       : 0

```

To view the mobility details, use the following command:

```

Device# show wireless stat redundancy client-recovery mobilityd
Mobility Client Deletion Reason Statistics
-----
Mobility Incomplete State      : 0
Inconsistency in WNCD & Mobility : 0
Partial Delete                 : 0

General statistics
-----
Cleanup sent to WNCD, Missing Delete case : 0

```

To view the Client SSO statistics for SISF, use the following command:

```

Device# show wireless stat redundancy client-recovery sisf
Client SSO statistics for SISF
-----
Number of recreate attempted post switchover : 1
Number of recreate succeeded post switchover : 1
Number of recreate failed because of no mac : 0
Number of recreate failed because of no ip : 0
Number of ipv4 entry recreate success      : 1
Number of ipv4 entry recreate failed       : 0
Number of ipv6 entry recreate success      : 0
Number of ipv6 entry recreate failed       : 0
Number of partial delete received         : 0

```

```

Number of client purge attempted           : 0
Number of heap and db entry purge success  : 0
Number of purge success for db entry only  : 0
Number of client purge failed              : 0
Number of garp sent                        : 1
Number of garp failed                      : 0
Number of IP entries validated in cleanup   : 0
Number of IP entry address errors in cleanup : 0
Number of IP entry deleted in cleanup      : 0
Number of IP entry delete failed in cleanup : 0
Number of IP table create callbacks on standby : 0
Number of IP table modify callbacks on standby : 0
Number of IP table delete callbacks on standby : 0
Number of MAC table create callbacks on standby : 1
Number of MAC table modify callbacks on standby : 0
Number of MAC table delete callbacks on standby : 0

```

To view the HA redundancy summary, use the following command:

```

Device# show wireless stat redundancy summary
HA redundancy summary
-----

```

```

AP recovery duration (ms)           : 264
SSO HA sync timer expired           : No

```

## Verifying High Availability

**Table 63: Commands for Monitoring Chassis and Redundancy**

Command Name	Description
<b>show chassis</b>	<p>Displays the chassis information.</p> <p><b>Note</b> When the peer timeout and retries are configured, the <b>show chassis ha-status</b> command output may show incorrect values.</p> <p>To check the peer keep-alive timer and retries, use the following commands:</p> <ul style="list-style-type: none"> <li>• <b>show platform software stack-mgr chassis active r0 peer-timeout</b></li> <li>• <b>show platform software stack-mgr chassis standby r0 peer-timeout</b></li> </ul>
<b>show redundancy</b>	Displays details about Active box and Standby box.
<b>show redundancy switchover history</b>	Displays the switchover counts, switchover reason, and the switchover time.

To start the packet capture in the redundancy HA port (RP), use the following commands:

- test wireless redundancy packet dump start
- test wireless redundancy packet dump stop

- test wireless redundancy packet dump start filter port 2300

```
Device# test wireless redundancy packetdump start
Redundancy Port PacketDump Start
Packet capture started on RP port.
```

```
Device# test wireless redundancy packetdump stop
Redundancy Port PacketDump Start
Packet capture started on RP port.
Redundancy Port PacketDump Stop
Packet capture stopped on RP port.
```

```
Device# dir bootflash:
```

```
Directory of bootflash:/
```

```
1062881 drwx          151552 Oct 20 2020 23:15:25 +00:00  tracelogs
47      -rw-          20480 Oct 20 2020 23:15:24 +00:00  haIntCaptureLo.pcap
1177345 drwx          4096 Oct 20 2020 19:56:14 +00:00  certs
294337  drwx          8192 Oct 20 2020 19:56:05 +00:00  license_evlog
15      -rw-           676 Oct 20 2020 19:56:01 +00:00  vlan.dat
14      -rw-           30 Oct 20 2020 19:55:16 +00:00  throughput_monitor_params
13      -rw-        134808 Oct 20 2020 19:54:57 +00:00  memleak.tcl
1586145 drwx          4096 Oct 20 2020 19:54:45 +00:00  .inv
1103761 drwx          4096 Oct 20 2020 19:54:39 +00:00  dc_profile_dir
17      -r--           114 Oct 20 2020 19:54:17 +00:00  debug.conf
1389921 drwx          4096 Oct 20 2020 19:54:17 +00:00  .installer
46      -rw-        1104760207 Oct 20 2020 19:26:41 +00:00  leela_katar_rping_test.SSA.bin
49057   drwx          4096 Oct 20 2020 16:11:21 +00:00  .prst_sync
45      -rw-        1104803200 Oct 20 2020 15:39:19 +00:00
C9800-L-universalk9_wlc.2020-10-20_14.57_yavadhan.SSA.bin
269809  drwx          4096 Oct 19 2020 23:41:49 +00:00  core
44      -rw-        1104751981 Oct 19 2020 17:42:12 +00:00
C9800-L-universalk9_wlc.BLD_POLARIS_DEV_LATEST_20201018_053825_2.SSA.bin
43      -rw-        1104286975 Oct 16 2020 12:05:47 +00:00
C9800-L-universalk9_wlc.BLD_POLARIS_DEV_LATEST_20201010_001654_2.SSA.bin
```

```
Device# test wireless redundancy packetdump start filter port 2300
Redundancy Port PacketDump Start
Packet capture started on RP port with port filter 2300.
```

To check connection between the two HA Ports (RP) and check if there are any drops, delays, or jitter in the connection, use the following command:

```
Device# test wireless redundancy rping
Redundancy Port ping
PING 169.254.64.60 (169.254.64.60) 56(84) bytes of data.
64 bytes from 169.254.64.60: icmp_seq=1 ttl=64 time=0.083 ms
64 bytes from 169.254.64.60: icmp_seq=2 ttl=64 time=0.091 ms
64 bytes from 169.254.64.60: icmp_seq=3 ttl=64 time=0.074 ms

--- 169.254.64.60 ping statistics ---
3 packets transmitted, 3 received, 0% packet loss, time 2041ms
rtt min/avg/max/mdev = 0.074/0.082/0.091/0.007 ms
test wireless redundancy
```

To see the HA port interface setting status, use the **show platform hardware slot R0 ha\_port interface stats** command.

```
Device# show platform hardware slot R0 ha_port interface stats
HA Port
ha_port  Link encap:Ethernet  HWaddr 70:18:a7:c8:80:70
         UP BROADCAST MULTICAST  MTU:1500  Metric:1
         RX packets:0 errors:0 dropped:0 overruns:0 frame:0
         TX packets:0 errors:0 dropped:0 overruns:0 carrier:0
         collisions:0 txqueuelen:1000
```

```

RX bytes:0 (0.0 B) TX bytes:0 (0.0 B)
Memory:e0900000-e0920000

```

```

Settings for ha_port:
Supported ports:          [ TP ]
Supported link modes:    10baseT/Half 10baseT/Full
                        100baseT/Half 100baseT/Full
                        1000baseT/Full

Supported pause frame use: Symmetric
Supports auto-negotiation: Yes
Supported FEC modes:     Not reported
Advertised link modes:   10baseT/Half 10baseT/Full
                        100baseT/Half 100baseT/Full
                        1000baseT/Full

Advertised pause frame use: Symmetric
Advertised auto-negotiation: Yes
Advertised FEC modes:   Not reported
Speed:                  Unknown!
Duplex:                 Unknown! (255)
Port:                   Twisted Pair
PHYAD:                  1
Transceiver:            internal
Auto-negotiation:      on
MDI-X:                  off (auto)
Supports Wake-on:      pumbg
Wake-on:                g
Current message level:  0x00000007 (7)
                        drv probe link
Link detected:          no

```

```

NIC statistics:
rx_packets:            0
tx_packets:            0
rx_bytes:              0
tx_bytes:              0
rx_broadcast:          0
tx_broadcast:          0
rx_multicast:          0
tx_multicast:          0
multicast:             0
collisions:            0
rx_crc_errors:         0
rx_no_buffer_count:   0
rx_missed_errors:     0
tx_aborted_errors:    0
tx_carrier_errors:    0
tx_window_errors:     0
tx_abort_late_coll:   0
tx_deferred_ok:       0
tx_single_coll_ok:    0
tx_multi_coll_ok:     0
tx_timeout_count:     0
rx_long_length_errors: 0
rx_short_length_errors: 0
rx_align_errors:      0
tx_tcp_seg_good:      0
tx_tcp_seg_failed:    0
rx_flow_control_xon:  0
rx_flow_control_xoff: 0
tx_flow_control_xon:  0
tx_flow_control_xoff: 0
rx_long_byte_count:   0
tx_dma_out_of_sync:   0
tx_smbus:              0

```

```

rx_smbus: 0
dropped_smbus: 0
os2bmc_rx_by_bmc: 0
os2bmc_tx_by_bmc: 0
os2bmc_tx_by_host: 0
os2bmc_rx_by_host: 0
tx_hwtstamp_timeouts: 0
rx_hwtstamp_cleared: 0
rx_errors: 0
tx_errors: 0
tx_dropped: 0
rx_length_errors: 0
rx_over_errors: 0
rx_frame_errors: 0
rx_fifo_errors: 0
tx_fifo_errors: 0
tx_heartbeat_errors: 0
tx_queue_0_packets: 0
tx_queue_0_bytes: 0
tx_queue_0_restart: 0
tx_queue_1_packets: 0
tx_queue_1_bytes: 0
tx_queue_1_restart: 0
rx_queue_0_packets: 0
rx_queue_0_bytes: 0
rx_queue_0_drops: 0
rx_queue_0_csum_err: 0
rx_queue_0_alloc_failed:0
rx_queue_1_packets: 0
rx_queue_1_bytes: 0
rx_queue_1_drops: 0
rx_queue_1_csum_err: 0
rx_queue_1_alloc_failed:0

```

## Configuring a Switchover

### Procedure

	Command or Action	Purpose
<b>Step 1</b>	<p><b>To force a failover to the standby unit, use the following command:</b></p> <p><b>Example:</b></p> <pre>Device#redundancy force-switchover</pre>	<p>In this case, the standby controller will take the role of the active controller, and the active controller will reload and become the new standby controller. This command can be used to test the stability of the high availability cluster and see if switchovers are working as expected.</p> <p><b>Note</b> Do not use any other command to test switchovers between the Cisco Catalyst 9800 series wireless controllers. Command such as "reload slot X" (where X is the active controller) might lead to unexpected behaviour and should not be used to perform a switchover.</p>

# Information About Redundancy Management Interface

The Redundancy Management Interface (RMI) is used as a secondary link between the active and standby Cisco Catalyst 9800 Series Wireless Controllers. This interface is the same as the wireless management interface, and the IP address on this interface is configured in the same subnet as the Wireless Management IP. The RMI is used for the following purposes:

- Dual Active Detection
- Exchange resource health information between controllers, for instance, gateway reachability status from either controller.
- Gateway reachability is checked on the active and the standby controller through the RMI when the feature is enabled. It takes approximately the configured gateway monitoring interval to detect that a controller has lost gateway reachability. The default gateway monitoring interval value is 8 seconds.

**Note**

- The RMI might trigger a switchover based on the gateway status of the active controller.
- Cisco TrustSec is not supported on the RMI.

When the device SGT is used, the IP-SGT mapping for RMI address is also applied along with the WMI address. So, you need to ensure that the SGACL is defined appropriately to allow ICMP and ARP traffic between the active and standby RMI addresses.

- If the RP and RMI links are down, the HA setup breaks into two active controllers. This leads to IP conflict in the network. The HA setup forms again when the RP link comes up. Depending on the state of the external switch at this time, the ARP table may or may not be updated to point to the active controller. That is, the switch may fail to process the GARP packets from the controller. As a best practice, we recommend that you keep the ARP cache timeout value to a low value for faster recovery from multiple fault scenarios. You need to select a value that does not impact the network traffic, for instance, 30 minutes.

**Note**

The AAA packets originating from the controller may use either the wireless management IP or the RMI IP. Therefore, ensure that you add RMI IP as the source IP along with WMI IP in the AAA server.

**Active Controller**

The primary address on the active controller is the management IP address. The secondary IPv4 address on the management VLAN is the RMI IP address for the active controller. Do not configure the secondary IPv4 addresses explicitly because a single secondary IPv4 address is configured automatically by RMI under the RMI.

**Standby Controller**

The standby controller does not have the wireless management IP configured; it has the RMI IP address configured as the primary IP address. When the standby controller becomes active, the management IP address

becomes the primary IP address and the RMI IP address becomes the secondary IP address. If the interface on the active controller is administratively down, the same state is reflected on the standby controller.

### Dual Stack Support on Management VLAN with RMI

Dual stack refers to the fact that the wireless management interface can be configured with IPv4 and IPv6 addresses. If an RMI IPv4 address is configured along with an IPv4 management IP address, you can additionally configure an IPv6 management address on the wireless management interface. This IPv6 management IP address will not be visible on the standby controller.

If an RMI IPv6 address is configured along with an IPv6 management IP address, you can additionally configure an IPv4 management address on the wireless management interface. This IPv4 management IP address will not be visible on the standby controller.

Therefore, you can monitor only the IPv6 gateway when the RMI IPv6 address is configured, or only the IPv4 gateway when the RMI IPv4 address is configured.



---

**Note** The RMI feature supports the RMI IPv4 or IPv6 addresses.

---

### RMI-Based High-Availability Pairing

You should consider the following scenarios for HA pairing:

- Fresh Installation
- Already Paired Controllers
- Upgrade Scenario
- Downgrade Scenario

Dynamic HA pairing requires both the active controller and the standby controller to reload. However, dynamic HA pairing occurs on the Cisco Catalyst 9800-L Wireless Controller, Cisco Catalyst 9800-40 Wireless Controller, and the Cisco Catalyst 9800-80 Wireless Controller when one of them reloads and becomes the standby controller.



---

**Note** Chassis numbers identify individual controllers. Unique chassis numbers must be configured before forming an HA pair.

---

### HA Pairing Without Previous Configuration

When HA pairing is done for the first time, no ROMMON variables are found for the RP IP addresses. You can choose from the existing privileged EXEC mode RP-based commands or the RMI IP-based mechanisms. However, the privileged EXEC mode RP-based commands will be deprecated soon. If you use Cisco Catalyst Center, you can choose the privileged EXEC mode RP-based CLI mechanism till the Cisco Catalyst Center migrates to support the RMI.

The RP IPs are derived from the RMI IPs after an HA pair is formed. Also, the privileged EXEC mode RP-based CLI method of clearing and forming an HA pair is not allowed after the RMI IP-based HA mechanism is chosen.



- 
- Note**
- Although you can choose RP or RMI for a fresh installation, we recommend that you use RMI install method.
  - To view the ROMMON variables, use the **show romvars** command.
- 

If you choose the privileged EXEC RP-based CLI mechanism, the RP IPs are configured the same way as in the 16.12 release.

The following occurs when the RMI-based HA pairing is done on a brand-new system:

- RP IPs are derived from RMI IPs and used in HA pairing.
- Privileged EXEC mode RP-based CLIs are blocked.



- 
- Note** The RMI migration is supported from Cisco Catalyst Center, 2.3.3.x release version.

The following are the limitations observed during RMI migration:

- The negative cases fail due to the following reasons:
    - When devices are not reachable.
    - When non-Cisco Catalyst 9800 Series Wireless Controllers are in use.
    - When an earlier controller version (Cisco IOS XE 17.3) is in use.
    - When High Availability is not configured.
    - When High Availability RMI is already configured.
  - When High Availability is upgraded to RMI-based High Availability for Cisco IOS XE release version greater than or equal to 17.3.
  - When upgrading to an already failed High Availability paired controller.
  - The controller GUI prohibits applying RMI migration configuration to High Availability failed devices.
- 

### Paired Controllers

If the controllers are already in an HA pair, the existing EXEC mode RP-based commands will continue to be used. You can enable RMI to migrate to the RMI-based HA pairing.

If the controllers are already paired and RMI is configured, it will overwrite the RP IPs with the RMI-derived IPs. The HA pair will not be disturbed immediately, but the controllers will pick up the new IP when the next reload happens. The RMI feature mandates a reload for the feature to be effective. When both the controllers are reloaded, they come up as a pair with the new RMI-derived RP IPs.

The following occurs when the RMI configuration is done:

- The RP IPs derived from the RMI IPs are overwritten, and used for HA pairing.
- If the active and standby controller already exist prior to HA pairing through the EXEC mode RP-based command mechanism, the pair is not interrupted.



- When the pair reloads later, the new RP IPs are used.
- EXEC mode RP-based commands are blocked.

### Upgrading from Cisco IOS XE 16.1.x to a Later Release

A system that is being upgraded can choose to:

- Migrate with the existing RP IP configuration intact—In this case, the existing RP IP configuration will continue to be used. The EXEC mode RP-based commands are used for future modifications.
- Migrate after clearing the HA configuration—In this case, you can choose between the old (EXEC mode RP-based commands) and new RMI-based RP configuration methods.



---

**Note** In case the older configuration is retained, the RMI configuration updates the RP IPs with the IPs derived from the RMI IPs.

---

### Downgrade Scenario



---

**Note** The downgrade scenario given below is not applicable for Cisco IOS XE Amsterdam 17.1.x.

---

The downgrade scenario will have only the EXEC mode RP-based commands. The following are the two possibilities:

- If the upgraded system used the RMI-based RP configuration.
- If the upgraded system continued to use the EXEC mode RP-based commands.



---

**Note** In the above cases, the downgraded system uses the EXEC mode RP-based commands to modify the configuration. However, the downgraded system will continue to use the new derived RP IPs.

---



---

**Note** When you downgrade the Cisco Catalyst 9800 Series Wireless Controller to any version below 17.1 and if the mDNS gateway is enabled on the WLAN/RLAN/GLAN interfaces, the mdns-sd-interface gateway goes down after the downgrade.

To enable the mDNS gateway on the WLAN/RLAN/GLAN interfaces in 16.12 and earlier versions, use the following commands:

**wlan test 1 test**

**mdns-sd gateway**

To enable the mDNS gateway on the WLAN/RLAN/GLAN interfaces from version 17.1 onwards, use the following command:

**mdns-sd-interface gateway**

---

### Gateway Monitoring

From Cisco IOS XE Amsterdam 17.2.1 onwards, the method to configure the gateway IP has been modified. The **ip default-gateway gateway-ip** command is not used. Instead, the gateway IP is selected based on the static routes configured. From among the static routes configured, the gateway IP that falls in the same subnet as the RMI subnet (the broadest mask and least gateway IP) is chosen. If no matching static route is found, gateway failover will not work (even if management gateway-failover is enabled).

## Configuring Redundancy Management Interface (GUI)

### Before you begin

Before configuring RMI + RP using GUI, ensure that WMI is available.

### Procedure

#### Step 1

In the **Administration > Device > Redundancy** window, perform the following:

- a. Set the **Redundancy Configuration** toggle button to **Enabled** to activate redundancy configuration.
- b. In the **Redundancy Pairing Type** field, select **RMI+RP** to perform RMI+RP redundancy pairing as follows:
  - In the **RMI IP for Chassis 1** field, enter RMI IP address for chassis 1.
  - In the **RMI IP for Chassis 2** field, enter RMI IP address for chassis 2.
  - From the **HA Interface** drop-down list, choose one of the HA interface.  
**Note** You can select the HA interface only for Cisco Catalyst 9800 Series Wireless Controllers.
  - Set the **Management Gateway Failover** toggle button to **Enabled** to activate management gateway failover.
  - In the **Gateway Failure Interval** field, enter an appropriate value. The valid range is between 6 and 12 (seconds). The default is 8 seconds.
- c. In the **Redundancy Pairing Type** field, select **RP** to perform RP redundancy pairing as follows:
  - In the **Local IP** field, enter an IP address for Local IP.
  - In the **Netmask** field, enter the subnet mask assigned to all wireless clients.
  - From the **HA Interface** drop-down list, choose one of the HA interface.  
**Note** You can select the HA interface only for Cisco Catalyst 9800 Series Wireless Controllers.
  - In the **Remote IP** field, enter an IP address for Remote IP.
- d. In the **Keep Alive Timer** field, enter an appropriate timer value. The valid range is between 1 and 10 (x100 milliseconds).

- e. In the **Keep Alive Retries** field, enter an appropriate retry value. The valid range is between 3 and 10 seconds.
- f. In the **Active Chassis Priority** field, enter a value.

**Step 2** Click **Apply** and reload controllers.

## Configuring Redundancy Management Interface (CLI)

### Procedure

	Command or Action	Purpose
<b>Step 1</b>	<p><b>chassis <i>chassis-num</i> priority <i>chassis-priority</i></b></p> <p><b>Example:</b></p> <pre>Device# chassis 1 priority 1</pre>	<p>(Optional) Configures the priority of the specified device.</p> <p><b>Note</b> From Cisco IOS XE Gibraltar 16.12.x onwards, device reload is not required for the chassis priority to become effective.</p> <ul style="list-style-type: none"> <li>• <i>chassis-num</i>—Enter the chassis number. The range is from 1 to 2.</li> <li>• <i>chassis-priority</i>—Enter the chassis priority. The range is from 1 to 2. The default value is 1.</li> </ul> <p><b>Note</b> When both the devices boot up at the same time, the device with higher priority becomes active, and the other one becomes standby. If both the devices are configured with the same priority value, the one with the smaller MAC address acts as active and its peer acts as standby.</p>
<b>Step 2</b>	<p><b>chassis redundancy ha-interface GigabitEthernet <i>interface-number</i></b></p> <p><b>Example:</b></p> <pre>Device# chassis redundancy ha-interface GigabitEthernet 3</pre>	<p>Creates an HA interface for your controller.</p> <ul style="list-style-type: none"> <li>• <i>interface-number</i>: GigabitEthernet interface number. The range is from 1 to 32.</li> </ul> <p><b>Note</b> This step is applicable only for Cisco Catalyst 9800-CL Series Wireless Controllers. The chosen interface is used as the dedicated interface for HA communication between the 2 controllers.</p>

	Command or Action	Purpose
Step 3	<b>configure terminal</b> <b>Example:</b> Device# configure terminal	Enters global configuration mode.
Step 4	<b>redun-management interface vlan</b> <i>vlan-interface-number chassis chassis-number</i> <b>address ip-address chassis chassis-number</b> <b>address ip-address</b> <b>Example:</b> Device(config)# redun-management interface Vlan 200 chassis 1 address 9.10.90.147 chassis 2 address 9.10.90.149	Configures Redundancy Management Interface. <ul style="list-style-type: none"> <li>• <i>vlan-interface-number</i> : VLAN interface number. The valid range is from 1 to 4094.</li> </ul> <p><b>Note</b> Here, the <i>vlan-interface-number</i> is the same VLAN as the Management VLAN. That is, both must be on the same subnet.</p> <ul style="list-style-type: none"> <li>• <i>chassis-number</i>: Chassis number. The valid range is from 1 to 2.</li> <li>• <i>ip-address</i>: Redundancy Management Interface IP address.</li> </ul> <p><b>Note</b> Each controller must have a unique chassis number for RMI to form the HA pair. The chassis number can be observed as SWITCH_NUMBER in the output of <b>show romvar</b> command. Modification of SWITCH_NUMBER is currently not available through the web UI.</p> <p>To disable the HA pair, use the <b>no redun-management interface vlan chassis</b> command.</p>
Step 5	<b>end</b> <b>Example:</b> Device(config)# end	Returns to privileged EXEC mode.
Step 6	<b>write memory</b> <b>Example:</b> Device# write memory	Saves the configuration.
Step 7	<b>reload</b> <b>Example:</b>	Reloads the controllers.

	Command or Action	Purpose
	Device# reload	<p><b>Note</b> When the RMI configuration is done, you must reload the controllers for the configuration to take effect.</p> <p>For Cisco Catalyst 9800-CL Wireless Controller VM, both the active and standby controllers reload automatically. In the case of hardware platforms, you should reload the active controller manually, as only standby the controller reloads automatically.</p>

## Configuring Gateway Monitoring (CLI)

### Procedure

	Command or Action	Purpose
<b>Step 1</b>	<b>configure terminal</b> <b>Example:</b> Device# configure terminal	Enters global configuration mode.
<b>Step 2</b>	<b>[no] management gateway-failover enable</b> <b>Example:</b> Device(config)# management gateway-failover enable	Enables gateway monitoring. (Use the <b>no</b> form of this command to disable gateway monitoring.)
<b>Step 3</b>	<b>end</b> <b>Example:</b> Device(config)# end	Returns to privileged EXEC mode. <b>Note</b> To save the configuration, use the <b>write memory</b> command.

## Configuring Gateway Monitoring Interval (CLI)

### Procedure

	Command or Action	Purpose
<b>Step 1</b>	<b>configure terminal</b> <b>Example:</b> Device# configure terminal	Enters global configuration mode.
<b>Step 2</b>	<b>management gateway-failover interval interval-value</b>	Configures the gateway monitoring interval.

	Command or Action	Purpose
	<b>Example:</b> Device(config)# management gateway-failover interval 6	<i>interval-value</i> - Refers to the gateway monitoring interval. The valid range is from 6 to 12. Default value is 8.
<b>Step 3</b>	<b>end</b>  <b>Example:</b> Device(config)# end	Saves the configuration and exits configuration mode and returns to privileged EXEC mode.

## Gateway Reachability Detection

### Information About Gateway Reachability Detection

Gateway Reachability Detection feature minimizes the downtime on APs and clients when the gateway reachability is lost on the active controller.

Both active and standby controllers keep track of gateway reachability. The gateway reachability is detected by sending Internet Control Message Protocol (ICMP) and ARP requests periodically to the gateway.

Both active and standby controllers use the RMI IP as the source IP. The messages are sent at 1 second interval. If it takes 8 (or configured value) consecutive failures in reaching the gateway, the controller declares the gateway as non-reachable. It takes approximately 8 seconds to detect if a controller has lost gateway reachability.

Gateway monitoring with native IPv6 uses ICMP Neighbor Discovery protocols and ICMPv6 ECHO to check gateway reachability.

Therefore, you can monitor only the IPv6 gateway when RMI IPv6 is configured.

This means that only one IPv4 or IPv6 gateways can be monitored.



---

**Note** If the standby controller loses gateway, the standby moves to the standby recovery mode.  
If the active controller loses gateway, the active reloads and standby becomes active.

---

### Configuration Workflow

1. Configuring Redundancy Management Interface (GUI) (or) Configuring Redundancy Management Interface (CLI). For more information, see [Configuring Redundancy Management Interface \(GUI\)](#), on page 1288.



---

**Note** For RMI configuration to take effect, ensure that you reload your controllers.

---

2. Configuring IPv6 Static Route. For information, see [Gateway Monitoring](#).
3. Configuring Gateway Monitoring Interval (CLI). For more information, see [Configuring Gateway Monitoring Interval \(CLI\)](#), on page 1291.

## Migrating to RMI IPv6

### From RMI IPv4

1. Unconfigure the RMI IPv4 using the following CLIs:

```
Device# conf t
Device(config)# no redun-management interface <vlan_name> chassis 1 address <ip_address1>
chassis 2 address <ip_address2>
```



---

**Note** This CLI unconfigures RMI on both the controllers.

---



2.

---

**Note** Take a backup of the running config on active before you reload the controller.

---

Reload the controller.

3. Copy the backed up config to the running config on the box which would have lost all the config.
4. Configure the RMI IPv6 on both the controllers. For information on the CLI, see [#unique\\_1620](#).
5. Reload the controller.

### From HA Pairing (Without RMI)

For information on HA pairing, see [Configuring Redundancy Management Interface \(GUI\)](#).

## Monitoring the Health of the Standby Controller

The Standby Monitoring feature allows you to monitor the health of a system on a standby controller using programmatic interfaces and commands. This feature allows you to monitor parameters such as CPU, memory, interface status, power supply, fan failure, and the system temperature. Standby Monitoring is enabled when Redundancy Management Interface (RMI) is configured, no other configuration is required. The RMI itself is used to connect to the standby and perform standby monitoring. Standby Monitoring feature cannot be dynamically enabled or disabled.



---

**Note** The active controller uses the management or RMI IP to initiate AAA requests. Whereas, the standby controller uses the RMI IP to initiate AAA requests. Thus, the RMI IPs must be added in AAA servers for a seamless client authentication and standby monitoring.

---

To enable standby console, ensure that the following configuration is in place:

```
redundancy
main-cpu
secondary console enable
```



**Note** The Standby Monitoring feature is not supported on a controller in the active-recovery and the standby-recovery modes.

The Standby Monitoring feature supports only the following traffic on the RMI interface of the standby controller:

- Address Resolution Protocol (ARP)
- Internet Control Message Protocol (ICMP)
- TCP Traffic (to or from) ports: 22, 443, 830, and 3200
- UDP RADIUS ports: 1645 and 1646
- UDP Extended RADIUS ports: 21645 to 21844

#### Feature Scenarios

- To monitor the health of the standby directly from the standby controller using Standby RMI IP.
- To get syslogs from the standby controller using the Standby RMI IP.

#### Use Cases

- Enabling SNMP agent and programmatic interfaces on the standby controller: You can directly perform an SNMP query or programmatic interface query to the standby's RMI IP and active controller.
- Enabling syslogs on the standby controller: You can directly get the standby syslogs from the standby controller.

## Monitoring the Health of Standby Parameters Using SNMP

### Standby Monitoring Using Standby RMI IP

When an SNMP agent is enabled on the standby controller, you can directly perform an SNMP query to the standby's RMI IP. From Release 17.5 onwards, you can query the following MIB on the standby controller:

*Table 64: MIB Name and Notes*

MIB Name	Notes
IF-MIB	This MIB is used to monitor the interface statistics of the standby controller using the standby RMI IP address.



**Note** If an SNMP agent is enabled on the active controller, by default, the SNMP is enabled on the standby controller.



## Standby Monitoring Using the Active Controller

### CISCO-LWAPP-HA-MIB

The CISCO-LWAPP-HA-MIB monitors the health parameters of the standby controller, that is, memory, CPU, port status, power statistics, peer gateway latencies, and so on.

You can query the following MIB objects of CISCO-LWAPP-HA-MIB.

*Table 65: MIB Objects and Notes*

MIB Objects	Notes
cLHaPeerHotStandbyEvent	This object can be used to check if the standby controller has turned hot-standby or not.
cLHaBulkSyncCompleteEvent	This object represents the time at which the bulksync is completed.

### CISCO-PROCESS-MIB

The CISCO-PROCESS-MIB monitors CPU and process statistics. Use it to monitor CPU-related or memory-related BINOS processes. The standby CISCO-PROCESS-MIB can be monitored using the active controller.

### ENTITY-MIB

The ENTITY-MIB is used to monitor hardware details of the active and standby controllers using the active controller.



---

**Note** The standby Route Processor (RP) sensors are appended in the active RP sensors.

---

## Standby IOS Linux Syslogs

The standby logs are relayed using the same method as on the active Cisco IOS for wireless controllers.

From Release 17.5 onwards, external logging of syslogs from the standby IOS is enabled. As BINOS processes on standby also forwards the syslogs to Cisco IOS, all the syslogs generated on the standby controller is forwarded to the configured external server.



---

**Note** RMI IP address is used for logging purpose.

---

The following is the expected behavior when an HA pair is configured with the RMI IPv6 address, the active controller has dual stack, and logging is configured on the IPv4 address:

The standby controller tries to send syslogs to the IPv4 server because logging is only configured on IPv4 even though IPv4 is not supported by standby.

## Standby Interface Status Using Active SNMP

The standby interface information is sent to the active controller using IPC in the following scenarios:

- When there is a change in the interface status.
- When a new interface is added or deleted on the standby controller.

When the active controller receives the interface information from the standby controller, the active controller's database is populated with the standby interface information.

When an SNMP query is received for the standby interface information, the SNMP handlers corresponding to the CISCO-LWAPP-HA-MIB reads them from the standby interface database on the active and populates the MIB objects in CISCO-LWAPP-HA-MIB.

You can query the following MIB objects of CISCO-LWAPP-HA-MIB.

**Table 66: MIB Objects of CISCO-LWAPP-HA-MIB**

MIB Object	Notes
stbyIfIndex	This is a unique value (greater than zero) for each interface of the standby controller.
stbyIfName	This is the name of the standby interface.
stbyIfPhysAddress	This is the interface address of the standby controller in the protocol sublayer.
stbyifOperStatus	This is the current operational state of the interface in the standby controller.
stbyifAdminStatus	This is the desired state of the interface of the standby controller.

To verify the logging on the active when the standby fails to send interface statistics, use the following command:

```
Device# debug snmp ha-chkpt
Device# debug snmp ha-intf_db
```

## Monitoring the Health of Standby Controller Using Programmatic Interfaces

You can monitor parameters such as CPU, memory, sensors, and interface status on a standby controller using programmatic interfaces such as NETCONF and RESTCONF. The RMI IP of the standby controller can be used for access to the following operational models:

The models can be accessed through .

- Cisco-IOS-XE-device-hardware-oper.yang
- Cisco-IOS-XE-process-cpu-oper.yang

- Cisco-IOS-XE-platform-software-oper.yang
- Cisco-IOS-XE-process-memory-oper.yang
- Cisco-IOS-XE-interfaces-oper.yang

For more information on the YANG models, see the *Programmability Configuration Guide, Cisco IOS XE Amsterdam 17.3.x*.

## Monitoring the Health of Standby Controller Using CLI

This section describes the different commands that can be used to monitor the standby device.

You can connect to the standby controller through SSH using the RMI IP of the standby controller. The user credentials must have been configured already. Both local authentication and RADIUS authentication are supported.



---

**Note** The **redun-management** command needs to be configured on both the controllers, primary and standby, prior to high availability (HA) pairing.

---

### Monitoring Port State

The following is a sample output of the **show interfaces interface-name** command:

```
Device-standby# show interfaces GigabitEthernet1

GigabitEthernet1 is down, line protocol is down
Shadow state is up, true line protocol is up
  Hardware is CSR vNIC, address is 000c.2909.33c2 (bia 000c.2909.33c2)
  MTU 1500 bytes, BW 1000000 Kbit/sec, DLY 10 usec,
    reliability 255/255, txload 1/255, rxload 1/255
  Encapsulation ARPA, loopback not set
  Keepalive set (10 sec)
  Full Duplex, 1000Mbps, link type is force-up, media type is Virtual
  output flow-control is unsupported, input flow-control is unsupported
  ARP type: ARPA, ARP Timeout 04:00:00
  Last input 00:00:06, output 00:00:24, output hang never
  Last clearing of "show interface" counters never
  Input queue: 30/375/0/0 (size/max/drops/flushes); Total output drops: 0
  Queueing strategy: fifo
  Output queue: 0/40 (size/max)
  5 minute input rate 389000 bits/sec, 410 packets/sec
  5 minute output rate 0 bits/sec, 0 packets/sec
    3696382 packets input, 392617128 bytes, 0 no buffer
    Received 0 broadcasts (0 multicasts)
    0 runs, 0 giants, 0 throttles
    0 input errors, 0 CRC, 0 frame, 0 overrun, 0 ignored
    0 watchdog, 0 multicast, 0 pause input
    18832 packets output, 1218862 bytes, 0 underruns
    Output 0 broadcasts (0 multicasts)
    0 output errors, 0 collisions, 2 interface resets
    3 unknown protocol drops
    0 babbles, 0 late collision, 0 deferred
    0 lost carrier, 0 no carrier, 0 pause output
    0 output buffer failures, 0 output buffers swapped out
```

The following is a sample output of the **show ip interface brief** command:

```
Device# show ip interface brief

Interface                IP-Address      OK? Method Status          Protocol
GigabitEthernet1        unassigned      YES unset  down            down
GigabitEthernet0        unassigned      YES NVRAM  administratively down down
Capwap1                  unassigned      YES unset  up              up
Capwap2                  unassigned      YES unset  up              up
Capwap3                  unassigned      YES unset  up              up
Capwap10                 unassigned      YES unset  up              up
Vlan1                    unassigned      YES NVRAM  down            down
Vlan56                   unassigned      YES unset  down            down
Vlan111                  111.1.1.85     YES NVRAM  up              up
```

### Monitoring CPU or Memory

The following is a sample output of the **show process cpu sorted 5sec** command:

```
Device-standby# show process cpu sorted 5sec

CPU utilization for five seconds: 0%/0%; one minute: 0%; five minutes: 0%
PID Runtime(ms)   Invoked    uSecs   5Sec   1Min   5Min  TTY Process
 10   1576556         281188    5606   0.15%  0.05%  0.05%  0 Check heaps
232   845057         54261160  15     0.07%  0.05%  0.06%  0 IPAM Manager
595    177            300       590   0.07%  0.02%  0.01%  2 Virtual Exec
138   1685973        108085955 15     0.07%  0.08%  0.08%  0 L2 LISP Punt Pro
193   19644          348767    56    0.07%  0.00%  0.00%  0 DTP Protocol
 5     0              1         0     0.00%  0.00%  0.00%  0 CTS SGACL db cor
 4     24            15        1600  0.00%  0.00%  0.00%  0 RF Slave Main Th
 6     0              1         0     0.00%  0.00%  0.00%  0 Retransmission o
 7     0              1         0     0.00%  0.00%  0.00%  0 IPC ISSU Dispatc
 2    117631         348801    337   0.00%  0.00%  0.00%  0 Load Meter
 8     0              1         0     0.00%  0.00%  0.00%  0 EDDRI_MAIN
```

To check CPU and memory utilization of binOS processes, run the following command:

```
Device-standby# show platform software process slot chassis standby R0 monitor

top - 23:24:14 up 8 days, 3:38, 0 users, load average: 0.69, 0.79, 0.81
Tasks: 433 total, 1 running, 431 sleeping, 1 stopped, 0 zombie
%Cpu(s): 1.7 us, 2.8 sy, 0.0 ni, 95.6 id, 0.0 wa, 0.0 hi, 0.0 si, 0.0 st
MiB Mem : 32059.2 total, 21953.7 free, 4896.8 used, 5208.6 buff/cache
MiB Swap: 0.0 total, 0.0 free, 0.0 used. 26304.6 avail Mem

PID USER PR NI VIRT RES SHR S %CPU %MEM TIME+ COMMAND
23565 root 20 0 2347004 229116 130052 S 41.2 0.7 5681:44 ucode_pkt+
2306 root 20 0 666908 106760 46228 S 5.9 0.3 15:06.14 smand
22807 root 20 0 3473004 230020 152120 S 5.9 0.7 510:56.90 fman_fp_i+
1 root 20 0 14600 11324 7424 S 0.0 0.0 0:31.07 systemd
2 root 20 0 0 0 0 S 0.0 0.0 0:00.28 kthreadd
3 root 0 -20 0 0 0 I 0.0 0.0 0:00.00 rcu_gp
4 root 0 -20 0 0 0 I 0.0 0.0 0:00.00 rcu_par_gp
6 root 0 -20 0 0 0 I 0.0 0.0 0:00.00 kworker/0+
7 root 20 0 0 0 0 I 0.0 0.0 0:00.49 kworker/u+
8 root 0 -20 0 0 0 I 0.0 0.0 0:00.00 mm_percpu+
9 root 20 0 0 0 0 S 0.0 0.0 0:03.26 ksoftirqd+
.
.
.
32258 root 20 0 57116 3432 2848 S 0.0 0.0 0:00.00 rotee
```

```

32318 root 20 0 139560 9500 7748 S 0.0 0.0 0:55.67 pttcd
32348 root 20 0 31.6g 3.1g 607364 S 0.0 9.8 499:12.04 linux_ios+
32503 root 20 0 3996 3136 2852 S 0.0 0.0 0:00.00 stack_snt+
32507 root 20 0 3700 1936 1820 S 0.0 0.0 0:00.00 sntp

```

## Monitoring Hardware

The following is a sample output of the **show environment summary** command:

```
Device# show environment summary
```

```

Number of Critical alarms: 0
Number of Major alarms: 0
Number of Minor alarms: 0

```

Slot	Sensor	Current State	Reading
Threshold (Minor, Major, Critical, Shutdown)			
-----	-----	-----	-----
P0	Vin	Normal	231 V AC na
P0	Iin	Normal	2 A na
P0	Vout	Normal	12 V DC na
P0	Iout	Normal	30 A na
P0	Temp1	Normal	25 Celsius (na ,na ,na ,na ) (Celsius)
P0	Temp2	Normal	31 Celsius (na ,na ,na ,na ) (Celsius)
P0	Temp3	Normal	37 Celsius (na ,na ,na ,na ) (Celsius)
R0	VDMB1: VX1	Normal	1226 mV na
R0	VDMB1: VX2	Normal	6944 mV na
R0	Temp: DMB IN	Normal	26 Celsius (45 ,55 ,65 ,70 ) (Celsius)
R0	Temp: DMB OUT	Normal	40 Celsius (70 ,75 ,80 ,85 ) (Celsius)
R0	Temp: Yoda 0	Normal	54 Celsius (95 ,105,110,115) (Celsius)
R0	Temp: Yoda 1	Normal	62 Celsius (95 ,105,110,115) (Celsius)
R0	Temp: CPU Die	Normal	43 Celsius (100,110,120,125) (Celsius)
R0	Temp: FC FANS	Fan Speed 70%	26 Celsius (29 ,39 ,0 ) (Celsius)
R0	VDDC1: VX1	Normal	1005 mV na
R0	VDDC1: VX2	Normal	7084 mV na
R0	VDDC2: VH	Normal	12003mV na
R0	Temp: DDC IN	Normal	25 Celsius (55 ,65 ,75 ,80 ) (Celsius)
R0	Temp: DDC OUT	Normal	35 Celsius (75 ,85 ,95 ,100) (Celsius)
P0	Stby Vin	Normal	230 V AC na
P0	Stby Iin	Normal	2 A na
P0	Stby Vout	Normal	12 V DC na
P0	Stby Iout	Normal	32 A na
P0	Stby Temp1	Normal	24 Celsius (na ,na ,na ,na ) (Celsius)
P0	Stby Temp2	Normal	29 Celsius (na ,na ,na ,na ) (Celsius)
P0	Stby Temp3	Normal	35 Celsius (na ,na ,na ,na ) (Celsius)
R0	Stby VDMB1: VX1	Normal	1225 mV na
R0	Stby VDMB1: VX2	Normal	6979 mV na
R0	Stby VDMB2: VX2	Normal	5005 mV na
R0	Stby VDMB2: VX3	Normal	854 mV na
R0	Stby VDMB3: VX1	Normal	972 mV na
R0	Stby Temp: DMB IN	Normal	22 Celsius (45 ,55 ,65 ,70 ) (Celsius)
R0	Stby Temp: DMB O	Normal	32 Celsius (70 ,75 ,80 ,85 ) (Celsius)
R0	Stby Temp: Yoda	Normal	43 Celsius (95 ,105,110,115) (Celsius)
R0	Stby Temp: Yoda	Normal	45 Celsius (95 ,105,110,115) (Celsius)
R0	Stby Temp: CPU D	Normal	33 Celsius (100,110,120,125) (Celsius)
R0	Stby Temp: FC FA	Fan Speed 70%	22 Celsius (29 ,39 ,0 ) (Celsius)
R0	Stby VDDC1: VX1	Normal	1005 mV na
R0	Stby VDDC1: VX2	Normal	7070 mV na
R0	Stby VDDC2: VX2	Normal	752 mV na
R0	Stby VDDC2: VX3	Normal	750 mV na
R0	Stby Temp: DDC IN	Normal	22 Celsius (55 ,65 ,75 ,80 ) (Celsius)
R0	Stby Temp: DDC O	Normal	28 Celsius (75 ,85 ,95 ,100) (Celsius)



---

**Note** The command displays both active and standby hardware details.

---



---

**Note** The **show environment summary** command displays data only for physical appliances such as Cisco Catalyst 9800-80 Wireless Controller, Cisco Catalyst 9800-40 Wireless Controller, Cisco Catalyst 9800-L Wireless Controller, and Cisco Catalyst 9800 Embedded Wireless Controller for Switch. The command does not display data for Cisco Catalyst 9800 Wireless Controller for Cloud.

---

## Verifying the Gateway-Monitoring Configuration

To verify the status of the gateway-monitoring configuration on an active controller, run the following command:

```
Device# show redundancy states

my state = 13 -ACTIVE
peer state = 8 -STANDBY HOT
Mode = Duplex
Unit = Primary
Unit ID = 1

Redundancy Mode (Operational) = sso
Redundancy Mode (Configured) = sso
Redundancy State = sso
Maintenance Mode = Disabled
Manual Swact = enabled
Communications = Up

client count = 129
client_notification_TMR = 30000 milliseconds
RF debug mask = 0x0
Gateway Monitoring = Disabled
Gateway monitoring interval = 8 secs
```

To verify the status of the gateway-monitoring configuration on a standby controller, run the following command:

```
Device-stby# show redundancy states

my state = 8 -STANDBY HOT
peer state = 13 -ACTIVE
Mode = Duplex
Unit = Primary
Unit ID = 2

Redundancy Mode (Operational) = sso
Redundancy Mode (Configured) = sso
Redundancy State = sso
Maintenance Mode = Disabled
Manual Swact = cannot be initiated from this the standby unit
Communications = Up

client count = 129
client_notification_TMR = 30000 milliseconds
RF debug mask = 0x0
```

```
Gateway Monitoring = Disabled
Gateway monitoring interval = 8 secs
```

## Verifying the RMI IPv4 Configuration

Verify the RMI IPv4 configuration.

```
Device# show running-config interface vlan management-vlan

Building configuration...

Current configuration : 109 bytes
!
interface Vlan90
ip address 9.10.90.147 255.255.255.0 secondary
ip address 9.10.90.41 255.255.255.0
end
```

To verify the interface configuration for a standby controller, use the following command:

```
Device-stby# show running-config interface vlan 90

Building configuration...

Current configuration : 62 bytes
!
interface Vlan90
ip address 9.10.90.149 255.255.255.0
end
```

To verify the chassis redundancy management interface configuration for an active controller, use the following command:

```
Device# show chassis rmi

Chassis/Stack Mac Address : 000c.2964.1eb6 - Local Mac Address
Mac persistency wait time: Indefinite
      H/W Current
Chassis# Role      Mac Address      Priority Version State IP           RMI-IP
-----
*1      Active    000c.2964.1eb6   1      V02    Ready 169.254.90.147 9.10.90.147
2       Standby   000c.2975.3aa6   1      V02    Ready 169.254.90.149 9.10.90.149
```

To verify the chassis redundancy management interface configuration for a standby controller, use the following command:

```
Device-stby# show chassis rmi

Chassis/Stack Mac Address : 000c.2964.1eb6 - Local Mac Address
Mac persistency wait time: Indefinite
      H/W Current
Chassis# Role      Mac Address      Priority Version State IP           RMI-IP
-----
1       Active    000c.2964.1eb6   1      V02    Ready 169.254.90.147 9.10.90.147
*2      Standby   000c.2975.3aa6   1      V02    Ready 169.254.90.149 9.10.90.149
```

To verify the ROMMON variables on an active controller, use the following command:

```
Device# show romvar | include RMI

RMI_INTERFACE_NAME = Vlan90
RMI_CHASSIS_LOCAL_IP = 9.10.90.147
RMI_CHASSIS_REMOTE_IP = 9.10.90.149
```

To verify the ROMMON variables on a standby controller, use the following command:

```
Device-stby# show romvar | include RMI

RMI_INTERFACE_NAME = Vlan90
RMI_CHASSIS_LOCAL_IP = 9.10.90.149
RMI_CHASSIS_REMOTE_IP = 9.10.90.147
```

To verify the switchover reason, use the following command:

```
Device# show redundancy switchover history
```

Index	Previous active	Current active	Switchover reason	Switchover time
1	2	1	Active lost GW	17:02:29 UTC Mon Feb 3 2020

## Verifying the RMI IPv6 Configuration

To verify the chassis redundancy management interface configuration for both active and standby controllers, run the following command:

```
Device# show chassis rmi

Chassis/Stack Mac Address : 00a3.8e23.a540 - Local Mac Address
Mac persistency wait time: Indefinite
Local Redundancy Port Type: Twisted Pair
```

Chassis#	Role	Mac Address	Priority	H/W Version	Current State	IP	RMI-IP
1	Standby	706d.1536.23c0	1	V02	Ready	169.254.254.17	2020:0:0:1::211
*2	Active	00a3.8e23.a540	1	V02	Ready	169.254.254.18	2020:0:0:1::212

To verify the RMI related ROMMON variables for both active and standby controllers, run the following command

```
Device# show romvar | i RMI

RMI_INTERFACE_NAME = Vlan52
RMI_CHASSIS_LOCAL_IPV6 = 2020:0:0:1::212
RMI_CHASSIS_REMOTE_IPV6 = 2020:0:0:1::211
```

## Verifying Redundancy Port Interface Configuration

To verify the Redundancy Port Interface (RIF) resource status in an active instance, run the following command:

```
Device# show platform software rif-mgr chassis active R0 resource-status
RIF Resource Status
```



```

RP Status          : Up
RMI Status         : Up
Current Chassis State : Active
Peer Chassis State  : Standby

```

To verify the RIF resource status in a standby instance, run the following command:

```

Device# show platform software rif-mgr chassis standby R0 resource-status
RIF Resource Status

```

```

RP Status          : Up
RMI Status         : Up
Current Chassis State : Standby
Peer Chassis State  : Active

```

To verify the RMI link re-establishment count and the time since the RMI link is Up in the active instance, run the following command:

```

Device# show platform software rif-mgr chassis active R0 rmi-connection-details
RMI Connection Details
RMI Link re-establish count : 2
RMI Link Uptime             : 21 hours 8 minutes 43 seconds
RMI Link Upsince            : 08/05/2021 13:46:01

```

To verify the RMI link re-establishment count and the time since the RMI link is Down in the active instance, run the following command:

```

Device# show platform software rif-mgr chassis active R0 rmi-connection-details
RMI Connection Details
RMI Link re-establish count : 1
RMI Link Downtime           : 28 seconds
RMI Link Downsince          : 07/16/2021 03:19:11

```

To verify the RMI link re-establishment count and the time since the RMI link is Up in the standby instance, run the following command:

```

Device# show platform software rif-mgr chassis standby R0 rmi-connection-details
RMI Connection Details
RMI Link re-establish count : 1
RMI Link Uptime             : 1 hour 39 minute 9 seconds
RMI Link Upsince            : 07/16/2021 01:31:41

```

To verify the RMI link re-establishment count and the time since the RMI link is Down in the standby instance, run the following command:

```

Device# show platform software rif-mgr chassis standby R0 rmi-connection-details
RMI Connection Details
RMI Link re-establish count : 1
RMI Link Downtime           : 22 seconds
RMI Link Downsince          : 07/16/2021 03:19:17

```

To verify the RP link re-establishment count and the time since the RP link is UP for days in the active instance, run the following command:

```

Device# show platform software rif-mgr chassis active R0 rp-connection-details
RP Connection Details
RP Connection Uptime : 12 days 17 hours 1 minute 39 seconds
RP Connection Upsince : 07/03/2021 07:06:20

```

To verify the RP link re-establishment count and the time since the RP link is Down in the active instance, run the following command:

```

Device# show platform software rif-mgr chassis active R0 rp-connection-details
RP Connection Details

```

```
RP Connection Downtime      : 4 seconds
RP Connection Downsince    : 07/16/2021 03:33:04
```

To verify the RP link re-establishment count and the time since the RP link is UP in the standby instance, run the following command:

```
Device# show platform software rif-mgr chassis standby R0 rp-connection-details
RP Connection Details
  RP Connection Uptime      : 12 days 17 hours 2 minutes 1 second
  RP Connection Upsince    : 07/03/2021 07:05:58
```

To verify the RP link re-establishment count and the time since the RP link is Down in the standby instance, run the following command:

```
Device# show platform software rif-mgr chassis standby R0 rp-connection-details
RP Connection Details
  RP Connection Downtime   : 22 seconds
  RP Connection Downsince  : 07/16/2021 03:19:17
```

To verify the RIF and stack manager internal statistics in the active instance, run the following command:

```
Device# show platform software rif-mgr chassis active R0 rif-stk-internal-stats
RIF Stack Manager internal stats

  Stack-mgr reported RP down          : False
  DAD link status reported to Stack-Mgr : True
```

To verify the RIF and stack manager internal statistics in the standby instance, run the following command:

```
Device# show platform software rif-mgr chassis standby R0 rif-stk-internal-stats
RIF Stack Manager internal stats

  Stack-mgr reported RP down          : False
  DAD link status reported to Stack-Mgr : True
```

To verify the number of packets sent or received for each type in the active instance, run the following command:

```
Device# show platform software rif-mgr chassis active R0 lmp-statistics
LMP Statistics

Info Type Sent           : 6
Solicit Info Type Sent   : 0
Unsolicit Info Type Sent : 6
Reload Type Sent         : 0
Recovery Type Sent       : 1
Gateway Info Type Sent   : 0
Enquiry Type Sent        : 0
Solicit Enquiry Type Sent : 0
Unsolicit Enquiry Type Sent : 0

Info Type Received       : 5
Solicit Info Type Received : 2
Unsolicit Info Type Received : 3
Reload Type Received     : 0
Recovery Type Received   : 0
Gateway Info Type Received : 4
Enquiry Type Received    : 0
Solicit Enquiry Type Received : 0
Unsolicit Enquiry Type Received : 0
```

To verify the number of packets sent or received for each type in the standby instance, run the following command:

```
Device# show platform software rif-mgr chassis standby R0 lmp-statistics
LMP Statistics
```

```

Info Type Sent : 6
Solicit Info Type Sent : 0
Unsolicit Info Type Sent : 6
Reload Type Sent : 0
Recovery Type Sent : 0
Gateway Info Type Sent : 4
Enquiry Type Sent : 0
Solicit Enquiry Type Sent : 0
Unsolicit Enquiry Type Sent : 0

Info Type Received : 5
Solicit Info Type Received : 3
Unsolicit Info Type Received : 2
Reload Type Received : 0
Recovery Type Received : 1
Gateway Info Type Received : 0
Enquiry Type Received : 0
Solicit Enquiry Type Received : 0
Unsolicit Enquiry Type Received : 0

```

## Information About Auto-Upgrade

The Auto-Upgrade feature enables the standby controller to upgrade with the software image of the active controller so that both controllers form an HA pair.



### Note

- This feature supports the active controller in INSTALL mode.
- This feature supports Cisco Catalyst 9800 Series Wireless Controller software versions 17.5.1 and later.
- This feature is triggered in the standby controller only when the active image is in committed state.

## Use Cases

The following are the use cases and functionalities supported by the Auto-Upgrade feature:

- Handling software version mismatch: During an upgrade, if one of the redundancy port is upgraded to a newer version, and the other one is not upgraded at the same time, the active port tries to copy its packages to the other port using the Auto-Upgrade feature. You can enable Auto-Upgrade in this situation using configuration or by manually running the **software auto-upgrade enable** privileged EXEC command.

The auto-upgrade configuration is enabled by default.



### Note

Auto-upgrade upgrades the mismatched redundancy port only when both the active redundancy port and the mismatched redundancy port are in INSTALL mode.

- HA pair: If one of the controller is not upgraded successfully, use Auto-Upgrade to upgrade the controller on the newly deployed HA pair, which can each be a different version.

- SMUs (APSP, APDP, and so on): If the SMUs that are successfully installed on the active controller when the standby controller was offline. In this scenario, when the standby controller comes up online, the Auto-Upgrade copies this SMU to the standby controller and installs it.

## Configuration Workflow

[#unique\\_1636](#)

### Configuring Auto-Upgrade (CLI)

#### Procedure

	Command or Action	Purpose
<b>Step 1</b>	<b>configure terminal</b> <b>Example:</b> Device# <code>configure terminal</code>	Enters global configuration mode.
<b>Step 2</b>	<b>software auto-upgrade enable</b> <b>Example:</b> Device(config)# <code>software auto-upgrade enable</code>	Enables the Auto-Upgrade feature. (This feature is enabled by default.)  If you disable this feature using the <b>no</b> form of this command, you need to manually auto upgrade using the <b>install autoupgrade</b> command in privileged EXEC mode.
<b>Step 3</b>	<b>end</b> <b>Example:</b> Device(config)# <code>end</code>	Returns to privileged EXEC mode.



## PART **X**

# Quality of Service

- [Quality of Service, on page 1309](#)
- [Wireless Auto-QoS, on page 1341](#)
- [Native Profiling, on page 1347](#)
- [Air Time Fairness, on page 1359](#)
- [IPv6 Non-AVC QoS Support, on page 1369](#)
- [QoS Basic Service Set Load, on page 1373](#)





## CHAPTER 142

# Quality of Service

---

- [Wireless QoS Overview, on page 1309](#)
- [Wireless QoS Targets, on page 1310](#)
- [Wireless QoS Mobility, on page 1311](#)
- [Precious Metal Policies for Wireless QoS, on page 1311](#)
- [Prerequisites for Wireless QoS, on page 1312](#)
- [Restrictions for QoS on Wireless Targets, on page 1312](#)
- [Metal Policy Format, on page 1313](#)
- [How to apply Bi-Directional Rate Limiting, on page 1320](#)
- [How to apply Per Client Bi-Directional Rate Limiting, on page 1327](#)
- [How to Configure Wireless QoS, on page 1331](#)
- [Configuring Custom QoS Mapping, on page 1336](#)
- [Configuring DSCP-to-User Priority Mapping Exception, on page 1337](#)
- [Configuring Trust Upstream DSCP Value, on page 1338](#)

## Wireless QoS Overview

Quality of Service (QoS), provides the ability to prioritize the traffic by giving preferential treatment to specific traffic over the other traffic types. Without QoS, the device offers best-effort service for each packet, regardless of the packet contents or size. The device sends the packets without any assurance of reliability, delay bounds, or throughput.

A target is the entity where the policy is applied. Wireless QoS policies for SSID and client are applied in the upstream and (or) downstream direction. The flow of traffic from a wired source to a wireless target is known as downstream traffic. The flow of traffic from a wireless source to a wired target is known as upstream traffic.

The following are some of the specific features provided by wireless QoS:

- SSID and client policies on wireless QoS targets
- Marking and Policing (also known as Rate Limiting ) of wireless traffic
- Mobility support for QoS

# Wireless QoS Targets

This section describes the various wireless QoS targets available on a device.

## SSID Policies

You can create QoS policies on SSID in both the ingress and egress directions. If not configured, there is no SSID policy applied.

The policy is applicable per AP per SSID.

You can configure policing and marking policies on SSID.

## Client Policies

Client policies are applicable in the ingress and egress direction. You can configure policing and marking policies on clients. AAA override is also supported.

## Supported QoS Features on Wireless Targets

This table describes the various features available on wireless targets.

**Table 67: QoS Features Available on Wireless Targets**

Target	Features	Direction Where Policies Are Applicable
SSID	<ul style="list-style-type: none"> <li>• Set</li> <li>• Police</li> <li>• Drop</li> </ul>	Upstream and downstream
Client	<ul style="list-style-type: none"> <li>• Set</li> <li>• Police</li> <li>• Drop</li> </ul>	Upstream and downstream

This table describes the various features available on wireless targets.

**Table 68: QoS Policy Actions**

Policy Action Types	Wireless Target Support	
	Local Mode	Flex Mode
Police	Supported	Supported
Set	Supported	Supported



This table describes the various features available on wireless targets.

**Table 69: QoS Policy Set Actions**

Set Action Types	Supported	
	Local Mode	Flex Mode
set dscp	Supported	Supported
set qos-group	Supported	Not Supported
set wlan user-priority (downstream only)	Supported (BSSID only)	Supported (BSSID only)

## Wireless QoS Mobility

Wireless QoS mobility enables you to configure QoS policies so that the network provides the same service anywhere in the network. A wireless client can roam from one location to another and as a result the client can get associated to different access points associated with a different device. Wireless client roaming can be classified into two types:

- Intra-device roaming
- Inter-device roaming



---

**Note** In a foreign WLC, client statistics are not displayed.

---



---

**Note** The client policies must be available on all of the devices in the mobility group. The same SSID policy must be applied to all devices in the mobility group so that the clients get consistent treatment.

---

## Precious Metal Policies for Wireless QoS

The precious metal policies are system-defined policies that are available on the controller. They cannot be removed or changed.

The following policies are available:

- Platinum—Used for VoIP clients.
- Gold—Used for video clients.
- Silver—Used for traffic that can be considered best-effort.
- Bronze—Used for NRT traffic.

These policies are pre-configured. They cannot be modified.

For client metal policies, they can be pushed using AAA.

Based on the policies applied, the 802.11e (WMM), and DSCP fields in the packets are affected.

For more information about metal policies format see the [Metal Policy Format, on page 1313](#) section.

For more information about DSCP to UP mapping, see the [#unique\\_1648](#) table.



---

**Note** APs in the FlexConnect local switching mode do not apply the QoS metal policy ceilings for upstream traffic. The ceiling limit will only be implemented at the controller's exit point. Therefore, the DSCP value remains unaffected by the AP when a metal QoS policy is applied to the policy profile.

---

## Prerequisites for Wireless QoS

Before configuring wireless QoS, you must have a thorough understanding of these items:

- Wireless concepts and network topologies.
- Understanding of QoS implementation.
- Modular QoS CLI (MQC). For more information on Modular QoS, see the [MQC](#) guide
- The types of applications used and the traffic patterns on your network.
- Bandwidth requirements and speed of the network.

## Restrictions for QoS on Wireless Targets

### General Restrictions

A target is an entity where a policy is applied. A policy can be applied to a wireless target, which can be an SSID or client target, in the downstream and/or upstream direction. Downstream indicates that traffic is flowing from the controller to the wireless client. Upstream indicates that traffic is flowing from wireless client to the controller.

- Hierarchical (Parent policy and child policy) QoS is not supported.
- SSID and client targets can be configured only with marking and policing policies.
- One policy per target per direction is supported.
- Class maps in a policy map can have different types of filters. However, only one marking action (set dscp) is supported.
- Only one set action per class is supported.
- Access group matching is not supported.
- Access group (ACL) matching is not supported by access points in flex mode for local switching traffic.
- SIP Call Admission Control (CAC) is not supported on the central switching mode.

- From Cisco IOS XE Amsterdam 17.3.1 onwards, SIP Call Admission Control (CAC) is not supported.
- Applying QoS on the WMI interface is not supported, as it may reboot the controller.

### AP Side Restrictions

- In Cisco Embedded Wireless Controller, FlexConnect local switching, and SDA deployments, the QoS policies are enforced on the AP. Due to this AP-side restriction, police actions (e.g., rate limiting) are only enforced at a per flow (5-tuple) level and not per client.
- For FlexConnect local switching (local authentication) with AAA override enabled and external AAA server, only air space VLAN and ACL are supported as part of the AAA override and not the QoS override or other overrides.

### Control Plane Rate Limiting and Policing

You need not explicitly configure control plane rate limiting or policing on the controller. The controller has embedded mechanisms (like policers) to protect the CPU by policing control plane traffic directed towards it. If you're migrating from AireOS to IOS-XE, this change is taken care of at the code level.

## Metal Policy Format

### Metal Policy Format

Metal Policies are system defined, and you cannot change it or delete it. There are four levels of metal policy - Platinum, Gold, Silver, and Bronze.



---

**Note** Each metal policy defines a DSCP ceiling so that the DSCP or the UP marking does not exceed a certain value.

For Platinum the value is 46, Gold is AF41, Silver is 22, and Bronze is CS1.

---

Policy Name	Policy-map Format	Class-map Format
platinum	<pre> policy-map platinum class cm-dscp-34   set dscp af41 class cm-dscp-45   set dscp 45 class cm-dscp-46   set dscp ef class cm-dscp-47   set dscp 47 </pre>	<pre> class-map match-any cm-dscp-34   match dscp af41  class-map match-any cm-dscp-45   match dscp 45  class-map match-any cm-dscp-46   match dscp ef </pre>
gold	<pre> policy-map gold class cm-dscp-45   set dscp af41 class cm-dscp-46   set dscp af41 class cm-dscp-47   set dscp af41 </pre>	<pre> class-map match-any cm-dscp-47   match dscp 47  class-map match-any cm-dscp-0   match dscp default </pre>
silver	<pre> policy-map silver class cm-dscp-34   set dscp default class cm-dscp-45   set dscp default class cm-dscp-46   set dscp default class cm-dscp-47   set dscp default </pre>	
bronze	<pre> policy-map bronze class cm-dscp-0   set dscp cs1 class cm-dscp-34   set dscp cs1 class cm-dscp-45   set dscp cs1 class cm-dscp-46   set dscp cs1 class cm-dscp-47   set dscp cs1 </pre>	

Policy Name	Policy-map Format	Class-map Format
platinum-up	<pre> policy-map platinum-up   class cm-dscp-set1-for-up-4     set dscp af41   class cm-dscp-set2-for-up-4     set dscp af41   class cm-dscp-for-up-5     set dscp af41   class cm-dscp-for-up-6     set dscp ef   class cm-dscp-for-up-7     set dscp ef </pre>	<pre> class-map match-any cm-dscp-for-up-0   match dscp default   match dscp cs2  class-map match-any cm-dscp-for-up-1   match dscp cs1  class-map match-any cm-dscp-set1-for-up-4   match dscp cs3   match dscp af31   match dscp af32   match dscp af33 </pre>
gold-up	<pre> policy-map gold-up   class cm-dscp-for-up-6     set dscp af41   class cm-dscp-for-up-7     set dscp af41 </pre>	<pre> class-map match-any cm-dscp-set2-for-up-4   match dscp af41   match dscp af42   match dscp af43 </pre>
silver-up	<pre> policy-map silver-up   class cm-dscp-set1-for-up-4     set dscp default   class cm-dscp-set2-for-up-4     set dscp default   class cm-dscp-for-up-5     set dscp default   class cm-dscp-for-up-6     set dscp default   class cm-dscp-for-up-7     set dscp default </pre>	<pre> class-map match-any cm-dscp-for-up-5   match dscp cs4   match dscp cs5  class-map match-any cm-dscp-for-up-6   match dscp 44   match dscp ef </pre>
bronze-up	<pre> policy-map bronze-up   class cm-dscp-for-up-0     set dscp cs1   class cm-dscp-for-up-1     set dscp cs1   class cm-dscp-set1-for-up-4     set dscp cs1   class cm-dscp-set2-for-up-4     set dscp cs1   class cm-dscp-for-up-5     set dscp cs1   class cm-dscp-for-up-6     set dscp cs1   class cm-dscp-for-up-7     set dscp cs1 </pre>	<pre> class-map match-any cm-dscp-for-up-7   match dscp cs6   match dscp cs7 </pre>

Policy Name	Policy-map Format	Class-map Format
clwmm-platinum	<pre> policy-map clwmm-platinum class voice-plat   set dscp ef class video-plat   set dscp af41 class class-default   set dscp default </pre>	<pre> class-map match-any voice-plat   match dscp ef class-map match-any video-plat   match dscp af41 class-map match-any voice-gold   match dscp ef class-map match-any video-gold   match dscp af41 </pre>
clwmm-gold	<pre> policy-map clwmm-gold class voice-gold   set dscp af41 class video-gold   set dscp af41 class class-default   set dscp default </pre>	
clnon-wmm-platinum	<pre> policy-map clnon-wmm-platinum class class-default   set dscp ef </pre>	
clnon-wmm-gold	<pre> policy-map clnon-wmm-gold class class-default   set dscp af41 </pre>	
clsilver	<pre> policy-map clsilver class class-default   set dscp default </pre>	
clbronze	<pre> policy-map clbronze class class-default   set dscp csl </pre>	

## Auto QoS Policy Format

Policy Name	Policy-map Format	Class-map Format
enterprise-avc	<pre> policy-map AutoQos-4.0-wlan-ET-SSID-Input-AVC-Policy class AutoQos-4.0-wlan-Voip-Data-Class   set dscp ef class AutoQos-4.0-wlan-Voip-Signal-Class   set dscp cs3 class AutoQos-4.0-wlan-Multimedia-Conf-Class   set dscp af41 class AutoQos-4.0-wlan-Transaction-Class   set dscp af21 class AutoQos-4.0-wlan-Bulk-Data-Class   set dscp af11 class AutoQos-4.0-wlan-Scavenger-Class   set dscp cs1 class class-default   set dscp default  policy-map AutoQos-4.0-wlan-ET-SSID-Output-Policy class AutoQos-4.0-RT1-Class   set dscp ef class AutoQos-4.0-RT2-Class   set dscp af31 class class-default </pre>	

Policy Name	Policy-map Format	Class-map Format
		<pre> class-map match-any AutoQos-4.0-wlan-Voip-Data-Class      match dscp ef  class-map match-any AutoQos-4.0-wlan-Voip-Signal-Class      match protocol skinny     match protocol cisco-jabber-control     match protocol sip     match protocol sip-tls  class-map match-any AutoQos-4.0-wlan-Multimedia-Conf-Class      match protocol cisco-phone-video     match protocol cisco-jabber-video     match protocol ms-lync-video     match protocol webex-media  class-map match-any AutoQos-4.0-wlan-Transaction-Class      match protocol cisco-jabber-im     match protocol ms-office-web-apps     match protocol salesforce     match protocol sap  class-map match-any AutoQos-4.0-wlan-Bulk-Data-Class      match protocol ftp     match protocol ftp-data     match protocol ftps-data     match protocol cifs  class-map match-any AutoQos-4.0-wlan-Saverager-Class      match protocol netflix     match protocol youtube     match protocol skype      match protocol bittorrent  class-map match-any AutoQos-4.0-RTT1-Class match dscp ef </pre>



Policy Name	Policy-map Format	Class-map Format
		<pre>match dscp cs6 class-map match-any AutoQos-4.0-RT2-Class match dscp cs4 match dscp cs3 match dscp af41</pre>
voice	<pre>policy-map platinum-up class dscp-for-up-4 set dscp 34 class dscp-for-up-5 set dscp 34 class dscp-for-up-6 set dscp 46 class dscp-for-up-7 set dscp 46  policy-map platinum class cm-dscp-34 set dscp 34 class cm-dscp-46 set dscp 46</pre>	
guest	<pre>Policy Map AutoQos-4.0-wlan-GT-SSID-Output-Policy Class class-default set dscp default  Policy Map AutoQos-4.0-wlan-GT-SSID-Input-Policy Class class-default set dscp default</pre>	
port (only applies to Local Mode)	<pre>policy-map AutoQos-4.0-wlan-Port-Output-Policy class AutoQos-4.0-Output-CAPWAP-C-Class priority level 1 class AutoQos-4.0-Output-Voice-Class priority level 2 class class-default  ip access-list extended AutoQos-4.0-Output-Acl-CAPWAP-C permit udp any eq 5246 16666 any</pre>	<pre>class-map match-any AutoQos-4.0-Output-CAPWAP-C-Class  match access-group name AutoQos-4.0-Output-Acl-CAPWAP-C  class-map match-any AutoQos-4.0-Output-Voice-Class  match dscp ef</pre>

## Architecture for Voice, Video and Integrated Data (AVVID)

IETF DiffServ Service Class	DSCP	IEEE 802.11e	
		User Priority	Access Category
Network Control	(CS7) CS6	0	AC_BE
Telephony	EF	6	AC_VO
VOICE-ADMIT	44	6	AC_VO
Signaling	CS5	5	AC_VI

IETF DiffServ Service Class	DSCP	IEEE 802.11e	
		User Priority	Access Category
Multimedia Conferencing	AF41 AF42 AF43	4	AC_VI
Real-Time Interactive	CS4	5	AC_VI
Multimedia Streaming	AF31 AF32 AF33	4	AC_VI
Broadcast Video	CS3	4	AC_VI
Low-Latency Data	AF21 AF22 AF23	3	AC_BE
OAM	CS2	0	AC_BE
High-Throughput Data	AF11 AF12 AF13	2	AC_BK
Standard	DF	0	AC_BE
Low-Priority Data	CS1	1	AC_BK
Remaining	Remaining	0	

## How to apply Bi-Directional Rate Limiting

### Information about Bi-Directional Rate Limiting

Bi-Directional Rate Limiting (BDRL) feature defines rate limits on both upstream and downstream traffic. These rate limits are individually configured. The rate limits can be configured on WLAN directly instead of QoS profiles, which will override QoS profile values. The WLAN rate limiting will always supersede Global QoS setting for controller and clients.

BDRL feature defines throughput limits for clients on their wireless networks and allows setting a priority service to a particular set of clients.

The following four QoS profiles are available to configure the rate limits:

- Gold

- Platinum
- Silver
- Bronze

The QoS profile is applied to all clients on the associated SSID. Therefore all clients connected to the same SSID will have the same rate limits.

To configure BDRL, select the QoS profile and configure the various rate limiting parameters. When rate limiting parameters are set to 0, the rate limiting feature is not functional. Each WLAN has a QoS profile associated with it in addition to the configuration in the QoS profile.



**Note** BDRL in a mobility Anchor-Foreign setup must be configured both on Anchor and Foreign controller. As a best practice, it is recommended to perform identical configuration on both the controllers to avoid breakage of any feature.

BDRL is supported on Guest anchor scenarios. The feature is supported on IRCM guest scenarios with AireOS as Guest anchor or Guest Foreign. Cisco Catalyst 9800 Series Wireless Controller uses **Policing** option to rate limit the traffic.

To apply metal policy with BDRL, perform the following tasks:

- [Configure Metal Policy on SSID](#)
- [Configure Metal Policy on Client](#)
- [#unique\\_1656](#)
- [#unique\\_1657](#)
- [#unique\\_1658](#)
- [#unique\\_1659](#)

## Prerequisites for Bi-Directional Rate Limiting

- Client metal policy is applied through AAA-override.
- You must specify the metal policy on ISE server.
- AAA-override must be enabled on policy profile.

## Configure Metal Policy on SSID

### Procedure

	Command or Action	Purpose
<b>Step 1</b>	<b>configure terminal</b> <b>Example:</b>	Enters global configuration mode.

	Command or Action	Purpose
	Device# configure terminal	
<b>Step 2</b>	<b>wireless profile policy</b> <i>policy-profile-name</i> <b>Example:</b> Device(config)# wireless profile policy policy-profile1	Configures WLAN policy profile and enters wireless policy configuration mode.
<b>Step 3</b>	<b>description</b> <i>description</i> <b>Example:</b> Device(config-wireless-policy)# description policy-profile1	Adds a user defined description to the new wireless policy.
<b>Step 4</b>	<b>service-policy input</b> <i>input-policy</i> <b>Example:</b> Device(config-wireless-policy)# service-policy input platinum-up	Sets platinum policy for input.
<b>Step 5</b>	<b>service-policy output</b> <i>output-policy</i> <b>Example:</b> Device(config-wireless-policy)# service-policy output platinum	Sets platinum policy for output.

## Configure Metal Policy on Client

### Procedure

	Command or Action	Purpose
<b>Step 1</b>	<b>configure terminal</b> <b>Example:</b> Device# configure terminal	Enters global configuration mode.
<b>Step 2</b>	<b>wireless profile policy</b> <i>policy-profile-name</i> <b>Example:</b> Device(config)# wireless profile policy policy-profile1	Configures WLAN policy profile and enters wireless policy configuration mode.
<b>Step 3</b>	<b>description</b> <i>description</i> <b>Example:</b> Device(config-wireless-policy)# description profile with aaa override	Adds a user defined description to the new wireless policy.
<b>Step 4</b>	<b>aaa-override</b> <b>Example:</b>	Enables AAA override on the WLAN.

	Command or Action	Purpose
	Device(config-wireless-policy)# aaa-override	<b>Note</b> After AAA-override is enabled and ISE server starts sending policy, client policy defined in service-policy client will not take effect.

## Configure Bi-Directional Rate Limiting for All Traffic

Use the police action in the policy-map to configure BDRL.

### Procedure

	Command or Action	Purpose
<b>Step 1</b>	<b>configure terminal</b> <b>Example:</b> Device# configure terminal	Enters global configuration mode.
<b>Step 2</b>	<b>policy-map <i>policy-map</i></b> <b>Example:</b> Device(config)# policy-map policy-sample 1	Creates a named object representing a set of policies that are to be applied to a set of traffic classes. Policy-map names can contain alphabetic, hyphen, or underscore characters, are case sensitive, and can be up to 40 characters.
<b>Step 3</b>	<b>class <i>class-map-name</i></b> <b>Example:</b> Device(config-pmap)# class class-default	Associates a class map with the policy map, and enters policy-map class configuration mode.
<b>Step 4</b>	<b>police <i>rate</i></b> <b>Example:</b> Device(config-pmap-c)# police 500000	Configures traffic policing (average rate, in bits per second). Valid values are 8000 to 200000000.

## Configure Bi-Directional Rate Limiting Based on Traffic Classification

### Procedure

	Command or Action	Purpose
<b>Step 1</b>	<b>configure terminal</b> <b>Example:</b> Device# configure terminal	Enters global configuration mode.
<b>Step 2</b>	<b>policy-map <i>policy-map</i></b> <b>Example:</b>	Creates a named object representing a set of policies that are to be applied to a set of traffic classes. Policy-map names can contain

	Command or Action	Purpose
	Device (config) # policy-map policy-sample2	alphabetic, hyphen, or underscore characters, are case sensitive, and can be up to 40 characters.
<b>Step 3</b>	<b>class</b> <i>class-map-name</i> <b>Example:</b> Device (config-pmap) # class class-sample-youtube	Associates a class map with the policy map, and enters policy-map class configuration mode.
<b>Step 4</b>	<b>police</b> <i>rate</i> <b>Example:</b> Device (config-pmap-c) # police 1000000	Configures traffic policing (average rate, in bits per second). Valid values are 8000 to 200000000.
<b>Step 5</b>	<b>conform-action</b> <b>drop</b> <b>Example:</b> Device (config-pmap-c-police) # conform-action drop	Specifies the drop action to take on packets that conform to the rate limit.
<b>Step 6</b>	<b>exceed-action</b> <b>drop</b> <b>Example:</b> Device (config-pmap-c-police) # exceed-action drop	Specifies the drop action to take on packets that exceeds the rate limit.
<b>Step 7</b>	<b>exit</b> <b>Example:</b> Device (config-pmap-c-police) # exit	Exits the policy-map class configuration mode.
<b>Step 8</b>	<b>set dscp</b> <b>default</b> <b>Example:</b> Device (config-pmap-c) # set dscp default	Sets the DSCP value to default.
<b>Step 9</b>	<b>police</b> <i>rate</i> <b>Example:</b> Device (config-pmap-c) # police 500000	Configures traffic policing (average rate, in bits per second). Valid values are 8000 to 200000000.
<b>Step 10</b>	<b>exit</b> <b>Example:</b> Device (config-pmap-c) # exit	Exits the policy-map class configuration mode.
<b>Step 11</b>	<b>exit</b> <b>Example:</b> Device (config-pmap) # exit	Exits the policy-map configuration mode.
<b>Step 12</b>	<b>class-map</b> <b>match-any</b> <i>class-map-name</i> <b>Example:</b>	Selects a class map.

	Command or Action	Purpose
	Device(config)# class-map match-any class-sample-youtube	
<b>Step 13</b>	<b>match protocol</b> <i>protocol</i>  <b>Example:</b> Device(config-cmap)# match protocol youtube	Configures the match criteria for a class map on the basis of the specified protocol.

## Apply Bi-Directional Rate Limiting Policy Map to Policy Profile

### Procedure

	Command or Action	Purpose
<b>Step 1</b>	<b>configure terminal</b>  <b>Example:</b> Device# configure terminal	Enters global configuration mode.
<b>Step 2</b>	<b>wireless profile policy</b> <i>policy-profile-name</i>  <b>Example:</b> Device(config)# wireless profile policy policy-profile3	Configures WLAN policy profile and enters wireless policy configuration mode.
<b>Step 3</b>	<b>description</b> <i>description</i>  <b>Example:</b> Device(config-wireless-policy)# description policy-profile3	Adds a user defined description to the new wireless policy.
<b>Step 4</b>	<b>service-policy client input</b> <i>input-policy</i>  <b>Example:</b> Device(config-wireless-policy)# service-policy client input platinum-up	Sets the input client service policy as platinum.
<b>Step 5</b>	<b>service-policy client output</b> <i>output-policy</i>  <b>Example:</b> Device(config-wireless-policy)# service-policy client output platinum	Sets the output client service policy as platinum.
<b>Step 6</b>	<b>service-policy input</b> <i>input-policy</i>  <b>Example:</b> Device(config-wireless-policy)# service-policy input platinum-up	Sets the input service policy as platinum.
<b>Step 7</b>	<b>service-policy output</b> <i>output-policy</i>  <b>Example:</b> Device(config-wireless-policy)# service-policy output platinum	Sets the output service policy as platinum.

## Apply Metal Policy with Bi-Directional Rate Limiting

### Procedure

	Command or Action	Purpose
<b>Step 1</b>	<b>configure terminal</b> <b>Example:</b> Device# configure terminal	Enters global configuration mode.
<b>Step 2</b>	<b>wireless profile policy <i>policy-profile-name</i></b> <b>Example:</b> Device(config)# wireless profile policy policy-profile3	Configures WLAN policy profile and enters wireless policy configuration mode.
<b>Step 3</b>	<b>description <i>description</i></b> <b>Example:</b> Device(config-wireless-policy)# description policy-profile3	Adds a user defined description to the new wireless policy.
<b>Step 4</b>	<b>service-policy client input <i>input-policy</i></b> <b>Example:</b> Device(config-wireless-policy)# service-policy client input platinum-up	Sets the input client service policy as platinum.
<b>Step 5</b>	<b>service-policy client output <i>output-policy</i></b> <b>Example:</b> Device(config-wireless-policy)# service-policy client output platinum	Sets the output client service policy as platinum.
<b>Step 6</b>	<b>service-policy input <i>input-policy</i></b> <b>Example:</b> Device(config-wireless-policy)# service-policy input platinum-up	Sets the input service policy as platinum.
<b>Step 7</b>	<b>service-policy output <i>output-policy</i></b> <b>Example:</b> Device(config-wireless-policy)# service-policy output platinum	Sets the output service policy as platinum.
<b>Step 8</b>	<b>exit</b> <b>Example:</b> Device(config-wireless-policy)# exit	Exits the policy configuration mode.
<b>Step 9</b>	<b>policy-map <i>policy-map</i></b> <b>Example:</b> Device(config)# policy-map policy-sample 1	Creates a named object representing a set of policies that are to be applied to a set of traffic classes. Policy map names can contain alphabetic, hyphen, or underscore characters,



	Command or Action	Purpose
		are case sensitive, and can be up to 40 characters.
<b>Step 10</b>	<b>class</b> <i>class-map-name</i> <b>Example:</b> Device(config-pmap) # class class-default	Associates a class map with the policy map, and enters configuration mode for the specified system class.
<b>Step 11</b>	<b>police</b> <i>rate</i> <b>Example:</b> Device(config-pmap-c) # police 500000	Configures traffic policing (average rate, in bits per second). Valid values are 8000 to 200000000.

## How to apply Per Client Bi-Directional Rate Limiting

### Information About Per Client Bi-Directional Rate Limiting

The Per Client Bi-Directional Rate Limiting feature adds bi-directional rate limiting for each wireless clients on 802.11ac Wave 2 APs in a Flex local switching configuration. Earlier, the Wave 2 APs supported only per-flow rate limiting for a wireless client. When wireless client starts multiple streams of traffic, the client-based rate limiting does not work as expected. This limitation is addressed by this feature.

For instance, if the controller is configured with QoS policy and you expect each client to have a rate limiting cap of 1000 kbps. Due to per-flow rate limiting on the AP, if the wireless client starts a Youtube stream and FTP stream, each of them will be rate limited at 1000 Kbps, therefore the client will be 2000 Kbps rates. This is not desirable.

#### Use Cases

The following are the use cases supported by the Per Client Bi-Directional Rate Limiting feature:

##### Use Case -1

###### Configuring only default class map

If policy map is configured only with default class map and mapped only to QoS client policy, AP does a per client rate limit to the client connected to AP.

##### Use Case-2

###### Changing from per client rate limit to per flow rate limit

If policy map is configured with another different class map along with a default class map and mapped to QoS client policy, AP performs per flow rate limit to client. As policy map has different class map along with the default class map. The per client rate limit values are cleared, if the AP has previously configured per client rate limit.

If the policy map has more than one class map, then additional class map is configured along with the default class map. So, the rate limit is applied from per client to per flow. The per client rate limit value is deleted from the rate info token bucket.

##### Use Case-3

### Changing from per flow rate limit to per client limit

If different class map is removed from policy map and policy map has only one default class map, AP performs a per client rate limit to client.

The following covers the high-level steps for Per Client Bi-Directional Rate Limiting feature:

1. Configure a policy map to WLAN through policy profile.
2. Map the QoS related policy map to WLAN.
3. Configure policy map with the default class map.
4. Configure different police rate value for class Default map.



---

**Note** If policy map has class Default with valid police rate value, AP applies that rate limit to the overall client data traffic flow.

---

5. Apply the policy map with class Default to QoS client policy in WLAN policy profile.

## Prerequisites for Per Client Bi-Directional Rate Limiting

- This feature is exclusive to QoS client policy, that is, the policy profile must have only QoS Policy or policy target as client.
- If policy map has class default with valid police rate value, AP applies that rate limit value to the overall client data traffic flow.

## Restrictions on Per Client Bi-Directional Rate Limiting

- If policy map has class map other than the class Default map, the per client rate limit does not work in AP.
- From Cisco IOS XE Bengaluru 17.5.x onwards, AAA override can be leveraged to push the attributes to achieve per client rate limit.
- From Cisco IOS XE Bengaluru 17.6 onwards, per client bi-directional rate limit is supported on 802.11ac Wave 2 APs and 11ax APs in the Flex local switching configuration. However, due to the [CSCwh74415](#) defect, in order to avoid the latest QoS policy return (which needs to be applied to all the clients connected to the same AP, thereby overriding all other QoS policies), you must add the AV-pairs in the authorization profile on Cisco ISE.

## Configuring Per Client Bi-Directional Rate Limiting (GUI)

### Procedure

---

- Step 1** Choose **Configuration > Tags & Profiles > Policy**.
- Step 2** Click the Policy Profile Name.

The **Edit Policy Profile** window is displayed.

**Note** The **Edit Policy Profile** window is displayed and configured in default class map only.

**Step 3** Choose the **QOS And AVC** tab.

**Step 4** In the **QoS Client Policy** settings, choose the policies from the **Egress** and **Ingress** drop-down lists.

**Note** You need to apply the default policy map to the QoS Client Policy.

**Step 5** Click **Update & Apply to Device**.

## Verifying Per Client Bi-Directional Rate Limiting

To verify whether per client is applied in AP, use the following command:

```
Device# show rate-limit client
Config:
      mac vap rt_rate_out rt_rate_in rt_burst_out rt_burst_in nrt_rate_out nrt_rate_in
      nrt_burst_out nrt_burst_in
A0:D3:7A:12:6C:5E 0          0          0          0          0          0
      0          0          0
Statistics:
      name      up down
      Unshaped  0   0
      Client RT pass 697610 8200
      Client NRT pass  0   0
      Client RT drops  0   0
      Client NRT drops  0  16
      9      180  0
Per client rate limit:
      mac vap rate_out rate_in      policy
A0:D3:7A:12:6C:5E  0      88      23 per_client_rate_2
```

## Configuring BDRL Using AAA Override

### Procedure

	Command or Action	Purpose
<b>Step 1</b>	<b>configure terminal</b>  <b>Example:</b> Device# <b>configure terminal</b>	Enters global configuration mode.
<b>Step 2</b>	<b>wireless profile policy</b> <i>profile-name</i>  <b>Example:</b> Device (config)# <b>wireless profile policy</b> <b>default-policy-profile</b>	Configures the WLAN policy profile and enters wireless policy configuration mode.
<b>Step 3</b>	<b>aaa-override</b>  <b>Example:</b> Device(config-wireless-policy)# <b>aaa</b>	Configures AAA override to apply policies coming from the AAA server or ISE the Cisco Identify Services Engine (ISE) server.

	Command or Action	Purpose
		<p>The following attributes are available in the RADIUS server:</p> <ul style="list-style-type: none"> <li>• Airespace-Data-Bandwidth-Average-Contract: 8001</li> <li>• Airespace-Real-Time-Bandwidth-Average-Contract: 8002</li> <li>• Airespace-Data-Bandwidth-Burst-Contract: 8003</li> <li>• Airespace-Real-Time-Bandwidth-Burst-Contract: 8004</li> <li>• Airespace-Data-Bandwidth-Average-Contract-Upstream: 8005</li> <li>• Airespace-Real-Time-Bandwidth-Average-Contract-Upstream: 8006</li> <li>• Airespace-Data-Bandwidth-Burst-Contract-Upstream: 8007</li> <li>• Airespace-Real-Time-Bandwidth-Burst-Contract-Upstream: 8008</li> </ul> <p><b>Note</b> 8001, 8002, 8003, 8004, 8005, 8006, 8007, and 8008 are the desired rate-limit values configured as an example.</p>

## Verifying Bi-Directional Rate-Limit

To verify the bi-directional rate limit, use the following command:

```
Device# show wireless client mac-address E8-8E-00-00-00-71 detail
Client MAC Address : e88e.0000.0071
Client MAC Type    : Universally Administered Address
Client IPv4 Address : 100.0.7.94
Client Username    : e88e00000071
AP MAC Address     : 0a0b.0c00.0200
AP Name           : AP6B8B4567-0002
AP slot           : 0
Client State       : Associated
Policy Profile     : dnas_qos_profile_policy
Flex Profile       : N/A
Wireless LAN Id    : 10
WLAN Profile Name  : QoS_wlan
Wireless LAN Network Name (SSID): QoS_wlan
BSSID             : 0a0b.0c00.0200
Connected For     : 28 seconds
Protocol          : 802.11n - 2.4 GHz
Channel           : 1
Client IIF-ID     : 0xa0000034
Association Id     : 10
```

```

Authentication Algorithm : Open System
Idle state timeout      : N/A
Session Timeout        : 1800 sec (Remaining time: 1777 sec)
Session Warning Time   : Timer not running
Input Policy Name      : None
Input Policy State     : None
Input Policy Source    : None
Output Policy Name     : None
Output Policy State    : None
Output Policy Source   : None
WMM Support            : Enabled
U-APSD Support        : Disabled
Fastlane Support       : Disabled
Client Active State    : In-Active
Power Save             : OFF
Supported Rates       : 1.0,2.0,5.5,6.0,9.0,11.0,12.0,18.0,24.0,36.0,48.0,54.0
AAA QoS Rate Limit Parameters:
  QoS Average Data Rate Upstream      : 8005 (kbps)
  QoS Realtime Average Data Rate Upstream : 8006 (kbps)
  QoS Burst Data Rate Upstream        : 8007 (kbps)
  QoS Realtime Burst Data Rate Upstream : 8008 (kbps)
  QoS Average Data Rate Downstream    : 8001 (kbps)
  QoS Realtime Average Data Rate Downstream : 8002 (kbps)
  QoS Burst Data Rate Downstream      : 80300 (kbps)
  QoS Realtime Burst Data Rate Downstream : 8004 (kbps)

```

To verify the rate-limit details from the AP terminal, use the following command

```

Device# show rate-limit client
Config:
mac vap rt_rate_out rt_rate_in rt_burst_out rt_burst_in nrt_rate_out nrt_rate_in nrt_burst_out
  nrt_burst_in
00:1C:F1:09:85:E7 0 8001 8002 8003 8004 8005 8006 8007 8008
Statistics:
name up down
Unshaped 0 0
Client RT pass 0 0
Client NRT pass 0 0
Client RT drops 0 0
Client NRT drops 0 0
Per client rate limit:
mac vap rate_out rate_in policy

```

## How to Configure Wireless QoS

### Configuring a Policy Map with Class Map (GUI)

#### Procedure

- 
- Step 1** Choose **Configuration > Services > QoS**.
  - Step 2** Click **Add** to view the **Add QoS** window.
  - Step 3** In the text box next to the **Policy Name**, enter the name of the new policy map that is being added.
  - Step 4** Click **Add Class-Maps**.

- Step 5** Configure **AVC** based policies or **User Defined** policies. To enable **AVC** based policies, and configure the following:
- Choose either **Match Any** or **Match All**.
  - Choose the required **Mark Type**. If you choose **DSCP** or **User Priority**, you must specify the appropriate **Mark Value**.
  - Check the **Drop** check box to drop traffic from specific sources.
 

**Note** When **Drop** is enabled, the **Mark Type** and **Police(kbps)** options are disabled.
  - Based on the chosen **Match Type**, select the required protocols from the **Available Protocol(s)** list and move them to the **Selected Protocol(s)** list. These selected protocols are the ones from which traffic is dropped.
  - Click **Save**.
- Note** To add more Class Maps, repeat steps 4 and 5.
- Step 6** To enable **User-Defined** QoS policy, and the configure the following:
- Choose either **Match Any** or **Match All**.
  - Choose either **ACL** or **DSCP** as the **Match Type** from the drop-down list, and then specify the appropriate **Match Value**.
  - Choose the required **Mark Type** to associate with the mark label. If you choose *DSCP*, you must specify an appropriate **Mark Value**.
  - Check the **Drop** check box to drop traffic from specific sources.
 

**Note** When **Drop** is enabled, the **Mark Type** and **Police(kbps)** options are disabled.
  - Click **Save**.
- Note** To define actions for all the remaining traffic, in the Class Default, choose **Mark** and/or **Police(kbps)** accordingly.
- Step 7** Click **Save & Apply to Device**.
- 

## Configuring a Class Map (CLI)

Follow the procedure given below to configure class maps for voice and video traffic:

### Procedure

	Command or Action	Purpose
<b>Step 1</b>	<b>configure terminal</b> <b>Example:</b> Device# <code>configure terminal</code>	Enters global configuration mode.
<b>Step 2</b>	<b>class-map</b> <i>class-map-name</i> <b>Example:</b>	Creates a class map.

	Command or Action	Purpose
	Device(config)# <b>class-map test</b>	
<b>Step 3</b>	<b>match dscp dscp-value</b> <b>Example:</b> Device(config-cmap)# <b>match dscp 46</b>	Matches the DSCP value in the IPv4 and IPv6 packets. <b>Note</b> By default for the class map the value is match-all.
<b>Step 4</b>	<b>end</b> <b>Example:</b> Device(config-cmap)# <b>end</b>	Exits the class map configuration and returns to the privileged EXEC mode.
<b>Step 5</b>	<b>show class-map class-map-name</b> <b>Example:</b> Device# show class-map <i>class_map_name</i>	Verifies the class map details.

## Configuring Policy Profile to Apply QoS Policy (GUI)

### Procedure

- 
- Step 1** Choose **Configuration > Tags & Profiles > Policy**.
- Step 2** On the **Policy Profile** page, click the name of the policy profile.
- Step 3** In the **Edit Policy Profile** window, click the **QoS and AVC** tab.
- Step 4** Under **QoS SSID Policy**, choose the appropriate **Ingress** and **Egress** policies for WLANs.
- Note** The ingress policies can be differentiated from the egress policies by the suffix *-up*. For example, the Platinum ingress policy is named *platinum-up*.
- Step 5** Under **QoS Client Policy**, choose the appropriate **Ingress** and **Egress** policies for clients.
- Step 6** Click **Update & Apply to Device**.
- Note** Only custom policies are displayed under **QoS Client Policy**. AutoQoS policies are auto generated and not displayed for user selection.
- 

## Configuring Policy Profile to Apply QoS Policy (CLI)

### Procedure

	Command or Action	Purpose
<b>Step 1</b>	<b>configure terminal</b> <b>Example:</b>	Enters global configuration mode.

	Command or Action	Purpose
	Device# <code>configure terminal</code>	
<b>Step 2</b>	<b>wireless profile policy</b> <i>profile-policy</i> <b>Example:</b> Device(config)# <code>wireless profile policy</code> <code>qostest</code>	Configures WLAN policy profile and enters the wireless policy configuration mode.
<b>Step 3</b>	<b>service-policy client</b> { <b>input</b>   <b>output</b> } <i>policy-name</i> <b>Example:</b> Device(config-wireless-policy)# <code>service-policy client input</code> <code>policy-map-client</code>	Applies the policy. The following options are available. <ul style="list-style-type: none"> <li>• <b>input</b>—Assigns the client policy for ingress direction on the policy profile.</li> <li>• <b>output</b>—Assigns the client policy for egress direction on the policy profile.</li> </ul>
<b>Step 4</b>	<b>service-policy</b> { <b>input</b>   <b>output</b> } <i>policy-name</i> <b>Example:</b> Device(config-wireless-policy)# <code>service-policy input policy-map-ssid</code>	Applies the policy to the BSSID. The following options are available. <ul style="list-style-type: none"> <li>• <b>input</b>—Assigns the policy-map to all clients in WLAN.</li> <li>• <b>output</b>—Assigns the policy-map to all clients in WLAN.</li> </ul>
<b>Step 5</b>	<b>no shutdown</b> <b>Example:</b> Device(config-wireless-policy)# <code>no</code> <code>shutdown</code>	Enables the wireless policy profile.

## Applying Policy Profile to Policy Tag (GUI)

### Procedure

- 
- Step 1** Choose **Configuration** > **Tags & Profiles** > **Tags**.
- Step 2** On the **Manage Tags** page in the **Policy** tab, click **Add**.
- Step 3** In the **Add Policy Tag** window that is displayed, enter a name and description for the policy tag.
- Step 4** Map the required WLAN IDs and WLAN profiles with appropriate policy profiles.
- Step 5** Click **Update & Apply to Device**.
-



## Applying Policy Profile to Policy Tag (CLI)

### Procedure

	Command or Action	Purpose
<b>Step 1</b>	<b>configure terminal</b> <b>Example:</b>  Device# <code>configure terminal</code>	Enters global configuration mode.
<b>Step 2</b>	<b>wireless tag policy <i>policy-tag-name</i></b> <b>Example:</b> Device(config-policy-tag)# <code>wireless tag policy qostag</code>	Configures policy tag and enters the policy tag configuration mode.
<b>Step 3</b>	<b>wlan <i>wlan-name</i> policy <i>profile-policy-name</i></b> <b>Example:</b> Device(config-policy-tag)# <code>wlan test policy qostest</code>	Maps a policy profile to a WLAN profile.
<b>Step 4</b>	<b>end</b> <b>Example:</b> Device(config-policy-tag)# <code>end</code>	Saves the configuration and exits the configuration mode and returns to privileged EXEC mode.
<b>Step 5</b>	<b>show wireless tag policy summary</b> <b>Example:</b> Device# <code>show wireless tag policy summary</code>	Displays the configured policy tags.  <b>Note</b> To view the detailed information of a policy tag, use the <b>show wireless tag policy detailed <i>policy-tag-name</i></b> command.

## Attaching Policy Tag to an AP

### Procedure

	Command or Action	Purpose
<b>Step 1</b>	<b>configure terminal</b> <b>Example:</b>  Device# <code>configure terminal</code>	Enters global configuration mode.
<b>Step 2</b>	<b>ap <i>mac-address</i></b> <b>Example:</b> Device(config)# <code>ap F866.F267.7DFB</code>	Configures Cisco APs and enters the ap profile configuration mode.

	Command or Action	Purpose
<b>Step 3</b>	<b>policy-tag</b> <i>policy-tag-name</i> <b>Example:</b> Device(config-ap-tag)# policy-tag qostag	Maps a Policy tag to the AP.
<b>Step 4</b>	<b>end</b> <b>Example:</b> Device(config-ap-tag)# end	Saves the configuration and exits the configuration mode and returns to privileged EXEC mode.
<b>Step 5</b>	<b>show ap tag summary</b> <b>Example:</b> Device# show ap tag summary	Displays the ap details and tags associated to it.

## Configuring Custom QoS Mapping

For interworking with IP networks, a map is devised between the 802.11e user priorities and the IP differentiated services code point (DSCP). Enable Hotspot 2.0 on the WLAN to support mapping exception.



**Note** Custom QoS mapping only applies to Hotspot 2.0.

Mapping is specified as DSCP ranges to individual user priority values, and as a set of exceptions with one-to-one mapping between DSCP values and UP values. If a QoS map is enabled and user-configurable mappings are not added, the default values are used.



**Note** Egress = Downstream = Output and Ingress = Upstream = Input

The following table shows a QoS map, where an AP provides a wireless client with the required mapping from IP DSCP to 802.11e user priority.

**Table 70: Default DSCP-Range-to-User Priority Mapping**

IP DSCP Range	802.11e User Priority
0-7	0
8-15	1
16-23	2
24-31	3
32-39	4
40-47	5

IP DSCP Range	802.11e User Priority
48-55	6
56-63	7

### Procedure

	Command or Action	Purpose
<b>Step 1</b>	<b>configure terminal</b>  <b>Example:</b> Device# configure terminal	Enters global configuration mode.
<b>Step 2</b>	<b>ap profile <i>profile-name</i></b>  <b>Example:</b> Device(config)# ap profile hs2-profile	Configures an AP profile and enters AP profile configuration mode.
<b>Step 3</b>	<b>qos-map dscp-to-up-range <i>user-priority up-to-dscp dscp-start dscp-end</i></b>  <b>Example:</b> Device(config-ap-profile)# qos-map dscp-to-up-range 6 52 23 62	Configures DSCP-to-user priority mapping.  You can configure up to eight configuration entries; one for each <i>user-priority</i> value. If you do not configure a custom value, a non-configured value (0xFF) is sent to the AP.  Use the <b>no</b> form of this command to disable the configuration. To delete all the custom mappings, use the <b>no dscp-to-up-range</b> command.

## Configuring DSCP-to-User Priority Mapping Exception

When you configure a QoS mapping or exception, a custom QoS map is created and sent to the corresponding AP.

If there are no DSCP-to-user priority mapping or exception entries, an empty QoS map is used.

The following table shows the set of exceptions with one-to-one mapping between DSCP values and user priority values.

**Table 71: Default DSCP-Range-to-User Priority Mapping Exceptions**

IP DSCP	802.11e User Priority
0	0
2	1
4	1
6	1

IP DSCP	802.11e User Priority
10	2
12	2
14	2
18	3
20	3
22	3
26	4
34	5
46	6
48	7
56	7

### Procedure

	Command or Action	Purpose
<b>Step 1</b>	<b>configure terminal</b> <b>Example:</b> Device# configure terminal	Enters global configuration mode.
<b>Step 2</b>	<b>ap profile <i>profile-name</i></b> <b>Example:</b> Device(config)# ap profile hs2-profile	Configures an AP profile and enters AP profile configuration mode.
<b>Step 3</b>	<b>qos-map dscp-to-up-exception <i>dscp-num</i> <i>user-priority</i></b> <b>Example:</b> Device(config-ap-profile)# qos-map dscp-to-up-exception 42 6	Configures DSCP-to-user priority exception.

## Configuring Trust Upstream DSCP Value

The controller marks the 802.11 user priority value in Traffic Identifier (TID) field based on the DSCP value in IP header.



**Note** The AP forwards the DSCP value to Air, if 802.11 user priority value is set.

## Procedure

	Command or Action	Purpose
<b>Step 1</b>	<b>configure terminal</b> <b>Example:</b> Device# configure terminal	Enters global configuration mode.
<b>Step 2</b>	<b>ap profile <i>profile-name</i></b> <b>Example:</b> Device(config)# ap profile hs2-profile	Configures an AP profile and enters AP profile configuration mode.
<b>Step 3</b>	<b>qos-map trust-dscp-upstream</b> <b>Example:</b> Device(config-ap-profile)# qos-map trust-dscp-upstream	Configures the AP to trust upstream DSCP instead of user priority.  Use the <b>no</b> form of the command to disable the configuration.  <b>Note</b> From the Cisco IOS XE 17.4.x release onwards, the <b>qos-map trust-dscp-upstream</b> is the default setting so that client DSCP is, by default, maintained end to end.





# CHAPTER 143

## Wireless Auto-QoS

- [Information About Auto QoS, on page 1341](#)
- [How to Configure Wireless AutoQoS, on page 1342](#)

### Information About Auto QoS

Wireless Auto QoS automates deployment of wireless QoS features. It has a set of predefined profiles which can be further modified by the customer to prioritize different traffic flows. Auto-QoS matches traffic and assigns each matched packet to qos-groups. This allows the output policy map to put specific qos-groups into specific queues, including into the priority queue.

#### AutoQoS Policy Configuration

Table 72: AutoQoS Policy Configuration

Mode	Client Ingress	Client Egress	BSSID Ingress	BSSID Egress	Port Ingress	Port Egress	Radio
Voice	N/A	N/A	P3	P4	N/A	P7	ACM on
Guest	N/A	N/A	P5	P6	N/A	P7	
Fastlane	N/A	N/A	N/A	N/A	N/A	P7	edca-parameters fastlane
Enterprise-avc	N/A	N/A	P1	P2	N/A	P7	

P1	AutoQos-4.0-wlan-ET-SSID-Input-AVC-Policy
P2	AutoQos-4.0-wlan-ET-SSID-Output-Policy
P3	platinum-up
P4	platinum
P5	AutoQos-4.0-wlan-GT-SSID-Input-Policy

P6	AutoQos-4.0-wlan-GT-SSID-Output-Policy
P7	AutoQos-4.0-wlan-Port-Output-Policy

# How to Configure Wireless AutoQoS

## Configuring Wireless AutoQoS on Profile Policy

You can enable AutoQoS on a profile policy.

### Procedure

	Command or Action	Purpose
<b>Step 1</b>	<b>enable</b> <b>Example:</b> Device# <b>enable</b>	Enables privileged EXEC mode. Enter your password if prompted.
<b>Step 2</b>	<b>wireless autoqos policy-profile <i>policy-name</i></b> <b>mode { enterprise-avc   fastlane   guest   voice}</b> <b>Example:</b> Device# <b>wireless autoqos policy-profile test-profile mode voice</b>	Configures AutoQoS wireless policy. <ul style="list-style-type: none"> <li>• <b>enterprise-avc</b>—Enables AutoQoS Wireless Enterprise AVC Policy.</li> <li>• <b>fastlane</b>—Enable AutoQoS Wireless Fastlane Policy.</li> <li>• <b>guest</b>—Enable AutoQoS Wireless Guest Policy.</li> <li>• <b>voice</b>—Enable AutoQoS Wireless Voice Policy.</li> </ul> <p><b>Note</b> AutoQoS MIB attribute does not support full functionality with service policy. Service policy must be configured manually. Currently, there is only support for AutoQoS mode.</p>

### What to do next



**Note** After enabling AutoQoS, we recommend that you wait for a few seconds for the policy to install and then try and modify the AutoQoS policy maps if required; or retry if the modification is rejected.



## Disabling Wireless AutoQoS

To globally disable Wireless AutoQoS:

### Procedure

	Command or Action	Purpose
<b>Step 1</b>	<b>enable</b> <b>Example:</b> Device# <b>enable</b>	Enables privileged EXEC mode. Enter your password if prompted.
<b>Step 2</b>	<b>shutdown</b> <b>Example:</b> Device# <b>shutdown</b>	Shuts down the policy profile.
<b>Step 3</b>	<b>wireless autoqos disable</b> <b>Example:</b> Device# <b>wireless autoqos disable</b>	Globally disables wireless AutoQoS.
<b>Step 4</b>	<b>[no] shutdown</b> <b>Example:</b> Device# <b>no shutdown</b>	Enables the wireless policy profile. <b>Note</b> Disabling Auto QoS does not reset global radio configurations like CAC and EDCA parameters.

## Rollback AutoQoS Configuration (GUI)

### Procedure

- 
- Step 1** Choose **Configuration > Services > QoS**.
  - Step 2** Click **Disable AutoQoS**.
  - Step 3** Click **Yes** to confirm.
- 

## Rollback AutoQoS Configuration

### Before you begin



---

**Note** AutoQoS MIB attribute does not support the full functionality with service policy. Currently, there is only support for AutoQoS mode. Service policy must be configured manually.

---

**Procedure**

	Command or Action	Purpose
<b>Step 1</b>	<b>enable</b> <b>Example:</b> Device <b>enable</b>	Enables privileged EXEC mode. Enter your password if prompted.
<b>Step 2</b>	<b>clear platform software autoqos config template { enterprise_avc   guest}</b> <b>Example:</b> Device# <b>clear platform software autoqos config template guest</b>	Resets AutoQoS configuration. <ul style="list-style-type: none"> <li>• enterprise-avc—Resets AutoQoS Enterprise AVC Policy Template.</li> <li>• guest—Resets AutoQoS Guest Policy Template.</li> </ul>

## Clearing Wireless AutoQoS Policy Profile (GUI)

**Procedure**

- 
- Step 1** Choose **Configuration > Tags & Profiles > Policy**.
- Step 2** Click on the **Policy Profile Name**.
- Step 3** Go to **QOS and AVC** tab.
- Step 4** From the **Auto Qos** drop-down list, choose **None**.
- Step 5** Click **Update & Apply to Device**.
- 

## Clearing Wireless AutoQoS Policy Profile

**Procedure**

	Command or Action	Purpose
<b>Step 1</b>	<b>enable</b> <b>Example:</b> Device# <b>enable</b>	Enables privileged EXEC mode. Enter your password if prompted.
<b>Step 2</b>	<b>shutdown</b> <b>Example:</b> Device# <b>shutdown</b>	Shuts down the policy profile.
<b>Step 3</b>	<b>wireless autoqos policy-profile <i>policy-name</i> mode clear</b> <b>Example:</b>	Clears the configured AutoQoS wireless policy.

	Command or Action	Purpose
	Device# <code>wireless autoqos policy-profile test-profile mode clear</code>	
<b>Step 4</b>	<b>[no] shutdown</b>  <b>Example:</b> <code>no shutdown</code>	Enables the wireless policy profile.

## Viewing AutoQoS on policy profile

### Before you begin

AutoQoS is supported on the local mode and flex mode. AutoQoS configures a set of policies and radio configurations depending on the template. It is possible to override the service-policy that is configured by AutoQoS. The latest configuration takes effect, with AAA override policy being of highest priority.

### Procedure

	Command or Action	Purpose
<b>Step 1</b>	<b>enable</b>  <b>Example:</b> <code>Device#enable</code>	Enables privileged EXEC mode. Enter your password if prompted.
<b>Step 2</b>	<b>show wireless profile policy detailed</b> <i>policy-profile-name</i>  <b>Example:</b> <code>Device# show wireless profile policy detailed testqos</code>	Shows policy-profile detailed parameters.





## CHAPTER 144

# Native Profiling

---

- [Information About Native Profiling, on page 1347](#)
- [Creating a Class Map \(GUI\), on page 1348](#)
- [Creating a Class Map \(CLI\), on page 1349](#)
- [Creating a Service Template \(GUI\), on page 1351](#)
- [Creating a Service Template \(CLI\), on page 1352](#)
- [Creating a Parameter Map, on page 1353](#)
- [Creating a Policy Map \(GUI\), on page 1353](#)
- [Creating a Policy Map \(CLI\), on page 1354](#)
- [Configuring Native Profiling in Local Mode, on page 1356](#)
- [Verifying Native Profile Configuration, on page 1356](#)

## Information About Native Profiling

You can profile devices based on HTTP and DHCP to identify the end devices on the network. You can configure device-based policies and enforce these policies per user or per device policy on the network.

Policies allow profiling of mobile devices and basic onboarding of the profiled devices to a specific VLAN. They also assign ACL and QoS or configure session timeouts.

The policies are defined based on the following attributes:

- User group or user role
- Device type such as Windows clients, smartphones, tablets, and so on
- Service Set Identifier (SSID)
- Location, based on the access point group that the end point is connected to
- Time of the day
- Extensible Authentication Protocol (EAP) type, to check what EAP method that the client is getting connected to

When a wireless client joins an access point, certain QoS policies get enforced on the access point. One such feature is the native profiling for both upstream and downstream traffic at AP. The native profiling feature when clubbed with AAA override supports specific set of policies based on the time of day and day of week. The AAA override then applies these policies coming from a RADIUS server to the access point.

Let's consider a use case of time of the day in conjunction with user role. Usually, the user role is used as an extra matching criteria along with the time of day. You can club the time of day usage with any matching criteria to get the desired result. The matching will be performed when the client joins the controller .

You can configure policies as two separate components:

- Defining policy attributes as service templates that are specific to clients joining the network and applying policy match criteria
- Applying match criteria to the policy.



---

**Note** Before proceeding with the native profile configuration, ensure that HTTP Profiling and DHCP Profiling are enabled.

---



---

**Note** Native profiling is not supported with FlexConnect Local Authentication and Local Switching. Hence, do not configure **no central switching**, **no central authentication**, and **subscriber-policy-name name** commands together. ISSU will fail for this type of configuration. Ensure that you remove the configuration before attempting ISSU.

---

To configure Native Profiling, use one of the following procedures:

- Create a service template
- Create a class map



---

**Note** You can apply a service template using either a class map or parameter map.

---

- Create a parameter-map and associate the service template to parameter-map
  - Create a policy map
    1. If class-map has to be used: Associate the class-map to the policy-map and associate the service-template to the class-map.
    2. If parameter-map has to be used: Associate the parameter-map to the policy-map
  - Associate the policy-map to the policy profile.

## Creating a Class Map (GUI)

### Procedure

---

**Step 1** Click **Configuration > Services > QoS**.

**Step 2** In the **QoS – Policy** area, click **Add** to create a new QoS Policy or click the one you want to edit.

- Step 3** Add **Add Class Map** and enter the details.
- Step 4** Click **Save**.
- Step 5** Click **Update and Apply to Device**.

## Creating a Class Map (CLI)



**Note** Configuration of class maps via CLI offer more options and can be more granular than GUI.

### Procedure

	Command or Action	Purpose
<b>Step 1</b>	<b>configure terminal</b> <b>Example:</b> Device# configure terminal	Enters global configuration mode.
<b>Step 2</b>	<b>class-map type control subscriber match-any <i>class-map-name</i></b> <b>Example:</b> Device(config)# class-map type control subscriber match-any cls_user	Specifies the class map type and name.
<b>Step 3</b>	<b>match username <i>username</i></b> <b>Example:</b> Device(config-filter-control-classmap)# match username ciscoise	Specifies the class map attribute filter criteria.
<b>Step 4</b>	<b>class-map type control subscriber match-any <i>class-map-name</i></b> <b>Example:</b> Device(config)# class-map type control subscriber match-any cls_userrole	Specifies the class map type and name.
<b>Step 5</b>	<b>match user-role <i>user-role</i></b> <b>Example:</b> Device(config-filter-control-classmap)# match user-role engineer	Specifies the class map attribute filter criteria.
<b>Step 6</b>	<b>class-map type control subscriber match-any <i>class-map-name</i></b> <b>Example:</b> Device(config)# class-map type control subscriber match-any cls_oui	Specifies the class map type and name.

	Command or Action	Purpose
<b>Step 7</b>	<b>match oui</b> <i>oui-address</i> <b>Example:</b> <pre>Device(config-filter-control-classmap)# match oui 48.f8.b3</pre>	Specifies the class map attribute filter criteria.
<b>Step 8</b>	<b>class-map type control subscriber</b> <b>match-any</b> <i>class-map-name</i> <b>Example:</b> <pre>Device(config)# class-map type control subscriber match-any cls_mac</pre>	Specifies the class map type and name.
<b>Step 9</b>	<b>match mac-address</b> <i>mac-address</i> <b>Example:</b> <pre>Device(config-filter-control-classmap)# match mac-address 0040.96b9.4a0d</pre>	Specifies the class map attribute filter criteria.
<b>Step 10</b>	<b>class-map type control subscriber</b> <b>match-any</b> <i>class-map-name</i> <b>Example:</b> <pre>Device(config)# class-map type control subscriber match-any cls_devtype</pre>	Specifies the class map type and name.
<b>Step 11</b>	<b>match device-type</b> <i>device-type</i> <b>Example:</b> <pre>Device(config-filter-control-classmap)# match device-type windows</pre>	Specifies the class map attribute filter criteria.
<b>Step 12</b>	<b>class-map type control subscriber match-all</b> <i>class-map-name</i> <b>Example:</b> <pre>Device(config)# class-map type control subscriber match-all match_tod</pre>	Specifies the class map type and name.
<b>Step 13</b>	<b>match join-time-of-day</b> <i>start-time end-time</i> <b>Example:</b> <pre>Device(config-filter-control-classmap)# match join-time-of-day 10:30 12:30</pre>	<p>Specifies a match to the time of day.</p> <p>Here, join time is considered for matching. For example, if the match filter is set from 11:00 am to 2:00 pm, a device joining at 10:59 am is not considered, even if it acquires credentials after 11:00 am.</p> <p>Here,</p> <p><i>start-time</i> and <i>end-time</i> specifies the 24-hour format.</p> <p>Use the <b>show class-map type control subscriber name</b> <i>name</i> command to verify the configuration.</p>



	Command or Action	Purpose
		<b>Note</b> You should also disable AAA override for this command to work.
<b>Step 14</b>	<b>match day</b> <i>day-of-week</i> <b>Example:</b> Device(config-filter-control-classmap)# match day Monday	Matches day of the week.  Use the <b>show class-map type control subscriber name name</b> command to verify the configuration.
<b>Step 15</b>	<b>class-map type control subscriber match-all</b> <i>class-map-name</i> <b>Example:</b> Device(config)# class-map type control subscriber match-all match_eap	Specifies the class map type and filter as EAP.
<b>Step 16</b>	<b>match eap-type</b> <i>eap-type</i> <b>Example:</b> Device(config-filter-control-classmap)# match eap-type peap	Specifies the policy match with EAP type.  Use the <b>show class-map type control subscriber name name</b> command to verify the configuration.
<b>Step 17</b>	<b>class-map type control subscriber match-all</b> <i>class-map-name</i> <b>Example:</b> Device(config)# class-map type control subscriber match-all match_device	Specifies the class map type and filter as device.
<b>Step 18</b>	<b>match device-type</b> <i>device-name</i> <b>Example:</b> Device(config-filter-control-classmap)# match device-type android	Matches name using the device type. Type a question mark (?) after the device type and select the device from the list.  <b>Note</b> You should enable the device classifier for the device list to be populated.

## Creating a Service Template (GUI)

### Procedure

- 
- Step 1** Choose **Configuration > Security > Local Policy**.
- Step 2** On the **Local Policy** page, **Service Template** tab, click **ADD**.
- Step 3** In the **Create Service Template** window, enter the following parameters:
- **Service Template Name:** Enter a name for the template.
  - **VLAN ID:** Enter the VLAN ID for the template. Valid range is between 1 and 4094.

- **Session Timeout (secs):** Sets the timeout duration for the template. Valid range is between 1 and 65535.
- **Access Control List:** Choose the Access Control List from the drop-down list.
- **Ingress QoS:** Choose the input QoS policy for the client from the drop-down list
- **Egress QoS:** Choose the output QoS policy for the client from the drop-down list.

**Step 4** Click **Save & Apply to Device**.

## Creating a Service Template (CLI)

### Procedure

	Command or Action	Purpose
<b>Step 1</b>	<b>configure terminal</b> <b>Example:</b> Device# configure terminal	Enters global configuration mode.
<b>Step 2</b>	<b>service-template <i>service-template-name</i></b> <b>Example:</b> Device(config)# service-template svcl	Enters service template configuration mode.
<b>Step 3</b>	<b>vnid <i>vnid</i></b> <b>Example:</b> Device(config-service-template)# vnid test	Specifies the VXLAN network identifier (VNID).  Use the <b>show service-template <i>service-template-name</i></b> command to verify the configuration.
<b>Step 4</b>	<b>access-group <i>access-list-name</i></b> <b>Example:</b> Device(config-service-template)# access-group acl-auto	Specifies the access list to be applied.
<b>Step 5</b>	<b>vlan <i>vlan-id</i></b> <b>Example:</b> Device(config-service-template)# vlan 10	Specifies VLAN ID. Valid range is from 1-4094.
<b>Step 6</b>	<b>absolute-timer <i>timer</i></b> <b>Example:</b> Device(config-service-template)# absolute-timer 1000	Specifies session timeout value for a service template. Valid range is from 1-65535.
<b>Step 7</b>	<b>service-policy qos input <i>qos-policy</i></b> <b>Example:</b>	Configures an input QoS policy for the client.

	Command or Action	Purpose
	Device(config-service-template)# service-policy qos input in_qos	
<b>Step 8</b>	<b>service-policy qos output qos-policy</b>  <b>Example:</b> Device(config-service-template)# service-policy qos output out_qos	Configures an output QoS policy for the client.

## Creating a Parameter Map

### Procedure

	Command or Action	Purpose
<b>Step 1</b>	<b>configure terminal</b>  <b>Example:</b> Device# configure terminal	Enters global configuration mode.
<b>Step 2</b>	<b>parameter-map type subscriber</b> <b>attribute-to-service parameter-map-name</b>  <b>Example:</b> Device(config)# parameter-map type subscriber attribute-to-service param	Specifies the parameter map type and name.
<b>Step 3</b>	<b>map-indexmap device-type eqfilter-name</b>  <b>Example:</b> Device(config-parameter-map-filter)# 1 map device-type eq "windows" mac-address eq 3c77.e602.2f91 username eq "cisco"	Specifies the parameter map attribute filter criteria. Multiple filters are used in the example provided here.
<b>Step 4</b>	<b>map-indexservice-template service-template-name</b> <b>precedence precedence-num</b>  <b>Example:</b> Device(config-parameter-map-filter-submode)# 1 service-template svcl precedence 150	Specifies the service template and its precedence.

## Creating a Policy Map (GUI)

### Procedure

- 
- Step 1** Choose **Configuration > Security > Local Policy > Policy Map** tab..
- Step 2** Enter a name for the Policy Map in the **Policy Map Name** text field.

- Step 3** Click **Add**
- Step 4** Choose the service template from the **Service Template** drop-down list.
- Step 5** For the following parameters select the type of filter from the drop-down list and enter the required match criteria
- Device Type
  - User Role
  - User Name
  - OUI
  - MAC Address
- Step 6** Click **Add Criteria**
- Step 7** Click **Update & Apply to Device**.

## Creating a Policy Map (CLI)

### Before you begin

Before removing a policy map or parameter map, you should remove it from the target or shut down the WLAN profile or delete the session.

### Procedure

	Command or Action	Purpose
<b>Step 1</b>	<b>configure terminal</b>  <b>Example:</b> Device# configure terminal	Enters global configuration mode.
<b>Step 2</b>	<b>policy-map type control subscriber</b> <i>policy-map-name</i>  <b>Example:</b> Device(config)# policy-map type control subscriber polmap5	Specifies the policy map type.
<b>Step 3</b>	<b>event identity-update match-all</b>  <b>Example:</b> Device(config-event-control-policymap)# event identity-update match-all	Specifies the match criteria to the policy map.
<b>Step 4</b>	You can apply a service template using either a class map or a parameter map, as shown here.  • <i>class-num</i> <b>class</b> <i>class-map-name</i> <b>do-until-failure</b>	Configures the local profiling policy class map number and specifies how to perform the action or activates the service template or maps an identity-update attribute to an auto-configured template.

	Command or Action	Purpose
	<ul style="list-style-type: none"> <li>• <i>action-index activate service-template service-template-name</i></li> <li>• <i>action-index map attribute-to-service table parameter-map-name</i></li> </ul> <p><b>Example:</b></p> <p>The following example shows how a class-map with a service-template has to be applied:</p> <pre>Device(config-class-control-policymap)#  10 class cls_mac do-until-failure Device(config-action-control-policymap)#  10 activate service-template svcl</pre> <p><b>Example:</b></p> <p>The following example shows how a parameter map has to be applied (service template is already associated with the parameter map 'param' while creating it):</p> <pre>Device(config-action-control-policymap)#1 map attribute-to-service table param</pre>	
<b>Step 5</b>	<p><b>end</b></p> <p><b>Example:</b></p> <pre>Device(config-action-control-policymap)# end</pre>	Exits configuration mode.
<b>Step 6</b>	<p><b>configure terminal</b></p> <p><b>Example:</b></p> <pre>Device# configure terminal</pre>	Enters global configuration mode.
<b>Step 7</b>	<p><b>wireless profile policy</b> <i>wlan-policy-profile-name</i></p> <p><b>Example:</b></p> <pre>Device(config)# wireless profile policy wlan-policy-profilename</pre>	Configures a wireless policy profile. <b>Caution</b> Do not configure aaa-override for native profiling under a named wireless profile policy. Native profiling is applied at a lower priority than AAA policy. If aaa-override is enabled, the AAA policies will override native profile policy.
<b>Step 8</b>	<p><b>description</b> <i>profile-policy-description</i></p> <p><b>Example:</b></p> <pre>Device(config-wireless-policy)# description "default policy profile"</pre>	Adds a description for the policy profile.
<b>Step 9</b>	<p><b>dhcp-tlv-caching</b></p> <p><b>Example:</b></p> <pre>Device(config-wireless-policy)# dhcp-tlv-caching</pre>	Configures DHCP TLV caching on a WLAN.

	Command or Action	Purpose
<b>Step 10</b>	<b>http-tlv-caching</b> <b>Example:</b> Device(config-wireless-policy)# http-tlv-caching	Configures client HTTP TLV caching on a WLAN.
<b>Step 11</b>	<b>subscriber-policy-name <i>policy-name</i></b> <b>Example:</b> Device(config-wireless-policy)# subscriber-policy-name polmap5	Configures the subscriber policy name.
<b>Step 12</b>	<b>vlan <i>vlan-id</i></b> <b>Example:</b> Device(config-wireless-policy)# vlan 1	Configures a VLAN name or VLAN ID.
<b>Step 13</b>	<b>no shutdown</b> <b>Example:</b> Device(config-wireless-policy)# no shutdown	Saves the configuration.

## Configuring Native Profiling in Local Mode

To configure native profiling in the local mode, you must follow the steps described in [#unique\\_1703](#). In the policy profile, you must enable central switching as described in the step given below in order to configure native profiling.

### Procedure

	Command or Action	Purpose
<b>Step 1</b>	<b>central switching</b> <b>Example:</b> Device(config-wireless-policy)# central switching	Enables central switching.

## Verifying Native Profile Configuration

Use the following **show** commands to verify the native profile configuration:

```
Device# show wireless client device summary
```

```
Active classified device summary
MAC Address      Device-type      User-role
Protocol-map
-----
1491.82b8.f94b   Microsoft-Workstation  sales
9
```

```
1491.82bc.2fd5    Windows7-Workstation    sales
41
```

```
Device# show wireless client device cache
```

```
Cached classified device info
```

```
MAC Address      Device-type          User-role
Protocol-map
```

```
-----
2477.031b.aal8   Microsoft-Workstation
9
30a8.db3b.a753   Un-Classified Device
9
4400.1011.e8b5   Un-Classified Device
9
980c.a569.7dd0   Un-Classified Device
```

```
Device# show wireless client mac-address 4c34.8845.e32c detail | s
Session Manager:
```

```
Interface :
IIF ID      : 0x90000002
Device Type : Microsoft-Workstation
Protocol Map : 0x000009
Authorized  : TRUE
Session timeout : 1800
Common Session ID: 78380209000000174BF2B5B9
Acct Session ID : 0
Auth Method Status List
Method : MAB
SM State   : TERMINATE
Authen Status : Success
Local Polices:
Service Template : wlan_svc_C414.3CCA.0A51 (priority 254)
Absolute-Timer   : 1800
Server Polices:
Resultant Policies:
Filter-ID        : acl-auto
Input QOS        : in_qos
Output QOS       : out_qos
Idle timeout     : 60 sec
VLAN             : 10
Absolute-Timer   : 1000
```

Use the following **show** command to verify the class map details for a class map name:

```
Device# show class-map type control subscriber name test
Class-map          Action                               Exec Hit Miss Comp
-----
match-any test     match day Monday                               0    0    0    0
match-any test     match join-time-of-day 8:00 18:00            0    0    0    0
```

Key:

```
"Exec" - The number of times this line was executed
"Hit"  - The number of times this line evaluated to TRUE
"Miss" - The number of times this line evaluated to FALSE
"Comp" - The number of times this line completed the execution of its
condition without a need to continue on to the end
```







## CHAPTER 145

# Air Time Fairness

---

- [Information About Air Time Fairness, on page 1359](#)
- [Restrictions on Cisco Air Time Fairness, on page 1361](#)
- [Cisco Air Time Fairness \(ATF\) Use Cases, on page 1362](#)
- [Configuring Cisco Air Time Fairness \(ATF\), on page 1362](#)
- [Verifying Cisco ATF Configurations, on page 1366](#)
- [Verifying Cisco ATF Statistics, on page 1366](#)

## Information About Air Time Fairness

Cisco Air Time Fairness (ATF) allows network administrators to group devices of a defined category and enables some groups to receive traffic from the WLAN more frequently than the other groups. Therefore, some groups are entitled to more air time than the other groups.

Cisco ATF has the following capabilities:

- Allocates Wi-Fi air time for user groups or device categories.
- Air time fairness is defined by the network administrator and not by the network.
- Provides a simplified mechanism for allocating air time.
- Dynamically adapts to changing conditions in a WLAN.
- Enables a more efficient fulfillment of service-level agreements.
- Augments standards-based Wi-Fi QoS mechanisms.

By enabling network administrators to define what fairness means in their environments with regards to the amount of air time per client group, the amount of traffic is also controlled.

To control air time on a percentage basis, the air time including both uplink and downlink transmissions of a client or SSID is continuously measured.

Only air time in the downlink direction, that is AP to client, can be controlled accurately by the AP. Although air time in the uplink direction, that is client to AP can be measured, it cannot be controlled. Although the AP can constrain air time for packets that it sends to clients, the AP can only measure air time for packets that it hears from clients because it cannot strictly limit their air time.

Cisco ATF establishes air time limits (defined as a percentage of total air time) and applies those limits on a per SSID basis, where the SSID is used as a parameter to define a client group. Other parameters can be used as well to define groups of clients. Furthermore, a single air time limit can be applied to individual clients.

If the air time limit for an SSID (or client) is exceeded, the packets in the downlink direction are dropped. Dropping downlink packets (AP to client) frees up air time whereas dropping uplink packets (client to AP) does not do anything to free up air time because the packet has already been transmitted over the air by the client.

### Client Fair Sharing

Cisco Air Time Fairness can be enforced on clients that are associated with an SSID or WLAN. This ensures that all clients in an SSID or WLAN are treated equally based on their utilization of the radio bandwidth. This feature is useful in scenarios where one or a few clients could use the complete air time allocated for an SSID or WLAN, thereby depriving Wi-Fi experience for other clients associated with the same SSID or WLAN.

- The percentage of air time to be given to each client is recomputed every time a client connects or disconnects.
- Client fair sharing is applicable only to downstream traffic.
- Clients can be categorized into usage groups at the policy level.
- Client-based ATF metrics accumulation is performed in the transmit complete routine. This allows the air time that is unused by clients in low-usage or medium-usage groups to be accumulated to a common share pool bucket where the high-usage clients can be replenished.

### Supported Access Point Platforms

Cisco ATF is supported on the following APs:

- Cisco Aironet 2700 Series Access Points
- Cisco Aironet 3700 Series Access Points
- Cisco Aironet 2800 Series Access Points
- Cisco Aironet 3800 Series Access Points
- Cisco Aironet 4800 Series Access Points
- Cisco Aironet 1540 Series Access Points
- Cisco Aironet 1560 Series Access Points



---

**Note** Cisco ATF is supported on MESH, if APs support ATF. ATF is supported on FlexConnect mode and the Local mode.

---



**Note** Cisco Catalyst APs offer capabilities that are equivalent to ATF by leveraging the enhancements in the Wi-Fi 6 and 6E protocols. 802.11ax features such as OFDMA, bidirectional MU-MIMO, and BSS coloring, combined with the advanced QoS features in the Cisco Catalyst 9800 Series Wireless Controllers, help resolve scheduling and congestion problems, accommodate multiple users at the same time, and allocate bandwidth more efficiently.

### Cisco ATF Modes

Cisco ATF operates in the following modes:

- Monitor mode in which users can do the following:
  - View the air time
  - Report air time usage for all AP transmissions
  - View reports
    - per SSID or WLAN
    - per site group/tag
  - Report air time usage at periodic intervals
  - No enforcement as part of Monitor mode
- Enforce Policy mode in which users can do the following:
  - Enforce air time based on configured policy
  - Enforce air time on the following:
    - A WLAN
    - All APs connected in a Cisco Catalyst 9800 Series Wireless Controller network
    - per site group/tag

## Restrictions on Cisco Air Time Fairness

- Cisco ATF can be implemented only on data frames in the downstream direction.
- When ATF is configured in per-SSID mode, all the WLANs are disabled before you enter any ATF configuration commands. The WLANs are enabled after you enter all the ATF commands.

# Cisco Air Time Fairness (ATF) Use Cases

## Public Hotspots (Stadium/Airport/Convention Center/Other)

In this instance, a public network is sharing a WLAN between two (or more) service providers and the venue. Subscribers to each service provider can be grouped and allocated a certain percentage of air time.

## Education

In this instance, a university is sharing a WLAN between students, faculty, and guests. The guest network can be further partitioned by the service provider, for distribution of bandwidth privileges to the guests. Each group can be assigned a certain percentage of air time.

## Enterprise/Hospitality/Retail

In this instance, the venue is sharing a WLAN between employees and guests. The guest network can be further partitioned by service provider. The guests could be sub-grouped by tier of service type with each subgroup being assigned a certain percentage of air time, for example a paid group is entitled for more air time than the free group.

## Time Shared Managed Hotspot

In this instance, the business entity managing the hotspot, such as a service provider or an enterprise, can allocate and subsequently lease air time to other business entities.

# Configuring Cisco Air Time Fairness (ATF)

## Configuring Cisco Air Time Fairness

The following are the high-level steps to configure Cisco ATF:

1. Enable Monitor mode to determine network usage (optional).
2. Create Cisco ATF policies.
3. Add WLAN ATF policies per network or per site group/tag.
4. Determine, if optimization must be enabled.
5. Periodically check the Cisco ATF statistics.

## Creating a Cisco ATF Profile (GUI)

### Procedure

---

- Step 1** Choose **Configuration > Wireless > Air Time Fairness**.

- Step 2** Click the **Profiles** tab and click the **Add** button, to create a new ATF policy. The **Add ATF Policy** window is displayed.
- Step 3** Specify a name, ID, and weight to the ATF policy. Weighted ratio is used instead of percentages so that the total can exceed 100. The minimum weight that you can set is 5. For example, if you configure the weight as 50, this means that the air time for this ATF profile is 50% when applied to an policy profile.
- Step 4** Use the slider to enable or disable the **Client Sharing** feature. When you enable this option in the Web UI, the default ATF configuration is set to **Enforce** and not **Monitor**.
- Step 5** Click **Apply to Device**.

## Creating Cisco ATF Profile (CLI)

### Procedure

	Command or Action	Purpose
<b>Step 1</b>	<b>configure terminal</b> <b>Example:</b> Device# <code>configure terminal</code>	Enters global configuration mode.
<b>Step 2</b>	<b>wireless profile airtime-fairness</b> <i>atf-policy-name atf-profile-id</i> <b>Example:</b> Device(config)# <code>wireless profile airtime-fairness atf-policy-name 1</code>	Creates a new Cisco ATF policy. <ul style="list-style-type: none"> <li>• <i>atf-policy-name</i>—Enters the ATF profile name.</li> <li>• <i>atf-profile-id</i>—Enters the ATF profile ID. Range is from 0 to 511.</li> </ul>
<b>Step 3</b>	<b>weight policy-weight</b> <b>Example:</b> Device(config-config-atf)# <code>weight 5</code>	Adds a weight to the Cisco ATF policy. <ul style="list-style-type: none"> <li>• <i>policy-weight</i>—Enters the policy weight. Range is from 5 to 100.</li> </ul>
<b>Step 4</b>	<b>client-sharing</b> <b>Example:</b> Device(config-config-atf)# <code>client-sharing</code>	Enables or disables the client sharing for Cisco ATF policy.
<b>Step 5</b>	<b>end</b> <b>Example:</b> Device(config-config-atf)# <code>end</code>	Returns to privileged EXEC mode. Alternatively, you can also press <b>Ctrl-Z</b> to exit global configuration mode.

## Attaching Cisco ATF Profile to a Policy Profile (GUI)

### Procedure

- 
- Step 1** Choose **Configuration > Tags & Profiles > Policy. Policy.**
- Step 2** Click **Add**.  
The **Add Policy Profile** window is displayed.
- Step 3** Click the **Advanced** tab.
- Step 4** Under the **Air Time Fairness Policies** section, select the required policy for 2.4 GHz and 5 GHz policies.
- Step 5** Click **Apply to Device**.
- 

## Attaching Cisco ATF Profile to a Policy Profile (CLI)

### Procedure

	Command or Action	Purpose
<b>Step 1</b>	<b>configure terminal</b>  <b>Example:</b> Device# <code>configure terminal</code>	Enters global configuration mode.
<b>Step 2</b>	<b>wireless profile policy <i>profile-name</i></b>  <b>Example:</b> Device(config)# <code>wireless profile policy profile-name</code>	Creates policy profile for the WLAN.  • <i>profile-name</i> —Is the profile name of the policy profile.
<b>Step 3</b>	<b>dot11 {24ghz   5ghz} airtime-fairness <i>atf-policy-name</i></b>  <b>Example:</b> Device(config-wireless-policy)# <code>dot11 24ghz airtime-fairness atf-policy-name</code>	Configures air time fairness policy for 2.4- or 5-GHz radio.  • <i>atf-policy-name</i> —Is the name of the air time fairness policy. For more details on creating Cisco ATF policy, refer to the <a href="#">Creating Cisco ATF Policy</a> .  <b>Note</b> You can assign the same ATF policy to both 2.4-GHz and 5-GHz radios (or) have two different ATF policies as well.
<b>Step 4</b>	<b>end</b>  <b>Example:</b> Device(config-wireless-policy)# <code>end</code>	Returns to privileged EXEC mode. Alternatively, you can also press <b>Ctrl-Z</b> to exit global configuration mode.

## Enabling ATF in the RF Profile (GUI)

### Procedure

- 
- Step 1** Choose **Configuration > Tags & Profiles > RF**.
- Step 2** Click **Add**.  
The **Add RF Profile** window is displayed.
- Step 3** Click the **Advanced** tab.
- Step 4** Under the **ATF Configuration** section, complete the following :
- Use the slider to enable or disable the **Status**. The **Mode** field is displayed.
  - Click the **Monitor** mode or **Enforced** mode radio option. If you enable the **Enforced** mode, use the slider to enable or disable **Optimization**.
  - Use the slider to enable to disable **Bridge Client Access**. This is applicable for mesh mode APs. Bridge Client Access determines the percentage of the ATF policy weight that is allocated to clients connected to the mesh APs.
- Step 5** Specify the **Airtime Allocation** value between 5 and 90.
- Step 6** Click **Apply to Device**.
- 

## Enabling ATF in the RF Profile (CLI)

Cisco ATF must be enabled on 2.4 GHz or 5 GHz radios separately.

### Procedure

	Command or Action	Purpose
<b>Step 1</b>	<b>configure terminal</b>  <b>Example:</b> Device# <code>configure terminal</code>	Enters global configuration mode.
<b>Step 2</b>	<b>ap dot11 {24ghz   5ghz} rf-profile rf-profile</b>  <b>Example:</b> Device(config)# <code>ap dot11 24ghz rf-profile rfprof24_1</code>	Configures an RF profile for 2.4- or 5-GHz radio.
<b>Step 3</b>	<b>airtime-fairness mode {enforce-policy   monitor}</b>  <b>Example:</b> Device(config-rf-profile)# <code>airtime-fairness mode enforce-policy</code>	Configures air time fairness in either of the modes: <ul style="list-style-type: none"> <li>Enforce-policy—This mode signifies that the ATF is operational.</li> <li>Monitor—This mode gathers information about air time and reports air time usage.</li> </ul>
<b>Step 4</b>	<b>airtime-fairness optimization</b>	Enables the air time fairness optimization.

	Command or Action	Purpose
	<b>Example:</b> Device (config-rf-profile) # <b>airtime-fairness optimization</b>	Optimization is effective when the current WLAN reaches the air time limit and the other available WLANs does not use air time to its full extent.
<b>Step 5</b>	<b>end</b>  <b>Example:</b> Device (config-rf-profile) # <b>end</b>	Returns to privileged EXEC mode. Alternatively, you can also press <b>Ctrl-Z</b> to exit global configuration mode.

## Verifying Cisco ATF Configurations

You can verify Cisco ATF configurations using the following commands:

*Table 73: Commands for Verifying Cisco ATF Configurations*

Commands	Description
<b>show wireless profile airtime-fairness summary</b>	Displays the summary of air time fairness profiles.
<b>show wireless profile airtime-fairness mapping</b>	Displays the ATF policy mapping with the wireless profiles.
<b>show ap airtime-fairness summary</b>	Displays the ATF configuration summary of all radios.
<b>show ap dot11 24ghz airtime-fairness</b>	Displays the ATF configuration for 2.4-GHz radio.
<b>show ap dot11 5ghz airtime-fairness</b>	Displays the ATF configuration for 5-GHz radio.
<b>show ap name ap-name airtime-fairness</b>	Displays the ATF configuration or statistics for an AP.
<b>show ap name ap-name dot11 {24ghz   5ghz} airtime-fairness statistics summary</b>	Displays the ATF statistics of 2.4- or 5GHz radio.

## Verifying Cisco ATF Statistics

*Table 74: ATF Statistics per WLAN*

Commands	Description
<b>show ap name ap-name dot11 {24ghz   5ghz} airtime-fairness wlan wlan_name statistics</b>	Displays the ATF statistics related to a WLAN.

*Table 75: ATF Statistics per ATF Policy*

Commands	Description
<b>show ap name ap-name dot11 {24ghz   5ghz} airtime-fairness policy policy-name statistics</b>	Displays the ATF statistics related to an ATF policy.



**Table 76: ATF Statistics per Client**

Commands	Description
<b>show ap airtime-fairness statistics client</b> <i>mac_address</i>	Displays the ATF statistics related to a client.





## CHAPTER 146

# IPv6 Non-AVC QoS Support

---

- [Information About IPv6 Non-AVC QoS Support, on page 1369](#)
- [Configuring IPv6 Non-AVC QoS, on page 1369](#)
- [Verifying IPv6 Non-AVC QoS, on page 1372](#)

## Information About IPv6 Non-AVC QoS Support

From Cisco IOS XE Amsterdam 17.2.1, the IPv6 Non-AVC QoS feature is supported on Fabric and FlexConnect local switching, where QoS is performed at the AP, on par with the IPv4 functionality.



---

**Note** This feature is not supported on Cisco Aironet 1700 Series Access Points, Cisco Aironet 2700 Series Access Points, and Cisco Aironet 3700 Series Access Points.

---

The following actions are supported for IPv6 Non-AVC QoS:

- Marking the DSCP value for IPv6 packets
- Dropping IPv6 packets based on the DSCP value
- Policing IPv6 traffic

## Configuring IPv6 Non-AVC QoS

The following sections contain information about the various configurations that comprise the configuration of IPv6 Non-AVC QoS:

## Marking DSCP Values for an IPv6 Packet

### Procedure

	Command or Action	Purpose
<b>Step 1</b>	<b>configure terminal</b> <b>Example:</b> Device# configure terminal	Enters global configuration mode.
<b>Step 2</b>	<b>policy-map <i>policy-map-name</i></b> <b>Example:</b> Device(config)# policy-map testpolicy	Creates a policy map.
<b>Step 3</b>	<b>class <i>class-map-name</i></b> <b>Example:</b> Device(config-pmap)#class testmap	Creates a policy criteria.
<b>Step 4</b>	<b>set dscp &lt;0-63&gt;</b> <b>Example:</b> Device(config-pmap-c)#set dscp 34	Sets the DSCP value in an IPv6 packet between 0 and 63.

## Dropping an IPv6 Packet with DSCP Values

### Procedure

	Command or Action	Purpose
<b>Step 1</b>	<b>configure terminal</b> <b>Example:</b> Device# configure terminal	Enters global configuration mode.
<b>Step 2</b>	<b>policy-map <i>policy-map-name</i></b> <b>Example:</b> Device(config)# policy-map drop_dscp	Creates a policy map.
<b>Step 3</b>	<b>class <i>class-map-name</i></b> <b>Example:</b> Device(config-pmap)#class drop_dscp_class	Creates a policy criteria.
<b>Step 4</b>	<b>police cir &lt;8000 - 10000000000&gt;</b> <b>Example:</b> Device(config-pmap-c)#police cir 8000	Polices the committed information rate between 8000 and 10000000000. Target bit rate (Bits per second).

	Command or Action	Purpose
<b>Step 5</b>	<b>conform-action drop</b> <b>Example:</b> Device(config-pmap-c-police)#conform action drop	Configures the <b>conform-action drop</b> command, the action when the rate is less than the conform burst.
<b>Step 6</b>	<b>exceed-action drop</b> <b>Example:</b> Device(config-pmap-c-police)#exceed-action drop	Configures the <b>exceed-action drop</b> command, the action when the rate is within the conform and conform plus exceed burst.

## Policing IPv6 Traffic

### Procedure

	Command or Action	Purpose
<b>Step 1</b>	<b>configure terminal</b> <b>Example:</b> Device# configure terminal	Enters global configuration mode.
<b>Step 2</b>	<b>policy-map <i>policy-map-name</i></b> <b>Example:</b> Device(config)# policy-map drop_dscp	Creates a policy map.
<b>Step 3</b>	<b>class <i>class-map-name</i></b> <b>Example:</b> Device(config-pmap)#class drop_dscp_class	Creates a policy criteria.
<b>Step 4</b>	<b>police cir &lt;8000 - 10000000000&gt;</b> <b>Example:</b> Device(config-pmap-c)#police cir 8000	Polices the committed information rate between 8000 and 10000000000. Target bit rate (Bits per second).
<b>Step 5</b>	<b>conform-action transmit</b> <b>Example:</b> Device(config-pmap-c-police)#conform-action transmit	Configures the <b>conform-action transmit</b> command, for transmitting packets.
<b>Step 6</b>	<b>exceed-action drop</b> <b>Example:</b> Device(config-pmap-c-police)#exceed-action drop	Configures the <b>exceed-action drop</b> command, the action when the rate is within conform and conform plus exceed burst.

## Verifying IPv6 Non-AVC QoS

- To verify the DSCP values for IPv6 packets, IPv6 packets that are dropped, and the policing of IPv6 traffic, use the **show policy-map** command:

The following is a sample output of the **show** command that verifies the DSCP value for an IPv6 packet:

```
Device# show policy-map
1 policymaps
Policy Map Set-dscp type:qos client:default
  Class Set-dscp1_ADV_UI_CLASS
    set dscp af41 (34)
  Class class-default
    no actions
```

- The following is a sample output of the **show** command that verifies the IPv6 packets that are dropped:

```
Device# show policy-map
1 policymaps
Policy Map Drop-dscp type:qos client:default
  Class Drop-dscp1_ADV_UI_CLASS
    drop

  Class class-default
    no actions
```

- The following is a sample output of the **show** command that verifies the policing of IPv6 traffic:

```
Device# show policy-map
1 policymaps
Policy Map Drop-traffic type:qos client:default
  Class Drop-traffic1_ADV_UI_CLASS
    police rate 2000000 bps (250000Bytes/s)
    conform-action
    exceed-action

  Class class-default
    no actions
```



## CHAPTER 147

# QoS Basic Service Set Load

---

- [Information About QoS Basic Set Service Load, on page 1373](#)
- [Configuring QBSS Load, on page 1374](#)
- [Verifying QoS Basic Set Service Load, on page 1375](#)

## Information About QoS Basic Set Service Load

The QoS Basic Set Service (QBSS) information element (IE) knob is a per-WLAN configuration that is configured to include or exclude the QBSS IE, which is sent in beacon frames and probe responses. QBSS IE advertises the channel load information of an AP. The QBSS IE functionality is enabled by default.

Until Cisco IOS XE Amsterdam 17.1.1s, the enablement of Wi-Fi Multimedia (WMM) automatically enabled the QBSS load advertisement in the probes and beacons and there was no separate knob to turn on QBSS load IE. However, from Cisco IOS XE Amsterdam 17.2.1, this behavior has changed with the introduction of a separate configuration knob.

Until Cisco IOS XE Amsterdam 17.1.1s:

- When WMM was enabled on WLAN, QBSS load was advertised in the beacon and probe frames.
- When WMM was disabled on WLAN, QBSS IE was not advertised in the beacon and probe frames.

From Cisco IOS XE Amsterdam 17.2.1,

- When you enable WMM and QBSS ID on WLAN, QBSS IE is advertised in the beacon and probe frames.
- When you enable WMM on WLAN and disable QBSS load IE on WLAN, QBSS load is not advertised in the beacon and probe frames.
- When you disable WMM on WLAN and enable QBSS load IE on WLAN, QBSS IE is advertised in the beacon and probe frames.



---

**Note** By default, QBSS load IE is enabled. The behavior can be configured on policy profile.

---

# Configuring QBSS Load

The following sections contain information about the various configurations that comprise the configuration of QoS basic service set load.

## Configuring Wi-Fi Multimedia

Perform the procedure given below to create a WLAN and then enable WMM.

### Procedure

	Command or Action	Purpose
<b>Step 1</b>	<b>configure terminal</b>  <b>Example:</b> Device# configure terminal	Enters global configuration mode.
<b>Step 2</b>	<b>wlan profile-name wlan-id [ssid]</b>  <b>Example:</b> Device(config)# wlan mywlan 34 mywlan-ssid	Specifies the WLAN name and ID: <ul style="list-style-type: none"> <li>• <i>profile-name</i>: Profile name of the WLAN. You can use between 1 to 32 alphanumeric characters.</li> <li>• <i>wlan-id</i>: WLAN ID. You can use between 1 to 512 alphanumeric characters.</li> <li>• <i>ssid</i>: Service Set Identifier (SSID) for this WLAN. If the SSID is not specified, the WLAN profile name is set as the SSID.</li> </ul> <p><b>Note</b> By default, the WLAN is disabled.</p>
<b>Step 3</b>	<b>no security wpa wpa2 ciphers aes</b>  <b>Example:</b> Device(config-wlan)# no security wpa wpa2 ciphers aes	Disables WPA2 ciphers for Advanced Encryption Standard (AES).
<b>Step 4</b>	<b>no security wpa akm dot1x</b>  <b>Example:</b> Device(config-wlan)# no security wpa akm dot1x	Disables security AKM for dot1x.
<b>Step 5</b>	<b>wmm {allowed   require}</b>  <b>Example:</b> Device(config-wlan)#wmm allowed	Configures WMM and allows WMM on the WLAN.
<b>Step 6</b>	<b>no shutdown</b>  <b>Example:</b>	Enables WLAN.



	Command or Action	Purpose
	Device(config-wlan)#no shutdown	

## Enabling QoS Basic Set Service Load

Perform the procedure given below to enable QBSS load.

### Procedure

	Command or Action	Purpose
<b>Step 1</b>	<b>configure terminal</b>  <b>Example:</b> Device# configure terminal	Enters global configuration mode.
<b>Step 2</b>	<b>wireless profile policy <i>profile-policy</i></b>  <b>Example:</b> Device(config)# wireless profile policy rr-xyz-policy-1	Configures WLAN policy profile and enters wireless policy configuration mode.
<b>Step 3</b>	<b>vlan <i>vlan-id</i></b>  <b>Example:</b> Device(config-wireless-policy)# vlan 24	Configures VLAN name or VLAN ID.
<b>Step 4</b>	<b>[no] qbss-load</b>  <b>Example:</b> Device(config-wireless-policy)#[no] qbss-load	Enables QoS enhanced basic service set information element. (Use the <b>no</b> form of this command to disable the feature.)
<b>Step 5</b>	<b>no shutdown</b>  <b>Example:</b> Device(config-wireless-policy)# no shutdown	Saves the configuration and exits configuration mode and returns to privileged EXEC mode.

### What to do next

1. Create a policy tag. For more information about creating policy tags, refer to *Configuring a Policy Tag (CLI)*.
2. Map the policy tag to the AP. For more information about mapping a policy tag to the AP, refer to *Attaching a Policy Tag and Site Tag to an AP (CLI)*.

## Verifying QoS Basic Set Service Load

To verify if QBSS load is enabled, use the **show wireless profile policy detailed *named-policy-profile*** command:

```
Device# show wireless profile policy detailed named-policy-profile show wireless profile
policy detailed named-policy-profile
Policy Profile Name      : named-policy-profile
Description              :
Status                   : ENABLED
VLAN                     : 91
Multicast VLAN          : 0
OSEN client VLAN        :
Multicast Filter         : DISABLED
QBSS Load                : ENABLED
Passive Client           : DISABLED
ET-Analytics             : DISABLED
StaticIP Mobility        : DISABLED
WLAN Switching Policy
  Flex Central Switching : ENABLED
  Flex Central Authentication : ENABLED
  Flex Central DHCP       : ENABLED
  Flex NAT PAT            : DISABLED
  Flex Central Assoc      : ENABLED
```



## PART **XI**

### **IPv6**

- [IPv6 Client IP Address Learning, on page 1379](#)
- [IPv6 ACL, on page 1397](#)
- [IPv6 Client Mobility, on page 1409](#)
- [IPv6 Support on Flex and Mesh, on page 1413](#)
- [IPv6 CAPWAP UDP Lite Support, on page 1417](#)
- [Neighbor Discovery Proxy, on page 1419](#)
- [Address Resolution Protocol Proxy, on page 1423](#)
- [IPv6 Ready Certification, on page 1425](#)





## CHAPTER 148

# IPv6 Client IP Address Learning

- [Information About IPv6 Client Address Learning, on page 1379](#)
- [Prerequisites for IPv6 Client Address Learning, on page 1383](#)
- [Configuring RA Throttle Policy \(CLI\), on page 1383](#)
- [Applying RA Throttle Policy on VLAN \(GUI\), on page 1384](#)
- [Applying RA Throttle Policy on a VLAN \(CLI\), on page 1385](#)
- [Configuring IPv6 Interface on a Switch \(GUI\), on page 1385](#)
- [Configuring IPv6 on Interface \(CLI\), on page 1386](#)
- [Configuring DHCP Pool on Switch \(GUI\), on page 1387](#)
- [Configuring DHCP Pool on Switch \(CLI\), on page 1387](#)
- [Configuring Stateless Auto Address Configuration Without DHCP on Switch \(CLI\), on page 1388](#)
- [Configuring Stateless Auto Address Configuration With DHCP on Switch , on page 1389](#)
- [Configuring Stateless Address Auto Configuration Without DHCP on Switch \(CLI\), on page 1391](#)
- [Native IPv6, on page 1392](#)

## Information About IPv6 Client Address Learning

Client Address Learning is configured on device to learn the IPv4 and IPv6 address of wireless client, and the client's transition state maintained by the device on association and timeout.

There are three ways for an IPv6 client to acquire IPv6 addresses:

- Stateless Address Auto-Configuration (SLAAC)
- Stateful DHCPv6
- Static Configuration

In all of these methods, the IPv6 client always sends a neighbor solicitation Duplicate Address Detection (DAD) request to ensure that there is no duplicate IP address on the network. The device snoops on the Neighbor Discovery Protocol (NDP) and DHCPv6 packets of the client to learn about its client IP addresses.

## Address Assignment Using SLAAC

The most common method for IPv6 client address assignment is SLAAC, which provides simple plug-and-play connectivity, where clients self-assign an address based on the IPv6 prefix.

SLAAC is configured as follows:

- A host sends a Router Solicitation message.
- The host waits for a Router Advertisement message.
- The host takes the first 64 bits of the IPv6 prefix from the Router Advertisement message and combines it with the 64-bit EUI-64 address (in the case of Ethernet, this is created from the MAC address) to create a global unicast message. The host also uses the source IP address, in the IP header, of the Router Advertisement message, as its default gateway.
- Duplicate Address Detection is performed by the IPv6 clients to ensure that random addresses that are picked do not collide with other clients.



**Note** The last 64 bits of the IPv6 address can be learned by using one of the following algorithms:

- EUI-64, which is based on the MAC address of the interface
- Private addresses that are randomly generated

**Figure 41: Address Assignment Using SLAAC**

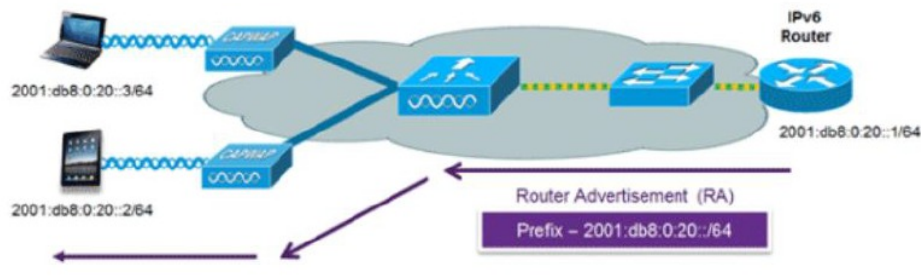

The following Cisco IOS configuration commands from a Cisco-capable IPv6 router are used to enable SLAAC addressing and router advertisements:

```

ipv6 unicast-routing
interface Vlan20
description IPv6-SLAAC
ip address 192.168.20.1 255.255.255.0
ipv6 address FE80:DB8:0:20::1 linklocal
ipv6 address 2001:DB8:0:20::1/64
ipv6 enable
end

```

## Stateful DHCPv6 Address Assignment

The use of DHCPv6 is not required for IPv6 client connectivity if SLAAC is already deployed. There are two modes of operation for DHCPv6, that is, Stateless and Stateful.

The DHCPv6 Stateless mode is used to provide clients with additional network information that is not available in the router advertisement, but not an IPv6 address, because this is already provided by SLAAC. This information includes the DNS domain name, DNS servers, and other DHCP vendor-specific options.

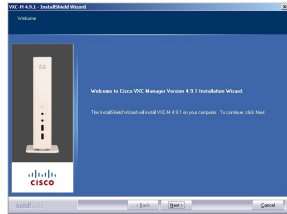
**Figure 42: Stateful DHCPv6 Address Assignment**

The following interface configuration is for a Cisco IOS IPv6 router implementing stateless DHCPv6 with SLAAC enabled:

```

ipv6 unicast-routing
ipv6 dhcp pool IPV6_DHCPPOOL
address prefix 2001:db8:5:10::/64
domain-name cisco.com
dns-server 2001:db8:6:6::1
interface Vlan20
description IPv6-DHCP-Stateless
ip address 192.168.20.1 255.255.255.0
ipv6 nd other-config-flag
ipv6 dhcp server IPV6_DHCPPOOL
ipv6 address 2001:DB8:0:20::1/64
end
  
```

## Router Solicitation

A Router Solicitation message is issued by a host controller to facilitate local routers to transmit a Router Advertisement from which the controller can obtain information about local routing, or perform stateless auto configuration. Router Advertisements are transmitted periodically and the host prompts with an immediate Router Advertisement using a Router Solicitation such as - when it boots or following a restart operation.

## Router Advertisement

A Router Advertisement message is issued periodically by a router or in response to a Router Solicitation message from a host. The information contained in these messages is used by a host to perform stateless auto configuration and to modify its routing table.

## Neighbor Discovery

IPv6 Neighbor Discovery is a set of messages and processes that determine relationships between neighboring nodes. Neighbor Discovery replaces the Address Resolution Protocol (ARP), Internet Control Message Protocol (ICMP) Router Discovery, and ICMP Redirect used in IPv4.

IPv6 Neighbor Discovery inspection analyzes neighbor discovery messages in order to build a trusted binding table database, and IPv6 Neighbor Discovery packets that do not comply, are dropped. The neighbor binding table in the tracks each IPv6 address and its associated MAC address. Clients are removed from the table according to neighbor-binding timers.

## Neighbor Discovery Suppression

The IPv6 addresses of wireless clients are cached by a device once the wireless client is in RUN state. When the device receives an NS multicast, it looks into the IPv6 addresses cached. If the target address is known to the device and belongs to one of its wireless clients, the device converts the NS from multicast to unicast and forward it to the wireless client. If the target address is not present in the cache, then device interprets that the Multicast NS is for a wired entity and forward it towards the wired side and not to the wireless client.

The same behavior is seen for ARP request in case of IPv4 address, where the device maintains IPv4 address of the wireless client in the cache.

When neither of the configuration is enabled, and when the device receives Non-DAD or DAD NS multicast looking for an IPv6 address, and if the target address is known to the device and belongs to one of its clients, the device will convert the multicast NS to unicast NS, with the destination MAC address, replaced with client's MAC and forward the unicast packet towards client.

When full-proxy is enabled, and when the device receives Non-DAD or DAD NS multicast, looking for an IPv6 address, and if the target address is known to the device and belongs to one of its clients, the device will reply with an NA message on behalf of the client.

You can use the **ipv6 nd proxy** command to enable or disable DAD or full proxy.

When the device receives an DAD-NS multicast looking for an IPv6 address, and if the target address is known to the device and belongs to one of its clients, the device will reply with an NA message on behalf of the client.

When the device receives Non-DAD NS multicast looking for an IPv6 address, and if the target address is known to the device and belongs to one of its clients, the device will convert the multicast NS to unicast NS, with the destination MAC address, replaced with client's MAC and forward the unicast packet towards client.

If the device does not have the IPv6 address of a wireless client, the device does not respond with NA; instead, it forwards the NS packet to the wired side. Reason for forwarding to Wired Side is due to the assumption that all wireless client IPv6 address and the its mapped MAC address should be available in the controller and if an IPv6 address required in the NS is not available, then that address is not a wireless client address, so forwarded to wired side.

## Router Advertisement Guard

The RA Guard feature increases the security of the IPv6 network by dropping router advertisements coming from wireless clients. Without this feature, misconfigured or malicious IPv6 clients could announce themselves as a router for the network, often with a high priority, which could take precedence over legitimate IPv6 routers. By default, RA guard is always enabled on the controller.

- Port on which the frame is received
- IPv6 source address
- Prefix list
- Trusted or Untrusted ports for receiving the router advertisement guard messages
- Trusted/Untrusted IPv6 source addresses of the router advertisement sender
- Trusted/Untrusted Prefix list and Prefix ranges
- Router preference



## Router Advertisement Throttling

RA throttling allows the controller to enforce limits to the RA packets headed toward the wireless network. By enabling RA throttling, routers that send multiple RA packets can be trimmed to a minimum frequency that will still maintain an IPv6 client connectivity. If a client sends an RS packet, an RA is sent back to the client. This RA is allowed through the controller and unicast to the client. This process ensures that the new clients or roaming clients are not affected by the RA throttling.

## Prerequisites for IPv6 Client Address Learning

Before configuring IPv6 client address learning, configure the clients to support IPv6.

To enable wireless IPv6 client connectivity, the underlying wired network must support IPv6 routing and an address assignment mechanism, such as SLAAC or DHCPv6. The wireless LAN controller must have L2 adjacency to the IPv6 router.



**Note** The AP learns IPv6 client address based on source IP address even though Neighbor Advertisements can hold rest of the IPv6 addresses. AP won't look into the Neighbor Advertisements to learn the IPv6 address learnt by the client. This behavior is seen only on Apple clients and not on Microsoft Windows clients.

## Configuring RA Throttle Policy (CLI)

Configure RA Throttle policy to allow the enforce the limits

### Procedure

	Command or Action	Purpose
<b>Step 1</b>	<b>configure terminal</b> <b>Example:</b> Device# <b>configure terminal</b>	Enters global configuration mode.
<b>Step 2</b>	<b>ipv6 nd ra-throttler policy ra-throttler1</b> <b>Example:</b> Device(config)# <b>ipv6 nd ra-throttler policy ra-throttler1</b>	Define the router advertisement (RA) throttler policy name and enter IPv6 RA throttle policy configuration mode.
<b>Step 3</b>	<b>throttleperiod 500</b> <b>Example:</b> Device(config-nd-ra-throttle)# <b>throttle-period 500</b>	Configures the throttle period in an IPv6 RA throttler policy. Throttle period is in seconds and it is the time while the controller will not forward RA to the wireless clients.

	Command or Action	Purpose
<b>Step 4</b>	<b>max-through 10</b> <b>Example:</b> Device(config-nd-ra-throttle)# max-through 15	Limits multicast RAs per VLAN per throttle period.
<b>Step 5</b>	<b>allow-atleast 5 at-most 10</b> <b>Example:</b> Device(config-nd-ra-throttle)# allow at-least 5 at-most 10	Limits the number of multicast RAs per device per throttle period in an RA throttler policy.

## Applying RA Throttle Policy on VLAN (GUI)

### Procedure

- 
- Step 1** Choose **Configuration > Services > RA Throttle Policy**.
- Step 2** Click **Add**. The **Add RA Throttle Policy** dialog box appears.
- Step 3** Enter a name for the policy in the **Name** field.
- Step 4** Choose the desired option from the **Medium Type** drop-down list.
- Step 5** Enter a value in the **Throttle Period** field. RA throttling takes place only after the Max Through limit is reached for the VLAN or the Allow At-Most value is reached for a particular router.
- Step 6** Enter a value for the **Max Through** field, which is the maximum number of RA packets on a VLAN that can be sent before throttling takes place. The **No Limit** option allows an unlimited number of RA packets through with no throttling.
- Step 7** Choose an **Interval Option**, which allows the device to act differently based on the RFC 3775 value set in IPv6 RA packets, from the following options:
- **Ignore**—Causes the RA throttle to treat packets with the interval option as a regular RA and subject to throttling if in effect.
  - **Passthrough**—Allows any RA messages with the RFC 3775 interval option to go through without throttling.
  - **Throttle**—Causes the RA packets with the interval option to always be subject to rate limiting.
- Step 8** Enter the minimum number of RA packets per router that can be sent as multicast before throttling takes place in the **At Least Multicast RAs** field.
- Step 9** Enter the maximum number of RA packets per router that can be sent as multicast before throttling takes place in the **At Most Multicast RAs** field. The **No Limit** option allows an unlimited number of RA packets through the router.
- Step 10** Click the **Add & Apply to Device** button.
-

## Applying RA Throttle Policy on a VLAN (CLI)

Applying the RA Throttle policy on a VLAN. By enabling RA throttling, routers that send many RA packets can be trimmed to a minimum frequency that will still maintain an IPv6 client connectivity.

### Procedure

	Command or Action	Purpose
<b>Step 1</b>	<b>configure terminal</b>  <b>Example:</b>  Device# <code>configure terminal</code>	Enters global configuration mode.
<b>Step 2</b>	<b>vlan configuration 1</b>  <b>Example:</b>  Device(config)# <code>vlan configuration 1</code>	Configures a VLAN or a collection of VLANs and enters VLAN configuration mode.
<b>Step 3</b>	<b>ipv6 nd ra throttler attach-policy ra-throttler1</b>  <b>Example:</b>  Device(config-vlan)# <code>ipv6 nd ra throttler attach-policy ra-throttler1</code>	Attaches an IPv6 RA throttler policy to a VLAN or a collection of VLANs.

## Configuring IPv6 Interface on a Switch (GUI)

### Procedure

- 
- Step 1** Choose **Configuration > Layer2 > VLAN > SVI**.
  - Step 2** Click **Add**.
  - Step 3** Enter **VLAN Number**, **Description** and **MTU (Bytes)**.
  - Step 4** Enable or disable the **Admin Status** toggle button.
  - Step 5** In **IP Options**, check the **IPv6** check box.
  - Step 6** Choose the type of **Static** address from the drop-down list and enter the Static Address.
  - Step 7** Check or uncheck the **DHCP**, **Autoconfig** and **Act as an IPv6 DHCP client** check boxes.  
  
If you check the **DHCP** check box, the **Rapid Commit** check box is displayed. Check or uncheck the **Rapid Commit** check box.
  - Step 8** Click **Apply to Device**.
-

# Configuring IPv6 on Interface (CLI)

Follow the procedure given below to configure IPv6 on an interface:

## Before you begin

Enable IPv6 on the client and IPv6 support on the wired infrastructure.

## Procedure

	Command or Action	Purpose
<b>Step 1</b>	<b>enable</b> <b>Example:</b> Device> <b>enable</b>	Enables privileged EXEC mode. Enter your password, if prompted.
<b>Step 2</b>	<b>configure terminal</b> <b>Example:</b> Device# <b>configure terminal</b>	Enters global configuration mode.
<b>Step 3</b>	<b>interface vlan <i>vlan-id</i></b> <b>Example:</b> Device(config)# <b>interface vlan 10</b>	Creates an interface and enters interface configuration mode.
<b>Step 4</b>	<b>ip address fe80::1 link-local</b> <b>Example:</b> Device(config-if)# <b>ip address 198.51.100.1 255.255.255.0</b> Device(config-if)# <b>ipv6 address fe80::1 link-local</b> Device(config-if)# <b>ipv6 address 2001:DB8:0:1:FFFF:1234::5/64</b> Device(config-if)# <b>ipv6 address 2001:DB8:0:0:E000::F/64</b>	Configures IPv6 address on the GigabitEthernet interface using the link-local option.
<b>Step 5</b>	<b>ipv6 enable</b> <b>Example:</b> Device(config)# <b>ipv6 enable</b>	(Optional) Enables IPv6 on the GigabitEthernet interface.
<b>Step 6</b>	<b>end</b> <b>Example:</b> Device(config)# <b>end</b>	Exits interface mode.

## Configuring DHCP Pool on Switch (GUI)

### Procedure

- 
- Step 1** Choose **Administration > DHCP**.
- Step 2** Click the **Add** button. The **Create DHCP Pool** dialog box appears.
- Step 3** Enter a pool name in the **DHCP Pool Name** field. The name must not be greater than 236 characters in length.
- Step 4** Choose either **IPv4** or **IPv6** from the **IP Type** drop-down list.
- Step 5** Enter an IP address in the **Network** field.
- Step 6** Choose any one of the available subnet masks from the **Subnet Mask** drop-down list.
- Step 7** Enter an IP address in the **Starting ip** field.
- Step 8** Enter an IP address in the **Ending ip** field.
- Step 9** Optional, set the status of the **Reserved Only** field to **Enabled** if you wish to reserve the DHCP pool.
- Step 10** Choose the desired option from the **Lease** drop-down list.
- Step 11** Selecting the **User Defined** option from the **Lease** drop-down list enables the **(0-365 days)**, **(0-23 hours)**, and **(0-59 minutes)** fields. Enter appropriate values.
- Step 12** Click the **Save & Apply to Device** button.
- Step 13** For IPv6, Enter the **DNS Server, DNS Domain Name, and Ipv6 Address Allocation**.
- 

## Configuring DHCP Pool on Switch (CLI)

Follow the procedure given below to configure DHCP Pool on an interface:

### Procedure

	Command or Action	Purpose
<b>Step 1</b>	<b>enable</b> <b>Example:</b> Device> <b>enable</b>	Enables privileged EXEC mode. Enter your password if prompted.
<b>Step 2</b>	<b>configure terminal</b> <b>Example:</b> Device# <b>configure terminal</b>	Enters global configuration mode.
<b>Step 3</b>	<b>ipv6 dhcp pool <i>vlan-id</i></b> <b>Example:</b> Device(config)# <b>ipv6 dhcp pool 21</b>	Enters the configuration mode and configures the IPv6 DHCP pool on the Vlan.

	Command or Action	Purpose
<b>Step 4</b>	<b>address prefix</b> <b>2001:DB8:0:1:FFFF:1234::/64</b> <b>lifetime 300 10</b>  <b>Example:</b> <pre>Device(config-dhcpv6)# address prefix 2001:DB8:0:1:FFFF:1234::/64 lifetime 300 10</pre>	Enters the configuration-dhcp mode and configures the address pool and its lifetime on a Vlan.
<b>Step 5</b>	<b>dns-server 2001:100:0:1::1</b>  <b>Example:</b> <pre>Device(config-dhcpv6)# dns-server 2001:20:21::1</pre>	Configures the DNS servers for the DHCP pool.
<b>Step 6</b>	<b>domain-name example.com</b>  <b>Example:</b> <pre>Device(config-dhcpv6)# domain-name example.com</pre>	Configures the domain name to complete unqualified host names.
<b>Step 7</b>	<b>end</b>  <b>Example:</b> <pre>Device(config)# end</pre>	Returns to privileged EXEC mode. Alternatively, you can also press <b>Ctrl-Z</b> to exit global configuration mode.

## Configuring Stateless Auto Address Configuration Without DHCP on Switch (CLI)

Follow the procedure given below to configure stateless auto address configuration without DHCP:

### Procedure

	Command or Action	Purpose
<b>Step 1</b>	<b>enable</b>  <b>Example:</b>  <pre>Device&gt; enable</pre>	Enables privileged EXEC mode.  Enter your password if prompted.
<b>Step 2</b>	<b>configure terminal</b>  <b>Example:</b>  <pre>Device# configure terminal</pre>	Enters global configuration mode.
<b>Step 3</b>	<b>interface vlan 1</b>  <b>Example:</b>	Creates an interface and enters interface configuration mode.

	Command or Action	Purpose
	Device(config)# <b>interface vlan 1</b>	
<b>Step 4</b>	<b>ip address fe80::1 link-local</b> <b>Example:</b> Device(config-if)# <b>ip address 198.51.100.1 255.255.255.0</b> Device(config-if)# <b>ipv6 address fe80::1 link-local</b> Device(config-if)# <b>ipv6 address 2001:DB8:0:1:FFF:1234::5/64</b> Device(config-if)# <b>ipv6 address 2001:DB8:0:0:E000::F/64</b>	Configures IPv6 address on the GigabitEthernet interface using the link-local option.
<b>Step 5</b>	<b>ipv6 enable</b> <b>Example:</b> Device(config)# <b>ipv6 enable</b>	(Optional) Enables IPv6 on the GigabitEthernet interface.
<b>Step 6</b>	<b>no ipv6 nd managed-config-flag</b> <b>Example:</b> Device(config)# <b>interface vlan 1</b> Device(config-if)# <b>no ipv6 nd managed-config-flag</b>	Ensures the attached hosts do not use stateful autoconfiguration to obtain addresses.
<b>Step 7</b>	<b>no ipv6 nd other-config-flag</b> <b>Example:</b> Device(config-if)# <b>no ipv6 nd other-config-flag</b>	Ensures the attached hosts do not use stateful autoconfiguration to obtain non-address options from DHCP (domain etc).
<b>Step 8</b>	<b>end</b> <b>Example:</b> Device(config)# <b>end</b>	Returns to privileged EXEC mode. Alternatively, you can also press <b>Ctrl-Z</b> to exit global configuration mode.

## Configuring Stateless Auto Address Configuration With DHCP on Switch

Follow the procedure given below to configure stateless auto address configuration with DHCP:

### Procedure

	Command or Action	Purpose
<b>Step 1</b>	<b>enable</b> <b>Example:</b> Device> <b>enable</b>	Enables privileged EXEC mode. Enter your password if prompted.

	Command or Action	Purpose
<b>Step 2</b>	<b>configure terminal</b> <b>Example:</b>  Device# <b>configure terminal</b>	Enters global configuration mode.
<b>Step 3</b>	<b>interface vlan 1</b> <b>Example:</b>  Device (config)# <b>interface vlan 1</b>	Creates an interface and enters interface configuration mode.
<b>Step 4</b>	<b>ip address fe80::1 link-local</b> <b>Example:</b> Device (config-if)# <b>ip address</b> <b>198.51.100.1 255.255.255.0</b> Device (config-if)# <b>ipv6 address</b> <b>fe80::1 link-local</b> Device (config-if)# <b>ipv6 address</b> <b>2001:DB8:0:1:FFFF:1234::5/64</b> Device (config-if)# <b>ipv6 address</b> <b>2001:DB8:0:0:E000::F/64</b>	Configures IPv6 address on the GigabitEthernet interface using the link-local option.
<b>Step 5</b>	<b>ipv6 enable</b> <b>Example:</b>  Device (config)# <b>ipv6 enable</b>	(Optional) Enables IPv6 on the GigabitEthernet interface.
<b>Step 6</b>	<b>ipv6 nd prefix ipaddress</b> <b>Example:</b>  ipv6 nd prefix 2001:9:3:54::/64 no-advertise	Specifies a subnet prefix.
<b>Step 7</b>	<b>no ipv6 nd managed-config-flag</b> <b>Example:</b>  Device (config)# <b>interface vlan 1</b> Device (config-if)# <b>no ipv6 nd</b> <b>managed-config-flag</b>	Ensures the attached hosts do not use stateful autoconfiguration to obtain addresses.
<b>Step 8</b>	<b>ipv6 nd other-config-flag</b> <b>Example:</b>  Device (config-if)# <b>no ipv6 nd</b> <b>other-config-flag</b>	Ensures the attached hosts do not use stateful autoconfiguration to obtain non-address options from DHCP (domain etc).
<b>Step 9</b>	<b>ipv6 dhcp server servername</b> <b>Example:</b>  ipv6 dhcp server VLAN54	Displays the configuration parameters.
<b>Step 10</b>	<b>end</b> <b>Example:</b>	Exits interface mode.



	Command or Action	Purpose
	Device(config)# <b>end</b>	

## Configuring Stateless Address Auto Configuration Without DHCP on Switch (CLI)

Follow the procedure given below to configure stateless auto address configuration without DHCP:

### Procedure

	Command or Action	Purpose
<b>Step 1</b>	<b>enable</b> <b>Example:</b> Device> <b>enable</b>	Enables privileged EXEC mode. Enter your password if prompted.
<b>Step 2</b>	<b>configure terminal</b> <b>Example:</b> Device# <b>configure terminal</b>	Enters global configuration mode.
<b>Step 3</b>	<b>interface vlan 1</b> <b>Example:</b> Device(config)# <b>interface vlan 1</b>	Creates an interface and enters interface configuration mode.
<b>Step 4</b>	<b>ip address fe80::1 link-local</b> <b>Example:</b> Device(config-if)# <b>ip address</b> <b>198.51.100.1 255.255.255.0</b> Device(config-if)# <b>ipv6 address</b> <b>fe80::1 link-local</b> Device(config-if)# <b>ipv6 address</b> <b>2001:DB8:0:1:FFFF:1234::5/64</b> Device(config-if)# <b>ipv6 address</b> <b>2001:DB8:0:0:E000::F/64</b>	Configures IPv6 address on the GigabitEthernet interface using the link-local option.
<b>Step 5</b>	<b>ipv6 enable</b> <b>Example:</b> Device(config)# <b>ipv6 enable</b>	(Optional) Enables IPv6 on the GigabitEthernet interface.
<b>Step 6</b>	<b>no ipv6 nd managed-config-flag</b> <b>Example:</b> Device(config)# <b>interface vlan 1</b> Device(config-if)# <b>no ipv6 nd</b> <b>managed-config-flag</b>	Ensures the attached hosts do not use stateful autoconfiguration to obtain addresses.

	Command or Action	Purpose
Step 7	<b>no ipv6 nd other-config-flag</b> <b>Example:</b> Device(config-if)# <b>no ipv6 nd other-config-flag</b>	Ensures the attached hosts do not use stateful autoconfiguration to obtain non-address options from DHCP (domain etc).
Step 8	<b>end</b> <b>Example:</b> Device(config)# <b>end</b>	Returns to privileged EXEC mode. Alternatively, you can also press <b>Ctrl-Z</b> to exit global configuration mode.

## Native IPv6

### Information About IPv6

IPv6 is a packet-based protocol used to exchange data, voice, and video traffic over digital networks. IPv6 is based on IP, but with a much larger address space, and improvements such as a simplified main header and extension headers. The architecture of IPv6 has been designed to allow existing IPv4 users to transition easily to IPv6 while continuing to use services such as end-to-end security, quality of service (QoS), and globally unique addresses. The larger IPv6 address space allows networks to scale and provide global reachability.



**Note** The features and functions that work on IPv4 networks with IPv4 addresses also work on IPv6 networks with IPv6 addresses.

#### General Guidelines

- For IPv6 functionality to work, ensure that you disable IPv6 multicast routing.
- The Wireless Management interface should have only one static IPv6 address.
- Router advertisement should be suppressed on the wireless management interface and client VLANs (if IPv6 is configured on the client VLAN).
- Preferred mode is part of an AP join profile. When you configure the preferred mode as IPv6, an AP attempts to join over IPv6 first. If it fails, the AP falls back to IPv4.
- You should use MAC addresses for RA tracing of APs and clients.
- APs can join IPv6 controllers only with an IPv6 static address. If you have a controller with auto configurations and multiple IPv6 addresses, APs cannot join the IPv6 controllers.

#### Unsupported Features

- UDP Lite is not supported.
- AP sniffer over IPv6 is not supported.
- IPv6 is not supported for the HA port interface.

- Auto RF grouping over IPv6 is not supported. Only static RF grouping is supported.

## Configuring IPv6 Addressing

Follow the procedure given below to configure IPv6 addressing:



**Note** All the features and functions that work on IPv4 networks with IPv4 addresses will work on IPv6 networks with IPv6 addresses too.

### Procedure

	Command or Action	Purpose
<b>Step 1</b>	<b>configure terminal</b> <b>Example:</b> Device# configure terminal	Enters global configuration mode.
<b>Step 2</b>	<b>ipv6 unicast-routing</b> <b>Example:</b> Device(config)# ipv6 unicast-routing	Configures IPv6 for unicasting.
<b>Step 3</b>	<b>interface vlan 1</b> <b>Example:</b> Device(config)# interface vlan 1	Creates an interface and enters interface configuration mode.
<b>Step 4</b>	<b>ipv6 address ipv6-address</b> <b>Example:</b> Device(config-if)# ipv6 address FD09:9:2:49::53/64	Specifies a global IPv6 address.
<b>Step 5</b>	<b>ipv6 enable</b> <b>Example:</b> Device(config-if)# ipv6 enable	Enables IPv6 on the interface.
<b>Step 6</b>	<b>ipv6 nd ra suppress all</b> <b>Example:</b> Device(config-if)# ipv6 nd ra suppress all	Suppresses IPv6 router advertisement transmissions on the interface.
<b>Step 7</b>	<b>exit</b> <b>Example:</b> Device(config-if)# exit	Returns to global configuration mode.

	Command or Action	Purpose
<b>Step 8</b>	<b>wireless management interface</b> <b>gigabitEthernet</b> <i>gigabitEthernet-interface-vlan 64</i>  <b>Example:</b> Device(config)# wireless management interface gigabitEthernet vlan 64	Configures the ports that are connected to the supported APs with the wireless management interface.
<b>Step 9</b>	<b>ipv6 route</b> <i>ipv6-address</i>  <b>Example:</b> Device(config)# ipv6 route ::/0 FD09:9:2:49::1	Specifies IPv6 static routes.

## Creating an AP Join Profile (GUI)

### Procedure

- 
- Step 1** Choose **Configuration > Tags & Profiles > AP Join**.
  - Step 2** On the **AP Join Profile** window, click the **General** tab and click **Add**.
  - Step 3** In the **Name** field enter, a name for the AP join profile.
  - Step 4** (Optional) Enter a description for the AP join profile.
  - Step 5** Choose **CAPWAP > Advanced**.
  - Step 6** Under the **Advanced** tab, from the **Preferred Mode** drop-down list, choose **IPv6**. This sets the preferred mode of APs as IPv6.
  - Step 7** Click **Save & Apply to Device**.
- 

## Creating an AP Join Profile (CLI)

### Procedure

	Command or Action	Purpose
<b>Step 1</b>	<b>configure terminal</b>  <b>Example:</b> Device# configure terminal	Enters global configuration mode.
<b>Step 2</b>	<b>ap profile</b> <i>ap-profile</i>  <b>Example:</b> Device(config)# ap profile xyz-ap-profile	Configures an AP profile and enters AP profile configuration mode.

	Command or Action	Purpose
<b>Step 3</b>	<b>description</b> <i>ap-profile-name</i> <b>Example:</b> Device(config-ap-profile)# description "xyz ap profile"	Adds a description for the AP profile.
<b>Step 4</b>	<b>preferred-mode</b> <b>ipv6</b> <b>Example:</b> Device(config-ap-profile)# preferred-mode ipv6	Sets the preferred mode of APs as IPv6.

## Configuring the Primary and Backup Controller (GUI)

### Before you begin

Ensure that you have configured an AP join profile prior to configuring the primary and backup controller s.

### Procedure

- 
- Step 1** Choose **Configuration > Tags & Profiles > AP Join**.
  - Step 2** On the **AP Join Profile** window, click the AP join profile name.
  - Step 3** In the **Edit AP Join Profile** window, click the **CAPWAP** tab.
  - Step 4** In the **High Availability** tab, under **Backup Controller Configuration**, check the **Enable Fallback** check box.
  - Step 5** Enter the primary and secondary controller names and IP addresses.
  - Step 6** Click **Update & Apply to Device**.
- 

## Configuring Primary and Backup Controller (CLI)

Follow the procedure given below to configure the primary and secondary controllers for a selected AP:

### Procedure

	Command or Action	Purpose
<b>Step 1</b>	<b>configure terminal</b> <b>Example:</b> Device# configure terminal	Enters global configuration mode.
<b>Step 2</b>	<b>ap profile</b> <i>profile-name</i> <b>Example:</b> Device(config)# ap profile yy-ap-profile	Configures an AP profile and enters AP profile configuration mode.

	Command or Action	Purpose
<b>Step 3</b>	<p><b>capwap backup primary</b> <i>primary-controller-name primary-controller-ip</i></p> <p><b>Example:</b></p> <pre>Device(config)# capwap backup primary WLAN-Controller-A 2001:DB8:1::1</pre>	<p>Configures AP CAPWAP parameters with the primary backup controller's name.</p> <p><b>Note</b> You need to enable fast heartbeat for <b>capwap backup primary</b> and <b>capwap backup secondary</b> to work.</p> <p>AP disconnection may occur if the link between the controller and AP is not reliable and fast heartbeat is enabled.</p>
<b>Step 4</b>	<p><b>ap capwap backup secondary</b> <i>secondary-controller-name secondary-controller-ip</i></p> <p><b>Example:</b></p> <pre>Device(config)# capwap backup secondary WLAN-Controller-B 2001:DB8:1::1</pre>	Configures AP CAPWAP parameters with the secondary backup controller's name.
<b>Step 5</b>	<p><b>syslog host ipaddress</b></p> <p><b>Example:</b></p> <pre>Device(config)# syslog host 2001:DB8:1::1</pre>	Configures the system logging settings for the APs.
<b>Step 6</b>	<p><b>tftp-downgrade tftp-server-ip imagename</b></p> <p><b>Example:</b></p> <pre>Device(config)# tftp-downgrade 2001:DB8:1::1 testimage</pre>	Initiates AP image downgrade from a TFTP server for all the APs.

## Verifying IPv6 Configuration

Use the following **show** command to verify the IPv6 configuration:

```
Device# show wireless interface summary
```

```
Wireless Interface Summary
```

```
Interface Name Interface Type VLAN ID IP Address IP Netmask MAC Address
-----
Vlan49 Management 49 0.0.0.0 255.255.255.0 001e.f64c.1eff
fd09:9:2:49::54/64
```



## CHAPTER 149

# IPv6 ACL

---

- [Information About IPv6 ACL, on page 1397](#)
- [Prerequisites for Configuring IPv6 ACL, on page 1398](#)
- [Restrictions for Configuring IPv6 ACL, on page 1398](#)
- [Configuring IPv6 ACLs , on page 1398](#)
- [How To Configure an IPv6 ACL, on page 1399](#)
- [Verifying IPv6 ACL, on page 1404](#)
- [Configuration Examples for IPv6 ACL, on page 1405](#)

## Information About IPv6 ACL

An access control list (ACL) is a set of rules used to limit access to a particular interface (for example, if you want to restrict a wireless client from pinging the management interface of the controller ). ACLs are configured on the device and applied to the management interface, the AP-manager interface, any of the dynamic interfaces, or a WLAN to control data traffic to and from wireless clients or to the controller central processing unit (CPU) to control all traffic destined for the CPU.

You can also create a preauthentication ACL for web authentication. Such an ACL is used to allow certain types of traffic before authentication is complete.

IPv6 ACLs support the same options as IPv4 ACLs including source, destination, source and destination ports.



---

**Note** You can enable only IPv4 traffic in your network by blocking IPv6 traffic. That is, you can configure an IPv6 ACL to deny all IPv6 traffic and apply it on specific or all WLANs.

---

## Understanding IPv6 ACLs

### Types of ACL

#### Per User IPv6 ACL

For the per-user ACL, the full access control entries (ACE) as the text strings are configured on the RADIUS server.

The ACE is not configured on the Cisco 9800 controller. The ACE is sent to the device in the `ACCESS-Accept` attribute and applies it directly for the client. When a wireless client roams into an foreign device, the ACEs are sent to the foreign device as an AAA attribute in the mobility Handoff message. Output direction, using per-user ACL is not supported.

## Filter ID IPv6 ACL

For the filter-Id ACL, the full ACEs and the `acl_name(filter-id)` is configured on the Cisco 9800 controller and only the `filter-id` is configured on the RADIUS Server.

The `filter-id` is sent to the device in the `ACCESS-Accept` attribute, and the device looks up the `filter-id` for the ACEs, and then applies the ACEs to the client. When the client L2 roams to the foreign device, only the `filter-id` is sent to the foreign device in the mobility Handoff message. Output filtered ACL, using per-user ACL is not supported. The foreign device has to configure the `filter-id` and ACEs beforehand.

## Prerequisites for Configuring IPv6 ACL

You can filter IP Version 6 (IPv6) traffic by creating IPv6 access control lists (ACLs) and applying them to interfaces similarly to the way that you create and apply IP Version 4 (IPv4) named ACLs. You can also create and apply input router ACLs to filter Layer 3 management traffic when the switch is running the Network Essentials license.

## Restrictions for Configuring IPv6 ACL

With IPv4, you can configure standard and extended numbered IP ACLs, named IP ACLs, and MAC ACLs. IPv6 supports only named ACLs. The IPv6 ACL does not support Flex connect mode.

The device supports most of the Cisco IOS-supported IPv6 ACLs with some exceptions:

- The device does not support matching on these keywords: **flowlabel**, **routing header**, and **undetermined-transport**.
- The device does not support reflexive ACLs (the **reflect** keyword).
- The device does not apply MAC-based ACLs on IPv6 frames.
- When configuring an ACL, there is no restriction on keywords entered in the ACL, regardless of whether or not they are supported on the platform. When you apply the ACL to an interface that requires hardware forwarding (physical ports or SVIs), the device checks to determine whether or not the ACL can be supported on the interface. If not, attaching the ACL is rejected.
- If an ACL is applied to an interface and you attempt to add an access control entry (ACE) with an unsupported keyword, the device does not allow the ACE to be added to the ACL that is currently attached to the interface

## Configuring IPv6 ACLs

Follow the procedure given below to filter IPv6 traffic:

1. Create an IPv6 ACL, and enter IPv6 access list configuration mode.



2. Configure the IPv6 ACL to block (deny) or pass (permit) traffic.
3. Apply the IPv6 ACL to the interface where the traffic needs to be filtered.
4. Apply the IPv6 ACL to an interface. For router ACLs, you must also configure an IPv6 address on the Layer 3 interface to which the ACL is applied.

## Default IPv6 ACL Configuration

There are no IPv6 ACLs configured or applied.

## Interaction with Other Features and Switches

- If a bridged frame is to be dropped due to a port ACL, the frame is not bridged.
- You can create both IPv4 and IPv6 ACLs on a switch or switch stack, and you can apply both IPv4 and IPv6 ACLs to the same interface. Each ACL must have a unique name; an error message appears if you try to use a name that is already configured.

You use different commands to create IPv4 and IPv6 ACLs and to attach IPv4 or IPv6 ACLs to the same Layer 2 or Layer 3 interface. If you use the wrong command to attach an ACL (for example, an IPv4 command to attach an IPv6 ACL), you receive an error message.

- You cannot use MAC ACLs to filter IPv6 frames. MAC ACLs can only filter non-IP frames.
- If the hardware memory is full, for any additional configured ACLs, packets are processed to the CPU, and the ACLs are applied in software. When the hardware is full a message is printed to the console indicating the ACL has been unloaded and the packets will be processed in software.



---

**Note** Only packets of the same type as the ACL that could not be added (ipv4, ipv6, MAC) will be processed in software.

---

- If the TCAM is full, for any additional configured ACLs, packets are forwarded to the CPU, and the ACLs are applied in software.

## How To Configure an IPv6 ACL

### Creating an IPv6 ACL (GUI)

#### Procedure

---

- Step 1** Choose **Configuration > Security > ACL**.
- Step 2** Click **Add**.
- Step 3** In the **Add ACL Setup** dialog box, enter the following parameters.

- **ACL Name:** Enter the name for the ACL
- **ACL Type:** IPv6
- **Sequence:** The valid range is between 100 and 199 or 2000 and 26991
- **Action:** Choose **Permit** or **Deny** the packet flow from the drop-down list.
- **Source Type:** Choose **any**, **Host** or **Network** from which the packet is sent.
- **Destination Type:** Choose **any**, **Host** or **Network** to which the packet is sent.
- **Protocol:** Choose a protocol from the drop-down list.
- **Log:** Enable or disable logging.
- **DSCP:** Enter to match packets with the DSCP value

**Step 4** Click **Add**.

**Step 5** Add the rest of the rules and click **Apply to Device**.

## Creating an IPv6 ACL

### Procedure

	Command or Action	Purpose
<b>Step 1</b>	<b>enable</b> <b>Example:</b> Device> <b>enable</b>	Enables privileged EXEC mode. Enter your password if prompted.
<b>Step 2</b>	<b>configure terminal</b> <b>Example:</b> Device# <b>configure terminal</b>	Enters global configuration mode.
<b>Step 3</b>	<b>ipv6 access-list <i>acl_name</i></b> <b>Example:</b> Device# <b>ipv6 access-list access-list-name</b>	Use a name to define an IPv6 access list and enter IPv6 access-list configuration mode.
<b>Step 4</b>	<b>{deny permit} protocol</b> <b>Example:</b> <pre>{deny   permit} protocol {source-ipv6-prefix/prefix-length   any    host source-ipv6-address} [operator [port-number]] {destination-ipv6-prefix/prefix-length</pre>	Enter deny or permit to specify whether to deny or permit the packet if conditions are matched. These are the conditions: <ul style="list-style-type: none"> <li>• For protocol, enter the name or number of an Internet protocol: ahp, esp, icmp, ipv6, pcp, stcp, tcp, or udp, or an integer</li> </ul>

	Command or Action	Purpose
	<pre>  any  host destination-ipv6-address) [operator [port-number]][dscp value] [fragments][log] [log-input] [routing][sequence value] [time-range name]</pre>	<p>in the range 0 to 255 representing an IPv6 protocol number.</p> <ul style="list-style-type: none"> <li>• The source-ipv6-prefix/prefix-length or destination-ipv6-prefix/ prefix-length is the source or destination IPv6 network or class of networks for which to set deny or permit conditions, specified in hexadecimal and using 16-bit values between colons (see RFC 2373).</li> <li>• Enter any as an abbreviation for the IPv6 prefix ::/0.</li> <li>• For host source-ipv6-address or destination-ipv6-address, enter the source or destination IPv6 host address for which to set deny or permit conditions, specified in hexadecimal using 16-bit values between colons.</li> <li>• (Optional) For operator, specify an operand that compares the source or destination ports of the specified protocol. Operands are lt (less than), gt (greater than), eq (equal), neq (not equal), and range.</li> </ul> <p>If the operator follows the source-ipv6-prefix/prefix-length argument, it must match the source port. If the operator follows the destination-ipv6-prefix/prefix-length argument, it must match the destination port.</p> <ul style="list-style-type: none"> <li>• (Optional) The port-number is a decimal number from 0 to 65535 or the name of a TCP or UDP port. You can use TCP port names only when filtering TCP. You can use UDP port names only when filtering UDP.</li> <li>• (Optional) Enter dscp value to match a differentiated services code point value against the traffic class value in the Traffic Class field of each IPv6 packet header. The acceptable range is from 0 to 63.</li> <li>• (Optional) For packet fragmentation, enter fragments to check noninitial</li> </ul>

	Command or Action	Purpose
		<p>fragments. This keyword is visible only if the protocol is ipv6.</p> <ul style="list-style-type: none"> <li>• (Optional) Enter log to cause an logging message to be sent to the console about the packet that matches the entry. Enter log-input to include the input interface in the log entry. Logging is supported only for router ACLs.</li> <li>• (Optional) Enter routing to specify that IPv6 packets be routed.</li> <li>• (Optional) Enter sequence value to specify the sequence number for the access list statement. The acceptable range is from 1 to 4294967295</li> <li>• (Optional) Enter time-range name to specify the time range that applies to the deny or permit statement.</li> </ul>
<b>Step 5</b>	<p><b>{deny permit} tcp</b></p> <p><b>Example:</b></p> <pre>{deny   permit} tcp {source-ipv6-prefix/prefix-length   any    hostsource-ipv6-address} [operator [port-number]]{destination-ipv6-prefix/prefix-length    any   hostdestination-ipv6-address} [operator [port-number]][ack] [dscp value][established] [fin] [log][log-input] [neq {port   protocol}]  [psh] [range{port   protocol}] [rst][routing] [sequence value] [syn] [time-range name][urg]</pre>	<p>(Optional) Define a TCP access list and the access conditions.</p> <p>Enter tcp for Transmission Control Protocol. The parameters are the same as those described in Step 3, with these additional optional parameters:</p> <ul style="list-style-type: none"> <li>• ack—Acknowledgment bit set.</li> <li>• established—An established connection. A match occurs if the TCP datagram has the ACK or RST bits set.</li> <li>• fin—Finished bit set; no more data from sender.</li> <li>• neq {port   protocol}—Matches only packets that are not on a given port number.</li> <li>• psh—Push function bit set.</li> <li>• range {port   protocol}—Matches only packets in the port number range.</li> <li>• rst—Reset bit set.</li> <li>• syn—Synchronize bit set.</li> <li>• urg—Urgent pointer bit set.</li> </ul>

	Command or Action	Purpose
<b>Step 6</b>	<p><b>{deny permit} udp</b></p> <p><b>Example:</b></p> <pre>{deny   permit} udp {source-ipv6-prefix/prefix-length   any    hostsource-ipv6-address} [operator [port-number]]{destination-ipv6-prefix/prefix-length    any   hostdestination-ipv6-address} [operator [port-number]][dscp value] [log][log-input] [neq {port  protocol}] [range {port  protocol}] [routing][sequence value][time-range name]</pre>	<p>(Optional) Define a UDP access list and the access conditions.</p> <p>Enter udp for the User Datagram Protocol. The UDP parameters are the same as those described for TCP, except that the operator [port] port number or name must be a UDP port number or name, and the established parameter is not valid for UDP.</p>
<b>Step 7</b>	<p><b>{deny permit} icmp</b></p> <p><b>Example:</b></p> <pre>{deny   permit} icmp {source-ipv6-prefix/prefix-length   any    hostsource-ipv6-address} [operator [port-number]] {destination-ipv6-prefix/prefix-length    any   hostdestination-ipv6-address} [operator [port-number]][icmp-type [icmp-code]  icmp-message] [dscpvalue] [log] [log-input] [routing] [sequence value][time-range name]</pre>	<p>(Optional) Define an ICMP access list and the access conditions.</p> <p>Enter icmp for Internet Control Message Protocol. The ICMP parameters are the same as those described for most IP protocols in Step 3a, with the addition of the ICMP message type and code parameters. These optional keywords have these meanings:</p> <ul style="list-style-type: none"> <li>• icmp-type—Enter to filter by ICMP message type, a number from 0 to 255.</li> <li>• icmp-code—Enter to filter ICMP packets that are filtered by the ICMP message code type, a number from 0 to 255.</li> <li>• icmp-message—Enter to filter ICMP packets by the ICMP message type name or the ICMP message type and code name. To see a list of ICMP message type names and code names, use the ? key or see command reference for this release.</li> </ul>
<b>Step 8</b>	<p><b>end</b></p> <p><b>Example:</b></p> <pre>Device(config)# end</pre>	<p>Returns to privileged EXEC mode. Alternatively, you can also press <b>Ctrl-Z</b> to exit global configuration mode.</p>
<b>Step 9</b>	<p><b>show ipv6 access-list</b></p> <p><b>Example:</b></p> <pre>show ipv6 access-list</pre>	<p>Verify the access list configuration.</p>
<b>Step 10</b>	<p><b>copy running-config startup-config</b></p> <p><b>Example:</b></p> <pre>copy running-config startup-config</pre>	<p>(Optional) Save your entries in the configuration file.</p>

## Creating WLAN IPv6 ACL (GUI)

### Procedure

- 
- Step 1** Choose **Configuration > Tags & Profiles > WLANs**.
  - Step 2** Click **Add**.
  - Step 3** In the **General** tab, enter the **Profile Name**, the **SSID** and the **WLAN ID**.
  - Step 4** Choose **Security > Layer3** tab, click **Show Advanced Settings** and under the **Preauthenticated ACL** settings, choose the ACL from the **IPv6** drop-down list.
  - Step 5** Click **Apply to Device**.
- 

## Creating WLAN IPv6 ACL

### Procedure

	Command or Action	Purpose
<b>Step 1</b>	<b>configure terminal</b>  <b>Example:</b> DeviceController # configure terminal	Configures the terminal.
<b>Step 2</b>	<b>wireless profile policy <i>profile-name</i></b>  <b>Example:</b> Device(config)# wireless profile policy test1	Creates policy profile for the WLAN.  The <i>profile-name</i> is the profile name of the policy profile.
<b>Step 3</b>	<b>ipv6 acl <i>acl_name</i></b>  <b>Example:</b> Device(config-wireless-policy)# ipv6 acl testacl	Creates a named WLAN ACL.
<b>Step 4</b>	<b>ipv6 traffic-filter web <i>acl_name-preauth</i></b>  <b>Example:</b> Device(config-wlan)# ipv6 traffic-filter web preauth1	Creates a pre-authentication ACL for web authentication.

## Verifying IPv6 ACL

### Displaying IPv6 ACLs

To display IPv6 ACLs, perform this procedure:

**Procedure**

	<b>Command or Action</b>	<b>Purpose</b>
<b>Step 1</b>	<b>enable</b> <b>Example:</b> Device> <b>enable</b>	Enables privileged EXEC mode. Enter your password if prompted.
<b>Step 2</b>	<b>configure terminal</b> <b>Example:</b> Device# <b>configure terminal</b>	Enters global configuration mode.
<b>Step 3</b>	<b>show access-list</b> <b>Example:</b> Device# <b>show access-lists</b>	Displays all access lists configured on the device
<b>Step 4</b>	<b>show ipv6 access-list <i>acl_name</i></b> <b>Example:</b> Device# <b>show ipv6 access-list</b> [ <i>access-list-name</i> ]	Displays all configured IPv6 access list or the access list specified by name.

## Configuration Examples for IPv6 ACL

### Example: Creating an IPv6 ACL

This example configures the IPv6 access list named CISCO. The first deny entry in the list denies all packets that have a destination TCP port number greater than 5000. The second deny entry denies packets that have a source UDP port number less than 5000. The second deny also logs all matches to the console. The first permit entry in the list permits all ICMP packets. The second permit entry in the list permits all other traffic. The second permit entry is necessary because an implicit deny -all condition is at the end of each IPv6 access list.



**Note** Logging is supported only on Layer 3 interfaces.

```
Device(config)# ipv6 access-list CISCO
Device(config-ipv6-acl)# deny tcp any any gt 5000
Device (config-ipv6-acl)# deny ::/0 lt 5000 ::/0 log
Device(config-ipv6-acl)# permit icmp any any
Device(config-ipv6-acl)# permit any any
```

### Example: Applying an IPv6 ACL to a Policy Profile in a Wireless Environment

This example shows how to apply an IPv6 ACL to a Policy Profile in a Wireless environment.



**Note** All IPv6 ACLs must be associated to a policy profile.

**1. Creating an IPv6 ACL.**

```
Device(config)# ipv6 access-list <acl-name>
Device(config-ipv6-acl)# permit tcp 2001:DB8::/32 any
Device(config-ipv6-acl)# permit udp 2001:DB8::/32 any
```

**2. Applying the IPv6 ACL to a policy profile.**

```
Device(config)# wireless profile policy <policy-profile-name>
Device(config-wireless-policy)# shutdown
Device(config-wireless-policy)# ipv6 acl <acl-name>
Device(config-wireless-policy)# no shutdown
```

## Displaying IPv6 ACLs

To display IPv6 ACLs, perform this procedure:

### Procedure

	Command or Action	Purpose
<b>Step 1</b>	<b>show access-list</b>  <b>Example:</b> Device# <b>show access-lists</b>	Displays all access lists configured on the device
<b>Step 2</b>	<b>show ipv6 access-list <i>acl_name</i></b>  <b>Example:</b> Device# <b>show ipv6 access-list</b> [ <i>access-list-name</i> ]	Displays all configured IPv6 access list or the access list specified by name.

## Example: Displaying IPv6 ACLs

This is an example of the output from the **show access-lists** privileged EXEC command. The output shows all access lists that are configured on the switch or switch stack.

```
Device #show access-lists
Extended IP access list hello
10 permit ip any any
IPv6 access list ipv6
permit ipv6 any any sequence 10
```

This is an example of the output from the **show ipv6 access-lists** privileged EXEC command. The output shows only IPv6 access lists configured on the switch or switch stack.

```
Device# show ipv6 access-list
IPv6 access list inbound
permit tcp any any eq bgp (8 matches) sequence 10
permit tcp any any eq telnet (15 matches) sequence 20
permit udp any any sequence 30

IPv6 access list outbound
```



```
deny udp any any sequence 10
deny tcp any any eq telnet sequence 20
```

## Example: Configuring RA Throttling

This task describes how to create an RA throttle policy in order to help the power-saving wireless clients from being disturbed by frequent unsolicited periodic RA's. The unsolicited multicast RA is throttled by the controller.

### Before you begin

Enable IPv6 on the client machine.

### Procedure

	Command or Action	Purpose
<b>Step 1</b>	<b>configure terminal</b> <b>Example:</b> Device# <code>configure terminal</code>	Enters global configuration mode.
<b>Step 2</b>	<b>ipv6 nd ra-throttler policy Mythrottle</b> <b>Example:</b> Device (config)# <code>ipv6 nd ra-throttler policy Mythrottle</code>	Creates a RA throttler policy called Mythrottle.
<b>Step 3</b>	<b>throttle-period 20</b> <b>Example:</b> Device (config-nd-ra-throttle)# <code>throttle-period 20</code>	Determines the time interval segment during which throttling applies.
<b>Step 4</b>	<b>max-through 5</b> <b>Example:</b> Device (config-nd-ra-throttle)# <code>max-through 5</code>	Determines how many initial RA's are allowed.
<b>Step 5</b>	<b>allow at-least 3 at-most 5</b> <b>Example:</b> Device (config-nd-ra-throttle)# <code>allow at-least 3 at-most 5</code>	Determines how many RA's are allowed after the initial RAs have been transmitted, until the end of the interval segment.
<b>Step 6</b>	<b>switch (config)# vlan configuration 100</b> <b>Example:</b> Device (config)# <code>vlan configuration 100</code>	Creates a per vlan configuration.
<b>Step 7</b>	<b>ipv6 nd ra-th attach-policy attach-policy_name</b> <b>Example:</b>	Enables the router advertisement throttling.

	Command or Action	Purpose
	Device (config)# ipv6 nd ra-throttle attach-policy attach-policy_name	
<b>Step 8</b>	<b>end</b>  <b>Example:</b> Device(config)# <b>end</b>	Returns to privileged EXEC mode. Alternatively, you can also press <b>Ctrl-Z</b> to exit global configuration mode.



## CHAPTER 150

# IPv6 Client Mobility

- [Information About IPv6 Client Mobility, on page 1409](#)
- [Prerequisites for IPv6 Client Mobility, on page 1411](#)
- [Monitoring IPv6 Client Mobility, on page 1412](#)

## Information About IPv6 Client Mobility

Link layer mobility is not enough to make wireless client Layer 3 applications continue to work seamlessly while roaming. Cisco IOSd's wireless mobility module uses mobility tunneling to retain seamless connectivity for the client's Layer 3 PoP (point of presence) when the client roams across different subnets on different switches.

IPv6 is the next-generation network layer Internet protocol intended to replace IPv4 in the TCP/IP suite of protocols. This new version increases the internet global address space to accommodate users and applications that require unique global IP addresses. IPv6 incorporates 128-bit source and destination addresses, which provide significantly more addresses than the 32-bit IPv4 addresses.

To support IPv6 clients across controllers, ICMPv6 messages must be dealt with specially to ensure the IPv6 client remains on the same Layer 3 network. The device keeps track of IPv6 clients by intercepting the ICMPv6 messages to provide seamless mobility and protect the network from network attacks. The NDP (neighbor discovery packets) packets are converted from multicast to unicast and delivered individually per client. This unique solution ensures that Neighbor Discovery and Router Advertisement packets are not leaked across VLANs. Clients can receive specific Neighbor Discovery and Router Advertisement packets ensuring correct IPv6 addressing to avoid unnecessary multicast traffic.

The configuration for IPv6 mobility is the same as IPv4 mobility and requires no separate software on the client side to achieve seamless roaming. The device must be part of the same mobility group. Both IPv4 and IPv6 client mobility are enabled by default.

IPv6 client mobility is used for the following:

- Retaining the client IPv6 multiple addresses in Layer-2 and Layer-3 roaming.
- IPv6 Neighbor Discovery Protocol (NDP) packet management.
- Client IPv6 addresses learning.



**Note** The configuration for IPv6 mobility in SDA wireless and Local mode is the same as of IPv4 mobility and requires no different software configuration on the client side to achieve seamless roaming. Refer to IPv4 mobility section for configuration information.



**Note** If ipv6 address is configured on the SVI, you should configure **ipv6 nd ra suppress all** command on all client VLAN SVI interfaces on the controller. This prevents multiple devices from advertising themselves as the routers.

## Using Router Advertisement

The Neighbor Discovery Protocol (NDP) operates in the link-layer and is responsible for the discovery of other nodes on the link. It determines the link-layer addresses of other nodes, finds the available routers, and maintains reachability information about the paths to other active neighbor nodes.

Router Advertisement (RA) is one of the IPv6 Neighbor Discovery Protocol (NDP) packets that is used by the hosts to discover available routers, acquire the network prefix to generate the IPv6 addresses, link MTU, and so on. The routers send RA on a regular basis, or in response to hosts Router Solicitation messages.

IPv6 wireless client mobility manages the IPv6 RA packet. The device forwards the link-local all-nodes multicast RA packets to the local and roaming wireless nodes mapped on same VLAN the RA was received on.

Figure 1 illustrates how a roaming client “MN” receives RA from VLAN 200 in a foreign controller and how it acquires a new IP address and breaks into L3 mobility’s point of presence.

**Figure 43: Roaming Client Receives Valid RA from Router 1**

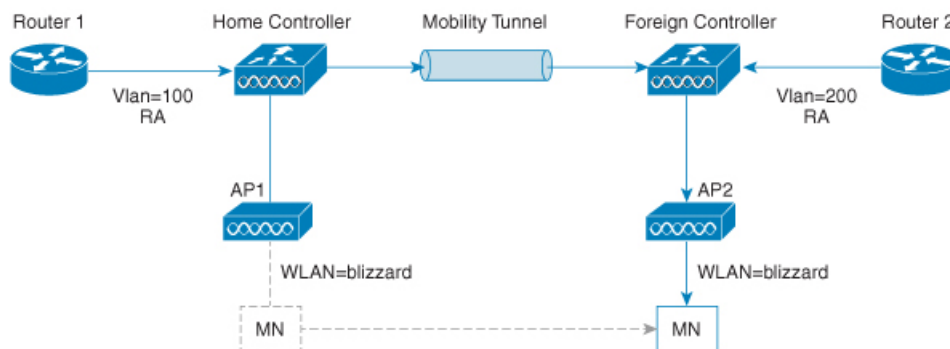

## Router Advertisement Throttling

RA throttling allows the controller to enforce limits to the RA packets headed toward the wireless network. By enabling RA throttling, routers that send multiple RA packets can be trimmed to a minimum frequency that will still maintain an IPv6 client connectivity. If a client sends an RS packet, an RA is sent back to the client. This RA is allowed through the controller and unicast to the client. This process ensures that the new clients or roaming clients are not affected by the RA throttling.

## IPv6 Address Learning

There are three ways for IPv6 client to acquire IPv6 addresses:

- Stateless Address Auto-Configuration (SLAAC)
- Stateful DHCPv6
- Static configuration

For these methods, the IPv6 client always sends NS DAD (duplicate address detection) to ensure that there is no duplicated IP address on the network. The device snoops the clients NDP and DHCPv6 packets to learn about its client IP addresses and then updates the controllers database. The database then informs the controller for the clients new IP address.

## Handling Multiple IP Addresses

In the case when the new IP address is received after RUN state, whether an addition or removal, the controller updates the new IP addresses on its local database for display purposes. Essentially, the IPv6 uses the existing or same PEM state machine code flow as in IPv4. When the IP addresses are requested by external entities, for example, from Prime Infrastructure, the controller will include all the available IP addresses, IPv4 and IPv6, in the API/SPI interface to the external entities.

An IPv6 client can acquire multiple IP addresses from stack for different purposes. For example, a link-local address for link local traffic, and a routable unique local or global address.

When the client is in the DHCP request state and the controller receives the first IP address notification from the database for either an IPv4 or IPv6 address, the PEM moves the client into the RUN state.

When a new IP address is received after the RUN state, either for addition or removal, the controller updates the new IP addresses on its local database for display purposes.

When the IP addresses are requested by external entities, for example, from Prime Infrastructure, the controller provides the available IP addresses, both IPv4 and IPv6, to the external entities.

## IPv6 Configuration

The device supports IPv6 client as seamlessly as the IPv4 clients. The administrator must manually configure the VLANs to enable the IPv6, IPv6's snooping and throttling functionality. This will enable the NDP packets to throttle between the device and its various clients.

## Prerequisites for IPv6 Client Mobility

- To enable wireless IPv6 client connectivity, the underlying wired network must support IPv6 routing and an address assignment mechanism such as SLAAC or DHCPv6. The device must have L2 adjacency to the IPv6 router, and the VLAN needs to be tagged when the packets enter the device. APs do not require connectivity on an IPv6 network, as all traffic is encapsulated inside the IPv4 CAPWAP tunnel between the AP and device.
- When using the IPv6 Client Mobility, clients must support IPv6 with either static stateless auto configuration or stateful DHCPv6 IP addressing .

- To allow smooth operation of stateful DHCPv6 IP addressing, you must have a switch or router that supports the DHCP for IPv6 feature that is configured to act like a DHCPv6 server, or you need a dedicated server such as a Windows 2008 server with a built-in DHCPv6 server.

## Monitoring IPv6 Client Mobility

The commands in Table 1 are used to monitor IPv6 Client mobility on the device.

*Table 77: Monitoring IPv6 Client Mobility Commands*

Commands	Description
<b>show wireless client summary</b>	Displays the wireless specific configuration of active clients.
<b>show wireless client mac-address (mac-addr-detail)</b>	Displays the wireless specific configuration of active clients based on their MAC address.



## CHAPTER 151

# IPv6 Support on Flex and Mesh

- [IPv6 Support on Flex + Mesh Deployment, on page 1413](#)
- [Configuring IPv6 Support for Flex + Mesh, on page 1413](#)
- [Verifying IPv6 on Flex+Mesh , on page 1415](#)

## IPv6 Support on Flex + Mesh Deployment

IPv6 is the backhaul transport of the Service Provider. The IPv6 support over flex + mesh feature is now supported on the Cisco Catalyst 9800 Series Wireless Controller . WLAN accepts IPv6 clients and forward the traffic.

## Configuring IPv6 Support for Flex + Mesh

Follow the procedure given below to enable the IPv6 routing on the controller :

### Procedure

	Command or Action	Purpose
<b>Step 1</b>	<b>configure terminal</b> <b>Example:</b> Device# configure terminal	Enters global configuration mode.
<b>Step 2</b>	<b>interface vlan <i>vlan-interface-number</i></b> <b>Example:</b> Device(config)#interface vlan 89	Creates an interface and enters the interface configuration mode.
<b>Step 3</b>	<b>shutdown</b> <b>Example:</b> Device(config-if)#shutdown	Disables the interface configuration.
<b>Step 4</b>	<b>ipv6 enable</b> <b>Example:</b> Device(config-if)#ipv6 enable	Optional. Enables IPv6 on the interface.

	Command or Action	Purpose
<b>Step 5</b>	<b>ipv6 address</b> <i>X:X:X:X::X/&lt;0-128&gt;</i> <b>Example:</b> Device(config-if)#ipv6 address 1:1:1:1::1/64	Configures IPv6 address on the interface using the IPv6 prefix option.
<b>Step 6</b>	<b>no shutdown</b> <b>Example:</b> Device(config-if)#no shutdown	Enables the IPv6 address.
<b>Step 7</b>	<b>no shutdown</b> <b>Example:</b> Device(config-if)#no shutdown	Enables the PIM dense-mode operation.
<b>Step 8</b>	<b>end</b> <b>Example:</b> Device(config-if)#end	Returns to privileged EXEC mode.
<b>Step 9</b>	<b>show ipv6 interface brief</b> <b>Example:</b> Device#show ipv6 interface brief	Verifies your entries.
<b>Step 10</b>	<b>ping ipv6</b> <i>destination-address or hostname</i> <b>Example:</b> Device#ping ipv6 1:1:1:1::10	Checks the gateway connectivity.

## Configuring Preferred IP Address as IPv6 (GUI)

### Procedure

- 
- Step 1** Choose **Configuration > Tags & Profiles > AP Join**.
  - Step 2** Click the AP Join Profile Name. The **Edit AP Join Profile** window is displayed.
  - Step 3** Choose **CAPWAP > Advanced**.
  - Step 4** From the **Preferred Mode** drop-down list, select **IPv6**.
  - Step 5** Click **Update & Apply to Device**.
-



## Configuring Preferred IP Address as IPv6

### Procedure

	Command or Action	Purpose
<b>Step 1</b>	<b>Configure Terminal</b> <b>Example:</b> Device# configure terminal	Enters global configuration mode.
<b>Step 2</b>	<b>ap profile default-ap-profile</b> <b>Example:</b> Device(config)# ap profile default-ap-profile	Enters AP profile configuration mode.
<b>Step 3</b>	<b>preferred-mode ipv6</b> <b>Example:</b> Device(config-ap-profile)# preferred-mode ipv6	Uses IPv6 to join the controller .
<b>Step 4</b>	<b>end</b> <b>Example:</b> Device(config-ap-profile)# end	Exits the configuration mode and returns to privileged EXEC mode.

## Verifying IPv6 on Flex+Mesh

To verify the IPv6 configuration on the controller , use the following **show** command:

```
Device#show ip interface brief
Interface          IP-Address      OK? Method Status          Protocol
GigabitEthernet2  unassigned     YES unset  up              up
GigabitEthernet0  unassigned     YES NVRAM  administratively down down
Capwap1           unassigned     YES unset  up              up
Capwap2           unassigned     YES unset  up              up
Vlan1             unassigned     YES NVRAM  administratively down down
Vlan89            9.10.89.90     YES NVRAM  up              up
Ewlc-9.10.89.90#show running-config interface vlan 89
Building configuration...

Current configuration : 120 bytes
!
interface Vlan89
 ip address 9.10.89.90 255.255.255.0
 ip helper-address 9.1.0.100
 no mop enabled
 no mop sysid
end
```





# CHAPTER 152

## IPv6 CAPWAP UDP Lite Support

- [Information About UDP Lite, on page 1417](#)
- [Enabling UDP Lite Support, on page 1417](#)
- [Verifying UDP Lite Support Configuration, on page 1418](#)

### Information About UDP Lite

The UDP Lite Support feature, which is an enhancement to the existing IPv6 functionality, supports the UDP Lite protocol.

This feature is only applicable to the IPv6 addresses of the controller and APs. IPv6 mandates complete payload checksum for UDP. The UDP Lite Support feature minimizes the performance impact on the controller and AP by restricting the checksum calculation coverage for the UDP Lite header to 8 bytes only.

The use of the UDP Lite Support feature impacts intermediate firewalls to allow UDP Lite protocol (protocol ID of 136) packets. Existing firewalls might not provide the option to open specific ports on UDP Lite protocol. In such cases, the administrator must open up all the ports on UDP Lite.

#### Restrictions for UDP Lite Support

- Mobility IPv6 tunnels do not support the UDP Lite Support feature.

### Enabling UDP Lite Support

The following procedure describes the steps involved in enabling UDP Lite for an AP profile.

#### Procedure

	Command or Action	Purpose
<b>Step 1</b>	<b>configure terminal</b>  <b>Example:</b> Device# <code>configure terminal</code>	Enters global configuration mode.
<b>Step 2</b>	<b>ap profile <i>ap-profile</i></b>  <b>Example:</b>	Configures an AP profile and enters AP profile configuration mode.

	Command or Action	Purpose
	Device(config)# ap profile default-ap-profile	
<b>Step 3</b>	<b>capwap udplite</b>  <b>Example:</b> Device(config-ap-profile)# capwap udplite	Enables IPv6 CAPWAP UDP Lite on the AP.  <b>Note</b> The following message is displayed after the configuration:  This feature is supported only for IPv6 data packets, APs will be rebooted.
<b>Step 4</b>	<b>end</b>  <b>Example:</b> Device(config-ap-profile)# end	Returns to privileged EXEC mode.  Alternatively, you can also press <b>Ctrl-Z</b> to exit global configuration mode.

## Verifying UDP Lite Support Configuration

To verify the CAPWAP UDP Lite status, use the following command:

```
Device# show ap profile name default-ap-profile detailed
CAPWAP UDP-Lite           : ENABLED
Lawful-Interception       : ENABLED
  LI timer                 : 60
AWIPS                     : DISABLED
AWIPS Forensic            : Unknown
Client RSSI Statistics
  Reporting                : ENABLED
  Reporting Interval       : 30 seconds
```



## CHAPTER 153

# Neighbor Discovery Proxy

---

- [Information About Neighbor Discovery](#), on page 1419
- [Configure Neighbor Discovery Proxy \(CLI\)](#), on page 1419
- [Configure Duplicate Address Detection Proxy \(CLI\)](#), on page 1420

## Information About Neighbor Discovery

In IPv6 networks, Neighbor Discovery Protocol (NDP) uses ICMPv6 messages and solicited-node multicast addresses to track and discover the other IPv6 hosts present on the other side of connected interfaces. As part of this process, a host queries for other node link-layer addresses to verify neighbor reachability using Neighbor Solicitation (NS) messages. In response to the NS messages, a Neighbor Advertisement (NA) is sent to provide information to neighbors.

## Configure Neighbor Discovery Proxy (CLI)

Neighbor Discovery (ND) Proxy is the ability of the controller to respond to the Neighbor Solicitation packet destined for wireless clients. During Neighbor Discovery suppression, the controller checks if proxy is enabled for the destined wireless clients. If proxy is enabled, the controller drops the Neighbor Solicitation packet and generates a response to the Neighbor Solicitation source in such a way that the packet appears to be coming from a wireless client. This helps in limiting the traffic to the wireless clients.

If Neighbor Discovery Proxy is not enabled, the multicast Neighbor Solicitation is converted into unicast Neighbor Solicitation with the MAC address of the target client and is forwarded to that client.



---

**Note**

- Neighbor Discovery proxy is applicable only in central switching mode.
  - A controller does not proxy the Neighbor Solicitation packet if the destination address is not that of a wireless client.
-

**Procedure**

	<b>Command or Action</b>	<b>Purpose</b>
<b>Step 1</b>	<b>configure terminal</b> <b>Example:</b> Device# configure terminal	Enters global configuration mode.
<b>Step 2</b>	<b>wireless profile policy <i>policy-profile-name</i></b> <b>Example:</b> Device(config)# wireless profile policy policy-profile1	Configures WLAN policy profile and enters wireless policy configuration mode.
<b>Step 3</b>	<b>ipv6 nd proxy full-proxy</b> <b>Example:</b> Device(config-wireless-policy)# ipv6 nd proxy full-proxy	Enables ND proxy.

## Configure Duplicate Address Detection Proxy (CLI)

The IPv6 Duplicate Address Detection (DAD) feature ensures that all the IP addresses assigned on a particular segment are unique. A proxy is required to ensure that multicast and unicast packets are not sent towards the wireless device for which it is enabled.

DAD verifies whether the host address is unique. The IPv6 DAD Proxy feature responds on behalf of the address owner when an address is in use.

However, in a scenario where nodes are restricted from talking to each other at Layer 2, DAD cannot detect a duplicate address. If DAD proxy is disabled, the multicast packet is converted into unicast and is sent to the target client.

**Note**

- DAD proxy is applicable only in central switching mode.
- A controller does not proxy the DAD NS packet if the destination address is not that of a wireless client.

**Procedure**

	<b>Command or Action</b>	<b>Purpose</b>
<b>Step 1</b>	<b>configure terminal</b> <b>Example:</b> Device# configure terminal	Enters global configuration mode.
<b>Step 2</b>	<b>wireless profile policy <i>policy-profile-name</i></b> <b>Example:</b> Device(config)# wireless profile policy policy-profile1	Configures a WLAN policy profile and enters wireless policy configuration mode.

	Command or Action	Purpose
<b>Step 3</b>	<b>ipv6 nd proxy dad-proxy</b>  <b>Example:</b> Device(config-wireless-policy)# ipv6 nd proxy dad-proxy	Enables DAD proxy.  <b>Note</b> Full proxy configuration is a superset of ND proxy and DAD proxy configuration. Hence, use the <b>ipv6 nd proxy full-proxy</b> command also to enable DAD proxy.







## CHAPTER 154

# Address Resolution Protocol Proxy

- [Information About Address Resolution Protocol](#), on page 1423
- [Configure Address Resolution Protocol Proxy \(CLI\)](#), on page 1423

## Information About Address Resolution Protocol

The address resolution protocol (ARP) is a protocol used by the Internet Protocol (IP) [RFC826], specifically IPv4, to map IP network addresses to the hardware addresses used by a data link protocol. When a wireless client sends an ARP request for an IP address of interest, the controller performs a search for that address in its database. If an entry is found in the controller database, then the ARP is converted to unicast and forwarded to that particular client. If there is no entry in the controller's database, the ARP request is flooded out to the VLAN wired ports.

## Configure Address Resolution Protocol Proxy (CLI)

ARP Proxy is the ability of the controller to respond to the ARP request packet destined for the wireless clients. During broadcast suppression, the controller checks if proxy is enabled for the destined wireless clients. If proxy is enabled, the controller drops the ARP request packet and generates a response to the source of the ARP request in a way that the packet appears to be coming from the wireless client. This helps in limiting the traffic to the wireless clients.

If ARP Proxy is not enabled, the broadcast ARP request is converted into an unicast ARP request with the MAC address of the target client, and is forwarded to only that client.



- Note**
- Proxy ARP is applicable only in central switching mode.
  - A device will not proxy the ARP request if the destination address is not that of a wireless client.

### Procedure

	Command or Action	Purpose
Step 1	configure terminal Example:	Enters global configuration mode.

	<b>Command or Action</b>	<b>Purpose</b>
	Device# configure terminal	
<b>Step 2</b>	<b>wireless profile policy <i>policy-profile-name</i></b> <b>Example:</b> Device(config)# wireless profile policy policy-profile1	Configures a WLAN policy profile and enters wireless policy configuration mode.
<b>Step 3</b>	<b>ipv4 arp-proxy</b> <b>Example:</b> Device(config-wireless-policy)# ipv4 arp-proxy	Enables ARP proxy.



# CHAPTER 155

## IPv6 Ready Certification

- [Feature History for IPv6-Ready Certification, on page 1425](#)
- [IPv6 Ready Certification, on page 1425](#)
- [Configuring IPv6 Route Information, on page 1426](#)
- [Verifying IPv6 Route Information, on page 1426](#)

### Feature History for IPv6-Ready Certification

This table provides release and related information for the feature explained in this module.

This feature is available in all the releases subsequent to the one in which it is introduced in, unless noted otherwise.

*Table 78: Feature History for IPv6-Ready Certification*

Release	Feature	Feature Information
Cisco IOS XE Bengaluru 17.6.1	IPv6-Ready Certification	This feature is enhanced with the implementation of various IPv6 functionalities that are required to comply with the latest RFC specifications.

### IPv6 Ready Certification

Cisco IOS XE Bengaluru, 17.6.1 has implemented various IPv6 functionalities that are required for compliance with the latest RFC specifications for IPv6 Ready Certification. The newly implemented IPv6 functionalities are:

- **Fragment Processing and Reassembly (RFC8200):** The first fragment must contain the mandatory extension header up to the first upper level protocol (ULP) header as specified in RFC 8200.
- **Handling Atomic Fragments in Neighbor Discovery (RFC6980):** Fragmented neighbor discovery packets must be dropped.
- **Packet too Big (RFC8201):** Atomic fragmentation is not supported. Packets failing to meet the IPv6 MTU requirement of 1280 are dropped.

- **Route Information Options (RIO) in IPv6 Router Advertisements (RFC4191):** A new RIO is added to the IPv6 Router Advertisement message for communicating specific routes from routers to hosts. Explicit route configuration ensures that only necessary routes are advertised to the hosts.
- **IPv6 Hop-by-Hop Processing (RFC 8200):** This enhancement allows explicit configuration of the nodes, along the delivery path of the packets that require hop-by-hop options header processing.

## Configuring IPv6 Route Information

The Route Information Option (RIO) in the IPv6 router advertisement messages helps in communicating specific routes from routers to hosts. This improves a host's ability to pick up an appropriate default router, when the host is multihomed and the routers are on different links. The explicit route configuration ensures that only necessary routes are advertised to the hosts.

### Procedure

	Command or Action	Purpose
<b>Step 1</b>	<b>configure terminal</b>  <b>Example:</b> Device# configure terminal	Enters global configuration mode.
<b>Step 2</b>	<b>interface interface</b>  <b>Example:</b> Device(config)# interface gigabitethernet1.1	Specifies the interface and enters interface configuration mode.
<b>Step 3</b>	<b>ipv6 nd ra specific-route prefix/length lifetime lifetime/infinity [preference preference ]</b>  <b>Example:</b> Device(config-if)# ipv6 nd ra specific-route 3::3/116 lifetime 11 preference medium	Configures RIO in IPv6 router advertisement messages.  For more information, see the <a href="#">ipv6 nd ra specific route</a> command.

## Verifying IPv6 Route Information

To identify the specific routes that are sent in the router advertisements, use the following command:

```
Device# show ipv6 nd ra specific-route
```

```
IPv6 Prefix/Length Lifetime Preference Interface
```

```
-----  
1234::12/127 1000 High GigabitEthernet2
```



## PART **XII**

### **CleanAir**

- [Cisco CleanAir, on page 1429](#)
- [Bluetooth Low Energy, on page 1445](#)
- [Persistent Device Avoidance, on page 1449](#)
- [Spectrum Intelligence, on page 1453](#)
- [Spectrum Analysis, on page 1457](#)





## CHAPTER 156

# Cisco CleanAir

- [Information About Cisco CleanAir, on page 1429](#)
- [Prerequisites for CleanAir, on page 1432](#)
- [Restrictions for CleanAir, on page 1433](#)
- [How to Configure CleanAir, on page 1433](#)
- [Verifying CleanAir Parameters, on page 1441](#)
- [Configuration Examples for CleanAir, on page 1442](#)
- [CleanAir FAQs, on page 1443](#)

## Information About Cisco CleanAir

Cisco CleanAir is a solution designed to proactively manage the challenges of a shared wireless spectrum. It allows you to see all the users of a shared spectrum (both native devices and foreign interferers). It also enables the network to act upon this information. For example, you can manually remove the interfering device, or the system can automatically change the channel away from the interference. CleanAir provides spectrum management and Radio Frequency (RF) visibility.

A Cisco CleanAir system consists of CleanAir-enabled access points and Cisco Catalyst 9800 Series Wireless Controller. These access points collect information about all the devices that operate in the industrial, scientific, and medical (ISM) bands, identify and evaluate the information as a potential interference source, and forward it to the controller. The controller controls the access points and displays the interference devices.

For every device operating in the unlicensed band, Cisco CleanAir provides information about what it is, how it is impacting your wireless network, and what actions you or your network should take. It simplifies RF so that you do not have to be an RF expert.

Wireless LAN systems operate in unlicensed 2.4-GHz and 5-GHz ISM bands. Many devices, such as microwave ovens, cordless phones, and Bluetooth devices also operate in these bands and can negatively affect the Wi-Fi operations.

Some of the most advanced WLAN services, such as voice-over-wireless and IEEE 802.11 radio communications, might be significantly impaired by the interference caused by other legal users of the ISM bands. The integration of Cisco CleanAir functionality addresses this problem of RF interference.

## Cisco CleanAir-Related Terms

Table 79: CleanAir-Related Terms

Term	Description
AQI	Air Quality Index. The AQI is an indicator of air quality, based on the RF interferences. An AQI of 0 is bad and an AQI > 85 is good.
AQR	Air Quality Report. AQRs contain information about total interference from all the identified sources represented by AQI and the summary of the most severe interference categories. AQRs are sent every 15 minutes to the Mobility Controller and every 30 seconds in the Rapid mode.
DC	Duty Cycle. Percentage of time that the channel is utilized by a device.
EDRRM	Event-Driven RRM. EDRRM allows an access point in distress to bypass normal RRM intervals and immediately change channels.
IDR	Interference Device Reports that an access point sends to the controller .
ISI	Interference Severity Index. The ISI is an indicator of the severity of the interference.
RSSI	Received Signal Strength Indicator. RSSI is a measurement of the power present in a received radio signal. It is the power at which an access point sees the interferer device.

## Cisco CleanAir Components

The basic Cisco CleanAir architecture consists of Cisco CleanAir-enabled APs and device.

Figure 44: Cisco CleanAir Solution

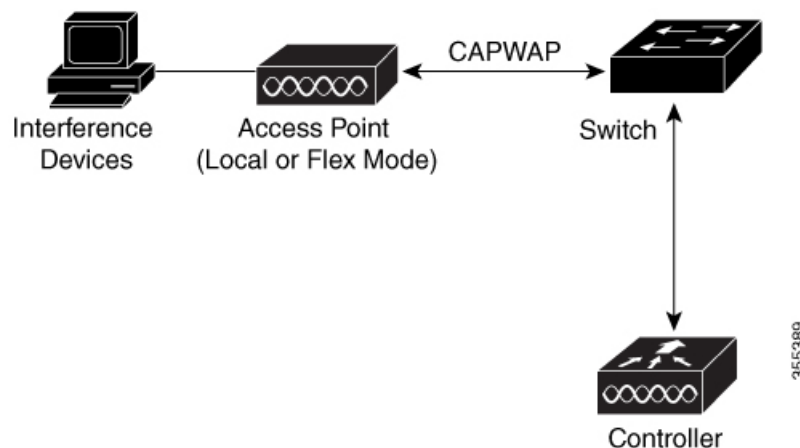

An access point equipped with Cisco CleanAir technology collects information about Wi-Fi interference sources and processes it. The access point collects and sends the Air Quality Report (AQR) and Interference Device Report (IDR) to the controller .

The controller controls and configures CleanAir-capable access points, and collects and processes spectrum data. The controller provides local user interfaces (GUI and CLI) to configure basic CleanAir features and services and display current spectrum information. The controller also detects, merges, and mitigates interference devices using RRM TPC and DCA For details, see Interference Device Merging.



The device performs the following tasks in a Cisco CleanAir system:

- Configures Cisco CleanAir capabilities on the access point.
- Provides interfaces (GUI and CLI) for configuring Cisco CleanAir features and retrieving data.
- Displays spectrum data.
- Collects and processes AQRs from the access point and stores them in the air quality database. AQRs contain information about the total interference from all the identified sources represented by the Air Quality Index (AQI) and the summary for the most severe interference categories. The CleanAir system can also include unclassified interference information under per-interference type reports that enable you to take action in scenarios where interference because of unclassified interfering devices is more.
- Collects and processes IDRs from the access point and stores them in the interference device database.



---

**Note** When Cisco CleanAir is disabled and Spectrum Intelligence (SI) is enabled in the controller, both CleanAir and Air Quality reporting are disabled. In spite of this, Air Quality is still populated for SI APs and viewed as disabled when **show ap dot11 5ghz/24ghz cleanair config** command is executed. This is an expected behavior as SI APs report Air Quality.

Here, Spectrum intelligence is a subset of CleanAir features. For more information on Spectrum Intelligence, see the *Spectrum Intelligence Deployment Guide*.

---

## Interference Types that Cisco CleanAir can Detect

Cisco CleanAir access points can detect and report severity of the interference. Spectrum event-driven RRM is one such mitigation strategy.

Wi-Fi chip-based RF management systems share these characteristics:

- Any RF energy that cannot be identified as a Wi-Fi signal is reported as noise.
- Noise measurements that are used to assign a channel plan tend to be averaged over a period of time to avoid instability or rapid changes that can be disruptive to certain client devices.
- Averaging measurements reduces the resolution of the measurement. As such, a signal that disrupts clients might not look like it needs to be mitigated after averaging.
- All RF management systems available today are reactive in nature.

Cisco CleanAir is different and can positively identify not only the source of the noise but also its potential impact to a WLAN. Having this information allows you to consider the noise within the context of the network and make intelligent and, where possible, proactive decisions. Spontaneous interference event is commonly used for CleanAir.



---

**Note** Spectrum event-driven RRM can be triggered only by Cisco CleanAir-enabled access points in local mode.

---

Spontaneous interference is interference that appears suddenly on a network, perhaps jamming a channel or a range of channels completely. The Cisco CleanAir spectrum event-driven RRM feature allows you to set a threshold for air quality (AQ) which, if exceeded, triggers an immediate channel change for the affected access

point. Most RF management systems can avoid interference, but this information takes time to propagate through the system. Cisco CleanAir relies on AQ measurements to continuously evaluate the spectrum and can trigger a move within 30 seconds. For example, if an access point detects interference from a video camera, it can recover by changing channels within 30 seconds of the camera becoming active. Cisco CleanAir also identifies and locates the source of interference so that more permanent mitigation of the device can be performed at a later time.

Microwave Ovens, Outdoor Ethernet bridges are two classes of devices that qualify as persistent, since once detected, it is likely that these devices will continue to be a random problem and are not likely to move. For these types of devices we can tell RRM of the detection and Bias the affected channel so that RRM "remembers" that there is a high potential for client impacting interference for the Detecting AP on the detected channel. For more information, see [https://www.cisco.com/c/en/us/td/docs/wireless/controller/technotes/8-3/b\\_RRM\\_White\\_Paper/b\\_RRM\\_White\\_Paper\\_chapter\\_0100.html?bookSearch=true#id\\_15217](https://www.cisco.com/c/en/us/td/docs/wireless/controller/technotes/8-3/b_RRM_White_Paper/b_RRM_White_Paper_chapter_0100.html?bookSearch=true#id_15217).

CleanAir PDA devices include:

- Microwave Oven
- WiMax Fixed
- WiMax Mobile
- Motorola Canopy

In the case of Bluetooth devices, Cisco CleanAir-enabled access points can detect and report interference only if the devices are actively transmitting. Bluetooth devices have extensive power-save modes. For example, interference can be detected when data or voice is being streamed between the connected devices.

## EDRRM and AQR Update Mode

EDRRM is a feature that allows an access point that is in distress to bypass normal RRM intervals and immediately change channels. A CleanAir access point always monitors AQ and reports the AQ every 15 minutes. AQ only reports classified interference devices. The key benefit of EDRRM is fast action time. If an interfering device is operating on an active channel and causes enough AQ degradation to trigger an EDRRM, then no clients will be able to use that channel or the access point. You must remove the access point from the channel. EDRRM is not enabled by default, you must first enable CleanAir and then enable EDRRM.

## Prerequisites for CleanAir

You can configure Cisco CleanAir only on CleanAir-enabled access points.

Only Cisco CleanAir-enabled access points using the following access point modes can perform Cisco CleanAir spectrum monitoring:

- Local—In this mode, each Cisco CleanAir-enabled access point radio provides air quality and interference detection reports for the current operating channel only. An AP can only measure air quality and interference when the AP is not busy transmitting Wi-Fi frames. This implies that CleanAir detections will be drastically lower if the AP is having a high channel utilization.
- FlexConnect—When a FlexConnect access point is connected to the controller, its Cisco CleanAir functionality is identical to local mode.

- **Monitor**—When Cisco CleanAir is enabled in monitor mode, the access point provides air quality and interference detection reports for all monitored channels.

The following options are available:

- **All**—All channels
- **DCA**—Channel selection governed by the DCA list
- **Country**—All channels are legal within a regulatory domain

## Restrictions for CleanAir

- Access points in monitor mode do not transmit Wi-Fi traffic or 802.11 packets. They are excluded from radio resource management (RRM) planning and are not included in the neighbor access point list. IDR clustering depends on the device's ability to detect neighboring in-network access points. Correlating interference device detections from multiple access points is limited between monitor-mode access points.
- For 4800 AP slot 1 5 GHz is dedicated and cannot be individually moved to monitor mode. However, slot 0 is XOR and can be moved to monitor as well as 2.4/5 GHz. Slot 2 is dedicated monitor and will operate in 5GHz and in AP monitor mode, slot 2 will be disabled because a monitor radio is already available in both 2.4/5GHz. 3700 AP has dedicated 2.4GHz (slot0) and 5GHz (slot1).
- Do not connect access points in SE connect mode directly to any physical port on the controller.
- CleanAir is not supported wherein the channel width is 160 MHz.

## How to Configure CleanAir

### Enabling CleanAir for the 2.4-GHz Band (GUI)

#### Procedure

- 
- |               |  |
|---------------|--|
| <b>Step 1</b> | Choose <b>Configuration &gt; Radio Configurations &gt; CleanAir</b>            |
| <b>Step 2</b> | On the <b>CleanAir</b> page, click the <b>me2.4 GHz Band &gt; General</b> tab. |
| <b>Step 3</b> | Check the <b>Enable CleanAir</b> checkbox.                                     |
| <b>Step 4</b> | Click <b>Apply</b> .   |
-

## Enabling CleanAir for the 2.4-GHz Band (CLI)

### Procedure

	Command or Action	Purpose
<b>Step 1</b>	<b>configure terminal</b> <b>Example:</b> Device# <code>configure terminal</code>	Enters global configuration mode.
<b>Step 2</b>	<b>ap dot11 24ghz cleanair</b> <b>Example:</b> Device(config)# <code>ap dot11 24ghz cleanair</code> Device(config)# <code>no ap dot11 24ghz cleanair</code>	Enables the CleanAir feature on the 802.11b network. Run the <b>no</b> form of this command to disable CleanAir on the 802.11b network.
<b>Step 3</b>	<b>end</b> <b>Example:</b> Device(config)# <code>end</code>	Returns to privileged EXEC mode. Alternatively, you can also press <b>Ctrl-Z</b> to exit global configuration mode.

## Configuring Interference Reporting for a 2.4-GHz Device (GUI)

### Procedure

- Step 1** Choose **Configuration > Radio Configurations > CleanAir**.
- Step 2** Click the **2.4 GHz Band** tab.
- Step 3** Choose the interference types and add them to the **Interference Types to detect** section.

The following interference types are available:

- BLE Beacon—Bluetooth low energy beacon
- Bluetooth Discovery
- Bluetooth Link
- Canopy
- Continuous Transmitter
- DECT-like Phone—Digital Enhanced Cordless Technology phone
- 802.11 FH—802.11 frequency hopping device
- WiFi Inverted—Device using spectrally inverted Wi-Fi signals
- Jammer
- Microwave Oven

- WiFi Invalid Channel—Device using nonstandard Wi-Fi channels
- TDD Transmitter
- Video Camera
- SuperAG—802.11 SuperAG device
- WiMax Mobile
- WiMax Fixed
- 802.15.4
- Microsoft Device
- SI\_FHSS

**Step 4** Click **Apply**.

## Configuring Interference Reporting for a 2.4-GHz Device (CLI)

### Procedure

	Command or Action	Purpose
<b>Step 1</b>	<b>configure terminal</b> <b>Example:</b> Device# <b>configure terminal</b>	Enters global configuration mode.
<b>Step 2</b>	<b>ap dot11 24ghz cleanair device {ble-beacon   bt-discovery   bt-link   canopy   cont-tx   dect-like   fh   inv   jammer   mw-oven   nonstd   report   superag   tdd-tx   video   wimax-fixed   wimax-mobile   xbox   zigbee }</b> <b>Example:</b> Device(config)# <b>ap dot11 24ghz cleanair device ble-beacon</b> Device(config)# <b>ap dot11 24ghz cleanair device bt-discovery</b> Device(config)# <b>ap dot11 24ghz cleanair device bt-link</b> Device(config)# <b>ap dot11 24ghz cleanair device canopy</b> Device(config)# <b>ap dot11 24ghz cleanair device cont-tx</b>	Configures the 2.4-GHz interference devices to report to the device. Run the <b>no</b> form of this command to disable the configuration. The following is a list of the keyword descriptions: <ul style="list-style-type: none"> <li>• <b>ble-beacon</b>—Bluetooth low energy beacon</li> <li>• <b>bt-discovery</b>—Bluetooth discovery</li> <li>• <b>bt-link</b>—Bluetooth link</li> <li>• <b>canopy</b>—Canopy device</li> <li>• <b>cont-tx</b>—Continuous transmitter</li> <li>• <b>dect-like</b>—Digital Enhanced Cordless Communication-like phone</li> <li>• <b>fh</b>—802.11-frequency hopping device</li> <li>• <b>inv</b>—Device using spectrally inverted Wi-Fi signals</li> </ul>

	Command or Action	Purpose
	<pre>Device(config)# ap dot11 24ghz cleanair device dect-like</pre> <pre>Device(config)# ap dot11 24ghz cleanair device fh</pre> <pre>Device(config)# ap dot11 24ghz cleanair device inv</pre> <pre>Device(config)# ap dot11 24ghz cleanair device jammer</pre> <pre>Device(config)# ap dot11 24ghz cleanair device mw-oven</pre> <pre>Device(config)# ap dot11 24ghz cleanair device nonstd</pre> <pre>Device(config)# ap dot11 24ghz cleanair device report</pre> <pre>Device(config)# ap dot11 24ghz cleanair device superag</pre> <pre>Device(config)# ap dot11 24ghz cleanair device tdd-tx</pre> <pre>Device(config)# ap dot11 24ghz cleanair device video</pre> <pre>Device(config)# ap dot11 24ghz cleanair device wimax-fixed</pre> <pre>Device(config)# ap dot11 24ghz cleanair device wimax-mobile</pre> <pre>Device(config)# ap dot11 24ghz cleanair device xbox</pre> <pre>Device(config)# ap dot11 24ghz cleanair device zigbee</pre> <pre>Device(config)# ap dot11 24ghz cleanair device alarm</pre>	<ul style="list-style-type: none"> <li>• <b>jammer</b>—Jammer</li> <li>• <b>mw-oven</b>—Microwave oven</li> <li>• <b>nonstd</b>—Device using nonstandard Wi-Fi channels</li> <li>• <b>report</b>—Interference device reporting</li> <li>• <b>superag</b>—802.11 SuperAG device</li> <li>• <b>tdd-tx</b>—TDD transmitter</li> <li>• <b>video</b>—Video camera</li> <li>• <b>wimax-fixed</b>—WiMax Fixed</li> <li>• <b>wimax-mobile</b>—WiMax Mobile</li> <li>• <b>microsoft xbox</b>—Microsoft Xbox device</li> <li>• <b>zigbee</b>—802.15.4 device</li> </ul>
<b>Step 3</b>	<pre>end</pre> <p><b>Example:</b></p> <pre>Device(config)# end</pre>	Returns to privileged EXEC mode. Alternatively, you can also press <b>Ctrl-Z</b> to exit global configuration mode.

## Enabling CleanAir for the 5-GHz Band (GUI)

### Procedure

**Step 1** Choose **Configuration > Radio Configurations > CleanAir**

- Step 2** On the **CleanAir** page, click the **me5 GHz Band > General** tab.
- Step 3** Check the **Enable CleanAir** checkbox.
- Step 4** Click **Apply**.

## Enabling CleanAir for the 5-GHz Band (CLI)

### Procedure

	Command or Action	Purpose
<b>Step 1</b>	<b>configure terminal</b> <b>Example:</b> Device# <code>configure terminal</code>	Enters global configuration mode.
<b>Step 2</b>	<b>ap dot11 5ghz cleanair</b> <b>Example:</b> Device(config)# <code>ap dot11 5ghz cleanair</code> Device(config)# <code>no ap dot11 5ghz cleanair</code>	Enables the CleanAir feature on a 802.11a network. Run the <b>no</b> form of this command to disable CleanAir on the 802.11a network.
<b>Step 3</b>	<b>end</b> <b>Example:</b> Device(config)# <code>end</code>	Returns to privileged EXEC mode. Alternatively, you can also press <b>Ctrl-Z</b> to exit global configuration mode.

## Configuring Interference Reporting for a 5-GHz Device (GUI)

### Procedure

- Step 1** Choose **Configuration > Radio Configurations > CleanAir**.
- Step 2** Click the **5 GHz Band** tab.
- Step 3** Choose the interference types and add them to the **Interference Types to detect** section.

The following interference types are available:

- Canopy
- Continuous Transmitter
- DECT-like Phone—Digital Enhanced Cordless Technology phone
- 802.11 FH—802.11 frequency hopping device
- WiFi Inverted—Device using spectrally inverted Wi-Fi signals
- Jammer
- WiFi Invalid Channel—Device using nonstandard Wi-Fi channels

- SuperAG—802.11 SuperAG device
- TDD Transmitter
- WiMax Mobile
- WiMax Fixed
- Video Camera

**Step 4** Click **Apply**.

## Configuring Interference Reporting for a 5-GHz Device (CLI)

### Procedure

	Command or Action	Purpose
<b>Step 1</b>	<b>configure terminal</b>  <b>Example:</b> Device# <b>configure terminal</b>	Enters global configuration mode.
<b>Step 2</b>	<b>ap dot11 5ghz cleanair device {canopy   cont-tx   dect-like   inv   jammer   nonstd   report   superag   tdd-tx   video   wimax-fixed   wimax-mobile}</b>  <b>Example:</b>  Device (config) # <b>ap dot11 5ghz cleanair device canopy</b>  Device (config) # <b>ap dot11 5ghz cleanair device cont-tx</b>  Device (config) # <b>ap dot11 5ghz cleanair device dect-like</b>  Device (config) # <b>ap dot11 5ghz cleanair device inv</b>  Device (config) # <b>ap dot11 5ghz cleanair device jammer</b>  Device (config) # <b>ap dot11 5ghz cleanair device nonstd</b>  Device (config) # <b>ap dot11 5ghz cleanair device report</b>  Device (config) # <b>ap dot11 5ghz cleanair device superag</b>	Configures a 5-GHz interference device to report to the device. Run the <b>no</b> form of this command to disable interference device reporting.  The following is a list of the keyword descriptions: <ul style="list-style-type: none"> <li>• <b>canopy</b>—Canopy device</li> <li>• <b>cont-tx</b>—Continuous transmitter</li> <li>• <b>dect-like</b>—Digital Enhanced Cordless Communication-like phone</li> <li>• <b>fh</b>—802.11-frequency hopping device</li> <li>• <b>inv</b>—Device using spectrally-inverted Wi-Fi signals</li> <li>• <b>jammer</b>—Jammer</li> <li>• <b>nonstd</b>—Device using nonstandard Wi-Fi channels</li> <li>• <b>superag</b>—802.11 SuperAG device</li> <li>• <b>tdd-tx</b>—TDD transmitter</li> <li>• <b>video</b>—Video camera</li> <li>• <b>wimax-fixed</b>—WiMax fixed</li> </ul>



	Command or Action	Purpose
	<pre>Device(config)#ap dot11 5ghz cleanair device tdd-tx  Device(config)#ap dot11 5ghz cleanair device video  Device(config)#ap dot11 5ghz cleanair device wimax-fixed  Device(config)#ap dot11 5ghz cleanair device wimax-mobile  Device(config)#ap dot11 5ghz cleanair device si_fhss  Device(config)#ap dot11 5ghz cleanair device alarm</pre>	<ul style="list-style-type: none"> <li>• <b>wimax-mobile</b>—WiMax mobile</li> </ul>
<b>Step 3</b>	<pre>end  Example: Device(config)# end</pre>	Returns to privileged EXEC mode. Alternatively, you can also press <b>Ctrl-Z</b> to exit global configuration mode.

## Configuring Event Driven RRM for a CleanAir Event (GUI)

### Procedure

- Step 1** Choose **Configuration > Radio Configurations > RRM**. The **Radio Resource Management** page is displayed.
- Step 2** Click the **DCA** tab.
- Step 3** In the **Event Driven RRM** section, check the **EDRRM** check box to run RRM when CleanAir-enabled AP detects a significant level of interference.
- Step 4** Configure the **Sensitivity Threshold** level at which RRM has to be invoked from the following options:
- **Low**: Represents a decreased sensitivity to changes in the environment and its value is set at 35.
  - **Medium**: Represents medium sensitivity to changes in the environment at its value is set at 50.
  - **High**: Represents increased sensitivity to changes in the environment at its value is set at 60.
  - **Custom**: If you choose this option, you must specify a custom value in the **Custom Threshold** box.
- Step 5** To configure rogue duty cycle, check the **Rogue Contribution** check box and then specify the **Rogue Duty-Cycle** in terms of percentage. The default value of rogue duty cycle is 80 percent.
- Note** Rogue Contribution is a new component included in ED-RRM functionality. Rogue Contribution allows ED-RRM to trigger based on identified Rogue Channel Utilization, which is completely separate from CleanAir metrics. Rogue Duty Cycle comes from normal off channel RRM metrics, and invokes a channel change based on neighboring rogue interference. Because this comes from RRM metrics and not CleanAir, the timing - assuming normal 180 second off channel intervals - would be within 3 minutes or 180 seconds worst case. It is configured separately from CleanAir ED-RRM and is disabled by default. This allows the AP to become reactive to Wi-Fi interference that is not coming from own network and is measured at each individual AP.

**Step 6** Save the configuration.

## Configuring EDRRM for a CleanAir Event (CLI)

### Procedure

	Command or Action	Purpose
<b>Step 1</b>	<b>configure terminal</b> <b>Example:</b> Device# <code>configure terminal</code>	Enters global configuration mode.
<b>Step 2</b>	<b>ap dot11 {24ghz   5ghz} rrm channel cleanair-event</b> <b>Example:</b> Device(config)# <code>ap dot11 24ghz rrm channel cleanair-event</code> Device(config)# <code>no ap dot11 24ghz rrm channel cleanair-event</code>	Enables EDRRM CleanAir event. Run the <b>no</b> form of this command to disable EDRRM.
<b>Step 3</b>	<b>ap dot11 {24ghz   5ghz} rrm channel cleanair-event [sensitivity {custom   high   low   medium}]</b> <b>Example:</b> Device(config)# <code>ap dot11 24ghz rrm channel cleanair-event sensitivity high</code>	Configures the EDRRM sensitivity of the CleanAir event. The following is a list of the keyword descriptions: <ul style="list-style-type: none"> <li>• <b>Custom</b>—Specifies custom sensitivity to non-Wi-Fi interference as indicated by the AQ value.</li> <li>• <b>High</b>—Specifies the most sensitivity to non-Wi-Fi interference as indicated by the AQ value.</li> <li>• <b>Low</b>—Specifies the least sensitivity to non-Wi-Fi interference as indicated by the AQ value.</li> <li>• <b>Medium</b>—Specifies medium sensitivity to non-Wi-Fi interference as indicated by the AQ value.</li> </ul>
<b>Step 4</b>	<b>end</b> <b>Example:</b> Device(config)# <code>end</code>	Returns to privileged EXEC mode. Alternatively, you can also press <b>Ctrl-Z</b> to exit global configuration mode.

## Verifying CleanAir Parameters

You can verify CleanAir parameters using the following commands:

**Table 80: Commands for verifying CleanAir**

Command Name	Description
show ap dot11 24ghz cleanair device type all	Displays all the CleanAir interferers for the 2.4-GHz band.
show ap dot11 24ghz cleanair device type ble-beacon	Displays all the Bluetooth BLE beacons for the 2.4-GHz band.
show ap dot11 24ghz cleanair device type bt-discovery	Displays CleanAir interferers of type BT Discovery for the 2.4-GHz band.
show ap dot11 24ghz cleanair device type bt-link	Displays CleanAir interferers of type BT Link for the 2.4-GHz band.
show ap dot11 24ghz cleanair device type canopy	Displays CleanAir interferers of type Canopy for the 2.4-GHz band.
show ap dot11 24ghz cleanair device type cont-tx	Displays CleanAir interferers of type Continuous transmitter for the 2.4-GHz band.
show ap dot11 24ghz cleanair device type dect-like	Displays CleanAir interferers of type DECT Like for the 2.4-GHz band.
show ap dot11 24ghz cleanair device type fh	Displays CleanAir interferers of type 802.11FH for the 2.4-GHz band.
show ap dot11 24ghz cleanair device type inv	Displays CleanAir interferers of type Wi-Fi Inverted for the 2.4-GHz band.
show ap dot11 24ghz cleanair device type jammer	Displays CleanAir interferers of type Jammer for the 2.4-GHz band.
show ap dot11 24ghz cleanair device type mw-oven	Displays CleanAir interferers of type MW Oven for the 2.4-GHz band.
show ap dot11 24ghz cleanair device type nonstd	Displays CleanAir interferers of type Wi-Fi inverted channel for the 2.4-GHz band.
show ap dot11 24ghz cleanair device type superag	Displays CleanAir interferers of type SuperAG for the 2.4-GHz band.
show ap dot11 24ghz cleanair device type tdd-tx	Displays CleanAir interferers of type TDD Transmit for the 2.4-GHz band.
show ap dot11 24ghz cleanair device type video	Displays CleanAir interferers of type Video Camera for the 2.4-GHz band.

Command Name	Description
show ap dot11 24ghz cleanair device type wimax-fixed	Displays CleanAir interferers of type WiMax Fixed for the 2.4-GHz band.

## Monitoring Interference Devices

When a CleanAir-enabled access point detects interference devices, detections of the same device from multiple sensors are merged together to create clusters. Each cluster is given a unique ID. Some devices conserve power by limiting the transmit time until actually needed, which results in the spectrum sensor to stop detecting the device temporarily. This device is then correctly marked as down. Such a device is correctly removed from the spectrum database. In cases when all the interferer detections for a specific device are reported, the cluster ID is kept alive for an extended period of time to prevent possible device-detection bouncing. If the same device is detected again, it is merged with the original cluster ID and the device-detection history is preserved.

For example, some Bluetooth headsets operate on battery power. These devices employ methods to reduce power consumption, such as turning off the transmitter when not actually needed. Such devices can appear to come and go from the classification. To manage these devices, CleanAir keeps the cluster IDs for longer and they are remerged into a single record upon detection. This process smoothens the user records and accurately represents the device history.



---

**Note** The following is a prerequisite for monitoring the interference devices:  
You can configure Cisco CleanAir only on CleanAir-enabled access points.

---

## Configuration Examples for CleanAir

This example shows how to enable CleanAir on the 2.4-GHz band and an access point operating in the channel:

```
Device#configure terminal
Device(config)#ap dot11 24ghz cleanair
Device(config)#exit
Device#ap name TAP1 dot11 24ghz cleanair
Device#end
```

This example shows how to enable an EDRRM CleanAir event in the 2.4-GHz band and configure high sensitivity to non-Wi-Fi interference:

```
Device#configure terminal
Device(config)#ap dot11 24ghz rrm channel cleanair-event
Device(config)#ap dot11 24ghz rrm channel cleanair-event sensitivity high
Device(config)#end
```

This example shows how to enable an access point in the monitor mode:

```
Device#ap name <ap-name> mode monitor
```

## CleanAir FAQs

- Q.** Multiple access points detect the same interference device. However, the device shows them as separate clusters or different suspected devices clustered together. Why does this happen?
- A.** Access points must be RF neighbors for the device to consider merging the devices that are detected by these access points. An access point takes time to establish neighbor relationships. A few minutes after the device reboots or after there is a change in the RF group, and similar events, clustering will not be very accurate.
- Q.** How do I view neighbor access points?
- A.** To view neighbor access points, use the **show ap ap\_name auto-rf dot11 {24ghz | 5ghz}** command.

This example shows how to display the neighbor access points:

```
Device#show ap name AS-5508-5-AP3 auto-rf dot11 24ghz
```

```
<snippet>
```

```
Nearby APs
```

```
AP 0C85.259E.C350 slot 0           : -12 dBm on 1 (10.10.0.5)
AP 0C85.25AB.CCA0 slot 0           : -24 dBm on 6 (10.10.0.5)
AP 0C85.25C7.B7A0 slot 0           : -26 dBm on 11 (10.10.0.5)
AP 0C85.25DE.2C10 slot 0           : -24 dBm on 6 (10.10.0.5)
AP 0C85.25DE.C8E0 slot 0           : -14 dBm on 11 (10.10.0.5)
AP 0C85.25DF.3280 slot 0           : -31 dBm on 6 (10.10.0.5)
AP 0CD9.96BA.5600 slot 0           : -44 dBm on 6 (10.0.0.2)
AP 24B6.5734.C570 slot 0           : -48 dBm on 11 (10.0.0.2)
```

```
<snippet>
```

- Q.** What are the AP debug commands available for CleanAir?
- A.** The AP debug commands for CleanAir are:
- **debug cleanair {bringup | event | logdebug | low | major | nsi | offchan}**
  - **debug rrm {neighbor | off-channel | reports}**





## CHAPTER 157

# Bluetooth Low Energy

- [Information About Bluetooth Low Energy, on page 1445](#)
- [Enabling Bluetooth Low Energy Beacon \(GUI\), on page 1446](#)
- [Enabling Bluetooth Low Energy Beacon, on page 1446](#)

## Information About Bluetooth Low Energy



**Note** This feature is not related to the Indoor IoT Services feature set that is part of Cisco Spaces.

This feature describes how Access Points and Catalyst 9800 can detect BLE devices as wireless interferers using Clean Air - not the BLE radio that is available on some Access Point models. This feature is not meant to be used for BLE-based asset tracking, environmental monitoring, or tag management use cases, which are powered using Cisco Spaces.

For full feature functionality of how BLE-related use cases are delivered in the Cisco solution, refer to Cisco Spaces configuration guides for [Indoor IoT services](#).

Bluetooth low energy (BLE) is a wireless personal area network technology aimed at enhancing location services for mobile devices. The small Bluetooth tag devices placed at strategic locations transmit universally unique identifiers (UUIDs) and, Major and Minor fields as their identity. These details are picked up by Bluetooth-enabled smartphones and devices. The location information of these devices are sent to the corresponding back-end server. Relevant advertisements and other important information are then pushed to the devices using this location-specific information.

By treating a tag device as an interferer and using the existing system capabilities, such as interference location, the tag device can be located on a map display in a wireless LAN deployment and its movement monitored. Besides this, information on missing tags can also be obtained. This feature can determine rogue and malicious tags using the unique identifier associated with each tag (or family of tags) against a predetermined allowed list from a customer. Using the management function, alerts can be displayed or emailed based on rogue tags, missing tags, or moved tags.

### Limitations of BLE Feature

- The wireless infrastructure must support Cisco CleanAir.
- Supports a maximum of only 250 unique BLE beacons (cluster entries) and 1000 device entries.

- Cisco CleanAir feature is only supported on Cisco Aironet 3700 Series Access Points with Hyperlocation module RM3010. The BLE feature on Wave 2 and Wi-Fi 6 APs works in a different manner (through cloud beacon center) and is not covered by this feature.

### Areas of Use

Since the BLE feature provides granular location details of devices (smart phones or bluetooth-enabled devices) that helps push context-sensitive advertising and other information to users. Possible areas of application include retail stores, museums, zoo, healthcare, fitness, security, advertising, and so on.

## Enabling Bluetooth Low Energy Beacon (GUI)

### Procedure

- 
- Step 1** Choose **Configuration > Radio Configurations > CleanAir > 2.4 GHz Band > General**.
  - Step 2** Check the **Enable CleanAir** check box.
  - Step 3** From the **Available Interference Types** list, select and move **BLE Beacon** to the **Interference Types to Detect** list.
  - Step 4** Click **Apply**.
- 

## Enabling Bluetooth Low Energy Beacon

Bluetooth low energy (BLE) detection is enabled by default. Use the procedure given below to enable BLE when it is disabled.

### Before you begin

- The wireless infrastructure must support Cisco CleanAir.
- Cisco CleanAir configuration and show commands are available only in Mobility Controller (MC) mode.

### Procedure

	Command or Action	Purpose
<b>Step 1</b>	<b>configure terminal</b>  <b>Example:</b> Controller# configure terminal	Enters global configuration mode.
<b>Step 2</b>	<b>[no] ap dot11 24ghz cleanair device [ble-beacon]</b>  <b>Example:</b> Controller(config)# ap dot11 24ghz cleanair device ble-beacon	Enables the BLE feature on the 802.11b network. Use the <b>no</b> form of the command to disable BLE feature on the 802.11b network.



	Command or Action	Purpose																														
<b>Step 3</b>	<b>exit</b> <b>Example:</b> Controller(config)# exit	Returns to privileged EXEC mode.																														
<b>Step 4</b>	<b>show ap dot11 24ghz cleanair config</b> <b>Example:</b> Controller# show ap dot11 24ghz cleanair config  Interference Device Settings: Interference Device Reporting..... : Enabled Bluetooth Link..... : Enabled  Microwave Oven..... : Enabled  BLE Beacon..... : Enabled	(Optional) Displays the BLE beacon configuration.																														
<b>Step 5</b>	<b>show ap dot11 24ghz cleanair device type ble-beacon</b> <b>Example:</b> Controller# show ap dot11 24ghz cleanair device type ble-beacon  DC = Duty Cycle (%) ISI = Interference Severity Index (1-Low Interference, 100-High Interference) RSSI = Received Signal Strength Index (dBm) DevID = Device ID  <table border="1"> <thead> <tr> <th>No</th> <th>ClusterID</th> <th>DevID</th> <th>Type</th> <th>ISI</th> <th>RSSI</th> </tr> <tr> <th>DC</th> <th>AP Name</th> <th>Channel</th> <th></th> <th></th> <th></th> </tr> </thead> <tbody> <tr> <td>1</td> <td>2c:92:80:00:00:22</td> <td>0xa001</td> <td>BLE Beacon</td> <td>--</td> <td>-74</td> </tr> <tr> <td>0</td> <td>5508_3_AP3600_f839</td> <td></td> <td></td> <td></td> <td></td> </tr> <tr> <td></td> <td>unknown</td> <td></td> <td></td> <td></td> <td></td> </tr> </tbody> </table>	No	ClusterID	DevID	Type	ISI	RSSI	DC	AP Name	Channel				1	2c:92:80:00:00:22	0xa001	BLE Beacon	--	-74	0	5508_3_AP3600_f839						unknown					(Optional) Displays the BLE beacon device-type information.
No	ClusterID	DevID	Type	ISI	RSSI																											
DC	AP Name	Channel																														
1	2c:92:80:00:00:22	0xa001	BLE Beacon	--	-74																											
0	5508_3_AP3600_f839																															
	unknown																															





## CHAPTER 158

# Persistent Device Avoidance

- [Information about Cisco Persistent Device Avoidance, on page 1449](#)
- [Configuring Persistent Device Avoidance \(GUI\), on page 1450](#)
- [Configuring Persistent Device Avoidance \(CLI\), on page 1450](#)
- [Verifying Persistent Device Avoidance, on page 1450](#)

## Information about Cisco Persistent Device Avoidance

The Cisco CleanAir Persistent device avoidance (PDA) feature is a part of spectrum management. Some interference devices, such as, outdoor bridges and microwave ovens, transmit signals only when required. These devices can cause significant interference to the local WLAN, because short-duration and periodic operations remain largely undetected by normal RF management metrics. With Cisco CleanAir (CleanAir), the RRM dynamic channel allocation (DCA) algorithm can detect, measure, register, and remember the impact, and adjust the RRM DCA algorithm. The PDA process minimizes the use of channels affected by persistent devices in the channel plan, local to the interference source. CleanAir detects and stores persistent device information in the controller. This information is used to mitigate the interfering channels.

**Persistent Devices Detection** - CleanAir-capable monitor mode APs collect information about persistent devices on all the configured channels and store the information in the controller. Local or bridge mode APs detect interference devices only on the serving channels.

The PDA feature works seamlessly on all platforms. All the AP models that are capable of CleanAir and Spectrum Intelligence support the PDA feature.

The supported platforms are:

- Cisco Aironet 1852 Access Points
- Cisco Aironet 1832 Access Points
- Cisco Aironet 2700 Series Access Points
- Cisco Aironet 2800 Series Access Points
- Cisco Aironet 3700 Series Access Points
- Cisco Aironet 3800 Series Access Points
- Cisco Aironet 4800 Series Access Points
- Cisco Catalyst 9115 Series Access Points

- Cisco Catalyst 9117 Series Access Points
- Cisco Catalyst 9120AX Series Access Points
- Cisco Catalyst 9124AX Series Access Points
- Cisco Catalyst 9130AX Access Points

## Configuring Persistent Device Avoidance (GUI)

### Procedure

- 
- Step 1** Choose **Configurations > Radio Configurations > RRM**
- Step 2** Click the **5 GHz Band** tab or the **2.4 GHz Band**, and click the **DCA** tab.
- Step 3** In the **DCA** window, under the **Dynamic Channel Assignment Algorithm** section, check the **Avoid Persistent Non-WiFi Interference** check box to enable the device to ignore persistent non-WiFi interference.
- Step 4** Click **Apply**.
- 

## Configuring Persistent Device Avoidance (CLI)

You can enable and disable the PDA feature and PDA propagation configuration mode through the RRM Manager.

### Procedure

	Command or Action	Purpose
<b>Step 1</b>	<b>configure terminal</b> <b>Example:</b> Device# configure terminal	Enters global configuration mode.
<b>Step 2</b>	<b>[no] ap dot11 {24ghz   5ghz} rrm channel device</b> <b>Example:</b> Device# [no] ap dot11 24ghz rrm channel device	Configures persistent non-WiFi device avoidance in the 802.11a or 802.11b channel assignment. Use the <b>no</b> form of this command to negate the command or to set its defaults.

## Verifying Persistent Device Avoidance

To verify the current state of **Device Aware** detail of the channel, use the following command:

```
Device#show ap dot11 24ghz channel
Leader Automatic Channel Assignment
Channel Assignment Mode           : AUTO
```

```

Channel Update Interval           : 600 seconds
Anchor time (Hour of the day)    : 0
Channel Update Contribution
  Noise                           : Enable
  Interference                     : Enable
  Load                            : Disable
Device Aware                   : Enable
CleanAir Event-driven RRM option : Disabled
Channel Assignment Leader        : cisco-vwlc (9.9.39.73)
Last Run                         : 166 seconds ago

DCA Sensitivity Level            : MEDIUM : 10 dB
DCA Minimum Energy Limit        : -95 dBm
Channel Energy Levels
  Minimum                         : -82 dBm
  Average                         : -82 dBm
  Maximum                         : -82 dBm
Channel Dwell Times
  Minimum                         : 8 days 0 hour 43 minutes 13 seconds
  Average                         : 8 days 0 hour 43 minutes 13 seconds
  Maximum                         : 8 days 0 hour 43 minutes 13 seconds
802.11b 2.4 GHz Auto-RF Channel List
  Allowed Channel List           : 1,6,11
  Unused Channel List           : 2,3,4,5,7,8,9,10

```

```

Device#show ap dot11 24ghz cleanair device type all
DC    = Duty Cycle (%), NA for SI APs
ISI   = Interference Severity Index (1-Low Interference, 100-High Interference), NA for SI APs
RSSI  = Received Signal Strength Index (dBm)
DevID = Device ID

```

ClusterID	Mac Address	DevID	Type	AP Type	AP Name
ISI	RSSI	DC	Channel		
a100.0000.0000	42f3.3e80.a001	0xa001	MW Oven	CA	AP-3800
11	-81	9	11		
a100.0000.0002	8bc5.4740.3001	0x3001	MW Oven	CA	AP-2800
13	-21	14	11		
a100.0000.0001	e647.20e0.3001	0x3001	MW Oven	CA	AP-4800
18	-31	12	11		

To verify all the reported interferers along with the class type, use the following command:

```

Device# show ap dot11 24ghz cleanair device type wimax-mobile
DC    = Duty Cycle (%)
ISI   = Interference Severity Index (1-Low Interference, 100-High Interference)
RSSI  = Received Signal Strength Index (dBm)
DevID = Device ID

```

ClusterID	Mac Address	DevID	Type	AP Name	ISI
RSSI	DC	Channel			
1900.0000.0006	xxxx.xxxx.xxx1	0xc001	WiMax Mobile	Cisco-AP	4
-88	1				
1900.0000.0007	xxxx.xxxx.xxx2	0xc002	WiMax Mobile	Cisco-AP	4
-88	1				

To verify the persistent device information under Auto-RF, use the following command:

```

Device#show ap auto-rf dot11 24ghz
Number of Slots      : 2
AP Name              : VANC-AP
MAC Address          : d4c9.3ce5.c760
Slot ID              : 0

```

```

Radio Type           : 802.11n - 2.4 GHz
.....
Noise Information
.....
Persistent Interference Devices
Class Type           Channel  DC (%)  RSSI (dBm)  Last Update Time
-----
MW Oven             11      NA     -71         08/22/2019 12:03:18 UTC
MW Oven             11      NA     -24         08/22/2019 12:03:19 UTC
MW Oven             11      NA     -17         08/22/2019 12:03:16 UTC
MW Oven             11      NA     -22         08/22/2019 12:03:19 UTC

```

To verify the persistent device information under Auto-RF for specific Cisco APs, use the following command:

```

Device#show ap name ap_name auto-rf dot11 24ghz

Number of Slots      : 2
AP Name              : VANC-AP
MAC Address          : d4c9.3ce5.c760
Slot ID              : 0
Radio Type           : 802.11n - 2.4 GHz
.....
Noise Information
.....
Persistent Interference Devices
Class Type           Channel  DC (%)  RSSI (dBm)  Last Update Time
-----
MW Oven             11      NA     -71         08/22/2019 12:03:18 UTC
MW Oven             11      NA     -24         08/22/2019 12:03:19 UTC
MW Oven             11      NA     -17         08/22/2019 12:03:16 UTC
MW Oven             11      NA     -22         08/22/2019 12:03:19 UTC

```

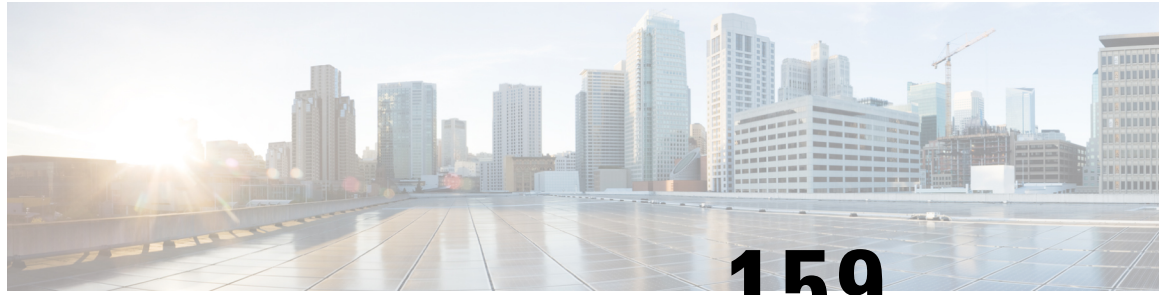

## CHAPTER 159

# Spectrum Intelligence

---

- [Spectrum Intelligence, on page 1453](#)
- [Configuring Spectrum Intelligence, on page 1454](#)
- [Verifying Spectrum Intelligence Information, on page 1454](#)
- [Debugging Spectrum Intelligence on Supported APs \(CLI\), on page 1455](#)

## Spectrum Intelligence

The Spectrum Intelligence feature scans for non-Wi-Fi radio interference on 2.4-GHz and 5-GHz bands. Spectrum intelligence provides basic functions to detect interferences of three types, namely microwave, continuous wave (like video bridge and baby monitor), wi-fi and frequency hopping (Bluetooth and frequency-hopping spread spectrum (FHSS) cordless phone).

The following Cisco access points (APs) support Spectrum Intelligence feature:

- Cisco Catalyst 9115 Series Wi-Fi 6 APs
- Cisco Aironet 1852E/I APs
- Cisco Aironet 1832I APs
- Cisco Aironet 1815W/T/I/M APs
- Cisco Aironet 1810W/T APs
- Cisco Aironet 1800I/S APs
- Cisco Aironet 1542D/I APs



---

**Note** You must enable Spectrum Intelligence feature on the Cisco Aironet 1832 and 1852 series APs to get radio details, such as noise, air-quality, interference, and radio utilization on the Cisco Catalyst Center Assurance AP health.

---

### Restrictions

- SI APs only report a single interference type in Local mode.

- SI does not support high availability for air quality or interference reports. High Availability is not supported because interference report/device reported will not be copied to standby after switchover. We expect AP to send it again, if at all interferer is still there.
- Spectrum Intelligence detects only three types of devices:
  - Microwave
  - Continuous wave—(video recorder, baby monitor)
  - SI-FHSS—(Bluetooth, Frequency hopping Digital European Cordless Telecommunications (DECT) phones)

## Configuring Spectrum Intelligence

Follow the procedure given below to configure spectrum intelligence:

### Procedure

	Command or Action	Purpose
<b>Step 1</b>	<b>configure terminal</b>  <b>Example:</b> Device# configure terminal	Enters global configuration mode.
<b>Step 2</b>	<b>ap dot11 {24ghz   5ghz} SI</b>  <b>Example:</b> Device(config)# ap dot11 24ghz SI	Configures the 2.4-GHz or 5-GHz Spectrum Intelligence feature on the 802.11a or 802.11b network.  Add <b>no</b> form of the command to disable SI on the 802.11a or 802.11b network.

## Verifying Spectrum Intelligence Information

Use the following commands to verify spectrum intelligence information:

To display the SI information for a 2.4-GHz or 5-GHz band, use the following command:

```
Device# show ap dot11 24ghz SI config

SI Solution..... : Enabled
Interference Device Settings:
  SI_FHSS..... : Enabled
Interference Device Types Triggering Alarms:
  SI_FHSS..... : Disabled
```

To display SI interferers of type Continuous transmitter for a 2.4-GHz band, use the following command:

```
Device# show ap dot11 24ghz SI device type cont_tx
RSSI = Received Signal Strength Index (dBm)
DevID = Device ID

Mac Address          DevID  Type          AP Name          RSSI  Channel
```



```
-----
xxxx.xxxx.xxxx      0xf001 Continuous TX Cisco-AP                      -47
```

To display 802.11a interference devices information for the given AP for 5-GHz, use the following command:

```
Device# show ap dot11 5ghz SI device type ap
```

```
DC      = Duty Cycle (%)
ISI     = Interference Severity Index (1-Low Interference, 100-High Interference)
RSSI    = Received Signal Strength Index (dBm)
DevID   = Device ID
AP type = CA, clean air, SI spectrum intelligence
```

```
No  ClusterID/BSSID  DevID  Type  AP Type AP Name  ISI  RSSI  DC  Channel
-----
```

To display SI interferers of type Continuous transmitter for a 5-GHz band, use the following command:

```
Device# show ap dot11 5ghz SI device type cont_tx
```

```
RSSI = Received Signal Strength Index (dBm)
DevID = Device ID
```

```
Mac Address      DevID  Type      AP Name      RSSI  Channel
-----
```

```
xxxx.xxxx.xxx1   0xf001 Continuous TX Cisco-AP                      -88
```

```
xxxx.xxxx.xxx2   0xf002 Continuous TX Cisco-AP                      -88
```

To display all Cisco CleanAir interferers for a 2.4-GHz band, use the following command:

```
Device# show ap dot11 24ghz cleanair device type all
```

## Debugging Spectrum Intelligence on Supported APs (CLI)

You need to enter these commands in the AP console. For information about APs that support this feature see [https://www.cisco.com/c/en/us/td/docs/wireless/access\\_point/feature-matrix/ap-feature-matrix.html](https://www.cisco.com/c/en/us/td/docs/wireless/access_point/feature-matrix/ap-feature-matrix.html).

### Procedure

- Generate major Spectrum Intelligence logs for an AP by entering this command:  
**debug cleanair major**
- Verify the Spectrum Intelligence scan schedule of 5 seconds on an AP by entering this command:  
**debug cleanair event**
- Generate logs at 10-minute interval, when interference is not detected or reported by the AP, by entering this command:  
**debug cleanair raw 10**

This command creates three files under **/tmp** directory from dev shell.

- spectrum.fft

- spectrum.dbg
  - spectrum.int
- 
- View the Spectrum Intelligence detected interfering devices by entering this command:  
**show cleanair interferers**
- 
- View the Spectrum Intelligence configuration status by entering this command:  
**show cleanair status**



## CHAPTER 160

# Spectrum Analysis

- [Information About Spectrum Analysis, on page 1457](#)
- [Live Spectrum Analysis, on page 1458](#)
- [Performing AP Spectrum Analysis \(GUI\), on page 1458](#)
- [Configuring Spectrum Analysis, on page 1459](#)
- [Verifying Spectrum Analysis, on page 1459](#)

## Information About Spectrum Analysis

Cisco Catalyst Center receives a spectrogram stream from access points and visualizes spectrum analysis as a real-time spectrogram view. Network administrators receive RF violation issues from end users or radio frequency issue from the Catalyst Center. To analyze a violation, you should select the corresponding AP and analyze the spectrogram stream.

Based on whether a setting is global or is meant for a specific channel, every AP uses a specific channel to communicate with clients.

When a lot of clients join on the same AP, there is a high possibility of frames getting dropped off. When there is an issue of clients dropping quickly, or not getting onboarded, you should perform the spectrum analysis to check if the channels are clogged.

You can enable spectrum analysis on every AP listed in the web UI and view the graphs based on the corresponding AP. When enabled, the APs send spectrum data to Catalyst Center which then aggregates it into 3 distinct charts.

You can view the following charts while performing a spectrum analysis:

- **Persistence Charts:** Plot the amplitude-to-power ratio of each signal at each channel for a period of five minutes. The chart is color coded with blue color representing one signal and red representing many signals. This chart also plots the opacity that represents the age of the signal data within the five minute interval, with older data being more transparent.
- **Waterfall Charts:** Plot all the signals that are analyzed in the channel for a period of five minutes with intensity on X axis, and with time represented in the Y axis. The chart is color coded, with blue color representing a low value and red representing a high value.
- **Interference and Duty Charts:** Plot the severity of detected interference for each channel band, and list the interference type. Interference is plotted as a circle, where the center represents the severity, and the radius represents the section of the channel band that is affected. The impact of the interference is measured

as severity, with values ranging from 0 to 100. The interference type is determined from RF signature identified by Cisco CleanAir technology of the interference.

## Live Spectrum Analysis

You can perform a live spectrum analysis of the AP radios, and monitor the spectrum of frequencies generated by the radios of the corresponding AP using the web UI. The live spectrum capture uses radio 2 if it is available. Otherwise, both radio 0 and radio 1 are used. When you enable live spectrum analysis on radio 2, Cisco Catalyst Center displays a consolidated view of the interference in both the 2.4 Ghz and 5 Ghz range. However, if the feature is enabled on radio 0 or radio 1, you can only view the part of the spectrum that the radios are associated with. You can select a radio in the web UI and view a live spectrum associated with this radio, for 10 minutes, and later extend the duration based on your requirement.

## Performing AP Spectrum Analysis (GUI)

### Before you begin

Use the Cisco Catalyst Center Discovery functionality to locate an AP to perform a spectrum analysis. .

### Procedure

---

- Step 1** Choose **Provision > Inventory**.  
The **Inventory** window is displayed.
- Step 2** Click **AP Name** .  
The **360 degree Device** window is displayed.
- Step 3** Click **Intelligent Capture** .
- Step 4** Click **Spectrum Analysis** to view the graphs.
- Step 5** From the **Radio** drop-down list, choose a radio.
- Step 6** Click **Start Spectrum Analysis** .  
The graphs are displayed on the web UI for you to analyze.  
To stop the analysis, click **Stop Spectrum Analysis**.
-

# Configuring Spectrum Analysis

## Procedure

	Command or Action	Purpose
<b>Step 1</b>	<b>configure terminal</b> <b>Example:</b> Device# configure terminal	Enters global configuration mode.
<b>Step 2</b>	<b>icap subscription ap rf spectrum enable</b> <b>Example:</b> Device# icap subscription ap rf spectrum enable	Configures spectrum analysis on the AP.
<b>Step 3</b>	<b>icap subscription ap rf spectrum slotnumber</b> <b>Example:</b> Device# icap subscription ap rf spectrum slot 0	Selects a radio slot to enable spectrum analysis.

## Verifying Spectrum Analysis

The following is a sample output of the **show ap icap subscription name** command that verifies spectrum analysis on a selected AP:

```
Device#show ap icap subscription name
Subscription list
-----
Full Pkt Capture : Disabled
Partial Pkt Capture : Enabled
Anomaly Event : Enabled
Debug : Disabled
Stats : Disabled
Ap Operational Data : Disabled
Sensor Message : Enabled
RRM Operational Data : Disabled
Client Events : Disabled
aWIPS Forensic Pkts: Disabled

MAC and Filters subscription list
-----
Full-packet-trace: None
Partial-packet-trace: None
Filters: None
Anomaly Detection: None

Client Stats
-----
None

RF Spectrum
```

```
-----  
Radio Slot(s) : 1
```



## PART **XIII**

# Mesh Access Points

- [Mesh Access Points, on page 1463](#)
- [Redundant Root Access Point \(RAP\) Ethernet Daisy Chaining, on page 1527](#)







## CHAPTER 161

# Mesh Access Points

---

- Introduction to the Mesh Network, on page 1465
- Restrictions for Mesh Access Points, on page 1466
- MAC Authorization, on page 1467
- Preshared Key Provisioning, on page 1468
- EAP Authentication, on page 1468
- Bridge Group Names, on page 1469
- Background Scanning, on page 1470
- Mesh Backhaul at 2.4 GHz and 5 GHz , on page 1470
- Information About Mesh Backhaul, on page 1470
- Dynamic Frequency Selection, on page 1471
- Country Codes, on page 1471
- Intrusion Detection System, on page 1472
- Mesh Interoperability Between Controllers, on page 1472
- Information About DHCP and NAT Functionality on Root AP (RAP), on page 1472
- Mesh Convergence, on page 1473
- Ethernet Bridging, on page 1473
- Multicast Over Mesh Ethernet Bridging Network, on page 1474
- Radio Resource Management on Mesh, on page 1475
- Air Time Fairness on Mesh, on page 1475
- Spectrum Intelligence for Mesh, on page 1476
- Indoor Mesh Interoperability with Outdoor Mesh, on page 1476
- Workgroup Bridge, on page 1476
- Link Test, on page 1477
- Mesh Daisy Chaining, on page 1477
- Mesh Leaf Node, on page 1478
- Flex+Bridge Mode, on page 1478
- Backhaul Client Access, on page 1478
- Mesh CAC, on page 1478
- Prerequisites for Mesh Ethernet Daisy Chaining, on page 1479
- Restrictions for Mesh Ethernet Daisy Chaining, on page 1479
- Speeding up Mesh Network Recovery Through Fast Detection of Uplink Gateway Reachability Failure, on page 1480
- Configuring MAC Authorization (GUI), on page 1480

- [Configuring MAC Authorization \(CLI\), on page 1481](#)
- [Configuring MAP Authorization - EAP \(GUI\), on page 1482](#)
- [Configuring MAP Authorization \(CLI\), on page 1483](#)
- [Configuring PSK Provisioning \(CLI\), on page 1483](#)
- [Configuring a Bridge Group Name \(GUI\), on page 1485](#)
- [Configuring a Bridge Group Name \(CLI\), on page 1485](#)
- [Configuring Background Scanning \(GUI\), on page 1486](#)
- [Configuring Background Scanning, on page 1486](#)
- [Configuring Backhaul Client Access \(GUI\), on page 1486](#)
- [Configuring Backhaul Client Access \(CLI\), on page 1487](#)
- [Configuring Dot11ax Rates on Mesh Backhaul Per Access Point \(GUI\), on page 1487](#)
- [Configuring Dot11ax Rates on Mesh Backhaul in Mesh Profile \(GUI\), on page 1488](#)
- [Configuring Wireless Backhaul Data Rate \(CLI\), on page 1488](#)
- [Configuring Data Rate Per AP \(CLI\), on page 1489](#)
- [Configuring Data Rate Using Mesh Profile \(CLI\), on page 1490](#)
- [Configuring Mesh Backhaul \(CLI\), on page 1490](#)
- [Configuring Dynamic Frequency Selection \(CLI\), on page 1491](#)
- [Configuring the Intrusion Detection System \(CLI\), on page 1491](#)
- [Configuring Ethernet Bridging \(GUI\), on page 1492](#)
- [Configuring Ethernet Bridging \(CLI\), on page 1492](#)
- [Configuring Multicast Modes over Mesh, on page 1494](#)
- [Configuring RRM on Mesh Backhaul \(CLI\), on page 1494](#)
- [Selecting a Preferred Parent \(GUI\), on page 1495](#)
- [Selecting a Preferred Parent \(CLI\), on page 1495](#)
- [Changing the Role of an AP \(GUI\), on page 1496](#)
- [Changing the Role of an AP \(CLI\), on page 1497](#)
- [Configuring the Mesh Leaf Node \(CLI\), on page 1497](#)
- [Configuring the Mesh Leaf Node \(GUI\), on page 1497](#)
- [Configuring Subset Channel Synchronization , on page 1498](#)
- [Provisioning LSC for Bridge-Mode and Mesh APs \(GUI\), on page 1498](#)
- [Provisioning LSC for Bridge-Mode and Mesh APs, on page 1499](#)
- [Specifying the Backhaul Slot for the Root AP \(GUI\), on page 1500](#)
- [Specifying the Backhaul Slot for the Root AP \(CLI\), on page 1500](#)
- [Using a Link Test on Mesh Backhaul \(GUI\), on page 1501](#)
- [Using a Link Test on Mesh Backhaul, on page 1501](#)
- [Configuring Battery State for Mesh AP \(GUI\), on page 1502](#)
- [Configuring Battery State for Mesh AP, on page 1502](#)
- [Configuring Mesh Convergence \(CLI\), on page 1502](#)
- [Configuring DHCP Server on Root Access Point \(RAP\), on page 1503](#)
- [Configuring Mesh Ethernet Daisy Chaining \(CLI\), on page 1504](#)
- [Enabling Mesh Ethernet Daisy Chaining, on page 1504](#)
- [Configuring Mesh CAC \(CLI\), on page 1505](#)
- [Configuring ATF on Mesh \(GUI\), on page 1505](#)
- [Configuring ATF on Mesh, on page 1506](#)
- [Create an ATF Policy for a MAP, on page 1506](#)
- [Creating an ATF Policy \(GUI\), on page 1507](#)

- [Adding an ATF to a Policy Profile \(GUI\), on page 1507](#)
- [Enabling ATF Mode in an RF Profile \(GUI\), on page 1507](#)
- [Configuring Fast Teardown for a Mesh AP Profile \(CLI\), on page 1508](#)
- [Flex Resilient with Flex and Bridge Mode Access Points, on page 1509](#)
- [Verifying ATF Configuration on Mesh, on page 1515](#)
- [Verifying Mesh Ethernet Daisy Chaining, on page 1516](#)
- [Verifying Mesh Convergence, on page 1516](#)
- [Verifying DHCP Server for Root AP Configuration, on page 1517](#)
- [Verifying Mesh Backhaul, on page 1517](#)
- [Verifying Mesh Configuration, on page 1518](#)
- [Verifying Dot11ax Rates on Mesh Backhaul, on page 1526](#)

## Introduction to the Mesh Network

Mesh networking employs Cisco Aironet outdoor mesh access points and indoor mesh access points along with Cisco Wireless Controller and Cisco Prime Infrastructure to provide scalability, central management, and mobility between indoor and outdoor deployments. Control and Provisioning of Wireless Access Points (CAPWAP) protocol manages the connection of mesh access points to the network.

End-to-end security within the mesh network is supported by employing Advanced Encryption Standard (AES) encryption between wireless mesh access points and Wi-Fi Protected Access 2 (WPA2) clients. For connections to a mesh access point (MAP) wireless client, such as MAP-to-MAP and MAP-to-root access point, WPA2 is applicable.

The wireless mesh terminates on two points on the wired network. The first location is where the root access point (RAP) is attached to the wired network, and where all bridged traffic connects to the wired network. The second location is where the CAPWAP controller connect to the wired network; this location is where the WLAN client traffic from the mesh network is connected to the wired network. The WLAN client traffic from CAPWAP is tunneled to Layer 2. Matching WLANs should terminate on the same switch VLAN on which the wireless controllers are co-located. The security and network configuration for each of the WLANs on the mesh depend on the security capabilities of the network to which the wireless controller is connected.

In the new configuration model, the controller has a default mesh profile. This profile is mapped to the default AP-join profile, which is in turn is mapped to the default site tag. If you are creating a named mesh profile, ensure that these mappings are put in place, and the corresponding AP is added to the corresponding site-tag.



**Important** The following are the mesh supported scenarios in IRCM from Cisco IOS XE Amsterdam 17.3 release up to Cisco IOS XE Cupertino 17.9 release, for the Cisco Wave 1 APs that are not supported:

- Cisco Wave 1 APs are not supported in the releases post Cisco IOS XE Amsterdam 17.3. This includes mesh support as well. Therefore, it is not possible for a Cisco Wave 1 AP to join a Cisco Catalyst 9800 Series Wireless Controller (controller) with Cisco IOS XE Amsterdam 17.4 and later versions. We recommend the following deployment mode for Cisco Wave 1 APs.
- In the case of Cisco mesh deployments, the following are the deployment limitations to be aware of, when the system is deployed:
  - MAP roaming is not allowed between Cisco Catalyst 9800 Series Wireless Controllers, if the controllers run different Cisco IOS XE versions (running on versions Cisco IOS XE Amsterdam 17.3 or Cisco IOS XE Cupertino 17.9) for any of the Cisco Wave 1 APs and Cisco Wave 2 APs.
  - You cannot have Cisco Wave 1 APs and Cisco Catalyst 9124 Series APs in the same mesh tree, in the releases post Cisco IOS XE Amsterdam 17.3.x. This can be achieved in 17.3.x, beginning from the 17.3.6 (upcoming) release.
  - The whole mesh tree containing Cisco Wave 1 APs must be joined to the 17.3 controller, by running the **strict-bgn** and **mac filtering** commands.



**Note** The limitations mentioned above are not valid for the Cisco Industrial Wireless 3702 Series APs which are supported until the Cisco IOS XE Cupertino 17.9 release.

## Restrictions for Mesh Access Points

The Mesh feature is supported only on the following AP platforms:

- Outdoor APs
  - Cisco Industrial Wireless 3702 Access Points (supported from Cisco IOS XE Gibraltar 16.11.1b).
  - Cisco Aironet 1542 Access Points
  - Cisco Aironet 1562 Access Points
  - Cisco Aironet 1572 Access Points
  - Cisco Catalyst IW6300 Heavy Duty Access Points
  - Cisco 6300 Series Embedded Services Access Points
  - Cisco Catalyst 9124AX Series Outdoor Access Points
- Indoor APs
  - Cisco Aironet 1815i Access Points
  - Cisco Aironet 1815m Access Points

- Cisco Aironet 1815w Access Points
- Cisco Aironet 1832i Access Points
- Cisco Aironet 1852i Access Points
- Cisco Aironet 1852e Access Points
- Cisco Aironet 2802i Access Points
- Cisco Aironet 2802e Access Points
- Cisco Aironet 3802i Access Points
- Cisco Aironet 3802e Access Points
- Cisco Aironet 3802p Access Points
- Cisco Aironet 4800 Access Points

The following mesh features are not supported:

- Serial backhaul AP support with separate backhaul radios for uplink and downlink.
- Public Safety channels (4.9-GHz band) support.
- Passive Beaconing (Anti-Stranding)



---

**Note**

- Only Root APs support SSO. MAPs will disconnect and rejoin after SSO.

The AP Stateful Switch Over (SSO) feature allows the access point (AP) to establish a CAPWAP tunnel with the Active controller and share a mirror copy of the AP database with the Standby controller. The overall goal for the addition of AP SSO support to the controller is to reduce major downtime in wireless networks due to failure conditions that may occur due to box failover or network failover.

- In a mixed regulatory domain mesh AP deployment, ensure that the Dynamic Channel Assignment (DCA) allowed channel list is supported by MAPs.
- 

## MAC Authorization

You must enter the MAC address of an AP in the controller to make a MAP join the controller. The controller responds only to those CAPWAP requests from MAPs that are available in its authorization list. Remember to use the MAC address provided at the back of the AP.

MAC authorization for MAPs connected to the controller over Ethernet occurs during the CAPWAP join process. For MAPs that join the controller over radio, MAC authorization takes place when the corresponding AP tries to secure an adaptive wireless path protocol (AWPP) link with the parent MAP. The AWPP is the protocol used in Cisco mesh networks.

The Cisco Catalyst 9800 Series Wireless Controller supports MAC authorization internally as well as using an external AAA server.

# Preshared Key Provisioning

Customers with mesh deployments can see their MAPs moving out of their network and joining another mesh network when both these mesh deployments use AAA with wild card MAC filtering to allow the association of MAPs. Since MAPs might use EAP-FAST, this cannot be controlled because a security combination of MAC address and type of AP is used for EAP, and no controlled configuration is available. The preshared key (PSK) option with a default passphrase also presents a security risk.

This issue is prominently seen in overlapping deployments of two service providers when the MAPs are used in a moving vehicle (public transportation, ferry, ship, and so on.). This way, there is no restriction on MAPs to remain with the service providers' mesh network, and MAPs can get hijacked or getting used by another service provider's network and cannot serve the intended customers of the original service providers in the deployment.

The PSK key provisioning feature enables a PSK functionality from the controller which helps make a controlled mesh deployment and enhance MAPs security beyond the default one. With this feature the MAPs that are configured with a custom PSK, will use the PSK key to do their authentication with their RAPS and controller.

# EAP Authentication

Local EAP is an authentication method that allows users and wireless clients to be authenticated locally on the controller. It is designed for use in remote offices that want to maintain connectivity with wireless clients when the backend system gets disrupted or the external authentication server goes down. When you enable local EAP, the controller serves as the authentication server and the local user database, which in turn, removes dependence on an external authentication server. Local EAP retrieves user credentials from the local user database or the LDAP backend database to authenticate users. Local EAP supports only the EAP-FAST authentication method for MAP authentication between the controller and wireless clients.

Local EAP uses an LDAP server as its backend database to retrieve user credentials for MAP authentication between the controller and wireless clients. An LDAP backend database allows the controller to query an LDAP server for the credentials (username and password) of a particular user. These credentials are then used to authenticate the user.



---

**Note** If RADIUS servers are configured on the controller, the controller tries to authenticate the wireless clients using the RADIUS servers first. Local EAP is attempted only if RADIUS servers are not found, timed out, or were not configured.

---

## EAP Authentication with LSC

Locally significant certificate-based (LSC-based) EAP authentication is also supported for MAPs. To use this feature, you should have a public key infrastructure (PKI) to control certification authority, define policies, validity periods, and restrictions and usages on the certificates that are generated, and get these certificates installed on the APs and controller.

After these customer-generated certificates or LSCs are available on the APs and controller, the devices can start using these LSCs, to join, authenticate, and derive a session key.

LSCs do not remove any preexisting certificates from an AP. An AP can have both LSC and manufacturing installed certificates (MIC). However, after an AP is provisioned with an LSC, the MIC certificate is not used during boot-up. A change from an LSC to MIC requires the corresponding AP to reboot.

The controller also supports mesh security with EAP authentication to a designated server in order to:

- Authenticate the mesh child AP
- Generate a master session key (MSK) for packet encryption.

## Bridge Group Names

Bridge group names (BGNs) control the association of MAPs to the parent mesh AP. BGNs can logically group radios to avoid two networks on the same channel from communicating with each other. The setting is also useful if you have more than one RAP in your network in the same sector (area). BGN is a string comprising a maximum of 10 characters.

A BGN of *NULL VALUE* is assigned by default during manufacturing. Although not visible to you, it allows a MAP to join the network prior to your assignment of your network-specific BGN.

If you have two RAPs in your network in the same sector (for more capacity), we recommend that you configure the two RAPs with the same BGN, but on different channels.

When Strict Match BGN is enabled on a MAP, it will scan ten times to find a matching BGN parent. After ten scans, if the AP does not find the parent with matching BGN, it will connect to the nonmatched BGN and maintain the connection for 15 minutes. After 15 minutes, the AP will again scan ten times, and this cycle continues. The default BGN functionalities remain the same when Strict Match BGN is enabled.

In Cisco Catalyst 9800 Series Wireless Controller, the BGN is configured on the mesh profile. Whenever a MAP joins the controller, the controller pushes the BGN that is configured on the mesh profile to the AP.

### Preferred Parent Selection

The preferred parent for a MAP enables you to enforce a linear topology in a mesh environment. With this feature, you can override the Adaptive Wireless Path Protocol-defined (AWPP-defined) parent selection mechanism and force a MAP to go to a preferred parent.

For Cisco Wave 1 APs, when you configure a preferred parent, ensure that you specify the MAC address of the actual mesh neighbor for the desired parent. This MAC address is the base radio MAC address that has the letter "f" as the final character. For example, if the base radio MAC address is 00:24:13:0f:92:00, then you must specify 00:24:13:0f:92:0f as the preferred parent.

```
Device# ap name ap1 mesh parent preferred 00:24:13:0f:92:0f
```

For Cisco Wave 2 APs, when you configure a preferred parent, the MAC address is the base radio MAC address that has "0x11" added to the last two characters. For example, if the base radio MAC address is 00:24:13:0f:92:00, then you must specify 00:24:13:0f:92:11 as the preferred parent.

```
Device# ap name ap1 mesh parent preferred 00:24:13:0f:92:11
```

## Background Scanning

Mesh background scanning improves convergence time, and reliability and stability of parent selection. With the help of the Background Scanning feature, a MAP can find and connect with a better potential parent across channels, and maintain its uplink with the appropriate parent all the time.

When background scanning is disabled, a MAP has to scan all the channels of the regulatory domain after detecting a parent loss in order to find a new parent and go through the authentication process. This delays the time taken for the mesh AP to connect back to the controller.

When background scanning is enabled, a MAP can avoid scanning across the channels to find a parent after detecting a parent loss, and select a parent from the neighbor list and establish the AWPP link.

## Mesh Backhaul at 2.4 GHz and 5 GHz

A backhaul is used to create only the wireless connection between MAPs. The backhaul interface is 802.11a/n/ac/g depending upon the AP. The default backhaul interface is 5-GHz. The rate selection is important for effective use of the available radio frequency spectrum. The rate can also affect the throughput of client devices. (Throughput is an important metric used by industry publications to evaluate vendor devices.)

Mesh backhaul is supported at 2.4-GHz and 5-GHz. However, in certain countries it is not allowed to use mesh network with a 5-GHz backhaul network. The 2.4-GHz radio frequencies allow you to achieve much larger mesh or bridge distances. When a RAP gets a slot-change configuration, it gets propagated from the RAP to all its child MAPs. All the MAPs get disconnected and join the new configured backhaul slot.

## Information About Mesh Backhaul

This section provides information about mesh backhaul at 2.4-GHz. By default, the backhaul interface for mesh APs is 802.11a/ac/ax. Certain countries do not allow the use of mesh network with a 5-GHz backhaul network. Even in countries where 5-GHz is permitted, we recommend that you use 2.4-GHz radio frequencies to achieve much larger mesh or bridge distances.

The Mesh backhaul at 2.4-GHz is supported on the following access points:

- Cisco Catalyst 9124AX Series Outdoor Access Point
- Cisco Aironet 1540 Series Outdoor Access Points
- Cisco Aironet 1542D Outdoor Access Points
- Cisco Aironet 1562D Outdoor Access Points
- Cisco Aironet 1562E Outdoor Access Points
- Cisco Aironet 1562I Outdoor Access Points
- Cisco Aironet 1562PS Access Points
- Cisco Aironet 1570 Series Outdoor Access Points
- Cisco Aironet 1815i Access Points
- Cisco Aironet 1815m Series Access Point



- Cisco Aironet 1830 Series Access Points
- Cisco Aironet 1850 Series Access Points
- Cisco Aironet 2800e Access Points
- Cisco Aironet 2800i Access Points
- Cisco Aironet 3800 Series Access Points
- Cisco Aironet 4800 Access Points
- Cisco Catalyst IW6300 DC Heavy Duty Access Point
- Cisco Catalyst IW6300 DCW Heavy Duty Access Point
- Cisco Catalyst IW6300 Series Heavy Duty Access Points
- Cisco 6300 Series Embedded Services Access Points



---

**Note** In Israel, you must ensure that you run the **ap country IO** command to enable the outdoor country code for the selected radio. After you configure using the **ap country IO** command, the 2.4-GHz radio is enabled and 5-GHz radio is disabled.

---

## Dynamic Frequency Selection

To protect the existing radar services, the regulatory bodies require that devices that have to share the newly opened frequency sub-band behave in accordance with the Dynamic Frequency Selection (DFS) protocol. DFS dictates that in order to be compliant, a radio device must be capable of detecting the presence of radar signals. When a radio detects a radar signal, the radio should stop transmitting for at least 30 minutes to protect that service. The radio should then select a different channel to transmit on, but only after monitoring it. If no radar is detected on the projected channel for at least one minute, the new radio service device can begin transmissions on that channel. The DFS feature allows mesh APs to immediately switch channels when a radar event is detected in any of the mesh APs in a sector.

## Country Codes

Controllers and APs are designed for use in many countries having varying regulatory requirements. The radios within the APs are assigned to a specific regulatory domain at the factory (such as -E for Europe), but the country code enables you to specify a particular country of operation (such as FR for France or ES for Spain). Configuring a country code ensures that each radio's broadcast frequency bands, interfaces, channels, and transmit power levels are compliant with country-specific regulations.

In certain countries, there is a difference in the following for indoor and outdoor APs:

- Regulatory domain code
- Set of channels supported
- Transmit power level

## Intrusion Detection System

The Cisco Intrusion Detection System/Intrusion Prevention System (CIDS/CIPS) instructs controllers to block certain clients from accessing a wireless network when attacks involving these clients are detected in Layer 3 through Layer 7. This system offers significant network protection by helping to detect, classify, and stop threats, including worms, spyware or adware, network viruses, and application abuse.

## Mesh Interoperability Between Controllers

Interoperability can be maintained between AireOS and the Cisco Catalyst 9800 Series Wireless Controller with the following support:

- MAPs can join an AireOS controller through a mesh network formed by APs connected to a Cisco Catalyst 9800 Series Wireless Controller.
- MAPs can join a Cisco Catalyst 9800 Series Wireless Controller through a mesh network formed by APs connected to as AireOS controller.
- MAP roaming is supported between parent mesh APs connected to AireOS and the Cisco Catalyst 9800 Series Wireless Controller by using PMK cache.



---

**Note** For seamless interoperability, AireOS controller and the Cisco Catalyst 9800 Series Wireless Controller should be in the same mobility group and use the image versions that support IRCM.

---

## Information About DHCP and NAT Functionality on Root AP (RAP)



---

**Note** This feature is applicable for Cisco Aironet 1542 series outdoor access points only.

---

The access points associated to a mesh network can play one of the two roles:

- Root Access Point (RAP) - An access point can be a root access point for multiple mesh networks.
- Mesh Access Point (MAP) - An access point can be a mesh access point for only one single mesh network at a time.

### DHCP and NAT Functionality on Root AP - IPv4 Scenario

This feature enables the controller to send a TLV to RAP when a new RAP joins the controller.

The following covers the workflow:

- Controller pushes TLV to RAP for enabling DHCP and NAT functionality.

- Client associates to an SSID.
- RAP executes DHCP functionality to assign private IPv4 address to the client.
- RAP executes NAT functionality to get the private IPv4 address of the client and allow access to the network.

## Mesh Convergence

Mesh convergence allows MAPs to reestablish connection with the controller, when it loses backhaul connection with the current parent. To improve the convergence time, each mesh AP maintains a subset of channels that is used for future scan-see and to identify a parent in the neighbor list subset.

The following convergence methods are supported.

**Table 81: Mesh Convergence**

Mesh Convergence	Parent Loss Detection / Keepalive Timers
Standard	21 / 3 seconds
Fast	7 / 3 seconds
Very Fast	4 / 2 seconds
Noise-tolerant-fast	21 / 3 seconds

## Noise-Tolerant Fast

Noise-tolerant fast detection is based on the failure to get a response for an AWPP neighbor request, which evaluates the current parent every 21 seconds in the standard method. Each neighbor is sent a unicast request every 3 seconds along with a request to the parent. Failure to get a response from the parent initiates either a roam if neighbors are available on the same channel or a full scan for a new parent.

## Ethernet Bridging

For security reasons, the Ethernet port on all the MAPs are disabled by default. They can be enabled only by configuring Ethernet bridging on the root and its respective MAP.

Both tagged and untagged packets are supported on secondary Ethernet interfaces.

In a point-to-point bridging scenario, a Cisco Aironet 1500 Series MAP can be used to extend a remote network by using the backhaul radio to bridge multiple segments of a switched network. This is fundamentally a wireless mesh network with one MAP and no WLAN clients. Just as in point-to-multipoint networks, client access can still be provided with Ethernet bridging enabled, although if bridging between buildings, MAP coverage from a high rooftop might not be suitable for client access. To use an Ethernet-bridged application, enable the bridging feature on the RAP and on all the MAPs in that sector.

Ethernet bridging should be enabled for the following scenarios:

- Use mesh nodes as bridges.
- Connect Ethernet devices, such as a video camera on a MAP using its Ethernet port.



**Note** Ensure that Ethernet bridging is enabled for every parent mesh AP taking the path from the mesh AP to the controller.

In a mesh environment with VLAN support for Ethernet bridging, the secondary Ethernet interfaces on MAPs are assigned a VLAN individually from the controller. All the backhaul bridge links, both wired and wireless, are trunk links with all the VLANs enabled. Non-Ethernet bridged traffic, as well as untagged Ethernet bridged traffic travels along the mesh using the native VLAN of the APs in the mesh. It is similar for all the traffic to and from the wireless clients that the APs are servicing. The VLAN-tagged packets are tunneled through AWPP over wireless backhaul links.

### VLAN Tagging for MAP Ethernet Clients

The backhaul interfaces of mesh APs are referred to as primary interfaces, and other interfaces are referred to as secondary interfaces.

Ethernet VLAN tagging allows specific application traffic to be segmented within a wireless mesh network and then forwarded (bridged) to a wired LAN (access mode) or bridged to another wireless mesh network (trunk mode).

## Multicast Over Mesh Ethernet Bridging Network

Mesh multicast modes determine how bridging-enabled APs such as MAP and RAP, send multicast packets among Ethernet LANs within a mesh network. Mesh multicast modes manage only non-CAPWAP multicast traffic. CAPWAP multicast traffic is governed by a different mechanism.

Three different mesh multicast modes are available to manage multicast and broadcast packets on all MAPs. When enabled, these modes reduce unnecessary multicast transmissions within the mesh network and conserve backhaul bandwidth.

The three mesh multicast modes are:

- Regular mode: Data is multicast across the entire mesh network and all its segments by bridging-enabled RAP and MAP.
- In-only mode: Multicast packets received from the Ethernet by a MAP are forwarded to the corresponding RAP's Ethernet network. No additional forwarding occurs, which ensures that non-CAPWAP multicasts received by the RAP are not sent back to the MAP Ethernet networks within the mesh network (their point of origin), and MAP to MAP multicasts do not occur because such multicasts are filtered out.
- In-out mode: The RAP and MAP both multicast but in a different manner.
  - If multicast packets are received at a MAP over Ethernet, they are sent to the RAP; however, they are not sent to other MAP over Ethernet, and the MAP-to-MAP packets are filtered out of the multicast.
  - If multicast packets are received at a RAP over Ethernet, they are sent to all the MAPs and their respective Ethernet networks. When the in-out mode is in operation, it is important to properly

partition your network to ensure that a multicast sent by one RAP is not received by another RAP on the same Ethernet segment and then sent back into the network.

## Radio Resource Management on Mesh

The Radio Resource Management (RRM) software embedded in the controller acts as a built-in RF engineer to consistently provide real-time RF management of your wireless network. RRM enables the controller to continually monitor the associated lightweight APs for information on traffic load, interference, noise, coverage, and other nearby APs:

The RRM measurement in the mesh AP backhaul is enabled based on the following conditions:

- Mesh AP has the Root AP role.
- Root AP has joined using Ethernet link.
- Root AP is not serving any child AP.

## Air Time Fairness on Mesh

The Air Time Fairness (ATF) on Mesh feature is conceptually similar to the ATF feature for local access points (APs). ATF is a form of wireless quality of service (QoS) that regulates downlink airtime (as opposed to egress bandwidth). Before a frame is transmitted, the ATF budget for that SSID is checked to ensure that there is sufficient airtime budget to transmit the frame. Each SSID can be thought of as having a token bucket (1 token = 1 microsecond of airtime). If the token bucket contains enough airtime to transmit the frame, it is transmitted over air. Otherwise, the frame can either be dropped or deferred. Deferring a frame means that the frame is not admitted into the Access Category Queue (ACQ). Instead, it remains in the Client Priority Queue (CPQ) and transmitted at a later time when the corresponding token bucket contains a sufficient number of tokens (unless the CPQ reaches full capacity, at which point, the frame is dropped). The majority of the work involved in the context of ATF takes place on the APs. The wireless controller is used to configure the ATF on Mesh and display the results.

In a mesh architecture, the mesh APs (parent and child MAPs) in a mesh tree access the same channel on the backhaul radio for mesh connectivity between parent and child MAPs. The root AP is connected by wire to the controller, and MAPs are connected wirelessly to the controller. Hence, all the CAPWAP and Wi-Fi traffic are bridged to the controller through the wireless backhaul radio and through RAP. In terms of physical locations, normally, RAPs are placed at the roof top and MAPs in multiple hops are placed some distance apart from each other based on the mesh network segmentation guidelines. Hence, each MAP in a mesh tree can provide 100 percent of its own radio airtime downstream to its users though each MAP accessing the same medium. Compare this to a non-mesh scenario, where neighboring local-mode unified APs in the arena next to each other in different rooms, serving their respective clients on the same channel, and each AP providing 100% radio airtime downstream. ATF has no control over clients from two different neighboring APs accessing the same medium. Similarly, it is applicable for MAPs in a mesh tree.

For outdoor or indoor mesh APs, ATF must be supported on client access radios that serve regular clients similarly to how it is supported on ATF on non-mesh unified local mode APs to serve the clients. Additionally, it must also be supported on backhaul radios which bridge the traffic to/from the clients on client access radios to RAPs (one hop) or through MAPs to RAPs (multiple hops). It is a bit tricky to support ATF on the backhaul radios using the same SSID/Policy/Weight/Client fair-sharing model. Backhaul radios do not have SSIDs and it always bridge traffic through their hidden backhaul nodes. Therefore, on the backhaul radios in a RAP or

a MAP, the radio airtime downstream is shared equally, based on the number of backhaul nodes. This approach provides fairness to users across a wireless mesh network, where clients associated to second-hop MAP can stall the clients associated to first-hop MAP where second-hop MAP is connected wireless to first-hop MAP through backhaul radio even though the Wi-Fi users in the MAPs are separated by a physical location. In a scenario where a backhaul radio has an option to serve normal clients through universal client access feature, ATF places the regular clients into a single node and groups them. It also enforces the airtime by equally sharing the radio airtime downstream, based on the number of nodes (backhaul nodes plus a single node for regular clients).

## Spectrum Intelligence for Mesh

The Spectrum Intelligence feature scans for non-Wi-Fi radio interference on 2.4-GHz and 5-GHz bands. The feature supports client serving mode and monitor mode. The Cisco CleanAir technology in mesh backhaul and access radios provides an Interference Device Report (IDR) and Air Quality Index (AQI). Two key mitigation features (Event-Driven Radio Resource Management [EDRRM] and Persistence Device Avoidance [PDA]) are present in CleanAir. Both rely directly on information that can only be gathered by CleanAir. In the client-access radio band, they work the same way in mesh networks as they do in non-mesh networks in the backhaul radio band, the CleanAir reports are only displayed on the controller. No action is taken through ED-RRM.

Note that no specific configuration options are available to enable or disable CleanAir for MAPs.

For more information about Spectrum Intelligence, see [#unique\\_1876](#) section.

## Indoor Mesh Interoperability with Outdoor Mesh

Interoperability of indoor MAPs with outdoor APs are supported. This helps to bring coverage from outdoors to indoors. However, we recommend that you use indoor MAPs for indoor use only, and deploy them outdoors only under limited circumstances such as a simple short-haul extension from an indoor WLAN to a hop in a parking lot.

Mobility groups can be shared between outdoor mesh networks and indoor WLAN networks. It is also possible for a single controller to control indoor and outdoor MAPs simultaneously. Not that the same WLANs are broadcast out of both indoor and outdoor MAPs.

## Workgroup Bridge

A workgroup bridge (WGB) is used to connect wired networks over a single wireless segment by informing the corresponding MAP of all the clients that the WGB has on its wired segment via IAPP messages. In addition to the IAPP control messages, the data packets for WGB clients contain an extra MAC address in the 802.11 header (four MAC headers, versus the normal three MAC data headers). The extra MAC in the header is the address of the workgroup bridge itself. This extra MAC address is used to route a packet to and from the corresponding clients.

APs can be configured as workgroup bridges. Only one radio interface is used for controller connectivity, Ethernet interface for wired client connectivity, and other radio interface for wireless client connectivity.

In Cisco Catalyst 9800 Series Wireless Controller, WGB acts as a client association, with the wired clients behind WGB supported for data traffic over the mesh network. Wired clients with different VLANs behind WGB are also supported.

## Link Test

A link test is used to determine the quality of the radio link between two devices. Two types of link-test packets are transmitted during a link test: request and response. Any radio receiving a link-test request packet fills in the appropriate text boxes and echoes the packet back to the sender with the response type set.

The radio link quality in the client-to-access point direction can differ from that in the access point-to-client direction due to the asymmetrical distribution of the transmit power and receive sensitivity on both sides. Two types of link tests can be performed: a ping test and a CCX link test.

With the ping link test, the controller can test link quality only in the client-to-access point direction. The RF parameters of the ping reply packets received by the access point are polled by the controller to determine the client-to-access point link quality.

With the CCX link test, the controller can also test the link quality in the access point-to-client direction. The controller issues link-test requests to the client, and the client records the RF parameters (received signal strength indicator [RSSI], signal-to-noise ratio [SNR], and so on) of the received request packet in the response packet. Both the link-test requestor and responder roles are implemented on the access point and controller. Not only can the access point or controller initiate a link test to a CCX v4 or v5 client, but a CCX v4 or v5 client can initiate a link test to the access point or controller.

## Mesh Daisy Chaining

Mesh APs have the capability to *daisy chain* APs when they function as MAPs. The *daisy chained* MAPs can either operate the APs as a serial backhaul, allowing different channels for uplink and downlink access, thus improving backhaul bandwidth, or extend universal access. Extending universal access allows you to connect a local mode or FlexConnect mode Mesh AP to the Ethernet port of a MAP, thus extending the network to provide better client access.

Daisy chained APs must be cabled differently depending on how the APs are powered. If an AP is powered using DC power, an Ethernet cable must be connected directly from the LAN port of the Primary AP to the PoE in a port of the Subordinate AP.

The following are the guidelines for the daisy chaining mode:

- Primary MAP should be configured as mesh AP.
- Subordinate MAP should be configured as root AP.
- Daisy chaining should be enabled on both primary and subordinate MAP.
- Ethernet bridging should be enabled on all the APs in the Bridge mode. Enable Ethernet bridging in the mesh profile and map all the bridge mode APs in the sector to the same mesh profile.
- VLAN support should be enabled on the wired root AP, subordinate MAP, and primary MAP along with proper native VLAN configuration.

## Mesh Leaf Node

You can configure a MAP with lower performance to work only as a leaf node. When the mesh network is formed and converged, the leaf node can only work as a child MAP, and cannot be selected by other MAPs as a parent MAP, thus ensuring that the wireless backhaul performance is not downgraded.

## Flex+Bridge Mode

Flex+Bridge mode is used to enable FlexConnect capabilities on mesh (bridge mode) APs. Mesh APs inherit VLANs from the root AP that is connected to it.

Any EWC capable AP in Flex mode connected to a MAP, should be in CAPWAP mode (AP-type CAPWAP).

You can enable or disable VLAN trunking and configure a native VLAN ID on each AP for any of the following modes:

- FlexConnect
- Flex+Bridge (FlexConnect+Mesh)

## Backhaul Client Access

When Backhaul Client Access is enabled, it allows wireless client association over the backhaul radio. The backhaul radio can be a 2.4-GHz or 5-GHz radio. This means that a backhaul radio can carry both backhaul traffic and client traffic.

When Backhaul Client Access is disabled, only backhaul traffic is sent over the backhaul radio, and client association is performed only over the access radio.



---

**Note** Backhaul Client Access is disabled by default. After the Backhaul Client Access is enabled, all the MAPs, except subordinate AP and its child APs in daisy-chained deployment, reboot.

---

## Mesh CAC

The Call Admission Control (CAC) enables a mesh access point to maintain controlled quality of service (QoS) on the controller to manage voice quality on the mesh network. Bandwidth-based, or static CAC enables the client to specify how much bandwidth or shared medium time is required to accept a new call. Each access point determines whether it is capable of accommodating a particular call by looking at the bandwidth available and compares it against the bandwidth required for the call. If there is not enough bandwidth available to maintain the maximum allowed number of calls with acceptable quality, the mesh access point rejects the call.

- When client roams from one MAP to another in same site, bandwidth availability is checked again in the new tree for the active calls.



- When MAP roams to new parent, the active calls are not terminated and it continues to be active with other active calls in the sub tree.
- High Availability (HA) for MAPs is not supported; calls attached to MAP's access radio are terminated on HA switchover.
- HA for RAP is supported, hence calls attached to RAP's access radio continues to be active in new controller after switchover.
- Mesh CAC algorithm is applicable only for voice calls.
- For Mesh backhaul radio bandwidth calculation, static CAC is applied. Load-based CAC is not used as the APs do not support load-based CAC in Mesh backhaul.
- Calls are allowed based on available bandwidth on a radio. Airtime Fairness (ATF) is not accounted for call admission and the calls that fall under ATF policy are given bandwidth as per ATF weight.

Mesh CAC is not supported for the following scenarios.

- APs in a Mesh tree assigned with different site tags.
- APs in a Mesh tree assigned with the default site tag.

## Prerequisites for Mesh Ethernet Daisy Chaining

- Ensure that you have configured the AP role as root AP.
- Ensure that you have enabled Ethernet Bridging and Strict Wired Uplink on the corresponding AP.
- Ensure that you have disabled VLAN transparency.
- To enable VLAN support on each root AP for bridge mode APs, use the **ap name name-of-rap mesh vlan-trunking [native] vlan-id** command to configure a trunk VLAN on the corresponding RAP.
- To enable VLAN support on each root AP, for Flex+Bridge APs, you must configure the native VLAN ID under the corresponding flex profile.
- Ensure that you use a 4-pair cables that support 1000 Mbps. This feature does not work properly with 2-pair cables supporting 100 Mbps.

## Restrictions for Mesh Ethernet Daisy Chaining

- This feature is applicable to the Cisco Industrial Wireless 3702 AP and Cisco Catalyst 9124 Series APs.
- This feature is applicable to APs operating in Bridge mode and Flex+Bridge mode only.
- In Flex+Bridge mode, if local switching WLAN is enabled, the work group bridge (WGB) multiple VLAN is not supported.
- To support the Ethernet daisy chain topology, you must not connect the Cisco Industrial Wireless 3702 PoE out port to other Cisco Industrial Wireless 3702 PoE in the port, and the power injector must be used as power supply for the AP.

- The network convergence time increases when the number of APs increase in the chain.
- Any EWC capable AP which is part of daisy chaining and has been assigned the RAP role, must be in CAPWAP mode (ap-type capwap).

## Speeding up Mesh Network Recovery Through Fast Detection of Uplink Gateway Reachability Failure

In all 802.11ac Wave 2 APs, the speed of mesh network recovery mechanism is increased through fast detection of uplink gateway reachability failure. The uplink gateway reachability of the mesh APs is checked using ICMP ping to the default gateway, either IPv4 or IPv6.

Mesh AP triggers the reachability check in the following two scenarios:

- After a new uplink is selected, until the mesh AP joins the controller

After a new uplink is selected, the mesh AP has a window of 45 seconds to reach gateway (via static IP or DHCP) through the selected uplink. If the mesh AP still fails to reach the gateway after 45 seconds, the current uplink is in blocked list and the uplink selection process is restarted. If the AP joins the controller within this 45-second window, the reachability check is stopped. Subsequently, there is no gateway reachability check during normal operations.

- As soon as the mesh AP times out its connection with the controller

After the mesh AP times out its connection with the controller and the AP fails to reach the gateway in 5 seconds, the current uplink is immediately added to the blocked list and the uplink selection process is restarted.

## Configuring MAC Authorization (GUI)

### Procedure

**Step 1** Choose **Configuration > Security > AAA > AAA Advanced > Device Authentication**.

**Step 2** Click **Add**.

The **Quick Step: MAC Filtering** window is displayed.

**Step 3** In the **Quick Step: MAC Filtering** window, complete the following:

- Enter the **MAC Address**. The MAC address can be in either `xx:xx:xx:xx:xx:xx`, `xx-xx-xx-xx-xx-xx`, or `xxxx.xxxx.xxxx` format.
- Choose the **Attribute List Name** from the drop-down list.
- Choose the **WLAN Profile Name** from the drop-down list.
- Click **Apply to Device**.

Both WebUI and CLI support mac user configuration in one of these formats: `xxxxxxxxxxxx`, `xx:xx:xx:xx:xx:xx`, `xx-xx-xx-xx-xx-xx`, or `xxxx.xxxx.xxxx` where AP sends the default mac address without delimiter. If the mac address is configured with delimiter, then AP authorization will fail unless it is configured in the format: `xxxxxxxxxxxx`.

- Step 4** Choose **Configuration > Security > AAA > AAA Method List > Authorization**.
- Step 5** Click **Add**.  
The **Quick Step: AAA Authorization** window is displayed.
- Step 6** In the **Quick Step: AAA Authorization** window, complete the following:
- Enter the **Method List Name**.
  - Choose the **Type** from the drop-down list.
  - Choose the **Group Type** from the drop-down list.
  - Check the **Fallback to Local** check box.
  - Check the **Authenticated** check box.
  - Move the required servers from the **Available Server Groups** to the **Assigned Server Groups**.
  - Click **Apply to Device**.
- Step 7** Choose **Configuration > Wireless > Mesh > Profiles**.
- Step 8** Click the mesh profile.  
The **Edit Mesh Profile** window is displayed.
- Step 9** Click the **Advanced** tab.
- Step 10** In the **Security** settings, from the **Method** drop-down list, choose **EAP**.
- Step 11** Choose the **Authentication Method** from the drop-down list.
- Step 12** Choose the **Authorization Method** from the drop-down list.
- Step 13** Click **Update & Apply to Device**.

## Configuring MAC Authorization (CLI)

Follow the procedure given below to add the MAC address of a bridge mode AP to the controller.

### Before you begin

- MAC filtering for bridge mode APs are enabled by default on the controller. Therefore, only the MAC address need to be configured. The MAC address that is to be used is the one that is provided at the back of the corresponding AP.
- MAC authorization is supported internally, as well as using an external AAA server.

### Procedure

	Command or Action	Purpose
<b>Step 1</b>	<b>configure terminal</b>  <b>Example:</b> Device# configure terminal	Enters global configuration mode.
<b>Step 2</b>	<b>username <i>user-name</i></b>  <b>Example:</b> Device(config)# username username1	Configures user name authentication for MAC filtering where username is MAC address.

	Command or Action	Purpose
<b>Step 3</b>	<b>aaa authorization credential-download</b> <i>method-name local</i>  <b>Example:</b> <pre>Device(config)# aaa authorization credential-download list1 local</pre>	Sets an authorization method list to use local credentials.
<b>Step 4</b>	<b>aaa authorization credential-download</b> <i>method-name radius group server-group-name</i>  <b>Example:</b> <pre>Device(config)# aaa authorization credential-download auth1 radius group radius-server-1</pre>	Sets an authorization method list to use a RADIUS server group.
<b>Step 5</b>	<b>wireless profile mesh</b> <i>profile-name</i>  <b>Example:</b> <pre>Device(config)# wireless profile mesh mesh1</pre>	Configures a mesh profile and enters mesh profile configuration mode.
<b>Step 6</b>	<b>method authorization</b> <i>method-name</i>  <b>Example:</b> <pre>Device(config-wireless-mesh-profile)# method authorization auth1</pre>	Configures the authorization method for mesh AP authorization.

## Configuring MAP Authorization - EAP (GUI)

### Procedure

- 
- Step 1** Choose **Configuration > Security > AAA > AAA Method List > Device Authentication**.
  - Step 2** Click **Add**.
  - Step 3** Enter **Method List Name**.
  - Step 4** Choose **Type** as dot1x and **Group Type** from the drop-down lists.  
dot1x
  - Step 5** Check or uncheck the **Fallback to Local** check box.
  - Step 6** Move the required servers from the **Available Server Groups** to the **Assigned Server Groups**.
  - Step 7** Click **Apply to Device**.
  - Step 8** Choose **Configuration > Wireless > Mesh > Profiles**.
  - Step 9** Click the mesh profile. The **Edit Mesh Profile** window is displayed.
  - Step 10** Choose the **Advanced** tab.
  - Step 11** In the **Security** settings, from the **Method** drop-down list, choose **EAP**.
  - Step 12** Choose the options from the **Authentication Method** and **Authorization Method** drop-down lists.

**Step 13** Click **Update & Apply to Device**.

## Configuring MAP Authorization (CLI)

Select and configure authentication method of EAP/PSK for MAP authentication.

### Procedure

	Command or Action	Purpose
<b>Step 1</b>	<b>configure terminal</b>  <b>Example:</b> Device# configure terminal	Enters global configuration mode.
<b>Step 2</b>	<b>aaa authentication <i>method-name</i> radius group <i>server-group-name</i></b>  <b>Example:</b> Device(config)# aaa authentication dot1x auth1 radius group radius-server-1	For local authentication:  Device(config)# aaa authentication dot1x auth1 local  Sets an authentication method list to use a RADIUS server group. This is required for EAP authentication.
<b>Step 3</b>	<b>wireless profile mesh <i>profile--name</i> local</b>  <b>Example:</b> Device(config)# wireless profile mesh mesh1	Sets an authorization method list to use local credentials.
<b>Step 4</b>	<b>security eap <i>server-group-name</i></b>  <b>Example:</b> Device(config-wireless-mesh-profile)# security eap / psk	Configures the mesh security EAP/PSK for mesh AP.
<b>Step 5</b>	<b>method authentication <i>method-name</i></b>  <b>Example:</b> Device(config-wireless-mesh-profile)# method authentication auth1	Configures the authentication method for mesh AP authentication.

## Configuring PSK Provisioning (CLI)

When PSK provisioning is enabled, the APs join with default PSK initially. After that PSK provisioning key is set, the configured key is pushed to the newly joined AP.

Follow the procedure given below to configure a PSK:

### Before you begin

The provisioned PSK should have been pushed to all the APs that are configured with PSK as mesh security.



- Note**
- PSKs are saved across reboots in the controller as well as on the corresponding mesh AP.
  - A controller can have total of five PSKs and one default PSK.
  - A mesh AP deletes its provisioned PSK only on factory reset.
  - A mesh AP never uses the default PSK after receiving the first provisioned PSK.

### Procedure

	Command or Action	Purpose
<b>Step 1</b>	<b>configure terminal</b> <b>Example:</b> Device# configure terminal	Enters global configuration mode.
<b>Step 2</b>	<b>wireless mesh security psk provisioning</b> <b>Example:</b> Device(config)# wireless mesh security psk provisioning	Configures the security method for wireless as PSK. <b>Note</b> The provisioned PSK is pushed only to those APs that are configured with PSK as the mesh security method.
<b>Step 3</b>	<b>wireless mesh security psk provisioning key index {0   8} pre-shared-key description</b> <b>Example:</b> Device(config)# wireless mesh security psk provisioning key 1 0 secret secret-key	Configures a new PSK for mesh APs.
<b>Step 4</b>	<b>wireless mesh security psk provisioning default-psk</b> <b>Example:</b> Device(config)# wireless mesh security psk provisioning default-psk	Enables default PSK-based authentication.
<b>Step 5</b>	<b>wireless mesh security psk provisioning inuse index</b> <b>Example:</b> Device(config)# wireless mesh security psk provisioning inuse 1	Specifies the PSK to be actively used. <b>Note</b> You should explicitly set the in-use key index in the global configuration pointing to the PSK index.

## Configuring a Bridge Group Name (GUI)

### Procedure

- 
- Step 1** Choose **Configuration > Wireless > Mesh > Profiles**
- Step 2** Click **Add**.
- Step 3** In the **Advanced** tab, under the **Bridge Group** settings, enter the **Bridge Group Name**.
- Step 4** Under the **Bridge Group** settings, check the **Strict Match** check box to enable the feature. When Strict Match BGN is enabled on a MAP, it scans ten times to find a matching BGN parent.
- Step 5** Click **Apply to Device**.
- 

## Configuring a Bridge Group Name (CLI)

- If a bridge group name (BGN) is configured on a mesh profile, whenever a MAP joins the controller, it pushes the BGN configured on the mesh profile to the AP.
- Whenever a mesh AP moves from AireOS controller to the Cisco Catalyst 9800 Series Wireless Controller, the BGN configured on the mesh profile is pushed to that AP and stored there.

### Procedure

	Command or Action	Purpose
<b>Step 1</b>	<b>configure terminal</b>  <b>Example:</b> Device# configure terminal	Enters global configuration mode.
<b>Step 2</b>	<b>wireless profile mesh <i>profile-name</i></b>  <b>Example:</b> Device(config)# wireless profile mesh mesh1	Configures a mesh profile and enters mesh profile configuration mode.
<b>Step 3</b>	<b>bridge-group name <i>bridge-grp-name</i></b>  <b>Example:</b> Device(config-wireless-mesh-profile)# bridge-group name bgn1	Configures a bridge group name.
<b>Step 4</b>	<b>bridge-group strict-match</b>  <b>Example:</b> Device(config-wireless-mesh-profile)# bridge-group strict-match	Configures bridge group strict matching.

# Configuring Background Scanning (GUI)

## Procedure

- Step 1** Choose **Configuration > Wireless > Mesh > Profiles**
- Step 2** Choose a profile.
- Step 3** In **General** tab, check the **Background Scanning** check box.
- Step 4** Click **Update & Apply to Device**.

# Configuring Background Scanning

## Procedure

	Command or Action	Purpose
<b>Step 1</b>	<b>configure terminal</b>  <b>Example:</b> Device# configure terminal	Enters global configuration mode.
<b>Step 2</b>	<b>wireless profile mesh <i>profile-name</i></b>  <b>Example:</b> Device(config)# wireless profile mesh mesh1	Configures a mesh profile and enters mesh profile configuration mode.
<b>Step 3</b>	<b>background-scanning</b>  <b>Example:</b> Device(config-wireless-mesh-profile)# background-scanning	Configures background scanning in mesh deployments.

# Configuring Backhaul Client Access (GUI)

## Procedure

- Step 1** Choose **Configuration > Wireless > Mesh > Profiles**
- Step 2** Choose a profile.
- Step 3** In **General** tab, check the **Backhaul Client Access** check box.
- Step 4** Click **Update & Apply to Device**.



## Configuring Backhaul Client Access (CLI)



**Note** Backhaul client access is disabled by default. After it is enabled, all the MAPs, except subordinate AP and its child APs in daisy-chained deployment, reboot.

Follow the procedure given below to enable backhaul client access on a mesh profile:

### Procedure

	Command or Action	Purpose
<b>Step 1</b>	<b>configure terminal</b>  <b>Example:</b> Device# configure terminal	Enters global configuration mode.
<b>Step 2</b>	<b>wireless profile mesh <i>profile-name</i></b>  <b>Example:</b> Device(config)# wireless profile mesh mesh1	Configures a mesh profile and enters mesh profile configuration mode.
<b>Step 3</b>	<b>client-access</b>  <b>Example:</b> Device(config-wireless-mesh-profile)# client-access	Configures backhaul with client access AP.

## Configuring Dot11ax Rates on Mesh Backhaul Per Access Point (GUI)

### Procedure

- Step 1** Choose **Configuration > Wireless > Access Points**.  
The **All Access Points** section, which lists all the configured APs in the network, is displayed with their corresponding details.
- Step 2** Click the configured mesh AP.  
The **Edit AP** window is displayed.
- Step 3** Choose the **Mesh** tab.
- Step 4** In the **General** section, under the **Backhaul** section, the default **Backhaul Radio Type**, **Backhaul Slot ID**, and **Rate Types** field details are displayed. Note that the values for **Backhaul Radio Type** and **Backhaul Slot ID** can be changed only for a root AP.
- Step 5** From the **Rate Types** drop-down list, choose the backhaul rate type.

Based on the choice, enter the details for the corresponding fields that are displayed. The backhaul interface varies between auto and 802.11a/b/g/n/ac/ax rates depending upon the AP. Cisco Catalyst 9124AX Outdoor Access Point is the only AP that support 11ax backhaul rates on the mesh backhaul.

- Step 6** In the **Backhaul MCS Index** field, enter the Modulation Coding Scheme (MCS) rate, that can be transmitted between the APs. The valid range is from 0 to 11, on both the bands.
- Step 7** In the **Spatial Stream** field, enter the number of spatial streams that are supported. The maximum number of spatial streams supported on a single radio in a 5-GHz radio band is 8, while 2.4-GHz radio band supports 4 spatial streams.
- Step 8** Click **Update and Apply to Device**.

## Configuring Dot11ax Rates on Mesh Backhaul in Mesh Profile (GUI)

### Procedure

- Step 1** Choose **Configuration > Wireless > Mesh > Profiles**.
- Step 2** Click **Add**.  
The **Add Mesh Profile** window is displayed.
- Step 3** In the **Add Mesh Profile** window, click the **General** tab.
- Step 4** In the **Name** field, enter the mesh profile name.
- Step 5** Click the **Advanced** tab.
- Step 6** In the **5 GHz Band Backhaul** section and the **2.4 GHz Band Backhaul** section, choose the **dot11ax** backhaul rate type from **Rate Types** the drop-down list.  
**Note** Cisco Catalyst 9124AXI/D Series outdoor Access Point is the only AP to support 11ax backhaul rates on the mesh backhaul.
- Step 7** In the **Dot11ax MCS index** field, specify the MCS rate at which data can be transmitted between the APs. The value range is between 0 to 11, on both the radio bands.
- Step 8** In the **Spatial Stream** field, enter a value. The maximum number of spatial streams supported on a single radio in a 5-GHz radio band is 8, while 2.4- GHz radio band supports 4 spatial streams.
- Step 9** Click **Update and Apply to Device**.

## Configuring Wireless Backhaul Data Rate (CLI)

Backhaul is used to create a wireless connection between APs. A backhaul interface can be 802.11bg/a/n/ac depending on the AP. The rate selection provides for effective use of the available RF spectrum. Data rates can also affect the RF coverage and network performance. Lower data rates, for example, 6 Mbps, can extend farther from the AP than can have higher data rates, for example, 1300 Mbps. As a result, the data rate affects cell coverage, and consequently, the number of APs required.



**Note** You can configure backhaul data rate, preferably, through the mesh profile. In certain cases, where a specific data rate is needed, use the command to configure the data rate per AP.

Follow the procedure given below to configure wireless backhaul data rate in privileged EXEC mode or in mesh profile configuration mode.

#### Procedure

	Command or Action	Purpose
<b>Step 1</b>	<b>enable</b> <b>Example:</b> Device> enable	Enters privileged EXEC mode.
<b>Step 2</b>	<b>ap name</b> <i>ap-name</i> <b>mesh backhaul rate</b> { <b>auto</b>   <b>dot11abg</b>   <b>dot11ac</b>   <b>dot11n</b> } <b>Example:</b> Device# #ap name ap1 mesh backhaul rate auto	Configures backhaul transmission rate.
<b>Step 3</b>	<b>wireless profile mesh</b> <i>profile-name</i> <b>Example:</b> Device(config)# wireless profile mesh mesh1	Configures a mesh profile and enters mesh profile configuration mode.
<b>Step 4</b>	<b>backhaul rate dot11</b> { <b>24ghz</b>   <b>5ghz</b> } <b>dot11n RATE_6M</b> <b>Example:</b> Device(config-wireless-mesh-profile)# backhaul rate dot11 5ghz dot11n mcs 31	Configures backhaul transmission rate. <b>Note</b> Note that the rate configured on the AP (step 2) should match with the rate configured on the mesh profile (step4).

## Configuring Data Rate Per AP (CLI)

#### Procedure

	Command or Action	Purpose
<b>Step 1</b>	<b>enable</b> <b>Example:</b> Device> enable	Enters privileged EXEC mode.
<b>Step 2</b>	<b>ap name</b> <i>ap-name</i> <b>mesh backhaul rate dot11ax mcs</b> <0-11> <b>ss</b> <1-8> <b>Example:</b>	Configures mesh backhaul 11ax rates for 2.4-GHz and 5-GHz bands.

	Command or Action	Purpose
	Device# ap name ap1 mesh backhaul rate dot11ax 5 ss 4	

## Configuring Data Rate Using Mesh Profile (CLI)

### Procedure

	Command or Action	Purpose
<b>Step 1</b>	<b>configure terminal</b> <b>Example:</b> Device# configure terminal	Enters global configuration mode.
<b>Step 2</b>	<b>wireless profile mesh <i>profile-name</i></b> <b>Example:</b> Device(config)# wireless profile mesh mesh1	Configures a mesh profile and enters mesh profile configuration mode.
<b>Step 3</b>	<b>backhaul rate dot11 {24ghz   5ghz} dot11ax mcs &lt;0-11&gt; spatial-stream &lt;1-8&gt;</b> <b>Example:</b> Device(config-wireless-mesh-profile)# backhaul rate dot11 5ghz dot11ax mcs 5 spatial-stream 6 Device(config-wireless-mesh-profile)# backhaul rate dot11 24ghz dot11ax mcs 5 spatial-stream 4	Configures backhaul transmission rate for 2.4-GHz band and 5-GHz band. The 802.11ax spatial stream value for 2.4-GHz band is from 1 to 4, and the spatial stream value for the 5-GHz band is from 1 to 8.

## Configuring Mesh Backhaul (CLI)

This section describes how to configure mesh backhaul at 2.4 GHz.

### Procedure

	Command or Action	Purpose
<b>Step 1</b>	<b>ap name <i>ap_name</i> mesh backhaul radio dot11 24ghz</b> <b>Example:</b> Device # ap name test-ap mesh backhaul radio dot11 24ghz	Changes the mesh backhaul to 2.4 GHz.

## Configuring Dynamic Frequency Selection (CLI)

DFS specifies the types of radar waveforms that should be detected along with certain timers for an unlicensed operation in the DFS channel.

### Procedure

	Command or Action	Purpose
<b>Step 1</b>	<b>configure terminal</b>  <b>Example:</b> Device# configure terminal	Enters global configuration mode.
<b>Step 2</b>	<b>wireless profile mesh <i>profile-name</i></b>  <b>Example:</b> Device(config)# wireless profile mesh mesh1	Configures a mesh profile and enters mesh profile configuration mode.
<b>Step 3</b>	<b>full-sector-dfs</b>  <b>Example:</b> Device(config-wireless-mesh-profile)# full-sector-dfs	Enables DFS.  <b>Note</b> DFS functionality allows a MAP that detects a radar signal to transmit that up to the RAP, which then acts as if it has experienced radar and moves the sector. This process is called the coordinated channel change. The coordinated channel change is always enabled for Cisco Wave 2 and the later versions. The coordinated channel change can be disabled only for Cisco Wave 1 APs.

## Configuring the Intrusion Detection System (CLI)

When enabled, the intrusion detection system generates reports for all the traffic on the client access. However, this is not applicable for the backhaul traffic.

### Procedure

	Command or Action	Purpose
<b>Step 1</b>	<b>configure terminal</b>  <b>Example:</b> Device# configure terminal	Enters global configuration mode.
<b>Step 2</b>	<b>wireless profile mesh <i>profile-name</i></b>  <b>Example:</b>	Configures a mesh profile and enters mesh profile configuration mode.

	Command or Action	Purpose
	Device(config)# wireless profile mesh mesh1	
<b>Step 3</b>	<b>ids</b>  <b>Example:</b> Device(config-wireless-mesh-profile)# ids	Configures intrusion detection system reporting for mesh APs.

## Configuring Ethernet Bridging (GUI)

### Procedure

- 
- Step 1** Choose **Configuration > Wireless > Mesh > Profiles**
  - Step 2** Click **Add**.
  - Step 3** In **General** tab, enter the **Name** of the mesh profile.
  - Step 4** In the **Advanced** tab, check the **VLAN Transparent** check box to enable VLAN transparency.
  - Step 5** In **Advanced** tab, check the **Ethernet Bridging** check box.
  - Step 6** Click **Apply to Device**.
- 

## Configuring Ethernet Bridging (CLI)

The Ethernet port on the MAPs are disabled by default. It can be enabled only by configuring Ethernet bridging on the Root AP and the other respective MAPs.

Ethernet bridging can be enabled for the following scenarios:

- To use the mesh nodes as bridges.
- To connect Ethernet devices, such as a video camera, on a MAP using the MAP's Ethernet port.

### Before you begin

- Ensure that you configure the following commands under the mesh profile configuration for Ethernet bridging to be enabled:
  - **ethernet-bridging**: Enables the Ethernet Bridging feature on an AP.
  - **no ethernet-vlan-transparent**: Makes the wireless mesh bridge VLAN aware. Allows VLAN filtering with the following AP command: **[no] mesh ethernet {0 | 1 | 2 | 3} mode trunk vlan allowed**.



**Note** If you wish to have all the VLANs bridged (where bridge acts like a piece of wire), then you must enable VLAN transparency, which allows all VLANs to pass. If you choose to use VLAN transparent mode, it is best to filter the VLANs on the wired side of the network to avoid unnecessary traffic from flooding the network.

- The switch port to which the Root AP is connected should be configured as the trunk port for Ethernet bridging to work.
- For Bridge mode APs, use the **ap name *name-of-rap* mesh vlan-trunking native *vlan-id*** command to configure a trunk VLAN on the corresponding RAP. The Ethernet Bridging feature will not be enabled on the AP without configuring this command.
- For FlexConnect+Bridge APs, configure the native VLAN ID under the corresponding flex profile.



**Note** To ensure that the MAPs apply the Ethernet VLAN configuration on the controller, configure the native VLAN on the RAP by running the following command:

```
Device# ap name ap-name no mesh vlan-trunking
Device# ap name ap-name mesh vlan-trunking native 247
```

Alternatively, you can configure native VLAN on the RAP and then the MAP in the following order:

```
Device# ap name ap-name no mesh vlan-trunking
Device# ap name ap-name mesh vlan-trunking native vlan_id
Device# ap name ap-name mesh ethernet 1 mode trunk vlan native native
Device# ap name ap-name mesh ethernet 0 mode trunk vlan allowed allowed
```

To verify the status of RAP and MAP, run the following command:

```
Device# show mesh forwarding all
```

### Procedure

	Command or Action	Purpose
<b>Step 1</b>	<b>enable</b> <b>Example:</b> Device# enable	Enables privileged EXEC mode. Enter your password, if prompted.
<b>Step 2</b>	<b>ap name <i>ap-name</i> mesh ethernet {0   1   2   3} mode access <i>vlan-id</i></b> <b>Example:</b> Device# ap name ap1 mesh ethernet 1 mode access 21	Configures the Ethernet port of the AP and sets the mode as trunk.
<b>Step 3</b>	<b>ap name <i>ap-name</i> mesh ethernet {0   1   2   3} mode trunk vlan <i>vlan-id</i></b> <b>Example:</b>	Sets the native VLAN for the trunk port.

	Command or Action	Purpose
	Device# ap name ap1 mesh ethernet 1 mode trunk vlan native 21	
<b>Step 4</b>	<b>ap name <i>ap-name</i> mesh ethernet {0   1   2   3} mode trunk vlan allowed <i>vlan-id</i></b>  <b>Example:</b> Device# ap name ap1 mesh ethernet 1 mode trunk vlan allowed 21	Configures the allowed VLANs for the trunk port.  Permits VLAN filtering on an ethernet port of any Mesh or Root Access Point. Active only when VLAN transparency is disabled in the mesh profile.

## Configuring Multicast Modes over Mesh

- If multicast packets are received at a MAP over Ethernet, they are sent to the RAP. However, they are not sent to other MAPs. MAP-to-MAP packets are filtered out of the multicast.
- If multicast packets are received at a RAP over Ethernet, they are sent to all the MAPs and their respective Ethernet networks.
- The *in-out* mode is the default mode. When this *in-out* mode is in operation, it is important to properly partition your network to ensure that a multicast sent by one RAP is not received by another RAP on the same Ethernet segment, and then sent back into the network.

### Procedure

	Command or Action	Purpose
<b>Step 1</b>	<b>configure terminal</b>  <b>Example:</b> Device# configure terminal	Enters global configuration mode.
<b>Step 2</b>	<b>wireless profile mesh <i>profile-name</i></b>  <b>Example:</b> Device(config)# wireless profile mesh mesh1	Configures a mesh profile and enters mesh profile configuration mode.
<b>Step 3</b>	<b>multicast {in-only   in-out   regular}</b>  <b>Example:</b> Device(config-wireless-mesh-profile)# multicast regular	Configures mesh multicast mode.

## Configuring RRM on Mesh Backhaul (CLI)

The RRM measurement in the mesh AP backhaul is enabled based on the following conditions:

- Mesh AP has the Root AP role.



- Root AP has joined using an Ethernet link.
- Root AP is not serving any child AP.

Follow the procedure given below to enable RRM in the mesh backhaul:

#### Procedure

	Command or Action	Purpose
<b>Step 1</b>	<b>configure terminal</b>  <b>Example:</b> Device# configure terminal	Enters global configuration mode.
<b>Step 2</b>	<b>wireless mesh backhaul rrm</b>  <b>Example:</b> Device(config)# wireless mesh backhaul rrm	Configures RRM on the mesh backhaul.

## Selecting a Preferred Parent (GUI)

#### Procedure

- 
- Step 1** Choose **Configuration > Wireless > Access Points**.
  - Step 2** Click the Access Point.
  - Step 3** In the **Mesh** tab, enter the **Preferred Parent MAC**.
  - Step 4** Click **Update & Apply to Device**.
- 

## Selecting a Preferred Parent (CLI)

Follow the procedure given below to configure a preferred parent for a MAP.

Using this mechanism, you can override the AWPP-defined parent selection mechanism and force a mesh AP to go to a preferred parent.

#### Procedure

	Command or Action	Purpose
<b>Step 1</b>	<b>enable</b>  <b>Example:</b> Device> enable	Enters privileged EXEC mode.

	Command or Action	Purpose
<b>Step 2</b>	<p><b>ap name</b> <i>ap-name</i> <b>mesh parent preferred</b> <i>mac-address</i></p> <p><b>Example:</b></p> <pre>Device# ap name ap1 mesh parent preferred 00:0d:ed:dd:25:8F</pre>	<p>Configures mesh parameters for the AP and sets the mesh-preferred parent MAC address.</p> <p><b>Note</b> Ensure that you use the radio MAC address of the preferred parent.</p> <p>For Cisco Wave 1 APs, when you configure a preferred parent, ensure that you specify the MAC address of the actual mesh neighbor for the desired parent. This MAC address is the base radio MAC address that has the letter "f" as the final character. For example, if the base radio MAC address is 00:24:13:0f:92:00, then you must specify 00:24:13:0f:92:0f as the preferred parent.</p> <pre>Device# ap name ap1 mesh parent preferred 00:24:13:0f:92:0f</pre> <p>For Cisco Wave 2 APs, when you configure a preferred parent, the MAC address is the base radio MAC address that has "0x11" added to the last two characters. For example, if the base radio MAC address is 00:24:13:0f:92:00, then you must specify 00:24:13:0f:92:11 as the preferred parent.</p> <pre>Device# ap name ap1 mesh parent preferred 00:24:13:0f:92:11</pre>

## Changing the Role of an AP (GUI)

### Procedure

- 
- Step 1** Choose **Configuration > Wireless > Access Points**.
  - Step 2** Click the **Access Point**.
  - Step 3** In the **Mesh** tab, choose **Root** or **Mesh** from the **Role** drop-down list.
  - Step 4** Click **Update & Apply to Device**.
- 

After the role change is triggered, the AP reboots.

## Changing the Role of an AP (CLI)

Follow the procedure to change the AP from MAP to RAP or vice-versa.

By default, APs join the controller in a mesh AP role.

### Procedure

	Command or Action	Purpose
<b>Step 1</b>	<b>enable</b>  <b>Example:</b> Device> enable	Enters privileged EXEC mode.
<b>Step 2</b>	<b>ap name <i>ap-name</i> role {mesh-ap   root-ap}</b>  <b>Example:</b> Device# #ap name ap1 root-ap	Changes the role for the Cisco bridge mode APs. After the role change is triggered, the AP reboots.

## Configuring the Mesh Leaf Node (CLI)

### Procedure

	Command or Action	Purpose
<b>Step 1</b>	<b>enable</b>  <b>Example:</b> Device> enable	Enters privileged EXEC mode.
<b>Step 2</b>	<b>ap name <i>ap-name</i> mesh block-child</b>  <b>Example:</b> Device# #ap name ap1 mesh block-child	Sets the AP to work only as a leaf node. This AP cannot be selected by other MAPs as a parent MAP.  <b>Note</b> Use the <b>no</b> form of this command to change it to a regular AP.

## Configuring the Mesh Leaf Node (GUI)

### Procedure

- 
- Step 1** Choose **Configuration > Wireless > Access Points**.
  - Step 2** Click the Access Point.
  - Step 3** In the **Mesh** tab, check the **Block Child** check box.

**Step 4** Click **Update & Apply to Device**.

## Configuring Subset Channel Synchronization

All the channels used by all the RAPs in a controller are sent to all the MAPs for future seek and convergence. The controller keeps a list of the subset channels for each Bridge Group Name (BGN). The list of subset channels are also shared across all the controllers in a mobility group.

Subset channel list is list of channels where RAP of particular BGN are operating. This list is communicated to all the MAPs within and across the controllers. The idea of subset channel list is for faster convergence of the Mesh APs. Convergence method can be selected in mesh profile. If the convergence method is not standard then subset channel list is pushed to MAPs.

Follow the procedure given below to configure subset channel synchronization for mobility group.

### Procedure

	Command or Action	Purpose
<b>Step 1</b>	<b>configure terminal</b>  <b>Example:</b> Device# configure terminal	Enters global configuration mode.
<b>Step 2</b>	<b>wireless mesh subset-channel-sync mac</b>  <b>Example:</b> Device(config)# wireless mesh subset-channel-sync	Configures subset channel synchronization for a mobility group.

## Provisioning LSC for Bridge-Mode and Mesh APs (GUI)

### Procedure

- Step 1** Choose **Configuration > Wireless > Access Points > LSC Provision**.
- Step 2** In the **Add APs to LSC Provision List** settings, click the **Select File** option to upload a CSV file that contains AP details.
- Step 3** Click **Upload File**.
- Step 4** You can also use the **AP MAC Address** field to search for APs using the MAC address and add them. The APs added to the provision list are displayed in the **APs in Provision List** list.
- Step 5** Click **Apply**.
- Step 6** Choose **Configuration > Wireless > Mesh > Profiles**
- Step 7** Click **Add**.
- Step 8** In the **General** tab, enter the **Name** of the mesh profile and check the **LSC** check box.

- Step 9** In the **Advanced** tab, under the **Security** settings, choose the authorization method from the **Authorization Method** drop-down list.
- Step 10** Click **Apply to Device**.

## Provisioning LSC for Bridge-Mode and Mesh APs

- Configuring Locally Significant Certificate (LSC) will not remove pre-existing certificates from an AP.
- An AP can have both LSC and Message Integrity Check (MIC) certificates. However, when an AP is provisioned with LSC, the MIC certificate is not used on boot-up. A change from LSC to MIC requires the AP to reboot.

Follow the procedure given below to configure LSC for bridge-mode and mesh APs:

### Procedure

	Command or Action	Purpose
<b>Step 1</b>	<b>configure terminal</b> <b>Example:</b> Device# configure terminal	Enters global configuration mode.
<b>Step 2</b>	<b>ap lsc-provision</b> <b>Example:</b> Device(config)# ap lsc-provision	Configures LSC provisioning on an AP. <b>Note</b> This step is applicable only for mesh APs.
<b>Step 3</b>	<b>ap lsc-provision provision-list</b> <b>Example:</b> Device(config)# ap lsc-provision provision-list	(Optional) Configures LSC provision for all the APs in the provision list.
<b>Step 4</b>	<b>aaa authentication dot1x auth-list radius group radius-server-grp</b> <b>Example:</b> Device(config)# aaa authentication dot1x list1 radius group sgl	Configures named authorization list for downloading EAP credential from radius group server.
<b>Step 5</b>	<b>wireless profile mesh profile-name</b> <b>Example:</b> Device(config)# wireless profile mesh mesh1	Configures a mesh profile and enters mesh profile configuration mode.
<b>Step 6</b>	<b>lsc-only-auth</b> <b>Example:</b> Device(config-wireless-mesh-profile)# lsc-only-auth	Configures mesh security to LSC-only MAP authentication. After this command is run, all the mesh APs reboot.

	Command or Action	Purpose
<b>Step 7</b>	<b>method authorization</b> <i>local</i> <b>Example:</b> Device (config-wireless-mesh-profile)# method authorization list1	Configures an authorization method for mesh AP authorization.

## Specifying the Backhaul Slot for the Root AP (GUI)

### Procedure

- 
- Step 1** Choose **Configuration > Wireless > Mesh > Profiles**
  - Step 2** Click **Add**.
  - Step 3** In **General** tab, enter the **Name** of the mesh profile.
  - Step 4** In **Advanced** tab, choose the rate types from the **Rate Types** drop-down list for **5 GHz Band Backhaul** and **2.4 GHz Band Backhaul**.
  - Step 5** Click **Apply to Device**.
- 

## Specifying the Backhaul Slot for the Root AP (CLI)

Follow the procedure given below to set the mesh backhaul rate.

### Procedure

	Command or Action	Purpose
<b>Step 1</b>	<b>enable</b> <b>Example:</b> Device> enable	Enters privileged EXEC mode.
<b>Step 2</b>	<b>ap name</b> <i>rap-name</i> <b>mesh backhaul radio</b> <b>dot11</b> {24ghz   5ghz} [slot <i>slot-id</i> ] <b>Example:</b> Device# ap name rap1 mesh backhaul radio dot11 24ghz slot 2	Sets the mesh backhaul radio slot.

## Using a Link Test on Mesh Backhaul (GUI)

### Procedure

- 
- Step 1** Choose **Monitoring > Wireless > AP Statistics > General**.
  - Step 2** Click the Access Point.
  - Step 3** Choose **Mesh > Neighbor > Linktest**.
  - Step 4** Choose the desired values from the **Date Rates**, **Packets to be sent (per second)**, **Packet Size (bytes)** and **Test Duration (seconds)** drop-down lists..
  - Step 5** Click **Start**.
- 

## Using a Link Test on Mesh Backhaul

Follow the procedure given below to trigger linktest between neighbor mesh APs.



---

**Note** Use the **test mesh linktest mac-address neighbor-ap-mac rate data-rate fps frames-per-second frame-size frame-size** command to perform link test from an AP.

---

### Procedure

	Command or Action	Purpose
<b>Step 1</b>	<b>enable</b> <b>Example:</b> Device> enable	Enters privileged EXEC mode.
<b>Step 2</b>	<b>ap name ap-name mesh linktest dest-ap-mac data-rate packet-per-sec packet-size test-duration</b> <b>Example:</b> Device# #ap name ap1 mesh linktest F866.F267.7DFB 24 234 1200 200	Sets link test parameters.

## Configuring Battery State for Mesh AP (GUI)

### Procedure

- 
- Step 1** Choose **Configuration > Wireless > Mesh > Profiles**
  - Step 2** Choose a profile.
  - Step 3** In **General** tab, check the **Battery State for an AP** check box.
  - Step 4** Click **Update & Apply to Device**.
- 

## Configuring Battery State for Mesh AP

Some Cisco outdoor APs come with the option of battery backup. There is also a POE-out port that can power a video surveillance camera. The integrated battery can be used for temporary backup power during external power interruptions.

### Procedure

	Command or Action	Purpose
<b>Step 1</b>	<b>configure terminal</b> <b>Example:</b> Device# configure terminal	Enters global configuration mode.
<b>Step 2</b>	<b>wireless profile mesh <i>profile-name</i></b> <b>Example:</b> Device(config)# wireless profile mesh mesh1	Configures a mesh profile and enters mesh profile configuration mode.
<b>Step 3</b>	<b>battery-state</b> <b>Example:</b> Device(config-wireless-mesh-profile)# battery-state	Configures the battery state for an AP.

## Configuring Mesh Convergence (CLI)

This section provides information about how to configure mesh convergence.



## Procedure

	Command or Action	Purpose
<b>Step 1</b>	<b>configure terminal</b> <b>Example:</b> Device# configure terminal	Enters global configuration mode.
<b>Step 2</b>	<b>wireless profile mesh <i>profile-name</i></b> <b>Example:</b> Device(config)# wireless profile mesh mesh1	Creates a mesh profile.
<b>Step 3</b>	<b>convergence {fast   noise-tolerant-fast   standard   very-fast}</b> <b>Example:</b> Device(config-wireless-mesh-profile)# convergence fast	Configures mesh convergence method in a mesh profile.

## Configuring DHCP Server on Root Access Point (RAP)

## Procedure

	Command or Action	Purpose
<b>Step 1</b>	<b>configure terminal</b> <b>Example:</b> Device# configure terminal	Enters global configuration mode.
<b>Step 2</b>	<b>ap profile <i>ap-profile-name</i></b> <b>Example:</b> Device(config)# ap profile ap-profile-name	Configures an AP Profile.
<b>Step 3</b>	<b>dhcp-server</b> <b>Example:</b> Device(config-ap-profile)# dhcp-server	Configures DHCP server on the root access point.
<b>Step 4</b>	<b>end</b> <b>Example:</b> Device(config-ap-profile)# end	Saves the configuration and exits configuration mode and returns to privileged EXEC mode.

## Configuring Mesh Ethernet Daisy Chaining (CLI)

The following section provides information about how to configure the Mesh Ethernet Daisy Chaining feature on a mesh AP.

### Procedure

	Command or Action	Purpose
<b>Step 1</b>	<b>configure terminal</b>  <b>Example:</b> Device# configure terminal	Enters global configuration mode.
<b>Step 2</b>	<b>ap profile default-ap-profile</b>  <b>Example:</b> Device(config)# ap profile default-ap-profile	Specifies an AP profile.
<b>Step 3</b>	<b>ssid broadcast persistent</b>  <b>Example:</b> Device(config-ap-profile)# ssid broadcast persistent	Configures persistent SSID broadcast and ensures strict wired uplink. RAP will not switch to wireless backhaul when you configure this command.

## Enabling Mesh Ethernet Daisy Chaining

The following section provides information about how to enable the Mesh Ethernet Daisy Chaining feature on a Cisco IW 3702 AP.

### Procedure

	Command or Action	Purpose
<b>Step 1</b>	<b>configure terminal</b>  <b>Example:</b> Device# configure terminal	Enters global configuration mode
<b>Step 2</b>	<b>wireless profile mesh default-mesh-profile</b>  <b>Example:</b> Device(config)# wireless profile mesh default-mesh-profile	Creates a mesh profile.
<b>Step 3</b>	<b>ethernet-bridging</b>  <b>Example:</b> Device(config)# ethernet-bridging	Connects remote wired networks to each other.

	Command or Action	Purpose
<b>Step 4</b>	<b>no ethernet-vlan-transparent</b> <b>Example:</b> Device(config)# no ethernet-vlan-transparent	Disables VLAN transparency to ensure that the bridge is VLAN aware.

## Configuring Mesh CAC (CLI)

### Procedure

	Command or Action	Purpose
<b>Step 1</b>	<b>configure terminal</b> <b>Example:</b> Device# configure terminal	Enters global configuration mode.
<b>Step 2</b>	<b>wireless mesh cac</b> <b>Example:</b> Device(config)# wireless mesh cac	Enables mesh CAC mode.

## Configuring ATF on Mesh (GUI)

### Procedure

- 
- Step 1** Choose **Configuration > Wireless > Airtime Fairness > Global Config**
  - Step 2** For **5 GHz Band** and **2.4 GHz Band**, enable the **Status** and the **Bridge Client Access** toggle button.
  - Step 3** To choose the **Mode**, click the **Monitor** or **Enforced** radio button.
  - Step 4** Enable or disable the **Optimization** toggle button.
  - Step 5** Enter the **Airtime Allocation**.
  - Step 6** Click **Apply to Device**.
-

# Configuring ATF on Mesh

## Procedure

	Command or Action	Purpose
<b>Step 1</b>	<b>configure terminal</b> <b>Example:</b> Device# configure terminal	Enters global configuration mode.
<b>Step 2</b>	<b>ap dot11 {24ghz   5ghz} rf-profile rf-profile</b> <b>Example:</b> Device(config)# ap dot11 24ghz rf-profile rfprof24_1	Configures an RF profile and enters RF profile configuration mode.
<b>Step 3</b>	<b>airtime-fairness bridge-client-access                      airtime-allocation                      allocation-weight-percentage</b> <b>Example:</b> Device(config-rf-profile)# airtime-fairness bridge-client-access airtime-allocation 10	Configures airtime allocation weight percentage on mesh APs.

# Create an ATF Policy for a MAP

## Procedure

	Command or Action	Purpose
<b>Step 1</b>	<b>configure terminal</b> <b>Example:</b> Device# configure terminal	Enters global configuration mode.
<b>Step 2</b>	<b>wireless profile policy profile-policy</b> <b>Example:</b> Device(config)# wireless profile policy rr-xyz-policy-1	Configures WLAN policy profile and enters wireless policy configuration mode.
<b>Step 3</b>	<b>dot11 24ghz airtime-fairness atf-policy</b> <b>Example:</b> Device(config-wireless-policy)# dot11 24ghz airtime-fairness atf-policy	Enables ATF in the existing RF profile.

## Creating an ATF Policy (GUI)

### Procedure

---

- Step 1** Choose **Configuration > Air Time Fairness > Profiles**.
- Step 2** On the **Profiles** window, click **Add**.
- Step 3** In the **Add ATF Policy** window, specify a name, ID, and weight for the ATF policy.
- Note** Weighted ratio is used instead of percentages so that the total can exceed 100. The minimum weight that you can set is 5.
- Step 4** Use the slider to enable or disable the Client Sharing feature.
- Step 5** Click **Save & Apply to Device** to save your ATF configuration.
- Step 6** (Optional) To delete a policy, check the check box next to the appropriate policy and click **Delete**.
- Step 7** (Optional) To edit an existing ATF policy, select the check box next to the policy you want to edit.
- In the **Edit ATF Policy** window that is displayed, you can modify the weight and client sharing details for the policy.
- 

## Adding an ATF to a Policy Profile (GUI)

### Procedure

---

- Step 1** Choose **Configuration > Tags & Profiles > Policy**.
- Step 2** Click the name of the corresponding policy profile.
- Step 3** Click the **Advanced** tab.
- Step 4** In the **Air Time Fairness Policies** section, choose the appropriate status for the following: 2.4-GHz Policy and 5-GHz Policy.
- Step 5** Click **Update & Apply to Device**.
- 

## Enabling ATF Mode in an RF Profile (GUI)

### Procedure

---

- Step 1** Choose **Configuration > Tags & Profiles > RF**.
- Step 2** Click the name of the corresponding RF profile.

**Step 3** In the **RF Profile** window, click the **Advanced** tab.

**Step 4** In the **ATF Configuration** section, choose the appropriate status for the following:

- **Status**—If you choose **Enabled** as the status, select the **Mode** as either **Monitor** or **Enforced**. Also, you can enable or disable optimization for this mode.
- **Bridge Client Access**
- **Airtime Allocation**—Enter the allocation value. You can set the value only after you enable the **Bridge Client Access**.

**Step 5** Click **Update & Apply to Device**.

## Configuring Fast Teardown for a Mesh AP Profile (CLI)

### Procedure

	Command or Action	Purpose
<b>Step 1</b>	<b>configure terminal</b>  <b>Example:</b> Device# configure terminal	Enters global configuration mode.
<b>Step 2</b>	<b>wireless profile mesh <i>profile-name</i></b>  <b>Example:</b> Device(config)# wireless profile mesh mesh1	Configures a mesh profile and enters the mesh profile configuration mode.
<b>Step 3</b>	<b>fast-teardown</b>  <b>Example:</b> Device(config-wireless-mesh-profile)# fast-teardown	Enables the fast teardown of mesh network and configures the feature's parameter.
<b>Step 4</b>	<b>enabled</b>  <b>Example:</b> Device(config-wireless-mesh-profile-fast-teardown)# enabled	Enables the fast teardown feature.
<b>Step 5</b>	<b>interval <i>duration</i></b>  <b>Example:</b> Device(config-wireless-mesh-profile-fast-teardown)# interval 5	(Optional) Configures the retry interval. The valid values range between 1 and 10 seconds.
<b>Step 6</b>	<b>latency-exceeded-threshold <i>duration</i></b>  <b>Example:</b> Device(config-wireless-mesh-profile-fast-teardown)# latency-exceeded-threshold 20	(Optional) Specifies the latency interval at which at least one ping must succeed in less than threshold time. The valid values range between 1 and 30 seconds.

	Command or Action	Purpose
<b>Step 7</b>	<b>latency-threshold</b> <i>threshold range</i> <b>Example:</b> Device(config-wireless-mesh-profile-fast-teardown)# latency-threshold 20	(Optional) Specifies the latency threshold. The valid values range between 1 and 500 milliseconds.
<b>Step 8</b>	<b>retries</b> <i>retry limit</i> <b>Example:</b> Device(config-wireless-mesh-profile-fast-teardown)# retries 1	(Optional) Specifies the number of retries until the gateway is considered unreachable. The valid values range between 1 and 10.
<b>Step 9</b>	<b>uplink-recovery-intervals</b> <i>recovery interval</i> <b>Example:</b> Device(config-wireless-mesh-profile-fast-teardown)# uplink-recovery-intervals 1	(Optional) Specifies the time during which root access point uplink has to be stable to accept child connections. The valid values range between 1 and 3600 seconds.

## Flex Resilient with Flex and Bridge Mode Access Points

### Information About Flex Resilient with Flex and Bridge Mode Access Points

The Flex Resilient with Flex and Bridge Mode Access Points describe how to set up a controller with Flex+Bridge mode Access Points (APs) and Flex Resilient feature. The Flex Resilient feature works only in Flex+Bridge mode APs. The feature resides in Mesh link formed between RAP - MAP, once the link is UP and RAP loses connection to the CAPWAP controller, both RAP and MAP continue to bridge the traffic. A child Mesh AP (MAP) maintains its link to a parent AP and continues to bridge till the parent link is lost. A child MAP cannot establish a new parent or child link till it reconnects to the CAPWAP controller.



**Note** Existing wireless clients in locally switching WLAN can stay connected with their AP in this mode. No new or disconnected wireless client can associate to the Mesh AP in this mode. Client traffic in Flex+Bridge MAP is dropped at RAP switchport for the locally switched WLANs.

## Configuring a Flex Profile (GUI)

### Procedure

- Step 1** Choose **Configuration > Tags & Profiles > Flex**.
- Step 2** Click a **Flex Profile Name**. The **Edit Flex Profile** dialog box appears.
- Step 3** Under the **General** tab, choose the **Flex Resilient** check box to enable the Flex Resilient feature.
- Step 4** Under the **VLAN** tab, choose the required VLANs.
- Step 5** (Optionally) Under the **Local Authentication** tab, choose the desired server group from the **Local Accounting RADIUS Server Group** drop-down list. Also, choose the **RADIUS** check box.

**Step 6** Click **Update & Apply to Device**.

## Configuring a Flex Profile (CLI)

### Procedure

	Command or Action	Purpose
<b>Step 1</b>	<b>configure terminal</b> <b>Example:</b> Device# configure terminal	Enters global configuration mode
<b>Step 2</b>	<b>wireless profile flex <i>flex-profile</i></b> <b>Example:</b> Device(config)# wireless profile flex new-flex-profile	Configures a Flex profile and enters Flex profile configuration mode.
<b>Step 3</b>	<b>arp-caching</b> <b>Example:</b> Device(config-wireless-flex-profile)# arp-caching	Enables ARP caching.
<b>Step 4</b>	<b>description <i>description</i></b> <b>Example:</b> Device(config-wireless-flex-profile)# description "new flex profile"	Enables default parameters for the Flex profile.
<b>Step 5</b>	<b>native-vlan-id</b> <b>Example:</b> Device(config-wireless-flex-profile)# native-vlan-id 2660	Configures native vlan-id information.
<b>Step 6</b>	<b>resilient</b> <b>Example:</b> Device(config-wireless-flex-profile)# resilient	Enables the resilient feature.
<b>Step 7</b>	<b>vlan-name <i>vlan_name</i></b> <b>Example:</b> Device(config-wireless-flex-profile)# vlan-name VLAN2659	Configures VLAN name.
<b>Step 8</b>	<b>vlan-id <i>vlan_id</i></b> <b>Example:</b> Device(config-wireless-flex-profile)# vlan-id 2659	Configures VLAN ID. The valid VLAN ID ranges from 1 to 4096.



	Command or Action	Purpose
<b>Step 9</b>	<b>end</b> <b>Example:</b> Device(config-wireless-flex-profile)# end	Exits configuration mode and returns to privileged EXEC mode.

## Configuring a Site Tag (CLI)

### Procedure

	Command or Action	Purpose
<b>Step 1</b>	<b>configure terminal</b> <b>Example:</b> Device# configure terminal	Enters global configuration mode
<b>Step 2</b>	<b>wireless tag site <i>site-name</i></b> <b>Example:</b> Device(config)# wireless tag site new-flex-site	Configures a site tag and enters site tag configuration mode.
<b>Step 3</b>	<b>flex-profile <i>flex-profile-name</i></b> <b>Example:</b> Device(config-site-tag)# flex-profile new-flex-profile	Configures a flex profile.
<b>Step 4</b>	<b>no local-site</b> <b>Example:</b> Device(config-site-tag)# no local-site	<b>Local site</b> is not configured on the site tag.
<b>Step 5</b>	<b>site-tag <i>site-tag-name</i></b> <b>Example:</b> Device(config-site-tag)# site-tag new-flex-site	Maps a site tag to an AP.
<b>Step 6</b>	<b>end</b> <b>Example:</b> Device(config-site-tag)# end	Exits configuration mode and returns to privileged EXEC mode.

## Configuring a Mesh Profile (CLI)

### Procedure

	Command or Action	Purpose
<b>Step 1</b>	<b>configure terminal</b> <b>Example:</b> Device# configure terminal	Enters global configuration mode
<b>Step 2</b>	<b>wireless profile mesh <i>profile-name</i></b> <b>Example:</b> Device(config)# wireless profile mesh Mesh_Profile	Configures a Mesh profile and enters the Mesh profile configuration mode.
<b>Step 3</b>	<b>no ethernet-vlan-transparent</b> <b>Example:</b> Device(config-wireless-profile-mesh)# no ethernet-vlan-transparent	Disables VLAN transparency to ensure that the bridge is VLAN aware.
<b>Step 4</b>	<b>end</b> <b>Example:</b> Device(config-wireless-profile-mesh)# end	Exits configuration mode and returns to privileged EXEC mode.

## Associating Wireless Mesh to an AP Profile (CLI)

### Procedure

	Command or Action	Purpose
<b>Step 1</b>	<b>configure terminal</b> <b>Example:</b> Device# configure terminal	Enters global configuration mode
<b>Step 2</b>	<b>ap profile <i>ap-profile-name</i></b> <b>Example:</b> Device(config)# ap profile new-ap-join-profile	Configures the AP profile and enters AP profile configuration mode.
<b>Step 3</b>	<b>mesh-profile <i>mesh-profile-name</i></b> <b>Example:</b> Device(config-ap-profile)# mesh-profile Mesh_Profile	Configures the Mesh profile in AP profile configuration mode.
<b>Step 4</b>	<b>ssh</b> <b>Example:</b>	Configures the Secure Shell (SSH).

	Command or Action	Purpose
	Device(config-ap-profile)# ssh	
<b>Step 5</b>	<b>mgmtuser username <i>username</i> password {0 8} <i>password</i></b> <b>Example:</b> <pre>Device(config-ap-profile)# mgmtuser username Cisco password 0 Cisco secret 0 Cisco</pre>	Specifies the AP management username and password for managing all of the access points configured to the controller. <ul style="list-style-type: none"> <li>• <b>0:</b> Specifies an UNENCRYPTED password.</li> <li>• <b>8:</b> Specifies an AES encrypted password.</li> </ul> <b>Note</b> While configuring an username, ensure that special characters are not used as it results in error with bad configuration.
<b>Step 6</b>	<b>end</b> <b>Example:</b> <pre>Device(config-ap-profile)# end</pre>	Exits configuration mode and returns to privileged EXEC mode.

## Attaching Site Tag to an Access Point (CLI)

### Procedure

	Command or Action	Purpose
<b>Step 1</b>	<b>configure terminal</b> <b>Example:</b> <pre>Device# configure terminal</pre>	Enters global configuration mode
<b>Step 2</b>	<b>ap <i>mac-address</i></b> <b>Example:</b> <pre>Device(config)# ap F866.F267.7DFB</pre>	Configures Cisco APs and enters ap-tag configuration mode.
<b>Step 3</b>	<b>site-tag <i>site-tag-name</i></b> <b>Example:</b> <pre>Device(config-ap-tag)# site-tag new-flex-site</pre>	Maps a site tag to the AP. <b>Note</b> Associating Site Tag causes the associated AP to reconnect.
<b>Step 4</b>	<b>end</b> <b>Example:</b> <pre>Device(config-ap-tag)# end</pre>	Exits configuration mode and returns to privileged EXEC mode.

## Configuring Switch Interface for APs (CLI)

### Procedure

	Command or Action	Purpose
<b>Step 1</b>	<b>configure terminal</b> <b>Example:</b> Device# configure terminal	Enters global configuration mode
<b>Step 2</b>	<b>interface <i>interface-id</i></b> <b>Example:</b> Device(config)# interface <int-id>	Enters the interface to be added to the VLAN.
<b>Step 3</b>	<b>switchport trunk native vlan <i>vlan-id</i></b> <b>Example:</b> Device(config-if)# switchport trunk native vlan 2660	Assigns the allowed VLAN ID to the port when it is in trunking mode.
<b>Step 4</b>	<b>switchport trunk allowed vlan <i>vlan-id</i></b> <b>Example:</b> Device(config-if)# switchport trunk allowed vlan 2659,2660	Assigns the allowed VLAN ID to the port when it is in trunking mode.
<b>Step 5</b>	<b>switchport mode trunk</b> <b>Example:</b> Device(config-if)# switchport mode trunk	Sets the trunking mode to trunk unconditionally. <b>Note</b> When the controller works as a host for spanning tree, ensure that you configure portfast trunk, using <b>spanning-tree portfast trunk</b> command, in the uplink switch to ensure faster convergence.
<b>Step 6</b>	<b>end</b> <b>Example:</b> Device(config-if)# end	Exits configuration mode and returns to privileged EXEC mode.

## Verifying Flex Resilient with Flex and Bridge Mode Access Points Configuration

To view the AP mode and model details, use the following command:

```
Device# show ap name <ap-name> config general | inc AP Mode
AP Mode           : Flex+Bridge
AP Model          : AIR-CAP3702I-A-K9
```

To view the MAP mode details, use the following command:

```
Device# show ap name MAP config general | inc AP Mode
AP Mode           : Flex+Bridge
AP Model          : AIR-CAP3702I-A-K9
```

To view the RAP mode details, use the following command:

```
Device# show ap name RAP config general | inc AP Mode
AP Mode                : Flex+Bridge
AP Model               : AIR-AP2702I-A-K9
```

To view if the Flex Profile - Resilient feature is enabled or not, use the following command:

```
Device# show wireless profile flex detailed FLEX_TAG | inc resilient
Flex resilient         : ENABLED
```

## Verifying ATF Configuration on Mesh

You can verify Cisco ATF configurations on mesh APs using the following commands.

Use the following **show** command to display the ATF configuration summary of all the radios:

```
Device# show ap airtime-fairness summary
```

AP Name Optimization	MAC Address	Slot	Admin	Oper	Mode
ap1/2 Enabled	6c:99:89:0c:73:a0	0	ENABLED	DOWN	Enforce-Policy
ap1/2 Enabled	6c:99:89:0c:73:a0	1	ENABLED	UP	Enforce-Policy
ap1/3 Enabled	6c:99:89:0c:73:a1	0	ENABLED	DOWN	Enforce-Policy
ap1/3 Enabled	6c:99:89:0c:73:a1	1	ENABLED	UP	Enforce-Policy

Use the following **show** command to display the ATF configuration for a 2.4-GHz radio:

```
Device# show ap dot11 24ghz airtime-fairness
```

AP Name Optimization	MAC Address	Slot	Admin	Oper	Mode
ap1/2 Enabled	6c:99:89:0c:73:a0	1	ENABLED	UP	Enforce-Policy

Use the following **show** command to display the ATF WLAN statistics:

```
Device# show ap name ap1 dot11 24ghz airtime-fairness wlan 12 statistics
```

AP Name Optimization	MAC Address	Slot	Admin	Oper	Mode
ap1/2 Enabled	6c:99:89:0c:73:a0	0	ENABLED	DOWN	Enforce-Policy
ap1/2 Enabled	6c:99:89:0c:73:a0	1	ENABLED	UP	Enforce-Policy
Network level					

Use the following **show** command to display the wireless mesh summary:

```
Device# show wireless profile mesh summary
```

```
Number of Profiles: 2
```

Profile-Name	BGN	Security	Bh-access	Description
--------------	-----	----------	-----------	-------------

```

-----
mesh1                                     EAP      DISABLED

default-mesh-profile                     EAP      DISABLED   default mesh profile

Device# show mesh atf client-access

AP Name          Client Access Allocation  Override  Current nodes
                Default %    Current %
-----
RAP              25          40        Enabled   4
RAP              33          40        Enabled   3

```

## Verifying Mesh Ethernet Daisy Chaining

- The following is a sample output of the **show ap config general** command that displays whether a persistent SSID is configured for an AP.

```

Device# show ap 3702-RAP config general

Persistent SSID Broadcast                Enabled/Disabled

```

- The following is a sample output of the **show wireless mesh persistent-ssid-broadcast summary** command that displays the persistent SSID broadcast status of all the bridge RAPs.

```

Device# show wireless mesh persistent-ssid-broadcast summary

AP Name      AP Model BVI MAC          BGN          AP Role          Persistent SSID
state
-----
3702-RAP     3702    5c71.0d07.db50 ap_name      Root AP          Enabled
1560-RAP     1562E   380e.4dbf.c6b0 ap_name      Root AP          Disabled

```

## Verifying Mesh Convergence

The following is a sample output of the **show wireless profile mesh detailed** command that displays the mesh convergence method used:

```

Device# show wireless profile mesh detailed default-mesh-profile

Mesh Profile Name          : default-mesh-profile
-----
Description                 : default mesh profile
Convergence Method         : Fast

```

The following is a sample output of the **show wireless mesh convergence subset-channels** command that displays the subset channels of the selected bridge group name:

```

Device# show wireless mesh convergence subset-channels

Bridge group name          Channel
-----
Default                    132

```

## Verifying DHCP Server for Root AP Configuration

To verify the DHCP server for root AP configuration, use the following command:

```
Device# show ap config general
Cisco AP Name   : AP4C77.6DF2.D588
=====
<SNIP>
Dhcp Server                    : Enabled
```

## Verifying Mesh Backhaul

The following is a sample output of the **show ap name mesh backhaul** command that shows details of the mesh backhaul at 2.4 GHz:

```
Device# show ap name test-ap mesh backhaul

MAC Address : xxxx.xxxx.xxxx
Current Backhaul Slot: 0
Radio Type: 0
Radio Subband: All
Mesh Radio Role: DOWNLINK
Administrative State: Enabled
Operation State: Up
Current Tx Power Level:
Current Channel: (11)
Antenna Type: N/A
Internal Antenna Gain (in .5 dBm units): 0
```

The following is a sample output of the **show wireless mesh ap backhaul** command that shows the mesh backhaul details:

```
Device# show wireless mesh ap backhaul

MAC Address : xxxx.xxxx.0x11
Current Backhaul Slot: 1
Radio Type: Main
Radio Subband: All
Mesh Radio Role: Downlink
Administrative State: Enabled
Operation State: Up
Current Tx Power Level: 6
Current Channel: (100)*
Antenna Type: N/A
Internal Antenna Gain (in .5 dBm units): 10
```

The following is a sample output of the **show ap summary** command that shows the radio MAC address and the corresponding AP name:

```
Device# show ap summary
Number of APs: 1
AP Name      Slots  AP Model      Ethernet  MAC Radio MAC  Location      Country
IP Address   State
-----
AP-Cisco-1  2      AIR-APXXXXX-E-K9  xxxx.xxxx.xxd4  xxxx.xxxx.0x11  default location  DE
10.11.70.170 Registered
```

# Verifying Mesh Configuration

Use the following **show** commands to verify the various aspects of mesh configuration.

- **show wireless mesh stats** *ap-name*
- **show wireless mesh security-stats** {*all* | *ap-name*}
- **show wireless mesh queue-stats** {*all* | *ap-name*}
- **show wireless mesh per-stats summary** {*all* | *ap-name*}
- **show wireless mesh neighbor summary** {*all* | *ap-name*}
- **show wireless mesh neighbor detail** *ap-name*
- **show wireless mesh ap summary**
- **show wireless mesh ap tree**
- **show wireless mesh ap backhaul**
- **show wireless mesh config**
- **show wireless mesh convergence detail** *bridge-group-name*
- **show wireless mesh convergence subset-channels**
- **show wireless mesh neighbor**
- **show wireless profile mesh detailed** *mesh-profile-name*
- **show wireless stats mesh security**
- **show wireless stats mesh queue**
- **show wireless stats mesh packet error**
- **show wireless mesh ap summary**
- **show ap name** *ap-name* **mesh backhaul**
- **show ap name** *ap-name* **mesh neighbor detail**
- **show ap name** *ap-name* **mesh path**
- **show ap name** *ap-name* **mesh stats packet error**
- **show ap name** *ap-name* **mesh stats queue**
- **show ap name** *ap-name* **mesh stats security**
- **show ap name** *ap-name* **mesh stats**
- **show ap name** *ap-name* **mesh bhrate**
- **show ap name** *ap-name* **config ethernet**
- **show ap name** *ap-name* **cablemodem**
- **show ap name** *ap-name* **environment**



- **show ap name *ap-name* gps location**
- **show ap name *ap-name* environment**
- **show ap name *ap-name* mesh linktest data *dest-mac***
- **show ap environment**
- **show ap gps location**

For details about these commands, see the [Cisco Catalyst 9800 Series Wireless Controller Command Reference](#) document.

### MAC Authorization

Use the following **show** command to verify the MAC authorization configuration:

```
Device# show run aaa
aaa authentication dot1x CENTRAL_LOCAL local
aaa authorization credential-download CENTRAL_AUTHOR local
username 002cc8de4f31 mac
username 00425a0a53b1 mac

ewlc_eft#sh wireless profile mesh detailed madhu-mesh-profile

Mesh Profile Name           : abc-mesh-profile
-----
Description                  :
Bridge Group Name           : bgn-abbc
Strict match BGN            : ENABLED
Amsdu                       : ENABLED
...
Battery State               : ENABLED
Authorization Method      : CENTRAL_AUTHOR
Authentication Method   : CENTRAL_LOCAL
Backhaul tx rate(802.11bg) : auto
Backhaul tx rate(802.11a)  : 802.11n mcs15
```

### PSK Provisioning

Use the following **show** command to verify PSK provisioning configuration:

```
Device# show wireless mesh config
Mesh Config
  Backhaul RRM                : ENABLED
  Mesh CAC                    : DISABLED
  Outdoor Ext. UNII B Domain channels(for BH) : ENABLED
  Mesh Ethernet Bridging STP BPDU Allowed    : ENABLED
  Rap Channel Sync             : ENABLED

Mesh Alarm Criteria
  Max Hop Count                : 4
  Recommended Max Children for MAP          : 10
  Recommended Max Children for RAP          : 20
  Low Link SNR                 : 12
  High Link SNR                : 60
  Max Association Number       : 10
  Parent Change Number        : 3

Mesh PSK Config
  PSK Provisioning      : ENABLED
  Default PSK           : ENABLED
```

```

PSK In-use key number          : 1
Provisioned PSKs (Maximum 5)

Index      Description
-----
1          key1

```

### Bridge Group Name

Use the following **show** command to verify the bridge group name configuration:

```

Device# show wireless profile mesh detailed abc-mesh-profile
Mesh Profile Name          : abc-mesh-profile
-----
Description                :
Bridge Group Name          : bgn-abc
Strict match BGN           : ENABLED
Amsdu                      : ENABLED
Background Scan           : ENABLED
Channel Change Notification : DISABLED
Backhaul client access     : ENABLED
Ethernet Bridging          : ENABLED
Ethernet Vlan Transparent  : DISABLED
Full Sector DFS            : ENABLED
IDS                        : ENABLED
Multicast Mode             : In-Out
Range in feet              : 12000
Security Mode              : EAP
Convergence Method         : Fast
LSC only Authentication    : DISABLED
Battery State              : ENABLED
Authorization Method        : CENTRAL_AUTHOR
Authentication Method       : CENTRAL_LOCAL
Backhaul tx rate(802.11bg) : auto
Backhaul tx rate(802.11a)  : 802.11n mcs15

```

### Backhaul Client Access

Use the following **show** command to verify the backhaul client access configuration:

```

Device# show wireless profile mesh detailed abc-mesh-profile
Mesh Profile Name          : abc-mesh-profile
-----
Description                :
Bridge Group Name          : bgn-abc
Strict match BGN           : ENABLED
Amsdu                      : ENABLED
Background Scan           : ENABLED
Channel Change Notification : DISABLED
Backhaul client access     : ENABLED
Ethernet Bridging          : ENABLED
Ethernet Vlan Transparent  : DISABLED
...
Backhaul tx rate(802.11bg) : auto
Backhaul tx rate(802.11a)  : 802.11n mcs15

```

### Wireless Backhaul Data Rate

Use the following **show** command to verify the wireless backhaul data rate configuration:

```

Device# show wireless profile mesh detailed abc-mesh-profile
Mesh Profile Name          : abc-mesh-profile
-----

```

```

Description                :
Bridge Group Name          : bgn-abc
Strict match BGN           : ENABLED
...
Authorization Method       : CENTRAL_AUTHOR
Authentication Method      : CENTRAL_LOCAL
Backhaul tx rate(802.11bg) : auto
Backhaul tx rate(802.11a) : 802.11n mcs15

```

### Dynamic Frequency Selection

Use the following **show** command to verify the dynamic frequency selection configuration:

```

Device# show wireless profile mesh detailed abc-mesh-profile
Mesh Profile Name          : abc-mesh-profile
-----
Description                :
Bridge Group Name          : bgn-abc
Strict match BGN           : ENABLED
Amsdu                      : ENABLED
Background Scan            : ENABLED
Channel Change Notification : DISABLED
Backhaul client access     : ENABLED
Ethernet Bridging          : ENABLED
Ethernet Vlan Transparent  : DISABLED
Full Sector DFS            : ENABLED
...
Backhaul tx rate(802.11a) : 802.11n mcs15

```

### Intrusion Detection System

Use the following **show** command to verify the wireless backhaul data rate configuration:

```

Device# show wireless profile mesh detailed abc-mesh-profile
Mesh Profile Name          : abc-mesh-profile
-----
Description                :
Bridge Group Name          : bgn-abc
Strict match BGN           : ENABLED
Amsdu                      : ENABLED
Background Scan            : ENABLED
Channel Change Notification : DISABLED
Backhaul client access     : ENABLED
Ethernet Bridging          : ENABLED
Ethernet Vlan Transparent  : DISABLED
Full Sector DFS            : ENABLED
IDS                        : ENABLED
Multicast Mode             : In-Out
...
Backhaul tx rate(802.11a) : 802.11n mcs15

```

### Ethernet Bridging

Use the following **show** command to verify ethernet bridging configuration:

```

Device# show wireless profile mesh detailed abc-mesh-profile
Mesh Profile Name          : abc-mesh-profile
-----
Description                :
Bridge Group Name          : bgn-abc
Strict match BGN           : ENABLED
Amsdu                      : ENABLED
Background Scan            : ENABLED

```

```

Channel Change Notification : DISABLED
Backhaul client access     : ENABLED
Ethernet Bridging       : ENABLED
Ethernet Vlan Transparent : DISABLED
Full Sector DFS           : ENABLED
IDS                       : ENABLED
Multicast Mode           : In-Out
...
Backhaul tx rate(802.11a) : 802.11n mcs15

```

### Multicast over Mesh

Use the following **show** command to verify multicast over Mesh configuration:

```

Device# show wireless profile mesh detailed abc-mesh-profile
Mesh Profile Name           : abc-mesh-profile
-----
Description                 :
Bridge Group Name           : bgn-abc
Strict match BGN            : ENABLED
Amsdu                       : ENABLED
Background Scan             : ENABLED
Channel Change Notification : DISABLED
Backhaul client access     : ENABLED
Ethernet Bridging           : ENABLED
Ethernet Vlan Transparent   : DISABLED
Full Sector DFS             : ENABLED
IDS                         : ENABLED
Multicast Mode         : In-Out
...
Backhaul tx rate(802.11a) : 802.11n mcs15

```

### RRM on Mesh Backhaul

Use the following **show** command to verify RRM on Mesh backhaul configuration:

```

Device# show wireless mesh config
Mesh Config
  Backhaul RRM : ENABLED
  Mesh CAC      : DISABLED
  Outdoor Ext. UNII B Domain channels(for BH) : ENABLED
  Mesh Ethernet Bridging STP BPDU Allowed : ENABLED
  Rap Channel Sync : ENABLED

Mesh Alarm Criteria
  Max Hop Count : 4
  Recommended Max Children for MAP : 10
  Recommended Max Children for RAP : 20
  Low Link SNR : 12
  High Link SNR : 60
  Max Association Number : 10
  Parent Change Number : 3

Mesh PSK Config
  PSK Provisioning : ENABLED
  Default PSK : ENABLED
  PSK In-use key number : 1
  Provisioned PSKs(Maximum 5)

  Index      Description
  -----
  1          key1

```

## Preferred Parent Selection

Use the following **show** command to verify preferred parent configuration:

```
Device# show wireless mesh ap tree
=====
AP Name [Hop Ctr,Link SNR,BG Name,Channel,Pref Parent,Chan Util,Clients]
=====

[Sector 1]
-----
1542-RAP [0, 0, bgn-madhu, (165), 0000.0000.0000, 1%, 0]
  |-MAP-2700 [1, 67, bgn-madhu, (165), 7070.8b7a.6fb8, 0%, 0]

Number of Bridge APs : 2
Number of RAPs : 1
Number of MAPs : 1

(*) Wait for 3 minutes to update or Ethernet Connected Mesh AP.
(**) Not in this Controller
```

## AP Role Change

Use the following **show** command to verify AP role change configuration:

```
Device# show wireless mesh ap summary
AP Name                AP Model BVI MAC          BGN          AP Role
-----
1542-RAP                1542D   002c.c8de.1338  bgn-abc     Root AP
MAP-2700                2702I   500f.8095.01e4  bgn-abc     Mesh AP

Number of Bridge APs      : 2
Number of RAPs           : 1
Number of MAPs           : 1
Number of Flex+Bridge APs : 0
Number of Flex+Bridge RAPs : 0
Number of Flex+Bridge MAPs : 0
```

## Mesh Leaf Node

Use the following **show** command to verify mesh leaf node configuration:

```
Device# show ap name MAP-2700 config general
Cisco AP Name : MAP-2700
=====

Cisco AP Identifier          : 7070.8bbc.d3e0
Country Code                 : Multiple Countries : IN,US,IO,J4
Regulatory Domain Allowed by Country : 802.11bg:-AEJQPQU 802.11a:-ABDUNPQU
AP Country Code              : IN - India
AP Regulatory Domain
  Slot 0                     : -A
  Slot 1                     : -D
MAC Address                  : 500f.8095.01e4
...
AP Mode                      : Bridge
Mesh profile name            : abc-mesh-profile
AP Role                      : Mesh AP
Backhaul radio type          : 802.11a
Backhaul slot id             : 1
Backhaul tx rate              : auto
Ethernet Bridging            : Enabled
Daisy Chaining                : Disabled
```

```

Strict Daisy Rap : Disabled
Bridge Group Name : bgn-abc
Strict-Matching BGN : Enabled
Preferred Parent Address : 7070.8b7a.6fb8
Block child state : Disabled
PSK Key Timestamp : Not Configured
...
FIPS status : Disabled
WLANCC status : Disabled
GAS rate limit Admin status : Disabled
WPA3 Capability : Disabled
EWC-AP Capability : Disabled
AWIPS Capability : Disabled
Proxy Hostname : Not Configured
Proxy Port : Not Configured
Proxy NO_PROXY list : Not Configured
GRPC server status : Disabled

```

### Subset Channel Synchronization

Use the following **show** command to verify the subset channel synchronization configuration:

```

Device# show wireless mesh config
Mesh Config
  Backhaul RRM : ENABLED
  Mesh CAC : DISABLED
  Outdoor Ext. UNII B Domain channels(for BH) : ENABLED
  Mesh Ethernet Bridging STP BPDU Allowed : ENABLED
  Rap Channel Sync : ENABLED

Mesh Alarm Criteria
  Max Hop Count : 4
  Recommended Max Children for MAP : 10
  Recommended Max Children for RAP : 20
  Low Link SNR : 12
  High Link SNR : 60
  Max Association Number : 10
  Parent Change Number : 3

Mesh PSK Config
  PSK Provisioning : ENABLED
  Default PSK : ENABLED
  PSK In-use key number : 1
  Provisioned PSKs(Maximum 5)

  Index Description
  -----
  1 key1

```

### Provisioning LSC for Bridge-Mode and Mesh APs

Use the following **show** command to verify the provisioning LSC for Bridge-Mode and Mesh AP configuration:

```

Device# show wireless profile mesh detailed default-mesh-profile
Mesh Profile Name : default-mesh-profile
-----
Description : default mesh profile
Bridge Group Name : bgn-abc
Strict match BGN : DISABLED
Amsdu : ENABLED
Background Scan : ENABLED
Channel Change Notification : ENABLED
Backhaul client access : ENABLED

```

```

Ethernet Bridging           : DISABLED
Ethernet Vlan Transparent  : ENABLED
Full Sector DFS             : ENABLED
IDS                         : DISABLED
Multicast Mode             : In-Out
Range in feet              : 12000
Security Mode              : EAP
Convergence Method        : Fast
LSC only Authentication  : DISABLED
Battery State              : ENABLED
Authorization Method       : default
Authentication Method     : default
Backhaul tx rate(802.11bg) : auto
Backhaul tx rate(802.11a) : auto

```

### Specify the Backhaul Slot for the Root AP

Use the following **show** command to verify the backhaul slot for the Root AP configuration:

```

Device# show ap name 1542-RAP mesh backhaul
MAC Address : 380e.4d85.5e60
Current Backhaul Slot: 1
Radio Type: 0
Radio Subband: All
Mesh Radio Role: DOWNLINK
Administrative State: Enabled
Operation State: Up
Current Tx Power Level:
Current Channel: (165)
Antenna Type: N/A
Internal Antenna Gain (in .5 dBm units): 18

```

### Using a Link Test on Mesh Backhaul

Use the following **show** command to verify the use of link test on mesh backhaul configuration:

```

Device# show ap name 1542-RAP mesh linktest data 7070.8bbc.d3ef
380e.4d85.5e60 ==> 7070.8bbc.d3ef

Started at : 05/11/2020 20:56:28
Status: In progress

Configuration:
=====
Data rate: Mbps
Packets per sec: : 234
Packet Size: : 1200
Duration: : 200

```

### Mesh CAC

Use the following **show** command to verify mesh CAC configuration:

```

Device# show wireless mesh config
Mesh Config
  Backhaul RRM                : ENABLED
  Mesh CAC                   : DISABLED
  Outdoor Ext. UNII B Domain channels(for BH) : ENABLED
  Mesh Ethernet Bridging STP BPDU Allowed    : ENABLED
  Rap Channel Sync                 : ENABLED

Mesh Alarm Criteria
  Max Hop Count                  : 4

```

```

Recommended Max Children for MAP      : 10
Recommended Max Children for RAP      : 20
Low Link SNR                          : 12
High Link SNR                         : 60
Max Association Number                : 10
Parent Change Number                  : 3

Mesh PSK Config
PSK Provisioning                      : ENABLED
Default PSK                           : ENABLED
PSK In-use key number                 : 1
Provisioned PSKs (Maximum 5)

```

Index	Description
-----	-----
1	key1

## Verifying Dot11ax Rates on Mesh Backhaul

To verify the 802.11ax rates on mesh backhaul in the mesh profile, use the following command:

```

Device# show wireless profile mesh detailed default-mesh-profile
Mesh Profile Name      : default-mesh-profile
-----
Description           : default mesh profile
.
.
Backhaul tx rate(802.11bg) : 802.11ax mcs7 ss1
Backhaul tx rate(802.11a)  : 802.11ax mcs9 ss2

```

To verify the 802.11ax rates on mesh backhaul in the general configuration of an AP, use the following command:

```

Device# show ap config general
Cisco AP Identifier    : 5c71.0d17.49e0
.
.
Backhaul slot id      : 1
Backhaul tx rate      : 802.11ax mcs7 ss1

```



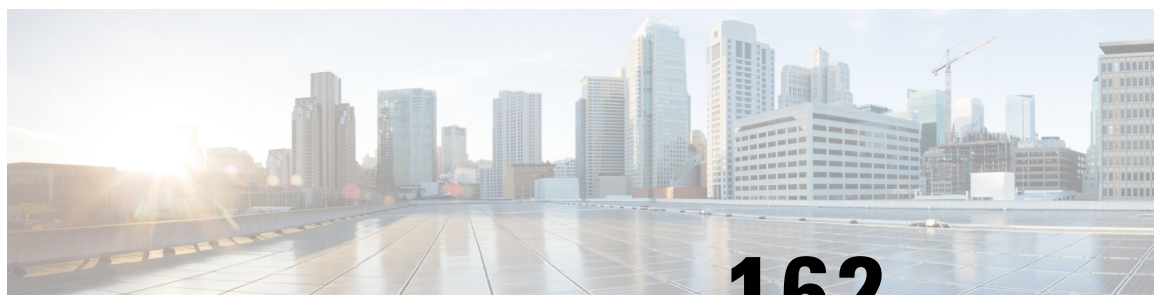

## CHAPTER 162

# Redundant Root Access Point (RAP) Ethernet Daisy Chaining

---

- [Overview of Redundant RAP Ethernet Daisy Chaining, on page 1527](#)
- [Prerequisites for Redundant RAP Ethernet Daisy Chaining Support, on page 1528](#)
- [Configuring Redundant RAP Ethernet Daisy Chaining Support \(CLI\), on page 1528](#)
- [Verifying Daisy Chain Redundancy \(CLI\), on page 1528](#)

## Overview of Redundant RAP Ethernet Daisy Chaining

The Root Access Point (RAP) Ethernet Daisy Chaining is a feature where RAPs are chained using wired Ethernet to avoid latency in backhaul link failure recovery.

This feature proposes a redundancy in the daisy chain, wherein, two switches act as a redundant Designated Port (DP), each connected to either end of the daisy chain. In case of a link failure, the link direction is reversed using a new STP root.

A redundant RAP ethernet daisy chain has similar capabilities to the existing mesh daisy chain feature. In a redundant RAP ethernet daisy chain topology, the packet is encapsulated with CAPWAP header and forwarded to the controller from its wireless client for each AP. The packet is bridged to its primary ethernet interface from its secondary ethernet interface including the other AP's wireless client CAPWAP packets. Both 2.4G and 5G radio are used for client access.



---

**Note** The daisy chain strict RAP configuration is applicable to Cisco IOS access points only.

---

Redundant RAP ethernet daisy chain is supported on the IW6300 AP model.

In case of ethernet daisy chain topology, if a CAPWAP loss occurs on the first RAP connected to switch, the entire chain loses its uplink. This takes a long time to recover. Thereby, if the RAP ethernet daisy chain is enabled, the CAPWAP data keepalive is extended to three times.



---

**Note** Only wired uplink configuration is valid, if you configure an AP as Bridge or Flex Bridge mode Root AP.

---

## Prerequisites for Redundant RAP Ethernet Daisy Chaining Support

- Ethernet bridging on should be enabled.
- Strict-wired-uplink feature should be enabled.

## Configuring Redundant RAP Ethernet Daisy Chaining Support (CLI)

Follow the procedure given below to enable redundant RAP ethernet daisy chaining on a mesh profile:

### Procedure

	Command or Action	Purpose
<b>Step 1</b>	<b>configure terminal</b>  <b>Example:</b> Device# <b>configure terminal</b>	Enters global configuration mode.
<b>Step 2</b>	<b>wireless profile mesh <i>profile-name</i></b>  <b>Example:</b> Device(config)# <b>wireless profile mesh default-mesh-profile</b>	Configures a mesh profile and enters mesh profile configuration mode.
<b>Step 3</b>	<b>daisychain-stp-redundancy</b>  <b>Example:</b> Device(config-wireless-mesh-profile)# <b>daisychain-stp-redundancy</b>	Configures daisy chain STP redundancy.

## Verifying Daisy Chain Redundancy (CLI)

To verify the ethernet daisy chain summary, use the following command:

```
Device# show wireless mesh ethernet daisy-chain summary
```

AP Name	BVI MAC	BGN	Backhaul	Ethernet	STP Red
RAP4	683b.78bf.15f0	IOT	Ethernet0	Up Up Dn Dn	Enabled
RAP3	683b.78bf.1634	IOT	Ethernet0	Up Up Dn Dn	Enabled
RAP1	6c8b.d383.b4d4	IOT	Ethernet0	Up Up Dn Dn	Enabled
RAP2	6c8b.d383.b4e8	IOT	Ethernet0	Up Up Up Dn	Enabled

To verify the ethernet daisy chain Bridge Group Name (BGN) details, use the following command:

```
Device# show wireless mesh ethernet daisy-chain bgn <IOT>
```

AP Name	BVI MAC	BGN	Backhaul	Ethernet	STP Red
RAP4	683b.78bf.15f0	IOT	Ethernet0	Up Up Dn Dn	Enabled
RAP3	683b.78bf.1634	IOT	Ethernet0	Up Up Dn Dn	Enabled
RAP1	6c8b.d383.b4d4	IOT	Ethernet0	Up Up Dn Dn	Enabled
RAP2	6c8b.d383.b4e8	IOT	Ethernet0	Up Up Up Dn	Enabled

To verify the mesh profile, use the following command:

```
Device# show wireless profile mesh detailed default-mesh-profile
```

```
Mesh Profile Name : default-mesh-profile
```

```
-----
Description : default mesh profile
Bridge Group Name : IOT
Strict match BGN : ENABLED
Amsdu : ENABLED
Background Scan : ENABLED
Channel Change Notification : ENABLED
Backhaul client access : ENABLED
Ethernet Bridging : ENABLED
Ethernet Vlan Transparent : DISABLED
Daisy Chain STP Redundancy : ENABLED
Full Sector DFS : ENABLED
IDS : ENABLED
Multicast Mode : In-Out
Range in feet : 12000
Security Mode : EAP
Convergence Method : Standard
LSC only Authentication : DISABLED
Battery State : ENABLED
Authorization Method : eap_methods
Authentication Method : eap_methods
Backhaul tx rate(802.11bg) : auto
Backhaul tx rate(802.11a) : auto
=====
```





## PART **XIV**

### **VideoStream**

- [VideoStream, on page 1533](#)





## CHAPTER 163

# VideoStream

---

- [Information about Media Stream, on page 1533](#)
- [Prerequisites for Media Stream, on page 1534](#)
- [How to Configure Media Stream, on page 1534](#)
- [Monitoring Media Streams, on page 1539](#)
- [Configuring the General Parameters for a Media Stream \(GUI\), on page 1539](#)
- [Adding Media Stream \(CLI\), on page 1540](#)
- [Enabling a Media Stream per WLAN \(GUI\), on page 1541](#)
- [Enabling a Media Stream per WLAN \(CLI\), on page 1541](#)
- [Configuring the General Parameters for a Media Stream \(GUI\), on page 1542](#)
- [Configuring the General Parameters for a Media Stream \(CLI\), on page 1542](#)
- [Configuring Multicast Direct Admission Control \(GUI\), on page 1543](#)
- [Configuring Multicast Direct Admission Control \(CLI\), on page 1543](#)
- [Create and Attach Policy-based QoS Profile, on page 1545](#)
- [Viewing Media Stream Information, on page 1550](#)

## Information about Media Stream

The IEEE 802.11 wireless multicast delivery mechanism does not provide a reliable way to acknowledge lost or corrupted packets. As a result, if any multicast packet is lost in the air, it is not sent again which may cause an IP multicast stream unviewable.

The Media Stream feature makes the delivery of the IP multicast stream reliable over air, by converting the multicast frame to a unicast frame over the air. Each Media Stream client acknowledges receiving a video IP multicast stream.



---

**Note** Support for IPv6 was added from Cisco IOS XE Gibraltar 16.12.1. You can use IPv6 multicast addresses in place of IPv4 multicast addresses to enable media stream on the IPv6 networks.

---

## Prerequisites for Media Stream

- Make sure that the Multicast feature is enabled. We recommend that you configure IP multicast on the controller in multicast-multicast mode.
- Check for the IP address on the client machine. The machine should have an IP address from the respective VLAN.
- Verify that the access points have joined the controllers .

## How to Configure Media Stream

### Configuring Multicast-Direct Globally for Media Stream (CLI)

#### Procedure

	Command or Action	Purpose
<b>Step 1</b>	<b>configure terminal</b> <b>Example:</b> Device# <code>configure terminal</code>	Enters global configuration mode.
<b>Step 2</b>	<b>wireless multicast</b> <b>Example:</b> Device(config)# <code>wireless multicast</code>	Enables multicast for wireless forwarding.
<b>Step 3</b>	<b>ip igmp snooping</b> <b>Example:</b> Device(config)# <code>ip igmp snooping</code>	Enables IGMP snooping on a per-VLAN basis. If the global setting is disabled, then all the VLANs are treated as disabled, whether they are enabled or not.
<b>Step 4</b>	<b>ip igmp snooping querier</b> <b>Example:</b> Device(config)# <code>ip igmp snooping querier</code>	Enables a snooping querier on an interface when there is no multicast router in the VLAN to generate queries.
<b>Step 5</b>	<b>wireless media-stream multicast-direct</b> <b>Example:</b> (config)# <code>wireless media-stream multicast-direct</code>	Configures the global multicast-direct on the controller.
<b>Step 6</b>	<b>wireless media-stream message</b> <b>Example:</b> (config)# <code>wireless media-stream message ?</code> Email Configure Session Announcement Email	Configures various message-configuration parameters such as phone, URL, email, and notes. That is, when a media stream is refused (due to bandwidth constraints), a message can be sent to the corresponding user. These parameters configure the messages that are to



	Command or Action	Purpose
	<pre>Notes Configure Session Announcement notes URL Configure Session Announcement URL phone Configure Session Announcement Phone number &lt;cr&gt;</pre>	be sent to the IT support email address, notes (message be displayed explaining why the stream was refused), URL to which the user can be redirected, and the phone number that the user can call about the refused stream.
<b>Step 7</b>	<p><b>wireless media-stream group</b> <i>name startIp endIp</i></p> <p><b>Example:</b></p> <pre>(config)#<b>wireless media-stream group</b> <b>grp1 231.1.1.1 239.1.1.3</b>      avg-packet-size Configure average packet size     default Set a command to its defaults      exit Exit sub-mode     max-bandwidth Configure maximum expected stream bandwidth in Kbps     no Negate a command or set its defaults     policy Configure media stream admission policy     priority Configure media stream priority, &lt;1:Lowest - 8:Highest&gt;     qos Configure over the air QoS class, &lt;'video'&gt; ONLY     rrc-evaluation Configure RRC re-evaluation admission     violation Configure stream violation policy on periodic re-evaluation</pre>	Configures each media stream and its parameters such as expected multicast destination addresses, stream bandwidth consumption, and stream-priority parameters.
<b>Step 8</b>	<p><b>end</b></p> <p><b>Example:</b></p> <pre>Device(config)# <b>end</b></pre>	Returns to privileged EXEC mode. Alternatively, you can also press <b>Ctrl-Z</b> to exit global configuration mode.

## Configuring Media Stream for 802.11 Bands (CLI)

### Procedure

	Command or Action	Purpose
<b>Step 1</b>	<p><b>configure terminal</b></p> <p><b>Example:</b></p> <pre>Device# <b>configure terminal</b></pre>	Enters global configuration mode.
<b>Step 2</b>	<p><b>ap dot11 {24ghz   5ghz } media-stream multicast-direct</b></p>	Configures whether MediaStream (multicast to unicast ) is allowed for the 802.11 band.

	Command or Action	Purpose
	<b>Example:</b> <pre>Device(config)#ap dot11 24ghz media-stream multicast-direct</pre>	You must disable 802.11 network to enable the MediaStream.
<b>Step 3</b>	<b>ap dot11 {24ghz   5ghz } media-stream video-redirect</b>  <b>Example:</b> <pre>Device(config)#ap dot11 24ghz media-stream video-redirect</pre>	Optional. Configures the redirection of unicast video traffic to the best-effort queue.
<b>Step 4</b>	<b>ap dot11 {24ghz   5ghz } media-stream multicast-direct admission-besteffort</b>  <b>Example:</b> <pre>Device(config)#ap dot11 24ghz media-stream multicast-direct admission-besteffort</pre>	Configures the media stream to be sent through the best-effort queue if that media stream cannot be prioritized due to bandwidth-availability limitations. Run the <b>no</b> form of the command to drop the stream, if the media stream cannot be prioritized due to bandwidth-availability limitations.
<b>Step 5</b>	<b>ap dot11 {24ghz   5ghz } media-stream multicast-direct client-maximum <i>value</i></b>  <b>Example:</b> <pre>Device(config)#ap dot11 24ghz media-stream multicast-direct client-max 15</pre>	Configures the maximum number of allowed media streams per individual client. The maximum is 15 and the default is 0. The value of 0 denotes unlimited streams.
<b>Step 6</b>	<b>ap dot11 {24ghz   5ghz } media-stream multicast-direct radio-maximum <i>value</i></b>  <b>Example:</b> <pre>Device(config)#ap dot11 24ghz media-stream multicast-direct radio-maximum 20</pre>	Configures maximum number of radio streams. The valid range is from 1 to 20. Default is 0. The value of 0 denotes unlimited streams.
<b>Step 7</b>	<b>ap dot11 {24ghz   5ghz } cac multimedia max-bandwidth <i>bandwidth</i></b>  <b>Example:</b> <pre>Device(config)#ap dot11 24ghz cac multimedia max-bandwidth 60</pre>	Configures maximum media (voice + video) bandwidth, in percent. The range is between 5-85%.
<b>Step 8</b>	<b>ap dot11 {24ghz   5ghz } cac media-stream multicast-direct min-client-rate <i>dot11_rate</i></b>  <b>Example:</b> <pre>Device(config)#ap dot11 24ghz cac media-stream multicast-direct min_client_rate</pre>	Configures the minimum PHY rate needed for a client to send a media stream as unicast. Clients communicating below this rate will not receive the media stream as a unicast flow. Typically, this PHY rate is equal to or higher than the rate at which multicast frames are sent.
<b>Step 9</b>	<b>ap dot11 {24ghz   5ghz } cac media-stream</b>  <b>Example:</b> <pre>Device(config)#ap dot11 5ghz cac media-stream</pre>	Configures Call Admission Control (CAC) parameters for media stream access category.

	Command or Action	Purpose
<b>Step 10</b>	<b>ap dot11 {24ghz   5ghz } cac multimedia</b> <b>Example:</b> Device (config) # <b>ap dot11 5ghz cac multimedia</b>	Configures CAC parameters for media access category: used for voice and video.
<b>Step 11</b>	<b>ap dot11 {24ghz   5ghz } cac voice</b> <b>Example:</b> Device (config) # <b>ap dot11 5ghz cac voice</b>	Configures CAC parameters for voice access category.
<b>Step 12</b>	<b>end</b> <b>Example:</b> Device (config) # <b>end</b>	Returns to privileged EXEC mode. Alternatively, you can also press <b>Ctrl-Z</b> to exit global configuration mode.

## Configuring a WLAN to Stream Video(GUI)

### Procedure

- 
- Step 1** Choose **Configuration > Wireless > WLANs > Wireless Networks**.
  - Step 2** Select a **WLAN** to view the **Edit WLAN** window.
  - Step 3** Click **Advanced** tab.
  - Step 4** Check the **Media Stream Multicast-Direct** check box to enable the feature.
  - Step 5** Click **Update & Apply to Device**.
- 

## Configuring a WLAN to Stream Video (CLI)

### Procedure

	Command or Action	Purpose
<b>Step 1</b>	<b>configure terminal</b> <b>Example:</b> Device# <b>configure terminal</b>	Enters global configuration mode.
<b>Step 2</b>	<b>wlan wlan_name</b> <b>Example:</b> (config) # <b>wlan wlan50</b>	Enters WLAN configuration mode.
<b>Step 3</b>	<b>shutdown</b> <b>Example:</b> (config-wlan) # <b>shutdown</b>	Disables the WLAN for configuring its parameters.

	Command or Action	Purpose
<b>Step 4</b>	<b>media-stream multicast-direct</b> <b>Example:</b> <code>(config)#media-stream multicast-direct</code>	Configures the multicast-direct on media stream for the WLAN.
<b>Step 5</b>	<b>no shutdown</b> <b>Example:</b> <code>(config-wlan)#no shutdown</code>	Enables the WLAN.
<b>Step 6</b>	<b>end</b> <b>Example:</b> <code>Device(config)# end</code>	Returns to privileged EXEC mode. Alternatively, you can also press <b>Ctrl-Z</b> to exit global configuration mode.

## Deleting a Media Stream (GUI)

### Procedure

- 
- Step 1** Choose **Configuration > Wireless > Media Stream**.
  - Step 2** Click the **Streams** tab.
  - Step 3** Check the checkbox adjacent to the Stream Name you want to delete.  
To delete multiple streams, select multiple stream name checkboxes.
  - Step 4** Click **Delete**.
  - Step 5** Click **Yes** on the confirmation window to delete the VLAN.
- 

## Deleting a Media Stream (CLI)

### Before you begin

The media stream should be enabled and configured for it to be deleted.

### Procedure

	Command or Action	Purpose
<b>Step 1</b>	<b>configure terminal</b> <b>Example:</b> <code>Device# configure terminal</code>	Enters global configuration mode.
<b>Step 2</b>	<b>no wireless media-stream group</b> <i>media_stream_name</i> <b>Example:</b>	Deletes the media stream that bears the name mentioned in the command.

	Command or Action	Purpose
	Device(config)#no wireless media-stream grp1	
<b>Step 3</b>	<b>end</b> <b>Example:</b> Device(config)# end	Returns to privileged EXEC mode. Alternatively, you can also press <b>Ctrl-Z</b> to exit global configuration mode.

## Monitoring Media Streams

Table 82: Commands for monitoring media streams

Commands	Description
show wireless media-stream client detail <i>group name</i>	Displays media stream client details of the particular group.
show wireless media-stream client summary	Displays the media stream information of all the clients.
show wireless media-stream group detail <i>group name</i>	Displays the media stream configuration details of the particular group.
show wireless media-stream group summary	Displays the media stream configuration details of all the groups.
show wireless media-stream message details	Displays the session announcement message details.
show wireless multicast	Displays the multicast-direct configuration state.
show ap dot11 {24ghz   5ghz} media-stream rrc	Displays 802.11 media Resource-Reservation-Control configurations.

## Configuring the General Parameters for a Media Stream (GUI)

### Procedure

- 
- Step 1** Choose **Configuration > Wireless > Media Stream**.
  - Step 2** In the **General** tab, check the **Multicast Direct Enable** check box.
  - Step 3** In the **Session Message Config** section, check the **Session Announcement State** check box to enable the session announcement mechanism. If the session announcement state is enabled, clients are informed each time a controller is not able to serve the multicast direct data to the client.
  - Step 4** In the **Session Announcement URL** field, enter the URL where the client can find more information when an error occurs during the multicast media stream transmission.
  - Step 5** In the **Session Announcement Email** field, enter the e-mail address of the person who can be contacted.
  - Step 6** In the **Session Announcement Phone** field, enter the phone number of the person who can be contacted.

- Step 7** In the **Session Announcement Note** field, enter a reason as to why a particular client cannot be served with a multicast media.
- Step 8** Click **Apply**.

## Adding Media Stream (CLI)

### Procedure

	Command or Action	Purpose
<b>Step 1</b>	<b>wireless media-stream group</b> <i>groupName</i> <i>startIpAddr endIpAddr</i> <b>Example:</b> Device(config)# wireless media-stream group group1 224.0.0.0 224.0.0.223	Configures each media stream and its parameters, such as expected multicast destination addresses, stream bandwidth consumption, and stream priority parameters.
<b>Step 2</b>	<b>avg-packet-size</b> <i>packetsize</i> <b>Example:</b> Device(media-stream)# avg-packet-size 100	Configures the average packet size.
<b>Step 3</b>	<b>max-bandwidth</b> <i>bandwidth</i> <b>Example:</b> Device(media-stream)# max-bandwidth 80	Configures the maximum expected stream bandwidth, in Kbps.
<b>Step 4</b>	<b>policy {admit   deny}</b> <b>Example:</b> Device(media-stream)# policy admit	Configure the media stream admission policy.
<b>Step 5</b>	<b>qos video</b> <b>Example:</b> Device(media-stream)# qos video	Configures over-the-air QoS class, as 'video'.
<b>Step 6</b>	<b>violation {drop   fallback}</b> <b>Example:</b> Device(media-stream)# violation drop	Configures the violation mode.
<b>Step 7</b>	<b>rrc-evaluation {initial   periodic}</b> <b>Example:</b> Device(media-stream)# rrc-evaluation initial	Configure Resource Reservation Control (RRC) re-evaluation admission, which provides initial or periodic admission evaluation. The re-evaluation admission occurs at 2, 4, 8, and so on seconds.
<b>Step 8</b>	<b>priority</b> <i>priority-value</i> <b>Example:</b>	Sets the priority value. The valid range is from 1-8, with 1 being the lowest.

	Command or Action	Purpose
	Device(media-stream)# priority 6	

## Enabling a Media Stream per WLAN (GUI)

### Procedure

- 
- Step 1** Choose **Configuration > Tags & Profiles > WLANs**.
  - Step 2** On the **WLANs** page, click the name of the **WLAN** or click **Add** to create a new one.
  - Step 3** In the **Add/Edit WLAN** window that is displayed, click the **Advanced** tab.
  - Step 4** Check the **Enabling a Media Stream for each WLAN** check box to enable Media Stream on the WLAN.
  - Step 5** Save the configuration.
- 

## Enabling a Media Stream per WLAN (CLI)

Follow the procedure given below to enable a media stream for each WLAN:

### Procedure

	Command or Action	Purpose
<b>Step 1</b>	<b>configure terminal</b> <b>Example:</b> Device# configure terminal	Enters global configuration mode.
<b>Step 2</b>	<b>wlan wlan_name</b> <b>Example:</b> Device(config)# wlan wlan5	Enters WLAN configuration mode.
<b>Step 3</b>	<b>shutdown</b> <b>Example:</b> Device(config-wlan)# shutdown	Disables the WLAN for configuring its parameters.
<b>Step 4</b>	<b>media-stream multicast-direct</b> <b>Example:</b> Device(config-wlan)# media-stream multicast-direct	Configures multicast-direct for the WLAN.
<b>Step 5</b>	<b>no shutdown</b> <b>Example:</b> Device(config-wlan)# no shutdown	Enables the WLAN.

## Configuring the General Parameters for a Media Stream (GUI)

### Procedure

- 
- Step 1** Choose **Configuration > Wireless > Media Stream**.
- Step 2** Check the **Multicast Direct Enable** check box to enable multicast direct globally on the local mode.
- Step 3** In the **Session Message Config** section, enter the values for the following parameters
- Session Announcement URL
  - Session Announcement Email
  - Session Announcement Phone
  - Session Announcement Note
- Step 4** Save the configuration.
- 

## Configuring the General Parameters for a Media Stream (CLI)

Follow the procedure given below to configure the general parameters for a media stream:

### Procedure

	Command or Action	Purpose
<b>Step 1</b>	<b>configure terminal</b>  <b>Example:</b> Device# configure terminal	Enters global configuration mode.
<b>Step 2</b>	<b>wireless media-stream message</b> {URL url   email email-address   phone phone-no   notes notes }  <b>Example:</b> Device(config)# wireless media-stream message url www.xyz.com	Configures various message configuration parameters, such as phone, URL, email, and notes.
<b>Step 3</b>	<b>wireless media-stream multicast-direct</b>  <b>Example:</b> Device(config)# wireless media-stream multicast-direct	Enables multicast direct globally for local mode.  <b>Note</b> This configuration will not impact flex and fabric media-stream configurations.
<b>Step 4</b>	<b>exit</b>  <b>Example:</b> Device(config)# exit	Returns to privileged EXEC mode.



## Configuring Multicast Direct Admission Control (GUI)

### Procedure

- 
- Step 1** Choose **Configuration > Wireless > Media Stream**.
- Step 2** Check the **Media Stream Admission Control (ACM)** check box to enable multicast direct admission control.
- Step 3** In the **Maximum Media Stream RF bandwidth (%)** field, enter the percentage of the maximum bandwidth to be allocated for media applications on this radio band. Valid range is from 5 to 85. When the client reaches a specified value, the AP rejects new calls on this radio band.
- Step 4** In the **Maximum Media Bandwidth (%)** field, enter the bandwidth. Valid range is from 5 to 85%.
- Step 5** From the **Client Minimum Phy Rate** drop-down list, select the minimum transmission data rate or the rate in kilobits per second at which the client can operate. If the transmission data rate is below the physical rate, either the video will not start or the client may be classified as a bad client. The bad client video can be demoted for better effort QoS or subject to denial.
- Step 6** In the **Maximum Retry Percent (%)** field, enter the percentage of maximum retries that are allowed. The default value is 80. If it exceeds 80, either the video will not start or the client might be classified as a bad client. The bad client video can be demoted for better effort QoS or subject to denial.
- Step 7** Click **Apply**.
- 

## Configuring Multicast Direct Admission Control (CLI)

Follow the procedure given below to configure multicast direct admission control:

### Procedure

	Command or Action	Purpose
<b>Step 1</b>	<b>configure terminal</b> <b>Example:</b> Device# configure terminal	Enters global configuration mode.
<b>Step 2</b>	<b>ap dot11 {24ghz   5ghz } shutdown</b> <b>Example:</b> Device(config)# ap dot11 24ghz shutdown	Disables the 802.11 network.
<b>Step 3</b>	<b>ap dot11 {24ghz   5ghz } media-stream video-redirect</b> <b>Example:</b> Device(config)# ap dot11 24ghz media-stream video-redirect	Configures the redirection of the unicast video traffic to best-effort queue.

	Command or Action	Purpose
Step 4	<b>ap dot11 {24ghz   5ghz} cac media-stream acm</b>  <b>Example:</b> <pre>Device(config)# ap dot11 24ghz cac media-stream acm</pre>	Enables admission control on the media-stream access category.
Step 5	<b>ap dot11 {24ghz   5ghz} cac media-stream max-bandwidth <i>bandwidth</i></b>  <b>Example:</b> <pre>Device(config)# ap dot11 24ghz cac media-stream max-bandwidth 65</pre>	Configures the maximum media bandwidth, in percent. The range is between 5-85%.
Step 6	<b>ap dot11 {24ghz   5ghz} cac multimedia max-bandwidth <i>bandwidth</i></b>  <b>Example:</b> <pre>Device(config)# ap dot11 24ghz cac multimedia max-bandwidth 65</pre>	Configures the maximum bandwidth allocated to Wi-Fi Multimedia (WMM) clients for media. The range is between 5-85%.
Step 7	<b>ap dot11 {24ghz   5ghz} cac media-stream multicast-direct min-client-rate <i>dot11Rate</i></b>  <b>Example:</b> <pre>Device(config)# ap dot11 24ghz cac media-stream multicast-direct min-client-rate 800</pre>	Configures the minimum PHY rate needed for a client to receive media stream as unicast. Clients communicating below this rate will not receive the media stream as a unicast flow. Typically, this PHY rate is equal to or higher than the rate at which multicast frames are sent.
Step 8	<b>ap dot11 {24ghz   5ghz} cac media-stream multicast-direct max-retry-percent <i>retryPercent</i></b>  <b>Example:</b> <pre>Device(config)# ap dot11 24ghz cac media-stream multicast-direct max-retry-percent 50</pre>	Configures CAC parameter maximum retry percent for multicast-direct streams.
Step 9	<b>ap dot11 {24ghz   5ghz} media-stream multicast-direct radio-maximum <i>value</i></b>  <b>Example:</b> <pre>Device(config)# ap dot11 24ghz media-stream multicast-direct radio-maximum 10</pre>	Configures the maximum number of radio streams. The range is from 1 to 20. Default is 0. Value 0 denotes unlimited streams.
Step 10	<b>ap dot11 {24ghz   5ghz} media-stream multicast-direct client-maximum <i>value</i></b>  <b>Example:</b> <pre>Device(config)# ap dot11 24ghz media-stream multicast-direct client-maximum 12</pre>	Configures the maximum number of allowed media streams per individual client. The maximum is 15 and the default is 0. Value 0 denotes unlimited streams.
Step 11	<b>ap dot11 {24ghz   5ghz} media-stream multicast-direct admission-besteffort</b>	Configures the media stream to still be sent through the best effort queue if a media stream

	Command or Action	Purpose
	<b>Example:</b> Device(config)# ap dot11 24ghz media-stream multicast-direct admission-besteffort	cannot be prioritized due to bandwidth availability limitations. Add <b>no</b> in the command to drop the stream if the media stream cannot be prioritized due to bandwidth availability limitations.
<b>Step 12</b>	<b>no ap dot11 {24ghz   5ghz } shutdown</b>  <b>Example:</b> Device(config)# no ap dot11 24ghz shutdown	Enables the 802.11 network.

## Create and Attach Policy-based QoS Profile

The high-level steps to create and attach policy-based QoS profile are as follows:

1. Create a QoS Profile
2. Create a Service Template
3. Map the Service Template to the Policy Map
4. Map the Policy Map to the Policy Profile

### Create a QoS Profile (GUI)

#### Procedure

- 
- Step 1** Click **Configuration > Services > QoS**.
  - Step 2** Click **Add** to create a new QoS Policy.
  - Step 3** Enter a **Policy Name**.
  - Step 4** Enter a **Description** for the policy.
  - Step 5** In the **Class Default** section, choose a value in the **Mark** drop-down list.
  - Step 6** Enter the **Police(kbps)** value.
  - Step 7** Click **Apply to Device**.
-

## Create a QoS Profile (CLI)

### Procedure

	Command or Action	Purpose
<b>Step 1</b>	<b>configure terminal</b> <b>Example:</b> Device# configure terminal	Enters global configuration mode.
<b>Step 2</b>	<b>policy-map <i>policy-map-name</i></b> <b>Example:</b> Device(config)# policy-map QoS_Drop_Youtube	Creates a policy map.
<b>Step 3</b>	<b>description <i>description</i></b> <b>Example:</b> Device(config-pmap)# description QoS_Drop_Youtube	Adds a description to the policy map.
<b>Step 4</b>	<b>class <i>class-map-name</i></b> <b>Example:</b> Device(config-pmap)# class QoS_Drop_Youtube1_AVC_UI_CLASS	Creates a policy criteria.
<b>Step 5</b>	<b>police cir <i>committ-information-rate</i></b> <b>Example:</b> Device(config-pmap-c)# police cir 8000	Polices the provided committed information rate.
<b>Step 6</b>	<b>conform-action drop</b> <b>Example:</b> Device(config-pmap-c-police)# conform-action drop	Configures the action when the rate is less than the conform burst.
<b>Step 7</b>	<b>exceed-action drop</b> <b>Example:</b> Device(config-pmap-c-police)# exceed-action drop	Configures the action when the rate is within the conform and conform plus exceed burst.
<b>Step 8</b>	<b>end</b> <b>Example:</b> Device(config-pmap-c-police)# end	Returns to privileged EXEC mode.

## Create a Service Template (GUI)

### Procedure

- 
- Step 1** Choose **Configuration > Security > Local Policy**.
- Step 2** On the **Local Policy** page, **Service Template** tab, click **Add**.
- Step 3** In the **Create Service Template** window, enter the following parameters:
- **Service Template Name:** Enter a name for the template.
  - **VLAN ID:** Enter the VLAN ID for the template. Valid range is between 1 and 4094.
  - **Session Timeout (secs):** Sets the timeout duration for the template. Valid range is between 1 and 65535.
  - **Access Control List:** Choose the Access Control List from the drop-down list.
  - **Ingress QoS:** Choose the input QoS policy for the client from the drop-down list
  - **Egress QoS:** Choose the output QoS policy for the client from the drop-down list.
- Step 4** Click **Apply to Device**.
- 

## Create a Service Template (CLI)

### Procedure

	Command or Action	Purpose
<b>Step 1</b>	<b>configure terminal</b>  <b>Example:</b> Device# configure terminal	Enters global configuration mode.
<b>Step 2</b>	<b>service-template <i>template-name</i></b>  <b>Example:</b> Device(config)# service-template qos-template	Configures the service-template or identity policy.
<b>Step 3</b>	<b>vlan <i>vlan-id</i></b>  <b>Example:</b> Device(config-service-template)# vlan 87	Specifies VLAN ID.
<b>Step 4</b>	<b>absolute-timer <i>timer</i></b>  <b>Example:</b> Device(config-service-template)# absolute-timer 3600	Specifies session timeout value for a service template.

	Command or Action	Purpose
<b>Step 5</b>	<b>service-policy qos input</b> <i>qos-policy</i> <b>Example:</b> Device(config-service-template)# service-policy qos input QoS_Drop_Youtube	Configures an input QoS policy for the client.
<b>Step 6</b>	<b>service-policy qos output</b> <i>qos-policy</i> <b>Example:</b> Device(config-service-template)# service-policy qos output QoS_Drop_Youtube	Configures an output QoS policy for the client.
<b>Step 7</b>	<b>end</b> <b>Example:</b> Device(config-service-template)# end	Returns to privileged EXEC mode.

## Map the Service Template to the Policy Map (GUI)

### Procedure

- 
- Step 1** Choose **Configuration** > **Tags & Profiles** > **Policy**.
  - Step 2** On the **Policy Profile** page, select the **Policy Profile** to be mapped.
  - Step 3** In the **Edit Policy Profile** window, click **Access Policies** tab.
  - Step 4** Use the **Local Subscriber Policy Name** drop-down list to select the policy name.
  - Step 5** Click **Update & Apply to Device**.
- 

## Map the Service Template to the Policy Map (CLI)

### Procedure

	Command or Action	Purpose
<b>Step 1</b>	<b>configure terminal</b> <b>Example:</b> Device# configure terminal	Enters global configuration mode.
<b>Step 2</b>	<b>parameter-map type subscriber</b> <b>attribute-to-service</b> <i>parameter-map-name</i> <b>Example:</b> Device(config)# parameter-map type subscriber attribute-to-service QoS-Policy_Map-param	Specifies the parameter map type and name.

	Command or Action	Purpose
<b>Step 3</b>	<p><i>map-index</i> <b>map device-type eq filter-name</b> <b>user-role eq user-name</b></p> <p><b>Example:</b></p> <pre>Device(config-parameter-map-filter)# 1 map device-type eq "Android" user-role eq "student"</pre>	Specifies the parameter map attribute filter criteria. Multiple filters are used in the example provided here.
<b>Step 4</b>	<p><i>map-index</i> <b>service-template</b> <i>service-template-name</i> <b>precedence</b> <i>precedence-num</i></p> <p><b>Example:</b></p> <pre>Device(config-parameter-map-filter-submode)# 1 service-template Qos_template</pre>	Specifies the service template.
<b>Step 5</b>	<p><b>end</b></p> <p><b>Example:</b></p> <pre>Device(config-parameter-map-filter-submode)# end</pre>	Returns to privileged EXEC mode.
<b>Step 6</b>	<p><b>configure terminal</b></p> <p><b>Example:</b></p> <pre>Device# configure terminal</pre>	Enters global configuration mode.
<b>Step 7</b>	<p><b>policy-map type control subscriber</b> <i>policy-map-name</i></p> <p><b>Example:</b></p> <pre>Device(config)# policy-map type control subscriber QoS-Policy_Map</pre>	Specifies the policy map type.
<b>Step 8</b>	<p><b>event identity-update match-all</b></p> <p><b>Example:</b></p> <pre>Device(config-event-control-policymap)# event identity-update match-all</pre>	Specifies the match criteria to the policy map.
<b>Step 9</b>	<p><i>class-num</i> <b>class always do-until-failure</b></p> <p><b>Example:</b></p> <pre>Device(config-event-control-policymap)# 1 class always do-until-failure</pre>	Applies a class-map with a service-template.
<b>Step 10</b>	<p><i>action-index</i> <b>map attribute-to-service table</b> <i>parameter-map-name</i></p> <p><b>Example:</b></p> <pre>Device(config-event-control-policymap)# 1 map attribute-to-service table QoS-Policy_Map-param</pre>	Applies a parameter map.

## Map the Policy Map (GUI)

### Procedure

- 
- Step 1** Choose **Configuration** > **Security** > **Local Policy** > **Policy Map** tab.
  - Step 2** Click **Add**.
  - Step 3** Enter a name in the **Policy Map Name** text field.
  - Step 4** Click **Add** to add the matching criteria information.
  - Step 5** Choose the service template from the **Service Template** drop-down list.
  - Step 6** Choose the filters from **Device Type**, **User Role**, **User Name**, **OUI** and **MAC Address** drop-down lists.
  - Step 7** Click **Add Criteria**
  - Step 8** Click **Apply to Device**.
- 

## Map the Policy Map (CLI)

### Procedure

	Command or Action	Purpose
<b>Step 1</b>	<b>configure terminal</b>  <b>Example:</b> Device# configure terminal	Enters global configuration mode.
<b>Step 2</b>	<b>wireless profile policy</b> <i>wlan-policy-profile-name</i>  <b>Example:</b> Device(config)# wireless profile policy test-policy-profile	Configures a wireless policy profile.
<b>Step 3</b>	<b>description</b> <i>profile-policy-description</i>  <b>Example:</b> Device(config-wireless-policy)# description "test policy profile"	Adds a description for the policy profile.
<b>Step 4</b>	<b>subscriber-policy-name</b> <i>policy-name</i>  <b>Example:</b> Device(config-wireless-policy)# subscriber-policy-name QoS-Policy_Map	Configures the subscriber policy name.

## Viewing Media Stream Information

Use the following **show** commands to view the media stream information.



To view media stream general information and status, use the following commands:

```
Device# show wireless media-stream multicast-direct state

Multicast-direct State..... : enabled
Allowed WLANs:
WLAN-Name                               WLAN-ID
-----
zsetup_mc                                1
vwlc-mc_mo                                3
mcuc_test1                                4
mcuc_test2                                5
```

```
Device# show wireless media-stream group summary
```

```
Number of Groups:: 4
```

Stream Name	Start IP	End IP	Status
new2	231.2.2.3	231.2.4.4	Enabled
my234	234.0.0.0	234.10.10.10	Enabled
uttest2	235.1.1.20	235.1.1.25	Enabled
uttest3	235.1.1.40	235.1.1.200	Enabled

To view the details of a particular media stream, use the **show wireless media-stream client detail *media\_stream\_name*** command:

```
Device# show wireless media-stream group detail uttest2
```

```
Media Stream Name       : uttest2
Start IP Address        : 235.1.1.20
End IP Address          : 235.1.1.25
RRC Parameters:
  Avg Packet Size(Bytes) : 1200
  Expected Bandwidth(Kbps) : 1000
  Policy                  : Admitted
  RRC re-evaluation       : Initial
  QoS                     : video
  Status                  : Multicast-direct
  Usage Priority          : 4
  Violation               : Drop
```

To view RRC information for a dot11 band, use the **show ap dot11 {24ghz | 5ghz } mediastream rrc** command:

```
Device# show ap dot11 5ghz media-stream rrc
```

```
Multicast-direct       : Enabled
Best Effort             : Disabled
Video Re-Direct        : Disabled
Max Allowed Streams Per Radio : Auto
Max Allowed Streams Per Client : 5
Max Media-Stream Bandwidth : 5
Max Voice Bandwidth     : 50
Max Media Bandwidth     : 43
Min PHY Rate (Kbps)    : 6000
Max Retry Percentage    : 5
```

To view session announcement message details, use the **show wireless media-stream message details** command:

```
Device# show wireless media-stream message details
URL           :
Email        : abc@cisc
Phone        :
Note         :
State        : Disabled
```

To view the list of clients in the blocked list database, use the **show ip igmp snooping igmpv2-tracking** command:

```
Device# show ip igmp snooping igmpv2-tracking

Client to SGV mappings
-----
Client: 10.10.10.215 Port: Ca1
  Group: 239.255.255.250 Vlan: 10 Source: 0.0.0.0 blacklisted: no
  Group: 234.5.6.7 Vlan: 10 Source: 0.0.0.0 blacklisted: no
  Group: 234.5.6.8 Vlan: 10 Source: 0.0.0.0 blacklisted: no
  Group: 234.5.6.9 Vlan: 10 Source: 0.0.0.0 blacklisted: no

Client: 10.10.101.177 Port: Ca2
  Group: 235.1.1.14 Vlan: 10 Source: 0.0.0.0 blacklisted: no
  Group: 235.1.1.16 Vlan: 10 Source: 0.0.0.0 blacklisted: no
  Group: 235.1.1.18 Vlan: 10 Source: 0.0.0.0 blacklisted: no

SGV to Client mappings
-----
Group: 234.5.6.7 Source: 0.0.0.0 Vlan: 10
  Client: 10.10.10.215 Port: Ca1 Blacklisted: no
```

To view wireless client summary, use the **show wireless media-stream client summary** command:

```
Device# show wireless media-stream client summary
```

To view details of a specific wireless media stream, use the **show wireless media-stream client detail** command:

```
Device# show wireless media-stream client detail uttest2

Media Stream Name      : uttest2
Start IP Address       : 235.1.1.20
End IP Address         : 235.1.1.25
RRC Parameters:
  Avg Packet Size(Bytes) : 1200
  Expected Bandwidth(Kbps) : 1000
  Policy                  : Admitted
  RRC re-evaluation       : Initial
  QoS                     : video
  Status                  : Multicast-direct
  Usage Priority           : 4
  Violation               : Drop
```



## PART **XV**

# Software-Defined Access Wireless

- [Software-Defined Access Wireless, on page 1555](#)
- [Passive Client, on page 1563](#)
- [Fabric in a Box with External Fabric Edge, on page 1571](#)





## CHAPTER 164

# Software-Defined Access Wireless

- [Information to Software-Defined Access Wireless, on page 1555](#)
- [Configuring SD-Access Wireless, on page 1558](#)
- [Verifying SD-Access Wireless, on page 1562](#)

## Information to Software-Defined Access Wireless

The Enterprise Fabric provides end-to-end enterprise-wide segmentation, flexible subnet addressing, and controller-based networking with uniform enterprise-wide policy and mobility. It moves the enterprise network from current VLAN-centric architecture to a user group-based enterprise architecture, with flexible Layer 2 extensions within and across sites.

Enterprise fabric is a network topology where traffic is passed through inter-connected switches, while providing the abstraction of a single Layer 2 or Layer 3 device. This provides seamless connectivity, with policy application and enforcement at the edge of the fabric. Fabric uses IP overlay, which makes the network appear as a single virtual entity without using clustering technologies.

The following definitions are used for fabric nodes:

- **Enterprise Fabric:** A network topology where traffic is passed through inter-connected switches, while providing the abstraction of a single Layer 2 or Layer 3 device.
- **Fabric Domain:** An independent operation part of the network. It is administered independent of other fabric domains.
- **End Points:** Hosts or devices that connect to the fabric edge node are known as end points (EPs). They directly connect to the fabric edge node or through a Layer 2 network.

The following figure shows the components of a typical SD-Access Wireless. It consists of Fabric Border Nodes (BN), Fabric Edge Nodes (EN), Wireless Controller, Cisco Catalyst Center, and Host Tracking Database (HDB).

Figure 45: Software-Defined Access Wireless

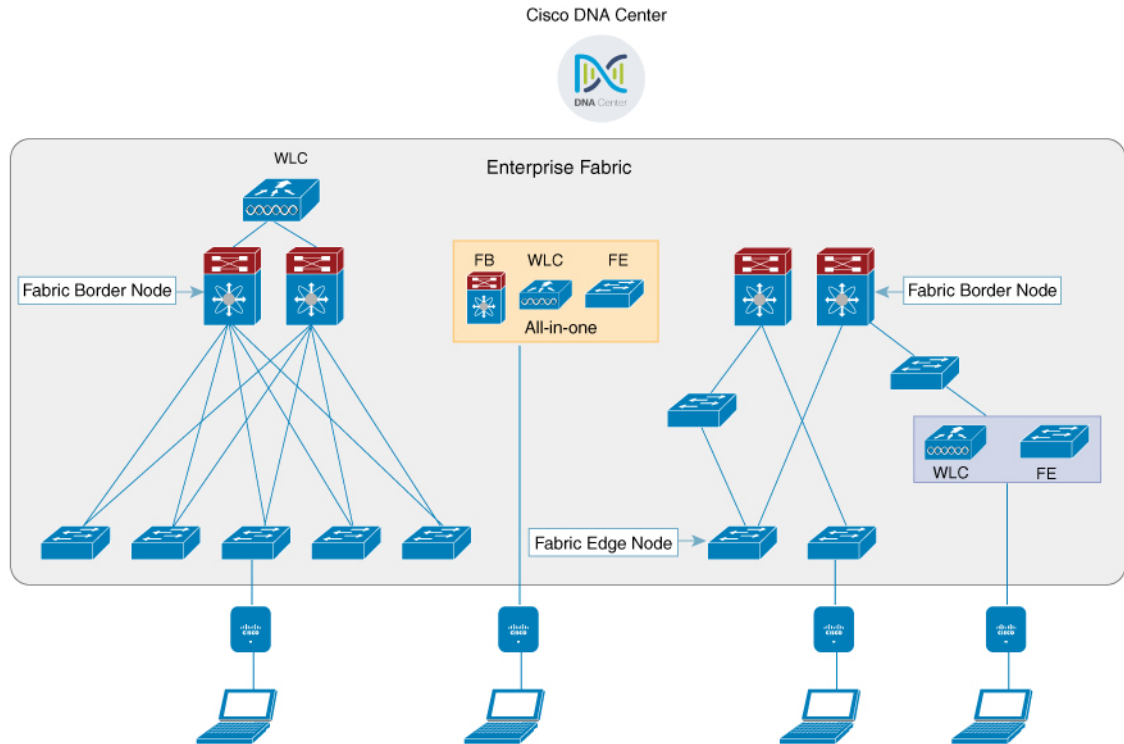

The figure covers the following deployment topologies:

- All-in-one Fabric—When we have all Fabric Edge, Fabric Border, Control-Plane and controller functionality enabled on a Cat 9K switch.  
This topology is depicted in the mid part of the figure.
- Split topology—When we have Fabric Border, or Control Plane, or controller on a Cat 9K switch with separate Fabric Edge. This topology is depicted in the left-most part of the figure.
- Co-located Fabric Edge and Controller—When we have Fabric Edge and controller on a Cat 9K switch. This topology is depicted in the right-most part of the figure.

**Cisco Catalyst Center:** Is an open, software-driven architecture built on a set of design principles with the objective of configuring and managing Cisco Catalyst 9800 Series Wireless Controllers.

**Control Plane:** This database allows the network to determine the location of a device or user. When the EP ID of a host is learnt, other end points can query the database about the location of the host. The flexibility of tracking subnets helps in summarization across domains and improves the scalability of the database.

**Fabric Border Node (Proxy Egress Tunnel Router [PxTR or Pitr/PETR] in LISP):** These nodes connect traditional Layer 3 networks or different fabric domains to the enterprise fabric domain. If there are multiple fabric domains, these nodes connect a fabric domain to one or more fabric domains, which could be of the same or different type. These nodes are responsible for translation of context from one fabric domain to another. When the encapsulation is the same across different fabric domains, the translation of fabric context is generally 1:1. The fabric control planes of two domains exchange reachability and policy information through this device.

**Fabric Edge Nodes (Egress Tunnel Router [ETR] or Ingress Tunnel Router [ITR] in LISP):** These nodes are responsible for admitting, encapsulating or decapsulating, and forwarding of traffic from the EPs. They lie at the perimeter of the fabric and are the first points of attachment of the policy. EPs could be directly or indirectly attached to a fabric edge node using an intermediate Layer 2 network that lies outside the fabric domain. Traditional Layer 2 networks, wireless access points, or end hosts are connected to fabric edge nodes.

**Wireless Controller:** The controller provides AP image and configuration management, client session management and mobility. Additionally, it registers the mac address of wireless clients in the host tracking database at the time of client join, as well as updates the location at the time of client roam.

**Access Points:** AP applies all the wireless media specific features. For example, radio and SSID policies, webauth punt, peer-to-peer blocking, and so on. It establishes CAPWAP control and data tunnel to controller. It converts 802.11 data traffic from wireless clients to 802.3 and sends it to the access switch with VXLAN encapsulation.

The SDA allows to simplify:

- Addressing in wireless networks
- Mobility in wireless networks
- Guest access and move towards multi-tenancy
- Leverage Sub-net extension (stretched subnet) in wireless network
- Provide consistent wireless policies



**Note** Role co-location between wireless controller and fabric edge is supported.

## Platform Support

*Table 83: Supported Platforms for Software-Defined Access Wireless*

Platforms	Support
Catalyst 9300	Yes
Catalyst 9400	Yes
Catalyst 9500H	Yes
Cisco Catalyst 9800 Series Wireless Controller for Cloud	Yes
Cisco Catalyst 9800-40 Series Wireless Controller	Yes
Cisco Catalyst 9800-80 Series Wireless Controller	Yes

*Table 84: Multi-Instance Support*

Multi-instance	Support
Multiple LISP sessions	Yes

Multi-instance	Support
Emulated database support	Yes
Client roaming between WNCd instances	Yes

Table 85: Feature Support

Feature	Support
Inter-WLC roam for IRCM	Only L2 mobility is supported as VLAN is stretched across the fabric.
DNS-IPv4-ACL	<ul style="list-style-type: none"> <li>• ACLs are enforced at AP.</li> <li>• Controller needs to push the DNS-ACL information to AP.</li> </ul>
IPv6 ACL for clients	Yes. Open, 802.11x, WebAuth, PSK WLANs, IPv6 address visibility are also supported.
Location tracking/Hyperlocation	Yes
Multicast Video-Stream (IPv4)	Yes
Smart Licensing	Yes

Table 86: Outdoor Access Points Support

AP	Support
1542	Yes
1560	Yes

## Configuring SD-Access Wireless

- To enable SD-Access wireless globally, you need to run the **wireless fabric** configuration command.
- During SD-Access Wireless provisioning, ensure that L2-VNID value is unique.

## Configuring Default Map Server (GUI)

### Procedure

- 
- Step 1** Click **Configuration > Wireless Plus > Fabric > Fabric Configuration**.
- Step 2** In the **Map Server** section, specify the IP address and preshared key details for Server 1.



- Step 3** Optionally, you can specify the IP address and preshared key details for Server 2.  
**Step 4** Click **Apply**.

## Configuring Default Map Server (CLI)

Follow the procedure given below to configure default map server:

### Procedure

	Command or Action	Purpose
<b>Step 1</b>	<b>configure terminal</b>  <b>Example:</b> Device# configure terminal	Enters the global configuration mode.
<b>Step 2</b>	<b>wireless fabric control-plane <i>map-server-name</i></b>  <b>Example:</b> Device(config)# wireless fabric control-plane map-server-name	Configures the default map server.  Here, <i>map-server-name</i> defines a pair of map servers.
<b>Step 3</b>	<b>ip address <i>ip-address</i> key <i>user_password</i> reenter_password</b>  <b>Example:</b> Device(config-wireless-cp)# ip address 200.0.0.0 key user-password user-password	Configures IP address for the default map server.
<b>Step 4</b>	<b>end</b>  <b>Example:</b> Device(config-wireless-cp)# end	Returns to privileged EXEC mode. Alternatively, you can also press <b>Ctrl-Z</b> to exit global configuration mode.

## Configuring SD-Access Wireless Profile (GUI)

### Procedure

- Step 1** Choose **Configuration > Wireless > Fabric**.  
**Step 2** On the **Fabric** page, click the **Profiles** tab and click **Add**.  
**Step 3** In the **Add New Profile** window that is displayed, specify the following parameters:
- Profile name
  - Description
  - L2 VNID; valid range is between 0 and 16777215
  - SGT tag; valid range is between 2 and 65519

**Step 4** Click **Save & Apply to Device**.

## Configuring SD-Access Wireless Profile (CLI)

Follow the procedure given below to configure SD-Access wireless profile:

### Procedure

	Command or Action	Purpose
<b>Step 1</b>	<b>configure terminal</b>  <b>Example:</b> Device# configure terminal	Enters the global configuration mode.
<b>Step 2</b>	<b>wireless profile fabric</b> <i>fabric-profile-name</i>  <b>Example:</b> Device(config)# wireless profile fabric fabric-profile-name	Configures the SD-Access wireless profile parameters.
<b>Step 3</b>	<b>sgt-tag</b> <i>sgt</i>  <b>Example:</b> Device(config-wireless-fabric)# sgt-tag 2	Configures SGT tag.  Here, <i>sgt</i> refers to the sgt tag value. The valid range is from 2-65519. The default value is 0.
<b>Step 4</b>	<b>client-l2-vnid</b> <i>client-l2-vnid</i>  <b>Example:</b> Device(config-wireless-fabric)# client-l2-vnid client-l2-vnid	Configures client L2-VNID.  Here, <i>client-l2-vnid</i> refers to the client L2-VNID value. The valid range is from 0-16777215.
<b>Step 5</b>	<b>end</b>  <b>Example:</b> Device(config-wireless-fabric)# end	Returns to privileged EXEC mode. Alternatively, you can also press <b>Ctrl-Z</b> to exit global configuration mode.

## Configuring Map Server in Site Tag (GUI)

### Before you begin

Ensure that you have configured a control plane at the time of configuring Wireless Fabric.

### Procedure

- 
- Step 1** Choose **Configuration > Tags & Profiles > Tags**.
  - Step 2** On the **Manage Tags** page, click the **Site** tab.
  - Step 3** Click the name of the site tag.

- Step 4** In the **Edit Site Tag** window, choose the Fabric control plane name from the **Control Plane Name** drop-down list.
- Step 5** Save the configuration.

## Configuring Map Server in Site Tag (CLI)

Follow the procedure given below to configure map server in site tag:

### Procedure

	Command or Action	Purpose
<b>Step 1</b>	<b>configure terminal</b>  <b>Example:</b> Device# configure terminal	Enters the global configuration mode.
<b>Step 2</b>	<b>wireless tag site <i>site-tag</i></b>  <b>Example:</b> Device(config)# wireless tag site default-site-tag	Configures site tag.  Here, <i>site-tag</i> refers to the site tag name.
<b>Step 3</b>	<b>fabric control-plane <i>map-server-name</i></b>  <b>Example:</b> Device(config-site-tag)# fabric control-plane map-server-name	Configures fabric control plane details.  Here, <i>map-server-name</i> refers to the fabric control plane name associated with the site tag.
<b>Step 4</b>	<b>end</b>  <b>Example:</b> Device(config-site-tag)# end	Returns to privileged EXEC mode. Alternatively, you can also press <b>Ctrl-Z</b> to exit global configuration mode.

## Configuring Map Server per L2-VNID (GUI)

### Procedure

- Step 1** Choose **Configuration > Wireless > Fabric**.
- Step 2** On the **Fabric Configuration** page in the **Fabric VNID Mapping** section, click **Add**.
- Step 3** In the **Add Client and AP VNID** window, specify a name for the Fabric, L2 VNID value (valid range is from 0 to 4294967295), control plane name.
- Step 4** Save the configuration.

## Configuring Map Server per L2-VNID (CLI)

Follow the procedure given below to configure map server in site tag:

### Procedure

	Command or Action	Purpose
<b>Step 1</b>	<b>configure terminal</b>  <b>Example:</b> Device# configure terminal	Enters the global configuration mode.
<b>Step 2</b>	<b>wireless fabric name name l2-vnid l2-vnid-value l3-vnid l3-vnid-value ip network-ip subnet-mask control-plane-name control-plane-name</b>  <b>Example:</b> Device(config)# wireless fabric name fabric_name l2-vnid 2 l3-vnid 2 ip 122.220.234.0 255.255.0.0 control-plane-name sample-control-plane	Configures the map server to the VNID map table. <ul style="list-style-type: none"> <li>• <i>name</i> refers to the fabric name.</li> <li>• <i>l2-vnid-value</i> refers to the L2 VNID value. The valid range is from 0 to 16777215.</li> <li>• <i>l3-vnid-value</i> refers to the L3 VNID value. The valid range is from 0 to 16777215.</li> <li>• <i>control-plane-name</i> refers to the control plane name.</li> </ul>
<b>Step 3</b>	<b>end</b>  <b>Example:</b> Device(config)# end	Returns to privileged EXEC mode.

## Verifying SD-Access Wireless

You can verify the SD-Access wireless configurations using the following commands:

**Table 87: Commands for Verifying SD-Access Wireless**

Commands	Description
<b>show wireless fabric summary</b>	Displays the fabric status.
<b>show wireless fabric vnid mapping</b>	Displays all the VNID mapping details.
<b>show wireless profile fabric detailed fabric_profile_name</b>	Displays the details of a given fabric profile name.
<b>show ap name AP_name config general</b>	Displays the general details of the Cisco AP.
<b>show wireless client mac MAC_addr detail</b>	Displays the detailed information for a client by MAC address.
<b>show wireless tag site detailed site_tag</b>	Displays the detailed parameters for a site tag.



## CHAPTER 165

# Passive Client

---

- [Information About Passive Clients, on page 1563](#)
- [Enabling Passive Client on WLAN Policy Profile \(GUI\), on page 1564](#)
- [Enabling Passive Client on WLAN Policy Profile \(CLI\), on page 1564](#)
- [Enabling ARP Broadcast on VLAN \(GUI\), on page 1565](#)
- [Enabling ARP Broadcast on VLAN \(CLI\), on page 1565](#)
- [Configuring Passive Client in Fabric Deployment, on page 1566](#)
- [Verifying Passive Client Configuration, on page 1569](#)

## Information About Passive Clients

Passive Clients are wireless devices, such as printers and devices configured using a static IP address. Such clients do not transmit any IP information after associating to an AP. That is why, the controller does not learn their IP address unless they perform the DHCP process.

In the controller, the clients just show up in the **Learn IP** state and get timed out because of the DHCP policy-timeout.

The Passive Client feature can be enabled on a per WLAN basis. Enabling this feature will change a few default behaviors in order to better accommodate passive clients. These changes include :

- No client will ever timeout in the IP\_LEARN phase. The controller will keep on waiting to learn their IP address. Note that the idle timeout remains active and will delete the client entry after the timeout period expiry, if the client remains silent all along.
- ARP coming from the wired side is broadcasted to all the APs, if the controller does not know the client IP address, to ensure that it reaches the passive client. After this, the controller learns the client IP from the ARP response.



**Note** In order to save air time, the controller transforms the ARP broadcast coming from the wired side or from other wireless clients and unicasts them to the wireless client it owns. This is only possible after the controller has learned the MAC-IP binding of its wireless client.

When the controller enables ARP broadcast, the controller does not transform the ARP broadcasts into unicasts but only forwards the broadcast, thereby wasting air time for other clients (with a frame that is not acknowledgeable and therefore less reliable). This pushes the passive client to respond to the ARP request and therefore every other client benefits from learning the MAC-IP binding of the wireless client.



**Note** Passive client feature is not supported on FlexConnect local switching mode.

## Enabling Passive Client on WLAN Policy Profile (GUI)

### Procedure

- 
- Step 1** Choose **Configuration > Tags & Profiles > Policy** page, click **Add** to open the **Add Policy Profile** page.
  - Step 2** In the **General** tab, use the slider to enable **Passive Client**.
  - Step 3** Click **Save & Apply to Device**.
- 

## Enabling Passive Client on WLAN Policy Profile (CLI)

### Procedure

	Command or Action	Purpose
<b>Step 1</b>	<b>configure terminal</b> <b>Example:</b> Device# configure terminal	Enters global configuration mode.
<b>Step 2</b>	<b>wireless profile policy <i>policy-profile</i></b> <b>Example:</b> Device(config)# wireless profile policy rr-xyz-policy-1	Configures WLAN policy profile and enters wireless policy configuration mode.
<b>Step 3</b>	<b>[no] passive-client</b> <b>Example:</b> Device(config-wireless-policy)# [no] passive-client	Enables Passive Client.

	Command or Action	Purpose
<b>Step 4</b>	<b>end</b> <b>Example:</b> Device(config-wireless-policy)# end	Returns to privileged EXEC mode.

## Enabling ARP Broadcast on VLAN (GUI)

### Procedure

- Step 1** Choose **Configuration > Layer2 > VLAN** page, click **VLAN** tab.
- Step 2** Click **Add** to view the **Create VLAN** window.
- Step 3** Use the slider to enable **ARP Broadcast**.
- Step 4** Click **Save & Apply to Device**.

## Enabling ARP Broadcast on VLAN (CLI)



**Note** ARP Broadcast feature is not supported on VLAN groups.

### Procedure

	Command or Action	Purpose
<b>Step 1</b>	<b>configure terminal</b> <b>Example:</b> Device# configure terminal	Enters global configuration mode.
<b>Step 2</b>	<b>vlan configuration <i>vlan-id</i></b> <b>Example:</b> Device(config)# vlan configuration 1	Configures a VLAN or a collection of VLANs and enters VLAN configuration mode.
<b>Step 3</b>	<b>[no] arp broadcast</b> <b>Example:</b> Device(config-vlan)# [no] arp broadcast	Enables ARP broadcast on VLAN.
<b>Step 4</b>	<b>end</b> <b>Example:</b> Device(config-vlan)# end	Returns to privileged EXEC mode. Alternatively, you can also press <b>Ctrl-Z</b> to exit global configuration mode.

# Configuring Passive Client in Fabric Deployment

You need to enable the following for passive client feature to work:

- ARP broadcast on VLANs
- LISP multicast. For information on LISP multicast, see:

[https://www.cisco.com/c/en/us/td/docs/ios-xml/ios/iproute\\_lisp/configuration/xs-3s/irl-xe-3s-book/irl-lisp-multicast.html](https://www.cisco.com/c/en/us/td/docs/ios-xml/ios/iproute_lisp/configuration/xs-3s/irl-xe-3s-book/irl-lisp-multicast.html)

For information on LISP (Locator ID Separation Protocol), see:

[https://www.cisco.com/c/en/us/td/docs/ios-xml/ios/iproute\\_lisp/configuration/xs-3s/irl-xe-3s-book/irl-cfg-lisp.html](https://www.cisco.com/c/en/us/td/docs/ios-xml/ios/iproute_lisp/configuration/xs-3s/irl-xe-3s-book/irl-cfg-lisp.html)

## Enabling Broadcast Underlay on VLAN



**Note** You can perform the following configuration tasks from Fabric Edge Node only and not from your controller.

### Procedure

	Command or Action	Purpose
<b>Step 1</b>	<b>configure terminal</b>  <b>Example:</b> FabricEdge# configure terminal	Enters global configuration mode.
<b>Step 2</b>	<b>router lisp</b>  <b>Example:</b> FabricEdge(config)# router lisp	Enters LISP configuration mode.
<b>Step 3</b>	<b>instance-id <i>instance</i></b>  <b>Example:</b> FabricEdge(config-router-lisp)# instance-id 3	Creates a LISP EID instance to group multiple services. Configurations under this instance-id are applicable to all services underneath it.
<b>Step 4</b>	<b>service ipv4</b>  <b>Example:</b> FabricEdge(config-router-lisp-instance)# service ipv4	Enables Layer 3 network services for the IPv4 address family and enters the service submode.
<b>Step 5</b>	<b>database-mapping <i>eid locator-set RLOC name</i></b>  <b>Example:</b>	Configures EID to RLOC mapping relationship.



	Command or Action	Purpose
	<pre>FabricEdge(config-router-lisp-instance-dynamic-eid)# database-mapping 66.66.66.64/32 locator-set rloc1</pre>	
<b>Step 6</b>	<b>map-cache destination-eid map-request</b> <b>Example:</b> <pre>FabricEdge(config-router-lisp-instance-service)# map-cache 0.0.0.0/0 map-request</pre>	Generates a static map request for the destination EID.
<b>Step 7</b>	<b>exit-service-ipv4</b> <b>Example:</b> <pre>FabricEdge(config-router-lisp-instance-service)# exit-service-ipv4</pre>	Exits service submode.
<b>Step 8</b>	<b>exit-instance-id</b> <b>Example:</b> <pre>FabricEdge(config-router-lisp-instance)# exit-instance-id</pre>	Exits instance submode.
<b>Step 9</b>	<b>instance-id instance</b> <b>Example:</b> <pre>FabricEdge(config-router-lisp)# instance-id 101</pre>	Creates a LISP EID instance to group multiple services.
<b>Step 10</b>	<b>service ethernet</b> <b>Example:</b> <pre>FabricEdge(config-router-lisp-instance)# service ethernet</pre>	Enables Layer 2 network services and enters service submode.
<b>Step 11</b>	<b>eid-table vlan vlan-number</b> <b>Example:</b> <pre>FabricEdge(config-router-lisp-instance-service)# eid-table vlan 101</pre>	Associates the LISP instance-id configured earlier with a VLAN through which the endpoint identifier address space is reachable.
<b>Step 12</b>	<b>broadcast-underlay multicast-group</b> <b>Example:</b> <pre>FabricEdge(config-router-lisp-instance-service)# broadcast-underlay 239.0.0.1</pre>	Specifies the multicast group used by the underlay to carry the overlay Layer 2 broadcast traffic.
<b>Step 13</b>	<b>exit-service-ethernet</b> <b>Example:</b> <pre>FabricEdge(config-router-lisp-instance-service)# exit-service-ethernet</pre>	Exits service sub mode.
<b>Step 14</b>	<b>exit-instance-id</b> <b>Example:</b> <pre>FabricEdge(config-router-lisp-instance)# exit-instance-id</pre>	Exits instance sub mode.

## Enabling ARP Flooding



**Note** You can perform the following configuration tasks from Fabric Edge Node only and not from your controller.

### Procedure

	Command or Action	Purpose
<b>Step 1</b>	<b>configure terminal</b> <b>Example:</b> FabricEdge# configure terminal	Enters global configuration mode.
<b>Step 2</b>	<b>router lisp</b> <b>Example:</b> FabricEdge(config)# router lisp	Enters LISP configuration mode.
<b>Step 3</b>	<b>instance-id <i>instance</i></b> <b>Example:</b> FabricEdge(config-router-lisp)# instance-id 3	Creates a LISP EID instance to group multiple services. Configurations under this instance-id are applicable to all services underneath it.
<b>Step 4</b>	<b>service ipv4</b> <b>Example:</b> FabricEdge(config-router-lisp-instance)# service ipv4	Enables Layer 3 network services for the IPv4 address family and enters the service submode.
<b>Step 5</b>	<b>database-mapping <i>eid locator-set RLOC name</i></b> <b>Example:</b> FabricEdge(config-router-lisp-instance-dynamic-eid)# database-mapping 66.66.66.64/32 locator-set rloc1	Configures EID to RLOC mapping relationship.
<b>Step 6</b>	<b>map-cache <i>destination-eid map-request</i></b> <b>Example:</b> FabricEdge(config-router-lisp-instance-service)# map-cache 0.0.0.0/0 map-request	Generates a static map request for the destination EID.
<b>Step 7</b>	<b>exit-service-ipv4</b> <b>Example:</b> FabricEdge(config-router-lisp-instance-service)# exit-service-ipv4	Exits service submode.
<b>Step 8</b>	<b>exit-instance-id</b> <b>Example:</b>	Exits instance submode.

	Command or Action	Purpose
	<code>FabricEdge (config-router-lisp-instance) # exit-instance-id</code>	
<b>Step 9</b>	<b>instance-id</b> <i>instance</i>  <b>Example:</b> <code>FabricEdge (config-router-lisp) # instance-id 101</code>	Creates a LISP EID instance to group multiple services.
<b>Step 10</b>	<b>service ethernet</b>  <b>Example:</b> <code>FabricEdge (config-router-lisp-instance) # service ethernet</code>	Enables Layer 2 network services and enters service submenu.
<b>Step 11</b>	<b>eid-table vlan</b> <i>vlan-number</i>  <b>Example:</b> <code>FabricEdge (config-router-lisp-instance-service) # eid-table vlan 101</code>	Associates the LISP instance-id configured earlier with a VLAN through which the endpoint identifier address space is reachable.
<b>Step 12</b>	<b>flood arp-nd</b>  <b>Example:</b> <code>FabricEdge (config-router-lisp-instance-service) # flood arp-nd</code>	Enables ARP flooding.
<b>Step 13</b>	<b>database-mapping</b> <i>mac locator-set RLOC name</i>  <b>Example:</b> <code>FabricEdge (config-router-lisp-instance-service) # database-mapping mac locator-set rloc1</code>	Configures EID to RLOC mapping relationship.
<b>Step 14</b>	<b>exit-service-ethernet</b>  <b>Example:</b> <code>FabricEdge (config-router-lisp-instance-service) # exit-service-ethernet</code>	Exits service sub mode.
<b>Step 15</b>	<b>exit-instance-id</b>  <b>Example:</b> <code>FabricEdge (config-router-lisp-instance) # exit-instance-id</code>	Exits instance sub mode.

## Verifying Passive Client Configuration

To verify the status of the Passive Client, use the following command:

```
Device# show wireless profile policy detailed sample-profile-policy
```

```
Policy Profile Name      : sample-profile-policy
Description              : sample-policy
Status                   : ENABLED
```

```
VLAN : 20
Client count : 0
Passive Client : ENABLED <-----
WLAN Switching Policy
  Central Switching : ENABLED
  Central Authentication : ENABLED
  Central DHCP : DISABLED
  Override DNS : DISABLED
  Override NAT PAT : DISABLED
  Central Assoc : DISABLED
.
.
.
```

To verify VLANs that have ARP broadcast enabled, use the following command:

```
Device# show platform software arp broadcast
```

```
Arp broadcast is enabled on vlans:
20
```



## CHAPTER 166

# Fabric in a Box with External Fabric Edge

- [Introduction to Fabric in a Box with External Fabric Edge, on page 1571](#)
- [Configuring a Fabric Profile \(CLI\), on page 1571](#)
- [Configuring a Policy Profile \(CLI\), on page 1572](#)
- [Configuring a Site Tag \(CLI\), on page 1573](#)
- [Configuring a WLAN \(CLI\), on page 1574](#)
- [Configuring a Policy Tag \(CLI\), on page 1574](#)
- [Configuring an AP Profile, on page 1575](#)
- [Configuring Map Server and AP Subnet \(CLI\), on page 1575](#)
- [Configuring Fabric on FiaB Node, on page 1576](#)
- [Configuring a Fabric Edge Node, on page 1582](#)
- [Verifying Fabric Configuration, on page 1589](#)

## Introduction to Fabric in a Box with External Fabric Edge

From Cisco IOS XE Amsterdam 17.2.1, the Fabric in a Box (FiaB) topology supports external fabric edge nodes. In a fabric-enabled wireless environment using FiaB (border node, control plane, fabric edge, and wireless controller in the same box), you can expand the network by adding external fabric edge nodes. The external fabric edge helps to increase the port density and extend the wireless reach by adding more APs. The APs and clients can exist on both the FiaB and the external fabric edge nodes. Also, the clients can roam between the APs on the FiaB and the external fabric edge nodes.

## Configuring a Fabric Profile (CLI)

### Procedure

	Command or Action	Purpose
Step 1	<b>configure terminal</b>  <b>Example:</b> Device# <code>configure terminal</code>	Enters global configuration mode.

	Command or Action	Purpose
<b>Step 2</b>	<b>wireless profile fabric</b> <i>fabric-profile-name</i> <b>Example:</b> Device(config)# wireless profile fabric test-fabric-profile	Configures the wireless fabric profile parameters.
<b>Step 3</b>	<b>client-l2-vnid</b> <i>client-l2-vnid</i> <b>Example:</b> Device(config-wireless-fabric)# client-l2-vnid 8189	Configures client L2-VNID.  Here, <i>client-l2-vnid</i> refers to the client L2-VNID value. The valid range is from 0 to 16777215.
<b>Step 4</b>	<b>description</b> <i>description</i> <b>Example:</b> Device(config-wireless-fabric)# description test-fabric-profile	Adds a description for the fabric profile.
<b>Step 5</b>	<b>end</b> <b>Example:</b> Device(config-wireless-fabric)# end	Returns to privileged EXEC mode.

## Configuring a Policy Profile (CLI)

### Procedure

	Command or Action	Purpose
<b>Step 1</b>	<b>configure terminal</b> <b>Example:</b> Device# configure terminal	Enters global configuration mode.
<b>Step 2</b>	<b>wireless profile policy</b> <i>profile-policy</i> <b>Example:</b> Device(config)# wireless profile policy test-policy-profile	Configures wireless policy profile and enters wireless policy configuration mode.  <b>Note</b> In Fabric deployments, local mode, local authentication, and local association are not supported.
<b>Step 3</b>	<b>no central dhcp</b> <b>Example:</b> Device(config-wireless-policy)# no central dhcp	Configures local DHCP mode, where the DHCP is performed in an AP.
<b>Step 4</b>	<b>no central switching</b> <b>Example:</b> Device(config-wireless-policy)# no central switching	Configures a WLAN for local switching.

	Command or Action	Purpose
<b>Step 5</b>	<b>fabric</b> <i>fabric-name</i> <b>Example:</b> Device(config-wireless-fabric)# fabric test-fabric-profile	Applies the fabric profile.
<b>Step 6</b>	<b>no shutdown</b> <b>Example:</b> Device(config-wireless-fabric)# no shutdown	Enables the policy profile.
<b>Step 7</b>	<b>end</b> <b>Example:</b> Device(config-wireless-fabric)# end	Returns to privileged EXEC mode.

## Configuring a Site Tag (CLI)

### Procedure

	Command or Action	Purpose
<b>Step 1</b>	<b>configure terminal</b> <b>Example:</b> Device# configure terminal	Enters the global configuration mode.
<b>Step 2</b>	<b>wireless tag site</b> <i>site-tag</i> <b>Example:</b> Device(config)# wireless tag site default-site-tag-fabric	Configures site tag and enters site tag configuration mode.
<b>Step 3</b>	<b>ap-profile</b> <i>ap-profile-name</i> <b>Example:</b> Device(config-site-tag)# ap-profile default-ap-profile-fabric	Assigns an AP profile to the wireless site.
<b>Step 4</b>	<b>description</b> <i>description</i> <b>Example:</b> Device(config-site-tag)# description fabric-site	Adds a description to the AP profile.
<b>Step 5</b>	<b>end</b> <b>Example:</b> Device(config-site-tag)# end	Returns to privileged EXEC mode.

## Configuring a WLAN (CLI)

### Procedure

	Command or Action	Purpose
<b>Step 1</b>	<b>configure terminal</b> <b>Example:</b> Device# configure terminal	Enters global configuration mode.
<b>Step 2</b>	<b>wlan wlan-name wlan-id SSID-name</b> <b>Example:</b> Device(config)# wlan test-wlan 1 test-wlan	Configures a WLAN and enters WLAN configuration submode.
<b>Step 3</b>	<b>no shutdown</b> <b>Example:</b> Device(config-wlan)# no shutdown	Enables the WLAN.

## Configuring a Policy Tag (CLI)

### Procedure

	Command or Action	Purpose
<b>Step 1</b>	<b>configure terminal</b> <b>Example:</b> Device# configure terminal	Enters global configuration mode.
<b>Step 2</b>	<b>wireless tag policy policy-tag-name</b> <b>Example:</b> Device(config)# wireless tag policy test-policy-tag	Configures policy tag and enters policy tag configuration mode.
<b>Step 3</b>	<b>wlan wlan-name policy profile-policy-name</b> <b>Example:</b> Device(config-policy-tag)# wlan test-wlan policy test-policy-profile	Maps a policy profile to a WLAN profile.
<b>Step 4</b>	<b>end</b> <b>Example:</b> Device(config-site-tag)# end	Returns to privileged EXEC mode.



## Configuring an AP Profile

### Procedure

	Command or Action	Purpose
<b>Step 1</b>	<b>configure terminal</b> <b>Example:</b> Device# configure terminal	Enters the global configuration mode.
<b>Step 2</b>	<b>ap profile <i>ap-profile-name</i></b> <b>Example:</b> Device(config)# ap profile test-ap-profile	Configures an AP profile and enters AP profile configuration mode.
<b>Step 3</b>	<b>ap <i>ap-ether-mac</i></b> <b>Example:</b> Device(config-ap-profile)# ap 006b.f126.036e	Enters AP configuration mode.
<b>Step 4</b>	<b>policy-tag <i>policy-tag</i></b> <b>Example:</b> Device(config-ap-profile)# policy-tag test-policy-tag	Specifies the policy tag that is to be attached to the AP.
<b>Step 5</b>	<b>end</b> <b>Example:</b> Device(config-ap-profile)# end	Returns to privileged EXEC mode.

## Configuring Map Server and AP Subnet (CLI)

### Procedure

	Command or Action	Purpose
<b>Step 1</b>	<b>configure terminal</b> <b>Example:</b> Device# configure terminal	Enters global configuration mode.
<b>Step 2</b>	<b>wireless fabric</b> <b>Example:</b> Device(config)# wireless fabric	Enables SD-Access wireless globally.

	Command or Action	Purpose
<b>Step 3</b>	<b>wireless fabric name</b> <i>name</i> <b>l2-vnid</b> <i>l2-vnid-value</i> <b>l3-vnid</b> <i>l3-vnid-value</i> <b>ip</b> <i>network-ip</i> <i>subnet-mask</i>  <b>Example:</b> <pre>Device(config)# wireless fabric name 40_40_0_0-INFRA_VN l2-vnid 8188 l3-vnid 4097 ip 40.40.0.0 255.255.0.0</pre>	Configures AP subnet Layer 2 and Layer 3 VNIDs.
<b>Step 4</b>	<b>wireless fabric name</b> <i>name</i> <b>l2-vnid</b> <i>l2-vnid-value</i>  <b>Example:</b> <pre>Device(config)# wireless fabric name 41_41_0_0-DEFAULT_VN l2-vnid 8189</pre>	Defines client Layer 2 VNID AAA override.
<b>Step 5</b>	<b>wireless fabric control-plane</b> <i>name</i>  <b>Example:</b> <pre>Device(config)# wireless fabric control-plane default-control-plane</pre>	Configures the control plane name.
<b>Step 6</b>	<b>ip address</b> <i>ip-address</i> <b>key</b> <i>shared-key</i>  <b>Example:</b> <pre>Device((config-wireless-cp)# ip address 5.5.5.5 key 0 3a18df</pre>	Configures the map server IP address and authentication key shared with the map server.
<b>Step 7</b>	<b>end</b>  <b>Example:</b> <pre>Device(config)# end</pre>	Returns to privileged EXEC mode. Alternatively, you can also press <b>Ctrl-Z</b> to exit global configuration mode.

## Configuring Fabric on FiaB Node

### Procedure

	Command or Action	Purpose
<b>Step 1</b>	<b>configure terminal</b>  <b>Example:</b> <pre>FiaB# configure terminal</pre>	Enters global configuration mode.
<b>Step 2</b>	<b>router lisp</b>  <b>Example:</b> <pre>FiaB(config)# router lisp</pre>	Enters LISP configuration mode.
<b>Step 3</b>	<b>locator-table default</b>  <b>Example:</b>	Associates a default Virtual Routing and Forwarding (VRF) table through which the routing locator address space is reachable to a

	Command or Action	Purpose
	<code>FiaB(config-router-lisp)# locator-table default</code>	router Locator ID Separation Protocol (LISP) instantiation.
<b>Step 4</b>	<b>locator-set</b> <i>locator-set-name</i> <b>Example:</b> <code>FiaB(config-router-lisp)# locator-set WLC</code>	Specifies a named locator set and enters LISP locator-set configuration mode.
<b>Step 5</b>	<i>ip-address</i> <b>Example:</b> <code>FiaB(config-router-lisp-locator-set)# 5.5.5.5</code>	Specifies an IP address of loopback or other egress tunnel router (ETR) interface.
<b>Step 6</b>	<b>exit-locator-set</b> <b>Example:</b> <code>FiaB(config-router-lisp-locator-set)# exit-locator-set</code>	Exits LISP locator-set configuration mode.
<b>Step 7</b>	<b>locator-set rloc_loopback</b> <b>Example:</b> <code>FiaB(config-router-lisp)# locator-set rloc_loopback</code>	Specifies an existing locator set and enters LISP locator-set configuration mode.
<b>Step 8</b>	<b>ipv4-interface</b> <i>interface</i> <b>Example:</b> <code>FiaB(config-router-lisp-locator-set)# IPv4-interface Loopback0</code>	Configures a locator address by creating a locator entry.
<b>Step 9</b>	<b>auto-discover-rlocs</b> <b>Example:</b> <code>FiaB(config-router-lisp-locator-set)# auto-discover-rlocs</code>	Configures the ETR to auto discover the locators registered by other xTRs. (Ingress tunnel router (ITR) and an ETR are known as an xTR.)
<b>Step 10</b>	<b>exit-locator-set</b> <b>Example:</b> <code>FiaB(config-router-lisp-locator-set)# exit-locator-set</code>	Exits LISP locator-set configuration mode.
<b>Step 11</b>	<b>service ipv4</b> <b>Example:</b> <code>FiaB(config-router-lisp)# service ipv4</code>	Enables Layer 3 network services for the IPv4 address family and enters service submode.
<b>Step 12</b>	<b>encapsulation vxlan</b> <b>Example:</b> <code>FiaB(config-lisp-srv-ipv4)# encapsulation vxlan</code>	Configures VXLAN as encapsulation type for data packets.

	<b>Command or Action</b>	<b>Purpose</b>
<b>Step 13</b>	<b>itr map-resolver</b> <i>map-resolver-address</i> <b>Example:</b> FiaB(config-lisp-srv-ipv4)# itr map-resolver 5.5.5.5	Configures map resolver address for sending map requests.
<b>Step 14</b>	<b>etr map-server</b> <i>map-server-address key</i> <i>key-type authentication-key</i> <b>Example:</b> FiaB(config-lisp-srv-ipv4)# etr map-server 5.5.5.5 key 7 #####	Configures the map server for ETR registration.
<b>Step 15</b>	<b>etr</b> <b>Example:</b> FiaB(config-lisp-srv-ipv4)# etr	Configures a LISP ETR.
<b>Step 16</b>	<b>sgt</b> <b>Example:</b> FiaB(config-lisp-srv-ipv4)# sgt	Enables security group tag propagation in LISP-encapsulated traffic.
<b>Step 17</b>	<b>no map-cache away-eids send-map-request</b> <b>Example:</b> FiaB(config-lisp-srv-ipv4)# no map-cache away-eids send-map-request	Removes the address family-specific map cache configuration.
<b>Step 18</b>	<b>proxy-itr</b> <i>ip-address</i> <b>Example:</b> FiaB(config-lisp-srv-ipv4)# proxy-itr 5.5.5.5	Enables the Proxy Ingress Tunnel Router (PITR) functionality and specifies the address to use when LISP encapsulating packets to LISP sites.
<b>Step 19</b>	<b>map-server</b> <b>Example:</b> FiaB(config-lisp-srv-ipv4)# map-server	Configures a LISP map server.
<b>Step 20</b>	<b>map-resolver</b> <b>Example:</b> FiaB(config-lisp-srv-ipv4)# map-resolver	Configures a LISP map resolver.
<b>Step 21</b>	<b>map-cache away-eids send-map-request</b> <b>Example:</b> FiaB(config-lisp-srv-ipv4)# map-cache 40.40.0.0/16 send-map-request	Exports table entries into the map cache, with the action set to send-map-request.
<b>Step 22</b>	<b>route-export site-registrations</b> <b>Example:</b>	Exports LISP site registrations to the routing information base (RIB).

	Command or Action	Purpose
	<code>FiaB(config-lisp-srv-ipv4)# route-export site-registrations</code>	
<b>Step 23</b>	<b>distance site-registrations <i>num</i></b> <b>Example:</b> <code>FiaB(config-lisp-srv-ipv4)# distance site-registrations 250</code>	Configures LISP installed routes of type site registrations.
<b>Step 24</b>	<b>map-cache site-registration</b> <b>Example:</b> <code>FiaB(config-lisp-srv-ipv4)# map-cache site-registration</code>	Installs the map cache to a map request for site registrations.
<b>Step 25</b>	<b>exit-service-ipv4</b> <b>Example:</b> <code>FiaB(config-lisp-srv-ipv4)# exit-service-ipv4</code>	Exits LISP service-ipv4 configuration mode.
<b>Step 26</b>	<b>service ethernet</b> <b>Example:</b> <code>FiaB(config-router-lisp)# service ethernet</code>	Selects service type as Ethernet and enters service submode.
<b>Step 27</b>	<b>database-mapping limit dynamic <i>limit</i></b> <b>Example:</b> <code>FiaB(config-lisp-srv-eth)# database-mapping limit dynamic 5000</code>	Configures the maximum number of dynamic local endpoint identifier (EID) prefix database entries.
<b>Step 28</b>	<b>itr map-resolver <i>map-resolver-address</i></b> <b>Example:</b> <code>FiaB(config-lisp-srv-eth)# itr map-resolver 5.5.5.5</code>	Configures the map-resolver address for sending map requests.
<b>Step 29</b>	<b>itr</b> <b>Example:</b> <code>FiaB(config-lisp-srv-eth)# itr</code>	Enables the LISP ITR functionality.
<b>Step 30</b>	<b>etr map-server <i>map-server-address</i> <b>key</b> <i>key-type</i> <i>authentication-key</i></b> <b>Example:</b> <code>FiaB(config-lisp-srv-eth)# etr map-server 5.5.5.5 key 7 1234</code>	Configures a map server for ETR registration.
<b>Step 31</b>	<b>etr</b> <b>Example:</b> <code>FiaB(config-lisp-srv-eth)# etr</code>	Enables the LISP ETR functionality.

	Command or Action	Purpose
<b>Step 32</b>	<b>map-server</b> <b>Example:</b> FiaB(config-lisp-srv-eth)# map-server	Enables the LISP map server functionality.
<b>Step 33</b>	<b>map-resolver</b> <b>Example:</b> FiaB(config-lisp-srv-eth)# map-resolver	Enables the LISP map resolver functionality.
<b>Step 34</b>	<b>exit-service-ethernet</b> <b>Example:</b> FiaB(config-lisp-srv-eth)# exit-service-ethernet	Exits LISP service-ethernet configuration mode.
<b>Step 35</b>	<b>instance-id <i>instance</i></b> <b>Example:</b> FiaB(config-router-lisp)# instance-id 101	Creates a LISP EID instance to group multiple services.
<b>Step 36</b>	<b>remote-rloc-probe on-route-change</b> <b>Example:</b> FiaB(config-lisp-inst)# remote-rloc-probe on-route-change	Configures the parameters for probing of remote routing locators (RLOCs).
<b>Step 37</b>	<b>dynamic-eid <i>dynamic-eid-name</i></b> <b>Example:</b> FiaB(config-lisp-inst)# dynamic-eid 40_40_0_0-INFRA_VN-IPV4	Configures a dynamic EID and enters dynamic EID configuration mode.
<b>Step 38</b>	<b>database-mapping <i>eid locator-set rloc_loopback</i></b> <b>Example:</b> FiaB(config-router-lisp-dynamic-eid)# database-mapping 40.40.0.0/16 locator-set rloc_loopback	Configures EID prefix and locator-set for dynamic EID.
<b>Step 39</b>	<b>exit-dynamic-id</b> <b>Example:</b> FiaB(config-router-lisp-dynamic-eid)# exit-dynamic-eid	Exits LISP dynamic-eid configuration mode.
<b>Step 40</b>	<b>exit-instance-id</b> <b>Example:</b> FiaB(config-router-lisp-instance)# exit-instance-id	Exits LISP instance-id configuration mode.

	Command or Action	Purpose
<b>Step 41</b>	<b>instance-id</b> <i>instance</i> <b>Example:</b> FiaB(config-router-lisp)# instance-id 101	Creates a LISP EID instance to group multiple services.
<b>Step 42</b>	<b>remote-rloc-probe on-route-change</b> <b>Example:</b> FiaB(config-lisp-inst)# remote-rloc-probe on-route-change	Configures parameters for probing remote RLOCs.
<b>Step 43</b>	<b>service ethernet</b> <b>Example:</b> FiaB(config-lisp-inst)# service ethernet	Enables Layer 2 network services and enters service submenu.
<b>Step 44</b>	<b>eid-table vlan</b> <i>vlan-number</i> <b>Example:</b> FiaB(config-lisp-inst-srv-eth)# eid-table vlan 101	Binds an EID table to VLAN.
<b>Step 45</b>	<b>database-mapping mac locator-set rloc_loopbac</b> <b>Example:</b> FiaB(config-lisp-inst-srv-eth)# database-mapping mac locator-set rloc_loopbac	Configures an address family-specific local EID prefixes database.
<b>Step 46</b>	<b>exit-service-ethernet</b> <b>Example:</b> FiaB(config-lisp-inst-srv-eth)# exit-service-ethernet	Exits LISP service-ethernet configuration mode.
<b>Step 47</b>	<b>exit-instance-id</b> <b>Example:</b> FiaB(config-lisp-inst)# exit-instance-id	Exits LISP instance-id configuration mode.
<b>Step 48</b>	<b>map-server session passive-open</b> <i>server</i> <b>Example:</b> FiaB(config-router-lisp)# map-server session passive-open WLC	Configures a map server with open passive TCP sockets to listen for incoming connections.
<b>Step 49</b>	<b>site</b> <i>site-name</i> <b>Example:</b> FiaB(config-router-lisp)# site site_uci	Configures a LISP site on a map server.
<b>Step 50</b>	<b>description</b> <i>map-server-description</i> <b>Example:</b>	Specifies a description text for the LISP site.

	Command or Action	Purpose
	<code>FiaB(config-router-lisp-site)# description map-server configured from Cisco DNA-Center</code>	
<b>Step 51</b>	<b>authentication-key</b> <i>key</i> <b>Example:</b> <code>FiaB(config-router-lisp-site)# authentication-key 7 #####</code>	Configures the authentication key used by the LISP site.
<b>Step 52</b>	<b>eid-record instance-id</b> <i>instance-id address</i> <b>accept-more-specifics</b> <b>Example:</b> <code>FiaB(config-router-lisp-site)# eid-record instance-id 4097 0.0.0.0/0 accept-more-specifics</code>	Specifies that any EID prefix that is more specific than the EID prefix configured is accepted and tracked.
<b>Step 53</b>	<b>eid-record instance-id</b> <i>instance-id any-mac</i> <b>Example:</b> <code>FiaB(config-router-lisp-site)# eid-record instance-id 8188 any-mac</code>	Accepts registrations, if any, for Layer 2 EID records.
<b>Step 54</b>	<b>exit-site</b> <b>Example:</b> <code>FiaB(config-router-lisp-site)# exit-site</code>	Exits LISP site configuration mode.
<b>Step 55</b>	<b>ipv4 locator reachability exclude-default</b> <b>Example:</b> <code>FiaB(config-router-lisp)# ipv4 locator reachability exclude-default</code>	Configures the IPv4 locator address of the LISP.
<b>Step 56</b>	<b>ipv4 source-locator</b> <i>interface-name</i> <b>Example:</b> <code>FiaB(config-router-lisp)# ipv4 source-locator Loopback0</code>	Configures the IPv4 source locator address of the interface.
<b>Step 57</b>	<b>exit-router-lisp</b> <b>Example:</b> <code>FiaB(config-router-lisp)# exit-router-lisp</code>	Exits LISP router-lisp configuration mode.

## Configuring a Fabric Edge Node



**Note** You can perform the following configuration tasks only from Fabric Edge Node, and not from your controller.



## Procedure

	Command or Action	Purpose
<b>Step 1</b>	<b>configure terminal</b> <b>Example:</b> FabricEdge# configure terminal	Enters global configuration mode.
<b>Step 2</b>	<b>router lisp</b> <b>Example:</b> FabricEdge(config)# router lisp	Enters LISP configuration mode.
<b>Step 3</b>	<b>locator-table default</b> <b>Example:</b> FabricEdge(config-router-lisp)# locator-table default	Associates a default VRF table through which the routing locator address space is reachable to a router LISP instantiation.
<b>Step 4</b>	<b>locator-set rloc_loopback</b> <b>Example:</b> FabricEdge(config-router-lisp)# locator-set rloc_loopback	Specifies a named locator set and enters LISP locator-set configuration mode.
<b>Step 5</b>	<b>ipv4-interface interface-num priority priority weight weight</b> <b>Example:</b> FabricEdge(config-router-lisp-locator-set)# IPv4-interface Loopback 0 priority 10 weight 10	Configures the IPv4 address of the interface as locator.
<b>Step 6</b>	<b>exit-locator-set</b> <b>Example:</b> FabricEdge(config-router-lisp-locator-set)# exit-locator-set	Exits LISP locator-set configuration mode.
<b>Step 7</b>	<b>exit-router-lisp</b> <b>Example:</b> FabricEdge(config-router-lisp-)# exit-router-lisp	Exits LISP router-lisp configuration mode.
<b>Step 8</b>	<b>interface vlan interface-num</b> <b>Example:</b> FabricEdge(config)# interface Vlan 2045	Configures an interface.
<b>Step 9</b>	<b>description description</b> <b>Example:</b> FabricEdge(config-if)# description Configured from Cisco DNA-Center	Specifies a description text for the interface.

	Command or Action	Purpose
<b>Step 10</b>	<b>mac-address</b> <i>mac-address</i>  <b>Example:</b> FabricEdge(config-if)# mac-address 0000.0c9f.f85c	Sets an interface MAC address manually.
<b>Step 11</b>	<b>ip address</b> <i>ip-address mask</i>  <b>Example:</b> FabricEdge(config-if)# ip address 192.168.1.1 255.255.255.252	Configures an IP address for the interface.
<b>Step 12</b>	<b>ip helper-address</b> <i>ip-address</i>  <b>Example:</b> FabricEdge(config-if)# ip helper-address 9.9.9.9	Specifies a destination address for UDP broadcasts.
<b>Step 13</b>	<b>no ip redirects</b>  <b>Example:</b> FabricEdge(config-if)# no ip redirects	Disables sending of ICMP redirect messages.
<b>Step 14</b>	<b>ip route-cache same-interface</b>  <b>Example:</b> FabricEdge(config-if)# ip route-cache same-interface	Enables fast-switching cache for outgoing packets on the same interface.
<b>Step 15</b>	<b>no lisp mobility liveness test</b>  <b>Example:</b> FabricEdge(config-if)# no lisp mobility liveness test	Removes liveness test on dynamic EID discovered on this interface.
<b>Step 16</b>	<b>lisp mobility</b> <i>dynamic-eid-name</i>  <b>Example:</b> FabricEdge(config-if)# lisp mobility 40_40_0_0-INFRA_VN-IPV4	Allows EID mobility on the interface.
<b>Step 17</b>	<b>exit</b>  <b>Example:</b> FabricEdge(config-if)# exit	Exits from interface configuration mode.
<b>Step 18</b>	<b>router lisp</b>  <b>Example:</b> FabricEdge(config)# router lisp	Enters LISP configuration mode.
<b>Step 19</b>	<b>locator-set</b> <i>locator-set-name</i>  <b>Example:</b> FabricEdge(config-router-lisp)# locator-set rloc_824ecb7	Specifies a locator set and enters LISP locator-set configuration mode.

	Command or Action	Purpose
<b>Step 20</b>	<b>exit-locator-set</b> <b>Example:</b> FabricEdge(config-router-lisp-locator-set)# exit-locator-set	Exits LISP locator-set configuration mode.
<b>Step 21</b>	<b>service ipv4</b> <b>Example:</b> FabricEdge(config-router-lisp)# service ipv4	Enables Layer 3 network services for the IPv4 address family and enters service submode.
<b>Step 22</b>	<b>use-petr ip-address</b> <b>Example:</b> FabricEdge(config-lisp-srv-ipv4)# use-petr 5.5.5.5	Configures the loopback IP address of the Proxy Egress Tunnel Router (PETR).
<b>Step 23</b>	<b>encapsulation vxlan</b> <b>Example:</b> FabricEdge(config-lisp-srv-ipv4)# encapsulation vxlan	Selects the encapsulation type as VXLAN for data packets.
<b>Step 24</b>	<b>itr map-resolver map-resolver-address</b> <b>Example:</b> FabricEdge(config-lisp-srv-ipv4)# itr map-resolver 5.5.5.5	Configures the map resolver address for sending map requests.
<b>Step 25</b>	<b>etr map-server map-server-address key key-type authentication-key</b> <b>Example:</b> FabricEdge(config-lisp-srv-ipv4)# etr map-server 5.5.5.5 key 7 #####	Configures the map server for ETR registration.
<b>Step 26</b>	<b>etr map-server map-server-address proxy-reply authentication-key</b> <b>Example:</b> FabricEdge(config-lisp-srv-ipv4)# etr map-server 5.5.5.5 proxy-reply	Configures the locator address of the LISP map server and the authentication key that this router, acting as a LISP ETR, will use to register with the LISP mapping system.
<b>Step 27</b>	<b>etr</b> <b>Example:</b> FabricEdge(config-lisp-srv-ipv4)# etr	Configures a LISP Egress Tunnel Router (ETR).
<b>Step 28</b>	<b>sgt</b> <b>Example:</b> FabricEdge(config-lisp-srv-ipv4)# sgt	Enable security group tag propagation in LISP encapsulated traffic.

	Command or Action	Purpose
<b>Step 29</b>	<b>no map-cache away-eids send-map-request</b> <b>Example:</b> FabricEdge(config-lisp-srv-ipv4)# no map-cache away-eids send-map-request	Removes the address family-specific map cache configuration.
<b>Step 30</b>	<b>proxy-itr ip-address</b> <b>Example:</b> FabricEdge(config-lisp-srv-ipv4)# proxy-itr 5.5.5.5	Enables the Proxy Ingress Tunnel Router (PITR) functionality and specifies the address to use when LISP encapsulating packets to LISP sites.
<b>Step 31</b>	<b>exit-service-ipv4</b> <b>Example:</b> FabricEdge(config-lisp-srv-ipv4)# exit-service-ipv4	Exits LISP service-ipv4 configuration mode.
<b>Step 32</b>	<b>service ethernet</b> <b>Example:</b> FabricEdge(config-router-lisp)# service ethernet	Selects the service type as Ethernet.
<b>Step 33</b>	<b>itr map-resolver map-resolver-address</b> <b>Example:</b> FabricEdge(config-lisp-srv-eth)# itr map-resolver 5.5.5.5	Configures the map-resolver address for sending map requests.
<b>Step 34</b>	<b>itr</b> <b>Example:</b> FabricEdge(config-lisp-srv-eth)# itr	Enables the LISP ITR functionality.
<b>Step 35</b>	<b>etr map-server map-server-address key key-type authentication-key</b> <b>Example:</b> FabricEdge(config-lisp-srv-eth)# etr map-server 5.5.5.5 key 7 1234	Configures the map server for ETR registration.
<b>Step 36</b>	<b>etr</b> <b>Example:</b> FabricEdge(config-lisp-srv-eth)# etr	Enables the LISP ETR functionality.
<b>Step 37</b>	<b>exit-service-ethernet</b> <b>Example:</b> FabricEdge(config-lisp-srv-eth)# exit-service-ethernet	Exits LISP service-ethernet configuration mode.
<b>Step 38</b>	<b>instance-id instance</b> <b>Example:</b>	Creates a LISP EID instance to group multiple services.

	Command or Action	Purpose
	<code>FabricEdge (config-router-lisp) # instance-id 101</code>	
<b>Step 39</b>	<b>remote-rloc-probe on-route-change</b> <b>Example:</b> <code>FabricEdge (config-lisp-inst) # remote-rloc-probe on-route-change</code>	Configures the parameters for probing remote Routing locators (RLOCs).
<b>Step 40</b>	<b>dynamic-eid <i>dynamic-eid-name</i></b> <b>Example:</b> <code>FabricEdge (config-lisp-inst) # dynamic-eid 40_40_0_0-INFRA_VN-IPV4</code>	Configures a dynamic EID and enters dynamic EID configuration mode.
<b>Step 41</b>	<b>database-mapping <i>eid locator-set rloc_loopback</i></b> <b>Example:</b> <code>FabricEdge (config-router-lisp-dynamic-eid) # database-mapping 40.40.0.0/16 locator-set rloc_loopback</code>	Configures the EID prefix and locator set for the dynamic EID.
<b>Step 42</b>	<b>exit-dynamic-id</b> <b>Example:</b> <code>FabricEdge (config-router-lisp-dynamic-eid) # exit-instance-id</code>	Exits dynamic instance submenu.
<b>Step 43</b>	<b>service ipv4</b> <b>Example:</b> <code>FabricEdge (config-lisp-inst) # service ipv4</code>	Selects service type as IPv4.
<b>Step 44</b>	<b>eid-table default</b> <b>Example:</b> <code>FabricEdge (config-lisp-inst-srv-ipv4) # eid-table default</code>	Binds an EID table.
<b>Step 45</b>	<b>exit-service-ipv4</b> <b>Example:</b> <code>FabricEdge (config-lisp-inst-srv-ipv4) # exit-service-ipv4</code>	Exits LISP service-ipv4 configuration mode.
<b>Step 46</b>	<b>exit-instance-id</b> <b>Example:</b> <code>FabricEdge (config-lisp-inst) # exit-instance-id</code>	Exits LISP instance-id configuration mode.
<b>Step 47</b>	<b>service ipv4</b> <b>Example:</b>	Selects service type as IPv4.

	Command or Action	Purpose
	<code>FabricEdge(config-router-lisp)# service ipv4</code>	
<b>Step 48</b>	<b>map-cache away-eids map-request</b> <b>Example:</b> <code>FabricEdge(config-lisp-srv-ipv4)# map-cache 40.40.0.0/16 map-request</code>	Exports away table entries into the map cache, with the action set to send-map-request.
<b>Step 49</b>	<b>exit-service-ipv4</b> <b>Example:</b> <code>FabricEdge(config-lisp-srv-ipv4)# exit-service-ipv4</code>	Exits LISP service-ipv4 configuration mode.
<b>Step 50</b>	<b>instance-id <i>instance</i></b> <b>Example:</b> <code>FabricEdge(config-router-lisp)# instance-id 8188</code>	Creates a LISP EID instance to group multiple services.
<b>Step 51</b>	<b>remote-rloc-probe on-route-change</b> <b>Example:</b> <code>FabricEdge(config-lisp-inst)# remote-rloc-probe on-route-change</code>	Configures parameters for probing remote RLOCs.
<b>Step 52</b>	<b>service ethernet</b> <b>Example:</b> <code>FabricEdge(config-lisp-inst)# service ethernet</code>	Enables Layer 2 network services and enters service submode.
<b>Step 53</b>	<b>eid-table vlan <i>vlan-number</i></b> <b>Example:</b> <code>FabricEdge(config-lisp-inst-srv-eth)# eid-table vlan 101</code>	Binds an EID table to VLAN.
<b>Step 54</b>	<b>database-mapping maclocator-set rloc_loopbac</b> <b>Example:</b> <code>FabricEdge(config-lisp-inst-srv-eth)# database-mapping mac locator-set rloc_loopbac</code>	Configures address family-specific local EID prefixes database.
<b>Step 55</b>	<b>exit-service-ethernet</b> <b>Example:</b> <code>FabricEdge(config-lisp-inst-srv-eth)# exit-service-ethernet</code>	Exits LISP service-ethernet configuration mode.
<b>Step 56</b>	<b>exit-instance-id</b> <b>Example:</b>	Exits from LISP instance-id configuration mode.

	Command or Action	Purpose
	<code>FabricEdge(config-lisp-inst)# exit-instance-id</code>	
<b>Step 57</b>	<b>ipv4 locator reachability minimum-mask-length <i>length</i></b>  <b>Example:</b> <code>FabricEdge(config-router-lisp)# ipv4 locator reachability minimum-mask-length 32</code>	Configures the IPv4 locator address of the LISP.
<b>Step 58</b>	<b>ipv4 source-locator <i>interface-name</i></b>  <b>Example:</b> <code>FabricEdge(config-router-lisp)# ipv4 source-locator Loopback0</code>	Configures the IPv4 source locator address of the interface.
<b>Step 59</b>	<b>exit-router-lisp</b>  <b>Example:</b> <code>FabricEdge(config-router-lisp)# exit-router-lisp</code>	Exits LISP router-lisp configuration mode.

## Verifying Fabric Configuration

Use the following commands to verify the fabric configuration.

To verify the LISP configuration on a device, use the following command:

```
FabricEdge# show running-config | section router lisp
```

```
router lisp
 locator-table default
 locator-set default
  exit-locator-set
 !
 locator-set rloc_loopback
  IPv4-interface Loopback0 priority 10 weight 10
  exit-locator-set
 !
 locator default-set rloc_loopback
 service ipv4
  encapsulation vxlan
  itr map-resolver 21.21.21.21
  itr
  etr map-server 21.21.21.21 key tasman
  etr map-server 21.21.21.21 proxy-reply
  etr
  use-petr 21.21.21.21 priority 1 weight 100
  exit-service-ipv4
 !
 service ethernet
  itr map-resolver 5.5.5.5
  itr map-resolver 21.21.21.21
  itr
  etr map-server 21.21.21.21 key tasman
  etr map-server 21.21.21.21 proxy-reply
```

```

etr
exit-service-ethernet
!
instance-id 0
loc-reach-algorithm lsb-reports ignore
dynamic-eid eid_10_56_25
  database-mapping 10.56.25.0/24 locator-set rloc_loopback
exit-dynamic-eid
!
service ipv4
  eid-table default
  database-mapping 26.26.26.26/32 locator-set rloc_loopback
exit-service-ipv4
!
exit-instance-id
!
instance-id 1
service ethernet
  eid-table vlan 25
  flood arp-nd
  database-mapping mac locator-set rloc_loopback
exit-service-ethernet
!
exit-instance-id
!
instance-id 101
service ipv4
  exit-service-ipv4
!
exit-instance-id
!
instance-id 8188
  exit-instance-id
!
loc-reach-algorithm lsb-reports ignore
exit-router-lisp

```

To verify the operational status of LISP as configured on a device, use the following command:

```
FabricEdge# show ip lisp
```

Information applicable to all EID instances:

```

Router-lisp ID:                0
Locator table:                 default
Ingress Tunnel Router (ITR):   enabled
Egress Tunnel Router (ETR):    enabled
Proxy-ITR Router (PITR):      disabled
Proxy-ETR Router (PETR):       disabled
NAT-traversal Router (NAT-RTR): disabled
Mobility First-Hop Router:     disabled
Map Server (MS):               disabled
Map Resolver (MR):             disabled
Mr-use-petr:                   disabled
Delegated Database Tree (DDT): disabled
Publication-Subscription:     enabled
  Publisher(s):                 *** NOT FOUND ***
ITR Map-Resolver(s):           21.21.21.21
ETR Map-Server(s):             21.21.21.21
xTR-ID:                        0xD89893A6-0x98749B2C-0x89810431-0x92F33C9C
site-ID:                       unspecified
ITR local RLOC (last resort):  *** NOT FOUND ***
ITR use proxy ETR RLOC(Encap IID): 21.21.21.21
ITR Solicit Map Request (SMR):  accept and process
  Max SMRs per map-cache entry:  8 more specifics

```



```

Multiple SMR suppression time:      20 secs
ETR accept mapping data:            disabled, verify disabled
ETR map-cache TTL:                  1d00h
Locator Status Algorithms:
  RLOC-probe algorithm:              disabled
  RLOC-probe on route change:        N/A (periodic probing disabled)
  RLOC-probe on member change:       disabled
  LSB reports:                       ignore
  IPv4 RLOC minimum mask length:     /0
  IPv6 RLOC minimum mask length:     /0
Map-cache:
  Map-cache limit:                   32768
  Map-cache activity check period:    60 secs
  Persistent map-cache:              disabled
Source locator configuration:
  GigabitEthernet1/0/1: 24.24.24.24 (Loopback0)
  Vlan25: 24.24.24.24 (Loopback0)
Database:
  Dynamic database mapping limit:     25000

```

To verify the operational status of the map cache on a device configured as an ITR or PITR, use the following command:

```
FabricEdge# show lisp instance-id iid ipv4 map-cache
```

```

LISP IPv4 Mapping Cache for EID-table default (IID 0), 5 entries

0.0.0.0/0, uptime: 2w5d, expires: never, via static-send-map-request
  Encapsulating to proxy ETR

10.56.25.0/24, uptime: 2w0d, expires: never, via dynamic-EID, send-map-request
  Encapsulating to proxy ETR

10.56.25.25/32, uptime: 2w5d, expires: 23:10:06, via map-reply, complete
  Locator      Uptime      State  Pri/Wgt  Encap-IID
  21.21.21.21  2w5d       up     0/0      -

22.0.0.0/8, uptime: 2w5d, expires: 00:04:54, via map-reply, forward-native
  Encapsulating to proxy ETR

26.26.26.26/32, uptime: 09:48:33, expires: 14:11:26, via map-reply, self, complete
  Locator      Uptime      State  Pri/Wgt  Encap-IID
  24.24.24.24  09:48:33   up, self  50/50    -

```

To verify the operational status of the database mapping on a device configured as an ETR, use the following command:

```
FabricEdge# show lisp instance-id iid ipv4 database
```

```

LISP ETR IPv4 Mapping Database for EID-table default (IID 0), LSBs: 0x1
Entries total 3, no-route 0, inactive 0

10.56.25.27/32, dynamic-eid eid_10_56_25, skip reg, inherited from default locator-set rloc_loopback
  Uptime: 00:25:11, Last-change: 00:25:11
  Domain-ID: unset
  Locator      Pri/Wgt  Source      State
  24.24.24.24  10/10    cfg-intf    site-self, reachable

10.56.25.67/32, dynamic-eid eid_10_56_25, inherited from default locator-set rloc_loopback
  Uptime: 00:24:47, Last-change: 00:24:47
  Domain-ID: unset
  Locator      Pri/Wgt  Source      State

```

```

24.24.24.24 10/10 cfg-intf site-self, reachable

26.26.26.26/32, locator-set rloc_loopback
Uptime: 2w5d, Last-change: 00:50:36
Domain-ID: unset
Locator      Pri/Wgt Source      State
24.24.24.24 10/10 cfg-intf site-self, reachable

```

To verify the configured LISP sites on a LISP map server, use the following command:

```
FabricEdge# show lisp instance-id iid ipv4 server
```

```

LISP Site Registration Information
* = Some locators are down or unreachable
# = Some registrations are sourced by reliable transport

Site Name      Last      Up      Who Last      Inst      EID Prefix
Register       Registered
eca            never     no      --            0         10.56.25.0/24
              04:52:53 yes#    21.21.21.21:40875 0         10.56.25.25/32
              04:07:09 yes#    27.27.27.27:24949 0         10.56.25.64/32
              03:21:16 yes#    24.24.24.24:23672 0         10.56.25.67/32
              04:52:53 yes#    21.21.21.21:40875 0         23.23.23.23/32
              03:47:04 yes#    24.24.24.24:23672 0         26.26.26.26/32
              2w0d     yes#    27.27.27.27:24949 0         29.29.29.29/32
site_uci       never     no      --            4097      0.0.0.0/0

```

To verify the operational status of LISP sites, use the following command in FiaB node:

```
FabricEdge# show lisp instance-id 1 ethernet server
```

```

=====
Output for router lisp 0 instance-id 1
=====
LISP Site Registration Information

=====
Output for router lisp 0 instance-id 1
=====
LISP Site Registration Information
* = Some locators are down or unreachable
# = Some registrations are sourced by reliable transport

Site Name      Last      Up      Who Last      Inst      EID Prefix
Register       Registered
eca            never     no      --            1         any-mac
              04:10:37 yes#    27.27.27.27:24949 1         00b0.e19c.2578/48
              04:09:20 yes#    22.22.22.22:64083 1         00b0.e19c.fc40/48
              03:24:52 yes#    24.24.24.24:23672 1         dcce.c130.0b70/48
              03:23:39 yes#    22.22.22.22:64083 1         dcce.c130.9820/48

```

To verify the operational status of LISP sites, use the following command in FiaB node:

```
FabricEdge# show lisp instance-id 0 ipv4 server
```

```

LISP Site Registration Information
* = Some locators are down or unreachable
# = Some registrations are sourced by reliable transport

Site Name      Last      Up      Who Last      Inst      EID Prefix
Register       Registered

```

```

eca          never    no      --          0          10.56.25.0/24
             6d18h   yes#    21.21.21.21:40875  0          10.56.25.25/32
             01:23:56 yes#    27.27.27.27:24949  0          10.56.25.64/32
             00:24:40 yes#    24.24.24.24:23672  0          10.56.25.72/32
             6d18h   yes#    21.21.21.21:40875  0          23.23.23.23/32
             6d17h   yes#    24.24.24.24:23672  0          26.26.26.26/32
             3w0d    yes#    27.27.27.27:24949  0          29.29.29.29/32

```

To verify the operational status of LISP sites on IPv4 database, use the following command in fabric edge node:

```
FabricEdge# show lisp instance-id 0 ipv4 database
```

```

LISP ETR IPv4 Mapping Database for EID-table default (IID 0), LSBs: 0x1
Entries total 3, no-route 0, inactive 0

10.56.25.27/32, dynamic-eid eid_10_56_25, skip reg, inherited from default locator-set
rloc_loopback
  Uptime: 00:25:54, Last-change: 00:25:54
  Domain-ID: unset
  Locator      Pri/Wgt  Source      State
  24.24.24.24  10/10    cfg-intf    site-self, reachable
10.56.25.72/32, dynamic-eid eid_10_56_25, inherited from default locator-set rloc_loopback
  Uptime: 00:25:25, Last-change: 00:25:25
  Domain-ID: unset
  Locator      Pri/Wgt  Source      State
  24.24.24.24  10/10    cfg-intf    site-self, reachable
26.26.26.26/32, locator-set rloc_loopback
  Uptime: 3w5d, Last-change: 6d17h
  Domain-ID: unset
  Locator      Pri/Wgt  Source      State
  24.24.24.24  10/10    cfg-intf    site-self, reachable

```

To verify the operational status of LISP sites on mac mapping database, use the following command on the FE node:

```
FabricEdge# show lisp instance-id 1 ethernet database
```

```

LISP ETR MAC Mapping Database for EID-table Vlan 25 (IID 1), LSBs: 0x1
Entries total 2, no-route 0, inactive 0

cc98.911b.73f1/48, dynamic-eid Auto-L2-group-1, skip reg, inherited from default locator-set
rloc_loopback
  Uptime: 00:00:49, Last-change: 00:00:49
  Domain-ID: unset
  Locator      Pri/Wgt  Source      State
  24.24.24.24  10/10    cfg-intf    site-self, reachable
dcce.c130.0b70/48, dynamic-eid Auto-L2-group-1, inherited from default locator-set
rloc_loopback
  Uptime: 00:00:50, Last-change: 00:00:50
  Domain-ID: unset
  Locator      Pri/Wgt  Source      State
  24.24.24.24  10/10    cfg-intf    site-self, reachable

```





## PART **XVI**

### **VLAN**

- [VLANs, on page 1597](#)
- [VLAN Groups, on page 1607](#)





## CHAPTER 167

# VLANs

---

- [Information About VLANs, on page 1597](#)
- [How to Configure VLANs, on page 1601](#)
- [Monitoring VLANs, on page 1604](#)

## Information About VLANs

### Logical Networks

A VLAN is a switched network that is logically segmented by function, project team, or application, without regard to the physical locations of the users. VLANs have the same attributes as physical LANs, but you can group end stations even if they are not physically located on the same LAN segment. Any controller port can belong to a VLAN, and unicast, broadcast, and multicast packets are forwarded and flooded only to end stations in the VLAN. Each VLAN is considered a logical network, and packets destined for stations that do not belong to the VLAN must be forwarded through a router or a controller supporting fallback bridging. Because a VLAN is considered a separate logical network, it contains its own bridge Management Information Base (MIB) information.

VLANs are often associated with IP subnet. For example, all the end stations in a particular IP subnet belong to the same VLAN. Interface VLAN membership on the controller is assigned manually on an interface-by-interface basis. When you assign controller interfaces to VLANs by using this method, it is known as interface-based, or static, VLAN membership.

### Supported VLANs

The controller supports VLANs in VTP client, server, and transparent modes. VLANs are identified by a number from 1 to 4094. VLAN 1 is the default VLAN and is created during system initialization. All of the VLANs except 1002 to 1005 are available for user configuration.

### VLAN Port Membership Modes

You configure a port to belong to a VLAN by assigning a membership mode that specifies the kind of traffic the port carries and the number of VLANs to which it can belong.

When a port belongs to a VLAN, the controller learns and manages the addresses associated with the port on a per-VLAN basis.

Table 88: Port Membership Modes and Characteristics

Membership Mode	VLAN Membership Characteristics	VTP Characteristics
Static-access	A static-access port can belong to one VLAN and is manually assigned to that VLAN.	VTP is not required. If you do not want VTP to globally propagate information, set the VTP mode to transparent. To participate in VTP, there must be at least one trunk port on the controller connected to a trunk port of a second controller.
Trunk IEEE 802.1Q) : <ul style="list-style-type: none"> <li>IEEE 802.1Q— Industry-standard trunking encapsulation.</li> </ul>	A trunk port is a member of all VLANs by default, including extended-range VLANs, but membership can be limited by configuring the allowed-VLAN list.	VTP is recommended but not required. VTP maintains VLAN configuration consistency by managing the addition, deletion, and renaming of VLANs on a network-wide basis. VTP exchanges VLAN configuration messages with other controller over trunk links.



**Note** If a client VLAN has two subnets, a primary subnet and a secondary subnet, the static IP address is not supported on the secondary subnet.

Consider the following SVI configuration example:

```
interface VlanX
ip address a.b.c.254 255.255.255.0 secondary
ip address a.d.e.254 255.255.255.0
```

In this scenario, you can't allocate the secondary subnet for clients with static IP addresses.

## VLAN Configuration Files

Configurations for VLAN IDs 1 to 1005 are written to the `vlan.dat` file (VLAN database), and you can display them by entering the **show vlan** privileged EXEC command. The `vlan.dat` file is stored in flash memory. If the VTP mode is transparent, they are also saved in the controller running configuration file.

You use the interface configuration mode to define the port membership mode and to add and remove ports from VLANs. The results of these commands are written to the running-configuration file, and you can display the file by entering the **show running-config** privileged EXEC command.

When you save VLAN and VTP information (including extended-range VLAN configuration information) in the startup configuration file and reboot the controller, the controller configuration is selected as follows:

- If the VTP mode is transparent in the startup configuration, and the VLAN database and the VTP domain name from the VLAN database matches that in the startup configuration file, the VLAN database is ignored (cleared), and the VTP and VLAN configurations in the startup configuration file are used. The VLAN database revision number remains unchanged in the VLAN database.



- If the VTP mode or domain name in the startup configuration does not match the VLAN database, the domain name and VTP mode and configuration for the VLAN IDs 1 to 1005 use the VLAN database information.
- In VTP versions 1 and 2, if VTP mode is server, the domain name and VLAN configuration for VLAN IDs 1 to 1005 use the VLAN database information. VTP version 3 also supports VLANs 1006 to 4094.



---

**Note** Ensure that you delete the `vlan.dat` file along with the configuration files before you reset the switch configuration using **write erase** command. This ensures that the switch reboots correctly on a reset.

---

## Normal-Range VLAN Configuration Guidelines

Follow these guidelines when creating and modifying normal-range VLANs in your network:

- Normal-range VLANs are identified with a number between 1 and 1001.
- VLAN configurations for VLANs 1 to 1005 are always saved in the VLAN database. If the VTP mode is transparent, VTP and VLAN configurations are also saved in the running configuration file.
- If the controller is in VTP server or VTP transparent mode, you can add, modify or remove configurations for VLANs 2 to 1001 in the VLAN database. (VLAN IDs 1 and 1002 to 1005 are automatically created and cannot be removed.)
- Extended-range VLANs created in VTP transparent mode are not saved in the VLAN database and are not propagated. VTP version 3 supports extended range VLAN (VLANs 1006 to 4094) database propagation in VTP server mode.

## Extended-Range VLAN Configuration Guidelines

Extended-range VLANs are VLANs with IDs from 1006 to 4094.

Follow these guidelines when creating extended-range VLANs:

- VLAN IDs in the extended range are not saved in the VLAN database and are not recognized by VTP unless the device is running VTP version 3.
- You cannot include extended-range VLANs in the pruning eligible range.
- For VTP version 1 or 2, you can set the VTP mode to transparent in global configuration mode. You should save this configuration to the startup configuration so that the device boots up in VTP transparent mode. Otherwise, you lose the extended-range VLAN configuration if the device resets. If you create extended-range VLANs in VTP version 3, you cannot convert to VTP version 1 or 2.

## Prerequisites for VLANs

The following are prerequisites and considerations for configuring VLANs:

- To configure VLAN through the Web UI, you must change the number of available Virtual Terminal (VTY) sessions to 50. Web UI uses VTY lines for processing HTTP requests. At times, when multiple

connections are open, the default VTY lines of 15 set by the device gets exhausted. Therefore, you must change the VTY lines to 50 before using the Web UI.



**Note** To increase the VTY lines in a device, run the following command in the configuration mode:

```
Device# configure terminal
Device(config)# service tcp-keepalives in
Device(config)# service tcp-keepalives out
```

```
Device# configure terminal
Device(config)# line vty 16-50
```



**Note** The maximum number of SSH VTY sessions supported on the standby controller is eight.

- Before you create VLANs, you must decide whether to use VLAN Trunking Protocol (VTP) to maintain global VLAN configuration for your network.
- Before adding a VLAN to a VLAN group, you should first create it on the device.

## Restrictions for VLANs

The following are restrictions for VLANs:

- You cannot delete a wireless management interface, if the associated VLAN interface is already deleted. To avoid this scenario, you should delete the wireless management interface before deleting the VLAN interface.
- The device supports IEEE 802.1Q trunking methods for sending VLAN traffic over Ethernet ports.
- When client VLAN is not configured for a policy profile, AP native VLAN is used.
- The behavior of VLAN 1 changes depending on the AP mode. These scenarios are described below:
  - **Local mode AP:** If you use *vlan-name*, clients are assigned to VLAN 1. However, if you use *vlan-id 1*, clients are assigned to the wireless management interface.
  - **FlexConnect mode AP:** If you use *vlan-name*, clients are assigned to VLAN 1. However, if you use *vlan-id 1*, clients are assigned to the native VLAN defined in the flex profile.

By default, the policy profile assigns *vlan-id 1* so that clients can use the wireless management VLAN.

- You cannot use the same VLAN on the same SSID for local switching and central switching.

# How to Configure VLANs

## How to Configure Normal-Range VLANs

You can set these parameters when you create a new normal-range VLAN or modify an existing VLAN in the VLAN database:

- VLAN ID
- VLAN name
- VLAN type
  - Ethernet
  - TrBRF or TrCRF
- VLAN state (active or suspended)
- Parent VLAN number for TrCRF VLANs
- VLAN number to use when translating from one VLAN type to another

You can cause inconsistency in the VLAN database if you attempt to manually delete the *vlan.dat* file. If you want to modify the VLAN configuration, follow the procedures in this section.

## Creating or Modifying an Ethernet VLAN

### Before you begin

With VTP version 1 and 2, if the controller is in VTP transparent mode, you can assign VLAN IDs greater than 1006, but they are not added to the VLAN database.

The controller supports only Ethernet interfaces.

### Procedure

	Command or Action	Purpose
<b>Step 1</b>	<b>vlan</b> <i>vlan-id</i> <b>Example:</b> Device(config)# <b>vlan 20</b>	Enters a VLAN ID, and enters VLAN configuration mode. Enter a new VLAN ID to create a VLAN, or enter an existing VLAN ID to modify that VLAN.  <b>Note</b> The available VLAN ID range for this command is 1 to 4094.
<b>Step 2</b>	<b>name</b> <i>vlan-name</i> <b>Example:</b> Device(config-vlan)# <b>name test20</b>	(Optional) Enters a name for the VLAN. If no name is entered for the VLAN, the default is to append the <i>vlan-id</i> value with leading zeros to the word VLAN. For example, VLAN0004 is a default VLAN name for VLAN 4.

	Command or Action	Purpose
<b>Step 3</b>	<b>media { ethernet   fd-net   trn-net }</b> <b>Example:</b> <pre>Device(config-vlan)# media ethernet</pre>	Configures the VLAN media type.
<b>Step 4</b>	<b>show vlan {name vlan-name   id vlan-id}</b> <b>Example:</b> <pre>Device# show vlan name test20 id 20</pre>	Verifies your entries.

## Assigning Static-Access Ports to a VLAN (GUI)

### Procedure

- 
- Step 1** Choose **Configuration > Layer2 > VLAN > VLAN**
  - Step 2** Click the **VLAN** tab.
  - Step 3** To assign **Port Members**, click the interfaces that are to be included as port members from the **Available** list and click on the arrow to move it to the **Associated** list.
  - Step 4** Click **Update & Apply to Device**.
- 

## Assigning Static-Access Ports to a VLAN

You can assign a static-access port to a VLAN without having VTP globally propagate VLAN configuration information by disabling VTP (VTP transparent mode). For more information on static-access ports, see *VLAN Port Membership Modes*.

If you assign an interface to a VLAN that does not exist, the new VLAN is created.

### Procedure

	Command or Action	Purpose
<b>Step 1</b>	<b>configure terminal</b> <b>Example:</b> <pre>Device# configure terminal</pre>	Enters global configuration mode
<b>Step 2</b>	<b>interface interface-id</b> <b>Example:</b> <pre>Device(config)# interface gigabitethernet2/0/1</pre>	Enters the interface to be added to the VLAN.

	Command or Action	Purpose
<b>Step 3</b>	<b>switchport mode access</b> <b>Example:</b> Device(config-if)# <b>switchport mode access</b>	Defines the VLAN membership mode for the port (Layer 2 access port).
<b>Step 4</b>	<b>switchport access vlan <i>vlan-id</i></b> <b>Example:</b> Device(config-if)# <b>switchport access vlan 2</b>	Assigns the port to a VLAN. Valid VLAN IDs are 1 to 4094.
<b>Step 5</b>	<b>end</b> <b>Example:</b> Device(config-if)# <b>end</b>	Returns to privileged EXEC mode.
<b>Step 6</b>	<b>show running-config interface <i>interface-id</i></b> <b>Example:</b> Device# <b>copy running-config startup-config</b>	Verifies the VLAN membership mode of the interface.
<b>Step 7</b>	<b>show interfaces <i>interface-id</i> switchport</b> <b>Example:</b> Device# <b>show interfaces gigabitethernet2/0/1</b>	Verifies your entries in the <i>Administrative Mode</i> and the <i>Access Mode VLAN</i> fields of the display.

## How to Configure Extended-Range VLANs

Extended-range VLANs enable service providers to extend their infrastructure to a greater number of customers. The extended-range VLAN IDs are allowed for any **switchport** commands that allow VLAN IDs.

With VTP version 1 or 2, extended-range VLAN configurations are not stored in the VLAN database, but because VTP mode is transparent, they are stored in the controller running configuration file, and you can save the configuration in the startup configuration file. Extended-range VLANs created in VTP version 3 are stored in the VLAN database.

## Creating an Extended-Range VLAN (GUI)

### Procedure

- 
- Step 1** Choose **Configuration > Layer2 > VLAN**.
- Step 2** In the VLAN page, click **ADD**.
- Step 3** Enter the extended range VLAN ID in the **VLAN ID** field.  
The extended range is between range is 1006 and 4094.
- Step 4** Enter a VLAN name in the **Name** field.
- Step 5** Save the configuration.
- 

## Creating an Extended-Range VLAN

### Procedure

	Command or Action	Purpose
<b>Step 1</b>	<b>configure terminal</b>  <b>Example:</b>  Device# <code>configure terminal</code>	Enters global configuration mode.
<b>Step 2</b>	<b>vlan <i>vlan-id</i></b>  <b>Example:</b>  Device(config)# <code>vlan 2000</code>	Enters an extended-range VLAN ID and enters VLAN configuration mode. The range is 1006 to 4094.
<b>Step 3</b>	<b>show vlan id <i>vlan-id</i></b>  <b>Example:</b>  Device# <code>show vlan id 2000</code>	Verifies that the VLAN has been created.

## Monitoring VLANs

Table 89: Privileged EXEC show Commands

Command	Purpose
<code>show interfaces [vlan <i>vlan-id</i>]</code>	Displays characteristics for all interfaces or for the specified VLAN configured on the controller.

Command	Purpose
<b>show vlan</b> [ <b>access-map</b> <i>name</i>   <b>brief</b>   <b>group</b>   <b>id</b> <i>vlan-id</i>   <b>ifindex</b>   <b>mtu</b>   <b>name</b> <i>name</i>   <b>summary</b> ]	Displays parameters for all VLANs or the specified VLAN on the controller. The following command options are available: <ul style="list-style-type: none"><li>• <b>brief</b>—Displays VTP VLAN status in brief.</li><li>• <b>group</b>—Displays the VLAN group with its name and the connected VLANs that are available.</li><li>• <b>id</b>—Displays VTP VLAN status by identification number.</li><li>• <b>ifindex</b>—Displays SNMP ifIndex.</li><li>• <b>mtu</b>—Displays VLAN MTU information.</li><li>• <b>name</b>—Displays the VTP VLAN information by specified name.</li><li>• <b>summary</b>—Displays a summary of VLAN information.</li></ul>







## CHAPTER 168

# VLAN Groups

---

- [Information About VLAN Groups, on page 1607](#)
- [Prerequisites for VLAN Groups, on page 1608](#)
- [Restrictions for VLAN Groups, on page 1608](#)
- [Creating a VLAN Group \(GUI\), on page 1608](#)
- [Creating a VLAN Group \(CLI\), on page 1609](#)
- [Adding a VLAN Group to Policy Profile \(GUI\), on page 1609](#)
- [Adding a VLAN Group to a Policy Profile, on page 1610](#)
- [Viewing the VLANs in a VLAN Group, on page 1610](#)

## Information About VLAN Groups

Whenever a client connects to a wireless network (WLAN), the client is placed in a VLAN that is associated with the policy profile mapped to the WLAN. In a large venue, such as an auditorium, a stadium, or a conference room where there are numerous wireless clients, having only a single WLAN to accommodate many clients might be a challenge.

The VLAN group feature uses a single policy profile that can support multiple VLANs. The clients can get assigned to one of the configured VLANs. This feature maps a policy profile to a single VLAN or multiple VLANs using the VLAN groups. When a wireless client associates to the WLAN, the VLAN is derived by an algorithm based on the MAC address of the wireless client. A VLAN is assigned to the client and the client gets the IP address from the assigned VLAN.

The system marks VLAN as *Dirty* for 30 minutes when the clients are unable to receive IP addresses using DHCP. The system might not clear the *Dirty* flag from the VLAN even after 30 minutes for a VLAN group. After 30 minutes, when the VLAN is marked non-dirty, new clients in the IP Learn state can get assigned with IP addresses from the VLAN if free IPs are available in the pool and DHCP scope is defined correctly. This is the expected behavior because the timestamp of each interface has to be checked to see if it is greater than 30 minutes, due to which there is a lag of 5 minutes for the global timer to expire.



**Note** The Controller marks the VLAN interface as *Dirty* when three or more clients fail to receive IP addresses through DHCP. The VLAN interface is deemed *Dirty* using the Non-Aggressive method, which involves counting one failure per association per client that surpasses the predefined **IP\_LEARN\_TIMEOUT** duration of 120 seconds. If a client sends a new association request before the **IP\_LEARN\_TIMEOUT** elapses, it will not be considered a failed client.

In Non-Aggressive method, each client gets a unique hash value derived from its MAC address. This approach ensures that clients belonging to the same vendor, which may differ only by a few bits, do not mistakenly trigger the *Dirty* marking of a VLAN.

## Prerequisites for VLAN Groups

- A VLAN should be present in the device for it to be added to the VLAN group.

## Restrictions for VLAN Groups

- If the number of VLANs in a VLAN group exceeds 32, the mobility functionality might not work as expected and Layer 2 multicast might break for some VLANs. Therefore, it is the responsibility of network administrators to configure a feasible number of VLANs in a VLAN group.  
For the VLAN Groups feature to work as expected, the VLANs mapped in a group must be present in the controller. The static IP client behavior is not supported.
- The VLAN Groups feature works for access points in local mode.
- The VLAN Groups feature works only in central switching mode and it cannot be used in FlexConnect local switching mode.
- ARP Broadcast feature is not supported on VLAN groups.
- VLAN group Multicast with VLAN group is only supported in local mode AP. Multicast VLAN is required when VLAN group is configured and uses multicast traffic.
- While you configure VLAN groups with multiple VLANs and each VLAN is used by a different subnet, clients having static IP addresses might be assigned to a wrong VLAN if SVIs are not present on the controller. Hence, for every VLAN that belongs to the VLAN group, ensure that you configure an SVI interface with a valid IP address.

## Creating a VLAN Group (GUI)

### Procedure

- Step 1** Choose **Configuration > Layer2 > VLAN**
- Step 2** On the **VLAN > VLAN** page, click **Add**.

- Step 3** Enter the VLAN ID in the **VLAN ID** field.  
The valid range is between 2 and 4094.
- Step 4** Enter the VLAN name in the **Name** field.  
Configure the other parameters if required.
- Step 5** Click **Update & Apply to Device**.

## Creating a VLAN Group (CLI)

### Procedure

	Command or Action	Purpose
<b>Step 1</b>	<b>configure terminal</b>  <b>Example:</b> Device# <b>configure terminal</b>	Enters global configuration mode.
<b>Step 2</b>	<b>vlan group</b> <i>WORD</i> <b>vlan-list</b> <i>vlan-ID</i>  <b>Example:</b> Device(config)# <b>vlan group vlangrp1</b> <b>vlan-list 91-95</b>	Creates a VLAN group with the given group name (vlangrp1) and adds all the VLANs listed in the command. The VLAN list ranges from 1 to 4096 and the maximum number of VLANs supported in a group is 64.
<b>Step 3</b>	<b>end</b>  <b>Example:</b> Device(config)# <b>end</b>	Exits the global configuration mode and returns to privileged EXEC mode. Alternatively, press <b>CTRL-Z</b> to exit the global configuration mode.

## Adding a VLAN Group to Policy Profile (GUI)

Policy profile broadly consists of network and switching policies. Policy profile is a reusable entity across tags. Anything that is a policy for the client that is applied on the AP or controller is moved to the policy profile. For example, VLAN, ACL, QoS, Session timeout, Idle timeout, AVC profile, Bonjour profile, Local profiling, Device classification, BSSID QoS, etc. However, all wireless related security attributes and features on the WLAN are grouped under the WLAN profile.

### Procedure

- Step 1** Choose **Configuration > Tags & Profiles > Policy**.
- Step 2** On the **Policy Profile** page, click on a policy profile name.
- Step 3** Click **Access Policies** tab.
- Step 4** Under **VLAN** section, use the **VLAN/VLAN Group** drop-down list to select a VLAN or VLAN Group.

**Step 5** Click **Update & Apply to Device**.

## Adding a VLAN Group to a Policy Profile

### Procedure

	Command or Action	Purpose
<b>Step 1</b>	<b>configure terminal</b> <b>Example:</b> Device# configure terminal	Enters global configuration mode.
<b>Step 2</b>	<b>wireless profile policy</b> <i>wlan-policy-profile-name</i> <b>Example:</b> Device(config)# wireless profile policy my-wlan-policy	Configures the WLAN policy profile.
<b>Step 3</b>	<b>vlan</b> <i>vlan-group1</i> <b>Example:</b> Device(config-wireless-policy)# vlan myvlan-group	Maps the VLAN group to the WLAN by entering the group name.
<b>Step 4</b>	<b>end</b> <b>Example:</b> Device(config-wlan)# end	Exits global configuration mode and returns to privileged EXEC mode.

## Viewing the VLANs in a VLAN Group

Command	Description
<b>show vlan group</b>	Displays the list of VLAN groups with name and the VLANs that are configured.
<b>show vlan group</b> <i>group-name</i> <i>group_name</i>	Displays the specified VLAN group details.
<b>show wireless client mac-address</b> <i>client-mac-addr</i> <b>detail</b>	Displays the VLAN group assigned to the client.
<b>show wireless vlan details</b>	Displays VLAN details.



## PART **XVII**

### **WLAN**

- [WLANs, on page 1613](#)
- [WLAN Security, on page 1643](#)
- [Remote LANs, on page 1657](#)
- [RLAN External Module, on page 1673](#)
- [802.11ax Per WLAN, on page 1675](#)
- [BSS Coloring, on page 1679](#)
- [DHCP for WLANs, on page 1687](#)
- [Aironet Extensions IE \(CCX IE\) , on page 1707](#)
- [Device Analytics, on page 1711](#)
- [BSSID Counters, on page 1717](#)
- [Fastlane+, on page 1721](#)
- [Workgroup Bridges, on page 1725](#)
- [Peer-to-Peer Client Support, on page 1743](#)
- [Deny Wireless Client Session Establishment Using Calendar Profiles, on page 1745](#)
- [Ethernet over GRE , on page 1755](#)
- [Wireless Guest Access, on page 1773](#)
- [Wired Guest Access, on page 1803](#)
- [Express Wi-Fi by Facebook, on page 1823](#)
- [User Defined Network, on page 1833](#)
- [Hotspot 2.0, on page 1841](#)
- [Client Roaming Across Policy Profile, on page 1867](#)
- [Assisted Roaming, on page 1875](#)
- [802.11r BSS Fast Transition, on page 1881](#)
- [802.11v, on page 1889](#)





# CHAPTER 169

## WLANs

---

- [Information About WLANs, on page 1613](#)
- [Prerequisites for WLANs, on page 1616](#)
- [Restrictions for WLANs, on page 1616](#)
- [How to Configure WLANs, on page 1618](#)
- [Verifying WLAN Properties \(CLI\), on page 1640](#)
- [Verifying WLAN-VLAN Information for an AP, on page 1640](#)
- [Verifying a WLAN Radio Policy, on page 1641](#)

## Information About WLANs

This feature enables you to control WLANs for lightweight access points. Each WLAN has a separate WLAN ID, a separate profile name, and a WLAN SSID. All access points can advertise up to 16 WLANs. However, you can create up to 4096 WLANs and then selectively advertise these WLANs (using profiles and tags) to different access points for better manageability.

You can configure WLANs with different SSIDs or with the same SSID. An SSID identifies the specific wireless network that you want the device to access.



---

**Note** The **wireless client max-user-login concurrent** command will work as intended even if the **no configure max-user-identity response** command is configured.

---



---

**Note** We recommend that you configure the **password encryption aes** and the **key config-key password-encrypt key** commands to encrypt your password.

---



---

**Note** For C9105, C9115, and C9120 APs, when a new WLAN is pushed from the controller and if the existing WLAN functional parameters are changed, the other WLAN clients will disconnect and reconnect.

---

## Band Selection

Band select enables client radios that are capable of dual-band (2.4 and 5-GHz) operations to move to a less congested 5-GHz access point. The 2.4-GHz band is often congested. Clients on this band typically experience interference from Bluetooth devices, microwave ovens, and cordless phones as well as co-channel interference from other access points because of the 802.11b/g limit of 3 nonoverlapping channels. To prevent these sources of interference and improve overall network performance, configure band selection on the device.

## Off-Channel Scanning Deferral

A lightweight access point, in normal operational conditions, periodically goes off-channel and scans another channel. This is in order to perform RRM operations such as the following:

- Transmitting and receiving Neighbor Discovery Protocol (NDP) packets with other APs.
- Detecting rogue APs and clients.
- Measuring noise and interference.

During the off-channel period, which normally is about 70 milliseconds, the AP is unable to transmit or receive data on its serving channel. Therefore, there is a slight impact on its performance and some client transmissions might be dropped.

While the AP is sending and receiving important data, it is possible to configure off-channel scanning deferral so that the AP does not go off-channel and its normal operation is not impacted. You can configure off-channel scanning deferral on a per-WLAN basis, per WMM UP class basis, with a specified time threshold in milliseconds. If the AP sends or receives, on a particular WLAN, a data frame marked with the given UP class within the specified threshold, the AP defers its next RRM off-channel scan. For example, by default, off-channel scanning deferral is enabled for UP classes 4, 5, and 6, with a time threshold of 100 milliseconds. Therefore, when RRM is about to perform an off-channel scan, a data frame marked with UP 4, 5, or 6 is received within the last 100 milliseconds, RRM defers going off-channel. The AP radio does not go off-channel when a voice call sending and receiving audio samples is marked as UP class 6 for every active 20 milliseconds.

Off-channel scanning deferral does come with a tradeoff. Off-channel scanning can impact throughput by 2 percent or more, depending on the configuration, traffic patterns, and so on. Throughput can be slightly improved if you enable off-channel scanning deferral for all traffic classes and increase the time threshold. However, by not going off-channel, RRM can fail to identify AP neighbors and rogues, resulting in negative impact to security, DCA, TPC, and 802.11k messages.

## DTIM Period

In the 802.11 networks, lightweight access points broadcast a beacon at regular intervals, which coincides with the Delivery Traffic Indication Map (DTIM). After the access point broadcasts the beacon, it transmits any buffered broadcast and multicast frames based on the value set for the DTIM period. This feature allows power-saving clients to wake up at the appropriate time if they are expecting broadcast or multicast data.

Typically, the DTIM value is set to 1 (to transmit broadcast and multicast frames after every beacon) or 2 (to transmit broadcast and multicast frames after every other beacon). For instance, if the beacon period of the 802.11 network is 100 ms and the DTIM value is set to 1, the access point transmits buffered broadcast and multicast frames for 10 times every second. If the beacon period is 100 ms and the DTIM value is set to 2, the access point transmits buffered broadcast and multicast frames for 5 times every second. Either of these settings are suitable for applications, including Voice Over IP (VoIP), that expect frequent broadcast and multicast frames.



However, the DTIM value can be set as high as 255 (to transmit broadcast and multicast frames after every 255th beacon). The only recommended DTIM values are 1 and 2; higher DTIM values will likely cause communications problems.



---

**Note** A beacon period, which is specified in milliseconds on the device, is converted internally by the software to 802.11 Time Units (TUs), where 1 TU = 1.024 milliseconds. Depending on the AP model, the actual beacon period may vary slightly; for example, a beacon period of 100 ms may in practice equate to 104.448 ms.

---

## WLAN Radio Policy

The existing WLAN feature allows you to broadcast WLAN on a specified radio on all the applicable slots. With the WLAN Radio Policy feature, you can broadcast the WLAN on the corresponding slot. Note that this option is supported only on 5-GHz band.

## Restrictions for WLAN Radio Policy

- WLAN is pushed to all the radios only if the following configuration is used:
  - WPA3 + AES cipher + 802.1x-SHA256 AKM
  - WPA3 + AES cipher + OWE AKM
  - WPA3 + AES cipher + SAE AKM
  - WPA3 + CCMP256 cipher + SUITEB192-1X AKM
  - WPA3 + GCMP256 cipher + SUITEB-1X AKM
  - WPA3 + GCMP128 cipher + SUITEB192-1X AKM

## Prerequisites for Configuring Cisco Client Extensions

- The software supports CCX versions 1 through 5, which enables devices and their access points to communicate wirelessly with third-party client devices that support CCX. CCX support is enabled automatically for every WLAN on the device and cannot be disabled. However, you can configure Aironet information elements (IEs).
- If Aironet IE support is enabled, the access point sends an Aironet IE 0x85 (which contains the access point name, load, number of associated clients, and so on) in the beacon and probe responses of this WLAN, and the device sends Aironet IEs 0x85 and 0x95 (which contains the management IP address of the device and the IP address of the access point) in the reassociation response if it receives Aironet IE 0x85 in the reassociation request.

## Peer-to-Peer Blocking

Peer-to-peer blocking is applied to individual WLANs, and each client inherits the peer-to-peer blocking setting of the WLAN to which it is associated. Peer-to-Peer enables you to have more control over how traffic

is directed. For example, you can choose to have traffic bridged locally within the device, dropped by the device, or forwarded to the upstream VLAN.

Peer-to-peer blocking is supported for clients that are associated with local and central switching WLANs.



---

**Note** Peer-to-peer blocking feature is VLAN-based. WLANs using the same VLAN has an impact, if Peer-to-peer blocking feature is enabled.

---

## Diagnostic Channel

You can choose a diagnostic channel to troubleshoot why the client is having communication problems with a WLAN. You can test the client and access points to identify the difficulties that the client is experiencing and allow corrective measures to be taken to make the client operational on the network. You can use the device GUI or CLI to enable the diagnostic channel, and you can use the device **diag-channel** CLI to run the diagnostic tests.



---

**Note** We recommend that you enable the diagnostic channel feature only for non-anchored SSIDs that use the management interface. CCX Diagnostic feature has been tested only with clients having Cisco ADU card

---

## Prerequisites for WLANs

- You can associate up to 16 WLANs with each access point group and assign specific access points to each group. Each access point advertises only the enabled WLANs that belong to its access point group. The access point (AP) does not advertise disabled WLANs in its access point group or WLANs that belong to another group.
- We recommend that you assign one set of VLANs for WLANs and a different set of VLANs for management interfaces to ensure that devices properly route VLAN traffic.

## Restrictions for WLANs

- Do not configure PSK and CCKM in a WLAN, as this configuration is not supported and impacts client join flow.
- Ensure that TKIP or AES ciphers are enabled with WPA1 configuration, else ISSU may break during upgrade process.
- When you change the WLAN profile name, then FlexConnect APs (using AP-specific VLAN mapping) will become WLAN-specific. If FlexConnect Groups are configured, the VLAN mapping will become Group-specific.
- Do not enable IEEE 802.1X Fast Transition on Flex Local Authentication enabled WLAN, as client association is not supported with Fast Transition 802.1X key management.
- Peer-to-peer blocking does not apply to multicast traffic.

- In FlexConnect, peer-to-peer blocking configuration cannot be applied only to a particular FlexConnect AP or a subset of APs. It is applied to all the FlexConnect APs that broadcast the SSID.
- The WLAN name and SSID can have up to 32 characters.
- WLAN and SSID names support only the following ASCII characters:
  - Numerals: 48 through 57 hex (0 to 9)
  - Alphabets (uppercase): 65 through 90 hex (A to Z)
  - Alphabets (lowercase): 97 through 122 hex (a to z)
  - ASCII space: 20 hex
  - Printable special characters: 21 through 2F, 3A through 40, and 5B through 60 hex, that is: ! " # \$ % & ' ( ) \* + , - . / : ; < = > ? @ [ \ ] ^ \_ ` { | } ~
- WLAN name cannot be a keyword; for example, if you try to create a WLAN with the name as 's' by entering the **wlan s** command, it results in shutting down all WLANs because 's' is used as a keyword for shutdown.
- You cannot map a WLAN to VLAN 0. Similarly, you cannot map a WLAN to VLANs 1002 to 1006.
- Dual stack clients with a static-IPv4 address is not supported.
- In a dual-stack with IPv4 and IPv6 configured in the Cisco 9800 controller, if an AP tries to join controller with IPv6 tunnel before its IPv4 tunnel gets cleaned, you would see a traceback and AP join will fail.
- When creating a WLAN with the same SSID, you must create a unique profile name for each WLAN.
- When multiple WLANs with the same SSID get assigned to the same AP radio, you must have a unique Layer 2 security policy so that clients can safely select between them.
- The SSID that is sent as part of the user profile will work only if **aaa override** command is configured.
- RADIUS server overwrite is not configured on a per WLAN basis, but rather on a per AAA server group basis.
- Downloadable ACL (DAACL) is supported only on the central switching mode. It is not supported for Flex Local switching or on the Cisco Embedded Wireless Controller.
- You cannot mix open configuration models with CLI-based, GUI-based, or Catalyst Center-based configurations. However, if you decide to use multiple model types, they must remain independent of each other. For example, in open configuration models, you can only manage configurations that have been created using an open configuration model, not a CLI-based or GUI-based model. Configurations that are created using open configuration models cannot be modified using a GUI-based model, or CLI-based model, or any other model.
- When you are configuring **dot11bg 11g** command and **radio dot11bg** or **radio dot11g** command, the clients can still connect in 5GHz radio. In this scenario, the client association needs to be blocked. This option is only available on a 2.4-GHz radio.

**Caution**

Some clients might not be able to connect to WLANs properly if they detect the same SSID with multiple security policies. Use this WLAN feature with care.

# How to Configure WLANs

## WLAN Wizard

A wireless local-area network (WLAN) is a group of devices that form a network based on radio transmissions rather than wired connections. The WLAN Wizard on the WebUI is a simplified workflow designed to help you quickly create a WLAN and setup some primary configurations for your specific deployment.

The Wizard supports the following wireless deployment modes:

- **Local mode:** In Local mode, the WLAN is broadcast in the campus locally.
- **Flex Connect mode:** In FlexConnect mode, the WLAN is broadcast remotely across the WAN in a branch.
- **Guest CWA mode:** In Guest CWA mode, the WLAN is created for guest access with Central Web Authentication (CWA).

There are different authentication methods supported for each deployment mode.

To configure a WLAN for your preferred wireless deployment mode using the WLAN wizard on the WebUI, go to **Configuration > Wireless Setup > WLAN Wizard**.

You can also navigate to the WLAN Wizard by the following paths:

- On the Toolbar, click on the **Wireless Setup** icon and select **WLAN Wizard** from the drop-down list.
- On the left navigation pane, go to **Configuration > Tags & Profiles > WLANs** and click on **WLAN Wizard** on the top-right corner.

On the **WLAN Wizard** page, select a wireless deployment mode for the WLAN to initiate steps for setting up the WLAN with profiles, authentication methods, tags, and APs and other configurations.

## Local Mode

The WLAN is deployed in Local mode when the WLAN is present in an office setup with no branch offices. In local mode, an AP creates two CAPWAP tunnels to the controller. One is for management, the other is data traffic. This behavior is known as "centrally switched" because the data traffic is tunneled (bridged) from the AP to the controller where it is then routed by some routing device. Locally switched means the traffic is terminated at the local switch adjacent to the access point.



## Authentication Method

To configure a WLAN for local mode, select the preferred authentication method from the left panel. The authentication method sets the method by which a client can access the WLAN and decides the level of security on the WLAN. The options are:

- **PSK:** A Pre-Shared Key (PSK) is a unique key created for individuals or groups of users on the same SSID. A client will have to enter the PSK to be authenticated and allowed to access the WLAN.
- **Dot1x:** The client must go through relevant EAP authentication model to start exchanging traffic in the WLAN.
- **Local Web Authentication:** The controller intercepts http(s) traffic and redirects the client to the internal web page for authentication.
- **External Web Authentication:** The controller intercepts http(s) traffic and redirects the client to the login page hosted on the external web server for authentication.
- **Central Web Authentication:** The controller redirects all web traffic from the client to the ISE login page for authentication.

## WLAN Profile and Policy

After selecting the Authentication method, click on **WLAN** on the left panel to enter the WLAN profile and policy details.

The WLAN profile defines the properties of a WLAN such as Profile Name, Status, WLAN ID, L2 and L3 Security parameters, AAA Server associated with this SSID and other parameters that are specific to a particular WLAN. The policy profile defines the network policies and the switching policies for a client (with the exception of QoS), which constitute the AP policies as well.

### Procedure

---

- Step 1** In the **Network Name** section, enter a **WLAN profile name**, which is a unique name for your wireless network. The name can be ASCII characters from 32 to 126, without leading and trailing spaces.
  - Step 2** Enter a valid **SSID** for the WLAN. A valid SSID can be up to 32 characters and can contain spaces. A valid SSID can be ASCII characters from 0 to 31, with leading and trailing spaces. This is the broadcast name for your WLAN.
  - Step 3** Enter the **WLAN ID**.
  - Step 4** In the **WLAN Policy** section, enter the **Policy Profile name**. The name can be ASCII characters from 32 to 126, without leading and trailing spaces.
  - Step 5** Select the **WLAN** to be associated with the Policy Profile from the drop-down list..
  - Step 6** To select an existing Policy Profile for the WLAN, click on **Select Existing** and choose a **Policy Profile** from the drop-down list..
- 

## Authentication Configurations

Set up the authentication configurations and filters for the WLAN depending on the method you have chosen. These include the keys, filters, ACLs, and parameter maps as applicable to the selected authentication method.

### Procedure

---

- Step 1** If you have selected **PSK** as the authentication method, configure the following:

- a) In the **WLAN > Pre-Shared Key (PSK)** section, select the PSK format. Choose between ASCII and Hexadecimal formats.
- b) From the **PSK type** drop-down list, choose if you want the key to be unencrypted or AES encrypted.
- c) In the **Pre-Shared Key** field, enter the pass key for the WLAN.

**Step 2** If you have selected **Dot1x** as the authentication method, configure the following:

- a) In the **WLAN > AAA** tab, configure the AAA server list for the WLAN.
- b) Select any of the available AAA servers to add to the WLAN.
- c) To add a new AAA server to the list, click on Add New Server and enter the IP address and server-key.
- d) To use an already configured AAA server list, click on **Use Existing** and select the appropriate list from the drop-down.

**Step 3** If you have selected **Local Web Authentication** as the authentication method, configure the following:

- a) In the **WLAN > Parameter Map** tab, configure the parameter map for the WLAN. A parameter map sets parameters that can be applied to subscriber sessions during authentication.
  1. In the **Global Configuration** section, configure the global parameter map.
  2. Enter an IPv4 or IPv6 address to configure a virtual IP address for redirecting the clients to the login page of the controller.
  3. From the Trustpoint drop-down list, select the trustpoint for HTTPS login page. The trustpoint corresponds to the device certificate the controller will use in conjunction with the virtual IP and hostname.
  4. In the **WLAN Specific Configuration** section, either create a new parameter map for the WLAN, or select an existing parameter map from the drop-down list.
- b) In the **WLAN > Local Users** tab, enter the username in the local database to establish a username-based authentication system.
  1. Enter the user name to be saved.
  2. From the **Password Encryption** drop-down list, choose if you want the password to be unencrypted or encrypted.
  3. In the **Password** field, specify the password the user must enter to gain access to the switch. The password must be from 1 to 25 characters and can contain embedded spaces.
  4. Click on the + sign to add the credentials to the database. Add as many user credentials as required.

**Step 4** If you have selected **External Web Authentication** as the authentication method, configure the following:

- a) In the **WLAN > Parameter Map** tab, configure the parameter map for the WLAN.
  1. In the **Global Configuration** section, configure the global parameter map.
  2. Enter an IPv4 or IPv6 address to configure the virtual IP address of the external web authentication login page to which the guest users are redirected.
  3. From the **Trustpoint** drop-down list, select the trustpoint for HTTPS login page. The trustpoint corresponds to the device certificate the controller will use in conjunction with the virtual IP and hostname.
  4. In the **WLAN Specific Configuration** section, either create a new parameter map for the WLAN, or select an existing parameter map from the drop-down list.

5. To create a new parameter map, enter the parameter-map name.
  6. In the **Redirect URL for login** field, enter the URL of the external server that will host the authentication page for login.
  7. In the **Portal IPv4 Address** field, enter the IPv4 address of the external server to send redirects. If the external server uses an IPv6 address, in the **Portal IPv6 Address** field, enter the IPv6 address of the portal to send redirects.
- b) In the **WLAN > ACL / URL Filter** tab, configure the ACL rules and the URL filter list.
1. In the **Pre Auth ACL** section, enter the name of the ACL.
  2. In the **IP address** field, enter the source IP address and the destination IP address. This will configure the ACL to permit packet transfer from and to the specified IP address. You can add as many IP addresses as required.
  3. In the **URL Filter** section, enter a name for the URL Filter list that you are creating.
  4. Use the slider to set the list action to **Permit** or **Deny** the URLs.
  5. Specify the URLs in the **URLs** box. Enter every URL on a new line.

**Step 5**

If you have selected Central Web Authentication as the authentication method, configure the following:

- a) In the **WLAN > AAA/ACL** tab, configure the AAA server list and ACL for the WLAN.
- b) In the **AAA Configuration** section, select any of the available AAA servers to add to the WLAN. This will be the server where the clients will get authenticated.
- c) To add a new AAA server to the list, click on **Add New Server** and enter the IP address and server-key.
- d) To use an already configured AAA server list, click on **Use Existing** and select the appropriate list from the drop-down.
- e) In the **ACL List** section, enter the name of the ACL. This ACL will contain the rules regarding URLs that can be accessed by the client and should match the name configured on the RADIUS server.

**Tags**

To configure tags on the WLAN, click on **Tags** from the left panel.

A Tag's property is defined by the policies associated to it. This property is in turn inherited by an associated client/AP. There are various type of tags, each associated to different profiles.

**Procedure****Step 1**

In the **Site Configuration** section, either enter a site tag to be added, or select an existing site tag from the drop-down list. You can add as many tags as required. In the local mode, the site tag contains the AP join profile only.

**Step 2**

In the **Policy Tag** section, either enter a policy tag to be added, or select an existing policy tag from the drop-down list. You can add as many tags as required. The policy tag constitutes mapping of the WLAN profile to the policy profile. The WLAN profile defines the wireless characteristics of the WLAN. The policy profile defines the network policies and the switching policies for the client.

- Step 3** In the **RF Tag** section, either enter an RF tag to be added, or select an existing RF tag from the drop-down list. You can add as many tags as required. The RF tag contains the 2.4 GHz and 5 GHz RF profiles.
- 

## AP Provisioning

Once the Wireless network and RF characteristics are set up, access points can be added to the local site either using static AP MAC address assignment or by assigning already joined APs to a specific location.

To add tags and associate APs to the WLAN, click on **AP Provisioning** from the left panel.

### Procedure

---

- Step 1** The APs already discovered by the controller are listed in the **Provision Joined APs** tab. You can select the APs to be associated to the WLAN from this table.
- Step 2** To add tags to the selected APs, select the appropriate Policy Tag, Site Tag, and RF Tag from the respective drop-down lists. Click on **Add** to apply the tags.
- Step 3** To add APs manually, click on the **Pre-provision APs** tab. You can either add individual MAC addresses of the APs or upload a CSV file with the AP MAC addresses listed. The added APs will be listed in the table below.
- Step 4** Select the APs to be associated to the WLAN from this table.
- Step 5** To add tags to the selected APs, select the appropriate Policy Tag, Site Tag, and RF Tag from the respective drop-down lists. Click on **Add** to apply the tags.
- A table of all the APs and the tags added to them is displayed in the **Selected APs** tab.
- Step 6** Click **Apply**.
- This will create a WLAN in local mode with the authentication method, authentication filters, tags, and APs configured on it.
- 

## FlexConnect Mode

FlexConnect is a wireless solution for branch office and remote office deployments. It enables you to configure and control access points (AP) in a branch or remote office from the corporate office through a wide area network (WAN) link without deploying a controller in each office. The FlexConnect access points can switch client data traffic and perform client authentication locally when their connection to the controller is lost. An AP in Flex mode offers network survivability in the event of a loss of connection to the centralized wireless controller.





## Authentication Method

To configure a WLAN for FlexConnect mode, select the preferred authentication method from the left panel. The authentication method sets the method by which a client can access the WLAN and decides the level of security on the WLAN.

The options are:

- **Local Web Authentication:** The controller intercepts http(s) traffic and redirects the client to the internal web page for authentication.
- **External Web Authentication:** The controller intercepts http(s) traffic and redirects the client to the login page hosted on the external web server for authentication.
- **Central Web Authentication:** The controller redirects all web traffic from the client to the ISE login page for authentication.

## WLAN Profile and Policy

After selecting the Authentication method, click on **WLAN** on the left panel to enter the WLAN profile and policy details.

The WLAN profile defines the properties of a WLAN such as Profile Name, Status, WLAN ID, L2 and L3 Security parameters, AAA Server associated with this SSID and other parameters that are specific to a particular WLAN. The policy profile defines the network policies and the switching policies for a client (with the exception of QoS), which constitute the AP policies as well.

### Procedure

- 
- Step 1** In the **Network Name** section, enter a **WLAN profile name**, which is a unique name for your wireless network. The name can be ASCII characters from 32 to 126, without leading and trailing spaces.
  - Step 2** Enter a valid **SSID** for the WLAN. A valid SSID can be up to 32 characters and can contain spaces. A valid SSID can be ASCII characters from 0 to 31, with leading and trailing spaces. This is the broadcast name for your WLAN.
  - Step 3** Enter the **WLAN ID**.
  - Step 4** In the **WLAN Policy** section, enter the **Policy Profile name**. The name can be ASCII characters from 32 to 126, without leading and trailing spaces.
  - Step 5** Select the **WLAN** to be associated with the Policy Profile from the drop-down list..
  - Step 6** To select an existing Policy Profile for the WLAN, click on **Select Existing** and choose a **Policy Profile** from the drop-down list..
- 

## Authentication Configurations

Set up the authentication configurations and filters for the WLAN depending on the method you have chosen. These include the keys, filters, ACLs, and parameter maps as applicable to the selected authentication method.

### Procedure

- 
- Step 1** If you have selected **Local Web Authentication** as the authentication method, configure the following:

- a) In the **WLAN > Parameter Map** tab, configure the parameter map for the WLAN. A parameter map sets parameters that can be applied to subscriber sessions during authentication.
  1. In the **Global Configuration** section, configure the global parameter map.
  2. Enter an IPv4 or IPv6 address to configure a virtual IP address for redirecting the clients to the login page of the controller.
  3. From the **Trustpoint** drop-down list, select the trustpoint for HTTPS login page. The trustpoint corresponds to the device certificate the controller will use in conjunction with the virtual IP and hostname.
  4. In the **WLAN Specific Configuration** section, either create a new parameter map for the WLAN, or select an existing parameter map from the drop-down list.
  
- b) In the **WLAN > Local Users / Flex** tab, configure a Flex profile and enter the username in the local database to establish a username-based authentication system.
  1. In the **Flex Profile** section, enter the name of the new flex profile and the native VLAN ID.
  2. To use an already existing Flex profile, click on **Select Existing** to choose a profile from the drop-down list and enter the native VLAN ID.
  3. In the **Local Users** section, enter the user name to be saved.
  4. From the **Password Encryption** drop-down list, choose if you want the password to be unencrypted or encrypted.
  5. In the **Password** field, specify the password the user must enter to gain access to the switch. The password must be from 1 to 25 characters and can contain embedded spaces.
  6. Click on the + sign to add the credentials to the database. Add as many user credentials as required.

**Step 2**

If you have selected **External Web Authentication** as the authentication method, configure the following:

- a) In the **WLAN > Parameter Map** tab, configure the parameter map for the WLAN.
  1. In the **Global Configuration** section, configure the global parameter map.
  2. Enter an IPv4 or IPv6 address to configure the virtual IP address of the external web authentication login page to which the guest users are redirected.
  3. From the **Trustpoint** drop-down list, select the trustpoint for HTTPS login page. The trustpoint corresponds to the device certificate the controller will use in conjunction with the virtual IP and hostname.
  4. In the **WLAN Specific Configuration** section, either create a new parameter map for the WLAN, or select an existing parameter map from the drop-down list.
  5. To create a new parameter map, enter the parameter-map name.
  6. In the **Redirect URL for login** field, enter the URL of the external server that will host the authentication page for login.
  7. In the **Portal IPV4 Address** field, enter the IPv4 address of the external server to send redirects. If the external server uses an IPv6 address, in the **Portal IPV6 Address** field, enter the IPv6 address of the portal to send redirects.

- b) In the **WLAN > ACL / URL Filter** tab, configure the ACL rules and the URL filter list.
1. In the **Flex Profile** section, enter the name of the new flex profile and the native VLAN ID.
  2. To use an already existing Flex profile, click on **Select Existing** to choose a profile from the drop-down list and enter the native VLAN ID.
  3. In the **Pre Auth ACL** section, enter the name of the ACL.
  4. In the **IP address** field, enter the source IP address and the destination IP address. This will configure the ACL to permit packet transfer from and to the specified IP address. You can add as many IP addresses as required.
  5. In the **URL Filter** section, enter a name for the URL Filter list that you are creating.
  6. Click on **Add** to add the URLs.
  7. Specify the URL to be added to the list and its preference.
  8. Use the slider to set the list action to **Permit** or **Deny** the URLs.
  9. Click **Save**.
- You can add as many URLs to the list as required.
- c) To add a new AAA server to the list, click on Add New Server and enter the IP address and server-key.
- d) To use an already configured AAA server list, click on **Use Existing** and select the appropriate list from the drop-down.

**Step 3**

If you have selected **Central Web Authentication** as the authentication method, configure the following:

- a) In the **WLAN > AAA/ACL** tab, configure the AAA server list and ACL for the WLAN.
- b) In the **AAA Configuration** section, select any of the available AAA servers to add to the WLAN. This will be the server where the clients will get authenticated.
- c) To add a new AAA server to the list, click on **Add New Server** and enter the IP address and server-key.
- d) To use an already configured AAA server list, click on **Use Existing** and select the appropriate list from the drop-down.
- e) In the **Flex Profile** section, enter the name of the new flex profile and the native VLAN ID.
- f) To use an already existing Flex profile, click on **Select Existing** to choose a profile from the drop-down list and enter the native VLAN ID.
- g) In the **ACL List** section, enter the name of the ACL. This ACL will contain the rules regarding URLs that can be accessed by the client and should match the name configured on the RADIUS server.

**Tags**

To configure tags on the WLAN, click on **Tags** from the left panel.

A Tag's property is defined by the policies associated to it. This property is in turn inherited by an associated client/AP. There are various type of tags, each associated to different profiles.

### Procedure

---

- Step 1** In the **Site Configuration** section, either enter a site tag to be added, or select an existing site tag from the drop-down list. You can add as many tags as required. In FlexConnect mode, the site tag contains the AP join profile and the Flex profile.
- Step 2** In the **Policy Tag** section, either enter a policy tag to be added, or select an existing policy tag from the drop-down list. You can add as many tags as required. The policy tag constitutes mapping of the WLAN profile to the policy profile. The WLAN profile defines the wireless characteristics of the WLAN. The policy profile defines the network policies and the switching policies for the client.
- Step 3** In the **RF Tag** section, either enter an RF tag to be added, or select an existing RF tag from the drop-down list. You can add as many tags as required. The RF tag contains the 2.4 GHz and 5 GHz RF profiles.
- 

## AP Provisioning

Once the Wireless network and RF characteristics are set up, access points can be added to the local site either using static AP MAC address assignment or by assigning already joined APs to a specific location.

To add tags and associate APs to the WLAN, click on **AP Provisioning** from the left panel.

### Procedure

---

- Step 1** The APs already discovered by the controller are listed in the **Provision Joined APs** tab. You can select the APs to be associated to the WLAN from this table.
- Step 2** To add tags to the selected APs, select the appropriate Policy Tag, Site Tag, and RF Tag from the respective drop-down lists. Click on **Add** to apply the tags.
- Step 3** To add APs manually, click on the **Pre-provision APs** tab. You can either add individual MAC addresses of the APs or upload a CSV file with the AP MAC addresses listed. The added APs will be listed in the table below.
- Step 4** Select the APs to be associated to the WLAN from this table.
- Step 5** To add tags to the selected APs, select the appropriate Policy Tag, Site Tag, and RF Tag from the respective drop-down lists. Click on **Add** to apply the tags.

A table of all the APs and the tags added to them is displayed in the **Selected APs** tab.

- Step 6** Click **Apply**.

This will create a WLAN in FlexConnect mode with the authentication method, authentication filters, tags, and APs configured on it.

---

## Guest CWA Mode

The Guest mode addresses the need to provide internet access to guests in a secure and accountable manner with Central Web Authentication as the security method. The implementation of a wireless guest network uses the enterprise's existing wireless and wired infrastructure to the maximum extent. This solution comprises of two controllers - a Guest Foreign and a Guest Anchor.



## Controller Type

To configure a WLAN for Guest CWA mode, select the type of controller configuration you want to set up on the device from the left panel.

The options are:

- **Foreign:** A Foreign is a controller in the WLAN that exists in the enterprise. A client sends a connection request to a Foreign controller to join the WLAN. It is a dedicated guest WLAN or SSID and is implemented throughout the campus wireless network wherever guest access is required. The Foreign controller manages the anchor controllers.
- **Anchor:** An Anchor is a controller or group of controllers in a WLAN that manage traffic within the network for a guest client. It provides internal security by forwarding the traffic from a guest client to a Cisco Wireless Controller in the demilitarized zone (DMZ) network.

## WLAN Profile and Policy

After selecting the Authentication method, click on **WLAN** on the left panel to enter the WLAN profile and policy details.

The WLAN profile defines the properties of a WLAN such as Profile Name, Status, WLAN ID, L2 and L3 Security parameters, AAA Server associated with this SSID and other parameters that are specific to a particular WLAN. The policy profile defines the network policies and the switching policies for a client (with the exception of QoS), which constitute the AP policies as well.

### Procedure

- 
- Step 1** In the **Network Name** section, enter a **WLAN profile name**, which is a unique name for your wireless network. The name can be ASCII characters from 32 to 126, without leading and trailing spaces.
  - Step 2** Enter a valid **SSID** for the WLAN. A valid SSID can be up to 32 characters and can contain spaces. A valid SSID can be ASCII characters from 0 to 31, with leading and trailing spaces. This is the broadcast name for your WLAN.
  - Step 3** Enter the **WLAN ID**.
  - Step 4** In the **WLAN Policy** section, enter the **Policy Profile name**. The name can be ASCII characters from 32 to 126, without leading and trailing spaces.
  - Step 5** Select the **VLAN** to be associated with the Policy Profile from the drop-down list..
  - Step 6** To select an existing Policy Profile for the WLAN, click on **Select Existing** and choose a **Policy Profile** from the drop-down list..

- Step 7** If you have selected **Foreign**, in the **Mobility Anchors** section, select the IP address of an available controller to assign it as the mobility anchor for the WLAN. This will extend the configurations on the Foreign controller onto the anchor controllers as well.
- 

## Authentication Configurations

For the Guest access mode, the authentication method is Central Web Authentication.

### Procedure

---

- Step 1** In the **WLAN > AAA/ACL** tab, configure the AAA server list and ACL for the WLAN.
- Step 2** In the **AAA Configuration** section, select any of the available AAA servers to add to the WLAN. This will be the server where the clients will get authenticated.
- Step 3** To add a new AAA server to the list, click on **Add New Server** and enter the IP address and server-key.
- Step 4** To use an already configured AAA server list, click on **Use Existing** and select the appropriate list from the drop-down.
- Step 5** In the **ACL List** section, enter the name of the ACL. This ACL will contain the rules regarding URLs that can be accessed by the client and should match the name configured on the RADIUS server.
- 

## Tags

To configure tags on the WLAN, click on **Tags** from the left panel.

A Tag's property is defined by the policies associated to it. This property is in turn inherited by an associated client/AP. There are various type of tags, each associated to different profiles.

### Procedure

---

- Step 1** In the **Site Configuration** section, either enter a site tag to be added, or select an existing site tag from the drop-down list. You can add as many tags as required.
- Step 2** In the **Policy Tag** section, either enter a policy tag to be added, or select an existing policy tag from the drop-down list. You can add as many tags as required. The policy tag constitutes mapping of the WLAN profile to the policy profile. The WLAN profile defines the wireless characteristics of the WLAN. The policy profile defines the network policies and the switching policies for the client.
- Step 3** In the **RF Tag** section, either enter an RF tag to be added, or select an existing RF tag from the drop-down list. You can add as many tags as required. The RF tag contains the 2.4 GHz and 5 GHz RF profiles.
- 

## AP Provisioning

Once the Wireless network and RF characteristics are set up, access points can be added to the local site either using static AP MAC address assignment or by assigning already joined APs to a specific location.

If you have selected **Foreign**, click on **AP Provisioning** from the left panel to add tags and associate APs to the WLAN.

### Procedure

- 
- Step 1** The APs already discovered by the controller are listed in the **Provision Joined APs** tab. You can select the APs to be associated to the WLAN from this table.
- Step 2** To add tags to the selected APs, select the appropriate Policy Tag, Site Tag, and RF Tag from the respective drop-down lists. Click on **Add** to apply the tags.
- Step 3** To add APs manually, click on the **Pre-provision APs** tab. You can either add individual MAC addresses of the APs or upload a CSV file with the AP MAC addresses listed. The added APs will be listed in the table below.
- Step 4** Select the APs to be associated to the WLAN from this table.
- Step 5** To add tags to the selected APs, select the appropriate Policy Tag, Site Tag, and RF Tag from the respective drop-down lists. Click on **Add** to apply the tags.
- A table of all the APs and the tags added to them is displayed in the **Selected APs** tab.
- Step 6** Click **Apply**.
- This will create a WLAN in Guest CWA mode with the authentication method, mobility anchors, authentication filters, tags, and APs configured on it.
- 

## Creating WLANs (GUI)

### Procedure

- 
- Step 1** In the **Configuration > Tags & Profiles > WLANs** page, click **Add**.
- The **Add WLAN** window is displayed.
- Step 2** Under the **General** tab and **Profile Name** field, enter the name of the WLAN. The name can be ASCII characters from 32 to 126, without leading and trailing spaces.
- Step 3** Click **Save & Apply to Device**.
- 

## Creating WLANs (CLI)

### Procedure

	Command or Action	Purpose
<b>Step 1</b>	<b>configure terminal</b>  <b>Example:</b> Device# <code>configure terminal</code>	Enters global configuration mode.
<b>Step 2</b>	<code>wlan profile-name wlan-id [ssid]</code>	Specifies the WLAN name and ID:

	Command or Action	Purpose
	<p><b>Example:</b></p> <pre>Device(config)# wlan mywlan 34 mywlan-ssid</pre>	<ul style="list-style-type: none"> <li>For the <i>profile-name</i>, enter the profile name. The range is from 1 to 32 alphanumeric characters.</li> <li>For the <i>wlan-id</i>, enter the WLAN ID. The range is from 1 to 512.</li> <li>For the <i>ssid</i>, enter the Service Set Identifier (SSID) for this WLAN. If the SSID is not specified, the WLAN profile name is set as the SSID.</li> </ul> <p><b>Note</b></p> <ul style="list-style-type: none"> <li>You can create SSID using GUI or CLI. However, we recommend that you use CLI to create SSID.</li> <li>By default, the WLAN is disabled.</li> </ul>
<b>Step 3</b>	<p><b>end</b></p> <p><b>Example:</b></p> <pre>Device(config)# end</pre>	Returns to privileged EXEC mode. Alternatively, you can also press <b>Ctrl-Z</b> to exit global configuration mode.

## Deleting WLANs (GUI)

### Procedure

- 
- Step 1** In the **Configuration > Tags & Profiles > WLANs** page, check the checkbox adjacent to the WLAN you want to delete.
- To delete multiple WLANs, select multiple WLANs checkboxes.
- Step 2** Click **Delete**.
- Step 3** Click **Yes** on the confirmation window to delete the WLAN.
- 

## Deleting WLANs

### Procedure

	Command or Action	Purpose
<b>Step 1</b>	<p><b>configure terminal</b></p> <p><b>Example:</b></p> <pre>Device# configure terminal</pre>	Enters global configuration mode.



	Command or Action	Purpose
<b>Step 2</b>	<b>no wlan</b> <i>wlan-name</i> <i>wlan-id</i> <i>ssid</i> <b>Example:</b> Device(config)# <b>no wlan test2</b>	Deletes the WLAN. The arguments are as follows: <ul style="list-style-type: none"> <li>• The <i>wlan-name</i> is the WLAN profile name.</li> <li>• The <i>wlan-id</i> is the WLAN ID.</li> <li>• The <i>ssid</i> is the WLAN SSID name configured for the WLAN.</li> </ul> <b>Note</b> If you delete a WLAN that is part of an AP group, the WLAN is removed from the AP group and from the AP's radio.
<b>Step 3</b>	<b>end</b> <b>Example:</b> Device(config)# <b>end</b>	Returns to privileged EXEC mode. Alternatively, you can also press <b>Ctrl-Z</b> to exit global configuration mode.

## Searching WLANs (CLI)

To verify the list of all WLANs configured on the controller, use the following show command:

```
Device# show wlan summary
Number of WLANs: 4
```

WLAN Profile Name	SSID	VLAN	Status
1 test1	test1-ssid	137	UP
3 test2	test2-ssid	136	UP
2 test3	test3-ssid	1	UP
45 test4	test4-ssid	1	DOWN

To use wild cards and search for WLANs, use the following show command:

```
Device# show wlan summary | include test-wlan-ssid
1 test-wlan test-wlan-ssid 137 UP
```

## Enabling WLANs (GUI)

### Procedure

- Step 1** Choose **Configuration > Tags & Profiles > WLANs**.
- Step 2** On the **WLANs** page, click the WLAN name.
- Step 3** In the **Edit WLAN** window, toggle the **Status** button to **ENABLED**.
- Step 4** Click **Update & Apply to Device**.

## Enabling WLANs (CLI)

### Procedure

	Command or Action	Purpose
<b>Step 1</b>	<b>configure terminal</b> <b>Example:</b> Device# <code>configure terminal</code>	Enters global configuration mode.
<b>Step 2</b>	<b>wlan <i>profile-name</i></b> <b>Example:</b> Device(config)# <code>wlan test4</code>	Enters WLAN configuration submode. The <i>profile-name</i> is the profile name of the configured WLAN.
<b>Step 3</b>	<b>no shutdown</b> <b>Example:</b> Device(config-wlan)# <code>no shutdown</code>	Enables the WLAN.
<b>Step 4</b>	<b>end</b> <b>Example:</b> Device(config-wlan)# <code>end</code>	Returns to privileged EXEC mode.

## Disabling WLANs (GUI)

### Procedure

- 
- Step 1** Choose **Configuration > Tags & Profiles > WLANs**.
  - Step 2** In the **WLANs** window, click the WLAN name.
  - Step 3** In the **Edit WLAN** window, set the **Status** toggle button as **DISABLED**.
  - Step 4** Click **Update & Apply to Device**.
- 

## Disabling WLANs (CLI)

### Procedure

	Command or Action	Purpose
<b>Step 1</b>	<b>configure terminal</b> <b>Example:</b> Device# <code>configure terminal</code>	Enters global configuration mode.

	Command or Action	Purpose
<b>Step 2</b>	<b>wlan <i>profile-name</i></b> <b>Example:</b> Device(config)# wlan test4	Enters WLAN configuration submode. The <i>profile-name</i> is the profile name of the configured WLAN.
<b>Step 3</b>	<b>shutdown</b> <b>Example:</b> Device(config-wlan)# shutdown	Disables the WLAN.
<b>Step 4</b>	<b>end</b> <b>Example:</b> Device(config-wlan)# end	Returns to privileged EXEC mode.
<b>Step 5</b>	<b>show wlan summary</b> <b>Example:</b> Device# show wlan summary	Displays the list of all WLANs configured on the device. You can search for the WLAN in the output.

## Configuring General WLAN Properties (CLI)

You can configure the following properties:

- Media stream
- Broadcast SSID
- Radio

### Procedure

	Command or Action	Purpose
<b>Step 1</b>	<b>configure terminal</b> <b>Example:</b> Device# configure terminal	Enters global configuration mode.
<b>Step 2</b>	<b>wlan <i>profile-name</i></b> <b>Example:</b> Device(config)# wlan test4	Enters WLAN configuration submode. The <i>profile-name</i> is the profile name of the configured WLAN.
<b>Step 3</b>	<b>shutdown</b> <b>Example:</b> Device(config-wlan)# shutdown	Disables the WLAN.
<b>Step 4</b>	<b>broadcast-ssid</b> <b>Example:</b> Device(config-wlan)# broadcast-ssid	Broadcasts the SSID for this WLAN.

	Command or Action	Purpose
<b>Step 5</b>	<b>dot11bg 11g</b> <b>Example:</b> Device(config-wlan)# <b>dot11bg 11g</b>	Configures the WLAN radio policy for dot11 radios.  Also see the section: Configuring a WLAN Radio Policy.
<b>Step 6</b>	<b>media-stream multicast-direct</b> <b>Example:</b> Device(config-wlan)# <b>media-stream multicast-direct</b>	Enables multicast VLANs on this WLAN.
<b>Step 7</b>	<b>no shutdown</b> <b>Example:</b> Device(config-wlan)# <b>no shutdown</b>	Enables the WLAN.
<b>Step 8</b>	<b>end</b> <b>Example:</b> Device(config-wlan)# <b>end</b>	Returns to privileged EXEC mode.

## Configuring Advanced WLAN Properties (CLI)

### Procedure

	Command or Action	Purpose
<b>Step 1</b>	<b>configure terminal</b> <b>Example:</b> Device# <b>configure terminal</b>	Enters global configuration mode.
<b>Step 2</b>	<b>wlan <i>profile-name</i></b> <b>Example:</b> Device(config)# <b>wlan test4</b>	Enters WLAN configuration submode. The <i>profile-name</i> is the profile name of the configured WLAN.
<b>Step 3</b>	<b>chd</b> <b>Example:</b> Device(config-wlan)# <b>chd</b>	Enables coverage hole detection for this WLAN.
<b>Step 4</b>	<b>ccx aironet-iesupport</b> <b>Example:</b> Device(config-wlan)# <b>ccx aironet-iesupport</b>	Enables support for Aironet IEs for this WLAN.

	Command or Action	Purpose
Step 5	<p><b>client association limit</b> { <i>clients-per-wlan</i>   <b>ap</b> <i>clients-per-ap-per-wlan</i>   <b>radioclients-per-ap-radio--per-wlan</b> }</p> <p><b>Example:</b></p> <pre>Device(config-wlan)# client association limit ap 400</pre>	Sets the maximum number of clients, clients per AP, or clients per AP radio that can be configured on a WLAN.
Step 6	<p><b>ip access-group web</b> <i>acl-name</i></p> <p><b>Example:</b></p> <pre>Device(config-wlan)# ip access-group web test-acl-name</pre>	Configures the IPv4 WLAN web ACL. The variable <i>acl-name</i> specifies the user-defined IPv4 ACL name.
Step 7	<p><b>peer-blocking</b> [ <b>allow-private-group</b>   <b>drop</b>   <b>forward-upstream</b> ]</p> <p><b>Example:</b></p> <pre>Device(config-wlan)# peer-blocking drop</pre>	<p>Configures peer to peer blocking parameters. The keywords are as follows:</p> <ul style="list-style-type: none"> <li>• <b>allow-private-group</b>—Enables peer-to-peer blocking on the Allow Private Group action.</li> <li>• <b>drop</b>—Enables peer-to-peer blocking on the drop action.</li> <li>• <b>forward-upstream</b>—No action is taken and forwards packets to the upstream.</li> </ul> <p><b>Note</b> The <b>forward-upstream</b> option is not supported for Flex local switching. Traffic is dropped even if this option is configured. Also, peer to peer blocking for local switching SSIDs are available only for the clients on the same AP.</p>
Step 8	<p><b>channel-scan</b> { <b>defer-priority</b> { <b>0-7</b> }   <b>defer-time</b> { <b>0 - 6000</b> } }</p> <p><b>Example:</b></p> <pre>Device(config-wlan)# channel-scan defer-priority 6</pre>	<p>Sets the channel scan defer priority and defer time. The arguments are as follows:</p> <ul style="list-style-type: none"> <li>• <b>defer-priority</b>—Specifies the priority markings for packets that can defer off-channel scanning. The range is from 0 to 7. The default is 3.</li> <li>• <b>defer-time</b>—Deferral time in milliseconds. The range is from 0 to 6000. The default is 100.</li> </ul>
Step 9	<p><b>end</b></p> <p><b>Example:</b></p> <pre>Device(config-wlan)# end</pre>	Returns to privileged EXEC mode.

# Configuring Advanced WLAN Properties (GUI)

## Before you begin

Ensure that you have configured an AP Join Profile prior to configuring the primary and backup controllers.

## Procedure

---

- Step 1** Choose **Configuration > Tags & Profiles > WLANs**.
- Step 2** Click **Add**.
- Step 3** Under the **Advanced** tab, check the **Coverage Hole Detection** check box.
- Step 4** Check the **Aironet IE** check box to enable Aironet IE on the WLAN.
- Step 5** Check the **Diagnostic Channel** check box to enable diagnostic channel on the WLAN.
- Step 6** From the **P2P Blocking Action** drop-down list, choose the required value.
- Step 7** Set the **Multicast Buffer** toggle button as enabled or disabled.
- Step 8** Check the **Media Stream Multicast-Direct** check box to enable the feature.
- Step 9** In the **Max Client Connections** section, specify the maximum number of client connections for the following:
- In the **Per WLAN** field, enter a value. The valid range is between 0 and 10000.
  - In the **Per AP Per WLAN** field, enter a value. The valid range is between 0 and 400.
  - In the **Per AP Radio Per WLAN** field, enter a value. The valid range is between 0 and 200.
- Step 10** In the **11v BSS Transition Support** section, perform the following configuration tasks:
- a) Check the **BSS Transition** check box to enable 802.11v BSS Transition support.
  - b) In the **Disassociation Imminent** field, enter a value. The valid range is between 0 and 3000.
  - c) In the **Optimized Roaming Disassociation Timer** field, enter a value. The valid range is between 0 and 40.
  - d) Select the check box to enable the following:
    - BSS Max Idle Service
    - BSS Max Idle Protected
    - Disassociation Imminent Service
    - Directed Multicast Service
    - Universal Admin
    - Load Balance
    - Band Select
    - IP Source Guard
- Step 11** In the **11ax** section, perform the following configuration tasks:
- a) Select the check box to enable the following:
    - Check the **Enable 11ax** checkbox to enable 802.11ax operation status on the WLAN.

- Check the **Downlink OFDMA** and **Uplink OFDMA** check boxes to enable downlink and uplink connections that use OFDMA.

Orthogonal Frequency Division Multiple Access (OFDMA) is a channel access mechanism that assures contention-free transmission to multiple clients in both the downlink (DL) and uplink (UL) within a respective single transmit opportunity.

- Check the **Downlink MU-MIMO** and **Uplink MU-MIMO** check boxes to enable downlink and uplink connections that use MU-MIMO.

With Multiuser MIMO (MU-MIMO), an AP can use its antenna resources to transmit multiple frames to different clients, all at the same time and over the same frequency spectrum.

- Enable the target wake up time configuration on the WLAN by checking the **BSS Target Wake Up Time** checkbox.

Target wake up time allows an AP to manage activity in the Wi-Fi network to minimize medium contention between stations, and to reduce the required amount of time that a station in the power-save mode needs to be awake. This is achieved by allocating stations to operate at non-overlapping times, and/or frequencies, and concentrate the frame exchanges in predefined service periods.

- Check the **Universal Admin** check box to enable Universal Admin support for the WLAN.
- Enable OKC on the WLAN by checking the **OKC** check box. Opportunistic Key Caching (OKC) allows the wireless client and the WLAN infrastructure to cache only one Pairwise Master Key (PMK) for the lifetime of the client association with this WLAN, even when roaming between multiple APs. This is enabled by default.
- Check the **Load Balance** check box to enable Aggressive Client Load Balancing. This allows lightweight access points to load balance wireless clients across access points.
- Check the **Band Select** check box to enable band selection for the WLAN. Band selection enables client radios that are capable of dual-band (2.4 and 5-GHz) operations to move to a less congested 5-GHz access point. The 2.4-GHz band is often congested with interference from other electronic devices as well as co-channel interference from other access points. Band selection helps prevent these sources of interference and improve overall network performance.
- Enable IP Source Guard on the WLAN by checking the **IP Source Guard** check box. IP Source Guard (IPSG) is a Layer 2 security feature that prevents the wireless controller from forwarding the packets with source IP addresses that are not known to it.

- b) From the **WMM Policy** drop-down list, choose the policy as **Allowed**, **Disabled**, or **Required**. By default, the WMM policy is **Allowed**. Wi-Fi Multimedia (WMM) is used to prioritize different types of traffic.

- **Disabled**: Disables WMM on the WLAN.
- **Required**: Requires client devices to use WMM. Devices that do not support WMM cannot join the WLAN.
- **Allowed**: Devices that cannot support WMM can join the WLAN but will not benefit from the 802.11n rates.

- c) From the **mDNS** drop-down list, choose **Bridging**, **Gateway**, or **Drop**. Multicast DNS (mDNS) provides the ability to perform DNS-like operations on the local link in the absence of any conventional Unicast DNS server.

- **Bridging:** Packets with mDNS multicast IP and multicast mac will be sent on multicast CAPWAP tunnel.
- **Gateway:** All ingress mDNS packets received from the wired network on a L3 interface (SVI or physical) would be intercepted by the Controller software and processed.
- **Drop:** All ingress mDNS packets will be dropped.

**Step 12** In the **Off Channel Scanning Defer** section, choose the appropriate **Defer Priority** values and then specify the required Scan Defer Time value in milliseconds.

**Step 13** In the **Assisted Roaming (11k)** section, choose the appropriate status for the following:

- Prediction Optimization
- Neighbor List
- Dual-Band Neighbor List

**Step 14** In the **DTIM Period (in beacon intervals)** section, specify a value for 802.11a/n and 802.11b/g/n radios. The valid range is from 1 to 255.

**Step 15** Click **Apply to Device**.

## Configuring WLAN Radio Policy (GUI)

### Procedure

**Step 1** On the **Configuration > Tags & Profiles > WLANs** page, click **Add** to create WLANs.

**Step 2** In the **General** tab, enter a **Profile Name**, which is a unique name of the your wireless network.

The name can be ASCII characters from 32 to 126, without leading and trailing spaces.

**Step 3** Enter a valid **SSID** for the WLAN.

A valid SSID can be up to 32 characters and can contain spaces. A valid SSID can be ASCII characters from 0 to 31, with leading and trailing spaces. This is the broadcast name for your WLAN.

**Step 4** Enter the **WLAN ID**. The valid range for the different models are listed below:

Model	WLAN ID Range
Cisco Catalyst 9800-80 Wireless Controller	1-4096
Cisco Catalyst 9800-CL Wireless Controller	1-4096
Cisco Catalyst 9800-40 Wireless Controller	1-4096
Cisco Catalyst 9800-L Wireless Controller	1-4096
Cisco Embedded Wireless Controller for an AP	1-16



- Step 5** Set the **WLAN Status** to Enabled.
- Step 6** To broadcast the SSID of the WLAN, set the status of Broadcast SSID to enabled. By default, this is disabled.
- Step 7** In the **Radio Policy** section, enable the desired radio band for the WLAN.
- 2.4ghz – Configures the policy on the 2.4-GHz radio.
  - 5ghz – Configures the policy on the 5-GHz radio.
- Step 8** If you enable the 5ghz radio band, select the radio slot to broadcast the WLAN on. The options are slot 0, slot 1, and slot 2. You can select multiple slots for the WLAN.
- Step 9** From the 802.11b/g Policy drop-down list, choose the radio policy from the following options:
- 802.11g only
  - 802.11b/g

Click **Apply to Device**.

## Configuring a WLAN Radio Policy (CLI)

Configure WLAN radio policy using commands.

### Procedure

	Command or Action	Purpose
<b>Step 1</b>	<b>configure terminal</b>  <b>Example:</b> Device# configure terminal	Enters global configuration mode.
<b>Step 2</b>	<b>wlan <i>profile-name</i></b>  <b>Example:</b> Device(config)# wlan test4	Enters WLAN configuration submode. The <i>profile-name</i> is the profile name of the configured WLAN.
<b>Step 3</b>	<b>shutdown</b>  <b>Example:</b> Device(config-wlan)# shutdown	Disables the WLAN.
<b>Step 4</b>	<b>radio policy dot11{5ghz   24ghz }</b>  <b>Example:</b> Device(config-wlan)# radio policy dot11 5ghz	Enables the corresponding radio policy on the WLAN. The options are: <ul style="list-style-type: none"> <li>• <b>2.4ghz</b>: Configures the WLAN on 2.4-GHz radio only.</li> <li>• <b>5ghz</b>: Configures the WLAN on 5-GHz radio only.</li> </ul>
<b>Step 5</b>	<b>slot {0  1   2}</b>  <b>Example:</b>	Configures the WLAN radio policy on the slot that you choose. The options are:

	Command or Action	Purpose
	Device(config-wlan-radio-5ghz)# slot 1	<ul style="list-style-type: none"> <li>• <b>0</b>: Configures the WLAN on the 5GHz radio with radio slot 0 (if using 5GHz).</li> <li>• <b>1</b>: Configures the WLAN on the 5GHz radio with radio slot 1.</li> <li>• <b>2</b>: Configures the WLAN on the 5GHz radio with radio slot 2 (if present).</li> </ul>
<b>Step 6</b>	<b>no shutdown</b> <b>Example:</b> Device(config-wlan)# no shutdown	Enables the WLAN.
<b>Step 7</b>	<b>end</b> <b>Example:</b> Device(config-wlan)# end	Returns to privileged EXEC mode.

## Verifying WLAN Properties (CLI)

To verify the WLAN properties based on the WLAN ID, use the following `show` command:

```
Device# show wlan id wlan-id
```

To verify the WLAN properties based on the WLAN name, use the following `show` command:

```
Device# show wlan name wlan-name
```

To verify the WLAN properties of all the configured WLANs, use the following `show` command:

```
Device# show wlan all
```

To verify the summary of all WLANs, use the following `show` command:

```
Device# show wlan summary
```

To verify the running configuration of a WLAN based on the WLAN name, use the following `show` command:

```
Device# show running-config wlan wlan-name
```

To verify the running configuration of all WLANs, use the following `show` command:

```
Device# show running-config wlan
```

## Verifying WLAN-VLAN Information for an AP

To verify the operational WLAN-VLAN mappings per AP, use the following command:

```
Device# show ap name test wlan vlan
```

```
Policy tag mapping
```

```
-----  

WLAN Profile Name Name Policy      VLAN    Flex Central Switching  IPv4 ACL  IPv6 ACL  

-----
```

jey_cwa	pp-local-1	46	Enabled	jey_acl1	Not Configured
swaguest	pp-local-1	46	Enabled	jey_acl1	Not Configured

## Verifying a WLAN Radio Policy

To verify the WLAN radio policy configuration status, use the following command:

```
Device# show wlan id 6 | sec Radio Bands
wpa3 enabled wlan:
Configured Radio Bands: All
Operational State of Radio Bands : All Bands Operational

wpa3 not enabled wlan :
Configured Radio Bands : All
Operational State of Radio Bands
2.4ghz : UP
5ghz   : UP

5ghz specify slot is enabled :
Configured Radio Bands
5ghz   : Enabled
Slot 0 : Enabled
Slot 1 : Disabled
Slot 2 : Disabled

Operational State of Radio Bands
5ghz   : UP
Slot 0 : Enabled
Slot 1 : Disabled
Slot 2 : Disabled
```





## CHAPTER 170

# WLAN Security

- [Information About WPA1 and WPA2, on page 1643](#)
- [Information About AAA Override, on page 1644](#)
- [Prerequisites for Layer 2 Security, on page 1647](#)
- [Restrictions for WPA2 and WP3, on page 1648](#)
- [Feature History for Fallback for AAA-Overridden VLAN, on page 1648](#)
- [Information About Fallback for AAA- Overridden VLAN, on page 1649](#)
- [Configuring Fallback for AAA-Overridden VLAN \(CLI\), on page 1650](#)
- [Verifying Fallback for AAA-Overridden VLAN, on page 1650](#)
- [How to Configure WLAN Security, on page 1651](#)

## Information About WPA1 and WPA2

Wi-Fi Protected Access (WPA or WPA1) and WPA2 are standards-based security solutions from the Wi-Fi Alliance that provide data protection and access control for wireless LAN systems. WPA1 is compatible with the IEEE 802.11i standard but was implemented prior to the standard's ratification; WPA2 is the Wi-Fi Alliance's implementation of the ratified IEEE 802.11i standard.

By default, WPA1 uses Temporal Key Integrity Protocol (TKIP) and Message Integrity Check (MIC) for data protection while WPA2 uses the stronger Advanced Encryption Standard encryption algorithm using Counter Mode with Cipher Block Chaining Message Authentication Code Protocol (AES-CCMP). By default, both WPA1 and WPA2 use the 802.1X for authenticated key management. However, the following options are also available:

- **PSK**—When you choose PSK (also known as WPA preshared key or WPA passphrase), you need to configure a preshared key (or a passphrase). This key is used as the Pairwise Master Key (PMK) between clients and authentication server.
- **Cisco Centralized Key Management** uses a fast rekeying technique that enables clients to roam from one access point to another without going through the controller, typically in under 150 milliseconds (ms). Cisco Centralized Key Management reduces the time required by the client to mutually authenticate with the new access point and derive a new session key during reassociation. Cisco Centralized Key Management fast secure roaming ensures that there is no perceptible delay in time-sensitive applications, such as wireless Voice over IP (VoIP), Enterprise Resource Planning (ERP), or Citrix-based solutions. Cisco Centralized Key Management is a CCXv4-compliant feature. If Cisco Centralized Key Management is selected, only Cisco Centralized Key Management clients are supported.

When Cisco Centralized Key Management is enabled, the behavior of access points differs from the controller's for fast roaming in the following ways:

- If an association request sent by a client has Cisco Centralized Key Management enabled in a Robust Secure Network Information Element (RSN IE) but Cisco Centralized Key Management IE is not encoded and only PMKID is encoded in RSN IE, then the controller does not do a full authentication. Instead, the controller validates the PMKID and does a four-way handshake.
- If an association request sent by a client has Cisco Centralized Key Management enabled in RSN IE and Cisco Centralized Key Management IE is encoded and only PMKID is present in the RSN IE, then the AP does a full authentication. The access point does not use PMKID sent with the association request when Cisco Centralized Key Management is enabled in RSN IE.
- 802.1X+Cisco Centralized Key Management—During normal operation, 802.1X-enabled clients mutually authenticate with a new access point by performing a complete 802.1X authentication, including communication with the main RADIUS server. However, when you configure your WLAN for 802.1X and Cisco Centralized Key Management fast secure roaming, Cisco Centralized Key Management-enabled clients securely roam from one access point to another without the need to reauthenticate to the RADIUS server. 802.1X+Cisco Centralized Key Management is considered as an optional Cisco Centralized Key Management because both Cisco Centralized Key Management and non-Cisco Centralized Key Management clients are supported when this option is selected.

On a single WLAN, you can allow WPA1, WPA2, and 802.1X/PSK/Cisco Centralized Key Management/802.1X+Cisco Centralized Key Management clients to join. All of the access points on such a WLAN advertise WPA1, WPA2, and 802.1X/PSK/Cisco Centralized Key Management/ 802.1X+Cisco Centralized Key Management information elements in their beacons and probe responses. When you enable WPA1 and/or WPA2, you can also enable one or two ciphers, or cryptographic algorithms, designed to protect data traffic. Specifically, you can enable AES and/or TKIP data encryption for WPA1 and/or WPA2. TKIP is the default value for WPA1, and AES is the default value for WPA2.

## Information About AAA Override

The AAA Override option of a WLAN enables you to configure the WLAN for identity networking. It enables you to apply VLAN tagging, Quality of Service (QoS), and Access Control Lists (ACLs) to individual clients based on the returned RADIUS attributes from the AAA server.

## Configuring AAA Override

### Procedure

	Command or Action	Purpose
<b>Step 1</b>	<b>configure terminal</b>  <b>Example:</b> Device# <code>configure terminal</code>	Enters global configuration mode.
<b>Step 2</b>	<b>wireless profile policy <i>profile-policy</i></b>  <b>Example:</b>	Configures WLAN policy profile and enters the wireless policy configuration mode.

	Command or Action	Purpose
	Device(config)# wireless profile policy test-wgb	
<b>Step 3</b>	<b>aaa-override</b>  <b>Example:</b> Device(config-wireless-policy)# aaa-override	Configures AAA policy override.  <b>Note</b> If VLAN is not pushed from the RADIUS server, the VLAN Override feature can be disabled from the RADIUS server.
<b>Step 4</b>	<b>end</b>  <b>Example:</b> Device(config-wireless-policy)# end	Returns to privileged EXEC mode.  Alternatively, you can also press <b>Ctrl-Z</b> to exit global configuration mode.

## Information About VLAN Override

The VLAN override requires the AAA Override to be enabled under the Policy Profile.

You can assign VLAN from the RADIUS server in two ways:

- Using IEFY RADIUS attributes 64, 65, and 81—The attribute 81 can be a VLAN ID, VLAN name, or VLAN group name. Both VLAN name and VLAN group are supported. Therefore, VLAN ID does not need to be predetermined on RADIUS.

The RADIUS user attributes used for the VLAN ID assignment are:

- 64 (Tunnel-Type)—Must be set to VLAN (Integer = 13).
- 65 (Tunnel-Medium-Type)—Must be set to 802 (Integer = 6).
- 81 (Tunnel-Private-Group-ID)—Must be set to the corresponding VLAN ID, VLAN name, or VLAN group name.
- Using Aire-Interface-Name attribute—Use this attribute to assign a successfully authenticated user to a VLAN interface name (or VLAN ID) as per the user configuration. When you use this attribute, the VLAN name is returned as a string.

The VLAN ID is 12-bits, and takes a value between 1 and 4094, inclusive. Because the Tunnel-Private-Group-ID is of type string, as defined in [RFC2868](#) for use with IEEE 802.1X, the VLAN ID integer value is encoded as a string. When these tunnel attributes are sent, it is necessary to fill in the Tag field.

## Configuring Override VLAN for Central Switching

### Procedure

	Command or Action	Purpose
<b>Step 1</b>	<b>configure terminal</b>  <b>Example:</b>	Enters global configuration mode.

	Command or Action	Purpose
	Device# configure terminal	
<b>Step 2</b>	<b>vlan</b> <i>vlan-id</i> <b>Example:</b> Device(config)# vlan 20	Defines VLANs that can be pushed from the RADIUS server. <b>Note</b> The valid VLAN ID ranges from 1 to 4094.
<b>Step 3</b>	<b>name</b> <i>vlan-name</i> <b>Example:</b> Device(config-vlan)# name vlan_ascii	(Optional) Changes the default name of the VLAN.
<b>Step 4</b>	<b>end</b> <b>Example:</b> Device(config-vlan)# end	Returns to privileged EXEC mode. Alternatively, you can also press <b>Ctrl-Z</b> to exit global configuration mode.

## Configuring Override VLAN for Local Switching

If the VLAN name ID mapping under flex profile is newly added or updated, then the WLAN policy profiles having a matching VLAN name configured, must be shut and unshut. This is to ensure that the updated WLAN-VLAN mapping is pushed to the APs and the client receives the IP address from the intended VLAN.

### Procedure

	Command or Action	Purpose
<b>Step 1</b>	<b>configure terminal</b> <b>Example:</b> Device# configure terminal	Enters global configuration mode.
<b>Step 2</b>	<b>wireless profile flex</b> <i>flex_profile_name</i> <b>Example:</b> Device(config)# wireless profile flex rr-xyz-flex-profile	Configures a Flex profile.
<b>Step 3</b>	<b>vlan-name</b> <i>vlan_name</i> <b>Example:</b> Device(config-wireless-flex-profile)# vlan-name vlan_123	Defines VLANs that can be pushed from the RADIUS server.
<b>Step 4</b>	<b>vlan-id</b> <i>vlan_id</i> <b>Example:</b> Device(config-wireless-flex-profile-vlan)# vlan-id 23	Configures VLAN ID. The valid VLAN ID ranges from 1 to 4096.
<b>Step 5</b>	<b>end</b> <b>Example:</b>	Returns to privileged EXEC mode.



	Command or Action	Purpose
	Device(config-wireless-flex-profile-vlan)# end	Alternatively, you can also press <b>Ctrl-Z</b> to exit global configuration mode.

## VLAN Override on Layer 3 Web Authentication

The VLAN override can be pushed from the RADIUS server during Layer 3 authentication.

When a client gets connected to the controller and authenticated using the RADIUS server for Local Web Authentication (LWA) and Central Web Authentication (CWA), the RADIUS server pushes back in access-accept the new VLAN. If the RADIUS server pushes back a new VLAN in the access-accept, the client goes back to IP learn state on the controller. The controller de-associates the client while maintaining the client state for 30 seconds. Once the client re-associates, the client lands immediately to the new VLAN and re-triggers a new DHCP request. The client then learns a new IP and moves to the RUN state on the controller.

The VLAN Override on Layer 3 Web authentication supports the following:

- Local clients
- Anchored clients
- FlexConnect central authentication, central or local switching

## Verifying VLAN Override on Layer 3 Web Authentication

To display the VLAN override after L3 authentication, use the following command:

```
Device# show wireless client mac <mac> detail
[...]
      Vlan Override after L3 Auth: True
```

To display the statistics about client, use the following command:

```
Device# show wireless stats client detail
[...]
Total L3 VLAN Override vlan change received      : 1
Total L3 VLAN Override disassociations sent      : 1
Total L3 VLAN Override re-associations received  : 1
Total L3 VLAN Override successful VLAN change    : 1
[...]
L3 VLAN Override connection timeout              : 0
```

## Prerequisites for Layer 2 Security

WLANs with the same SSID must have unique Layer 2 security policies so that clients can make a WLAN selection based on the information advertised in beacon and probe responses. The available Layer 2 security policies are as follows:

- None (open WLAN)
- WPA+WPA2

**Note**

- Although WPA and WPA2 cannot be used by multiple WLANs with the same SSID, you can configure two WLANs with the same SSID with WPA/TKIP with PSK and Wi-Fi Protected Access (WPA)/Temporal Key Integrity Protocol (TKIP) with 802.1X, or with WPA/TKIP with 802.1X or WPA/AES with 802.1X.
- A WLAN configured with TKIP support will not be enabled on an RM3000AC module.

- Static WEP (not supported on Wave 2 APs)

## Restrictions for WPA2 and WP3

- You cannot enable security ft or ft-adaptive without enabling WPA2 or WPA3.
- You cannot enable ft-dot1x or ft-psk without enabling WPA2 or WPA3.
- You cannot enable 802.1x or PSK simultaneously with SHA256 key derivation type without enabling WPA2 or WPA3 on a WLAN.
- You cannot configure PMF on WPA1 WLAN without WPA2 security.
- IOS APs do not support WPA3.

## Feature History for Fallback for AAA-Overridden VLAN

This table provides release and related information for the feature explained in this module.

This feature is available in all the releases subsequent to the one in which it is introduced in, unless noted otherwise.

**Table 90: Feature History for Fallback for AAA-Overridden VLAN**

Release	Feature	Feature Information
Cisco IOS XE Bengaluru 17.6.1	Fallback for AAA-Overridden VLAN	<p>In Cisco IOS XE Bengaluru 17.5.1 and earlier releases, if there is a network with a single AAA server dictating policies that need to be applied to a client; and this client moves across different sites that have different policy definitions. If these policy definitions are not defined on the site to which the client needs to connect, the client does not get access to the network.</p> <p>For example, if a client is to be given access in VLAN 1, and VLAN 1 is not defined on the site to which the client connects, the client is excluded and does not get any access to the network.</p> <p>The Fallback for AAA-Overridden VLAN feature is introduced to allow fallback to policy profile VLAN when the overridden VLAN is not available.</p>

## Information About Fallback for AAA- Overridden VLAN

From Cisco IOS XE Bengaluru 17.6.1, fallback for AAA-overridden VLAN or VLAN groups is supported on the wireless policy profile.

A new command is introduced in the wireless policy profile to configure the Fallback for AAA-Overridden VLAN feature. In Cisco IOS XE Bengaluru 17.6.1, you cannot configure the Fallback for AAA Overridden VLAN feature using the GUI.

## Central Switching and FlexConnect Mode Scenarios

If fallback is enabled for AAA-overridden VLAN or VLAN groups, you might encounter the following scenarios in Central Switching and FlexConnect modes.

### Central Switching:

If the AAA server gives a VLAN policy to a client, and the VLAN ID or the VLAN name is defined in the controller, the client is assigned to the VLAN specified by the AAA server. If the VLAN is not defined in the controller, the client is assigned to a VLAN that is configured on the wireless policy profile.

If a VLAN group is configured on a wireless policy profile, the VLAN, as computed by the existing VLAN group logic, is assigned to the client. In the VLAN group case, fallback to policy profile VLAN occurs only when all the VLANs in the group are not configured in the controller, or, if the VLAN group is not defined in the controller.

If both, AAA-overridden VLAN and the VLAN configured on the wireless policy profile are not defined in the controller, the configuration is termed as invalid, and the client is excluded.

If a VLAN policy is not configured, or, if the default wireless policy profile is configured, the client is assigned a VLAN from the management VLAN.

### FlexConnect Mode:

If the AAA server assigns a VLAN policy to a client configured in the FlexConnect profile, the VLAN is resolved by the controller. If the VLAN is not configured on the FlexConnect profile, the behavior of the

VLAN name and the VLAN ID is made consistent, with the help of the fallback feature, and the client receives the IP address from the wireless policy profile configuration.

The following points summarize the FlexConnect mode behavior:

- If AAA VLAN is defined in FlexConnect profile, the client is assigned the AAA VLAN.
- If AAA VLAN is not defined in the FlexConnect profile, FlexConnect VLAN Central Switching is configured, and VLAN is defined in the controller, and the client is assigned AAA VLAN and is centrally switched.
- If AAA VLAN is not defined in the FlexConnect profile, FlexConnect VLAN Central Switching is configured, the VLAN is not defined in the controller, and the client is assigned a VLAN from the wireless policy profile.
- If AAA VLAN is not defined in the FlexConnect profile, and FlexConnect VLAN Central Switching is not configured, the client is assigned a VLAN from the wireless policy profile.

## Configuring Fallback for AAA-Overridden VLAN (CLI)

### Procedure

	Command or Action	Purpose
<b>Step 1</b>	<b>configure terminal</b>  <b>Example:</b> Device# configure terminal	Enters global configuration mode.
<b>Step 2</b>	<b>wireless profile policy</b> <i>wlan-policy-profile-name</i>  <b>Example:</b> Device(config)# wireless profile policy <i>wlan-policy-profile-name</i>	Configures the WLAN policy profile. Enters the wireless policy profile configuration mode.
<b>Step 3</b>	<b>aaa-override vlan fallback</b>  <b>Example:</b> Device(config-wireless-policy)# aaa-override vlan fallback	Allows fallback to the policy profile VLAN when the overridden VLAN is not available.

## Verifying Fallback for AAA-Overridden VLAN

To verify if the fallback for AAA-overridden VLAN is enabled, use the following command:

```
Device# show wireless profile policy detailed default-policy-profile | sec AAA Policy Params
AAA Policy Params
  AAA Override           : DISABLED
  NAC                    : DISABLED
  AAA Policy name       : default-aaa-policy
  AAA Vlan Fallback     : ENABLED
```

# How to Configure WLAN Security

## Configuring Static WEP Layer 2 Security Parameters (GUI)

### Procedure

- 
- Step 1** Choose **Configuration** > **Tags & Profiles** > **WLANs**.
- Step 2** On the **WLANs** page, click the name of the WLAN.
- Step 3** In the **Edit WLAN** window, click the **Security** tab.
- Step 4** From the **Layer 2 Security Mode** drop-down list, select the **Static WEP** option.
- Step 5** (Optional) Check the **Shared Key Authentication** check box to set the authentication type as shared. By leaving the check box unchecked, the authentication type is set to open.
- Step 6** Set the **Key Size** as either **40 bits** or **104 bits**.
- 40 bits: The keys with 40-bit encryption must contain 5 ASCII text characters or 10 hexadecimal characters.
  - 104 bits: The keys with 104-bit encryption must contain 13 ASCII text characters or 26 hexadecimal characters.
- Step 7** Set the appropriate **Key Index**; you can choose between 1 to 4.
- Step 8** Set the **Key Format** as either **ASCII** or **Hex**.
- Step 9** Enter a valid **Encryption Key**.
- 40 bits: The keys with 40-bit encryption must contain 5 ASCII text characters or 10 hexadecimal characters.
  - 104 bits: The keys with 104-bit encryption must contain 13 ASCII text characters or 26 hexadecimal characters.
- Step 10** Click **Update & Apply to Device**.
- 

## Configuring Static WEP Layer 2 Security Parameters (CLI)

### Before you begin

You must have administrator privileges.

### Procedure

	Command or Action	Purpose
<b>Step 1</b>	<b>configure terminal</b>  <b>Example:</b> Device# <code>configure terminal</code>	Enters global configuration mode.

	Command or Action	Purpose
<b>Step 2</b>	<b>wlan</b> <i>profile-name</i> <i>wlan-id</i> <i>SSID_Name</i> <b>Example:</b> Device# <b>wlan test4 1 test4</b>	Enters the WLAN configuration submode. <i>profile-name</i> is the profile name of the configured WLAN. <i>wlan-id</i> is the wireless LAN identifier. The range is 1 to 512. <i>SSID_Name</i> is the SSID which can contain 32 alphanumeric characters. <b>Note</b> If you have already configured this command, enter <b>wlan profile-name</b> command.
<b>Step 3</b>	<b>disable ft</b> <b>Example:</b> Device(config-wlan)# <b>disable ft</b>	Disables fast transition.
<b>Step 4</b>	<b>no security ft over-the-ds</b> <b>Example:</b> Device(config-wlan)# <b>no security ft over-the-ds</b>	Disables fast transition over the data source on the WLAN.
<b>Step 5</b>	<b>no security ft</b> <b>Example:</b> Device(config-wlan)# <b>no security ft</b>	Disables 802.11r Fast Transition on the WLAN.
<b>Step 6</b>	<b>no security wpa</b> {akm   wpa1   wpa2} <b>Example:</b> Device(config-wlan)# <b>no security wpa wpa1 ciphers tkip</b>	Disables the WPA/WPA2 support for a WLAN.
<b>Step 7</b>	<b>security static-wep-key</b> [ authentication {open   shared} ] <b>Example:</b> Device(config-wlan)# <b>security static-wep-key authentication open</b>	The keywords are as follows: <ul style="list-style-type: none"> <li>• <b>static-wep-key</b>—Configures Static WEP Key authentication.</li> <li>• <b>authentication</b>—Specifies the authentication type you can set. The values are open and shared.</li> </ul>
<b>Step 8</b>	<b>security static-wep-key</b> [ encryption {104   40} {ascii   hex} [0   8]] <b>Example:</b> Device(config-wlan)# <b>security static-wep-key encryption 104 ascii 0 1234567890123 1</b>	The keywords are as follows: <ul style="list-style-type: none"> <li>• <b>static-wep-key</b>—Configures Static WEP Key authentication.</li> <li>• <b>encryption</b>—Specifies the encryption type that you can set. The valid values are 104 and 40. 40-bit keys must contain 5 ASCII text characters or 10 hexadecimal</li> </ul>

	Command or Action	Purpose
		characters. 104-bit keys must contain 13 ASCII text characters or 26 hexadecimal characters. <ul style="list-style-type: none"> <li>• <b>ascii</b>—Specifies the key format as ASCII.</li> <li>• <b>hex</b>—Specifies the key format as HEX.</li> </ul>
<b>Step 9</b>	<b>end</b>  <b>Example:</b> Device(config)# <b>end</b>	Returns to privileged EXEC mode. Alternatively, you can also press <b>Ctrl-Z</b> to exit global configuration mode.

## Configuring WPA + WPA2 Layer 2 Security Parameters (GUI)

### Procedure

- 
- Step 1** Click **Configuration > Tags and Profiles > WLANs**.
  - Step 2** Click **Add** to add a new WLAN Profile or click the one you want to edit.
  - Step 3** In the **Edit WLAN** window, click **Security > Layer2**.
  - Step 4** From **Layer 2 Security Mode** drop-down menu, select **WPA + WPA2**.
  - Step 5** Configure the security parameters and then click **Save and Apply to Device**.
- 

## Configuring WPA + WPA2 Layer 2 Security Parameters (CLI)



- 
- Note** The default values for security policy WPA2 are:
- Encryption is AES.
  - Authentication Key Management (AKM) is dot1x.
- 

### Before you begin

You must have administrator privileges.

### Procedure

	Command or Action	Purpose
<b>Step 1</b>	<b>configure terminal</b>  <b>Example:</b> Device# <b>configure terminal</b>	Enters global configuration mode.

	Command or Action	Purpose
Step 2	<p><b>wlan</b> <i>profile-name</i> <i>wlan-id</i> <i>SSID_Name</i></p> <p><b>Example:</b> Device# <b>wlan test4 1 test4</b></p>	<p>Enters the WLAN configuration submode.</p> <ul style="list-style-type: none"> <li>• <i>profile-name</i> is the profile name of the configured WLAN.</li> <li>• <i>wlan-id</i> is the wireless LAN identifier. The range is 1 to 512.</li> <li>• <i>SSID_Name</i> is the SSID that contains 32 alphanumeric characters.</li> </ul> <p><b>Note</b> If you have already configured this command, enter <b>wlan</b> <i>profile-name</i> command.</p>
Step 3	<p><b>security wpa</b> {akm   wpa1   wpa2}</p> <p><b>Example:</b> Device (config-wlan) # <b>security wpa</b></p>	<p>Enables WPA or WPA2 support for WLAN.</p>
Step 4	<p><b>security wpa wpa1</b></p> <p><b>Example:</b> Device (config-wlan) # <b>security wpa wpa1</b></p>	<p>Enables WPA.</p>
Step 5	<p><b>security wpa wpa1 ciphers</b> [aes   tkip]</p> <p><b>Example:</b> Device (config-wlan) # <b>security wpa wpa1 ciphers aes</b></p>	<p>Specifies the WPA1 cipher. Choose one of the following encryption types:</p> <ul style="list-style-type: none"> <li>• <b>aes</b>—Specifies WPA/AES support.</li> <li>• <b>tkip</b>—Specifies WPA/TKIP support.</li> </ul> <p>The default values are TKIP for WPA1 and AES for WPA2.</p> <p><b>Note</b> You can enable or disable TKIP encryption only using the CLI. Configuring TKIP encryption is not supported in GUI.</p> <p>When you have VLAN configuration on WGB, you need to configure the encryption cipher mode and keys for a particular VLAN, for example, <b>encryption vlan 80 mode ciphers tkip</b>. Then, you need to configure the encryption cipher mode globally on the multicast interface by entering the following command: <b>encryption mode ciphers tkip</b>.</p>
Step 6	<p><b>security wpa akm</b> {cckm  dot1x   dot1x-sha256   ft   psk  psk-sha256}</p> <p><b>Example:</b></p>	<p>Enable or disable Cisco Centralized Key Management, 802.1x, 802.1x with SHA256 key derivation type, Fast Transition, PSK or PSK with SHA256 key derivation type.</p>



	Command or Action	Purpose
	Device(config-wlan)# <b>security wpa akm psk-sha256</b>	<p><b>Note</b></p> <ul style="list-style-type: none"> <li>You cannot enable 802.1x and PSK with SHA256 key derivation type simultaneously.</li> <li>When you configure Cisco Centralized Key Management SSID, you must enable the <b>ccx aironet-iesupport</b> for Cisco Centralized Key Management to work.</li> <li>WPA3 Enterprise dot1x-sha256 is supported only in local mode.</li> </ul>
<b>Step 7</b>	<b>security wpa psk set-key {ascii   hex} {0   8} password</b>  <b>Example:</b> Device(config-wlan)# <b>security wpa psk set-key ascii 0 test</b>	Enter this command to specify a preshared key, if you have enabled PSK.  WPA preshared keys must contain 8 to 63 ASCII text characters or 64 hexadecimal characters.
<b>Step 8</b>	<b>security wpa akm ft {dot1x   psk  sae}</b>  <b>Example:</b> Device(config-wlan)# <b>security wpa akm ft psk</b>	Enable or disable authentication key management suite for fast transition.  <p><b>Note</b> You can now choose between PSK and fast transition PSK as the AKM suite.</p>
<b>Step 9</b>	<b>security wpa wpa2</b>  <b>Example:</b> Device(config-wlan)# <b>security wpa wpa2</b>	Enables WPA2.
<b>Step 10</b>	<b>security wpa wpa2 ciphers aes</b>  <b>Example:</b> Device(config-wlan)# <b>security wpa wpa2</b>  <b>Example:</b>	Configure WPA2 cipher. <ul style="list-style-type: none"> <li><b>aes</b>—Specifies WPA/AES support.</li> </ul>
<b>Step 11</b>	<b>show wireless pmk-cache</b>	Displays the remaining time before the PMK cache lifetime timer expires.  If you have enabled WPA2 with 802.1X authenticated key management or WPA1 or WPA2 with Cisco Centralized Key Management authenticated key management, the PMK cache lifetime timer is used to trigger reauthentication with the client when necessary. The timer is based on the timeout value received from the AAA server or the WLAN session timeout setting.

	Command or Action	Purpose
		<p>If you configure 802.1x with session timeout between 0 and 299, Pairwise Master Key (PMK) cache is created with a timer of 1 day 84600 seconds.</p> <p><b>Note</b></p> <ul style="list-style-type: none"><li>• The command will show VLAN ID with VLAN pooling feature in VLAN-Override field.</li><li>• Sticky key caching (SKC) is not supported.</li></ul>



## CHAPTER 171

# Remote LANs

---

- [Information About Remote LANs, on page 1657](#)
- [Configuring Remote LANs \(RLANs\), on page 1659](#)

## Information About Remote LANs

A Remote LAN (RLAN) is used for authenticating wired clients using the controller. Once the wired client successfully joins the controller, the LAN ports switch the traffic between central or local switching modes. The traffic from wired client is treated as wireless client traffic.

The RLAN in Access Point (AP) sends the authentication request to authenticate the wired client. The authentication of wired client in RLAN is similar to the central authenticated wireless client.

The supported AP models are:

- Cisco Catalyst 9105AXW
- Cisco Aironet OEAP 1810 series
- Cisco Aironet 1815T series
- Cisco Aironet 1810W series
- Cisco Aironet 1815W

### Information About Ethernet (AUX) Port

The second Ethernet port in Cisco Aironet 1850, 2800, and 3800 Series APs is used as a link aggregation (LAG) port, by default. It is possible to use this LAG port as an RLAN port when LAG is disabled.

The following APs use LAG port as an RLAN port:

- 1852E
- 1852I
- 2802E
- 2802I
- 3802E
- 3802I

- 3802P
- 4802

### Limitation for RLAN

- RLAN supports only a maximum of four wired clients regardless of the AP model.
- RLAN support with Virtual Routing and Forwarding (VRF) is not available.

### Limitations for Using AUX port in Cisco 2700 Access Points

- RLAN supports AUX port and non-native VLAN for this port.
- Local mode supports wired client traffic on central switch. Whereas, FlexConnect mode does not support central switch.
- FlexConnect mode supports wired client traffic on local switch and not on central switch.
- AUX port cannot be used as a trunk port. Even switches or bridges cannot be added behind the port.
- AUX port does not support dot1x.

### Role of Controller

- The controller acts as an authenticator, and Extensible Authentication Protocol (EAP) over LAN (EAPOL) messages from the wired client reaching the controller through an AP.
- The controller communicates with the configured Authentication, Authorization, and Accounting (AAA) server.
- The controller configures the LAN ports for an AP and pushes them to the corresponding AP.



#### Note

- RLAN is supported in APs that have more than one Ethernet port.
- In RLAN (local mode - local switching mode), if you want to use the AP native VLAN for client IP, the VLAN should be configured as either **no vlan** or **vlan 1** in the RLAN policy profile. For example, if the native VLAN ID is 80, do not use the number 80 in the RLAN policy profile. Also, do not use VLAN name *VLANxxx* to configure VLAN in the RLAN policy profile.  
When a new client is connected to an AP, the client's details are available in the controller initially. However, after the CAPWAP DOWN/UP state, the client details are no longer listed in the controller.
- APs in local mode central switching do not support VLAN tagged traffic from RLAN clients, and the traffic gets dropped.
- The VLAN name (without any numerals) configured in remote-lan-policy does not provide the mapped VLAN ID for central switching.

# Configuring Remote LANs (RLANs)

## Enabling or Disabling all RLANs

### Procedure

	Command or Action	Purpose
<b>Step 1</b>	<b>configure terminal</b> <b>Example:</b> Device# <code>configure terminal</code>	Enters global configuration mode.
<b>Step 2</b>	<b>[no] ap remote-lan shutdown</b> <b>Example:</b> Device(config)# <code>[no] ap remote-lan shutdown</code>	Enables or disables all RLANs.
<b>Step 3</b>	<b>end</b> <b>Example:</b> Device(config)# <code>end</code>	Returns to privileged EXEC mode. Alternatively, you can also press <b>Ctrl-Z</b> to exit global configuration mode.

## Creating RLAN Profile (GUI)

### Procedure

- 
- Step 1** Choose **Configuration > Tags & Profiles > Remote LAN**.
  - Step 2** Click **Add**.
  - Step 3** Enter the **Profile Name**, **RLAN ID** and enable or disable the **Status** toggle button. The name can be ASCII characters from 32 to 126, without leading and trailing spaces.
  - Step 4** Click **Apply to Device**.
- 

## Creating RLAN Profile (CLI)

### Procedure

	Command or Action	Purpose
<b>Step 1</b>	<b>configure terminal</b> <b>Example:</b> Device# <code>configure terminal</code>	Enters global configuration mode.

	Command or Action	Purpose
<b>Step 2</b>	<p><b>ap remote-lan profile-name</b> <i>remote-lan-profile-name rlan-id</i></p> <p><b>Example:</b></p> <pre>Device(config)# ap remote-lan profile-name rlan_profile_name 3</pre>	<p>Configures remote LAN profile.</p> <ul style="list-style-type: none"> <li>• <i>remote-lan-profile</i>—Is the remote LAN profile name. Range is from 1 to 32 alphanumeric characters.</li> <li>• <i>rlan-id</i>—Is the remote LAN identifier. Range is from 1 to 128.</li> </ul> <p><b>Note</b> You can create a maximum of 128 RLANs. You cannot use the <i>rlan-id</i> of an existing RLAN while creating another RLAN.</p> <p>Both RLAN and WLAN profile cannot have the same names. Similarly, RLAN and WLAN policy profile cannot have the same names.</p>

## Configuring RLAN Profile Parameters (GUI)

### Procedure

- 
- Step 1** Choose **Configuration > Tags & Profiles > Remote LAN**.
- Step 2** On the **RLAN Profile** tab, click **Add**.  
The **Add RLAN Profile** window is displayed.
- Step 3** In the **General** tab:
- Enter a **Name** and **RLAN ID** for the RLAN profile. The name can be ASCII characters from 32 to 126, without leading and trailing spaces.
  - Set the number of client connections per RLAN in the **Client Association Limit** field.  
The range depends on the maximum number of clients supported by the platform.
  - To enable the profile, set the status as **Enable**.
- Step 4** In the **Security > Layer2** tab
- To enable 802.1x for an RLAN, set the **802.1x** status as **Enabled**.  
**Note** You can activate either web or 802.1x authentication list at a time.
  - Choose the authorization list name from the **MAC Filtering** drop-down list.
  - Choose the 802.1x for an RLAN authentication list name from the **Authentication List** drop-down list.
- Step 5** In the **Security > Layer3** tab
- To enable web authentication for an RLAN, set the **Web Auth** status as **Enabled**.  
**Note** You can activate either web or 802.1x authentication list at a time.
  - Choose the web authentication parameter map from the **Webauth Parameter Map** drop-down list.

c) Choose the web authentication list name from the **Authentication List** drop-down list.

**Step 6** In the **Security > AAA** tab

a) Set the **Local EAP Authentication** to enabled. Also, choose the required **EAP Profile Name** from the drop-down list.

**Step 7** Save the configuration.

## Configuring RLAN Profile Parameters (CLI)

### Before you begin

The configurations in this section are not mandatory for an RLAN profile.

In case of central switching mode, you need to configure both central switching and central DHCP.

### Procedure

	Command or Action	Purpose
<b>Step 1</b>	<b>client association limit</b> <i>client-connections</i>  <b>Example:</b> Device(config-remote-lan) # <b>client association limit 1</b>	Configures client connections per RLAN.  <i>client-connections</i> —Is the maximum client connections per RLAN. Range is from 0 to 10000. 0 refers to unlimited.
<b>Step 2</b>	<b>ip access-group web</b> <i>IPv4-acl-name</i>  <b>Example:</b> Device(config-remote-lan) # <b>ip access-group web acl_name</b>	Configures RLAN IP configuration commands.  <i>IPv4-acl-name</i> —Refers to the IPv4 ACL name or ID.
<b>Step 3</b>	<b>local-auth</b> <i>profile name</i>  <b>Example:</b> Device(config-remote-lan) # <b>local-auth profile_name</b>	Sets EAP Profile on an RLAN.  <i>profile name</i> —Is the EAP profile on an RLAN.
<b>Step 4</b>	<b>mac-filtering</b> <i>mac-filter-name</i>  <b>Example:</b> Device(config-remote-lan) # <b>mac-filtering mac_filter</b>	Sets MAC filtering support on an RLAN.  <i>mac-filter-name</i> —Is the authorization list name.
<b>Step 5</b>	<b>security dot1x authentication-list</b> <i>list-name</i>  <b>Example:</b> Device(config-remote-lan) # <b>security dot1x authentication-list dot1_auth_list</b>	Configures 802.1X for an RLAN.  <i>list-name</i> —Is the authentication list name.
<b>Step 6</b>	<b>security web-auth authentication-list</b> <i>list-name</i>  <b>Example:</b>	Configures web authentication for an RLAN.  <i>list-name</i> —Is the authentication list name.

	Command or Action	Purpose
	Device(config-remote-lan)# <b>security web-auth authentication-list web_auth_list</b>	<b>Note</b> You can activate either web or dot1x authentication list at a time.
<b>Step 7</b>	[no] <b>shutdown</b>  <b>Example:</b> Device(config-remote-lan)# <b>shutdown</b>	Enables or disables RLAN profile.
<b>Step 8</b>	<b>end</b>  <b>Example:</b> Device(config-remote-lan)# <b>end</b>	Returns to privileged EXEC mode.

## Creating RLAN Policy Profile (GUI)

### Procedure

- 
- Step 1** Choose **Configuration > Wireless > Remote LAN > RLAN Policy**
  - Step 2** Click **Add**.
  - Step 3** In the **General** tab, enter the **Policy Name**.
  - Step 4** Click **Apply to Device**.
- 

## Creating RLAN Policy Profile (CLI)

### Procedure

	Command or Action	Purpose
<b>Step 1</b>	<b>configure terminal</b>  <b>Example:</b> Device# <code>configure terminal</code>	Enters global configuration mode.
<b>Step 2</b>	<b>ap remote-lan-policy policy-name profile name</b>  <b>Example:</b> Device(config)# <b>ap remote-lan-policy policy-name rlan_policy_prof_name</b>	Configures RLAN policy profile and enters wireless policy configuration mode.



## Configuring RLAN Policy Profile Parameters (GUI)

### Procedure

- Step 1** Choose **Configuration > Wireless > Remote LAN**.
- Step 2** On the **Remote LAN** page, click **RLAN Policy** tab.
- Step 3** On the **RLAN Policy** page, click the name of the **Policy** or click **Add** to create a new one.  
The **Add/Edit RLAN Policy** window is displayed.
- Step 4** In the **General** tab:
- Enter a **Name** and **Description** for the policy profile.
  - Set **Central Authentication** to **Enabled** state.
  - Set **Central DHCP** to **Enabled** state.
  - Set the **PoE** check box to enable or disable state.
  - To enable the policy, set the status as **Enable**.
- Step 5** In the **Access Policies** Tab, choose the VLAN name or number from the **VLAN** drop-down list.
- Note** When central switching is disabled, the VLAN in the RLAN policy cannot be configured as the AP's native VLAN. To use the AP's native VLAN for client IP, the VLAN should be configured as either **no vlan** or **vlan 1** in the RLAN policy profile.
- Step 6** From the **Host Mode** drop-down list, choose the **Host Mode** for the remote-LAN802.1x from the following options:
- **Single-Host Mode**—Is the default host mode. In this mode, the switch port allows only a single host to be authenticated and passes traffic one by one.
  - **Multi-Host Mode**—The first device to authenticate opens up to the switch port, so that all other devices can use the port. You need not authenticate other devices independently, if the authenticated device becomes authorized the switch port is closed.
  - **Multi-Domain Mode**—The authenticator allows one host from the data domain and another from the voice domain. This is a typical configuration on switch ports with IP phones connected.
- Note**
- For an RLAN profile with open-auth configuration, you must map the RLAN-policy with single host mode. Mapping RLAN-policy with multi-host or multi-domain mode is not supported.
  - The controller does not assign data versus voice VLAN, based on traffic. RLAN only supports multiple VLAN assignments through 802.1x AAA override. You must create data and voice VLANs and then assign these VLANs to respective clients, based on their authentication through the 802.1x AAA override.
- Step 7** Configure IPv6 ACL or Flexible NetFlow.
- Under the **Access Policies > Remote LAN ACL** section, choose the **IPv6 ACL** from the drop-down list.
  - Under the **Access Policies > AVC > Flow Monitor IPv6** section, check the **Egress Status** and **Ingress Status** check boxes and choose the policies from the drop-down lists.
- Step 8** Click the **Advanced** tab.

- a) Configure the violation mode for Remote-LAN 802.1x from the **Violation Mode** drop-down list, choose the violation mode type from the following options:
- Shutdown—Disables the port
  - Replace—Removes the current session and initiates authentication for the new host. This is the default behavior.
  - Protect—Drops packets with unexpected MAC addresses without generating a system message.
- b) Enter the **Session Timeout (sec)** value to define the client's duration of a session.  
The range is between 20 and 86400 seconds.
- c) Under **AAA Policy Params** section, check the **AAA Override** check box to enable AAA override.
- d) Under the **Exclusionlist Params** section, check the **Exclusionlist** check box and enter the **Exclusionlist Timeout** value.  
This sets the exclusion time for a client. The range is between 0 and 2147483647 seconds. 0 refers to no timeout.

**Step 9** Save the configuration.

## Configuring RLAN Policy Profile Parameters (CLI)

### Before you begin

RLAN does not support the following features:

- Central Web Authentication (CWA)
- Quality of Service (QoS)
- Bi-Directional Rate Limiting (BDRL)
- Identity PSK (iPSK)

### Procedure

	Command or Action	Purpose
<b>Step 1</b>	<b>central switching</b>  <b>Example:</b> Device(config-remote-lan-policy)# <b>central switching</b>	Configures central switching.
<b>Step 2</b>	<b>central dhcp</b>  <b>Example:</b> Device(config-remote-lan-policy)# <b>central dhcp</b>	Configures central DHCP.
<b>Step 3</b>	<b>exclusionlist timeout</b> <i>timeout</i>	Sets exclusion-listing on RLAN.

	Command or Action	Purpose
	<b>Example:</b> Device(config-remote-lan-policy) # <b>exclusionlist timeout 200</b>	<i>timeout</i> —Sets the time, up to which the client will be in excluded state. Range is from 0 to 2147483647 seconds. 0 refers to no timeout.
<b>Step 4</b>	<b>vlan</b> <i>vlan</i> <b>Example:</b> Device(config-remote-lan-policy) # <b>vlan</b> <b>vlan1</b>	Configures VLAN name or ID.  - <i>vlan</i> —Is the vlan name.
<b>Step 5</b>	<b>Example:</b> Device(config-remote-lan-policy) # <b>ipv6</b> <b>acl ipv6_acl</b>	
<b>Step 6</b>	<b>aaa-override</b> <b>Example:</b> Device(config-remote-lan-policy) # <b>aaa-override</b>	Configures AAA policy override.
<b>Step 7</b>	<b>session-timeout</b> <i>timeout in seconds</i> <b>Example:</b> Device(config-remote-lan-policy) # <b>session-timeout 21</b>	Configures client session timeout.  <i>timeout in seconds</i> —Defines the duration of a session. Range is from 20 to 86400 seconds.
<b>Step 8</b>	<b>host-mode</b> { <b>multidomain</b> <i>voice domain</i>   <b>multihost</b>   <b>singlehost</b> } <b>Example:</b> Device(config-remote-lan-policy) # <b>host-mode multidomain</b>	Configures host mode for remote-LAN 802.1x. <i>voice domain</i> —Is the RLAN voice domain VLAN ID. Range is from 0 to 65535. You can configure the following IEEE 802.1X authentication modes: <ul style="list-style-type: none"> <li>• Multi-Domain Mode—The authenticator allows one host from the data domain and another from the voice domain. This is a typical configuration on switch ports with IP phones connected.</li> <li>• Multi-Host Mode—The first device to authenticate opens up to the switch port, so that all other devices can use the port. You need not authenticate other devices independently, if the authenticated device becomes authorized the switch port is closed.</li> <li>• Single-Host Mode—Is the default host mode. In this mode, the switch port allows only a single host to be authenticated and passes traffic one by one.</li> </ul>

	Command or Action	Purpose
<b>Step 9</b>	<b>violation-mode</b> { <b>protect</b>   <b>replace</b>   <b>shutdown</b> }  <b>Example:</b> Device (config-remote-lan-policy) # <b>violation-mode protect</b>	Configures violation mode for Remote-LAN 802.1x.  When a security violation occurs, a port is protected based on the following configured violation actions: <ul style="list-style-type: none"> <li>• Shutdown—Disables the port.</li> <li>• Replace—Removes the current session and initiates authentication for the new host. This is the default behavior.</li> <li>• Protect—Drops packets with unexpected MAC addresses without generating a system message. In the single-host authentication mode, a violation is triggered when more than one device is detected in data VLAN. In a multi-host authentication mode, a violation is triggered when more than one device is detected in data VLAN or voice VLAN.</li> </ul>
<b>Step 10</b>	<b>[no] poe</b>  <b>Example:</b> Device (config-remote-lan-policy) # <b>poe</b>	Enables or disables PoE.
<b>Step 11</b>	<b>[no] shutdown</b>  <b>Example:</b> Device (config-remote-lan-policy) # <b>shutdown</b>	Enables or disables an RLAN policy profile.
<b>Step 12</b>	<b>end</b>  <b>Example:</b> Device (config-remote-lan-policy) # <b>end</b>	Returns to privileged EXEC mode. Alternatively, you can also press <b>Ctrl-Z</b> to exit global configuration mode.

## Configuring Policy Tag and Mapping an RLAN Policy Profile to an RLAN Profile (CLI)

### Procedure

	Command or Action	Purpose
<b>Step 1</b>	<b>configure terminal</b>  <b>Example:</b> Device# <b>configure terminal</b>	Enters global configuration mode.

	Command or Action	Purpose
<b>Step 2</b>	<b>wireless tag policy</b> <i>policy-tag-name</i> <b>Example:</b> Device(config)# <b>wireless tag policy</b> <b>remote-lan-policy-tag</b>	Configures policy tag and enters policy tag configuration mode.
<b>Step 3</b>	<b>remote-lan</b> <i>remote-lan-profile-name</i> <b>policy</b> <i>rlan-policy-profile-name</i> <b>port-id</b> <i>port-id</i> <b>Example:</b> Device(config-policy-tag)# <b>remote-lan</b> <b>rlan_profile_name</b> <i>policy</i> <b>rlan_policy_profile</b> <i>port-id</i> 2	Maps an RLAN policy profile to an RLAN profile. <ul style="list-style-type: none"> <li>• <i>remote-lan-profile-name</i>—Is the name of the RLAN profile.</li> <li>• <i>rlan-policy-profile-name</i>—Is the name of the policy profile.</li> <li>• <i>port-id</i>—Is the LAN port number on the access point. Range is from 1 to 4.</li> </ul>
<b>Step 4</b>	<b>end</b> <b>Example:</b> Device(config-policy-tag)# <b>end</b>	Returns to privileged EXEC mode. Alternatively, you can also press <b>Ctrl-Z</b> to exit global configuration mode.

## Configuring LAN Port (CLI)

### Procedure

	Command or Action	Purpose
<b>Step 1</b>	<b>ap name</b> <i>ap name</i> <b>lan port-id</b> <i>lan port id</i> { <b>disable</b>   <b>enable</b> } <b>Example:</b> Device# <b>ap name</b> L2_1810w_2 <b>lan port-id</b> 1 <b>enable</b>	Configures a LAN port. <ul style="list-style-type: none"> <li>• <b>enable</b>—Enables the LAN port.</li> <li>• <b>disable</b>—Disables the LAN port.</li> </ul>

## Attaching Policy Tag to an Access Point (GUI)

### Procedure

- 
- Step 1** Choose **Configuration > Wireless > Access Points**.
- Step 2** Select the AP to attach the Policy Tag.
- Step 3** Under the **Tags** section, use the **Policy** drop-down to select a policy tag.
- Step 4** Click **Update & Apply to Device**.
-

## Attaching Policy Tag to an Access Point (CLI)

### Procedure

	Command or Action	Purpose
<b>Step 1</b>	<b>configure terminal</b>  <b>Example:</b> Device# <code>configure terminal</code>	Enters global configuration mode.
<b>Step 2</b>	<b>ap ap-ethernet-mac</b>  <b>Example:</b> Device(config)# <code>ap 00a2.891c.21e0</code>	Configures MAP address for an AP and enters AP configuration mode.
<b>Step 3</b>	<b>policy-tag policy-tag-name</b>  <b>Example:</b> Device(config-ap-tag)# <code>policy-tag remote-lan-policy-tag</code>	Attaches policy tag to the access point.  <i>policy-tag-name</i> —Is the name of the policy tag defined earlier.
<b>Step 4</b>	<b>end</b>  <b>Example:</b> Device(config-ap-tag)# <code>end</code>	Returns to privileged EXEC mode. Alternatively, you can also press <b>Ctrl-Z</b> to exit global configuration mode.

## Verifying RLAN Configuration

To view the summary of all RLANs, use the following command:

```
Device# show remote-lan summary
```

```
Number of RLANs: 1
```

```

RLAN      Profile Name      Status
-----
1         rlan_test_1         Enabled

```

To view the RLAN configuration by ID, use the following command:

```
Device# show remote-lan id <id>
```

```

Remote-LAN Profile Name      : rlan_test_1
=====
Identifier                    : 1
Status                        : Enabled
Mac-filtering                 : Not Configured
Number of Active Clients      : 1
Security_8021X                : Disabled
8021.x Authentication list name : Not Configured
Local Auth eap Profile Name   : Not Configured
Web Auth Security             : Disabled
Webauth Authentication list name : Not Configured
Web Auth Parameter Map       : Not Configured
Client association limit      : 0
Ipv4 Web Pre Auth Acl        : Not Configured
Ipv6 Web Pre Auth Acl        : Not Configured

```

To view the RLAN configuration by profile name, use the following command:

```
Device# show remote-lan name <profile-name>
```

```
Remote-LAN Profile Name           : rlan_test_1
=====
Identifier                         : 1
Status                             : Enabled
Mac-filtering                      : Not Configured
Number of Active Clients           : 1
Security_8021X                    : Disabled
8021.x Authentication list name    : Not Configured
Local Auth eap Profile Name       : Not Configured
Web Auth Security                 : Disabled
Webauth Authentication list name  : Not Configured
Web Auth Parameter Map            : Not Configured
Client association limit          : 0
Ipv4 Web Pre Auth Acl            : Not Configured
Ipv6 Web Pre Auth Acl            : Not Configured
```

To view the detailed output of all RLANs, use the following command:

```
Device# show remote-lan all
```

```
Remote-LAN Profile Name           : rlan_test_1
=====
Identifier                         : 1
Status                             : Enabled
Mac-filtering                      : Not Configured
Number of Active Clients           : 1
Security_8021X                    : Disabled
8021.x Authentication list name    : Not Configured
Local Auth eap Profile Name       : Not Configured
Web Auth Security                 : Disabled
Webauth Authentication list name  : Not Configured
Web Auth Parameter Map            : Not Configured
Client association limit          : 0
Ipv4 Web Pre Auth Acl            : Not Configured
Ipv6 Web Pre Auth Acl            : Not Configured
```

```
Remote-LAN Profile Name           : rlan_test_2
=====
Identifier                         : 2
Status                             : Enabled
Mac-filtering                      : Not Configured
Number of Active Clients           : 1
Security_8021X                    : Disabled
8021.x Authentication list name    : Not Configured
Local Auth eap Profile Name       : Not Configured
Web Auth Security                 : Disabled
Webauth Authentication list name  : Not Configured
Web Auth Parameter Map            : Not Configured
Client association limit          : 0
Ipv4 Web Pre Auth Acl            : Not Configured
Ipv6 Web Pre Auth Acl            : Not Configured
```

```
Device# show remote-lan policy summary
```

```
Number of Policy Profiles: 1
```

Profile Name	Description	Status
rlan_named_pp1	Testing RLAN policy profile	Enabled

To view the LAN port configuration of a Cisco AP, use the following command:

```

Device# show ap name <ap_name> lan port summary
LAN Port status for AP L2_1815w_1
Port ID      status      vlanId      poe
-----
LAN1         Enabled     20          Disabled
LAN2         Enabled     20          NA
LAN3         Disabled    0           NA

```

To view the summary of all clients, use the following command:

```

Device# show wireless client summary
Number of Local Clients: 1

```

MAC Address	AP Name	WLAN	State	Protocol	Method	Role
d8eb.97b6.fcc6	L2_1815w_1	1	* Run	Ethernet	None	Local

To view the client details with the specified username, use the following command:

```

Device# show wireless client username cisco
MAC Address      AP Name      Status      WLAN      Auth Protocol
-----
0014.d1da.a977   L2_1815w_1   Run 1 *     Yes       Ethernet
d8eb.97b6.fcc6   L2_1815w_1   Run 1 *     Yes       Ethernet

```

To view the detailed information for a client by MAC address, use the following command:

```

Device# show wireless client mac-address d8eb.97b6.fcc6 detail
Client MAC Address : d8eb.97b6.fcc6
Client IPv4 Address : 9.2.20.78
Client IPv6 Addresses : fe80::1863:292f:feaa:2cf
Client Username: N/A
AP MAC Address : 707d.b99e.c2e0
AP Name: L2_1815w_1
AP slot : 2
Client State : Associated
Policy Profile : rlan_named_pp1
Flex Profile : rlan-flex-profile
Remote LAN Id : 1
Remote LAN Name: rlan_test_1
BSSID : 707d.b99e.c2e1
Connected For : 1159 seconds
Protocol : Ethernet
Channel : 0
Port ID: 2
Client IIF-ID : 0xa0000001
Association Id : 1
Authentication Algorithm : Open System
Client CCX version : No CCX support
Session Timeout : 1800 sec (Remaining time: 641 sec)
Input Policy Name : None
Input Policy State : None
Input Policy Source : None
Output Policy Name : None
Output Policy State : None
Output Policy Source : None
WMM Support : Disabled
Fastlane Support : Disabled
Power Save : OFF
Current Rate : 0.0
Mobility:
  Move Count : 0
  Mobility Role : Local
  Mobility Roam Type : None
  Mobility Complete Timestamp : 07/06/2018 11:25:26 IST
Policy Manager State: Run

```



```
NPU Fast Fast Notified : No
Last Policy Manager State : IP Learn Complete
Client Entry Create Time : 1159 seconds
Policy Type : N/A
Encryption Cipher : None
Encrypted Traffic Analytics : No
Management Frame Protection : No
Protected Management Frame - 802.11w : No
EAP Type : Not Applicable
VLAN : 20
Access VLAN : 20
Anchor VLAN : 0
WFD capable : No
Managed WFD capable : No
Cross Connection capable : No
Support Concurrent Operation : No
Session Manager:
  Interface      : capwap_90000008
  IIF ID         : 0x90000008
  Authorized     : TRUE
  Session timeout : 1800
  Common Session ID: 32130209000000136C48A29D
  Acct Session ID : 0x00000000
  Aaa Server Details
  Server IP      :
  Auth Method Status List
  Method : None
Local Policies:
  Service Template : wlan_svc_rlan_named_pp1_local (priority 254)
  Absolute-Timer   : 1800
  VLAN             : 20
Server Policies:
Resultant Policies:
  VLAN           : 20
  Absolute-Timer : 1800
DNS Snooped IPv4 Addresses : None
DNS Snooped IPv6 Addresses : None
Client Capabilities
  CF Pollable : Not implemented
  CF Poll Request : Not implemented
  Short Preamble : Not implemented
  PECC : Not implemented
  Channel Agility : Not implemented
  Listen Interval : 0
Fast BSS Transition Details :
  Reassociation Timeout : 0
11v BSS Transition : Not implemented
FlexConnect Data Switching : Central
FlexConnect Dhcp Status : Central
FlexConnect Authentication : Central
FlexConnect Central Association : No
Client Statistics:
  Number of Bytes Received : 6855
  Number of Bytes Sent : 1640
  Number of Packets Received : 105
  Number of Packets Sent : 27
  Number of Policy Errors : 0
  Radio Signal Strength Indicator : 0 dBm
  Signal to Noise Ratio : 0 dB
Fabric status : Disabled
Client Scan Reports
Assisted Roaming Neighbor List
```

To view the summary of all AP tags, use the following command:

```
Device# show ap tag summary
Number of APs: 2
```

AP Name Tag Name	AP Mac Misconfigured	Site Tag Name Tag Source	Policy Tag Name	RF
L2_1810d_1	0008.3296.24c0	default-site-tag	default-policy-tag	
default-rf-tag	No	Default		
L2_1810w_2	00b0.e18c.5880	rlan-site-tag	rlan_pt_1	
default-rf-tag	No	Static		

To view the summary of all policy tags, use the following command:

```
Device# show wireless tag policy summary
Number of Policy Tags: 2
```

Policy Tag Name	Description
rlan_pt_1	
default-policy-tag	default policy-tag

To view details of a specific policy tag, use the following command:

```
Device# show wireless tag policy detailed <rlan_policy_tag_name>
Policy Tag Name : rlan_pt_1
Description      :
```

```
Number of WLAN-POLICY maps: 0
```

```
Number of RLAN-POLICY maps: 2
```

REMOTE-LAN Profile Name	Policy Name	Port Id
rlan_test_1	rlan_named_pp1	1
rlan_test_1	rlan_named_pp1	2



## CHAPTER 172

# RLAN External Module

---

- [Information About External Module, on page 1673](#)
- [Prerequisites for Configuring External Module, on page 1673](#)
- [Configuring External Module \(GUI\), on page 1673](#)
- [Configuring External Module \(CLI\), on page 1674](#)
- [Verifying External Module, on page 1674](#)

## Information About External Module

The External Module feature enables traffic to flow in and out from the Cisco Aironet Developer Platform module when an access point (AP) is in both local and flex connect mode.

## Prerequisites for Configuring External Module

Before you begin, you must ensure the following:

- The external module is powered on.
- The RLAN status is enabled.

## Configuring External Module (GUI)

### Procedure

---

- Step 1** Choose **Configuration > Tags & Profiles > Tags**.
- Step 2** In the **Policy** tab, select one of the **Policy Tag Name** and click **Add**.
- Step 3** In **Add Policy Tag** page and **RLAN-POLICY Maps** section, click **Add**.
- Step 4** From the **Port ID** drop-down list, choose **ext-module**.
- Step 5** From the **RLAN Profile** drop-down list, choose an RLAN profile.
- Step 6** From the **RLAN Policy Profile** drop-down list, choose an RLAN policy profile.

**Step 7** Click the check mark icon.

## Configuring External Module (CLI)

### Procedure

	Command or Action	Purpose
<b>Step 1</b>	<b>configure terminal</b> <b>Example:</b> Device# configure terminal	Enters global configuration mode.
<b>Step 2</b>	<b>wireless tag policy default-policy-tag</b> <b>Example:</b> Device(config)# wireless tag policy default-policy-tag	Configures a policy tag to the external module for the remote LAN.
<b>Step 3</b>	<b>remote-lan rlan-profile policy rlan-policy ext-module</b> <b>Example:</b> Device(default-policy-tag)# remote-lan rlan policy abc ext-module	Configures a remote LAN policy to the external module.

## Verifying External Module

To view the external module remote LAN configuration, use the following command:

```
Device# show ap name ap_name lan port summary
```

```
LAN Port status for AP ap_name
```

```
Port ID      status      vlanId      poe          power-level  RLAN
-----
ext-module   Enabled     39          NA           NA           Enabled
```

To view the external module inventory details, use the following command:

```
Device# show ap name abc inventory
```

```
NAME: AP3800, DESCR: Cisco Aironet 3800 Series (IEEE 802.11ac) Access Point
PID: AIR-AP3802I-D-K9, VID: 01, SN: xxxxxxxxxxxx
```

```
MODULE NAME: Expansion Module, DESCR: Cisco HDK Module (rev2)
```

```
PID: Unknown, SN: xxxxxxxxxxxx, MaxPower: 2700mW
```

```
VersionID: V22, Capabilities: RLAN (UP)
```



## CHAPTER 173

# 802.11ax Per WLAN

---

- [Information About 802.11ax Mode Per WLAN, on page 1675](#)
- [Configuring 802.11ax Mode Per WLAN \(GUI\), on page 1675](#)
- [Configuring 802.11ax Mode Per WLAN \(CLI\), on page 1676](#)
- [Verifying 802.11ax Mode Per WLAN, on page 1676](#)

## Information About 802.11ax Mode Per WLAN

Prior to Cisco IOS XE Bengaluru Release 17.4.1, the 802.11ax mode was configured per radio band. In this configuration, the 11ax mode was either enabled or disabled for all WLANs (AP) that were configured per radio, all at once. When 11ax was enabled per radio, the 11ac clients were not able to scan or connect to the SSID if the beacon had 11ax information elements. Client could not probe an access point (AP), if the beacon has 11ax IE.

Therefore, a 11ax configuration knob per AP is introduced, from Cisco IOS XE Bengaluru Release 17.5.1. This knob is introduced under the WLAN profile. By default, the 11ax knob per WLAN is now enabled on the controller.

## Configuring 802.11ax Mode Per WLAN (GUI)

### Procedure

---

- Step 1** Choose **Configuration > Tags & Profiles > WLANs**.
- Step 2** Click **Add**.  
The **Add WLAN** window is displayed.
- Step 3** Click the **Advanced** tab.
- Step 4** In the **11ax** section, check the **Enable 11ax** check box to enable 802.11ax operation status on the WLAN.
- Note** When 11ax is disabled, beacons will not display 11ax IE, and all the 11ax features will be operationally disabled on the WLAN.
- Step 5** Click **Apply to Device**.
-

## Configuring 802.11ax Mode Per WLAN (CLI)

### Procedure

	Command or Action	Purpose
<b>Step 1</b>	<b>configure terminal</b>  <b>Example:</b> Device# configure terminal	Enters global configuration mode.
<b>Step 2</b>	<b>wlan wlan-profile-name</b>  <b>Example:</b> Device(config)# wlan wlan-profile	Specifies the WLAN name and enters the WLAN configuration mode.
<b>Step 3</b>	<b>dot11ax</b>  <b>Example:</b> Device(config-wlan)# dot11ax	Configures 802.11ax on a WLAN.
<b>Step 4</b>	<b>no dot11ax</b>  <b>Example:</b> Device(config-wlan)# no dot11ax	Disables 802.11ax on the WLAN profile.

## Verifying 802.11ax Mode Per WLAN

To display the status of the 11ax parameter, run the following command:

```
Device# show wlan id 6
WLAN Profile Name      : power
=====
Identifier              : 6
Description             :
Network Name (SSID)    : power
Status                 : Enabled
Broadcast SSID         : Enabled
Advertise-Apname       : Disabled
Universal AP Admin     : Disabled
Max Associated Clients per WLAN : 0
Max Associated Clients per AP per WLAN : 0
Max Associated Clients per AP Radio per WLAN : 200
.
.
.
802.11ac MU-MIMO       : Enabled
802.11ax parameters
  802.11ax Operation Status : Enabled
  OFDMA Downlink         : Enabled
  OFDMA Uplink           : Enabled
  MU-MIMO Downlink       : Enabled
  MU-MIMO Uplink         : Enabled
  BSS Target Wake Up Time : Enabled
  BSS Target Wake Up Time Broadcast Support : Enabled
```

·  
·  
·







## CHAPTER 174

# BSS Coloring

- [Information About BSS Coloring](#) , on page 1679
- [Configuring BSS Color on AP \(GUI\)](#), on page 1680
- [Configuring BSS Color in the Privileged EXEC Mode](#), on page 1681
- [Configuring BSS Color Globally \(GUI\)](#), on page 1681
- [Configuring BSS Color in the Configuration Mode](#), on page 1682
- [Configuring Overlapping BSS Packet Detect \(GUI\)](#), on page 1682
- [Configuring OBSS-PD Spatial Reuse Globally \(CLI\)](#), on page 1683
- [Configuring OBSS PD in an RF Profile \(GUI\)](#), on page 1683
- [Configuring OBSS-PD Spatial Reuse in the RF Profile Mode \(CLI\)](#), on page 1684
- [Verifying BSS Color and OBSS-PD](#), on page 1684

## Information About BSS Coloring

The 802.11 Wi-Fi standard minimizes the chance of multiple devices interfering with one another by transmitting at the same time. This carrier-sense multiple access with collision avoidance (CSMA/CA) technology is based on static thresholds that allow Wi-Fi devices to avoid interfering with each other on air. However, with an increase in density and the number of Wi-Fi devices, these static thresholds often lead to CSMA/CA causing devices to defer transmissions unnecessarily.

For example, if two devices that are associated with different BSS, can hear every transmission from each other at relatively low signal strengths, each device should defer its transmission when it receives a transmission from the other. But if both the devices were to transmit at the same time, it is likely that neither would cause enough interference at the other BSS' receiver to cause reception failure for either transmission.

Devices today must demodulate packets to look at the MAC header in order to determine whether or not a received packet belongs to their own BSS. This process of demodulation consumes power, which can be saved if devices can quickly identify the BSS by looking at the PHY header alone, and subsequently drop packets that are from a different BSS. Prior to Wi-Fi 6, there was no provision for devices to do this.

The new 802.11ax (Wi-Fi 6) standard addresses both of the issues discussed above, through the new BSS Coloring and Spatial Reuse mechanism. BSS Coloring is a new provision that allows devices operating in the same frequency space to quickly distinguish between packets from their own BSS and packets from an Overlapping BSS (OBSS), by simply looking at the BSS color value contained in the HE PHY header. In some scenarios, Spatial Reuse allows devices, to transmit at the same time as the OBSS packets they receive, instead of deferring transmissions because of legacy interference thresholds. Since every Wi-Fi 6 device understands the BSS color, it can be leveraged to increase power savings by dropping packets earlier, and to identify spatial reuse opportunities.

## BSS Coloring

BSS Coloring is a method used to differentiate between the BSS of access points and their clients on the same RF channel. Wi-Fi 6 enables each AP radio to assign a value (from 1 to 63), known as BSS color, to be included in the PHY header of all HE transmissions from devices in its BSS. With devices of each BSS transmitting a locally-unique color, a device can quickly and easily distinguish transmissions coming from its BSS from those of a neighboring BSS.

The following platforms support this feature:

- Cisco Catalyst 9800 Series Wireless Controllers
- Cisco Catalyst 9115 Access Points
- Cisco Catalyst 9117 Access Point
- Cisco Catalyst 9120AX Series Access Points
- Cisco Catalyst 9124AX Series Access Points
- Cisco Catalyst 9130AX Access Points

## OBSS-PD and Spatial Reuse

Overlapping BSS Packet Detect (OBSS-PD) is a more aggressive Wi-Fi packet detect threshold for inter-BSS packets, which can be higher than the typical/legacy -82 dBm. Inter-BSS packets are easily identified by comparing the BSS color in the HE PHY header of the packets received with the BSS color of the device.

In OBSS-PD based Spatial Reuse, to improve throughput and network efficiency by increasing transmitting opportunities, a Wi-Fi 6 or 802.11ax device can transmit over an inter-BSS packet with an RSSI that is below the OBSS-PD threshold instead of deferring.



---

**Note** Cisco Catalyst 9120AX Series Access Points do not support OBSS-PD.

---

## Configuring BSS Color on AP (GUI)

### Procedure

---

- Step 1** Choose **Configuration > Wireless > Access Points**.
- Step 2** Click the **5 GHz Radios** section or the **2.4 GHz Radios** section.  
The list of the AP radios in the band is displayed.
- Step 3** Click the required AP name.  
The **Edit Radios** window is displayed.
- Step 4** From the **Edit Radios** window, select the **Configure** tab.  
The general information, Antenna Parameters, RF Channel Assignment, Tx Power Level Assignment, and BSS Color are displayed.
- Step 5** In the **BSS Color** area and from the **BSS Color Configuration** drop-down list, choose **Custom** configuration

- **Custom:** To manually select the BSS color configuration for the AP radio.
  - a. Click the **BSS Color Status** field to disable or enable the feature.
  - b. In the **Current BSS Color** field, specify a corresponding BSS color for the AP radio. The valid range is between 1 and 63.

**Step 6** Click **Update & Apply to Device**.

## Configuring BSS Color in the Privileged EXEC Mode

### Procedure

	Command or Action	Purpose
<b>Step 1</b>	<b>enable</b> <b>Example:</b> Device> enable	Enables privileged EXEC mode. Enter your password, if prompted.
<b>Step 2</b>	<b>ap name</b> <i>ap-name</i> <b>dot11</b> { <b>24ghz</b>   <b>5ghz</b>   <b>dual-band</b> [ <i>slot slot-id</i> ] } <b>dot11ax bss-color</b> <1-63> <b>Example:</b> Device#ap name <i>apn</i> dot11 24ghz slot 0 dot11ax bss-color 12 <b>Example:</b> Device#ap name <i>apn</i> no dot11 24ghz slot 0 dot11ax bss-color	Sets the BSS color on the 2.4-GHz, 5-GHz, or dual-band radio, for a specific access point on the following slots: <ul style="list-style-type: none"> <li>• 5 GHz: Slot 1 and 2</li> <li>• 2.4 GHz: Slot 0</li> <li>• Dual-band: Slot 0</li> </ul> Use the <b>no</b> form of this command to disable BSS color.

## Configuring BSS Color Globally (GUI)

### Procedure

- Step 1** Choose **Configuration > Radio Configurations > Parameters**.
- Step 2** In the **11ax Parameters** section, enable BSS color globally for the 5 GHz and 2.4 GHz radios by checking the **BSS Color** check box.

## Configuring BSS Color in the Configuration Mode

### Procedure

	Command or Action	Purpose
<b>Step 1</b>	<b>enable</b> <b>Example:</b> Device> enable	Enables privileged EXEC mode. Enter your password if prompted.
<b>Step 2</b>	<b>configure terminal</b> <b>Example:</b> Device# configure terminal	Enters global configuration mode.
<b>Step 3</b>	<b>[no] ap dot11 {24ghz   5ghz } dot11ax bss-color</b> <b>Example:</b> Device(config)#[no] ap dot11 24ghz dot11ax bss-color	Enables the 802.11ax BSS color on all 2.4-GHz or 5-GHz radios.  Use the <code>no</code> form of this command to disable BSS color.

## Configuring Overlapping BSS Packet Detect (GUI)

### Procedure

- 
- Step 1** Choose **Configuration > Radio Configurations > Parameters**.
- The parameters page is displayed where you can configure global parameters for 5 GHz Band and 2.4 GHz Band radios.
- Step 2** In the **11ax Parameters** section, check the **OBSS PD** check box to enable the overlapping BSS packet detect (OBSS PD) feature.
- Step 3** In the **Non-SRG OBSS PD Max Threshold** field, enter the threshold in decibel-milliwatts. Value range is between -82 dBm and -62 dBm.
-

## Configuring OBSS-PD Spatial Reuse Globally (CLI)

### Procedure

	Command or Action	Purpose
<b>Step 1</b>	<b>configure terminal</b>  <b>Example:</b> Device# configure terminal	Enters global configuration mode.
<b>Step 2</b>	<b>[no] ap dot11 {24ghz   5ghz } dot11ax spatial-reuse obss-pd</b>  <b>Example:</b> Device(config)# [no] ap dot11 24ghz dot11ax spatial-reuse obss-pd	Configures 802.11ax OBSS PD based spatial reuse on all 2.4-GHz or 5-GHz radios.  Use the <code>no</code> form of this command to disable this feature.
<b>Step 3</b>	<b>ap dot11 {24ghz   5ghz } dot11ax spatial-reuse obss-pd non-srg-max -82 - -62</b>  <b>Example:</b> Device(config)# [no] ap dot11 24ghz dot11ax spatial-reuse obss-pd non-srg-max -62	Configure 802.11ax non-SRG OBSS PD max on all 2.4-GHz or 5-GHz radios. The default value is -62.

## Configuring OBSS PD in an RF Profile (GUI)

### Procedure

- 
- Step 1** Choose **Configuration > Tags & Profiles > RF**.
- Step 2** On the **RF Profile** page, click **Add** to configure the following:
- General
  - 802.11
  - RRM
  - Advanced
- Step 3** In the **Advanced** tab, under the **11ax Parameters** section, complete the following:
- a) Use the toggle button to enable or disable the **OBSS PD** field.
  - b) In the **Non-SRG OBSS PD Max Threshold (dBm)**, enter the threshold value. The default value is -62 dBm. Values range between -82 dBm and -62 dBm.
- Step 4** Click **Save & Apply to Device**.
-

## Configuring OBSS-PD Spatial Reuse in the RF Profile Mode (CLI)

### Procedure

	Command or Action	Purpose
<b>Step 1</b>	<b>configure terminal</b>  <b>Example:</b> Device# configure terminal	Enters global configuration mode.
<b>Step 2</b>	<b>ap dot11 {24ghz   5ghz } rf-profile rf-profile-name</b>  <b>Example:</b> Device(config)# ap dot11 24ghz rf-profile rfprof24_1	Configures an RF profile and enters RF profile configuration mode.
<b>Step 3</b>	<b>[no] dot11ax spatial-reuse obss-pd</b>  <b>Example:</b> Device(config-rf-profile)#[no] dot11ax spatial-reuse obss-pd	Configures 802.11ax OBSS PD based spatial reuse in the RF profile configuration mode.  Use the <code>no</code> form of this command to disable this feature.
<b>Step 4</b>	<b>dot11ax spatial-reuse obss-pd non-srg-max -82 - -62</b>  <b>Example:</b> Device(config-rf-profile)# dot11ax spatial-reuse obss-pd non-srg-max -62	Configure 802.11ax non-SRG OBSS PD max on all 2.4-GHz or 5-GHz radios. The default value is -62.

## Verifying BSS Color and OBSS-PD

To verify if the global per-band BSS color and OBSS-PD are enabled, use the following **show** command:

```
Device# show ap dot11 24ghz network
802.11b Network                : Enabled
11gSupport                    : Enabled
11nSupport                    : Enabled
.
.
.
802.11ax                      : Enabled
  DynamicFrag                 : Enabled
  MultiBssid                  : Enabled
  Target Wakeup Time          : Enabled
  Target Wakeup Time Broadcast : Enabled
  BSS Color                   : Enabled
  OBSS PD                     : Enabled
  Non-SRG OBSS PD Max        : -62 dBm
802.11ax MCS Settings:
  MCS 7, Spatial Streams = 1   : Supported
.
.
.
```

To view the RF profile OBSS-PD configuration, use the following **show** command:

```
Device# show ap rf-profile name rf-profile-name detail
Description                : pre configured rfprofile for 5gh radio
RF Profile Name            : rf-profile-name
Band                       : 5 GHz
Transmit Power Threshold v1 : -65 dBm
Min Transmit Power        : 7 dBm
Max Transmit Power        : 30 dBm
.
.
.
802.11ax
  OBSS PD                   : Enabled
  Non-SRG OBSS PD Max      : -62 dBm
  NDP mode                  : Auto
```

To view the BSS color configuration of all the AP radios on a band in the summary list, along with Channel, TX Power and so on, use the following **show** command:

```
Device# show ap dot11 24ghz summary extended
AP Name      Txpwr      Channel      Mac Address      Slot  Admin State  Oper State  Width
-----
Ed2-JFW-AP1  1/6 (17 dBm)  (136,132)*  84b2.61ba.4730  1     Enabled      Up          40
11AX-9120-AP1  1/8 (23 dBm)  (36)        d4ad.bda2.3fc0  1     Enabled      Up          20
Ed2-JFW-AP2  1/5 (15 dBm)  (40)        f8c2.8885.59f0  1     Enabled      Up          20
```

To view the BSS color configuration and the capability of an AP radio, use the following **show** commands:

```
Device# show ap name AP7069.5A74.816C config dot11 24ghz
Cisco AP Identifier        : 502f.a876.1e60
Cisco AP Name              : AP7069.5A74.816C
Attributes for Slot 0
  Radio Type               : 802.11b
  Radio Mode               : REAP
  Radio Role               : Auto
  Radio SubType            : Main
  Administrative State     : Enabled
  Operation State          : Up
.
.
.
Phy OFDM Parameters
  Configuration            : Automatic
  Current Channel          : 6
  Channel Width            : 20 MHz
  TI Threshold             : 1157693440
  Antenna Type             : External
  External Antenna Gain (in .5 dBi units) : 8
.
.
.
!BSS color details are displayed below:
802.11ax Parameters
  HE Capable               : Yes
  BSS Color Capable        : Yes
  BSS Color Configuration  : Customized
  Current BSS Color        : 34

Device# show ap name AP70XX.5XX4.8XXX config slot 0
Cisco AP Identifier        : 502f.a876.1e60
```

```

Cisco AP Name                : AP70XX.5XX4.8XXX
Country Code                 : US
AP Country Code              : US - United States
AP Regulatory Domain         : -A
MAC Address                  : 7069.5a74.816c
IP Address Configuration     : DHCP
IP Address                   : Disabled
.
.
.
Attributes for Slot 0
Radio Type                   : 802.11n - 2.4 GHz
Radio Role                   : Auto
Radio Mode                   : REAP
Radio SubType                : Main
Administrative State         : Enabled
.
.
.
Phy OFDM Parameters
Configuration                 : Automatic
Current Channel               : 6
Channel Assigned By          : DCA
Extension Channel             : NONE
Channel Width                 : 20
Allowed Channel List         : 1,2,3,4,5,6,7,8,9,10,11
TI Threshold                  : 1157693440
DCA Channel List              :
Antenna Type                  : EXTERNAL_ANTENNA
External Antenna Gain (in .5 dBi units) : 8
Diversity                     : DIVERSITY_ENABLED
  802.11n Antennas
    A                         : ENABLED
    B                         : ENABLED
    C                         : ENABLED
    D                         : ENABLED
.
.
.
!BSS color details are displayed below:
802.11ax Parameters
HE Capable                   : Yes
BSS Color Capable            : Yes
BSS Color Configuration      : Customized
Current BSS Color             : 34
.
.
.

```





## CHAPTER 175

# DHCP for WLANs

---

- [Information About Dynamic Host Configuration Protocol, on page 1687](#)
- [Restrictions for Configuring DHCP for WLANs, on page 1690](#)
- [Guidelines for DHCP Relay Configuration, on page 1690](#)
- [How to Configure DHCP for WLANs, on page 1691](#)
- [Configuring the Internal DHCP Server, on page 1693](#)
- [Configuring DHCP-Required for FlexConnect, on page 1703](#)

## Information About Dynamic Host Configuration Protocol

You can configure WLANs to use the same or different Dynamic Host Configuration Protocol (DHCP) servers or no DHCP server. Two types of DHCP servers are available—internal and external.

### Internal DHCP Servers

The device contains an internal DHCP server. This server is typically used in branch offices that do not have a DHCP server.

The internal server provides DHCP addresses to wireless clients, direct-connect APs, and DHCP requests that are relayed from APs. Only lightweight APs are supported. If you want to use the internal DHCP server, ensure that you configure SVI for the client VLAN, and set the IP address as DHCP server IP address.

DHCP option 43 is not supported on the internal server. Therefore, the APs must use an alternative method to locate the management interface IP address of the device, such as local subnet broadcast, Domain Name System (DNS), or priming.

When clients use the internal DHCP server of the device, IP addresses are not preserved across reboots. As a result, multiple clients can be assigned to the same IP address. To resolve any IP address conflicts, clients must release their existing IP address and request a new one.



---

**Note**

- VRF is not supported in the internal DHCP servers.
  - DHCPv6 is not supported in the internal DHCP servers.
-

### General Guidelines

- Internal DHCP server serves both wireless client and wired client (wired client includes AP).
- To serve wireless client with internal DHCP server, an unicast DHCP server IP address must be configured for wireless client. Internal DHCP server IP address must be configured under the server facing interface, which can be loopback interface, SVI interface, or L3 physical interface.
- To use internal DHCP server for both wireless and wired client VLAN, an IP address must be configured under client VLAN SVI interface.
- For wireless client, in DHCP helper address configuration, the IP address of the internal DHCP server must be different from address of wireless client VLAN SVI interface.
- For wireless client with internal DHCP server support, the internal DHCP server can be configured using global configuration command, under the client VLAN SVI interface or under the wireless policy profile.
- An internal DHCP server pool can also serve clients of other controllers .

## External DHCP Servers

The operating system is designed to appear as a DHCP relay to the network and as a DHCP server to clients with industry-standard external DHCP servers that support DHCP Relay, which means that each controller appears as a DHCP relay agent to the DHCP server, and as a DHCP server in the virtual IP address to wireless clients.

Because the controller captures the client IP address that is obtained from a DHCP server, it maintains the same IP address for that client during intra controller, inter controller, and inter-subnet client roaming.



---

**Note** External DHCP servers support DHCPv6.

---

## DHCP Assignments

You can configure DHCP on a per-interface or per-WLAN basis. We recommend that you use the primary DHCP server address that is assigned to a particular interface.

You can assign DHCP servers for individual interfaces. You can configure the management interface, AP manager interface, and dynamic interface for a primary and secondary DHCP server, and configure the service-port interface to enable or disable DHCP servers. You can also define a DHCP server on a WLAN (in this case, the server overrides the DHCP server address on the interface assigned to the WLAN).

### Security Considerations

For enhanced security, we recommend that you ask all clients to obtain their IP addresses from a DHCP server. To enforce this requirement, you can configure all the WLANs with a DHCP Address Assignment Required setting, which disallows client static IP addresses. If DHCP Address Assignment Required is selected, clients must obtain an IP address through DHCP. Any client with a static IP address is not allowed on the network. The controller monitors DHCP traffic because it acts as a DHCP proxy for the clients.



- Note**
- WLANs that support management over wireless must allow management (device-servicing) clients to obtain an IP address from a DHCP server.
  - The operating system is designed to appear as a DHCP relay to the network and as a DHCP server to clients with industry-standard external DHCP servers that support DHCP relay. This means that each controller appears as a DHCP relay to the DHCP server and as a DHCP server at the virtual IP address to wireless clients.

You can create WLANs with DHCP Address Assignment Required disabled. If you do this, clients have the option of using a static IP address or obtaining an IP address from a designated DHCP server. However, note that this might compromise security.



- Note** DHCP Address Assignment Required is not supported for wired guest LANs.

You can create separate WLANs with DHCP Address Assignment Required configured as disabled. This is applicable only if DHCP proxy is enabled for the controller. You must not define the primary or secondary configuration DHCP server instead you should disable the DHCP proxy. These WLANs drop all the DHCP requests and force clients to use a static IP address. These WLANs do not support management over wireless connections.

## DHCP Option 82

DHCP option 82 provides additional security when DHCP is used to allocate network addresses. It enables the controller to act as a DHCP relay agent to prevent DHCP client requests from untrusted sources. You can configure the controller to add option 82 information to DHCP requests from clients before forwarding the requests to the DHCP server.

**Figure 46: DHCP Option 82**

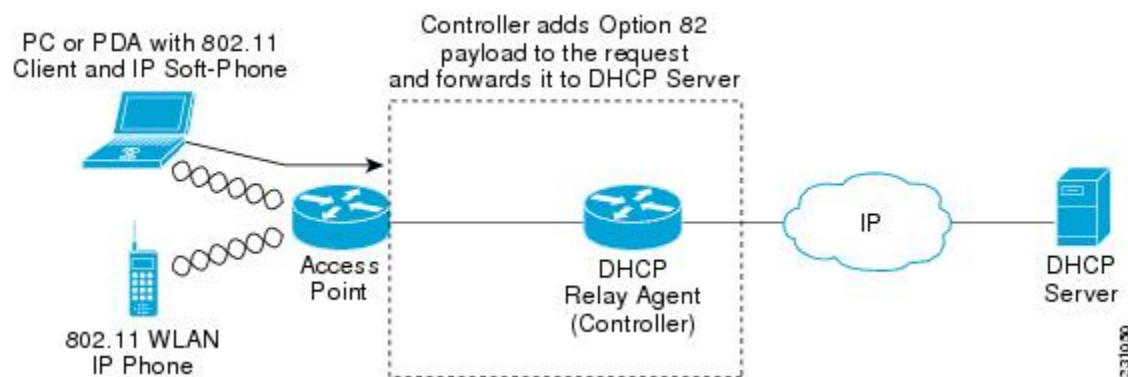

The AP forwards all the DHCP requests from a client to the controller. The controller adds the DHCP option 82 payload and forwards the request to the DHCP server. The payload can contain the MAC address or the MAC address and SSID of the AP, depending on how you configure this option.



---

**Note** DHCP packets that already include a relay agent option are dropped at the controller.

---

For DHCP option 82 to operate correctly, DHCP proxy must be enabled.

## Restrictions for Configuring DHCP for WLANs

- If you override the DHCP server in a WLAN, you must ensure that you configure the underlying Cisco IOS configuration to make sure that the DHCP server is reachable.
- WLAN DHCP override works only if DHCP service is enabled on the controller.

You can configure DHCP service in either of the following ways:

- Configuring the DHCP pool on the controller.
- Configuring a DHCP relay agent on the SVI. Note that the VLAN of the SVI must be mapped to the WLAN where DHCP override is configured.

## Guidelines for DHCP Relay Configuration

### Relay Agent Source IP

- If you configure source interface VLAN in the SVI interface, the IP address of the VLAN interface configured as source is used.
- If the Relay Agent source IP is not mentioned, the IP address of the SVI interface created for the corresponding client's VLAN is used.
- If the Relay Agent source IP is not mentioned, the source address specified at the global level is used.



- 
- Note**
- The DHCP packets are sourced from the IP address of the Wireless Management Interface (WMI), if VLAN is not configured in the policy profile and AAA override.
  - The SVI interface configuration is mandatory to achieve the DHCP relay functionality in central DHCP or local switching.
  - Even though many interface options are available in the **ip dhcp relay source-interface <>** command, only VLAN interface is applicable.
- 

### DHCP Server

- If the DHCP server address is configured in the wireless policy profile, the server address configured in the policy profile takes precedence.

- If the DHCP server address is not configured in the policy profile, the server address configured in SVI takes precedence.



---

**Note** You can configure two server addresses in the SVI. In this case, the DHCP packets from the client are sent to both the servers.

The Option 82 configured in policy profile, SVI, and globally is considered and honored together.

---

# How to Configure DHCP for WLANs

## Configuring DHCP Scopes (GUI)

### Procedure

---

- Step 1** Choose **Administration > DHCP Pools**.
- Step 2** In the **Pools** section, click **Add** to add a new DHCP pool.  
The **Create DHCP Pool** dialog box is displayed.
- Step 3** In the **DHCP Pool Name** field, enter a name for the new DHCP pool.
- Step 4** From the **IP Type** drop-down list, choose the IP address type.
- Step 5** In the **Network** field, enter the network served by this DHCP scope. This IP address is used by the management interface with netmask applied, as configured in the **Interfaces** window.
- Step 6** In the **Subnet Mask** field, enter the subnet mask assigned to all the wireless clients.
- Step 7** In the **Starting ip** field, enter the starting IP address.
- Step 8** In the **Ending ip** field, enter the trailing IP address.
- Step 9** In the **Reserved Only** field, enable or disable it.
- Step 10** From the **Lease** drop-down list, choose the lease type as either **User Defined** or **Never Expires**. If you choose User Defined, you can enter the amount of time that an IP address is granted to a client.
- Step 11** To perform advanced configuration for DHCP scope, click **Advanced**.
- Step 12** Check the **Enable DNS Proxy** check box to enable DNS proxy.
- Step 13** In the **Default Router(s)** field, enter the IP address of the optional router or routers that connect to the device and click the + icon to add them to the list. Each router must include a DHCP forwarding agent that enables a single device to serve the clients of multiple devices.
- Step 14** In the **DNS Server(s)** field, enter the IP address of the optional DNS server or servers and click the + icon to add them to the list. Each DNS server must be able to update a client's DNS entry to match the IP address assigned by the DHCP scope.
- Step 15** In the **NetBios Name Server(s)** field, enter the IP address of the optional Microsoft NetBIOS name server or servers, such as Microsoft Windows Internet Naming Service (WINS) server, and click the + icon to add them to the list.

- Step 16** In the **Domain** field, enter the optional domain name of the DHCP scope for use with one or more DNS servers.
- Step 17** To add **DHCP** options, click **Add** in the **DHCP Options List** section. DHCP provides an internal framework for passing configuration parameters and other control information, such as DHCP options, to the clients on your network. DHCP options carry parameters as tagged data stored within protocol messages exchanged between the DHCP server and its clients.
- Step 18** Enter the **DHCP** option that you want to add.
- Step 19** Click **Save & Apply to Device**.

## Configuring DHCP Scopes (CLI)

### Procedure

	Command or Action	Purpose
<b>Step 1</b>	<b>configure terminal</b> <b>Example:</b> Device# configure terminal	Enters global configuration mode.
<b>Step 2</b>	<b>ip dhcp pool <i>pool-name</i></b> <b>Example:</b> Device(config)# ip dhcp pool test-pool	Configures the DHCP pool address.
<b>Step 3</b>	<b>network <i>network-name mask-address</i></b> <b>Example:</b> Device(dhcp-config)# network 209.165.200.224 255.255.255.0	Specifies the network number in dotted-decimal notation and the mask address.
<b>Step 4</b>	<b>dns-server <i>hostname</i></b> <b>Example:</b> Device(dhcp-config)# dns-server example.com	Specifies the DNS name server. You can specify an IP address or a hostname.
<b>Step 5</b>	<b>end</b> <b>Example:</b> Device(dhcp-config)# end	Returns to privileged EXEC mode.

# Configuring the Internal DHCP Server

## Configuring the Internal DHCP Server Under Client VLAN SVI (GUI)

### Procedure

- 
- Step 1** Choose **Configuration > Layer2 > VLAN > SVI**.
  - Step 2** Click an SVI.
  - Step 3** Click the **Advanced** tab.
  - Step 4** Under **DHCP Relay** settings, enter the **IPv4 Helper Address**.
  - Step 5** Click **Update & Apply to Device**.
- 

## Configuring the Internal DHCP Server Under Client VLAN SVI (CLI)

### Before you begin

- For wireless clients, only two DHCP servers are supported.
- To use the internal DHCP server for both wireless and wired client VLAN, an IP address must be configured under the client VLAN SVI.
- For wireless clients, the IP address of the internal DHCP server must be different from the address of the wireless client VLAN SVI (in the DHCP helper address configuration).
- For wireless clients, the internal DHCP server can be configured under the client VLAN SVI or under the wireless policy profile.

### Procedure

	Command or Action	Purpose
<b>Step 1</b>	<b>configure terminal</b>  <b>Example:</b> Device# configure terminal	Enters global configuration mode.
<b>Step 2</b>	<b>interface loopback</b> <i>interface-number</i>  <b>Example:</b> Device(config)# interface Loopback0	Creates a loopback interface and enters interface configuration mode.
<b>Step 3</b>	<b>ip address</b> <i>ip-address</i>  <b>Example:</b> Device(config-if)# ip address 10.10.10.1 255.255.255.255	Configures the IP address for the interface.

	Command or Action	Purpose
<b>Step 4</b>	<b>exit</b> <b>Example:</b> Device(config-if)# exit	Exits interface configuration mode.
<b>Step 5</b>	<b>interface vlan <i>vlan-id</i></b> <b>Example:</b> Device(config)# interface vlan 32	Configures the VLAN ID.
<b>Step 6</b>	<b>ip address <i>ip-address</i></b> <b>Example:</b> Device(config-if)# ip address 192.168.32.100 255.255.255.0	Configures the IP address for the interface.
<b>Step 7</b>	<b>ip helper-address <i>ip-address</i></b> <b>Example:</b> Device(config-if)# ip helper-address 10.10.10.1	Configures the destination address for UDP broadcasts. <b>Note</b> If the IP address used in the <b>ip helper-address</b> command is an internal address of the controller an internal DHCP server is used. Otherwise, the external DHCP server is used.
<b>Step 8</b>	<b>no mop enabled</b> <b>Example:</b> Device(config-if)# no mop enabled	Disables the Maintenance Operation Protocol (MOP) for an interface.
<b>Step 9</b>	<b>no mop sysid</b> <b>Example:</b> Device(config-if)# no mop sysid	Disables the task of sending MOP periodic system ID messages.
<b>Step 10</b>	<b>exit</b> <b>Example:</b> Device(config-if)# exit	Exits interface configuration mode.
<b>Step 11</b>	<b>ip dhcp excluded-address <i>ip-address</i></b> <b>Example:</b> Device(config)# ip dhcp excluded-address 192.168.32.1	Specifies the IP address that the DHCP server should not assign to DHCP clients.
<b>Step 12</b>	<b>ip dhcp excluded-address <i>ip-address</i></b> <b>Example:</b> Device(config)# ip dhcp excluded-address 192.168.32.100	Specifies the IP addresses that the DHCP server should not assign to DHCP clients.



	Command or Action	Purpose
<b>Step 13</b>	<b>ip dhcp pool</b> <i>pool-name</i> <b>Example:</b> Device(config)# ip dhcp pool pool-vlan32	Configures the DHCP pool address.
<b>Step 14</b>	<b>network</b> <i>network-name mask-address</i> <b>Example:</b> Device(dhcp-config)# network 192.168.32.0 255.255.255.0	Specifies the network number in dotted-decimal notation, along with the mask address.
<b>Step 15</b>	<b>default-router</b> <i>ip-address</i> <b>Example:</b> Device(dhcp-config)# default-router 192.168.32.1	Specifies the IP address of the default router for a DHCP client.
<b>Step 16</b>	<b>exit</b> <b>Example:</b> Device(dhcp-config)# exit	Exits DHCP configuration mode.
<b>Step 17</b>	<b>wireless profile policy</b> <i>profile-policy</i> <b>Example:</b> Device(config)# wireless profile policy default-policy-profile	Configures the WLAN policy profile and enters wireless policy configuration mode.
<b>Step 18</b>	<b>central association</b> <b>Example:</b> Device(config-wireless-policy)# central association	Configures central association for locally switched clients.
<b>Step 19</b>	<b>central dhcp</b> <b>Example:</b> Device(config-wireless-policy)# central dhcp	Configures the central DHCP for locally switched clients.
<b>Step 20</b>	<b>central switching</b> <b>Example:</b> Device(config-wireless-policy)# central switching	Configures WLAN for central switching.
<b>Step 21</b>	<b>description</b> <i>policy-profile-name</i> <b>Example:</b> Device(config-wireless-policy)# description "default policy profile"	Adds a description for the policy profile
<b>Step 22</b>	<b>vlan</b> <i>vlan-name</i> <b>Example:</b> Device(config-wireless-policy)# vlan 32	Assigns the profile policy to the VLAN.

	Command or Action	Purpose
<b>Step 23</b>	<b>no shutdown</b>  <b>Example:</b> Device(config-wireless-policy)# no shutdown	Enables the wireless profile policy.

## Configuring the Internal DHCP Server Under a Wireless Policy Profile (GUI)

### Procedure

- 
- Step 1** Choose **Configuration > Tags & Profiles > Policy**.
  - Step 2** Click a policy name.
  - Step 3** Click the **Advanced** tab.
  - Step 4** Under **DHCP** settings, check or uncheck the **IPv4 DHCP Required** check box and enter the **DHCP Server IP Address**.
  - Step 5** Click **Update & Apply to Device**.
- 

## Configuring the Internal DHCP Server Under a Wireless Policy Profile

### Procedure

	Command or Action	Purpose
<b>Step 1</b>	<b>configure terminal</b>  <b>Example:</b> Device# configure terminal	Enters global configuration mode.
<b>Step 2</b>	<b>interface loopback <i>interface-number</i></b>  <b>Example:</b> Device(config)# interface Loopback0	Creates a loopback interface and enters interface configuration mode.
<b>Step 3</b>	<b>ip address <i>ip-address</i></b>  <b>Example:</b> Device(config-if)# ip address 10.10.10.1 255.255.255.255	Configures the IP address for the interface.
<b>Step 4</b>	<b>exit</b>  <b>Example:</b> Device(config-if)# exit	Exits interface configuration mode.
<b>Step 5</b>	<b>interface vlan <i>vlan-id</i></b>  <b>Example:</b>	Configures the VLAN ID.

	Command or Action	Purpose
	Device(config)# interface vlan 32	
<b>Step 6</b>	<b>ip address</b> <i>ip-address</i> <b>Example:</b> Device(config-if)# ip address 192.168.32.100 255.255.255.0	Configures the IP address for the interface.
<b>Step 7</b>	<b>no mop enabled</b> <b>Example:</b> Device(config-if)# no mop enabled	Disables the Maintenance Operation Protocol (MOP) for an interface.
<b>Step 8</b>	<b>no mop sysid</b> <b>Example:</b> Device(config-if)# no mop sysid	Disables the task of sending MOP periodic system ID messages.
<b>Step 9</b>	<b>exit</b> <b>Example:</b> Device(config-if)# exit	Exits interface configuration mode.
<b>Step 10</b>	<b>ip dhcp excluded-address</b> <i>ip-address</i> <b>Example:</b> Device(config)# ip dhcp excluded-address 192.168.32.100	Specifies the IP address that the DHCP server should not assign to DHCP clients.
<b>Step 11</b>	<b>ip dhcp pool</b> <i>pool-name</i> <b>Example:</b> Device(config)# ip dhcp pool pool-vlan32	Configures the DHCP pool address.
<b>Step 12</b>	<b>network</b> <i>network-name mask-address</i> <b>Example:</b> Device(dhcp-config)# network 192.168.32.0 255.255.255.0	Specifies the network number in dotted-decimal notation along with the mask address.
<b>Step 13</b>	<b>default-router</b> <i>ip-address</i> <b>Example:</b> Device(dhcp-config)# default-router 192.168.32.1	Specifies the IP address of the default router for a DHCP client.
<b>Step 14</b>	<b>exit</b> <b>Example:</b> Device(dhcp-config)# exit	Exits DHCP configuration mode.
<b>Step 15</b>	<b>wireless profile policy</b> <i>profile-policy</i> <b>Example:</b> Device(config)# wireless profile policy default-policy-profile	Configures a WLAN policy profile and enters wireless policy configuration mode.

	Command or Action	Purpose
<b>Step 16</b>	<b>central association</b> <b>Example:</b> Device(config-wireless-policy)# central association	Configures central association for locally switched clients.
<b>Step 17</b>	<b>central switching</b> <b>Example:</b> Device(config-wireless-policy)# central switching	Configures local switching.
<b>Step 18</b>	<b>description <i>policy-profile-name</i></b> <b>Example:</b> Device(config-wireless-policy)# description "default policy profile"	Adds a description for the policy profile.
<b>Step 19</b>	<b>ipv4 dhcp opt82</b> <b>Example:</b> Device(config-wireless-policy)# ipv4 dhcp opt82	Enables DHCP Option 82 for the wireless clients.
<b>Step 20</b>	<b>ipv4 dhcp opt82 ascii</b> <b>Example:</b> Device(config-wireless-policy)# ipv4 dhcp opt82 ascii	Enables ASCII on DHCP Option 82.
<b>Step 21</b>	<b>ipv4 dhcp opt82 format <i>vlan_id</i></b> <b>Example:</b> Device(config-wireless-policy)# ipv4 dhcp opt82 format vlan32	Enables VLAN ID.
<b>Step 22</b>	<b>ipv4 dhcp opt82 rid <i>vlan_id</i></b> <b>Example:</b> Device(config-wireless-policy)# ipv4 dhcp opt82 rid	Supports the addition of Cisco 2-byte Remote ID (RID) for DHCP Option 82.
<b>Step 23</b>	<b>ipv4 dhcp server <i>ip-address</i></b> <b>Example:</b> Device(config-wireless-policy)# ipv4 dhcp server 10.10.10.1	Configures the WLAN's IPv4 DHCP server.
<b>Step 24</b>	<b>vlan <i>vlan-name</i></b> <b>Example:</b> Device(config-wireless-policy)# vlan 32	Assigns the profile policy to the VLAN.
<b>Step 25</b>	<b>no shutdown</b> <b>Example:</b>	Enables the wireless profile policy.

	Command or Action	Purpose
	Device(config-wireless-policy)# no shutdown	

## Configuring the Internal DHCP Server Globally (GUI)

### Procedure

- 
- Step 1** Choose **Administration > DHCP Pools > Pools**.
- Step 2** Click **Add**.  
The **Create DHCP Pool** window is displayed.
- Step 3** Enter the **DHCP Pool Name**, **Network**, **Starting ip**, and **Ending ip**.
- Step 4** From the **IP Type**, **Subnet Mask**, and **Lease** drop-down lists, choose a value.
- Step 5** Click the **Reserved Only** toggle button.
- Step 6** Click **Apply to Device**.
- 

## Configuring the Internal DHCP Server Globally (CLI)

### Procedure

	Command or Action	Purpose
<b>Step 1</b>	<b>configure terminal</b> <b>Example:</b> Device# configure terminal	Enters global configuration mode.
<b>Step 2</b>	<b>interface loopback <i>interface-num</i></b> <b>Example:</b> Device(config)# interface Loopback0	Creates a loopback interface and enters interface configuration mode.
<b>Step 3</b>	<b>ip address <i>ip-address</i></b> <b>Example:</b> Device(config-if)# ip address 10.10.10.1 255.255.255.255	Configures the IP address for the interface.
<b>Step 4</b>	<b>exit</b> <b>Example:</b> Device(config-if)# exit	Exits interface configuration mode.
<b>Step 5</b>	<b>interface vlan <i>vlan-id</i></b> <b>Example:</b> Device(config)# interface vlan 32	Configures the VLAN ID.

	<b>Command or Action</b>	<b>Purpose</b>
<b>Step 6</b>	<b>ip address</b> <i>ip-address</i> <b>Example:</b> Device(config-if)# ip address 192.168.32.100 255.255.255.0	Configures the IP address for the interface.
<b>Step 7</b>	<b>no mop enabled</b> <b>Example:</b> Device(config-if)# no mop enabled	Disables the Maintenance Operation Protocol (MOP) for an interface.
<b>Step 8</b>	<b>no mop sysid</b> <b>Example:</b> Device(config-if)# no mop sysid	Disables the task of sending the MOP periodic system ID messages.
<b>Step 9</b>	<b>exit</b> <b>Example:</b> Device(config-if)# exit	Exits the interface configuration mode.
<b>Step 10</b>	<b>ip dhcp-server</b> <i>ip-address</i> <b>Example:</b> Device(config)# ip dhcp-server 10.10.10.1	Specifies the target DHCP server parameters.
<b>Step 11</b>	<b>ip dhcp excluded-address</b> <i>ip-address</i> <b>Example:</b> Device(config)# ip dhcp excluded-address 192.168.32.100	Specifies the IP address that the DHCP server should not assign to DHCP clients.
<b>Step 12</b>	<b>ip dhcp pool</b> <i>pool-name</i> <b>Example:</b> Device(config)# ip dhcp pool pool-vlan32	Configures the DHCP pool address.
<b>Step 13</b>	<b>network</b> <i>network-name mask-address</i> <b>Example:</b> Device(dhcp-config)# network 192.168.32.0 255.255.255.0	Specifies the network number in dotted-decimal notation along with the mask address.
<b>Step 14</b>	<b>default-router</b> <i>ip-address</i> <b>Example:</b> Device(dhcp-config)# default-router 192.168.32.1	Specifies the IP address of the default router for a DHCP client.
<b>Step 15</b>	<b>exit</b> <b>Example:</b> Device(dhcp-config)# exit	Exits DHCP configuration mode.

	Command or Action	Purpose
<b>Step 16</b>	<b>wireless profile policy</b> <i>profile-policy</i> <b>Example:</b> Device(config)# wireless profile policy default-policy-profile	Configures a WLAN policy profile and enters wireless policy configuration mode.
<b>Step 17</b>	<b>central association</b> <b>Example:</b> Device(config-wireless-policy)# central association	Configures central association for locally switched clients.
<b>Step 18</b>	<b>central dhcp</b> <b>Example:</b> Device(config-wireless-policy)# central dhcp	Configures central DHCP for locally switched clients.
<b>Step 19</b>	<b>central switching</b> <b>Example:</b> Device(config-wireless-policy)# central switching	Configures local switching.
<b>Step 20</b>	<b>description</b> <i>policy-profile-name</i> <b>Example:</b> Device(config-wireless-policy)# description "default policy profile"	Adds a description for the policy profile.
<b>Step 21</b>	<b>vlan</b> <i>vlan-name</i> <b>Example:</b> Device(config-wireless-policy)# vlan 32	Assigns the profile policy to the VLAN.
<b>Step 22</b>	<b>no shutdown</b> <b>Example:</b> Device(config-wireless-policy)# no shutdown	Enables the profile policy.

## Verifying Internal DHCP Configuration

To verify client binding, use the following command:

```
Device# show ip dhcp binding
```

```
Bindings from all pools not associated with VRF:
IP address      Client-ID/          Lease expiration    Type      State
Interface
                Hardware address/
                User name
192.168.32.3    0130.b49e.491a.53   Mar 23 2018 06:42 PM Automatic Active
Loopback0
```

To verify the DHCP relay statistics for a wireless client, use the following command:

```
Device# show wireless dhcp relay statistics
```

```
DHCP Relay Statistics
-----

DHCP Server IP : 10.10.10.1

Message                Count
-----
DHCPDISCOVER          : 1
BOOTP FORWARD         : 137
BOOTP REPLY           : 0
DHCPOFFER             : 0
DHCPREQUEST           : 54
DHCPACK               : 0
DHCPNAK               : 0
DHCPEDECLINE         : 0
DHCPRELEASE           : 0
DHCPINFORM            : 82

Tx/Rx Time :
-----
LastTxTime : 18:42:18
LastRxTime : 00:00:00

Drop Counter :
-----
TxDropCount : 0
```

To verify the DHCP packet punt statistics in CPP, use the following command:

```
Device# show platform hardware chassis active qfp feature wireless punt statistics
```

```
CPP Wireless Punt stats:
```

App Tag	Packet Count
-----	-----
CAPWAP_PKT_TYPE_DOT11_PROBE_REQ	14442
CAPWAP_PKT_TYPE_DOT11_MGMT	50
CAPWAP_PKT_TYPE_DOT11_IAPP	9447
CAPWAP_PKT_TYPE_DOT11_RFID	0
CAPWAP_PKT_TYPE_DOT11_RRM	0
CAPWAP_PKT_TYPE_DOT11_DOT1X	0
CAPWAP_PKT_TYPE_CAPWAP_KEEPALIVE	2191
CAPWAP_PKT_TYPE_MOBILITY_KEEPALIVE	0
CAPWAP_PKT_TYPE_CAPWAP_CNTRL	7034
CAPWAP_PKT_TYPE_CAPWAP_DATA	0
CAPWAP_PKT_TYPE_MOBILITY_CNTRL	0
WLS_SMD_WEBAUTH	0
SISF_PKT_TYPE_ARP	5292
SISF_PKT_TYPE_DHCP	140
SISF_PKT_TYPE_DHCP6	1213
SISF_PKT_TYPE_IPV6_ND	350
SISF_PKT_TYPE_DATA_GLEAN	44
SISF_PKT_TYPE_DATA_GLEAN_V6	51
SISF_PKT_TYPE_DHCP_RELAY	122
CAPWAP_PKT_TYPE_CAPWAP_RESERVED	0



# Configuring DHCP-Required for FlexConnect

## Information About FlexConnect DHCP-Required

The DHCP-Required knob on a policy profile forces a connected wireless client to get the IP address from DHCP. When the client completes the DHCP process and acquires an IP address, this IP address is learnt by the controller and only then the client traffic is switched on to the network. The DHCP-Required feature is already supported in central switching.

In Cisco IOS XE Amsterdam 17.2.1, the feature is supported on FlexConnect local switching clients. Prior to Release 17.2.1, DHCP-Required was not enforced on FlexConnect local switching clients. The IP address learnt by the AP or the controller for the wireless client is tracked to create an IP-MAC binding. As part of this feature, when a FlexConnect local switching client roams from one AP to another, the client need not do the DHCP again in the same L2 network, because the controller tracks the IP address and pushes the binding to the newly roaming AP.

The FlexConnect DHCP-Required feature can be configured from open configuration models, CLI, and from the GUI. The CLI and GUI configurations are described in this chapter. For more information about the open configuration modes, see the [https://www.cisco.com/c/en/us/td/docs/ios-xml/ios/prog/configuration/172/b\\_172\\_programmability\\_cg.html](https://www.cisco.com/c/en/us/td/docs/ios-xml/ios/prog/configuration/172/b_172_programmability_cg.html).

## Restrictions and Limitations for FlexConnect DHCP-Required

The following are the restrictions and limitations for the FlexConnect DHCP-Required feature:

- The DHCP-Required feature is applicable for IPv4 addresses only.
- The IP-MAC binding can be pushed to other APs only through the custom policy profile. IP-MAC binding is not available in the default policy. The mapping is propagated to all the APs in the same custom policy profile.
- The DHCP-Required feature works on IP-MAC binding basis and is not supported with third party workgroup bridge (WGB), where WGB wired client information is not shared to AP by the WGB.
- Cisco Wave 2 APs take 180 seconds to remove a client entry with static IP, when DHCP-required is enabled.

## Configuring FlexConnect DHCP-Required (GUI)

Perform the steps given below to configure the FlexConnect DHCP-Required feature through the GUI:

### Procedure

- 
- Step 1** Choose **Configuration > Tags & Profiles > Policy**.
  - Step 2** On the **Policy** window, click the name of the corresponding Policy Profile. The **Edit Policy Profile** window is displayed.
  - Step 3** Click the **Advanced** tab.

- Step 4** In the **DHCP** section, check the **IPv4 DHCP Required** check box to enable the feature.
- Step 5** Click **Update & Apply to Device**.

## Configuring FlexConnect DHCP-Required (CLI)

Perform the procedure given below to configure FlexConnect DHCP-Required through the CLI:

### Procedure

	Command or Action	Purpose
<b>Step 1</b>	<b>configure terminal</b>  <b>Example:</b> Device#configure terminal	Enters global configuration mode.
<b>Step 2</b>	<b>wireless profile policy <i>profile-policy</i></b>  <b>Example:</b> Device#wireless profile policy rr-xyz-policy-1	Configures WLAN policy profile and enters the wireless policy configuration mode.
<b>Step 3</b>	<b>ipv4 dhcp required</b>  <b>Example:</b> Device(config-wireless-policy)#ipv4 dhcp required	Enables the FlexConnect DHCP-Required feature.
<b>Step 4</b>	<b>no shutdown</b>  <b>Example:</b> Device(config-wireless-policy)#no shutdown	Saves the configuration.

## Verifying FlexConnect DHCP-Required

- To verify the IP address learnt for a client on an IP DHCP-Required policy-enabled WLAN, use the **show wireless client summary** command:



**Note** The controller or AP does not learn the IP address through other means such as ARP or data gleaning, when IPv4 DHCP-Required is enabled.

```
Device# show wireless client summary
Number of Clients: 1
MAC Address          AP Name              Type ID State      Protocol  Method
Role
-----
1cXX.bXXX.59XX      APXXXX.7XXX.4XXX   WLAN 3   IP Learn  11ac     Dot1x
Local
```

- This example shows that the client IP is in the **Run** state, indicating that the client has received the IP address from DHCP:

```
Device# show wireless client summary
```

```
Number of Clients: 1
```

MAC Address	AP Name	Type	ID	State	Protocol
Method	Role				
5XXX.37XX.c3XX	APXXXX.4XXX.4XXX	WLAN	3	Run	11n (5)
None	Local				





## CHAPTER 176

# Aironet Extensions IE (CCX IE)

---

- [Information About Aironet Extensions Information Element](#) , on page 1707
- [Configuring Aironet Extensions IE \(GUI\)](#), on page 1707
- [Configuring Aironet Extensions IE \(CLI\)](#), on page 1707
- [Verifying the Addition of AP Name](#), on page 1708

## Information About Aironet Extensions Information Element

The Cisco Aironet Extensions Information Element (IE) is an attribute used by Cisco devices for better connectivity. It contains information such as the AP name, device type, radio type, AP load, and the number of associated clients, in the beacon and probe responses of the WLAN. The Cisco Client Extensions use this information to associate with the best AP.

The Aironet Extensions IE configuration is disabled by default. With this feature you can set the AP name not through enabling the whole IE extension, but by just inserting just the AP name.

## Configuring Aironet Extensions IE (GUI)

### Procedure

---

- Step 1** Choose **Configuration** > **Tags & Profiles** > **WLANs** .
  - Step 2** In the **WLANs** window, click **Add**.
  - Step 3** In the **Add WLAN** window, under the **Advanced** tab, check the **Aironet IE** check box to enable Aironet IE on the WLAN.
  - Step 4** Click **Apply to Device**.
- 

## Configuring Aironet Extensions IE (CLI)

Perform this procedure to create a WLAN and enable the Aironet Extensions IE feature on the WLAN:



**Note** For more information about the open configuration models, refer to the Programmability Configuration Guide, Cisco IOS XE Amsterdam 17.1.x.

### Procedure

	Command or Action	Purpose
<b>Step 1</b>	<b>configure terminal</b> <b>Example:</b> Device# configure terminal	Enters global configuration mode.
<b>Step 2</b>	<b>wlan profile-name wlan-id [ssid]</b> <b>Example:</b> Device(config)# wlan mywlan 34 mywlan-ssid	Specifies the WLAN name and ID: <ul style="list-style-type: none"> <li>• <i>profile-name</i>: Profile name. The range is from 1 to 32 alphanumeric characters.</li> <li>• <i>wlan-id</i>: WLAN ID. The range is from 1 to 512.</li> <li>• <i>ssid</i>: Service Set Identifier (SSID) for this WLAN. If the SSID is not specified, the WLAN profile name is set as the SSID.</li> </ul> <p><b>Note</b> By default, the WLAN is disabled.</p>
<b>Step 3</b>	<b>[no] ccx aironet-iesupport</b> <b>Example:</b> Device(config-wlan)#ccx aironet-iesupport	Configures the Cisco Client Extensions option and sets the support of Aironet IE on the WLAN. (Use the <b>no</b> form of this command to disable the configuration.)

### What to do next

1. Create a policy tag. For more information about creating policy tags, refer to *Configuring a Policy Tag (CLI)*.
2. Map the policy tag to the AP. For more information about mapping a policy tag to the AP, refer to *Attaching a Policy Tag and Site Tag to an AP (CLI)*.

## Verifying the Addition of AP Name

The following example shows how to verify the addition of the AP Name (using Open Configuration) in the beacon without enabling IE:

```
Device# show wlan id 1
WLAN Profile Name      : wlan-test
=====
Identifier              : 1
```

```
Description :
Network Name (SSID) : wlan2
Status : Disabled
Broadcast SSID : Enabled
Advertise-Apname : Enabled
Universal AP Admin : Disabled
Max Associated Clients per WLAN : 0
Max Associated Clients per AP per WLAN : 0
Max Associated Clients per AP Radio per WLAN : 200
OKC : Enabled
Number of Active Clients : 0
CHD per WLAN : Enabled
WMM : Allowed
Channel Scan Defer Priority:
  Priority (default) : 5
  Priority (default) : 6
Scan Defer Time (msecs) : 100
Media Stream Multicast-direct : Disabled
CCX - AironetIe Support : Enabled
Peer-to-Peer Blocking Action : Disabled
```







## CHAPTER 177

# Device Analytics

---

- [Device Analytics](#), on page 1711
- [Adaptive 802.11r](#), on page 1715

## Device Analytics

### Information About Device Analytics

The Device Analytics feature enhances the enterprise Wi-Fi experience for client devices to ensure seamless connectivity. This feature provides a set of data analytics tools for analyzing wireless client device behavior. With device profiling enabled on the controller, information is exchanged between the client device and the controller and AP. This data is encrypted using AES-256-CBC to ensure device security.

Starting from Cisco IOS XE Bengaluru 17.6.1, this feature is supported on Intel devices with AC9560, AC8561, AX201, AX200, AX1650, AX210, AX211, and AX1675 chipsets. Device information and other information received from the Intel devices are shared with Cisco Catalyst Center. It will also be used to enhance device profiling on the controller.



---

**Note** Apple clients such as iPhones and iPads use 802.11k action frames to send device information to the controller. When they fail to send 802.11k action frames, the controller will not perform device classification based on the 802.11 protocol. Hence, this falls back to legacy device classification which is based on HTTP and DHCP protocols.

---

### Restrictions for Device Analytics

- This feature is applicable only for Cisco device ecosystem partners.
- This feature is supported only on the 802.11ax and Wave 2 APs.
- This feature is supported using central authentication in either local mode or FlexConnect mode.
- To support Intel devices, AP should have PMF capability and PMF should set to optional or required on the WLAN.

## Configuring Device Analytics (GUI)

### Procedure

- 
- Step 1** Choose **Configuration > Tags & Profiles > WLANs**.
- Step 2** On the **WLANs** page, click the name of the WLAN.
- Step 3** In the **Edit WLAN** window, click the **Advanced** tab.
- Step 4** In the **Device Analytics** section, select the **Advertise Support** check box.
- Step 5** Select the **Advertise PC Analytics Support** check box to enable PC analytics on the WLAN.
- Step 6** (Optional) In the **Device Analytics** section, select the **Share Data with Client** check box.
- Step 7** Click **Update & Apply to Device**.
- 

## Configuring Device Analytics (CLI)

### Procedure

	Command or Action	Purpose
<b>Step 1</b>	<b>configure terminal</b>  <b>Example:</b> Device# configure terminal	Enters global configuration mode.
<b>Step 2</b>	<b>wlan wlan-name wlan-id SSID-name</b>  <b>Example:</b> Device(config)# wlan device_analytics 1 device_analytics	Enters the WLAN configuration sub-mode. <ul style="list-style-type: none"> <li>• <i>wlan-name</i>—Enter the profile name. The range is from 1 to 32 alphanumeric characters.</li> <li>• <i>wlan-id</i>—Enter the WLAN ID. The range is from 1 to 512.</li> <li>• <i>SSID-name</i>—Enter the Service Set Identifier (SSID) for this WLAN. If the SSID is not specified, the WLAN profile name is set as the SSID.</li> </ul> <p><b>Note</b> If you have already configured WLAN, enter <b>wlan wlan-name</b> command.</p>
<b>Step 3</b>	<b>client association limit {clients-per-wlan   apclients-per-ap-per-wlan   radio clients-per-ap-radio-per-wlan}</b>  <b>Example:</b> Device(config)# client association limit 1 1	Sets the maximum number of clients, clients per AP, or clients per AP radio that can be configured on a WLAN.

	Command or Action	Purpose
<b>Step 4</b>	<b>[no] device-analytics</b> <b>Example:</b> Device(config)# device-analytics	This is enabled by default.  Enables or disables device analytics. WLANs advertise analytics capability in beacons & probe responses.
<b>Step 5</b>	<b>[no] device-analytics [export]</b> <b>Example:</b> Device(config)# device-analytics export	When <b>export</b> option is set, the information from Cisco devices are shared with compatible clients (such as, Samsung devices). Here, information from Cisco devices refer to the Cisco controller details, AP version, and model number.  This configuration is disabled by default.
<b>Step 6</b>	<b>device-analytics pc-analytics</b> <b>Example:</b> Device(config)# device-analytics pc-analytics	Enables PC analytics on the WLAN. WLANs advertise analytics capability in beacons & probe responses.
<b>Step 7</b>	<b>no shutdown</b> <b>Example:</b> Device(config)# no shutdown	Enables the WLAN.
<b>Step 8</b>	<b>end</b> <b>Example:</b> Device(config)# end	Returns to privileged EXEC mode.

## Verifying Device Analytics

### Procedure

- 
- Step 1** On the **Monitoring > Wireless > Clients** page, click on a client in the table to view its properties and statistics.
- Step 2** In the **General** tab, click on **Client Properties** to view the **PC Analytics** reports. This section displays the neighbor AP information, candidate BSSIDs, and reports for low RSSI, beacon miss, failed APs, and unknown APs.
- 

## Verifying Device Analytics Configuration

To view the status of device analytics export, use the following command:

```
Device# show wlan 1 test-wlan

WLAN Profile Name      : test-wlan
=====
Identifier              : 1
Description             :
```

```

Network Name (SSID)           : test-open-ssid
Status                         : Enabled
Broadcast SSID                 : Enabled
Advertise-Apname              : Disabled
Universal AP Admin             : Disabled

Device Analytics
  Advertise Support            : Enabled
  Share Data with Client       : Disabled

```

To view client device information, use the following command:

```

Device# show device classifier mac-address 0040.96ae.xxx detail

Client Mac: 0040.96ae.xxxx
Device Type: Samsung Galaxy S10e(Phone)
Confidence Level: 40
Device Name: android-dhcp-9
Software Version(Carrier Code): SD7(TMB)
Device OS: Android 9
Device Vendor: android-dhcp-9
Country: US

```

To view the last disconnect reason, use the following command:

```

Device# show device classifier mac-address 0040.96ae.xxxx detail

Client MAC Address : 0040.96ae.xxxx
Client IPv4 Address : 12.1.0.52
Client IPv6 Addresses : fe80::631b:5b4f:f9b6:53cc
Client Username: N/A
AP MAC Address : 7069.5a51.53c0
AP Name: AP4C77.6D9E.61B2
AP slot : 1
Client State : Associated

Assisted Roaming Neighbor List
Nearby AP Statistics:
EoGRE : No/Simple client
Last Disconnect Reason : User initiated disconnection - Device was powered off or Wi-Fi
turned off

```

To view the per client pc-analytics reports, use the following command:

```

Device# show wireless client mac-address 3413.e8b6.xxxx stats pc-analytics

-----
Neighbor APs Info:
-----
Reported time:: 06/21/2021 18:50:34
-----
Roaming Reasons:
-----
Selected AP RSSI:: -67
Candidate BSSIDs:
-----
Neighbor AP RSSI(dB)
a4b2.3903.d10e -70
-----
PC Analytics report stats
-----
-----
Report Type Processed Reports Dropped Reports

```

---

```
STA Info 1 0
Neigh AP 1 0
Low RSSI 0 0
Beacon Miss 0 0
Failed AP 0 0
Unknown APs 0 0
```

## Adaptive 802.11r

### Information About Adaptive 802.11r

The Cisco device ecosystem partner now supports 11r functionality on an adaptive 802.11r SSID. Samsung is one of the partners.



---

**Note** The Adaptive 802.11r is enabled by default. This means that when you create a WLAN, the adaptive 802.11r is configured by default.

---

Client device information such as its model number, supported operating system is shared with the controller and AP while the device receives information such as controller and AP type, software release, etc. Also, this enables 802.11r-compatible devices to benefit from adaptive 802.11r on Cisco networks. This ecosystem comes handy especially for troubleshooting device disconnection from the AP as the controller receives information such as the disconnect reason code from the client device.



---

**Note** Devices without 11r support cannot join an SSID where 11r is enabled.

---

To use the 11r functionality on devices, you need to create a separate SSID with 11r enabled and another with 11r disabled to support the non-11r devices in the network.

Adaptive dot11r is supported by Apple iPad, Apple iPhone, and Samsung S10 devices. However; some software update creates a MIC mismatch error in these devices. But these errors are transient and clients will successfully be able to associate to the SSID in subsequent results.

---

### Configuring Adaptive 802.11r (GUI)

#### Procedure

---

- Step 1** Choose **Configuration > Tags & Profiles > WLANs**.
- Step 2** On the **WLANs** page, click the name of the WLAN.
- Step 3** In the **Edit WLAN** window, click the **Security > Layer2** tab.
- Step 4** In the **WPA Parameters** section and **Fast Transition** drop-down list, choose **Adaptive Enabled**.

**Step 5** Click **Update & Apply to Device**.

---

## Verifying Adaptive 802.11r

To view the details, use the following command:

```
Device# show running-config all  
wlan test-psk 2 test-psk  
  security ft adaptive  
"adaptive" is optional
```



---

**Note** The following command is used to enable or disable adaptive 11r:

**[no] security ft adaptive**

The following command is used to enable or disable 802.11r:

**[no] security ft**

---



# CHAPTER 178

## BSSID Counters

- [BSSID Counters](#), on page 1717
- [Enabling BSSID Statistics and BSSID Neighbor Statistics](#), on page 1717
- [Verifying BSSID Statistics on the Controller](#), on page 1718

## BSSID Counters

This feature helps to retrieve the BSSID statistics when a client is associated with a WLAN for every configured interval. A new configuration is introduced in the controller per AP profile to enable or disable BSSID statistics on the access points. The feature is disabled by default.



**Note** BSSID counter is not supported on the Cisco Aironet 1800 series APs and Cisco Catalyst 9100 series APs.

## Enabling BSSID Statistics and BSSID Neighbor Statistics

### Procedure

	Command or Action	Purpose
<b>Step 1</b>	<b>configure terminal</b> <b>Example:</b> Device# configure terminal	Enters global configuration mode.
<b>Step 2</b>	<b>ap profile <i>ap-profile-name</i></b> <b>Example:</b> Device(config)# ap profile <i>ap-profile-name</i>	Enters the AP profile configuration submode. <i>ap-profile-name</i> is the profile name of the configured AP.
<b>Step 3</b>	<b>bssid-stats</b> <b>Example:</b> Device(config-ap-profile)#[no] bssid-stats	Enables BSSID statistics. Use the <b>no</b> form of the command to disable the feature.

	Command or Action	Purpose
<b>Step 4</b>	<b>bssid-stats bssid-stats-frequency</b> <i>bssid-timer-seconds</i>  <b>Example:</b> Device(config-ap-profile)# bssid-stats bssid-stats-frequency 40	Sets the BSSID stats frequency timer. BSSID statistics frequency timer is in the range of 1 to 180 seconds.
<b>Step 5</b>	<b>bssid-neighbor-stats</b>  <b>Example:</b> Device(config-ap-profile)# [no] bssid-neighbor-stats	Enables BSSID neighbor statistics. Use the <b>no</b> form of the command to disable the feature.
<b>Step 6</b>	<b>bssid-neighbor-stats interval</b> <i>bssid-interval</i> <i>&lt;1-180&gt;</i>  <b>Example:</b> Device(config-ap-profile)# [no] bssid-neighbor-stats interval 50	Sets the interval at which BSSID neighbor statistics is sent from the AP. The BSSID neighbor stats interval is in the range of 1 to 180 seconds.

## Verifying BSSID Statistics on the Controller

To verify the BSSID statistics on the controller, use the following command:

- **show wireless stats ap name** *ap-name* **dot11 24ghz slot** *0* **wlan-id** *<wlan-id>* **statistics**

```
Device# show wireless stats ap name APXXXX.6DXX.58XX dot11 24ghz slot 0 wlan-id 18 stat
BSSID           : 7069.5a38.112e
WLAN ID         : 18
Client Count    : 1
TX Statistics
```

```
-----
Mgmt           Retries      Data Bytes      Data Retries      Subframe Retries
-----
12             18           16081           18                 0
RX Statistics
```

```
-----
Mgmt           Data Bytes
```

```
-----
74             17693
```

```
Data Distribution
```

```
-----
Bytes           RX           TX
-----
0-64            55           93
65-128          66           40
129-256         21           5
257-512         10           3
513-1024        1            9
1025-2048       0            1
2049-4096       0            0
4097-8192       0            0
8193-16384      0            0
16385-32768     0            0
32769-65536     0            0
65537-131072    0            0
131073-262144  0            0
```



```

262145-524288          0          0
524289-1048576        0          0
WMM Statistics
-----

```

```

          RX          TX
-----
Voice          0          43
Video          0          0
Best Effort    154         39
Background     0          0
MCS
-----

```

```

MCS          RX          TX
-----
mcs0          39          0
mcs1           2          0
mcs2           5          0
mcs3           7          0
mcs4          25          0
mcs5          59          0
mcs6         290          0
mcs7         1148          3
mcs8         2288          0
mcs9         4440          2

```

• **show ap name *ap\_name* neighbor summary**

```
Device#show ap name APXXXX.6DXX.59XX neighbor summary
```

BSSID	Channel SSID	Channel-width	Slot	RSSI	Last-Heard Neighbour
0008.2f1c.8040 18:25:14	1 aprusty-un-dot1x	20 Mhz	0	-39	03/17/2020 FALSE
0008.2f1c.8041 18:25:14	1 aprusty-sim-11	20 Mhz	0	-39	03/17/2020 FALSE
0008.2f1c.8042 18:25:14	1 one-ph	20 Mhz	0	-39	03/17/2020 FALSE
0008.2f1c.8044 18:25:14	1 aprusty-test	20 Mhz	0	-38	03/17/2020 FALSE
0008.3296.f340 10:39:27	11 ewlc-ap-dot1x	20 Mhz	0	-51	03/18/2020 FALSE
0008.3296.f341 10:39:27	11 vewlc_small_psk	20 Mhz	0	-49	03/18/2020 FALSE
002a.1022.d950 18:25:14	1 ewlc-ap-dot1x	20 Mhz	0	-57	03/17/2020 FALSE
002a.105c.bfd0 18:25:14	1 ewlc-ap-dot1x	20 Mhz	0	-36	03/17/2020 FALSE
002a.105c.bfd1 18:25:14	1 vewlc_small_psk	20 Mhz	0	-37	03/17/2020 FALSE
002c.c864.76d0 10:37:37	11 rajwlan	20 Mhz	0	-61	03/18/2020 FALSE

```

BSSID          Channel  Channel-width Slot  RSSI          Last-Heard

```

		SSID			Neighbour	
002c.c8de.59e0 18:25:14	1	20 Mhz	0	-48	03/17/2020	FALSE
		WQ				
002c.c8de.5d80 10:39:27	11	20 Mhz	0	-54	03/18/2020	FALSE
		ewlc-ap-dot1x				
002c.c8de.5d81 10:39:27	11	20 Mhz	0	-55	03/18/2020	FALSE
		vewlc_small_psk				
002c.c8de.7260 10:39:27	11	20 Mhz	0	-53	03/18/2020	FALSE
		ewlc-ap-dot1x				
002c.c8de.7261 10:39:27	11	20 Mhz	0	-54	03/18/2020	FALSE
		vewlc_small_psk				
005d.7390.e1e0 18:25:14	1	20 Mhz	0	-54	03/17/2020	FALSE
		rlan				
006b.f114.95a0 18:25:14	1	20 Mhz	0	-60	03/17/2020	FALSE
		zavc				
006b.f114.b0e0 18:25:14	1	20 Mhz	0	-46	03/17/2020	FALSE
		ewlc-ap-dot1x				
006c.bc61.2340 18:24:44	1	20 Mhz	0	-63	03/17/2020	FALSE
		dnac-swim				
006c.bc72.5ce0 10:39:17	11	20 Mhz	0	-58	03/18/2020	FALSE
		dnac-swim				



# CHAPTER 179

## Fastlane+

- [Information About Fastlane+, on page 1721](#)
- [Configuring an Fastlane+ on a WLAN \(CLI\), on page 1721](#)
- [Configuring an Fastlane+ on a WLAN \(GUI\), on page 1722](#)
- [Monitoring Fastlane+, on page 1722](#)
- [Verifying Fastlane+, on page 1723](#)

### Information About Fastlane+

IEEE 802.11ax allows scheduled access-based uplink transmissions by periodically collecting buffer status reports from clients. The Fastlane+ feature improves the effectiveness of estimating the uplink buffer status for clients, thereby enhancing the user experience for latency-sensitive applications. The Fastlane+ feature can be enabled or disabled on a per-WLAN basis. Support for this feature is indicated in the beacons and probe responses transmitted by an AP.



**Note** This feature works only if Protected Management Frame (PMF) is configured as optional or mandatory for a WLAN.

### Configuring an Fastlane+ on a WLAN (CLI)

#### Procedure

	Command or Action	Purpose
<b>Step 1</b>	<b>configure terminal</b> <b>Example:</b> Device# configure terminal	Enters global configuration mode.
<b>Step 2</b>	<b>wlan profile-name wlan-id SSID_Name</b> <b>Example:</b>	Configures a WLAN and enters WLAN configuration submode.

	Command or Action	Purpose
	Device(config)# wlan wlan-test 3 ssid-test	<b>Note</b> If you have already configured a WLAN, enter the <b>wlan profile-name</b> command.
<b>Step 3</b>	<b>scheduler asr</b>  <b>Example:</b> Device(config-wlan)# scheduler asr	Configures Fastlane+ feature on a WLAN.

## Configuring an Fastlane+ on a WLAN (GUI)

### Procedure

- 
- Step 1** Choose **Configuration > Tags & Profiles > WLANs**.
  - Step 2** Select a WLAN.
  - Step 3** Click **Advanced** tab.
  - Step 4** Check the **Advanced Scheduling Requests Handling** check box to enable the feature on a per-WLAN basis.
  - Step 5** Click **Update & Apply to Device**.
- 

## Monitoring Fastlane+

### Procedure

- 
- Step 1** Choose **Monitoring > Wireless > Clients**.
  - Step 2** Click a client name from the client list.  
The **Client** window with multiple tabs is activated.
  - Step 3** Click **General** tab.
  - Step 4** Click **Client Statistics** tab.  
The most recent uplink latency statistics received from the client is displayed in the **Uplink Latency Distribution** section.
  - Step 5** Click **Client Properties** tab.  
The Fastlane+ feature-related client capabilities information is displayed at the bottom of the window.
-

## Verifying Fastlane+

The following example shows how to verify whether Fastlane+ is enabled or disabled for a WLAN:

```
Device# show wlan 2 | include ASR

Advanced Scheduling Requests Handling : Enabled
```

The following example shows how to verify Fastlane+ capability information and the most recent client uplink latency statistics:

```
Device# show wireless client mac-address f45c.89b0.xxxx detail
.
.
.
Regular ASR support: : ENABLED
Non-default Fastlane Profile: : Active
Range Voice Video Background Best-Effort
-----
[0-20ms] 400 300 200 100
[20-40ms] 401 301 201 101
[40-100ms] 402 302 202 102
[>100ms] 403 303 203 103
```

The following example shows how to verify Fastlane+ statistics along with Fastlane+ capability and uplink latency statistics for all the Fastlane+ clients on a WLAN.



**Note** `show interfaces dot11radio asr-info all` is an AP command, and does not work on the controller.

```
Device# show interfaces Dot11Radio 1 asr-info all

[*10/12/2020 18:45:21.0149]
[*10/12/2020 18:45:21.0150] Client-MAC:[26:52:CF:C8:D0:1C] AID:[3] ASR-Capability:[0x1]
[*10/12/2020 18:45:21.0150] BE- LAT[0-20]:[267] LAT[20-40]:[57] LAT[40-100]:[32]
LAT[>100]:[26]
[*10/12/2020 18:45:21.0150] BK- LAT[0-20]:[0] LAT[20-40]:[0] LAT[40-100]:[0] LAT[>100]:[0]
[*10/12/2020 18:45:21.0150] VI- LAT[0-20]:[0] LAT[20-40]:[0] LAT[40-100]:[0] LAT[>100]:[0]
[*10/12/2020 18:45:21.0150] VO- LAT[0-20]:[2222] LAT[20-40]:[409] LAT[40-100]:[224]
LAT[>100]:[163]
[*10/12/2020 18:45:21.0150]
[*10/12/2020 18:45:21.0206] HTT_PEER_DETAILS_TLV:
[*10/12/2020 18:45:21.0206] peer_type = 0
[*10/12/2020 18:45:21.0206] sw_peer_id = 98
[*10/12/2020 18:45:21.0206] vdev_id = 25
[*10/12/2020 18:45:21.0206] pdev_id = 0
[*10/12/2020 18:45:21.0206] ast_idx = 1187
[*10/12/2020 18:45:21.0206] mac_addr = 26:52:cf:c8:d0:1c
[*10/12/2020 18:45:21.0206] peer_flags = 0x200006f9
[*10/12/2020 18:45:21.0206] qpeer_flags = 0x8
[*10/12/2020 18:45:21.0206]
[*10/12/2020 18:45:21.0206] HTT_STATS_PEER_ASR_STATS_TLV
[*10/12/2020 18:45:21.0206] asr_bmap: 0x8
[*10/12/2020 18:45:21.0206] asr_muedca_update_cnt: 1
[*10/12/2020 18:45:21.0206] asr_muedca_reset_cnt: 1
[*10/12/2020 18:45:21.0206] asr_ul_mu_bsr_trigger: 2376
[*10/12/2020 18:45:21.0206] asr_min_trig_intv- BE:0 BK:0 VI:0 VO:19
[*10/12/2020 18:45:21.0206] asr_max_trig_intv- BE:0 BK:0 VI:0 VO:20
[*10/12/2020 18:45:21.0207] asr_min_alloc_rate- BE:0 BK:0 VI:0 VO:12
[*10/12/2020 18:45:21.0207] asr_ul_su_data_ppdu_cnt- BE:0 BK:0 VI:0 VO:2149
```

```

[*10/12/2020 18:45:21.0207] asr_ul_su_data_ppdu_bytes- BE:0          BK:0 VI:0 VO:757546
[*10/12/2020 18:45:21.0207] asr_ul_mu_trig_ppdu_cnt- BE:0          BK:0 VI:0 VO:5002
[*10/12/2020 18:45:21.0207] asr_ul_mu_trig_ppdu_bytes- BE:0          BK:0 VI:0 VO:2400960
[*10/12/2020 18:45:21.0207] asr_ul_mu_data_ppdu_cnt- BE:0          BK:0 VI:0 VO:2134
[*10/12/2020 18:45:21.0207] asr_ul_mu_data_ppdu_bytes- BE:0        BK:0 VI:0 VO:736578
[*10/12/2020 18:45:21.0207] asr_ul_mu_data_padding_bytes- BE:0     BK:0 VI:0 VO:2953488

```

The following examples show how to verify scheduling statistics along with capability and uplink latency statistics for a given client on a WLAN:



**Note** The `show interfaces dot11radio asr-info` is an AP command and it will not work on the controller.

```

Device# show interfaces Dot11Radio 1 asr-info 26:XX:CF:XX:D0:XX

[*10/12/2020 18:45:21.0149]
[*10/12/2020 18:45:21.0150] Client-MAC:[26:52:CF:C8:D0:1C] AID:[3] ASR-Capability:[0x1]
[*10/12/2020 18:45:21.0150] BE- LAT[0-20]:[267] LAT[20-40]:[57] LAT[40-100]:[32]
LAT[>100]:[26]
[*10/12/2020 18:45:21.0150] BK- LAT[0-20]:[0] LAT[20-40]:[0] LAT[40-100]:[0] LAT[>100]:[0]
[*10/12/2020 18:45:21.0150] VI- LAT[0-20]:[0] LAT[20-40]:[0] LAT[40-100]:[0] LAT[>100]:[0]
[*10/12/2020 18:45:21.0150] VO- LAT[0-20]:[2222] LAT[20-40]:[409] LAT[40-100]:[224]
LAT[>100]:[163]
[*10/12/2020 18:45:21.0150]
[*10/12/2020 18:45:21.0206] HTT_PEER_DETAILS_TLV:
[*10/12/2020 18:45:21.0206] peer_type = 0
[*10/12/2020 18:45:21.0206] sw_peer_id = 98
[*10/12/2020 18:45:21.0206] vdev_id = 25
[*10/12/2020 18:45:21.0206] pdev_id = 0
[*10/12/2020 18:45:21.0206] ast_idx = 1187
[*10/12/2020 18:45:21.0206] mac_addr = 26:xx:cf:xx:d0:xx
[*10/12/2020 18:45:21.0206] peer_flags = 0x200006f9
[*10/12/2020 18:45:21.0206] qpeer_flags = 0x8
[*10/12/2020 18:45:21.0206]
[*10/12/2020 18:45:21.0206] HTT_STATS_PEER_ASR_STATS_TLV
[*10/12/2020 18:45:21.0206] asr_bmap: 0x8
[*10/12/2020 18:45:21.0206] asr_muedca_update_cnt: 1
[*10/12/2020 18:45:21.0206] asr_muedca_reset_cnt: 1
[*10/12/2020 18:45:21.0206] asr_ul_mu_bsr_trigger: 2376
[*10/12/2020 18:45:21.0206] asr_min_trig_intv- BE:0          BK:0 VI:0 VO:19
[*10/12/2020 18:45:21.0206] asr_max_trig_intv- BE:0          BK:0 VI:0 VO:20
[*10/12/2020 18:45:21.0207] asr_min_alloc_rate- BE:0          BK:0 VI:0 VO:12
[*10/12/2020 18:45:21.0207] asr_ul_su_data_ppdu_cnt- BE:0          BK:0 VI:0 VO:2149
[*10/12/2020 18:45:21.0207] asr_ul_su_data_ppdu_bytes- BE:0          BK:0 VI:0 VO:757546
[*10/12/2020 18:45:21.0207] asr_ul_mu_trig_ppdu_cnt- BE:0          BK:0 VI:0 VO:5002
[*10/12/2020 18:45:21.0207] asr_ul_mu_trig_ppdu_bytes- BE:0          BK:0 VI:0 VO:2400960
[*10/12/2020 18:45:21.0207] asr_ul_mu_data_ppdu_cnt- BE:0          BK:0 VI:0 VO:2134
[*10/12/2020 18:45:21.0207] asr_ul_mu_data_ppdu_bytes- BE:0          BK:0 VI:0 VO:736578
[*10/12/2020 18:45:21.0207] asr_ul_mu_data_padding_bytes- BE:0     BK:0 VI:0 VO:2953488

```



# CHAPTER 180

## Workgroup Bridges

- [Cisco Workgroup Bridges, on page 1725](#)
- [Configuring Workgroup Bridge on a WLAN, on page 1727](#)
- [Verifying the Status of a Workgroup Bridge on the Controller, on page 1729](#)
- [Configuring Access Points as Workgroup Bridge, on page 1729](#)

## Cisco Workgroup Bridges

A workgroup bridge (WGB) is an Access Point (AP) mode to provide wireless connectivity to wired clients that are connected to the Ethernet port of the WGB AP. A WGB connects a wired network over a single wireless segment by learning the MAC addresses of its wired clients on the Ethernet interface and reporting them to the WLC through infrastructure AP using Internet Access Point Protocol (IAPP) messaging. The WGB establishes a single wireless connection to the root AP, which in turn, treats the WGB as a wireless client.

**Figure 47: Example of a WGB**

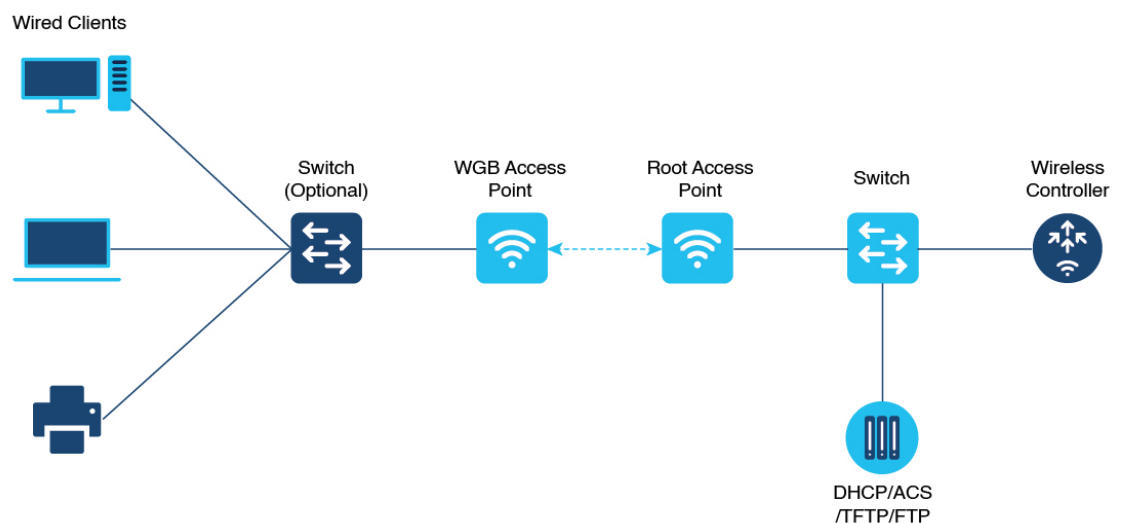

The following features are supported for use with a WGB:

**Table 91: WGB Feature Matrix**

Feature	Cisco Wave 1 APs	Cisco Wave 2
802.11r	Supported	Supported
QOS	Supported	Supported
UWGB mode	Supported	Supported on Wave 2 APs
IGMP Snooping or Multicast	Supported	Supported
802.11w	Supported	Supported
PI support (without SNMP)	Supported	Not supported
IPv6	Supported	Supported
VLAN	Supported	Supported
802.11i (WPAv2)	Supported	Supported
Broadcast tagging/replicate	Supported	Supported
Unified VLAN client	Implicitly supported (No CLI required)	Supported
WGB client	Supported	Supported
802.1x – PEAP, EAP-FAST, EAP-TLS	Supported	Supported
NTP	Supported	Supported
Wired client support on all LAN ports	Supported in Wired-0 and Wired-1 interfaces	Supported in all Wired-0, 1 and LAN ports 1, 2, and 3

The following table shows the supported and unsupported authentication and switching modes for Cisco APs when connecting to a WGB.



**Note** Workgroup Bridge mode is supported on the WiFi6 Pluggable Module from Cisco IOS XE Bengaluru 17.6.1.

**Table 92: Supported Access Points and Requirements**

Access Points	Requirements
Cisco Aironet 2700, 3700, and 1572 Series	Requires autonomous image.
Cisco Aironet 2800, 3800, 4800, 1562, and Cisco Catalyst 9105, 9115, IW6300 and ESW6300 Series	CAPWAP image starting from Cisco AireOS 8.8 release.



Table 93: WGB Support on APs

WGB WLAN Support	Cisco Wave 2 APs	Cisco Catalyst 9100 Series APs
Central Authentication	Supported	Supported
Central Switching	Supported	Supported
Local Authentication	Not Supported	Not Supported
Local Switching	Supported	Supported

- MAC filtering is not supported for wired clients.
- Idle timeout is not supported for both WGB and wired clients.
- Session timeout is not applicable for wired clients.
- Web authentication is not supported.
- WGB supports only up to 20 clients.
- If you want to use a chain of certificates, copy all the CA certificates to a file and install it under a trust point on the WGB, else server certificate validation may fail.
- Wired clients connected to the WGB are not authenticated for security. Instead, the WGB is authenticated against the access point to which it associates. Therefore, we recommend that you physically secure the wired side of the WGB.
- Wired clients connected to a WGB inherit the WGB's QoS and AAA override attributes.
- To enable the WGB to communicate with the root AP, create a WLAN and make sure that Aironet IE is enabled under the Advanced settings.

## Configuring Workgroup Bridge on a WLAN

Follow the procedure given below to configure a WGB on a WLAN:

For WGB to join a wireless network there are specific settings on the WLAN and on the related policy profile.



**Note** For the configuration given below, it is assumed that the WLAN security is already configured.

### Procedure

	Command or Action	Purpose
<b>Step 1</b>	<b>configure terminal</b> <b>Example:</b> Device# configure terminal	Enters global configuration mode.

	Command or Action	Purpose
<b>Step 2</b>	<b>wlan</b> <i>profile-name</i> <b>Example:</b> Device(config)# wlan WGB_Test	Enters WLAN configuration submode. The <i>profile-name</i> is the profile name of the configured WLAN.
<b>Step 3</b>	<b>ccx aironet-iesupport</b> <b>Example:</b> Device(config-wlan)# ccx aironet-iesupport	Configures the Cisco Client Extensions option and sets the support of Aironet IE on the WLAN.
<b>Step 4</b>	<b>exit</b> <b>Example:</b> Device(config-wlan)# exit	Exits the WLAN configuration submode.
<b>Step 5</b>	<b>wireless profile policy</b> <i>profile-policy</i> <b>Example:</b> Device(config)# wireless profile policy test-wgb	Configures WLAN policy profile and enters the wireless policy configuration mode.
<b>Step 6</b>	<b>description</b> <i>description</i> <b>Example:</b> Device(config-wireless-policy)# description "test-wgb"	Adds a description for the policy profile.
<b>Step 7</b>	<b>vlan</b> <i>vlan-no</i> <b>Example:</b> Device(config-wireless-policy)# vlan 48	Assigns the profile policy to the VLAN.
<b>Step 8</b>	<b>wgb vlan</b> <b>Example:</b> Device(config-wireless-policy)# wgb vlan	Configures WGB VLAN client support.
<b>Step 9</b>	<b>wgb broadcast-tagging</b> <b>Example:</b> Device(config-wireless-policy)# wgb broadcast-tagging	Configures WGB broadcast tagging on a WLAN.
<b>Step 10</b>	<b>no shutdown</b> <b>Example:</b> Device(config-wireless-policy)# no shutdown	Restarts the policy profile.
<b>Step 11</b>	<b>exit</b> <b>Example:</b> Device(config-wireless-policy)# exit	Exits the wireless policy configuration mode.

	Command or Action	Purpose
<b>Step 12</b>	<b>wireless tag policy</b> <i>policy-tag</i> <b>Example:</b> Device(config)# wireless tag policy WGB_Policy	Configures policy tag and enters policy tag configuration mode.
<b>Step 13</b>	<b>wlan profile-name policy</b> <i>profile-policy</i> <b>Example:</b> Device(config-policy-tag)# wlan WGB_Test policy test-wgb	Maps a policy profile to a WLAN profile.
<b>Step 14</b>	<b>end</b> <b>Example:</b> Device(config-policy-tag)# end	Exits policy tag configuration mode, and returns to privileged EXEC mode.

## Verifying the Status of a Workgroup Bridge on the Controller

Use the following commands to verify the status of a WGB.

To display the wireless-specific configuration of active clients, use the following command:

```
Device# show wireless client summary
```

To display the WGBs on your network, use the following command:

```
Device# show wireless wgb summary
```

To display the details of wired clients that are connected to a particular WGB, use the following command:

```
Device# show wireless wgb mac-address 00:0d:ed:dd:25:82 detail
```

## Configuring Access Points as Workgroup Bridge

### Turning Cisco Aironet 2700/3700/1572 Series AP into Autonomous Mode

#### Before you begin

Download the autonomous image for the specific access point from [software.cisco.com](http://software.cisco.com) and place it on a TFTP server.

#### Procedure

	Command or Action	Purpose
<b>Step 1</b>	<b>debug capwap console cli</b> <b>Example:</b> Device# debug capwap console cli	Enables the console CLI.

	Command or Action	Purpose
<b>Step 2</b>	<b>archive download-sw force-reload overwrite</b> <b>tftp:ipaddress filepath filename</b>  <b>Example:</b> Device(config)# archive download-sw force-reload overwrite tftp://10.10.10.1/tftp/c1800.tar	Downloads the autonomous image to the access point.

## Configuring Cisco Wave 2 APs in Workgroup Bridge or CAPWAP AP Mode (CLI)

### Procedure

	Command or Action	Purpose
<b>Step 1</b>	<b>enable</b>  <b>Example:</b> Device# enable	Enters in to the privileged mode of the AP.
<b>Step 2</b>	<b>ap-type workgroup-bridge</b>  <b>Example:</b> Device# ap-type workgroup-bridge	Moves the AP in to the Workgroup Bridge mode.
<b>Step 3</b>	<b>configure ap address ipv4 dhcp</b> or <b>configure ap address ipv4 static</b> <i>ip-address netmask gateway-ipaddress</i>  <b>Example:</b> DHCP IP Address Device# configure ap address ipv4 dhcp  Static IP Address Device# configure ap address ipv4 static 10.10.10.2 255.255.255.234 192.168.4.1	Configures DHCP or Static IP address.
<b>Step 4</b>	<b>configure ap management add username</b> <i>username password password secret secret</i>  <b>Example:</b> Device# configure ap management add username xyz-user password ***** secret cisco	Configures an username for the AP management.
<b>Step 5</b>	<b>configure ap hostname</b> <i>host-name</i>  <b>Example:</b> Device# configure ap hostname xyz-host	Configures the AP hostname.

## Configure an SSID Profile for Cisco Wave 2 APs (CLI)

This procedure is an AP procedure. The CLIs listed in the procedure given below work only on the AP console and not on the controller.

### Procedure

	Command or Action	Purpose
<b>Step 1</b>	<p><b>configure ssid-profile</b> <i>ssid-profile-name</i> <b>ssid</b> <i>radio-serv-name</i> <b>authentication</b> {<b>open</b>   <b>psk</b> <i>preshared-key</i> <b>key-management</b> {<b>dot11r</b>   <b>wpa2</b>   <b>dot11w</b>   {<b>optional</b>   <b>required</b> } }   <b>eap</b> <b>profile</b> <i>eap-profile-name</i> <b>key-management</b> {<b>dot11r</b>   <b>wpa2</b>   <b>dot11w</b>   {<b>optional</b>   <b>required</b> } }</p> <p><b>Example:</b></p> <p>SSID profile with open authentication.</p> <pre>Device# configure ssid-profile test WRT s1 authentication open</pre> <p>SSID profile with PSK authentication.</p> <pre>Device# configure ssid-profile test WRT s1 authentication psk 1234 key-management dot11r optional</pre> <p>SSID profile with EAP authentication.</p> <pre>Device# configure ssid-profile test WRT s1 authentication eap profile test2 key-management dot11r optional</pre>	Choose an authentication protocol (Open, PSK, or EAP) for the SSID profile.
<b>Step 2</b>	<p><b>configure dot11radio</b> <i>radio-interface</i> <b>mode</b> <b>wgb</b> <b>ssid-profile</b> <i>profile-name</i></p> <p><b>Example:</b></p> <pre>Device# configure dot11radio r1 mode wgb ssid-profile doc-test</pre>	Attaches an SSID profile to a radio interface.
<b>Step 3</b>	<p><b>configure ssid-profile</b> <i>profile-name</i> <b>delete</b></p> <p><b>Example:</b></p> <pre>Device# configure ssid-profile doc-test delete</pre>	(Optional) Deletes an SSID profile.
<b>Step 4</b>	<p><b>show wgb ssid</b></p> <p><b>Example:</b></p> <pre>Device# show wgb ssid</pre>	(Optional) Displays summary of configured and connected SSIDs.
<b>Step 5</b>	<p><b>show wgb packet statistics</b></p> <p><b>Example:</b></p> <pre>Device# show wgb packet statistics</pre>	(Optional) Displays management, control, and data packet statistics.

## Configuring a Dot1X Credential (CLI)

### Procedure

	Command or Action	Purpose
<b>Step 1</b>	<b>configure dot1x credential</b> <i>profile-name</i> <b>username</b> <i>name</i> <b>password</b> <i>password</i>  <b>Example:</b> Device# configure dot1x credential test1 username XYZ password *****	Configures a dot1x credential.
<b>Step 2</b>	<b>configure dot1x credential</b> <i>profile-name</i> <b>delete</b>  <b>Example:</b> Device# configure dot1x credential test1 delete	Removes a dot1x profile.
<b>Step 3</b>	<b>clear wgb client</b> { <b>all</b>   <b>single</b> <i>mac-addr</i> }  <b>Example:</b> Device# clear wgb client single xxxx.xxxx.xxxx.xxxx	Deauthenticates a WGB client.

## Configuring an EAP Profile (CLI)

### Procedure

	Command or Action	Purpose
<b>Step 1</b>	<b>configure eap-profile</b> <i>profile-name</i> <b>method</b> { <b>fast</b>   <b>leap</b>   <b>peap</b>   <b>tls</b> }  <b>Example:</b> Device# configure eap-profile test-eap method fast	Configures an EAP profile.
<b>Step 2</b>	<b>configure eap-profile</b> <i>profile-name</i> <b>trustpoint</b> <b>default</b> or <b>configure eap-profile</b> <i>profile-name</i> <b>trustpoint</b> <i>name</i> <i>trustpoint-name</i>  <b>Example:</b> EAP Profile to Trustpoint with MIC Certificate. Device# configure eap-profile test-eap trustpoint default  EAP Profile to Trustpoint with CA Certificate. Device# configure eap-profile test-eap trustpoint cisco	Configures an EAP profile with a trustpoint.
<b>Step 3</b>	<b>configure eap-profile</b> <i>profile-name</i> <b>trustpoint</b> { <b>default</b>   <b>name</b> <i>trustpoint-name</i> }	Attaches the CA trustpoint.

	Command or Action	Purpose
	<b>Example:</b> Device# configure eap-profile test-eap trustpoint default	<b>Note</b> With the default profile, WGB uses the internal MIC certificate for authentication.
<b>Step 4</b>	<b>configure eap-profile</b> <i>profile-name</i> <b>dot1x-credential</b> <i>profile-name</i>  <b>Example:</b> Device# configure eap-profile test-eap dot1x-credential test-profile	Configures the 802.1X credential profile.
<b>Step 5</b>	<b>configure eap-profile</b> <i>profile-name</i> <b>delete</b>  <b>Example:</b> Device# configure eap-profile test-eap delete	(Optional) Deletes an EAP profile.
<b>Step 6</b>	<b>show wgb eap dot1x credential profile</b>  <b>Example:</b> Device# show wgb eap dot1x credential profile	(Optional) Displays the WGB EAP dot1x profile summary.
<b>Step 7</b>	<b>show wgb eap profile</b>  <b>Example:</b> Device# show wgb eap profile	(Optional) Displays the EAP profile summary.
<b>Step 8</b>	<b>show wgb eap profile all</b>  <b>Example:</b> Device# show wgb eap profile all	(Optional) Displays the EAP and dot1x profiles.

## Configuring Manual-Enrollment of a Trustpoint for Workgroup Bridge (CLI)

### Procedure

	Command or Action	Purpose
<b>Step 1</b>	<b>configure crypto pki trustpoint</b> <i>ca-server-name</i> <b>enrollment terminal</b>  <b>Example:</b> Device# configure crypto pki trustpoint ca-server-US enrollment terminal	Configures a trustpoint in WGB.
<b>Step 2</b>	<b>configure crypto pki trustpoint</b> <i>ca-server-name</i> <b>authenticate</b>  <b>Example:</b>	Authenticates a trustpoint manually.  Enter the base 64 encoded CA certificate and end the certificate by entering <b>quit</b> in a new line.

	Command or Action	Purpose
	Device# configure crypto pki trustpoint ca-server-US authenticate	
<b>Step 3</b>	<b>configure crypto pki trustpoint</b> <i>ca-server-name key-size key-length</i>  <b>Example:</b> Device# configure crypto pki trustpoint ca-server-US key-size 60	Configures a private key size.
<b>Step 4</b>	<b>configure crypto pki trustpoint</b> <i>ca-server-name subject-name name</i> <i>[2ltr-country-code  state-name  locality</i> <i> org-name  org-unit  email]</i>  <b>Example:</b> Device# configure crypto pki trustpoint ca-server-US subject-name test US CA abc cisco AP test@cisco.com	Configures the subject name.
<b>Step 5</b>	<b>configure crypto pki trustpoint</b> <i>ca-server-name enrol</i>  <b>Example:</b> Device# configure crypto pki trustpoint ca-server-US enroll	Generates a private key and Certificate Signing Request (CSR).  Afterwards, create the digitally signed certificate using the CSR output in the CA server.
<b>Step 6</b>	<b>configure crypto pki trustpoint</b> <i>ca-server-name import certificate</i>  <b>Example:</b> Device# configure crypto pki trustpoint ca-server-US import certificate	Import the signed certificate in WGB.  Enter the base 64 encoded CA certificate and end the certificate by using <b>quit</b> command in a new line.
<b>Step 7</b>	<b>configure crypto pki trustpoint</b> <i>ca-server-name delete</i>  <b>Example:</b> Device# configure crypto pki trustpoint ca-server-US delete	(Optional) Delete a trustpoint.
<b>Step 8</b>	<b>show crypto pki trustpoint</b>  <b>Example:</b> Device# show crypto pki trustpoint	(Optional) Displays the trustpoint summary.
<b>Step 9</b>	<b>show crypto pki trustpoint</b> <i>trustpoint-name</i> <b>certificate</b>  <b>Example:</b>	(Optional) Displays the content of the certificates that are created for a trustpoint.



	Command or Action	Purpose
	Device# show crypto pki trustpoint ca-server-US certificate	

## Configuring Auto-Enrollment of a Trustpoint for Workgroup Bridge (CLI)

### Procedure

	Command or Action	Purpose
<b>Step 1</b>	<b>configure crypto pki trustpoint</b> <i>ca-server-name enrollment url ca-server-url</i> <b>Example:</b> Device# configure crypto pki trustpoint ca-server-US enrollment url https://cisco/certsrv	Enrolls a trustpoint in WGB using the server URL.
<b>Step 2</b>	<b>configure crypto pki trustpoint</b> <i>ca-server-name authenticate</i> <b>Example:</b> Device# configure crypto pki trustpoint ca-server-US authenticate	Authenticates a trustpoint by fetching the CA certificate from CA server automatically.
<b>Step 3</b>	<b>configure crypto pki trustpoint</b> <i>ca-server-name key-size key-length</i> <b>Example:</b> Device# configure crypto pki trustpoint ca-server-US key-size 60	Configures a private key size.
<b>Step 4</b>	<b>configure crypto pki trustpoint</b> <i>ca-server-name subject-name name</i> <i>[2ltr-country-code  state-name  locality</i> <i> org-name  org-unit  email ]</i> <b>Example:</b> Device# configure crypto pki trustpoint ca-server-US subject-name test US CA abc cisco AP test@cisco.com	Configures the subject name.
<b>Step 5</b>	<b>configure crypto pki trustpoint</b> <i>ca-server-name enrol l</i> <b>Example:</b> Device# configure crypto pki trustpoint ca-server-US enroll	Enrolls the trustpoint.  Request the digitally signed certificate from the CA server.

	Command or Action	Purpose
<b>Step 6</b>	<b>configure crypto pki trustpoint</b> <i>ca-server-name</i> <b>auto-enroll enable</b> <i>renew-percentage</i>  <b>Example:</b> <pre>Device# configure crypto pki trustpoint ca-server-US auto-enroll enable 10</pre>	Enables auto-enroll of the trustpoint.  You can disable auto-enrolling by using the <b>disable</b> option in the command.
<b>Step 7</b>	<b>configure crypto pki trustpoint</b> <i>trustpoint-name</i> <b>delete</b>  <b>Example:</b> <pre>Device# configure crypto pki trustpoint ca-server-US delete</pre>	(Optional) Deletes a trustpoint.
<b>Step 8</b>	<b>show crypto pki trustpoint</b>  <b>Example:</b> <pre>Device# show crypto pki trustpoint</pre>	(Optional) Displays the trustpoint summary.
<b>Step 9</b>	<b>show crypto pki trustpoint</b> <i>trustpoint-name</i> <b>certificate</b>  <b>Example:</b> <pre>Device# show crypto pki trustpoint ca-server-US certificate</pre>	(Optional) Displays the content of the certificates that are created for a trustpoint.
<b>Step 10</b>	<b>show crypto pki timers</b>  <b>Example:</b> <pre>Device# show crypto pki timers</pre>	(Optional) Displays the PKI timer information.

## Configuring Manual Certificate Enrolment Using TFTP Server (CLI)

### Procedure

	Command or Action	Purpose
<b>Step 1</b>	<b>configure crypto pki trustpoint</b> <i>ca-server-name</i> <b>enrollment tftp</b> <i>addr/file-name</i>  <b>Example:</b> <pre>Device# configure crypto pki trustpoint ca-server-US enrollment tftp://10.8.0.6/all_cert.txt</pre>	Specifies the enrolment method to retrieve the CA certificate and client certificate for a trustpoint in WGB.
<b>Step 2</b>	<b>configure crypto pki trustpoint</b> <i>ca-server-name</i> <b>authenticate</b>  <b>Example:</b>	Retrieves the CA certificate and authenticates it from the specified TFTP server. If the file specification is included, the wgb will append the extension “.ca” to the specified filename.

	Command or Action	Purpose
	Device# configure crypto pki trustpoint ca-server-US authenticate	
<b>Step 3</b>	<b>configure crypto pki trustpoint</b> <i>ca-server-name key-size key-length</i>  <b>Example:</b> Device# configure crypto pki trustpoint ca-server-US key-size 60	Configures a private key size.
<b>Step 4</b>	<b>configure crypto pki trustpoint</b> <i>ca-server-name subject-name name</i> <i>[2 tr-country-code  state-name  locality</i> <i> org-name  org-unit  email ]</i>  <b>Example:</b> Device# configure crypto pki trustpoint ca-server-US subject-name test US CA abc cisco AP test@cisco.com	Configures the subject name.
<b>Step 5</b>	<b>configure crypto pki trustpoint</b> <i>ca-server-name enrol</i>  <b>Example:</b> Device# configure crypto pki trustpoint ca-server-US enroll	Generate a private key and Certificate Signing Request (CSR) and writes the request out to the TFTP server. The filename to be written is appended with the extension “.req”.
<b>Step 6</b>	<b>configure crypto pki trustpoint</b> <i>ca-server-name import certificate</i>  <b>Example:</b> Device# configure crypto pki trustpoint ca-server-US import certificate	Import the signed certificate in WGB using TFTP at the console terminal, which retrieves the granted certificate.  The WGB will attempt to retrieve the granted certificate using TFTP using the same filename and the file name append with “.crt” extension.
<b>Step 7</b>	<b>show crypto pki trustpoint</b>  <b>Example:</b> Device# show crypto pki trustpoint	(Optional) Displays the trustpoint summary.
<b>Step 8</b>	<b>show crypto pki trustpoint</b> <i>trustpoint-name certificate</i>  <b>Example:</b> Device# show crypto pki trustpoint ca-server-US certificate	(Optional) Displays the content of the certificates that are created for a trustpoint.

## Importing the PKCS12 Format Certificates from the TFTP Server (CLI)

### Procedure

	Command or Action	Purpose
<b>Step 1</b>	<b>configure crypto pki trustpoint</b> <i>ca-server-name</i> <b>import pkcs12 tftp</b> <i>addr/file-name</i> <b>password</b> <i>pwd</i>  <b>Example:</b> <pre>Device# configure crypto pki trustpoint ca-server-US enrollment tftp://10.8.0.6/all_cert.txt password *****</pre>	Imports PKCS12 format certificate from the TFTP server.
<b>Step 2</b>	<b>show crypto pki trustpoint</b>  <b>Example:</b> <pre>Device# show crypto pki trustpoint</pre>	(Optional) Displays the trustpoint summary.
<b>Step 3</b>	<b>show crypto pki trustpoint</b> <i>trustpoint-name</i> <b>certificate</b>  <b>Example:</b> <pre>Device# show crypto pki trustpoint ca-server-US certificate</pre>	(Optional) Displays the content of the certificates that are created for a trustpoint.

## Configuring Radio Interface for Workgroup Bridges (CLI)

From the available two radio interfaces, before configuring WGB or UWGB mode on one radio interface, configure the other radio interface to root AP mode.

### Procedure

	Command or Action	Purpose
<b>Step 1</b>	<b>configure dot11radio</b> <i>radio-int</i> <b>mode root-ap</b>  <b>Example:</b> <pre>Device# configure dot11Radio 0/3/0 mode root-ap</pre>	Maps a radio interface as root AP.  <b>Note</b> When an active SSID or EAP profile is modified, you need to reassociate the profile to the radio interface for the updated profile to be active.
<b>Step 2</b>	<b>configure dot11Radio</b> <i>&lt;0 1&gt;</i> <b>beacon-period</b> <i>beacon-interval</i>  <b>Example:</b> <pre>Device# configure dot11radio 1 beacon-period 120</pre>	Configures the periodic beacon interval in milli-seconds. The value range is between 2 and 2000 milli-seconds.
<b>Step 3</b>	<b>configure dot11Radio</b> <i>radio-int</i> <b>mode wgb</b> <b>ssid-profile</b> <i>ssid-profile-name</i>	Maps a radio interface to a WGB SSID profile.

	Command or Action	Purpose
	<b>Example:</b> Device# configure dot11Radio 0/3/0 mode wgb ssid-profile bgl18	
<b>Step 4</b>	<b>configure dot11Radio radio-int mode uwgb mac-addr ssid-profile ssid-profile-name</b>  <b>Example:</b> Device# configure dot11Radio 0/3/0 mode uwgb 0042.5AB6.0EF0 ssid-profile bgl18	Maps a radio interface to a WGB SSID profile.
<b>Step 5</b>	<b>configure dot11Radio radio-int {enable disable}</b>  <b>Example:</b> Device# configure dot11Radio 0/3/0 mode enable	Configures a radio interface.  <b>Note</b> After configuring the uplink to the SSID profile, we recommend that you disable and enable the radio for the changes to be active.
<b>Step 6</b>	<b>configure dot11Radio radio-int antenna {a-antenna   ab-antenna   abc-antenna   abcd-antenna}</b>  <b>Example:</b> Device# configure dot11Radio 0/3/0 antenna a-antenna	Configures a radio antenna.
<b>Step 7</b>	<b>configure dot11Radio radio-int encryption mode ciphers aes-ccm {</b>  <b>Example:</b> Device# configure dot11Radio radio-int encryption mode ciphers aes-ccm	Configures the radio interface.
<b>Step 8</b>	<b>configure wgb mobile rate {basic 6 9 18 24 36 48 54   mcs mcs-rate}</b>  <b>Example:</b> Device# configure wgb mobile rate basic 6 9 18 24 36 48 54	Configures the device channel rate.
<b>Step 9</b>	<b>configure wgb mobile period secondsthres-signal</b>  <b>Example:</b> Device# configure wgb mobile period 30 -50	Configure the threshold duration and signal strength to trigger scanning.
<b>Step 10</b>	<b>configure wgb mobile station interface dot11Radio radio-int scan channel-number add</b>  <b>Example:</b> Device# configure wgb mobile station interface dot11Radio 0/3/0 scan 2 add	Configures the static roaming channel.

	Command or Action	Purpose
Step 11	<p><b>configure wgb mobile station interface dot11Radio</b> <i>radio-int scan channel-number delete</i></p> <p><b>Example:</b></p> <pre>Device# configure wgb mobile station interface dot11Radio 0/3/0 scan 2 delete</pre>	(Optional) Delete the mobile channel.
Step 12	<p><b>configure wgb mobile station interface dot11Radio</b> <i>radio-int scan disable</i></p> <p><b>Example:</b></p> <pre>Device# configure wgb mobile station interface dot11Radio 0/3/0 scan disable</pre>	(Optional) Disable the mobile channel.
Step 13	<p><b>configure wgb beacon miss-count</b> <i>value</i></p> <p><b>Example:</b></p> <pre>Device# configure wgb beacon miss-count 12</pre>	<p>(Optional) Configure the beacon miss-count. By default, this is set to disabled.</p> <p><b>Note</b> When you set the beacon miss-count value to 10 or lower, then the beacon miss-count gets disabled. Set the value to 11 or higher to enable this function.</p>
Step 14	<p><b>show wgb wifi</b> <i>wifi-interface stats</i></p> <p><b>Example:</b></p> <pre>Device# show wgb wifi 0/3/0 stats</pre>	(Optional) Displays the Wi-Fi station statistics.
Step 15	<p><b>show controllers dot11Radio</b> <i>radio-interface antenna</i></p> <p><b>Example:</b></p> <pre>Device# show controllers dot11Radio 0/3/0 antenna</pre>	(Optional) Displays the radio antenna statistics.
Step 16	<p><b>show wgb mobile scan channel</b></p> <p><b>Example:</b></p> <pre>Device# show wgb mobile scan channel</pre>	(Optional) Displays the mobile station channels scan configuration.
Step 17	<p><b>show configuration</b></p> <p><b>Example:</b></p> <pre>Device# show configuration</pre>	(Optional) Displays the configuration that is stored in the NV memory.
Step 18	<p><b>show running-config</b></p> <p><b>Example:</b></p> <pre>Device# show running-config</pre>	(Optional) Displays the running configuration in the device.

## Configuring Workgroup Bridge Timeouts (CLI)

### Procedure

	Command or Action	Purpose
<b>Step 1</b>	<b>configure wgb association response timeout</b> <i>response-millisecs</i> <b>Example:</b> Device# configure wgb association response timeout 4000	Configures the WGB association response timeout. The default value is 5000 milliseconds. The valid range is between 300 and 5000 milliseconds.
<b>Step 2</b>	<b>configure wgb authentication response timeout</b> <i>response-millisecs</i> <b>Example:</b> Device# configure wgb authentication response timeout 4000	Configures the WGB authentication response timeout. The default value is 5000 milliseconds. The valid range is between 300 and 5000 milliseconds.
<b>Step 3</b>	<b>configure wgb uclient timeout</b> <i>timeout-secs</i> <b>Example:</b> Device# configure wgb uclient timeout 70	Configure the Universal WGB client response timeout. The default timeout value is 60 seconds. The valid range is between 1 and 65535 seconds..
<b>Step 4</b>	<b>configure wgb eap timeout</b> <i>timeout-secs</i> <b>Example:</b> Device# configure wgb eap timeout 20	Configures the WGB EAP timeout. The default timeout value is 3 seconds. The valid range is between 2 and 60 seconds.
<b>Step 5</b>	<b>configure wgb channel scan timeout</b> {fast  medium   slow} <b>Example:</b> Device# configure wgb channel scan timeout slow	Configures the WGB channel scan timeout.
<b>Step 6</b>	<b>configure wgb dhcp response timeout</b> <i>timeout-secs</i> <b>Example:</b> Device# configure wgb dhcp response timeout 70	Configures the WGB DHCP response timeout. The default value is 60 seconds. The valid range is between 1000 and 60000 milliseconds.
<b>Step 7</b>	<b>show wgb dot11 association</b> <b>Example:</b> Device# show wgb dot11 association	Displays the WGB association summary.

## Configuring Bridge Forwarding for Workgroup Bridge (CLI)

### Before you begin

The Cisco Wave 2 APs as Workgroup Bridge recognizes the Ethernet clients only when the traffic has the bridging tag.

We recommend setting the WGB bridge client timeout value to default value of 300 seconds, or less in environment where change is expected, such as:

- Ethernet cable is unplugged and plugged back.
- Endpoint is changed.
- Endpoint IP is changed (static to DHCP and vice versa).

If you need to retain the client entry in the WGB table for a longer duration, we recommend you increase the client WGB bridge timeout duration.

### Procedure

	Command or Action	Purpose
<b>Step 1</b>	<b>configure wgb bridge client add</b> <i>mac-address</i> <b>Example:</b> Device# configure wgb bridge client add F866.F267.7DFB-	Adds a WGB client using the MAC address.
<b>Step 2</b>	<b>configure wgb bridge client timeout</b> <i>timeout-secs</i> <b>Example:</b> Device# configure wgb bridge client timeout 400	Configures the WGB bridge client timeout. Default timeout value is 300 seconds. The valid range is between 10 and 1000000 seconds.
<b>Step 3</b>	<b>show wgb bridge</b> <b>Example:</b> Device# show wgb bridge	Displays the WGB wired clients over the bridge.
<b>Step 4</b>	<b>show wgb bridge wired gigabitEthernet</b> <i>interface</i> <b>Example:</b> Device# show wgb bridge wired gigabitEthernet 0/1	Displays the WGB Gigabit wired clients over the bridge.
<b>Step 5</b>	<b>show wgb bridge dot11Radio</b> <i>interface-number</i> <b>Example:</b> Device# show wgb bridge dot11Radio 0/3/1	Displays the WGB bridge radio interface summary.





## CHAPTER 181

# Peer-to-Peer Client Support

- [Information About Peer-to-Peer Client Support, on page 1743](#)
- [Configure Peer-to-Peer Client Support, on page 1743](#)

## Information About Peer-to-Peer Client Support

Peer-to-peer client support can be applied to individual WLANs, with each client inheriting the peer-to-peer blocking setting of the WLAN to which it is associated. The peer-to-Peer Client Support feature provides a granular control over how traffic is directed. For example, you can choose to have traffic bridged locally within a device, dropped by a device, or forwarded to the upstream VLAN.

Peer-to-peer blocking is supported for clients that are associated with local and central switching WLANs.

### Restrictions

- Peer-to-peer blocking does not apply to multicast traffic.
- Peer-to-peer blocking is not enabled by default.
- In FlexConnect, peer-to-peer blocking configuration cannot be applied only to a particular FlexConnect AP or a subset of APs. It is applied to all the FlexConnect APs that broadcast the SSID.
- FlexConnect central switching clients supports peer-to-peer upstream-forward. However, this is not supported in the FlexConnect local switching. This is treated as peer-to-peer drop and client packets are dropped.

FlexConnect central switching clients supports peer-to-peer blocking for clients associated with different APs. However, for FlexConnect local switching, this solution targets only clients connected to the same AP. FlexConnect ACLs can be used as a workaround for this limitation.

## Configure Peer-to-Peer Client Support

Follow the procedure given below to configure Peer-to-Peer Client Support:

## Procedure

	Command or Action	Purpose
<b>Step 1</b>	<b>configure terminal</b> <b>Example:</b> Device# configure terminal	Enters global configuration mode.
<b>Step 2</b>	<b>wlan profile-name</b> <b>Example:</b> Device(config)# wlan wlan1	Enters WLAN configuration submenu. The <i>profile-name</i> is the profile name of the configured WLAN.
<b>Step 3</b>	<b>peer-blocking [allow-private-group   drop   forward-upstream]</b> <b>Example:</b> Device(config-wlan)# peer-blocking drop	Configures peer to peer blocking parameters. The keywords are as follows: <ul style="list-style-type: none"> <li>• <b>allow-private-group</b>—Enables peer-to-peer blocking on the Allow Private Group action.</li> <li>• <b>drop</b>—Enables peer-to-peer blocking on the drop action.</li> <li>• <b>forward-upstream</b>—No action is taken and forwards packets to the upstream.</li> </ul> <p><b>Note</b> The <b>forward-upstream</b> option is not supported for Flex local switching. Traffic is dropped even if this option is configured. Also, peer to peer blocking for local switching SSIDs are available only for the clients on the same AP.</p>
<b>Step 4</b>	<b>end</b> <b>Example:</b> Device(config)# end	Returns to privileged EXEC mode.
<b>Step 5</b>	<b>show wlan id wlan-id</b> <b>Example:</b> Device# show wlan id 12	Displays the details of the selected WLAN.



## CHAPTER 182

# Deny Wireless Client Session Establishment Using Calendar Profiles

---

- [Information About Denial of Wireless Client Session Establishment, on page 1745](#)
- [Configuring Daily Calendar Profile, on page 1746](#)
- [Configuring Weekly Calendar Profile, on page 1747](#)
- [Configuring Monthly Calendar Profile, on page 1748](#)
- [Mapping a Daily Calendar Profile to a Policy Profile, on page 1749](#)
- [Mapping a Weekly Calendar Profile to a Policy Profile, on page 1750](#)
- [Mapping a Monthly Calendar Profile to a Policy Profile, on page 1751](#)
- [Verifying Calendar Profile Configuration, on page 1752](#)
- [Verifying Policy Profile Configuration, on page 1752](#)

## Information About Denial of Wireless Client Session Establishment

Denial of client session establishment feature allows the controller to stop client session establishment based on a particular time. This helps control the network in efficient and controlled manner without any manual intervention.

In Cisco Catalyst 9800 Series Wireless Controller , you can deny the wireless client session based on the following recurrences:

- Daily
- Weekly
- Monthly

The Calendar Profiles created are then mapped to the policy profile. By attaching the calendar profile to a policy profile, you will be able to create different recurrences for the policy profile using different policy tag.



**Note** You need to create separate Calendar Profile for Daily, Weekly, and Monthly sub-categories.

The following is the workflow for denial of wireless client session establishment feature:

- Create a calendar profile.
- Apply the calendar profile to a policy profile.



**Note** A maximum of 100 calendar profile configuration and 5 calendar profile association to policy profile is supported.

### Points to Remember

If you boot up your controller, the denial of client session establishment feature kicks in after a minute from the system boot up.

If you change the system time after the calendar profile is associated to a policy profile, you can expect a maximum of 30 second delay to adapt to the new clock timings.



**Note** You cannot use the **no action deny-client** command to disable action while associating the calendar profile to a policy profile.

If you want to disable the action command, you need to disassociate the calendar profile from the policy profile, and re-configure again.

## Configuring Daily Calendar Profile

### Procedure

	Command or Action	Purpose
<b>Step 1</b>	<b>configure terminal</b>  <b>Example:</b> Device# configure terminal	Enters global configuration mode.
<b>Step 2</b>	<b>wireless profile calendar-profile name name</b>  <b>Example:</b> Device(config)# wireless profile calendar-profile name daily_calendar_profile	Configures a calendar profile.  Here, <i>name</i> refers to the name of the calendar profile.
<b>Step 3</b>	<b>start start_time end end_time</b>  <b>Example:</b>	Configures start and end time for the calendar profile.

	Command or Action	Purpose
	Device(config-calendar-profile)# start 09:00:00 end 17:00:00	Here,  <i>start_time</i> is the start time for the calendar profile. You need to enter start time in <b>HH:MM:SS</b> format.  <i>end_time</i> is the end time for the calendar profile. You need to enter end time in <b>HH:MM:SS</b> format.
<b>Step 4</b>	<b>recurrence daily</b>  <b>Example:</b> Device(config-calendar-profile)# recurrence daily	Configures daily recurrences for a calendar profile.
<b>Step 5</b>	<b>end</b>  <b>Example:</b> Device(config-calendar-profile)# end	Returns to privileged EXEC mode.  Alternatively, you can also press <b>Ctrl-Z</b> to exit global configuration mode.  <b>Note</b> When the calendar profile kicks in, the AP power profile rules (for example, radio state and USB device state) that are defined for the Ethernet speed are not applied and continue to be as per the fixed power profile.

## Configuring Weekly Calendar Profile

### Procedure

	Command or Action	Purpose
<b>Step 1</b>	<b>configure terminal</b>  <b>Example:</b> Device# configure terminal	Enters global configuration mode.
<b>Step 2</b>	<b>wireless profile calendar-profile name name</b>  <b>Example:</b> Device(config)# wireless profile calendar-profile name weekly_calendar_profile	Configures a calendar profile.  Here,  <i>name</i> refers to the name of the calendar profile.
<b>Step 3</b>	<b>start start_time end end_time</b>  <b>Example:</b> Device(config-calendar-profile)# start 18:00:00 end 19:00:00	Configures start and end time for the calendar profile.  Here,

	Command or Action	Purpose
		<p><i>start_time</i> is the start time for the calendar profile. You need to enter start time in <b>HH:MM:SS</b> format.</p> <p><i>end_time</i> is the end time for the calendar profile. You need to enter end time in <b>HH:MM:SS</b> format.</p>
<b>Step 4</b>	<p><b>recurrence weekly</b></p> <p><b>Example:</b></p> <pre>Device(config-calendar-profile)# recurrence weekly</pre>	Configures weekly recurrences for the calendar profile.
<b>Step 5</b>	<p><b>day {friday   monday   saturday   sunday   thursday   tuesday   wednesday}</b></p> <p><b>Example:</b></p> <pre>Device(config-calendar-profile)# day friday Device(config-calendar-profile)# day monday</pre>	<p>Configure days when the weekly calendar needs to be active.</p> <p><b>Note</b> You can configure multiple days using this command.</p>
<b>Step 6</b>	<p><b>end</b></p> <p><b>Example:</b></p> <pre>Device(config-calendar-profile)# end</pre>	<p>Returns to privileged EXEC mode.</p> <p>Alternatively, you can also press <b>Ctrl-Z</b> to exit global configuration mode.</p>

## Configuring Monthly Calendar Profile

### Procedure

	Command or Action	Purpose
<b>Step 1</b>	<p><b>configure terminal</b></p> <p><b>Example:</b></p> <pre>Device# configure terminal</pre>	Enters global configuration mode.
<b>Step 2</b>	<p><b>wireless profile calendar-profile name name</b></p> <p><b>Example:</b></p> <pre>Device(config)# wireless profile calendar-profile name monthly_calendar_profile</pre>	<p>Configures a calendar profile.</p> <p>Here, <i>name</i> refers to the name of the calendar profile.</p>
<b>Step 3</b>	<p><b>start start_time end end_time</b></p> <p><b>Example:</b></p> <pre>Device(config-calendar-profile)# start 18:00:00 end 19:00:00</pre>	<p>Configures start and end time for the calendar profile.</p> <p>Here,</p>

	Command or Action	Purpose
		<p><i>start_time</i> is the start time for the calendar profile. You need to enter start time in <b>HH:MM:SS</b> format.</p> <p><i>end_time</i> is the end time for the calendar profile. You need to enter end time in <b>HH:MM:SS</b> format.</p>
<b>Step 4</b>	<p><b>recurrence monthly</b></p> <p><b>Example:</b></p> <pre>Device(config-calendar-profile)# recurrence monthly</pre>	Configures monthly recurrences for the calendar profile.
<b>Step 5</b>	<p><b>date value</b></p> <p><b>Example:</b></p> <pre>Device(config-calendar-profile)# date 25</pre>	<p>Configures a date for the calendar profile.</p> <p><b>Note</b> If the requirement is to perform denial of service in certain timing, such as, 2, 10, and 25 of every month, all three days need to be configured using the <b>date</b> command. There is no range for date. You need to configure the dates as per your requirement.</p>
<b>Step 6</b>	<p><b>end</b></p> <p><b>Example:</b></p> <pre>Device(config-calendar-profile)# end</pre>	<p>Returns to privileged EXEC mode.</p> <p>Alternatively, you can also press <b>Ctrl-Z</b> to exit global configuration mode.</p>

## Mapping a Daily Calendar Profile to a Policy Profile

### Procedure

	Command or Action	Purpose
<b>Step 1</b>	<p><b>configure terminal</b></p> <p><b>Example:</b></p> <pre>Device# configure terminal</pre>	Enters global configuration mode.
<b>Step 2</b>	<p><b>wireless profile policy <i>profile-name</i></b></p> <p><b>Example:</b></p> <pre>Device(config)# wireless profile policy default-policy-profile</pre>	<p>Creates policy profile for the WLAN.</p> <p>The <i>profile-name</i> is the profile name of the policy profile.</p>
<b>Step 3</b>	<p><b>calender-profile name <i>calendar-profile-name</i></b></p> <p><b>Example:</b></p> <pre>Device(config-wireless-policy)# calender-profile name daily_calendar_profile</pre>	<p>Maps a calendar profile to a policy profile.</p> <p>The <i>calendar-profile-name</i> is the name of the calendar profile name created in <a href="#">#unique_2219</a>.</p>

	Command or Action	Purpose
		<p><b>Note</b> You need to disable Policy Profile before associating a calendar profile to a policy profile. The following needs to be done:</p> <pre>Device(config-wireless-policy)# shutdown</pre>
<b>Step 4</b>	<p><b>action deny-client</b></p> <p><b>Example:</b></p> <pre>Device(config-policy-profile-calender)# action deny-client</pre>	<p>Configures deny client session establishment during calendar profile interval.</p> <p><b>Note</b> Client associations are denied daily between timeslot 9:00:00 to 17:00:00. For start and end time details, see <a href="#">#unique_2219</a>.</p>
<b>Step 5</b>	<p><b>end</b></p> <p><b>Example:</b></p> <pre>Device(config-policy-profile-calender)# end</pre>	<p>Returns to privileged EXEC mode.</p> <p>Alternatively, you can also press <b>Ctrl-Z</b> to exit global configuration mode.</p>

## Mapping a Weekly Calendar Profile to a Policy Profile

### Procedure

	Command or Action	Purpose
<b>Step 1</b>	<p><b>configure terminal</b></p> <p><b>Example:</b></p> <pre>Device# configure terminal</pre>	Enters global configuration mode.
<b>Step 2</b>	<p><b>wireless profile policy <i>profile-name</i></b></p> <p><b>Example:</b></p> <pre>Device(config)# wireless profile policy default-policy-profile</pre>	<p>Creates policy profile for the WLAN.</p> <p>The <i>profile-name</i> is the profile name of the policy profile.</p>
<b>Step 3</b>	<p><b>calender-profile name <i>calendar-profile-name</i></b></p> <p><b>Example:</b></p> <pre>Device(config-wireless-policy)# calender-profile name weekly_calendar_profile</pre>	<p>Maps a calender profile to a policy profile.</p> <p>The <i>calendar-profile-name</i> is the name of the calendar profile name created in <a href="#">#unique_2221</a>.</p> <p><b>Note</b> You need to disable Policy Profile before associating a calendar profile to a policy profile. The following needs to be done:</p> <pre>Device(config-wireless-policy)# shutdown</pre>



	Command or Action	Purpose
<b>Step 4</b>	<b>action deny-client</b> <b>Example:</b> <pre>Device(config-policy-profile-calender)# action deny-client</pre>	Configures deny client session establishment during calendar profile interval. <b>Note</b> Client associations are denied daily between timeslot 9:00:00 to 17:00:00. For start and end time details, see <a href="#">#unique_2221</a> .  On Monday and Tuesday, clients are denied between 17:30:00 and 19:00:00 besides regular time 9:00:00 to 17:00:00.  On 25th of every month, clients are denied between 18:00:00 and 19:00:00 besides regular time 9:00:00 to 17:00:00.
<b>Step 5</b>	<b>end</b> <b>Example:</b> <pre>Device(config-policy-profile-calender)# end</pre>	Returns to privileged EXEC mode.  Alternatively, you can also press <b>Ctrl-Z</b> to exit global configuration mode.

## Mapping a Monthly Calendar Profile to a Policy Profile

### Procedure

	Command or Action	Purpose
<b>Step 1</b>	<b>configure terminal</b> <b>Example:</b> <pre>Device# configure terminal</pre>	Enters global configuration mode.
<b>Step 2</b>	<b>wireless profile policy <i>profile-name</i></b> <b>Example:</b> <pre>Device(config)# wireless profile policy default-policy-profile</pre>	Creates policy profile for the WLAN.  The <i>profile-name</i> is the profile name of the policy profile.
<b>Step 3</b>	<b>calender-profile name <i>calendar-profile-name</i></b> <b>Example:</b> <pre>Device(config-wireless-policy)# calender-profile name monthly_calendar_profile</pre>	Maps a calender profile to a policy profile.  The <i>calendar-profile-name</i> is the name of the calendar profile name created in <a href="#">#unique_2223</a> .
<b>Step 4</b>	<b>action deny-client</b> <b>Example:</b>	Configures deny client session establishment for the defined calendar profile interval.

	Command or Action	Purpose
	Device(config-policy-profile-calender)# action deny-client	<p><b>Note</b> Every day client associations are denied between timeslot 9:00:00 to 17:00:00. For start and end time details, see <a href="#">#unique_2223</a>.</p> <p>On Monday and Tuesday, clients are denied between 17:30:00 and 19:00:00 besides regular time 9:00:00 to 17:00:00.</p> <p>On 25th of every month, clients are denied between 18:00:00 and 19:00:00 besides regular time 9:00:00 to 17:00:00.</p>
<b>Step 5</b>	<p><b>end</b></p> <p><b>Example:</b></p> <pre>Device(config-policy-profile-calender)# end</pre>	<p>Returns to privileged EXEC mode.</p> <p>Alternatively, you can also press <b>Ctrl-Z</b> to exit global configuration mode.</p>

## Verifying Calendar Profile Configuration

To view the summary of calendar profiles, use the following command:

```
Device# show wireless profile calendar-profile summary
Number of Calendar Profiles: 3

Profile-Name
-----
monthly_25_profile
weekly_mon_profile
daily_calendar_profile
```

To view the calendar profile details for a specific profile name, use the following command:

```
Device# show wireless profile calendar-profile detailed daily_calendar_profile
Calendar profiles                : daily_calendar_profile
-----
Recurrence                       : DAILY
Start Time                       : 09:00:00
End Time                         : 17:00:00
```

## Verifying Policy Profile Configuration

To view the detailed parameters for a specific policy profile, use the following command:

```
Device# show wireless profile policy detailed default-policy-profile
Tunnel Profile
  Profile Name                   : Not Configured
Calendar Profile
  Profile Name                   : monthly_25_profile
Wlan Enable                      : Not Configured
```

```

Client Block                : Client Block Configured
-----
Profile Name                : weekly_mon_profile
Wlan Enable                 : Not Configured
Client Block                : Client Block Configured
-----
Profile Name                : daily_calendar_profile
Wlan Enable                 : Not Configured
Client Block                : Client Block Configured
-----
Fabric Profile
  Profile Name              : Not Configured

```

To view the configured calendar profile information under policy profile, use the following command:

```

Device# show wireless profile policy all
Tunnel Profile
Profile Name : Not Configured
Calendar Profile
Profile Name : daily_calendar_profile
Wlan Enable : Not Configured
Client Block : Client Block Configured
-----
Profile Name : weekly_calendar_profile
Wlan Enable : Not Configured
Client Block : Client Block Configured
-----
Fabric Profile
Profile Name : Not Configured

```



---

**Note** The anchor priority is always displayed as local. Priorities can be assigned on the foreign controller.

---





## CHAPTER 183

# Ethernet over GRE

- [Introduction to EoGRE, on page 1755](#)
- [Create a Tunnel Gateway, on page 1757](#)
- [Configuring the Tunnel Gateway \(GUI\), on page 1758](#)
- [Configuring a Tunnel Domain, on page 1758](#)
- [Configuring Tunnel Domain \(GUI\), on page 1759](#)
- [Configuring EoGRE Global Parameters, on page 1760](#)
- [Configuring EoGRE Global Parameters \(GUI\), on page 1760](#)
- [Configuring a Tunnel Profile, on page 1761](#)
- [Configuring the Tunnel Profile \(GUI\), on page 1762](#)
- [Associating WLAN to a Wireless Policy Profile, on page 1763](#)
- [Attaching a Policy Tag and a Site Tag to an AP, on page 1764](#)
- [Verifying the EoGRE Tunnel Configuration, on page 1764](#)

## Introduction to EoGRE

Ethernet over GRE (EoGRE) is an aggregation solution for grouping Wi-Fi traffic from hotspots. This solution enables customer premises equipment (CPE) devices to bridge the Ethernet traffic coming from an end-host, and encapsulate the traffic in Ethernet packets over an IP Generic Routing Encapsulation (GRE) tunnel. When the IP GRE tunnels are terminated on a service provider's broadband network gateway, the end-host traffic is forwarded and subscriber sessions are initiated.

### Client IPv6

Client IPv6 traffic is supported on IPv4 EoGRE tunnels. A maximum of eight different client IPv6 addresses are supported per client. Wireless controller s send all the client IPv6 addresses that they have learned to the accounting server using the accounting update message. All RADIUS or accounting messages exchanged between controller s and tunnel gateways or RADIUS servers are outside the EoGRE tunnel.

### EoGRE for WLAN

To enable EoGRE for a WLAN, the wireless policy profile should be mapped to a tunnel profile, which may contain the following:

- AAA override: Allows you to bypass rule filtering for a client.
- Gateway RADIUS proxy: Allows forwarding of AAA requests to tunnel gateways.

- Tunnel rules: Defines the domain to use for each realm. They also define VLAN tagging for the client traffic towards tunnel gateways.
- DHCP option 82: Provides a set of predefined fields.

### EoGRE Deployment with Multiple Tunnel Gateways

The wireless controller embedded wireless controller sends keepalive pings to the primary and secondary tunnel gateways and keeps track of the missed pings. When a certain threshold level is reached for the missed pings, switchover is performed and the secondary tunnel is marked as active. This switchover deauthenticates all the clients to enable them to rejoin the access points (APs). When the primary tunnel come back online, all the client traffic are reverted to the primary tunnel. However, this behavior depends on the type of redundancy.

### Load Balancing in EtherChannels

Load balancing of tunneled traffic over Etherchannels works by hashing the source or destination IP addresses or mac addresses of the tunnel endpoint pair. Because the number of tunnels is very limited when compared to clients (each tunnel carries traffic for many clients), the spreading effect of hashing is highly reduced and optimal utilization of Etherchannel links can be hard to achieve.

Using the EoGRE configuration model, you can use the *tunnel source* option of each tunnel interface to adjust the load-balancing parameters and spread tunnels across multiple links.

You can use different source interfaces on each tunnel for load balancing based on the source or destination IP address. For that choose the source interface IP address in such a way that traffic flows take different links for each src-dest IP pair. The following is an example with four ports:

```
Client traffic on Tunnel1 - Src IP: 40.143.0.72  Dest IP: 40.253.0.2
Client traffic on Tunnel2 - Src IP: 40.146.0.94  Dest IP: 40.253.0.6
Client traffic on Tunnel3 - Src IP: 40.147.0.74  Dest IP: 40.253.0.10
```

Use the **show platform software port-channel link-select interface port-channel 4 ipv4 src\_ip dest\_ip** command to determine the link that a particular flow will take.

## EoGRE Configuration Overview

The EoGRE solution can be deployed in two different ways:

- Central-Switching: EoGRE tunnels connect the controller to the tunnel gateways.
- Flex or Local-Switching: EoGRE tunnels are initiated on the APs and terminated on the tunnel gateways.

To configure EoGRE, perform the following tasks:

1. Create a set of tunnel gateways.
2. Create a set of tunnel domains.
3. Create a tunnel profile with rules that define how to match clients to domains.
4. Create a policy profile and attach the tunnel profile to it.
5. Map the policy profile to WLANs using policy tags.



**Note** The EoGRE tunnel fallback to the secondary tunnel is triggered after the *max-skip-count* ping fails in the last measurement window. Based on the starting and ending instance of the measurement window, the fall-back may take more time than the duration that is configured.

**Table 94: EoGRE Authentication Methods**

Method Name	First Supported Release	Mode
PSK	17.2.1	Local/Flex (central authentication)
Open	16.12.1	Local/Flex (central authentication)
LWA	16.12.1	Local/Flex (central authentication)
Dot1x	16.12.1	Local/Flex (central authentication)
CWA	16.12.1	Local/Flex (central authentication)

## Create a Tunnel Gateway



**Note** In the Cisco Catalyst 9800 Series Wireless Controller , a tunnel gateway is modeled as a tunnel interface.

### Procedure

	Command or Action	Purpose
<b>Step 1</b>	<b>configure terminal</b>  <b>Example:</b> Device# configure terminal	Enters global configuration mode.
<b>Step 2</b>	<b>interface tunnel <i>tunnel_number</i></b>  <b>Example:</b> Device(config)# interface tunnel 21	Configures a tunnel interface and enters interface configuration mode.
<b>Step 3</b>	<b>tunnel source <i>source_intf</i></b>  <b>Example:</b> Device(config-if)# tunnel source 22	Sets the source address of the tunnel interface. The source interface can be VLAN, Gigabit Ethernet or loopback.
<b>Step 4</b>	<b>tunnel destination <i>tunnel-address</i></b>  <b>Example:</b> Device(config-if)# tunnel destination 10.11.12.13	Sets the destination address of the tunnel.

	Command or Action	Purpose
<b>Step 5</b>	<b>tunnel mode ethernet gre { ipv4   ipv6 } p2p</b>  <b>Example:</b> Device(config-if)# tunnel mode ethernet gre ipv4 p2p	Sets the encapsulation mode of the tunnel to Ethernet over GRE IPv4 or Ethernet over GRE IPv6.

## Configuring the Tunnel Gateway (GUI)

Follow the steps given below to configure the tunnel gateway:

### Procedure

- 
- Step 1** Choose **Configuration > Tags & Profiles > EoGRE**.
  - Step 2** Click the **Gateways** tab.  
The **Add Gateway** window is displayed.
  - Step 3** In the **Tunnel Id** field, specify the tunnel ID.
  - Step 4** In the **Destination address(IPv4/IPv6)** field, specify the IPv4 or IPv6 address.
  - Step 5** From the **Source Interface** drop-down list, select an interface.
  - Step 6** In the **AAA Proxy** section, slide the **AAA Proxy** slider to **Enabled**. When AA Proxy is enabled, complete the following steps:
    - a) From the **Encryption Type** drop-down list, select either **UNENCRYPTED** or **AES ENCRYPTION**.
    - b) In the **Key Phrase** field, specify the key phrase.
  - Step 7** Click **Apply to Device**.
- 

## Configuring a Tunnel Domain



---

**Note** Tunnel domains are a redundancy grouping of tunnels. The following configuration procedure specifies a primary and a secondary tunnel, along with a redundancy model.

---

### Procedure

	Command or Action	Purpose
<b>Step 1</b>	<b>configure terminal</b>  <b>Example:</b> Device# configure terminal	Enters global configuration mode.



	Command or Action	Purpose
<b>Step 2</b>	<b>tunnel eogre domain</b> <i>domain</i> <b>Example:</b> Device(config)# tunnel eogre domain dom1	Configures EoGRE redundancy domain.
<b>Step 3</b>	<b>primary tunnel</b> <i>primary-tunnel_intf</i> <b>Example:</b> Device(config-eogre-domain)# primary tunnel 21	Configures the primary tunnel.
<b>Step 4</b>	<b>secondary tunnel</b> <i>secondary-tunnel_intf</i> <b>Example:</b> Device(config-eogre-domain)# secondary tunnel 22	Configures the secondary tunnel.
<b>Step 5</b>	<b>redundancy revertive</b> <b>Example:</b> Device(config-eogre-domain)# redundancy revertive	Sets the redundancy model as revertive.  When redundancy is set to revertive and the primary tunnel goes down, a switchover to secondary tunnel is performed. When the primary tunnel comes back up, a switchover to the primary tunnel is performed, because the primary tunnel has priority over the secondary tunnel.  When redundancy is not set to revertive, tunnels will have the same priority, and a switchover to the primary tunnel is not performed if the active tunnel is the secondary tunnel and the primary tunnel comes back up.

## Configuring Tunnel Domain (GUI)

Follow the steps given below to configure the tunnel domain:

### Procedure

- 
- Step 1** Choose **Configuration > Tags & Profiles > EoGRE**.
  - Step 2** Click the **Domains** tab.  
The **Add Domain** window is displayed.
  - Step 3** In the **Name** field, specify the domain name. The name can be ASCII characters from 32 to 126, without leading and trailing spaces.
  - Step 4** From the **Primary Tunnel Gateway** drop-down list, choose an option.
  - Step 5** From the **Secondary Tunnel Gateway** drop-down list, choose an option.
  - Step 6** Slide the **Status** button to **Enabled**, to activate the domain status.
  - Step 7** Slide the **Revertive Redundancy** button to **Enabled**, to activate revertive redundancy.

**Step 8** Click **Apply to Device**.

## Configuring EoGRE Global Parameters

### Procedure

	Command or Action	Purpose
<b>Step 1</b>	<b>configure terminal</b>  <b>Example:</b> Device# configure terminal	Enters global configuration mode.
<b>Step 2</b>	<b>tunnel eogre heartbeat interval <i>interval-value</i></b>  <b>Example:</b> Device(config)# tunnel eogre heartbeat interval 600	Sets EoGRE tunnel heartbeat periodic interval.
<b>Step 3</b>	<b>tunnel eogre heartbeat max-skip-count <i>skip-count</i></b>  <b>Example:</b> Device(config)# tunnel eogre heartbeat max-skip-count 7	Sets the maximum number of tolerable dropped heartbeats.  After reaching the maximum number of heartbeats that can be dropped, the tunnel is declared as down and a switchover is performed.
<b>Step 4</b>	<b>tunnel eogre source loopback <i>tunnel_source</i></b>  <b>Example:</b> Device(config)# tunnel eogre source loopback 12	Sets the tunnel EoGRE source interface.
<b>Step 5</b>	<b>tunnel eogre interface tunnel <i>tunnel-intf</i> aaa proxy key <i>key</i> <i>key-name</i></b>  <b>Example:</b> Device(config)# tunnel eogre interface tunnel 21 aaa proxy key 0 mykey	(Optional) Configures AAA proxy RADIUS key for the AAA proxy setup.  <b>Note</b> When the tunnel gateway is behaving as the AAA proxy server, only this step is required for the configuration.

## Configuring EoGRE Global Parameters (GUI)

Follow the steps given below to configure the EoGRE global parameters:

### Procedure

**Step 1** Choose **Configuration > Tags & Profiles > EoGRE**.  
The EoGRE **Global Config** tab is displayed.

- Step 2** In the **Heartbeat Interval (seconds)** field, specify an appropriate timer value for heartbeat interval. The valid range is between 60 and 600 seconds.
- Step 3** In the **Max Heartbeat Skip Count** field, specify the maximum heartbeat skip count. The valid range is between 3 and 10.
- Step 4** From the **Interface Name** drop-down list, choose an interface name.
- Step 5** Click **Apply**.

## Configuring a Tunnel Profile

### Before you begin

Ensure that you define the destination VLAN on the controller. If you do not define the VLAN, clients will not be able to connect.

### Procedure

	Command or Action	Purpose
<b>Step 1</b>	<b>configure terminal</b> <b>Example:</b> Device# configure terminal	Enters global configuration mode.
<b>Step 2</b>	<b>wireless profile policy <i>profile-policy-name</i></b> <b>Example:</b> Device(config)# wireless profile policy eogre_policy	Configures a WLAN policy profile.
<b>Step 3</b>	<b>tunnel-profile <i>tunnel-profile-name</i></b> <b>Example:</b> Device(config-wireless-policy)# tunnel-profile tunnell	Creates a tunnel profile.
<b>Step 4</b>	<b>exit</b> <b>Example:</b> Device(config-wireless-policy)# exit	Returns to global configuration mode.
<b>Step 5</b>	<b>wireless profile tunnel <i>tunnel-profile-name</i></b> <b>Example:</b> Device(config)# wireless profile tunnel wl-tunnel-1	Configures a wireless tunnel profile.
<b>Step 6</b>	<b>dhcp-opt82 enable</b> <b>Example:</b> Device(config-tunnel-profile)# dhcp-opt82 enable	Activates DHCP Option 82 for the tunneled clients.

	Command or Action	Purpose
<b>Step 7</b>	<b>dhcp-opt82 remote-id <i>remote-id</i></b> <b>Example:</b> Device(config-tunnel-profile)# dhcp-opt82 remote-id vlan	Configures Remote ID options.  Choose from the comma-separated list of options such as <b>ap-mac</b> , <b>ap-ethmac</b> , <b>ap-name</b> , <b>ap-group-name</b> , <b>flex-group-name</b> , <b>ap-location</b> , <b>vlan</b> , <b>ssid-name</b> , <b>ssid-type</b> , and <b>client-mac</b> .
<b>Step 8</b>	<b>aaa-override</b> <b>Example:</b> Device(config-tunnel-profile)# aaa-override	Enables AAA policy override.
<b>Step 9</b>	<b>gateway-radius-proxy</b> <b>Example:</b> Device(config-tunnel-profile)# gateway-radius-proxy	Enables the gateway RADIUS proxy.
<b>Step 10</b>	<b>gateway-accounting-radius-proxy</b> <b>Example:</b> Device(config-tunnel-profile)# gateway-accounting-radius-proxy	Enables the gateway accounting RADIUS proxy.
<b>Step 11</b>	<b>rule <i>priority</i> realm-filter <i>realm</i> domain <i>domain-name</i> vlan <i>vlan-id</i></b> <b>Example:</b> Device(config-tunnel-profile)# rule 12 realm-filter realm domain dom1 vlan 5	Creates a rule to choose a domain, using the realm filter, for client Network Access Identifier (NAI), tunneling domain name, and destination VLAN.

## Configuring the Tunnel Profile (GUI)

Follow the steps given below to configure the tunnel profile:

### Procedure

- 
- Step 1** Choose **Configuration > Tags & Profiles > EoGRE**.
- Step 2** Click the **Tunnel Profiles** tab.
- Step 3** Click the **Add** button.  
The **Add Tunnel Profile** window is displayed.
- Step 4** Click the **General** tab and complete the following steps:
- In the **Name** field, specify the tunnel profile name. The name can be ASCII characters from 32 to 126, without leading and trailing spaces.
  - In the **Status** field, slide the button to change the status to **Enabled**.
  - In the **Central Forwarding** field, slide the button to **Enabled**, to enable the feature.

- d) In the **DHCP Option-82** section, change the **Status** field and the **ASCII** field to **Enabled**, as per requirement.
- e) In the **Delimiter** field, specify the delimiter.
- f) From the **Circuit ID Available Services** list, select an available services and click the > sign to add the services to the assigned list.
- g) From the **Remote ID Available Services** list, select an available services and click the > sign to add the services to the assigned list.
- h) In the **AAA** section, choose an appropriate status for the **Radius Proxy** field, the **Accounting Proxy** field, and the **Override** field.

**Step 5** Click the **Rules** tab, and complete the following steps:

- a) Click the **Add Rules** button.
- b) In the **Priority** field, specify the priority of the rule from a range of 1 to 100.
- c) In the **Realm** field, specify a realm.
- d) From the **Domain** drop-down list, choose a domain.
- e) In the **VLAN Id** field, specify the VLAN ID that ranges between 1 and 4094.
- f) Click **Save**.

**Step 6** Click **Apply to Device**.

## Associating WLAN to a Wireless Policy Profile

### Procedure

	Command or Action	Purpose
<b>Step 1</b>	<b>configure terminal</b> <b>Example:</b> Device# configure terminal	Enters global configuration mode.
<b>Step 2</b>	<b>wireless tag policy <i>policy-tag-name</i></b> <b>Example:</b> Device(config)# wireless tag policy eogre_tag	Configures a policy tag and enters policy tag configuration mode.
<b>Step 3</b>	<b>wlan <i>wlan-name</i> policy <i>profile-policy-name</i></b> <b>Example:</b> Device(config-policy-tag)# wlan eogre_open_eogre policy eogre_policy	Maps an EoGRE policy profile to a WLAN profile.
<b>Step 4</b>	<b>end</b> <b>Example:</b> Device(config-policy-tag)# end	Saves the configuration, exits configuration mode, and returns to privileged EXEC mode.

## Attaching a Policy Tag and a Site Tag to an AP

### Procedure

	Command or Action	Purpose
<b>Step 1</b>	<b>configure terminal</b> <b>Example:</b> Device# configure terminal	Enters global configuration mode.
<b>Step 2</b>	<b>ap mac-address</b> <b>Example:</b> Device(config)# ap 80E8.6FD4.0BB0	Configures an AP and enters AP profile configuration mode.
<b>Step 3</b>	<b>policy-tag policy-tag-name</b> <b>Example:</b> Device(config-ap-tag)# policy-tag eogre_tag	Maps the EoGRE policy tag to the AP.
<b>Step 4</b>	<b>site-tag site-tag-name</b> <b>Example:</b> Device(config-ap-tag)# site-tag sp-flex-site	Maps a site tag to the AP.
<b>Step 5</b>	<b>end</b> <b>Example:</b> Device(config-ap-tag)# end	Saves the configuration, exits configuration mode, and returns to privileged EXEC mode.

## Verifying the EoGRE Tunnel Configuration

The `show tunnel eogre` command displays the EoGRE clients, domains, gateways, global-configuration, and manager information in the local mode.

To display the EoGRE domain summary in the local mode, use the following command:

```
Device# show tunnel eogre domain summary
```

```
Domain Name      Primary GW      Secondary GW      Active GW      Redundancy
-----
domain1          Tunnel1        Tunnel2          Tunnel1        Non-Revertive
eogre_domain     Tunnel1        Tunnel2          Tunnel1        Non-Revertive
```

To display the details of an EoGRE domain in the local mode, use the following command:

```
Device# show tunnel eogre domain detailed domain-name
```

```
Domain Name      : eogre_domain
Primary GW       : Tunnel1
Secondary GW     : Tunnel2
```

```
Active GW      : Tunnell
Redundancy    : Non-Revertive
```

To view the EoGRE tunnel gateway summary and statistics in the local mode, use the following command:

```
Device# show tunnel eogre gateway summary
```

Name	Type	Address	AdminState	State	Clients
Tunnell	IPv4	9.51.1.11	Up	Up	0
Tunnel2	IPv4	9.51.1.12	Up	Down	0
Tunnel10	IPv6	fd09:9:8:21::90	Down	Down	0
Tunnel11	IPv4	9.51.1.11	Up	Up	0
Tunnel12	IPv6	fd09:9:8:21::90	Up	Down	0
Tunnel100	IPv4	9.51.1.100	Up	Down	0

To view the details of an EoGRE tunnel gateway in the local mode, use the following command:

```
Device# show tunnel eogre gateway detailed gateway-name
```

```
Gateway : Tunnell
Mode    : IPv4
IP      : 9.51.1.11
Source  : Vlan51 / 9.51.1.1
State   : Up
SLA ID  : 56
MTU     : 1480
Up Time: 4 minutes 45 seconds

Clients
Total Number of Wireless Clients      : 0
Traffic
Total Number of Received Packets      : 0
Total Number of Received Bytes        : 0
Total Number of Transmitted Packets    : 0
Total Number of Transmitted Bytes     : 0
Keepalives
Total Number of Lost Keepalives       : 0
Total Number of Received Keepalives   : 5
Total Number of Transmitted Keepalives: 5
Windows                               : 1
Transmitted Keepalives in last window : 2
Received Keepalives in last window    : 2
```

To view the client summary of EoGRE in the local mode, use the following command:

```
Device# show tunnel eogre client summary
```

Client MAC	AP MAC	Domain	Tunnel	VLAN	Local
74da.3828.88b0	80e8.6fd4.9520	eogre_domain	N/A	2121	No

To view the details of an EoGRE global configuration in the local mode, use the following command:

```
Device# show tunnel eogre global-configuration
```

```
Heartbeat interval      : 60
Max Heartbeat skip count : 3
Source Interface       : (none)
```

To view the details of the global tunnel manager statistics in the local mode, use the following command:

```
Device# show tunnel eogre manager stats global
```

```
Tunnel Global Statistics
Last Updated           : 02/18/2019 23:50:35
EoGRE Objects
  Gateways              : 6
  Domains               : 2

EoGRE Flex Objects
  AP Gateways           : 2
  AP Domains            : 1
  AP Gateways HA inconsistencies : 0
  AP Domains HA inconsistencies : 0

Config events
  IOS Tunnel updates    : 806
  IOS Domain updates    : 88
  Global updates        : 48
  Tunnel Profile updates : 120
  Tunnel Rule updates   : 16
  AAA proxy key updates : 0

AP events
  Flex AP Join          : 1
  Flex AP Leave         : 0
  Local AP Join         : 0
  Local AP leave        : 0
  Tunnel status (rx)    : 4
  Domain status (rx)    : 1
  IAPP stats msg (rx)   : 3
  Client count (rx)     : 6
  VAP Payload msg (tx)  : 4
  Domain config (tx)    : 1
  Global config (tx)    : 1
  Client delete (tx)    : 1
  Client delete per domain (tx) : 3
  DHCP option 82 (tx)   : 4

Client events
  Add-mobile            : 2
  Run-State             : 3
  Delete                : 1
  Cleanup               : 0
  Join                  : 2
  Plumb                 : 0
  Join Errors           : 0
  HandOff               : 0
  MsPayload              : 2
  FT Recover            : 0
  Zombie GW counter increase : 0
  Zombie GW counter decrease : 0
  Tunnel Profile reset  : 88
  Client deauth         : 0
  HA reconciliation     : 0

Client Join Events
  Generic Error         : 0
  MSPayload Fail        : 0
  Invalid VLAN          : 0
```



```

Invalid Domain           : 0
No GWs in Domain        : 0
Domain Shut              : 0
Invalid GWs             : 0
GWs Down                : 0
Rule Match Error        : 0
AAA-override            : 0
Flex No Active GW       : 0
Open Auth join attempt  : 2
Dot1x join attempt      : 2
Mobility join attempt   : 0
Tunnel Profile not valid : 2
Tunnel Profile valid    : 2
No rule match           : 0
Rule match              : 2
AAA proxy               : 0
AAA proxy accounting    : 0
AAA eogre attributes    : 0
Has aaa override        : 0
Error in handoff payload : 0
Handoff AAA override    : 0
Handoff no AAA override : 0
Handoff payload received : 0
Handoff payload sent    : 0

SNMP Traps
Client                  : 0
Tunnel                  : 2
Domain                  : 0

IPC
IOSd TX messages       : 0

Zombie Client
Entries                 : 0

```

To view the tunnel manager statistics of a specific process instance in the local mode, use the following command:

```
Device# show tunnel eogre manager stats instance instance-number
```

```

Tunnel Manager statistics for process instance : 0
Last Updated           : 02/18/2019 23:50:35
EoGRE Objects
  Gateways              : 6
  Domains               : 2

EoGRE Flex Objects
  AP Gateways          : 2
  AP Domains           : 1
  AP Gateways HA inconsistencies : 0
  AP Domains HA inconsistencies : 0

Config events
  IOS Tunnel updates   : 102
  IOS Domain updates   : 11
  Global updates       : 6
  Tunnel Profile updates : 15
  Tunnel Rule updates  : 2
  AAA proxy key updates : 0

AP events
  Flex AP Join         : 1

```

```

Flex AP Leave           : 0
Local AP Join           : 0
Local AP leave          : 0
Tunnel status (rx)     : 4
Domain status (rx)     : 1
IAPP stats msg (rx)    : 3
Client count (rx)      : 6
VAP Payload msg (tx)   : 4
Domain config (tx)     : 1
Global config (tx)     : 1
Client delete (tx)     : 1
Client delete per domain (tx) : 3
DHCP option 82 (tx)   : 4

Client events
Add-mobile             : 2
Run-State              : 3
Delete                 : 1
Cleanup                : 0
Join                   : 2
Plumb                  : 0
Join Errors            : 0
HandOff                : 0
MsPayload              : 2
FT Recover             : 0
Zombie GW counter increase : 0
Zombie GW counter decrease : 0
Tunnel Profile reset   : 11
Client deauth          : 0
HA reconciliation      : 0

Client Join Events
Generic Error          : 0
MSPayload Fail         : 0
Invalid VLAN           : 0
Invalid Domain         : 0
No GWs in Domain       : 0
Domain Shut            : 0
Invalid GWs            : 0
GWs Down               : 0
Rule Match Error       : 0
AAA-override           : 0
Flex No Active GW      : 0
Open Auth join attempt : 2
Dot1x join attempt     : 2
Mobility join attempt  : 0
Tunnel Profile not valid : 2
Tunnel Profile valid   : 2
No rule match          : 0
Rule match              : 2
AAA proxy              : 0
AAA proxy accounting   : 0
AAA eogre attributes   : 0
Has aaa override       : 0
Error in handoff payload : 0
Handoff AAA override   : 0
Handoff no AAA override : 0
Handoff payload received : 0
Handoff payload sent   : 0

SNMP Traps
Client                 : 0
Tunnel                  : 2
Domain                  : 0

```

```
IPC
  IOSd TX messages          : 0

Zombie Client
  Entries                   : 0
```

The `show ap tunnel eogre` command displays the tunnel domain information, EoGRE events, and the tunnel gateway status on the APs, in the flex mode.

To view the summary information of an EoGRE tunnel gateway in the flex mode, use the following command:

```
Device# show ap tunnel eogre domain summary
```

```
AP MAC          Domain          Active Gateway
-----
80e8.6fd4.9520  eogre_domain          Tunnel1
```

To view the wireless tunnel profile summary, use the following command:

```
Device# show wireless profile tunnel summary
```

```
Profile Name          AAA-Override AAA-Proxy DHCP Opt82 Enabled
-----
eogre_tunnel          No           No       Yes       Yes
eogre_tunnel_set      No           No       Yes       No
eogre_tunnel_snmp     No           No       No        No
```

To view a wireless tunnel profile's details, use the following command:

```
Device# show wireless profile tunnel detailed profile-name
```

```
Profile Name : eogre_tunnel
Status : Enabled
AAA-Proxy/Accounting-Proxy: Disabled / Disabled
AAA-Override : Disabled
DHCP Option82 : Enabled
Circuit-ID : ap-mac,ap-ethmac,ap-location,vlan
Remote-ID : ssid-name,ssid-type,client-mac,ap-name
```

Tunnel Rules

```
Priority Realm          Vlan Domain (Status/Primary GW/Secondary GW)
-----
1          *          2121 eogre_domain (Enabled/Tunnel1/Tunnel2)
```

To view detailed information about an EoGRE tunnel domain's status, use the following command:

```
Device# show ap tunnel eogre domain detailed
```

```
Domain      : eogre_domain
AP MAC      : 80e8.6fd4.9520
Active GW   : Tunnel1
```

To view the EoGRE events on an AP, use the following command:

```
Device# show ap tunnel eogre events
```

```
AP 80e8.6fd4.9520  Event history
Timestamp          #Times  Event          RC Context
-----
-----
```

```

02/18/2019 23:50:26.341 6      IAPP_STATS      0 GW Tunnel2 uptime:0s
02/18/2019 23:49:40.222 2      CLIENT_JOIN     0 74da.3828.88b0, (eogre_domain/2121)
02/18/2019 23:48:43.549 1      CLIENT_LEAVE    0 74da.3828.88b0, (eogre_domain/2121)
02/18/2019 23:47:33.127 1      DOMAIN_STATUS  0 eogre_domain Active GW: Tunnell
02/18/2019 23:47:33.124 4      AP_TUNNEL_STATUS 0 Tunnel2 Dn
02/18/2019 23:47:33.124 1      MSG_CLIENT_DEL  0 GW Tunnel2 (IP: 9.51.1.12)
02/18/2019 23:47:33.124 2      TUNNEL_ADD      0 GW Tunnel2
02/18/2019 23:47:33.120 3      MSG_CLIENT_DEL_PD 0 GW Tunnell (IP: 9.51.1.11)
02/18/2019 23:47:31.763 2      AP_DOMAIN_PUSH  0 Delete:eogre_domain_set, 0 GWs
02/18/2019 23:47:31.753 4      AP_VAP_PUSH     0 profile:'eogre_tunnel',
wlan:pyats_eogre

```

To view the summary information of the EoGRE tunnel gateway, use the following command:

```
Device# show ap tunnel eogre gateway summary
```

AP MAC	Gateway	Type	IP	State	Clients
80e8.6fd4.9520	Tunnell	IPv4	9.51.1.11	Up	1
80e8.6fd4.9520	Tunnel2	IPv4	9.51.1.12	Down	0

To view detailed information about an EoGRE tunnel gateway, use the following command:

```
Device# show ap tunnel eogre gateway detailed gateway-name
```

```

Gateway : Tunnell
Mode    : IPv4
IP      : 9.51.1.11
State   : Up
MTU     : 1476
Up Time: 14 hours 25 minutes 2 seconds
AP MAC  : 80e8.6fd4.9520

Clients
Total Number of Wireless Clients      : 1
Traffic
Total Number of Received Packets     : 6
Total Number of Received Bytes       : 2643
Total Number of Transmitted Packets   : 94
Total Number of Transmitted Bytes     : 20629
Total Number of Lost Keepalive       : 3

```

To view summary information about the EoGRE tunnel gateway status, use the following command:

```
Device# show ap tunnel eogre domain summary
```

AP MAC	Domain	Active Gateway
80e8.6fd4.9520	eogre_domain	Tunnell

To view information about EoGRE events on an AP, use the following command:

Device# **show ap name** *ap-name* **tunnel eogre events**

```

AP 80e8.6fd4.9520 Event history
Timestamp          #Times  Event                               RC Context
-----
02/18/2019 23:50:26.341 6      IAPP_STATS                          0 GW Tunnel2 uptime:0s
02/18/2019 23:49:40.222 2      CLIENT_JOIN                          0 74da.3828.88b0, (eogre_domain/2121)
02/18/2019 23:48:43.549 1      CLIENT_LEAVE                         0 74da.3828.88b0, (eogre_domain/2121)
02/18/2019 23:47:33.127 1      DOMAIN_STATUS                       0 eogre_domain Active GW: Tunnel1
02/18/2019 23:47:33.124 4      AP_TUNNEL_STATUS                    0 Tunnel2 Dn
02/18/2019 23:47:33.124 1      MSG_CLIENT_DEL                      0 GW Tunnel2 (IP: 9.51.1.12)
02/18/2019 23:47:33.124 2      TUNNEL_ADD                          0 GW Tunnel2
02/18/2019 23:47:33.120 3      MSG_CLIENT_DEL_PD                   0 GW Tunnel1 (IP: 9.51.1.11)
02/18/2019 23:47:31.763 2      AP_DOMAIN_PUSH                      0 Delete:eogre_domain_set, 0 GWs
02/18/2019 23:47:31.753 4      AP_VAP_PUSH                         0 profile:'eogre_tunnel',
wlan:pyats_eogre

```

To view the summary information about EoGRE tunnel domain's status on an AP, use the following command:

Device# **show ap name** *ap-name* **tunnel eogre domain summary**

```

AP MAC          Domain          Active Gateway
-----
80e8.6fd4.9520  eogre_domain

```

To view the detailed information about EoGRE tunnel domain on an AP, use the following command:

Device# **show ap name** *ap-name* **tunnel eogre domain detailed**

```

Domain Name      : eogre_domain
Primary GW      : Tunnel1
Secondary GW    : Tunnel2
Active GW       : Tunnel1
Redundancy      : Non-Revertive
AdminState      : Up

```

To view the summary information about EoGRE tunnel gateways on an AP, use the following command:

Device# **show ap name** *ap-name* **tunnel eogre gateway summary**

```

AP MAC          Gateway          Type  IP              State  Clients
-----
80e8.6fd4.9520  Tunnel1          IPv4  9.51.1.11      Up     1
80e8.6fd4.9520  Tunnel2          IPv4  9.51.1.12      Down  0

```

To view detailed information about an EoGRE tunnel gateway's status on an AP, use the following command:

Device# **show ap name** *ap-name* **tunnel eogre gateway detailed** *gateway-name*

```

Gateway : Tunnel2
Mode    : IPv4

```

```
IP      : 9.51.1.12
State   : Down
MTU     : 0
AP MAC  : 80e8.6fd4.9520
```

## Clients

```
Total Number of Wireless Clients      : 0
Traffic
Total Number of Received Packets       : 0
Total Number of Received Bytes         : 0
Total Number of Transmitted Packets    : 0
Total Number of Transmitted Bytes      : 0
Total Number of Lost Keepalive         : 151
```



## CHAPTER 184

# Wireless Guest Access

---

- [Wireless Guest Access](#), on page 1773
- [Load Balancing Among Multiple Guest Controllers](#), on page 1777
- [Guidelines and Limitations for Wireless Guest Access](#), on page 1777
- [Configure Mobility Tunnel for Guest Access \(GUI\)](#), on page 1778
- [Configure Mobility Tunnel for Guest Access \(CLI\)](#), on page 1778
- [Configuring Guest Access Policy \(GUI\)](#), on page 1778
- [Configuring Guest Access Policy \(CLI\)](#), on page 1779
- [Viewing Guest Access Debug Information \(CLI\)](#), on page 1781
- [Verifying Wireless Guest Access Enablement](#), on page 1781
- [Configure Guest Access Using Different Security Methods](#), on page 1781

## Wireless Guest Access

The Wireless Guest Access feature addresses the need to provide internet access to guests in a secure and accountable manner. The implementation of a wireless guest network uses the enterprise's existing wireless and wired infrastructure to the maximum extent. This reduces the cost and complexity of building a physical overlay network. Wireless Guest Access solution comprises of two controllers - a Guest Foreign and a Guest Anchor. An administrator can limit bandwidth and shape the guest traffic to avoid impacting the performance of the internal network.



---

**Note**

- When a client joins through a capwap tunnel from an AP, the RADIUS NAS-Port-Type is set as "wireless 802.11". Here, Point of Attachment (PoA) and Point of Presence (PoP) is the same.
- When a client joins through a mobility tunnel, the RADIUS NAS-Port-Type is set as "virtual". Here, PoA is the Foreign controller and PoP is the Anchor controller as the client is anchored. For information on the standard types, see the following link:

<https://www.iana.org/assignments/radius-types/radius-types.xhtml#radius-types-13>

---

Wireless Guest Access feature comprises the following functions:

- Guest Anchor controller is the point of presence for a client.

- Guest Anchor Controller provides internal security by forwarding the traffic from a guest client to a Cisco Wireless Controller in the demilitarized zone (DMZ) network through the anchor controller.
- Guest Foreign controller is the point of attachment of the client.
- Guest Foreign Controller is a dedicated guest WLAN or SSID and is implemented throughout the campus wireless network wherever guest access is required. A WLAN with mobility anchor (guest controller) configured on it identifies the guest WLAN.
- Guest traffic segregation implements Layer 2 or Layer 3 techniques across the campus network to restrict the locations where guests are allowed.
- Guest user-level QoS is used for rate limiting and shaping, although it is widely implemented to restrict the bandwidth usage for a guest user.
- Access control involves using embedded access control functionality within the campus network, or implementing an external platform to control guest access to the Internet from the enterprise network.
- Authentication and authorization of guests that are based on variables, including date, duration, and bandwidth.
- An audit mechanism to track who is currently using, or has used, the network.
- A wider coverage is provided by including areas such as lobbies and other common areas that are otherwise not wired for network connectivity.
- The need for designated guest access areas or rooms is removed.



**Note** To use IRCM with AireOS in your network, contact Cisco TAC for assistance.

**Table 95: Supported Controllers**

Controller Name	Supported as Guest Anchor	Supported as Guest Foreign
Cisco Catalyst 9800-40 Wireless Controller	Yes	Yes
Cisco Catalyst 9800-80 Wireless Controller	Yes	Yes
Cisco Catalyst 9800-CL Wireless Controller	Yes	Yes
Cisco Catalyst 9800-L Wireless Controller	Yes	Yes
Cisco Catalyst 9800 Embedded Wireless Controller for Switch	No	No
Cisco Catalyst 9800 Embedded Wireless Controller on Cisco Catalyst 9100 Series APs	No	No



Following is a list of features supported by Cisco Guest Access:

### Supported Features

- Sleeping Clients
- FQDN
- AVC (AP upstream and downstream)
- Native Profiling
- Open Authentication
- OpenDNS
- Supported Security Methods:
  - MAB Central Web Authentication (CWA)
  - Local Web Authentication (LWA)
  - LWA on MAB Failure
  - 802.1x + CWA
  - 802.1x
  - PSK
  - 802.1x + LWA
  - PSK + CWA
  - PSK + LWA
  - iPSK + CWA
  - MAB Failure + PSK
  - MAB Failure + OWE
  - MAB Failure + SAE
- SSID QoS Upstream and Downstream (Foreign)
- AP/ Client SSO
- Static IP Roaming
- Client IPv6
- Roaming across controllers
- RADIUS Accounting



---

**Note**

In a guest access scenario, accounting is always performed at the foreign controller for all authentication methods.

---

- QoS: Client-Level Rate Limiting
- Guest Anchor Load Balancing
- Workgroup Bridges (WGB)



---

**Note** To enable the controller to support multiple VLANs from a WGB, use **wgb vlan** command.

---

## Foreign Map Overview

Guest Access supports Foreign Map using Policy Profile and WLAN Profile configuration models in Cisco Catalyst 9800 Series Wireless Controller.

Foreign Map support in Cisco Catalyst 9800 Series Wireless Controller is achieved with the following policy profile and WLAN profile config model.

- Guest Foreign commands:
  - **Foreign1: wlanProf1 PolicyProf1**
  - **Foreign2: wlanProf2 PolicyProf2**
- Guest Anchor commands:
  - **wlanProf1, wlanProf2**
  - **PolicyProf1: Vlan100 - subnet1**
  - **PolicyProf2: Vlan200 - subnet2**

### Foreign Map Roaming

Configure two different WLAN profiles on the two Guest Foreigns and seamless roaming is not allowed between them. This is expected configuration. However, seamless roaming is allowed if the same WLAN profile is configured on two Guest Foreigns, but it prevents Foreign Map feature from working.

## Wireless Guest Access: Use Cases

The wireless guest access feature can be used to meet different requirements. Some of the possibilities are shared here.

### Scenario One: Providing Secured Network Access During Company Merger

This feature can be configured to provide employees of **company A** who are visiting **company B** to access company A resources on company B network securely.

### Scenario Two: Shared Services over Existing Setup

Using this feature, you can provide multiple services using multiple vendors piggy backing on the existing network. A company can provide services on an SSID which is anchored on the existing controller. This is while the existing service continues to serve over the same controller and network.

## Load Balancing Among Multiple Guest Controllers

- You can configure export anchors to load balance large guest client volumes. For a single export foreign guest WLAN configuration, up to 72 controllers are allowed. To configure mobility guest controllers, use **mobility anchor ip address**.
- You can specify primary anchors with priority (1,3) and choose another anchor as backup in case of failure.
- In a multi-anchor scenario, when the primary anchor goes down, the clients get disconnected from the primary anchor and joins the secondary anchor.

## Guidelines and Limitations for Wireless Guest Access

- Match the security profiles under WLAN on both Guest Foreign, and Guest Anchor.
- Match the policy profile attributes such as NAC and AAA Override on both Guest Foreign, and Guest Anchor controllers.
- On Export Anchor, the WLAN profile name and Policy profile name is chosen when a client joins at runtime and the same should match with the Guest Foreign controller.

## Troubleshooting IPv6

When a guest export client cannot get a routable IPv6 address through SLAAC or cannot pass traffic when the IPv6 address is learned through DHCPv6, you can use the following workarounds:

- On IPv6 Routers: You can work around the RA multicast to unicast conversion by modifying behavior on the IPv6 gateway. Depending on the product, this may be the default behavior or may require configuration.
  - On Cisco IPv6 Routers
    - Cisco Nexus platform: Has solicited unicast RA enabled by default to help with wireless deployment.
    - Cisco IOS-XE platform: Use the following configuration command to turn on unicast RA to help with wireless deployment:  
**ipv6 nd ra solicited unicast**
  - On non-Cisco IPv6 Routers: If non-Cisco network devices do not support configuration command to enable solicited unicast RA then a work around does not exist.

## Configure Mobility Tunnel for Guest Access (GUI)

### Procedure

- 
- Step 1** Choose **Configure > Tags and Profiles > WLANs**.
  - Step 2** In the **Wireless Networks** area, click the relevant WLAN or RLAN and click **Mobility Anchor**.
  - Step 3** In the **Wireless Network Details** section, choose a device from the **Switch IP Address** drop-down list.
  - Step 4** Click **Apply**.
- 

## Configure Mobility Tunnel for Guest Access (CLI)

Follow the procedure given below to configure a mobility tunnel.

### Procedure

	Command or Action	Purpose
<b>Step 1</b>	<b>wireless mobility group name</b> <i>group name</i> <b>Example:</b> Device(config)# wireless mobility group name mtunnelgrp	Configures a mobility group.
<b>Step 2</b>	<b>wireless mobility mac-address</b> <i>mac address</i> <b>Example:</b> Device(config)# wireless mobility mac-address 0d:4c:da:3a:f2:21	Configures a mobility MAC address.
<b>Step 3</b>	<b>wireless mobility group member mac</b> <i>mac address ip ip address group group name</i> <b>Example:</b> Device(config)# wireless mobility group member mac-address df:07:a1:a7:a8:55 ip 206.223.123.2 group mtgrp	Configures a mobility peer.

## Configuring Guest Access Policy (GUI)

### Procedure

- 
- Step 1** Choose **Configuration > Tags & Profiles > Policy**.
  - Step 2** Click **Add**.

- Step 3** In the **General** tab, enter the **Name** and enable the **Central Switching** toggle button.
- Step 4** In the **Access Policies** tab, under the **VLAN** settings, choose the vlans from the **VLAN/VLAN Group** drop-down list.
- Step 5** In the **Mobility** tab, under the **Mobility Anchors** settings, check the **Export Anchor** check box.
- Step 6** In the **Advanced** tab, under the **WLAN Timeout** settings, enter the **Idle Timeout (sec)**.
- Step 7** Click **Apply to Device**.

## Configuring Guest Access Policy (CLI)

Follow the procedure given below to create and configure the guest access profile policy. Alternately, you may use the existing default policy profile after configuring the mobility anchor to that policy.

You can only configure anchors which are peers. Ensure that the IP address that is used is a mobility peer and is included in the mobility group. The system shows an invalid anchor IP address error message when any other IP address is used.

To delete the mobility group, ensure that the mobility peer which is also a mobility anchor is removed from the policy profile.



- Note**
- No payload is sent to Guest Foreign to display the VLAN.
  - To avoid a client exclusion from occurring due to VLAN, Cisco Catalyst 9800 Series Controllers need to define VLAN along with the associated name being pushed from ISE.

### Procedure

	Command or Action	Purpose
<b>Step 1</b>	<b>configure terminal</b> <b>Example:</b> Device# configure terminal	Enters global configuration mode.
<b>Step 2</b>	<b>wireless profile policy wlan_policy_profile</b> <b>Example:</b> Device(config)# wireless profile policy guest-test-policy	Configures the policy profile and enters wireless profile configuration mode. <b>Note</b> • You can use the <b>default-policy-profile</b> to configure the profile policy.
<b>Step 3</b>	<b>shutdown</b> <b>Example:</b> Device(config-wireless-policy)# shutdown	Shuts down the policy if it exists before configuring the anchor.
<b>Step 4</b>	<b>central switching</b> <b>Example:</b>	(Optional) Enables central switching.

	Command or Action	Purpose
	Device (config-wireless-policy)# central switching	
<b>Step 5</b>	<p>Choose the first option to configure the Guest Foreign or second option to configure the Guest Anchor:</p> <ul style="list-style-type: none"> <li>• <b>mobility anchor</b> <i>anchor-ip-address</i></li> <li>• <b>mobility anchor</b></li> </ul> <p><b>Example:</b></p> <p>For Guest Foreign:</p> <pre>Device (config-wireless-policy)# mobility anchor 19.0.2.1</pre> <p>For Guest Anchor:</p> <pre>Device (config-wireless-policy)# mobility anchor</pre>	Configures Guest Foreign or Guest Anchor.
<b>Step 6</b>	<p><b>idle-timeout</b> <i>timeout</i></p> <p><b>Example:</b></p> <pre>Device (config-wireless-policy)# idle-timeout 1000</pre>	(Optional) Configures duration of idle timeout, in seconds.
<b>Step 7</b>	<p><b>vlan</b> <i>vlan-id</i></p> <p><b>Example:</b></p> <pre>Device (config-wireless-policy)# vlan 2</pre>	<p>Configures VLAN name or VLAN Id.</p> <p><b>Note</b> VLAN is optional for a Guest Foreign controller.</p>
<b>Step 8</b>	<p><b>no shutdown</b></p> <p><b>Example:</b></p> <pre>Device (config-wireless-policy)# no shutdown</pre>	Enables policy profile.
<b>Step 9</b>	<p><b>end</b></p> <p><b>Example:</b></p> <pre>Device (config-wireless-policy)# end</pre>	Exits the configuration mode and returns to privileged EXEC mode.
<b>Step 10</b>	<p><b>show wireless profile policy summary</b></p> <p><b>Example:</b></p> <pre>Device# show wireless profile policy summary</pre>	(Optional) Displays the configured profiles.
<b>Step 11</b>	<p><b>show wireless profile policy detailed</b> <i>policy-profile-name</i></p> <p><b>Example:</b></p> <pre>Device# show wireless profile policy detailed guest-test-policy</pre>	(Optional) Displays detailed information of a policy profile.

## Viewing Guest Access Debug Information (CLI)

- To display client level detailed information about mobility state and the anchor IP address, use the following command:  
**show wireless client mac-add *mac-address* detail**
- To display the client mobility statistics, use the following command:  
**show wireless client mac-address *mac-address* mobility statistics**
- To display client level roam history for an active client in sub-domain, use the following command:  
**show wireless client mac-address *mac-address* mobility history**
- To display detailed parameters of a given profile policy, use the following command:  
**show wireless profile policy detailed *policy-name***
- To display the global level summary for all mobility messages, use the following command:  
**show wireless mobility summary**
- To display the statistics for the Mobility manager, use the following command:  
**show wireless stats mobility**

## Verifying Wireless Guest Access Enablement

To check if wireless guest access is enabled, run the following command.

```
Device# show platform hardware chassis active qfp feature sw client vlan all  
  
-----  
Vlan : 666  
Learning Enabled : true  
DHCPDN Enabled : true  
Non IP Multicast Enabled : false  
Broadcast Enabled : false  
Wireless Passive Client Enabled : false  
Guest-Ian Enabled : true  
MTU : 65535  
Input UIDB : 65503  
Output UIDB : 65497  
Flood List : 0XB8658A0
```

## Configure Guest Access Using Different Security Methods

The following sections provide information about the following:

### Open Authentication

To configure the guest access with open authentication, follow the steps:

1. Configuring the WLAN Profile
2. [#unique\\_2253](#)



**Note** No tag is required unless AVC is enabled.

## Configure a WLAN Profile for Guest Access with Open Authentication (GUI)

### Procedure

- 
- Step 1** Choose **Configuration > Tags & Profiles > WLANs**.
- Step 2** Click **Add**.
- Step 3** In the **General** tab, enter the **Profile Name**, the **SSID** and the **WLAN ID**. Choose the radio policy from the **Radio Policy** drop-down list. Enable or disable the **Status** and **Broadcast SSID** toggle buttons.
- Step 4** Choose **Security > Layer2** tab. Uncheck the **WPA Policy**, **WPA2 Policy**, **AES** and **802.1x** check boxes.
- Step 5** Click **Apply to Device**.
- 

## Configure a WLAN Profile For Guest Access with Open Authentication (CLI)

### Procedure

	Command or Action	Purpose
<b>Step 1</b>	<b>configure terminal</b>  <b>Example:</b> Device# configure terminal	Enters global configuration mode.
<b>Step 2</b>	<b>wlan profile-name wlan-id ssid-name.</b>  <b>Example:</b> Device(config)# wlan mywlan 34 mywlan-ssid	Configures the WLAN and SSID.
<b>Step 3</b>	<b>no security wpa</b>  <b>Example:</b> Device(config-wlan)# no security wpa	Disables WPA security.
<b>Step 4</b>	<b>no security wpa akm dot1x</b>  <b>Example:</b> Device(config-wlan)# no security wpa akm dot1x	Disables security AKM for dot1x.
<b>Step 5</b>	<b>no security wpa wpa2</b>  <b>Example:</b>	Disables WPA2 security.



	Command or Action	Purpose
	Device(config-wlan)# no security wpa wpa2	
<b>Step 6</b>	<b>no security wpa wpa2 ciphers aes</b> <b>Example:</b> Device(config-wlan)# no security wpa wpa2 ciphers aes	Disables WPA2 ciphers for AES.
<b>Step 7</b>	<b>no shutdown</b> <b>Example:</b> Device(config-wlan)# no shutdown	Saves the configuration.

## Configuring a Policy Profile

### Procedure

	Command or Action	Purpose
<b>Step 1</b>	<b>configure terminal</b> <b>Example:</b> Device# configure terminal	Enters global configuration mode.
<b>Step 2</b>	<b>wireless profile policy <i>wlan-policy-profile</i></b> <b>Example:</b> Device(config)# wireless profile policy open_it	Configures WLAN policy profile and enters the wireless policy configuration mode.
<b>Step 3</b>	Choose the first option to configure a Guest Foreign or second option to configure a Guest Anchor: <ul style="list-style-type: none"> <li>• <b>mobility anchor <i>anchor-ip-address</i></b></li> <li>• <b>mobility anchor</b></li> </ul> <b>Example:</b> For Guest Foreign: Device (config-wireless-policy)# mobility anchor 19.0.2.1 For Guest Anchor: Device (config-wireless-policy)# mobility anchor	Configures Guest Foreign or Guest Anchor.
<b>Step 4</b>	<b>central switching.</b> <b>Example:</b> Device(config-wireless-policy)# central switching	Enables Central switching
<b>Step 5</b>	<b>vlan <i>id</i></b>	Configures a VLAN name or VLAN ID.

	Command or Action	Purpose
	<b>Example:</b> Device(config-wireless-policy)# vlan 16	<b>Note</b> VLAN is optional for a Guest Foreign controller.
<b>Step 6</b>	<b>no shutdown</b> <b>Example:</b> Device(config-wireless-policy)# no shutdown	Enables the policy profile.

## Local Web Authentication

To configure LWA, follow these steps:

1. [Configure a Parameter Map \(CLI\)](#)
2. [Configure a WLAN Profile for Guest Access with Local Web Authentication \(CLI\)](#)
3. [Applying Policy Profile on a WLAN](#)
4. [Configure an AAA Server for Local Web Authentication \(CLI\)](#)

### Configure a Parameter Map (GUI)

#### Procedure

- 
- Step 1** Choose **Configuration > Security > Web Auth**.
- Step 2** Click **Add**.
- Step 3** Enter the **Parameter-map name**, **Maximum HTTP connections**, **Init-State Timeout(secs)** and choose **webauth** in the **Type** drop-down list.
- Step 4** Click **Apply to Device**.
- 

### Configure a Parameter Map (CLI)

#### Procedure

	Command or Action	Purpose
<b>Step 1</b>	<b>configure terminal</b> <b>Example:</b> Device# configure terminal	Enters global configuration mode.
<b>Step 2</b>	<b>parameter-map type webauth global</b> <b>Example:</b> Device(config)# parameter-map type webauth global	Creates a parameter map and enters parameter-map webauth configuration mode.

	Command or Action	Purpose
<b>Step 3</b>	<b>type webauth</b> <b>Example:</b> Device (config-params-parameter-map) #type webauth	Configures the webauth type parameter.
<b>Step 4</b>	<b>timeout init-state sec <i>timeout-seconds</i></b> <b>Example:</b> Device (config-params-parameter-map) # timeout inti-state sec 3600	Configures the WEBAUTH timeout in seconds. Valid range for the time in sec parameter is 60 to 3932100 seconds.
<b>Step 5</b>	<b>virtual-ip ipv4 <i>virtual_IP_address</i></b> <b>Example:</b> Device (config-params-parameter-map) #virtual-ip ipv4 209.165.201.1	Configures a VLAN name or VLAN ID.

## Configure a WLAN Profile for Guest Access with Local Web Authentication (GUI)

### Procedure

- 
- Step 1** Choose **Configuration > Tags & Profiles > WLANs**.
  - Step 2** Click on the **WLAN** name.
  - Step 3** Choose **Security > Layer3**.
  - Step 4** Check the **Web Policy** check box.
  - Step 5** Choose a parameter map from the **Web Auth Parameter Map** drop-down list.
  - Step 6** Choose an authentication list from the **Authentication List** drop-down list.
  - Step 7** Click **Update & Apply to Device**.
- 

## Configure a WLAN Profile for Guest Access with Local Web Authentication (CLI)

### Procedure

	Command or Action	Purpose
<b>Step 1</b>	<b>configure terminal</b> <b>Example:</b> Device# configure terminal	Enters global configuration mode.
<b>Step 2</b>	<b>wlan <i>wlan-id ssid-name</i></b> <b>Example:</b> Device# Device (config) # wlan mywlan 38 mywlan-ssid1	Configures the WLAN and SSID.

	Command or Action	Purpose
<b>Step 3</b>	<b>security web-auth</b> <b>Example:</b> Device(config-wlan)# security web-auth	Enables web authentication for a WLAN.
<b>Step 4</b>	<b>security web-auth parameter-map default</b> <b>Example:</b> Device(config-wlan)# security web-auth parameter-map default	Configure the default parameter map. <b>Note</b> When <b>security web-auth</b> is enabled, you get to map the <b>default authentication-list</b> and global <b>parameter-map</b> . This is applicable for authentication-list and parameter-map that are not explicitly mentioned.
<b>Step 5</b>	<b>security web-auth parameter-map global</b> <b>Example:</b> Device(config-wlan)# security web-auth parameter-map global	Configure the global parameter map.
<b>Step 6</b>	<b>security web-auth authentication-list LWA-AUTHENTICATION</b> <b>Example:</b> Device(config-wlan)# security web-auth authentication-list LWA-AUTHENTICATION	Sets the authentication list for IEEE 802.1x.

## Configure an AAA Server for Local Web Authentication (GUI)

### Procedure

- 
- Step 1** Choose **Configuration > Security > AAA > AAA Advanced > Global Config**.
  - Step 2** Choose the options from the **Local Authentication, Authentication Method List, Local Authorization and Authorization Method List** drop-down lists.
  - Step 3** Enable or Disable the **Radius Server Load Balance** using toggle button.
  - Step 4** Check the **Interim Update** check box.
  - Step 5** Click **Apply**.
- 

## Configure an AAA Server for Local Web Authentication (CLI)

### Procedure

	Command or Action	Purpose
<b>Step 1</b>	<b>configure terminal</b> <b>Example:</b> Device# configure terminal	Enters global configuration mode.

	Command or Action	Purpose
<b>Step 2</b>	<b>aaa authentication login</b> <b>LWA-AUTHENTICATION local</b>  <b>Example:</b> Device(config)#aaa authentication login lwa-authentication local	Defines the authentication method at login.
<b>Step 3</b>	<b>aaa authorization network default local</b> <b>if-authenticated</b>  <b>Example:</b> Device(config)#aaa authorization network default local if-authenticated	Sets the authorization method to local if the user has authenticated.

## Global Configuration

Follow the procedure given below for global configuration:

### Procedure

	Command or Action	Purpose
<b>Step 1</b>	<b>configure terminal</b>  <b>Example:</b> Device# configure terminal	Enters global configuration mode.
<b>Step 2</b>	<b>username name password 0</b> <b>clear-text-password</b>  <b>Example:</b> Device(config)# #username base password 0 pass1	Sets the clear text password for the user.
<b>Step 3</b>	<b>ip http server</b>  <b>Example:</b> Device(config)#ip http server	Enables the HTTP server.
<b>Step 4</b>	<b>ip http authentication local</b>  <b>Example:</b> Device(config)#ip http authentication local	Sets the HTTP server authentication method to local.  <b>Note</b> You will get the admin access rights regardless of the user privilege, if the <b>ip http authentication local</b> is disabled and username is the same as enable password.

## Central Web Authentication

To configure CWA, follow these steps:

1. [Configure a WLAN Profile for Guest Access with Central Web Authentication \(CLI\)](#)
2. [#unique\\_2267](#)
3. [AAA Server Configuration \(CLI\)](#)
4. [#unique\\_2269](#)

## Configure a WLAN Profile for Guest Access with Central Web Authentication (GUI)

### Procedure

- 
- Step 1** Choose **Configuration > Tags & Profiles > WLANs**.
- Step 2** Click **Add**.
- Step 3** In the **General** tab, enter the **Profile Name**, the **SSID**, and the **WLAN ID**.
- Step 4** To enable the WLAN, set **Status** as **Enabled**.
- Step 5** From the **Radio Policy** drop-down list, select the radio policy.
- Step 6** To enable the **Broadcast SSID**, set the status as **Enabled**.
- Step 7** Choose **Security > Layer2** tab. Uncheck the **WPA Policy**, **WPA2 Policy**, **AES** and **802.1x** check boxes.
- Step 8** Check the **MAC Filtering** check box to enable the feature. With MAC Filtering enabled, choose the Authorization list from the **Authorization List** drop-down list.
- Step 9** Click **Apply to Device**.
- 

## Configure a WLAN Profile for Guest Access with Central Web Authentication (CLI)

### Procedure

	Command or Action	Purpose
<b>Step 1</b>	<b>configure terminal</b>  <b>Example:</b> Device# configure terminal	Enters global configuration mode.
<b>Step 2</b>	<b>wlan wlan-id ssid-name</b>  <b>Example:</b> Device# Device(config)# wlan mywlan 38 mywlan-ssid1	Configures the WLAN and SSID.
<b>Step 3</b>	<b>mac-filtering remote_authorization_list_name</b>  <b>Example:</b> Device(config-wlan)# mac-filtering auth-list	Enables MAB authentication for the remote RADIUS server.
<b>Step 4</b>	<b>no security wpa</b>  <b>Example:</b>	Disables WPA security.

	Command or Action	Purpose
	Device(config-wlan)# no security wpa	
<b>Step 5</b>	<b>no security wpa akm dot1x</b> <b>Example:</b> Device(config-wlan)# no security wpa akm dot1x	Disables security AKM for dot1x.
<b>Step 6</b>	<b>no security wpa wpa2</b> <b>Example:</b> Device(config-wlan)# no security wpa wpa2	Disables WPA2 security.
<b>Step 7</b>	<b>no security wpa wpa2 ciphers aes</b> <b>Example:</b> Device(config-wlan)# no security wpa wpa2 ciphers aes	Disables WPA2 ciphers for AES.
<b>Step 8</b>	<b>no shutdown</b> <b>Example:</b> Device(config-wlan)# no shutdown	Saves the configuration.

## AAA Server Configuration (GUI)

### Procedure

- 
- Step 1** Choose **Configuration > Security > AAA > Servers/Groups > RADIUS > Server Groups**.
  - Step 2** Click the RADIUS server group.
  - Step 3** From the **MAC-Delimiter** drop-down list, choose an option.
  - Step 4** From the **MAC-Filtering** drop-down list, choose an option.
  - Step 5** Enter the **Dead-Time (mins)**.
  - Step 6** From the **Available Servers** on the left, move the servers you need to **Assigned Servers** on the right.
  - Step 7** Click **Update & Apply to Device**.
  - Step 8** Choose **Configuration > Security > AAA > Servers/Groups > RADIUS > Servers**.
  - Step 9** Click the RADIUS server.
  - Step 10** Enter the **IPv4/IPv6 Server Address, Auth Port, Acct Port, Server Timeout (seconds)** and **Retry Count**.
  - Step 11** Check or uncheck the **PAC Key** checkbox and choose the Key Type from the **Key Type** drop-down list. Enter the **Key** and **Confirm Key**.
  - Step 12** Enable or disable the **Support for CoA** toggle button.
  - Step 13** Click **Update & Apply to Device**.
-

## AAA Server Configuration (CLI)



**Note** Configure AAA server for Guest Foreign only.

### Procedure

	Command or Action	Purpose
<b>Step 1</b>	<b>configure terminal</b> <b>Example:</b> Device# configure terminal	Enters global configuration mode.
<b>Step 2</b>	<b>aaa authorization network <i>authorization-list</i></b> <b>local group <i>Server-group-name</i></b> <b>Example:</b> Device(config)#aaa authorization network cwa local group ise	Sets the authorization method to local.
<b>Step 3</b>	<b>aaa group server radius <i>server-group-name</i></b> <b>Example:</b> Device(config)#aaa group server radius ise	Configures RADIUS server group definition. <b>Note</b> <i>server-group-name</i> refers to the server group name. The valid range is from 1 to 32 alphanumeric characters.
<b>Step 4</b>	<b>server name <i>radius-server-name</i></b> <b>Example:</b> Device(config-sg-radius)#server name ise1	Configures the RADIUS server name.
<b>Step 5</b>	<b>subscriber mac-filtering security-mode mac</b> <b>Example:</b> Device(config-sg-radius)#\$mac-filtering security-mode mac	Sets the MAC address as the password.
<b>Step 6</b>	<b>mac-delimiter colon</b> <b>Example:</b> Device(config-sg-radius)#mac-delimiter colon	Sets the MAC address delimiter to colon.
<b>Step 7</b>	<b>end</b> <b>Example:</b> Device(config-sg-radius)#end	Saves the configuration, exits configuration mode, and returns to privileged EXEC mode.
<b>Step 8</b>	<b>radius server <i>name</i></b> <b>Example:</b> Device(config)#radius server ISE1	Sets the RADIUS server name



	Command or Action	Purpose
<b>Step 9</b>	<b>address ipv4 radius-server-ipaddress</b> <b>auth-port port-number acct-port port-number</b>  <b>Example:</b> Device(config-radius-server)#address ipv4 209.165.201.1 auth-port 1635 acct-port 33	Configures the RADIUS server IP address authentication and accounting ports.

## Configuring 802.1x with Local Web Authentication

### Procedure

	Command or Action	Purpose
<b>Step 1</b>	<b>configure terminal</b>  <b>Example:</b> Device# configure terminal	Enters global configuration mode.
<b>Step 2</b>	<b>wlan wlan-profile wlan-id ssid</b>  <b>Example:</b> Device(config)# wlan testwprofile 22 ssid-3	Configures the WLAN and SSID.
<b>Step 3</b>	<b>security dot1x authentication-list default</b>  <b>Example:</b> Device(config-wlan)# security dot1x authentication-list default	Configures 802.1X for an WLAN.
<b>Step 4</b>	<b>security web-auth authentication-list</b> <b>authenticate-list-name</b>  <b>Example:</b> Device(config-wlan)# security web-auth authentication-list default	Enables authentication list for 802.1x security on the WLAN.
<b>Step 5</b>	<b>security web-auth parameter-map global</b>  <b>Example:</b> Device(config-wlan)# security web-auth parameter-map global	Configures the global parameter map.
<b>Step 6</b>	<b>no shutdown</b>  <b>Example:</b> Device(config-wlan)# no shutdown	Enables the WLAN.

## Configuring Local Web Authentication with PSK Protocol

### Procedure

	Command or Action	Purpose
<b>Step 1</b>	<b>configure terminal</b> <b>Example:</b> Device# configure terminal	Enters global configuration mode.
<b>Step 2</b>	<b>wlan wlan-profile wlan-id ssid</b> <b>Example:</b> Device(config)# wlan psksec-profile 22 ssid-4	Configures the WLAN and SSID.
<b>Step 3</b>	<b>no security wpa</b> <b>Example:</b> Device(config-wlan)# no security wpa	Disables WPA security.
<b>Step 4</b>	<b>no security wpa wpa2</b> <b>Example:</b> Device(config-wlan)# no security wpa wpa2	Disables WPA2 security.
<b>Step 5</b>	<b>no security wpa akm dot1x</b> <b>Example:</b> Device(config-wlan)# no security wpa akm dot1x	Disables security AKM for dot1x.
<b>Step 6</b>	<b>security wpa psk</b> <b>Example:</b> Device(config-wlan)# security wpa akm psk	Enables the security type as PSK.
<b>Step 7</b>	<b>security wpa psk set-key {ascii hex} key</b> <b>Example:</b> Device(config-wlan)# security wpa akm psk set-key ascii 0	Configures the PSK shared key.
<b>Step 8</b>	<b>security web-auth</b> <b>Example:</b> Device(config-wlan)# security web-auth	Enables the web authentication for the WLAN.
<b>Step 9</b>	<b>security web-auth authentication-list default</b> <b>Example:</b> Device(config-wlan)# security web-auth authentication-list default	Enables authentication list for the WLAN.

	Command or Action	Purpose
<b>Step 10</b>	<b>security web-auth parameter-map <i>global</i></b> <b>Example:</b> Device(config-wlan)# security web-auth parameter-map global	Configure the global parameter map.

## Central Web Authentication with PSK Protocol

To configure the CWA with PSK security protocol, follow the steps:

1. [Configure WLAN Profile for Central Web Authentication with PSK Protocol](#)
2. [Applying Policy Profile on a WLAN](#)

### Configure WLAN Profile for Central Web Authentication with PSK Protocol

#### Procedure

	Command or Action	Purpose
<b>Step 1</b>	<b>configure terminal</b> <b>Example:</b> Device# configure terminal	Enters global configuration mode.
<b>Step 2</b>	<b>wlan <i>wlan-profile wlan-id ssid</i></b> <b>Example:</b> Device(config)# wlan cwasec-profile 27 ssid-5	Configures the WLAN and SSID.
<b>Step 3</b>	<b>no security wpa</b> <b>Example:</b> Device(config-wlan)# no security wpa	Disables WPA security.
<b>Step 4</b>	<b>no security wpa wpa2</b> <b>Example:</b> Device(config-wlan)# no security wpa wpa2	Disables WPA2 security.
<b>Step 5</b>	<b>no security wpa akm dot1x</b> <b>Example:</b> Device(config-wlan)# no security wpa akm dot1x	Disables security AKM for dot1x.
<b>Step 6</b>	<b>security wpa psk</b> <b>Example:</b> Device(config-wlan)# security wpa psk	Enables the security type as PSK.

	Command or Action	Purpose
<b>Step 7</b>	<b>security wpa psk set-key</b> { <i>ascii</i>   <i>hex</i> } <i>key</i> <b>Example:</b> Device(config-wlan)# security wpa psk set-key ascii 0	Configures the PSK shared key.
<b>Step 8</b>	<b>mac-filtering</b> <i>authorization_list_name</i> <b>Example:</b> Device(config-wlan)# mac-filtering cwa-list	Enables MAC filtering for PSK web authentication.

## Central Web Authentication with iPSK Protocol

To configure the CWA with iPSK security protocol, follow the steps:

1. [Configure WLAN Profile for Central Web Authentication with iPSK Protocol](#)

### Configure WLAN Profile for Central Web Authentication with iPSK Protocol

#### Procedure

	Command or Action	Purpose
<b>Step 1</b>	<b>wlan</b> <i>guest-wlan-name wlan-id ssid</i> <b>Example:</b> config# wlan ipsk-cwa-profile 28 ssid-6	Configures guest WLAN.
<b>Step 2</b>	<b>no security wpa akm dot1x</b> <b>Example:</b> Device(config-wlan)# no security wpa akm dot1x	Disables security AKM for 802.1x.
<b>Step 3</b>	<b>security wpa akm psk set-key</b> { <i>ascii</i>   <i>hex</i> } <i>key</i> <b>Example:</b> Device(config-wlan)# security wpa akm psk set-key ascii 0	Configures the PSK AKM shared key.
<b>Step 4</b>	<b>mac-filtering</b> <i>authorization_list_name</i> <b>Example:</b> Device(config-wlan)# mac-filtering cwa-list	Enables MAC filtering for iPSK authentication.

## Configure Web Authentication on MAC Address Bypass failure (GUI)

### Procedure

- Step 1** Click **Configuration > Tags and Profiles > WLANs**.
- Step 2** Click **Add** to add a new WLAN Profile or click the one you want to edit.
- Step 3** In the **Edit WLAN** window, complete the following steps:
- Choose **Security > Layer2** and check the **MAC Filtering** check box to enable MAC filtering.
  - From the **Authorization List** drop-down list, select a value.
  - Choose the **Layer3** tab.
  - Click **Show Advanced Settings** and check the **On MAC Filter Failure** checkbox.

## Configure Web Authentication on MAC Address Bypass Failure (CLI)

You can configure authentication to fall back to web authentication, if a client cannot authenticate using MAC filter (Local or RADIUS), while trying to connect to a WLAN. To enable this feature, configure both MAC filtering and Web Authentication on the device. This can also avoid disassociations that happen only because of MAC filter authentication failure. To configure this feature, follow the procedure:

### Configure a Policy Profile

#### Procedure

	Command or Action	Purpose
<b>Step 1</b>	<b>configure terminal</b>  <b>Example:</b> Device# configure terminal	Enters global configuration mode.
<b>Step 2</b>	<b>wireless profile policy <i>policy-name</i></b>  <b>Example:</b> Device(config)# wireless profile policy cwa	Configures WLAN policy profile and enters the wireless policy configuration mode.
<b>Step 3</b>	<b>central switching</b>  <b>Example:</b> Device(config-wireless-policy)# central switching	Enables Central switching.
<b>Step 4</b>	Choose the first option to configure a Guest Foreign or second option to configure a Guest Anchor:  <ul style="list-style-type: none"> <li>• <b>mobility anchor <i>anchor-ip-address</i></b></li> <li>• <b>mobility anchor</b></li> </ul>	Configures Guest Foreign or Guest Anchor.

	Command or Action	Purpose
	<b>Example:</b> For Guests Foreign: <pre>Device (config-wireless-policy)# mobility anchor 19.0.2.1</pre> For Guest Anchor: <pre>Device (config-wireless-policy)# mobility anchor</pre>	
<b>Step 5</b>	<b>vlan name</b> <b>Example:</b> <pre>Device(config-wireless-policy)# vlan 16</pre>	Configures a VLAN name or VLAN ID. <b>Note</b> VLAN is optional for a Guest Foreign controller.
<b>Step 6</b>	<b>no shutdown</b> <b>Example:</b> <pre>Device (config-wireless-policy)# no shutdown</pre>	Enables the policy profile.

## Configure a WLAN Profile

### Procedure

	Command or Action	Purpose
<b>Step 1</b>	<b>wlan guest-wlan-name wlan-id ssid</b> <b>Example:</b> <pre>config# wlan test-wlan-guest 10 wlan-ssid</pre>	Configures guest WLAN.
<b>Step 2</b>	<b>mac-filtering mac-auth-listname</b> <b>authorization-override override-auth-listname</b> <b>Example:</b> <pre>config-wlan# mac-filtering mac-auth-listname authorization-override</pre>	Configures MAC filtering support on WLAN.
<b>Step 3</b>	<b>security web-auth</b> <b>Example:</b> <pre>config-wlan# security web-auth</pre>	Enables web authentication.
<b>Step 4</b>	<b>security web-auth on-macfilter-failure</b> <b>Example:</b> <pre>config-wlan# security web-auth on-macfilter-failure</pre>	Enables web authentication if MAC filter authentication fails.

## Configure WLAN for Web Authentication on MAC Authentication Bypass Failure with Pre-Shared Key (CLI)

### Procedure

	Command or Action	Purpose
Step 1	<b>configure terminal</b> <b>Example:</b> Device# <b>configure terminal</b>	Enters global configuration mode.
Step 2	<b>wlan profile-name wlan-id SSID_Name</b> <b>Example:</b> Device (config)# <b>wlan wlan-test 3 ssid-test</b>	Enters WLAN configuration submode. <ul style="list-style-type: none"> <li>• <i>profile-name</i>: Profile name of the configured WLAN.</li> <li>• <i>wlan-id</i>: Wireless LAN identifier. Range is from 1 to 512.</li> <li>• <i>SSID_Name</i>: SSID that can contain 32 alphanumeric characters.</li> </ul> <p><b>Note</b> If you have already configured this command, enter the <b>wlan profile-name</b> command.</p>
Step 3	<b>mac-filtering auth-list-name</b> <b>Example:</b> Device (config-wlan)# <b>mac-filtering test-auth-list</b>	Sets the MAC filtering parameters.
Step 4	<b>security wpa psk set-key ascii/hex key password</b> <b>Example:</b> Device (config-wlan)# <b>security wpa psk set-key ascii 0 PASSWORD</b>	Configures the PSK AKM shared key.
Step 5	<b>no security wpa akm dot1x</b> <b>Example:</b> Device (config-wlan)# <b>no security wpa akm dot1x</b>	Disables security AKM for dot1x.
Step 6	<b>security wpa akm psk</b> <b>Example:</b> Device (config-wlan)# <b>security wpa akm psk</b>	Configures PSK support.
Step 7	<b>security web-auth authentication-list authenticate-list-name</b>	Enables authentication list for dot1x security.

	Command or Action	Purpose
	<b>Example:</b> Device(config-wlan)# <b>security web-auth authentication-list default</b>	
<b>Step 8</b>	<b>security web-auth authorization-list authorize-list-name</b>  <b>Example:</b> Device(config-wlan)# <b>security web-auth authorization-list default</b>	Enables authorization list for dot1x security.
<b>Step 9</b>	<b>security web-auth on-macfilter-failure</b>  <b>Example:</b> Device(config-wlan)# <b>security web-auth on-macfilter-failure</b>	Enables web authentication on MAC filter failure.
<b>Step 10</b>	<b>security web-auth parameter-map parameter-map-name</b>  <b>Example:</b> Device(config-wlan)# <b>security web-auth parameter-map WLAN1_MAP</b>	Configures the parameter map.  <b>Note</b> If a parameter map is not associated with a WLAN, the configuration is considered from the global parameter map.
<b>Step 11</b>	<b>no shutdown</b>  <b>Example:</b> Device(config-wlan)# <b>no shutdown</b>	Enables the WLAN.

## Configure WLAN for Web Authentication on MAC Authentication Bypass Failure with OWE (CLI)

### Procedure

	Command or Action	Purpose
<b>Step 1</b>	<b>configure terminal</b>  <b>Example:</b> Device# <b>configure terminal</b>	Enters global configuration mode.
<b>Step 2</b>	<b>wlan profile-name wlan-id SSID_Name</b>  <b>Example:</b> Device(config)# <b>wlan wlan-test 3 ssid-test</b>	Enters WLAN configuration submode. <ul style="list-style-type: none"> <li>• <i>profile-name</i>: Profile name of the configured WLAN.</li> <li>• <i>wlan-id</i>: Wireless LAN identifier. Range is from 1 to 512.</li> <li>• <i>SSID_Name</i>: SSID that can contain 32 alphanumeric characters.</li> </ul>



	Command or Action	Purpose
		<b>Note</b> If you have already configured this command, enter the <b>wlan profile-name</b> command.
<b>Step 3</b>	<b>mac-filtering</b> <i>auth-list-name</i>  <b>Example:</b> Device(config-wlan)# <b>mac-filtering test-auth-list</b>	Sets the MAC filtering parameters.
<b>Step 4</b>	<b>no security wpa akm dot1x</b>  <b>Example:</b> Device(config-wlan)# <b>no security wpa akm dot1x</b>	Disables security AKM for dot1x.
<b>Step 5</b>	<b>security wpa wpa3</b>  <b>Example:</b> Device(config-wlan)# <b>security wpa wpa3</b>	Enables WPA3 support.
<b>Step 6</b>	<b>security wpa akm owe</b>  <b>Example:</b> Device(config-wlan)# <b>security wpa akm owe</b>	Enables WPA3 OWE support.
<b>Step 7</b>	<b>security web-auth authentication-list</b> <i>authenticate-list-name</i>  <b>Example:</b> Device(config-wlan)# <b>security web-auth authentication-list default</b>	Enables authentication list for dot1x security.
<b>Step 8</b>	<b>security web-auth authorization-list</b> <i>authorize-list-name</i>  <b>Example:</b> Device(config-wlan)# <b>security web-auth authorization-list default</b>	Enables authorization list for dot1x security.
<b>Step 9</b>	<b>security web-auth on-macfilter-failure</b>  <b>Example:</b> Device(config-wlan)# <b>security web-auth on-macfilter-failure</b>	Enables web authentication on MAC filter failure.
<b>Step 10</b>	<b>security web-auth parameter-map</b> <i>parameter-map-name</i>  <b>Example:</b> Device(config-wlan)# <b>security web-auth parameter-map WLAN1_MAP</b>	Configures the parameter map.  <b>Note</b> If a parameter map is not associated with a WLAN, the configuration is considered from the global parameter map.

	Command or Action	Purpose
Step 11	<b>no shutdown</b> <b>Example:</b> Device (config-wlan) # <b>no shutdown</b>	Enables the WLAN.

## Configure WLAN for Web Authentication on MAC Authentication Bypass Failure with Secure Agile Exchange (CLI)

### Procedure

	Command or Action	Purpose
Step 1	<b>configure terminal</b> <b>Example:</b> Device# <b>configure terminal</b>	Enters global configuration mode.
Step 2	<b>wlan profile-name wlan-id SSID_Name</b> <b>Example:</b> Device (config) # <b>wlan wlan-test 3 ssid-test</b>	Enters WLAN configuration submode. <ul style="list-style-type: none"> <li>• <i>profile-name</i>: Profile name of the configured WLAN.</li> <li>• <i>wlan-id</i>: Wireless LAN identifier. Range is from 1 to 512.</li> <li>• <i>SSID_Name</i>: SSID that can contain 32 alphanumeric characters.</li> </ul> <p><b>Note</b> If you have already configured this command, enter the <b>wlan profile-name</b> command.</p>
Step 3	<b>mac-filtering auth-list-name</b> <b>Example:</b> Device (config-wlan) # <b>mac-filtering test-auth-list</b>	Sets the MAC filtering parameters.
Step 4	<b>no security wpa akm dot1x</b> <b>Example:</b> Device (config-wlan) # <b>no security wpa akm dot1x</b>	Disables security AKM for dot1x.
Step 5	<b>security wpa wpa3</b> <b>Example:</b> Device (config-wlan) # <b>security wpa wpa3</b>	Enables WPA3 support.
Step 6	<b>security wpa akm sae</b> <b>Example:</b>	Enables AKM SAE support.

	Command or Action	Purpose
	Device(config-wlan)# security wpa akm sae	
<b>Step 7</b>	<b>security web-auth authentication-list</b> <i>authenticate-list-name</i>  <b>Example:</b> Device(config-wlan)# security web-auth authentication-list default	Enables authentication list for dot1x security.
<b>Step 8</b>	<b>security web-auth authorization-list</b> <i>authorize-list-name</i>  <b>Example:</b> Device(config-wlan)# security web-auth authorization-list default	Enables authorization list for dot1x security.
<b>Step 9</b>	<b>security web-auth on-macfilter-failure</b>  <b>Example:</b> Device(config-wlan)# security web-auth on-macfilter-failure	Enables web authentication on MAC filter failure.
<b>Step 10</b>	<b>security web-auth parameter-map</b> <i>parameter-map-name</i>  <b>Example:</b> Device(config-wlan)# security web-auth parameter-map WLAN1_MAP	Configures the parameter map.  <b>Note</b> If a parameter map is not associated with a WLAN, the configuration is considered from the global parameter map.
<b>Step 11</b>	<b>no shutdown</b>  <b>Example:</b> Device(config-wlan)# no shutdown	Enables the WLAN.

## Configuring WLAN for Web Authentication on MAC Authentication Failure with Dot1x (CLI)

### Procedure

	Command or Action	Purpose
<b>Step 1</b>	<b>configure terminal</b>  <b>Example:</b> Device# configure terminal	Enters global configuration mode.
<b>Step 2</b>	<b>wlan profile-name wlan-id SSID_Name</b>  <b>Example:</b> Device(config)# wlan wlan-test 3 ssid-test	Enters WLAN configuration submode.  • <i>profile-name</i> : Profile name of the configured WLAN.

	Command or Action	Purpose
		<ul style="list-style-type: none"> <li>• <i>wlan-id</i>: Wireless LAN identifier. Range is from 1 to 512.</li> <li>• <i>SSID_Name</i>: SSID that can contain 32 alphanumeric characters.</li> </ul> <p><b>Note</b> If you have already configured a WLAN, enter the profile name of the configured WLAN in the command (<b>wlan profile-name</b>) and continue with the rest of the configuration steps.</p>
<b>Step 3</b>	<b>mac-filtering</b> <i>auth-list-name</i> <b>Example:</b> Device(config-wlan)# <b>mac-filtering test-auth-list</b>	Sets the MAC filtering parameters.
<b>Step 4</b>	<b>security dot1x authentication-list</b> <i>dot1x-authentication-list</i> <b>Example:</b> Device(config-wlan)# <b>security dot1x authentication-list dot1x-authentication-list</b>	Configures 802.1x.
<b>Step 5</b>	<b>security web-auth authentication-list</b> <i>authenticate-list-name</i> <b>Example:</b> Device(config-wlan)# <b>security web-auth authentication-list default</b>	Enables the authentication list.
<b>Step 6</b>	<b>security web-auth on-macfilter-failure</b> <b>Example:</b> Device(config-wlan)# <b>security web-auth on-macfilter-failure</b>	Enables web authentication on MAC filter failure.
<b>Step 7</b>	<b>security web-auth parameter-map</b> <i>parameter-map-name</i> <b>Example:</b> Device(config-wlan)# <b>security web-auth parameter-map WLAN1_MAP</b>	Configures the web authentication parameter map.  <p><b>Note</b> If a parameter map is not associated with a WLAN, the configuration is considered from the global parameter map.</p>
<b>Step 8</b>	<b>no shutdown</b> <b>Example:</b> Device(config-wlan)# <b>no shutdown</b>	Enables the WLAN.



## CHAPTER 185

# Wired Guest Access

---

- [Information About Wired Guest Access, on page 1803](#)
- [Restrictions for Wired Guest Access, on page 1806](#)
- [Configuring Access Switch for Wired Guest Client, on page 1806](#)
- [Configuring Access Switch for Foreign Controller, on page 1807](#)
- [Configuring Foreign Controller with Open Authentication \(GUI\), on page 1808](#)
- [Configuring Foreign Controller with Open Authentication, on page 1808](#)
- [Configuring Foreign Controller with Local Web Authentication \(GUI\), on page 1810](#)
- [Configuring Foreign Controller with Local WEB Authentication, on page 1811](#)
- [Configuring Anchor Controller with Open Authentication \(GUI\), on page 1812](#)
- [Configuring Anchor Controller with Open Authentication, on page 1813](#)
- [Configuring Anchor Controller with Local Web Authentication \(GUI\), on page 1814](#)
- [Configuring Anchor Controller with Local Web Authentication, on page 1815](#)
- [Configuring Session Timeout for a Profile Policy, on page 1816](#)
- [Global Configuration \(GUI\), on page 1817](#)
- [Verifying Wired Guest Configurations, on page 1817](#)
- [Wired Guest Access—Use Cases, on page 1821](#)

## Information About Wired Guest Access

The Wired Guest Access feature enables guest users of an enterprise network that supports both wired and wireless access to connect to the guest access network. The wired guest clients can connect from the designated and configured wired Ethernet ports for the guest access after they complete the configured authentication methods. Wired session guests are directed to a wireless guest controller in a demilitarized zone (DMZ) through a Control And Provisioning of Wireless Access Points (CAPWAP) tunnel.

Wired guest access can be configured in a dual-controller configuration that uses both an anchor controller and a foreign controller. A dual-controller configuration isolates wired guest access traffic from the enterprise user traffic.

The wired session guests are provided open or web-authenticated access from the wireless controller.

Figure 48: Guest Access Architecture

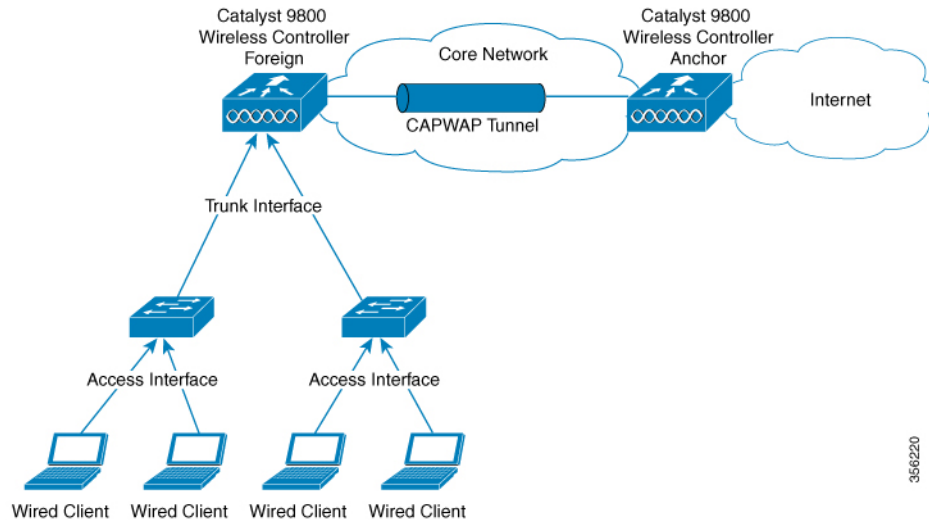

### IPv6 Router Advertisement Forwarding for a Wired Guest

Wired clients get the IPv6 based connectivity when they receive the IPv6 Router Advertisement (RA) message. The IPv6 router sends these RA messages and it contains information such as IPv6 prefix and router link-local address.

These RA messages are sent as Unicast or Multicast messages. The Unicast RA messages are routed as same as the client directed traffic. The Multicast RA messages are forwarded to all the clients present in the intended VLAN. RA message forwarding is enabled by default and requires no specific configuration.

**Guest Anchor Controller:** Guest anchor controller forwards the RA packets, from the receiving VLAN, to all the foreign controllers using the mobility data tunnel. The RA packets are tagged with the anchor VLAN to ensure the message is forwarded to the correct clients using the foreign controller data path.

**Guest Foreign Controller:** Guest foreign controller forwards the received RAs from the guest anchor to the wired ports on which the wired guest clients are connected. To forward the RAs to the intended clients, the guest foreign controller keeps a track of the wired guest clients—per interface, access VLANs, and anchor VLANs.

### Supported Features

- Cisco Catalyst 9800 Series Wireless Controllers-Anchor
- Cisco AireOS Wireless Controllers-Anchor
- Cisco Catalyst 9800 Series Wireless Controllers-Foreign
- Cisco AireOS Wireless Controllers-Foreign
- Dual controller solution (foreign + anchor) and access switch
- Trunk Ports
- Open Authentication
- Local Web Authentication

To configure Web Authentication, see [Web-based Authentication](#) section of the Cisco Catalyst 9800 Series Wireless Controller Software Configuration Guide.

- Local Web Authentication (web consent).



---

**Note** In AireOS, this is referred to as **web pass-through**.

---

- Local Web Authentication + ISE (External Web Authentication).
- LWA (local web authentication), with a username and a password.
- Web consent (LWA + consent), that is with a username, a password and the check box of acceptance.
- Scale max 2k clients and 5 guest-LANs (5 VLANs max)
- Client IPv6 support
- Idle Timeout and Session Timeout
- Accounting on Foreign



---

**Note** Statistics computation not supported.

---

- Manageability (SNMP/Yang/WebUI)
- QoS Rate-Limiting and MQC Policies (Upstream at foreign, Upstream, and Downstream at the anchor)



---

**Note** QoS rate-limiting supports bps rate-limiting, pps rate-limiting is not supported.

---

- QoS support with AireOS Anchor setup
- Stateful Switch Over (SSO)
- Port Channel support on Anchor and Foreign with no restrictions to the controller's role.
- Access Port on Foreign
- Cisco Umbrella (not supported in AireOS Anchor)
- ACL support at anchor
- Fully Qualified Domain Name (FQDN) URL filtering is supported at Anchor controller.
- IP theft detection
- Sleeping Client

## Restrictions for Wired Guest Access

- A maximum of five guest LANs are supported on the foreign controller.
- A maximum of 2000 clients per foreign are supported.
- No Multicast or Broadcast support.
- You can map only one wired VLAN to a guest LAN.
- You can map only one guest LAN to one policy profile.
- Every guest LAN has a unique name and this name cannot be shared with RLAN or WLAN.
- Ensure that the Anchor VLAN ID and the wired VLAN ID configured on the Foreign controller is not the same.
- QoS is not supported on VLAN and on physical interfaces of the controller.

## Configuring Access Switch for Wired Guest Client

### Procedure

	Command or Action	Purpose
<b>Step 1</b>	<b>configure terminal</b> <b>Example:</b> Device# <code>configure terminal</code>	Enters global configuration mode.
<b>Step 2</b>	<b>vlan <i>vlan-id</i></b> <b>Example:</b> Device(config)# <code>vlan 200</code>	Creates the VLAN ID.
<b>Step 3</b>	<b>exit</b> <b>Example:</b> Device(config)# <code>exit</code>	Returns to configuration mode.
<b>Step 4</b>	<b>interface GigabitEthernet<i>interface number</i></b> <b>Example:</b> Device(config)# <code>interface GigabitEthernet1/0/1</code>	Enters the interface to be added to the VLAN.
<b>Step 5</b>	<b>switchport access vlan <i>vlan-id</i></b> <b>Example:</b> Device(config-if)# <code>switchport access vlan 200</code>	Assigns the port to a VLAN. The valid VLAN IDs range is between 1 and 4094.



	Command or Action	Purpose
<b>Step 6</b>	<b>switchport mode access</b> <b>Example:</b> Device(config-if)#switchport mode access	Defines the VLAN membership mode for the port.
<b>Step 7</b>	<b>no cdp enable</b> <b>Example:</b> Device(config-if)#no cdp enable	Disables CDP on the interface.
<b>Step 8</b>	<b>end</b> <b>Example:</b> Device(config-if)#end	Saves the configuration and exits configuration mode and returns to privileged EXEC mode.

## Configuring Access Switch for Foreign Controller

### Procedure

	Command or Action	Purpose
<b>Step 1</b>	<b>configure terminal</b> <b>Example:</b> Device# configure terminal	Enters global configuration mode.
<b>Step 2</b>	<b>vlan <i>vlan-id</i></b> <b>Example:</b> Device(config)#vlan 200	Creates the VLAN ID.
<b>Step 3</b>	<b>exit</b> <b>Example:</b> Device(config)#exit	Returns to configuration mode.
<b>Step 4</b>	<b>interface GigabitEthernet<i>interface number</i></b> <b>Example:</b> Device(config)#interface GigabitEthernet1/0/2	Enters the interface to be added to the VLAN.
<b>Step 5</b>	<b>switchport trunk allowed vlan <i>vlan-id</i></b> <b>Example:</b> Device(config-if)#switchport trunk allowed vlan 200	Assigns the allowed VLAN ID to the port when it is in trunking mode.
<b>Step 6</b>	<b>switchport mode trunk</b> <b>Example:</b> Device(config-if)#switchport mode trunk	Sets the trunking mode to trunk unconditionally.

	Command or Action	Purpose
<b>Step 7</b>	<b>end</b>  <b>Example:</b> Device(config-if)#end	Saves the configuration and exits configuration mode and returns to privileged EXEC mode.

## Configuring Foreign Controller with Open Authentication (GUI)

### Procedure

- 
- Step 1** Choose **Configuration > Tags & Profiles > Policy**.
  - Step 2** Click on a **Policy Name**.
  - Step 3** Go to the **Mobility** tab.
  - Step 4** In the **Mobility Anchors** section, check the **Export Anchor** check box.
  - Step 5** Click **Apply to Device**.
  - Step 6** Choose **Configuration > Wireless > Guest LAN > Guest LAN Configuration**
  - Step 7** Click **Add**.
  - Step 8** In the **General** tab, enter the **Profile Name**, **Guest LAN ID**, **Client Association Limit**.
  - Step 9** Choose the desired mode from the **mDNS Mode** drop-down list.
  - Step 10** Enable or disable the **Status** and **Wired VLAN Status** toggle button.
  - Step 11** In the **Security** tab, disable the **Web Auth** toggle button.
  - Step 12** Click **Apply to Device**.
  - Step 13** Choose **Configuration > Wireless > Guest LAN > Guest LAN Map Configuration**
  - Step 14** Click **Add Map**.
  - Step 15** In the Add Guest LAN Map window, enter the **Guest LAN Map**.
  - Step 16** Click **Apply to Device**.
  - Step 17** Click **Add**.
  - Step 18** Choose the values from the **Profile Name** and **Policy Name** drop-down lists.
  - Step 19** Click **Save**.
- 

## Configuring Foreign Controller with Open Authentication

### Procedure

	Command or Action	Purpose
<b>Step 1</b>	<b>configure terminal</b>  <b>Example:</b> Device# configure terminal	Enters global configuration mode.

	Command or Action	Purpose
<b>Step 2</b>	<b>wireless profile policy</b> <i>wlan-policy-profile-name</i>  <b>Example:</b> <pre>Device(config)#wireless profile policy testpro-1</pre>	Configures the WLAN policy profile.
<b>Step 3</b>	<b>mobility anchor</b> <i>non-local-mobility-ctrlr-ip</i> <b>priority</b> <i>priority</i>  <b>Example:</b> <pre>Device(config-wireless-policy)#mobility anchor 192.168.201.111 priority 1</pre>	Configures the mobility anchor and sets its priority.
<b>Step 4</b>	<b>no shutdown</b>  <b>Example:</b> <pre>Device(config-wireless-policy)#no shutdown</pre>	Enables the configuration.
<b>Step 5</b>	<b>exit</b>  <b>Example:</b> <pre>Device(config-wireless-policy)#exit</pre>	Returns to configuration mode.
<b>Step 6</b>	<b>guest-lan profile-name</b> <i>guest-profile-name</i> <i>guest-lan-id</i> <b>wired-vlan</b> <i>wired-vlan-id</i>  <b>Example:</b> <pre>Device(config)#guest-lan profile-name gstpro-1 1 wired-vlan 25</pre>	Configures guest LAN profile with a wired VLAN.  <b>Note</b> Configure the wired VLAN only for the Guest Foreign controller.
<b>Step 7</b>	<b>no security web-auth</b>  <b>Example:</b> <pre>Device(config-guest-lan)#no security web-auth</pre>	Disables web-authentication.
<b>Step 8</b>	<b>no shutdown</b>  <b>Example:</b> <pre>Device(config-guest-lan)#no shutdown</pre>	Enables the guest LAN.
<b>Step 9</b>	<b>exit</b>  <b>Example:</b> <pre>Device(config-guest-lan)#exit</pre>	Returns to configuration mode.
<b>Step 10</b>	<b>wireless guest LAN map</b> <i>gst-map-name</i>  <b>Example:</b> <pre>Device(config)#wireless guest LAN map gstmap-1</pre>	Configures a guest LAN map.

	Command or Action	Purpose
<b>Step 11</b>	<b>guest-lan</b> <i>guest-profile-name</i> <b>policy</b> <i>wlan-policy-profile-name</i>  <b>Example:</b> Device (config-guest-lan-map) #guest-lan gstpro-1 policy testpro-1	Attaches a guest LAN map to the policy profile.
<b>Step 12</b>	<b>exit</b>  <b>Example:</b> Device (config-guest-lan-map) #exit	Returns to configuration mode.

## Configuring Foreign Controller with Local Web Authentication (GUI)

### Procedure

- 
- Step 1** Choose **Configuration > Tags & Profiles > Policy**.
  - Step 2** Select a **Policy Name**.
  - Step 3** Go to the **Mobility** tab.
  - Step 4** In the **Mobility Anchors** section, check the **Export Anchor** check box.
  - Step 5** Click **Update & Apply to Device**.
  - Step 6** Choose **Configuration > Wireless > Guest LAN > Guest LAN Configuration**
  - Step 7** Click **Add**.
  - Step 8** In the **General** tab, enter the **Profile Name**, **Guest LAN ID**, **Client Association Limit**.
  - Step 9** Choose the desired mode from the **mDNS Mode** drop-down list.
  - Step 10** Enable or disable the **Status** and **Wired VLAN Status** using toggle button.
  - Step 11** Go to the **Security** tab.
  - Step 12** Enable the **Web Auth** using toggle button.
  - Step 13** Choose the values from the **Web Auth Parameter Map**, **Authentication List** and **Authorization List** drop-down lists.
  - Step 14** Click **Apply to Device**.
  - Step 15** Choose **Configuration > Wireless > Guest LAN > Guest LAN Map Configuration**
  - Step 16** Click **Add Map**.
  - Step 17** In the Add Guest LAN Map window, enter the **Guest LAN Map**.
  - Step 18** Click **Apply to Device**.
  - Step 19** Click **Add**.
  - Step 20** Choose the values from the **Profile Name** and **Policy Name** drop-down lists.
  - Step 21** Click **Save**.
-

# Configuring Foreign Controller with Local WEB Authentication

## Procedure

	Command or Action	Purpose
<b>Step 1</b>	<b>configure terminal</b> <b>Example:</b> Device# configure terminal	Enters global configuration mode.
<b>Step 2</b>	<b>wireless profile policy</b> <i>wlan-policy-profile-name</i> <b>Example:</b> Device(config)#wireless profile policy testpro-1	Configures the WLAN policy profile.
<b>Step 3</b>	<b>mobility anchor</b> <i>non-local-mobility-cntlr-ip</i> <b>priority</b> <i>priority</i> <b>Example:</b> Device(config-wireless-policy)#mobility anchor 192.168.201.111 priority 1	Configures the mobility anchor and sets its priority.
<b>Step 4</b>	<b>no shutdown</b> <b>Example:</b> Device(config-wireless-policy)#no shutdown	Enables the configuration.
<b>Step 5</b>	<b>exit</b> <b>Example:</b> Device(config-wireless-policy)#exit	Returns to configuration mode.
<b>Step 6</b>	<b>guest-lan profile-name</b> <i>guest-profile-name</i> <i>guest-lan-id</i> <b>wired-vlan</b> <i>wired-vlan-id</i> <b>Example:</b> Device(config)#guest-lan profile-name gstpro-2 3 wired-vlan 26	Configures guest LAN profile with a wired VLAN.
<b>Step 7</b>	<b>security web-auth</b> <b>Example:</b> Device(config-guest-lan)#security web-auth	Enables web-authentication.
<b>Step 8</b>	<b>security web-auth authentication-list</b> <i>auth-list-name</i> <b>Example:</b> Device(config-guest-lan)#security web-auth authentication-list default	Configures the authentication list for a IEEE 802.1x network.

	Command or Action	Purpose
<b>Step 9</b>	<b>security web-auth parameter-map</b> <i>parameter-map-name</i>  <b>Example:</b> Device(config-guest-lan)#security web-auth parameter-map global	Configures the security web-auth parameter map.
<b>Step 10</b>	<b>no shutdown</b>  <b>Example:</b> Device(config-guest-lan)#no shutdown	Enables the guest LAN.
<b>Step 11</b>	<b>exit</b>  <b>Example:</b> Device(config-guest-lan)#exit	Returns to configuration mode.
<b>Step 12</b>	<b>wireless guest-lan map</b> <i>gst-map-name</i>  <b>Example:</b> Device(config)#wireless guest-lan map gstmap-2	Configures a guest LAN map.
<b>Step 13</b>	<b>guest-lan</b> <i>guest-lan-profile-name</i> <b>policy</b> <i>policy-profile-name</i>  <b>Example:</b> Device(config-guest-lan-map)#guest-lan gstpro-2 policy testpro-1	Attaches a guest LAN map to the policy profile.
<b>Step 14</b>	<b>exit</b>  <b>Example:</b> Device(config-guest-lan-map)#exit	Returns to configuration mode.

**What to do next**

For more information about Local Web Authentication, see [https://www.cisco.com/c/en/us/td/docs/wireless/controller/9800/config-guide/b\\_wl\\_16\\_10\\_cg/wireless-web-authentication.html](https://www.cisco.com/c/en/us/td/docs/wireless/controller/9800/config-guide/b_wl_16_10_cg/wireless-web-authentication.html)

## Configuring Anchor Controller with Open Authentication (GUI)

**Procedure**

- 
- Step 1** Choose **Configuration > Tags & Profiles > Policy**.
  - Step 2** Click **Add**.
  - Step 3** In the **General** tab, enter the **Name**.
  - Step 4** Go to the **Access Policies** tab.
  - Step 5** Under the **VLAN** settings, choose the vlans from the **VLAN/VLAN Group** drop-down list.

- Step 6** Go to the **Mobility** tab.
- Step 7** Under the **Mobility Anchors** settings, check the **Export Anchor** check box.
- Step 8** Click **Apply to Device**.
- Step 9** Choose **Configuration > Wireless > Guest LAN**.
- Step 10** Click **Add**.
- Step 11** In the **General** tab, enter the **Profile Name**, the **Guest LAN ID** and the **Client Association Limit**.
- Step 12** In the **Security** tab, under the **Layer3** settings, disable the **Web Auth** toggle button.
- Step 13** Click **Apply to Device**.

## Configuring Anchor Controller with Open Authentication

### Procedure

	Command or Action	Purpose
<b>Step 1</b>	<b>configure terminal</b> <b>Example:</b> Device# configure terminal	Enters global configuration mode.
<b>Step 2</b>	<b>wireless profile policy</b> <i>wlan-policy-profile-name</i> <b>Example:</b> Device(config)#wireless profile policy testpro-2	Configures the WLAN policy profile.
<b>Step 3</b>	<b>mobility anchor</b> <b>Example:</b> Device(config-wireless-policy)#mobility anchor	Configures the mobility anchor.
<b>Step 4</b>	<b>vlan <i>vlan-id</i></b> <b>Example:</b> Device(config-wireless-policy)#vlan 29	Configure a VLAN name or a VLAN ID.
<b>Step 5</b>	<b>no shutdown</b> <b>Example:</b> Device(config-wireless-policy)#no shutdown	Enables the configuration.
<b>Step 6</b>	<b>exit</b> <b>Example:</b> Device(config-wireless-policy)#exit	Returns to configuration mode.

	Command or Action	Purpose
<b>Step 7</b>	<b>guest-lan profile-name</b> <i>guest-profile-name</i> <i>guest-lan-id</i>  <b>Example:</b> Device (config) #guest-lan profile-name testpro-2 1	Configures the guest LAN profile with a wired VLAN.
<b>Step 8</b>	<b>client association limit</b> <i>guest-lan-client-limit</i>  <b>Example:</b> Device (config-guest-lan) #client association limit	Configures the maximum client connections per guest LAN. The valid range is between 1 and 2000.
<b>Step 9</b>	<b>no security web-auth</b>  <b>Example:</b> Device (config-guest-lan) #no security web-auth	Disables web authentication.
<b>Step 10</b>	<b>no shutdown</b>  <b>Example:</b> Device (config-guest-lan) #no shutdown	Enables the guest LAN.
<b>Step 11</b>	<b>exit</b>  <b>Example:</b> Device (config-guest-lan) #exit	Returns to configuration mode.

## Configuring Anchor Controller with Local Web Authentication (GUI)

### Procedure

- 
- Step 1** Choose **Configuration > Tags & Profiles > Policy**.
  - Step 2** Click **Add**.
  - Step 3** In the **General** tab, enter the **Name**.
  - Step 4** Go to the **Access Policies** tab.
  - Step 5** Under the **VLAN** settings, choose the vlans from the **VLAN/VLAN Group** drop-down list.
  - Step 6** Go to the **Mobility** tab.
  - Step 7** Under the **Mobility Anchors** settings, check the **Export Anchor** check box.
  - Step 8** Click **Apply to Device**.
  - Step 9** Choose **Configuration > Wireless > Guest LAN**.
  - Step 10** Click **Add**.
  - Step 11** In the **General** tab, enter the **Profile Name**, the **Guest LAN ID** and the **Client Association Limit**.



- Step 12** In the **Security** tab, under the **Layer3** settings, enable the **Web Auth** toggle button. Choose the Parameter map from the **Web Auth Parameter Map** drop-down list and the authentication list from the **Authentication List** drop-down list.
- Step 13** Click **Apply to Device**.

## Configuring Anchor Controller with Local Web Authentication

### Procedure

	Command or Action	Purpose
<b>Step 1</b>	<b>configure terminal</b> <b>Example:</b> Device# configure terminal	Enters global configuration mode.
<b>Step 2</b>	<b>wireless profile policy</b> <i>wlan-policy-profile-name</i> <b>Example:</b> Device(config)#wireless profile policy testpro-2	Configures the WLAN policy profile.
<b>Step 3</b>	<b>mobility anchor</b> <b>Example:</b> Device(config-wireless-policy)#mobility anchor	Configures the mobility anchor.
<b>Step 4</b>	<b>vlan</b> <i>vlan-id</i> <b>Example:</b> Device(config-wireless-policy)#vlan 30	Configure a VLAN name or a VLAN ID.
<b>Step 5</b>	<b>no shutdown</b> <b>Example:</b> Device(config-wireless-policy)#no shutdown	Enables the configuration.
<b>Step 6</b>	<b>exit</b> <b>Example:</b> Device(config-wireless-policy)#exit	Returns to configuration mode.
<b>Step 7</b>	<b>guest-lan profile-name</b> <i>guest-profile-name</i> <i>guest-lan-id</i> <b>Example:</b> Device(config)#guest-lan profile-name testpro-2 1	Configure a guest LAN profile with a wired VLAN.

	Command or Action	Purpose
<b>Step 8</b>	<b>client association limit</b> <i>guest-lan-client-limit</i> <b>Example:</b> Device (config-guest-lan) #client association limit	Configures the maximum client connections per guest LAN. The valid range is between 1 and 2000.
<b>Step 9</b>	<b>security web-auth</b> <b>Example:</b> Device (config-guest-lan) #security web-auth	Configures web authentication.
<b>Step 10</b>	<b>security web-auth parameter-map</b> <i>parameter-map-name</i> <b>Example:</b> Device (config-guest-lan) #security web-auth parameter-map testmap-1	Configures the security web-auth parameter map.
<b>Step 11</b>	<b>security web-auth authentication-list</b> <i>authentication-list-name</i> <b>Example:</b> Device (config-guest-lan) #security web-auth authentication-list testlwa-1	Configures the authentication list for the IEEE 802.1x network.
<b>Step 12</b>	<b>no shutdown</b> <b>Example:</b> Device (config-guest-lan) #no shutdown	Enables the guest-LAN.
<b>Step 13</b>	<b>exit</b> <b>Example:</b> Device (config-guest-lan) #exit	Returns to configuration mode.

## Configuring Session Timeout for a Profile Policy

Session Timeout for a wired guest is set to infinite by default. Perform the following procedure to configure the timeout values to the wired guest.

### Procedure

	Command or Action	Purpose
<b>Step 1</b>	<b>configure terminal</b> <b>Example:</b> Device# configure terminal	Enters global configuration mode.
<b>Step 2</b>	<b>wireless profile policy</b> <i>wlan-policy-profile-name</i>	Configures the WLAN policy profile.

	Command or Action	Purpose
	<b>Example:</b> Device(config)#wireless profile policy testpol-1	
<b>Step 3</b>	<b>guest-lan enable-session-timeout</b>  <b>Example:</b> Device(config-wireless-policy)#guest-lan enable-session-timeout	Enables the client session timeout on the guest LAN.
<b>Step 4</b>	<b>session-timeout timeout-duration</b>  <b>Example:</b> Device(config-wireless-policy)#session-timeout 1000	Configures the client session timeout in seconds. The valid range is between 0 and 86400 seconds.

## Global Configuration (GUI)

### Procedure

- 
- Step 1** Choose **Administration > User Administration**.
  - Step 2** Click **Add**.
  - Step 3** Enter the **Username**, **Password** and **Confirm Password**.
  - Step 4** Choose the desired value from the **Policy** and **Privilege** drop-down lists.
  - Step 5** Click **Apply to Device**.
  - Step 6** Choose **Administration > Management > HTTP/HTTPS/Netconf**.
  - Step 7** In the **HTTP/HTTPS Access Configuration** settings, enable or disable the **HTTP Access**, **HTTPS Access** and **Personal Identity Verification** toggle buttons.
  - Step 8** Enter the **HTTP Port** and **HTTPS Port**.
  - Step 9** Click **Apply**.
- 

## Verifying Wired Guest Configurations

To validate the wireless configuration, use the following command:

```
Device# wireless config validate
```

```
Wireless Management Trustpoint Name: 'WLC-29c_WLC_TP'
Trustpoint certificate type is WLC-SSC
Wireless management trustpoint config is valid
```

```
Jan 22 07:49:15.371: %CONFIG_VALIDATOR_MESSAGE-5-EWLC_GEN_ERR: Chassis 1 R0/0: wncmgrd:
Error in No record found for VLAN 9, needed by Guest-LAN open-wired
```

To display the summary of all Guest-LANs, use the following command:

Device# **show guest-lan summary**

Number of Guest LANs: 1

GLAN	GLAN Profile Name	Status
1	wired_guest_open	UP

To view the detailed output of all Guest-LANs, use the following command:

Device# **show guest-lan all**

```

Guest-LAN Profile Name      : open
=====
Guest-LAN ID                : 1
Wired-Vlan                  : 200
Status                      : Enabled
Number of Active Clients    : 1
Max Associated Clients       : 2000
Security
  WebAuth                   : Enabled
  Webauth Parameter Map     : global
  Webauth Authentication List : LWA-AUTHENTICATION
  Webauth Authorization List : LWA-AUTHENTICATION

```

To view the guest-LAN configuration by ID, use the following command:

Device# **show guest-lan id 1**

```

Guest-LAN Profile Name      : open
=====
Guest-LAN ID                : 1
Wired-Vlan                  : 200
Status                      : Enabled
Number of Active Clients    : 1
Max Associated Clients       : 2000
Security
  WebAuth                   : Enabled
  Webauth Parameter Map     : global
  Webauth Authentication List : LWA-AUTHENTICATION
  Webauth Authorization List : LWA-AUTHENTICATION

```

To view the guest-LAN configuration by profile name, use the following command:

Device# **show guest-lan name open**

```

Guest-LAN Profile Name      : open
=====
Guest-LAN ID                : 1
Wired-Vlan                  : 200
Status                      : Enabled
Number of Active Clients    : 1
Max Associated Clients       : 2000
Security
  WebAuth                   : Enabled
  Webauth Parameter Map     : global
  Webauth Authentication List : LWA-AUTHENTICATION
  Webauth Authorization List : LWA-AUTHENTICATION

```

To view the guest-LAN map summary, use the following command:

Device# **show wireless guest-lan-map summary**

Number of Guest-Lan Maps: 2

WLAN Profile Name	Policy Name
open_wired_guest	open_wired_guest
lwa_wired_guest	lwa_wired_guest

To view the active clients, use the following command:

Device# **show wireless client summary**

Number of Local Clients: 1

MAC Address	AP Name	Type	ID	State
Protocol Method	Role			
000a.bd15.0001	N/A	GLAN	1	Run
802.3	Web Auth	Export		Foreign

To view the detailed information about a client by MAC address, use the following command:

Device# **show wireless client mac-address 3383.0000.0001 detail**

```
Client MAC Address : 3383.0000.0001
Client IPv4 Address : 155.165.152.151
Client Username: N/A
AP MAC Address: N/A
AP slot : N/A
Client State : Associated
Policy Profile : guestlan_lwa
Flex Profile : N/A
Guest Lan:
  GLAN Id: 2
  GLAN Name: guestlan_lwa
  Wired VLAN: 312
Wireless LAN Network Name (SSID) : N/A
BSSID : N/A
Connected For : 128 seconds
Protocol : 802.3
Channel : N/A
Client IIF-ID : 0xa0000002
Association Id : 0
Authentication Algorithm : Open System
Session Timeout : 1800 sec (Timer not running)
Session Warning Time : Timer not running
Input Policy Name : clsilver
Input Policy State : Installed
Input Policy Source : AAA Policy
Output Policy Name : None
Output Policy State : None
Output Policy Source : None
WMM Support : Disabled
Fastlane Support : Disabled
Power Save : OFF
AAA QoS Rate Limit Parameters:
  QoS Average Data Rate Upstream      : 0 (kbps)
  QoS Realtime Average Data Rate Upstream : 0 (kbps)
  QoS Burst Data Rate Upstream        : 0 (kbps)
  QoS Realtime Burst Data Rate Upstream : 0 (kbps)
  QoS Average Data Rate Downstream    : 0 (kbps)
```

```

QoS Realtime Average Data Rate Downstream : 0 (kbps)
QoS Burst Data Rate Downstream           : 0 (kbps)
QoS Realtime Burst Data Rate Downstream   : 0 (kbps)
Mobility:
Anchor IP Address                        : 101.0.0.1
Point of Attachment                      : 0x00000008
Point of Presence                        : 0xA0000001
AuthC status                             : Enabled
Move Count                               : 0
Mobility Role                            : Export Foreign
Mobility Roam Type                       : L3 Requested
Mobility Complete Timestamp              : 05/07/2019 22:31:45 UTC
Client Join Time:
Join Time Of Client                      : 05/07/2019 22:31:42 UTC
Policy Manager State: Run
Last Policy Manager State                : IP Learn Complete
Client Entry Create Time                  : 125 seconds
Policy Type                               : N/A
Encryption Cipher                        : N/A
Encrypted Traffic Analytics               : No
Protected Management Frame - 802.11w     : No
EAP Type                                 : Not Applicable
VLAN : default
Multicast VLAN                           : 0
Access VLAN                              : 153
Anchor VLAN                              : 155
WFD capable                              : No
Managed WFD capable                     : No
Cross Connection capable                  : No
Support Concurrent Operation              : No
Session Manager:
Point of Attachment                      : TenGigabitEthernet0/0/0
IIF ID                                   : 0x00000008
Authorized                               : TRUE
Session timeout                           : 1800
Common Session ID: 00000000000000CB946C8BA3
Acct Session ID                          : 0x00000000
Last Tried Aaa Server Details:
Server IP :
Auth Method Status List
Method : Web Auth
Webauth State                            : Authz
Webauth Method                           : Webauth
Local Policies:
Service Template                         : wlan_svc_guestlan_lwa_local (priority 254)
VLAN                                      : 153
Absolute-Timer                            : 1800
Server Policies:
QOS Level                                 : 0
Resultant Policies:
VLAN Name                                : VLAN0153
QOS Level                                 : 0
VLAN                                      : 153
Absolute-Timer                            : 1800
DNS Snooped IPv4 Addresses                : None
DNS Snooped IPv6 Addresses                : None
Client Capabilities
CF Pollable                              : Not implemented
CF Poll Request                           : Not implemented
Short Preamble                            : Not implemented
PBCC                                       : Not implemented
Channel Agility                           : Not implemented
Listen Interval                           : 0
Fast BSS Transition Details :

```

```
Reassociation Timeout : 0
11v BSS Transition : Not implemented
11v DMS Capable : No
QoS Map Capable : No
FlexConnect Data Switching : N/A
FlexConnect Dhcp Status : N/A
FlexConnect Authentication : N/A
FlexConnect Central Association : N/A
Client Statistics:
  Number of Bytes Received : 0
  Number of Bytes Sent : 0
  Number of Packets Received : 8
  Number of Packets Sent : 0
  Number of Policy Errors : 0
  Radio Signal Strength Indicator : 0 dBm
  Signal to Noise Ratio : 0 dB
  Idle time : 0 seconds
  Last idle time update : 05/07/2019 22:32:27
  Last statistics update : 05/07/2019 22:32:27
Fabric status : Disabled
Client Scan Reports
Assisted Roaming Neighbor List
Nearby AP Statistics:
EoGRE : Pending Classification
```

## Wired Guest Access—Use Cases

This feature while performing as a guest access feature can be used to meet different requirements. Some of the possibilities are shared here.

### Scenario One—Equipment Software Update

This feature can be configured to allow the wired port to connect to the manufacture or vendor website for equipment maintenance, software, or firmware updates.

### Scenario Two—Video Streaming

This feature can be configured to allow devices that are connected to a wired port to stream video to visitor information screens.







## CHAPTER 186

# Express Wi-Fi by Facebook

---

- [Information About Express Wi-Fi by Facebook, on page 1823](#)
- [Restrictions for Express Wi-Fi by Facebook, on page 1824](#)
- [Enabling Express Wi-Fi by Facebook NAC for Policy Profile \(GUI\), on page 1824](#)
- [Enabling Accounting RADIUS Server for Flex Profile \(GUI\), on page 1825](#)
- [Configuring Captive Portal for Express Wi-Fi by Facebook \(GUI\), on page 1825](#)
- [Configuring Captive Portal for Express Wi-Fi by Facebook \(CLI\), on page 1825](#)
- [Configuring Express Wi-Fi by Facebook Policy on Controller \(CLI\), on page 1826](#)
- [Configuring RADIUS Server for Accounting and Authentication in FlexConnect Profile \(CLI\), on page 1828](#)
- [Verifying Express Wi-Fi by Facebook Configurations on Controller, on page 1829](#)
- [Verifying Express Wi-Fi by Facebook Configurations on the AP, on page 1829](#)

## Information About Express Wi-Fi by Facebook

Express Wi-Fi by Facebook is a cloud-based, low-cost solution for local entrepreneurs and SMBs in emerging countries to provide Wi-Fi access. Using Express Wi-Fi by Facebook, users can buy data packs and find nearby hotspots.

Facebook provides the software (and sometimes hardware) infrastructure while the ISP or SMB provides internet connectivity and deployments to the subscribers. These service providers provision guest access through a captive portal. This can include both free and paid services including paid internet access with quota enforcement.

Express Wi-Fi by Facebook feature is enabled through a FlexConnect deployment based on the cloud-hosted Cisco Catalyst 9800 Series Wireless Controller where the Cisco AP performs client-related functions such as web authentication, captive portal redirect, matching and accounting of traffic classes and connection to the RADIUS server. This feature also supports FQDN (DNS ACLs) and IP ACLs as well as MAC authentication on the AP. The controller provisions the AP with the required configuration for these tasks.



---

**Note** If an AP reboots in standalone mode, the flexconnect URL ACL is not retained. This will cause Express Wi-Fi by Facebook to stop working.

---

The Express Wi-Fi by Facebook solution comprises the following components:

- Cisco Catalyst 9800 Series Wireless Controller

- Cisco Aironet Wave 2 or Catalyst APs
- Facebook infrastructure

## Restrictions for Express Wi-Fi by Facebook

- Express Wi-Fi by Facebook is supported only in a FlexConnect deployment with local switching, local authentication, and local association.
- Express Wi-Fi by Facebook is supported only on Cisco Aironet Wave 2 and Catalyst access points.
- Only three traffic classes are supported.
- The AP supports only three ACLs per client.
- All APs forming a roaming domain should have Layer 2 reachability.
- Up to 64 complex rules and 512 simple rules per ACL are supported, where a simple rule comprises of a destination IP address and port. A complex rule contains more than a destination IP address and port information.
- Only RADIUS CoA messages with the Facebook attribute are supported on the AP.

## Enabling Express Wi-Fi by Facebook NAC for Policy Profile (GUI)

### Procedure

---

- Step 1** Choose **Configuration > Tags & Profiles > Policy**.
- Step 2** On the **Policy** page, click the name of the desired Policy Profile.
- Step 3** In the **Edit Policy Profile** window, click the **Advanced** tab.
- Step 4** In the **AAA Policy** section, enable the **AAA override**. The AAA Override option of a WLAN enables you to configure the WLAN for identity networking. It enables you to apply VLAN tagging, Quality of Service (QoS), and Access Control Lists (ACLs) to individual clients based on the returned RADIUS attributes from the AAA server.
- Step 5** Enable the **NAC State** check box to enable Cisco Network Admission Control (NAC).
- Note** You can enable NAC state only when AAA override is enabled.
- Step 6** From the **NAC Type** drop-down list, select the type of NAC. The default is *XWF*.
- Step 7** From the **Policy Name** drop-down list, choose a policy name.
- Step 8** From the **Accounting List** drop-down list, choose an accounting list.
- Step 9** Enable **Interim Accounting** to maintain a session with NAC.
- Step 10** Click **Update & Apply to Device**.
-

## Enabling Accounting RADIUS Server for Flex Profile (GUI)

### Procedure

- 
- Step 1** Choose **Configuration > Tags & Profiles > Flex**.
  - Step 2** On the Flex page, click the name of the desired Flex Profile.
  - Step 3** In the **Edit Flex Profile** window, click the **Local Authentication** tab.
  - Step 4** Choose the desired server group from the **Local Accounting RADIUS Server Group** drop-down list.
  - Step 5** Select the **Local Client Roaming** check box.
  - Step 6** Click **Update & Apply to Device**.
- 

## Configuring Captive Portal for Express Wi-Fi by Facebook (GUI)

### Procedure

- 
- Step 1** Choose **Configuration > Security > Web Auth**.
  - Step 2** On the **Web Auth** page, click the name of the desired parameter map.
  - Step 3** In the **Edit Web Auth Parameter** window, click the **Advanced** tab.
  - Step 4** In the **Redirect to External Server** section, select the **Express Wi-Fi Key Type** from the drop-down list.
  - Step 5** Enter the vendor specific key in the **Express Wi-Fi Key** field.
  - Step 6** Click **Update & Apply to Device**.
- 

## Configuring Captive Portal for Express Wi-Fi by Facebook (CLI)

### Before you begin

- Configure the URL filter list.
- Configure the IP ACL.

### Procedure

	Command or Action	Purpose
<b>Step 1</b>	configure terminal  <b>Example:</b> Device# <code>configure terminal</code>	Enters global configuration mode.

	Command or Action	Purpose
Step 2	<b>parameter-map type webauth</b> <i>parameter-map-name</i> <b>Example:</b> Device(config)# <b>parameter-map type webauth</b> <i>FACEBOOK-MAP</i>	Creates a parameter map and enters parameter-map webauth configuration mode.
Step 3	<b>type webauth</b> <b>Example:</b> Device(config-params-parameter-map)# <b>type webauth</b>	Configures the webauth type parameter.
Step 4	<b>redirect for-login url-string</b> <b>Example:</b> Device(config-params-parameter-map)# <b>redirect for-login</b> <i>https://xwfcisco-us.expresswifi.com/customer/captive_portal</i>	Configures the URL string for redirection during login.
Step 5	<b>captive-bypass-portal</b> <b>Example:</b> Device(config-params-parameter-map)# <b>captive-bypass-portal</b>	Configures captive bypassing.
Step 6	<b>redirect vendor-specific xwf key 0 vendor-key</b> <b>Example:</b> Device(config-params-parameter-map)# <b>redirect vendor-specific xwf key 0</b> <i>vendor-key</i>	Configures the URL string for redirection during login.
Step 7	<b>end</b> <b>Example:</b> Device(config-params-parameter-map)# <b>end</b>	Returns to privileged EXEC mode.

## Configuring Express Wi-Fi by Facebook Policy on Controller (CLI)

### Before you begin

- Enable web authentication and MAC filtering on the WLAN.
- Configure RADIUS proxy server and accounting server.

## Procedure

	Command or Action	Purpose
<b>Step 1</b>	configure terminal <b>Example:</b> Device# <b>configure terminal</b>	Enters global configuration mode.
<b>Step 2</b>	<b>wireless profile policy</b> <i>policy-profile-name</i> <b>Example:</b> Device (config)# <b>wireless profile policy</b> <i>default-policy- profile</i>	Configures the wireless profile policy.
<b>Step 3</b>	<b>aaa-override</b> <b>Example:</b> Device (config-wireless-policy)# <b>aaa override</b>	Configures AAA override to apply policies coming from the AAA or ISE servers.
<b>Step 4</b>	<b>no central switching</b> <b>Example:</b> Device (config-wireless-policy)# <b>no central switching</b>	Disables central switching and enables local switching.
<b>Step 5</b>	<b>no central association</b> <b>Example:</b> Device (config-wireless-policy)# <b>no central association</b>	Disables central association and enables local association for locally switched clients.
<b>Step 6</b>	<b>no central authentication</b> <b>Example:</b> Device (config-wireless-policy)# <b>no central authentication</b>	Disables central authentication and enables local authentication.
<b>Step 7</b>	<b>nac xwf</b> <b>Example:</b> Device (config-wireless-policy)# <b>nac xwf</b>	Configures NAC in the policy profile.
<b>Step 8</b>	<b>vlan</b> <i>vlan-name</i> <b>Example:</b> Device (config-wireless-policy)# <b>vlan</b> <i>9</i>	Configures a VLAN name or VLAN ID.
<b>Step 9</b>	<b>no shutdown</b> <b>Example:</b>	Enables the profile policy.

	Command or Action	Purpose
	Device (config-wireless-policy) # <b>no shutdown</b>	
<b>Step 10</b>	<b>end</b> <b>Example:</b> Device (config) # end	Returns to privileged EXEC mode.

## Configuring RADIUS Server for Accounting and Authentication in FlexConnect Profile (CLI)

### Procedure

	Command or Action	Purpose
<b>Step 1</b>	configure terminal <b>Example:</b> Device# <b>configure terminal</b>	Enters global configuration mode.
<b>Step 2</b>	<b>wireless profile flex</b> <i>flex-profile-name</i> <b>Example:</b> Device (config) # <b>wireless profile flex</b> <i>default-flex-profile</i>	Configures the wireless flex profile and enters wireless flex profile configuration mode.
<b>Step 3</b>	<b>local-auth radius-server-group</b> <i>group-name</i> <b>Example:</b> Device (config-wireless-flex-profile) # <b>local-auth radius-server-group</b> <i>FB_GROUP</i>	Configures the authentication server group name.
<b>Step 4</b>	<b>local-accounting radius-server-group</b> <i>group-name</i> <b>Example:</b> Device (config-wireless-flex-profile) # <b>local-accounting radius-server-group</b> <i>group-name</i>	Configures the accounting server group name.
<b>Step 5</b>	<b>local-roaming</b> <b>Example:</b> Device (config-wireless-flex-profile) # <b>local-roaming</b>	Enables local roaming.
<b>Step 6</b>	<b>acl-policy</b> <i>policy-name</i> <b>Example:</b>	Configures ACL policy.

	Command or Action	Purpose
	Device(config-wireless-flex-profile)# <b>acl-policy</b> <i>fb</i> s	
<b>Step 7</b>	<b>urlfilter list</b> <i>list-name</i>  <b>Example:</b> Device(config-wireless-flex-profile)# <b>urlfilter list</b> <i>fb</i> s	Applies the URL list to the Flex profile.  Here, <i>list-name</i> refers to the URL filter list name. The list name must not exceed 32 alphanumeric characters.  Note: For a given traffic class, the <i>list-name</i> should match the above ACL <i>policy-name</i> .
<b>Step 8</b>	<b>end</b>  <b>Example:</b> Device(config-wireless-flex-profile)# end	Returns to privileged EXEC mode.

## Verifying Express Wi-Fi by Facebook Configurations on Controller

To view ACLs applied on a specific client and the associated AP's MAC address, use the following command:

```
Device# show wireless client mac-address 0102.0304.0506 detail
[...]
Local Roaming Client:
Client ACLs: xwf,fb
Client State Servers: a03d.6f6b.bebe, cc16.7edc.27d8
```

## Verifying Express Wi-Fi by Facebook Configurations on the AP

To view client state, use the following command:

```
Device# show flexconnect client
```

To view all ACLs applied to a specific client, use the following command:

```
Device# show client access-list {post-auth | pre-auth} all client_mac_address
```

```
Device# show client access-list post-auth all 1C:36:BB:10:1B:2C
Post-Auth URL ACLs for Client: 1C:36:BB:10:1B:2C IPv4 ACL: xwf
Fbs
IPv6 ACL:
ACTION URL-LIST
allow cisco.com
allow yahoo.com
allow google.com
allow xwf.facebook.com
allow xwf-static.xx.fbcdn.net allow cisco-us.expresswifi.com allow xwf-scontent.xx.fbcdn.net
allow xwfcisco-us.expresswifi.com
Resolved IPs for Client: 1C:36:BB:10:1B:2C HIT-COUNT URL ACTION IP-LIST
xwf
rule 0:
```

```

rule 1:
rule 2:
rule 3:
rule 4:
rule 5:
rule 6:
allow true and ip proto 6 and dst port 22
allow true and ip proto 6 and src port 22
allow true and dst 171.70.168.183 mask 255.255.255.255 allow true and src 171.70.168.183
mask 255.255.255.255 allow true and dst 157.240.22.50 mask 255.255.255.255 allow true and
src 157.240.22.50 mask 255.255.255.255 allow true and src 30.1.1.155 mask 255.255.255.255
and dst
30.1.1.18 mask 255.255.255.255 and ip proto 1
rule 7: allow true and src 30.1.1.18 mask 255.255.255.255 and dst
30.1.1.155 mask 255.255.255.255 and ip proto 1 rule 8: allow true and ip proto 17 rule 9:
allow true and ip proto 17 rule 10: deny all
fbs
rule 0: allow true and dst 31.13.0.0 mask 255.255.0.0
rule 1: allow true and dst 66.220.0.0 mask 255.255.0.0
rule 6: allow true and src 31.13.0.0 mask 255.255.0.0
rule 10: allow true and src 179.60.0.0 mask 255.255.0.0
rule 12: allow true and dst 171.70.168.183 mask 255.255.255.255 rule 14: allow true and ip
proto 17
rule 16: deny all
No IPv6 ACL found

```

```

Device# show client access-list pre-auth all 1C:36:BB:10:1B:2C
Pre-Auth URL ACLs for Client: 1C:36:BB:10:1B:2C
IPv4 ACL: xwf
IPv6 ACL:
ACTION URL-LIST
allow cisco.com
allow yahoo.com
allow google.com
allow xwf.facebook.com
allow xwf-static.xx.fbcdn.net allow cisco-us.expresswifi.com allow xwf-scontent.xx.fbcdn.net
allow xwfcisco-us.expresswifi.com
Resolved IPs for Client: 1C:36:BB:10:1B:2C HIT-COUNT URL ACTION IP-LIST
xwf
rule 0: allow true and ip proto 6 and dst port 22
rule 1: allow true and ip proto 6 and src port 22
rule 2: allow true and dst 171.70.168.183 mask 255.255.255.255 rule 3: allow true and src
171.70.168.183 mask 255.255.255.255 rule 4: allow true and dst 157.240.22.50 mask
255.255.255.255 rule 5: allow true and src 157.240.22.50 mask 255.255.255.255 rule 6: allow
true and src 30.1.1.155 mask 255.255.255.255 and dst
30.1.1.18 mask 255.255.255.255 and ip proto 1
rule 7: allow true and src 30.1.1.18 mask 255.255.255.255 and dst
30.1.1.155 mask 255.255.255.255 and ip proto 1 rule 8: allow true and ip proto 17 rule 9:
allow true and ip proto 17 rule 10: deny all
No IPv6 ACL found
Redirect URL for client: 1C:36:BB:10:1B:2C
https://xwfcisco-us.expresswifi.com/customer/captive_portal

```

To view authentication server details applied to a specific client, use the following command where the **wlan\_id** ranges from 1 to 15:

Device# **show running-config authentication dot11radio {0 | 1} wlan wlan\_id**

```

Device# show running-config authentication dot11radio 1 wlan 1
bssid=00:a7:42:f6:4a:8e ssid=aa_namsoo_webauth beacon_period=100
auth=LOCAL AP_OPER_MODE=CONNECTED AP_OPER_MODE from WPA=CONNECTED
AUTH_SERVER[0]=30.1.1.18 AUTH_SERVER_PORT[0]=2812 ACCT_SERVER[0]=30.1.1.18
ACCT_SERVER_PORT[0]=2813 AUTH_SERVER[0]=30.1.1.18 AUTH_SERVER_PORT[0]=2812
ACCT_SERVER[0]=30.1.1.18 ACCT_SERVER_PORT[0]=2813

```



To view client accounting details, use the following command:

```
Device# show controller dot11Radio {0/1} client client_mac_address
```

```
Device# show client access-list pre-auth redirect-url 1C:36:BB:10:1B:2C  
Redirect URL for client: 1C:36:BB:10:1B:2C  
https://xwfcisco-us.expresswifi.com/customer/captive_portal
```

To view DCDS (distributed client datastore) or roaming configuration details for an associated client, use the following command:

```
Device# show dot11 clients data-store details client_mac_address
```

```
Device# show dot11 clients data-store details 1C:36:BB:10:1B:2C  
First AP Name: APF8B7.E2CC.5D48  
Current AP Name: APF8B7.E2CC.5D48  
Current AP IP: 30.1.1.169  
Current AP BSSID: f8:b7:e2:cd:cb:8e  
Current AP SSID: aa_namsoo_webauth  
Client VLAN: 1  
Client State: 4  
Audit Session ID: 3204365612  
Accounting Session ID High: 0  
Accounting Session ID Low: 0  
Client Traffic Class Name: xwf  
Client Traffic Class Name: fbs
```





## CHAPTER 187

# User Defined Network

---

- [Information About User Defined Network, on page 1833](#)
- [Restrictions for User Defined Network, on page 1835](#)
- [Configuring a User Defined Network, on page 1835](#)
- [Configuring a User Defined Network \(GUI\), on page 1836](#)
- [Verifying User Defined Network Configuration, on page 1837](#)

## Information About User Defined Network

A user defined network (UDN) is a solution that is aimed at providing secure and remote on-boarding of devices in shared service environments like dormitory rooms, resident halls, class rooms and auditoriums. This solution allows users to securely use Simple Discovery Protocols (SDP) like Apple Bonjour and mDNS-based protocols (Air Play, Air Print, Screen Cast, Print, and so on.), and UPnP based protocols to interact and share information with only their registered devices in a shared environment. It also enables the users to share their devices and resources with friends and roommates securely.

The UDN solution provides an easy way to create a virtual segment that allows user to create a private segment to add their devices. Traffic (unicast, non-Layer 3 multicast, or broadcast) to these devices can be seen only by other devices and users in the private segment. This feature also eliminates the security concern where users knowingly or unknowingly take control of devices that belong to other users in a shared environment. As of now, the UDN is supported only in local mode.

Figure 49: User Defined Network Topology

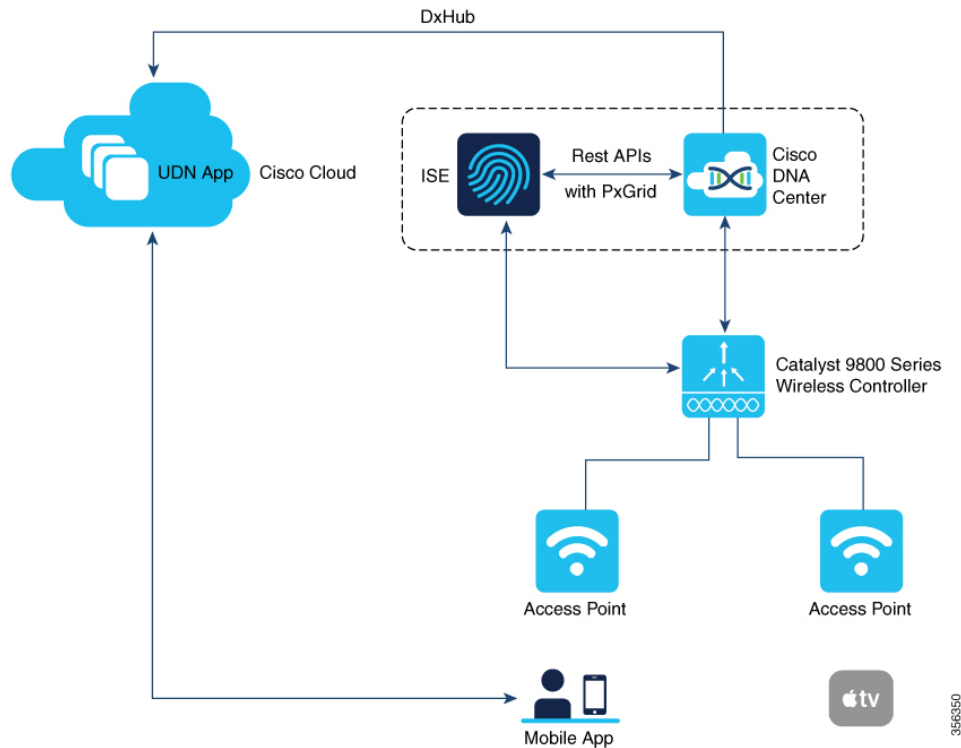

### User Defined Network Solution Workflow

- User Defined Network is enabled on the controller, using policy profile, and the policy configuration is pushed to all the WLANs on a site.
- User Defined Network association is automatically generated by the UDN cloud service and is inherited by all the devices belonging to an user.
- Users can add or modify devices to the User Defined Network assigned to them by using a web portal or a mobile application. Users can also add devices to another User Defined Network, if they are invited to join that User Defined Network.
- The controller is updated with the client or resource information assigned to the User Defined Network.



**Note** Cisco Identity Services Engine (ISE) policy infrastructure is not used to update User Defined Network information. Whenever, there is a change in the User Defined Network, the ISE updates the controller with an explicit or a separate Change of Authorization (CoA) containing only the change of the User Defined Network ID.

## Restrictions for User Defined Network

- A user can be associated to only one UDN.
- Roaming across controllers is not supported.
- This feature is not applicable for Cisco Mobility Express and Cisco AireOS platforms. Hence, IRCM is not supported.
- This feature is supported only in local mode on the Wave 2 access points and Cisco Catalyst 9100 series access points.
- This feature is supported only for centrally switched SSIDs.
- This feature is not supported for Flex mode APs.
- This feature is not supported for Fabric SSIDs.
- This feature is not supported for Guest Anchor scenario.
- Layer 2 and Layer 3 roaming is not supported.
- Layer 3 multicast (except SSDP/UPnP) containment using UDN is not supported, L3 multicast will continue to work as it is today.

## Configuring a User Defined Network

The User Defined Network configuration is site based and is added as part of a policy profile. When applied, the policy is enforced to all the clients or devices in a network for a site, across WLANs.

When enabled, the policy profile also enforces the filtering of mDNS queries based on the UDN-ID.

### Before you begin

- RADIUS server should be configured for the UDN solution to work.
- Configure aaa-override in the policy profile.

### Procedure

	Command or Action	Purpose
<b>Step 1</b>	<b>configure terminal</b>  <b>Example:</b> Device# configure terminal	Enters global configuration mode.
<b>Step 2</b>	<b>wireless profile policy <i>profile-name</i></b>  <b>Example:</b> Device(config)# wireless profile policy policy-wpn	Creates a policy profile.  <i>profile-name</i> is the profile name of the policy profile.

	Command or Action	Purpose
<b>Step 3</b>	<b>user-defined-network</b> <b>Example:</b> Device(config-wireless-policy)# user-defined-network	Enables user defined private-network.
<b>Step 4</b>	<b>user-defined-network drop-unicast</b> <b>Example:</b> Device(config-wireless-policy)# user-defined-network drop-unicast	Sets action to drop unicast traffic.  By default, unicast traffic is allowed across UDN.
<b>Step 5</b>	<b>exit</b> <b>Example:</b> Device(config-wireless-policy)# exit	Enters global configuration mode.
<b>Step 6</b>	<b>ap remote-lan-policy policy-name</b> <i>policy-name</i> <b>Example:</b> Device(config)# ap remote-lan-policy policy-name policy-wpn	Configures a remote LAN policy profile.
<b>Step 7</b>	<b>user-defined-network</b> <b>Example:</b> Device(config-remote-lan-policy)# user-defined-network	Enables user defined private-network.
<b>Step 8</b>	<b>user-defined-network drop-unicast</b> <b>Example:</b> Device(config-remote-lan-policy)# user-defined-network drop-unicast	Sets action to drop unicast traffic.

## Configuring a User Defined Network (GUI)

### Procedure

- 
- Step 1** Choose **Configuration > Tags & Profiles > Policy**.
  - Step 2** In the **Policy Profile** window, select a policy profile.
  - Step 3** In the **Edit Policy Profile** window, click the **Advanced** tab.
  - Step 4** In the **User Defined Network** section, check the **Status** check box to enable a user personal network.
  - Step 5** Check the **Drop Unicast** check box to set the action to Drop Unicast traffic.  
By default, unicast traffic is not contained.
-

## Verifying User Defined Network Configuration

To view the status of the UDN feature (either enabled or disabled) and also information about the drop unicast flag, use the following command:

```
Device# show wireless profile policy detailed default-policy-profile

User Defined (Private) Network           : Enabled
User Defined (Private) Network Unicast Drop : Enabled
```

To view the name of the UDN to which the client belongs, use the following command:

```
Device# show wireless client mac-address 00:0d:ed:dd:35:80 detailed

User Defined (Private) Network : Enabled
User Defined (Private) Network Drop Unicast : Enabled
Private group name: upn*group*7
Private group id : 7777
Private group owner: 1
Private group name: upn*group*7
Private group id : 7777
Private group owner:
```

To view the UDN payload sent from an AP to the controller, use the following command:

```
Device# show wireless stats client detail | inc udn

Total udn payloads sent           : 1
```

When mDNS gateway is enabled on the controller, the mDNS services are automatically filtered based on the user private network ID for all the clients on the WLANs where user private network is enabled.

To view the service instances of a private network, use the following command:

```
Device# show mdns-sd cache udn 7777 detail

Name: _services._dns-sd._udp.local
Type: PTR
TTL: 4500
WLAN: 2
WLAN Name: mdns-psk
VLAN: 16
Client MAC: f4f9.51e2.a6a6
AP Ethernet MAC: 002a.1087.d68a
Remaining-Time: 4486
Site-Tag: default-site-tag
mDNS Service Policy: madhu-mDNS-Policy
Overriding mDNS Service Policy: NO
UDN-ID: 7777
UDN-Status: Enabled
Rdata: _airplay._tcp.local
.
.
.
```

To view the service instances that are learnt from a shared UDN ID, use the following command:

```
Device# show mdns-sd cache udn shared

----- PTR Records -----
RECORD-NAME                                TTL      TYPE      ID      CLIENT-MAC
```

## RR-RECORD-DATA

RR-RECORD-DATA	TTL	TYPE	ID	CLIENT-MAC
9.1.1.7.5.D.E.F.F.F.6.C.7.E.2.1.0.0.0.0.0.0.0	4500	WLAN	2	10e7.c6d5.7119
HP10E7C6D57119-2860.local				
_services._dns-sd._udp.local	4500	WLAN	2	10e7.c6d5.7119
_ipps._tcp.local				
_universal._sub._ipps._tcp.local	4500	WLAN	2	10e7.c6d5.7119
HP DeskJet 5000 series [D57119] (3127)._ipps._tcp._print._sub._ipps._tcp.local	4500	WLAN	2	10e7.c6d5.7119
HP DeskJet 5000 series [D57119] (3127)._ipps._tcp._ePCL._sub._ipps._tcp.local	4500	WLAN	2	10e7.c6d5.7119
HP DeskJet 5000 series [D57119] (3127)._ipps._tcp._ipps._tcp.local	4500	WLAN	2	10e7.c6d5.7119
HP DeskJet 5000 series [D57119] (3127)._ipps._tcp._services._dns-sd._udp.local	4500	WLAN	2	10e7.c6d5.7119
_ipp._tcp.local				
_universal._sub._ipp._tcp.local	4500	WLAN	2	10e7.c6d5.7119
HP DeskJet 5000 series [D57119] (3127)._ipp._tcp.1				
_print._sub._ipp._tcp.local	4500	WLAN	2	10e7.c6d5.7119
HP DeskJet 5000 series [D57119] (3127)._ipp._tcp.1				
_ePCL._sub._ipp._tcp.local	4500	WLAN	2	10e7.c6d5.7119
HP DeskJet 5000 series [D57119] (3127)._ipp._tcp.1				
_ipp._tcp.local	4500	WLAN	2	10e7.c6d5.7119
HP DeskJet 5000 series [D57119] (3127)._ipp._tcp.1				
.				
.				
.				

## ----- SRV Records

RECORD-NAME	TTL	TYPE	ID	CLIENT-MAC
RR-RECORD-DATA				
HP DeskJet 5000 series [D57119] (3127)._ipp._0 631 HP10E7C6D57119-2860.local	4500	WLAN	2	10e7.c6d5.7119 0
HP DeskJet 5000 series [D57119] (3127)._http._0 80 HP10E7C6D57119-2860.local	4500	WLAN	2	10e7.c6d5.7119 0
HP DeskJet 5000 series [D57119] (3127)._ipps._0 631 HP10E7C6D57119-2860.local	4500	WLAN	2	10e7.c6d5.7119 0
HP DeskJet 5000 series [D57119] (3127)._uscan._0 8080 HP10E7C6D57119-2860.local	4500	WLAN	2	10e7.c6d5.7119 0
.				
.				
.				

## ----- A/AAAA Records

RECORD-NAME	TTL	TYPE	ID	CLIENT-MAC
RR-RECORD-DATA				
HP10E7C6D57119-2860.local	4500	WLAN	2	10e7.c6d5.7119
8.16.16.99				

## ----- TXT Records

RECORD-NAME	TTL	TYPE	ID	CLIENT-MAC
RR-RECORD-DATA				
HP DeskJet 5000 series [D57119] (3127)._ipp._[502]'txtvers=1''adminurl=http://HP10E7C6D57119-28	4500	WLAN	2	10e7.c6d5.7119
HP DeskJet 5000 series [D57119] (3127)._http._[1]''	4500	WLAN	2	10e7.c6d5.7119
HP DeskJet 5000 series [D57119] (3127)._ipps._[502]'txtvers=1''adminurl=http://HP10E7C6D57119-28	4500	WLAN	2	10e7.c6d5.7119
.				



.

To view the multicast DNS (mDNS) Service Discovery cache detail, use the following command:

```
Device# show mdns-sd cache detail
```

```
Name: _printer._tcp.local
Type: PTR
TTL: 4500
VLAN: 21
Client MAC: ace2.d3bc.047e
Remaining-Time: 4383
mDNS Service Policy: default-mdns-service-policy
Rdata: HP OfficeJet Pro 8720 [BC047E] (2)._printer._tcp.local
```





## CHAPTER 188

# Hotspot 2.0

- [Introduction to Hotspot 2.0, on page 1841](#)
- [Open Roaming, on page 1843](#)
- [Configuring Hotspot 2.0, on page 1845](#)

## Introduction to Hotspot 2.0

The Hotspot 2.0 feature enables IEEE 802.11 devices to interwork with external networks. The interworking service aids network discovery and selection, enabling information transfer from external networks. It provides information to the stations about the networks before association.

Interworking not only helps users within the home, enterprise, and public access domains, but also assists manufacturers and operators to provide common components and services for IEEE 802.11 customers. These services are configured on a per-WLAN basis on the Cisco Wireless Controller (controller).

Hotspot 2.0, also known as HS2 and Wi-Fi Certified Passpoint, is based on the IEEE 802.11u and Wi-Fi Alliance Hotspot 2.0 standards. It seeks to provide better bandwidth and services-on-demand to end users. The Hotspot 2.0 feature allows mobile devices to join a Wi-Fi network automatically, including during roaming, when the devices enter the Hotspot 2.0 area.

The Hotspot 2.0 feature has four distinct parts:

- **Hotspot 2.0 Beacon Advertisement:** Allows a mobile device to discover Hotspot 2.0-compatible and 802.11u-compatible WLANs.
- **Access Network Query Protocol (ANQP) Queries:** Sends queries about the networks from IEEE 802.11 devices, such as network type (private or public); connectivity type (local network, internet connection, and so on), or the network providers supported by a given network.
- **Online Sign-up:** Allows a mobile device to obtain credentials to authenticate itself with the Hotspot 2.0 or WLAN.
- **Authentication and Session Management:** Provides authentication (802.1x) and management of the STA session (session expiration, extension, and so on).

In order to mark a WLAN as Hotspot 2.0-compatible, the 802.11u-mandated information element and the Hotspot 2.0 information element is added to the basic service set (BSS) beacon advertised by the corresponding AP, and in WLAN probe responses.



**Note** The Hotspot 2.0 feature supports only local mode or FlexConnect mode (central switching and central authentication).

FlexConnect local switching is only supported when the Open Roaming configuration template is set up using the **wireless hotspot anqp-server server-name type open-roaming** command. If the configuration diverges from this template, FlexConnect local switching will not be supported.

The following figure shows a standard deployment of the Hotspot 2.0 network architecture:

**Figure 50: Hotspot 2.0 Deployment Topology**

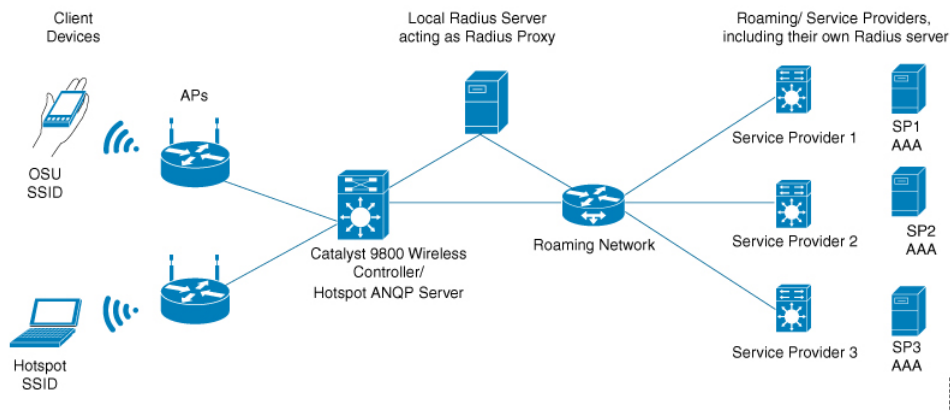

### Hotspot 2.0 Enhancements

From Cisco IOS XE Amsterdam 17.3.1, the Hotspot 2.0 feature has been enhanced with the following options:

- New ANQP elements:
  - Advice of charge: Provides information on the financial charges for using the SSID of the NAI realm
  - Operator icon metadata
  - Venue URL: Defines an optional URL for each of the configured venue names
- Introduction of Terms and Conditions: This requires a user to accept certain Terms and Conditions before being allowed internet access, after connecting to a Hotspot SSID.
- Integration of OSEN security and WPA2 security on the same SSID.

From Cisco IOS XE Amsterdam 17.3.1 onwards, two encryption methods are supported on a single SSID, namely WPA2 802.1x for Hotspot 2.0 and OSEN for online sign-up. Based on the type of encryption selected during client association, the client will be put on Hotspot 2.0 VLAN or online sign-up VLAN.

In WPA2 802.1x authentication, a client should match the credentials provisioned on a device. In online sign-up, a service provider WLAN is used by a client to perform online sign-up. For Hotspot 2.0 SSIDs, the RADIUS server enforces the terms and conditions before allowing internet connectivity to clients.

This release also supports OSEN-specific VLAN in a policy profile. If an OSEN VLAN is defined in a policy profile, OSEN clients are added to the VLAN. Otherwise, clients are added to the regular policy profile VLAN.

or to the default VLAN. If OSEN is enabled with WPA2 on an SSID, it is mandatory to define an OSEN VLAN in the policy profile. Otherwise, clients cannot join the VLAN.

In FlexConnect mode, if an OSEN VLAN is defined in a policy profile, the same VLAN needs to be added to the flex profile. Failing to do so excludes the clients from the VLAN.



**Note** When Hotspot 2.0 is enabled in a WLAN, the Wi-Fi direct clients that support cross-connect feature should not be allowed to associate to the Hotspot 2.0 WLAN. To make sure this policy is enforced, ensure that the following configuration is in place:

```
wlan <wlan-name> <wlan-name> <ssid>
wifi-direct policy xconnect-not-allow
```

### Restrictions

- Clients are excluded if an OSEN VLAN is not added to a flex profile.
- In FlexConnect mode, clients are excluded if an OSEN VLAN is not added in a flex profile.
- In FlexConnect deployments, the URL filter should reference an existing URL filter (configured using the **urlfilter list** *urlfilter-name* command). Otherwise, a client is added to the excluded list, after authentication.
- Only central authentication is supported.
- Fragmented ANQP replies are not synchronized to the standby controller in high-availability mode. Therefore, clients have to re-issue a query if there is a switchover.

## Open Roaming

From Cisco IOS XE Amsterdam Release 17.2.1, the controller supports open roaming configuration, which enables mobile users to automatically and seamlessly roam across Wi-Fi and cellular networks.

The new configuration template of the open roaming ANQP server simplifies the task of setting up a Hotspot 2.0 ANQP server. When you configure open roaming, fixed ANQP parameters are automatically populated.

You can configure different identity types by defining roaming organizational identifiers. The organizational unique identifier (OUI) is a three-octet number that identifies the type of organizations available in a given roaming consortium. The OUI list determines the type of identities allowed to roam into the network. The default configuration allows all the identities on the access network. However, access networks can customize the Roaming Consortium Organization Identifier (RCOI) they advertise.

You can configure three types of policies for access networks:

- Allow all: Accepts users from any identity provider (IDP), with any privacy policy.
- Real ID: Accepts users from any IDP, but only with a privacy policy that shares real identity (anonymous not accepted).
- Custom: Accepts users of select identity types and privacy policies associated with the identity types; basically all the other RCOIs.

Users can select the following privacy modes:

- Anonymous
- Share real identity

The list of currently defined organizational identifiers and their aliases are given in the following table.

**Table 96: Roaming Organizational Identifiers and Aliases**

Description	Roaming Organizational Identifier	WBA Value	Display Name
All	004096	5A03BA0000	All
All with real ID	00500b	5A03BA1000	All with real-id only
All paid members	00500f	BAA2D00000	All paid
Device manufacturer all ID	00502a	5A03BA0A00	Device Manufacturer
Device manufacturer real ID only	0050a7	5A03BA1A00	Device Manufacturer real-id
Cloud or Social ID	005014	5A03BA0200	Cloud ID
Cloud or Social real ID	0050bd	5A03BA1200	Cloud ID real-id
Enterprise Employee ID	00503e	5A03BA0300	Enterprise ID
Enterprise Employee real ID	0050d1	5A03BA1300	Enterprise ID real ID
Enterprise Customer ID	005050	-	Enterprise Customer program ID
Enterprise Customer real ID	0050e2	-	Enterprise Customer program real ID
Loyalty Retail ID	005053	5A03BA0B00	Loyalty Retail
Loyalty Retail real ID	0050f0	5A03BA1B00	Loyalty Retail real ID
Loyalty Hospitality ID	005054	5A03BA0600	Loyalty Hospitality
Loyalty Hospitality real ID	00562b	5A03BA1600	Loyalty Hospitality real ID
SP free Bronze QoS	005073	5A03BA0100	SP free Bronze QoS
SP free Bronze QoS Real ID	0057D2	5A03BA1100	SP free Bronze QoS Real ID
SP paid Bronze QoS	-	BAA2D00100	SP paid Bronze QoS
SP paid Bronze QoS real ID	-	BAA2D01100	SP paid Bronze QoS real ID
SP paid Silver QoS	-	BAA2D02100	SP paid Silver QoS
SP paid Silver QoS real ID	-	BAA2D03100	SP paid Silver QoS real ID
SP paid Gold QoS	-	BAA2D04100	SP paid Gold QoS

Description	Roaming Organizational Identifier	WBA Value	Display Name
SP paid Gold QoS real ID	-	BAA2D05100	SP paid Gold QoS real ID
Government ID free	-	5A03BA0400	Government ID free
Automotive ID free	-	5A03BA0500	Automotive ID free
Automotive Paid	-	BAA2D00500	Automotive Paid
Education or Research ID free	-	5A03BA0800	Education or Research ID free
Cable ID free	-	5A03BA0900	Cable ID free

## Configuring Hotspot 2.0

### Configuring an Access Network Query Protocol Server

The Access Network Query Protocol Server (ANQP) is a query and response protocol that defines the services offered by an AP, usually at a Wi-Fi Hotspot 2.0.



**Note** When configuring roaming-oi in the ANQP server, ensure that you set the **beacon** keyword for at least one roaming-oi, as mandated by the 802.11u standard.

#### Procedure

	Command or Action	Purpose
<b>Step 1</b>	<b>configure terminal</b> <b>Example:</b> Device# configure terminal	Enters global configuration mode.
<b>Step 2</b>	<b>wireless hotspot anqp-server <i>server-name</i></b> <b>Example:</b> Device(config)# wireless hotspot anqp-server my_server	Configures a Hotspot 2.0 ANQP server.
<b>Step 3</b>	<b>description <i>description</i></b> <b>Example:</b> Device(config-wireless-anqp-server)# description "My Hotspot 2.0"	Adds a description for the ANQP server.
<b>Step 4</b>	<b>3gpp-info <i>mobile-country-code</i></b> <b><i>mobile-network-code</i></b>	Configures a 802.11u Third Generation Partnership Project (3GPP) cellular network.

	Command or Action	Purpose
	<b>Example:</b> Device(config-wireless-anqp-server) # 3gpp-info us mcc	The <i>mobile-country-code</i> should be a 3-digit decimal number. The <i>mobile-network-code</i> should be a 2-digit or 3-digit decimal number.
<b>Step 5</b>	<b>anqp fragmentation-threshold</b> <i>threshold-value</i>  <b>Example:</b> Device(config-wireless-anqp-server) # anqp fragmentation-threshold 100	Configures the ANQP reply fragmentation threshold, in bytes.  The ANQP protocol can be customized by setting the fragmentation threshold, after which the ANQP reply is split into multiple messages.  <b>Note</b> We recommend that you use the default values for the deployment.
<b>Step 6</b>	<b>anqp-domain-id</b> <i>domain-id</i>  <b>Example:</b> Device(config-wireless-anqp-server) # anqp-domain-id 100	Configures the Hotspot 2.0 ANQP domain identifier.
<b>Step 7</b>	<b>authentication-type</b> { <b>dns-redirect</b>   <b>http-https-redirect</b>   <b>online-enrollment</b>   <b>terms-and-conditions</b> }  <b>Example:</b> Device(config-wireless-anqp-server) # authentication-type online-enrollment	Configures the 802.11u network authentication type. Depending on the authentication type, a URL is needed for HTTP and HTTPS.
<b>Step 8</b>	<b>connection-capability</b> <i>ip-protocol</i> <i>port-number</i> { <b>closed</b>   <b>open</b>   <b>unknown</b> }  <b>Example:</b> Device(config-wireless-anqp-server) # connection-capability 12 40 open	Configures the Hotspot 2.0 protocol and port capabilities.  <b>Note</b> Hotspot 2.0 specifications require that you predefine some open ports and protocols. Ensure that you meet these requirements in order to comply with the Hotspot 2.0 specifications. See the <b>connection-capability</b> command in the <a href="#">Cisco Catalyst 9800 Series Wireless Controller Command Reference</a> document for a list of open ports and protocols.
<b>Step 9</b>	<b>domain</b> <i>domain-name</i>  <b>Example:</b> Device(config-wireless-anqp-server) # domain my-domain	Configures an 802.11u domain name. You can configure up to 32 domain names. The <i>domain-name</i> should not exceed 220 characters.
<b>Step 10</b>	<b>ipv4-address-type</b> <i>ipv4-address-type</i>  <b>Example:</b> Device(config-wireless-anqp-server) # ipv4-address-type public	Configures an 802.11u IPv4 address type in the Hotspot 2.0 network.



	Command or Action	Purpose
<b>Step 11</b>	<b>ipv6-address-type</b> <i>ipv6-address-type</i> <b>Example:</b> Device(config-wireless-anqp-server) # ipv6-address-type available	Configures an 802.11u IPv6 address type in the Hotspot 2.0 network.
<b>Step 12</b>	<b>nai-realm</b> <i>realm-name</i> <b>Example:</b> Device(config-wireless-anqp-server) # nai cisco.com	Configures an 802.11u NAI realm profile that identifies the realm that is accessible using the AP.
<b>Step 13</b>	<b>operating-class</b> <i>class-id</i> <b>Example:</b> Device(config-wireless-anqp-server) # operating-class 25	Configures a Hotspot 2.0-operating class identifier.
<b>Step 14</b>	<b>operator</b> <i>operator-name language-code</i> <b>Example:</b> Device(config-wireless-anqp-server) # operator XYZ-operator eng	Configures a Hotspot 2.0 operator-friendly name in a given language. Use only the first three letters of the language, in lower case, for the language code. For example, use <i>eng</i> for English.  To see the full list of language codes, go to: <a href="http://www.loc.gov/standards/iso639-2/php/code_list.php">http://www.loc.gov/standards/iso639-2/php/code_list.php</a> .  <b>Note</b> You can configure only one operator per language.
<b>Step 15</b>	<b>osu-ssid</b> <i>SSID</i> <b>Example:</b> Device(config-wireless-anqp-server) # osu-ssid test	Configures the SSID that wireless clients will use for OSU.  The SSID length can be up to 32 characters.
<b>Step 16</b>	<b>roaming-oi</b> <i>OI-value</i> [ <b>beacon</b> ] <b>Example:</b> Device(config-wireless-anqp-server) # roaming-oi 24 beacon	Configures the 802.11u roaming organization identifier.  If the <b>beacon</b> keyword is specified, the roaming OUI is advertised in the AP WLAN beacon or probe response. Otherwise, it will only be returned while performing the roaming OUI ANQP query.  <b>Note</b> The hex string of a roaming OUI should contain only lowercase letters.
<b>Step 17</b>	<b>venue</b> <i>venue-name language-code</i> <b>Example:</b> Device(config-wireless-anqp-server) # venue bank eng	Configures the 802.11u venue information.  The <i>venue-name</i> should not exceed 220 characters and the <i>language-code</i> should only be 2 or 3 lowercase letters (a-z) in length.

## Configuring ANQP Global Server Settings (GUI)

### Procedure

---

- Step 1** Choose **Configuration > Wireless > Hotspot/OpenRoaming**.
- Step 2** Select an existing server from the list of servers.
- Step 3** Click the **Server Settings** tab.
- Step 4** Go to the **Global Server Settings** section.
- Step 5** From the **IPv4 Type** drop-down list, choose an IPv4 type.
- Step 6** From the **IPv6 Type** drop-down list, choose an IPv6 type.
- Step 7** In the **OSU SSID** field, enter the SSID that wireless clients will use for Online Sign-Up (OSU).
- Step 8** Click the **Show Advanced Configuration** link to view the advanced options.
- In the **Fragmentation Threshold (bytes)** field, enter the fragmentation threshold.  
**Note** Packets that are larger than the size you specify here will be fragmented.
  - In the **GAS Request Timeout (ms)** field, enter the number of Generic Advertisement Services (GAS) request action frames sent that can be sent to the controller by an AP in a given interval.
- Step 9** Click **Apply to Device**.
- 

## Configuring Open Roaming (CLI)

The new configuration template of the open roaming ANQP server simplifies the task of setting up a Hotspot 2.0 ANQP server. When you configure open roaming using this template, default ANQP parameters are automatically populated. The default values defined in the template always override any user-defined configuration values. For example, these are the default values enforced with the type open-roaming template:

- nai-realm open.openroaming.org
- eap-method eap-tls
- eap-method eap-ttls
- inner-auth-non-eap mschap-v2
- inner-auth-non-eap pap
- eap-method eap-aka

You can add more fields to the existing template, but ensure that they do not overlap with the existing default values. Also, if you change any of these default values, you will need to re-configure every time you enter in anqp type open-roaming config.

**Procedure**

	<b>Command or Action</b>	<b>Purpose</b>
<b>Step 1</b>	<b>configure terminal</b> <b>Example:</b> Device# configure terminal	Enters global configuration mode.
<b>Step 2</b>	<b>wireless hotspot anqp-server <i>server-name</i> type open-roaming</b> <b>Example:</b> Device(config)# wireless hotspot anqp-server my-server type open-roaming	Configures a Hotspot 2.0 ANQP server with open roaming.
<b>Step 3</b>	<b>open-roaming-oi <i>alias</i></b> <b>Example:</b> Device(config-wireless-anqp-server)# open-roaming-oi allow-all	Sets the open roaming element alias.
<b>Step 4</b>	<b>domain <i>domain-name</i></b> <b>Example:</b> Device(config)# domain my-domain	Configures a preferred domain name to ensure that clients roam into a preferred network.  You can configure up to 32 domain names. The <i>domain-name</i> should not exceed 220 characters.

## Configuring Open Roaming (GUI)

**Procedure**

- 
- Step 1** Choose **Configuration > Wireless > Hotspot/OpenRoaming**.
- Step 2** Click **Add**.  
The **Add New ANQP Server** window is displayed.
- Step 3** In the **Name** field, enter a name for the server.
- Step 4** In the **Description** field, enter a description for the server.
- Step 5** Check the **OpenRoaming Server** check box to use the server as an open roaming server.  
**Note** You can set the server as an open roaming server only at the time of server creation.
- Step 6** Check the **Internet Access** check box to enable internet access for the server.
- Step 7** From the **Network Type** drop-down list, choose the network type.
- Step 8** Click **Apply to Device**.
-

## Configuring NAI Realms (GUI)

### Procedure

---

**Step 1** Choose **Configuration > Wireless > Hotspot/OpenRoaming**.

**Step 2** Select an existing server from the list of servers.

**Step 3** Go to the **NAI Realms** section.

**Step 4** Click **Add**.

The **Add NAI Realm** window is displayed.

**Step 5** In the **NAI Realm Name** field, enter an 802.11u NAI realm of the OSU operator.

**Step 6** In the **EAP Methods** section, use the toggle button to enable the required EAP methods.

After an EAP method is enabled, a pane is displayed to configure the details. Users are shown a configuration section where they can enable *credential*, *inner-auth-eap*, *inner-auth-non-eap*, *tunneled-eap-credential*. The user can select multiple options for each of the configuration.

- The **Credential** window has options such as certificate, hw-token, nfc, none, sim, softoken, username-password, and usim. Check the corresponding check box.
- The **inner-auth-eap** window has options such as eap-aka, eap-fast, eap-sim, eap-tls, eap-ttls, eap-leap, and eap-peap. Check the corresponding check box.
- The **inner-auth-eap** window has options such as eap-aka, eap-fast, eap-sim, eap-tls, eap-ttls, eap-leap, and eap-peap. Check the corresponding check box.
- The **tunneled-eap-credential** window has options such as anonymous, certificate, hw-token, nfc, sim, softoken, username-password, and usim. Check the corresponding check box.
- Click **Save**.

**Step 7** Click **Apply to Device**.

---

## Configuring Organizational Identifier Alias (GUI)

### Procedure

---

**Step 1** Choose **Configuration > Wireless > Hotspot/OpenRoaming**.

**Step 2** Select an existing server from the list of servers.

**Step 3** In the **Roaming OIs** area, enter an 802.11u roaming organization identifier in the **Roaming OI** field.

**Step 4** Check the **Beacon State** check box to enable the beacon.

If the beacon is specified, the roaming OUI is advertised in the AP WLAN beacon or probe response. Otherwise, it will only be returned while performing the roaming OUI ANQP query.

**Note** Only three OUIs can be enabled in the beacon state.

- Step 5** Click **Add** to add a roaming OI.
- Step 6** In the **Available OpenRoaming OI** window, a list of organizational identifiers are displayed, along with the ones you have added. Select an organizational identifier and click the right arrow to add an **OpenRoaming OI**.
- Step 7** In the **Domains** area, enter an 802.11u domain name in the **Domain Name** field.
- Step 8** Click **Add** to use the domain name that you have entered as the preferred domain.
- Step 9** Click **Apply to Device**.

## Configuring WAN Metrics (GUI)

### Procedure

- Step 1** Choose **Configuration > Wireless > Hotspot/OpenRoaming**.
- Step 2** Select an existing server from the list of servers.
- Step 3** Click the **Server Settings** tab.
- Step 4** Go to the **WAN Metrics** area.
- Step 5** In the **Downlink Load** field, enter the WAN downlink load.
- Step 6** In the **Downlink Speed (kbps)** field, enter the WAN downlink speed, in kbps.
- Step 7** In the **Load Duration (100ms)** field, enter the load duration.
- Step 8** In the **Upload Load** field, enter the WAN upload load.
- Step 9** In the **Upload Speed (kbps)** field, enter the WAN upload speed, in kbps.
- Step 10** From the **Link Status** drop-down list, choose the link status.
- Step 11** Use the **Full Capacity Link** toggle button to enable the WAN link to operate at its maximum capacity.
- Step 12** Click **Apply to Device**.

## Configuring WAN Metrics

This procedure shows you how to configure the Wide Area Network (WAN) parameters such as uplink and downlink speed, link status, load, and so on.

### Procedure

	Command or Action	Purpose
<b>Step 1</b>	<b>configure terminal</b>  <b>Example:</b> Device# configure terminal	Enters global configuration mode.
<b>Step 2</b>	<b>wireless hotspot anqp-server <i>server-name</i></b>  <b>Example:</b>	Configures a Hotspot 2.0 ANQP server.

	Command or Action	Purpose
	Device(config)# wireless hotspot anqp-server my_server	
<b>Step 3</b>	<b>wan-metrics downlink-load</b> <i>load-value</i>  <b>Example:</b> Device(config-wireless-anqp-server)# wan-metrics downlink-load 100	Configures the WAN downlink load.
<b>Step 4</b>	<b>wan-metrics downlink-speed</b> <i>speed</i>  <b>Example:</b> Device(config-wireless-anqp-server)# wan-metrics downlink-speed 1000	Configures the WAN downlink speed, in kbps.
<b>Step 5</b>	<b>wan-metrics full-capacity-link</b>  <b>Example:</b> Device(config-wireless-anqp-server)# wan-metrics full-capacity-link	Configures the WAN link to operate at its maximum capacity.
<b>Step 6</b>	<b>wan-metrics link-status</b> { <b>down</b>   <b>not-configured</b>   <b>test-state</b>   <b>up</b> }  <b>Example:</b> Device(config-wireless-anqp-server)# wan-metrics link-status down	Sets the WAN link status.
<b>Step 7</b>	<b>wan-metrics load-measurement-duration</b> <i>duration</i>  <b>Example:</b> Device(config-wireless-anqp-server)# wan-metrics load-measurement-duration 100	Configures the uplink or downlink load measurement duration.
<b>Step 8</b>	<b>wan-metrics uplink-load</b> <i>load-value</i>  <b>Example:</b> Device(config-wireless-anqp-server)# wan-metrics uplink-load 100	Configures the WAN uplink load.
<b>Step 9</b>	<b>wan-metrics uplink-speed</b> <i>speed</i>  <b>Example:</b> Device(config-wireless-anqp-server)# wan-metrics uplink-speed 1000	Configures the WAN uplink speed, in kbps.

## Configuring Beacon Parameters (GUI)

### Procedure

**Step 1** Choose **Configuration > Wireless > Hotspot/OpenRoaming**.

- Step 2** Select an existing server from the list of servers.
- Step 3** Click **Server Settings** tab.
- Step 4** Go to the **Beacon Parameters** section.
- Step 5** In the **Hess id** field, enter the homogenous extended service set identifier. The Hess ID can be either in *xx:xx:xx:xx:xx:xx*, *xx-xx-xx-xx-xx-xx*, or *xxxx.xxxx.xxxx* format.
- Step 6** In the **Domain id** field, enter the domain's identifier.
- Step 7** From the **Venue Type** drop-down list, select the venue.  
Choosing a venue activates the subvenue type.
- Step 8** From the **subvenue-type** drop-down list, select the sub-venue.
- Step 9** Click **Apply to Device**.
- 

## Configuring Authentication and Venue (GUI)

### Procedure

---

- Step 1** Choose **Configuration > Wireless > Hotspot/OpenRoaming**.
- Step 2** Select an existing server from the list of servers.
- Step 3** Click the **Authentication/Venue** tab.
- Step 4** Under the **Network Auth Types** section, check the **DNS Redirect**, **Online Enrolment**, **HTTP/HTTPS Redirect**, **Terms and Conditions** check boxes.  
For **HTTP/HTTPS Redirect** and **Terms and Conditions**, the URL field is enabled after selecting them.
- Step 5** Add the URL for the corresponding authentication type.
- Step 6** Click **Apply**.
- Step 7** Go to the **Venues** section and click **Add**.  
The **Venue Details** pane is displayed.
- Step 8** In the **Language Code** field, enter the language code.  
Use the first two or three letters of the language, in lower case, for the language code. For example, use *eng* for English. To see the full list of language codes, go to:  
[http://www.loc.gov/standards/iso639-2/php/code\\_list.php](http://www.loc.gov/standards/iso639-2/php/code_list.php).
- Step 9** In the **Venue URL** field, enter the URL of the venue.
- Step 10** In the **Venue Name** field, enter the name of the venue.
- Step 11** Click check mark icon to add the venue details.
- Step 12** Go to the **Connection Capability** section and click **Add**.  
The **Connection Capabilities** pane is displayed. See the **connection-capability** command in the [Cisco Catalyst 9800 Series Wireless Controller Command Reference](#) document for a list of open ports and protocols.
- Step 13** In the **Port Number** field, enter the port number.
- Step 14** From the **Connection Status** drop-down list, choose a connection status.

- Step 15** In the **IP Protocol** field, enter the IP protocol number.
- Hotspot 2.0 specifications require that you predefine some open ports and protocols. Ensure that you meet these requirements in order to comply with the Hotspot 2.0 specifications. See the **connection-capability** command in the [Cisco Catalyst 9800 Series Wireless Controller Command Reference](#) document for a list of open ports and protocols.
- Step 16** Click the check mark icon to add the connection details.
- Step 17** Click **Apply to Device**.
- 

## Configuring 3GPP/Operator (GUI)

### Procedure

---

- Step 1** Choose **Configuration > Wireless > Hotspot/OpenRoaming**.
- Step 2** Select an existing server from the list of servers.
- Step 3** Go to the **3GPP/Operator** tab.
- Step 4** In the **Operating Class Indicator** field, enter the operating class identifier and click the + icon.
- The operating class identifier is added and displayed in the pane below. Use the delete icon to delete them, if required.
- Note** Class IDs should be in the following ranges: 81-87, 94-96, 101-130, 180, and 192-254.
- Step 5** Go to the **3GPP Cellular Networks** section and click **Add**.
- The **3GPP Network Details** pane is displayed.
- Step 6** In the **Mobile Country Code (MCC)** field, enter the mobile country code, which should be a 3-digit decimal number.
- Step 7** In the **Mobile Network Code (MNC)** field, enter the mobile network code, which should be a 2 or 3-digit decimal number.
- For the list of Mobile Country Codes (MCC) and Mobile Network Codes (MNC), see the following links: <https://www.itu.int/pub/T-SP-E.212B-2018> or <https://www.mcc-mnc.com>.
- Step 8** Click check mark icon to add the network details.
- Step 9** Go to the **Hotspot 2.0 Operators** section and click **Add**.
- The **Operator Details** pane is displayed.
- Step 10** In the **Language Code** field, enter the language code.
- Use only the first three letters of the language, in lower case, for the language code. For example, use *eng* for English. To see the full list of language codes, go to: [http://www.loc.gov/standards/iso639-2/php/code\\_list.php](http://www.loc.gov/standards/iso639-2/php/code_list.php).
- Step 11** In the **Name** field, enter the name of the OSU operator.
- Step 12** Click check mark icon to add the operator details.



**Step 13** Click **Apply to Device**.

---

## Configuring OSU Provider (GUI)

### Procedure

---

- Step 1** Choose **Configuration > Wireless > Hotspot/OpenRoaming**.
- Step 2** Select an existing server from the list of servers.
- Step 3** Go to the **OSU Provider** tab.
- Step 4** Click **Add**.
- The **General Config** pane is displayed.
- Step 5** In the **Provider Name** field, enter the OSU provider name.
- Step 6** In the **NAI Realm** field, enter the Network Access Identifier (NAI) realm of the OSU operator.
- Step 7** From the **Primary Method** drop-down list, choose the primary supported OSU method of the OSU operator. This activates the **Secondary Method** drop-down list. If you choose *None* as the primary supported OSU method, you will not get the secondary method.
- Step 8** (Optional) From the **Secondary Method** drop-down list, choose the secondary supported OSU method of the OSU operator.
- Step 9** In the **Server URI** field, enter the server Uniform Resource Identifier (URI) of the OSU operator.
- Step 10** Click **Icon Config** tab.
- Step 11** Click **Add**.
- Step 12** From the **Icon Name** drop-down list, choose the icon name.
- Step 13** Click **Save**.
- Step 14** Click **Friendly Names** tab.
- Step 15** Click **Add**.
- Step 16** In the **Language** field, enter the language code.
- Step 17** In the **Name** field, enter the name of the OSU operator.
- Step 18** In the **Description** field, enter the description for the OSU operator.
- Step 19** Click **Save**.
- Step 20** Click the check mark icon to save.
- Step 21** Click **Apply to Device**.
-

## Configuring an Online Sign-Up Provider

### Procedure

	Command or Action	Purpose
<b>Step 1</b>	<b>configure terminal</b>  <b>Example:</b> Device# configure terminal	Enters global configuration mode.
<b>Step 2</b>	<b>wireless hotspot icon</b> <b>bootflash:system-file-name media-type language-code icon-width icon-height</b>  <b>Example:</b> Device(config)# wireless hotspot icon bootflash:logol image eng 100 200	Configures an icon for Hotspot 2.0 and its parameters, such as media type, language code, icon width, and icon height.
<b>Step 3</b>	<b>wireless hotspot anqp-server server-name</b>  <b>Example:</b> Device(config)# wireless hotspot anqp-server my_server	Configures a Hotspot 2.0 ANQP server.
<b>Step 4</b>	<b>osu-provider osu-provider-name</b>  <b>Example:</b> Device(config-wireless-anqp-server)# osu-provider my-osu	Configures a Hotspot 2.0 OSU provider name.
<b>Step 5</b>	<b>name osu-operator-name lang-code description</b>  <b>Example:</b> Device(config-anqp-osu-provider)# name xyz-oper eng xyz-operator	Configures the name of the OSU operator in a given language.  The <i>osu-operator-name</i> and <i>description</i> should not exceed 220 characters. The language code should be 2 or 3 lower-case letters (a-z).
<b>Step 6</b>	<b>server-uri server-uri</b>  <b>Example:</b> Device(config-anqp-osu-provider)# server-uri cisco.com	Configures the server Uniform Resource Identifier (URI) of the OSU operator.
<b>Step 7</b>	<b>method { oma-dm   soap-xml-spp }</b>  <b>Example:</b> Device(config-anqp-osu-provider)# method oma-dm	Configures the primary supported OSU method of the OSU operator.
<b>Step 8</b>	<b>nai-realm nai-realm</b>  <b>Example:</b> Device(config-anqp-osu-provider)# nai-realm cisco.com	Configures the Network Access Identifier (NAI) realm of the OSU operator.  The <i>nai-realm</i> should not exceed 220 characters.
<b>Step 9</b>	<b>icon file-name</b>	Configures the icon for the OSU provider.

	Command or Action	Purpose
	<b>Example:</b> Device(config-anqp-osu-provider)# icon xyz.jpeg	The <i>file-name</i> should not exceed 100 characters.

## Configuring Hotspot 2.0 WLAN

### Procedure

	Command or Action	Purpose
<b>Step 1</b>	<b>configure terminal</b>  <b>Example:</b> Device# configure terminal	Enters global configuration mode.
<b>Step 2</b>	<b>wlan wlan-name wlan-id ssid</b>  <b>Example:</b> Device(config)# wlan hs2 1 hs2	Configures a WLAN and enters WLAN configuration mode.
<b>Step 3</b>	<b>security wpa wpa2 gtk-randomize</b>  <b>Example:</b> Device(config-wlan)# security wpa wpa2 gtk-randomize	Configures random GTK for hole 196 mitigation.  Hole 196 is the name of WPA2 vulnerability.
<b>Step 4</b>	<b>no shutdown</b>  <b>Example:</b> Device(config-wlan)# no shutdown	Enables the WLAN.

## Configuring an Online Subscription with Encryption WLAN

Online subscription with Encryption (OSEN) WLAN is used to onboard a Hotspot 2.0 network (to get the necessary credentials) in a secure manner.



**Note** You cannot apply a policy profile to the OSEN WLAN if a Hotspot 2.0 server is enabled on the WLAN.

### Procedure

	Command or Action	Purpose
<b>Step 1</b>	<b>configure terminal</b>  <b>Example:</b> Device# configure terminal	Enters global configuration mode.

	Command or Action	Purpose
<b>Step 2</b>	<b>wlan</b> <i>wlan-name wlan-id ssid</i> <b>Example:</b> Device(config)# wlan hs2 1 hs2	Configures a WLAN and enters WLAN configuration mode.
<b>Step 3</b>	<b>security wpa osen</b> <b>Example:</b> Device(config-wlan)# security wpa osen	Enables WPA OSEN security support. <b>Note</b> OSEN and robust security network (RSN) are mutually exclusive. If RSN is enabled on a WLAN, OSEN cannot be enabled on the same WLAN.
<b>Step 4</b>	<b>no shutdown</b> <b>Example:</b> Device(config-wlan)# no shutdown	Enables the WLAN.

## Attaching an ANQP Server to a Policy Profile

### Procedure

	Command or Action	Purpose
<b>Step 1</b>	<b>configure terminal</b> <b>Example:</b> Device# configure terminal	Enters global configuration mode.
<b>Step 2</b>	<b>wireless profile policy</b> <i>policy-profile-name ssid</i> <b>Example:</b> Device(config)# wireless profile policy policy-hotspot	Configures a policy profile.
<b>Step 3</b>	<b>shutdown</b> <b>Example:</b> Device(config-wireless-policy)# shutdown	Disables the policy profile.
<b>Step 4</b>	<b>hotspot anqp-server</b> <i>server-name</i> <b>Example:</b> Device(config-wireless-policy)# hotspot anqp-server my-server	Attaches the Hotspot 2.0 ANQP server to the policy profile.
<b>Step 5</b>	<b>no shutdown</b> <b>Example:</b> Device(config-wireless-policy)# no shutdown	Enables the policy profile.

**What to do next**

Attach the policy profile to the WLAN to make the WLAN Hotspot 2.0 enabled.

## Configuring Interworking for Hotspot 2.0

**Procedure**

	Command or Action	Purpose
<b>Step 1</b>	<b>configure terminal</b> <b>Example:</b> Device# configure terminal	Enters global configuration mode.
<b>Step 2</b>	<b>wireless hotspot anqp-server <i>server-name</i></b> <b>Example:</b> Device(config)# wireless hotspot anqp-server my_server	Configures a Hotspot 2.0 ANQP server.
<b>Step 3</b>	<b>network-type allowed <i>network-type</i></b> <b>internet-access { allowed   forbidden }</b> <b>Example:</b> Device(config-wireless-anqp-server) # network-type guest-private internet-access allowed	Configures a 802.11u network type.
<b>Step 4</b>	<b>hessid <i>HESSID-value</i></b> <b>Example:</b> Device(config-wireless-anqp-server) # hessid 12.13.14	(Optional) Configures a homogenous extended service set.
<b>Step 5</b>	<b>group <i>venue-group venue-type</i></b> <b>Example:</b> Device(config-wireless-anqp-server) # group business bank	Selects a group type and venue type from the list of available options.

## Configuring the Generic Advertisement Service Rate Limit

**Procedure**

	Command or Action	Purpose
<b>Step 1</b>	<b>configure terminal</b> <b>Example:</b> Device# configure terminal	Enters global configuration mode.
<b>Step 2</b>	<b>ap profile <i>profile-name</i></b> <b>Example:</b>	Configures an AP profile and enters AP profile configuration mode.

	Command or Action	Purpose
	<code>Device(config)# ap profile hs2-profile</code>	
<b>Step 3</b>	<b>gas-ap-rate-limit</b> <i>request-number interval</i> <b>Example:</b> <code>Device(config-ap-profile)#  gas-ap-rate-limit 20 120</code>	Configures the number of Generic Advertisement Services (GAS) request action frames sent to the controller by an AP in a given interval.
<b>Step 4</b>	<b>exit</b> <b>Example:</b> <code>Device(config-ap-profile)# exit</code>	Returns to global configuration mode.
<b>Step 5</b>	<b>wireless hotspot gas-rate-limit</b> <i>gas-requests-to-process</i> <b>Example:</b> <code>Device(config)# wireless hotspot  gas-rate-limit 100</code>	Configures the number of GAS request action frames to be processed by the controller.

## Configuring Global Settings

### Procedure

- 
- Step 1** Choose **Configuration > Wireless > Hotspot/OpenRoaming > Global Settings**.
- Step 2** In the **Gas Rate Limit (Requests per sec)** field, enter the number of GAS request action frames to be processed by the controller.
- Step 3** Go to the **Icons Configuration** area.
- Step 4** Click **Add**.
- The **Add Global Icon** window is displayed.
- Step 5** From the **System Path** drop-down list, choose the path.
- Step 6** In the **Icon Name** field, enter the icon name.
- Step 7** In the **Icon Type** field, enter the icon type.
- Step 8** In the **Language Code** field, enter the language code.
- Step 9** In the **Icon Height** field, enter the icon height.
- Step 10** In the **Icon Width** field, enter the icon width.
- Step 11** Click **Apply to Device**.
- 

## Configuring Advice of Charge

Use the following procedure to configure the advice of charge information for using the SSID of the Network Access Identifier (NAI) realm.

**Procedure**

	<b>Command or Action</b>	<b>Purpose</b>
<b>Step 1</b>	<b>configure terminal</b> <b>Example:</b> Device# configure terminal	Enters global configuration mode.
<b>Step 2</b>	<b>wireless hotspot anqp-server <i>server-name</i></b> <b>Example:</b> Device(config)# wireless hotspot anqp-server my_server	Configures a Hotspot 2.0 ANQP server.
<b>Step 3</b>	<b>advice-charge <i>type</i></b> <b>Example:</b> Device(config-wireless-anqp-server)# advice-charge data	Configures advice of charge for data usage.  Advice of charge provides information on the financial charges for using the SSID of the NAI realm.
<b>Step 4</b>	<b>plan <i>language currency info plan-info-file</i></b> <b>Example:</b> Device(config-anqp-advice-charge)# plan eng eur info bootflash:plan_eng.xml	Configures advice of charge information, which includes language, currency, and plan information.  <b>Note</b> You can configure up to 32 plans.
<b>Step 5</b>	<b>nai-realm <i>nai-realm</i></b> <b>Example:</b> Device(config-anqp-advice-charge)# nai-realm cisco	Configures NAI realm for this advice of charge.  <b>Note</b> You can configure up to 32 realms.

## Configuring Terms and Conditions

**Before you begin**

Define a URL filter list, as shown in the following example:

```
urlfilter list <url-filter-name>
  action permit
  filter-type post-authentication
  url <allow-url>
```

For information on configuring an URL list, see the *Defining URL Filter List* section.

**Procedure**

	<b>Command or Action</b>	<b>Purpose</b>
<b>Step 1</b>	<b>configure terminal</b> <b>Example:</b> Device# configure terminal	Enters global configuration mode.

	Command or Action	Purpose
<b>Step 2</b>	<b>wireless hotspot anqp-server</b> <i>server-name</i> <b>Example:</b> Device(config)# wireless hotspot anqp-server my_server	Configures a Hotspot 2.0 ANQP server.
<b>Step 3</b>	<b>terms-conditions filename</b> <i>file-name</i> <b>Example:</b> Device(config-wireless-anqp-server)# terms-conditions filename xyz-file	Configures the terms and conditions filename for the clients.
<b>Step 4</b>	<b>terms-conditions timestamp</b> <i>date time</i> <b>Example:</b> Device(config-wireless-anqp-server)# terms-conditions timestamp 2020-02-20 20:20:20	Configures the terms and conditions timestamp.
<b>Step 5</b>	<b>terms-conditions urlfilter list</b> <i>url-filter-list</i> <b>Example:</b> Device(config-wireless-anqp-server)# terms-conditions urlfilter list filter-yy	Configures the terms and conditions URL filter list name.

## Defining ACL and URL Filter in AP for FlexConnect

### Procedure

	Command or Action	Purpose
<b>Step 1</b>	<b>configure terminal</b> <b>Example:</b> Device# configure terminal	Enters global configuration mode.
<b>Step 2</b>	<i>sequence-number</i> <b>permit udp any eq bootpc any eq bootps</b> <b>Example:</b> Device(config-ext-nacl)# 10 permit udp any eq bootpc any eq bootps	Defines an extended UDP access list and sets the access conditions to match only the packets on a given port number of bootstrap protocol (BOOTP) clients from any source host to match only the packets on a given port number of the bootstrap protocol (BOOTP) server of a destination host.
<b>Step 3</b>	<i>sequence-number</i> <b>permit udp any eq bootps any eq bootpc</b> <b>Example:</b> Device(config-ext-nacl)# 20 permit udp any eq bootps any eq bootpc	Defines an extended UDP access list to forward packets and sets the access conditions to match only the packets on a given port number of bootstrap protocol (BOOTP) server from any source host to match only the packets of a given port number of the bootstrap protocol (BOOTP) clients of a destination host.



	Command or Action	Purpose
<b>Step 4</b>	<b><i>sequence-number</i> permit udp any eq domain any eq domain</b> <b>Example:</b> Device(config-ext-nacl)# 30 permit udp any eq domain any eq domain	Defines an extended UDP access list to forward packets and sets the access conditions to match a destination host Domain Name Service (DNS) with only the packets from a given port number of the source DNS.
<b>Step 5</b>	<b><i>sequence-number</i> permit ip any host dest-address</b> <b>Example:</b> Device(config-ext-nacl)# 40 permit ip any host 10.10.10.8	Defines an extended IP access list to forward packets from a source host to a single destination host.
<b>Step 6</b>	<b><i>sequence-number</i> permit ip host dest-address any</b> <b>Example:</b> Device(config-ext-nacl)# 50 permit ip host 10.10.10.8 any	Defines an extended IP access list to forward packets from a single source host to a destination host.
<b>Step 7</b>	<b>exit</b> <b>Example:</b> Device(config-ext-nacl)# exit	Returns to global configuration mode.
<b>Step 8</b>	<b>wireless profile flex flex-profile-name</b> <b>Example:</b> Device(config)# wireless profile flex test-flex-profile	Configures a new FlexConnect policy and enters wireless flex profile configuration mode.
<b>Step 9</b>	<b>acl-policy acl-policy-name</b> <b>Example:</b> Device(config-wireless-flex-profile)# acl-policy acl_name	Configures an ACL policy.
<b>Step 10</b>	<b>urlfilter list url-filter-name</b> <b>Example:</b> Device(config-wireless-flex-profile)# urlfilter list urllist_flex	Applies the URL filter list to the FlexConnect profile.
<b>Step 11</b>	<b>vlan-name prod-vlanID</b> <b>Example:</b> Device(config-wireless-flex-profile)# vlan-name test-vlan	Configures a production VLAN.  Ensure that <b>filter-type post-authentication</b> configuration is in place for the URL filter to work. For information on configuring URL filter list, see the <i>Defining URL Filter List</i> section of the chapter DNS-Based Access Control Lists.
<b>Step 12</b>	<b>vlan-id prod-vlanID</b> <b>Example:</b>	Creates a new production VLAN ID.

	Command or Action	Purpose
	Device(config-wireless-flex-profile-vlan)# vlan-id 10	
<b>Step 13</b>	<b>vlan-name</b> <i>OSU-vlanID</i> <b>Example:</b> vlan-name test-vlan	Configures an OSU VLAN.
<b>Step 14</b>	<b>vlan-id</b> <i>OSU-vlanID</i> <b>Example:</b> vlan-id 20	Creates an OSU VLAN ID.

## Configuring an OSEN WLAN (Single SSID)

### Procedure

	Command or Action	Purpose
<b>Step 1</b>	<b>configure terminal</b> <b>Example:</b> Device# configure terminal	Enters global configuration mode.
<b>Step 2</b>	<b>wlan</b> <i>wlan-name wlan-id ssid</i> <b>Example:</b> Device(config)# wlan hs2 1 hs2	Configures a WLAN and enters WLAN configuration mode.
<b>Step 3</b>	<b>no security ft over-the-ds</b> <b>Example:</b> Device(config-wlan)# no security ft over-the-ds	Disables fast transition over the data source on the WLAN.
<b>Step 4</b>	<b>no security ft adaptive</b> <b>Example:</b> Device(config-wlan)# no security ft adaptive	Disables adaptive 11r.
<b>Step 5</b>	<b>security wpa wpa2</b> <b>Example:</b> Device(config-wlan)# security wpa wpa2	Enables WPA2 security.
<b>Step 6</b>	<b>security wpa wpa2 ciphers aes</b> <b>Example:</b> Device(config-wlan)# security wpa wpa2 ciphers aes	Enables WPA2 ciphers for AES.
<b>Step 7</b>	<b>security wpa osen</b> <b>Example:</b>	Enables WPA OSEN security support.

	Command or Action	Purpose
	<code>Device(config-wlan)# security wpa osen</code>	
<b>Step 8</b>	<b>no shutdown</b> <b>Example:</b> <code>Device(config-wlan)# no shutdown</code>	Enables the WLAN.
<b>Step 9</b>	<b>exit</b> <b>Example:</b> <code>Device(config-wlan)# exit</code>	Returns to global configuration mode.
<b>Step 10</b>	<b>wireless profile policy <i>policy-profile-name</i> <i>ssid</i></b> <b>Example:</b> <code>Device(config)# wireless profile policy policy-hotspot</code>	Configures a policy profile.
<b>Step 11</b>	<b>hotspot anqp-server <i>server-name</i></b> <b>Example:</b> <code>Device(config-wireless-policy)# hotspot anqp-server my-server</code>	Attaches the Hotspot 2.0 ANQP server to the policy profile.
<b>Step 12</b>	<b>vlan <i>vlan</i> encryption osen</b> <b>Example:</b> <code>Device(config-wireless-policy)# vlan 10 encryption osen</code>	Configures the VLAN ID with OSEN encryption for single SSID.

## Verifying Hotspot 2.0 Configuration

Use the following **show** commands to verify the quality of service (QoS) and AP GAS rate limit.

To view whether a QoS map ID is user configured or the default one, use the following command:

```
Device# show ap profile <profile name> detailed
```

```
QoS Map                : user-configured
```

To view the QoS map values used and their source, use the following command:

```
Device# show ap profile <profile name> qos-map
```

```
QoS Map                : default
DSCP ranges to User Priorities
  User Priority   DSCP low   DSCP high   Upstream UP to DSCP
-----
                0           0           7           0
                2           16          23          10
                3           24          31          18
                4           32          39          26
                5           40          47          34
                6           48          55          46
                7           56          63          48
```

```
DSCP to UP mapping exceptions
```

DSCP	User Priority
0	0
2	1
4	1
6	1
10	2
12	2
14	2
18	3
20	3
22	3

To view the AP rate limiter configuration, use the following command:

```
Device# show ap name AP0462.73e8.f2c0 config general | i GAS

GAS rate limit Admin status           : Enabled
Number of GAS request per interval    : 30
GAS rate limit interval (msec)        : 100
```

## Verifying Client Details

To verify the wireless-specific configuration of active clients based on their MAC address, use the following command:

```
Device# show wireless client mac 001e.f64c.1eff detail
.
.
.
Hotspot version : Hotspot 2.0 Release 2
Hotspot PPS MO ID :
Hotspot Terms and Conditions URL :
http://host1.ciscohspot.com/terms.php?addr=b8:27:eb:5a:dc:39&ap=123
.
.
.
Policy Type : OSEN (within RSN)
Resultant Policies:
  VLAN Name      : VLAN0010
  VLAN           : 10
```



## CHAPTER 189

# Client Roaming Across Policy Profile

- [Information about Client Roaming Policy Profile, on page 1867](#)
- [Configuring Client Roaming Across Policy Profile, on page 1868](#)
- [Verifying Client Roaming Across Policy Profiles, on page 1869](#)

## Information about Client Roaming Policy Profile

In Cisco Catalyst 9800 Series Wireless controller, each WLAN must be associated to a policy profile using a policy tag. Since the policy profile represent the policy defined by the administrator, the general rule is that the controller will not allow seamless roaming between same WLAN associated with different policy profile. The client will be disconnected hence disrupting seamless roaming and client will be required to join again and the new policy can be evaluated and implemented.

When you enable roaming across policy profile, if the two policy profiles differ only in the settings as listed, then client seamless roaming is allowed to same wlan associated to different policy profiles.

A typical use case is when clients roaming across two APs that belong to different policy tag and have WLAN associated with different policy profiles with different VLAN setting for each policy profile. If roaming across policy profile is enabled, the controller allows seamless roaming to another policy profile even if the VLAN is different and the client retains the original IP address. The controller applies all other attributes except VLAN from the new policy profile to which client has joined.

Client roaming across policy profiles is not allowed if there are different policy profile configurations. However; the following are the exceptions:

- Accounting list
- CTS
- DHCP-TLV-caching
- Dot11 5 Ghz airtime-fairness
- Dot11 24 Ghz airtime-fairness
- ET-analytics enable
- http-TLV-caching
- Idle-threshold
- Idle-timeout

- MDnS-SD service policy
- IPv4 ACL
- IPv6 ACL
- QBSS load
- RADIUS profiling
- Session timeout
- SIP CAC disassociation client
- SIP CAC send-486busy
- VLAN

You must execute the configuration in the global configuration mode. When a client roam across policy profile is attempted, the roam is either a success or a failure. However; the total roam across policy profiles counter under client global statistics section increments. But when the roam across policy profile is denied then roam across policy profile deny delete reason counter is incremented.



**Note** This feature is not supported on fabric and on Cisco 9800 FlexConnect.

The following is an example in which case a client roams across policy profiles PP1 and PP2 will be denied.

```
wireless profile policy PP1
vlan 42
no shutdown
wireless profile policy PP2
aaa-override
vlan 43
no shutdown
```

## Configuring Client Roaming Across Policy Profile

### Procedure

	Command or Action	Purpose
<b>Step 1</b>	<b>configure terminal</b> <b>Example:</b> Device# configure terminal	Enables configuration mode
<b>Step 2</b>	<b>wireless client vlan-persistent</b> <b>Example:</b> Device(config) # wireless client vlan-persistent	Enables client roaming across different policy profiles.
<b>Step 3</b>	<b>end</b> <b>Example:</b>	Ends the session.

	Command or Action	Purpose
	Device(config) # end	

## Verifying Client Roaming Across Policy Profiles

The following shows the client roaming from policy profile PP1 configured with VLAN 42 to policy profile PP2 configured with VLAN 43.

The following is the sample output of the **show wireless client mac-address xxxx.xxxx.xxxx detail** command that shows the client is connected to policy profile PP1.

```

Device#show wireless client mac-address xxxx.xxxx.xxxx detail

Client MAC Address : xxxx.xxxx.xxxx
Client MAC Type : Universally Administered Address
Client IPv4 Address : 169.254.189.170
Client Username : cisco
AP MAC Address : xxxx.xxxx.xxxx
AP Name: vinks_ios
AP slot : 1
Client State : Associated
Policy Profile : PP1
Flex Profile : N/A
Wireless LAN Id: 3
WLAN Profile Name: prateekk_dotlx
Wireless LAN Network Name (SSID): prateekk_dotlx
BSSID : 0081.c4f6.6bfb
Connected For : 688 seconds
Protocol : 802.11ac
Channel : 161
Client IIF-ID : 0xa0000001
Association Id : 1
Authentication Algorithm : Open System
Idle state timeout : N/A
Re-Authentication Timeout : 1800 sec (Remaining time: 1112 sec)
Session Warning Time : Timer not running
Input Policy Name : client-default
Input Policy State : Installed
Input Policy Source : QOS Internal Policy
Output Policy Name : client-default
Output Policy State : Installed
Output Policy Source : QOS Internal Policy
WMM Support : Enabled
U-APSD Support : Enabled
  U-APSD value : 0
  APSD ACs : BK, BE, VI, VO
Fastlane Support : Disabled
Client Active State : Active
Power Save : OFF
Current Rate : m8 ssl
Supported Rates : 9.0,18.0,36.0,48.0,54.0
Mobility:
  Move Count : 0
  Mobility Role : Local
  Mobility Roam Type : None
  Mobility Complete Timestamp : 07/13/2020 02:00:22 UTC
Client Join Time:
  Join Time Of Client : 07/13/2020 02:00:22 UTC
Client State Servers : None

```

```

Client ACLs : None
Policy Manager State: Run
Last Policy Manager State : IP Learn Complete
Client Entry Create Time : 688 seconds
Policy Type : WPA2
Encryption Cipher : CCMP (AES)
Authentication Key Management : 802.1x
User Defined (Private) Network : Disabled
User Defined (Private) Network Drop Unicast : Disabled
Encrypted Traffic Analytics : No
Protected Management Frame - 802.11w : No
EAP Type : EAP-FAST
VLAN Override after Webauth : No
VLAN : 42
Multicast VLAN : 0
WiFi Direct Capabilities:
  WiFi Direct Capable          : No
Central NAT : DISABLED
Session Manager:
  Point of Attachment : capwap_90400006
  IIF ID               : 0x90400006
  Authorized           : TRUE
  Session timeout      : 1800
Common Session ID: 3C2A09090000000E45E6D59E
Acct Session ID : 0x00000000
Last Tried Aaa Server Details:
  Server IP : 9.10.8.247
Auth Method Status List
  Method : Dot1x
  SM State      : AUTHENTICATED
  SM Bend State : IDLE
Local Policies:
  Service Template : wlan_svc_PP1_local (priority 254)
  VLAN              : 42
  Absolute-Timer    : 1800
Server Policies:
Resultant Policies:
  VLAN Name      : VLAN0042
  VLAN          : 42
  Absolute-Timer : 1800
DNS Snooped IPv4 Addresses : None
DNS Snooped IPv6 Addresses : None
Client Capabilities
  CF Pollable : Not implemented
  CF Poll Request : Not implemented
  Short Preamble : Not implemented
  PBCC : Not implemented
  Channel Agility : Not implemented
  Listen Interval : 0
Fast BSS Transition Details :
  Reassociation Timeout : 0
11v BSS Transition : Not implemented
11v DMS Capable : No
QoS Map Capable : No
FlexConnect Data Switching : N/A
FlexConnect Dhcp Status : N/A
FlexConnect Authentication : N/A
FlexConnect Central Association : N/A
Client Statistics:
  Number of Bytes Received from Client : 19442
  Number of Bytes Sent to Client : 3863
  Number of Packets Received from Client : 197
  Number of Packets Sent to Client : 36
  Number of Policy Errors : 0

```



```

Radio Signal Strength Indicator : -39 dBm
Signal to Noise Ratio : 55 dB
Fabric status : Disabled
Radio Measurement Enabled Capabilities
  Capabilities: None
Client Scan Report Time : Timer not running
Client Scan Reports
Assisted Roaming Neighbor List
Nearby AP Statistics:
EoGRE : Pending Classification
Device Type      : Apple-Device
Device Name      : APPLE, INC.
Protocol Map     : 0x000001 (OUI)
Max Client Protocol Capability: 802.11ac Wave 2
Cellular Capability : N/A
Apple Specific Requests(ASR) Capabilities/Statistics Summary
  Regular ASR support: : DISABLED

```

The following is the sample output of the **show wireless client mac-address xxxx.xxxx.xxxx detail** command after client has roamed to a policy profile PP2.

```

Client MAC Address : xxxx.xxxx.xxxx
Client MAC Type : Universally Administered Address
Client IPv4 Address : 9.9.42.236
Client Username : cisco
AP MAC Address : xxxx.xxxx.xxxx
AP Name: prateekk_cos_1
AP slot : 1
Client State : Associated
Policy Profile : PP2
Flex Profile : N/A
Wireless LAN Id: 3
WLAN Profile Name: prateekk_dot1x
Wireless LAN Network Name (SSID): prateekk_dot1x
BSSID : a0f8.4985.0029
Connected For : 11 seconds
Protocol : 802.11ac
Channel : 36
Client IIF-ID : 0xa0000001
Association Id : 1
Authentication Algorithm : Open System
Idle state timeout : N/A
Re-Authentication Timeout : 1800 sec (Remaining time: 1789 sec)
Session Warning Time : Timer not running
Input Policy Name : client-default
Input Policy State : Installed
Input Policy Source : QOS Internal Policy
Output Policy Name : client-default
Output Policy State : Installed
Output Policy Source : QOS Internal Policy
WMM Support : Enabled
U-APSD Support : Enabled
  U-APSD value : 0
  APSD ACs      : BK, BE, VI, VO
Fastlane Support : Disabled
Client Active State : Active
Power Save : OFF
Current Rate : m9 ss3
Supported Rates : 9.0,18.0,36.0,48.0,54.0
Mobility:
  Move Count          : 0
  Mobility Role       : Local
  Mobility Roam Type  : L2
  Mobility Complete Timestamp : 07/13/2020 02:12:19 UTC

```

```

Client Join Time:
  Join Time Of Client : 07/13/2020 02:12:19 UTC
Client State Servers : None
Client ACLs : None
Policy Manager State: Run
Last Policy Manager State : IP Learn Complete
Client Entry Create Time : 728 seconds
Policy Type : WPA2
Encryption Cipher : CCMP (AES)
Authentication Key Management : 802.1x
User Defined (Private) Network : Disabled
User Defined (Private) Network Drop Unicast : Disabled
Encrypted Traffic Analytics : No
Protected Management Frame - 802.11w : No
EAP Type : EAP-FAST
VLAN Override after Webauth : No
VLAN : 43
Multicast VLAN : 0
WiFi Direct Capabilities:
  WiFi Direct Capable : No
Central NAT : DISABLED
Session Manager:
  Point of Attachment : capwap_90000005
  IIF ID : 0x90000005
  Authorized : TRUE
  Session timeout : 1800
Common Session ID: 3C2A09090000000E45E6D59E
  Acct Session ID : 0x00000000
  Last Tried Aaa Server Details:
    Server IP : 9.10.8.247
  Auth Method Status List
    Method : Dot1x
      SM State : AUTHENTICATED
      SM Bend State : IDLE
  Local Policies:
    Service Template : vlan-42-template (priority 200)
      VLAN : 42
    Service Template : wlan_svc_PP2_local (priority 254)
      Absolute-Timer : 1800
  Server Policies:
  Resultant Policies:
    VLAN Name : VLAN0042
    VLAN : 42
    Absolute-Timer : 1800
  DNS Snooped IPv4 Addresses : None
  DNS Snooped IPv6 Addresses : None
  Client Capabilities
    CF Pollable : Not implemented
    CF Poll Request : Not implemented
    Short Preamble : Not implemented
    PBCC : Not implemented
    Channel Agility : Not implemented
    Listen Interval : 0
  Fast BSS Transition Details :
    Reassociation Timeout : 0
  11v BSS Transition : Not implemented
  11v DMS Capable : No
  QoS Map Capable : No
  FlexConnect Data Switching : N/A
  FlexConnect Dhcp Status : N/A
  FlexConnect Authentication : N/A
  FlexConnect Central Association : N/A
  Client Statistics:
    Number of Bytes Received from Client : 23551

```

```
Number of Bytes Sent to Client : 12588
Number of Packets Received from Client : 239
Number of Packets Sent to Client : 71
Number of Policy Errors : 0
Radio Signal Strength Indicator : -28 dBm
Signal to Noise Ratio : 60 dB
Fabric status : Disabled
Radio Measurement Enabled Capabilities
  Capabilities: None
Client Scan Report Time : Timer not running
Client Scan Reports
Assisted Roaming Neighbor List
Nearby AP Statistics:
  prateekk_cos_1 (slot 1)
    antenna 0: 13 s ago ..... -25 dBm
    antenna 1: 13 s ago ..... -25 dBm
EoGRE : No/Simple client
Device Type      : Apple-Device
Device Name     : APPLE, INC.
Protocol Map    : 0x000001 (OUI)
Protocol       : DHCP
Type          : 0 0
Data         : 00

Max Client Protocol Capability: 802.11ac Wave 2
Cellular Capability : N/A
Apple Specific Requests(ASR) Capabilities/Statistics Summary
  Regular ASR support: : DISABLED
```

The following is the sample output of the **show wireless stats client detail** command that displays that client roam across policy profile is attempted and roam across policy is not denied.

```
Device #show wireless stats client detail | in Roam
Total Roam Across Policy Profiles : 1
Roam across policy profile deny : 0
```





## CHAPTER 190

# Assisted Roaming

---

- [802.11k Neighbor List and Assisted Roaming, on page 1875](#)
- [Restrictions for Assisted Roaming, on page 1876](#)
- [How to Configure Assisted Roaming, on page 1876](#)
- [Verifying Assisted Roaming, on page 1878](#)
- [Configuration Examples for Assisted Roaming, on page 1878](#)

## 802.11k Neighbor List and Assisted Roaming

The 802.11k standard allows an AP to inform 802.11k-capable clients of neighboring BSSIDs (APs in the same SSID). This can help the client to optimize its scanning and roaming behavior. Additionally, the Assisted Roaming Prediction Optimization feature can be used with non-802.11k clients, to discourage them from roaming to suboptimal APs.



---

**Note** We recommend not configuring two SSIDs with the same name in the controller, which may cause roaming issues.

---

### Prediction Based Roaming - Assisted Roaming for Non-802.11k Clients

You can optimize roaming for non-802.11k clients by generating a prediction neighbor list for each client without sending an 802.11k neighbor list request. When prediction based roaming enables a WLAN, after each successful client association/re-association, the same neighbor list optimization applies on the non-802.11k client to generate and store the neighbor list in the mobile station software data structure. Clients at different locations have different lists because the client probes are seen with different RSSI values by the different neighbors as the clients usually probe before any association or re-association. This list is created with the most updated probe data and predicts the next AP that the client is likely to roam to.

The wireless infrastructure discourages clients from roaming to those less desirable neighbors by denying association if the association request to an AP does not match the entries on the stored prediction neighbor list.

- Denial count: Maximum number of times a client is refused association.
- Prediction threshold: Minimum number of entries required in the prediction list for the assisted roaming feature to activate.

For more information, see [https://www.cisco.com/c/en/us/td/docs/wireless/controller/8-5/Enterprise-Mobility-8-5-Design-Guide/Enterprise\\_Mobility\\_8-5\\_Deployment\\_Guide/Chapter-11.html#pgfld-1140097](https://www.cisco.com/c/en/us/td/docs/wireless/controller/8-5/Enterprise-Mobility-8-5-Design-Guide/Enterprise_Mobility_8-5_Deployment_Guide/Chapter-11.html#pgfld-1140097).

## Restrictions for Assisted Roaming

- This feature is supported only on 802.11n capable indoor access points. For a single band configuration, a maximum of 6 neighbors are visible in a neighbor list. For dual band configuration, a maximum of 12 neighbors are visible.
- You can configure assisted roaming only using the device CLI.

## How to Configure Assisted Roaming

### Configuring Assisted Roaming (GUI)

Assisted roaming allows clients to request neighbor reports containing information about known neighbor access points that are candidates for a service set transition.

#### Before you begin

Ensure that you have configured an AP Join Profile prior to configuring the primary and backup controllers.

#### Procedure

- 
- Step 1** Choose **Configuration** > **Tags & Profiles** > **WLAN** and click **Add** to add a WLAN or select an existing WLAN.
  - Step 2** On the **Advanced** tab, go to the **Assisted Roaming (11K)** and select the **Prediction Optimization** checkbox to optimize roaming for non 802.11k clients by generating a prediction neighbor list for each client without sending an 802.11k neighbor list request.
  - Step 3** Select the **Neighbor List** checkbox to optimize roaming for 802.11K clients by generating a neighbor list for each client without sending an 802.11k neighbor list request. By default, the neighbor list contains only neighbors in the same band with which the client is associated. However, if you select the **Dual Band Neighbor List** checkbox, it allows 802.11k to return neighbors in both bands.
  - Step 4** Click **Apply to Device**.
-

## Configuring Assisted Roaming (CLI)

### Procedure

	Command or Action	Purpose
<b>Step 1</b>	<b>configure terminal</b> <b>Example:</b> Device# <code>configure terminal</code>	Enters global configuration mode.
<b>Step 2</b>	<b>wireless assisted-roaming floor-bias dBm</b> <b>Example:</b> Device(config)# <code>wireless assisted-roaming floor-bias 20</code>	Configures neighbor floor label bias. The valid range is from 5 to 25 dBm, and the default value is 15 dBm.
<b>Step 3</b>	<b>wlan wlan-id</b> <b>Example:</b> Device(config)# <code>wlan wlan1</code>	Enters the WLAN configuration submode. The <i>wlan-name</i> is the profile name of the configured WLAN.
<b>Step 4</b>	<b>assisted-roaming neighbor-list</b> <b>Example:</b> Device(wlan)# <code>assisted-roaming neighbor-list</code>	Configures an 802.11k neighbor list for a WLAN. By default, assisted roaming is enabled on the neighbor list when you create a WLAN. The <b>no</b> form of the command disables assisted roaming neighbor list.
<b>Step 5</b>	<b>assisted-roaming dual-list</b> <b>Example:</b> Device(wlan)# <code>assisted-roaming dual-list</code>	Configures a dual-band 802.11k dual list for a WLAN. By default, assisted roaming is enabled on the dual list when you create a WLAN. The <b>no</b> form of the command disables assisted roaming dual list.
<b>Step 6</b>	<b>assisted-roaming prediction</b> <b>Example:</b> Device(wlan)# <code>assisted-roaming prediction</code>	Configures assisted roaming prediction list feature for a WLAN. By default, the assisted roaming prediction list is disabled. <b>Note</b> A warning message is displayed and load balancing is disabled for the WLAN if load balancing is already enabled for the WLAN.
<b>Step 7</b>	<b>wireless assisted-roaming prediction-minimum count</b> <b>Example:</b> Device# <code>wireless assisted-roaming prediction-minimum</code>	Configures the minimum number of predicted APs required for the prediction list feature to be activated. The default value is 3. <b>Note</b> If the number of the AP in the prediction assigned to the client is less than the number that you specify, the assisted roaming feature will not apply on this roam.

	Command or Action	Purpose
<b>Step 8</b>	<b>wireless assisted-roaming denial-maximum</b> <i>count</i>  <b>Example:</b> Device# <b>wireless assisted-roaming</b> <b>denial-maximum 8</b>	Configures the maximum number of times a client can be denied association if the association request is sent to an AP does not match any AP on the prediction. The valid range is from 1 to 10, and the default value is 5.
<b>Step 9</b>	<b>end</b>  <b>Example:</b> Device(config)# <b>end</b>	Returns to privileged EXEC mode. Alternatively, you can also press <b>Ctrl-Z</b> to exit global configuration mode.

## Verifying Assisted Roaming

The following command can be used to verify assisted roaming configured on a WLAN:

Command	Description
<b>show wlan id</b> <i>wlan-id</i>	Displays the WLAN parameters on the WLAN.

## Configuration Examples for Assisted Roaming

This example shows how to configure the neighbor floor label bias:

```
Device# configure terminal
Device(config)# wireless assisted-roaming floor-bias 10
Device(config)# end
Device# show wlan id 23
```

This example shows how to disable neighbor list on a specific WLAN:

```
Device# configure terminal
Device(config)# wlan test1
Device(config) (wlan)# no assisted-roaming neighbor-list
Device(config) (wlan)# end
Device# show wlan id 23
```

This example shows how to configure the prediction list on a specific WLAN:

```
Device# configure terminal
Device(config)# wlan test1
Device(config) (wlan)# assisted-roaming prediction
Device(config) (wlan)# end
Device# show wlan id 23
```

This example shows how to configure the prediction list based on assisted roaming prediction threshold and maximum denial count on a specific WLAN:

```
Device# configure terminal
Device(config)# wireless assisted-roaming prediction-minimum 4
```



```
Device(config)# wireless assisted-roaming denial-maximum 4
Device(config)(wlan)# end
Device# show wlan id 23
```





## CHAPTER 191

# 802.11r BSS Fast Transition

- [Information About 802.11r Fast Transition, on page 1881](#)
- [Restrictions for 802.11r Fast Transition, on page 1882](#)
- [Monitoring 802.11r Fast Transition \(CLI\), on page 1883](#)
- [Configuring 802.11r BSS Fast Transition on a Dot1x Security Enabled WLAN \(CLI\), on page 1884](#)
- [Configuring 802.11r Fast Transition in an Open WLAN \(CLI\), on page 1885](#)
- [Configuring 802.11r Fast Transition on a PSK Security–Enabled WLAN \(CLI\), on page 1887](#)
- [Disabling 802.11r Fast Transition \(GUI\), on page 1888](#)
- [Disabling 802.11r Fast Transition \(CLI\), on page 1888](#)

## Information About 802.11r Fast Transition

802.11r, which is the IEEE standard for fast roaming, introduces a new concept of roaming where the initial handshake with a new AP is done even before the corresponding client roams to the target access point. This concept is called Fast Transition. The initial handshake allows a client and the access points to do the Pairwise Transient Key (PTK) calculation in advance. These PTK keys are applied to the client and the access points after the client responds to the reassociation request or responds to the exchange with new target AP.

The FT key hierarchy is designed to allow clients to make fast BSS transitions between APs without requiring reauthentication at every AP. WLAN configuration contains a new Authenticated Key Management (AKM) type called FT (Fast Transition).

### Client Roaming

For a client to move from its current AP to a target AP using the FT protocols, message exchanges are performed using one of the following methods:

- **Over-the-Air**—The client communicates directly with the target AP using IEEE 802.11 authentication with the FT authentication algorithm.
- **Over-the-Distribution System (DS)**—The client communicates with the target AP through the current AP. The communication between the client and the target AP is carried in FT action frames between the client and the current AP and is then sent through the device.

Figure 51: Message Exchanges when Over-the-Air Client Roaming is Configured

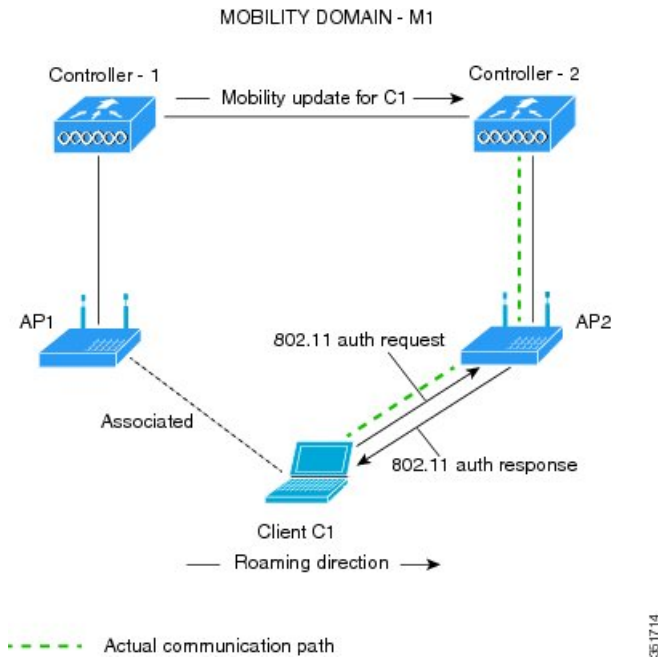
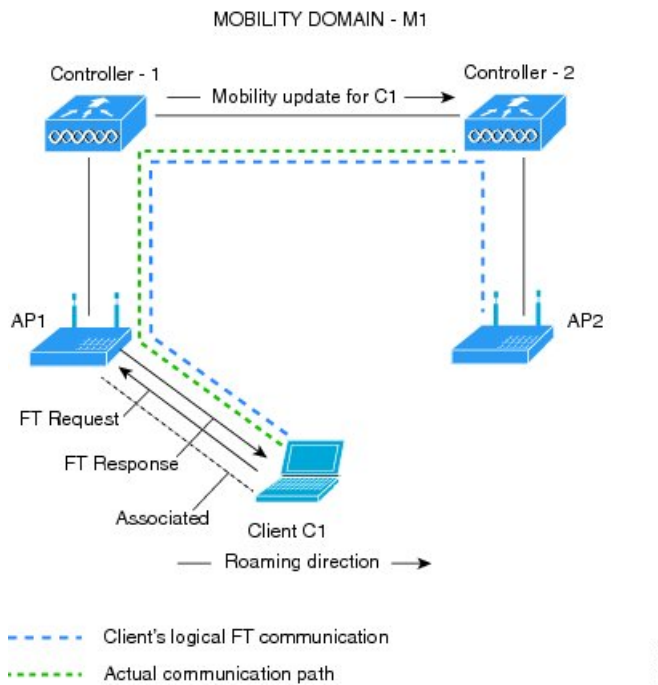

Figure 52: Message Exchanges when Over-the-DS Client Roaming is Configured



## Restrictions for 802.11r Fast Transition

- EAP LEAP method is not supported.

- Traffic Specification (TSPEC) is not supported for 802.11r fast roaming. Therefore, RIC IE handling is not supported.
- If WAN link latency exists, fast roaming is also delayed. Voice or data maximum latency should be verified. The Cisco WLC handles 802.11r Fast Transition authentication requests during roaming for both Over-the-Air and Over-the-DS methods.
- Legacy clients cannot associate with a WLAN that has 802.11r enabled if the driver of the supplicant that is responsible for parsing the Robust Security Network Information Exchange (RSN IE) is old and not aware of the additional AKM suites in the IE. Due to this limitation, clients cannot send association requests to WLANs. These clients, however, can still associate with non-802.11r WLANs. Clients that are 802.11r-capable can associate as 802.11i clients on WLANs that have both 802.11i and 802.11r Authentication Key Management Suites enabled.

The workaround is to enable or upgrade the driver of the legacy clients to work with the new 802.11r AKMs, after which the legacy clients can successfully associate with 802.11r-enabled WLANs.

Another workaround is to have two SSIDs with the same name, but with different security settings (FT and non-FT).

- Fast Transition resource-request protocol is not supported because clients do not support this protocol. Also, the resource-request protocol is an optional protocol.
- To avoid any Denial of Service (DoS) attack, each Cisco WLC allows a maximum of three Fast Transition handshakes with different APs.
- Non-802.11r-capable devices will not be able to associate with FT-enabled WLAN.
- We do not recommend 802.11r FT + PMF.
- We recommend 802.11r FT Over-the-Air roaming for FlexConnect deployments.
- 802.11r ft-over-ds is enabled by default, when a WLAN is created in the controller . In Cisco Wave 2 APs, local switching local authentication with 802.11r is not supported. To make the local switching local authentication work with Cisco Wave 2 APs, explicitly disable 802.11r in WLAN. A sample configuration is given below:

```
wlan local-dot1x 24 local-dot1x
no security ft over-the-ds
no security ft adaptive
security dot1x authentication-list spwifi_dot1x
no shutdown
```

## Monitoring 802.11r Fast Transition (CLI)

The following command can be used to monitor 802.11r Fast Transition:

Command	Description
<code>show wlan name <i>wlan-name</i></code>	Displays a summary of the configured parameters on the WLAN.

Command	Description
<code>show wireless client mac-address mac-address</code>	<p>Displays the summary of the 802.11r authentication key management configuration on a client.</p> <pre> . . . . . . Client Capabilities   CF Pollable : Not implemented   CF Poll Request : Not implemented   Short Preamble : Not implemented   PBCC : Not implemented   Channel Agility : Not implemented   Listen Interval : 15   Fast BSS Transition : Implemented Fast BSS Transition Details : Client Statistics:   Number of Bytes Received : 9019   Number of Bytes Sent : 3765   Number of Packets Received : 130   Number of Packets Sent : 36   Number of EAP Id Request Msg Timeouts : 0   Number of EAP Request Msg Timeouts : 0   Number of EAP Key Msg Timeouts : 0   Number of Data Retries : 1   Number of RTS Retries : 0   Number of Duplicate Received Packets : 1   Number of Decrypt Failed Packets : 0   Number of Mic Failed Packets : 0   Number of Mic Missing Packets : 0   Number of Policy Errors : 0   Radio Signal Strength Indicator : -48 dBm   Signal to Noise Ratio : 40 dB . . . . . . </pre>

## Configuring 802.11r BSS Fast Transition on a Dot1x Security Enabled WLAN (CLI)

### Procedure

	Command or Action	Purpose
<b>Step 1</b>	<b>configure terminal</b> <b>Example:</b> Device# <code>configure terminal</code>	Enters global configuration mode.
<b>Step 2</b>	<b>wlan profile-name</b> <b>Example:</b> Device# <code>wlan test4</code>	Enters WLAN configuration submenu. The <i>profile-name</i> is the profile name of the configured WLAN.

	Command or Action	Purpose
Step 3	<b>client vlan</b> <i>vlan-name</i> <b>Example:</b> Device(config-wlan) # <b>client vlan 0120</b>	Associates the client VLAN to this WLAN.
Step 4	<b>local-auth</b> <i>local-auth-profile-eap</i> <b>Example:</b> Device(config-wlan) # <b>local-auth</b>	Enables the local auth EAP profile.
Step 5	<b>security dot1x authentication-list default</b> <b>Example:</b> Device(config-wlan) # <b>security dot1x authentication-list default</b>	Enables security authentication list for dot1x security. The configuration is similar for all dot1x security WLANs.
Step 6	<b>security ft</b> <b>Example:</b> Device(config-wlan) # <b>security ft</b>	Enables 802.11r Fast Transition on the WLAN.
Step 7	<b>security wpa akm ft dot1x</b> <b>Example:</b> Device(config-wlan) # <b>security wpa akm ft dot1x</b>	Enables 802.1x security on the WLAN.
Step 8	<b>no shutdown</b> <b>Example:</b> Device(config-wlan) # <b>no shutdown</b>	Enables the WLAN.
Step 9	<b>end</b> <b>Example:</b> Device(config-wlan) # <b>end</b>	Returns to privileged EXEC mode. Alternatively, you can also press <b>Ctrl-z</b> to exit global configuration mode

## Configuring 802.11r Fast Transition in an Open WLAN (CLI)

### Procedure

	Command or Action	Purpose
Step 1	<b>configure terminal</b> <b>Example:</b> Device# <b>configure terminal</b>	Enters global configuration mode.
Step 2	<b>wlan</b> <i>profile-name</i> <b>Example:</b> Device# <b>wlan test4</b>	Enters WLAN configuration submenu. The <i>profile-name</i> is the profile name of the configured WLAN.

	Command or Action	Purpose
<b>Step 3</b>	<b>client vlan <i>vlan-id</i></b> <b>Example:</b> Device(config-wlan)# <b>client vlan 0120</b>	Associates the client VLAN to the WLAN.
<b>Step 4</b>	<b>no security wpa</b> <b>Example:</b> Device(config-wlan)# <b>no security wpa</b>	Disables WPA security.
<b>Step 5</b>	<b>no security wpa akm dot1x</b> <b>Example:</b> Device(config-wlan)# <b>no security wpa akm dot1x</b>	Disables security AKM for dot1x.
<b>Step 6</b>	<b>no security wpa wpa2</b> <b>Example:</b> Device(config-wlan)# <b>no security wpa wpa2</b>	Disables WPA2 security.
<b>Step 7</b>	<b>no wpa wpa2 ciphers aes</b> <b>Example:</b> Device(config-wlan)# <b>no security wpa wpa2 ciphers aes</b>	Disables WPA2 ciphers for AES.
<b>Step 8</b>	<b>security ft</b> <b>Example:</b> Device(config-wlan)# <b>security ft</b>	Specifies the 802.11r Fast Transition parameters.
<b>Step 9</b>	<b>no shutdown</b> <b>Example:</b> Device(config-wlan)# <b>shutdown</b>	Shuts down the WLAN.
<b>Step 10</b>	<b>end</b> <b>Example:</b> Device(config-wlan)# <b>end</b>	Returns to privileged EXEC mode. Alternatively, you can also press <b>Ctrl-z</b> to exit global configuration mode



# Configuring 802.11r Fast Transition on a PSK Security–Enabled WLAN (CLI)

## Procedure

	Command or Action	Purpose
Step 1	<b>configure terminal</b> <b>Example:</b> Device# <b>configure terminal</b>	Enters global configuration mode.
Step 2	<b>wlan <i>profile-name</i></b> <b>Example:</b> Device# <b>wlan test4</b>	Enters WLAN configuration submode. The <i>profile-name</i> is the profile name of the configured WLAN.
Step 3	<b>client vlan <i>vlan-name</i></b> <b>Example:</b> Device(config-wlan)# <b>client vlan 0120</b>	Associates the client VLAN to this WLAN.
Step 4	<b>no security wpa akm dot1x</b> <b>Example:</b> Device(config-wlan)# <b>no security wpa akm dot1x</b>	Disables security AKM for dot1x.
Step 5	<b>security wpa akm ft psk</b> <b>Example:</b> Device(config-wlan)# <b>security wpa akm ft psk</b>	Configures Fast Transition PSK support.
Step 6	<b>security wpa akm psk set-key {ascii {0   8}   hex {0   8}}</b> <b>Example:</b> Device(config-wlan)# <b>security wpa akm psk set-key ascii 0 test</b>	Configures PSK AKM shared key.
Step 7	<b>security ft</b> <b>Example:</b> Device(config-wlan)# <b>security ft</b>	Configures 802.11r Fast Transition.
Step 8	<b>no shutdown</b> <b>Example:</b> Device(config-wlan)# <b>no shutdown</b>	Enables the WLAN.

	Command or Action	Purpose
<b>Step 9</b>	<b>end</b>  <b>Example:</b> Device(config-wlan)# <b>end</b>	Returns to privileged EXEC mode. Alternatively, you can also press <b>Ctrl-z</b> to exit global configuration mode

## Disabling 802.11r Fast Transition (GUI)

### Procedure

- 
- Step 1** Choose **Configuration > Tags & Profiles > WLANs**.
  - Step 2** On the **WLANs** page, click the WLAN name.
  - Step 3** In the **Edit WLAN** window, click the **Security > Layer2** tab.
  - Step 4** From the **Fast Transition** drop-down list, choose **Disabled**. Note that you cannot enable or disable Fast Transition, if you have configured an SSID with Open Authentication.
  - Step 5** Click **Update & Apply to Device**.
- 

## Disabling 802.11r Fast Transition (CLI)

### Procedure

	Command or Action	Purpose
<b>Step 1</b>	<b>configure terminal</b>  <b>Example:</b> Device# <b>configure terminal</b>	Enters global configuration mode.
<b>Step 2</b>	<b>wlan <i>profile-name</i></b>  <b>Example:</b> Device# <b>wlan test4</b>	Enters WLAN configuration submode. The <i>profile-name</i> is the profile name of the configured WLAN.
<b>Step 3</b>	<b>no security ft [over-the-ds   reassociation-timeout <i>timeout-in-seconds</i>]</b>  <b>Example:</b> Device(config-wlan)# <b>no security ft over-the-ds</b>	Disables 802.11r Fast Transition on the WLAN.
<b>Step 4</b>	<b>end</b>  <b>Example:</b> Device(config)# <b>end</b>	Returns to privileged EXEC mode. Alternatively, you can also press <b>Ctrl-Z</b> to exit global configuration mode.



## CHAPTER 192

### 802.11v

---

- [Information About 802.11v, on page 1889](#)
- [Prerequisites for Configuring 802.11v, on page 1890](#)
- [Restrictions for 802.11v, on page 1890](#)
- [Enabling 802.11v BSS Transition Management, on page 1890](#)
- [Configuring 802.11v BSS Transition Management \(GUI\), on page 1891](#)
- [Configuring 802.11v BSS Transition Management \(CLI\), on page 1891](#)

## Information About 802.11v

The controller supports 802.11v amendment for wireless networks, which describes numerous enhancements to wireless network management.

One such enhancement is Network assisted Power Savings which helps clients to improve the battery life by enabling them to sleep longer. As an example, mobile devices typically use a certain amount of idle period to ensure that they remain connected to access points and therefore consume more power when performing the following tasks while in a wireless network.

Another enhancement is Network assisted Roaming which enables the WLAN to send requests to associated clients, advising the clients as to better APs to associate to. This is useful for both load balancing and in directing poorly connected clients.

## Enabling 802.11v Network Assisted Power Savings

Wireless devices consume battery to maintain their connection to the clients, in several ways:

- By waking up at regular intervals to listen to the access point beacons containing a DTIM, which indicates buffered broadcast or multicast traffic that the access point delivers to the clients.
- By sending null frames to the access points, in the form of keepalive messages— to maintain connection with access points.
- Devices also periodically listen to beacons (even in the absence of DTIM fields) to synchronize their clock to that of the corresponding access point.

All these processes consume battery and this consumption particularly impacts devices (such as Apple), because these devices use a conservative session timeout estimation, and therefore, wake up often to send keepalive messages. The 802.11 standard, without 802.11v, does not include any mechanism for the controller or the access points to communicate to wireless clients about the session timeout for the local client.

To save the power of clients due to the mentioned tasks in wireless network, the following features in the 802.11v standard are used:

- Directed Multicast Service
- Base Station Subsystem (BSS) Max Idle Period

### Directed Multicast Service

Using Directed Multicast Service (DMS), the client requests the access point to transmit the required multicast packet as unicast frames. This allows the client to receive the multicast packets it has ignored while in sleep mode and also ensures Layer 2 reliability. Furthermore, the unicast frame is transmitted to the client at a potentially higher wireless link rate which enables the client to receive the packet quickly by enabling the radio for a shorter duration, thus also saving battery power. Since the wireless client also does not have to wake up at each DTIM interval in order to receive multicast traffic, longer sleeping intervals are allowed.

### BSS Max Idle Period

The BSS Max Idle period is the timeframe during which an access point (AP) does not disassociate a client due to nonreceipt of frames from the connected client. This helps ensure that the client device does not send keepalive messages frequently. The idle period timer value is transmitted using the association and reassociation response frame from the access point to the client. The idle time value indicates the maximum time that a client can remain idle without transmitting any frame to an access point. As a result, the clients remain in sleep mode for a longer duration without transmitting the keepalive messages often. This in turn contributes to saving battery power.

## Prerequisites for Configuring 802.11v

- Applies for Apple clients like Apple iPad, iPhone, and so on, that run on Apple iOS version 7 or later.
- Supports local mode; also supports FlexConnect access points in central authentication modes only.

## Restrictions for 802.11v

Client needs to support 802.11v BSS Transition.

## Enabling 802.11v BSS Transition Management

802.11v BSS Transition is applied in the following three scenarios:

- Solicited request—Client can send an 802.11v Basic Service Set (BSS) Transition Management Query before roaming for a better option of AP to reassociate with.
- Unsolicited Load Balancing request—If an AP is heavily loaded, it sends out an 802.11v BSS Transition Management Request to an associated client.
- Unsolicited Optimized Roaming request—If a client's RSSI and rate do not meet the requirements, the corresponding AP sends out an 802.11v BSS Transition Management Request to this client.



**Note** 802.11v BSS Transition Management Request is a suggestion (or advice) given to a client, which the client can choose to follow or ignore. To force the task of disassociating a client, turn on the disassociation-imminent function. This disassociates the client after a period if the client is not reassociated to another AP.

## Configuring 802.11v BSS Transition Management (GUI)

### Procedure

- 
- Step 1** Choose **Configuration > Tags & Profiles > WLANs**.
- Step 2** Click **Add** to create WLANs.  
The **Add WLAN** page is displayed.
- Step 3** In the **Advanced** tab and **11v BSS Transition Support** section, select the **BSS Transition** check box to enable BSS transition per WLAN.
- Step 4** Enable the **Dual Neighbor List** check box to include the neighbors of other radio slots of the same AP in the BSS transition response.  
**Note** This is applicable only for 2.4 GHz and 5 GHz radio slots.
- Step 5** Enable the **BSS Max Idle Service** check box to help clients and APs efficiently decide how long to remain associated when no traffic is being transmitted. The device uses this information to preserve device battery life.
- Step 6** Enable the **BSS Max Idle Protected** check box to enable the AP to accept only authenticated frames (encrypted with Robust Security Network (RSN) information) from the client to reset the BSS Max Idle period counter. Without protected mode, any data or management frame (encrypted or unencrypted) sent by the client will reset the idle timer for the client.
- Step 7** Enable the **Directed Multicast Service** check box to request the AP to send a multicast stream as unicast, to any DMS capable client on this WLAN.
- Step 8** Click **Save & Apply to Device**.
- 

## Configuring 802.11v BSS Transition Management (CLI)

802.11v BSS Transition is applied in the following three scenarios:

### Procedure

	Command or Action	Purpose
<b>Step 1</b>	<b>configure terminal</b>  <b>Example:</b> Device# configure terminal	Enters the global configuration mode.

	<b>Command or Action</b>	<b>Purpose</b>
<b>Step 2</b>	<b>wlan <i>profile-name</i></b> <b>Example:</b> Device(config)# wlan test-wlan	Configures WLAN profile and enters the WLAN profile configuration mode.
<b>Step 3</b>	<b>shut</b> <b>Example:</b> Device(config-wlan)# shut	Shutdown the WLAN profile.
<b>Step 4</b>	<b>bss-transition</b> <b>Example:</b> Device(config-wlan)# bss-transition	Configure BSS transition per WLAN.
<b>Step 5</b>	<b>bss-transition disassociation-imminent</b> <b>Example:</b> Device(config-wlan)# bss-transition disassociation-imminent	Configure BSS transition disassociation Imminent per WLAN.
<b>Step 6</b>	<b>no shutdown</b> <b>Example:</b> Device(config-wlan)# no shutdown	Enables the WLAN profile.
<b>Step 7</b>	<b>end</b> <b>Example:</b> Device(config-wlan)# end	Return to privilege EXEC mode. Alternatively, you can press <b>CTRL + Z</b> to exit global configuration mode.



## PART XVIII

### Cisco DNA Service for Bonjour

- [Cisco DNA Service for Bonjour Solution Overview](#), on page 1895
- [Configuring Local and Wide Area Bonjour Domains](#), on page 1907
- [Configuring Local Area Bonjour for Wireless Local Mode](#), on page 1947
- [Configuring Local Area Bonjour for Wireless FlexConnect Mode](#), on page 1967
- [Configuration Example for Local Mode - Wireless and Wired](#), on page 1989
- [Configuration Example for FlexConnect Mode - Wireless and Wired](#), on page 2007







## CHAPTER 193

# Cisco DNA Service for Bonjour Solution Overview

---

- [About the Cisco DNA Service for Bonjour Solution, on page 1895](#)
- [Solution Components, on page 1896](#)
- [Supported Platforms, on page 1897](#)
- [Supported Network Design, on page 1898](#)

## About the Cisco DNA Service for Bonjour Solution

The Apple Bonjour protocol is a zero-configuration solution that simplifies rich services and enables intuitive experience between connected devices, services, and applications. Using Bonjour, you can discover and use IT-managed, peer-to-peer, audio and video, or Internet of Things (IoT) services with minimal intervention and technical knowledge. Bonjour is originally designed for single Layer 2 small to mid-size networks, such as home or branch networks. The Cisco DNA Service for Bonjour solution eliminates the single Layer 2 domain constraint and expands the matrix to enterprise-grade traditional wired and wireless networks, including overlay networks such as Cisco Software-Defined Access (SD-Access) and industry-standard BGP EVPN with VXLAN. The Cisco Catalyst 9000 Series LAN switches, Cisco Nexus 9300 Series Switches, and Cisco Catalyst 9800 Series Wireless Controller follow the industry standard, RFC 6762-based multicast DNS (mDNS) specification to support interoperability with various compatible wired and wireless consumer products in enterprise networks.

The Cisco Wide Area Bonjour application on Catalyst Center enables mDNS service routing to advertise and discover services across enterprise-grade wired and wireless networks. The new-distributed architecture is designed to eliminate mDNS flood boundaries and transition to unicast-based service routing, providing policy enforcement points and enabling the management of Bonjour services.

The following figure illustrates how the Cisco Wide Area Bonjour application operates across two integrated service-routing domains.

Figure 53: Cisco Wide Area Bonjour Solution Architecture

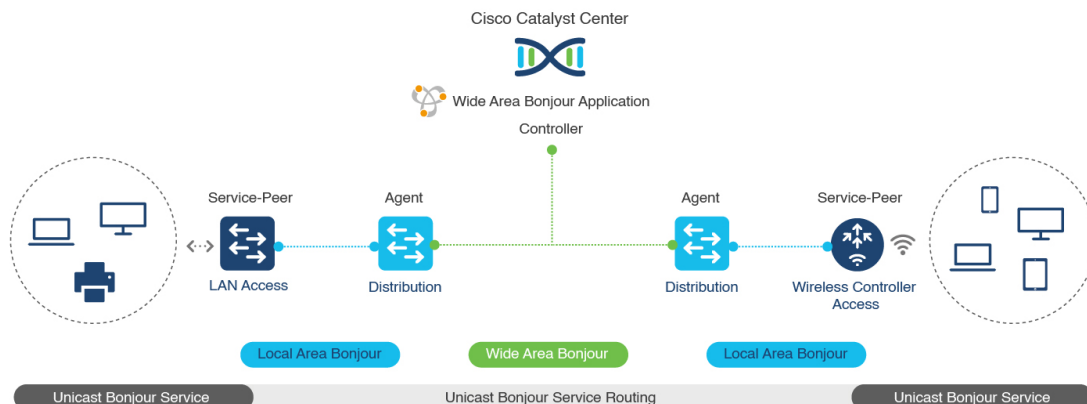

- Local Area Service Discovery Gateway Domain - Unicast Mode:** The new enhanced Layer 2 unicast policy-based deployment model. The new mDNS service discovery and distribution using the Layer 2 unicast address enables flood-free LAN and wireless networks. Cisco Catalyst 9000 Series Switches and Cisco Catalyst 9800 Series Wireless Controller in Layer 2 mode introduce a new service-peer role, replacing the classic flood-n-learn, for new unicast-based service routing support in the network. The service-peer switch and wireless controller also replace mDNS flood-n-learn with unicast-based communication with any RFC 6762 mDNS-compatible wired and wireless endpoints.
- Wide-Area Service Discovery Gateway Domain:** The Wide Area Bonjour domain is a controller-based solution. The Bonjour gateway role and responsibilities of Cisco Catalyst and Cisco Nexus 9300 Series Switches are extended from a single SDG switch to an SDG agent, enabling Wide Area Bonjour service routing beyond a single IP gateway. The network-wide distributed SDG agent devices establish a lightweight, stateful, and reliable communication channel with a centralized Catalyst Center controller running the Cisco Wide Area Bonjour application. The SDG agents route locally discovered services based on the export policy.



**Note** The classic Layer 2 multicast flood-n-learn continues to be supported on wired and wireless networks with certain restrictions to support enhanced security and location-based policy enforcement. The Cisco Catalyst and Cisco Nexus 9300 Series Switches at Layer 3 boundary function as an SDG to discover and distribute services between local wired or wireless VLANs based on applied policies.

## Solution Components

The Cisco DNA Service for Bonjour solution is an end-to-end solution that includes the following key components and system roles to enable unicast-based service routing across the local area and Wide Area Bonjour domain:

- Cisco Service Peer:** Cisco Catalyst Switches and Cisco Wireless Controllers in Layer 2 access function in service peer mode to support unicast-based communication with local attached endpoints and export service information to the upstream Cisco Catalyst SDG agent in the distribution layer.



**Note** Cisco Nexus 9300 Series Switches don't support unicast-based service routing with downstream Layer 2 access network devices.

- **Cisco SDG Agent:** Cisco Catalyst and Cisco Nexus 9300 Series Switches function as an SDG agent and communicate with the Bonjour service endpoints in Layer 3 access mode. At the distribution layer, the SDG agent aggregates information from the downstream Cisco service peer switch and wireless controller, or local Layer 2 networks, and exports information to the central Catalyst Center controller.



**Note** Cisco Nexus 9300 Series Switches don't support multilayer LAN-unicast deployment mode.

- **Catalyst Center controller:** The Catalyst Center controller builds the Wide Area Bonjour domain with network-wide and distributed trusted SDG agents using a secure communication channel for centralized services management and controlled service routing.
- **Endpoints:** A Bonjour endpoint is any device that advertises or queries Bonjour services conforming to RFC 6762. The Bonjour endpoints can be in either LANs or WLANs. The Cisco Wide Area Bonjour application is designed to integrate with RFC 6762-compliant Bonjour services, including AirPlay, Google Chrome cast, AirPrint, and so on.

## Supported Platforms

The following table lists the supported controllers, along with the supported hardware and software versions.

*Table 97: Supported Controllers with Supported Hardware and Software Versions*

Supported Controller	Hardware	Software Version
Catalyst Center appliance	DN2-HW-APL DN2-HW-APL-L DN2-HW-APL-XL	Catalyst Center, Release 2.3.6
Cisco Wide Area Bonjour application	—	2.4.660.75403

The following table lists the supported SDG agents along with their licenses and software requirements.

*Table 98: Supported SDG Agents with Supported License and Software Requirements*

Supported Platform	Supported Role	Local Area SDG	Wide Area SDG	Minimum Software
Cisco Catalyst 9200 Series Switches	SDG agent Service peer	Cisco DNA Advantage	Cisco DNA Advantage	Cisco IOS XE Release 17.11.1

Supported Platform	Supported Role	Local Area SDG	Wide Area SDG	Minimum Software
Cisco Catalyst 9200L Series Switches	SDG agent Service peer	Cisco DNA Advantage	Cisco DNA Advantage	Cisco IOS XE Release 17.11.1
Cisco Catalyst 9300 and 9300-X Series Switches	Service peer SDG agent	Cisco DNA Advantage	Cisco DNA Advantage	Cisco IOS XE Release 17.11.1
Cisco Catalyst 9400 and 9400-X Series Switches	Service peer SDG agent	Cisco DNA Advantage	Cisco DNA Advantage	Cisco IOS XE Release 17.11.1
Cisco Catalyst 9500 and 9500-X Series Switches	Service peer SDG agent	Cisco DNA Advantage	Cisco DNA Advantage	Cisco IOS XE Release 17.11.1
Cisco Catalyst 9500 High Performance Series Switches	Service peer SDG agent	Cisco DNA Advantage	Cisco DNA Advantage	Cisco IOS XE Release 17.11.1
Cisco Catalyst 9600 and 9600-X Series Switches	Service peer SDG agent	Cisco DNA Advantage	Cisco DNA Advantage	Cisco IOS XE Release 17.11.1
Cisco Catalyst 9800 Wireless Controller	Service peer	Cisco DNA Advantage	Cisco DNA Advantage	Cisco IOS XE Release 17.11.1
Cisco Catalyst 9800-L Wireless Controller	Service peer	Cisco DNA Advantage	Cisco DNA Advantage	Cisco IOS XE Release 17.11.1
Cisco Nexus 9300 Series Switches	SDG agent	Cisco DNA Advantage	Cisco DNA Advantage	Cisco NX-OS Release 10.2(3)F

## Supported Network Design

The Cisco DNA Service for Bonjour supports a broad range of enterprise-grade networks. The end-to-end unicast-based Bonjour service routing is supported on traditional, Cisco SD-Access, and BGP EVPN-enabled wired and wireless networks.

### Traditional Wired and Wireless Networks

Traditional networks are classic Layer 2 or Layer 3 networks for wired and wireless modes deployed in enterprise networks. Cisco DNA Service for Bonjour supports a broad range of network designs to enable end-to-end service routing and replace flood-n-learn-based deployment with a unicast mode-based solution.

The following figure illustrates traditional LAN and central-switching wireless local mode network designs that are commonly deployed in an enterprise.

**Figure 54: Enterprise Traditional LAN and Wireless Local Mode Network Design**

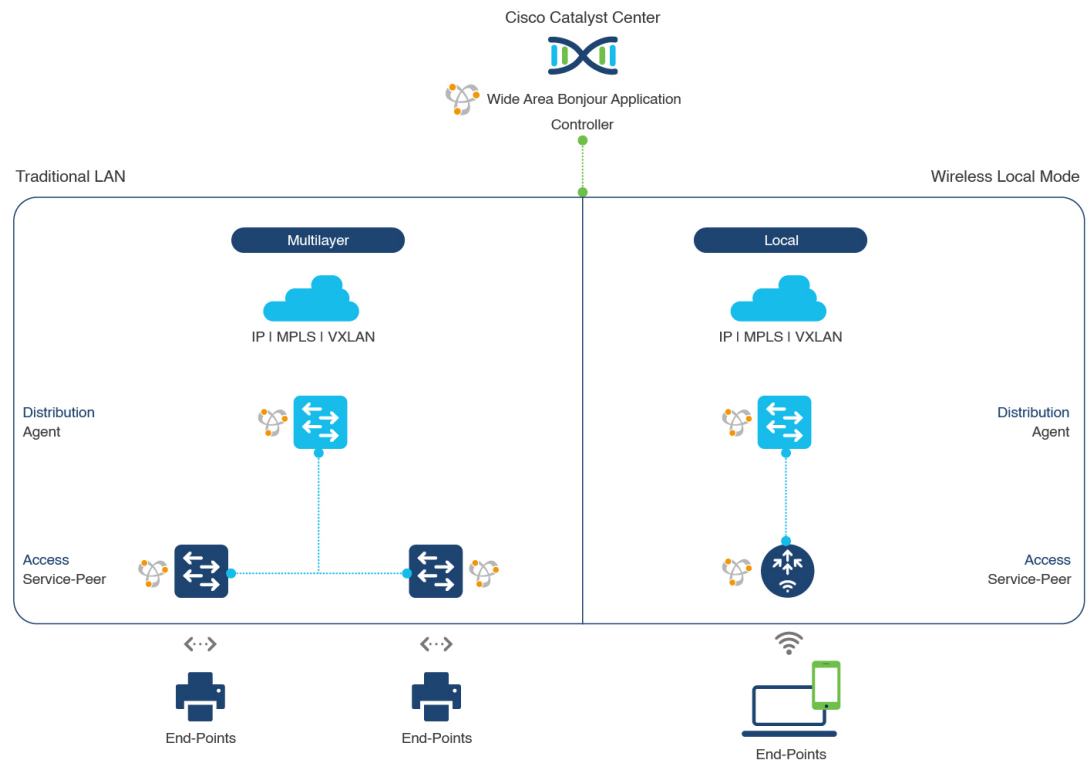

## Wired Networks

The following figure shows the supported traditional LAN network designs that are commonly deployed in an enterprise.

Figure 55: Enterprise Wired Multilayer and Routed Access Network Design

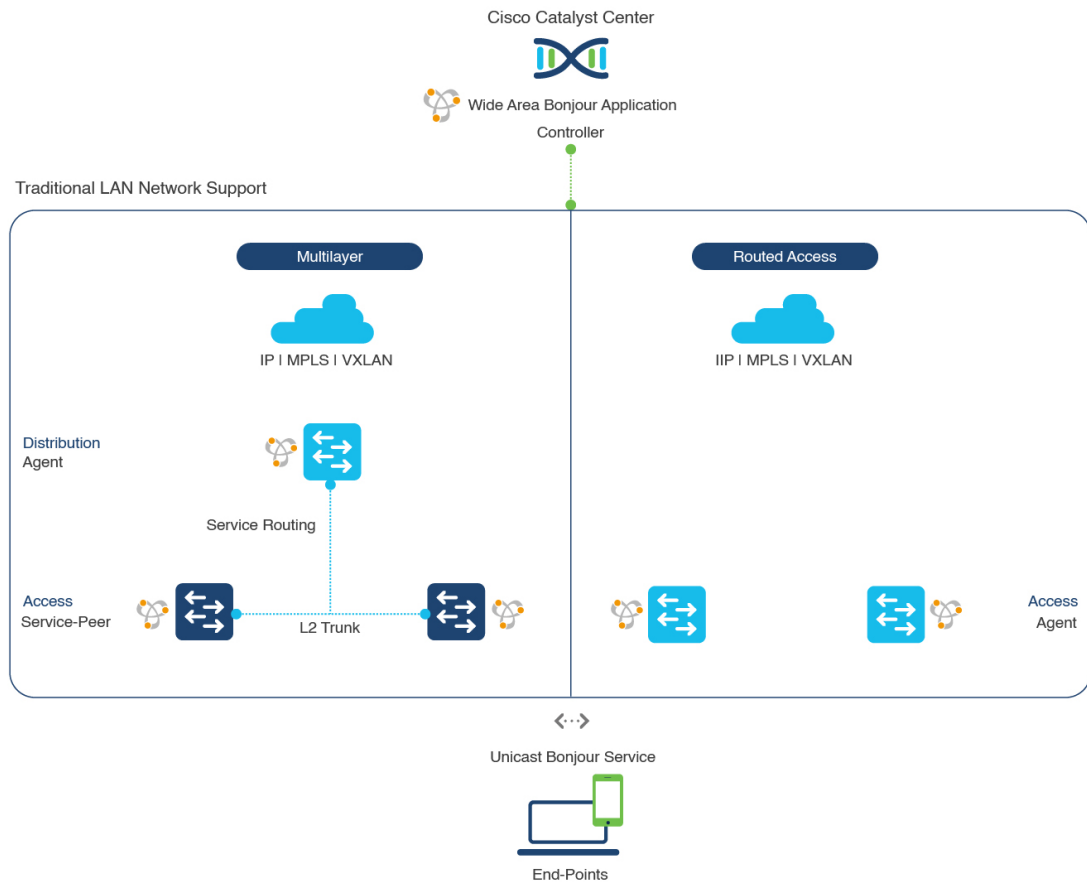

The Cisco Catalyst or Cisco Nexus 9300 Series Switches in SDG agent role that provide Bonjour gateway functions are typically IP gateways for wired endpoints that could reside in the distribution layer in multilayer network designs, or in the access layer in Layer 3 routed access network designs:

- **Multilayer LAN—Unicast Mode:** In this deployment mode, the Layer 2 access switch provides the first-hop mDNS gateway function to locally attached wired endpoints. In unicast mode, the mDNS services are routed to the distribution layer systems providing IP gateway and SDG agent mode. The policy-based service routing between the SDG agents is performed by the Catalyst Center controller.
- **Multilayer LAN—Flood-n-Learn Mode:** In this deployment mode, the Layer 2 access switch or wireless controller are in mDNS passthrough modes with the Cisco Catalyst or Cisco Nexus 9300 Series Switches operating in the SDG agent mode. The mDNS gateway function at distribution layer in a network enables inter-VLAN mDNS local proxy. It also builds stateful Wide Area Bonjour unicast service routing with the Catalyst Center to discover or distribute mDNS services beyond a single IP gateway.
- **Routed Access:** In this deployment mode, the first-hop Cisco Catalyst or Cisco Nexus 9300 Series Switch is an IP gateway boundary and, therefore, it must also perform the SDG agent role. The policy-based service routing between the SDG agents is performed by the Catalyst Center controller.

## Wireless Networks

The Cisco DNA Service for Bonjour extends the single wireless controller mDNS gateway function into the Wide Area Bonjour solution. The mDNS gateway on Cisco Catalyst 9800 Series Wireless Controller can be deployed in an enhanced mode as a service peer. In this mode, the wireless controller builds unicast service routing with an upstream Cisco Catalyst gateway switch for end-to-end mDNS service discovery. It replaces the classic flood-n-learn mDNS services from wired network using mDNS AP or other methods.

The following figure shows the supported traditional wireless LAN network designs that are commonly deployed in an enterprise. Based on the wireless network design, the mDNS gateway function may be on the wireless controller, or first-hop Layer 2 or Layer 3 Ethernet switch of an Access Point in local-switching mode.

**Figure 56: Enterprise Traditional Wireless LAN Network Design**

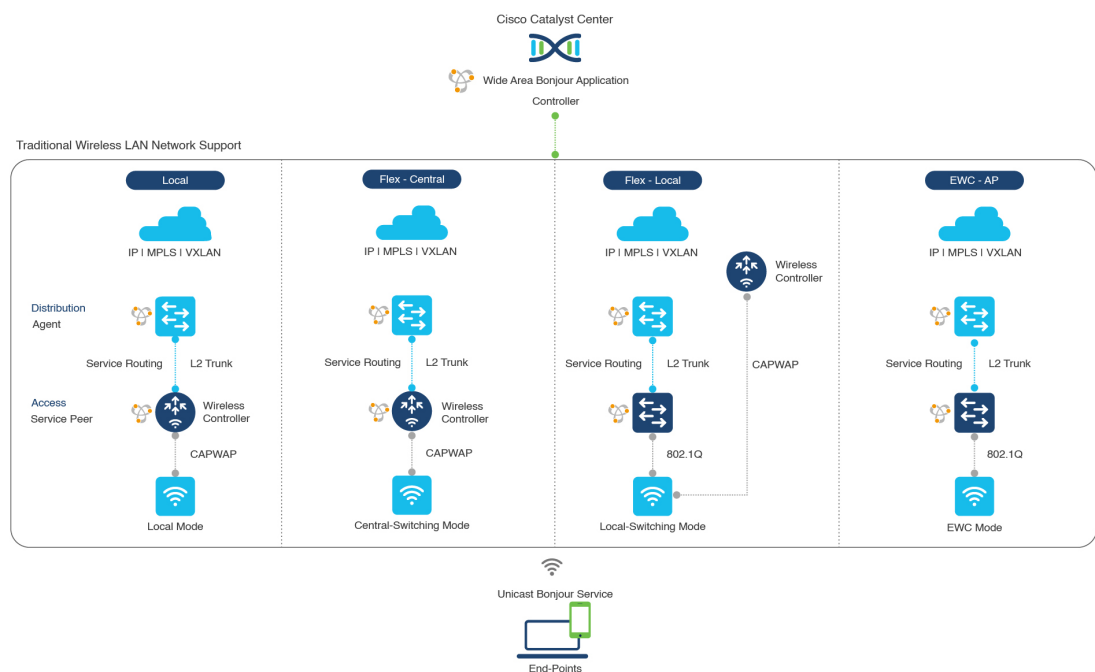

The Cisco DNA Service for Bonjour supports the following modes for wireless LAN networks:

- **Local Mode:** In the central switching wireless deployment mode, the m-DNS traffic from local mode Cisco access points is terminated on the Cisco Catalyst 9800 Series Wireless Controller. The Cisco Catalyst 9800 Series Wireless Controller extends the mDNS gateway function to the new service peer mode. The wireless controller can discover and distribute services to local wireless users and perform unicast service routing over a wireless management interface to the upstream Cisco Catalyst Switch in the distribution layer, which acts as the IP gateway and the SDG agent.
- **FlexConnect—Central:** The mDNS gateway function for Cisco access point in FlexConnect central switch SSID functions consistently as described in **Local Mode**. The new extended mDNS gateway mode on the Cisco Wireless Controller and upstream service routing with SDG agent operate consistently to discover services across network based on policies and locations.
- **FlexConnect—Local:** In FlexConnect local switching mode, the Layer 2 access switch in mDNS gateway service peer mode provides the policy-based mDNS gateway function to locally attached wired and wireless users. The Cisco Catalyst Switches in the distribution layer function as SDG agents and enable

mDNS service-routing across all Layer 2 ethernet switches to support unicast-based service routing to LAN and wireless LAN user groups.

- **Embedded Wireless Controller—Access Point:** The Layer 2 access switch in service peer mode provides unified mDNS gateway function to wired and wireless endpoints associated with Cisco Embedded Wireless Controller on Cisco Catalyst 9100 Series Access Points. The SDG agent in the distribution layer provides unicast service routing across all Layer 2 service peer switches in the Layer 2 network block without any mDNS flooding.

## Cisco SD-Access Wired and Wireless Networks

Cisco SD-Access-enabled wired and wireless networks support Cisco DNA Service for Bonjour across fabric networks. The Cisco Catalyst 9000 Series Switches support VRF-aware Wide Area Bonjour service routing to provide secure and segmented mDNS service discovery and distribution management for virtual networks. The VRF-aware unicast service routing eliminates the need to extend Layer 2 flooding, and improves the scale and performance of the fabric core network and endpoints.

**Figure 57: Cisco SD-Access Wired and Wireless Network Design**

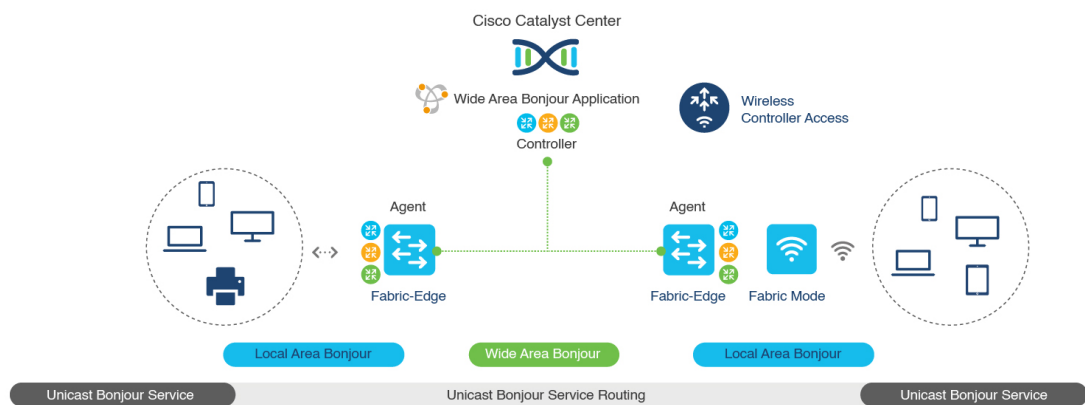

Cisco SD-Access supports flexible wired and wireless network design alternatives to manage fully distributed, integrated, and backward-compatible traditional network infrastructure. Wide Area Bonjour service routing is supported in all network designs providing intuitive user experience. The following figure illustrates the various SD-Access enabled wired and wireless network design alternatives.



Figure 58: Cisco SD-Access Wired and Wireless Network Design Alternatives

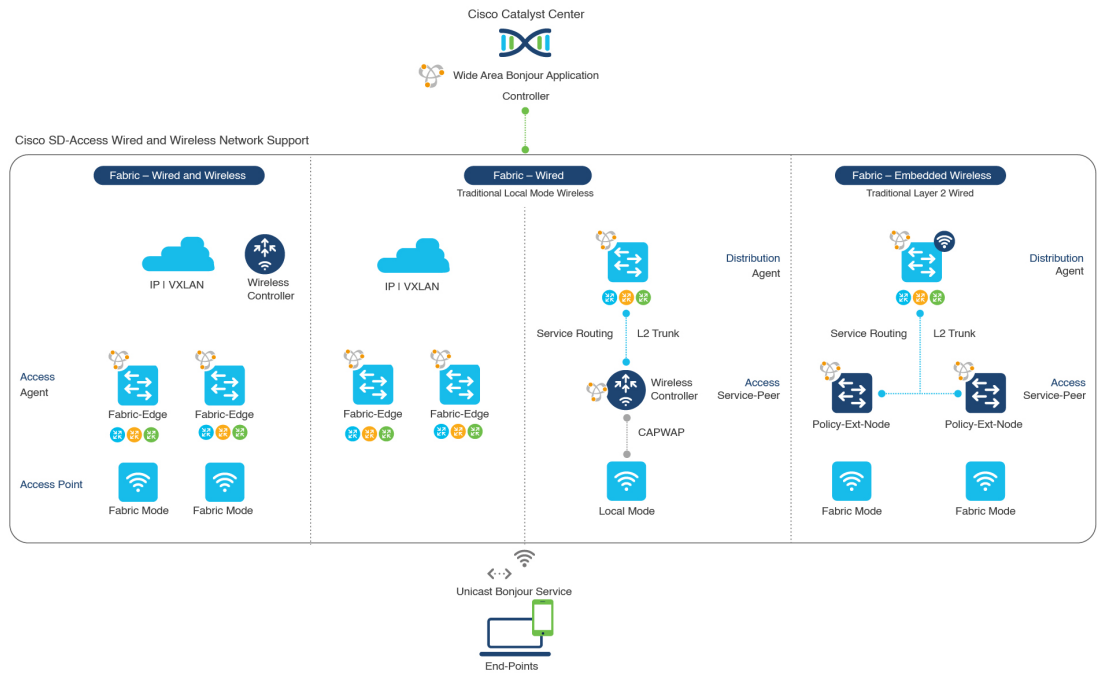

The Cisco DNA Service for Bonjour for SD-Access enabled wired and fabric, or traditional mode-wireless networks use two-tier service routing providing end-to-end unicast-based mDNS solution. Based on the network design, each solution component is enabled in a unique role to support the Wide Area Bonjour domain:

- Fabric Edge SDG Agent:** The Layer 3 Cisco Catalyst Fabric Edge switch in the access layer configured as SDG agent provides unicast-based mDNS gateway function to the locally attached wired and wireless endpoints. The VRF-aware mDNS service policy provides network service security and segmentation in a virtual network environment. The mDNS services can be locally distributed and routed through centralized Catalyst Center.
- Policy Extended Node:** The Layer 2 Cisco Catalyst access layer switch enables first-hop mDNS gateway function without flooding across the Layer 2 broadcast domain. The unicast-based service routing with upstream Fabric Edge switch in the distribution layer enables mDNS service routing within the same Layer 2 network block. It can also perform remote service discovery and distribution from centralized Catalyst Center.
- Cisco Wireless Controller:** Based on the following wireless deployment modes, Cisco Wireless Controller supports unique function to enable mDNS service routing in Cisco SD-Access enabled network:
  - Fabric-Enabled Wireless:** Cisco Wireless Controller doesn't require any mDNS gateway capability to be enabled in distributed fabric-enabled wireless deployments.
  - Local Mode Wireless:** As Cisco Wireless Controller provides central control and data plane termination, it provides mDNS gateway in service peer mode for wireless endpoints. The wireless controller provides mDNS gateway between locally associated wireless clients. The wireless controller builds service routing with upstream SDG agent Catalyst switch providing IP gateway and service routing function for wireless endpoints.
  - Embedded Wireless Controller—Switch:** The Cisco Embedded Wireless Controller solution enables the lightweight integrated wireless controller function within the Cisco Catalyst 9300 Series

Switch. The Cisco Catalyst switches in the distribution layer function as SDG agents to the wired and wireless endpoints. The SDG agent in the distribution layer provides unicast service routing across all wireless access points and Layer 2 service peer switches without mDNS flooding.

- **Catalyst Center Controller:** The Cisco Wide Area Bonjour application on Catalyst Center supports policy and location-based service discovery, and distribution between network-wide distributed Fabric Edge switches in SDG agent mode.

The Wide Area Bonjour communication between the SDG agent and controller takes place through the network underlay. Based on policies, the SDG agent forwards the endpoint announcements or queries to the Catalyst Center. After discovering a service, the endpoints can establish direct unicast communication through the fabric overlay in the same virtual network. The inter-virtual network unicast communication takes place through the Fusion router or external Firewall system. This communication is subject to the configured overlay IP routing and Security Group Tag (SGT) policies.

## BGP EVPN Networks

The BGP EVPN-based technology provides a flexible Layer 3 segmentation and Layer 2 extension overlay network. The VRF and EVPN VXLAN-aware Wide Area Bonjour service routing provides secure and segmented mDNS service solution. The overlay networks eliminate mDNS flooding over EVPN-enabled Layer 2 extended networks and solve the service reachability challenges for Layer 3 segmented routed networks in the fabric.

The following figure shows the BGP EVPN leaf switch in the distribution layer, supporting overlay Bonjour service routing for a BGP EVPN-enabled traditional Layer 2 wired access switch and traditional wireless local mode enterprise network interconnected through various types of Layer 2 networks and Layer 3 segmented VRF-enabled networks.

**Figure 59: Overlay Bonjour Service for a BGP EVPN-Enabled Enterprise Network**

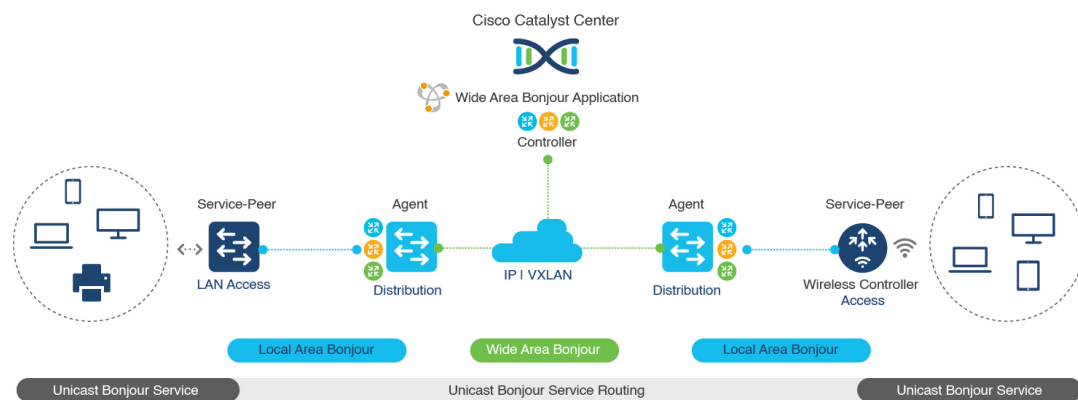

Cisco DNA Service for Bonjour supports all the industry-standard overlay network designs enabling end-to-end unicast-based mDNS service routing, and preventing flooding and service boundary limitation across wired and wireless networks.

The following figure illustrates the various BGP EVPN VXLAN reference overlay network design alternatives. This network design enables end-to-end mDNS service discovery and distribution based on overlay network policies.

Figure 60: BGP EVPN VXLAN Wired and Wireless Design Alternatives

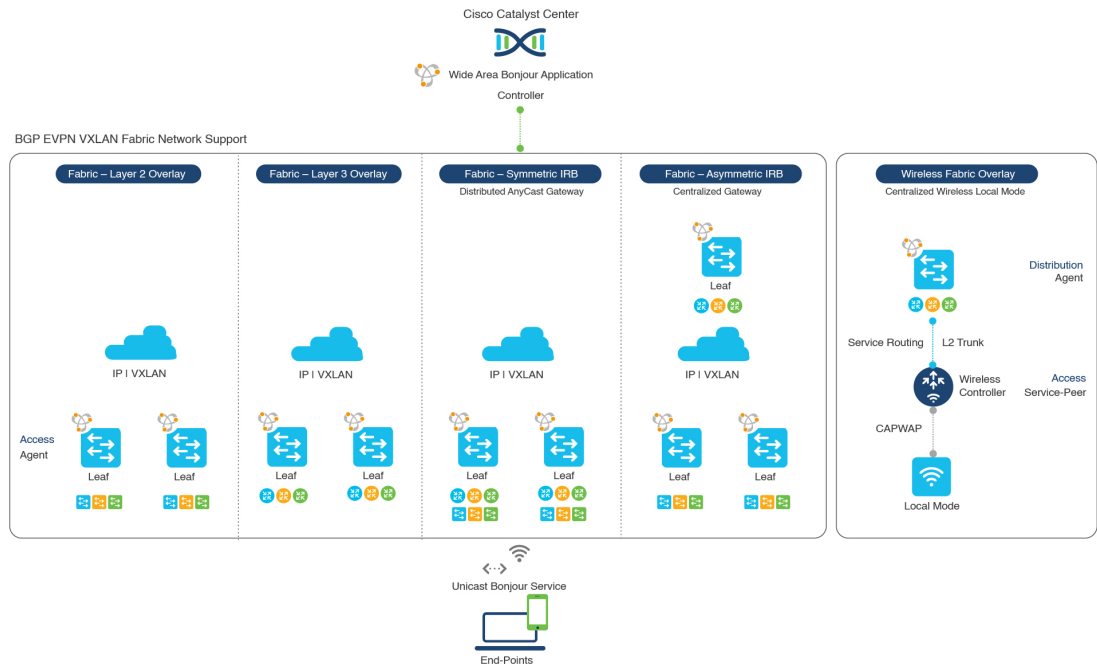

The Cisco Catalyst and Cisco Nexus 9000 Series Switches can be deployed in Layer 2 or Layer 3 leaf roles supporting mDNS service routing for a broad range of overlay networks. In any role, the mDNS communication is limited locally and supports end-to-end unicast-based service routing across Wide Area Bonjour domain:

- **Layer 2 Leaf SDG Agent:** The Cisco Catalyst or Cisco Nexus switches can be deployed as Layer 2 leaf supporting end-to-end bridged network with IP gateway within or beyond BGP EVPN VXLAN fabric network. By default, the mDNS is flooded as Broadcast, Unknown Unicast, Multicast (BUM) over the fabric-enabled core network. This mDNS flooding may impact network performance and security. The Layer 2 leaf, enabled as SDG agent, prevents mDNS flooding over VXLAN and supports unicast-based service routing.
- **Layer 3 Leaf SDG Agent:** The Cisco Catalyst or Cisco Nexus switches can be deployed as SDG agent supporting Layer 3 overlay network in BGP EVPN VXLAN fabric. The IP gateway and mDNS service boundary is terminated at the SDG agent switches and remote services can be discovered or distributed through centralized Catalyst Center.
- **Local Mode Wireless:** The centralized wireless local mode network can be terminated within or outside the EVPN VXLAN fabric domain to retain network segmentation and service discovery for wireless endpoints. The Cisco Catalyst 9800 Series Wireless Controller in service peer mode can build unicast service routing with distribution layer IP and SDG agent Cisco Catalyst switch to discover services from BGP EVPN VXLAN fabric overlay network.
- **Catalyst Center:** Catalyst Center supports Wide Area Bonjour capability to dynamically discover and distribute mDNS services based on Layer 2 or Layer 3 Virtual Network ID (VNID) policies to route the mDNS services between SDG agent switches in the network.

For more information about BGP EVPN networks, see [Cisco DNA Service for Bonjour Configuration Guide, Cisco IOS XE Bengaluru 17.6.x \(Catalyst 9600 Switches\)](#).





## CHAPTER 194

# Configuring Local and Wide Area Bonjour Domains

---

- [Cisco DNA Service for Bonjour Solution Overview](#), on page 1907
- [Configuring Local and Wide Area Bonjour Domains](#), on page 1919
- [Configuring Hot Standby Router Protocol-aware \(HSRP-aware\) mDNS Service-Routing on SDG](#), on page 1937
- [Configuring Hot Standby Router Protocol-aware \(HSRP-aware\) mDNS Service-Routing on Service-Peer \(CLI\)](#), on page 1938
- [Verifying Local Area Bonjour in Multicast DNS Mode for LAN and Wireless Networks](#), on page 1938
- [Additional References for DNA Service for Bonjour](#), on page 1944
- [Feature History for Cisco DNA Service for Bonjour](#), on page 1944

## Cisco DNA Service for Bonjour Solution Overview

### Restrictions

- Cisco Service Discovery Gateway (SDG) and Wide Area Bonjour gateway function is supported on Cisco Catalyst Switch and Cisco ISR 4000 series routers. See [Solution Components](#), on page 1896 for the complete list of supporting platforms, software versions and license levels.
- Cisco IOS supports classic and new method of building local Bonjour configuration policies. The classic method is based on **service-list mdns-sd** CLI whereas the new method is based on **mdns-sd gateway**. We recommend using the new **mdns-sd gateway** method since the classic configuration support will be deprecated in near future releases.
- The classic to new method CLI migration is manual procedure to convert the configuration.
- The Bonjour service policies on Cisco SDG Gateways are effective between local VLANs. In addition to these, a specific egress policy controls the type of services to be exported to the controller. The Layer 2 Multicast-DNS Bonjour communication between two end-points on same broadcast domain is transparent to gateway.
- To enable end-to-end Wide Area Bonjour solution on Wireless networks, the Cisco WLC controller must not enable mDNS Snooping function. The upstream IP gateway on the dedicated Cisco Catalyst switch must have the Bonjour gateway function enabled for wireless clients.

- Cisco Wireless LAN Controller must enable AP Multicast with unique Multicast group. Without AP joining WLC Multicast group the mDNS messages will not be processed between client and gateway switch. Multicast on Client SSID or VLAN is optional for other multicast applications and not mandatory or required for Bonjour solution.
- Cisco Catalyst 9800 WLC can be configured as mDNS Gateway. In this mode, the Cisco Catalyst 9800 WLC supports Local-Area Bonjour gateway solution limited to Wireless only networks. Cisco Catalyst 9800 does not support Wide Area Bonjour. For end-to-end Wired and Wireless Bonjour support, we recommend using upstream Cisco Catalyst Switch as IP and Bonjour gateway.

## Cisco Wide Area Bonjour Service Workflow

The Cisco Wide Area Bonjour solution follows a client-server model. The SDG Agent functions as a client and the Cisco Wide Area Bonjour application Cisco Catalyst Center functions as a server.

The following sections describe the workflow of service announcement and discovery in the IP network.

### Announcing Services to the Network

- The endpoint devices (Source) in the Local Area Bonjour domain send service announcements to the SDG Agent and specify what services they offer. For example, `_airplay._tcp.local`, `_raop._tcp.local`, `_ipp._tcp.local`, and so on.
- The SDG Agent listens to these announcements and matches them against the configured Local Area SDG Agent policies. If the announcement matches the configured policies, the SDG Agent accepts the service announcement and routes the service to the controller.

### Discovering Services Available in the Network

- The endpoint device (Receiver) connected to the Local Area SDG Agent sends a Bonjour query to discover the services available, using the mDNS protocol.
- If the query conforms to configured policies, SDG Agent responds with the services obtained from appropriate service routing via the Wide Area Bonjour Controller.

### Wide Area Bonjour Multi-Tier Policies

The various policies that can be used to control the Bonjour announcements and queries are classified as the following:

- **Local Area SDG Agent Filters:** Enforced on the SDG Agent in Layer-2 Network Domain. These bi-directional policies control the Bonjour announcements or queries between the SDG Agents and the Bonjour endpoints.
- **Wide Area SDG Agent Filters:** Enforced on the SDG Agent for export control to the Controller. This egress unidirectional policy controls the service routing from the SDG Agent to the controller.
- **Cisco Wide Area Bonjour Policy:** Enforced on Controller for global service discovery and distribution. Policy enforcement, between the controller and the IP network is bi-directional.

# Cisco Wide Area Bonjour Supported Network Design

## Traditional Wired and Wireless Networks

The Cisco DNA Service for Bonjour supports various LAN network designs commonly deployed in the enterprise. The SDG Agent providing Bonjour gateway functions is typically an IP gateway for wired end-points that could be residing in the distribution layer in multilayer network designs, or in the access layer in routed access network designs.

The following figure shows various topologies which are explained further in the section.

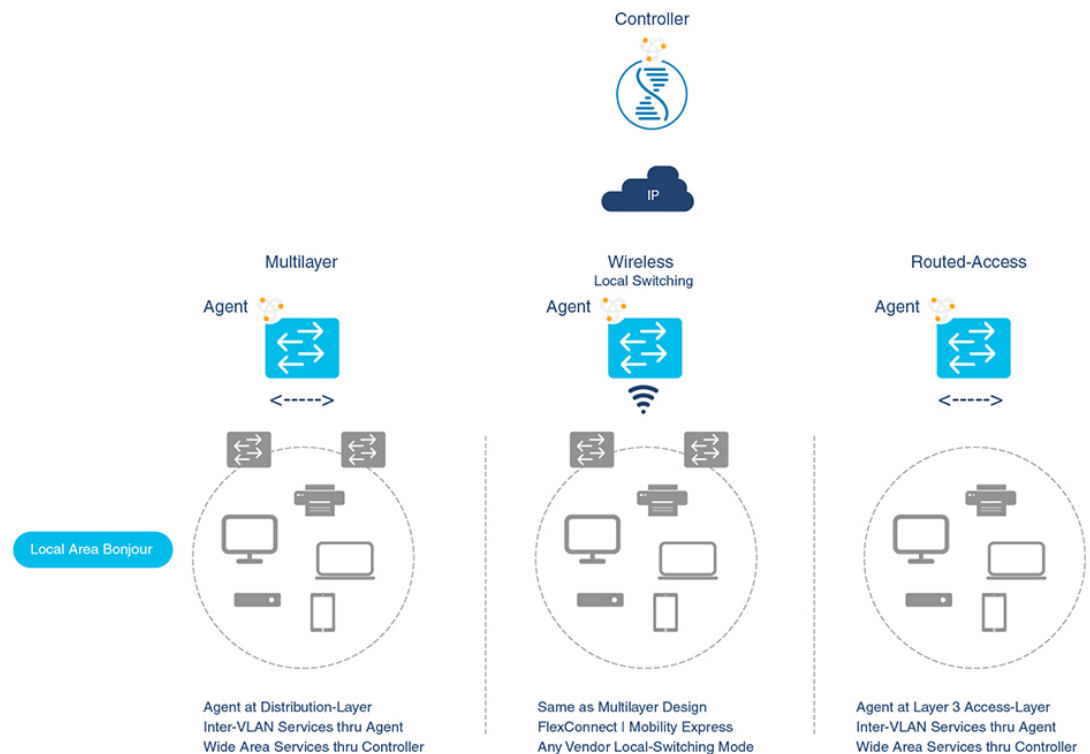

- **Multilayer LAN:** In this deployment mode, the Layer 2 Access switch provides the transparent bridging function of Bonjour services to Distribution-layer systems that act as the IP gateway and SDG Agent. There is no additional configuration or new requirement to modify the existing Layer-2 trunk settings between the Access and Distribution Layer Cisco Catalyst Switches.
- **Routed Access:** In this deployment mode, the first-hop switch is an IP gateway boundary and therefore, it must be combined with the SDG Agent role.

The Cisco DNA Service for Bonjour also supports various Wireless LAN network designs commonly deployed in the Enterprise. The SDG Agent provides consistent Bonjour gateway functions for the wireless endpoints as in wired networks. In general, the IP gateway of the wireless clients is also a Bonjour gateway. However, the placement of the SDG Agent may vary depending on the Wireless LAN deployment mode.

## Cisco SD Access Wired and Wireless Networks

In Cisco SD-Access network, the Fabric Edge switch is configured as the SDG Agent for fabric-enabled wired and wireless networks. Wide Area Bonjour policies need to be aligned with the SD-Access network policies with respect to Virtual Networks and SGT policies, if any.

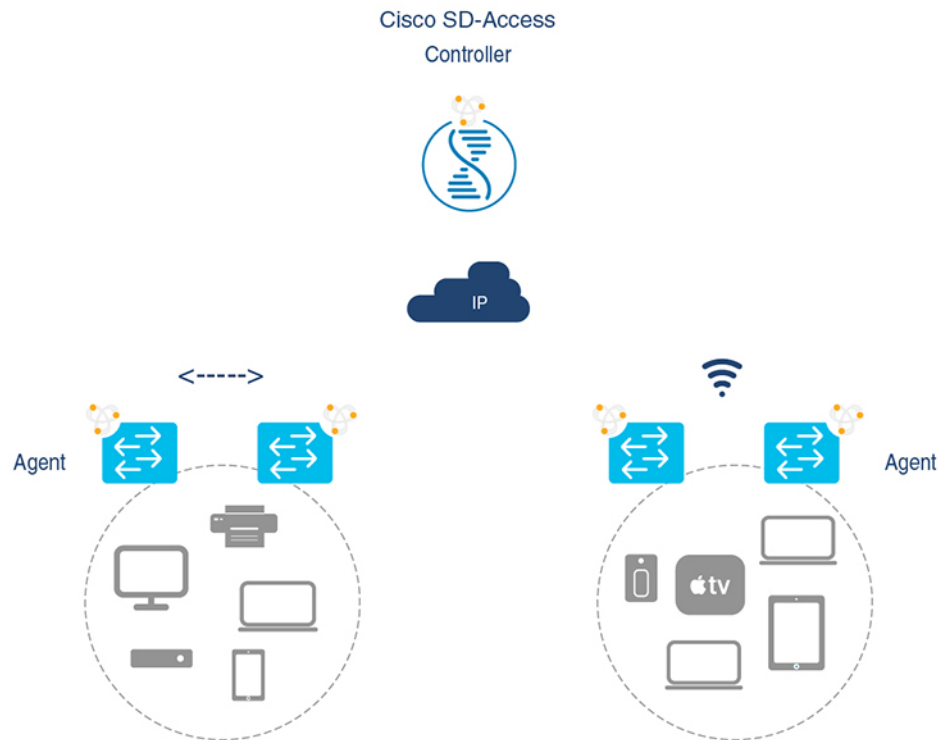

Wide Area Bonjour uses two logical components in a network:

- **SDG Agent:** The Fabric Edge switch is configured as the SDG Agent, and the configuration is added only after the SD-Access is configured.
- **Wide Area Bonjour Controller:** The Wide Area Bonjour application in the Cisco Catalyst Center acts as the Controller.

The Wide Area Bonjour communication between the SDG Agent and the Controller takes place through the network underlay. The SDG Agent forwards the endpoint announcements or queries to the Controller through the fabric underlay. After discovering a service, a Bonjour-enabled application establishes direct unicast communication with the discovered device through the fabric overlay. This communication is subject to any configured routing and SDG policies.

## Local and Wide Area Bonjour Policies

The Cisco Wide Area Bonjour policy is divided into four unique function to enable policy based Bonjour services discovery and distribution in two-tier domains. The network administrator must identify the list of Bonjour services that needs to be enabled and set the discovery boundary that can be limited to local or global based on requirements. Figure below illustrates enforcement point and direction of all four types of Bonjour policies at the SDG Agent level and in Cisco Catalyst Center Wide Area Bonjour application:



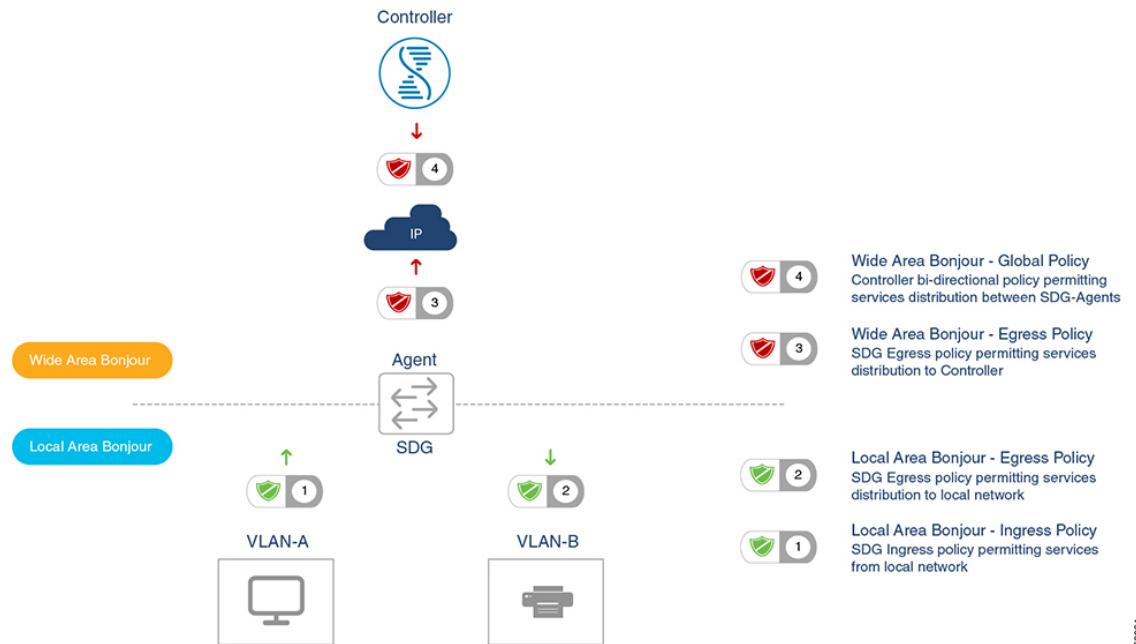

350304

## Local Area Bonjour Policy

The Cisco IOS Bonjour policy structure is greatly simplified and scalable with the new configuration mode. The services can be enabled with intuitive user-friendly service-type instead individual mDNS PoinTeR (PTR) records types, for example select AirPlay that automatically enables video and audio service support from Apple TV or equivalent capable devices. Several common types of services in Enterprise can be enabled with built-in service-types. If built-in service type is limited, network administrator can create custom service-type and enable the service distribution in the network.

The policy configuration for the Local Area Bonjour domain is mandatory, and is a three step process. Figure below illustrates the step-by-step procedure to build the Local-Area Bonjour policy, and apply to enable the gateway function on selected local networks:

Figure 61: Local Area Bonjour Policy Hierarchy

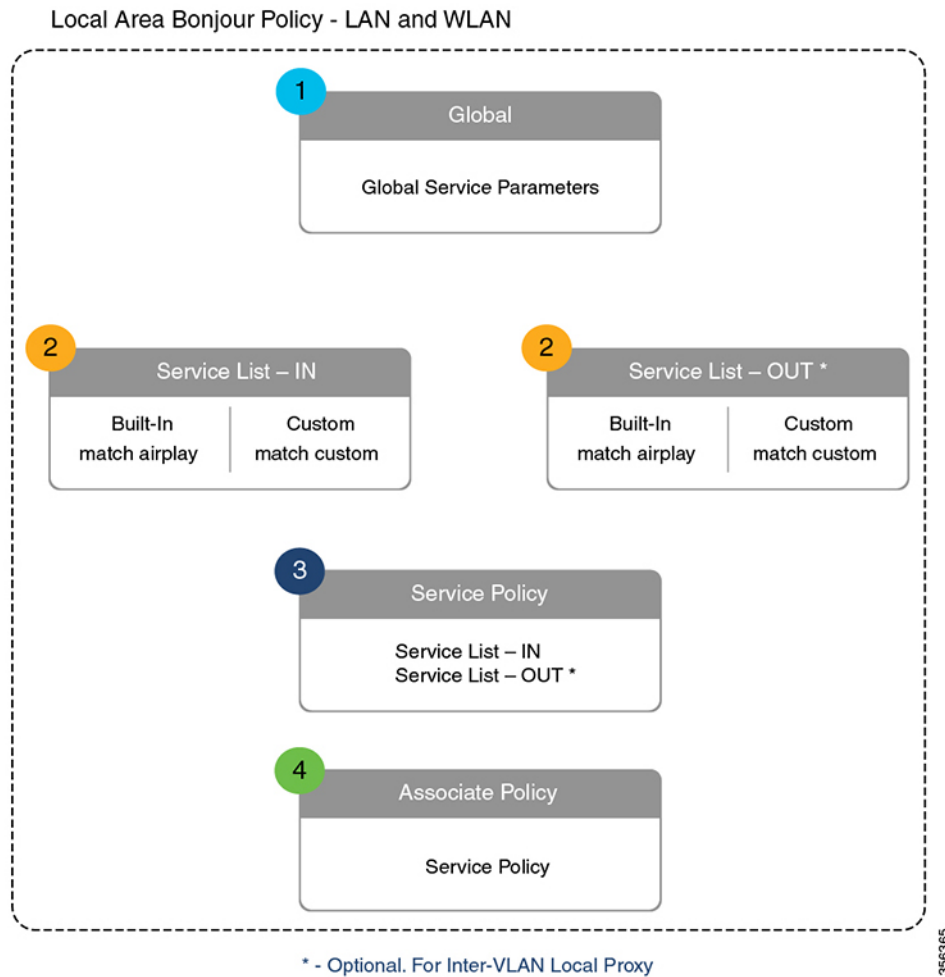

To configure local area Bonjour policies, enable mDNS globally. For the device to receive mDNS packets on the interface, configure mDNS gateway on the interface. Create a service-list by using filter options within it allow services into or out of a device or interface. After enabling mDNS gateway globally and on the interface, you can apply filters (IN-bound filtering or OUT-bound filtering) on service discovery information by using **service-policy** commands.

### Built-In Service List

The Cisco IOS software includes built-in list of services that may consist of one more Bonjour service-type. A single service-list may contain more than one service-type entries with default rule to accept service announcement from service-provider and the service query request from receiver end-points. If selected service-type contains more than one Bonjour service-types (PTR), then a service announcement or a service query is honored when the announcement/query is for any one of these included Bonjour service-types. For example, Apple Time Capsule Data service-type consists of both `_adisk` and `_afpovertcp` built-in PTRs, however if any end-point announces or requests for only `_afpovertcp` service, then SDG Agent will successfully classify and process the announcement or request. The service-list contains implicit-deny for all un-defined built-in or custom services entries.

Table below illustrates complete list of built-in Bonjour services that can be used to create policies in local area Bonjour.

**Table 99: Cisco IOS Built-In Bonjour Service Database**

Service	Service Name	mDNS PTRs
Airplay	airplay	_airplay._tcp.local
Apple TV	apple-tv	_airplay._tcp.local _raop._tcp.local
Audinate	audinate	_dante-safe._udp.local _dante-upgr._udp.local _netaudio-arc._udp.local _netaudio-chan._udp.local _netaudio-cmc._udp.local _netaudio-dbc._udp.local
AirServer Mirroring Service	airserver	_airplay._tcp.local _airserver._tcp.local
Apple AirTunes	airtunes	_raop._tcp.local
Amazon Fire TV	amazon-fire-tv	_amzn-wplay._tcp.local
Apple AirPrint	apple-airprint	_ipp._tcp.local _universal._sub._ipp._tcp.local
Apple TV 2	apple-continuity	_companion-link._tcp.local
Apple File Share	apple-file-share	_afpovertcp._tcp.local
Apple HomeKit	apple-homekit	_homekit._ipp.local _hap._tcp.local
Apple iTunes Library	apple-itunes-library	_atc._tcp.local
Apple iTunes Music	apple-itunes-music	_daap._tcp.local
Apple iTunes Photo	apple-itunes-photo	_dpap._tcp.local
Apple KeyNote Remote Control	apple-keynote	_keynotecontrol._tcp.local _keynotepair._tcp.local
Apple Remote Desktop	apple-rdp	_afpovertcp._tcp.local _net-assistant._tcp.local
Apple Remote Event	apple-remote-events	_eppc._tcp.local

Service	Service Name	mDNS PTRs
Apple Remote Login	apple-remote-login	_sftp-ssh._tcp.local _ssh._tcp.local
Apple Screen Share	apple-screen-share	_rfb._tcp.local
Google Expeditions	google-expeditions	_googexpeditions._tcp.local
Apple Time Capsule Data	apple-timecapsule	_adisk._tcp.local _afpovertcp._tcp.local
Apple Time Capsule Management	apple-timecapsule-mgmt	_airport._tcp.local
Apple MS Window File Share	apple-windows-fileshare	_smb._tcp.local
Fax	fax	_fax-ipp._tcp.local
Google ChromeCast	google-chromecast	_googlecast._tcp.local _googlerpc._tcp.local _googlezone._tcp.local
Apple HomeSharing	homesharing	_home-sharing._tcp.local
Apple iTunes Data Sync	itunes-wireless-devicesharing2	_apple-mobdev2._tcp.local
Multifunction Printer	multifunction-printer	_ipp._tcp.local _scanner._tcp.local _fax-ipp._tcp.local
Phillips Hue Lights	phillips-hue-lights	_hap._tcp.local
Printer – Internet Printing Protocol	printer-ipp	_ipp._tcp.local
Printer – IPP over SSL	printer-ipp	_ipps._tcp.local
Linux Printer – Line Printer Daemon	printer-lpd	_printer._tcp.local
Printer Socket	printer-socket	_pdl-datastream._tcp.local
Roku Media Player	roku	_rsp._tcp.local
Scanner	scanner	_scanner._tcp.local
Spotify Music Service	spotify	_spotify-connect._tcp.local
Web-Server	web-server	_http._tcp.local
WorkStation	workstation	_workstation._tcp.local

### Custom Service List

The Custom service list allows network administrator to configure service if built-in Bonjour database does not support specific service or bundled service types. For example, the file-sharing requirement demands to support Apple Filing Protocol (AFP) between macOS users and Server Message Block (SMB) file transfer capability between macOS and Microsoft Windows devices. For such requirements the network administrator can create an custom service list combining AFP (`_afpovertcp_tcp.local`) and SMB (`_smb_tcp.local`).

The Service-List provides flexibility to network administrator to combine built-in and custom service definition under single list. There is no restriction on numbers of custom service definitions list and association to single service-list.

### Policy Direction

The Local Area Bonjour policy in Cisco IOS provides flexibility to network administrator to construct service policies that can align service announcement and query management in same or different local networks. The service-policies can be tied to either ingress or egress direction to enforce service control in both directions. The following sub-sections provide more details on service policy configuration.

#### Ingress Service Policy

The ingress service policy is a mandatory configuration element that is used to permit the processing of incoming mDNS service announcement and query requests. Without ingress service policy, the Bonjour gateway function on a targeted Wired or Wireless network is not enabled. The ingress service policy provides flexibility to permit service announcement and query on each user-defined service-types, i.e. permit accepting AirPlay service announcement and query request, but enable Printer service query request only.

#### Egress Service Policy

The egress service policy is an optional configuration and not required in following two conditions:

- The egress service policy is not applicable in local VLAN where the expected Bonjour end-points are service-provider only, i.e. Service-VLAN network may contain only IT managed service-provider end-points such as Apple TV, Printers etc. as these end-points do not query for other service-types in the network.
- The Wired or Wireless users must receive services only from Wide Area Bonjour domain by Cisco Catalyst Center, and not from other Bonjour end points connected to the same SDG Agent.. The egress service policy configuration is only required when an SDG-Agent must distribute locally discovered Bonjour services information from one VLAN to other. For example, based on ingress service policy the SDG-Agent discovered and cache the AirPrint capable Printer from VLAN-A, if the receiver endpoint in VLAN-B wants to discover Printer information from VLAN-A then the SDG-Agent must have ingress and egress service policy permitting AirPrint service on both VLANs.

#### Conditional Egress Service Policy

The network administrator can optionally customize the egress service policy to enable conditional service response from sourced from specific VLAN network. For example, based on ingress service policy the SDG-Agent may discover AirPrint capable Printers from VLAN-A and VLAN-C networks. With conditional Local Area Bonjour egress service policy rule, the network administrator may limit distributing Printer information discovered from VLAN-A to the receivers in VLAN-B network and automatically filters VLAN-C Printers. The conditional egress service policy support is optional setting and only applicable on out direction service policy.

### Service Status Timer Management

The Bonjour service-provider end-points may announce one or more services in the network combining mDNS records and time-to-live (TTL) service timers for each record. The TTL value provides assurance of end-point availability and serviceability in the network. The SDG Agents ensure that it contains up-to-date information in its local and updates global services in Controller based on TTL and other events in Local Area Bonjour domain. The network administrator must configure the service status timer where service-provider endpoint discovery is permitted.

## Wide Area Bonjour Policy

The SDG-Agent mandatorily requires the controller bound Wide Area Bonjour service export policy to control routing local services and discover remote services from Cisco Catalyst Center. As the Cisco Catalyst Center and SDG-Agent build a trusted communication channel, the remote service response from Wide Area Bonjour App is implicitly permitted at SDG-Agent. Hence the Wide Area Bonjour policy is unidirectional; it only requires egress service policy towards controller.

The Wide Area Bonjour policy hierarchy and structure is identical as described in Local Area Bonjour Policy structure section. Following sub-section provides step-by-step reference configuration to build and enforce the policy to enable the successful communication with Wide Area Bonjour App in Cisco Catalyst Center.

### Service List – Built-In and Custom

The network administrator must create a new controller-bound egress service list for the Wide Area Bonjour domain. In most common network deployment models, the Wide Area Bonjour service list may contain the same service-types as the Local Area Bonjour to implement common services between both domains. Based on requirements, certain services can be limited to Local Area and prevented from being routed in Wide Area Domain, then by default only allowed service list entries are permitted and the rest are dropped with an implicit deny rule.

### Ingress Policy Direction

The ingress service policy for Wide Area Bonjour domain is not required and cannot be associated to the controller.

### Egress Policy Direction

As described, the Bonjour policy structure between Local Area and Wide Area is consistent, however the enforcement point is different. We recommend configuring separate Service-List and Service-Policy for Wide Area Bonjour domain as it may help building a unique policy set for each domain.

### Conditional Egress Service List

The Wide Area Bonjour egress service list configuration can be customized to conditionally route the service or query request to the Cisco Catalyst Center. With this alternative configuration settings, the network administrator can route the service or query the request in Wide Area Bonjour domain from a specific local source VLAN network instead of globally from the entire system.

### Wide Area Bonjour Service Status Timer Management

The Cisco Catalyst Center centralizes the services information from large-scale distributed SDG-Agents across the network. To maintain a scale and performance of controller, the services routing information is transmitted and synchronized periodically by each SDG-Agent network devices. To protect system and network performance, the scheduler-based service information exchange allows a graceful and reliable way to discover and distribute Bonjour services across Wide Area Bonjour domain.

In most large-scale network environment, the default Bonjour service timers on SDG-Agents are by default fine-tuned and may not need any further adjustments. Cisco recommends retaining the interval timer values to default and adjust only based on any user experience issue and consider modified parameters do not introduce scale and performance impact.

## Default mDNS Service Configurations

Starting with Cisco IOS XE Bengaluru 17.6.1, an intuitive approach to configuring mDNS services, known as the default mDNS service configuration is introduced. The default service configuration contains a default service policy that creates a service list with default service-types that is automatically enforced in the ingress or egress direction. The following figure illustrates the default mDNS service configurations:

**Figure 62: Default mDNS Service Configurations**



The default mDNS service configurations accelerates solution adoption, increases user productivity, and reduces operation overhead. Additionally, you can define a custom policy and service list with custom-defined service types, and enforce it in the ingress or egress direction.

## HSRP-Aware mDNS Service-Routing

Starting from Cisco IOS XE Bengaluru 17.6.1, Hot Standby Router Protocol-aware (HSRP-aware) mDNS Service-Routing is supported between Service Peers and SDG agents in a multilayer network. During a changeover, that is when the primary SDG agent fails and the secondary SDG agent becomes the new primary, the service-routing session between the Service Peer and the SDG agent remains uninterrupted. The new primary SDG agent establishes a session with the Service Peer and cache information is resynced.

The HSRP virtual IP address of the management VLAN is enabled on the SDG agent using the **standby group\_number ip ip\_address** command. The HSRP virtual IP address needs to be configured on the Service Peer as the IP address of the SDG agent.



**Note** The HSRP virtual IP address must be reachable and in active state during a changeover.

The following figure illustrates a wired and wireless network that supports HSRP-aware mDNS Service-Routing:

Figure 63: HSRP-Aware mDNS Service-Routing

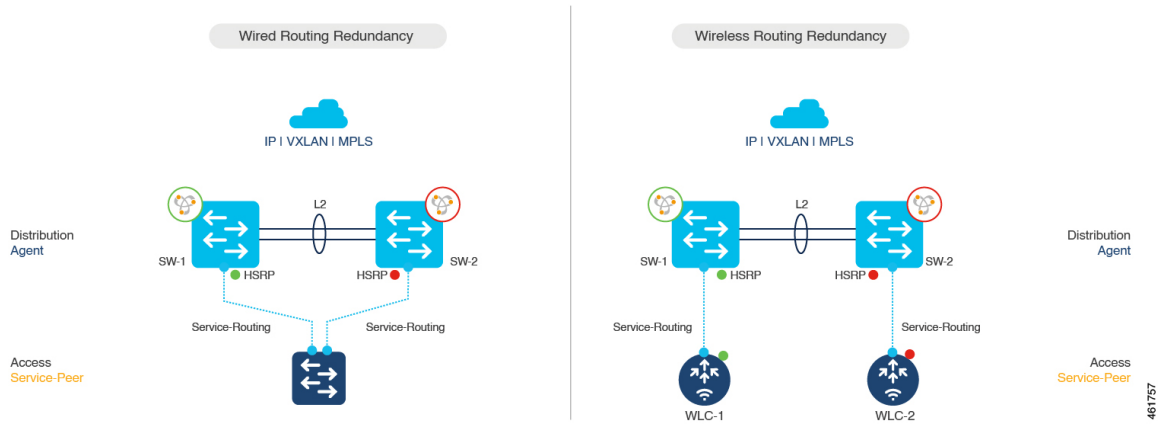

The HSRP offers the following advantages:

- Automatic gateway selection.
- Rapid switchover.
- Reduces service convergence.

## mDNS Service-Gateway SSO Support

Starting from Cisco IOS XE Bengaluru 17.6.1, mDNS Stateful Switchover (SSO) is supported on network devices configured in Service Peer role. In SSO-enabled devices, one device is selected as an active device and the other as a standby device. The cache information learnt by the active device is synced with the standby device. When the active device fails, the standby device becomes the new active device and continues the mDNS service discovery process.

Figure 64: mDNS Service-Gateway SSO

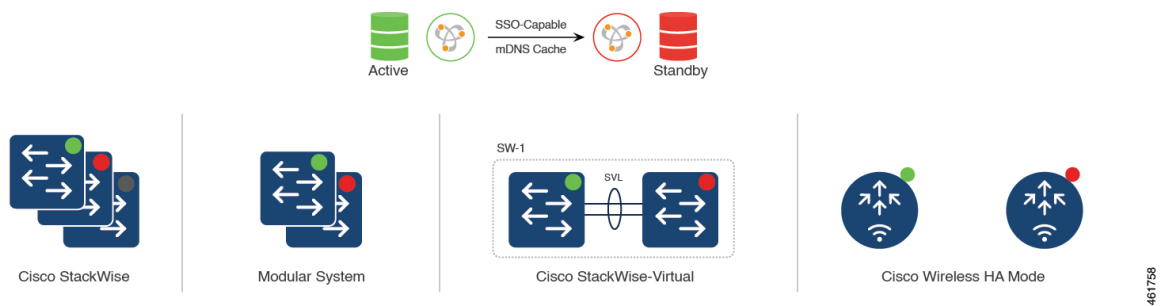



# Configuring Local and Wide Area Bonjour Domains

## How to configure Multicast DNS Mode for LAN and Wired Networks

This section provides information about how to configure Local Area Bonjour in multicast DNS mode.

### Enabling mDNS Gateway on the Device

To configure mDNS on the device, follow these steps:

#### Procedure

	Command or Action	Purpose
<b>Step 1</b>	<b>enable</b> <b>Example:</b> Device> <b>enable</b>	Enables privileged EXEC mode. Enter your password, if prompted.
<b>Step 2</b>	<b>configure terminal</b> <b>Example:</b> Device# <b>configure terminal</b>	Enters global configuration mode.
<b>Step 3</b>	<b>mdns-sd gateway</b> <b>Example:</b> Device(config)# <b>mdns-sd gateway</b>	Enables mDNS on the device and enters mDNS gateway configuration mode. Enter the following commands in mDNS gateway configuration mode to enable the respective functionalities: <ul style="list-style-type: none"> <li>• <b>air-print-helper</b>: Enables IOS devices like iPADS to discover and use older printers that support Bonjour</li> <li>• <b>cache-memory-max</b>: Configures the percentage memory for cache</li> <li>• <b>ingress-client</b>: Configures Ingress Client Packet Tuners</li> <li>• <b>rate-limit</b>: Enables rate limiting of incoming mDNS packets</li> <li>• <b>service-announcement-count</b>: Configures maximum service advertisement count</li> <li>• <b>service-announcement-timer</b>: Configures advertisements announce timer periodicity</li> <li>• <b>service-query-count</b>: Configures maximum query count</li> </ul>

	Command or Action	Purpose
		<ul style="list-style-type: none"> <li>• <b>service-query-timer</b>: Configures query forward timer periodicity</li> </ul> <p><b>Note</b> For <b>cache-memory-max</b>, <b>ingress-client</b>, <b>rate-limit</b>, <b>service-announcement-count</b>, <b>service-announcement-timer</b>, <b>service-query-count</b>, and <b>service-query-timer</b> commands, you can retain the default value of the respective parameter for general deployments. Configure a different value, if required, for a specific deployment.</p>
<b>Step 4</b>	<b>exit</b>  <b>Example:</b> Device(config-mdns-sd)# exit	Exits mDNS gateway configuration mode.

## Creating Custom Service Definition (GUI)

### Procedure

- 
- Step 1** Choose **Configuration > Services > mDNS > Service Policy > Service Definition**.
  - Step 2** Click **Add**.
  - Step 3** Enter the **Service Definition Name** and **Description**.
  - Step 4** Enter the **Service Type** and click the + icon.
  - Step 5** Click **Apply to Device**.
- 

## Creating Custom Service Definition

Service definition is a construct that provides an admin friendly name to one or more mDNS service types or PTR Resource Record Name. By default, a few built-in service definitions are already predefined and available for admin to use. In addition to built-in service definitions, admin can also define custom service definitions.

### Procedure

	Command or Action	Purpose
<b>Step 1</b>	<b>enable</b>  <b>Example:</b> Device> enable	Enables privileged EXEC mode.  Enter your password, if prompted.

	Command or Action	Purpose
<b>Step 2</b>	<b>configure terminal</b> <b>Example:</b> Device# <b>configure terminal</b>	Enters global configuration mode.
<b>Step 3</b>	<b>mdns-sd service-definition</b> <i>service-definition-name</i> <b>Example:</b> Device(config)# <b>mdns-sd</b> <b>service-definition CUSTOM1</b>	Configures mDNS service definition. <b>Note</b> All the created custom service definitions are added to the primary service list. Primary service list comprises of a list of custom and built-in service definitions.
<b>Step 4</b>	<b>service-type</b> <i>string</i> <b>Example:</b> Device(config-mdns-ser-def)# <b>service-type</b> <b>_custom1._tcp.local</b>	Configures mDNS service type.
<b>Step 5</b>	Repeat step 4 to configure more than one service type in the custom service definition.	
<b>Step 6</b>	<b>exit</b> <b>Example:</b> Device(config-mdns-ser-def)# <b>exit</b>	Exit mDNS service definition configuration mode.

## Creating Service List (GUI)

### Procedure

- 
- Step 1** Choose **Configuration > Services > mDNS > Service Policy > Service List**.
  - Step 2** Click **Add**.
  - Step 3** Enter the **Service List Name** and choose the direction from the **Direction** drop-down list.
  - Step 4** Click **Add Service**.
  - Step 5** Choose the service from the **Available Services** drop-down list and the message type from the **Message Type** drop-down list.
  - Step 6** Click **Save**.
  - Step 7** Click **Apply to Device**.
- 

## Creating Service List

mDNS service list is a collection of service definitions. To create a service list, follow these steps:

## Procedure

	Command or Action	Purpose
<b>Step 1</b>	<b>enable</b> <b>Example:</b> Device> <b>enable</b>	Enables privileged EXEC mode. Enter your password, if prompted.
<b>Step 2</b>	<b>configure terminal</b> <b>Example:</b> Device# <b>configure terminal</b>	Enters global configuration mode.
<b>Step 3</b>	<b>mdns-sd service-list <i>service-list-name</i> {in   out}</b> <b>Example:</b> Device(config)# <b>mdns-sd service-list VLAN100-list in</b>	Configures mDNS service list.
<b>Step 4</b>	<b>match <i>service-definition-name</i> [message-type {any   announcement   query}]</b> <b>Example:</b> Device(config-mdns-sl-in)# <b>match PRINTER-IPPS message-type announcement</b>	Matches the service to the message type. Here, <i>service-definition-name</i> refers to the names of services, such as, airplay, airserver, airtunes, and so on. <b>Note</b> To add a service, the service name must be part of the primary service list. If the mDNS service list is set to IN, the applicable command syntax is: <b>match <i>service-definition-name</i> [message-type {any   announcement   query}]</b> . If the mDNS service list is set to OUT, the applicable command syntax is: <b>match <i>service-definition-name</i> [message-type {any   announcement   query}] [location-filter <i>location-filter-name</i>] [source-interface {mDNS-VLAN-number   mDNS-VLAN-range}]</b> .
<b>Step 5</b>	<b>exit</b> <b>Example:</b> Device(config-mdns-sl-in)# <b>exit</b>	Exits mDNS service list configuration mode.

## Creating Service Policy (GUI)

### Procedure

- 
- Step 1** Choose **Configuration > Services > mDNS > Service Policy > Service Policy**.
  - Step 2** Click **Add**.
  - Step 3** Enter the **Service Policy Name**.
  - Step 4** Choose the service list input from the **Service List Input** drop-down list.
  - Step 5** Choose the service list output from the **Service List Output** drop-down list.
  - Step 6** Choose the location from the **Location** drop-down list.
  - Step 7** Click **Apply to Device**.
- 

## Creating Service Policy

A Service Policy that is applied to an interface specifies the allowed Bonjour service announcements or the queries of specific service types that should be processed, in ingress direction or egress direction or both. For this, the service policy specifies two service-lists, one each for ingress and egress directions. In the Local Area Bonjour domain, the same service policy can be attached to one or more Bonjour client VLANs; however, different VLANs may have different service policies.

To configure service policy with service lists, follow these steps:

### Procedure

	Command or Action	Purpose
<b>Step 1</b>	<b>enable</b> <b>Example:</b> Device> <b>enable</b>	Enables privileged EXEC mode. Enter your password, if prompted.
<b>Step 2</b>	<b>configure terminal</b> <b>Example:</b> Device# <b>configure terminal</b>	Enters global configuration mode.
<b>Step 3</b>	<b>mdns-sd service-policy <i>service-policy-name</i></b> <b>Example:</b> Device(config)# <b>mdns-sd service-policy mdns-policy1</b>	Configures mDNS service policy.
<b>Step 4</b>	<b>service-list <i>service-list-name</i> {in   out}</b> <b>Example:</b> Device(config-mdns-ser-pol)# <b>service-list VLAN100-list in</b> Device(config-mdns-ser-pol)# <b>service-list VLAN300-list out</b>	Configures service lists for IN and OUT directions.

	Command or Action	Purpose
<b>Step 5</b>	<b>exit</b> <b>Example:</b> Device(config-mdns-ser-pol)# exit	Exits mDNS service policy configuration mode.

## Associating Service Policy to an Interface

To configure mDNS on the device, follow these steps:

### Procedure

	Command or Action	Purpose
<b>Step 1</b>	<b>enable</b> <b>Example:</b> Device> enable	Enables privileged EXEC mode. Enter your password, if prompted.
<b>Step 2</b>	<b>configure terminal</b> <b>Example:</b> Device# configure terminal	Enters global configuration mode.
<b>Step 3</b>	<b>interface <i>interface-name</i></b> <b>Example:</b> Device(config)# interface Vlan 601	Enters interface mDNS configuration mode and enables interface configuration.
<b>Step 4</b>	<b>mdns-sd gateway</b> <b>Example:</b> Device(config-if)# mdns-sd gateway	Configures mDNS gateway on the interface. Enter the following commands in the interface mDNS gateway configuration mode to enable the respective functionalities: <ul style="list-style-type: none"> <li>• <b>active-query</b>: Sets the time interval for SDG agent to refresh the active status of connected Bonjour client services. The timer value ranges from 60 to 3600 seconds.</li> <li><b>Note</b> This configuration is mandatory only on VLANs whose Bonjour policy is configured to accept Bonjour service announcements from connected Bonjour clients. If the VLAN is configured to only accept Bonjour queries but not Bonjour service announcements, this configuration is optional.</li> <li>• <b>service-instance-suffix(Optional)</b> : Appends the service instance suffix to any</li> </ul>

	Command or Action	Purpose
		<p>announced service name that is forwarded to the controller.</p> <ul style="list-style-type: none"> <li>• <b>service-mdns-query</b> [<b>ptr</b>   <b>all</b>] : Configures mDNS query request message processing for the specified query types. This command is applicable when the controller is in service-peer mode.</li> </ul> <p><b>Note</b> By default, the <b>service-mdns-query</b> command allows only PTR queries. If you need to respond to all (PTR, SRV, and TXT) queries, you need to execute the following command:</p> <p style="padding-left: 40px;"><b>service-mdns-query all</b></p> <ul style="list-style-type: none"> <li>• <b>service-policy</b> <i>policy-name</i>: Attaches the specified service policy to the VLAN. Bonjour announcements, and queries received by and sent from the VLAN are governed by the policies configured in the service policy. This configuration is mandatory for all VLANs.</li> </ul> <p><b>Note</b> Service policies can only be attached at interface level.</p> <ul style="list-style-type: none"> <li>• <b>transport</b> [<b>all</b>   <b>ipv4</b>   <b>ipv6</b>] (Optional): Configures BCP parameter.</li> </ul> <p>It is recommended to use <b>transport ipv4</b> command, except in those networks where the Bonjour clients send only IPv6 announcements and queries.</p>
<b>Step 5</b>	<p><b>exit</b></p> <p><b>Example:</b></p> <pre>Device(config-if-mdns-sd)# exit</pre>	Exits mDNS gateway configuration mode.

## How to Configure Local Area Bonjour in Multicast DNS Mode for Wireless Networks

The configuration of local area Bonjour on a switch that acts as the SDG Agent in a wireless network involves the same set of procedures that are used to configure local area Bonjour on a switch that acts as the SDG Agent in a wired network.

The Bonjour protocol operates on service announcements and queries. Each query or advertisement is sent to the mDNS IPv4 address 224.0.0.251 and IPv6 address FF02::FB. The mDNS messages are carried over well-known industry standard UDP port 5353, over both Layer 3 transport types.

The Layer 2 address used by the Bonjour protocol is link-local multicast address and therefore it's only forwarded to the same Layer 2 network. As multicast DNS (mDNS) is limited to a Layer 2 domain, for a client to discover a service, it has to be a part of the same Layer 2 domain. This isn't always possible in a large-scale deployment or enterprise.

To enable mDNS communication between Wireless endpoints and Cisco Catalyst switch that acts as an SDG Agent, the intermediate WLC must transparently allow the network to transmit and receive mDNS messages.

Hence, for a Multicast DNS Mode Wireless network deployment, disable the mDNS Snooping on Cisco AireOS based WLC and enable mDNS Gateway feature on Cisco Catalyst 9800 series WLC and set the AP Multicast Mode to Multicast.

Figure below illustrates a prerequisite configuration for Wireless network to enable seamless communication between SDG-Agent switches and Wireless endpoints.

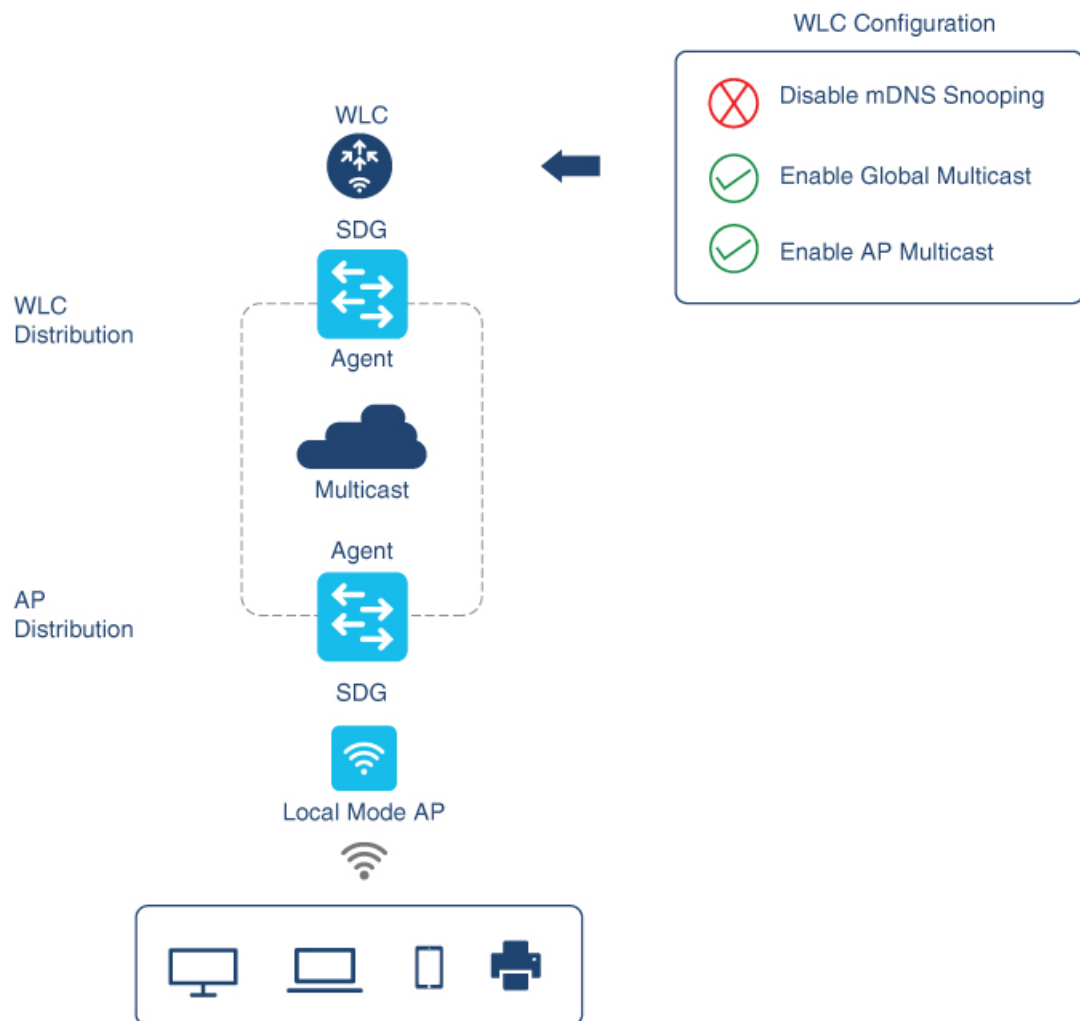

The Cisco WLC and Access Points by default prevent the forwarding of Layer 2 or Layer 3 Multicast frames between Wireless and Wired network infrastructure. The forwarding is supported with stateful capabilities



enabled using AP Multicast. The network administrator must globally enable Multicast and configure a unique Multicast Group to advertise in the network. This multicast group is only required for Cisco Access Points to enable Multicast over Multicast (MCMC) capabilities across the LAN network. The Bonjour solution doesn't require any Multicast requirements on Wireless Client VLAN; thus, it's optional and applicable only for other Layer 3 Multicast applications.

The core network must be configured with appropriate Multicast routing to allow the Access Points to join WLC Multicast Group. The Multicast configuration must be enabled on Cisco WLC management VLAN and on the Cisco Access Points of their respective distribution layer switch.

## Enabling mDNS Gateway on the Device

To configure mDNS on the device, follow these steps:

### Procedure

	Command or Action	Purpose
<b>Step 1</b>	<b>enable</b> <b>Example:</b> Device> <b>enable</b>	Enables privileged EXEC mode. Enter your password, if prompted.
<b>Step 2</b>	<b>configure terminal</b> <b>Example:</b> Device# <b>configure terminal</b>	Enters global configuration mode.
<b>Step 3</b>	<b>mdns-sd gateway</b> <b>Example:</b> Device(config)# <b>mdns-sd gateway</b>	Enables mDNS on the device and enters mDNS gateway configuration mode. Enter the following commands in mDNS gateway configuration mode to enable the respective functionalities: <ul style="list-style-type: none"> <li>• <b>air-print-helper</b>: Enables IOS devices like iPads to discover and use older printers that support Bonjour</li> <li>• <b>cache-memory-max</b>: Configures the percentage memory for cache</li> <li>• <b>ingress-client</b>: Configures Ingress Client Packet Tuners</li> <li>• <b>rate-limit</b>: Enables rate limiting of incoming mDNS packets</li> <li>• <b>service-announcement-count</b>: Configures maximum service advertisement count</li> <li>• <b>service-announcement-timer</b>: Configures advertisements announce timer periodicity</li> <li>• <b>service-query-count</b>: Configures maximum query count</li> </ul>

	Command or Action	Purpose
		<ul style="list-style-type: none"> <li>• <b>service-query-timer</b>: Configures query forward timer periodicity</li> </ul> <p><b>Note</b> For <b>cache-memory-max</b>, <b>ingress-client</b>, <b>rate-limit</b>, <b>service-announcement-count</b>, <b>service-announcement-timer</b>, <b>service-query-count</b>, and <b>service-query-timer</b> commands, you can retain the default value of the respective parameter for general deployments. Configure a different value, if required, for a specific deployment.</p>
<b>Step 4</b>	<b>exit</b> <b>Example:</b> Device(config-mdns-sd)# exit	Exits mDNS gateway configuration mode.

## Creating Custom Service Definition

Service definition is a construct that provides an admin friendly name to one or more mDNS service types or PTR Resource Record Name. By default, a few built-in service definitions are already predefined and available for admin to use. In addition to built-in service definitions, admin can also define custom service definitions.

### Procedure

	Command or Action	Purpose
<b>Step 1</b>	<b>enable</b> <b>Example:</b> Device> enable	Enables privileged EXEC mode. Enter your password, if prompted.
<b>Step 2</b>	<b>configure terminal</b> <b>Example:</b> Device# configure terminal	Enters global configuration mode.
<b>Step 3</b>	<b>mdns-sd service-definition</b> <i>service-definition-name</i> <b>Example:</b> Device(config)# mdns-sd service-definition CUSTOM1	Configures mDNS service definition. <p><b>Note</b> All the created custom service definitions are added to the primary service list. Primary service list comprises of a list of custom and built-in service definitions.</p>
<b>Step 4</b>	<b>service-type</b> <i>string</i> <b>Example:</b>	Configures mDNS service type.

	Command or Action	Purpose
	Device(config-mdns-ser-def)# <b>service-type</b> _custom1._tcp.local	
<b>Step 5</b>	Repeat step 4 to configure more than one service type in the custom service definition.	
<b>Step 6</b>	<b>exit</b> <b>Example:</b> Device(config-mdns-ser-def)# exit	Exit mDNS service definition configuration mode.

## Creating Service List

mDNS service list is a collection of service definitions. To create a service list, follow these steps:

### Procedure

	Command or Action	Purpose
<b>Step 1</b>	<b>enable</b> <b>Example:</b> Device> <b>enable</b>	Enables privileged EXEC mode. Enter your password, if prompted.
<b>Step 2</b>	<b>configure terminal</b> <b>Example:</b> Device# <b>configure terminal</b>	Enters global configuration mode.
<b>Step 3</b>	<b>mdns-sd service-list</b> <i>service-list-name</i> { <b>in</b>   <b>out</b> } <b>Example:</b> Device(config)# <b>mdns-sd service-list</b> VLAN100-list <b>in</b>	Configures mDNS service list.
<b>Step 4</b>	<b>match</b> <i>service-definition-name</i> [ <b>message-type</b> { <b>any</b>   <b>announcement</b>   <b>query</b> }] <b>Example:</b> Device(config-mdns-sl-in)# <b>match</b> PRINTER-IPPS <b>message-type announcement</b>	Matches the service to the message type. Here, <i>service-definition-name</i> refers to the names of services, such as, airplay, airserver, airtunes, and so on.

	Command or Action	Purpose
		<p><b>Note</b> To add a service, the service name must be part of the primary service list.</p> <p>If the mDNS service list is set to IN, the applicable command syntax is:  <b>match</b> <i>service-definition-name</i>  <b>[message-type {any   announcement   query}]</b>.</p> <p>If the mDNS service list is set to OUT, the applicable command syntax is:  <b>match</b> <i>service-definition-name</i>  <b>[message-type {any   announcement   query}] [location-filter</b>  <i>location-filter-name</i> <b>]</b> <b>[source-interface</b>  <i>{mDNS-VLAN-number   mDNS-VLAN-range}</i> <b>]</b>.</p>
<b>Step 5</b>	<b>exit</b>  <b>Example:</b> <pre>Device(config-mdns-sl-in)# exit</pre>	Exits mDNS service list configuration mode.

## Creating Service Policy

A Service Policy that is applied to an interface specifies the allowed Bonjour service announcements or the queries of specific service types that should be processed, in ingress direction or egress direction or both. For this, the service policy specifies two service-lists, one each for ingress and egress directions. In the Local Area Bonjour domain, the same service policy can be attached to one or more Bonjour client VLANs; however, different VLANs may have different service policies.

To configure service policy with service lists, follow these steps:

### Procedure

	Command or Action	Purpose
<b>Step 1</b>	<b>enable</b>  <b>Example:</b> <pre>Device&gt; enable</pre>	Enables privileged EXEC mode.  Enter your password, if prompted.
<b>Step 2</b>	<b>configure terminal</b>  <b>Example:</b> <pre>Device# configure terminal</pre>	Enters global configuration mode.
<b>Step 3</b>	<b>mdns-sd service-policy</b> <i>service-policy-name</i>  <b>Example:</b> <pre>Device(config)# mdns-sd service-policy mdns-policy1</pre>	Configures mDNS service policy.

	Command or Action	Purpose
<b>Step 4</b>	<b>service-list</b> <i>service-list-name</i> {in   out} <b>Example:</b> Device(config-mdns-ser-pol)# <b>service-list</b> <b>VLAN100-list in</b> Device(config-mdns-ser-pol)# <b>service-list</b> <b>VLAN300-list out</b>	Configures service lists for IN and OUT directions.
<b>Step 5</b>	<b>exit</b> <b>Example:</b> Device(config-mdns-ser-pol)# <b>exit</b>	Exits mDNS service policy configuration mode.

## Associating Service Policy with Wireless Profile Policy

A default mDNS service policy is already attached once the wireless profile policy is created. Use the following steps to override the default mDNS service policy with any of your service policy:

### Procedure

	Command or Action	Purpose
<b>Step 1</b>	<b>enable</b> <b>Example:</b> Device> <b>enable</b>	Enables privileged EXEC mode. Enter your password, if prompted.
<b>Step 2</b>	<b>configure terminal</b> <b>Example:</b> Device# <b>configure terminal</b>	Enters global configuration mode.
<b>Step 3</b>	<b>wireless profile policy</b> <i>profile-policy-name</i> <b>Example:</b> Device(config)# <b>wireless profile policy</b> <b>default-policy-profile</b>	Configures wireless profile policy.
<b>Step 4</b>	<b>mdns-sd service-policy</b> <i>custom-mdns-service-policy</i> <b>Example:</b> Device(config-wireless-policy)# <b>mdns-sd</b> <b>service-policy</b> <b>custom-mdns-service-policy</b>	Associates an mDNS service policy with the wireless profile policy. The default mDNS service policy name is <b>default-mdns-service-policy</b> .
<b>Step 5</b>	<b>exit</b> <b>Example:</b> Device(config-wireless-policy)# <b>exit</b>	Exits wireless profile policy configuration mode.

## Configuring Wide Area Bonjour Domain

The Wide Area Bonjour domain configuration specifies the parameters of the controller, that is the Wide Area Bonjour Application running on Cisco Catalyst Center, as well as the service types that need to be exported to it from the SDG Agent. Configuring Wide Area Bonjour Domain involves creating service-lists and service policy similar to those created in Local Area Bonjour configuration; however, only egress policy from SDG Agent to controller is applicable.

### Enabling mDNS Gateway on the Device

To configure mDNS on the device, follow these steps:

#### Procedure

	Command or Action	Purpose
<b>Step 1</b>	<b>enable</b> <b>Example:</b> Device> <b>enable</b>	Enables privileged EXEC mode. Enter your password, if prompted.
<b>Step 2</b>	<b>configure terminal</b> <b>Example:</b> Device# <b>configure terminal</b>	Enters global configuration mode.
<b>Step 3</b>	<b>mdns-sd gateway</b> <b>Example:</b> Device(config)# <b>mdns-sd gateway</b>	Enables mDNS on the device and enters mDNS gateway configuration mode. Enter the following commands in mDNS gateway configuration mode to enable the respective functionalities: <ul style="list-style-type: none"> <li>• <b>air-print-helper</b>: Enables IOS devices like iPads to discover and use older printers that support Bonjour</li> <li>• <b>cache-memory-max</b>: Configures the percentage memory for cache</li> <li>• <b>ingress-client</b>: Configures Ingress Client Packet Tuners</li> <li>• <b>rate-limit</b>: Enables rate limiting of incoming mDNS packets</li> <li>• <b>service-announcement-count</b>: Configures maximum service advertisement count</li> <li>• <b>service-announcement-timer</b>: Configures advertisements announce timer periodicity</li> <li>• <b>service-query-count</b>: Configures maximum query count</li> </ul>

	Command or Action	Purpose
		<ul style="list-style-type: none"> <li>• <b>service-query-timer</b>: Configures query forward timer periodicity</li> </ul> <p><b>Note</b> For <b>cache-memory-max</b>, <b>ingress-client</b>, <b>rate-limit</b>, <b>service-announcement-count</b>, <b>service-announcement-timer</b>, <b>service-query-count</b>, and <b>service-query-timer</b> commands, you can retain the default value of the respective parameter for general deployments. Configure a different value, if required, for a specific deployment.</p>
<b>Step 4</b>	<b>exit</b>  <b>Example:</b> Device(config-mdns-sd)# exit	Exits mDNS gateway configuration mode.

## Creating Custom Service Definition

Service definition is a construct that provides an admin friendly name to one or more mDNS service types or PTR Resource Record Name. By default, a few built-in service definitions are already predefined and available for admin to use. In addition to built-in service definitions, admin can also define custom service definitions.

### Procedure

	Command or Action	Purpose
<b>Step 1</b>	<b>enable</b>  <b>Example:</b> Device> enable	Enables privileged EXEC mode.  Enter your password, if prompted.
<b>Step 2</b>	<b>configure terminal</b>  <b>Example:</b> Device# configure terminal	Enters global configuration mode.
<b>Step 3</b>	<b>mdns-sd service-definition</b> <i>service-definition-name</i>  <b>Example:</b> Device(config)# mdns-sd service-definition CUSTOM1	Configures mDNS service definition.  <b>Note</b> All the created custom service definitions are added to the primary service list. Primary service list comprises of a list of custom and built-in service definitions.
<b>Step 4</b>	<b>service-type</b> <i>string</i>  <b>Example:</b>	Configures mDNS service type.

	Command or Action	Purpose
	Device (config-mdns-ser-def) # <b>service-type</b> _custom1._tcp.local	
<b>Step 5</b>	Repeat step 4 to configure more than one service type in the custom service definition.	
<b>Step 6</b>	<b>exit</b> <b>Example:</b> Device (config-mdns-ser-def) # exit	Exit mDNS service definition configuration mode.

## Creating Service List

mDNS service list is a collection of service definitions. To create a service list, follow these steps:

### Procedure

	Command or Action	Purpose
<b>Step 1</b>	<b>enable</b> <b>Example:</b> Device> <b>enable</b>	Enables privileged EXEC mode. Enter your password, if prompted.
<b>Step 2</b>	<b>configure terminal</b> <b>Example:</b> Device# <b>configure terminal</b>	Enters global configuration mode.
<b>Step 3</b>	<b>mdns-sd service-list</b> <i>service-list-name</i> { <b>in</b>   <b>out</b> } <b>Example:</b> Device (config)# <b>mdns-sd service-list</b> <b>VLAN100-list in</b>	Configures mDNS service list.
<b>Step 4</b>	<b>match</b> <i>service-definition-name</i> [ <b>message-type</b> { <b>any</b>   <b>announcement</b>   <b>query</b> }] <b>Example:</b> Device (config-mdns-sl-in) # <b>match</b> <b>PRINTER-IPPS message-type announcement</b>	Matches the service to the message type. Here, <i>service-definition-name</i> refers to the names of services, such as, airplay, airserver, airtunes, and so on.



	Command or Action	Purpose
		<p><b>Note</b> To add a service, the service name must be part of the primary service list.</p> <p>If the mDNS service list is set to IN, the applicable command syntax is:  <b>match</b> <i>service-definition-name</i> [message-type {any   announcement   query}].</p> <p>If the mDNS service list is set to OUT, the applicable command syntax is:  <b>match</b> <i>service-definition-name</i> [message-type {any   announcement   query}] [location-filter <i>location-filter-name</i>] [source-interface {mDNS-VLAN-number   mDNS-VLAN-range}].</p>
<b>Step 5</b>	<p><b>exit</b></p> <p><b>Example:</b></p> <pre>Device(config-mdns-sl-in)# exit</pre>	Exits mDNS service list configuration mode.

## Creating Service Policy

A Service Policy that is applied to an interface specifies the allowed Bonjour service announcements or the queries of specific service types that should be processed, in ingress direction or egress direction or both. For this, the service policy specifies two service-lists, one each for ingress and egress directions. In the Local Area Bonjour domain, the same service policy can be attached to one or more Bonjour client VLANs; however, different VLANs may have different service policies.

To configure service policy with service lists, follow these steps:

### Procedure

	Command or Action	Purpose
<b>Step 1</b>	<p><b>enable</b></p> <p><b>Example:</b></p> <pre>Device&gt; enable</pre>	<p>Enables privileged EXEC mode.</p> <p>Enter your password, if prompted.</p>
<b>Step 2</b>	<p><b>configure terminal</b></p> <p><b>Example:</b></p> <pre>Device# configure terminal</pre>	Enters global configuration mode.
<b>Step 3</b>	<p><b>mdns-sd service-policy</b> <i>service-policy-name</i></p> <p><b>Example:</b></p> <pre>Device(config)# mdns-sd service-policy mdns-policy1</pre>	Configures mDNS service policy.

	Command or Action	Purpose
<b>Step 4</b>	<b>service-list</b> <i>service-list-name</i> { <b>in</b>   <b>out</b> } <b>Example:</b> Device(config-mdns-ser-pol)# <b>service-list</b> <b>VLAN100-list in</b> Device(config-mdns-ser-pol)# <b>service-list</b> <b>VLAN300-list out</b>	Configures service lists for IN and OUT directions.
<b>Step 5</b>	<b>exit</b> <b>Example:</b> Device(config-mdns-ser-pol)# <b>exit</b>	Exits mDNS service policy configuration mode.

## Associating Service Policy with the Controller in Wide Area Bonjour Domain

In Wide Area Bonjour, the service policy is configured globally and does not get associated with a VLAN as in the case of Local Area Bonjour.

To configure service policy globally, follow these steps:

### Procedure

	Command or Action	Purpose
<b>Step 1</b>	<b>enable</b> <b>Example:</b> Device> <b>enable</b>	Enables privileged EXEC mode. Enter your password, if prompted.
<b>Step 2</b>	<b>configure terminal</b> <b>Example:</b> Device# <b>configure terminal</b>	Enters global configuration mode.
<b>Step 3</b>	<b>service-export mdns-sd controller</b> <i>controller name</i> <b>Example:</b> Device(config)# <b>service-export mdns-sd</b> <b>controller</b> Cisco Catalyst Center-BONJOUR-CONTROLLER	Specifies a name for the controller and enters service-export mode
<b>Step 4</b>	<b>controller-address</b> <i>ipv4-address</i> <b>Example:</b> Device(config-mdns-sd-se)# <b>controller-address</b> 199.245.1.7	Specifies the controller address.
<b>Step 5</b>	<b>controller-port</b> <i>port-number</i> <b>Example:</b> Device(config-mdns-sd-se)# <b>controller-port</b> 9991	Specifies the port number on which the controller is listening.

	Command or Action	Purpose
<b>Step 6</b>	<b>controller-source-interface</b> <i>interface-name</i> <b>Example:</b> Device(config-mdns-sd-se) # <b>controller-source-interface</b> Loopback0	Specifies the source-interface for the controller.
<b>Step 7</b>	<b>controller-service-policy</b> <i>service-policy-name</i> <b>out</b> <b>Example:</b> Device(config-mdns-sd-se) # <b>controller-service-policy</b> policy1 OUT	Specifies the service policy to be used by the controller. <b>Note</b> Only OUT policy is applicable for Wide Area Bonjour.
<b>Step 8</b>	<b>exit</b> <b>Example:</b> Device(config-mdns-sd) # exit	Exits controller service export configuration mode.
<b>Step 9</b>	<b>mdns-sd gateway</b> <b>Example:</b> Device(config) # <b>mdns-sd gateway</b>	Enters mDNS gateway configuration mode.
<b>Step 10</b>	<b>ingress-client query-suppression enable</b> <b>Example:</b> Device(config-mdns-sd) # ingress-client query-suppression enable	Enables ingress query suppression for better scale and performance.
<b>Step 11</b>	<b>exit</b> <b>Example:</b> Device(config-mdns-sd) # exit	Exits mDNS gateway configuration mode.

## Configuring Hot Standby Router Protocol-aware (HSRP-aware) mDNS Service-Routing on SDG

For information, see the following guides:

- [Software Configuration Guide, Cisco IOS XE Bengaluru 17.6.x \(Catalyst 9300 Switches\)](#)
- [Software Configuration Guide, Cisco IOS XE Bengaluru 17.6.x \(Catalyst 9400 Switches\)](#)
- [Software Configuration Guide, Cisco IOS XE Bengaluru 17.6.x \(Catalyst 9600 Switches\)](#)

# Configuring Hot Standby Router Protocol-aware (HSRP-aware) mDNS Service-Routing on Service-Peer (CLI)

## Procedure

	Command or Action	Purpose
<b>Step 1</b>	<b>configure terminal</b> <b>Example:</b> Device# configure terminal	Enters global configuration mode.
<b>Step 2</b>	<b>mdns-sd gateway</b> <b>Example:</b> Device(config)# mdns-sd gateway	Enables mDNS on the device and enters mDNS gateway configuration mode.
<b>Step 3</b>	<b>mode service-peer</b> <b>Example:</b> Device(config-mdns-sd)# mode service-peer	Enables mDNS gateway in service-peer mode.
<b>Step 4</b>	<b>source-interface vlan</b> vlan-interface-number <b>Example:</b> Device(config-mdns-sd)# source-interface vlan 23	Configures source interface to communicate between SDG Agent and service-peer. <b>Note</b> <i>vlan-interface-number</i> - The valid range is from 1 to 4094.
<b>Step 5</b>	<b>sdg-agent ip-address</b> <b>Example:</b> Device(config-mdns-sd)# sdg-agent 9.6.16.10	Configures SDG agent IPv4 or IPv6 address. <b>Note</b> The <i>ip-address</i> refers to the HSRP-enabled IP address.
<b>Step 6</b>	<b>end</b> <b>Example:</b> Device(config-mdns-sd)# end	Exits server group configuration mode and enters privileged EXEC mode.

## Verifying Local Area Bonjour in Multicast DNS Mode for LAN and Wireless Networks

This section shows how to verify Local Area Bonjour in Multicast DNS mode for LAN and Wireless networks.

### Verifying SDG-Agent Status

The following is a sample output of the **show mdns-sd service-list** *service-list-name* {**in** | **out**} command.

Name	Direction	Service	Message-Type	Source
VLAN100-list	In	Printer	Announcement	-
	In	Airplay	Query	-
	In	CUSTOM1	Any	-
VLAN300-list	Out	Printer	Announcement	V1200

The following is a sample output of the **show mdns-sd service-definition** *service-definition-name* **service-type** *{custom | built-in}* command.

Service	PTR	Type
apple-tv	_airplay._tcp.local	Built-In
	_raop._tcp.local	
apple-file-share	_afpovertcp._tcp.local	Built-In
CUSTOM1	_custom1._tcp.local	Custom
CUSTOM2	_customA._tcp.local	Custom
	_customA._tcp.local	

The following is a sample output of the **show mdns-sd** *service-policy-name* **interface** *interface-name* command.

Name	Service-List-In	Service-List-Out
mdns-policy-1	VLAN100-list	VLAN300-list
mdns-policy-2	VLAN400-list	VLAN400-list

The following is a sample output of the **show mdns-sd summary** command.

```

mDNS Gateway: Enabled
Mode: Service Peer
Service Announcement Periodicity(in seconds): 30
Service Announcement Count: 50
Service Query Periodicity(in seconds): 15
Service Query Count: 50
Active Response Timer (in seconds): Disabled
ANY Query Forward: Disabled
SDG Agent IP: 9.8.57.10
Active Query Periodicity (in minutes): 30
mDNS Query Type: PTR only
Transport Type: IPv4
mDNS AP service policy: default-mdns-service-policy

```

The following is a sample output of the **show mdns-sd sp-sdg statistics** command.

```

mDNS SP Statistics
last reset time: 07/27/21 15:36:33
Messages sent:
Query : 122
ANY query : 35
Advertisements : 12

```

```

Advertisement Withdraw : 1
Service-peer cache clear : 0
Resync response : 3
Srvc Discovery response : 0
Keep-Alive : 2043
Messages received:
Query response : 0
ANY Query response : 0
Cache-sync : 9
Get service-instance : 0
Srvc Discovery request : 0
Keep-Alive Response : 2042

```

## Verifying Wide Area Bonjour Controller Status

The following is a sample output of the **show mdns controller summary** command.

```
Device# show mdns controller summary
```

```
Controller Summary
```

```

=====
Controller Name   : Cisco Catalyst Center-BONJOUR-CONTROLLER
Controller IP    : 10.104.52.241
State            : UP
Port             : 9991
Interface        : Loopback0
Filter List      : policy1
Dead Time        : 00:01:00

```

The following is a sample output of the **show mdns controller export-summary** command.

```
Device# show mdns controller export-summary
```

```
Controller Export Summary
```

```

=====
Controller IP    : 10.104.52.241
State           : UP
Filter List      : policy1
Count           : 100
Delay Timer      : 30 seconds
Export          : 300
Drop            : 0
Next Export      : 00:00:01

```

The following is a sample output of the **show mdns controller statistics** command.

```
Device# show mdns controller statistics
```

```

Total BCP message sent           : 47589
Total BCP message received       : 3
Interface WITHDRAW messages sent : 0
Clear cache messages sent        : 0
Total RESYNC state count         : 0
Last successful RESYNC           : Not-Applicable

```

```

Service Advertisements:
  IPv6 advertised           : 0
  IPv4 advertised           : 300
  Withdraws sent           : 0
  Advertisements Filtered   : 0
  Total service resynced    : 0

Service Queries:
  IPv6 queries sent         : 0
  IPv6 query responses received : 0
  IPv4 queries sent         : 0
  IPv4 query responses received : 0

```

The following is a sample output of the **show mdns controller detail** command.

```

Device# show mdns controller detail

Controller : Cisco Catalyst Center-BONJOUR-CONTROLLER
  IP : 10.104.52.241, Dest Port : 9991, Src Port : 0, State : UP
  Source Interface : Loopback0, MD5 Disabled
  Hello Timer 0 sec, Dead Timer 0 sec, Next Hello 00:00:00
  Uptime 00:00:00
Service Announcement :
  Filter : policy1
  Count 100, Delay Timer 30 sec, Pending Announcement 0, Pending Withdraw
  0
  Total Export Count 300, Next Export in 00:00:16
Service Query :
  Query Suppression Disabled
  Query Count 50, Query Delay Timer 15 sec, Pending 0
  Total Query Count 0, Next Query in 00:00:01

```

## Verifying mDNS Cache Configurations

The following show commands display cache from both Active and Standby devices using the chassis option:

```

Device# show mdns-sd cache chassis active R0

----- PTR Records -----
-----
RECORD-NAME                                TTL      TYPE      ID      CLIENT-MAC
RR-RECORD-DATA
-----
_home-sharing._tcp.local                   4500     WLAN      1       0205.2c23.0001
AP6B8B4567-sta00001._home-sharing._tcp.local

----- SRV Records -----
-----
RECORD-NAME                                TTL      TYPE      ID      CLIENT-MAC
RR-RECORD-DATA
-----
AP6B8B4567-sta00001._home-sharing._tcp.local 4500     WLAN      1       0205.2c23.0001  0
  0 5353 AP6B8B4567-sta00001.local

```

```

----- A/AAAA Records
-----
RECORD-NAME                               TTL      TYPE      ID      CLIENT-MAC
RR-RECORD-DATA
-----
AP6B8B4567-sta00001.local                 4500     WLAN      1       0205.2c23.0001
9.2.57.106

----- TXT Records
-----
RECORD-NAME                               TTL      TYPE      ID      CLIENT-MAC
RR-RECORD-DATA
-----
AP6B8B4567-sta00001._home-sharing._tcp.local 4500     WLAN      1       0205.2c23.0001
[14] 'model=MacMini'

```



**Note** Alternatively, you can issue the **show mdns-sd cache** command to display the cache from the Active controller.

```

Device# show mdns-sd cache chassis standby R0

----- PTR Records
-----
RECORD-NAME                               TTL      TYPE      ID      CLIENT-MAC
RR-RECORD-DATA
-----
_home-sharing._tcp.local                 4500     WLAN      1       0205.2c23.0001
AP6B8B4567-sta00001._home-sharing._tcp.local

----- SRV Records
-----
RECORD-NAME                               TTL      TYPE      ID      CLIENT-MAC
RR-RECORD-DATA
-----
AP6B8B4567-sta00001._home-sharing._tcp.local 4500     WLAN      1       0205.2c23.0001  0
0 5353 AP6B8B4567-sta00001.local

----- A/AAAA Records
-----
RECORD-NAME                               TTL      TYPE      ID      CLIENT-MAC
RR-RECORD-DATA
-----
AP6B8B4567-sta00001.local                 4500     WLAN      1       0205.2c23.0001
9.2.57.106

----- TXT Records
-----
RECORD-NAME                               TTL      TYPE      ID      CLIENT-MAC
RR-RECORD-DATA
-----
AP6B8B4567-sta00001._home-sharing._tcp.local 4500     WLAN      1       0205.2c23.0001
[14] 'model=MacMini'

```

## Verifying Additional mDNS Cache Configurations

To verify the cache from the Active DB, use the following commands:

```
show mdns-sd cache ap-mac 0a0b.0cf0.000e chassis active R0
```



```

show mdns-sd cache client-mac 0269.fe06.0023 chassis active R0
show mdns-sd cache detail chassis active R0
show mdns-sd cache glan-id <> chassis active R0
show mdns-sd cache glan-id <> detail chassis active R0
show mdns-sd cache location-group <> chassis active R0
show mdns-sd cache location-group <> detail chassis active R0
show mdns-sd cache mdns-ap <> detail chassis active R0
show mdns-sd cache mdns-ap <> chassis active R0
show mdns-sd cache rlan-id <> detail chassis active R0
show mdns-sd cache rlan-id <> chassis active R0
show mdns-sd cache type TXT chassis active R0
show mdns-sd cache type A-AAAA detail chassis active R0
show mdns-sd cache wired chassis active R0
show mdns-sd cache wired detail chassis active R0
show mdns-sd cache wlan-id 10 chassis active R0
show mdns-sd cache wlan-id 1 detail chassis active R0

```

To verify the cache from the Standby DB, use the following commands:

```

show mdns-sd cache ap-mac <> chassis standby R0
show mdns-sd cache client-mac <> chassis standby R0
show mdns-sd cache detail chassis standby R0
show mdns-sd cache glan-id <> chassis standby R0
show mdns-sd cache glan-id <> detail chassis standby R0
show mdns-sd cache location-group <> chassis standby R0
show mdns-sd cache location-group <> detail chassis standby R0
show mdns-sd cache mdns-ap <> detail chassis standby R0
show mdns-sd cache mdns-ap <> chassis standby R0
show mdns-sd cache rlan-id <> detail chassis standby R0
show mdns-sd cache rlan-id <> chassis standby R0
show mdns-sd cache type [A-AAAA|PTR|SRV|TXT] chassis standby R0
show mdns-sd cache type [A-AAAA|PTR|SRV|TXT] detail chassis standby R0
show mdns-sd cache wired chassis standby R0
show mdns-sd cache wired detail chassis standby R0
show mdns-sd cache wlan-id <> chassis standby R0
show mdns-sd cache wlan-id <> detail chassis standby R0

```

## Verifying Local Area Bonjour Configuration for LAN and Wireless Networks

The following is a sample output of the **show run** command.

```

mdns-sd gateway

mdns-sd service-definition custom1
  service-type _airplay._tcp.local
  service-type _raop._tcp.local

mdns-sd service-list list1 IN
  match custom1
mdns-sd service-list list2 OUT
  match custom1

mdns-sd service-policy policy1
  service-list list1 IN

```

```
service-list list2 OUT
```

```
service-export mdns-sd controller Cisco Catalyst Center-CONTROLLER-POLICY
controller-address 99.99.99.10
controller-service-policy policy1 OUT
controller-source-interface Loopback0
```

## Additional References for DNA Service for Bonjour

Related Topic	Document Title
Cisco Wide Area Bonjour Application on Cisco Catalyst Center User Guide	<a href="#">Cisco Wide Area Bonjour Application on Cisco Catalyst Center User Guide, Release 1.3.1.0</a>

### MIBs

MIB	MIBs Link
CISCO-SDG-MDNS-MIB	This MIB module defines objects describing the statistics of 63 local area and wide area mDNS SDG agent. Statistics could be 64 either global or per interface specific.

## Feature History for Cisco DNA Service for Bonjour

The following table provides release information about the feature or features described in this module. This table lists only the software release that introduced support for a given feature in a given software release train. Unless noted otherwise, subsequent releases of that software release train also support that feature.

Release	Modification
Cisco IOS 15.2(6) E2	Cisco DNA Service for Local Area Bonjour and Wide Area Bonjour was introduced on the following platforms: <ul style="list-style-type: none"> <li>• Cisco Catalyst 2960-X Series Switches</li> <li>• Cisco Catalyst 2960-XR Series Switches</li> </ul>
Cisco IOS 15.5(1)SY4	Cisco DNA Service for Local Area Bonjour and Wide Area Bonjour was introduced on Cisco Catalyst 6800 Series Switches.

Release	Modification
Cisco IOS XE 3.11.0 E	Cisco DNA Service for Local Area Bonjour and Wide Area Bonjour was introduced on the following platforms: <ul style="list-style-type: none"> <li>• Cisco Catalyst 4500-E Series Switches</li> <li>• Cisco Catalyst 4500-X Series Switches</li> </ul>
Cisco IOS XE Gibraltar 16.11.1	Cisco DNA Service for Local Area Bonjour and Wide Area Bonjour was introduced on the following platforms: <ul style="list-style-type: none"> <li>• Cisco Catalyst 3650 Series Switches</li> <li>• Cisco Catalyst 3850 Series Switches</li> <li>• Cisco Catalyst 9300 Series Switches</li> <li>• Cisco Catalyst 9400 Series Switches</li> <li>• Cisco Catalyst 9500 Series Switches</li> <li>• Cisco Catalyst 9500 Series Switches - High Performance</li> <li>• Cisco Catalyst 9600 Series Switches</li> <li>• Cisco Catalyst 9800 Series Wireless Controllers</li> <li>• Cisco 5500 Series Wireless Controllers</li> <li>• Cisco 8540 Wireless Controllers</li> <li>• Cisco 4000 Series Integrated Services Routers (ISR)</li> </ul>
Cisco IOS XE Amsterdam 17.1.1	Cisco DNA Service for Local Area Bonjour and Wide Area Bonjour was introduced on Cisco Catalyst 9200 Series Switches.
Cisco IOS XE Amsterdam 17.2.1	Introduced Cisco DNA Service for Bonjour support for the following: <ul style="list-style-type: none"> <li>• SD-Access network</li> <li>• Unicast mode for LAN network</li> </ul>
Cisco IOS XE Amsterdam 17.3.2a	Introduced Cisco DNA Service for Bonjour support for the following: <ul style="list-style-type: none"> <li>• Multilayer networks</li> <li>• Location grouping in wired networks</li> <li>• mDNS AP group in wireless networks</li> </ul>

Release	Modification
Cisco IOS XE Bengaluru 17.6.1	<p data-bbox="987 289 1477 382">Introduced support for the following features for Local Area Bonjour in Unicast Mode for LAN networks:</p> <ul data-bbox="1023 403 1461 537" style="list-style-type: none"><li data-bbox="1023 403 1461 436">• Default mDNS Service Configurations</li><li data-bbox="1023 453 1461 487">• HSRP-Aware mDNS Service-Routing</li><li data-bbox="1023 504 1461 537">• mDNS Service-Gateway SSO Support</li></ul>



## CHAPTER 195

# Configuring Local Area Bonjour for Wireless Local Mode

---

- [Overview of Local Area Bonjour for Wireless Local Mode, on page 1947](#)
- [Prerequisites for Local Area Bonjour for Wireless Local Mode, on page 1947](#)
- [Restrictions for Local Area Bonjour for Wireless Local Mode, on page 1948](#)
- [Understanding Local Area Bonjour for Wireless Local Mode, on page 1948](#)
- [Configuring Wireless AP Multicast, on page 1949](#)
- [Configuring Local Area Bonjour for Wireless Local Mode, on page 1952](#)
- [Verifying mDNS Gateway Configuration, on page 1963](#)
- [Reference, on page 1965](#)

## Overview of Local Area Bonjour for Wireless Local Mode

The Cisco Catalyst 9800 series controller introduces unicast mode function in Local Area Bonjour network domain. The enhanced gateway function at the first hop of Wired and Wireless networks communicates directly with any industry standard RFC 6762 compliant Multicast DNS (mDNS) end point in Layer 2 Unicast mode. The controller also introduces new service-peer mode expanding classic single-gateway controller to end-to-end service-routing with upstream SDG agent switch to enable unicast-mode, increased scale, performance and resiliency in the network.

## Prerequisites for Local Area Bonjour for Wireless Local Mode

The Cisco Catalyst 9800 series controller must be successfully configured and be operational before implementing Cisco Local Area Bonjour for local mode wireless networks.

The following list provides the prerequisites for the controller that is to be deployed in service-peer mode:

- Ensure that the targeted controller for the service-peer role has the required Cisco IOS-XE software version. See *Supported SDG Agents with Supported Licenses and Software Requirements* table in Cisco DNA Service for Bonjour Solution Overview chapter.
- Ensure that the controller runs a valid Cisco DNA-Advantage license.
- Ensure that the upstream distribution-layer Cisco Catalyst switch in SDG agent mode runs a valid Cisco DNA-Advantage license.

- Ensure that the controller is interconnected as Layer 2 trunk in static 802.1Q mode, when Layer 2 Unicast service-routing is running between SDG agent in distribution-layer and the controller service-peer.
- Ensure that the controller has IP reachability to upstream Cisco Catalyst 9000 series switches in SDG agent mode over same the IPv4 wireless management subnet.
- Ensure that global multicast is enabled on the controller and AP is set to multicast mode. All local mode APs must join the multicast group in the network to successfully process mDNS messages.

## Restrictions for Local Area Bonjour for Wireless Local Mode

- Controller management port is not supported for service-routing with upstream Catalyst SDG Agent switch.
- The controller in service peer mode supports location-based service for access points in local mode and FlexConnect central switching mode.
- The controller supports location-based capabilities only between wireless connected service provider and the receiver.
- The controller does not support service-routing configuration using GUI.

## Understanding Local Area Bonjour for Wireless Local Mode

The traditional wireless controller supported mDNS snooping function with various advancements for wireless networks. As the enterprise requirements expands, it drives the IT organization to introduce new network deployment models, supporting mobile devices and distributed zero-configuration services following increased scale, granular security control and resiliency for mission critical networks. The unified Cisco IOS-XE operating system across Cisco Catalyst 9000 series LAN switches and Cisco Catalyst 9800 series controller enables distributed Bonjour gateway function at the network edge. With end-to-end Wide Area Bonjour service-routing, the new solution enables service-oriented enterprise networks with intuitive user-experience.

The following figure illustrates the controller platform supporting mDNS gateway function to wireless users in local mode and builds service-routing peering with upstream Cisco Catalyst 9000 series switch for network-wide services discovery and distribution based on IT-managed granular policies and locations. The unicast based service-routing between the controller in service-peer mode and upstream SDG-Agent switch eliminates mDNS flooding over Layer 2 trunk ports and provide increase bandwidth and eliminates mDNS flood over wireless networks and Layer 2 trunk to upstream network.

Figure 65: Cisco Catalyst 9800 Series Controller Local Area Bonjour for Wireless Local Mode



## Configuring Wireless AP Multicast

The controller and AP by default prevents forwarding of Layer 2 or Layer 3 Multicast frames between wireless and wired network infrastructure. The forwarding is supported with stateful capabilities enabled using AP multicast. To allow mDNS message processing over a wireless network, multicast must be enabled and unique AP multicast group must be configured on the controller to advertise in IP core network. This AP multicast group is only required for APs to enable Multicast over Multicast (MCMC) capabilities in the network. The Bonjour solution do not require any other multicast requirements on wireless client VLAN; thus, it is optional and applicable only for other Layer 3 multicast applications.

The figure given below illustrates end-to-end wireless multicast configuration requirement to ensure wireless APs successfully join the controller-announced multicast group.

Figure 66: Multicast Routing in IP Core Network

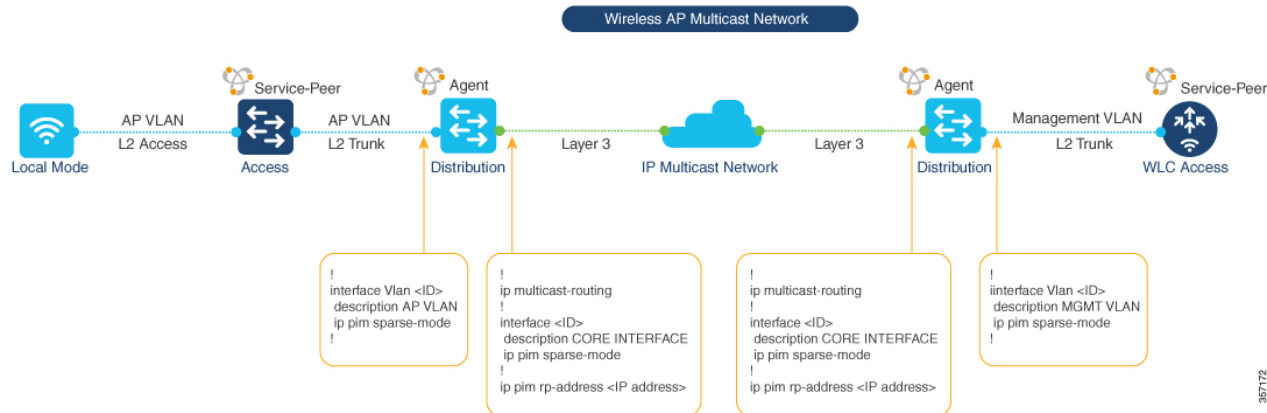

## Configuring Wireless AP Multicast (GUI)

This procedure configures wireless AP multicast on a controller in service-peer mode.

### Procedure

- Step 1** Choose **Configuration > Services > Multicast**.
- Step 2** Set the **Global Wireless Multicast Mode** to **Enabled**.
- Step 3** From the AP Capwap Multicast drop-down list, select **Multicast**.
- Step 4** Enter a unique IP address at **AP Capwap IPv4 Multicast group Address**.
- Step 5** Click **Apply**.
- Step 6** Click **Save**.

## Configuring Wireless AP Multicast (CLI)

This procedure configures wireless AP multicast on a controller in service-peer mode.

### Procedure

	Command or Action	Purpose
<b>Step 1</b>	<b>configure terminal</b> <b>Example:</b> Device# configure terminal	Enters global configuration mode.
<b>Step 2</b>	<b>wireless multicast</b> <b>Example:</b> Device(config)# wireless multicast	Enable global IP multicast processing.



	Command or Action	Purpose
<b>Step 3</b>	<b>wireless multicast</b> <i>IPv4-multicast-address</i> <b>Example:</b> Device(config)# wireless multicast 239.254.254.1	Enables AP CAPWAP mode to Multicast with unique IPv4 multicast address configurations.
<b>Step 4</b>	<b>exit</b> <b>Example:</b> Device(config-mdns-sd)# exit	Exits mDNS gateway configuration mode.

## Configuring Multicast in IP Network (CLI)

This procedure configures IP Multicast under AP VLAN, Management VLAN and IP core interfaces on upstream Catalyst LAN distribution-layer switch.

### Procedure

	Command or Action	Purpose
<b>Step 1</b>	<b>configure terminal</b> <b>Example:</b> Device# configure terminal	Enters global configuration mode.
<b>Step 2</b>	<b>ip multicast-routing</b> <b>Example:</b> Device(config)# ip multicast-routing	Enables IP multicast processing.
<b>Step 3</b>	<b>interface</b> <i>interface-id</i> <b>Example:</b> Device(config)# interface TenGigabitEthernet 1/0	Selects an interface that is connected to hosts and network devices on which PIM can be enabled.
<b>Step 4</b>	<b>ip pim sparse-mode</b> <b>Example:</b> Device(config-if)# ip pim sparse-mode	Enables IP Multicast on Layer 3 interfaces of distribution and core layer network switches: <ul style="list-style-type: none"> <li>• <b>AP VLAN</b>– Enables IP multicast on SVI interface on VLAN assigned to wireless APs of wireless AP distribution layer switch.</li> <li>• <b>Management VLAN</b>– Enables IP multicast on SVI interface on VLAN assigned to controller management VLAN of wireless distribution layer switch.</li> <li>• <b>Layer 3 Interface</b>– Enable IP multicast routing on all core network devices and Layer 3 interfaces.</li> </ul>

	Command or Action	Purpose
<b>Step 5</b>	<b>exit</b>  <b>Example:</b> Device(config-if)# exit	Exits interface configuration mode.
<b>Step 6</b>	<b>ip pim rp-address rp-address</b>  <b>Example:</b> Device(config)# ip pim rp-address 239.254.254.100	Configures IP Multicast RP address on core and distribution network switches. IP network may have alternate multicast routing method.

## Configuring Local Area Bonjour for Wireless Local Mode

This section provides configuration guidelines to implement Cisco Catalyst 9800 series controller as mDNS gateway and enable service-peer mode to enable service-routing with upstream distribution-layer Cisco Catalyst 9000 series switch in SDG-Agent mode to build Local Area Bonjour.

### Configuring mDNS Service Policy (GUI)

The mDNS service policy consists of creating a service-list to permit built-in or user-defined custom service-types, associate service-list to a service-policy to enforce in ingress or egress direction and apply the service-policy to targeted Wireless Profile. This configuration is common on the controller in service peer or single-gateway solution for wireless networks.

This procedure configures mDNS Service-Policy on a controller in service-peer mode.

#### Procedure

- 
- Step 1** Choose **Configuration > Services > mDNS**.
- Step 2** Set the mDNS Gateway button to **Enabled**.
- Step 3** Click **Service Policy** Tab.
- Step 4** Click **Service List** and click **Add**.
- This activates the Service List window.
- Step 5** In the **Service List Name** field, enter a unique name with alphanumeric value.
- Step 6** From the **Direction** drop-down list, select service list policy direction. Use **IN** for ingress or **OUT** for egress mDNS message matching policy.
- Step 7** Click **+Add Services** to add mDNS service-types in selected service list.
- Step 8** From the **Available Services** drop-down list, select built-in or custom mDNS service-type.
- Step 9** From the **Message Type** drop-down list, select **Announcement** to accept service advertisement or **Query** to permit service discovery from the network. Default message-type is **any**.
- Step 10** Click **Save** button to add mDNS service-type entry.
- Note** Repeat Step-7 to Step-9 to add more mDNS service-types in selected service list.

- Step 11** Click **Apply to Device**.  
This creates a new mDNS Service List for selected direction.  
**Note** Repeat Step-5 to Step-11 for bi-directional service list.
- Step 12** Click **Service-Policy** tab.
- Step 13** Click **+Add** to create new mDNS service-policy.
- Step 14** In the **Service Policy Name** field, enter a unique mDNS service policy name.
- Step 15** From the **Service List Input** drop-down list, select ingress mDNS service list input to enforce mDNS policies on ingress direction from wireless networks.
- Step 16** From the **Service List Output** drop-down list, select mDNS policies on egress direction to wireless networks.
- Step 17** Click **Apply to Device**.  
This creates a new mDNS service policy.
- Step 18** Choose **Configuration > Tags & Profiles > Policy**
- Step 19** Choose or create a new **Policy Profile**.
- Step 20** Click **Advanced** tab.
- Step 21** From the **mDNS Service Policy** drop-down list, select an mDNS service policy.  
Refer to Cisco Catalyst 9800 Series Configuration Guide to configure other policy profile parameters.
- Step 22** Click **Apply to Device** button.  
This creates a new policy profile or updates an existing policy profile with mDNS service policy.
- Step 23** Click **Save**.

## Configuring mDNS Service Policy (CLI)

This procedure builds and applies service-policies on target wireless profile in service-peer mode.

### Procedure

	Command or Action	Purpose
<b>Step 1</b>	<b>configure terminal</b>  <b>Example:</b> Device# configure terminal	Enters global configuration mode.
<b>Step 2</b>	<b>mdns-sd service-list</b> <i>service-list-name</i> {in   out}  <b>Example:</b> Device(config)# mdns-sd service-list VLAN100-LIST-IN in Device(config)# mdns-sd service-list VLAN100-LIST-OUT out	Configures mDNS service-list to classify one or more service-types. Unique service-list is required to process incoming mDNS message and outbound response to requesting end points.

	Command or Action	Purpose
<b>Step 3</b>	<b>match service-definition-name</b> [ <b>message-type</b> { <b>any</b>   <b>announcement</b>   <b>query</b> } ]  <b>Example:</b> <pre>Device(config)# mdns-sd service-list VLAN100-LIST-IN in Device(config-mdns-sl-in)# match APPLE-TV Device(config-mdns-sl-in)# match PRINTER-IPPS message-type announcement</pre>	Matches inbound service-list. The controller validates to accept or drop incoming mDNS service-type (for example, Apple TV) advertisement or query matching message type. The service-list contains implicit deny at the end. Default message-type is “any”.
<b>Step 4</b>	<b>match service-definition-name</b> [ <b>message-type</b> { <b>any</b>   <b>announcement</b>   <b>query</b> } ]  <b>Example:</b> <pre>Device(config)# mdns-sd service-list VLAN100-LIST-OUT out Device(config-mdns-sl-in)# match APPLE-TV Device(config-mdns-sl-in)# match PRINTER-IPPS</pre>	Matches an outbound service-list. The controller provides local service proxy function by responding matching service-type to the requesting end points. For example, the Apple-TV and Printer learnt from VLAN 100 will be distributed to receiver in same VLAN 100. The service-list contains implicit deny at the end.  The message-type for outbound service-list is not required.
<b>Step 5</b>	<b>exit</b>  <b>Example:</b> <pre>Device(config-mdns-sl-in)# exit</pre>	Returns to global configuration mode.
<b>Step 6</b>	<b>mdns-sd service-policy</b> <i>service-policy-name</i>  <b>Example:</b> <pre>Device(config)# mdns-sd service-policy VLAN100-POLICY</pre>	Creates a unique mDNS service-policy.
<b>Step 7</b>	<b>service-list</b> <i>service-list-name</i> { <b>in</b>   <b>out</b> }  <b>Example:</b> <pre>Device(config-mdns-ser-policy)# service-list VLAN100-LIST-IN in Device(config-mdns-ser-policy)# service-list VLAN100-LIST-OUT out</pre>	Configure mDNS service-policy to associate service-list for each direction.
<b>Step 8</b>	<b>exit</b>  <b>Example:</b> <pre>Device(config-mdns-ser-policy)# exit</pre>	Exits mDNS service policy configuration mode.
<b>Step 9</b>	<b>wireless profile policy</b> <i>policy-name</i>  <b>Example:</b> <pre>Device(config)# wireless profile policy WLAN-PROFILE</pre>	Configures unique wireless profile policy name to associate mDNS service-policy.

	Command or Action	Purpose
<b>Step 10</b>	<b>mdns-sd service-policy</b> <i>service-policy</i> <b>Example:</b> Device(config-wireless-policy) # mdns-sd service-policy VLAN100-POLICY	Associates mDNS service-policy to configured VLAN IDs. <b>Note</b> This step requires wireless profile policy to be administratively shutdown prior association service-policy and re-activate with no shutdown to make service-policy effective.
<b>Step 11</b>	<b>exit</b> <b>Example:</b> Device(config-mdns-sd) # exit	Exits mDNS gateway configuration mode.

## Configuring Custom Service Definition (GUI)

The Cisco IOS-XE supports various built-in well-known mDNS service-definition types mapping to key mDNS PTR records to user-friendly names. For example, built-in Apple-TV service-type is associated with `_airplay._tcp.local` and `_raop._tcp.local` PTR records to successfully enable service in the network. The network administrator can create custom service-definition with matching mDNS PTR records to enable end mDNS service-routing in the network.

This procedure configures custom mDNS service definition and applies it to policy.

### Procedure

- 
- Step 1** Choose **Configuration > Services > mDNS**.
- Step 2** Set the mDNS Gateway button to **Enabled**.
- Step 3** Click **Service Policy** Tab.
- Step 4** Click **Add** to create new custom mDNS service-list definition.  
This activates Service Definition window.
- Step 5** In the **Service Definition Name** field, enter a unique alphanumeric value.
- Step 6** (Optional) In the **Description** field, enter a description for the service definition.
- Step 7** In the **Service Type** field, enter single mDNS PoinTeR (PTR) record entry in `_service-type>._<protocol>.local` regular expression format. For example, `_airplay._tcp.local`
- Step 8** Click **+** to add custom mDNS service-type in selected definition list.  
**Note** Repeat Steps 7 and Step 8 to add more custom service-type in selected definition list.
- Step 9** Click **Apply**.
- Step 10** Perform steps give in *Configuring mDNS Service Policy (GUI)* by selecting built-in or custom service-type to configure service list.
- Step 11** Click **Save**.
-

## Configuring Custom Service Definition (CLI)

This procedure creates custom service-definition configuration to discover mDNS services from local wireless networks.

### Procedure

	Command or Action	Purpose
<b>Step 1</b>	<b>configure terminal</b>  <b>Example:</b> Device# configure terminal	Enters global configuration mode.
<b>Step 2</b>	<b>mdns-sd service-definition-name</b> <i>service-definition-name</i>  <b>Example:</b> Device(config)# mdns-sd service-definition APPLE-CLASSROOM	Creates unique service-definition name for custom service-types.
<b>Step 3</b>	<b>service-type</b> <i>custom-mDNS-PTR</i>  <b>Example:</b> Device(config-mdns-ser-def)# service-type _classroom._tcp.local	Configure an regular-expression string for custom mDNS PoinTeR(PTR) record.
<b>Step 4</b>	<b>exit</b>  <b>Example:</b> Device(config-mdns-ser-def)# exit	Returns to global configuration mode.

## Configuring mDNS Gateway on WLAN (GUI)

The mDNS gateway activation on targeted WLAN is required to start processing incoming mDNS messages from associated wireless clients. To activate mDNS gateway the WLAN must be administratively shutdown and re-enable thus it may require network downtime planning.

This procedure configures custom mDNS gateway and required policies.

### Procedure

- 
- Step 1** Choose **Configuration > Tags & Profiles > WLANs**.
  - Step 2** Click to enable the mDNS Gateway on existing **WLAN** row of Catalyst 9800 controller. Click + **Add** button to create new WLAN if required. Refer to Catalyst 9800 Series Wireless Controller Configuration Guide for step-by-step WLAN configuration.
  - Step 3** Click **Advanced** tab.
  - Step 4** From the **mDNS Mode** drop-down list, select **Gateway** to activate mDNS Gateway on the selected WLAN.
  - Step 5** Click **Apply to Device**.

**Step 6** Click Save.

## Configuring mDNS Gateway on WLAN (CLI)

This procedure implements mDNS gateway on a targeted WLAN of the controller in service-peer mode.

### Procedure

	Command or Action	Purpose
<b>Step 1</b>	<b>configure terminal</b> <b>Example:</b> Device# configure terminal	Enters global configuration mode.
<b>Step 2</b>	<b>wlan profile-name WLAN-ID SSID-name</b> <b>Example:</b> Device(config)# wlan WLAN-PROFILE 1 blizzard	Creates a unique WLAN.
<b>Step 3</b>	<b>mdns-sd-interface gateway</b> <b>Example:</b> Device(config-wlan)# mdns-sd-interface gateway	Configure mDNS gateway on targeted WLAN. <b>Note</b> This step requires wireless profile policy to be administratively shutdown prior association service-policy and re-activate with no shutdown to make service-policy effective.
<b>Step 4</b>	<b>exit</b> <b>Example:</b> Device(config-wlan)# exit	Returns to global configuration mode.

## Configuring Service-Routing on Service-Peer

The controller deployed in Service-Peer mode extends mDNS service discovery and distribution boundary beyond single controller to global IP network using on unicast based service-routing. The controller service peer must establish IP based unicast service-routing with Cisco Catalyst 9000 series switch in distribution layer network for global service-routing.

This procedure configures the controller in service peer mode.

### Procedure

	Command or Action	Purpose
<b>Step 1</b>	<b>configure terminal</b> <b>Example:</b> Device# configure terminal	Enters global configuration mode.

	Command or Action	Purpose
Step 2	<p><b>mdns-sd gateway</b></p> <p><b>Example:</b></p> <pre>Device(config)# mdns-sd gateway</pre>	<p>Enables mDNS and enters in mDNS gateway configuration mode. The following optional parameters are available:</p> <ul style="list-style-type: none"> <li>• <b>active-query</b>: Periodic mDNS query to refresh dynamic cache.</li> <li>• <b>active-response</b>: Periodic active mDNS response instead per request processing.</li> <li>• <b>mode</b>: Set Catalyst 9800 in service-peer mode.</li> <li>• <b>sdg-agent</b>: Unicast service-routing with targeted SDG-Agent.</li> <li>• <b>service-announcement-count</b>: Configures maximum advertisements in service-routing to SDG-Agent.</li> <li>• <b>service-announcement-timer</b>: Configures advertisements announce timer periodicity in service-routing to SDG-Agent.</li> <li>• <b>service-query-count</b>: Configures maximum queries in service-routing to SDG-Agent.</li> <li>• <b>service-query-timer</b>: Configures query forward timer periodicity in service-routing to SDG-Agent.</li> <li>• <b>service-type-enumeration</b>: Configures service enumeration.</li> <li>• <b>source-interface</b>: Configures the source interface. If the source interface is configured, it will be used for all mDNS transactions. By default, wireless management interface will be used.</li> <li>• <b>transport</b>: Use IPv4 (default) or IPv6 transport for mDNS messaging to end points.</li> </ul>



	Command or Action	Purpose
		<b>Note</b> For <b>rate-limit</b> , <b>service-announcement-count</b> , <b>service-announcement-timer</b> , <b>service-query-count</b> and <b>service-query-timer</b> commands, you can retain the default value of the respective parameter for general deployments. Configure a different value, if required, for a specific deployment.
<b>Step 3</b>	<b>mode [service-peer]</b> <b>Example:</b> Device(config-mdns-sd)# mode service-peer	Configure mDNS gateway in service-peer mode.
<b>Step 4</b>	<b>sdg-agent [IPv4 Address]</b> <b>Example:</b> Device(config-mdns-sd)# sdg-agent 10.0.2.254	Configure SDG Agent IPv4 address. Typically, the management VLAN gateway address. If FHRP mode, then use FHRP Virtual-IP address of management VLAN.
<b>Step 5</b>	<b>exit</b> <b>Example:</b> Device(config-mdns-sd)# exit	Returns to global configuration mode.

## Configuring Location-Based mDNS on Service-Peer (GUI)

Cisco Catalyst 9800 series controller supports location-based mDNS service discovery and distribution between wireless service provider and receiver endpoints. The location-based mDNS service support can be implemented using multiple supporting AP classification methods to implement policy-based service distributions in wireless networks. The location-based mDNS service is effective and supported on wireless APs in Local-Mode or FlexConnect Central Switching modes.

The figure given below illustrates various LSS based mDNS service mode discovery and distribution support:

Figure 67: Location-Based mDNS Gateway

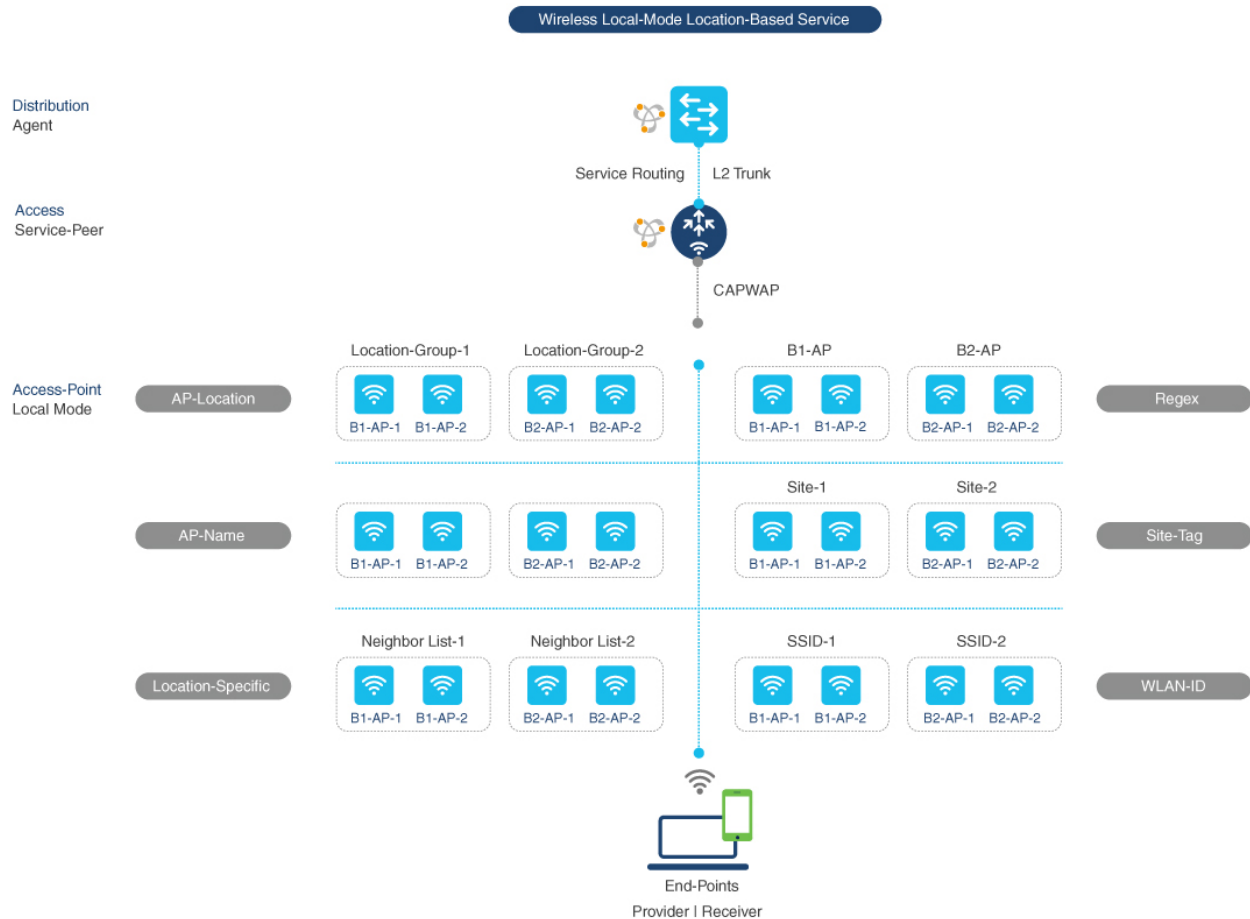

This procedure configures location-based mDNS service policy.

## Procedure

- Step 1** Choose **Configuration > Services > mDNS**.
- Step 2** Set the mDNS Gateway button to **Enabled**.
- Step 3** Click **Service Policy** Tab.
- Step 4** Click **Service List** and click **Add**.  
This activates the Service List window.
- Step 5** In the **Service List Name** field, enter a unique name with alphanumeric value.
- Step 6** From the **Direction** drop-down list, select service list policy direction. Use **IN** for ingress or **OUT** for egress mDNS message matching policy.
- Step 7** Click **+Add Services** to add mDNS service-types in selected service list.
- Step 8** From the **Available Services** drop-down list, select built-in or custom mDNS service-type.

- Step 9** From the **Message Type** drop-down list, select **Announcement** to accept service advertisement or **Query** to permit service discovery from the network. Default message-type is **any**.
- Step 10** Click **Save** button to add mDNS service-type entry.
- Note** Repeat Step-7 to Step-9 to add more mDNS service-types in selected service list.
- Step 11** Click **Apply to Device**.
- This creates a new mDNS Service List for selected direction.
- Note** Repeat Step-5 to Step-11 for bi-directional service list.
- Step 12** Click **Service-Policy** tab.
- Step 13** Click **+Add** to create new mDNS service-policy.
- Step 14** In the **Service Policy Name** field, enter a unique mDNS service policy name.
- Step 15** From the **Service List Input** drop-down list, select ingress mDNS service list input to enforce mDNS policies on ingress direction from wireless networks.
- Step 16** From the **Service List Output** drop-down list, select mDNS policies on egress direction to wireless networks.
- Step 17** Click **Apply to Device**.
- This creates a new mDNS service policy.
- Step 18** Choose **Configuration > Tags & Profiles > Policy**
- Step 19** Choose or create a new **Policy Profile**.
- Step 20** Click **Advanced** tab.
- Step 21** From the **mDNS Service Policy** drop-down list, select an mDNS service policy.
- Refer to Cisco Catalyst 9800 Series Configuration Guide to configure other policy profile parameters.
- Step 22** Click **Apply to Device** button.
- This creates a new policy profile or updates an existing policy profile with mDNS service policy.
- Step 23** Click **Save**.

## Configuring Location-Based mDNS on Service-Peer (CLI)

This procedure implements LSS based mDNS service discovery and distribution between wireless endpoints on the targeted WLAN of the controller in service-peer mode.

### Procedure

	Command or Action	Purpose
<b>Step 1</b>	<b>configure terminal</b>  <b>Example:</b> Device# <code>configure terminal</code>	Enters global configuration mode.

	Command or Action	Purpose
<b>Step 2</b>	<b>mdns-sd service-policy</b> <i>service-policy-name</i> <b>Example:</b> <pre>Device(config)# mdns-sd service-policy VLAN100-POLICY</pre>	Creates a unique mDNS service-policy.
<b>Step 3</b>	<b>location</b> { <b>ap-location</b>   <b>ap-name</b>   <b>lss</b>   <b>regex</b>   <b>site-tag</b>   <b>ssid</b> } <b>Example:</b> <pre>Device(config-mdns-ser-policy)# location ap-location</pre>	Creates a unique mDNS service-policy. <ul style="list-style-type: none"> <li>• <b>ap-location:</b> Enables mDNS service discovery and distribution between wireless service provider and receiver connected to one or more AP configured in the same location name. The mDNS services from non-matching AP location is automatically filtered.</li> <li>• <b>ap-name:</b> Enables mDNS service discovery and distribution between wireless service provider and receiver connected to single AP matching same AP name. The mDNS services from non-matching AP name is automatically filtered.</li> <li>• <b>lss:</b> Enables mDNS service discovery and distribution between wireless service provider and receiver connected to same and neighboring one or more AP based on RRM. The mDNS services from non-matching AP neighbor-list is automatically filtered.</li> <li>• <b>regex:</b> Enables mDNS service discovery and distribution between wireless service provider and receiver connected to one or more AP configured within matching AP name or AP Location name using regular-expression string. The mDNS services from non-matching AP names is automatically filtered.</li> <li>• <b>site-tag:</b> Enables mDNS service discovery and distribution between wireless service provider and receiver connected to one or more AP configured same site tag name. The mDNS services from non-matching site tag is automatically filtered.</li> <li>• <b>ssid:</b> Enables mDNS service discovery and distribution between wireless service provider and receiver connected to one or more AP configured same SSID name. The</li> </ul>

	Command or Action	Purpose
		mDNS services from non-matching SSID is automatically filtered.
<b>Step 4</b>	<b>exit</b> <b>Example:</b> Device(config-mdns-ser-policy)# exit	Exits mDNS service policy configuration mode.

## Verifying mDNS Gateway Configuration

This section provides guidelines to verify various Local Area Bonjour domain mDNS service configuration parameters, cache records, statistics and more on the controller in service peer mode.

Table 100:

Command or Action	Purpose
<pre>show mdns-sd cache { ap-mac   client-mac   detail   glan-ID   mdns-ap   rlan-id   statistics   type   udn   wired   wlan-id }</pre>	<p>Displays available mDNS cache records supporting multiple following variables providing granular source details:</p> <ul style="list-style-type: none"> <li>• <b>ap-mac</b>: Displays one or more mDNS service instance cache records discovered from provided AP MAC address.</li> <li>• <b>client-mac</b>: Displays one or more mDNS service instance(s) cache records discovered from service provider wireless client MAC address.</li> <li>• <b>detail</b>: Displays mDNS record detail information combined with client and network attributes and other service parameters.</li> <li>• <b>glan-ID</b>: Displays one or more mDNS service instance(s) cache records discovered from provided Wired Guest LAN ID MAC address.</li> <li>• <b>mdns-ap</b>: Displays one or more mDNS service instance(s) cache records discovered from provided Wireless mDNS AP MAC address.</li> <li>• <b>rlan-id</b>: Displays one or more mDNS service instances(s) cache records discovered from provided Wired Remote LAN ID. Range 1-128.</li> <li>• <b>statistics</b>: Displays detail global bi-directional mDNS statistics for IPv4 and IPv6 transports with packet processing count for each mDNS record-type.</li> <li>• <b>type</b>: Displays one or more service-instance(s) cache records matching mDNS record-type, i.e., A-AAAA, PTR, SRV and TXT.</li> <li>• <b>udn</b>: Displays one or more mDNS service instance(s) cache records discovered from segmented Wireless service provider in User-Defined-Group (UDN) or shared-services.</li> <li>• <b>wired</b>: Displays one or more mDNS service instance(s) cache records discovered from upstream Layer 2 wired network.</li> <li>• <b>wlan-id</b>: Displays one or more mDNS service instance(s) cache records discovered from matching provided wlan-ID. Range 1-4096.</li> </ul>

Command or Action	Purpose
<b>show mdns-sd statistics</b> { <b>debug</b>   <b>flexconnect</b>   <b>glan-id</b>   <b>rln-id</b>   <b>wired</b>   <b>wlan-id</b> }	Displays detailed mdns statistics processed bi-directionally by system on each mDNS gateway enabled VLAN configured mDNS in Unicast mode. The expanded keyword of mDNS statistics can provide detail view on interface, policy, service-list and services.
<b>show mdns-sd summary</b>	Displays brief information about mDNS gateway and key configuration status on all VLANs and interfaces of the system.

### Verifying Catalyst WLC Service-Peer Configuration

This section provides guidelines to verify service peer service configuration and statistics.

*Table 101:*

Command or Action	Purpose
<b>show mdns-sd sp-sdg statistics</b>	Displays mDNS service-routing statistics between Catalyst 9800 service-peer and upstream SDG Agent switch for global service discovery and distribution.
<b>show mdns-sd summary</b>	Displays brief information about mDNS gateway and key configuration status and parameters of the system.

## Reference

*Table 102:*

Related Topic	Document Title
DNA Service for Bonjour Deployment on Cisco Catalyst 9600 Switch	<a href="#">Cisco Catalyst 9600 Series Switch Software Configuration Guide, Release 17.5.X</a>
DNA Service for Bonjour Deployment on Cisco Catalyst 9500 Switch	<a href="#">Cisco Catalyst 9500 Series Switch Software Configuration Guide, Release 17.5.X</a>
DNA Service for Bonjour Deployment on Cisco Catalyst 9400 Switch	<a href="#">Cisco Catalyst 9400 Series Switch Software Configuration Guide, Release 17.5.X</a>
DNA Service for Bonjour Deployment on Cisco Catalyst 9300 Switch	<a href="#">Cisco Catalyst 9300 Series Switch Software Configuration Guide, Release 17.5.X</a>
Cisco Wide Area Bonjour Application on Cisco Catalyst Center User Guide	<a href="#">Cisco Wide Area Bonjour Application on Cisco Catalyst Center User Guide, Release 2.2.2</a>







## CHAPTER 196

# Configuring Local Area Bonjour for Wireless FlexConnect Mode

---

- [Overview of Local Area Bonjour for Wireless FlexConnect Mode, on page 1967](#)
- [Restrictions for Local Area Bonjour for Wireless FlexConnect Mode, on page 1967](#)
- [Prerequisites for Local Area Bonjour for Wireless FlexConnect Mode, on page 1968](#)
- [Understanding mDNS Gateway Alternatives for Wireless FlexConnect Mode, on page 1968](#)
- [Understanding Local Area Bonjour for Wireless FlexConnect Mode, on page 1970](#)
- [Configuring Local Area Bonjour for Wireless FlexConnect Mode, on page 1972](#)
- [Verifying Local Area Bonjour in Service-Peer Mode, on page 1984](#)
- [Verifying Local Area Bonjour in SDG Agent Mode, on page 1986](#)
- [Reference, on page 1988](#)

## Overview of Local Area Bonjour for Wireless FlexConnect Mode

The Cisco Catalyst 9800 series controller introduces unicast mode function in Local Area Bonjour network domain. The enhanced gateway function at the first hop of Wired and Wireless networks communicates directly with any industry standard RFC 6762 compliant Multicast DNS (mDNS) end point in Layer 2 Unicast mode. The controller also introduces new service-peer mode expanding single-gateway to end-to-end service-routing with upstream SDG-Agent switch to enable unicast-mode, increased scale, performance and resiliency in the network.

## Restrictions for Local Area Bonjour for Wireless FlexConnect Mode

- In FlexConnect mode network deployments, the mDNS gateway and service-peer mode on the controller must not be configured and must be in disabled state.

# Prerequisites for Local Area Bonjour for Wireless FlexConnect Mode

The Cisco Catalyst 9800 series controller must be successfully configured and operational before implementing Cisco Local Area Bonjour for FlexConnect mode wireless networks.

The following list provides the prerequisites for the controller that is to be deployed to enable successful mDNS gateway solution for Wireless FlexConnect:

- Ensure that the targeted Layer 2 Catalyst 9000 Series Ethernet switch is configured in service-peer role and running the required Cisco IOS-XE software version.
- Ensure that the Catalyst 9000 Series Ethernet switch runs a valid Cisco DNA-Advantage license.
- Ensure that the upstream distribution-layer Cisco Catalyst switch for Wired and FlexConnect Local Switching Wireless networks is configured in SDG-Agent mode and runs a valid Cisco DNA-Advantage license.

## Understanding mDNS Gateway Alternatives for Wireless FlexConnect Mode

The controller continues to innovate mDNS gateway function to address evolving business and technical requirements in the Enterprise networks. The FlexConnect Local Switching based wireless networks implement mDNS gateway using the following two methods depicted in the figure:

Figure 68: mDNS Gateway Alternatives for FlexConnect Mode

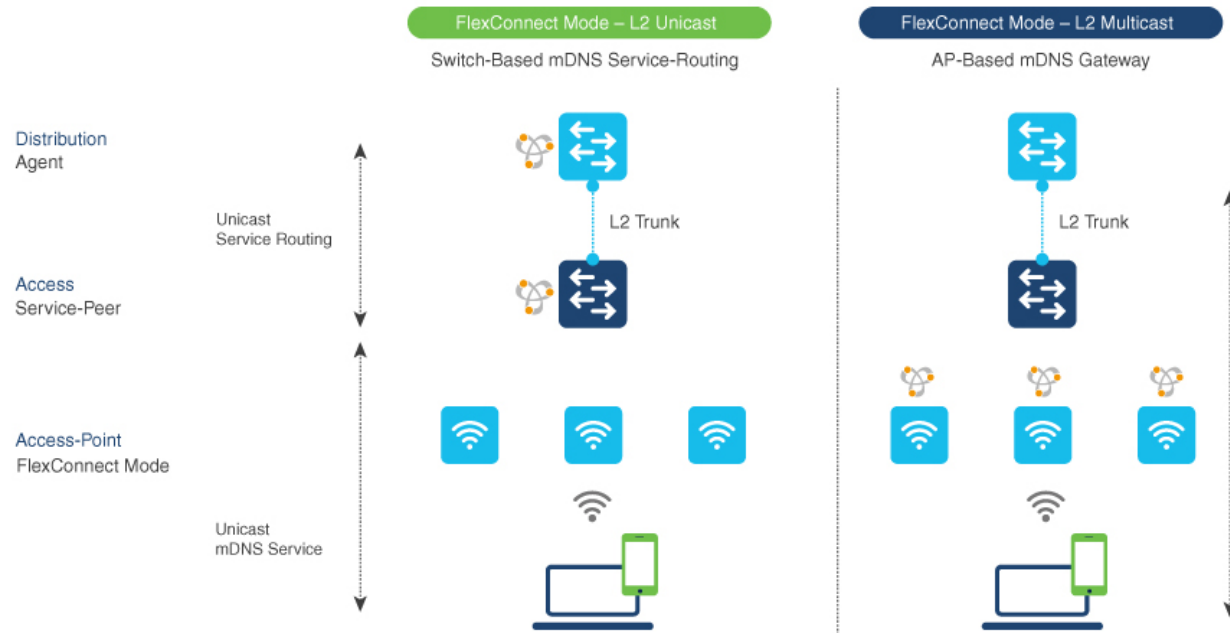

Based on the operating network environment, the mDNS gateway for FlexConnect mode wireless network can be implemented in one of the following modes to address service discovery and distribution:

- **Switch Based mDNS Gateway**—In Layer 2 access, the Cisco Catalyst 9000 series Ethernet switch must be implemented as mDNS gateway in Service-Peer role. The following are the key benefits:
  - Replaces flood-n-learn with the new enhanced Unicast-based mDNS communication with FlexConnect mode wireless users.
  - Eliminates mDNS flood with Unicast service-routing to LAN distribution. The Unicast service-routing between LAN distribution and Layer 2 access layer switches forms Local Area Bonjour domain to enable policy and location-based service discovery and distribution. The Unicast based service-routing over Layer 2 trunk eliminates mDNS flood-free and enables service-oriented wireless networks.
  - Eliminates the requirement to forward wired network traffic to wireless Access Points improving wireless scale, performance, and network reliability.
- **AP Based mDNS Gateway**—The Cisco FlexConnect mode wireless access points can alternatively be implemented as mDNS gateway when connected to unsupported LAN access switch. In this method, the mDNS service discovery and distribution follows flood-n-learn mechanism over the Layer 2 wireless network. To implement AP based mDNS gateway, see the [Multicast Domain Name System](#) chapter.

# Understanding Local Area Bonjour for Wireless FlexConnect Mode

The controller supports mDNS gateway function with various advancements for broad range of wireless networks. As the enterprise requirements expands it drives IT organization to introduce new network deployment models, supporting mobile devices and distributed zero-configuration services following increased scale, granular security control and resiliency for mission critical networks. The common unified Cisco IOS-XE operating system across Cisco Catalyst 9000 series LAN switches and Cisco Catalyst 9800 series controller enables distributed Bonjour gateway function at network edge. With end-to-end Wide Area Bonjour service-routing, the new solution enables service-oriented enterprise networks with intuitive user-experience.

The following figure illustrates how the controller connected to wireless access points support mDNS gateway function to wireless users in FlexConnect Local Switching mode.

Figure 69: Cisco Catalyst 9800 Series Controller Local Area Bonjour for Wireless - FlexConnect Mode

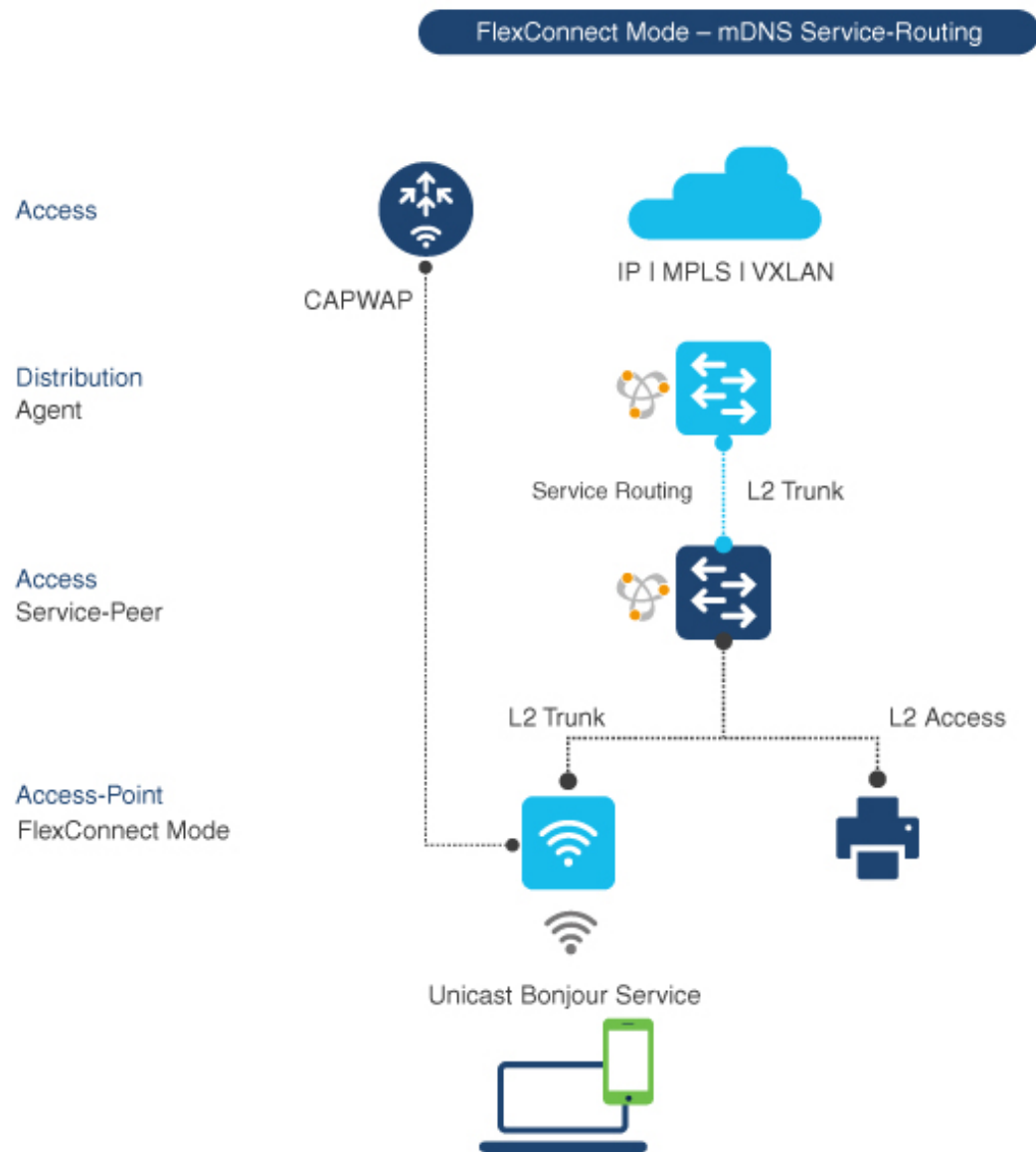

The Cisco Catalyst 9000 series switches in the Layer 2 access layer and Layer 3 distribution layer must be configured in the following mDNS gateway mode to enable Unicast-based mDNS service-routing between wired and FlexConnect Local Switching mode wireless users within the same Layer 2 network block:

- **Service-Peer** - The Layer 2 access switch connecting wireless access point in FlexConnect Local Switching mode must be configured with mDNS gateway in Service-Peer mode. Each Layer 2 access switch provides mDNS gateway function between locally attached wired and FlexConnect mode wireless users. The Unicast-based mDNS service discovery and distribution within same or different VLANs is supported with bi-directional mDNS policies on single Layer 2 access switch.
- **SDG Agent** - The mDNS flood-n-learn based method in Layer 2 network is replaced with simple Unicast based service-routing between Layer 2 access switch in Service-Peer mode and upstream distribution-layer

in mDNS gateway SDG Agent mode. The Unicast based mDNS service-routing eliminates mDNS flood over Layer 2 trunk ports providing increased bandwidth, enhanced security, location-based services, and flood control management in wired and FlexConnect wireless network.

## Configuring Local Area Bonjour for Wireless FlexConnect Mode

This section provides configuration guidelines to implement Cisco Catalyst 9000 series Ethernet switch as mDNS gateway and enable service-peer and SDG Agent mode to enable service-routing with upstream distribution-layer Cisco Catalyst 9000 series switch in SDG Agent mode to build Local Area Bonjour.

### Configuring mDNS Gateway Mode (CLI)

To enable mDNS gateway and Service-Peer mode on Layer 2 access switch and SDG Agent mode on Layer 3 distribution layer switch, perform the following:

#### Procedure

	Command or Action	Purpose
<b>Step 1</b>	<b>enable</b> <b>Example:</b> Device# <b>enable</b>	Enables privileged EXEC mode. Enter your password, if prompted.
<b>Step 2</b>	<b>configure terminal</b> <b>Example:</b> Device# <b>configure terminal</b>	Enters global configuration mode.
<b>Step 3</b>	<b>mdns-sd gateway</b> <b>Example:</b> Device(config)# <b>mdns-sd gateway</b>	Enables mDNS on the Layer 2 Catalyst switch and enters the mDNS gateway configuration mode. (Optional) You can configure the following additional parameters: <ul style="list-style-type: none"> <li>• <b>air-print-helper</b>: Enables communication between Apple iOS devices like iPhone or iPad to discover and use older printers that does not support driverless AirPrint function.</li> <li>• <b>cache-memory-max</b>: Configures the percentage memory for cache.</li> <li>• <b>ingress-client</b>: Configures Ingress client packet tuners.</li> <li>• <b>rate-limit</b>: Enables rate limiting of incoming mDNS packets.</li> <li>• <b>service-announcement-count</b>: Configures maximum advertisements.</li> </ul>

	Command or Action	Purpose
		<ul style="list-style-type: none"> <li>• <b>service-announcement-timer</b>: Configures advertisements announcement timer periodicity.</li> <li>• <b>service-query-count</b>: Configures maximum queries.</li> <li>• <b>service-query-timer</b>: Configures query forward timer periodicity.</li> <li>• <b>service-type-enumeration</b>: Configures service enumeration.</li> </ul> <p><b>Note</b> For <b>cache-memory-max</b>, <b>ingress-client</b>, <b>rate-limit</b>, <b>service-announcement-count</b>, <b>service-announcement-timer</b>, <b>service-query-count</b>, <b>service-query-timer</b>, and <b>service-type-enumeration</b> commands, you can retain the default value of the respective parameter for general deployments. Configure a different value, if required, for a specific deployment.</p>
<b>Step 4</b>	<b>mode {service-peer   sdg-agent}</b> <b>Example:</b> Device (config-mdns-sd) # <b>mode service-peer</b> Device (config-mdns-sd) # <b>mode sdg-agent</b>	Configure mDNS gateway in one of the following modes based on the system settings: <ul style="list-style-type: none"> <li>• <b>service-peer</b>– Enables Layer 2 Catalyst access switch in mDNS Service-Peer mode.</li> <li>• <b>sdg-agent</b>– Default. Enables Layer 3 distribution layer Catalyst switch in SDG Agent mode to peer with central Cisco Catalyst Center controller for Wide Area Bonjour service routing.</li> </ul>
<b>Step 5</b>	<b>exit</b> <b>Example:</b> Device (config-mdns-sd) # <b>exit</b>	Exits mDNS gateway configuration mode.

## Configuring mDNS Service Policy (CLI)

You need to perform the following to configure an mDNS service policy:

1. Create service-list to permit built-in or user-defined custom service types.
2. Associate service-list to a service-policy to enforce ingress or egress direction.

3. Apply the service policy to the new VLAN configuration mode.



**Note** You will need this configuration in Service-Peer mode for Layer 2 Catalyst switch and SDG agent mode for Layer 3 Catalyst switch.

The following figure shows how to configure mDNS policies on Catalyst switch in Service-Peer and SDG agent modes.

**Figure 70: mDNS Service Policy Configuration on Catalyst Switch in Service-Peer and SDG Agent Modes**

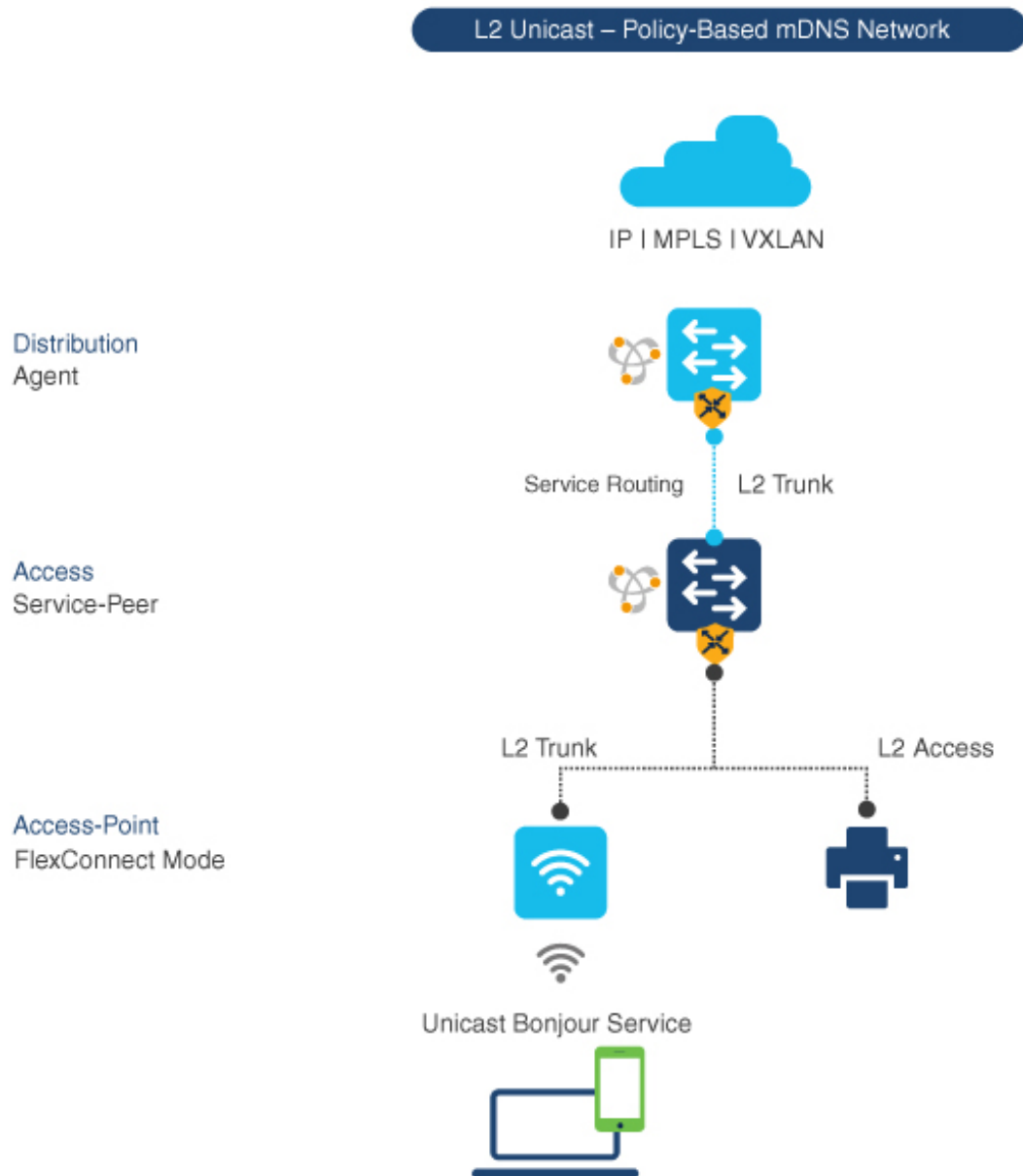

357161



This procedure builds and applies service-policies on target VLAN in service-peer and SDG agent modes.

### Procedure

	Command or Action	Purpose
<b>Step 1</b>	<b>enable</b> <b>Example:</b> Device# <b>enable</b>	Enables privileged EXEC mode. Enter your password, if prompted.
<b>Step 2</b>	<b>configure terminal</b> <b>Example:</b> Device# <b>configure terminal</b>	Enters global configuration mode.
<b>Step 3</b>	<b>mdns-sd service-list</b> <i>service-list-name</i> { <b>in</b>   <b>out</b> } <b>Example:</b> Device (config)# <b>mdns-sd service-list VLAN100-LIST-IN in</b> Device (config)# <b>mdns-sd service-list VLAN100-LIST-OUT out</b>	Configure mDNS service-list to classify one or more service types. Unique service-list is required to process incoming mDNS message and outbound response to request locally connected wired or FlexConnect wireless end points.
<b>Step 4</b>	<b>match</b> <i>service-definition-name</i> [ <b>message-type</b> { <b>any</b>   <b>announcement</b>   <b>query</b> }] <b>Example:</b> Device (config)# <b>mdns-sd service-list VLAN100-LIST-IN in</b> Device (config-mdns-sl-in) # <b>match APPLE-TV</b> Device (config-mdns-sl-in) # <b>match PRINTER-IPPS message-type announcement</b>	Matches inbound service-list. The Catalyst switch validates to accept or drop incoming mDNS service-type (such as, Apple TV) advertisement or query matching message type from locally connected wired or FlexConnect wireless end points. The service-list contains implicit deny at the end. The default message-type used is <b>any</b> .
<b>Step 5</b>	<b>match</b> <i>service-definition-name</i> [ <b>message-type</b> { <b>any</b>   <b>announcement</b>   <b>query</b> }] <b>Example:</b> Device (config)# <b>mdns-sd service-list VLAN100-LIST-OUT out</b> Device (config-mdns-sl-in) # <b>match APPLE-TV</b> Device (config-mdns-sl-in) # <b>match PRINTER-IPPS</b>	Matches outbound service-list. The Catalyst switch provides local service proxy function by responding matching service-type to the requesting end point(s). For example, the Apple-TV and Printer learnt from VLAN 100 will be distributed to FlexConnect wireless receiver in same VLAN 100. The service-list contains implicit deny at the end. The message-type for outbound service-list is not required.
<b>Step 6</b>	<b>mdns-sd service-policy</b> <i>service-policy-name</i> <b>Example:</b> Device (config)# <b>mdns-sd service-policy VLAN100-POLICY</b>	Creates unique mDNS service-policy in global configuration mode.

	Command or Action	Purpose
<b>Step 7</b>	<b>service-list</b> <i>service-list-name</i> { <b>in</b>   <b>out</b> } <b>Example:</b> Device (config) # <b>mdns-sd service-policy</b> <b>VLAN100-POLICY</b> Device (config-mdns-ser-policy) # <b>service-list VLAN100-LIST-IN in</b> Device (config-mdns-ser-policy) # <b>service-list VLAN100-LIST-OUT out</b>	Configures mDNS service-policy to associate service-list for each direction.
<b>Step 8</b>	<b>vlan configuration</b> <i>ID</i> <b>Example:</b> Device (config) # <b>vlan configuration 100</b>	Enables wired or wireless FlexConnect user VLAN configuration for advanced service parameters. One or more VLANs can be created for the same settings. Here, <i>ID</i> refers to the VLAN configuration ID. The range is from 101 to 110 and 200. This range allows to configure consecutive and non-consecutive VLAN ID(s).
<b>Step 9</b>	<b>mdns-sd gateway</b> <b>Example:</b> Device (config-vlan) # <b>mdns-sd gateway</b>	Enables mDNS gateway on configured wired or FlexConnect wireless user VLAN ID(s).
<b>Step 10</b>	<b>service-policy</b> <i>service-policy-name</i> <b>Example:</b> Device (config-vlan-mdns) # <b>service-policy</b> <b>VLAN100-POLICY</b>	Associates mDNS service-policy to the configured wired or FlexConnect wireless user VLAN ID(s).
<b>Step 11</b>	<b>exit</b> <b>Example:</b> Device (config-vlan-mdns) # <b>exit</b>	Exits mDNS gateway configuration mode.

## Configuring mDNS Location-Filter (CLI)

Optionally, you can configure mDNS location-filter to allow service discovery and distribution between locally configured VLAN IDs associated to FlexConnect wireless user networks.

The following figure illustrates and references location-filter policy on Catalyst switch in Service-Peer mode permitting to discover and distribute mDNS services between wired and FlexConnect wireless user VLANs.

Figure 71: Catalyst Service-Peer mDNS Location-Filter Configuration

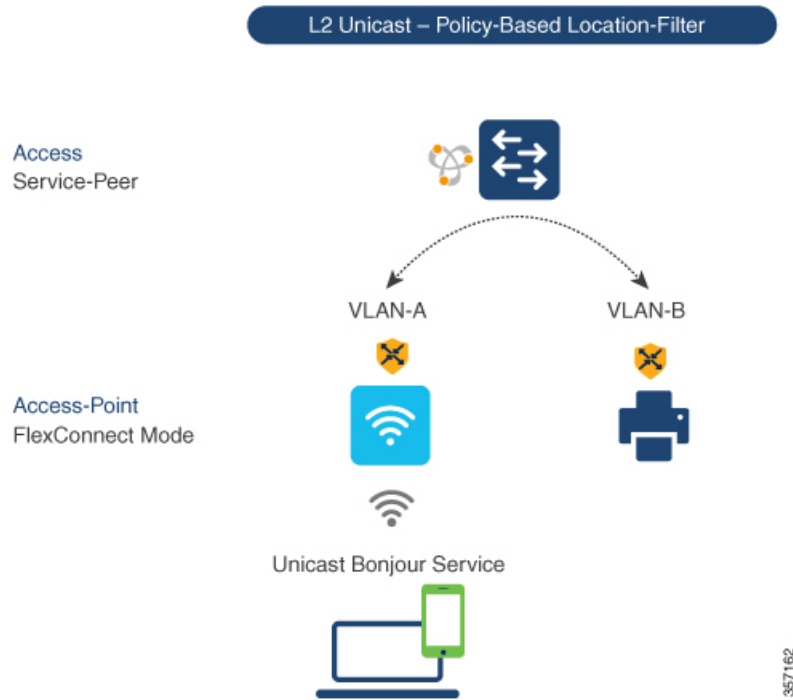

To enable local service proxy on Cisco Catalyst switch in Service-Peer mode and discover mDNS services between local wired and wireless FlexConnect user VLANs, perform the following:

### Procedure

	Command or Action	Purpose
<b>Step 1</b>	<b>enable</b> <b>Example:</b> Device# <b>enable</b>	Enables privileged EXEC mode. Enter your password, if prompted.
<b>Step 2</b>	<b>configure terminal</b> <b>Example:</b> Device# <b>configure terminal</b>	Enters global configuration mode.
<b>Step 3</b>	<b>mdns-sd location-filter</b> <i>location-filter-name</i> <b>Example:</b> Device (config)# <b>mdns-sd location-filter</b> <b>LOCAL-PROXY</b>	Configures a unique location-filter in global configuration mode.
<b>Step 4</b>	<b>match location-group</b> {all   default   ID} vlan [ID] <b>Example:</b>	Configures the match criteria to mutually distribute the permitted services between grouped VLANs. For example, mDNS services can be discovered and distributed using the

	Command or Action	Purpose
	<pre>Device (config-mdns-loc-filter)# match location-group default vlan 100  Device (config-mdns-loc-filter)# match location-group default vlan 101</pre>	Unicast mode between wireless FlexConnect user VLAN ID 100 and wired user VLAN ID 101.
<b>Step 5</b>	<p><b>mdns-sd service-list</b> <i>service-list-name</i> {in   out}</p> <p><b>Example:</b></p> <pre>Device (config)# mdns-sd service-list VLAN100-LIST-OUT out</pre>	<p>Configures the mDNS service-list to classify one or more service types.</p> <p>The <b>service-list</b> configuration is required to process any incoming or outgoing mDNS messages.</p>
<b>Step 6</b>	<p><b>match</b> <i>service-definition-name</i> [message-type {any   announcement   query}]</p> <p><b>Example:</b></p> <pre>Device (config)# mdns-sd service-list VLAN100-LIST-OUT out  Device (config-mdns-sl-out)# match APPLE-TV location-filter LOCAL-PROXY</pre>	<p>Associates location-filter to one or more service types to enable local proxy between local VLANs. For example, the Apple-TV learnt from VLAN 100 and VLAN 101 will be distributed to receiver in VLAN 100.</p> <p><b>Note</b> You do not require a <b>message-type</b> for the outbound service-list.</p>
<b>Step 7</b>	<p><b>mdns-sd service-policy</b> <i>service-policy-name</i></p> <p><b>Example:</b></p> <pre>Device (config)# mdns-sd service-policy VLAN100-POLICY</pre>	Creates unique mDNS service-policy in global configuration mode.
<b>Step 8</b>	<p><b>service-list</b> <i>service-list-name</i> {in   out}</p> <p><b>Example:</b></p> <pre>Device (config)# mdns-sd service-policy VLAN100-POLICY  Device (config-mdns-ser-policy)# service-list VLAN100-LIST-OUT out</pre>	Configures mDNS service-policy to associate service-list for each direction.
<b>Step 9</b>	<p><b>vlan configuration</b> <i>ID</i></p> <p><b>Example:</b></p> <pre>Device (config)# vlan configuration 100</pre>	<p>Enables VLAN configuration for advanced service parameters. You can create one or more VLANs with the same settings.</p> <p>Here, <i>ID</i> refers to the VLAN configuration ID. The range is from 101 to 110 and 200. This range allows to configure consecutive and non-consecutive VLAN ID(s).</p>
<b>Step 10</b>	<p><b>mdns-sd gateway</b></p> <p><b>Example:</b></p> <pre>Device (config-vlan-config)# mdns-sd gateway</pre>	Enables mDNS gateway on configured VLAN ID(s).
<b>Step 11</b>	<p><b>service-policy</b> <i>service-policy-name</i></p> <p><b>Example:</b></p>	Associates mDNS service-policy to the configured VLAN ID(s).

	Command or Action	Purpose
	Device (config-vlan-mdns-sd) # <b>service-policy VLAN100-POLICY</b>	
<b>Step 12</b>	<b>exit</b>  <b>Example:</b> Device (config-vlan-mdns-sd) # <b>exit</b>	Exits mDNS gateway configuration mode.

## Configuring Custom Service Definition (CLI)

The Cisco IOS-XE supports mapping of various built-in well-known mDNS service-definition types to key mDNS PTR records and user-friendly names. For example, built-in Apple-TV service-type is associated with `_airplay._tcp.local` and `_raop._tcp.local` PTR records to successfully enable service in the network. Network administrators create custom service-definition with matching mDNS PTR records to enable end mDNS service-routing in the network.

The custom service-definition can be associated to the service-list as described in the following steps:

### Procedure

	Command or Action	Purpose
<b>Step 1</b>	<b>enable</b>  <b>Example:</b> Device# <b>enable</b>	Enables privileged EXEC mode.  Enter your password, if prompted.
<b>Step 2</b>	<b>configure terminal</b>  <b>Example:</b> Device# <b>configure terminal</b>	Enters global configuration mode.
<b>Step 3</b>	<b>mdns-sd service-definition</b> <i>service-definition-name</i>  <b>Example:</b> Device (config) # <b>mdns-sd</b> <b>service-definition APPLE-CLASSROOM</b>	Creates a unique service-definition name for custom service-types.
<b>Step 4</b>	<b>service-type</b> <i>custom-mDNS-PTR</i>  <b>Example:</b> Device (config-mdns-ser-def) # <b>service-type</b> <b>_classroom._tcp.local</b>	Configures a regular-expression string for custom mDNS PoinTeR(PTR) record.
<b>Step 5</b>	<b>exit</b>  <b>Example:</b> Device (config-mdns-ser-def) # <b>exit</b>	Exits mDNS gateway configuration mode.

## Configuring Service-Routing on Service-Peer (CLI)

The Layer 2 Cisco Catalyst switch in Service-Peer mode builds a service-routing with an upstream distribution-layer switch in the SDG Agent mode. To build service-routing, the Layer 2 Cisco Catalyst switch requires at least one interface with valid IP address to reach the upstream SDG Agent Catalyst switch. The switch management port is unsupported.

The following figure illustrates the topology to enable unicast-based service-routing over Layer 2 trunk between access-layer Catalyst switch in the Service-Peer mode and distribution-layer Catalyst switch in SDG Agent mode.

Figure 72: Catalyst Service-Peer Service-Routing Configuration

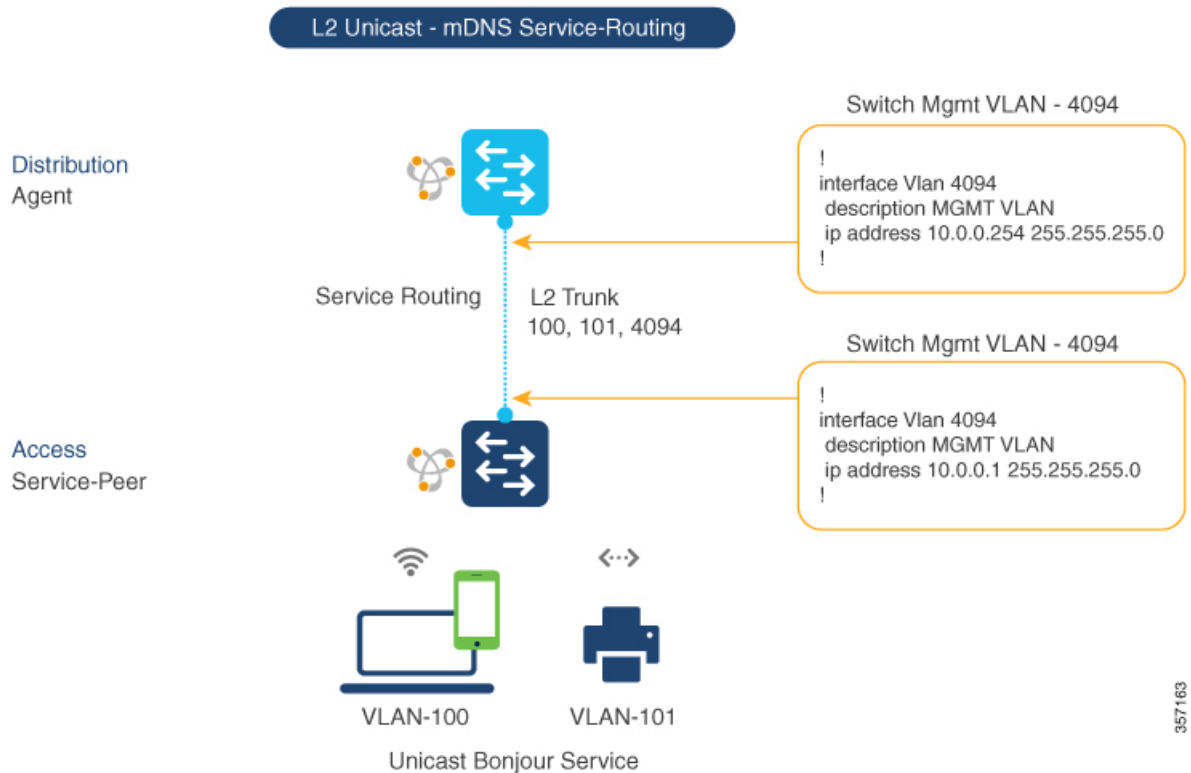

To enable service-routing on Cisco Catalyst switch in Service-Peer mode and setup mDNS trust interface settings, follow the procedure given below:

### Procedure

	Command or Action	Purpose
Step 1	<b>enable</b> <b>Example:</b> Device# <b>enable</b>	Enables Privileged EXEC mode. Enter your password, if prompted.
Step 2	<b>configure terminal</b> <b>Example:</b>	Enters the global configuration mode.

	Command or Action	Purpose
	Device# <code>configure terminal</code>	
<b>Step 3</b>	<p><b>vlan configuration <i>ID</i></b></p> <p><b>Example:</b></p> <pre>Device(config)# vlan configuration 100</pre>	<p>Enables Wired and FlexConnect user VLAN configuration for advanced service parameters. One or more VLANs can be created for the same settings.</p> <p>Here, <i>ID</i> refers to the VLAN configuration ID. For example, <i>vlan configuration 101-110, 200</i> range, allows to configure consecutive and non-consecutive VLAN ID(s).</p>
<b>Step 4</b>	<p><b>mdns-sd gateway</b></p> <p><b>Example:</b></p> <pre>Device(config-vlan-config)# mdns-sd gateway</pre>	<p>Enables mDNS gateway on configured VLAN ID(s).</p> <p>To enable the respective functionalities, enter the following commands in the mDNS gateway configuration mode:</p> <ul style="list-style-type: none"> <li>• <b>active-query timer [sec]:</b> Configure to enable refresh discovered services and their records with periodic mDNS Query message for permitted service types. The valid range is from 60 to 3600 seconds. The recommended value is 3600 seconds.</li> <li>• <b>service-mdns-query {ptr   srv   txt}:</b> Permits processing specific Query type. The default query type is PTR.</li> <li>• <b>transport {ipv4   ipv6   both}:</b> Permits processing for IPv4, IPv6, or both. It is recommended to use one network type to reduce redundant processing and respond with the same information over two network types. The default network type is IPv4.</li> </ul>
<b>Step 5</b>	<p><b>source-interface <i>ID</i></b></p> <p><b>Example:</b></p> <pre>Device(config-vlan-mdns-sd)# source-interface vlan 4094</pre>	<p>Selects the interface with a valid IP address to source service-routing session with the upstream Cisco Catalyst SDG Agent switch. Typically, the management VLAN interface can be used.</p>
<b>Step 6</b>	<p><b>sdg-agent [<i>IPv4_address</i>]</b></p> <p><b>Example:</b></p> <pre>Device(config-vlan-mdns-sd)# sdg-agent 10.0.0.254</pre>	<p>Configures the SDG Agent IPv4 address, typically, the management VLAN gateway address. If FHRP mode, then use the FHRP virtual IP address of the management VLAN.</p>
<b>Step 7</b>	<p><b>exit</b></p> <p><b>Example:</b></p> <pre>Device(config-vlan-mdns-sd)# exit</pre>	<p>Exits the mDNS gateway configuration mode.</p>

## Configuring Location-Based mDNS

By default, the Layer 2 Catalyst switch in the Service-Peer mode enables per-switch mDNS discovery and distribution in FlexConnect wireless users attached locally to the switch. This default per-switch location-based mDNS is supported even when the FlexConnect user VLANs may be extended between multiple Layer 2 Catalyst switches for user mobility purpose. The mDNS service-policy configuration SDG Agent is required to accept policy-based mDNS service provider and receiver information from downstream Service-Peer access-layer switch.

**Figure 73: Per-Switch Location-Based FlexConnect Configuration**

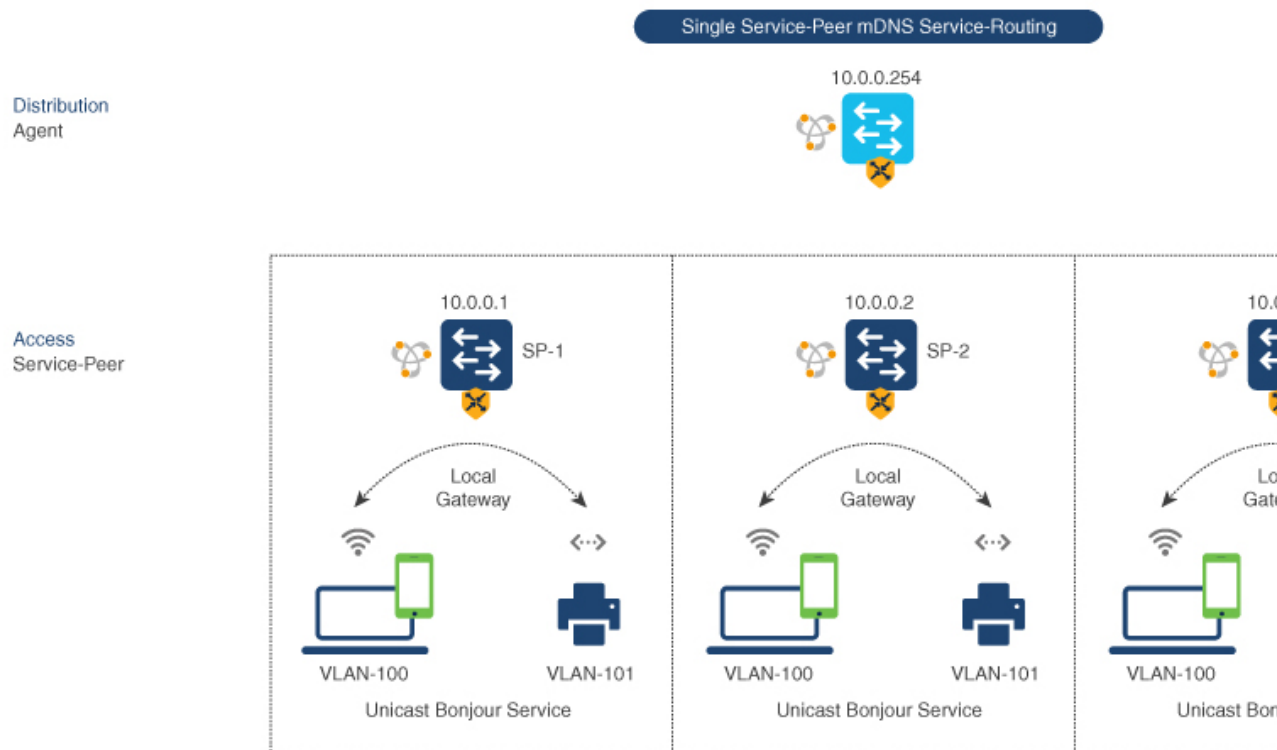

**Note** Configure the mDNS service policy on the distribution layer SDG Agent switch before proceeding to the next configuration step. For more information, see the [Configuring mDNS Service Policy](#) section.

## Configuring Service-Routing on SDG Agent (CLI)

The Cisco Catalyst 9000 series switches support SDG Agent mode automatically at the distribution layer and enables Unicast mode Bonjour service-routing with the downstream Layer 2 access-layer Ethernet switches connected to the FlexConnect wireless users. The SDG Agent must be configured with mDNS service-policy on wireless FlexConnect user VLAN to accept mDNS service cache from downstream Service-Peer switches.

This section provides step-by-step configuration guidelines to enable policy-based service discovery and distribution between locally paired Layer 2 access network switches in the Service-Peer mode.



The following figure illustrates unicast service-routing on SDG Agent and downstream Layer 2 access network switches in the Service-Peer mode.

**Figure 74: Catalyst SDG Agent Service-Routing Configuration**

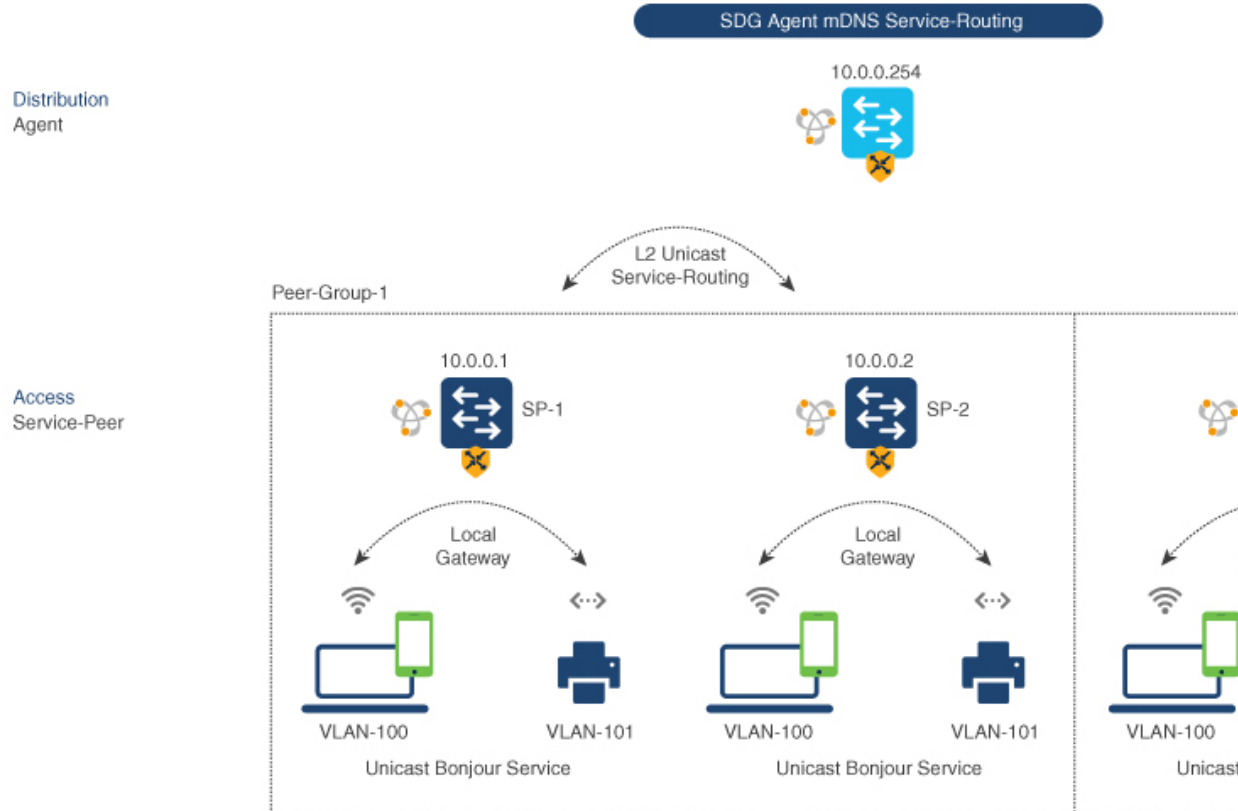

**Note** Configure the mDNS service policy on the distribution layer SDG Agent switch before proceeding to the next configuration step. For more information, see the [Configuring mDNS Service Policy](#) section.

To enable the mDNS service policy and peer-group on SDG Agent switch, and enable Unicast mode service-routing with Layer 2 access network switches in Service-Peer mode, perform the following:

#### Procedure

	Command or Action	Purpose
<b>Step 1</b>	<b>enable</b> <b>Example:</b> Device# <b>enable</b>	Enables privileged EXEC mode. Enter your password, if prompted.
<b>Step 2</b>	<b>configure terminal</b> <b>Example:</b>	Enters global configuration mode.

	Command or Action	Purpose
	Device# <b>configure terminal</b>	
<b>Step 3</b>	<b>mdns-sd service-peer group</b> <i>service-peer-group-name</i>  <b>Example:</b> Device(config)# <b>mdns-sd service-peer group group_1</b>	Configures a unique Service-Peer group.
<b>Step 4</b>	<b>peer-group [ID]</b>  <b>Example:</b> Device(config-mdns-svc-peer)# <b>peer-group 1</b>	Assigns a unique peer-group ID to the Service-Peers pair permitting mDNS service discovery and distribution within the assigned group list.  The valid peer-group range is from 1 to 1000 for each SDG Agent switch.
<b>Step 5</b>	<b>service-policy service-policy-name</b>  <b>Example:</b> Device(config-mdns-svc-peer-grp)# <b>service-policy VLAN100-POLICY</b>	Associates an mDNS service policy to accept service advertisements and query from the paired Service-Peers.
<b>Step 6</b>	<b>service-peer [IPv4_address] location-group {all   default   id}</b>  <b>Example:</b> Device(config-mdns-svc-peer-grp)# <b>service-peer 10.0.0.1 location-group default</b>  Device(config-mdns-svc-peer-grp)# <b>service-peer 10.0.0.2 location-group default</b>	Configures at least one Service-Peer to accept the mDNS service advertisement or query message. When a group has more than one Service-Peers, the SDG Agent provides Layer 2 Unicast mode routing between the configured peers.  For example, the SDG Agent provides Unicast based service gateway function between three (10.0.0.1 and 10.0.0.2) Layer 2 Service-Peer switches matching the associated service-policy.  The mDNS service information from the unpaired Layer 2 Service-Peer (10.0.0.3) cannot announce or receive mDNS services with the other grouped Service-Peers (10.0.0.1 and 10.0.0.2).
<b>Step 7</b>	<b>exit</b>  <b>Example:</b> Device(config-mdns-svc-peer-grp)# <b>exit</b>	Exits mDNS gateway configuration mode.

## Verifying Local Area Bonjour in Service-Peer Mode

This section provides guidelines to verify various Local Area Bonjour domain mDNS service configuration parameters, cache records, statistics and more on the controller in service-peer mode

Table 103:

Command or Action	Purpose
<b>show mdns-sd cache {all   interface   mac   name   service-peer   static   type   vlan}</b>	Displays available mDNS cache records supporting multiple variables providing granular source details received from wired or wireless FlexConnect user VLANs. The variables are as follows: <ul style="list-style-type: none"> <li>• all – Displays all available cache records discovered from multiple source connections of a system.</li> <li>• interface – Displays available cache records discovered from the specified Layer 3 interface.</li> <li>• mac - Displays available cache records discovered from the specified MAC address.</li> <li>• name - Displays available cache records based on the service provider announced name.</li> <li>• service-peer - Displays available cache records discovered from the specified Layer 2 Service-Peer.</li> <li>• static – Displays locally configured static mDNS cache entry.</li> <li>• type – Displays available cache records based on the specific mDNS record type, such as, PTR, SRV, TXT, A or AAAA.</li> <li>• vlan - Displays available cache records discovered from the specified Layer 2 VLAN ID in the Unicast mode.</li> </ul>
<b>show mdns-sd service-definition {name   type}</b>	Displays built-in and user-defined custom service-definition that maps service name to the mDNS PTR records. The service-definition can be filtered by name or type.
<b>show mdns-sd service-list {direction   name}</b>	Displays inbound or outbound direction list of configured service-list to classify matching service-types for service-policy. The list can be filtered by name or specific direction.
<b>show mdns-sd service-policy {interface   name}</b>	Displays list of mDNS service-policy mapped with inbound or outbound service-list. The service-policy list can be filtered by an associated specified interface or name.

Command or Action	Purpose
<b>show mdns-sd statistics</b> {all   cache   debug   interface   service-list   service-policy   services   vlan}	<p>Displays detailed mDNS statistics processed bi-directionally by the system on each mDNS gateway enabled VLAN configured mDNS in Unicast mode. The expanded keyword for mDNS statistics can provide detailed view on interface, policy, service-list, and services.</p> <p><b>Note</b> This command displays all mDNS packets received from directly connected (Local Mode) or Flex clients in WLAN.</p>
<b>show mdns-sd summary</b> {interface   vlan}	<p>Displays brief information about mDNS gateway and key configuration status on all wired and wireless FlexConnect user VLANs, and interfaces of the system.</p>

## Verifying Local Area Bonjour in SDG Agent Mode

This section provides guidelines to verify various Local Area Bonjour domain mDNS service configuration parameters, cache records, statistics and more on the controller in SDG Agent mode

Table 104:

Command or Action	Purpose
<b>show mdns-sd cache {all   interface   mac   name   service-peer   static   type   vlan   vrf}</b>	<p>Displays available mDNS cache records supporting multiple variables providing granular source details. The variables are as follows:</p> <ul style="list-style-type: none"> <li>• all – Displays all available cache records discovered from multiple source connections of a system.</li> <li>• interface – Displays available cache records discovered from the specified Layer 3 interface.</li> <li>• mac - Displays available cache records discovered from the specified MAC address.</li> <li>• name - Displays available cache records based on the service provider announced name.</li> <li>• service-peer - Displays available cache records discovered from the specified Layer 2 Service-Peer.</li> <li>• static – Displays locally configured static mDNS cache entry.</li> <li>• type – Displays available cache records based on the specific mDNS record type, such as, PTR, SRV, TXT, A or AAAA.</li> <li>• vlan - Displays available cache records discovered from the specified Layer 2 VLAN ID in the Unicast mode.</li> <li>• vrf - Displays per-VRF available cache records based on specific mDNS record type, i.e., PTR, SRV, TXT, A or AAAA.</li> </ul>
<b>show mdns-sd service-definition {name   type}</b>	<p>Displays built-in and user-defined custom service-definition that maps service name to the mDNS PTR records. The service-definition can be filtered by name or type.</p>
<b>show mdns-sd service-list {direction   name}</b>	<p>Displays inbound or outbound direction list of the configured service-list to classify matching service-types for service-policy. The list can be filtered by name or specific direction.</p>
<b>show mdns-sd service-policy {interface   name}</b>	<p>Displays list of mDNS service-policy mapped with inbound or outbound service-list. The service-policy list can be filtered by an associated specified interface or name.</p>

Command or Action	Purpose
<b>show mdns-sd statistics</b> {all   cache   debug   interface   service-list   service-policy   services   vlan}	Displays detailed mDNS statistics processed bi-directionally by the system on each mDNS gateway enabled VLAN configured mDNS in Unicast mode. The expanded keyword for mDNS statistics can provide detailed view on interface, policy, service-list, and services.
<b>show mdns-sd summary</b> {interface   vlan}	Displays brief information about mDNS gateway and key configuration status on all VLANs and interfaces of the system.

## Reference

*Table 105:*

Related Topic	Document Title
DNA Service for Bonjour Deployment on Cisco Catalyst 9600 Switch	<a href="#">Cisco Catalyst 9600 Series Switch Software Configuration Guide, Release 17.5.X</a>
DNA Service for Bonjour Deployment on Cisco Catalyst 9500 Switch	<a href="#">Cisco Catalyst 9500 Series Switch Software Configuration Guide, Release 17.5.X</a>
DNA Service for Bonjour Deployment on Cisco Catalyst 9400 Switch	<a href="#">Cisco Catalyst 9400 Series Switch Software Configuration Guide, Release 17.5.X</a>
DNA Service for Bonjour Deployment on Cisco Catalyst 9300 Switch	<a href="#">Cisco Catalyst 9300 Series Switch Software Configuration Guide, Release 17.5.X</a>
Cisco Wide Area Bonjour Application on Cisco Catalyst Center User Guide	<a href="#">Cisco Wide Area Bonjour Application on Cisco Catalyst Center User Guide, Release 2.2.2</a>



## CHAPTER 197

# Configuration Example for Local Mode - Wireless and Wired

---

- [Overview, on page 1989](#)
- [Configuring Wireless AP Multicast Mode, on page 1990](#)
- [Configuration Example for Default Service List and Policy in Wide Area Bonjour Between Multilayer Wired and Wireless Endpoints, on page 1991](#)
- [Configuration Example for Customized Service List and Policy in Wide Area Bonjour Between Multilayer Wired and Wireless Endpoints, on page 1993](#)
- [Cisco Catalyst Center Traditional Multilayer Wired and Wireless Configuration, on page 1996](#)
- [Verifying Wide Area Bonjour Between Multilayer Wired and Wireless Local Mode, on page 1998](#)
- [Reference, on page 2005](#)

## Overview

This chapter provides configuration guidelines to implement Wide Area Bonjour enabling end-to-end policy-based mDNS service discovery and distribution across multilayer wired and wireless local mode. The first hop mDNS gateway at Layer 2 access switch and the controller must be implemented in service peer mode and paired with LAN and wireless distribution-layer switch in SDG agent role. The network-wide distributed SDG agent must be paired with the Cisco Catalyst Center to enable mDNS service-routing across IP core network based on multiple services and network attributes.

The following figure illustrates unicast mode Bonjour network environment with AirPrint capable printer and user computer (macOS, Microsoft Windows, etc.) connected to same Ethernet switch. The computers and mobile devices of the wireless user are associated to wireless AP in local mode across multi-hop IP boundary from printers.

Figure 75: Wide Area Bonjour Service-Routing Multilayer Wired and Wireless Local Mode

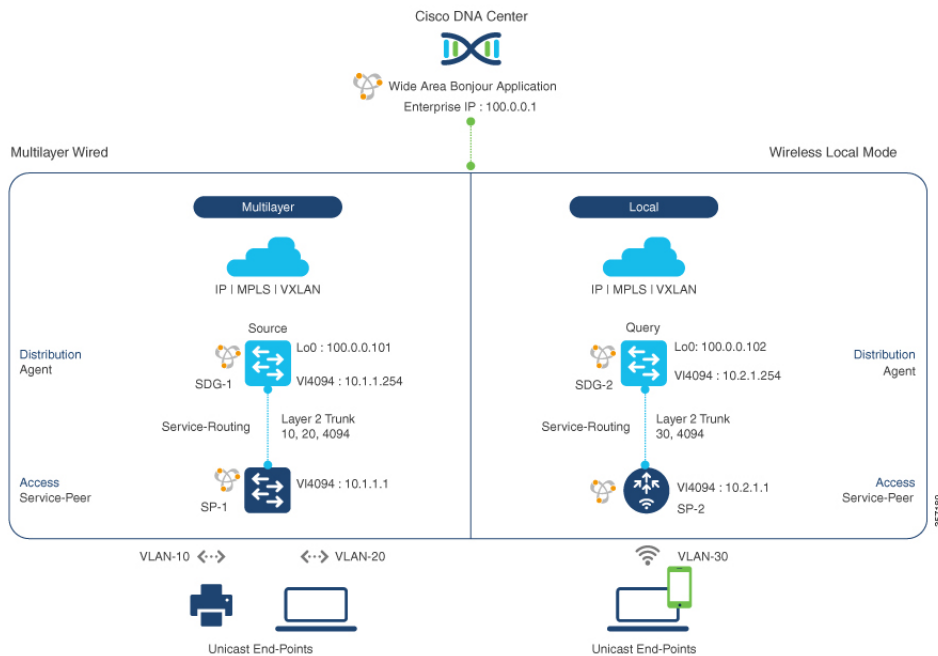

## Configuring Wireless AP Multicast Mode

This procedure configures wireless AP multicast on the controller for local mode APs and IP network.

The controller must be configured with unique IP multicast address for wireless AP in local mode to permit mDNS communication across wired and wireless networks.

Step	Controller Service Peer Configuration
<b>Step-1</b> Enable global IP Multicast on Cisco Catalyst 9800 series controller.	<pre>! wireless multicast !</pre>
<b>Step-2</b> Configure Wireless AP mode to Multicast with unique IP Multicast address.	<pre>! wireless multicast 239.254.254.1 !</pre>

The following table provides step-by-step IP multicast configuration guidelines on SDG agent (SDG-1 and SDG-2) at the distribution layer network.



Step	Switch SDG Agent Configuration	WLC SDG Agent Configuration
<b>Step-1</b> Enable IP multicast-routing on distribution layer switches connecting Cisco Wireless Local Mode Access Point and Cisco Wireless LAN Controller.	<pre>! ip multicast-routing !</pre>	<pre>! ip multicast-routing !</pre>
<b>Step-2</b> Configure IP PIM Rendezvous-Point (RP) on distribution layer switches.	<pre>! ip pim rp-address 10.150.255.1 !</pre>	<pre>! ip pim rp-address 10.150.255.1 !</pre>
<b>Step-3</b> Enable IP PIM on SVI Interface of distribution layer switches connected Cisco Wireless Local Mode Access Point and Cisco WLC Management VLAN.	<pre>! interface Vlan 101 description CONNECTED TO WIRELESS AP - LOCAL MODE ip pim sparse-mode !</pre>	<pre>! interface Vlan 4094 description CONNECTED TO WIRELESS MGMT - WLC ip pim sparse-mode !</pre>
<b>Step-4</b> Enable IP PIM on Layer 3 uplink Interface of distribution layer switches connected Cisco Wireless Local Mode Access Point and Cisco WLC Management VLAN.	<pre>! interface range FortyGigabitEthernet 1/1/1 - 2 description CONNECTED TO IP CORE NETWORK ip pim sparse-mode !</pre>	<pre>! interface range FortyGigabitEthernet 1/1/1 - 2 description CONNECTED TO IP CORE NETWORK ip pim sparse-mode !</pre>



**Note** IP Multicast must be enabled in the Layer 3 core network to allow Cisco wireless APs in local mode to successfully join the WLC announced multicast group. For more information, refer to the Cisco online documentation to implement IP multicast networks.

## Configuration Example for Default Service List and Policy in Wide Area Bonjour Between Multilayer Wired and Wireless Endpoints

This section provides guidance on configuring Service-Peer, SDG Agent, and Cisco Catalyst Center, allowing the wired and wireless endpoints to dynamically discover default service list using Layer 2 unicast and policy.

### Example: Wired and Wireless Access Layer Service Peer Configuration

The following table provides a sample configuration of wired and wireless controller access layer service peer.

Table 106: Configuring Wired and Wireless Access Layer Service Peer

Configuration Step	Sample Configuration: SP-1 Service-Peer Configuration	Sample Configuration: SP-2 Service-Peer Configuration
<b>Step-1:</b> Enable mDNS gateway and set the gateway mode.  <b>Note</b> In wireless controller, service peer mode is enabled by default with mDNS gateway configuration.	<pre>! mdns-sd gateway mode service-peer !</pre>	<pre>! mdns-sd gateway mode service-peer !</pre>
<b>Step-2:</b> Activate unicast mDNS gateway and attach service policy on wired VLAN and wireless FlexConnect user VLAN of SP-1 and SP-2 Layer 2 access switch.	<pre>! vlan configuration 10, 30 mdns-sd gateway service-policy LOCAL-AREA-POLICY active-query timer 3600 !</pre>	<pre>! vlan configuration 20, 30 mdns-sd gateway service-policy LOCAL-AREA-POLICY active-query timer 3600 !</pre>
<b>Step-3:</b> Enable unicast service routing between wired and wireless service peer and SDG agent using wired management source VLAN ID and IP address.	<pre>vlan configuration 10, 30 mdns-sd gateway source-interface vlan 4094 sdg-agent 10.1.1.254 !</pre>	<pre>! vlan configuration 20, 30 mdns-sd gateway source-interface vlan 4094 sdg-agent 10.1.1.254 !</pre>

## Example: Wired and Wireless Distribution Layer SDG Agent Configuration

The following table provides a sample configuration of distribution layer SDG agent.

Table 107: Configuring Wired and Wireless Distribution Layer SDG Agent

Configuration Step	Sample Configuration: SDG-1 – SDG Agent
<b>Step-1:</b> Enable mDNS gateway and set the gateway mode. The default mode is sdg-agent.	<pre>! mdns-sd gateway !</pre>
<b>Step-2:</b> Activate unicast mDNS gateway on wired VLAN and wireless user VLAN on SDG agents.	<pre>! vlan configuration 10, 20, 30 mdns-sd gateway !</pre>
<b>Step-3:</b> Configure the service peer-group and attach service-policy on the SDG agent distribution switch and enable service-routing between the assigned Service Peer switch group.	<pre>! mdns-sd service-peer group peer-group 1 service-policy LOCAL-AREA-POLICY service-peer 10.1.1.1 location-group default  service-peer 10.1.1.2 location-group default !</pre>

Configuration Step	Sample Configuration: SDG-1 – SDG Agent
<b>Step-4:</b> Associate outbound service-list to a unique service-policy.	! mdns-sd service-policy WIDE-AREA-POLICY service-list WIDE-AREA-SERVICES-OUT !
<b>Step-5:</b> Enable Wide Area Bonjour service-routing with service export configuration association controller IP Address, source interface for stateful connection, and mandatory egress policy for Wide Area service-routing.	! service-export mdns-sd controller DNAC-CONTROLLER-POLICY controller-address 100.0.0.1 controller-source-interface LOOPBACK 0 controller-service-policy WIDE-AREA-POLICY !

## Configuration Example for Customized Service List and Policy in Wide Area Bonjour Between Multilayer Wired and Wireless Endpoints

This section provides guidance on configuring Service-Peer, SDG Agent and Cisco Catalyst Center, allowing the wired and wireless endpoints to dynamically discover printer using Layer 2 unicast and policy.

### Example: Wired and Wireless Access Layer Service Peer Configuration

The following table provides a sample configuration of wired and wireless controller access layer service peer.

**Table 108: Configuring Wired and Wireless Access Layer Service Peer**

Configuration Step	Sample Configuration: Switch Service Peer	Sample Configuration: Wireless Controller Service Peer
<b>Step-1:</b> Enable mDNS gateway and set the gateway mode.  <b>Note</b> In wireless controller, service peer mode is enabled by default with mDNS gateway configuration.	! mdns-sd gateway mode service-peer !	! mdns-sd gateway !
<b>Step-2:</b> Create unique mDNS inbound policy to permit ingress AirPrint service announcement on the Catalyst Switch and wireless controller in service peer mode.	! mdns-sd service-list LOCAL-AREA-SERVICES-IN in match printer-ipp !	! mdns-sd service-list LOCAL-AREA-SERVICES-IN in match printer-ipp !

Configuration Step	Sample Configuration: Switch Service Peer	Sample Configuration: Wireless Controller Service Peer
<p><b>Step-3:</b> Create unique mDNS outbound policy to permit egress AirPrint service response on the Catalyst Switch and wireless controller in service peer mode</p>	<pre>! mdns-sd service-list LOCAL-AREA-SERVICES-OUT out match printer-ipp !</pre>	<pre>! mdns-sd service-list LOCAL-AREA-SERVICES-OUT out match printer-ipp !</pre>
<p><b>Step-4:</b> Associate inbound and outbound service list to a unique service policy.</p>	<pre>! mdns-sd service-policy LOCAL-AREA-POLICY service-list LOCAL-AREA-SERVICES-IN service-list LOCAL-AREA-SERVICES-OUT !</pre>	<pre>mdns-sd service-policy LOCAL-AREA-POLICY service-list LOCAL-AREA-SERVICES-IN service-list LOCAL-AREA-SERVICES-OUT !</pre>
<p><b>Step-5:</b> Activate unicast mDNS gateway and attach service policy on wired VLAN and WLAN.</p> <ul style="list-style-type: none"> <li>• <b>Switch:</b> Activate mDNS gateway per VLAN.</li> <li>• <b>Controller:</b> Activate mDNS gateway per WLAN policy profile and SSID</li> </ul>	<pre>! vlan configuration 10, 20 mdns-sd gateways service-policy LOCAL-AREA-POLICY active-query timer 3600 !</pre>	<pre>! wireless profile policy WLAN-PROFILE shutdown mdns-sd service-policy LOCAL-AREA-POLICY no shutdown ! wlan WLAN-PROFILE 1 blizzard shutdown mdns-sd-interface gateway no shutdown !</pre>
<p><b>Step-6:</b> (Optional) Enable service routing on wired service peer mDNS between local VLANs. Also, enable location-based wireless service on the controller.</p> <ul style="list-style-type: none"> <li>• <b>Switch:</b> Configure location filter group to discover and distribute between paired local VLAN.</li> <li>• <b>Controller:</b> Configure wireless location-based services.</li> </ul>	<pre>! mdns-sd location-filter LOCAL-PROXY match location-group default vlan 10 match location-group default vlan 20 ! mdns-sd service-list LOCAL-AREA-SERVICES-OUT OUT match printer-ipps location-filter LOCAL-PROXY !</pre>	<pre>! mdns-sd service-policy LOCAL-AREA-POLICY location ap-location !</pre>

Configuration Step	Sample Configuration: Switch Service Peer	Sample Configuration: Wireless Controller Service Peer
<p><b>Step-7:</b> Enable unicast service routing between wired and wireless service peer and SDG agent.</p> <ul style="list-style-type: none"> <li>• <b>Switch:</b> Configure SDG agent IP and wired management source VLAN ID and IP address.</li> <li>• <b>Controller:</b> Configure SDG Agent IP and wireless management source VLAN ID and IP address.</li> </ul>	<pre>vlan configuration 10, 20 mdns-sd gateways source-interface vlan 4094 sdg-agent 10.1.1.254 !</pre>	<pre>! mdns-sd gateway source-interface vlan 4094 sdg-agent 10.2.1.254 !</pre>

## Example: Wired and Wireless Distribution Layer SDG Agent Configuration

The following table provides a sample configuration of distribution layer SDG agent.

**Table 109: Configuring Distribution Layer SDG Agent**

Configuration Step	Sample Configuration: Wired SDG Agent	Sample Configuration: Wireless SDG Agent
Step-1: Enable mDNS gateway and set the gateway mode.	<pre>! mdns-sd gateway !</pre>	<pre>! mdns-sd gateway !</pre>
Step-2: Activate unicast mDNS gateway on wired VLAN and wireless user VLAN on respective SDG agents.	<pre>! vlan configuration 10, 20 mdns-sd gateway !</pre>	<pre>! vlan configuration 30 mdns-sd gateway !</pre>
Step-3: Create unique controller bound mDNS policy to permit egress AirPrint service discovery and distribution from Catalyst Switch in SDG agent mode. Inbound policy towards controller is not required.	<pre>! mdns-sd service-list WIDE-AREA-SERVICES-OUT out match printer-ipp !</pre>	<pre>! mdns-sd service-list WIDE-AREA-SERVICES-OUT out match printer-ipp !</pre>
Step-4: Associate outbound service-list to a unique service-policy.	<pre>! mdns-sd service-policy WIDE-AREA-POLICY service-list WIDE-AREA-SERVICES-OUT !</pre>	<pre>! mdns-sd service-policy WIDE-AREA-POLICY service-list WIDE-AREA-SERVICES-OUT !</pre>

Configuration Step	Sample Configuration: Wired SDG Agent	Sample Configuration: Wireless SDG Agent
Step-5: Enable Wide Area Bonjour service-routing with service export configuration association controller IP Address, source interface for stateful connection and mandatory egress policy for Wide Area service-routing.	<pre>! service-export mdns-sd controller DNAC-CONTROLLER-POLICY controller-address 100.0.0.1 controller-source-interface LOOPBACK 0 controller-service-policy WIDE-AREA-POLICY !</pre>	<pre>! service-export mdns-sd controller DNAC-CONTROLLER-POLICY controller-address 100.0.0.1 controller-source-interface LOOPBACK 0 controller-service-policy WIDE-AREA-POLICY !</pre>

# Cisco Catalyst Center Traditional Multilayer Wired and Wireless Configuration

## Configuring Service Filters for Traditional Multilayer Wired and Wireless - Local Mode (GUI)

This procedure implements global service filters, which permit the Cisco Wide Area Bonjour application to dynamically discover and distribute service information between trusted Cisco Catalyst SDG agent switches across the IP network.

### Procedure

- 
- Step 1** Navigate to the **Configuration** tab in the Wide Area Bonjour application.
  - Step 2** From the sidebar, select the subdomain for which you want to create the service filter.
  - Step 3** Check the **Service Filter** box.
  - Step 4** Click **Service Filter** icon from the topology to view a list of the service filters for the selected domain. You can also manually edit existing service filters from this list.
  - Step 5** Click **Create Service Filter**.
  - Step 6** From the **Network Mode** drop-down list, choose **Traditional** (the default mode).
  - Step 7** Enter a unique name for the service filter.
  - Step 8** (Optional) Enter a description for the service filter.
  - Step 9** Select one or more service types to permit announcements and queries.
  - Step 10** Enable or disable service filters after creating them. By default, service filters are enabled.
-

## Configuring Source SDG Agents in Traditional Multilayer Wired and Wireless - Local Mode (GUI)

This procedure configures discovery of wired printer sources from the LAN distribution switches paired with Layer 2 Catalyst Switches in a service peer role. The wireless distribution switches paired with a controller in a service peer role receive query responses for wired printers and distribute the responses to querying devices over the wireless local mode network.

### Procedure

---

- Step 1** Click **Add** in the upper-right portion of the Catalyst Center Policy screen.
  - Step 2** Select the **Query SDG agent** radio button. By default, the **Source** radio button is selected.
  - Step 3** From the **SDG Agent/IP** drop-down list, select an SDG agent (100.0.0.101) which announces the services, for example, Printer.
  - Step 4** Select **Peer** from the **Service Layer** drop-down list.
  - Step 5** Uncheck the box **Any**. By default, this is enabled.
  - Step 6** Select the query **VLAN** (Vlan-10) to distribute services (Printer) from a specific network.
  - Step 7** Enable or disable services from the selected query IPv4 subnet. By default, this is enabled.
  - Step 8** Enable or disable services from the selected query IPv6 subnet. By default, this is enabled.
  - Step 9** Enter the **service peer IPv4 address** (10.1.1.1).
  - Step 10** Click the + icon to add more service peers, if any. Select **Any** to accept services from any peer on a selected VLAN.
  - Step 11** (Optional) Click **Add Next** to add more source SDG agents. (Repeat the preceding steps.)
  - Step 12** Click **DONE**.
  - Step 13** Click **CREATE**.
- 

## Configuring Query SDG Agents in Traditional Multilayer Wired and Wireless - Local Mode (GUI)

This procedure configures distributed services to query SDG agents connected to a controller in service peer mode, based on a policy.

### Procedure

---

- Step 1** Click **Add** in the upper-right portion of the DNA-Center Policy screen.
- Step 2** Select the **Query SDG agent** radio button. By default, the **Source** radio button is selected.
- Step 3** From the **SDG Agent/IP** drop-down list, select an SDG agent (100.0.0.102) that receives queries for the services (Printer).
- Step 4** Select **Peer** from the **Service Layer** drop-down list.
- Step 5** Uncheck the box **Any**. By default, this is enabled.
- Step 6** Select the query **VLAN** (Vlan-30) to distribute services (Printer) to a specific network.

- Step 7** Enable or disable services from the selected query IPv4 subnet. By default, this is enabled.
- Step 8** Enable or disable services from the selected query IPv6 subnet. By default, this is enabled.
- Step 9** Enter the **service peer IPv4 address** (10.2.1.254).
- Step 10** Click the + icon to add more service-peers, if any. Select **Any** to accept services from any peer on a selected VLAN.
- Step 11** (Optional) Click **Add Next** to add more query agents. (Repeat the preceding steps.)
- Step 12** Click **DONE**.
- Step 13** Click **CREATE**.

## Verifying Wide Area Bonjour Between Multilayer Wired and Wireless Local Mode

This section provides step-by-step mDNS configuration and service discovery and distribution status based on applied policy on Wired Layer 2 access switch in service peer and SDG agent mode.

### Verifying Wired Service-Peer Configuration

Use the following commands on the Cisco Catalyst switch in service peer (SP-1) mode to determine the operational status after applying configuration and discovering the AirPrint service from the local network.

```
Device# show mdns-sd summary vlan 10

VLAN: 10
=====
mDNS Gateway: Enabled
mDNS Service Policy: LOCAL-AREA-POLICY
Active Query: Enabled
                : Periodicity 3600 Seconds
Transport Type: IPv4
Service Instance Suffix: Not Configured
mDNS Query Type: ALL
SDG Agent IP: 10.1.1.254
Source Interface: Vlan4094

Device# show mdns-sd service-policy name LOCAL-AREA-POLICY

Service Policy Name Service List IN Name Service List Out Name
=====
LOCAL-AREA-POLICY      LOCAL-AREA-SERVICES-IN      LOCAL-AREA-SERVICES-OUT

Device# show mdns-sd cache vlan 10
```

Name	Type	TTL/ Remaining	Vlan-Id/ Interface-name	MAC Address	RR Record Data
_universal._sub._ipp.	PTR	4500/4486	Vl10	ac18.2651.03fe	Bldg-1-FL1-PRN.
_tcp.local					_ipp._tcp.local



Name	Type	TTL/ Remaining	Vlan-Id/ Interface-name	MAC Address	RR Record Data
_ipp._tcp.local	PTR	4500/4486	V110	ac18.2651.03fe	Bldg-1-FL1-PRN. _ipp._tcp.local
Bldg-1-FL1- PRN._ipp._tcp.local	SRV	4500/4486	V110	ac18.2651.03fe	Bldg-1-FL1-PRN. local
Bldg-1-FL1- PRN.local	A	4500/4486	V110	ac18.2651.03fe	10.153.1.1
Bldg-1-FL1- PRN.local	AAAA	4500/4486	V110	ac18.2651.03fe	2001:10:153:1:79: A40C:6BEE:AEEC
Bldg-1-FL1- PRN._ipp._tcp.local	TXT	4500/4486	V110	ac18.2651.03fe	(451)'txtvers=1"priori ty=EPSON WF-3620 usb_MFG=EPSON" usb_MDL=W~

Device# **show mdns-sd statistics vlan 10**

mDNS Statistics

V110:

```

mDNS packets sent           : 612
  IPv4 sent                  : 612
    IPv4 advertisements sent : 0
    IPv4 queries sent        : 612
  IPv6 sent                  : 0
    IPv6 advertisements sent : 0
    IPv6 queries sent        : 0
Unicast sent                 : 0
mDNS packets rate limited    : 0
mDNS packets received        : 42
  advertisements received    : 28
  queries received           : 14
    IPv4 received            : 42
      IPv4 advertisements received: 28
      IPv4 queries received      : 14
    IPv6 received            : 0
      IPv6 advertisements received: 0
      IPv6 queries received      : 0
mDNS packets dropped         : 0

```

```

=====
Query Type                   : Count
=====

```

```

PTR                           : 12
SRV                           : 0
A                             : 0
AAAA                          : 0
TXT                           : 0
ANY                           : 3
=====

```

```

PTR Name                      Advertisement  Query

```

```
=====
_ipp. _tcp.local          9          4
```

## Verifying Wired SDG Agent Configuration and Service-Routing Status

This section provides information on mDNS configuration and service-routing on Wired SDG Agent (SDG-1) with locally attached Layer 2 access switches in Service-Peer (SP-1) mode and with centrally paired Cisco Catalyst Center for Wide Area Bonjour service-routing.

```
Device# show mdns-sd summary vlan 10
```

```
VLAN: 10
=====
mDNS Gateway           : Enabled
mDNS Service Policy    : LOCAL-AREA-POLICY
Active Query           : Disabled
Transport Type         : IPv4
Service Instance Suffix : Not-Configured
mDNS Query Type        : ALL
SDG Agent IP           : Not-Configured
Source Interface        : Not-Configured
```

```
Device# show mdns-sd cache vlan 10
```

```
VLAN: 10
=====
mDNS Gateway           : Enabled
mDNS Service Policy    : LOCAL-AREA-POLICY
Active Query           : Disabled
Transport Type         : IPv4
Service Instance Suffix : Not-Configured
mDNS Query Type        : ALL
SDG Agent IP           : Not-Configured
Source Interface        : Not-Configured
```

Name	Type	TTL/ Remaining	Vlan-Id /Interface-name	MAC Address	RR Record Data
_universal. _sub._ipp _tcp.local	PTR	4500/4500	V110	ac18.2651.03fe	Bldg-1-FL1-PRN. _ipp. _tcp.local
_ipp. _tcp.local	PTR	4500/4500	V110	ac18.2651.03fe	Bldg-1-FL1-PRN. _ipp. _tcp.local
Bldg-1-FL1- PRN. _ipp. _tcp.local	SRV	4500/4500	V110	ac18.2651.03fe	0 0 631 Bldg-1-FL1-PRN. local
Bldg-1-FL1 -PRN.local	A	4500/4500	V110	ac18.2651.03fe	10.153.1.1

Name	Type	TTL/ Remaining	Vlan-Id /Interface-name	MAC Address	RR Record Data
Bldg-1-FL1- PRN.local	AAAA	4500/4500	V110	ac18.2651.03fe	2001:10:153: 1:79: A40C:6BEE: AEEC
Bldg-1-FL1- PRN._ipp. _tcp.local	TXT	4500/4500	V110	ac18.2651.03fe	(51) was ip priority=30 ty=EPSON WF-3620 Series" upMGH80MDW-

Device# **show mdns-sd sp-sdg statistics**

```

                                One min, 5 mins, 1 hour
Average Input rate (pps)       : 0,      0,      0
Average Output rate (pps)     : 0,      0,      0
Messages received:
  Query                        : 15796
  ANY query                   : 0
  Advertisements              : 28
  Advertisement Withdraw      : 0
  Interface down               : 0
  Vlan down                   : 0
  Service-peer ID change      : 0
  Service-peer cache clear    : 12
  Resync response             : 6
Messages sent:
  Query response               : 5975
  ANY Query response          : 0
  Cache-sync                  : 61
  Get service-instance        : 0

```

Device# **show mdns-sd controller detail**

```

Controller: DNAC-Policy
IP: 100.0.0.1, Dest Port : 9991, Src Port : 42446, State : UP
Source Interface : Loopback0, MD5 Disabled
Hello Timer 30 sec, Dead Timer 120 sec, Next Hello 00:00:24
Uptime 2d05h (17:02:37 UTC Jan 15 2021)
Service Buffer: Enabled

Service Announcement:
Filter: DNAC-CONTROLLER-POLICY
Count 50, Delay Timer 30 sec, Pending Announcement 0, Pending Withdraw 0
Total Export Count 56, Next Export in 00:00:24

Service Query:
Query Suppression Enabled
Query Count 50, Query Delay Timer 15 sec, Pending 0
Total Query Count 15791, Next Query in 00:00:09

```

## Verifying Wireless Service-Peer Configuration and Service Status

The command given below helps determine the operational status after applying configuration and discovering the AirPrint service from the remote network.

```
Device# show mdns-sd summary
```

```
mDNS Gateway: Enabled
Mode: Service Peer
Service Announcement Periodicity (in seconds): 30
Service Announcement Count: 50
Service Query Periodicity (in seconds): 15
Service Query Count: 50
Active Response Timer (in seconds): Disabled
ANY Query Forward: Disabled
SDG Agent IP: 10.2.1.254
Source Interface: Vlan4094
Active Query Periodicity (in minutes): 15
Transport Type: IPv4
mDNS AP service policy: default-mdns-service-policy
```

```
Device# show wireless profile policy detailed WLAN-PROFILE | sec mDNS
```

```
mDNS Gateway
  mDNS Service Policy name      : LOCAL-AREA-POLICY
```

```
Device# show mdns-sd statistics wlan-id 1
```

```
mDNS Packet Statistics
-----
mDNS stats last reset time: 01/10/21 21:38:19
mDNS packets sent: 4592
  IPv4 sent: 4592
    IPv4 advertisements sent: 4592
    IPv4 queries sent: 0
  IPv6 sent: 0
    IPv6 advertisements sent: 0
    IPv6 queries sent: 0
  Multicast sent: 0
    IPv4 sent: 0
    IPv6 sent: 0
mDNS packets received: 297
  advertisements received: 80
  queries received: 217
  IPv4 received: 297
    IPv4 advertisements received: 80
    IPv4 queries received: 217
  IPv6 received: 0
    IPv6 advertisements received: 0
    IPv6 queries received: 0
mDNS packets dropped: 297
Query Type Statistics
  PTR queries received: 1720
  SRV queries received: 8
  A query received: 8
  AAAA queries received: 8
  TXT queries received: 97
  ANY queries received: 153
  OTHER queries received: 0
```

```
Device# show mdns-sd sp-sdg statistics
```

```
mDNS SP Statistics
```

```

last reset time: 01/10/21 21:37:36

Messages sent:
  Query                : 12675
  ANY query            : 0
  Advertisements       : 24
  Advertisement Withdraw : 0
  Service-peer ID change : 0
  Service-peer cache clear : 7
  Resync response      : 5
Messages received:
  Query response       : 4619
  ANY Query response   : 0
  Cache-sync          : 48
  Get service-instance : 0

```

```
Device# show mdns-sd query-db
```

```
MDNS QUERY DB
```

```

Client MAC: 4c32. 7593.e3af
Vlan ID: 30
Wlan ID: 1
Location Group ID: 0
PTR Name(s):
  _ipp._tcp.local

```

## Verifying Wireless SDG Agent Configuration and Service-Routing Status

This section provides information on mDNS configuration and service-routing on Wireless SDG Agent (SDG-2) with locally attached controller in service peer (SP-2) mode and with centrally paired Cisco DNA-Center for Wide Area Bonjour service-routing.

```
Device# show mdns-sd summary vlan 30
```

```

VLAN: 30
=====
mDNS Gateway           : Enabled
mDNS Service Policy    : LOCAL-AREA-POLICY
Active Query           : Disabled
Transport Type         : IPv4
Service Instance Suffix : Not Configured
mDNS Query Type        : ALL
SDG Agent IP           : Not Configured
Source Interface       : Not Configured

```

```
Device# show mdns-sd sp-sdg statistics
```

```

One min, 5 mins, 1 hour
Average Input rate (pps) :0,      0,      0
Average Output rate (pps) :0,      0,      0
Messages received:
  Query                : 12191
  ANY query            : 0
  Advertisements       : 0
  Advertisement Withdraw : 0
  Interface down       : 0
  Vlan down            : 0
  Service-peer ID change : 0
  Service-peer cache clear : 18
  Resync response      : 10

```

```

Messages sent:
Query response           : 1975
ANY Query response      : 0
Cache-sync              : 19
Get service-instance     : 0

Device# show mdns-sd controller detail

Controller: DNAC-Policy
IP: 100.0.0.1, Dest Port : 9991, Src Port : 42931, State : UP
Source Interface: Loopback0, MD5 Disabled
Hello Timer 30 sec, Dead Timer 120 sec, Next Hello 00:00:19
Uptime 2d05h (17:10:18 UTC Jan 15 2021)
Service Buffer: Enabled

Service Announcement:
Filter: DNAC-CONTROLLER-POLICY
Count 50, Delay Timer 30 sec, Pending Announcement 0, Pending Withdraw 0
Total Export Count 0, Next Export in 00:00:19

Service Query:
Query Suppression Enabled
Query Count 50, Query Delay Timer 15 sec, Pending 0
Total Query Count 17093, Next Query in 00:00:19

```

## Verifying Cisco Catalyst Center Configuration and Service-Routing Status

The Cisco Wide Area Bonjour application supports comprehensive assurance capabilities to manage service-routing with network-wide distributed Cisco Catalyst switches in SDG-Agent role and mDNS services discovered over Wide Area Bonjour domain. The assurance capabilities in Cisco Wide Area Bonjour provides ability to determine service-routing state, mDNS service state and many more information at various levels for day-2 operations, analysis and troubleshooting. Each category serves unique function to manage and troubleshoot Wide Area Bonjour service-routing for day-2 operation.

This sub-section provides brief overview for each category of monitor function:

- **Dashboard:** The landing page of Cisco Wide Area Bonjour application provides key statistics in various formats to quickly determine service-routing health across the network. The network administrator can monitor operational status of service-routing with SDG Agent devices, historical chart of service discovery request, processing and drops from network-wide distributed devices and top five talkers across the network.
- **Sub-Domain 360°:** The network administrator can briefly collect statistics and status counts in 360° view. The left-panel monitoring, and configuration bar is automatically open upon clicking selected sub-domain to verify configured policies, discovered service-instances on per sub domain basis of the configuration section.
- **Monitor:** A comprehensive 3-tier monitoring and troubleshooting function of Cisco Wide Area Bonjour application for various day-2 operations. The detail view of SDG Agent, Service-Instance and advanced Troubleshooting capabilities allows network administrator to manage and troubleshoot Wide Area Bonjour domain with single of glass on Cisco Catalyst Center.

For more information, see [Cisco Wide Area Bonjour on Cisco Catalyst Center User Guide, Release 2.1.2](#) guide. The assurance capabilities and operation details are explained in Monitor the Cisco Wide Area Bonjour Application chapter to manage Cisco Wide Area Bonjour application with various supporting service-routing assurance function.

# Reference

*Table 110:*

<b>Related Topic</b>	<b>Document Title</b>
DNA Service for Bonjour Deployment on Cisco Catalyst 9600 Switch	<a href="#">Cisco Catalyst 9600 Series Switch Software Configuration Guide, Release 17.5.X</a>
DNA Service for Bonjour Deployment on Cisco Catalyst 9500 Switch	<a href="#">Cisco Catalyst 9500 Series Switch Software Configuration Guide, Release 17.5.X</a>
DNA Service for Bonjour Deployment on Cisco Catalyst 9400 Switch	<a href="#">Cisco Catalyst 9400 Series Switch Software Configuration Guide, Release 17.5.X</a>
DNA Service for Bonjour Deployment on Cisco Catalyst 9300 Switch	<a href="#">Cisco Catalyst 9300 Series Switch Software Configuration Guide, Release 17.5.X</a>
Cisco Wide Area Bonjour Application on Cisco Catalyst Center User Guide	<a href="#">Cisco Wide Area Bonjour Application on Cisco Catalyst Center User Guide, Release 2.2.2</a>







## CHAPTER 198

# Configuration Example for FlexConnect Mode - Wireless and Wired

---

- [Overview, on page 2007](#)
- [Configuration Example for Default Service List and Policy in FlexConnect Mode - Wireless and Wired, on page 2008](#)
- [Configuration Example for Customized Service List and Policy in FlexConnect Mode - Wireless and Wired, on page 2011](#)
- [Verifying Configuration Example for FlexConnect Mode - Wireless and Wired, on page 2015](#)
- [Reference, on page 2019](#)

## Overview

This chapter provides configuration guidelines to implement Local Area Bonjour enabling end-to-end policy-based mDNS service discovery and distribution across multilayer wired and wireless FlexConnect local-switching mode. The first hop mDNS gateway at Layer 2 access switch must be implemented in service peer mode and paired with common distribution-layer switch in SDG agent role IP gateway function to wired and wireless clients. The network-wide distributed SDG agent can be paired alternatively with the Cisco Catalyst Center to enable mDNS service-routing across IP core network providing mDNS service assurance, monitoring and troubleshooting.

The following figure illustrates unicast mode Bonjour network environment with AirPrint capable printer and wireless user computer (macOS, Microsoft Windows, and so on.) connected to the same Ethernet switch. The network administrator implements the policy permitting additional endpoints associated to nearby location Ethernet switch to discover and use remote AirPrint capable Printer without flooding mDNS over wired and wireless networks.

Figure 76: Local Area Bonjour Service-Routing Multilayer Wired and Wireless FlexConnect Local-Switching Mode

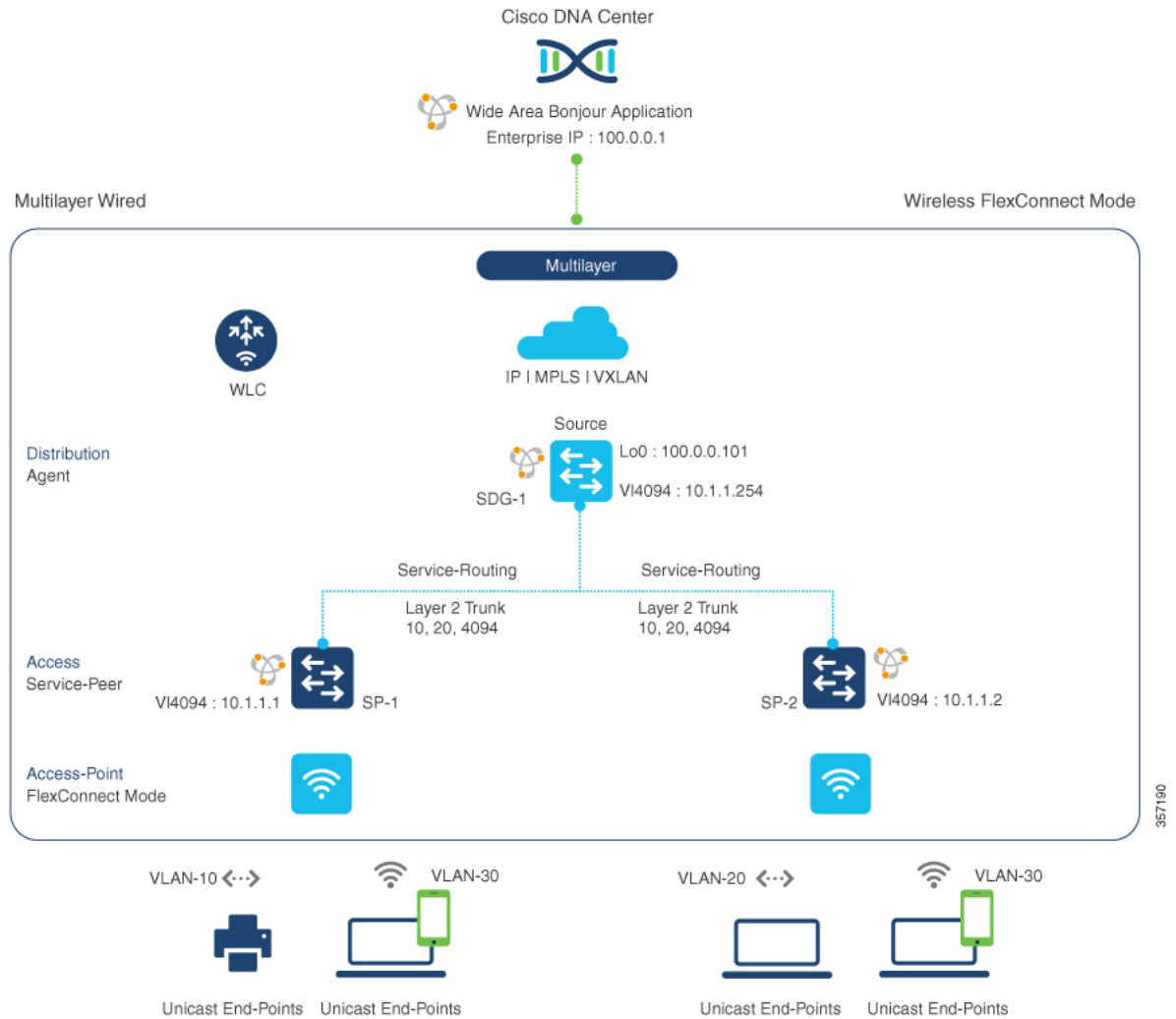

## Configuration Example for Default Service List and Policy in FlexConnect Mode - Wireless and Wired

This section provides guidance on configuring Service-Peer, SDG Agent, and Cisco Catalyst Center, allowing the wired and wireless endpoints to dynamically discover the default service list using Layer 2 unicast and policy.

### Example: Wired and Wireless Access Layer Service Peer Configuration

The following table provides a sample configuration of wired and wireless controller access layer service peer.

Table 111: Configuring Wired and Wireless Access Layer Service Peer

Configuration Step	Sample Configuration: SP-1 Service-Peer Configuration	Sample Configuration: SP-2 Service-Peer Configuration
<b>Step-1:</b> Enable mDNS gateway and set the gateway mode.	! mdns-sd gateway mode service-peer !	! mdns-sd gateway mode service-peer !
<b>Step-2:</b> Create unique mDNS inbound policy to permit ingress AirPrint service announcement and query on the Catalyst Switch in service peer mode.	! mdns-sd service-list LOCAL-AREA-SERVICES-IN in match printer-ipp !	! mdns-sd service-list LOCAL-AREA-SERVICES-IN in match printer-ipp !
<b>Step-3:</b> Create unique mDNS outbound policy to permit egress AirPrint service response on the Catalyst Switch in service peer mode	! mdns-sd service-list LOCAL-AREA-SERVICES-OUT out match printer-ipp !	! mdns-sd service-list LOCAL-AREA-SERVICES-OUT out match printer-ipp !
<b>Step-4:</b> Associate inbound and outbound service list to a unique service policy.	! mdns-sd service-policy LOCAL-AREA-POLICY service-list LOCAL-AREA-SERVICES-IN service-list LOCAL-AREA-SERVICES-OUT !	! mdns-sd service-policy LOCAL-AREA-POLICY service-list LOCAL-AREA-SERVICES-IN service-list LOCAL-AREA-SERVICES-OUT !
<b>Step-5:</b> Activate unicast mDNS gateway and attach service policy on wired VLAN and wireless FlexConnect user VLAN of SP-1 and SP-2 Layer 2 access switch.	! vlan configuration 10, 30 mdns-sd gateway service-policy LOCAL-AREA-POLICY active-query timer 3600 !	! vlan configuration 20, 30 mdns-sd gateway service-policy LOCAL-AREA-POLICY active-query timer 3600 !
<b>Step-6:</b> Enable service routing on wired service peer mDNS between mDNS source and receiver local VLANs.  <b>Note</b> This step is optional for SP-2 switch as it does not have local mDNS service provider endpoints or VLANs.	! mdns-sd location-filter LOCAL-PROXY match location-group default vlan 10 match location-group default vlan 30 ! mdns-sd service-list LOCAL-AREA-SERVICES-OUT OUT match printer-ipps location-filter LOCAL-PROXY !	
<b>Step-7:</b> Enable unicast service routing between wired and wireless service peer and SDG agent using wired management source VLAN ID and IP address.	! vlan configuration 10, 30 mdns-sd gateway source-interface vlan 4094 sdg-agent 10.1.1.254 !	! vlan configuration 20, 30 mdns-sd gateway source-interface vlan 4094 sdg-agent 10.1.1.254 !

## Example: Wired and Wireless Distribution Layer SDG Agent Configuration

The following table provides a sample configuration of distribution layer SDG agent.

**Table 112: Configuring Wired and Wireless Distribution Layer SDG Agent**

Configuration Step	Sample Configuration: SDG-1 – SDG Agent
<b>Step-1:</b> Enable mDNS gateway and set the gateway mode. The default mode is sdg-agent.	<pre>! mdns-sd gateway !</pre>
<b>Step-2:</b> Create a unique mDNS inbound policy to permit ingress AirPrint service announcement and query the Catalyst Switch in Service-Peer mode.	<pre>! mdns-sd service-list LOCAL-AREA-SERVICES-IN in   match printer-ipp !</pre>
<b>Step-3:</b> Create a unique mDNS outbound policy to permit egress AirPrint service response on Catalyst Switch in Service-Peer mode.	<pre>! mdns-sd service-list LOCAL-AREA-SERVICES-OUT out   match printer-ipp !</pre>
<b>Step-4:</b> Associate the inbound and outbound service-list to a unique service-policy.	<pre>! mdns-sd service-policy LOCAL-AREA-POLICY service-list LOCAL-AREA-SERVICES-IN service-list LOCAL-AREA-SERVICES-OUT !</pre>
<b>Step-5:</b> Activate unicast mDNS gateway on wired VLAN and wireless user VLAN on SDG agents.	<pre>! vlan configuration 10, 20, 30 mdns-sd gateway !</pre>
<b>Step-6:</b> Configure the service peer-group and attach service-policy on the SDG agent distribution switch and enable service-routing between the assigned Service Peer switch group.	<pre>! mdns-sd service-peer group peer-group 1   service-policy LOCAL-AREA-POLICY   service-peer 10.1.1.1 location-group default    service-peer 10.1.1.2 location-group default !</pre>
<b>Step-7:</b> Create a unique controller bound mDNS policy to permit egress AirPrint service discovery and distribution from Catalyst Switch in SDG agent mode. Inbound policy towards controller is not required.	<pre>! mdns-sd service-list WIDE-AREA-SERVICES-OUT out   match printer-ipp !</pre>
<b>Step-8:</b> Associate outbound service-list to a unique service-policy.	<pre>! mdns-sd service-policy WIDE-AREA-POLICY service-list WIDE-AREA-SERVICES-OUT !</pre>

Configuration Step	Sample Configuration: SDG-1 – SDG Agent
<b>Step-9:</b> Enable Wide Area Bonjour service-routing with service export configuration association controller IP Address, source interface for stateful connection, and mandatory egress policy for Wide Area service-routing.	<pre>! service-export mdns-sd controller DNAC-CONTROLLER-POLICY controller-address 100.0.0.1 controller-source-interface LOOPBACK 0 controller-service-policy WIDE-AREA-POLICY !</pre>

## Configuration Example for Customized Service List and Policy in FlexConnect Mode - Wireless and Wired

This section provides guidance on configuring Service-Peer, SDG Agent, and Cisco Catalyst Center, allowing the wired and wireless endpoints to dynamically discover printer using Layer 2 unicast and policy.

### Example: Wired and Wireless Access Layer Service Peer Configuration

The following table provides a sample configuration of wired and wireless controller access layer service peer.

**Table 113: Configuring Wired and Wireless Access Layer Service Peer**

Configuration Step	Sample Configuration: SP-1 Service-Peer Configuration	Sample Configuration: SP-2 Service-Peer Configuration
<b>Step-1:</b> Enable mDNS gateway and set the gateway mode.	<pre>! mdns-sd gateway mode service-peer !</pre>	<pre>! mdns-sd gateway mode service-peer !</pre>
<b>Step-2:</b> Create unique mDNS inbound policy to permit ingress AirPrint service announcement and query on the Catalyst Switch in service peer mode.	<pre>! mdns-sd service-list LOCAL-AREA-SERVICES-IN in match printer-ipp !</pre>	<pre>! mdns-sd service-list LOCAL-AREA-SERVICES-IN in match printer-ipp !</pre>
<b>Step-3:</b> Create unique mDNS outbound policy to permit egress AirPrint service response on the Catalyst Switch in service peer mode	<pre>! mdns-sd service-list LOCAL-AREA-SERVICES-OUT out match printer-ipp !</pre>	<pre>! mdns-sd service-list LOCAL-AREA-SERVICES-OUT out match printer-ipp !</pre>
<b>Step-4:</b> Associate inbound and outbound service list to a unique service policy.	<pre>! mdns-sd service-policy LOCAL-AREA-POLICY service-list LOCAL-AREA-SERVICES-IN service-list LOCAL-AREA-SERVICES-OUT !</pre>	<pre>mdns-sd service-policy LOCAL-AREA-POLICY service-list LOCAL-AREA-SERVICES-IN service-list LOCAL-AREA-SERVICES-OUT !</pre>

Configuration Step	Sample Configuration: SP-1 Service-Peer Configuration	Sample Configuration: SP-2 Service-Peer Configuration
<b>Step-5:</b> Activate unicast mDNS gateway and attach service policy on wired VLAN and wireless FlexConnect user VLAN of SP-1 and SP-2 Layer 2 access switch.	<pre>! vlan configuration 10, 30 mdns-sd gateway   service-policy     LOCAL-AREA-POLICY   active-query timer 3600 !</pre>	<pre>! vlan configuration 20, 30 mdns-sd gateway   service-policy     LOCAL-AREA-POLICY   active-query timer 3600 !</pre>
<b>Step-6:</b> Enable service routing on wired service peer mDNS between mDNS source and receiver local VLANs.  <b>Note</b> This step is optional for SP-2 switch as it does not have local mDNS service provider endpoints or VLANs.	<pre>! mdns-sd location-filter LOCAL-PROXY   match location-group default   vlan 10   match location-group default   vlan 30 ! mdns-sd service-list LOCAL-AREA-SERVICES-OUT OUT   match printer-ipps location-filter LOCAL-PROXY !</pre>	
<b>Step-7:</b> Enable unicast service routing between wired and wireless service peer and SDG agent using wired management source VLAN ID and IP address.	<pre>vlan configuration 10, 30 mdns-sd gateway   source-interface vlan 4094   sdg-agent 10.1.1.254 !</pre>	<pre>! vlan configuration 20, 30 mdns-sd gateway   source-interface vlan 4094   sdg-agent 10.1.1.254 !</pre>

## Example: Wired and Wireless Distribution Layer SDG Agent Configuration

The following table provides a sample configuration of distribution layer SDG agent.

**Table 114: Configuring Wired and Wireless Distribution Layer SDG Agent**

Configuration Step	Sample Configuration: SDG-1 – SDG Agent
<b>Step-1:</b> Enable mDNS gateway and set the gateway mode. The default mode is sdg-agent.	<pre>! mdns-sd gateway !</pre>
<b>Step-2:</b> Create a unique mDNS inbound policy to permit ingress AirPrint service announcement and query the Catalyst Switch in Service-Peer mode.	<pre>! mdns-sd service-list LOCAL-AREA-SERVICES-IN in   match printer-ipp !</pre>
<b>Step-3:</b> Create a unique mDNS outbound policy to permit egress AirPrint service response on Catalyst Switch in Service-Peer mode.	<pre>! mdns-sd service-list LOCAL-AREA-SERVICES-OUT out   match printer-ipp !</pre>

Configuration Step	Sample Configuration: SDG-1 – SDG Agent
<b>Step-4:</b> Associate the inbound and outbound service-list to a unique service-policy.	<pre>! mdns-sd service-policy LOCAL-AREA-POLICY service-list LOCAL-AREA-SERVICES-IN service-list LOCAL-AREA-SERVICES-OUT !</pre>
<b>Step-5:</b> Activate unicast mDNS gateway on wired VLAN and wireless user VLAN on SDG agents.	<pre>! vlan configuration 10, 20, 30 mdns-sd gateway !</pre>
<b>Step-6:</b> Configure the service peer-group and attach service-policy on the SDG agent distribution switch and enable service-routing between the assigned Service Peer switch group.	<pre>! mdns-sd service-peer group peer-group 1 service-policy LOCAL-AREA-POLICY service-peer 10.1.1.1 location-group default  service-peer 10.1.1.2 location-group default !</pre>
<b>Step-7:</b> Create a unique controller bound mDNS policy to permit egress AirPrint service discovery and distribution from Catalyst Switch in SDG agent mode. Inbound policy towards controller is not required.	<pre>! mdns-sd service-list WIDE-AREA-SERVICES-OUT out match printer-ipp !</pre>
<b>Step-8:</b> Associate outbound service-list to a unique service-policy.	<pre>! mdns-sd service-policy WIDE-AREA-POLICY service-list WIDE-AREA-SERVICES-OUT !</pre>
<b>Step-9:</b> Enable Wide Area Bonjour service-routing with service export configuration association controller IP Address, source interface for stateful connection, and mandatory egress policy for Wide Area service-routing.	<pre>! service-export mdns-sd controller DNAC-CONTROLLER-POLICY controller-address 100.0.0.1 controller-source-interface LOOPBACK 0 controller-service-policy WIDE-AREA-POLICY !</pre>

## Cisco Catalyst Center Traditional Multilayer Wired and Wireless Configuration

### Configuring Service Filters for Traditional Multilayer Wired and Wireless FlexConnect Local-Switching Mode (GUI)

This procedure implements global service filters, which permit the Cisco Wide Area Bonjour application to dynamically discover and distribute service information between trusted Cisco Catalyst SDG agent switches across the IP network.

#### Procedure

**Step 1** Navigate to the **Configuration** tab in the Wide Area Bonjour application.

- Step 2** From the sidebar, select the sub-domain for which you want to create the service filter.
  - Step 3** Check the **Service Filter** box.
  - Step 4** Click **Service Filter** icon from the topology to view a list of the service filters for the selected domain. You can also manually edit existing service filters from this list.
  - Step 5** Click **Create Service Filter**.
  - Step 6** From the **Network Mode** drop-down list, choose **Traditional** (the default mode).
  - Step 7** Enter a unique name for the service filter.
  - Step 8** (Optional) Enter a description for the service filter.
  - Step 9** Select one or more service types to permit announcements and queries.
  - Step 10** Enable or disable service filters after creating them. By default, service filters are enabled.
- 

## Configuring Source SDG Agents in Traditional Multilayer Wired and Wireless FlexConnect Local-Switching Mode (GUI)

This procedure configures discovery of wired printer sources from the LAN distribution switches paired with Layer 2 Catalyst Switches in a service peer role. The wireless distribution switches paired with a controller in a service peer role receive query responses for wired printers and distribute the responses to querying devices over the wireless FlexConnect local switching mode network.

### Procedure

---

- Step 1** Click **Add** on the upper-right of Cisco Catalyst Center.
  - Step 2** Click the **Source** radio button to select a source SDG agent. By default, this radio button is selected.
  - Step 3** From the **SDG Agent/IP** drop-down list, select an SDG agent (100.0.0.101) which announces the services, for example, Printer.
  - Step 4** Select **Peer** from the **Service Layer** drop-down list.
  - Step 5** Uncheck the box **Any**. By default, this is unchecked.
  - Step 6** Select the query **VLAN** (Vlan-10) to distribute services (Printer) from a specific network.
  - Step 7** Enable or disable services from the selected query IPv4 subnet. By default, this is enabled.
  - Step 8** Enable or disable services from the selected query IPv6 subnet. By default, this is enabled.
  - Step 9** Enter the **service peer IPv4 address** (10.1.1.1).
 

**Note** Select **Any** to accept services from any peer on a selected VLAN.
  - Step 10** (Optional) Click **Add Next** to add more source SDG agents. (Repeat the preceding steps.)
  - Step 11** Click **DONE**.
  - Step 12** Click **CREATE**.
-



## Configuring Query SDG Agents in Traditional Multilayer Wired and Wireless FlexConnect Local-Switching Mode (GUI)

This procedure configures distributed services to query SDG agents connected to a controller in service peer mode, based on a policy.

If the network environment is different, see the [Cisco Wide Area Bonjour on Cisco Catalyst Center User Guide, Release 2.1.2](#).

### Procedure

- 
- Step 1** Click **Add** on the upper-right of Cisco Catalyst Center.
  - Step 2** Select the **Query SDG agent** radio button. By default, the **Source** radio button is selected.
  - Step 3** From the **SDG Agent/IP** drop-down list, select an SDG agent (100.0.0.102) that receives queries for the services (Printer).
  - Step 4** Select **Peer** from the **Service Layer** drop-down list.
  - Step 5** Uncheck the box **Any**. By default, this is enabled.
  - Step 6** Select the query **VLAN** (Vlan-30) to distribute services (Printer) to a specific network.
  - Step 7** Enable or disable services from the selected query IPv4 subnet. By default, this is enabled.
  - Step 8** Enable or disable services from the selected query IPv6 subnet. By default, this is enabled.
  - Step 9** Enter the **service peer IPv4 address** (10.2.1.254).
  - Step 10** Click the + icon to add more service-peers, if any. Select **Any** to accept services from any peer on a selected VLAN.
  - Step 11** (Optional) Click **Add Next** to add more query agents. (Repeat the preceding steps.)
  - Step 12** Click **DONE**.
  - Step 13** Click **CREATE**.
- 

## Verifying Configuration Example for FlexConnect Mode - Wireless and Wired

This section provides step-by-step mDNS configuration and service discovery and distribution status based on applied policy on Wired Layer 2 access switch in service peer and SDG agent mode.

### Verifying Wired Service-Peer Configuration

Use the following commands on the Cisco Catalyst switch in service peer (SP-1 and SP-2) mode to determine the operational status after applying configuration and discovering the AirPrint service from the local network.

```
Device# show mdns-sd summary vlan 10

VLAN: 10
=====
mDNS Gateway: Enabled
mDNS Service Policy: LOCAL-AREA-POLICY
```

## Verifying Wired Service-Peer Configuration

```

Active Query: Enabled
                : Periodicity 3600 Seconds
Transport Type: IPv4
Service Instance Suffix: Not Configured
mDNS Query Type: ALL
SDG Agent IP: 10.1.1.254
Source Interface: Vlan4094

```

```
Device# show mdns-sd service-policy name LOCAL-AREA-POLICY
```

```

Service Policy Name      Service List IN Name      Service List Out Name
=====
LOCAL-AREA-POLICY      LOCAL-AREA-SERVICES-IN    LOCAL-AREA-SERVICES-OUT

```

```
Device# show mdns-sd cache vlan 10
```

Name	Type	TTL/ Remaining	Vlan-Id/ Interface-name	MAC Address	RR Record Data
_universal._sub._ipp._tcp.local	PTR	4500/4486	Vl10	ac18.2651.03fe	Bldg-1-FL1-PRN._ipp._
_ipp._tcp.local	PTR	4500/4486	Vl10	ac18.2651.03fe	Bldg-1-FL1-PRN._ipp._
Bldg-1-FL1-PRN._ipp._tcp.local	SRV	4500/4486	Vl10	ac18.2651.03fe	0 0 631 Bldg-1-FL1-PRN
Bldg-1-FL1-PRN.local	A	4500/4486	Vl10	ac18.2651.03fe	10.153.1.1
Bldg-1-FL1-PRN.local	AAAA	4500/4486	Vl10	ac18.2651.03fe	2001:10:153:1:79:A40C
Bldg-1-FL1-PRN._ipp._tcp.local	TXT	4500/4486	Vl10	ac18.2651.03fe	(451)'txtvers=1"priority= ty=EPSON WF-3620 Ser usb_MFG=EPSON" usb_MDL=W~!~

```
Device# show mdns-sd statistics vlan 10
```

```
mDNS Statistics
```

```

Vl10:
mDNS packets sent          : 612
  IPv4 sent                 : 612
    IPv4 advertisements sent : 0
    IPv4 queries sent       : 612
  IPv6 sent                 : 0
    IPv6 advertisements sent : 0
    IPv6 queries sent       : 0
Unicast sent               : 0
mDNS packets rate limited  : 0
mDNS packets received      : 42
advertisements received    : 28
queries received           : 14
  IPv4 received             : 42
    IPv4 advertisements received: 28
    IPv4 queries received    : 14

```

```

IPv6 received          : 0
IPv6 advertisements received: 0
IPv6 queries received  : 0
mDNS packets dropped   : 0
=====
Query Type              : Count
=====
PTR                     : 12
SRV                     : 0
A                       : 0
AAAA                   : 0
TXT                     : 0
ANY                     : 3
=====
PTR Name                Advertisement      Query
=====
_ipp._tcp.local         9          4

```

## Verifying Wired SDG Agent Configuration and Service-Routing Status

This section provides information on mDNS configuration and service-routing on Wired and Wireless SDG Agent (SDG-1) with locally attached Layer 2 access switches in Service-Peer (SP-1 and SP-2) mode and with centrally paired Cisco Catalyst Center for Wide Area Bonjour service-routing.

```
Device# show mdns-sd summary vlan 10
```

```

VLAN: 10
=====
mDNS Gateway           : Enabled
mDNS Service Policy    : LOCAL-AREA-POLICY
Active Query           : Disabled
Transport Type         : IPv4
Service Instance Suffix : Not Configured
mDNS Query Type        : ALL
SDG Agent IP           : Not-Configured
Source Interface       : Not-Configured

```

```
Device# show mdns-sd cache vlan 10
```

Name	Type	TTL/ Remaining	Vlan-Id /Interface-name	MAC Address	RR Record Data
_universal._sub._ipp._tcp.local	PTR	4500/4500	V110	ac18.2651.03fe	Bldg-1-FL1-PRN._ipp._tcp.local
_ipp._tcp.local	PTR	4500/4500	V110	ac18.2651.03fe	Bldg-1-FL1-PRN._ipp._tcp.local
Bldg-1-FL1-PRN._ipp._tcp.local	SRV	4500/4500	V110	ac18.2651.03fe	0 0 631 Bldg-1-FL1-PRNlocal
Bldg-1-FL1-PRN.local	A	4500/4500	V110	ac18.2651.03fe	10.153.1.1

Name	Type	TTL/ Remaining	Vlan-Id /Interface-name	MAC Address	RR Record Data
Bldg-1-FL1-PRN.local	AAAA	4500/4500	V110	ac18.2651.03fe	2001:10:153: 1:79 A40C:6BEE: AEEC
Bldg-1-FL1-PRN._ipp._tcp.local	TXT	4500/4500	V110	ac18.2651.03fe	(5) <del>type=EPSON</del> type=EPSON WF-3620 Series" <del>type=EPSON</del>

Device# **show mdns-sd sp-sdg statistics**

```

                                One min, 5 mins, 1 hour
Average Input rate (pps)       : 0,      0,      0
Average Output rate (pps)     : 0,      0,      0
Messages received:
  Query                        : 15796
  ANY query                   : 0
  Advertisements              : 28
  Advertisement Withdraw      : 0
  Interface down              : 0
  Vlan down                   : 0
  Service-peer ID change      : 0
  Service-peer cache clear    : 12
  Resync response             : 6
Messages sent:
  Query response              : 5975
  ANY Query response          : 0
  Cache-sync                  : 61
  Get service-instance        : 0

```

Device# **show mdns-sd controller detail**

```

Controller: DNAC-Policy
IP: 100.0.0.1, Dest Port : 9991, Src Port : 42446, State : UP
Source Interface: Loopback0, MD5 Disabled
Hello Timer 30 sec, Dead Timer 120 sec, Next Hello 00:00:24
Uptime 2d05h (17:02:37 UTC Jan 15 2021)
Service Buffer: Enabled

Service Announcement:
Filter: DNAC-CONTROLLER-POLICY
Count 50, Delay Timer 30 sec, Pending Announcement 0, Pending Withdraw 0
Total Export Count 56, Next Export in 00:00:24

Service Query:
Query Suppression Enabled
Query Count 50, Query Delay Timer 15 sec, Pending 0
Total Query Count 15791, Next Query in 00:00:09

```

## Verifying Cisco Catalyst Center Configuration and Service Routing Status

The Cisco Wide Area Bonjour application supports comprehensive assurance capabilities to manage service routing with network-wide distributed Cisco Catalyst switches in SDG Agent role and mDNS services discovered over Wide Area Bonjour domain. The assurance capabilities in Cisco Wide Area Bonjour provides the ability to determine service routing state, mDNS service state, and many more information at various levels for day-2 operations, analysis and troubleshooting. Each category serves unique function to manage and troubleshoot Wide Area Bonjour service routing for day-2 operation.

This sub-section provides brief overview for each category of monitor function:

- **Dashboard:** The landing page of Cisco Wide Area Bonjour application provides key statistics in various formats to quickly determine service routing health across the network. The network administrator can monitor operational status of service routing with SDG Agent devices, historical chart of service discovery request, processing and drops from network-wide distributed devices and top five talkers across the network.
- **Sub-Domain 360°:** The network administrator can briefly collect statistics and status counts in 360° view. The left-panel monitoring, and configuration bar is automatically open upon clicking selected sub-domain to verify configured policies, discovered service-instances on per sub-domain basis of the configuration section.
- **Monitor:** A comprehensive 3-tier monitoring and troubleshooting function of Cisco Wide Area Bonjour application for various day-2 operations. The detail view of SDG Agent, Service-Instance, and advanced Troubleshooting capabilities allows network administrator to manage and troubleshoot Wide Area Bonjour domain with a single pane of glass on Cisco Catalyst Center.

For more information, see [Cisco Wide Area Bonjour on Cisco Catalyst Center User Guide, Release 2.1.2](#) guide. The assurance capabilities and operation details are explained in **Monitor the Cisco Wide Area Bonjour Application** chapter to manage Cisco Wide Area Bonjour application with various supporting service routing assurance function.

## Reference

**Table 115:**

Related Topic	Document Title
DNA Service for Bonjour Deployment on Cisco Catalyst 9600 Switch	<a href="#">Cisco Catalyst 9600 Series Switch Software Configuration Guide, Release 17.5.X</a>
DNA Service for Bonjour Deployment on Cisco Catalyst 9500 Switch	<a href="#">Cisco Catalyst 9500 Series Switch Software Configuration Guide, Release 17.5.X</a>
DNA Service for Bonjour Deployment on Cisco Catalyst 9400 Switch	<a href="#">Cisco Catalyst 9400 Series Switch Software Configuration Guide, Release 17.5.X</a>
DNA Service for Bonjour Deployment on Cisco Catalyst 9300 Switch	<a href="#">Cisco Catalyst 9300 Series Switch Software Configuration Guide, Release 17.5.X</a>
Cisco Wide Area Bonjour Application on Cisco Catalyst Center User Guide	<a href="#">Cisco Wide Area Bonjour Application on Cisco Catalyst Center User Guide, Release 2.2.2</a>





## PART **XIX**

# Multicast Domain Name System

- [Multicast Domain Name System, on page 2023](#)







## CHAPTER 199

# Multicast Domain Name System

- Introduction to mDNS Gateway, on page 2024
- Guidelines and Restrictions for Configuring mDNS AP, on page 2024
- Enabling mDNS Gateway (GUI), on page 2026
- Enabling or Disabling mDNS Gateway (GUI), on page 2026
- Enabling or Disabling mDNS Gateway (CLI), on page 2026
- Creating Default Service Policy, on page 2028
- Creating Custom Service Definition (GUI), on page 2028
- Creating Custom Service Definition, on page 2028
- Creating Service List (GUI), on page 2029
- Creating Service List, on page 2030
- Creating Service Policy (GUI), on page 2032
- Creating Service Policy, on page 2032
- Configuring a Local or Native Profile for an mDNS Policy, on page 2033
- Configuring an mDNS Flex Profile (GUI), on page 2034
- Configuring an mDNS Flex Profile (CLI), on page 2034
- Applying an mDNS Flex Profile to a Wireless Flex Connect Profile (GUI), on page 2035
- Applying an mDNS Flex Profile to a Wireless Flex Connect Profile (CLI), on page 2036
- Enabling the mDNS Gateway on the VLAN Interface, on page 2036
- Location-Based Service Filtering, on page 2037
- Configuring mDNS AP, on page 2040
- Enabling mDNS Gateway on the RLAN Interface, on page 2041
- Enabling mDNS Gateway on Guest LAN Interface, on page 2043
- Associating mDNS Service Policy with Wireless Profile Policy (GUI), on page 2044
- Associating mDNS Service Policy with Wireless Profile Policy, on page 2045
- Enabling or Disabling mDNS Gateway for WLAN (GUI), on page 2048
- Enabling or Disabling mDNS Gateway for WLAN, on page 2048
- mDNS Gateway with Guest Anchor Support and mDNS Bridging, on page 2049
- Configuring mDNS Gateway on Guest Anchor, on page 2050
- Configuring mDNS Gateway on Guest Foreign (Guest LAN), on page 2050
- Configuring mDNS Gateway on Guest Anchor, on page 2051
- Configuring mDNS Gateway on Guest Foreign (Guest WLAN), on page 2052
- Verifying mDNS Gateway Configurations, on page 2052

# Introduction to mDNS Gateway

Multicast Domain Name System (mDNS) is an Apple service discovery protocol which locates devices and services on a local network with the use of mDNS service records.

The Bonjour protocol operates on service announcements and queries. Each query or advertisement is sent to the Bonjour multicast address ipv4 224.0.0.251 (ipv6 FF02::FB). This protocol uses mDNS on UDP port 5353.

The address used by the Bonjour protocol is link-local multicast address and therefore is only forwarded to the local L2 network. As, multicast DNS is limited to an L2 domain for a client to discover a service it has to be part of the same L2 domain, This is not always possible in any large scale deployment or enterprise.

In order to address this issue, the Cisco Catalyst 9800 Series Wireless Controller acts as a Bonjour Gateway. The controller then listens for Bonjour services, caches these Bonjour advertisements (AirPlay, AirPrint, and so on) from the source or host. For example, Apple TV responds back to Bonjour clients when asked or requested for a service. This way you can have sources and clients in different subnets.

By default, the mDNS gateway is disabled on the controller. To enable mDNS gateway functionality, you must explicitly configure mDNS gateway using CLI or Web UI.

## Prerequisite

Since the Cisco Catalyst 9800 Series Wireless Controller will respond and advertise for services cached when acting as a Bonjour Gateway, it must have an SVI interface with a valid IP address on every VLAN where mDNS is allowed or used. This will be the source IP address of those mDNS packets that are coming out from the controller acting as mDNS Gateway.

# Guidelines and Restrictions for Configuring mDNS AP

- Cisco recommends deploying scalable Wide Area Bonjour to route mDNS service between Wired and Wireless networks. Cisco Catalyst 9800 Series Wireless LAN Controller (WLC) introduces a new mDNS gateway called Service-Peer mode to replace the classic mDNS flood-n-learn to support Enterprise-grade scalable, stateful, and reliable complete unicast-based mDNS service-routing with upstream gateway Cisco Catalyst 9000 Series Switches. For more information, see [Cisco DNA Service for Bonjour](#).
- The mDNS AP (classic flood-n-learn based feature) is enhanced with complete unicast-based service-routing using Cisco Wide Area Bonjour supporting flood-free Wired and Wireless networks to overcome several operational, scalable, and service resiliency challenges.
- The mDNS AP extends the mDNS flood from Wired VLANs to AP and further extends over the CAPWAP tunnel to WLC for central processing across Core network. Cisco recommends that the mDNS AP must be considered only for small network environments.
- The mDNS AP is supported only in Local and Monitor modes. If Cisco Wireless AP is in FlexConnect mode, the Fabric mode AP does not support mDNS AP feature. For more information on how to enable the mDNS service-routing for various distributed Wireless modes, see [Cisco DNA Service for Bonjour](#).
- Wireless users connected to mDNS AP may not be able to browse the Wired mDNS services across flooded Wired VLAN to mDNS AP.

- The Wired mDNS service-provider VLANs must be extended to flood the mDNS traffic up to mDNS AP ethernet port in trunk mode settings. The Wired VLAN extension to mDNS AP may include other Wired flood traffic, such as Broadcast, Unknown Unicast, and Layer 2 Multicast that impacts the mDNS AP scale and performance.
- It is recommended to have minimum one mDNS AP for each Layer 3 Access switch. All Wired mDNS traffic is flooded using alternate L2 methods, if single mDNS AP is shared between multiple Layer 3 Access switch.
- The maximum mDNS AP scale limit for each Cisco Catalyst 9800 Series Wireless LAN Controller (WLC) is limited.
- The maximum mDNS Wired VLAN count for each WLC is limited.
- The old Wired mDNS service entry continues to be advertised to all Wireless users up to 4500 seconds based on the mDNS cache timers on WLC. The stale entries require manual clearing from local cache in WLC.
- The mDNS AP does not support mDNS Query packet suppression or rate-limiter in AP. The Wired mDNS flood from all Wired VLAN is extended to WLC for central processing of policy enforcement.
- The maximum number of flooded packets for each second processing from Wired VLANs to mDNS AP is limited. The mDNS AP performance and reliability may get compromised in large network environments.
- A maximum of 10 Wired VLANs' mDNS flood can be extended to mDNS AP. Combined large Wired VLAN and mDNS AP scale may impact scale and performance in AP and WLC.
- Only one mDNS AP is supported for each Wired VLAN. Multiple mDNS APs cannot be configured to map the same Wired VLAN ID as it causes service instability and duplicate processing.
- High Availability is not supported in multiple mDNS AP. The mDNS services across Wired and Wireless network gets disrupted when connectivity to mDNS AP is lost due to any kinds of failures.
- Only one Wired mDNS service-policy is supported for all network-wide mDNS AP.
- All WLAN users can discover all flooded Wired mDNS services without granular Location-Based service. The mDNS AP in large and flooded network impacts user-experience on mobile devices.
- The mDNS AP do not support IPv6 for Wired mDNS service-provider or service-receiver. Only IPv4 is supported.
- The mDNS AP do not support role-based mDNS service filtering between Wired and Wireless networks.
- The mDNS AP do not detect and auto-resolve duplicate mDNS service-instance names across Wired VLANs. The Cisco Catalyst 9800 Series Wireless LAN Controller (WLC) discovers and records the first service instance with unique name in its local cache database. If a duplicate service instance name is discovered, the WLC rejects the duplicate name and does not distribute it to the Wireless clients.
- Wireless multicast link-local is enabled by default. When wireless link-local is enabled, only mDNS Bridging mode is supported. If you require mDNS Gateway for wired services, disable wireless link-local.
- If you have a FlexConnect AP as an mDNS gateway, ensure that you do not use "." in the service provider name, as it is not supported.

## Enabling mDNS Gateway (GUI)

### Procedure

---

- Step 1** Choose **Configuration** > **Services** > **mDNS**.
- Step 2** In the **Global** section, toggle the slider to enable or disable the **mDNS Gateway**.
- Step 3** From the **Transport** drop-down list, choose one of the following types:
- **ipv4**
  - **ipv6**
  - **both**
- Step 4** Enter an appropriate timer value in **Active-Query Timer**. The valid range is between 1 to 120 minutes. The default is 30 minutes.
- Step 5** From the **mDNS-AP Service Policy** drop-down list, choose an mDNS service policy.
- Note** Service policy is optional only if mDNS-AP is configured. If mDNS-AP is not configured, the system uses default-service-policy.
- Step 6** Click **Apply**.
- 

## Enabling or Disabling mDNS Gateway (GUI)

### Procedure

---

- Step 1** Choose **Configuration** > **Services** > **mDNS** > **Global**.
- Step 2** Enable or disable the **mDNS Gateway** toggle button.
- Step 3** Choose **ipv4** or **ipv6** or **both** from the **Transport** drop-down list.
- Step 4** Enter the **Active-Query Timer**.
- Step 5** Click **Apply**.
- 

## Enabling or Disabling mDNS Gateway (CLI)



- Note**
- mDNS gateway is disabled by default globally on the controller.
  - You need both global and WLAN configurations to enable mDNS gateway.
-

## Procedure

	Command or Action	Purpose
<b>Step 1</b>	<b>enable</b> <b>Example:</b> Device> enable	Enables privileged EXEC mode. Enter your password, if prompted.
<b>Step 2</b>	<b>configure terminal</b> <b>Example:</b> Device# configure terminal	Enters global configuration mode.
<b>Step 3</b>	<b>mdns-sd gateway</b> <b>Example:</b> Device(config)# mdns-sd gateway	Enables mDNS gateway.
<b>Step 4</b>	<b>transport {ipv4   ipv6   both}</b> <b>Example:</b> Device(config-mdns-sd)# transport ipv4	Processes mDNS message on a specific transport. Here, <b>ipv4</b> signifies that the IPv4 mDNS message processing is enabled. This is the default value. <b>ipv6</b> signifies that the IPv6 mDNS message processing is enabled. <b>both</b> signifies that the IPv4 and IPv6 mDNS message is enabled for each network.
<b>Step 5</b>	<b>active-query timer <i>active-query-periodicity</i></b> <b>Example:</b> Device(config-mdns-sd)# active-query timer 15	Changes the periodicity of mDNS multicast active query. <b>Note</b> An active query is a periodic mDNS query to refresh dynamic cache. Here, <i>active-query-periodicity</i> refers to the active query periodicity in Minutes. The valid range is from 1 to 120 minutes. Active query runs with a default periodicity of 30 minutes.
<b>Step 6</b>	<b>exit</b> <b>Example:</b> Device(config-mdns-sd)# exit	Returns to global configuration mode.

## Creating Default Service Policy

When the mdns gateway is enabled on any of the WLANs by default, mdns-default-service-policy is associated with it. Default service policy consists of default-service-list and their details are explained in this section. You can override the default service policy with a custom service policy.

### Procedure

---

- Step 1** Create a service-definition if the service is not listed in the preconfigured services.
  - Step 2** Create a service list for IN and OUT by using the service-definitions.
  - Step 3** Use the existing service list to create a new service. For more information, refer to *Creating Service Policy* section.
  - Step 4** Attach the mdns-service-policy to the profile or VLAN that needs to be enforced.
  - Step 5** To check the default-mdns-service list, use the following command:  
**show mdns-sd default-service-list**
- 

## Creating Custom Service Definition (GUI)

### Procedure

---

- Step 1** Choose **Configuration > Services > mDNS**.
  - Step 2** In the **Service Definition** section, click **Add**.
  - Step 3** In the **Quick Setup: Service Definition** page that is displayed, enter a name and description for the service definition.
  - Step 4** Enter a service type and click + to add the service type.
  - Step 5** Click **Apply to Device**.
- 

## Creating Custom Service Definition

Service definition is a construct that provides an admin friendly name to one or more mDNS service types or A pointer (PTR) Resource Record Name.

By default, few built-in service definitions are already predefined and available for admin to use.

In addition to built-in service definitions, admin can also define custom service definitions.

You can execute the following command to view the list of all the service definitions (built-in and custom):

```
Device# show mdns-sd master-service-list
```

**Procedure**

	<b>Command or Action</b>	<b>Purpose</b>
<b>Step 1</b>	<b>enable</b> <b>Example:</b> Device> enable	Enables privileged <b>EXEC</b> mode. Enter your password, if prompted.
<b>Step 2</b>	<b>configure terminal</b> <b>Example:</b> Device# configure terminal	Enters global configuration mode.
<b>Step 3</b>	<b>mdns-sd service-definition</b> <i>service-definition-name</i> <b>Example:</b> Device(config)# mdns-sd service-definition CUSTOM1	Configures mDNS service definition. <b>Note</b> <ul style="list-style-type: none"> <li>• All the created custom service definitions are added to the primary service list.</li> <li>• Primary service list comprises of a list of custom and built-in service definitions.</li> </ul>
<b>Step 4</b>	<b>service-type</b> <i>string</i> <b>Example:</b> Device(config-mdns-ser-def)# service-type _custom1._tcp.local	Configures mDNS service type.
<b>Step 5</b>	<b>exit</b> <b>Example:</b> Device(config-mdns-ser-def)# exit	Returns to global configuration mode.

## Creating Service List (GUI)

**Procedure**

- 
- Step 1** Choose **Configuration > Services > mDNS**.
- Step 2** In the **Service List** section, click **Add**.
- Step 3** In the **Quick Setup: Service List** page that is displayed, enter a name for the service list.
- Step 4** From the **Direction** drop-down list, choose **IN** for inbound filtering or **OUT** for outbound filtering.
- Step 5** From the **Available Services** drop-down list, choose a service type to match the service list.
- Note** To allow all services, choose the **all** option.
- Step 6** Click **Add Services**.
- Step 7** From the **Message Type** drop-down list, choose the message type to match from the following options:

- **any**—To allow all messages.
- **announcement**—To allow only service advertisements or announcements for the device.
- **query**—To allow only a query from the client for a service in the network.

**Step 8** Click **Save** to add services.

**Step 9** Click **Apply to Device**.

## Creating Service List

mDNS service list is a collection of service definitions.

### Procedure

	Command or Action	Purpose
<b>Step 1</b>	<b>enable</b> <b>Example:</b> Device> enable	Enables privileged <b>EXEC</b> mode. Enter your password, if prompted.
<b>Step 2</b>	<b>configure terminal</b> <b>Example:</b> Device# configure terminal	Enters global configuration mode.
<b>Step 3</b>	<b>mdns-sd service-list <i>service-list-name</i> {IN   OUT}</b> <b>Example:</b> Device(config)# mdns-sd service-list Basic-In IN Device(config)# mdns-sd service-list Basic-Out OUT	Configures mDNS service list. <ul style="list-style-type: none"> <li>• <b>IN</b>: Provides inbound filtering.</li> <li>• <b>Out</b>: Provides outbound filtering.</li> </ul>
<b>Step 4</b>	<b>match <i>service-definition-name</i> message-type {announcement   any   query}</b> <b>Example:</b> Device(config-mdns-sl-in)# match CUSTOM1 message-type query	Matches the service to the message type. Here, <i>service-definition-name</i> refers to the names of services, such as, airplay, airserver, airtunes, and so on.



	Command or Action	Purpose
		<p><b>Note</b> To add a service, the service name must be part of the primary service list.</p> <p>If the mDNS service list is set to IN, you get to view the following command: <b>match service-definition-name message-type {announcement   any   query}</b>.</p> <p>If the mDNS service list is set to Out, you get to view the following command: <b>match service-definition-name</b>.</p> <p>(OR)</p>
<b>Step 5</b>	<p><b>match all message-type {announcement   any   query}</b></p> <p><b>Example:</b></p> <pre>Device(config-mdns-sl-in)# match all message-type query</pre>	<p>Matches all services to the message type.</p> <p><b>Note</b> To add a service, the service name must be part of the primary service list.</p> <p>If the mDNS service list is set to IN, you get to view the following command: <b>match all message-type {announcement   any   query}</b>.</p> <p>If the mDNS service list is set to OUT, you get to view the following command: <b>match all</b>.</p> <p>In case of IN or OUT filter, if any of the service contains the same or subset of the message type (query or announcement), the <b>match all</b> is not allowed unless the existing services are removed.</p>
<b>Step 6</b>	<p><b>show mdns-sd service-list {direction   name }</b></p>	<p>Displays inbound or outbound direction list of the configured service-list to classify matching service-types for service-policy. The list can be filtered by name or specific direction.</p>
<b>Step 7</b>	<p><b>exit</b></p> <p><b>Example:</b></p> <pre>Device(config-mdns-sl-in)# exit</pre>	<p>Returns to global configuration mode.</p>

# Creating Service Policy (GUI)

## Procedure

- Step 1** Choose **Configuration > Services > mDNS**.
- Step 2** In the **Service Policy** section, click **Add**.
- Step 3** In the **Quick Setup: Service Policy** page that is displayed, enter a name for the service policy.
- Step 4** From the **Service List Input** drop-down list, choose one of the types.
- Step 5** From the **Service List Output** drop-down list, choose one of the types.
- Step 6** From the **Location** drop-down list, choose the location you want to associate with the service list.
- Step 7** Click **Apply to Device**.

# Creating Service Policy

mDNS service policy is used for service filtering while learning services or responding to queries.

## Procedure

	Command or Action	Purpose
<b>Step 1</b>	<b>enable</b> <b>Example:</b> Device> enable	Enables privileged <b>EXEC</b> mode. Enter your password, if prompted.
<b>Step 2</b>	<b>configure terminal</b> <b>Example:</b> Device# configure terminal	Enters global configuration mode.
<b>Step 3</b>	<b>mdns-sd service-policy service-policy-name</b> <b>Example:</b> Device(config)# mdns-sd service-policy mdns-policy1	Enables mDNS service policy.
<b>Step 4</b>	<b>location {lss   site-tag}</b> <b>Example:</b>	Filters mDNS service types based on LSS or site-tag.

	Command or Action	Purpose
	<pre>Device(config-mdns-ser-pol)# location lss</pre>	<p><b>Note</b> In Location Specific Services (LSS) based filtering, the mDNS gateway responds with the service instances learnt from the neighboring APs of the querying client AP. Other service instances for the rest of APs are filtered.</p> <p>In Site tag based filtering, the mDNS gateway responds with the service instances that belong to the same site-tag as that of querying client.</p> <p>The mDNS gateway responds back with wired services even if the location based filtering is configured.</p>
<b>Step 5</b>	<p><b>service-list</b> <i>service-list-name</i> {IN   OUT}</p> <p><b>Example:</b></p> <pre>Device(config-mdns-ser-pol)# service-list VLAN100-list IN</pre>	<p>Configures various service-list names for IN and OUT directions.</p> <p><b>Note</b> If an administrator decides to create or use a custom service policy, then the custom service policy must be configured with service-lists for both directions (IN and OUT); otherwise, the mDNS Gateway will not work (will not learn services if there is no IN service-list, or will not reply or announce services learned if there is no OUT service-list).</p>
<b>Step 6</b>	<p><b>exit</b></p> <p><b>Example:</b></p> <pre>Device(config-mdns-ser-pol)# exit</pre>	Returns to global configuration mode.

## Configuring a Local or Native Profile for an mDNS Policy

When an administrator configures local authentication and authorization and does not expect to get any mDNS policy from the AAA server, the administrator can configure a local or native profile to select a mDNS policy based on user, role, or device type. When this local or native profile is mapped to the wireless profile policy, mDNS service policy is applied on the mDNS packets that are processed on that WLAN.

### Procedure

	Command or Action	Purpose
<b>Step 1</b>	<p><b>configure terminal</b></p> <p><b>Example:</b></p>	Enters global configuration mode.

	Command or Action	Purpose
	Device# <code>configure terminal</code>	
<b>Step 2</b>	<b>service-template</b> <i>template-name</i> <b>Example:</b> Device(config)# <code>service-template mdns</code>	Configures the service-template or identity policy.
<b>Step 3</b>	<b>mdns-service-policy</b> <i>mdns-policy-name</i> <b>Example:</b> Device(config-service-template)# <code>mdns-service-policy mdnsTV</code>	Configures the mDNS policy.
<b>Step 4</b>	<b>exit</b> <b>Example:</b> Device(config-service-template)# <code>exit</code>	Returns to global configuration mode.

## Configuring an mDNS Flex Profile (GUI)

### Procedure

- 
- Step 1** Choose **Configuration > Services > mDNS**.
  - Step 2** In the **mDNS Flex Profile** section, click **Add**. The **Add mDNS Flex Profile** window is displayed.
  - Step 3** In the **Profile Name** field, enter the flex mDNS profile name.
  - Step 4** In the **Service Cache Update Timer** field, specify the service cache update time. The default value is 1 minute. The valid range is from 1 to 100 minutes.
  - Step 5** In the **Statistics Update Timer** field, specify the statistics update timer. The default value is 1 minute. The valid range is from 1 to 100 minutes.
  - Step 6** In the **VLANs** field, specify the VLAN ID. You can enter multiple VLAN IDs separated by commas, or enter a range of VLAN IDs. Maximum number of VLANs allowed is 16.
  - Step 7** Click **Apply to Device**.
- 

## Configuring an mDNS Flex Profile (CLI)

### Procedure

	Command or Action	Purpose
<b>Step 1</b>	<b>configure terminal</b> <b>Example:</b> Device# <code>configure terminal</code>	Enters global configuration mode.

	Command or Action	Purpose
<b>Step 2</b>	<b>mdns-sd flex-profile</b> <i>mdns-flex-profile-name</i> <b>Example:</b> Device(config)# mdns-sd flex-profile <i>mdns-flex-profile-name</i>	Enters the mDNS Flex Profile mode.
<b>Step 3</b>	<b>update-timer service-cache</b> <i>service-cache timer-value &lt;1-100&gt;</i> <b>Example:</b> Device(config-mdns-flex-profile)# update-timer service-cache 60	Configures the mDNS update service cache timer for the flex profile.  The default value is 1 minute. Value range is between 1 minute and 100 minutes.
<b>Step 4</b>	<b>update-timer statistics</b> <i>statistics timer-value &lt;1-100&gt;</i> <b>Example:</b> Device(config-mdns-flex-profile)# update-timer statistics 65	Configures the mDNS update statistics timer for the flex profile.  The default value is 1 minute. The valid range is from 1 to 100 minutes.
<b>Step 5</b>	<b>wired-vlan-range</b> <i>wired-vlan-range value</i> <b>Example:</b> Device(config-mdns-flex-profile)# wired-vlan-range 10 - 20	Configures the mDNS wired VLAN range for the flex profile.  The default value is 1 minute. The valid range is from 1 minute to 100 minutes.

## Applying an mDNS Flex Profile to a Wireless Flex Connect Profile (GUI)

### Procedure

- 
- Step 1** Choose **Configuration > Tags & Profiles > Flex**.
- Step 2** Click **Add**.  
The **Add Flex Profile** window is displayed.
- Step 3** Under the **General** tab, from the **mDNS Flex Profile** drop-down list, choose a flex profile name from the list.
- Step 4** Click **Apply to Device**.
-

## Applying an mDNS Flex Profile to a Wireless Flex Connect Profile (CLI)

### Procedure

	Command or Action	Purpose
<b>Step 1</b>	<b>configure terminal</b> <b>Example:</b> Device# configure terminal	Enters global configuration mode.
<b>Step 2</b>	<b>wireless profile flex</b> <i>wireless-flex-profile-name</i> <b>Example:</b> Device# wireless profile flex <i>wireless-flex-profile-name</i>	Enters wireless flex profile configuration mode.
<b>Step 3</b>	<b>mdns-sd</b> <i>mdns-flex-profile</i> <b>Example:</b> Device(config-wireless-flex-profile)# mdns-sd <i>mdns-flex-profile-name</i>	Enables the mDNS features for all the APs in the profile

## Enabling the mDNS Gateway on the VLAN Interface

This procedure configures the mDNS service policy for a specific VLAN. This allows the administrator to configure different settings to the mDNS packets on per VLAN interface basis and not on per WLAN basis.

### Procedure

	Command or Action	Purpose
<b>Step 1</b>	<b>configure terminal</b> <b>Example:</b> Device# configure terminal	Enters global configuration mode.
<b>Step 2</b>	<b>interface vlan</b> <i>vlan-interface-number</i> <b>Example:</b> Device(config)# interface vlan 200	Configures a VLAN ID and enters interface configuration mode.
<b>Step 3</b>	<b>ip address</b> <i>ip-address subnet-mask</i> <b>Example:</b> Device(config-if)# ip address 111.1.1.1 255.255.255.0	Configures the IP address for the interface.

	Command or Action	Purpose
<b>Step 4</b>	<b>mdns-sd gateway</b> <b>Example:</b> Device(config-if)# mdns-sd gateway	Enables mDNS configuration on a VLAN interface.
<b>Step 5</b>	<b>service-policy <i>service-policy-name</i></b> <b>Example:</b> Device(config-if-mdns-sd)# service-policy test-mDNS-service-policy	Configures the service policy.  <b>Note</b> If specific <i>service-policy-name</i> is not defined, the VLAN will use the <b>default-mdns-service-policy</b> by default.  By default, <b>default-mDNS-service-policy</b> gets created in the system and it will use <b>default-mDNS-service-list</b> configuration for filtering mDNS service announcement and queries.
<b>Step 6</b>	<b>end</b> <b>Example:</b> Device(config-if-mdns-sd)# end	Returns to privileged EXEC mode.  Alternatively, you can also press <b>Ctrl-Z</b> to exit global configuration mode.

## Location-Based Service Filtering

### Prerequisite for Location-Based Service Filtering

You need to create the Service Definition and Service Policy. For more information, see [Creating Custom Service Definition](#) section and [Creating Service Policy](#) section.

### Configuring mDNS Location-Based Filtering Using SSID

When a service policy is configured with the SSID as the location name, the response to the query will be the services that were learnt on that SSID.

#### Procedure

	Command or Action	Purpose
<b>Step 1</b>	<b>configure terminal</b> <b>Example:</b> Device# configure terminal	Enters global configuration mode.
<b>Step 2</b>	<b>mdns-sd service-policy <i>service-policy-name</i></b> <b>Example:</b>	Configures the service policy.

	Command or Action	Purpose
	<code>Device(config)# mdns-sd service-policy mdns-policy1</code>	
<b>Step 3</b>	<b>location ssid</b>  <b>Example:</b> <code>Device(config-mdns-ser-pol)# location ssid</code>	Configures location-based filtering using SSID.
<b>Step 4</b>	<b>end</b>  <b>Example:</b> <code>Device(config-mdns-ser-pol)# end</code>	Returns to privileged EXEC mode.  Alternatively, you can also press <b>Ctrl-Z</b> to exit global configuration mode.

## Configuring mDNS Location-Based Filtering Using AP Name

When a service policy is configured with the AP name as the location, the response to the query will be the services that were learnt on that AP.

### Procedure

	Command or Action	Purpose
<b>Step 1</b>	<b>configure terminal</b>  <b>Example:</b> <code>Device# configure terminal</code>	Enters global configuration mode.
<b>Step 2</b>	<b>mdns-sd service-policy <i>service-policy-name</i></b>  <b>Example:</b> <code>Device(config)# mdns-sd service-policy mdns-policy1</code>	Configures the service policy.
<b>Step 3</b>	<b>location ap-name</b>  <b>Example:</b> <code>Device(config-mdns-ser-pol)# location ap-name</code>	Configures location-based filtering using an AP name.
<b>Step 4</b>	<b>end</b>  <b>Example:</b> <code>Device(config-mdns-ser-pol)# end</code>	Returns to privileged EXEC mode.  Alternatively, you can also press <b>Ctrl-Z</b> to exit global configuration mode.

## Configuring mDNS Location-Based Filtering Using AP Location

When a service policy is configured with location as the AP-location, the response to the query will be the services that were learnt on all the APs using the same AP "location" name (not to be confused with "site-tag").



**Procedure**

	<b>Command or Action</b>	<b>Purpose</b>
<b>Step 1</b>	<b>configure terminal</b> <b>Example:</b> Device# configure terminal	Enters global configuration mode.
<b>Step 2</b>	<b>mdns-sd service-policy <i>service-policy-name</i></b> <b>Example:</b> Device(config)# mdns-sd service-policy mdns-policy1	Configures the service policy.
<b>Step 3</b>	<b>location ap-location</b> <b>Example:</b> Device(config-mdns-ser-pol)# location ap-location	Configures location-based filtering using the AP location.
<b>Step 4</b>	<b>end</b> <b>Example:</b> Device(config-mdns-ser-pol)# end	Returns to privileged EXEC mode.  Alternatively, you can also press <b>Ctrl-Z</b> to exit global configuration mode.

## Configuring mDNS Location-Based Filtering Using Regular Expression

- When a service policy is configured with the location as a regular expression that matches the corresponding AP name, the response to the query will be the services that were learnt on a group of APs based on the AP name.
- When a service policy is configured with the location as a regular expression that matches the corresponding AP location, the response to the query will be the services that were learnt on a group of APs based on the AP location.

**Procedure**

	<b>Command or Action</b>	<b>Purpose</b>
<b>Step 1</b>	<b>configure terminal</b> <b>Example:</b> Device# configure terminal	Enters global configuration mode.
<b>Step 2</b>	<b>mdns-sd service-policy <i>service-policy-name</i></b> <b>Example:</b> Device(config)# mdns-sd service-policy mdns-policy1	Configures the service policy.
<b>Step 3</b>	<b>location regex {<i>ap-location regular-expression</i>   <i>ap-name regular-expression</i>}</b> <b>Example:</b>	Configures location-based filtering using regular expression.

	Command or Action	Purpose
	<pre>Device(config-mdns-ser-pol)# location regex ap-location dns_location  Device(config-mdns-ser-pol)# location regex ap-name dns_name</pre>	
<b>Step 4</b>	<p><b>end</b></p> <p><b>Example:</b></p> <pre>Device(config-mdns-ser-pol)# end</pre> <p><b>Note</b> To filter the services for which AP names have the specific keyword such as <i>AP-2FLR-SJC-123</i>, you can use the regex AP name as <i>AP-2FLR-</i> to match the services that are learnt from the set of access points.</p>	<p>Returns to privileged EXEC mode.</p> <p>Alternatively, you can also press <b>Ctrl-Z</b> to exit global configuration mode.</p>

## Configuring mDNS AP

In most of the deployments, the services may be available in VLANs that the APs can hear in the wired side (allowed in the switchport where the AP is directly connected: its own VLAN, or even more VLANs if switchport is a trunk).

The following procedure shows how to configure mDNS AP:

### Procedure

	Command or Action	Purpose
<b>Step 1</b>	<p><b>configure terminal</b></p> <p><b>Example:</b></p> <pre>Device# configure terminal</pre>	Enters global configuration mode.
<b>Step 2</b>	<p><b>mdns-sd gateway</b></p> <p><b>Example:</b></p> <pre>Device(config)# mdns-sd gateway</pre>	Configures the mDNS gateway.
<b>Step 3</b>	<p><b>ap name <i>ap-name</i> mdns-ap enable vlan <i>vlan-id</i></b></p> <p><b>Example:</b></p> <pre>Device# ap name ap1 mdns-ap enable vlan 22</pre>	Enables mDNS on the AP, and configures a VLAN for the mDNS AP.
<b>Step 4</b>	<p><b>ap name <i>ap-name</i> mdns-ap vlan add <i>vlan-id</i></b></p> <p><b>Example:</b></p> <pre>Device# ap name ap1 mdns-ap vlan add 200</pre>	Adds a VLAN to the mDNS AP. <i>vlan-id</i> ranges from 1 to 4096.

	Command or Action	Purpose
<b>Step 5</b>	<b>ap name <i>ap-name</i> mdns-ap vlan del <i>vlan-id</i></b> <b>Example:</b> Device# ap name ap1 mdns-ap vlan del 2	Deletes a VLAN from the mDNS AP.
<b>Step 6</b>	<b>ap name <i>ap-name</i> mdns-ap disable</b> <b>Example:</b> Device# ap name ap1 mdns-ap disable	(Optional) Disables the mDNS AP.
<b>Step 7</b>	<b>end</b> <b>Example:</b> Device# end	Returns to privileged EXEC mode.  Alternatively, you can also press <b>Ctrl-Z</b> to exit global configuration mode.  <b>Note</b> You can configure a maximum of 10 VLANs per AP.

## Enabling mDNS Gateway on the RLAN Interface

By configuring the mDNS gateway mode on the RLAN interface, you can configure the mDNS service policy for a specific RLAN.

### Procedure

	Command or Action	Purpose
<b>Step 1</b>	<b>configure terminal</b> <b>Example:</b> Device# configure terminal	Enters global configuration mode.
<b>Step 2</b>	<b>ap remote-lan profile-name <i>remote-lan-profile-name rlan-id</i></b> <b>Example:</b> Device(config)# ap remote-lan profile-name rlan_test_1 1	Configures a remote LAN profile. <ul style="list-style-type: none"> <li>• <i>remote-lan-profile</i>: Remote LAN profile name. Range is from 1 to 32 alphanumeric characters.</li> <li>• <i>rlan-id</i>: Remote LAN identifier. Range is from 1 to 128.</li> </ul> <b>Note</b> You can create a maximum of 128 RLANs. Also, you cannot use the <i>rlan-id</i> of an existing RLAN while creating another RLAN.
<b>Step 3</b>	<b>mdns-sd-interface {gateway   drop}</b> <b>Example:</b> mdns-sd-interface	Enables mDNS configuration on an RLAN interface.

	Command or Action	Purpose
	Device (config-remote-lan) # mdns-sd-interface gateway	
<b>Step 4</b>	<b>no shutdown</b>  <b>Example:</b> Device (config-remote-lan) # no shutdown	Restarts the RLAN profile.
<b>Step 5</b>	<b>exit</b>  <b>Example:</b> Device (config-remote-lan) # exit	Exits remote LAN configuration mode.
<b>Step 6</b>	<b>ap remote-lan-policy policy-name profile name</b>  <b>Example:</b> Device (config) # ap remote-lan-policy policy-name rlan_named_ppl	Configures the RLAN policy profile and enters wireless policy configuration mode.
<b>Step 7</b>	<b>mdns-sd service-policy service-policy-name</b>  <b>Example:</b> Device (config-remote-lan-policy) # mdns-sd service-policy mdnsTV6	Enables an mDNS service policy.
<b>Step 8</b>	<b>central switching</b>  <b>Example:</b> Device (config-remote-lan-policy) # central switching	Configures the RLAN for central switching.
<b>Step 9</b>	<b>central dhcp</b>  <b>Example:</b> Device (config-remote-lan-policy) # central dhcp	Configures the central DHCP for centrally switched clients.
<b>Step 10</b>	<b>vlan vlan-name</b>  <b>Example:</b> Device (config-remote-lan-policy) # vlan 141	Assigns the profile policy to a VLAN.
<b>Step 11</b>	<b>no shutdown</b>  <b>Example:</b> Device (config-remote-lan-policy) # no shutdown	Restarts the RLAN profile.
<b>Step 12</b>	<b>wireless tag policy policy-tag-name</b>  <b>Example:</b> Device (config) # wireless tag policy rlan_pt_1	Configures a policy tag.

	Command or Action	Purpose
<b>Step 13</b>	<p><b>remote-lan</b> <i>remote-lan-profile-name</i> <b>policy</b> <i>rlan-policy-profile-name</i> <b>port-id</b> <i>port-id</i></p> <p><b>Example:</b></p> <pre>Device(config-policy-tag)# remote-lan rlan_test_1 policy rlan_named_pp1 port-id 1  Device(config-policy-tag)# remote-lan rlan_test_1 policy rlan_named_pp1 port-id 2  Device(config-policy-tag)# remote-lan rlan_test_1 policy rlan_named_pp1 port-id 3  Device(config-policy-tag)# remote-lan rlan_test_1 policy rlan_named_pp1 port-id 4</pre>	<p>Maps the RLAN policy profile to the RLAN profile.</p> <ul style="list-style-type: none"> <li>• <i>remote-lan-profile-name</i>: Name of the RLAN profile.</li> <li>• <i>rlan-policy-profile-name</i>: Name of the policy profile.</li> <li>• <i>port-id</i>: LAN port number on the access point. Range is from 1 to 4.</li> </ul>
<b>Step 14</b>	<p><b>exit</b></p> <p><b>Example:</b></p> <pre>Device(config-policy-tag)# exit</pre>	Returns to global configuration mode.
<b>Step 15</b>	<p><b>ap</b> <i>mac-address</i></p> <p><b>Example:</b></p> <pre>Device (config)# ap 0042.5AB6.0EF0</pre>	<p>Configures the AP and enters the AP tag configuration mode.</p> <p><b>Note</b> Use the Ethernet MAC address.</p>
<b>Step 16</b>	<p><b>policy-tag</b> <i>policy-tag-name</i></p> <p><b>Example:</b></p> <pre>Device (config-ap-tag)# policy-tag rlan_pt_1</pre>	Maps a policy tag to the AP.
<b>Step 17</b>	<p><b>end</b></p> <p><b>Example:</b></p> <pre>Device(config-guest-lan)# end</pre>	Returns to privileged EXEC mode.

## Enabling mDNS Gateway on Guest LAN Interface

By configuring the mDNS gateway mode on a Guest LAN interface, you can configure the mDNS service policy for a specific Guest LAN interface.

### Procedure

	Command or Action	Purpose
<b>Step 1</b>	<p><b>configure terminal</b></p> <p><b>Example:</b></p> <pre>Device# configure terminal</pre>	Enters global configuration mode.

	Command or Action	Purpose
<b>Step 2</b>	<p><b>guest-lan profile-name</b>  <i>guest_lan_profile_name num wired-vlan</i>  <i>wired_vlan_num</i></p> <p><b>Example:</b></p> <pre>Device(config)# guest-lan profile-name open 1 wired-vlan 666</pre>	<p>Configures guest LAN profile with a wired VLAN.</p> <p><b>Note</b> Configures the wired VLAN only for the Guest Foreign controller.</p> <ul style="list-style-type: none"> <li>• <i>num</i>: Guest LAN identifier. The valid range is from 1 to 5.</li> <li>• <i>wired_vlan_num</i>: Wired VLAN number. The valid range is from 1 to 4094.</li> </ul>
<b>Step 3</b>	<p><b>guest-lan profile-name</b>  <i>guest_lan_profile_name num</i></p> <p><b>Example:</b></p> <pre>Device(config)# guest-lan profile-name open 1</pre>	<p>Configures the guest LAN profile without a VLAN for the Guest Anchor controller.</p>
<b>Step 4</b>	<p><b>mdns-sd-interface {gateway   drop}</b></p> <p><b>Example:</b></p> <pre>Device(config-guest-lan)# mdns-sd gateway</pre>	<p>Configures the mDNS gateway for a Guest LAN.</p> <p><b>Note</b> You need to enable mDNS gateway globally for the Guest LAN to work.</p>
<b>Step 5</b>	<p><b>end</b></p> <p><b>Example:</b></p> <pre>Device(config-guest-lan)# end</pre>	<p>Returns to privileged EXEC mode.</p> <p>Alternatively, you can also press <b>Ctrl-Z</b> to exit global configuration mode.</p>

## Associating mDNS Service Policy with Wireless Profile Policy (GUI)

### Procedure

- 
- Step 1** Choose **Configuration > Tags & Profiles > Policy**.
  - Step 2** Click the **policy profile** name.
  - Step 3** In the **Advanced** tab, choose the mDNS service policy from the **mDNS Service Policy** drop-down list.
  - Step 4** Click **Update & Apply to Device**.
-

# Associating mDNS Service Policy with Wireless Profile Policy



**Note** You must globally configure the mDNS service policy before associating it with the wireless profile policy.

A default mDNS service policy is already attached once the wireless profile policy is created. You can use the following commands to override the default mDNS service policy with any of your service policy:

## Procedure

	Command or Action	Purpose
<b>Step 1</b>	<b>configure terminal</b> <b>Example:</b> Device# configure terminal	Enters global configuration mode.
<b>Step 2</b>	<b>wireless profile policy <i>profile-policy</i></b> <b>Example:</b> Device(config)# wireless profile policy default-policy-profile	Configures wireless profile policy. Here, <i>profile-policy</i> refers to the name of the WLAN policy profile.
<b>Step 3</b>	<b>mdns-sd service-policy <i>custom-mdns-service-policy</i></b> <b>Example:</b> Device(config-wireless-policy)# mdns-sd service-policy custom-mdns-service-policy	Associates an mDNS service policy with the wireless profile policy. The default mDNS service policy name is <b>default-mdns-service-policy</b> .

	Command or Action	Purpose
		Note



	Command or Action	Purpose																				
		<p>The <b>default-mdns-profile-policy</b> uses <b>default-mdns-service-list</b> configuration for filtering mDNS service announcement and queries.</p> <p>In wireless network, the mDNS packets are consumed by the mDNS gateway and clients or device is deprived of learning this service. To share the service with the device and provide ease of configuration to the administrator, a list of few standard service types are shared by default on the wireless network. The list of such standard service types is termed as default service policy that comprises a set of service types.</p> <p>The table covers a sample service list in the default service policy.</p> <p><b>Table 116: Default Name and mDNS Service Type</b></p> <table border="1" data-bbox="1105 957 1520 1869"> <thead> <tr> <th data-bbox="1105 957 1312 1047">Default Name</th> <th data-bbox="1312 957 1520 1047">mDNS Service Type</th> </tr> </thead> <tbody> <tr> <td data-bbox="1105 1047 1312 1152">Apple TV</td> <td data-bbox="1312 1047 1520 1152">_airplay._tcp.local _raop._tcp.local</td> </tr> <tr> <td data-bbox="1105 1152 1312 1241">Apple HomeSharing</td> <td data-bbox="1312 1152 1520 1241">_home-sharing._tcp.local</td> </tr> <tr> <td data-bbox="1105 1241 1312 1297">Printer-IPPS</td> <td data-bbox="1312 1241 1520 1297">_ipp._tcp.local</td> </tr> <tr> <td data-bbox="1105 1297 1312 1402">Apple-airprint</td> <td data-bbox="1312 1297 1520 1402">_ipp._tcp.local _universal-ipp._tcp.local</td> </tr> <tr> <td data-bbox="1105 1402 1312 1556">Google-chromecast</td> <td data-bbox="1312 1402 1520 1556">_googlecast._tcp.local _googlerpc._tcp.local _googlezone._tcp.local</td> </tr> <tr> <td data-bbox="1105 1556 1312 1661">Apple-remote-login</td> <td data-bbox="1312 1556 1520 1661">_sftp-ssh._tcp.local _ssh._tcp.local</td> </tr> <tr> <td data-bbox="1105 1661 1312 1717">Apple-screen-share</td> <td data-bbox="1312 1661 1520 1717">_rfb._tcp.local</td> </tr> <tr> <td data-bbox="1105 1717 1312 1774">Google-expeditions</td> <td data-bbox="1312 1717 1520 1774">_google-expeditions._tcp.local</td> </tr> <tr> <td data-bbox="1105 1774 1312 1869">Multifunction-printer</td> <td data-bbox="1312 1774 1520 1869">_fax-ipp._tcp.local _ipp._tcp.local</td> </tr> </tbody> </table>	Default Name	mDNS Service Type	Apple TV	_airplay._tcp.local _raop._tcp.local	Apple HomeSharing	_home-sharing._tcp.local	Printer-IPPS	_ipp._tcp.local	Apple-airprint	_ipp._tcp.local _universal-ipp._tcp.local	Google-chromecast	_googlecast._tcp.local _googlerpc._tcp.local _googlezone._tcp.local	Apple-remote-login	_sftp-ssh._tcp.local _ssh._tcp.local	Apple-screen-share	_rfb._tcp.local	Google-expeditions	_google-expeditions._tcp.local	Multifunction-printer	_fax-ipp._tcp.local _ipp._tcp.local
Default Name	mDNS Service Type																					
Apple TV	_airplay._tcp.local _raop._tcp.local																					
Apple HomeSharing	_home-sharing._tcp.local																					
Printer-IPPS	_ipp._tcp.local																					
Apple-airprint	_ipp._tcp.local _universal-ipp._tcp.local																					
Google-chromecast	_googlecast._tcp.local _googlerpc._tcp.local _googlezone._tcp.local																					
Apple-remote-login	_sftp-ssh._tcp.local _ssh._tcp.local																					
Apple-screen-share	_rfb._tcp.local																					
Google-expeditions	_google-expeditions._tcp.local																					
Multifunction-printer	_fax-ipp._tcp.local _ipp._tcp.local																					

	Command or Action	Purpose	
		Default Name	mDNS Service Type
			_scanner._tcp.local
		Apple-windows-fileshare	_smb._tcp.local
		<b>Note</b> <ul style="list-style-type: none"> <li>• Location would be disabled on mDNS default service policy.</li> <li>• You cannot change the contents of the mDNS default service policy. However, you can create separate mDNS service policies and associate them under the wireless policy profile.</li> </ul>	
<b>Step 4</b>	<b>exit</b> <b>Example:</b> Device(config-wireless-policy)# exit	Returns to global configuration mode.	

## Enabling or Disabling mDNS Gateway for WLAN (GUI)

### Procedure

- 
- Step 1** Choose **Configuration > Tags & Profiles > WLANs**.
- Step 2** Click on the WLAN.
- Step 3** In the **Advanced** tab, choose the mode in **mDNS Mode** drop-down list.
- Step 4** Click **Update & Apply to Device**.
- 

## Enabling or Disabling mDNS Gateway for WLAN



---

**Note** Bridging is the default behaviour. This means that the mDNS packets are always bridged.

---

## Procedure

	Command or Action	Purpose
<b>Step 1</b>	<b>configure terminal</b> <b>Example:</b> Device# configure terminal	Enters global configuration mode.
<b>Step 2</b>	<b>wlan profile-name wlan-id ssid-name</b> <b>Example:</b> Device(config)# wlan test 24 ssid1	Specifies the WLAN name and ID. <ul style="list-style-type: none"> <li>• <i>profile-name</i> is the WLAN name which can contain 32 alphanumeric characters</li> <li>• <i>wlan-id</i> is the wireless LAN identifier. The valid range is from 1 to 4096.</li> <li>• <i>ssid-name</i> is the SSID which can contain 32 alphanumeric characters.</li> </ul> <p><b>Note</b> Global configuration must be in place for mDNS gateway to work.</p>
<b>Step 3</b>	<b>mdns-sd-interface {gateway   drop}</b> <b>Example:</b> Device(config-wlan)# mdns-sd gateway Device(config-wlan)# mdns-sd drop	Enables or disables mDNS gateway and bridge functions on WLAN.
<b>Step 4</b>	<b>exit</b> <b>Example:</b> Device(config-wlan)# exit	Returns to global configuration mode.
<b>Step 5</b>	<b>show wlan name wlan-name   show wlan all</b> <b>Example:</b> Device# show wlan name test   show wlan all	Verifies the status of mDNS on WLAN.
<b>Step 6</b>	<b>show wireless profile policy</b> <b>Example:</b> Device# show wireless profile policy	Verifies the service policy configured in WLAN.

## mDNS Gateway with Guest Anchor Support and mDNS Bridging

When mDNS Gateway is enabled on both Anchor and Foreign controller, the mDNS gateway functionality is supported in guest anchor deployment where clients on guest LAN or WLAN with guest anchor enabled will be responded with any services or cache from export foreign controller itself. All advertisements received on Guest LAN or WLAN on export foreign are learnt on the export foreign itself. All queries received on guest LAN or WLAN are responded by the export foreign itself.

When mDNS Gateway is enabled on Anchor and Disabled on Foreign controller [Bridging Mode], the mDNS gateway functionality is supported in guest anchor deployment where clients on guest LAN or WLAN with guest anchor enabled will be responded with any services or cache from export Anchor even though the clients are connected on Foreign. All advertisements received on guest LAN or WLAN on export foreign is forwarded to Anchor and the cache is stored on the Anchor itself. All queries received on guest LAN or WLAN are responded by the export Anchor itself.



- Note**
- You must configure the guest-LAN to a wireless profile policy which is configured with the required mDNS service-policy.
  - To configure non guest LAN mDNS gateway, see the [mDNS Gateway](#) chapter.

## Configuring mDNS Gateway on Guest Anchor

### Procedure

	Command or Action	Purpose
<b>Step 1</b>	<b>configure terminal</b>  <b>Example:</b> Device# configure terminal	Enters global configuration mode.
<b>Step 2</b>	<b>guest-lan profile-name</b> <i>guest-lan-profile-name</i> <i>guest-lan-id</i>  <b>Example:</b> Device(config)# guest-lan profile-name g-lanpro 2	Configures the guest LAN profile with a wired VLAN.
<b>Step 3</b>	<b>mdns-sd gateway</b>  <b>Example:</b> Device(config-guest-lan)# mdns-sd gateway	Enables mDNS gateway on the guest LAN.

## Configuring mDNS Gateway on Guest Foreign (Guest LAN)

### Procedure

	Command or Action	Purpose
<b>Step 1</b>	<b>configure terminal</b>  <b>Example:</b> Device# configure terminal	Enters global configuration mode.

	Command or Action	Purpose
<b>Step 2</b>	<b>guest-lan profile-name</b> <i>guest-lan-profile-name</i> <b>guest-lan-id</b> <b>wired-vlan</b> <i>vlan-id</i> <b>Example:</b> Device(config)# guest-lan profile-name g-lanpro 2 wired-vlan 230	Configures guest LAN profile with a wired VLAN. <b>Note</b> Configure the wired VLAN only for the Guest Foreign controller.
<b>Step 3</b>	<b>mdns-sd gateway</b> <b>Example:</b> Device(config-guest-lan)# mdns-sd gateway	Enables mDNS gateway on the guest LAN.
<b>Step 4</b>	<b>exit</b> <b>Example:</b> Device(config-wireless-policy)# exit	Returns to global configuration mode.

## Configuring mDNS Gateway on Guest Anchor

### Procedure

	Command or Action	Purpose
<b>Step 1</b>	<b>configure terminal</b> <b>Example:</b> Device# configure terminal	Enters global configuration mode.
<b>Step 2</b>	<b>guest-wlan profile-name</b> <b>guest-lan-profile-name</b> <i>guest-wlan-id</i> <b>Example:</b> Device(config)# guest-wlan profile-name g-lanpro 2	Configures the guest WLAN profile with a wired VLAN.
<b>Step 3</b>	<b>mdns-sd gateway</b> <b>Example:</b> Device(config-guest-wlan)# mdns-sd gateway	Enables mDNS gateway on the guest WLAN.

## Configuring mDNS Gateway on Guest Foreign (Guest WLAN)

### Procedure

	Command or Action	Purpose
<b>Step 1</b>	<b>configure terminal</b>  <b>Example:</b> Device# configure terminal	Enters global configuration mode.
<b>Step 2</b>	<b>guest-wlan profile-name</b> <i>guest-lan-profile-name guest-wlan-id</i> <b>wired-vlan vlan-id</b>  <b>Example:</b> Device(config)# guest-wlan profile-name g-lanpro 2 wired-vlan 230	Configures guest WLAN profile with a wired VLAN.  <b>Note</b> Configure the wired VLAN only for the Guest Foreign controller.
<b>Step 3</b>	<b>mdns-sd gateway</b>  <b>Example:</b> Device(config-guest-wlan)# mdns-sd gateway	Enables mDNS gateway on the guest WLAN.
<b>Step 4</b>	<b>exit</b>  <b>Example:</b> Device(config-wireless-policy)# exit	Returns to global configuration mode.

## Verifying mDNS Gateway Configurations

To verify the mDNS summary, use the following command:

```
Device# show mdns-sd summary
mDNS Gateway: Enabled
Active Query: Enabled
  Periodicity (in minutes): 30
Transport Type: IPv4
```

To verify the mDNS cache, use the following command:

```
Device# show mdns-sd cache
----- PTR Records
-----
RECORD-NAME                               TTL      WLAN  CLIENT-MAC      RR-RECORD-DATA
-----
_airplay._tcp.local                       4500    30    07c5.a4f2.dc01  CUST1._airplay._tcp.local
_ipp._tcp.local                           4500    30    04c5.a4f2.dc01  CUST3._ipp._tcp.local2
_ipp._tcp.local                           4500    15    04c5.a4f2.dc01  CUST3._ipp._tcp.local4
```

```

_ipp._tcp.local          4500    10    04c5.a4f2.dc01    CUST3._ipp._tcp.local6
_veer_custom._tcp.local 4500    10    05c5.a4f2.dc01
CUST2._veer_custom._tcp.local8

```

To verify the mDNS cache from wired service provider, use the following command:

```
Device# show mdns-sd cache wired
```

```

----- PTR Records
-----
RECORD-NAME                TTL      VLAN      CLIENT-MAC          RR-RECORD-DATA
-----
_airplay._tcp.local        4500     16        0866.98ec.97af
wiredapple._airplay._tcp.local
_raop._tcp.local          4500     16        0866.98ec.97af
086698EC97AF@wiredapple._raop._tcp.local

----- SRV Records
-----
RECORD-NAME                TTL      VLAN      CLIENT-MAC          RR-RECORD-DATA
-----
wiredapple._airplay._tcp.local 4500     16        0866.98ec.97af    0 0 7000
wiredapple.local
086698EC97AF@wiredapple._raop._tcp.local 4500     16        0866.98ec.97af    0 0 7000
wiredapple.local

----- A/AAAA Records
-----
RECORD-NAME                TTL      VLAN      CLIENT-MAC          RR-RECORD-DATA
-----
wiredapple.local          4500     16        0866.98ec.97af
2001:8:16:16:e5:c446:3218:7437

----- TXT Records
-----
RECORD-NAME                TTL      VLAN      CLIENT-MAC          RR-RECORD-DATA
-----
wiredapple._airplay._tcp.local 4500     16        0866.98ec.97af
[343]'acl=0'deviceid=08:66:98:EC:97:AF'features=
086698EC97AF@wiredapple._raop._tcp.local 4500     16        0866.98ec.97af
[193]'cn=0,1,2,3'da=true'et=0,3,5'ft=0x5A7FFF7

```

To verify the mdns-sd type PTR, use the following command:

```
Device# show mdns-sd cache type {PTR | SRV | A-AAA | TXT}
```

```

RECORD-NAME                TTL      WLAN      CLIENT-MAC
RR-Record-Data
-----
_custom1._tcp.local        4500     2         c869.cda8.77d6
service_t1._custom1._tcp.local
_custom1._tcp.local        4500     2         c869.cda8.77d6
vk11._custom1._tcp.local
_ipp._tcp.local            4500     2         c869.cda8.77d6
service-4._ipp._tcp.local

```

To verify the mdns-sd cache for a client MAC, use the following command:

```
Device# show mdns-sd cache {ap-mac <ap-mac> | client-mac <client-mac> | glan-id <glan-id>
| mdns-ap <mac-address> | rlan-id <rlan-id> | wlan-id <wlan-id> | wired}
```

```

RECORD-NAME                TTL      WLAN      CLIENT-MAC
RR-Record-Data
-----

```

```

_custom1._tcp.local          4500      2          c869.cda8.77d6
service_t1._custom1._tcp.local
_custom1._tcp.local          4500      2          c869.cda8.77d6
vk11._custom1._tcp.local
_ipp._tcp.local              4500      2          c869.cda8.77d6
service-4._ipp._tcp.local

----- SRV Records -----
-----
RECORD-NAME          TTL      WLAN      CLIENT-MAC
RR-Record-Data
-----
service-4._ipp._tcp.local      4500      2          c869.cda8.77d6   0 0 1212
mDNS-Client1s-275.local
vk11._custom1._tcp.local      4500      2          c869.cda8.77d6   0 0 987
mDNS-Client1s-275.local
service_t1._custom1._tcp.local  4500      2          c869.cda8.77d6   0 0 197
mDNS-Client1s-275.local

----- A/AAAA Records -----
-----
RECORD-NAME          TTL      WLAN      CLIENT-MAC
RR-Record-Data
-----
mDNS-Client1s-275.local      4500      2          c869.cda8.77d6   120.1.1.33

----- TXT Records -----
-----
RECORD-NAME          TTL      WLAN      CLIENT-MAC
RR-Record-Data
-----
service-4._ipp._tcp.local      4500      2          c869.cda8.77d6   'Client1'
vk11._custom1._tcp.local      4500      2          c869.cda8.77d6
'txtvers=11'
service_t1._custom1._tcp.local  4500      2          c869.cda8.77d6
'txtvers=12'

```

To verify the mdns-sd cache with respect to the RLAN ID, use the following command:

```
Device# show mdns-sd cache rlan-id 1 detail
```

```

Name: _printer._tcp.local

Type: PTR
TTL: 4500
RLAN: 1
RLAN Name: rlan_test_1
VLAN: 141
Client MAC: 000e.c688.3942
AP Ethernet MAC: 0042.5ab6.0ef0
Remaining-Time: 4485
Site-Tag: default-site-tag
mDNS Service Policy: mdnsTV6
Overriding mDNS Service Policy: NO
UPN-Status: Disabled
Rdata: printer._printer._tcp.local

Name: lab-47-187.local
Type: A/AAAA
TTL: 4500
RLAN: 1
RLAN Name: rlan_test_1
VLAN: 141

```



```

Client MAC: 000e.c688.3942
AP Ethernet MAC: 0042.5ab6.0ef0
Remaining-Time: 4485
Site-Tag: default-site-tag
mDNS Service Policy: mdnsTV6
Overriding mDNS Service Policy: NO
UPN-Status: Disabled
Rdata: 10.15.141.124

```

To verify the mdns-sd cache with respect to mDNS-AP, use the following command:

```

Device# show mdns-sd cache mdns-ap 706b.b97d.b060 detail
Name: _printer._tcp.local

```

```

Type: PTR
TTL: 4500
VLAN: 145
Client MAC: 0050.b626.5bfa
mDNS AP Radio MAC: 706b.b97d.b060
mDNS AP Ethernet MAC: 706b.b97c.5208
Remaining-Time: 4480
mDNS Service Policy: mdnsTV
Rdata: printer._printer._tcp.local

```

```

Name: Client-46-153.local
Type: A/AAAA
TTL: 4500
VLAN: 145
Client MAC: 0050.b626.5bfa
mDNS AP Radio MAC: 706b.b97d.b060
mDNS AP Ethernet MAC: 706b.b97c.5208
Remaining-Time: 4480
mDNS Service Policy: mdnsTV
Rdata: 10.15.145.103

```

To verify the mdns-sd cache in detail, use the following command:

```

Device# show mdns-sd cache detail

```

```

Name: _custom1._tcp.local
Type: PTR
TTL: 4500
WLAN: 2
WLAN Name: mdns120
VLAN: 120
Client MAC: c869.cda8.77d6
AP Ethernet MAC: 7069.5ab8.33d0
Expiry-Time: 09/09/18 21:50:47
Site-Tag: default-site-tag
Rdata: service_t1._custom1._tcp.local

```

To verify the mdns-sd cache statistics, use the following command:

```

Device# show mdns-sd cache statistics

```

```

mDNS Cache Stats

```

```

Total number of Services: 4191

```

To verify the mdns-sd statistics, use the following command:

```

Device# show mdns-sd statistics

```

```

-----

```

## Consolidated mDNS Packet Statistics

```

-----
mDNS stats last reset time: 03/11/19 04:17:35
mDNS packets sent: 61045
  IPv4 sent: 30790
    IPv4 advertisements sent: 234
    IPv4 queries sent: 30556
  IPv6 sent: 30255
    IPv6 advertisements sent: 17
    IPv6 queries sent: 30238
  Multicast sent: 57558
    IPv4 sent: 28938
    IPv6 sent: 28620
mDNS packets received: 72796
  advertisements received: 13604
  queries received: 59192
  IPv4 received: 40600
    IPv4 advertisements received: 6542
    IPv4 queries received: 34058
  IPv6 received: 32196
    IPv6 advertisements received: 7062
    IPv6 queries received: 25134
mDNS packets dropped: 87

```

## Wired mDNS Packet Statistics

```

-----
mDNS stats last reset time: 03/11/19 04:17:35
mDNS packets sent: 61033
  IPv4 sent: 30778
    IPv4 advertisements sent: 222
    IPv4 queries sent: 30556
  IPv6 sent: 30255
    IPv6 advertisements sent: 17
    IPv6 queries sent: 30238
  Multicast sent: 57558
    IPv4 sent: 28938
    IPv6 sent: 28620
mDNS packets received: 52623
  advertisements received: 1247
  queries received: 51376
  IPv4 received: 32276
    IPv4 advertisements received: 727
    IPv4 queries received: 31549
  IPv6 received: 20347
    IPv6 advertisements received: 520
    IPv6 queries received: 19827
mDNS packets dropped: 63

```

## mDNS Packet Statistics, for WLAN: 2

```

-----
mDNS stats last reset time: 03/11/19 04:17:35
mDNS packets sent: 12
  IPv4 sent: 12
    IPv4 advertisements sent: 12
    IPv4 queries sent: 0
  IPv6 sent: 0
    IPv6 advertisements sent: 0
    IPv6 queries sent: 0
  Multicast sent: 0
    IPv4 sent: 0
    IPv6 sent: 0
mDNS packets received: 20173

```

```

advertisements received: 12357
queries received: 7816
IPv4 received: 8324
  IPv4 advertisements received: 5815
  IPv4 queries received: 2509
IPv6 received: 11849
  IPv6 advertisements received: 6542
  IPv6 queries received: 5307
mDNS packets dropped: 24

```

To verify the default service list details, use the following command:

```

Device# show mdns-sd default-service-list
-----
mDNS Default Service List
-----

Service Definition: apple-tv
Service Names: _airplay._tcp.local
             _raop._tcp.local

Service Definition: homesharing
Service Names: _home-sharing._tcp.local

Service Definition: printer-ipp
Service Names: _ipp._tcp.local

Service Definition: apple-airprint
Service Names: _ipp._tcp.local
             _universal._sub._ipp._tcp.local

Service Definition: google-chromecast
Service Names: _googlecast._tcp.local
             _googlerpc._tcp.local
             _googlezone._tcp.local

Service Definition: apple-remote-login
Service Names: _sftp-ssh._tcp.local
             _ssh._tcp.local

Service Definition: apple-screen-share
Service Names: _rfb._tcp.local

Service Definition: google-expeditions
Service Names: _googexpeditions._tcp.local

Service Definition: multifunction-printer
Service Names: _fax-ipp._tcp.local
             _ipp._tcp.local
             _scanner._tcp.local

Service Definition: apple-windows-fileshare
Service Names: _smb._tcp.local

```

To verify the primary service list details, use the following command:

```

Device# show mdns-sd master-service-list
-----
mDNS Master Service List
-----

Service Definition: fax
Service Names: _fax-ipp._tcp.local

```

```

Service Definition: roku
Service Names: _rsp._tcp.local

Service Definition: airplay
Service Names: _airplay._tcp.local

Service Definition: scanner
Service Names: _scanner._tcp.local

Service Definition: spotify
Service Names: _spotify-connect._tcp.local

Service Definition: airtunes
Service Names: _raop._tcp.local

Service Definition: airserver
Service Names: _airplay._tcp.local
                _airserver._tcp.local

.
.
.

```

```

Service Definition: itune-wireless-devicesharing2
Service Names: _apple-mobdev2._tcp.local

```

To verify the mdns-sd service statistics on the controller, use the following command:

```
Device# show mdns-sd service statistics
```

Service Name	Service Count
_atc._tcp.local	137
_hap._tcp.local	149
_ipp._tcp.local	149
_rfb._tcp.local	141
_smb._tcp.local	133
_ssh._tcp.local	142
_daap._tcp.local	149
_dpap._tcp.local	149
_eppc._tcp.local	138
_adisk._tcp.local	149

To verify the mDNS-AP configured on the controller and VLAN(s) associated with it, use the following command:

```
Device# show mdns-sd ap
```

```
Number of mDNS APs..... 1
```

AP Name	Ethernet MAC	Number of Vlans	Vlanidentifiers
AP3600-1	7069.5ab8.33d0	1	300

### Further Debug

To debug mDNS further, use the following procedure:

1. Run this command at the controller:

```
set platform software trace wncd <0-7> chassis active R0 mdns debug
```

2. Reproduce the issue.

3. Run this command to gather the traces enabled:

```
show wireless loadbalance ap affinity wncd 0
```

AP MAC	Discovery Timestamp	Join Timestamp	Tag	Vlanidentifiers
0cd0.f894.0600	06/30/21 12:39:48	06/30/21 12:40:021	default-site-tag	300

