



Connecting Mesh Access Points to the Network

- [Overview, on page 1](#)
- [Adding Mesh Access Points to the Mesh Network, on page 2](#)
- [Mesh PSK Key Provisioning , on page 7](#)
- [Configuring Global Mesh Parameters, on page 9](#)
- [Backhaul Client Access, on page 11](#)
- [Configuring Local Mesh Parameters, on page 12](#)
- [Configuring Antenna Gain, on page 17](#)
- [Configuring Mesh Leaf Node, on page 18](#)
- [Configuring Advanced Features, on page 19](#)
- [Configuring Mesh Leaf Node, on page 66](#)

Overview

This chapter describes how to connect the Cisco mesh access points to the network.

The wireless mesh terminates on two points on the wired network. The first location is where the RAP attaches to the wired network, and where all bridged traffic connects to the wired network. The second location is where the CAPWAP controller connects to the wired network; this location is where the WLAN client traffic from the mesh network connects to the wired network. The WLAN client traffic from CAPWAP is tunneled at Layer 2, and matching WLANs should terminate on the same switch VLAN where the controllers are collocated. The security and network configuration for each of the WLANs on the mesh depend on the security capabilities of the network to which the controller is connected.

Figure 1: Mesh Network Traffic Termination

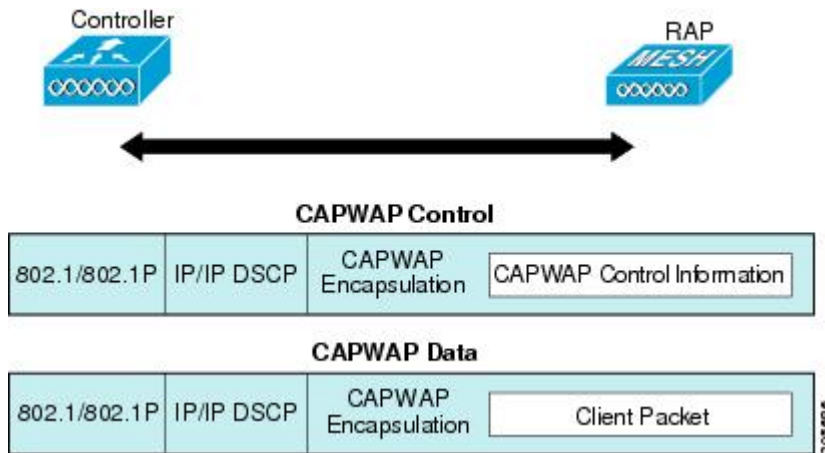

Note When an HSRP configuration is in operation on a mesh network, we recommend that the In-Out multicast mode be configured. For more details on multicast configuration, see the *Enabling Multicast on the Network (CLI)* section.

For more information about designing and deploying mesh networks, see the relevant mesh deployment guides at

<https://www.cisco.com/c/en/us/support/wireless/wireless-lan-controller-software/products-technical-reference-list.html>.

For more information about upgrading to a new controller software release, see the *Release Notes for Cisco Wireless Controllers and Lightweight Access Points* at <https://www.cisco.com/c/en/us/support/wireless/wireless-lan-controller-software/products-release-notes-list.html>.

For more information about mesh and controller software releases and the compatible access points, see the *Cisco Wireless Solutions Software Compatibility Matrix* at <https://www.cisco.com/c/en/us/td/docs/wireless/compatibility/matrix/compatibility-matrix.html>.

Adding Mesh Access Points to the Mesh Network

This section assumes that the controller is already active in the network and is operating in Layer 3 mode.



Note Controller ports that the mesh access points connect to should be untagged.

Before adding a mesh access point to a network, do the following:

Procedure

- Step 1** Add the MAC address of the mesh access point to the controller's MAC filter. See the Adding MAC Addresses of Mesh Access Points to MAC Filter section.
 - Step 2** Define the role (RAP or MAP) for the mesh access point. See the Defining Mesh Access Point Role section.
 - Step 3** Verify that Layer 3 is configured on the controller. See the Verifying Layer 3 Configuration section.
 - Step 4** Configure a primary, secondary, and tertiary controller for each mesh access point. See the Configuring Multiple Controllers Using DHCP 43 and DHCP 60 section.
Configure a backup controller. See the Configuring Backup Controllers section.
 - Step 5** Configure external authentication of MAC addresses using an external RADIUS server. See the Configuring External Authentication and Authorization Using a RADIUS Server.
 - Step 6** Configure global mesh parameters. See the Configuring Global Mesh Parameters section.
 - Step 7** Configure backhaul client access. See the Configuring Advanced Features section.
 - Step 8** Configure local mesh parameters. See the Configuring Local Mesh Parameters section.
 - Step 9** Configure antenna parameters. See the Configuring Antenna Gain section.
 - Step 10** Configure channels for serial backhaul. This step is applicable only to serial backhaul access points. See the Backhaul Channel Deselection on Serial Backhaul Access Point section.
 - Step 11** Configure the DCA channels for the mesh access points. See the Configuring Dynamic Channel Assignment section.
 - Step 12** Configure mobility groups (if desired) and assign controllers. See the Configuring Mobility Groups chapter in the *Cisco Wireless Controller Configuration Guide*.
 - Step 13** Configure Ethernet bridging (if desired). See the Configuring Ethernet Bridging section.
 - Step 14** Configure advanced features such as Ethernet VLAN tagging network, video, and voice. See the Configuring Advanced Features section.
-

Adding MAC Addresses of Mesh Access Points to MAC Filter

You must enter the radio MAC address for all mesh access points that you want to use in the mesh network into the appropriate controller. A controller only responds to discovery requests from outdoor radios that appear in its authorization list. MAC filtering is enabled by default on the controller, so only the MAC addresses need to be configured. If the access point has an SSC and has been added to the AP Authorization List, then the MAC address of the AP does not need to be added to the MAC Filtering List.

You can add the mesh access point using either the GUI or the CLI.



Note You can also download the list of mesh access point MAC addresses and push them to the controller using Cisco Prime Infrastructure.

Adding the MAC Address of the Mesh Access Point to the Controller Filter List (CLI)

To add a MAC filter entry for the mesh access point on the controller using the controller CLI, follow these steps:

Procedure

Step 1 To add the MAC address of the mesh access point to the controller filter list, enter this command:

```
config macfilter add ap_mac wlan_id interface [description]
```

A value of zero (0) for the *wlan_id* parameter specifies any WLAN, and a value of zero (0) for the *interface* parameter specifies none. You can enter up to 32 characters for the optional *description* parameter.

Step 2 To save your changes, enter this command:

```
save config
```

Defining Mesh Access Point Role

By default, AP1500s are shipped with a radio role set to MAP. You must reconfigure a mesh access point to act as a RAP.

Configuring the AP Role (CLI)

To configure the role of a mesh access point using the CLI, enter the following command:

```
config ap role {rootAP | meshAP} Cisco_AP
```

Configuring Multiple Controllers Using DHCP 43 and DHCP 60

To configure DHCP Option 43 and 60 for mesh access points in the embedded Cisco IOS DHCP server, follow these steps:

Procedure

Step 1 Enter configuration mode at the Cisco IOS CLI.

Step 2 Create the DHCP pool, including the necessary parameters such as the default router and name server. The commands used to create a DHCP pool are as follows:

```
ip dhcp pool pool name
network IP Network Netmask
default-router Default router
dns-server DNS Server
```

where:

```
pool name is the name of the DHCP pool, such as AP1520
IP Network is the network IP address where the controller resides, such as 10.0.15.1
Netmask is the subnet mask, such as 255.255.255.0
Default router is the IP address of the default router, such as 10.0.0.1
DNS Server is the IP address of the DNS server, such as 10.0.10.2
```

Step 3 Add the option 60 line using the following syntax:

```
option 60 ascii "VCI string"
```

For the VCI string, use one of the values below. The quotation marks must be included.

```
For Cisco 1550 series access points, enter "Cisco AP c1550"  
For Cisco 1520 series access points, enter "Cisco AP c1520"  
For Cisco 1240 series access points, enter "Cisco AP c1240"  
For Cisco 1130 series access points, enter "Cisco AP c1130"
```

Step 4 Add the option 43 line using the following syntax:

```
option 43 hex hex string
```

The hex string is assembled by concatenating the TLV values shown below:

Type + Length + Value

Type is always f1(hex). *Length* is the number of controller management IP addresses times 4 in hex. *Value* is the IP address of the controller listed sequentially in hex.

For example, suppose that there are two controllers with management interface IP addresses 10.126.126.2 and 10.127.127.2. The type is f1(hex). The length is $2 * 4 = 8 = 08$ (hex). The IP addresses translate to 0a7e7e02 and 0a7f7f02. Assembling the string then yields f1080a7e7e020a7f7f02.

The resulting Cisco IOS command added to the DHCP scope is listed below:

```
option 43 hex f1080a7e7e020a7f7f02
```

Configuring External Authentication and Authorization Using a RADIUS Server

External authorization and authentication of mesh access points using a RADIUS server such as Cisco ACS (4.1 and later) is supported in release 5.2 and later releases. The RADIUS server must support the client authentication type of EAP-FAST with certificates.

Before you employ external authentication within the mesh network, ensure that you make these changes:

- The RADIUS server to be used as an AAA server must be configured on the controller.
- The controller must also be configured on the RADIUS server.
- Add the mesh access point configured for external authorization and authentication to the user list of the RADIUS server.
 - For additional details, see the Adding a Username to a RADIUS Server section.
- Configure EAP-FAST on the RADIUS server and install the certificates. EAP-FAST authentication is required if mesh access points are connected to the controller using an 802.11a interface; the external RADIUS servers need to trust Cisco Root CA 2048. For information about installing and trusting the CA certificates, see the Configuring RADIUS Servers section.



Note If mesh access points connect to a controller using a Fast Ethernet or Gigabit Ethernet interface, only MAC authorization is required.



Note This feature also supports local EAP and PSK authentication on the controller.

Configuring RADIUS Servers

To install and trust the CA certificates on the RADIUS server, follow these steps:

Procedure

-
- Step 1** Download the CA certificates for Cisco Root CA 2048 from the following locations:
- <https://www.cisco.com/security/pki/certs/crca2048.cer>
 - <https://www.cisco.com/security/pki/certs/cmca.cer>
- Step 2** Install the certificates as follows:
- a) From the CiscoSecure ACS main menu, click **System Configuration > ACS Certificate Setup > ACS Certification Authority Setup**.
 - b) In the **CA certificate file** box, type the CA certificate location (path and name). For example:
C:\Certs\crca2048.cer.
 - c) Click **Submit**.
- Step 3** Configure the external RADIUS servers to trust the CA certificate as follows:
- a) From the CiscoSecure ACS main menu, choose **System Configuration > ACS Certificate Setup > Edit Certificate Trust List**. The Edit Certificate Trust List appears.
 - b) Select the check box next to the **Cisco Root CA 2048 (Cisco Systems)** certificate name.
 - c) Click **Submit**.
 - d) To restart ACS, choose **System Configuration > Service Control**, and then click **Restart**.
-

For additional configuration details on Cisco ACS servers, see the following:

- http://www.cisco.com/en/US/products/sw/secursw/ps2086/products_installation_and_configuration_guides_list.html(Windows)
- <http://www.cisco.com/en/US/products/sw/secursw/ps4911/>(UNIX)

Enable External Authentication of Mesh Access Points (CLI)

To enable external authentication for mesh access points using the CLI, enter the following commands:

Procedure

- Step 1** **config mesh security eap**
 - Step 2** **config macfilter mac-delimiter colon**
 - Step 3** **config mesh security rad-mac-filter enable**
 - Step 4** **config mesh radius-server *index* enable**
 - Step 5** **config mesh security force-ext-auth enable (Optional)**
-

View Security Statistics (CLI)

To view security statistics for mesh access points using the CLI, enter the following command:

```
show mesh security-stats Cisco_AP
```

Use this command to display packet error statistics and a count of failures, timeouts, and association and authentication successes as well as reassociations and reauthentications for the specified access point and its child.

Mesh PSK Key Provisioning

Customers with Cisco Mesh deployment will see their Mesh Access Points (MAP) possibly moving out of their network and joining another Mesh network when both of these Mesh Deployments use AAA with wild card MAC filtering to allow MAPs association. As Mesh APs security may use EAP-FAST this cannot be controlled since for EAP security combination of MAC address and type of AP is used and there is no controlled configuration is available. PSK option with default passphrase also presents security risk and hijack possibility. This issue will be prominently seen in overlapping deployments of two different SPs when the MAPs are used in a moving vehicle (public transportations, ferry, ship and so on.). This way, there is no restriction on MAPs to 'stick' to the SPs mesh network and MAPs can be hijacked / getting used by another SPs network / and cannot serve intended customers of SPs in a deployment.

SP Mesh Adjacent Network Architecture that can create MAP hijacking

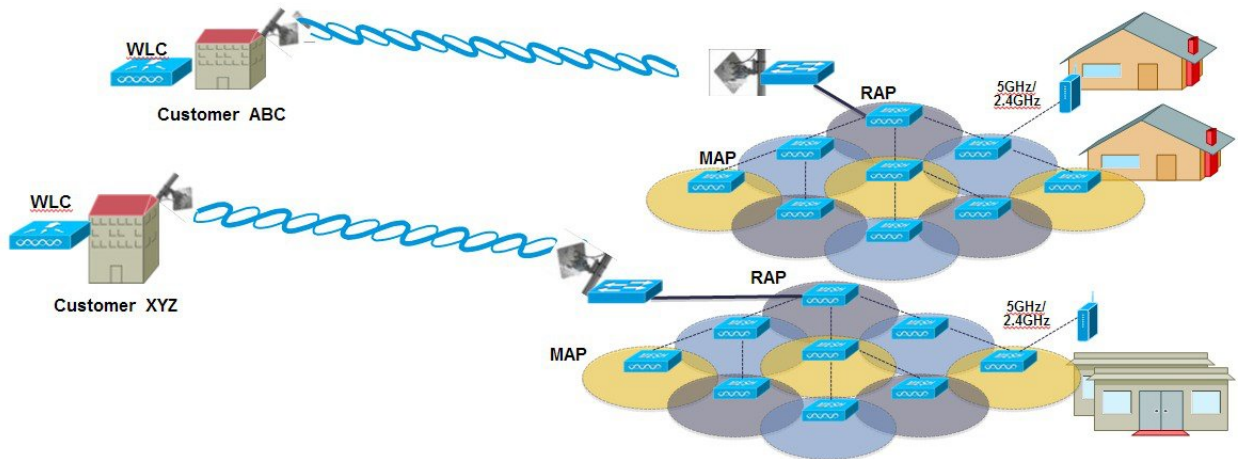

The new feature introduced in 8.2 release will enable a provision-able PSK functionality from WLC which will help make a controlled mesh deployment and enhance MAPs security beyond default 'cisco' PSK used today. With this new feature the MAPs which are configured with a custom PSK, will use this key to do their authentication with their RAPs and WLC. A special precaution should be taken when upgrading from Controller Software release 8.1 and below or downgrading from release 8.2. Admin needs to understand the implications when MAP software is moving in and out of PSK support.

If a mesh PSK mismatch occurs, we recommend that you do any one of the following three tasks to address the issue:

1. Delete the PSK key from the MAP as follows:
 - a. With MAP in connected state, move the MAP to EAP.
 - b. On the controller UI, navigate to the Mesh tab and delete the PSK key for the MAP.
2. Have a wired connection between MAP and the controller and then clear the configuration on the MAP.
3. Clear the configuration from the MAP console.

CLI Commands for PSK Provisioning

- `config mesh security psk provisioning {enable | disable}`
- `config mesh security psk provisioning key pre-shared-key`
- `config mesh security psk provision window {enable | disable}`
- `config mesh security psk provisioning delete_psk {ap ap-name | wlc psk_index}`

Configuring Global Mesh Parameters

This section provides instructions to configure the mesh access point to establish a connection with the controller including:

- Setting the maximum range between RAP and MAP (not applicable to indoor MAPs).
- Enabling a backhaul to carry client traffic.
- Defining if VLAN tags are forwarded or not.
- Defining the authentication mode (EAP or PSK) and method (local or external) for mesh access points including security settings (local and external authentication).

You can configure the necessary mesh parameters using either the GUI or the CLI. All parameters are applied globally.

Configuring Global Mesh Parameters (CLI)

To configure global mesh parameters including authentication methods using the controller CLI, follow these steps:



Note See the Configuring Global Mesh Parameters (GUI) section for descriptions, valid ranges, and default values of the parameters used in the CLI commands.

Procedure

-
- Step 1** To specify the maximum range (in feet) of all mesh access points in the network, enter this command:
- ```
config mesh range feet
```
- To see the current range, enter the **show mesh range** command.
- Step 2** To enable or disable IDS reports for all traffic on the backhaul, enter this command:

```
config mesh ids-state {enable | disable}
```

**Step 3** To specify the rate (in Mbps) at which data is shared between access points on the backhaul interface, enter this command:

```
config ap bhrate {rate | auto} Cisco_AP
```

**Step 4** To enable or disable client association on the primary backhaul (802.11a) of a mesh access point, enter these commands:

```
config mesh client-access {enable | disable}
config ap wlan {enable | disable} 802.11a Cisco_AP
config ap wlan {add | delete} 802.11a wlan_id Cisco_AP
```

**Step 5** To enable or disable VLAN transparent, enter this command:

**config mesh ethernet-bridging VLAN-transparent {enable | disable}**

**Step 6**

To define a security mode for the mesh access point, enter one of the following commands:

- a) To provide local authentication of the mesh access point by the controller, enter this command:

**config mesh security {eap | psk}**

- b) To store the MAC address filter in an external RADIUS server for authentication instead of the controller (local), enter these commands:

**config macfilter mac-delimiter colon**

**config mesh security rad-mac-filter enable**

**config mesh radius-server *index* enable**

- c) To provide external authentication on a RADIUS server and define a local MAC filter on the controller, enter these commands:

**config mesh security eap**

**config macfilter mac-delimiter colon**

**config mesh security rad-mac-filter enable**

**config mesh radius-server *index* enable**

**config mesh security force-ext-auth enable**

- d) To provide external authentication on a RADIUS server using a MAC username (such as c1520-123456) on the RADIUS server, enter these commands:

**config macfilter mac-delimiter colon**

**config mesh security rad-mac-filter enable**

**config mesh radius-server *index* enable**

**config mesh security force-ext-auth enable**

**Step 7**

To save your changes, enter this command:

**save config**

## Viewing Global Mesh Parameter Settings (CLI)

Use these commands to obtain information on global mesh settings:

- **show mesh client-access**—When Backhaul Client Access is enabled, it allows wireless client association over the backhaul radio. Generally, backhaul radio is a 5-GHz radio for most of the mesh access points. This means that a backhaul radio can carry both backhaul traffic and client traffic.

When Backhaul Client Access is disabled, only backhaul traffic is sent over the backhaul radio and client association is only over the second radio(s).

```
(Cisco Controller)> show mesh client-access
Backhaul with client access status: enabled
```

- **show mesh ids-state**—Shows the status of the IDS reports on the backhaul as either enabled or disabled.

```
(Cisco Controller)> show mesh ids-state
Outdoor Mesh IDS (Rogue/Signature Detect): Disabled
```

- **show mesh config**—Displays global configuration settings.

```
(Cisco Controller)> show mesh config
Mesh Range..... 12000
Mesh Statistics update period..... 3 minutes
Backhaul with client access status..... disabled
Background Scanning State..... enabled
Backhaul Amsdu State..... disabled

Mesh Security
Security Mode..... EAP
External-Auth..... disabled
Use MAC Filter in External AAA server..... disabled
Force External Authentication..... disabled

Mesh Alarm Criteria
Max Hop Count..... 4
Recommended Max Children for MAP..... 10
Recommended Max Children for RAP..... 20
Low Link SNR..... 12
High Link SNR..... 60
Max Association Number..... 10
Association Interval..... 60 minutes
Parent Change Numbers..... 3
Parent Change Interval..... 60 minutes

Mesh Multicast Mode..... In-Out
Mesh Full Sector DFS..... enabled

Mesh Ethernet Bridging VLAN Transparent Mode..... enabled
```

## Backhaul Client Access

When Backhaul Client Access is enabled, it allows wireless client association over the backhaul radio. The backhaul radio is a 5-GHz radio. This means that a backhaul radio can carry both backhaul traffic and client traffic.

When Backhaul Client Access is disabled, only backhaul traffic is sent over the backhaul radio and client association is only over the second radio(s).



---

**Note** Backhaul Client Access is disabled by default. After this feature is enabled, all mesh access points, except subordinate AP and its child APs in Daisy-chained deployment, reboot.

---

This feature is applicable to mesh access points with two radios (1552, 1532, 1540, 1560, 1572, and Indoor APs in Bridge mode).

## Configuring Backhaul Client Access (GUI)

### Procedure

---

- Step 1** Choose **Wireless > Mesh** to navigate to the **Mesh** page.
  - Step 2** In the **General** section, check the **Backhaul Client Access** check box.
  - Step 3** Save the configuration.
- 

### What to do next

In a Flex+Bridge deployment, after you enable Backhaul Client Access globally, for the 5-GHz radios to beacon as expected, you must enable the **Install mapping on radio backhaul** option for the root APs operating in Flex+Bridge mode.

For more information about enabling the **Install mapping on radio backhaul** option, see the "Configuring Flex+Bridge Mode (GUI)" section.

### Related Topics

[Configuring Flex+Bridge Mode \(GUI\)](#)

## Configuring Backhaul Client Access (CLI)

Use the following command to enable Backhaul Client Access:

```
(Cisco Controller)> config mesh client-access enable
```

The following message is displayed:

```
All Mesh APs will be rebooted
Are you sure you want to start? (y/N)
```

### What to do next

In a Flex+Bridge deployment, after you enable Backhaul Client Access globally, for the 5-GHz radios to beacon as expected, you must enable the **Install mapping on radio backhaul** option for the root APs operating in Flex+Bridge mode.

For more information about enabling the **Install mapping on radio backhaul** option, see the "Configuring Flex+Bridge Mode (CLI)" section.

### Related Topics

[Configuring Flex+Bridge Mode \(CLI\)](#)

## Configuring Local Mesh Parameters

After configuring global mesh parameters, you must configure the following local mesh parameters for these specific features if in use in your network:

- Backhaul Data Rate.
- Ethernet Bridging.
- Bridge Group Name.
- Workgroup Bridge.
- Power and Channel Setting.
- Antenna Gain Settings.
- Dynamic Channel Assignment.

## Configuring Wireless Backhaul Data Rate

Backhaul is used to create only the wireless connection between the access points. The backhaul interface vary between 802.11a/n/ac rates depending upon the access point. The rate selection is important for effective use of the available RF spectrum. The rate can also affect the throughput of client devices, and throughput is an important metric used by industry publications to evaluate vendor devices.

Dynamic Rate Adaptation (DRA) introduces a process to estimate optimal transmission rate for packet transmissions. It is important to select rates correctly. If the rate is too high, packet transmissions fail resulting in communication failure. If the rate is too low, the available channel bandwidth is not used, resulting in inferior products, and the potential for catastrophic network congestion and collapse.

Data rates also affect the RF coverage and network performance. Lower data rates, for example 6 Mbps, can extend farther from the access point than can higher data rates, for example 1300 Mbps. As a result, the data rate affects cell coverage and consequently the number of access points required. Different data rates are achieved by sending a more redundant signal on the wireless link, allowing data to be easily recovered from noise. The number of symbols sent out for a packet at the 1-Mbps data rate is higher than the number of symbols used for the same packet at 11 Mbps. Therefore, sending data at the lower bit rates takes more time than sending the equivalent data at a higher bit rate, resulting in reduced throughput.

In the controller release 5.2, the default data rate for the mesh 5-GHz backhaul is 24 Mbps. It remains the same with 6.0 and 7.0 controller releases.

With the 6.0 controller release, mesh backhaul can be configured for 'Auto' data rate. Once configured, the access point picks the highest rate where the next higher rate cannot be used because of conditions not being suitable for that rate and not because of conditions that affect all rates. That is, once configured, each link is free to settle down to the best possible rate for its link quality.

We recommend that you configure the mesh backhaul to Auto.

For example, if mesh backhaul chose 48 Mbps, then this decision is taken after ensuring that we cannot use 54 Mbps as there is not enough SNR for 54 and not because some just turned the microwave oven on which affects all rates.

A lower bit rate might allow a greater distance between MAPs, but there are likely to be gaps in the WLAN client coverage, and the capacity of the backhaul network is reduced. An increased bit rate for the backhaul network either requires more MAPs or results in a reduced SNR between MAPs, limiting mesh reliability and interconnection.

This figure shows the RAP using the "auto" backhaul data rate, and it is currently using 54 Mbps with its child MAP.

Figure 2: Bridge Rate Set to Auto

The screenshot shows the Cisco Wireless Controller interface for configuring an AP. The 'Wireless' menu is open, and the 'Details for AP1572-7a7f.09c0' page is displayed. The 'General' tab is selected, and the 'Bridge Data Rate (Mbps)' is set to 'auto'. The 'Backhaul Interface' is '802.11a/n/ac'. Other settings include 'AP Role' (RootAP), 'Bridge Type' (Outdoor), 'Bridge Group Name' (tme), 'Strict Matching BGN' (unchecked), 'Ethernet Bridging' (unchecked), 'Preferred Parent' (none), 'Backhaul Interface' (802.11a/n/ac), 'Ethernet Link Status' (UpDnDnNANA), 'PSK Key TimeStamp' (Tue Aug 2 16:33:42 2016), 'VLAN Support' (checked), and 'Native VLAN ID' (70). The 'Mesh RAP Downlink Backhaul' section shows '5 GHz' selected and '2.4 GHz' unselected.



**Note** The data rate can be set on the backhaul on a per-AP basis. It is not a global command.

**Related Commands** Use these commands to obtain information about backhaul:

| Command | Description |
|---------|-------------|
|---------|-------------|

|                         |                                               |
|-------------------------|-----------------------------------------------|
| <b>config ap bhrate</b> | Configures the Cisco Bridge backhaul Tx rate. |
|-------------------------|-----------------------------------------------|

The syntax is as follows:

```
(controller) > config ap bhrate backhaul-rate ap-name
```

| Command | Description |
|---------|-------------|
|---------|-------------|



**Note** Preconfigured data rates for each AP (RAP=18 Mbps, MAP1=36 Mbps) are preserved after the upgrade to 6.0 or later software releases. Before you upgrade to the 6.0 release, if you have the backhaul data rate configured to any data rate, then the configuration is preserved.

The following example shows how to configure a backhaul rate of 36000 Kbps on a RAP:

```
(controller) > config ap bhrate 36000 HPRAP1
```

**show ap bhrate**—Displays the Cisco Bridge backhaul rate.

The syntax is as follows:

```
(controller) > show ap bhrate ap-name
```

**show mesh neigh summary**—Displays the link rate summary including the current rate being used in backhaul

Example:

```
(controller) > show mesh neigh summary HPRAP1
```

| AP Name/Radio     | Channel | Rate | Link-Snr | Flags      | State          |
|-------------------|---------|------|----------|------------|----------------|
| 00:0B:85:5C:B9:20 | 0       | auto | 4        | 0x10e8fcb8 | BEACON         |
| 00:0B:85:5F:FF:60 | 0       | auto | 4        | 0x10e8fcb8 | BEACON DEFAULT |
| 00:0B:85:62:1E:00 | 165     | auto | 4        | 0x10e8fcb8 | BEACON         |
| 00:0B:85:70:8C:A0 | 0       | auto | 1        | 0x10e8fcb8 | BEACON         |
| HMPAP1            | 165     | 54   | 40       | 0x36       | CHILD BEACON   |
| HJMAP2            | 0       | auto | 4        | 0x10e8fcb8 | BEACON         |

Backhaul capacity and throughput depends upon the type of the AP, that is, if it is 802.11a/n or only 802.11a, number of backhaul radios it has, and so on.

## Configuring Ethernet Bridging

For security reasons, the Ethernet port on all MAPs is disabled by default. It can be enabled only by configuring Ethernet bridging on the root and its respective MAP.

When Ethernet bridging is enabled:

- VLAN ID 0 can be configured as a native VLAN and an access VLAN, but not as non-native VLAN.
- All native VLANs can be configured as a non-native VLANs also and vice-versa.
- Deleting a native VLAN from the allowed VLAN list does not interfere with the native VLAN.
- An old native VLAN will not be automatically added to the allowed VLAN list.



**Note** Exceptions are allowed for a few protocols even though Ethernet bridging is disabled. For example, the following protocols are allowed:

- Spanning Tree Protocol (STP)
- Address Resolution Protocol (ARP)
- Control and Provisioning of Wireless Access Points (CAPWAP)
- Bootstrap Protocol (BOOTP) packets

Enable Spanning Tree Protocol (STP) on all connected switch ports to avoid Layer 2 looping.

Ethernet bridging has to be enabled for two scenarios:

1. When you want to use the mesh nodes as bridges.



**Note** You do not need to configure VLAN tagging to use Ethernet bridging for point-to-point and point-to-multipoint bridging deployments.

2. When you want to connect any Ethernet device such as a video camera on the MAP using its Ethernet port. This is the first step to enable VLAN tagging.

**Figure 3: Point-to-Multipoint Bridging**

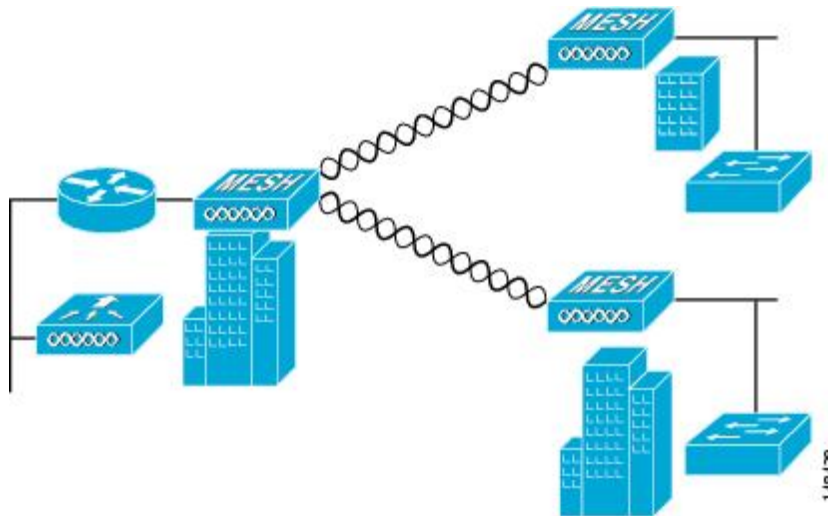

## Configuring Native VLAN (CLI)



**Note** Prior to 8.0, the Native VLAN on the wired backhaul was set as VLAN 1. Starting with the 8.0 release, the Native VLAN can be set.



1. Set the Native VLAN on the wired backhaul port using the command **config ap vlan-trunking native *vlan-id ap-name***.

This applies the Native VLAN configuration to the access point.

## Configuring Bridge Group Names

Bridge group names (BGNs) control the association of mesh access points. BGNs can logically group radios to avoid two networks on the same channel from communicating with each other. The setting is also useful if you have more than one RAP in your network in the same sector (area). BGN is a string of 10 characters maximum.

A BGN of *NULL VALUE* is assigned by default by manufacturing. Although not visible to you, it allows a mesh access point to join the network prior to your assignment of your network-specific BGN.

If you have two RAPs in your network in the same sector (for more capacity), we recommend that you configure the two RAPs with the same BGN, but on different channels.

When Strict Match BGN is enabled on the mesh AP, it will scan ten times to find the matched BGN parent. After ten scans, if the AP does not find the parent with matched BGN, it will connect to the non-matched BGN and maintain the connection for 15 minutes. After 15 minutes the AP will again scan ten times and this cycle continues. The default BGN functionalities remain the same when Strict Match BGN is enabled.

## Configuring Bridge Group Names (CLI)

### Procedure

---

- Step 1** To set a bridge group name (BGN), enter this command:

```
config ap bridgegroupname set group-name ap-name
```

**Note** The mesh access point reboots after a BGN configuration.

**Caution** Exercise caution when you configure a BGN on a live network. Always start a BGN assignment from the farthest-most node (last node, bottom of mesh tree) and move up toward the RAP to ensure that no mesh access points are dropped due to mixed BGNs (old and new BGNs) within the same network.

- Step 2** To verify the BGN, enter the following command:

```
show ap config general ap-name
```

---

## Configuring Antenna Gain

You must configure the antenna gain for the mesh access point to match that of the antenna installed using the controller GUI or controller CLI.

## Configuring Antenna Gain (CLI)

Enter this command to configure the antenna gain for the 802.11a backhaul radio using the controller CLI:

```
config 802.11a antenna extAntGain antenna_gain AP_name
```

where gain is entered in 0.5-dBm units (for example, 2.5 dBm =5).

## Configuring Mesh Leaf Node

Access points within a mesh network operate in one of the following two ways:

1. Root access point (RAP)
2. Mesh access point (MAP)

While the RAPs have wired connections to their controller (WLC), the MAPs have wireless connections to their controller. MAPs communicate among themselves and back to the RAP using wireless connections over the 802.11a/n/g radio backhaul. MAPs use the Cisco Adaptive Wireless Path Protocol (AWPP) to determine the best path through the other mesh access points to the controller.

Relationships among mesh access points are as a parent, child, or neighbor.

- A parent access point offers the best route back to the RAP. A parent can be either the RAP itself or another MAP.
- A child access point selects the parent access point as its best route back to the RAP.
- A neighbor access point is within RF range of another access point but is not selected as its parent or a child.

You can configure the MAP with lower performance to work only as a leaf node. When the mesh network is formed and converged, the leaf node can only work as a child MAP, and cannot be selected by other MAPs as a parent MAP, so that the wireless backhaul performance will not be downgraded.



---

**Note** The mesh leaf node feature is supported only for the IR829 AP803 and the IW3700 Series access points.

---

Use the following command to configure an MAP as a leaf node:

```
(Cisco Controller) >config mesh block-child <ap_name> {enable|disable}
```

```
enable Enable blocking child for an MAP
disable Disable blocking child for an MAP
```

Use the following commands to display the details of the leaf node configuration:

```
(Cisco Controller) >show mesh block-child {summary|<ap_name>}
```

### Examples

```
(Cisco Controller) >show mesh block-child summary
```

```

AP Name AP Model BVI MAC Hop Bridge Group Name Block Child Set

AP3 AIR-CAP3602I-C-K9 4c:00:82:07:64:6b 1 mesh True

```

```
Number of Mesh APs Block Child Set..... 1
```

```
(Cisco Controller) >show mesh block-child AP3
```

```

AP Name AP Model BVI MAC Hop Bridge Group Name Block Child Set

AP3 AIR-CAP3602I-C-K9 4c:00:82:07:64:6b 1 mesh True

```

## Configuring Advanced Features

### Configuring Ethernet VLAN Tagging

Ethernet VLAN tagging allows specific application traffic to be segmented within a wireless mesh network and then forwarded (bridged) to a wired LAN (access mode) or bridged to another wireless mesh network (trunk mode).

A typical public safety access application that uses Ethernet VLAN tagging is the placement of video surveillance cameras at various outdoor locations within a city. Each of these video cameras has a wired connection to a MAP. The video of all these cameras is then streamed across the wireless backhaul to a central command station on a wired network.

Figure 4: Ethernet VLAN Tagging

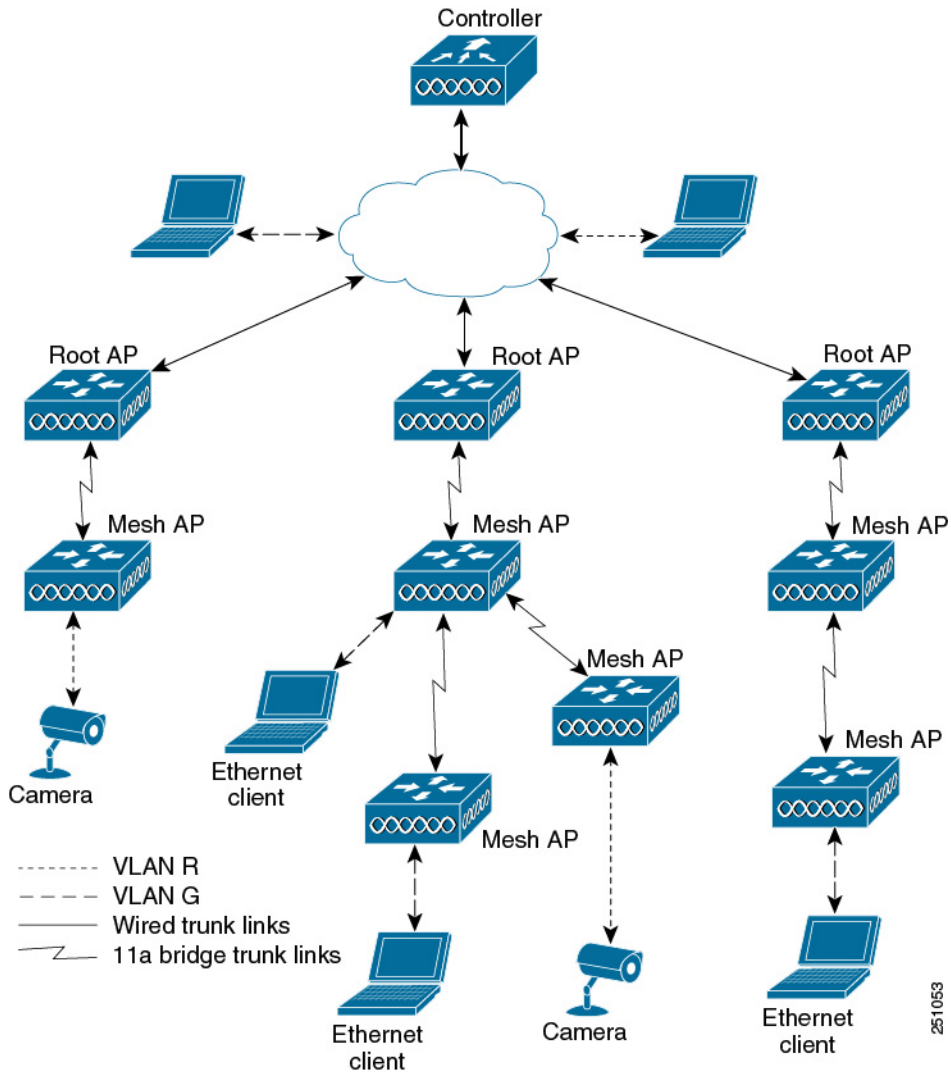

## Ethernet Port Notes

Ethernet VLAN tagging allows Ethernet ports to be configured as normal, access, or trunk in both indoor and outdoor implementations:



---

**Note** When VLAN Transparent is disabled, the default Ethernet port mode is normal. VLAN Transparent must be disabled for VLAN tagging to operate and to allow configuration of Ethernet ports. To disable VLAN Transparent, which is a global parameter, see the Configuring Global Mesh Parameters section.

- **Access Mode**—In this mode, only untagged packets are accepted. All incoming packets are tagged with user-configured VLANs called access-VLANs.

Use the access mode for applications in which information is collected from devices connected to the MAP, such as cameras or PCs, and then forwarded to the RAP. The RAP then applies tags and forwards traffic to a switch on the wired network.

- **Trunk mode**—This mode requires the user to configure a native VLAN and an allowed VLAN list (no defaults). In this mode, both tagged and untagged packets are accepted. Untagged packets are accepted and are tagged with the user-specified native VLAN. Tagged packets are accepted if they are tagged with a VLAN in the allowed VLAN list.
- Use the trunk mode for bridging applications such as forwarding traffic between two MAPs that reside on separate buildings within a campus.



---

**Note** The Master AP blocks the ethernet port when it receives any Bridge Protocol Data Unit (BPDU) on any VLAN on it as it works globally (one BPDU is enough to block the port on all VLANs). This method avoids loops, and the MAP's port does not operate until the wired link between switches is down.

In Release 8.10 and later releases, the AP performs a loop detection and drops all VLAN packets and BPDU so that the switch does not block the port itself.

---

Ethernet VLAN tagging operates on Ethernet ports that are not used as backhauls.



---

**Note** In the controller releases prior to 7.2, the Root Access Point (RAP) native VLAN is forwarded out of Mesh Access Point (MAP) Ethernet ports with Mesh Ethernet Bridging and VLAN Transparent enabled.

In the 7.2 and 7.4 releases, the Root Access Point (RAP) native VLAN is not forwarded out of Mesh Access Point (MAP) Ethernet ports with Mesh Ethernet Bridging and VLAN Transparent enabled. This behavior is changed starting 7.6, where the native VLAN is forwarded by the MAP when VLAN transparent is enabled.

This change in behavior increases reliability and minimizes the possibility of forwarding loops on Mesh Backhauls.

---

## VLAN Registration

To support a VLAN on a mesh access point, all the uplink mesh access points must also support the same VLAN to allow segregation of traffic that belongs to different VLANs. The activity by which a mesh access point communicates its requirements for a VLAN and gets response from a parent is known as VLAN registration.



---

**Note** VLAN registration occurs automatically. No user intervention is required.

---

VLAN registration is summarized below:

1. Whenever an Ethernet port on a mesh access point is configured with a VLAN, the port requests its parent to support that VLAN.
2. If the parent is able to support the request, it creates a bridge group for the VLAN and propagates the request to its parent. This propagation continues until the RAP is reached.
3. When the request reaches the RAP, it checks whether it is able to support the VLAN request. If yes, the RAP creates a bridge group and a subinterface on its uplink Ethernet interface to support the VLAN request.
4. If the mesh access point is not able to support the VLAN request by its child, at any point, the mesh access point replies with a negative response. This response is propagated to downstream mesh access points until the mesh access point that requested the VLAN is reached.
5. Upon receiving negative response from its parent, the requesting mesh access point defers the configuration of the VLAN. However, the configuration is stored for future attempts. Given the dynamic nature of mesh, another parent and its uplink mesh access points might be able to support it in the case of roaming or a CAPWAP reconnect.

## Ethernet VLAN Tagging Guidelines

Follow these guidelines for Ethernet tagging:

- For security reasons, the Ethernet port on a mesh access point (RAP and MAP) is disabled by default. It is enabled by configuring Ethernet bridging on the mesh access point port.
- Ethernet bridging must be enabled on all the mesh access points in the mesh network to allow Ethernet VLAN tagging to operate.
- VLAN mode must be set as non-VLAN transparent (global mesh parameter). See the Configuring Global Mesh Parameters (CLI) section. VLAN transparent is enabled by default. To set as non-VLAN transparent, you must unselect the VLAN transparent option on the Wireless > Mesh page.
- VLAN tagging can only be configured on Ethernet interfaces as follows:
  - On AP1500s, three of the four ports can be used as secondary Ethernet interfaces: port 0-PoE in, port 1-PoE out, and port 3- fiber. Port 2 - cable cannot be configured as a secondary Ethernet interface.
  - In Ethernet VLAN tagging, port 0-PoE in on the RAP is used to connect to the trunk port of the switch of the wired network. Port 1-PoE out on the MAP is used to connect to external devices such as video cameras.
- Backhaul interfaces (802.11a radios) act as primary Ethernet interfaces. Backhauls function as trunks in the network and carry all VLAN traffic between the wireless and wired network. No configuration of primary Ethernet interfaces is required.
- For indoor mesh networks, the VLAN tagging feature functions as it does for outdoor mesh networks. Any access port that is not acting as a backhaul is *secondary* and can be used for VLAN tagging.

- VLAN tagging cannot be implemented on RAPs because the RAPs do not have a secondary Ethernet port, and the primary port is used as a backhaul. However, VLAN tagging can be enabled on MAPs with a single Ethernet port because the Ethernet port on a MAP does not function as a backhaul and is therefore a secondary port.
- No configuration changes are applied to any Ethernet interface acting as a backhaul. A warning displays if you attempt to modify the backhaul's configuration. The configuration is only applied after the interface is no longer acting as a backhaul.
- No configuration is required to support VLAN tagging on any 802.11a backhaul Ethernet interface within the mesh network as follows:
  - This includes the RAP uplink Ethernet port. The required configuration occurs automatically using a registration mechanism.
  - Any configuration changes to an 802.11a Ethernet link acting as a backhaul are ignored and a warning results. When the Ethernet link no longer functions as a backhaul, the modified configuration is applied.
- VLAN configuration is not allowed on port-02-cable modem port of AP1500s (wherever applicable). VLANs can be configured on ports 0 (PoE-in), 1 (PoE-out), and 3 (fiber).
- Up to 16 VLANs are supported on each sector. The cumulative number of VLANs supported by a RAP's children (MAP) cannot exceed 16.
- The switch port connected to the RAP must be a trunk:
  - The trunk port on the switch and the RAP trunk port must match.
  - The RAP must always connect to the native VLAN ID 1 on a switch. The RAP's primary Ethernet interface is by default the native VLAN of 1.
  - The switch port in the wired network that is attached to the RAP (port 0—PoE in) must be configured to accept tagged packets on its trunk port. The RAP forwards all tagged packets received from the mesh network to the wired network.
  - No VLANs, other than those destined for the mesh sector, should be configured on the switch trunk port.
- A configured VLAN on a MAP Ethernet port cannot function as a Management VLAN.
- Configuration is effective only when a mesh access point is in the CAPWAP RUN state and VLAN-Transparent mode is disabled.
- Whenever there roaming or a CAPWAP restart, an attempt is made to apply configuration again.

## Configuring Ethernet VLAN Tagging (CLI)

To configure a MAP *access* port, enter this command:

```
config ap ethernet 1 mode access enable AP1500-MAP 50
```

where *AP1500-MAP* is the variable *AP\_name* and *50* is the variable *access\_vlan ID*

To configure a RAP or MAP *trunk* port, enter this command:

```
config ap ethernet 0 mode trunk enable AP1500-MAP 60
```

where *AP1500-MAP* is the variable *AP\_name* and *60* is the variable *native\_vlan ID*

To add a VLAN to the VLAN allowed list of the native VLAN, enter this command:

```
config ap ethernet 0 mode trunk add AP1500-MAP3 65
```

where *AP1500-MAP 3* is the variable *AP\_name* and *65* is the variable *VLAN ID*

## Viewing Ethernet VLAN Tagging Configuration Details (CLI)

### Procedure

- To view VLAN configuration details for Ethernet interfaces on a specific mesh access point (*AP Name*) or all mesh access points (*summary*), enter this command:

```
show ap config ethernet ap-name
```

- To see if VLAN transparent mode is enabled or disabled, enter this command:

```
show mesh config
```

## Workgroup Bridge Interoperability with Mesh Infrastructure

A workgroup bridge (WGB) is a small standalone unit that can provide a wireless infrastructure connection for Ethernet-enabled devices. Devices that do not have a wireless client adapter to connect to the wireless network can be connected to the WGB through the Ethernet port. The WGB is associated with the root AP through the wireless interface, which means that wired clients get access to the wireless network.

A WGB is used to connect wired networks over a single wireless segment by informing the mesh access point of all the clients that the WGB has on its wired segment via IAPP messages. The data packets for WGB clients contain an additional MAC address in the 802.11 header (4 MAC headers, versus the normal 3 MAC data headers). The additional MAC in the header is the address of the WGB itself. This additional MAC address is used to route the packet to and from the clients.

WGB association is supported on all radios of every mesh access point.



Figure 5: WGB Example

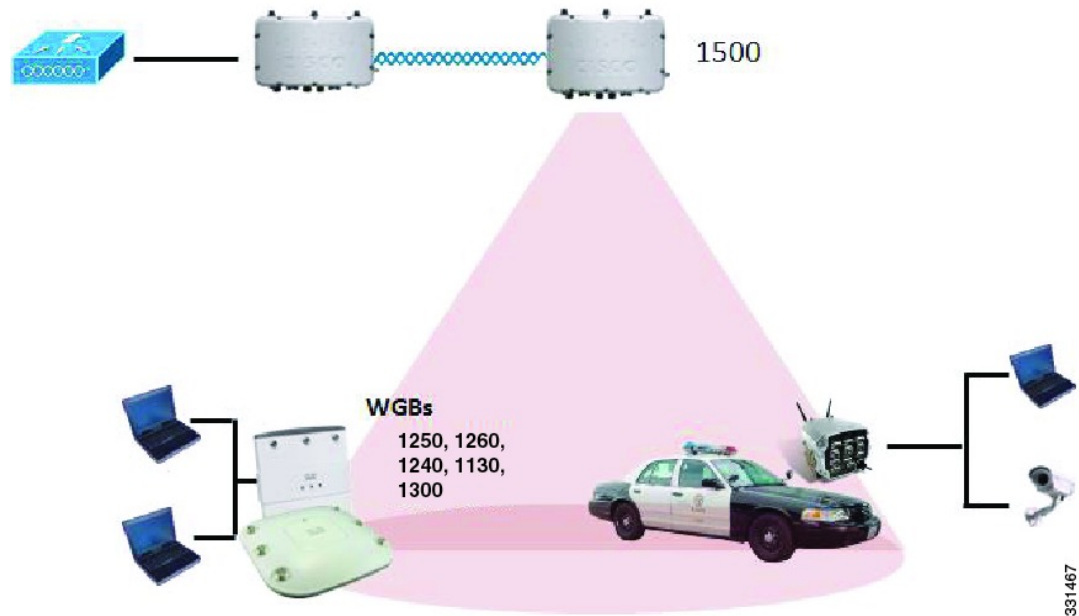

In the current architecture, while an autonomous AP functions as a workgroup bridge, only one radio interface is used for controller connectivity, Ethernet interface for wired client connectivity, and other radio interface for wireless client connectivity. dot11radio 1 (5 GHz) can be used to connect to a controller (using the mesh infrastructure) and Ethernet interface for wired clients. dot11radio 0 (2.4 GHz) can be used for wireless client connectivity. Depending on the requirement, dot11radio 1 or dot11radio 0 can be used for client association or controller connectivity.

With the 7.0 release, a wireless client on the second radio of the WGB is not dissociated by the WGB upon losing its uplink to a wireless infrastructure or in a roaming scenario.

With two radios, one radio can be used for client access and the other radio can be used for accessing the access points. Having two independent radios performing two independent functions provides you better control and lowers the latency. Also, wireless clients on the second radio for the WGB do not get dissociated by the WGB when an uplink is lost or in a roaming scenario. One radio has to be configured as a Root AP (radio role) and the second radio has to be configured as a WGB (radio role).



---

**Note** If one radio is configured as a WGB, then the second radio cannot be a WGB or a repeater.

---

The following features are not supported for use with a WGB:

- Idle timeout
- Web authentication—If a WGB associates to a web-authentication WLAN, the WGB is added to the exclusion list, and all of the WGB-wired clients are deleted (web-authentication WLAN is another name for a guest WLAN).
- For wired clients behind the WGB, MAC filtering, link tests, and idle timeout

## Configuring Workgroup Bridges

A workgroup bridge (WGB) is used to connect wired networks over a single wireless segment by informing the mesh access point of all the clients that the WGB has on its wired segment via IAPP messages. In addition to the IAPP control messages, the data packets for WGB clients contain an extra MAC address in the 802.11 header (4 MAC headers, versus the normal 3 MAC data headers). The extra MAC in the header is the address of the workgroup bridge itself. This extra MAC address is used to route the packet to and from the clients.

WGB association is supported on both the 2.4-GHz (802.11b/g) and 5-GHz (802.11a) radios on all Cisco APs.

Supported platforms are autonomous 1600, 1700, 2600, 2700, 3600, 3700, 1530, 1550, and 1570, which are configured as WGBs can associate with a mesh access point. See the “Cisco Workgroup Bridges” section in *Cisco Wireless LAN Controller Configuration Guide* for configuration steps at <https://www.cisco.com/c/en/us/support/wireless/8500-series-wireless-controllers/products-installation-and-configuration-guides-list.html>

The supported WGB modes and capacities are as follows:

- The autonomous access points configured as WGBs must be running Cisco IOS release 12.4.25d-JA or later.



---

**Note** If your mesh access point has two radios, you can only configure workgroup bridge mode on one of the radios. We recommend that you disable the second radio. Workgroup bridge mode is not supported on access points with three radios.

---

- Client mode WGB (BSS) is supported; however, infrastructure WGB is not supported. The client mode WGB is not able to trunk VLAN as in an infrastructure WGB.
- Multicast traffic is not reliably transmitted to WGB because no ACKs are returned by the client. Multicast traffic is unicast to infrastructure WGB, and ACKs are received back.
- If one radio is configured as a WGB in a Cisco IOS access point, then the second radio cannot be a WGB or a repeater.
- Mesh access points can support up to 200 clients including wireless clients, WGB, and wired clients behind the associated WGB.
- A WGB cannot associate with mesh access points if the WLAN is configured with WPA1 (TKIP) +WPA2 (AES), and the corresponding WGB interface is configured with only one of these encryptions (either WPA1 or WPA2):

Figure 6: WPA Security Settings for a WGB

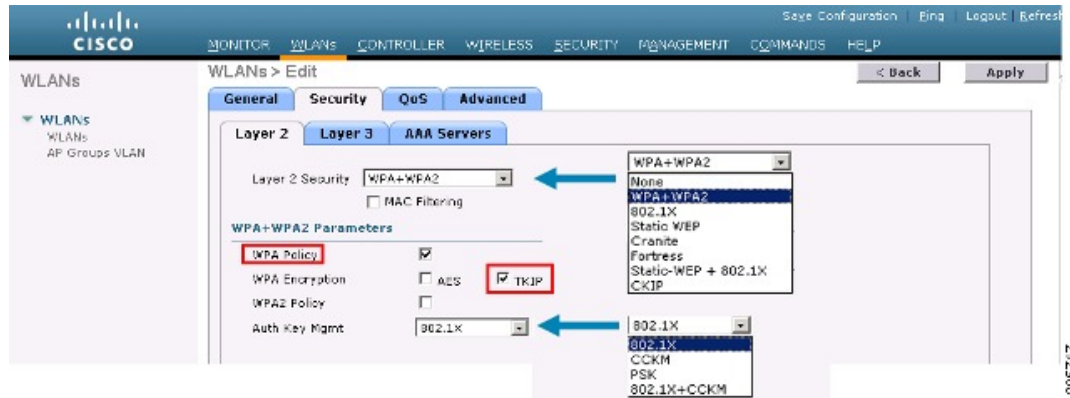
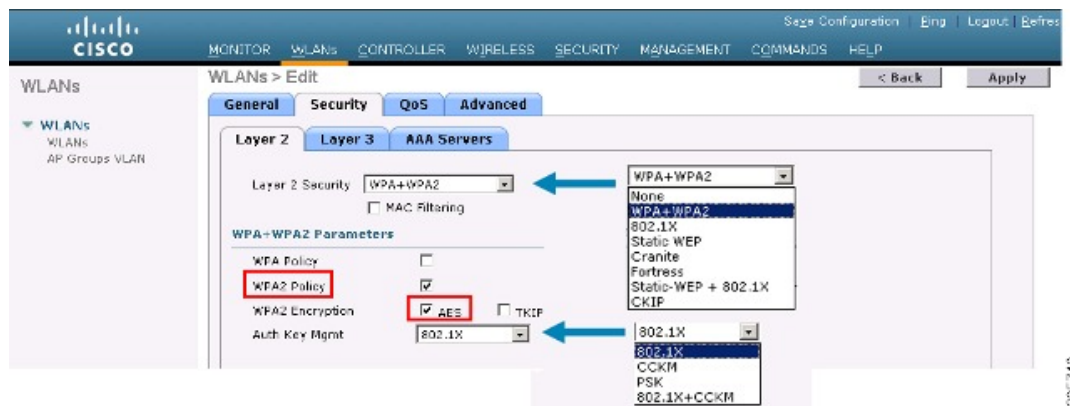

Figure 7: WPA-2 Security Settings for a WGB



To view the status of a WGB client, follow these steps:

**Procedure**

- Step 1** Choose **Monitor > Clients**.
- Step 2** On the client summary page, click on the MAC address of the client or search for the client using its MAC address.
- Step 3** In the page that appears, note that the client type is identified as a *WGB* (far right).

Figure 8: Clients are Identified as a WGB

| Client MAC Addr     | AP Name                | WLAN Profile | Protocol | Status     | Auth | Port | WGB |
|---------------------|------------------------|--------------|----------|------------|------|------|-----|
| 00:05:19:1:3f:57:26 | SkyRep-70:7b:a0        | WLANS        | 802.11g  | Associated | Yes  | 29   | Yes |
| 00:06:16:1:fe:00:84 | SkyRep-70:7b:a0        | WLANS        | 002.11b  | Associated | Yes  | 29   | No  |
| 00:13:8e:1d:0:5e:0f | RAP001b-2a2b-f992-1130 | Unknown      | 802.11a  | Probing    | No   | 29   | No  |
| 00:15:1d:14:1:25:1d | RAP001a-1449-1408Plus  | WLANS        | 802.11a  | Associated | Yes  | 29   | No  |
| 00:16:36:1:5f:4b:74 | MAP2-001e-1448-ec0c0c  | WLANS        | 802.11a  | Associated | Yes  | 29   | No  |

**Step 4** Click on the MAC address of the client to view configuration details:

- For a wireless client, the page seen in **Monitor > Clients > Detail Page (Wireless WGB Client)** is displayed.
- For a wired client, the page seen in **Monitor > Clients > Detail Page (Wireless WGB Client)** is displayed.

**Figure 9: Monitor > Clients > Detail Page (Wireless WGB Client)**

The screenshot shows the Cisco Monitor interface for a Wireless WGB Client. The page is titled "Clients > Detail" and includes navigation buttons: "< Back", "Apply", "Link Test", and "Remove".

| Client Properties           |                    | AP Properties         |                       |
|-----------------------------|--------------------|-----------------------|-----------------------|
| MAC Address                 | 00:15:03:ad:a9:70F | AP Address            | 00:1e:14:40:1ec0:00   |
| IP Address                  | 209.186.200.236    | AP Name               | MAP2-001e-1448-cc00Hr |
| Client Type                 | WGB Client         | AP Type               | 802.11a               |
| WGB MAC Address             | 00:1d:45:95:74-44  | WLAN Profile          | WLAN5                 |
| User Name                   |                    | Status                | Associated            |
| Port Number                 | 29                 | Association ID        | 0                     |
| Interface                   | management         | 802.11 Authentication | Open System           |
| VLAN ID                     | 70                 | Reason Code           | 0                     |
| CCX Version                 | Not Supported      | Status Code           | 0                     |
| E2E Version                 | Not Supported      | CF Pollable           | Not Implemented       |
| Mobility Role               | Local              | CF Poll Request       | Not Implemented       |
| Mobility Peer IP Address    | N/A                | Short Preamble        | Implemented           |
| Policy Manager State        | RUN                | PBCC                  | Not Implemented       |
| Mirror Mode                 | Disable            | Channel Agility       | Not Implemented       |
| Management Frame Protection | No                 | Timeout               | 0                     |
|                             |                    | WEP State             | WEP Disable           |

Additional buttons at the bottom right include "Send CCXVS Req" and "Display".

**Figure 10: Monitor > Clients > Detail Page (Wired WGB Client)**

The screenshot shows the Cisco Monitor interface for a Wired WGB Client. The page is titled "Clients > Detail" and includes navigation buttons: "< Back", "Apply", "Link Test", and "Remove".

| Client Properties           |                   | AP Properties         |                   |
|-----------------------------|-------------------|-----------------------|-------------------|
| MAC Address                 | 00:05:9e:2f:07:00 | AP Address            | 00:05:05:70:7b:a0 |
| IP Address                  | 70.1.0.54         | AP Name               | SkyRap:70:7b:a0   |
| Client Type                 | WGB               | AP Type               | 802.11g           |
| Number of Wired Client(s)   | 1                 | WLAN Profile          | WLAN5             |
| User Name                   |                   | Status                | Associated        |
| Port Number                 | 29                | Association ID        | 1                 |
| Interface                   | management        | 802.11 Authentication | Open System       |
| VLAN ID                     | 70                | Reason Code           | 0                 |
| CCX Version                 | CCXV5             | Status Code           | 0                 |
| E2E Version                 | Not Supported     | CF Pollable           | Not Implemented   |
| Mobility Role               | Local             | CF Poll Request       | Not Implemented   |
| Mobility Peer IP Address    | N/A               | Short Preamble        | Implemented       |
| Policy Manager State        | RUN               | PBCC                  | Not Implemented   |
| Mirror Mode                 | Disable           | Channel Agility       | Not Implemented   |
| Management Frame Protection | No                | Timeout               | 0                 |
|                             |                   | WEP State             | WEP Enable        |

Additional buttons at the bottom right include "Send CCXVS Req" and "Display".

## Guidelines for Configuration

Follow these guidelines when you configure:

- We recommend using a 5-GHz radio for the uplink to Mesh AP infrastructure so you can take advantage of a strong client access on two 5-GHz radios available on mesh access points. A 5-GHz band allows more Effective Isotropic Radiated Power (EIRP) and is less polluted. In a two-radio WGB, configure 5-GHz radio (radio 1) mode as WGB. This radio will be used to access the mesh infrastructure. Configure the second radio 2.4-GHz (radio 0) mode as Root for client access.
- On the Autonomous access points, only one SSID can be assigned to the native VLAN. You cannot have multiple VLANs in one SSID on the autonomous side. SSID to VLAN mapping should be unique because this is the way to segregate traffic on different VLANs. In a unified architecture, multiple VLANs can be assigned to one WLAN (SSID).
- Only one WLAN (SSID) for wireless association of the WGB to the access point infrastructure is supported. This SSID should be configured as an infrastructure SSID and should be mapped to the native VLAN.
- A dynamic interface should be created in the controller for each VLAN configured in the WGB.
- A second radio (2.4-GHz) on the access point should be configured for client access. You have to use the same SSID on both radios and map to the native VLAN. If you create a separate SSID, then it is not possible to map it to a native VLAN, due to the unique VLAN/SSID mapping requirements. If you try to map the SSID to another VLAN, then you do not have multiple VLAN support for wireless clients.
- All Layer 2 security types are supported for the WLANs (SSIDs) for wireless client association in WGB.
- This feature does not depend on the AP platform. On the controller side, both mesh and nonmesh APs are supported.
- There is a limitation of 20 clients in the WGB. The 20-client limitation includes both wired and wireless clients. If the WGB is talking to autonomous access points, then the client limit is very high.
- The controller treats the wireless and wired clients behind a WGB in the same manner. Features such as MAC filtering and link test are not supported for wireless WGB clients from the controller.
- If required, you can run link tests for a WGB wireless client from an autonomous AP.
- Multiple VLANs for wireless clients associated to a WGB are not supported.
- Up to 16 multiple VLANs are supported for wired clients behind a WGB from the 7.0 release and later releases.
- Roaming is supported for wireless and wired clients behind a WGB. The wireless clients on the other radio will not be dissociated by the WGB when an uplink is lost or in a roaming scenario.

We recommend that you configure radio 0 (2.4 GHz) as a Root (one of the mode of operations for Autonomous AP) and radio 1 (5 GHz) as a WGB.

## Configuration Example

When you configure from the CLI, the following are mandatory:

- dot11 SSID (security for a WLAN can be decided based on the requirement).
- Map the subinterfaces in both the radios to a single bridge group.



---

**Note** A native VLAN is always mapped to bridge group 1 by default. For other VLANs, the bridge group number matches the VLAN number; for example, for VLAN 46, the bridge group is 46.

---

- Map the SSID to the radio interfaces and define the role of the radio interfaces.

In the following example, one SSID (WGBTEST) is used in both radios, and the SSID is the infrastructure SSID mapped to NATIVE VLAN 51. All radio interfaces are mapped to bridge group -1.

```
WGB1#config t
WGB1 (config)#interface Dot11Radio1.51
WGB1 (config-subif)#encapsulation dot1q 51 native
WGB1 (config-subif)#bridge-group 1
WGB1 (config-subif)#exit
WGB1 (config)#interface Dot11Radio0.51
WGB1 (config-subif)#encapsulation dot1q 51 native
WGB1 (config-subif)#bridge-group 1
WGB1 (config-subif)#exit
WGB1 (config)#dot11 ssid WGBTEST
WGB1 (config-ssid)#VLAN 51
WGB1 (config-ssid)#authentication open
WGB1 (config-ssid)#infrastructure-ssid
WGB1 (config-ssid)#exit
WGB1 (config)#interface Dot11Radio1
WGB1 (config-if)#ssid WGBTEST
WGB1 (config-if)#station-role workgroup-bridge
WGB1 (config-if)#exit
WGB1 (config)#interface Dot11Radio0
WGB1 (config-if)#ssid WGBTEST
WGB1 (config-if)#station-role root
WGB1 (config-if)#exit
```

You can also use the GUI of an autonomous AP for configuration. From the GUI, subinterfaces are automatically created after the VLAN is defined.

Figure 11: SSID Configuration Page



## WGB Association Check

Both the WGB association to the controller and the wireless client association to WGB can be verified by entering the `show dot11 associations client` command in autonomous AP.

WGB#`show dot11 associations client`

802.11 Client Stations on Dot11Radio1:

SSID [WGBTEST] :

| MAC Address    | IP Address      | Device       | Name  | Parent | State |
|----------------|-----------------|--------------|-------|--------|-------|
| 0024.130f.920e | 209.165.200.225 | LWAPP-Parent | RAPSB | -      | Assoc |

From the controller, choose **Monitor > Clients**. The WGB and the wireless/wired client behind the WGB are updated and the wireless/wired client are shown as the WGB client.

Figure 12: Updated WGB Clients



Figure 13: Updated WGB Clients



Figure 14: Updated WGB Clients

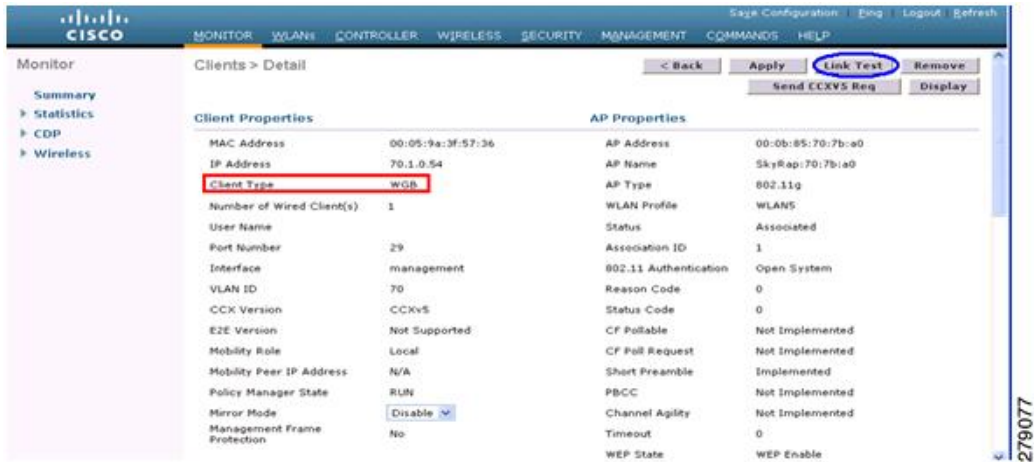

## Link Test Result

Figure 15: Link Test Results



A link test can also be run from the controller CLI using the following command:



```
(Cisco Controller) > linktest client mac-address
```

Link tests from the controller are only limited to the WGB, and they cannot be run beyond the WGB from the controller to a wired or wireless client connected to the WGB. You can run link tests for the wireless client connected to the WGB from the WGB itself using the following command:

```
ap#dot11 dot11Radio 0 linktest target client-mac-address
Start linktest to 0040.96b8.d462, 100 512 byte packets
ap#
```

| POOR (4% lost) | Time (msec) | Strength (dBm) |     | SNR Quality |     | Retries |     |
|----------------|-------------|----------------|-----|-------------|-----|---------|-----|
|                |             | In             | Out | In          | Out | In      | Out |
| Sent: 100      | Avg. 22     | -37            | -83 | 48          | 3   | Tot. 34 | 35  |
| Lost to Tgt: 4 | Max. 112    | -34            | -78 | 61          | 10  | Max. 10 | 5   |
| Lost to Src: 4 | Min. 0      | -40            | -87 | 15          | 3   |         |     |

```
Rates (Src/Tgt) 24Mb 0/5 36Mb 25/0 48Mb 73/0 54Mb 2/91
Linktest Done in 24.464 msec
```

## WGB Wired/Wireless Client

You can also use the following commands to know the summary of WGBs and clients associated with a Cisco lightweight access point:

```
(Cisco Controller) > show wgb summary
Number of WGBs..... 2
```

| MAC Address       | IP Address      | AP Name | Status | WLAN | Auth | Protocol | Clients |
|-------------------|-----------------|---------|--------|------|------|----------|---------|
| 00:1d:70:97:bd:e8 | 209.165.200.225 | c1240   | Assoc  | 2    | Yes  | 802.11a  | 2       |
| 00:1e:be:27:5f:e2 | 209.165.200.226 | c1240   | Assoc  | 2    | Yes  | 802.11a  | 5       |

```
(Cisco Controller) > show client summary
Number of Clients..... 7
```

| MAC Address       | AP Name | Status     | WLAN/Guest-Lan | Auth | Protocol | Port | Wired |
|-------------------|---------|------------|----------------|------|----------|------|-------|
| 00:00:24:ca:a9:b4 | R14     | Associated | 1              | Yes  | N/A      | 29   | No    |
| 00:24:c4:a0:61:3a | R14     | Associated | 1              | Yes  | 802.11a  | 29   | No    |

|                   |     |            |   |     |         |    |    |
|-------------------|-----|------------|---|-----|---------|----|----|
| 00:24:c4:a0:61:f4 | R14 | Associated | 1 | Yes | 802.11a | 29 | No |
| 00:24:c4:a0:61:f8 | R14 | Associated | 1 | Yes | 802.11a | 29 | No |
| 00:24:c4:a0:62:0a | R14 | Associated | 1 | Yes | 802.11a | 29 | No |
| 00:24:c4:a0:62:42 | R14 | Associated | 1 | Yes | 802.11a | 29 | No |
| 00:24:c4:a0:71:d2 | R14 | Associated | 1 | Yes | 802.11a | 29 | No |

```
(Cisco Controller) > show wgb detail 00:1e:be:27:5f:e2
```

```
Number of wired client(s): 5
```

| MAC Address       | IP Address      | AP Name | Mobility | WLAN | Auth |
|-------------------|-----------------|---------|----------|------|------|
| 00:16:c7:5d:b4:8f | Unknown         | c1240   | Local    | 2    | No   |
| 00:21:91:f8:e9:ae | 209.165.200.232 | c1240   | Local    | 2    | Yes  |
| 00:21:55:04:07:b5 | 209.165.200.234 | c1240   | Local    | 2    | Yes  |
| 00:1e:58:31:c7:4a | 209.165.200.236 | c1240   | Local    | 2    | Yes  |
| 00:23:04:9a:0b:12 | Unknown         | c1240   | Local    | 2    | No   |

## Client Roaming

High-speed roaming of Cisco Compatible Extension (CX), version 4 (v4) clients is supported at speeds up to 70 miles per hour in outdoor mesh deployments. An example application might be maintaining communication with a terminal in an emergency vehicle as it moves within a mesh public network.

Three Cisco CX v4 Layer 2 client roaming enhancements are supported:

- Access point assisted roaming—Helps clients save scanning time. When a Cisco CX v4 client associates to an access point, it sends an information packet to the new access point listing the characteristics of its previous access point. Roaming time decreases when the client recognizes and uses an access point list built by compiling all previous access points to which each client was associated and sent (unicast) to the client immediately after association. The access point list contains the channels, BSSIDs of neighbor access points that support the client's current SSID(s), and time elapsed since disassociation.
- Enhanced neighbor list—Focuses on improving a Cisco CX v4 client's roam experience and network edge performance, especially when servicing voice applications. The access point provides its associated client information about its neighbors using a neighbor-list update unicast message.

- Roam reason report—Enables Cisco CX v4 clients to report the reason why they roamed to a new access point. It also allows network administrators to build and monitor a roam history.



**Note** Client roaming is enabled by default. For more information, see the Enterprise Mobility Design Guide at <http://www.cisco.com/en/US/docs/solutions/Enterprise/Mobility/emob41dg/eMob4.1.pdf>

## WGB Roaming Guidelines

Follow these guidelines for WGB roaming:

- Configuring a WGB for roaming—If a WGB is mobile, you can configure it to scan for a better radio connection to a parent access point or bridge. Use the `ap(config-if)#mobile station period 3 threshold 50` command to configure the workgroup bridge as a mobile station.

When you enable this setting, the WGB scans for a new parent association when it encounters a poor Received Signal Strength Indicator (RSSI), excessive radio interference, or a high frame-loss percentage. Using these criteria, a WGB configured as a mobile station searches for a new parent association and roams to a new parent before it loses its current association. When the mobile station setting is disabled (the default setting), a WGB does not search for a new association until it loses its current association.

- Configuring a WGB for Limited Channel Scanning—In mobile environments such as railroads, a WGB instead of scanning all the channels is restricted to scan only a set of limited channels to reduce the hand-off delay when the WGB roams from one access point to another. By limiting the number of channels, the WGB scans only those required channels; the mobile WGB achieves and maintains a continuous wireless LAN connection with fast and smooth roaming. This limited channel set is configured using the `ap(config-if)#mobile station scan set of channels`.

This command invokes scanning to all or specified channels. There is no limitation on the maximum number of channels that can be configured. The maximum number of channels that can be configured is restricted only by the number of channels that a radio can support. When executed, the WGB scans only this limited channel set. This limited channel feature also affects the known channel list that the WGB receives from the access point to which it is currently associated. Channels are added to the known channel list only if they are also part of the limited channel set.

## Configuration Example

The following example shows how to configure a roaming configuration:

```
ap(config)#interface dot11radio 1
ap(config-if)#ssid outside
ap(config-if)#packet retries 16
ap(config-if)#station role workgroup-bridge
ap(config-if)#mobile station
ap(config-if)#mobile station period 3 threshold 50
ap(config-if)#mobile station scan 5745 5765
```

Use the `no mobile station scan` command to restore scanning to all the channels.

## Troubleshooting Tips

If a wireless client is not associated with a WGB, use the following steps to troubleshoot the problem:

1. Verify the client configuration and ensure that the client configuration is correct.
2. Check the **show bridge** command output in autonomous AP, and confirm that the AP is reading the client MAC address from the right interface.
3. Confirm that the subinterfaces corresponding to specific VLANs in different interfaces are mapped to the same bridge group.
4. If required, clear the bridge entry using the **clear bridge** command (remember that this command will remove all wired and wireless clients associated in a WGB and make them associate again).
5. Check the **show dot11 association** command output and confirm that the WGB is associated with the controller.
6. Ensure that the WGB has not exceeded its 20-client limitation.

In a normal scenario, if the **show bridge** and **show dot11 association** command outputs are as expected, wireless client association should be successful.

## Configuring Voice Parameters in Indoor Mesh Networks

You can configure call admission control (CAC) and QoS on the controller to manage voice and video quality on the mesh network.

The indoor mesh access points are 802.11e capable, and QoS is supported on the local 2.4 and 5-GHz access radio and the 2.4 and 5 GHz access radio and the 2.4 and 5 GHz backhaul radio. CAC is supported on the backhaul and the CCXv4 clients (which provides CAC between the mesh access point and the client)



---

**Note** Voice is supported only on indoor mesh networks. Voice is supported on a best-effort basis in the outdoors in a mesh network.

---

## Call Admission Control

Call Admission Control (CAC) enables a mesh access point to maintain controlled quality of service (QoS) when the wireless LAN is experiencing congestion. The Wi-Fi Multimedia (WMM) protocol deployed in CCXv3 ensures sufficient QoS as long as the wireless LAN is not congested. However, to maintain QoS under differing network loads, CAC in CCXv4 or later is required.



---

**Note** CAC is supported in Cisco Compatible Extensions (CCX) v4 or later. See Chapter 6 of the *Cisco Wireless LAN Controller Configuration Guide* at <http://www.cisco.com/en/US/docs/wireless/controller/7.0/configuration/guide/c70sol.html>

---

Two types of CAC are available for access points: static CAC and load-based CAC. All calls on a mesh network are bandwidth-based, so mesh access points use only static CAC.

Static CAC enables the client to specify how much bandwidth or shared medium time is required to accept a new call. Each access point determines whether it is capable of accommodating a particular call by looking at the bandwidth available and compares it against the bandwidth required for the call. If there is not enough bandwidth available to maintain the maximum allowed number of calls with acceptable quality, the mesh access point rejects the call.

## Quality of Service and Differentiated Services Code Point Marking

Cisco supports 802.11e on the local access and on the backhaul. Mesh access points prioritize user traffic based on classification, and therefore all user traffic is treated on a best-effort basis.

Resources available to users of the mesh vary, according to the location within the mesh, and a configuration that provides a bandwidth limitation in one point of the network can result in an oversubscription in other parts of the network.

Similarly, limiting clients on their percentage of RF is not suitable for mesh clients. The limiting resource is not the client WLAN, but the resources available on the mesh backhaul.

Similar to wired Ethernet networks, 802.11 WLANs employ Carrier Sense Multiple Access (CSMA), but instead of using collision detection (CD), WLANs use collision avoidance (CA), which means that instead of each station trying to transmit as soon as the medium is free, WLAN devices will use a collision avoidance mechanism to prevent multiple stations from transmitting at the same time.

The collision avoidance mechanism uses two values called CWmin and CWmax. CW stands for contention window. The CW determines what additional amount of time an endpoint should wait, after the interframe space (IFS), to attend to transmit a packet. Enhanced distributed coordination function (EDCF) is a model that allows end devices that have delay-sensitive multimedia traffic to modify their CWmin and CWmax values to allow for statically greater (and more frequent) access to the medium.

Cisco access points support EDCF-like QoS. This provides up to eight queues for QoS.

These queues can be allocated in several different ways, as follows:

- Based on TOS / DiffServ settings of packets
- Based on Layer 2 or Layer 3 access lists
- Based on VLAN
- Based on dynamic registration of devices (IP phones)

AP1500s, with Cisco controllers, provide a minimal integrated services capability at the controller, in which client streams have maximum bandwidth limits, and a more robust differentiated services (diffServ) capability based on the IP DSCP values and QoS WLAN overrides.

When the queue capacity has been reached, additional frames are dropped (tail drop).

### Encapsulations

Several encapsulations are used by the mesh system. These encapsulations include CAPWAP control and data between the controller and RAP, over the mesh backhaul, and between the mesh access point and client(s). The encapsulation of bridging traffic (noncontroller traffic from a LAN) over the backhaul is the same as the encapsulation of CAPWAP data.

There are two encapsulations between the controller and the RAP. The first is for CAPWAP control, and the second is for CAPWAP data. In the control instance, CAPWAP is used as a container for control information

and directives. In the instance of CAPWAP data, the entire packet, including the Ethernet and IP headers, is sent in the CAPWAP container.

Figure 16: Encapsulations

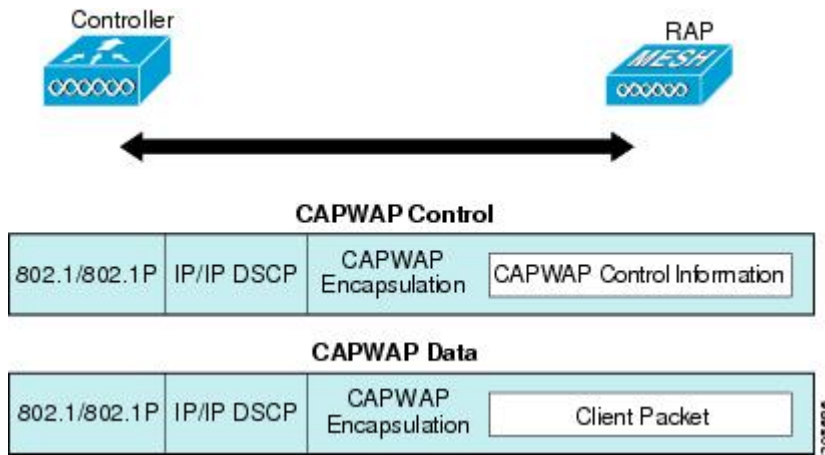

For the backhaul, there is only one type of encapsulation, encapsulating mesh traffic. However, two types of traffic are encapsulated: bridging traffic and CAPWAP control and data traffic. Both types of traffic are encapsulated in a proprietary mesh header.

In the case of bridging traffic, the entire packet Ethernet frame is encapsulated in the mesh header.

All backhaul frames are treated identically, regardless of whether they are MAP to MAP, RAP to MAP, or MAP to RAP.

Figure 17: Encapsulating Mesh Traffic

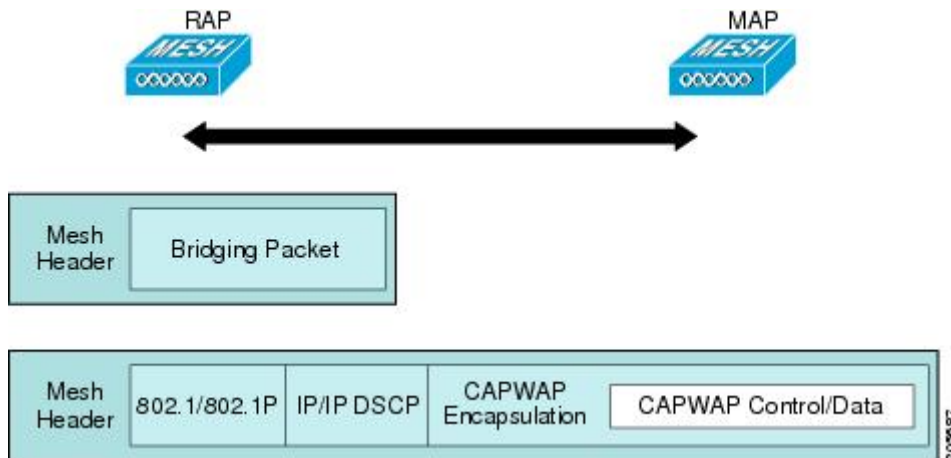

**Note** Mesh Data DTLS encryption is only supported on the wave 2 Mesh AP such as 1540 and 1560 models only.

**Queuing on the Mesh Access Point**

The mesh access point uses a high speed CPU to process ingress frames, Ethernet, and wireless on a first-come, first-serve basis. These frames are queued for transmission to the appropriate output device, either Ethernet

or wireless. Egress frames can be destined for either the 802.11 client network, the 802.11 backhaul network, or Ethernet.

AP1500s support four FIFOs for wireless client transmissions. These FIFOs correspond to the 802.11e platinum, gold, silver, and bronze queues, and obey the 802.11e transmission rules for those queues. The FIFOs have a user configurable queue depth.

The backhaul (frames destined for another outdoor mesh access point) uses four FIFOs, although user traffic is limited to gold, silver, and bronze. The platinum queue is used exclusively for CAPWAP control traffic and voice, and has been reworked from the standard 802.11e parameters for CWmin, CWmax, and so on, to provide more robust transmission but higher latencies.

The 802.11e parameters for CWmin, CWmax, and so on, for the gold queue have been reworked to provide lower latency at the expense of slightly higher error rate and aggressiveness. The purpose of these changes is to provide a channel that is more conducive to video applications.

Frames that are destined for Ethernet are queued as FIFO, up to the maximum available transmit buffer pool (256 frames). There is support for a Layer 3 IP Differentiated Services Code Point (DSCP), so marking of the packets is there as well.

In the controller to RAP path for the data traffic, the outer DSCP value is set to the DSCP value of the incoming IP frame. If the interface is in tagged mode, the controller sets the 802.1Q VLAN ID and derives the 802.1p UP (outer) from 802.1p UP incoming and the WLAN default priority ceiling. Frames with VLAN ID 0 are not tagged.

Figure 18: Controller to RAP Path

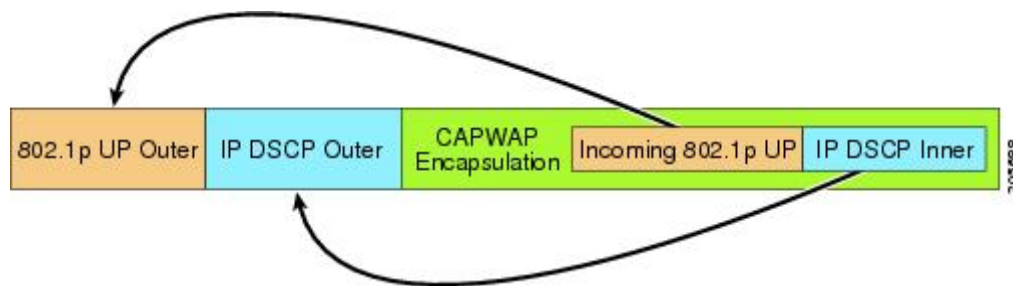

For CAPWAP control traffic the IP DSCP value is set to 46, and the 802.1p user priority is set to 7. Prior to transmission of a wireless frame over the backhaul, regardless of node pairing (RAP/MAP) or direction, the DSCP value in the outer header is used to determine a backhaul priority. The following sections describe the mapping between the four backhaul queues the mesh access point uses and the DSCP values shown in Backhaul Path QoS.

Table 1: Backhaul Path QoS

| DSCP Value             | Backhaul Queue |
|------------------------|----------------|
| 2, 4, 6, 8 to 23       | Bronze         |
| 26, 32 to 63           | Gold           |
| 46 to 56               | Platinum       |
| All others including 0 | Silver         |



**Note** The platinum backhaul queue is reserved for CAPWAP control traffic, IP control traffic, and voice packets. DHCP, DNS, and ARP requests are also transmitted at the platinum QoS level. The mesh software inspects each frame to determine whether it is a CAPWAP control or IP control frame in order to protect the platinum queue from use by non-CAPWAP applications.

For a MAP to the client path, there are two different procedures, depending on whether the client is a WMM client or a normal client. If the client is a WMM client, the DSCP value in the outer frame is examined, and the 802.11e priority queue is used.

**Table 2: MAP to Client Path QoS**

| DSCP Value             | Backhaul Queue |
|------------------------|----------------|
| 2, 4, 6, 8 to 23       | Bronze         |
| 26, 32 to 45, 47       | Gold           |
| 46, 48 to 63           | Platinum       |
| All others including 0 | Silver         |

If the client is not a WMM client, the WLAN override (as configured at the controller) determines the 802.11e queue (bronze, gold, platinum, or silver), on which the packet is transmitted.

For a client of a mesh access point, there are modifications made to incoming client frames in preparation for transmission on the mesh backhaul or Ethernet. For WMM clients, a MAP illustrates the way in which the outer DSCP value is set from an incoming WMM client frame.

**Figure 19: MAP to RAP Path**



The minimum value of the incoming 802.11e user priority and the WLAN override priority is translated using the information listed in [Table 3: DSCP to Backhaul Queue Mapping, on page 40](#) to determine the DSCP value of the IP frame. For example, if the incoming frame has as its value a priority indicating the gold priority, but the WLAN is configured for the silver priority, the minimum priority of silver is used to determine the DSCP value.

**Table 3: DSCP to Backhaul Queue Mapping**

| DSCP Value       | 802.11e UP | Backhaul Queue | Packet Types                    |
|------------------|------------|----------------|---------------------------------|
| 2, 4, 6, 8 to 23 | 1, 2       | Bronze         | Lowest priority packets, if any |
| 26, 32 to 34     | 4, 5       | Gold           | Video packets                   |



| DSCP Value             | 802.11e UP | Backhaul Queue | Packet Types                                               |
|------------------------|------------|----------------|------------------------------------------------------------|
| 46 to 56               | 6, 7       | Platinum       | CAPWAP control, AWPP, DHCP/DNS, ARP packets, voice packets |
| All others including 0 | 0, 3       | Silver         | Best effort, CAPWAP data packets                           |

If there is no incoming WMM priority, the default WLAN priority is used to generate the DSCP value in the outer header. If the frame is an originated CAPWAP control frame, the DSCP value of 46 is placed in the outer header.

With the 5.2 code enhancements, DSCP information is preserved in an AWPP header.

All wired client traffic is restricted to a maximum 802.1p UP value of 5, except DHCP/DNS and ARP packets, which go through the platinum queue.

The non-WMM wireless client traffic gets the default QoS priority of its WLAN. The WMM wireless client traffic may have a maximum 802.11e value of 6, but it must be below the QoS profile configured for its WLAN. If admission control is configured, WMM clients must use TSPEC signaling and get admitted by CAC.

The CAPWAPP data traffic carries wireless client traffic and has the same priority and treatment as wireless client traffic.

Now that the DSCP value is determined, the rules described earlier for the backhaul path from the RAP to the MAP are used to further determine the backhaul queue on which the frame is transmitted. Frames transmitted from the RAP to the controller are not tagged. The outer DSCP values are left intact, as they were first constructed.

### Bridging Backhaul Packets

Bridging services are treated a little differently from regular controller-based services. There is no outer DSCP value in bridging packets because they are not CAPWAP encapsulated. Therefore, the DSCP value in the IP header as it was received by the mesh access point is used to index into the table as described in the path from the mesh access point to the mesh access point (backhaul).

### Bridging Packets from and to a LAN

Packets received from a station on a LAN are not modified in any way. There is no override value for the LAN priority. Therefore, the LAN must be properly secured in bridging mode. The only protection offered to the mesh backhaul is that non-CAPWAP control frames that map to the platinum queue are demoted to the gold queue.

Packets are transmitted to the LAN precisely as they are received on the Ethernet ingress at entry to the mesh.

The only way to integrate QoS between Ethernet ports on AP1500 and 802.11a is by tagging Ethernet packets with DSCP. AP1500s take the Ethernet packet with DSCP and places it in the appropriate 802.11e queue.

AP1500s do not tag DSCP itself:

- On the ingress port, the AP1500 sees a DSCP tag, encapsulates the Ethernet frame, and applies the corresponding 802.11e priority.
- On the egress port, the AP1500 decapsulates the Ethernet frame, and places it on the wire with an untouched DSCP field.

Ethernet devices, such as video cameras, should have the capability to mark the bits with DSCP value to take advantage of QoS.



---

**Note** QoS only is relevant when there is congestion on the network.

---

## Guidelines For Using Voice on the Mesh Network

Follow these guidelines when you use voice on the mesh network:

- Voice is supported only on indoor mesh networks. For outdoors, voice is supported on a best-effort basis on a mesh infrastructure.
- When voice is operating on a mesh network, calls must not traverse more than two hops. Each sector must be configured to require no more than two hops for voice.
- RF considerations for voice networks are as follows:
  - Coverage hole of 2 to 10 percent
  - Cell coverage overlap of 15 to 20 percent
  - Voice needs RSSI and SNR values that are at least 15 dB higher than data requirements
  - RSSI of -67 dBm for all data rates should be the goal for 11b/g/n and 11a/n
  - SNR should be 25 dB for the data rate used by client to connect to the AP
  - Packet error rate (PER) should be configured for a value of one percent or less
  - Channel with the lowest utilization (CU) must be used
- On the **802.11a/n/ac** or **802.11b/g/n** > *Global* parameters page, do the following:
  - Enable dynamic target power control (DTPC).
  - Disable all data rates less than 11 Mbps.
- On the **802.11a/n/ac** or **802.11b/g/n** > *Voice* parameters page, do the following:
  - Load-based CAC must be disabled.
  - Enable admission control (ACM) for CCXv4 or v5 clients that have WMM enabled. Otherwise, static CAC does not operate properly.
  - Set the maximum RF bandwidth to 50 percent.
  - Set the reserved roaming bandwidth to 6 percent.
  - Enable traffic stream metrics.
- On the **802.11a/n/ac** or **802.11b/g/n** > *EDCA* parameters page, you should do the following:
  - Set the EDCA profile for the interface as voice optimized.
  - Disable low latency MAC.

- On the **QoS** > *Profile* page, you should do the following:
  - Create a voice profile and select 802.1Q as the wired QoS protocol type.
- On the **WLANS** > *Edit* > *QoS* page, you should do the following:
  - Select a QoS of platinum for voice and gold for video on the backhaul.
  - Select allowed as the WMM policy.
- On the **WLANS** > *Edit* > *QoS* page, you should do the following:
  - Select CCKM for authorization (*auth*) key management (*mgmt*) if you want to support fast roaming.
- On the **x** > *y* page, you should do the following:
  - Disable voice active detection (VAD).

## Voice Call Support in a Mesh Network

Table 4: Calls Possible with 1550 Series in 802.11a/n 802.11b/g/n Radios, on page 43 shows the actual calls in a clean, ideal environment.

**Table 4: Calls Possible with 1550 Series in 802.11a/n 802.11b/g/n Radios**

| No. of Calls<br><sup>1</sup> | 802.11a/n Radio<br>20 MHz | 802.11a/n Radio<br>40 MHz | 802.11b/g/n<br>Backhaul<br>Radio 20 MHz | 802.11b/g/n Backhaul<br>Radio 40 MHz |
|------------------------------|---------------------------|---------------------------|-----------------------------------------|--------------------------------------|
| RAP                          | 20                        | 35                        | 20                                      | 20                                   |
| MAP1 (First Hop)             | 10                        | 20                        | 15                                      | 20                                   |
| MAP2 (Second Hop)            | 8                         | 15                        | 10                                      | 15                                   |

<sup>1</sup> Traffic was bidirectional 64K voice flows. VoCoder type: G.711, PER <= 1%. Network setup was daisy-chained with no calls traversing more than 2 hops. No external interference.

While making a call, observe the MOS score of the call on the 7921 phone. A MOS score between 3.5 and 4 is acceptable.

**Table 5: MOS Ratings**

| MOS rating | User satisfaction       |
|------------|-------------------------|
| > 4.3      | Very satisfied          |
| 4.0        | Satisfied               |
| 3.6        | Some users dissatisfied |
| 3.1        | Many users dissatisfied |
| < 2.58     | —                       |

## Enabling Mesh Multicast Containment for Video

You can use the controller CLI to configure three mesh multicast modes to manage video camera broadcasts on all mesh access points. When enabled, these modes reduce unnecessary multicast transmissions within the mesh network and conserve backhaul bandwidth.

Mesh multicast modes determine how bridging-enabled access points MAP and RAP send multicasts among Ethernet LANs within a mesh network. Mesh multicast modes manage non-CAPWAP multicast traffic only. CAPWAP multicast traffic is governed by a different mechanism.

The three mesh multicast modes are as follows:

- **Regular mode**—Data is multicast across the entire mesh network and all its segments by bridging-enabled RAP and MAP.
- **In-only mode**—Multicast packets received from the Ethernet by a MAP are forwarded to the RAP's Ethernet network. No additional forwarding occurs, which ensures that non-CAPWAP multicasts received by the RAP are not sent back to the MAP Ethernet networks within the mesh network (their point of origin), and MAP to MAP multicasts do not occur because they are filtered out.



---

**Note** When an HSRP configuration is in operation on a mesh network, we recommend the In-Out multicast mode be configured.

---

- **In-out mode**—The RAP and MAP both multicast but in a different manner:
  - In-out mode is the default mode.
  - If multicast packets are received at a MAP over Ethernet, they are sent to the RAP; however, they are not sent to other MAP over Ethernet, and the MAP to MAP packets are filtered out of the multicast.
  - If multicast packets are received at a RAP over Ethernet, they are sent to all the MAPs and their respective Ethernet networks. When the in-out mode is in operation, it is important to properly partition your network to ensure that a multicast sent by one RAP is not received by another RAP on the same Ethernet segment and then sent back into the network.



---

**Note** If 802.11b clients need to receive CAPWAP multicasts, then multicast must be enabled globally on the controller as well as on the mesh network (using the **config network multicast global enable** CLI command). If multicast does not need to extend to 802.11b clients beyond the mesh network, the global multicast parameter should be disabled (using the **config network multicast global disable** CLI command).

---

## Viewing the Voice Details for Mesh Networks (CLI)

Use the commands in this section to view details on voice and video calls on the mesh network:

Figure 20: Mesh Network Example

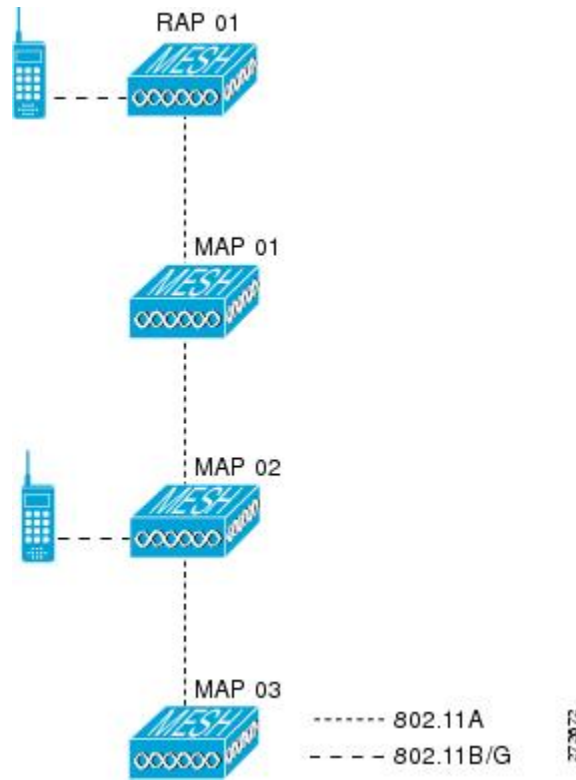

- To view the total number of voice calls and the bandwidth used for voice calls on each RAP, enter this command:

**show mesh cac summary**

Information similar to the following appears:

| AP Name | Slot# | Radio | BW Used/Max | Calls |
|---------|-------|-------|-------------|-------|
| SB_RAP1 | 0     | 11b/g | 0/23437     | 0     |
|         | 1     | 11a   | 0/23437     | 2     |
| SB_MAP1 | 0     | 11b/g | 0/23437     | 0     |
|         | 1     | 11a   | 0/23437     | 0     |
| SB_MAP2 | 0     | 11b/g | 0/23437     | 0     |
|         | 1     | 11a   | 0/23437     | 0     |
| SB_MAP3 | 0     | 11b/g | 0/23437     | 0     |
|         | 1     | 11a   | 0/23437     | 0?    |

- To view the mesh tree topology for the network and the bandwidth utilization (used/maximum available) of voice calls and video links for each mesh access point and radio, enter this command:

**show mesh cac bwused {voice | video} AP\_name**

Information similar to the following appears:

| AP Name | Slot# | Radio | BW Used/Max |
|---------|-------|-------|-------------|
| SB_RAP1 | 0     | 11b/g | 1016/23437  |

```

 1 11a 3048/23437
|SB_MAP1 0 11b/g 0/23437
 1 11a 3048/23437
|| SB_MAP2 0 11b/g 2032/23437
 1 11a 3048/23437
||| SB_MAP3 0 11b/g 0/23437
 1 11a 0/23437

```



---

**Note** The bars (|) to the left of the AP Name field indicate the number of hops that the MAP is from its RAP.

---



---

**Note** When the radio type is the same, the backhaul bandwidth utilization (bw used/max) at each hop is identical. For example, mesh access points *map1*, *map2*, *map3*, and *rap1* are all on the same radio backhaul (802.11a) and are using the same bandwidth (3048). All of the calls are in the same interference domain. A call placed anywhere in that domain affects the others.

---

- To view the mesh tree topology for the network and display the number of voice calls that are in progress by mesh access point radio, enter this command:

**show mesh cac access *AP\_name***

Information similar to the following appears:

```

AP Name Slot# Radio Calls

SB_RAP1 0 11b/g 0
 1 11a 0
| SB_MAP1 0 11b/g 0
 1 11a 0
|| SB_MAP2 0 11b/g 1
 1 11a 0
||| SB_MAP3 0 11b/g 0
 1 11a 0

```



---

**Note** Each call received by a mesh access point radio causes the appropriate calls summary column to increment by one. For example, if a call is received on the 802.11b/g radio on *map2*, then a value of one is added to the existing value in that radio's *calls* column. In this case, the new call is the only active call on the 802.11b/g radio of *map2*. If one call is active when a new call is received, the resulting value is two.

---

- To view the mesh tree topology for the network and display the voice calls that are in progress, enter this command:

**show mesh cac callpath *AP\_name***

Information similar to the following appears:

| AP Name | Slot# | Radio | Calls |
|---------|-------|-------|-------|
| SB_RAP1 | 0     | 11b/g | 0     |
|         | 1     | 11a   | 1     |
| SB_MAP1 | 0     | 11b/g | 0     |
|         | 1     | 11a   | 1     |
| SB_MAP2 | 0     | 11b/g | 1     |
|         | 1     | 11a   | 1     |
| SB_MAP3 | 0     | 11b/g | 0     |
|         | 1     | 11a   | 0     |



**Note** The *calls* column for each mesh access point radio in a call path increments by one. For example, for a call that initiates at map2 (**show mesh cac call path SB\_MAP2**) and terminates at rap1 by way of map1, one call is added to the map2 802.11b/g and 802.11a radio *calls* column, one call to the map1 802.11a backhaul radio *calls* column, and one call to the rap1 802.11a backhaul radio *calls* column.

- To view the mesh tree topology of the network, the voice calls that are rejected at the mesh access point radio due to insufficient bandwidth, and the corresponding mesh access point radio where the rejection occurred, enter this command:

**show mesh cac rejected AP\_name**

Information similar to the following appears:

| AP Name | Slot# | Radio | Calls |
|---------|-------|-------|-------|
| SB_RAP1 | 0     | 11b/g | 0     |
|         | 1     | 11a   | 0     |
| SB_MAP1 | 0     | 11b/g | 0     |
|         | 1     | 11a   | 0     |
| SB_MAP2 | 0     | 11b/g | 1     |
|         | 1     | 11a   | 0     |
| SB_MAP3 | 0     | 11b/g | 0     |
|         | 1     | 11a   | 0     |



**Note** If a call is rejected at the map2 802.11b/g radio, its *calls* column increments by one.

- To view the number of bronze, silver, gold, platinum, and management queues active on the specified access point, enter this command. The peak and average length of each queue are shown as well as the overflow count.

**show mesh queue-stats AP\_name**

Information similar to the following appears:

| Queue Type | Overflows | Peak length | Average length |
|------------|-----------|-------------|----------------|
| Silver     | 0         | 1           | 0.000          |
| Gold       | 0         | 4           | 0.004          |

|            |   |   |       |
|------------|---|---|-------|
| Platinum   | 0 | 4 | 0.001 |
| Bronze     | 0 | 0 | 0.000 |
| Management | 0 | 0 | 0.000 |

Overflows—The total number of packets dropped due to queue overflow.

Peak Length—The peak number of packets waiting in the queue during the defined statistics time interval.

Average Length—The average number of packets waiting in the queue during the defined statistics time interval.

## Enabling Multicast on the Mesh Network (CLI)



### Note

- Cisco Aironet 1540 and 1560 Series Outdoor Access Points support in-out mode only.
- Cisco Aironet 1530, 1550, and 1570 Series Outdoor Access Points support all the modes.

### Procedure

- To enable multicast mode on the mesh network to receive multicasts from beyond the mesh networks, enter these commands:

```
config network multicast global enable
```

```
config mesh multicast {regular | in-only | in-out}
```

- To enable multicast mode only the mesh network (multicasts do not need to extend to 802.11b clients beyond the mesh network), enter these commands:

```
config network multicast global disable
```

```
config mesh multicast {regular | in-only | in-out}
```



### Note

Multicast for mesh networks cannot be enabled using the controller GUI.

## IGMP Snooping

IGMP snooping delivers improved RF usage through selective multicast forwarding and optimizes packet forwarding in voice and video applications.

A mesh access point transmits multicast packets only if a client is associated with the mesh access point that is subscribed to the multicast group. So, when IGMP snooping is enabled, only that multicast traffic relevant to given hosts is forwarded.

To enable IGMP snooping on the controller, enter the following command:

```
configure network multicast igmp snooping enable
```



A client sends an IGMP *join* that travels through the mesh access point to the controller. The controller intercepts the *join* and creates a table entry for the client in the multicast group. The controller then proxies the IGMP *join* through the upstream switch or router.

You can query the status of the IGMP groups on a router by entering the following command:

```
router# show ip gmp groups
IGMP Connected Group Membership

Group Address Interface Uptime Expires Last Reporter
233.0.0.1 Vlan119 3w1d 00:01:52 10.1.1.130
```

For Layer 3 roaming, an IGMP query is sent to the client's WLAN. The controller modifies the client's response before forwarding and changes the source IP address to the controller's dynamic interface IP address.

The network hears the controller's request for the multicast group and forwards the multicast to the new controller.

For more information about video, see the following:

- *Video Surveillance over Mesh Deployment Guide*: [http://www.cisco.com/en/US/tech/tk722/tk809/technologies\\_tech\\_note09186a0080b02511.shtml](http://www.cisco.com/en/US/tech/tk722/tk809/technologies_tech_note09186a0080b02511.shtml)
- *Cisco Unified Wireless Network Solution: VideoStream Deployment Guide*: [http://www.cisco.com/en/US/products/ps10315/products\\_tech\\_note09186a0080b6e11e.shtml](http://www.cisco.com/en/US/products/ps10315/products_tech_note09186a0080b6e11e.shtml)

## Locally Significant Certificates for Mesh APs

Until the 7.0 release, mesh APs supported only the Manufactured Installed Certificate (MIC) to authenticate and get authenticated by controllers to join the controller. You might have had to have your own public key infrastructure (PKI) to control CAs, to define policies, to define validity periods, to define restrictions and usages on the certificates that are generated, and get these certificates installed on the APs and controllers. After these customer-generated or locally significant certificates (LSCs) are present on the APs and controllers, the devices start using these LSCs, to join, authenticate, and derive a session key. Cisco supported normal APs from the 5.2 release and later releases and extended the support for mesh APs as well from the 7.0 release.

- Graceful fallback to MIC if APs are unable to join the controller with LSC certificates—Local APs try to join a controller with an LSC for the number of times that are configured on the controller (the default value is 3). After these trials, the AP deletes the LSC and tries to join a controller with an MIC.

Mesh APs try to join a controller with an LSC until its lonely timer expires and the AP reboots. The lonely timer is set for 40 minutes. After the reboot, the AP tries to join a controller with an MIC. If the AP is again not able to join a controller with an MIC in 40 minutes, the AP reboots and then tries to join a controller with an LSC.



---

**Note** An LSC in mesh APs is not deleted. An LSC is deleted in mesh APs only when the LSC is disabled on the controller, which causes the APs to reboot.

---

- Over the air provisioning of MAPs.

## Guidelines for Configuration

Follow these guidelines when using LSCs for mesh APs:

- This feature does not remove any preexisting certificates from an AP. It is possible for an AP to have both LSC and MIC certificates.
- After an AP is provisioned with an LSC, it does not read in its MIC certificate on boot-up. A change from an LSC to an MIC will require the AP to reboot. APs do it for a fallback if they cannot be joined with an LSC.
- Provisioning an LSC on an AP does not require an AP to turn off its radios, which is vital for mesh APs, which may get provisioned over-the-air.
- Because mesh APs need a dot1x authentication, a CA and ID certificate is required to be installed on the server in the controller.
- LSC provisioning can happen over Ethernet and over-the-air in case of MAPs. You have to connect the mesh AP to the controller through Ethernet and get the LSC certificate provisioned. After the LSC becomes the default, an AP can be connected over-the-air to the controller using the LSC certificate.

## Differences Between LSCs for Mesh APs and Normal APs

CAPWAP APs use LSC for DTLS setup during a JOIN irrespective of the AP mode. Mesh APs also use the certificate for mesh security, which involves a dot1x authentication with the controller through the parent AP. After the mesh APs are provisioned with an LSC, they need to use the LSC for this purpose because MIC will not be read in.

Mesh APs use a statically configured dot1x profile to authenticate.

This profile is hardcoded to use "cisco" as the certificate issuer. This profile needs to be made configurable so that vendor certificates can be used for mesh authentication (enter the **config local-auth eap-profile cert-issuer vendor "prfMaP1500LIEAuth93"** command).

You must enter the **config mesh lsc enable/disable** command to enable or disable an LSC for mesh APs. This command will cause all the mesh APs to reboot.



---

**Note** An LSC on mesh is open for very specific Oil and Gas customers with the 7.0 release. Initially, it is a hidden feature. The **config mesh lsc enable/disable** is a hidden command. Also, the **config local-auth eap-profile cert-issuer vendor "prfMaP1500LIEAuth93"** command is a normal command, but the "prfMaP1500LIEAuth93" profile is a hidden profile, and is not stored on the controller and is lost after the controller reboot.

---

## Certificate Verification Process in LSC AP

LSC-provisioned APs have both LSC and MIC certificates, but the LSC certificate will be the default one. The verification process consists of the following two steps:

1. The controller sends the AP the MIC device certificate, which the AP verifies with the MIC CA.
2. The AP sends the LSC device certificate to the controller, which the controller verifies with the LSC CA.

## Getting Certificates for LSC Feature

To configure LSC, you must first gather and install the appropriate certificates on the controller. The following steps show how to accomplish this using Microsoft 2003 Server as the CA server.

To get the certificates for LSC, follow these steps:

### Procedure

---

- Step 1** Go to the CA server (<http://<ip address of caserver/crtsrv>>) and login.
- Step 2** Get the CA certificate as follows:
- Click the Download a CA certificate link, certificate chain, or CRF.
  - Choose the encoding method as DER.
  - Click the Download CA certificate link and use the save option to download the CA certificate on to your local machine.
- Step 3** To use the certificate on the controller, convert the downloaded certificate to PEM format. You can convert this in a Linux machine using the following command:
- ```
# openssl x509 -in <input.cer> -inform DER -out <output.cer> -outform PEM
```
- Step 4** Configure the CA certificate on the controller as follows:
- Choose **COMMANDS > Download File**.
 - Choose the file type as Vendor CA Certificate from the File Type drop-down list.
 - Update the rest of the fields with the information of the TFTP server where the certificate is located.
 - Click **Download**.
- Step 5** To install the Device certificate on the WLC, login to the CA server as mentioned in Step 1 and do the following:
- Click the Request a certificate link.
 - Click the advanced certificate request link.
 - Click Create and submit a request to this CA link.
 - Go to the next screen and choose the Server Authentication Certificate from the Certificate Template drop-down list.
 - Enter a valid name, email, company, department, city, state, and country/region. (Remember it in case you want the cap method to check the username against its database of user credentials).
- Note** The e-mail is not used.
- Enable Mark keys as exportable.
 - Click **Submit**.
 - Install the certificate on your laptop.
- Step 6** Convert the device certificate obtained in the Step 5. To get the certificate, go to your internet browser options and choose exporting to a file. Follow the options from your browser to do this. You need to remember the password that you set here.
- To convert the certificate, use the following command in a Linux machine:
- ```
openssl pkcs12 -in <input.pfx> -out <output.cer>
```

- Step 7** On the controller GUI, choose **Command > Download File**. Choose Vendor Device Certificate from the File Type drop-down list. Update the rest of the fields with the information of the TFTP server where the certificate is located and the password you set in the previous step and click **Download**.
- Step 8** Reboot the controller so that the certificates can then be used.
- Step 9** You can check that the certificates were successfully installed on the controller using this command:  
**show local-auth certificates**

## Configuring a Locally Significant Certificate (CLI)

To configure a locally significant certificate (LSC), follow these steps:

### Procedure

- Step 1** Enable LSC and provision the LSC CA certificate in the controller.
- Step 2** Enter the following command:  
**config local-auth eap-profile cert-issuer vendor prfMaP1500LIEAuth93**
- Step 3** Turn on the feature by entering the following command:  
**config mesh lsc {enable | disable}**
- Step 4** Connect the mesh AP through Ethernet and provision for an LSC certificate.
- Step 5** Let the mesh AP get a certificate and join the controller using the LSC certificate.

Figure 21: Local Significant Certificate Page

Figure 22: AP Policy Configuration

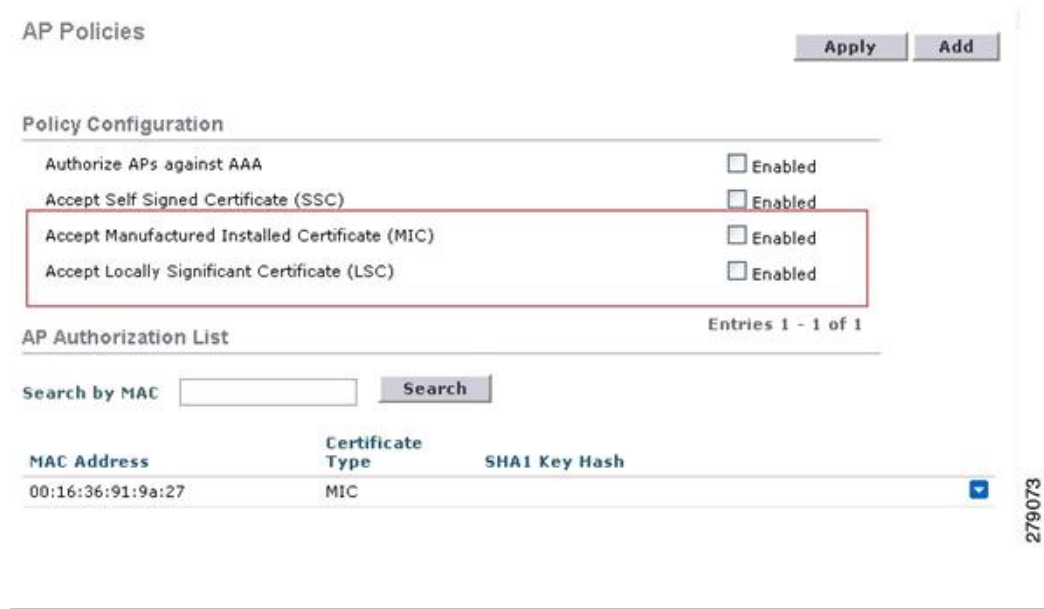

## LSC only MAP Authentication using wild card MAC

### Information about LSC-Only MAP Authentication using wild card MAC

The 8.0 release supports LSC only authentication using a wild card MAC address thus disabling the MAC filter. To ensure only authorized access points authenticate, the Cisco WLC must be able to force the EAP with LSC authentication.

The table shows the different forms of LSC authentication.

Table 6: MAP Authentication Methods

| Operation                            | MAC Filter             | LSC Only Authentication          |
|--------------------------------------|------------------------|----------------------------------|
| LSC-Only MAP Authentication enabled  | disabled               | enabled                          |
| LSC-Only MAP Authentication disabled | enabled                | disabled                         |
| Security mode: EAP & PSK             | EAP or PSK can be used | Only EAP with LSC should be used |
| Certificates: MIC & LSC              | MIC or LSC can be used | Only EAP with LSC should be used |

WLC includes the wildcard MAC address in mac filter list and allows all APs to join the WLC. MAC authorization is disabled automatically. EAP security mode provides valid security with LSC. During EAP-FAST, the AP gets authenticated using LSC and gets the MSK key from WLC. Any rogue APs are filtered out. Using these keys message handshake happens and the PTK key is generated. The Mesh AP joins the WLC using LSC only.

The PSK security mode leads to security threat. As the MSK key is hardcoded inside the code of the mesh AP, any AP even a rogue AP can join the WLC. Using these keys, message handshake happens and the PTK

key is generated. The Mesh AP joins the WLC using LSC only. Wildcard with PSK must be used only for the debugging purposes.

### Configuring LSC-Only Authentication for Mesh Access Points (GUI)

Mesh access points must authenticate before associating with the Cisco WLC. It is not feasible to enter every AP MAC address into every Cisco WLC filter list. Service providers have locally significant certificates (LSC), which you can use to bypass MAC authentication and use only LSC.

#### Procedure

- 
- Step 1** Choose **Security > Certificate > LSC** .  
The **Locally Significant Certificates** page is displayed.
  - Step 2** Select the **AP Provisioning** tab.
  - Step 3** Select the **Enable LSC on Controller** check box.
  - Step 4** Select the **General** tab.
  - Step 5** Select the **Enable** check box in the **AP Provisioning** group.
  - Step 6** Choose **Wireless > Mesh**.  
The **Mesh** page is displayed.
  - Step 7** Select or unselect the **LSC Only MAP Authentication** check box.
  - Step 8** Click **Apply**.
  - Step 9** Click **Save Configuration**.
- 

### Configuring LSC-Only Authentication for Mesh Access Points (CLI)

Mesh access points must authenticate before associating with the Cisco WLC. It is not feasible to enter every AP MAC address into every Cisco WLC filter list. Service providers have locally significant certificates (LSC), which you can use to bypass MAC authentication and use only LSC.

#### Procedure

- Configure LSC-only authentication for mesh access points by entering this command:  
**config mesh security lsc-only-auth {enable | disable}**

### LSC-Related Commands

The following commands are related to LSCs:

- **config certificate lsc {enable | disable}**
  - **enable**—To enable an LSC on the system.
  - **disable**—To disable an LSC on the system. Use this keyword to remove the LSC device certificate and send a message to an AP, to do the same and disable an LSC, so that subsequent joins could be made using the MIC/SSC. The removal of the LSC CA cert on the WLC should be done explicitly by using the CLI to accommodate any AP that has not transitioned back to the MIC/SSC.

- **config certificate lsc ca-server url-path** *ip-address*

Following is the example of the URL when using Microsoft 2003 server:

```
http:<ip address of CA>/sertsrv/mscep/mscep.dll
```

This command configures the URL to the CA server for getting the certificates. The URL contains either the domain name or the IP address, port number (typically=80), and the CGI-PATH.

```
http://ipaddr:port/cgi-path
```

Only one CA server is allowed to be configured. The CA server has to be configured to provision an LSC.

- **config certificate lsc ca-server delete**

This command deletes the CA server configured on the controller.

- **config certificate lsc ca-cert** {add | delete}

This command adds or deletes the LSC CA certificate into/from the controller's CA certificate database as follows:

- **add**—Queries the configured CA server for a CA certificate using the SSCEP getca operation, and gets into the WLC and installs it permanently into the WLC database. If installed, this CA certificate is used to validate the incoming LSC device certificate from the AP.
- **delete**—Deletes the LSC CA certificate from the WLC database.

- **config certificate lsc subject-params** *Country State City Orgn Dept Email*

This command configures the parameters for the device certificate that will be created and installed on the controller and the AP.

All of these strings have 64 bytes, except for the Country that has a maximum of 3 bytes. The Common Name is automatically generated using its Ethernet MAC address. This should be given prior to the creation of the controller device certificate request.

The above parameters are sent as an LWAPP payload to the AP, so that the AP can use these parameters to generate the certReq. The CN is automatically generated on the AP using the current MIC/SSC "Cxxxx-MacAddr" format, where xxxx is the product number.

- **config certificate lsc other-params** *keysize*

The default keysize value is 2048 bits.

- **config certificate lsc ap-provision** {enable | disable}

This command enables or disables the provisioning of the LSCs on the APs if the APs just joined using the SSC/MIC. If enabled, all APs that join and do not have the LSC will get provisioned.

If disabled, no more automatic provisioning will be done. This command does not affect the APs, which already have LSCs in them.

- **config certificate lsc ra-cert** {add | delete}

We recommend this command when the CA server is a Cisco IOS CA server. The controller can use the RA to encrypt the certificate requests and make communication more secure. RA certificates are not currently supported by other external CA servers, such as MSFT.

- **add**—Queries the configured CA server for an RA certificate using the SCEP operation and installs it into the controller database. This keyword is used to get the certReq signed by the CA.
- **delete**—Deletes the LSC RA certificate from the WLC database.

- **config auth-list ap-policy lsc {enable | disable}**

After getting the LSC, an AP tries to join the controller. Before the AP tries to join the controller, you must mandatorily enter this command on the controller console. By default, the **config auth-list ap-policy lsc** command is in the disabled state, and the APs are not allowed to join the controller using the LSC.

- **config auth-list ap-policy mic {enable | disable}**

After getting the MIC, an AP tries to join the controller. Before the AP tries to join the controller, you must mandatorily enter this command on the controller console. By default, the **config auth-list ap-policy mic** command is in the enabled state. If an AP cannot join because of the enabled state, this log message on the controller side is displayed: LSC/MIC AP is not allowed to join.

- **show certificate lsc summary**

This command displays the LSC certificates installed on the WLC. It would be the CA certificate, device certificate, and optionally, an RA certificate if the RA certificate has also been installed. It also indicates if an LSC is enabled or not.

- **show certificate lsc ap-provision**

This command displays the status of the provisioning of the AP, whether it is enabled or disabled, and whether a provision list is present or not.

- **show certificate lsc ap-provision details**

This command displays the list of MAC addresses present in the AP provisioning lists.

## Controller GUI Security Settings

Although the settings are not directly related to the feature, it might help you in achieving the desired behavior with respect to APs provisioned with an LSC.

- Case 1—Local MAC Authorization and Local EAP Authentication

Add the MAC address of RAP/MAP to the controller MAC filter list.

Example:

```
(Cisco Controller) > config macfilter mac-delimiter colon
(Cisco Controller) > config macfilter add 00:0b:85:60:92:30 0 management
```

- Case 2—External MAC Authorization and Local EAP authentication

Enter the following command on the WLC:

```
(Cisco Controller) > config mesh security rad-mac-filter enable
```

or

Check only the external MAC filter authorization on the GUI page and follow these guidelines:



- Do not add the MAC address of the RAP/MAP to the controller MAC filter list.
- Configure the external radius server details on the WLC.
- Enter the **config macfilter mac-delimiter colon** command configuration on the WLC.
- Add the MAC address of the RAP/MAP in the external radius server in the following format:  
User name: 11:22:33:44:55:66 Password : 11:22:33:44:55:66

## Deployment Guidelines

- When using local authorization, the controller should be installed with the vendor's CA and device certificate.
- When using an external AAA server, the controller should be installed with the vendor's CA and device certificate.
- Mesh security should be configured to use 'vendor' as the cert-issuer.
- MAPs cannot move from an LSC to an MIC when they fall back to a backup controller.

The **config mesh lsc {enable | disable}** command is required to enable or disable an LSC for mesh APs. This command causes all the mesh APs to reboot.

## Configuring Antenna Band Mode

### Information About Configuring Antenna Band Modes

You can configure the antenna band modes for mesh access points as either of the following:

- Dual Antenna Band Mode—The bottom two ports, port 1 and port 2, are used for dual band 2.4-GHz and 5-GHz dual radiating element (DRE) antennas.
- Single Antenna Band Mode—The top two ports, port 3 and port 4, are used for 5-GHz single radiating element (SRE) antennas and the bottom two ports, port 1 and port 2, are used for 2.4-GHz SRE antennas.

#### Restrictions for Configuring Antenna Band Modes

The antenna band mode configuration is available on the Cisco Aironet 1532E and 1572EC/EAC access point models.



---

**Note** The Cisco Aironet 1532I access point model has internal antenna and does not require additional antennas.

---

## Configuring Antenna Band Mode (CLI)

### Before you begin

Ensure that the physical antennas are correctly configured before changing the antenna band mode. If the antenna band mode is incorrectly configured, the mesh AP could be stranded.

**Procedure**

- Configure antenna band mode for a mesh AP by entering this command on the Cisco WLC CLI:  
`config ap antenna-band-mode {single | dual} mesh-ap-name`
- View the status of the antenna band mode by entering this command:  
`show ap config general mesh-ap-name`

**Configuring Antenna Band Mode (AP CLI)****Procedure**

- Configure antenna band mode on the mesh AP CLI by entering this command on the AP console:  
`capwap ap ant-band-mode {dual | single}`

## Configuring Daisy Chaining on Cisco Aironet 1530 Series Access Points

### Information About Daisy Chaining the Cisco Aironet 1530 Series Access Points

The Cisco Aironet 1530 Series Access Points have the capability to "daisy chain" access points when they function as mesh APs (MAPs). The "daisy chained" MAPs can either operate the access points as a serial backhaul, allowing different channels for uplink and downlink access thus improving backhaul bandwidth, or extend universal access. Extending universal access allows you to connect a local mode or FlexConnect mode Cisco AP1530 to the Ethernet port of a MAP, thus extending the network to provide better client access.

Daisy chained access points must be cabled differently depending on how the APs are powered. If the access point is powered using DC power, an Ethernet cable must be connected directly from the LAN port of the primary AP to the PoE in port of the subordinate AP.

**Figure 23: Daisy Chained APs using DC Power**

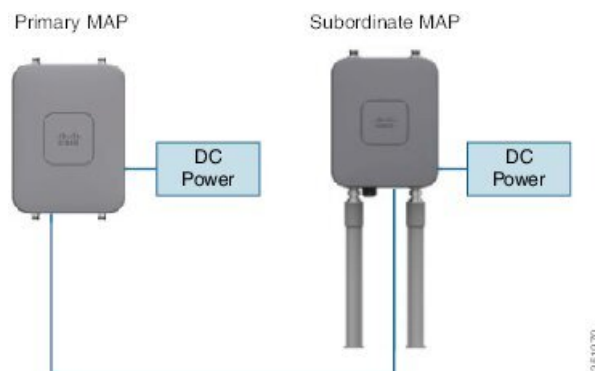

If the access point is powered using PoE, an Ethernet cable must be connected from the LAN port of the primary AP into the PoE Injector, which powers the subordinate AP.

Figure 24: Daisy Chained APs using PoE Injector

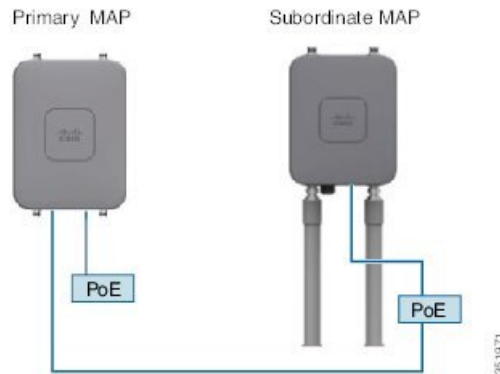

### Daisy Chaining with the 1572

One of the key features of the 1572 access point (AP) is the ability to “daisy chain” APs while they are operating as Mesh APs (MAPs). By “daisy chaining” MAPs, customers can either operate the APs as a serial backhaul, allowing different channels for uplink and downlink access thus improving backhaul bandwidth, or to extend universal access. Extending universal access allows a customer to connect a local mode or flexconnect mode 1572 AP to the Ethernet port of a MAP, thus extending the network to provide better client access. These features are explained in detail in the following sections.

In the 8.0MR release, when the 1572 is configured as a primary AP, the following APs are supported as subordinate APs:

- 1572EAC
- 1572EC
- 1572IC
- 1552
- 1532E/I
- 3700P

Daisy-chained access points need to be cabled differently depending on the AP type of their terminating subordinate AP.

If both the primary AP and subordinate APs are 1572s, there should be an Ethernet cable from the primary AP’s Ethernet port to the subordinate AP’s Ethernet port. Daisy chaining should be enabled on both APs.



#### Caution

We recommend that you connect Ethernet Bridged wired clients or Daisy-chained APs to either the Ethernet port or PoE-Out port only. Ethernet Bridged wired clients should never be connected to PoE-in port.

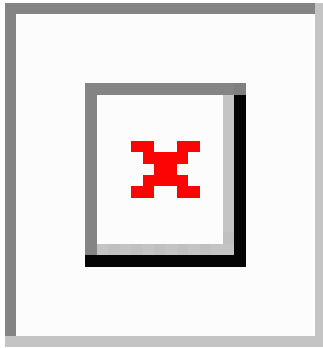

If the primary AP is a 1570 and the subordinate AP is a 1532 or 3700P, the Ethernet cable connects the PoE-Out port of the primary AP to the PoE-In port of the subordinate AP.

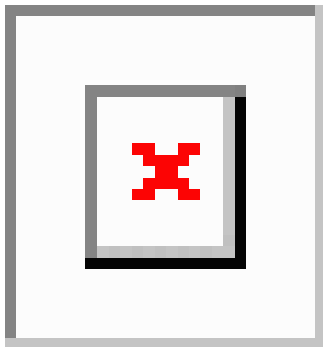

If the primary AP is a 1570 and the subordinate AP is a 1520 or 1550, the Ethernet cable connects the 1572's Ethernet port to any Ethernet port on the 1552.

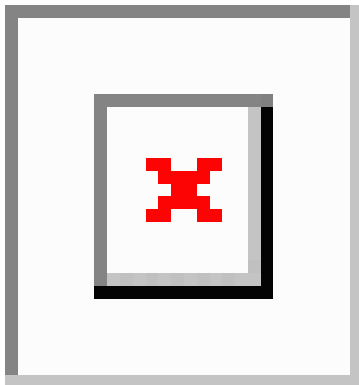

### Serial Backhaul on the Cisco Aironet 1530/1572 Series Access Points

Daisy chaining on the Cisco Aironet Access Points can be used to provide a serial-backhaul mesh. MAP1a is the primary MAP and has a preferred parent selected as the RAP. MAP1b is the subordinate MAP and has no preferred parent selected. MAP1b is configured in "Bridge" AP mode with "RootAP" role. Daisy chaining is enabled for MAP1b. MAP2 has preferred parent selected as MAP1b.

**Figure 25: Daisy Chaining with Serial-Backhaul Mesh**

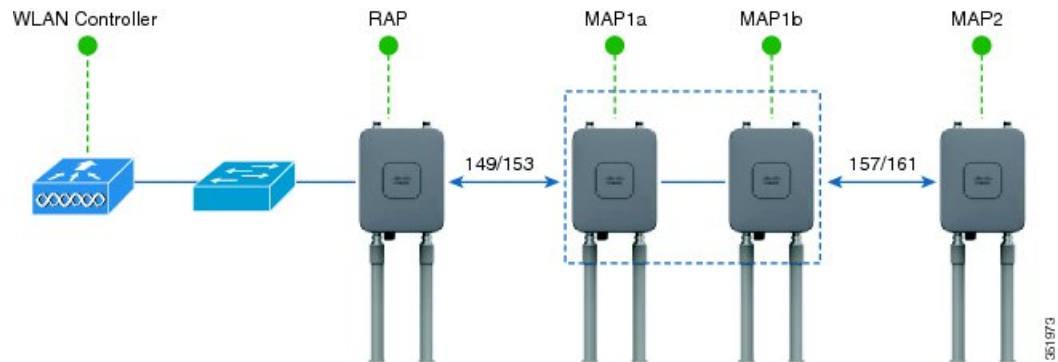

High gain directional antenna must be used in typical serial-backhaul deployments. Additionally, preferred parent configurations must be used to create serial-backhaul mesh networks.

The child AP selects the preferred parent based on the following conditions:

- Preferred parent is the best parent.
- Preferred parent has a link SNR of at least 20 dB.
- Preferred parent has a link SNR in the range 12 dB and 20 dB, but no other parent is significantly better (SNR of more than 20 percent is better). For SNR that is lower than 12 dB, the configuration is ignored.
- Preferred parent is not in a blocked list.
- Preferred parent is not in silent mode because of dynamic frequency selection (DFS).
- Preferred parent is in the same bridge group name (BGN). If the configured preferred parent is not in the same BGN and no other parent is available, the child will associate with the parent AP using the default BGN.

### Extended Universal Access

Daisy chaining on the Cisco Aironet 1530 Series Access Points can be used to extend Universal Access across a mesh network. In this example MAP1a is the primary MAP, it is backhauled wirelessly with the RAP. MAP1b, the subordinate MAP is operating in local/Flex-connect mode and is providing client access on both the 2.4GHz and 5GHz radio.

Figure 26: Daisy Chaining to Extend Universal Access

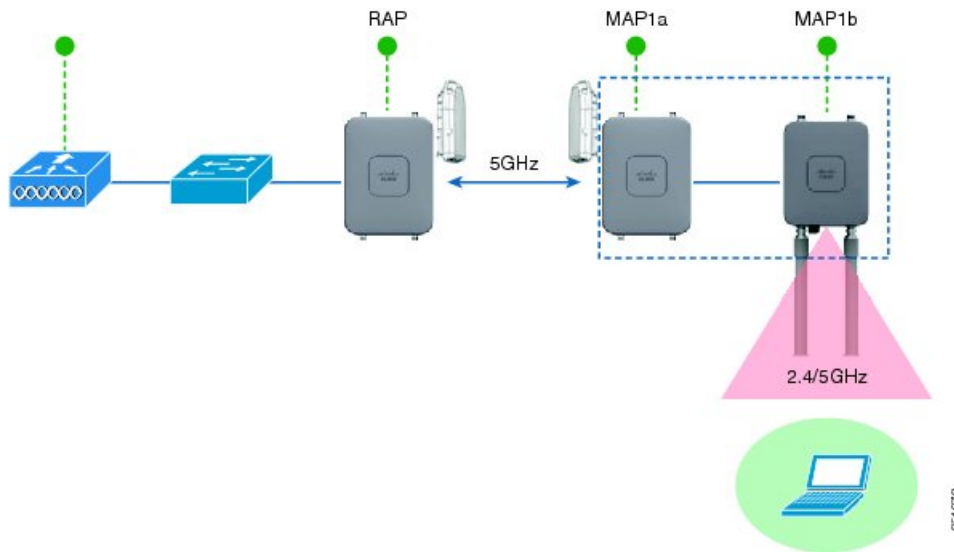

### Important Points to Note When Configuring Daisy Chaining the Cisco Aironet 1530/1570 Series Access Points

- Only Mesh Access Points (MAPs) can operate as a daisy chained APs.
- The uplink daisy-chained AP is considered the primary AP; the connected AP is considered as the subordinate AP.
- The connecting Ethernet cable must go from the LAN port of the primary AP to the PoE in port of the subordinate AP.
- There must be a preferred parent set for each daisy-chained mesh hop; the primary MAP should have a preferred parent.
- Daisy chaining must be enabled on the subordinate AP in the Bridge mode through Cisco WLC GUI or CLI or on the AP console.
- Directional antennas must be used when you create a daisy chain; the antennas must be used to guide the mesh tree formation to suit your needs.
- Directional antenna must have a physical separation of 3 meters.
- Ethernet bridging must be enabled on all the APs in the Bridge mode.

## Configuring Daisy Chaining (CLI)

### Procedure

- Configure daisy chaining by entering this command:  
**config ap daisy-chaining {enable | disable} cisco-mesh-ap**
- Configure the preferred parent for each serial-backhaul AP by entering this command:  
**config mesh parent preferred cisco-ap parent-mac-address**
- View the status of daisy chaining and the preferred parent that is configured by entering this command:

```
show ap config general cisco-ap
```

## Configuring Daisy Chaining (AP CLI)

### Procedure

- Configure daisy chaining on the AP by entering this command on the AP console:  
**capwap ap daisy-chaining {enable | disable}**

## Configuring a Daisy-Chain

There are a few key components to address when configuring a daisy-chaining deployment:

- Only Mesh Access Points (MAPs) can operate as a daisy chained AP.
- The uplink daisy-chained AP is considered the primary AP, and the connected AP is considered the subordinate AP.
- There must be a preferred parent set for each daisy-chained mesh hop. The primary MAP should have a preferred parent.
- Daisy-chaining must be enabled on the AP, either via WLC GUI, WLC CLI, or AP CLI.
- Directional antennas should be used when creating a daisy-chain, which guides the mesh tree formation to the customer needs.

### Enabling Daisy-Chaining using the WLC GUI

To enable Daisy-Chaining from the controller GUI, go to **Wireless > Access Point > (AP\_NAME) > Mesh**, and then check the **Daisy-Chaining** check box. If the AP is used in a serial-backhaul solution, a **Preferred Parent** must be selected.



---

**Note** Daisy-chaining should only be enabled on the subordinate RAP. The primary MAP should have daisy-chaining as disabled.

---

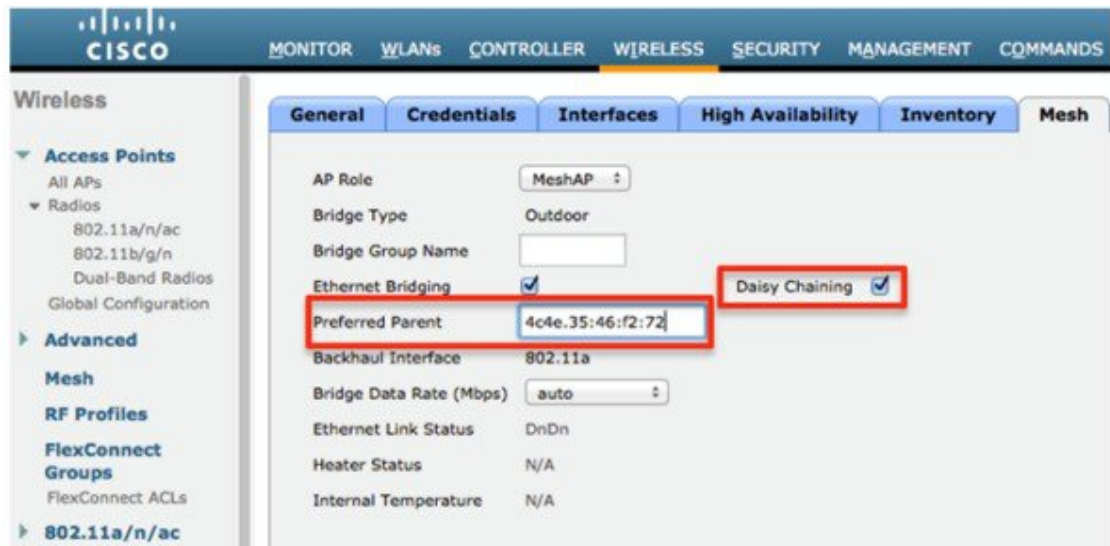

### Enabling Daisy-Chaining using the WLC CLI

To enable Daisy-Chaining from the WLC CLI, issue the command:

```
(Cisco Controller) >config ap daisy-chaining [enable/disable] <ap_name>
```

The daisy chaining feature must be enabled on a per access point basis:

```
(Cisco Controller) >show ap config general <ap_name>
```

Then scroll down the Daisy Chaining entry

```
Daisy Chaining Disabled
```

### Enabling Daisy-Chaining using the AP CLI

To enable Daisy-Chaining from the AP CLI, issue the command:

```
AP#capwap ap daisy-chaining <enable/disable>
```

### Setting a Preferred Parent for each Serial-Backhaul AP

To set up a preferred parent for each serial-backhaul AP, issue the command:

```
(Cisco Controller) >config mesh parent preferred <ap_name> <PARENT_MAC_ADDRESS>
```

An access point's preferred parent can be seen by issuing:

```
Cisco Controller) >show ap config general <ap_name>
```

Then scroll down the Mesh preferred parent entry

```
Mesh preferred parent 00:24:13:0f:92:00
```



**Note** For more details, see this [page](#).



# Configuring Mesh Convergence

## Information About Mesh Convergence

Using Cisco WLC, you can configure mesh convergence methods per mesh AP (MAP) or for all mesh APs. This enables you to choose the convergence methods based on deployment without affecting the existing convergence mechanism. The default setting is the existing convergence mechanism.

| Mesh Convergence | Parent Loss Detection / Keep Alive Timers | Channel Scan / Seek            | DHCP / CAPWAP Information |
|------------------|-------------------------------------------|--------------------------------|---------------------------|
| Standard         | 21 / 3 seconds                            | Scan/Seek all 5-GHz channels   | Renew/Restart CAPWAP      |
| Fast             | 7 / 3 seconds                             | Scan/Seek only preset channels | Maintain DHCP and CAPWAP  |
| Very Fast        | 4 / 1.5 seconds                           | Scan/Seek only preset channels | Maintain DHCP and CAPWAP  |

## Restrictions on Mesh Convergence

In Cisco Wave 2 APs, the convergence settings are as follows:

**Table 7: Frequency to Seek Parent**

| Convergence Setting | Frequency to Seek Parent |
|---------------------|--------------------------|
| Very Fast           | Every 500 milliseconds   |
| Fast                | Every 750 milliseconds   |
| Standard            | Every 1 second           |

The frequency to seek neighbors for all convergence settings is 15 seconds.

If the AP fails to respond 8 times, the parent or the neighbor is assumed lost.

**Table 8: Total Time Taken to Calculate Parent Loss**

| Convergence Setting | Total Time Taken |
|---------------------|------------------|
| Very Fast           | 4 seconds        |
| Fast                | 6 seconds        |
| Standard            | 8 seconds        |

The neighbor (non-parent), loss time is 2 minutes.

In fast and very fast convergence, a subset channel seek is performed. The AP maintains a list of channels supported by neighboring parents and directly seeks those channels than going for a channel scan. For standard convergence, a channel scan is performed when the parent is lost.

## Configuring Mesh Convergence (CLI)

### Procedure

- Configure mesh convergence on the Cisco WLC CLI by entering this command:  
**config mesh convergence {fast | standard | very-fast} all**



---

**Note** The **all** keyword denotes all MAP nodes.

---

- Mesh convergence commands on the AP console:
  - To see the current subset list of channels:  
**show mesh convergence**
  - To debug mesh convergence:  
**debug mesh convergence**
  - To set convergence method at the AP:  
**test mesh convergence {fast | standard | very\_fast}**

## Switching Between LWAPP and Autonomous Images (AP CLI)

By default, the Cisco AP1532 and AP1572 are set to unified mode.

### Procedure

- Switch the access point from LWAPP mode to autonomous mode (aIOS) by entering this command on the AP console:  
**capwap ap autonomous**



---

**Note** This command should be used only once, during initial priming of the access point. For information about switching back from autonomous mode to LWAPP mode, see <https://supportforums.cisco.com/docs/DOC-14960>.

---

## Configuring Mesh Leaf Node

Access points within a mesh network operate in one of the following two ways:

1. Root access point (RAP)
2. Mesh access point (MAP)

While the RAPs have wired connections to their controller (WLC), the MAPs have wireless connections to their controller. MAPs communicate among themselves and back to the RAP using wireless connections over

the 802.11a/n/g radio backhaul. MAPs use the Cisco Adaptive Wireless Path Protocol (AWPP) to determine the best path through the other mesh access points to the controller.

Relationships among mesh access points are as a parent, child, or neighbor.

- A parent access point offers the best route back to the RAP. A parent can be either the RAP itself or another MAP.
- A child access point selects the parent access point as its best route back to the RAP.
- A neighbor access point is within RF range of another access point but is not selected as its parent or a child.

You can configure the MAP with lower performance to work only as a leaf node. When the mesh network is formed and converged, the leaf node can only work as a child MAP, and cannot be selected by other MAPs as a parent MAP, so that the wireless backhaul performance will not be downgraded.



**Note** The mesh leaf node feature is supported only for the IR829 AP803 and the IW3700 Series access points.

Use the following command to configure an MAP as a leaf node:

```
(Cisco Controller) >config mesh block-child <ap_name> {enable|disable}

enable Enable blocking child for an MAP
disable Disable blocking child for an MAP
```

Use the following commands to display the details of the leaf node configuration:

```
(Cisco Controller) >show mesh block-child {summary|<ap_name>}
```

### Examples

```
(Cisco Controller) >show mesh block-child summary
```

| AP Name | AP Model          | BVI MAC Hop         | Bridge Group Name | Block Child Set |
|---------|-------------------|---------------------|-------------------|-----------------|
| AP3     | AIR-CAP3602I-C-K9 | 4c:00:82:07:64:6b 1 | mesh              | True            |

Number of Mesh APs Block Child Set..... 1

```
(Cisco Controller) >show mesh block-child AP3
```

| AP Name | AP Model          | BVI MAC Hop         | Bridge Group Name | Block Child Set |
|---------|-------------------|---------------------|-------------------|-----------------|
| AP3     | AIR-CAP3602I-C-K9 | 4c:00:82:07:64:6b 1 | mesh              | True            |

