



Services Ready Medium Branch Network System Assurance Guide

Version 2

Americas Headquarters

Cisco Systems, Inc.
170 West Tasman Drive
San Jose, CA 95134-1706
USA
<http://www.cisco.com>
Tel: 408 526-4000
800 553-NETS (6387)
Fax: 408 527-0883

Cisco Validated Design

The Cisco Validated Design Program consists of systems and solutions designed, tested, and documented to facilitate faster, more reliable, and more predictable customer deployments. For more information visit [www.cisco.com/go/validated designs](http://www.cisco.com/go/validated_designs).

THE SPECIFICATIONS AND INFORMATION REGARDING THE PRODUCTS IN THIS MANUAL ARE SUBJECT TO CHANGE WITHOUT NOTICE. ALL STATEMENTS, INFORMATION, AND RECOMMENDATIONS IN THIS MANUAL ARE BELIEVED TO BE ACCURATE BUT ARE PRESENTED WITHOUT WARRANTY OF ANY KIND, EXPRESS OR IMPLIED. USERS MUST TAKE FULL RESPONSIBILITY FOR THEIR APPLICATION OF ANY PRODUCTS.

THE SOFTWARE LICENSE AND LIMITED WARRANTY FOR THE ACCOMPANYING PRODUCT ARE SET FORTH IN THE INFORMATION PACKET THAT SHIPPED WITH THE PRODUCT AND ARE INCORPORATED HEREIN BY THIS REFERENCE. IF YOU ARE UNABLE TO LOCATE THE SOFTWARE LICENSE OR LIMITED WARRANTY, CONTACT YOUR CISCO REPRESENTATIVE FOR A COPY.

The Cisco implementation of TCP header compression is an adaptation of a program developed by the University of California, Berkeley (UCB) as part of UCB's public domain version of the UNIX operating system. All rights reserved. Copyright © 1981, Regents of the University of California.

NOTWITHSTANDING ANY OTHER WARRANTY HEREIN, ALL DOCUMENT FILES AND SOFTWARE OF THESE SUPPLIERS ARE PROVIDED "AS IS" WITH ALL FAULTS. CISCO AND THE ABOVE-NAMED SUPPLIERS DISCLAIM ALL WARRANTIES, EXPRESSED OR IMPLIED, INCLUDING, WITHOUT LIMITATION, THOSE OF MERCHANTABILITY, FITNESS FOR A PARTICULAR PURPOSE AND NONINFRINGEMENT OR ARISING FROM A COURSE OF DEALING, USAGE, OR TRADE PRACTICE.

IN NO EVENT SHALL CISCO OR ITS SUPPLIERS BE LIABLE FOR ANY INDIRECT, SPECIAL, CONSEQUENTIAL, OR INCIDENTAL DAMAGES, INCLUDING, WITHOUT LIMITATION, LOST PROFITS OR LOSS OR DAMAGE TO DATA ARISING OUT OF THE USE OR INABILITY TO USE THIS MANUAL, EVEN IF CISCO OR ITS SUPPLIERS HAVE BEEN ADVISED OF THE POSSIBILITY OF SUCH DAMAGES.

CCDE, CCENT, CCSI, Cisco Eos, Cisco HealthPresence, Cisco IronPort, the Cisco logo, Cisco Nurse Connect, Cisco Pulse, Cisco SensorBase, Cisco StackPower, Cisco StadiumVision, Cisco TelePresence, Cisco Unified Computing System, Cisco WebEx, DCE, Flip Channels, Flip for Good, Flip Mino, Flipshare (Design), Flip Ultra, Flip Video, Flip Video (Design), Instant Broadband, and Welcome to the Human Network are trademarks; Changing the Way We Work, Live, Play, and Learn, Cisco Capital, Cisco Capital (Design), Cisco:Financed (Stylized), Cisco Store, Flip Gift Card, and One Million Acts of Green are service marks; and Access Registrar, Aironet, AllTouch, AsyncOS, Bringing the Meeting To You, Catalyst, CCDA, CCDP, CCIE, CCIP, CCNA, CCNP, CCSP, CCVP, Cisco, the Cisco Certified Internetwork Expert logo, Cisco IOS, Cisco Lumin, Cisco Nexus, Cisco Press, Cisco Systems, Cisco Systems Capital, the Cisco Systems logo, Cisco Unity, Collaboration Without Limitation, Continuum, EtherFast, EtherSwitch, Event Center, Explorer, Follow Me Browsing, GainMaker, iLYNX, IOS, iPhone, IronPort, the IronPort logo, Laser Link, LightStream, Linksys, MeetingPlace, MeetingPlace Chime Sound, MGX, Networkers, Networking Academy, PCNow, PIX, PowerKEY, PowerPanels, PowerTV, PowerTV (Design), PowerVu, Prisma, ProConnect, ROSA, SenderBase, SMARTnet, Spectrum Expert, StackWise, WebEx, and the WebEx logo are registered trademarks of Cisco Systems, Inc. and/or its affiliates in the United States and certain other countries.

All other trademarks mentioned in this document or website are the property of their respective owners. The use of the word partner does not imply a partnership relationship between Cisco and any other company. (0910R)

Any Internet Protocol (IP) addresses and phone numbers used in this document are not intended to be actual addresses and phone numbers. Any examples, command display output, network topology diagrams, and other figures included in the document are shown for illustrative purposes only. Any use of actual IP addresses or phone numbers in illustrative content is unintentional and coincidental.

Services Ready Medium Branch Network System Assurance Guide

© 2009 Cisco Systems, Inc. All rights reserved.

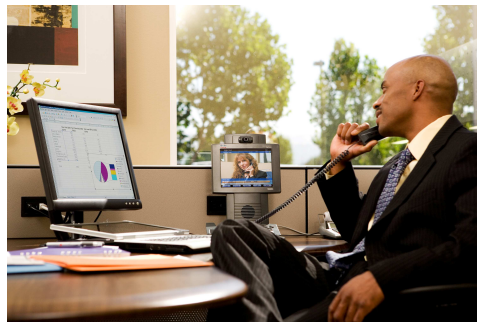

CONTENTS

Preface xi

Services Ready Medium Branch Network Overview 1-1

Contents	1-1
Introduction	1-1
Medium Branch Design Considerations	1-4
System Design	1-7
Topology	1-11
Cisco Platforms and Versions Evaluated	1-12
References and Recommended Reading	1-13

Features and Services 2-1

Contents	2-1
Branch Network Components	2-1
Selecting Network Components	2-3
WAN Services	2-9
Selecting WAN Service	2-11
Leased-line Deployment	2-16
Frame Relay Service Deployment	2-18
L3VPN Service Deployment	2-19
VPWS Services	2-21
MPLS Switched WAN Services	2-21
Ethernet Switched WAN Services	2-22
LAN Deployment Model	2-23
Virtual LANs	2-27
VLAN Trunks and VLAN Trunking Protocol	2-29
Power-over-Ethernet	2-31
Spanning Tree Protocol	2-31
EtherChannel Link Aggregation	2-31
Network Fundamentals	2-32
Path Redundancy, Rapid Recovery, and Disaster Recovery	2-32
Backup WAN Link	2-34
Backup LAN Links	2-37

IP Addressing and IP Routing	2-37
Routing Protocols	2-39
Multicast	2-40
DHCP	2-41
NAT and PAT	2-41
Quality of Service	2-41
Classification and Marking	2-46
Policing and Markdown	2-47
Scheduling	2-47
Shaping	2-48
Scavenger Class QoS	2-48
Security Services	2-48
Infrastructure Protection	2-49
Access Control	2-51
Authentication	2-52
Authorization	2-53
Accounting	2-53
Secure Connectivity	2-53
Threat Protection, Detection, and Mitigation	2-60
Management Services	2-63
Cisco Configuration Professional	2-65
Simple Network Management Protocol	2-65
Syslog	2-66
NetFlow	2-66
Network Based Application Recognition	2-67
IP Service Level Agreement	2-67
Network Time Protocol	2-67
Cisco Configuration Engine	2-67
Voice Services	2-69
Voice Quality Considerations	2-70
WAN Capacity Considerations	2-72
IP Telephony	2-75
Centralized Call Control	2-76
Local Call Control	2-77
Selecting a Call Control Model	2-78
IP Phones	2-79
Voice Gateway	2-79
Call Admission Control	2-83
Conferencing and Transcoding	2-85

Music on Hold	2-86
Dial Plan	2-86
Voice Mail and Auto Attendant Services	2-87
Traditional Telephony	2-87
Analog Device Connectivity	2-87
Emergency Services	2-88
Optimization Services	2-88
Selecting a Cisco WAE Module	2-91
Cisco WAAS General Design Considerations	2-92
Cisco WAAS High-Availability and Rapid Recovery Considerations	2-93
Cisco WAAS Security Considerations	2-93
Cisco WAAS Management Considerations	2-94
System Implementation	3-1
Contents	3-1
Network Topology	3-1
WAN Services Implementation	3-4
Single-Port DS-3 Interface with Frame Relay Encapsulation	3-4
Verification of Single-Port DS-3 Interface with Frame Relay Encapsulation	3-5
Single-Port DS-3 Interface with Point-to-Point Encapsulation	3-5
Multiport DS-1 Interface with Multilink Point-to-Point Encapsulation	3-6
Verification of Multiport DS-1 Interface with Multilink PPP Encapsulation	3-7
Multiport DS-1 Interface with Multilink Frame Relay Encapsulation	3-8
Onboard Gigabit Ethernet Interface	3-9
LAN Services Implementation	3-10
Edge Layer	3-10
Data VLAN	3-11
Voice VLAN	3-11
DMZ VLAN	3-12
Management VLAN	3-12
Distribution Layer	3-12
Configuring EtherSwitch Service Module	3-13
VLAN Trunking Protocol Implementation	3-13
VLAN Implementation	3-14
Spanning Tree Implementation	3-15
Uplink to Router Implementation	3-15
EtherChannel Implementation	3-15
DOT1X Services	3-17
Access Layer	3-18
VTP Implementation	3-19

Spanning Tree Implementation	3-19
EtherChannel Implementation	3-19
VLAN Implementation	3-20
DOT1X Services	3-20
QoS Implementation	3-21
Assigning QoS to Switch Port	3-24
Network Fundamental Services Implementation	3-25
Path Redundancy	3-25
Redundant WAN Link	3-25
IP Addressing and IP Routing	3-27
Routing Protocol Implementation	3-27
Multicast Implementation	3-34
DHCP Implementation	3-35
NAT Implementation	3-35
Quality of Service Implementation	3-36
Security Services Implementation	3-43
Infrastructure Protection Implementation	3-43
Securing Unused Ports	3-44
Turning Off Unused Services	3-44
Routing Protocol Security	3-50
Additional Services Measures	3-51
Access Control Implementation	3-51
Password Management	3-51
Secure Connectivity Implementation	3-52
GETVPN Key Server	3-53
DMVPN Implementation	3-54
SSL VPN Implementation	3-56
Threat Defense Detection and Mitigation Implementation	3-58
Zone-based Policy Firewall Implementation	3-59
Cisco IOS IPS Implementation	3-71
Access Control List Implementation	3-72
uRPF Implementation	3-72
Layer 2 Security	3-72
Port Security Implementation	3-72
Dynamic ARP Inspection Implementation	3-73
IP Source Guard Implementation	3-75
DHCP Snooping Implementation	3-75
BPDU Guard Implementation	3-76
Management Services Implementation	3-76
NetFlow Implementation	3-76

SNMP Implementation	3-77
NTP Implementation	3-78
IP SLA Implementation	3-79
Syslog Implementation	3-80
Cisco Configuration Professional Implementation	3-80
Cisco Configuration Engine Implementation	3-85
Voice Services Implementation	3-91
PRI-Trunk and FXS Port Implementation	3-92
Cisco Unified CME with SCCP Endpoints Implementation	3-93
Cisco Unified CME with SCCP Endpoints: Telephony Service Setup	3-93
Cisco Unified CME with SCCP Endpoints: IP Phone Installation and Configuration	3-95
Cisco Unified CME with SCCP Endpoints: H.323 Voice Gateway Implementation	3-97
Cisco Unified CME with SCCP Endpoints: Dial Plan Implementation	3-97
Cisco Unified CME with SCCP Endpoints: CAC Implementation	3-98
Cisco Unified CME with SCCP Endpoints: Transcoding and Conferencing Implementation	3-98
Cisco Unified CME with SCCP Endpoints: Music on Hold Implementation	3-100
Cisco Unified CME with SCCP Endpoints: Voice Mail and Auto Attendant Integration	3-100
Cisco Unified CME with SCCP Endpoints: Emergency Services Implementation	3-107
Cisco Unified CME with SCCP Endpoints Verification	3-108
Cisco Unified CME with SIP Endpoints Implementation	3-110
Cisco Unified CME with SIP Endpoints: Telephony Service Setup	3-110
Cisco Unified CME with SIP Endpoints: IP Phone Installation and Configuration	3-111
Cisco Unified CME with SIP Endpoints: SIP Voice Gateway Implementation	3-112
Cisco Unified CME with SIP Endpoints: Dial Plan Implementation	3-112
Cisco Unified CME with SIP Endpoints: CAC Implementation	3-114
Cisco Unified CME with SIP Endpoints: Transcoding Implementation	3-114
Cisco Unified CME with SIP Endpoints: Music on Hold Implementation	3-114
Cisco Unified CME with SIP Endpoints: Voice Mail and Auto Attendant Integration	3-115
Cisco Unified CME with SIP Endpoints: Emergency Services Implementation	3-116
Cisco Unified SRST with SCCP Endpoints Implementation	3-116
Cisco Unified SRST with SCCP Endpoints: Telephony Service Setup	3-117
Cisco Unified SRST with SCCP Endpoints: IP Phone Installation and Configuration	3-118
Cisco Unified SRST with SCCP Endpoints: H.323 Voice Gateway Implementation	3-119
Cisco Unified SRST with SCCP Endpoints: Dial Plan Implementation	3-121
Cisco Unified SRST with SCCP Endpoints: RSVP Implementation	3-123
Cisco Unified SRST with SCCP Endpoints: Transcoding and Conferencing Implementation	3-124
Cisco Unified SRST with SCCP Endpoints: Music on Hold Implementation	3-126
Cisco Unified SRST with SCCP Endpoints: Voice Mail and Auto Attendant Integration	3-126
Cisco Unified SRST with SCCP Endpoints: Emergency Services Implementation	3-127
Cisco Unified SRST with SIP Endpoints Implementation	3-128

Cisco Unified SRST with SIP Endpoints: Telephony Service Setup	3-128
Cisco Unified SRST with SIP Endpoints: Cisco Unified SRST Fallback Mode at the Branch Router	3-130
Cisco Unified SRST with SIP Endpoints: IP Phone Installation and Configuration	3-131
Cisco Unified SRST with SIP Endpoints: SIP Voice Gateway Implementation	3-131
Cisco Unified SRST with SIP Endpoints: Dial Plan Implementation	3-133
Cisco Unified SRST with SIP Endpoints: RSVP Implementation	3-135
Cisco Unified SRST with SIP Endpoints: Transcoding and Conferencing Implementation	3-135
Cisco Unified SRST with SIP Endpoints: Music on Hold Implementation	3-138
Cisco Unified SRST with SIP Endpoints: Voice Mail and Auto Attendant Integration	3-138
Cisco Unified SRST with SIP Endpoints: Emergency Services Implementation	3-139
Optimization Services Implementation	3-140
Cisco WAAS Implementation	3-140
Router and Cisco WAE Module Configuration	3-141
Additional Cisco WAE—Application Accelerator Configuration	3-142
Activating the Application Accelerators	3-143
Cisco WAE—Central Manager Implementation	3-145
Caveats	3-147
Configuration Verification	4-1
Contents	4-1
General Configuration Verification	4-2
QoS Verification	4-3
Routing Verification	4-3
Security Verification	4-4
Voice Verification	4-5
Cisco Unity Express Verification	4-7
Cisco Wide Area Application Services Verification	4-7
Additional Command Reference Documentation	4-9
Troubleshooting	5-1
Contents	5-1
Baseline Troubleshooting Commands	5-1
Voice Troubleshooting Commands	5-2
Cisco WAAS Troubleshooting Commands	5-2
System Testing	6-1
Contents	6-1
Test Result Summary	6-1

Test Setups	6-5
Traffic Profile	6-7
Test Cases	6-7
WAN Connectivity Test Cases	6-9
Network Services Test Cases	6-13
High Availability Test Cases	6-74
Network Management Test Cases	6-88
WAN Optimization Test Cases	6-89
Cisco Unified CME Test Cases	6-93
Cisco Unified SRST Test Cases	6-108
Performance Test Cases	6-124

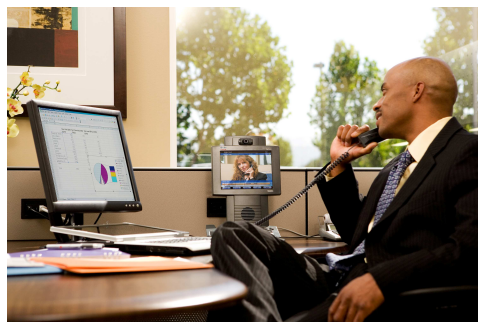

Preface

Revised: November 6, 2009

This guide provides a detailed blueprint for deploying a secure, converged network at a medium enterprise branch. It describes a single branch network design to address common connectivity, security, availability, voice, and application optimization requirements for a branch office of 50 to 100 users. The design has undergone an intensive system assurance test program. The goal of this validated blueprint is to minimize the total cost of ownership (TCO) of a branch office network by accelerating and simplifying its deployment. The focus is on networking services that directly integrate into the branch office router. This guide supplements the general Cisco enterprise branch architecture documents, which can be found at:

http://www.cisco.com/en/US/netsol/ns816/networking_solutions_program_home.html

Obtaining Documentation and Submitting a Service Request

For information on obtaining documentation, submitting a service request, and gathering additional information, see the monthly *What's New in Cisco Product Documentation*, which also lists all new and revised Cisco technical documentation, at:

<http://www.cisco.com/en/US/docs/general/whatsnew/whatsnew.html>

Subscribe to the *What's New in Cisco Product Documentation* as a Really Simple Syndication (RSS) feed and set content to be delivered directly to your desktop using a reader application. The RSS feeds are a free service and Cisco currently supports RSS Version 2.0.

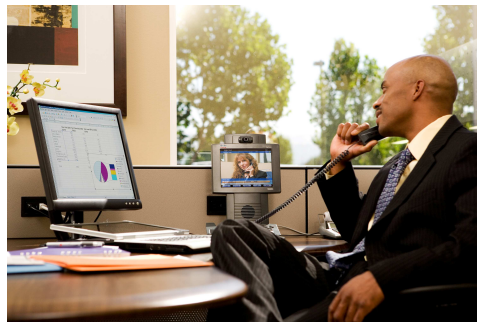

Services Ready Medium Branch Network Overview

Revised: November 6, 2009

This chapter describes the Services Ready Medium Branch Network design and components.

Contents

- [Introduction, page 1](#)
- [Medium Branch Design Considerations, page 4](#)
- [System Design, page 7](#)
- [Topology, page 11](#)
- [Cisco Platforms and Versions Evaluated, page 12](#)
- [References and Recommended Reading, page 13](#)

Introduction

The Services Ready Medium Branch Network enables enterprises with branch offices of 50 to 100 users to deploy high-value network services such as unified communication and application optimization on top of a secure branch network infrastructure that is connected to a campus or data center core (central site) over a variety of WAN technologies. The goal of the Services Ready Medium Branch Network is to make deployment of these services fast, simple, and predictable.

The Services Ready Medium Branch Network is one of the Cisco Integrated Services Networks for the branch office. These networks focus on providing branch office deployment blueprints for connectivity, security, voice, and application optimization services integrated into the branch router. Integrated Services Branch Networks consist of three Services Ready Branch Networks, two Streamlined Branch Networks, and one Basic Branch Network, each corresponding to a different size branch office and branch router platform, as shown in [Figure 1](#).

Figure 2 Common Integrated Services in Enterprise Branch Networks

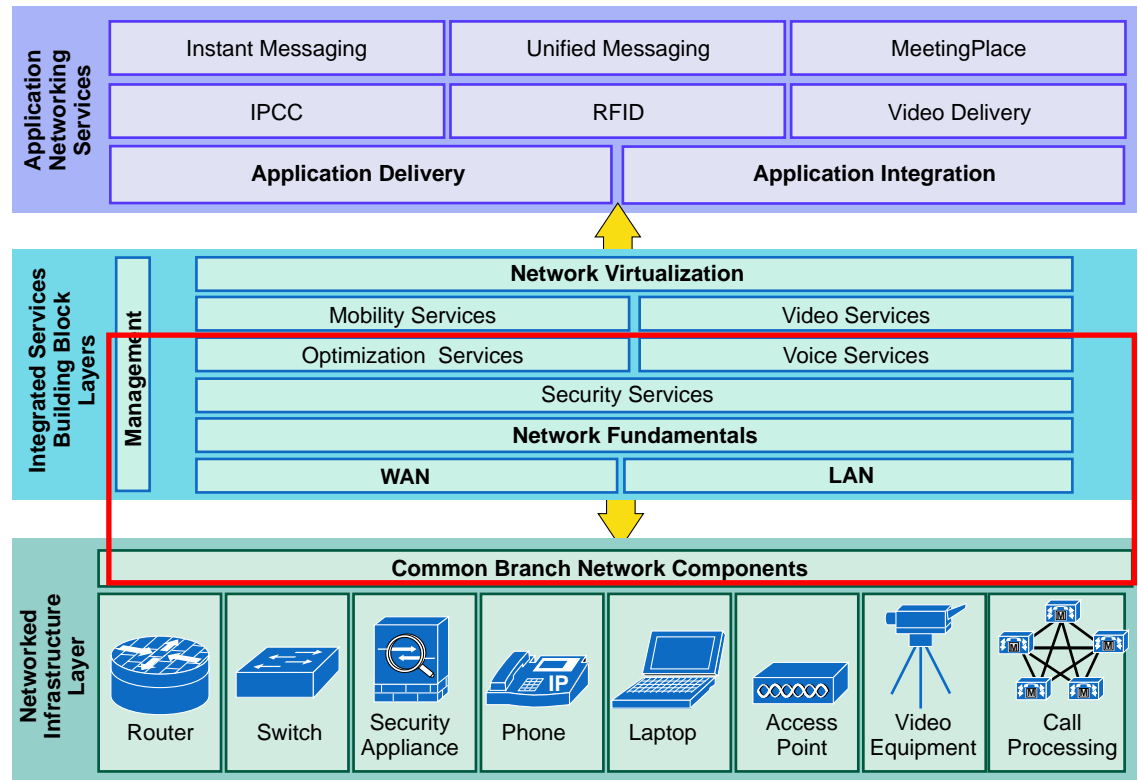

270991

This guide focuses on deployment of the Services Ready Medium Branch Network. It provides design, implementation, and testing guidelines for the following features for a medium branch network:

- WAN services
- LAN services
- Network fundamentals
 - IP routing and addressing
 - Quality of service (QoS)
- Security services
 - Infrastructure protection
 - Access control
 - Secure connectivity
 - Threat prevention, detection, and mitigation
- Network management
- Voice services
 - IP telephony with centralized call control
 - IP telephony with local call control
 - Traditional telephony and fax
- Optimization services

- WAN optimization
- Application optimization

The blueprint begins with a list of design criteria for a secure medium branch office network architected to accommodate additional value-added network services. The [“System Design” section on page 7](#) describes the network topology and network services that address these design criteria. The [“System Implementation”](#) chapter provides a step-by-step implementation of the topology and configuration of each service. Finally, testing methodology for the system is provided along with test cases and test results in the [“System Testing”](#) chapter. The [“References and Recommended Reading” section on page 13](#) lists additional detailed documents on the various technologies used in the Services Ready Medium Branch Network.

For a list of tested platforms, interface cards, modules, and software versions, see the [“Cisco Platforms and Versions Evaluated” section on page 12](#).

Medium Branch Design Considerations

Today most enterprise resources are typically located at the corporate headquarters and accessed from a branch office over a private WAN. However, certain types of applications and services continue to be deployed in the branch office. To support them, a branch network must meet additional requirements beyond basic connectivity. For the medium branch office, these requirements typically include scalability, security, manageability, telephony, and application optimization. The Services Ready Medium Branch Foundation has been designed to meet such requirements. The following are its main design criteria:

- [Branch Network Components, page 4](#)
- [WAN Services, page 5](#)
- [LAN Services, page 5](#)
- [Network Fundamentals, page 5](#)
- [Security Services, page 6](#)
- [Network Management, page 6](#)
- [Voice Services, page 6](#)
- [Optimization Services, page 7](#)

Branch Network Components

- 50 to 100 active users within the branch office
- Multiple integrated network services deployed in the branch router
- Converged data, voice, and video network
- Minimal carbon footprint
- Majority of corporate resources are centrally located
- Telephony that supports the following use cases:
 - Moderate call volume user
 - Heavy call volume user
 - Decision maker
 - Video-conferencing user

- Conference room

WAN Services

- Dedicated bandwidth ranging from 6 to 44 Mb/s to handle data, voice, and video traffic
- Gigabit Ethernet, T3/E3, or multiple T1 dedicated lines to WAN service providers network
- Traditional Layer 2 private WAN with various encapsulation options to guarantee privacy and reliability

or

Layer 3 Multiprotocol Label Switching (MPLS) Virtual Private Network (VPN) for increased flexibility and reduced bandwidth cost

or

Layer 2 Ethernet or MPLS VPN for greater control and simplified connectivity

LAN Services

- Hierarchical network design to simplify deployment, troubleshooting, and management
- Connectivity to branch devices at Fast Ethernet or Gigabit Ethernet speeds
- Near-wire-speed performance between all devices
- Provisions for accommodating future expansion
- Networking device redundancy without traffic loops
- Power-over-Ethernet (PoE)

Network Fundamentals

- High availability, rapid recovery, and disaster recovery
 - Rapid recovery in case of component failure
 - Automatic switchover to backup WAN link that has a minimum one-quarter of the bandwidth of the primary WAN link
 - Ability to restore service within 24 hours in the event of a disaster
- Quality of service (QoS)
 - Application-specific traffic prioritization both within the branch office and across the enterprise WAN
 - Bandwidth management for WAN-based traffic
 - Provisions for IP telephony, business video, critical and bulk data applications
 - Provisions to mitigate denial of service (DoS) and worm attacks
 - Identification and classification of critical application flows for QoS
- IP routing and addressing
 - Routing within the enterprise and between the branch and the service provider network
 - Direct Internet access from the branch
 - Support for multicast applications
 - Translation of private addresses and ports in order to access the Internet
 - Dynamic allocation of IP addresses for end devices

Security Services

- Infrastructure protection
 - Physical securing of access to networking devices
 - Disabling of unused services that may be used to exploit the network
 - Authentication of routing protocol updates
- Access control
 - Authentication and authorization services for controlling access to network resources
 - Logging capabilities for auditing access to network devices and resources
 - Integration with global access management system to enforce access privileges
- Secure connectivity
 - Secure interoffice connectivity for full-mesh and hub-and-spoke WAN topologies
 - Secure access into the branch network for remote or home office workers
 - Voice, video, and data separation on the LAN
 - Separation of network management traffic
 - Access to the server in the branch by home office users
- Threat protection, detection, and mitigation
 - Blocking of unauthorized traffic from entering or leaving the branch
 - Access to servers in the branch by home office users
 - Verification of source addresses for incoming traffic
 - Identification and mitigation of common DoS attacks and worms
 - Prevention of malicious attacks on the branch office network from outside
 - Prevention of attacks and security breaches from within the branch office

Network Management

- Monitoring of networking services through a unified management console
- Analysis of IP services and generation of data needed for verification of service level agreements
- Ability to synchronize network time to accurately analyze network performance
- Traffic monitoring and accounting
- Common infrastructure for collecting and logging events generated by network devices
- Ability to automate initial software installation and configuration of all network devices
- Ability to automate reconfiguration of all network devices

Voice Services

- Ability to use IP-based and traditional analog telephones in the branch network
- Support for WAN-based (Toll Bypass), LAN-based (Private Exchange), and PSTN (Traditional) calling
- Ability to regulate quantity of calls placed over the WAN
- Support for direct dial to extension, caller ID, and calling number identification
- Support for voice and video calls

- Local voice mail and auto attendant
- Ability to use traditional analog fax devices
- Support for conference calling
- Transcoding of various voice codecs
- Connectivity to emergency services
- Support for multiple dial peers and plans
- Music on hold for waiting callers
- Capacity to support:
 - 5:1 user-to-active call ratio
 - 4:1 WAN-to-PSTN call ratio
 - 4:1 WAN-to-LAN call ratio
 - 2 percent of calls to be video
 - 5 percent of calls to be conferencing calls
 - 10 percent of calls resulting in a transcoding session
- Survivable central-site call control
or
Local call control

Optimization Services

- Maximize WAN link bandwidth utilization and throughput
- Improve response time of typical enterprise client/server applications

System Design

Branch network design varies greatly from one enterprise to another. Each design reflects the size, location, cost constraints, and business requirements of the corresponding branch office. However, regardless of the network architecture, a set of common branch networking elements provides:

- Network connectivity within the branch, to the Internet, and to the rest of the enterprise
- Security for data residing in the branch or crossing the network
- Unified network management and configuration
- Voice and fax services to support reliable, converged VoIP and POTS communication
- Response time or data throughput acceleration for centrally located enterprise applications

To help enterprises address these common connectivity, security, management, voice, and optimization needs, the Services Ready Medium Branch Network assembles the most important and common of these elements in a single, rigorously tested design. The goals of this design are to provide assurance that the various features interoperate and to provide a starting point for customization. The design focuses only on the services that integrate directly into the branch office router. Alternative designs that feature external appliances and provide the same functionality as the Services Ready Medium Branch Network are equally viable.

For guidance on implementation of such designs, see the Cisco enterprise branch architecture documents at:

http://www.cisco.com/en/US/netsol/ns656/networking_solutions_program_home.html.

The following components and fundamental connectivity, security, and management services were tested in the Services Ready Medium Branch Network:

- [Branch Network Components, page 8](#)
- [WAN Services, page 8](#)
- [LAN Services, page 9](#)
- [Network Fundamentals, page 9](#)
- [Security Services, page 9](#)
- [Management Services, page 10](#)
- [Voice Services, page 10](#)
- [Optimization Services, page 11](#)

Branch Network Components

- Cisco 3945 and Cisco 3925 Integrated Services Routers (ISRs)
- Catalyst 3560 Switches
- Cisco Unified IP Phones 7942G, 7945G, 7961G, 7962G, 7965G, 7971G, and 7985G
- Cisco Unified IP Conference Station 7937G

WAN Services

- Dedicated leased lines through service provider network
 - T3 line with PPP or Frame Relay (FR) encapsulation
 - Four T1 lines with Multilink Frame Relay, Multilink Point-to-Point Protocol (MLPPP) encapsulation
 - Gigabit Ethernet line shaped to 12 Mb/s
- Virtual lines through service provider network provisioned at provider edge (PE) devices
 - Frame Relay service
 - Connectivity to service provider's PE device
 - T3 line with FR encapsulation
 - 4 T1 lines with Multilink Frame Relay (MLFR) encapsulation
 - Layer 3 Virtual Private Network (L3VPN)
 - Connectivity to service provider's PE device
 - T3 line with PPP encapsulation
 - 4 T1 lines with MLPPP encapsulation
 - Layer 2 Virtual Private Wire Service (VPWS)
 - Connectivity to service provider's PE device:
 - T3 line with PPP encapsulation
 - 4 T1 lines with MLPPP encapsulation
 - T3 line with FR encapsulation

4 T1 lines with Multilink Frame Relay (MLFR) encapsulation
Gigabit Ethernet line shaped to 12 Mb/s

LAN Services

- Access switches with EtherChannel configuration
- Power-over-Ethernet (PoE)
- Fast Ethernet and Gigabit Ethernet connectivity

Network Fundamentals

- High availability, rapid recovery, and disaster recovery
 - Redundant links among networking devices
 - Backup WAN link with Symmetric High-Speed Digital Subscriber Line (SHDSL)
 - EtherChannel configuration for switches
 - Routers and switches with modular, field-replaceable components
- IP addressing and routing
 - Network Address Translation (NAT)/Port Address Translation (PAT)
 - Open Shortest Path First (OSPF)
 - Enhanced Interior Gateway Routing Protocol (EIGRP)
 - Border Gateway Protocol (BGP)
 - Routing Information Protocol (RIP) Version 2
 - Dynamic Host Configuration Protocol (DHCP)
 - Multicast
- QoS
 - Hierarchical 8-class QoS Model using Low Latency Queuing (LLQ), Class-Based Weighted Fair Queuing (CBWFQ), Weighted Random Early Detection (WRED), and Differentiated Services Code Point (DSCP)-WRED on the router
 - Policing of voice and video traffic on the egress WAN interface
 - Shaping on the egress WAN interface
 - Class of service (CoS) to DSCP mapping with Weighted Round Robin (WRR) queuing on LAN switches
 - DSCP re-marking on LAN switches
 - Rate policing on LAN switches
 - Congestion-only queuing on LAN switches
 - Network Based Application Recognition (NBAR)

Security Services

- Infrastructure protection
 - Disabling of unused services
 - Console timeouts
 - Password protection

- Secure Shell (SSH) access
- Routing protocol security
- Access control
 - Authentication, Authorization, and Accounting (AAA) with RADIUS and TACACS+
 - Syslog
- Secure connectivity
 - Encryption with 3 DES (Data Encryption Standard) and 256-bit Advanced Encryption Standard (AES)
 - Key exchange with Diffie-Hellman Group 2
 - Data integrity with Message Digest 5 (MD5) and Secure Hash Algorithm 1 (SHA-1)
 - Preshared key (PSK)
 - IP Security (IPsec) Dynamic Multipoint VPN (DMVPN)
 - IPsec Group Encrypted Transport VPN (GETVPN)
 - 802.1Q virtual LANs (VLANs)
 - WebVPN (SSL VPN)
- Threat Protection, Detection, and Mitigation
 - Cisco IOS Intrusion Prevention System (IPS) with advanced signature set
 - Zone-based Cisco IOS firewall
 - 802.1x
 - Port security
 - IP source guard
 - PortFast bridge protocol data unit (BPDU) guard
 - DHCP snooping
 - Dynamic Address Resolution Protocol (ARP) inspection
 - Standard and extended Access Control Lists (ACLs)
 - Unicast Reverse Path Forwarding (uRPF)
 - DoS attack and worm detection and mitigation with NBAR

Management Services

- Simple Network Management Protocol (SNMPv3)
- Cisco Configuration Professional (CCP)
- Network Time Protocol (NTP)
- IP service level agreements (SLAs)
- NetFlow version 5
- Syslog
- Cisco Configuration Engine

Voice Services

- Cisco Unified Communications Manager (Cisco Unified CM)

- Survivable Remote Site Telephony (Cisco Unified SRST)
- Cisco Unified Communications Manager Express (Cisco Unified CME)
- Voice Gateway
- Cisco Unity Express
- Resource Reservation Protocol (RSVP) agent
- Digital trunk line for PSTN connectivity
- Analog device connectivity
- Emergency services
- Packet voice digital signal processing modules (PVDM)
- Fax pass-through
- Fax T.38 relay
- Transcoding
- Conferencing
- G.711 and G.729a codecs
- cRTP
- Music on hold (MOH)

Optimization Services

- Cisco Wide Area Application Services (Cisco WAAS)

Topology

The Services Ready Medium Branch Network provides scalability, performance, security, and network manageability for the medium branch, and integrates the various network services into the branch office router. As [Figure 3](#) shows, it consists of Cisco 3900 series ISR (either Cisco 3925 or Cisco 3945 ISRs) for WAN termination and services aggregation, a 16-port distribution layer EtherSwitch service module, and an access layer with two Catalyst 3560 switches for LAN connectivity. Access layer switches provide connectivity to end devices and provide control of access to the network. The distribution layer switch controls traffic flows and manages LAN services. This topology meets the criteria highlighted in the [“Medium Branch Design Considerations”](#) section on page 4.

Table 1 **Hardware Configurations**

Platform	Configuration
Cisco 3945	C3900-SPE150/K9, EHWIC, 256MB flash ,1 GB DRAM Cisco IOS Release ???–Advanced Enterprise Services Image
Cisco 3925	C3900-SPE100/K9, EHWIC, 256MB flash , 1 GB DRAM Cisco IOS Release ???–Advanced Enterprise Services Image

Table 1 **Hardware Configurations (continued)**

Platform	Configuration
EtherSwitch	NME-16ES-1G Cisco IOS Release 12.2(25)SEE4—IP Services Image
Catalyst 3560	WS-C3560G-48PS-S WS-C3560G-48TS-S 128 MB DRAM, 32 MB flash Cisco IOS Release 12.2(25)SEE4—IP Services Image

Table 2 **Hardware and Software Versions**

Component	Version
NM-CUE	3.1
AIM-CUE	3.1
NME-WAE-522	4.0.19
Cisco Unified IP Phones 7942G, 7945G, 7961G, 7962G, 7965G, 7971G, 7985G	8.3.x
Cisco Unified Conference Station 7936	1.2(1)
Cisco Unified Communications Manager Express (Cisco Unified CME)	4.1
Cisco Unified Survivable Remote Site Telephony (Cisco Unified SRST)	4.1
Cisco IOS Intrusion Prevention System (Cisco IOS IPS)	5.0
Cisco Configuration Engine	3.0

References and Recommended Reading

For more information on topics described in this guide, see the following documents:

- [Cisco WAFS Benchmark Tool for Microsoft Office Applications Installation and Configuration Note](#)
- [High Availability Campus Network Design—Routed Access Layer Using EIGRP or OSPF](#)
- [LAN Baseline Architecture Branch Office Network Reference Design Guide](#)
- [Enterprise QoS Solution Reference Network Design Guide](#)
- [Business Ready Teleworker Design Guide](#)
- [Enterprise Branch Security Design Guide](#)
- [Enhanced IP Resiliency Using Cisco Stateful Network Address Translation](#)
- [Stateful Failover for IPSec](#)

The following information is referenced in this guide:

- [Cisco Design Zone for Security](#)
- [Cisco IOS Configuration Fundamentals Command Reference](#)
- [Cisco IOS Debug Command Reference](#)
- [Cisco IOS IP Addressing Services Command Reference](#)
- [Cisco IOS IP Application Services Command Reference](#)
- [Cisco IOS IP Multicast Command Reference](#)
- [Cisco IOS IP Routing Protocols Command Reference](#)
- [Cisco IOS LAN Switching Command Reference](#)
- [Cisco IOS NetFlow Command Reference](#)
- [Cisco IOS Quality of Service Solutions Command Reference](#)
- [Cisco IOS Security Command Reference](#)
- [Cisco IOS Voice Command Reference](#)
- [Cisco Solution Reference Network Design Guides](#)
- [Services Ready Medium Branch Network Quick Start Guide](#)
- [Support–Cisco Systems](#)

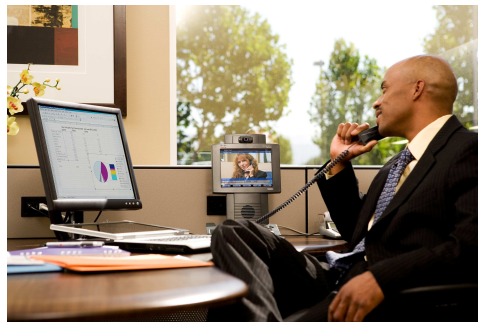

Features and Services

Revised: November 6, 2009

This chapter briefly describes all the services and features that are part of the Services Ready Medium Branch Network design and that meet the business criteria outlined in [“Medium Branch Design Considerations” section on page 4](#). The building blocks of the Cisco Enterprise Branch Architecture framework are described as they apply to the Services Ready Medium Branch Network.

Contents

- [Branch Network Components, page 1](#)
- [WAN Services, page 9](#)
- [LAN Deployment Model, page 23](#)
- [Network Fundamentals, page 32](#)
- [Security Services, page 48](#)
- [Management Services, page 63](#)
- [Voice Services, page 69](#)
- [Optimization Services, page 88](#)

Branch Network Components

Cisco offers a broad and versatile portfolio of routers, switches, and IP Phones. There are three product lines of routers and four product lines of switches for the branch office. Each product line offers different performance and features, enabling enterprise IT departments to meet a wide range of functional requirements. [Figure 1](#) provides an overview of the various Cisco Integrated Services Routers Generation 2 (Cisco ISRs G2) that are commonly deployed in the branch office.

Figure 1 Branch Office Integrated Services Router Portfolio



To learn more about each router product line, see the *Cisco Router Guide*:

http://www.cisco.com/en/US/prod/collateral/routers/ps5855/prod_brochure0900aecd8019dc1f.pdf

Figure 2 provides a high-level overview of the various Catalyst switches that are commonly deployed in the branch office.

Figure 2 Branch Office Catalyst Switch Portfolio

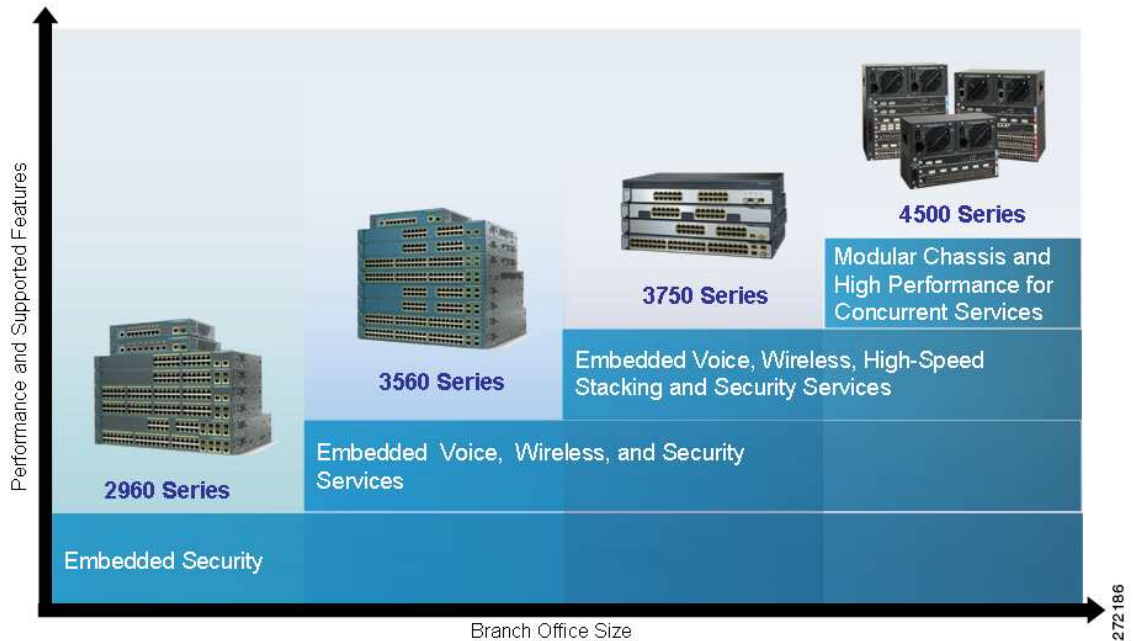

To learn more about each switch product line, see the *Cisco Catalyst Switch Guide*:

http://www.cisco.com/en/US/prod/switches/ps5718/ps708/networking_solutions_products_genericcont0900aecd805f0955.pdf

There are four desktop IP Phone product lines that are suited for the branch office. Each phone offers different functions and capabilities, as shown in [Figure 3](#).

Figure 3 Branch Office Cisco Unified IP Phone 7900 Series Portfolio



To learn more about each IP Phone, visit:

http://www.cisco.com/en/US/products/sw/voicesw/products_category_buyers_guide.html#number_1

Selecting Network Components

Selecting the appropriate routing and switching platforms for a branch office involves numerous considerations. The most important considerations are:

- Branch office size: The platform must support required port densities for the expected number of end-user devices.
- Features and services: The platform must support required networking services, interfaces, and modules.
- Performance: The platform, including features and services, must handle wire speeds required by branch applications.
- Scalability: The platform must have extra slots for DRAM, flash, interface and module expansion.
- Resiliency: The platform must support high availability and fault tolerance.

In accordance with the business criteria outlined in the “[Medium Branch Design Considerations](#)” section on [page 4](#), Cisco 3925 and Cisco 3945 Integrated Services Routers (ISRs) were selected for the Services Ready Medium Branch Network.

The Cisco 3945 ISR, shown in [Figure 4](#), is ideal for medium-sized and large business and enterprise branch offices. It offers embedded video, WAN optimization, network awareness, voice, wireless, switching, and security features. Built for performance, it delivers multiple concurrent services at a wire speed of up to a T3/E3 rate. High availability is supported through online network module insertion and removal, redundant internal power supply, field-replaceable components, and Cisco IOS software features for redundant system design.

Need two different photos of 3945 and 3925?

Figure 4 Cisco 3945 Integrated Services Router



To learn more about the Cisco 3945 ISR, visit:

<http://www.cisco.com/en/US/products/ps10541/index.html>

The Cisco 3925 ISR, shown in [Figure 5](#), offers similar functionality to that of the Cisco 3945 ISR. It differs from the Cisco 3945 ISR in the following ways:

- Performance: Half the wire speed with concurrent services (up to one-half the T3/E3 rate)
- Resiliency: Absence of redundant internal power supply
- Scalability: Two fewer network module slots

Figure 5 Cisco 3925 Integrated Services Router



To learn more about the Cisco 3925 ISR, visit:

<http://www.cisco.com/en/US/products/ps10542/index.html>

Catalyst 3560 series switches and an EtherSwitch service modules were selected for the Services Ready Medium Branch Network. Several different models are available in each product family. The selection of a specific model depends on the desired number of ports, support for PoE, and Gigabit Ethernet connectivity, and will vary from enterprise to enterprise.

The Catalyst 3560 series switch, shown in [Figure 6](#) is an ideal access layer switch for branch-office environments, combining both 10/100/1000 and PoE configurations and enabling the deployment of new applications such as IP telephony, wireless access, and video surveillance. It offers Fast Ethernet and Gigabit Ethernet connectivity and concurrent QoS, ACL, port security, link aggregation, and VLAN functionality at forwarding rates of up to 32 Gb/s. For scalability, the Catalyst WS-C3560G-48PS-S and Catalyst WS-C3560G-48TS-S models provide up to forty-eight 10/100/1000 ports and four small form-factor pluggable (SFP) ports. The Catalyst WS-C3560G-48PS-S also adds the PoE option. The main selection criterion for the Catalyst 3560 switch is support for the PoE option; however, the Catalyst WS-C3560G-48TS-S model was tested to provide an option for connecting devices that do not require PoE.

Figure 6 Catalyst WS-C3560G-48PS-S/Catalyst WC-C3560G-48TS-S Switch



To learn more about the Catalyst 3560 switch series, visit:

<http://www.cisco.com/en/US/products/hw/switches/ps5528/index.html>

The EtherSwitch service module, shown in [Figure 7](#), is an ideal switch for providing scaled down distribution layer functionality in medium branch office environments. The 16-port NME-16ES-1G-P offers Fast Ethernet and Gigabit Ethernet connectivity and concurrent QoS, ACL, port security, link aggregation, and VLAN functionality. It provides up to sixteen 10/100 Mb/s ports with PoE and one 1000 Mb/s port.

Figure 7 Cisco NME-16ES-1G-P EtherSwitch Service Module

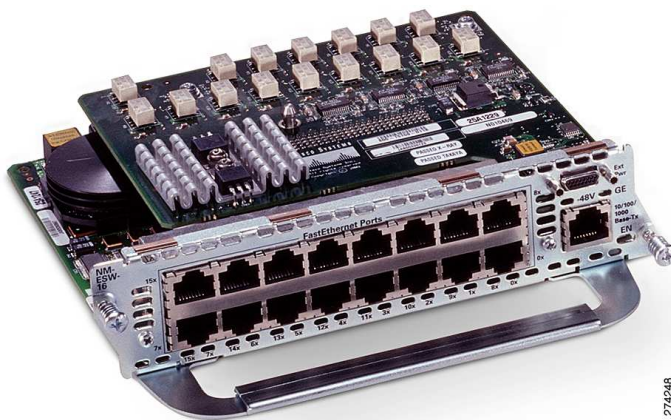

To learn more about the EtherSwitch switch modules, visit:

http://www.cisco.com/en/US/prod/collateral/routers/ps5855/product_data_sheet0900aecd8028d15f.html

Cisco offers a variety of IP Phones. Selection of the appropriate phone depends on its intended usage. The most important selection criteria for Cisco Unified 7900 Series office worker IP Phones are:

- **Display:** The applications used on the phone determine the need for backlight, color, and touch screen.
- **Line count:** The expected usage determines the required number of phone lines or telephony features.
- **Physical features:** The amount and type of phone traffic and the applications determine the required number of buttons, the functionality of the navigation wheel, and the need to support key expansion modules.
- **Video:** Video conferencing requires video capabilities.

When considering an IP Phone, in general, there are numerous other features to evaluate (e.g., QoS, codec). However, all office worker Cisco 7900 Series Unified IP Phones implement the same core features required of an enterprise class IP Phone. Therefore, the above criteria are the primary considerations when selecting from the various options. To learn more about the features of the Cisco Unified IP Phones, see the *Cisco Unified IP Phone Features A - Z*:

http://www.cisco.com/en/US/docs/voice_ip_comm/cuipph/all_models/phone_a_to_z/english/user/guide/az_user.html

Business criteria outlined in the “[Medium Branch Design Considerations](#)” section on page 4 specify five different use cases for IP Phones in a branch office: moderate call volume user, heavy call volume user, decision maker, video conferencing user, and conference room. For each of the first three use cases two different phones were selected.

The Cisco Unified IP Phone 7942G and Cisco Unified IP Phone 7945G, shown in [Figure 8](#), were chosen for the moderate call-volume use case. Both phones support:

- High-fidelity audio
- High-resolution display for advanced XML applications and double-byte characters/Unicode
- IEEE 803.af PoE (Class 2) or local power supply
- Access to two phone lines (or combination of line access and telephony features)
- Integrated Ethernet switch and 10/100BASE-T Ethernet connection through an RJ-45 interface for LAN connectivity
- Standards-compliant Session Initiation Protocol (SIP) support.

In addition, the Cisco Unified IP Phone 7945G phone offers Gigabit Ethernet VoIP telephony technology and a large backlit color display.

Figure 8 Cisco Unified IP Phones 7942G and 7945G



The Cisco Unified IP Phone 7962G GE and Cisco Unified IP Phone 7965G, shown in [Figure 9](#), were selected for the high call-volume use case. Both phones support the same features and differences as the Cisco Unified IP Phone 7942G and Cisco Unified IP Phone 7945G phones, and both phones support four additional phone lines.

272192

Figure 9 Cisco Unified IP Phones 7962G and 7965G



The Cisco Unified IP Phone 7971G GE and Cisco Unified IP Phone 7975G, shown in [Figure 10](#), were selected for the decision-maker use case. Both phones support the following features:

- High-fidelity audio
- Gigabit Ethernet VoIP telephony technology
- Backlit high-resolution, color touch screen for easy access to communications information
- XML applications
- Integrated Ethernet switch and 10/100/1000BASE-T Ethernet connection via an RJ-45 interface for LAN connectivity
- IEEE 802.3af Power (Class 3) over Ethernet (PoE) or a local power supply
- Standards-compliant SIP phone support

In addition, the Cisco Unified IP Phone 7975G features a high-resolution screen, high-fidelity wideband audio, and Internet Low Bit Rate Codec (iLBC) support for use in lossy networks.

Figure 10 Cisco Unified IP Phones 7971G-GE and 7975G



[Table 1](#) provides a high-level feature comparison of the six IP Phone models.

Table 1 Comparison of Cisco Unified IP Phone Models for Medium Branch Offices

Use Case	Moderate Call Volume		Heavy Call Volume		Decision Maker	
	7942G	7945G	7962G	7965G	7971G-GE	7975G
Cisco Unified IP Phone	7942G	7945G	7962G	7965G	7971G-GE	7975G
Display	Grayscale	Color	Grayscale	Color	12-bit Color	16-bit Color
Touch screen	No	No	No	No	Yes	Yes
Wideband speaker	Yes	Yes	Yes	Yes	No	Yes
Wideband handset	Yes	Yes	Yes	Yes	Accessory	Yes
Wideband headset	Supported	Supported	Supported	Supported	Supported	Supported
iLBC	Yes	Yes	Yes	Yes	No	Yes
Navigation cluster	2-way	4-way + Select	2-way	4-way + Select	4-way	4-way + Select
Gigabit Ethernet	No	Yes	No	Yes	Yes	Yes
Line keys	2	2	6 (+KEM)	6 (+KEM)	6 (+KEM)	8 (+KEM)
KEM support ¹	No	No	Yes	Yes	Yes	Yes

1. KEM: Key Expansion Module.

The Cisco Unified IP Phone 7985G, shown in [Figure 11](#), was selected for the video-conferencing use case. The phone supports personal desktop video for instant, face-to-face communications, incorporates all the components required for video calls (camera, LCD screen, speaker, keypad, and handset), provides integrated Ethernet switch and 10/100BASE-T Ethernet connection through an RJ-45 interface for LAN connectivity, and has dedicated buttons that control the video features: Self View, Picture in Picture, Video Mute, Display, and Brightness.

Figure 11 Cisco Unified IP Phone 7985G

The Cisco Unified IP Conference Station 7936, shown in [Figure 12](#), was selected for the conference room scenario. The conference station offers a regular telephone keypad plus three soft keys, menu navigation keys, and a backlit, pixel-based LCD display.

Figure 12 Cisco Unified IP Conference Station 7936



WAN Services

A number of WAN technologies are available to meet the diverse business requirements of an enterprise. This guide does not address considerations and issues pertaining to enterprise WAN design. However, certain aspects of WAN deployment, such as basic connectivity and routing, affect configuration of the branch office router and influence the use of specific features and services in the branch network. To ensure its relevance and applicability, the Services Ready Medium Branch Network was validated with the most commonly deployed enterprise WANs. For detailed guidance on WAN design and implementation see the Cisco WAN design documents at:

http://www.cisco.com/en/US/netsol/ns817/networking_solutions_program_home.html.

Today enterprises have five common WAN connectivity options for the branch office. Each option, as shown in Figure 13, has its own set of benefits and trade-offs.

Private WAN

- **Dedicated leased lines:** Permanent point-to-point links connecting two fixed points across a provider network. In general, the links are based on Layer 1 (SONET/SDH, T1/E1, T3/E3, xDSL) technology. Today, because of the availability of cheaper alternatives, only branches that have special business requirements, that are geographically near a central site, or that are limited by availability of local connection options, favor dedicated lines.
- **Circuit-switched transmission service:** Dynamically created point-to-point links over telephone wires. The links are typically based on analog dialup or ISDN technology. Today, because of bandwidth limitations and lengthy call setup, they are mainly used for voice services or as a primary link backup.
- **Packet-switched transition service:** Virtual point-to-point or point-to-multipoint links that are established over a provider-administered Layer 2 network. The provider network is based on Frame Relay, ATM, or Ethernet technology. Although this is the most widely used connectivity option for branch offices, Frame Relay and ATM as services are declining in popularity because of MPLS based alternatives. Using Ethernet implemented over SONET or using Ethernet switches is gaining popularity in the form of carrier Ethernet services (L2VPN) such as Ethernet Private Line (EPL), Ethernet Virtual Private Line (EVPL), or Ethernet-LAN (E-LAN).

- **Label-switched transmission service:** Virtual any-to-any links running on top of a packet or circuit-switched network. The provider network is based on MPLS technology, which is emerging as the foundation of next-generation WANs that can deliver a wide range of advanced services such as Layer 3 VPN (L3VPN), or as transport mechanisms for carrier Ethernet services (L2VPN) mentioned above.

Public WAN

- **Internet broadband link:** Shared any-to-any links over the Internet. This has become an attractive connectivity option in recent years for smaller branch offices as VPN technologies has matured and as broadband connectivity has become more widely available. For medium branch offices, this connectivity option is mainly used as a primary link backup. In general, broadband links are based on dialup, cable, and terrestrial or satellite wireless technologies.

Figure 13 WAN Service Options

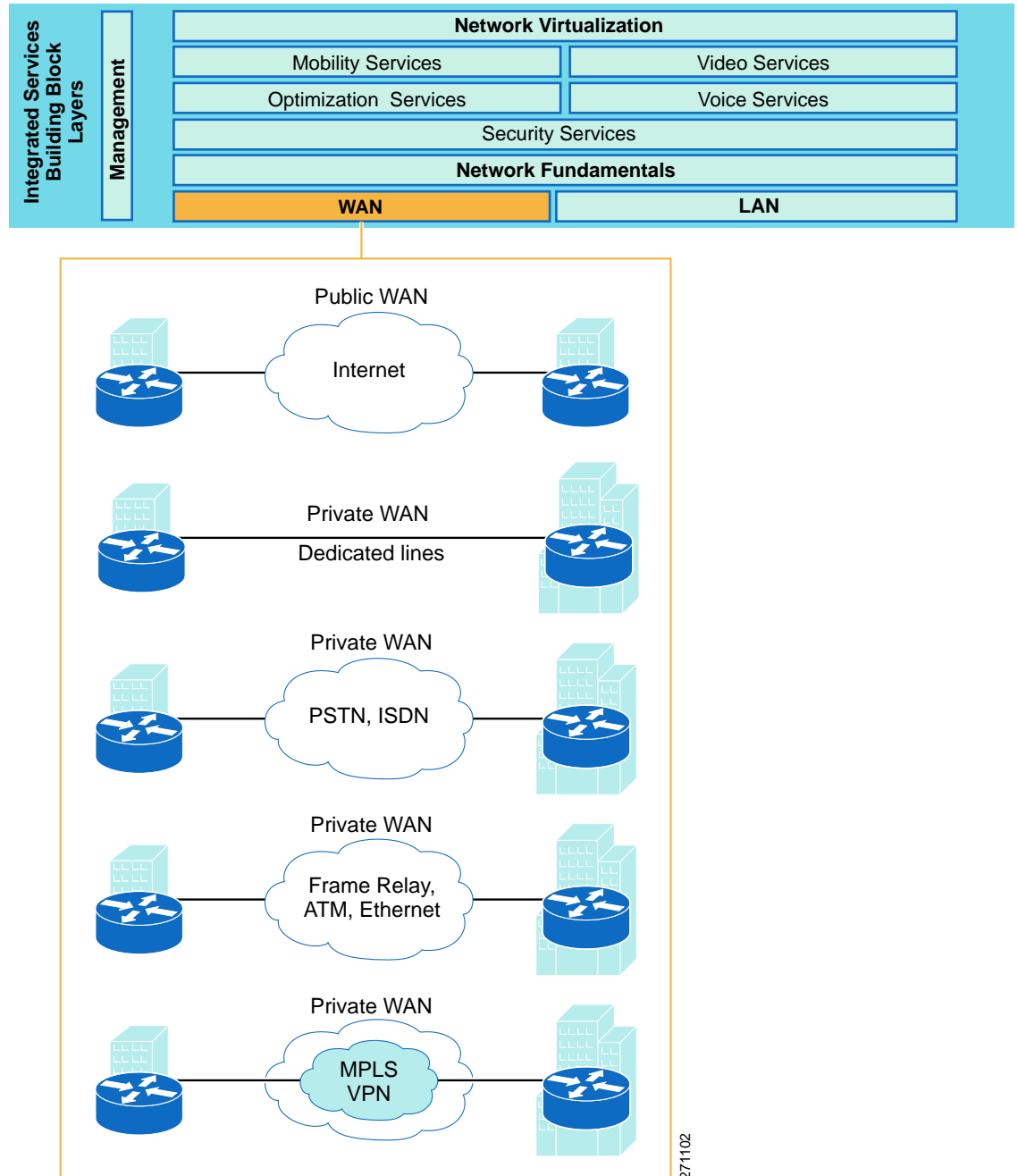

Selecting WAN Service

A WAN includes transmission service available from a service provider and an access link to the service provider network. Selecting the appropriate provider network service and the access link involves many considerations. For a branch office, the most important considerations are:

- Purpose: The WAN service must provide seamless access to any site in the enterprise.
- Geographic scope: The WAN service must provide access to both regional and global sites.

- **Traffic profile:** For the Services Ready Medium Branch, the WAN service must support up to 45 Mb/s of data, voice, and video traffic.
- **Quality guarantee:** The WAN service must provide a mechanism to ensure quality of service (QoS).
- **Security:** The WAN service must provide a mechanism to ensure traffic privacy.
- **Existing infrastructure:** The WAN service must be consistent with or must leverage existing WAN deployment.
- **Availability:** Selection of the WAN service must take into account local availability.
- **Cost:** The WAN service cost must be evaluated based on how well it meets the above considerations.

Table 2 lists advantages and disadvantages of the most commonly used WAN transmission services for a branch office.

Table 2 Common WAN Transmission Service Options for a Medium Branch Office

Service Type	Advantage	Disadvantage	Appropriate for Branches
Leased Line	<ul style="list-style-type: none"> • Secure and private • Uncontended bandwidth • Reliable and predictable • Supports any protocol 	<ul style="list-style-type: none"> • Expensive • Point-to-point • Fixed bandwidth 	<ul style="list-style-type: none"> • Geographically close to campus or data center • With critical applications that require guaranteed bandwidth
Frame Relay (FR) Service	<ul style="list-style-type: none"> • Cost effective • Adjustable bandwidth • Extensive coverage • Secure and private • Reliable and resilient • Flexible and scalable • IP and non-IP protocols 	<ul style="list-style-type: none"> • Variable bandwidth, latency, and jitter • Point-to-point • Inefficient QoS 	<ul style="list-style-type: none"> • With legacy FR WAN deployment • With hub-and-spoke WAN topology • With non-IP applications

Table 2 Common WAN Transmission Service Options for a Medium Branch Office (continued)

Service Type	Advantage	Disadvantage	Appropriate for Branches
Layer 3 Virtual Private Network Service (MPLS L3VPN)	<ul style="list-style-type: none"> • Same benefits as Frame Relay except for support of non-IP protocols • Any-to-any connectivity • QoS provisioning • Traffic engineering • Support wide variety of IP applications 	<ul style="list-style-type: none"> • Potentially costly migration • Proprietary to service provider network • Limited global availability • Supports only IP 	<ul style="list-style-type: none"> • Most medium and large branch offices
Layer 2 Virtual Private Wire Service (VPWS)	<ul style="list-style-type: none"> • Same benefits as Frame Relay • Transparent LAN integration • Low administrative overhead 	<ul style="list-style-type: none"> • Potentially costly migration • Limited availability • Limited scalability • Point-to-point 	<ul style="list-style-type: none"> • With enterprise control over WAN routing • With non-IP applications

In addition to these general considerations, a WAN service must meet the business criteria outlined in the “[Medium Branch Design Considerations](#)” section on page 4. To ensure its relevance and applicability, the Services Ready Medium Branch Network was validated with all the WAN service options listed in Table 2. Specific design considerations related to each WAN service type are described in the following sections:

- [Leased-line Deployment](#), page 16
- [Frame Relay Service Deployment](#), page 18
- [L3VPN Service Deployment](#), page 19
- [VPWS Services](#), page 21

To access the WAN service, a branch office needs a local loop to the nearest location where the provider makes the service available. Typically, this is a dedicated leased line to the edge of the provider’s network. To support 50 to 100 active users and a large number of centrally hosted applications, the following connection types and bandwidth options are appropriate:

- Multiple T1 carrier lines connected to an HWIC-4T interface, shown in [Figure 14](#)

Figure 14 *4-Port Serial High-Speed WAN Interface Card (HWIC-4T) with 4 T1 High-Speed Serial Ports*

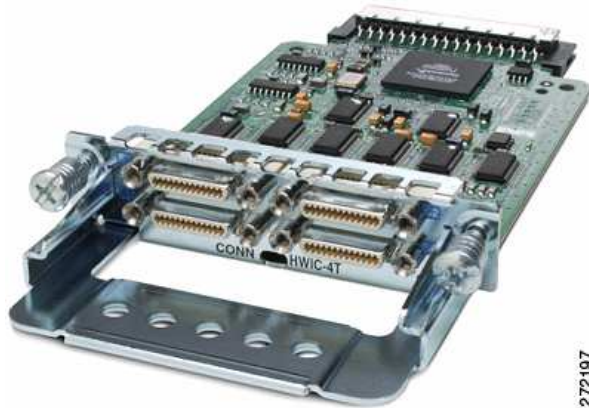

272197

To learn more about the HWIC-4T interface card, visit:

http://www.cisco.com/en/US/prod/collateral/modules/ps5949/ps6182/product_data_sheet0900aecd80274416.html

- Gigabit Ethernet line connected to an onboard small form pluggable (SFP) port.
- T3/E3 carrier line connected to a NM-1T3/E3 interface shown in [Figure 15](#).

Figure 15 *1-Port Network Module (NM-1T3/E3) with One T3 High-Speed Serial Port and One E3 High-Speed Serial Port*



272199

To learn more about the NM-1T3/E3 interface card, visit:

http://www.cisco.com/en/US/prod/collateral/modules/ps2797/ps4909/product_data_sheet09186a008010fba2.html

The specific selection of a WAN access link depends on the number of end user devices, the branch traffic profile, the applications used in the branch, and the available budget. The Services Ready Medium Branch Network was validated with the two interface cards and the onboard SFP port described previously.

Physical layer standards define the mechanical connection and electrical signaling to connect the branch router to the service provider network, which are typically done through a channel service unit (CSU)/data service unit (DSU) device that provides termination for digital signals, clocking, and synchronization, and that converts T-carrier line frames into frames that the LAN can interpret and vice versa. The branch router typically uses serial communication to connect to the CSU/DSU. The specific serial standard and socket type depend on the CSU/DSU equipment supplied by the service provider.

The Services Ready Medium Branch Network was validated with the following serial communication specifications:

- V.35 shown in [Figure 16](#). This serial specification is typically used to connect a Cisco router to a T1/E1 and fractional T1/E1 through a CSU/DSU. A single V.35 connector can achieve up to 2.048 Mb/s speed.

Figure 16 Male (CAB-SS-V35MC) and Female (CAB-SS-V35FC) V.35 Connectors

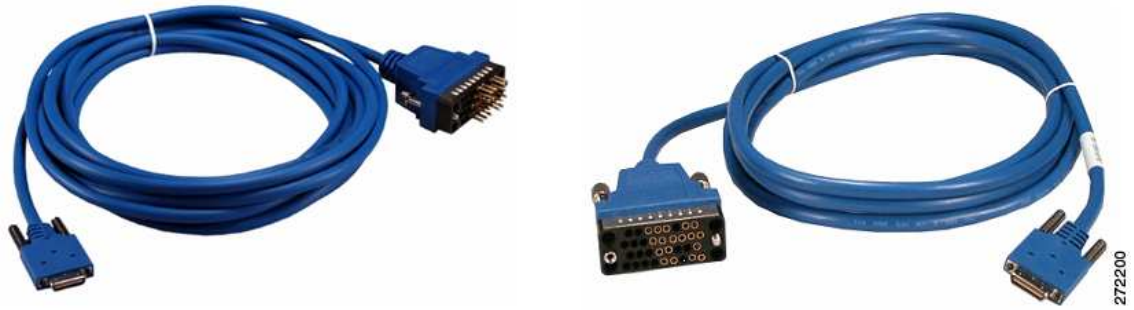

To learn more about Cisco High-Speed Serial Interface options, visit:

http://www.cisco.com/en/US/prod/collateral/modules/ps5949/ps6182/product_data_sheet0900aecd80274416.html

The Gigabit Ethernet interface has an SFP slot on which to interchange different copper or optical SFP modules. Selection of a specific SFP depends on the distance to the nearest service provider point of presence and the type of 1000BASE-X Ethernet available. The Services Ready Medium Branch Network was validated with the following SFP module:

- GLC-LH-SM, shown in [Figure 17](#). This is a connector for long-wavelength/long-haul (1000BASE-LX/LH) single-mode fiber and contains a Class 1 1300-nm laser that can reach up to 6.2 miles.

Figure 17 GLC-LH-SM Small Form-Factor Pluggable Module



To learn more about Cisco SFP modules, visit:

http://www.cisco.com/en/US/docs/routers/7200/install_and_upgrade/gbic_sfp_modules_install/5067g.html

Each T3/E3 port on the NM-T3/E3 module consists of a pair of 75-ohm BNC coaxial connectors (Type RG-59), one for transmit data and one for receive data. The module provides an integrated DSU that allows T3/E3 lines to be directly terminated on a Cisco router, eliminating the need for external DSU equipment.

Table 3 summarizes the WAN access line types, bandwidth, physical connection for the link, and Cisco ISR interface or module that provides access to the provider network.

Change HWIC-4T to EHWIC?

Table 3 WAN Access Link Summary

WAN Access Line Type	Bandwidth	Physical Connection	Cisco ISR Interface or Module
T3/E3 line	43/34 Mb/s	BNC terminated coaxial cable	NM-1T3/E3
4 T1/E1 lines	6 Mb/s	V.35 cable	HWIC-4T
Gigabit Ethernet line	Shaped to 12 Mb/s	LX/LH single mode fiber	Onboard Gigabit Ethernet SFP

Each deployment scenario was also validated with a backup link to the WAN. The details are described in the “[Path Redundancy, Rapid Recovery, and Disaster Recovery](#)” section on page 32.

The routing and addressing aspects of each WAN deployment are described in the [IP Addressing and IP Routing](#), page 37.

Leased-line Deployment

When a branch office requires a permanent dedicated connection, a point-to-point leased line is used to provide a preestablished digital circuit from the branch through the service provider network to the central site. The service provider reserves the circuits for exclusive use by the enterprise. For a branch office, leased lines are typically available in fractional, full, or multiple T1/E1 or T3/E3 capacities. They are generally priced based on bandwidth and distance between the two connected endpoints. The cost of a leased-line WAN can become significant when it is used to connect a branch to many sites over increasing distance. Therefore, leased-line WANs are typically used to connect the branch to a central site, only when it is over a geographically short distance; when branch applications have critical bandwidth, latency, and/or jitter requirements; or when no acceptable alternatives are available in the geographic area. However, leased lines are used extensively to connect branches to a local point of presence (POP) that serves as an entry point into a service provider network offering other types of WAN transmission services.

Figure 18 shows the Services Ready Medium Branch Network leased-line deployment scenario.

Frame Relay Service Deployment

The traditional alternative to permanent leased lines has been virtual circuits provisioned over a service provider-administered Frame Relay network. A branch office is connected to the network by attaching a point-to-point link from the branch router (DTE) to the provider's nearest Frame Relay switch (DCE). When connections are in place for both the branch and a central site, a virtual circuit is set up to allow communication between the two locations. The virtual circuit is typically configured to stay active all the time. A virtual circuit is identified by Data Link Connection Identifier (DLCI), which ensures bidirectional communication from one DTE device to another and which guarantees data privacy. A number of virtual circuits can be multiplexed into a single physical line for transmission across the network. Therefore, it is relatively easy to connect one branch office to multiple destinations.

Frame Relay is an any-to-any service over a network shared by many subscribers. The sharing allows service providers to offer lower monthly rates in comparison to dedicated leased lines. The data rate is also more flexible. Instead of one fixed rate, bursts are allowed if the network has available capacity. The downside to a shared network is a potential drop in service when traffic increases. To provide acceptable performance, service providers usually offer a minimum committed rate that is guaranteed to a subscriber. Frame Relay can provide speeds from 56 kb/s to 43 Mb/s, depending on the capability of the service provider's network.

While Frame Relay is considered legacy today, it is used extensively to implement enterprise WANs. Its primary advantages are cost and deployment flexibility. In comparison to leased lines, bandwidth is cheaper because it is shared, and only a short local loop is required to connect the branch to the nearest Frame Relay switch. Adding virtual circuits or increasing bandwidth is simple and fast.

The leased-line connection to the Frame Relay network typically uses one of the following Frame Relay encapsulation mechanisms:

- Frame Relay (FR) protocol: Specifies how data moves between the DTE and DCE over a single line.

To learn more about FR, visit:

http://www.cisco.com/en/US/tech/tk713/tk237/technologies_tech_note09186a008014f8a7.shtml

- Multilink Frame Relay (MLFR): Enables multiple lines to be aggregated into a single bundle of bandwidth.

To learn more about MLFR, visit:

http://www.cisco.com/en/US/docs/ios/12_0s/feature/guide/17s_mfr.html

The Services Ready Medium Branch Network was validated with the following combination of Frame Relay encapsulation protocols:

- T3/E3 line with FR protocol
- Four T1 lines with MLFR protocol

L3VPN services offer several unique advantages over traditional private WANs:

- They offer scalable any-to-any connectivity. A CE router peers with a PE router that maintains the full mesh topology. Unlike Frame Relay (or ATM), there is no complex virtual circuit topology to manage. Adding a new site to the mesh involves no other connections beyond the one connection to the PE router.
- Two branches can have overlapping address space if they are members of different VPNs.
- MPLS is IP aware and has a single control plane that matches the physical topology of the network. This allows better mapping of traffic into available resources or rapid redistribution of traffic in response to changes in the topology.
- Service providers are leveraging IP QoS to offer a full range of service guarantees for critical traffic.

The main limitation of MPLS stems from its dependence on IP. Only IP-based traffic is supported, and all other protocols must use a tunneling mechanism.

To learn more about Layer 3 MPLS VPN, visit:

http://www.cisco.com/en/US/solutions/ns340/ns414/ns465/net_design_guidance0900aecd80375d78.pdf

http://www.cisco.com/en/US/docs/net_mgmt/vpn_solutions_center/1.1/user/guide/VPN_UG1.html

The leased-line connection to the PE device typically uses one of the following data link layer encapsulation mechanisms:

- PPP: Described in the “Leased-line Deployment” section on page 16.
- MLPPP: Described in the “Leased-line Deployment” section on page 16.

The Services Ready Medium Branch Network was validated with the following combination of access links to a PE device:

- T3/E3 line with PPP
- Four T1 lines with MLPPP

Ethernet Switched WAN Services

- Permanent Point-to-Point Ethernet Line: Dedicated Ethernet circuit. The permanent point-to-point Ethernet switched WAN series are described in the “[Leased-line Deployment](#)” section on page 16.
- Virtual Ethernet Connections: Connectivity over a service provider’s shared Ethernet network.
 - E-Line: Point-to-point Ethernet services (single link configuration)
 - Ethernet Private Line (EPL): Dedicated point-to-point virtual line. The connection from the branch goes to a dedicated User Network Interface (UNI) device. Multiple EPLs require multiple UNIs. EPL is an alternative to dedicated leased lines.
 - Ethernet Virtual Private Line (EVPL): Multipoint-to-point virtual lines. A single UNI multiplexes multiple virtual connections. EVPL is an alternative to Frame Relay or ATM PVCs.
 - E-Tree: Point-to-multipoint Ethernet services (hub-and-spoke configuration)
 - Ethernet Private Tree (EP-Tree): Single point-to-multipoint virtual lines.
 - Ethernet Virtual Private Tree (EVP-Tree): Multipoint-to-multipoint virtual lines.
 - E-LAN: Multipoint-to-multipoint Ethernet service (full-mesh configuration)
 - Ethernet Private LAN (EP-LAN): Single multipoint-to-multipoint virtual lines.
 - Ethernet Virtual Private LAN (EVP-LAN): Multiple multipoint-to-multipoint virtual lines.

Selecting the most appropriate Ethernet-switched WAN service from this list involves several considerations. One of the first decision points is between L3VPN or L2VPN service. [Table 4](#) provides a high-level comparison of the two options. Ultimately, the decision depends on the amount of control that the enterprise wants to retain over its WAN deployment.

Table 4 High-Level Comparison Between L2VPNs and L3VPNs

L2VPN	L3VPN
Provider forwards frames, based on Layer 2 information	Provider forwards packets, based on Layer 3 information
Provider involved in routing	Provider not involved in routing
Supports only Ethernet as access technology	Supports any access technology
Enterprise controls Layer 3 policies (routing, QoS)	Provider controls Layer 3 policies (routing, QoS)
Supports any Layer 3 protocol	Supports only IP
Limited scalability	Scalable

The Services Ready Medium Branch Network was validated with Virtual Private Wire Services (VPWS). In this deployment, the service provider network acts as a Layer 2 switch. It maps incoming traffic to pseudowires based on Layer 2 headers. [Figure 21](#) shows a VPWS deployment scenario.

To learn more about Layer 2 MPLS VPNs, visit:

http://www.cisco.com/en/US/technologies/tk436/tk891/technologies_white_paper0900aecd80162178_ns585_Networking_Solutions_White_Paper.html

- Distribution layer: Aggregates the data that is received from the access layer switches, provides for data separation and forwards traffic to the core layer for routing to its final destination. It controls the flow of traffic, delineates broadcast domains, and provides resiliency.
- Edge layer: Aggregates the data that is received from the distribution layer switches and serves as an entry and exit point between the LAN and WAN. This is typically the branch router.

This design has the following benefits:

- Scalability: The modularity of the design provides room for easily adding devices as the network grows.
- Resiliency: Connecting the access layer switches to multiple distribution switches ensures path redundancy.
- Performance: Hierarchical layering enables fewer higher performing switches to aggregate traffic from many lower performing switches. The need for fewer higher performing switches results in both cost savings and optimal use of network devices.
- Security: Different security policies can be implemented at various levels of the hierarchy
- Manageability: All switches in one layer perform the same function, making it easy to propagate changes.

Hierarchical LAN design is only a logical layout of network devices. A medium branch office has three prominent physical implementation options, shown in [Figure 22](#), that map into the logical hierarchical design:

- Access router that is connected to physically separate distribution and access switches
- Access router with integrated distribution switches and physically separate access switches
- Access router that provides distribution layer functionality and is connected to physically separate access switches

- Authentication services: Authenticates the connecting device with RADIUS server.
- Power over Ethernet: Provides power to the connected IP Phones.
- Spanning Tree Protocol (STP): Eliminates any accidentally introduced loops from the network.
- High availability and link aggregation via EtherChannel to distribution layer switches: Provide bandwidth bundling and alternate paths to distribution layer switches in case of failure.

The distribution layer switch controls traffic flow from access switches and is an aggregation point for LAN management. When certain types of client/server applications are deployed in the branch, such as print services, building access control, or video surveillance, many of these applications run on servers that can be equipped with multiple NICs and connected to the distribution layer switches. Moreover, branch offices can provide remote workers with access to web, application, or database servers located in the branch. It is a security “best practice” to isolate these servers into a demilitarized zone (DMZ) VLAN. The distribution layer is the most appropriate place in the network to configure the DMZ VLAN. Finally, if the branch office requires wireless access points, the distribution layer can access ports for these devices. For the Services Ready Medium Branch Network, the distribution layer provides the following functions:

- Voice, data, black hole, management, and DMZ VLANs: Switches VLAN traffic between access switches, and provides DMZ VLAN for servers accessible by home office workers.
- Internal uplink connections with a VTP trunk to the router: Extends VLANs to the edge router.
- VTP server: Propagates VLAN information across the LAN.
- STP: Eliminates any accidentally introduced loops from the network.

**Note**

Only limited interVLAN routing is required between virtual LANs of the Services Ready Medium Branch Network. Therefore, no Layer 3 functionality is enabled on the distribution layer switch. All interVLAN routing is performed by the branch router in the edge layer.

The edge layer provides:

- Connectivity, security, and management services described throughout this guide
- Voice, data, black hole, management, and DMZ VLANs: Switches interVLAN traffic between access switches

Virtual LANs

A VLAN defines a group of logically connected devices that act as an independent LAN while sharing the same physical infrastructure with other VLANs. Each VLAN is a logically separate IP subnet. A switch can carry multiple VLANs, and a VLAN can be extended across multiple Layer 2 and Layer 3 devices. VLANs offer several benefits:

- Security: Traffic in a VLAN is separated from all other traffic by Layer 2 tags.
- Performance: VLANs reduce unnecessary traffic and use bandwidth more efficiently by delimiting broadcast domains.
- Management: VLANs are managed globally, and configuration is propagated across the network.

Several VLANs were defined for the Services Ready Medium Branch Network:

- Data VLAN: Carries traffic generated by laptops, PCs, and servers.
- Voice VLAN: Carries traffic generated by IP Phones, and singles out voice traffic for QoS.

Figure 25 *Integrated Switch in Cisco Unified IP Phone 7900 Series*

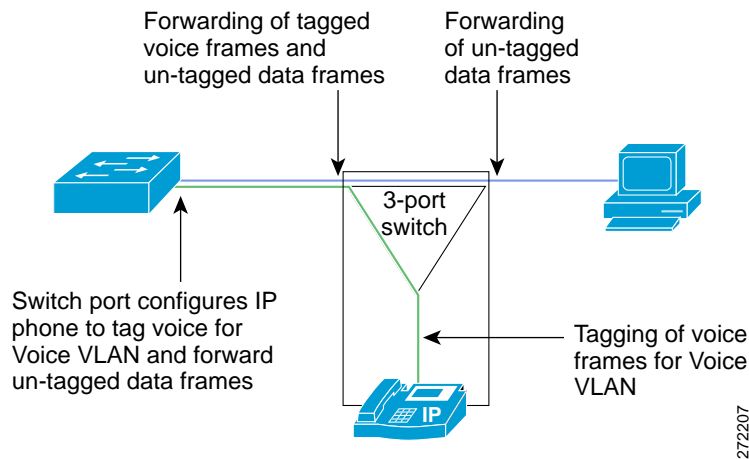

The DMZ VLAN and the black hole VLAN are described in the [“Security Services” section on page 48](#). The Management VLAN is described in the [“Management Services” section on page 63](#). In addition to the VLANs that were defined for the Services Ready Medium Branch Network, other VLANs could be required. If the branch office has wireless access points, they should be connected to the distribution layer switch and the traffic generated through these devices should be assigned to the wireless VLAN. Moreover, some networks could continue to use older equipment that does not support 802.1Q frame tagging. Isolate these devices in their own native VLAN that supports both untagged and tagged traffic.

VLAN Trunks and VLAN Trunking Protocol

VLAN trunks are point-to-point links between two Ethernet interfaces that carry traffic for multiple VLANs. They are used to extend VLANs across the entire network. VLAN Trunking Protocol (VTP) propagates VLAN information from one switch (server) to other switches in the network (clients). VTP maintains VLAN configuration consistency by managing the addition, deletion, and changes to VLANs across multiple switches.

Power-over-Ethernet

Power-over-Ethernet (PoE) provides power to devices that are attached to the switches such as IP Phones or wireless access points. All access layer switches in the Services Ready Medium Branch Network are provided with the PoE option. In the distribution layer, the EtherSwitch is provided with PoE. It is assumed that the distribution layer switch will primarily be used to connect to other network devices or servers that do not require PoE. However, because there maybe wireless access points connected to the distribution layer one of the switches provides PoE. Although all access layer switches should provide PoE, one non-PoE Catalyst 3560 was inserted into the Services Ready Medium Branch Network for validation completion.

Spanning Tree Protocol

Spanning Tree Protocols (STPs) are used to detect and prevent traffic loops or duplicate frames in a network with redundant paths. In addition, STP prevents accidental loops that frequently occur in the wiring closet or when users connect desktop switches to the network. Rapid VLAN Spanning Tree (RVST) protocol was enabled on all the switches in the network. The distribution layer switch served as the root bridge for the protocol. The Services Ready Medium Branch Network does have a traffic loop by design, and therefore it is critical that STP is enabled on all switches. The EtherChannel link that connects the two access layer switches provides 2 Gbp/s of bandwidth. Therefore, it will always be selected by the STP algorithm as the preferred path to the root bridge over one of the 200 Mbp/s uplinks that connect each of the access layer switches to the EtherSwitch service module. This is the desired behavior. The EtherChannel link between the access layer switches is used for intraVLAN traffic while the uplinks provide redundant paths to the distribution layer switch. Only one of them should be active at any given time.

To learn more about STP, visit:

http://www.cisco.com/univercd/cc/td/doc/product/rtrmgmt/sw_ntman/cwsimain/cwsi2/cwsiug2/vlan2/stpapp.htm

EtherChannel Link Aggregation

EtherChannel allows multiple physical Ethernet links to combine into one logical channel. The logical channel provides load sharing of traffic among the links and redundancy in the event that one or more links in the channel fail.

EtherChannel configuration is used in the Services Ready Medium Branch Network to aggregate bandwidth and to provide fault tolerance. A 2-port EtherChannel is created between the two access layer switches and between each access layer switch and the distribution switch, ensuring that if one of the links to the router fails, there is an alternate path to external networks.

To learn more about Cisco EtherChannel technology, visit:

http://www.cisco.com/en/US/tech/tk389/tk213/technologies_white_paper09186a0080092944.shtml

Figure 29 Aladdin Knowledge Systems USB eToken and Cisco ISR



To learn more about the Aladdin eToken, visit:

http://www.cisco.com/en/US/prod/collateral/modules/ps6247/product_data_sheet0900aecd80232473.html

Backup WAN Link

Any of the WAN connectivity options that are described in “[WAN Services](#)” [section on page 9](#) can be used as a backup link mechanism. In practice, however, PSTN and Internet based connections are primarily used for this purpose. The main considerations when selecting the backup link are:

- Service provider: The backup link should go through a different service provider network than the primary link. There should be no or minimal sharing of back-end infrastructure by the providers.
- Service availability: Selection of backup link service must take into account local availability.
- Availability and recovery requirements: The properties and type of service expected for the backup connection.
- Cost: The backup link cost must be evaluated based on how well it meets the availability requirements.

Table 5 lists advantages and disadvantages of the most commonly used backup connections for a branch office.

Table 5 Common WAN Backup Link Options for a Medium Branch Office

Service Type	Advantages	Disadvantages	Appropriate for Branches
ISDN (PRI or BRI)	<ul style="list-style-type: none"> Concurrent data and voice transmission Symmetric and dedicated bandwidth Works over telephone wires 	<ul style="list-style-type: none"> Call setup Limited bandwidth 	<ul style="list-style-type: none"> Telephone wires are the only connection option, and the office is too far from POP for xDSL link. Voice is the primary traffic (use PRI). Diversify service provider for backup.
xDSL	<ul style="list-style-type: none"> Concurrent data and voice transmission Dedicated bandwidth Works over telephone wires Relatively high bandwidth 	<ul style="list-style-type: none"> Quality dependent on wiring and distance to POP Asymmetric bandwidth 	<ul style="list-style-type: none"> Appropriate for most branch offices.
Cable	<ul style="list-style-type: none"> High bandwidth 	<ul style="list-style-type: none"> Asymmetric bandwidth Shared bandwidth Less secure 	<ul style="list-style-type: none"> Require high bandwidth.
3G	<ul style="list-style-type: none"> Easy installation Small antenna No cabling 	<ul style="list-style-type: none"> Limited bandwidth Limited availability Unreliable link 	<ul style="list-style-type: none"> Locations without wiring. Diversify service providers for backup.
Satellite	<ul style="list-style-type: none"> Global coverage 	<ul style="list-style-type: none"> Link delay Unreliable link Large antenna 	<ul style="list-style-type: none"> Remote locations. Diversify service provider for backup.

In addition to these general considerations, a backup link must meet the business criteria outlined in the “[Medium Branch Design Considerations](#)” section on page 4. At present, the Services Ready Medium Branch Network has been validated only with SHDSL as a backup WAN link. In future updates to this guide, some of the other options listed in Table 5 will be validated and documented.

All WAN deployments described in the “WAN Services” section on page 9 provide a backup link to the central site. The traffic is encrypted and directed over the Internet as shown in Figure 38. The backup link connects the branch to the nearest location where the provider makes access to the Internet service available. The link can be set to standby mode and used only for backup when the primary WAN link fails, or it can stay active and provide access to the Internet using a split tunneling mechanism. Both of these options were validated in the design.

For the Services Ready Medium Branch Network, the following connection option was selected for backup:

- A single broadband G.SHDSL link connected to the Cisco HWIC-4SHDSL interface is shown in Figure 30

Figure 30 4-Port Symmetric High-Speed DSL (SHDSL) WAN Interface Card (HWIC-4SHDSL)



To learn more about the Cisco HWIC-4SHDSL interface card, visit:

http://www.cisco.com/en/US/prod/collateral/modules/ps5949/ps7175/product_data_sheet0900aecd80581fa0.html

Physical connectivity for the xDSL line consists of one or multiple telephone wires terminated at a DSL access multiplexer (DSLAM) in the provider’s nearest point of presence (POP). The Cisco HWIC-4SHDSL comes with a cable that directly connects its single RJ-45 port to two telephone lines terminated at one of the supported DSLAMs. Table 6 identifies the WAN backup link, bandwidth, physical connection for the link, and Cisco ISR G2 interface that provides access to the Internet provider’s network.

Should be EHWIC?

Table 6 WAN Backup Line Option

WAN Backup Line Type	Bandwidth	Physical Connection	ISR Interface or Module
SHDSL with IMA	4.6 Mb/s	Two twisted-pair telephone wires	HWIC-4SHDSL

- xDSL Connection
 Digital subscriber line (DSL) technology is a popular option for connecting home office workers and small branch offices to the enterprise network. In a medium branch office, it is used mainly as a backup link. DSL creates an always-on connection that uses existing telephone wires to transport high-bandwidth data and to provide IP-based services. A DSL modem converts digital signals to and from analog signals. At the telephone company POP, a DSLAM is used to redigitize the signal and

forward it to the Internet service provider. There are various DSL standards, all under the general name xDSL, for various x. The Services Ready Medium Branch Network office used single-pair high-speed DSL (G.SHDSL).

The universal choice of Layer-2 encapsulation protocol for use on xDSL lines is asynchronous transfer mode (ATM). ATM adaptation layer (AAL) is a mechanism for segmenting upper-layer information into ATM cells at the transmitter and reassembling them at the receiver. AAL5 provides support for segmenting and reassembling routed/switched protocols over ATM permanent virtual circuits (PVCs) using Logical Link Control Layer (LLC)/Subnet Access Protocol (SNAP) or virtual channel multiplexing (VCMUX). LLC/SNAP adds an extra header that allows multiplexing of multiple protocols over the same PVC circuit. VCMUX allows multiple virtual circuits (VCs) on the xDSL link and maps each protocol to a different VC. For simplicity, AAL5+SNAP encapsulation was chosen for the Services Ready Medium Branch Network.

Inverse multiplexing over ATM (IMA) allows bundling of several xDSL lines to form a single logical link of higher combined bandwidth. Two telephone lines were bundled together in the Services Ready Medium Branch Network to create a bandwidth of 4.6 Mb/s.

To learn more about IMA, visit:

http://www.cisco.com/en/US/tech/tk39/tk356/technologies_q_and_a_item09186a0080111162.shtml

In summary, the Services Ready Medium Branch Network used the following xDSL configuration:

- G.SHDSL with 2-line IMA and AAL5+SNAP encapsulation

Backup LAN Links

The EtherChannel technology described in the “[EtherChannel Link Aggregation](#)” section on page 31 provides redundant paths between the access switches and the distribution switch. Each access layer switch has a direct link to the distribution switch. The Spanning Tree Protocol (STP) configures one of the links as a primary and the other as a secondary. If the primary link fails, STP automatically redirects traffic to the secondary link.

IP Addressing and IP Routing

Cisco offers a broad portfolio of IP routing and addressing technologies. Only some of these technologies are relevant to branch offices. To meet the design criteria in the “[Medium Branch Design Considerations](#)” section on page 4, the Services Ready Medium Branch Network was deployed with the following IP routing and addressing services enabled in the Cisco IOS software on the routers:

- [Routing Protocols, page 39](#)
- [Multicast, page 40](#)
- [DHCP, page 41](#)
- [NAT and PAT, page 41](#)

When assigning IP addresses to the various devices in the branch office, it is important to follow the IP addressing scheme and conventions set for the entire enterprise network. Today, enterprises use classless IP addressing, classless IP routing protocols, and route summarization. The Services Ready Medium Branch Network uses a private addressing scheme allocated from the 10.0.0.0/22 address pool that has 2046 available hosts. The design assumes that a single user will need two IP addresses: one for the PC and another for the IP Phone. The other addresses are used for server and network devices, or are left unallocated.

Routing Protocols

Several routing protocols are relevant to the branch office. Although there are design differences among these routing protocols, all have a common goal of stability, availability, fast convergence, and high performance. However, no one protocol is best suited for all situations, and trade-offs must be considered when deciding on the appropriate one. The following are the most common routing protocols:

- **Static routing:** Manually defined routes as next hops to various destinations. Static routes are generally used in very small networks or when the routing is managed by the service provider. In a medium branch, a static route is typically used to forward traffic to the Internet service provider network.

For more information about static routes, visit:

http://www.cisco.com/en/US/tech/tk365/technologies_tech_note09186a00800ef7b2.shtml

- **Routing Information Protocol version 2 (RIPv2):** Distance vector protocol now considered a legacy. It should be used only in small legacy networks that have little need to grow.

For more information about RIP, visit:

http://www.cisco.com/en/US/tech/tk365/tk554/tsd_technology_support_sub-protocol_home.html

- **Enhanced Interior Gateway Routing Protocol (EIGRP):** Enhanced distance vector protocol proprietary to Cisco. Unlike traditional distance vector protocols, EIGRP does not age out routing entries or uses periodic updates. The Distributed Update Algorithm (DUAL) algorithm is used to determine the best path to a destination network. The EIGRP protocol maintains a topology table that includes both the best path and any loop-free backup paths. When a route becomes unavailable, the DUAL algorithm finds the best backup path to the destination. The protocol uses bandwidth and delay to select the preferred path, and can optionally include link reliability and jitter. EIGRP works best in small to medium-sized networks that have a flat design and use only Cisco routers.

For more information about EIGRP, visit:

http://www.cisco.com/en/US/tech/tk365/tk207/tsd_technology_support_sub-protocol_home.html

- **Open Shortest Path First (OSPF):** Link state protocol standardized by IETF. OSPF floods link state information to its neighbors and builds a complete view of the network topology. The Shortest Path First (SPF) algorithm is used to determine the best path to a destination. The protocol uses bandwidth to determine the best path, or can be optionally forced to use a manually defined cost for a path. OSPF works best in networks that are large, have a hierarchical design, have a mixture of Cisco and non-Cisco routers, are expected to grow to a large scale, or require fast convergence time.

For more information about OSPF, visit:

http://www.cisco.com/en/US/tech/tk365/tk480/tsd_technology_support_sub-protocol_home.html

- **External Border Gateway Protocol (eBGP):** An exterior gateway path vector protocol. The eBGP protocol is used to exchange routing information between different autonomous systems. In general, eBGP is not used in branch routers unless there are special considerations, such as connecting to two service providers and actively using both links or when routing information needs to be exchanged with the service provider when there are downstream routers, especially for MPLS-based WANs.

For more information about eBGP, visit:

http://www.cisco.com/en/US/tech/tk365/tk80/tsd_technology_support_sub-protocol_home.html

Choosing the appropriate routing protocol in most cases depends on the routing protocol currently used in the enterprise network. Therefore, to ensure its relevance and applicability, the Services Ready Medium Branch Network was validated with all of the routing protocols listed.

In all WAN deployments, with the exception of Layer 3 Virtual Private Network (L3VPN), the enterprise manages routing. RIPv2, EIGRP, or OSPF is used to route traffic on the primary link. Both the primary and backup links have a default static route to either the PE or the ISP router. With a standby mode backup interface configuration, the backup default route is automatically inserted into the routing table only after the backup interface becomes active. With an active mode backup interface configuration, the primary default route was assigned a lower cost than the backup default route. The primary default route became active and started directing Internet traffic to the central site only after the backup link failed, and its default route was removed from the routing table.

The eBGP protocol was added to route the backup WAN link traffic. Generally, either eBGP or an IGP can be used to advertise the customer's public routes to the provider's ISP router. In the case of eBGP, the branch routers directly connected networks are distributed into the global instance of the local eBGP process. Then, an eBGP session between the branch router and the provider's ISP router is used to advertise the networks to the provider's ISP router as standard BGP updates. In the case of IGP, the protocols advertise the directly connected networks to the provider's ISP router. In general, the service provider disables routing updates from the ISP router to prevent Internet routing tables from propagating into the branch router. If this disabling is not provided, the branch router can filter out routing updates in order to minimize the size of its routing table.

VPN access by the Services Ready Medium Branch Network is accomplished by the following:

- Split Tunneling

The Services Ready Medium Branch Network provides direct access to the Internet through split tunneling. To access the Internet, NAT and PAT are used to map the branch network private addresses to public addresses. See the [“NAT and PAT” section on page 41](#). Split tunneling is accomplished by running a separate routing process for the Internet-bound traffic. There are four options for split tunneling in the Services Ready Medium Branch Network, depending on the type of VPN used for the primary link and whether the backup interface is in active or standby mode. The [“Routing Protocol Implementation” section on page 27](#) provides detailed configurations. The following are the four different options:

- Active/Standby Primary/Backup WAN links with DMVPN
- Active/Standby Primary/Backup WAN links with GETVPN
- Active/Active Primary/Backup WAN links with DMVPN
- Active/Active Primary/Backup WAN links with GETVPN

- Remote User Access

In the Services Ready Medium Branch Network, remote office workers have direct access to the DMZ VLAN over SSL VPN. The users connect to the SSL VPN gateway that is running in the branch office.

Multicast

IP multicast was enabled in the Services Ready Medium Branch Network for applications that take advantage of multicast technologies, such as video conferencing, corporate communications, distance learning, and distribution of software. Cisco Protocol Independent Multicast (PIM) was used to forward multicast traffic. The protocol leverages the router's unicast routing table populated by IGP protocols to maintain a multicast routing table that is used strictly for multicast traffic. PIM does not send routing updates, and it relies on IGP protocols to keep routing information up-to-date.

There are several modes of operation for PIM. In dense mode, the router floods multicast traffic to all interfaces except the one through which the multicast packet arrived. In sparse mode, multicast receivers request multicast traffic to be forwarded to their network segment. This information is propagated between the PIM-enabled network nodes. Sparse-dense mode allows an interface to be configured in both modes in order for different multicast groups to leverage either propagation mechanism.

To learn more about multicast, visit:

http://www.cisco.com/en/US/tech/tk828/tech_brief09186a00800a4415.html

DHCP

Dynamic Host Control Protocol (DHCP) was enabled in the Services Ready Medium Branch Network to automatically assign and manage end device IP addresses from specified address pools within the router.

When a DHCP-enabled end device is connected to the network, the end device first sends out a DHCP discovery request. Then, any available DHCP server offers a lease for an IP address to the end device. However, before the IP address can be assigned, the DHCP server must first check that no other device is currently using this same address. To perform this check, the DHCP server pings the address and waits for the response. When the end device receives a lease offer, it then returns a formal request for the offered IP address to the originating DHCP server. The server confirms that the IP address has been exclusively allocated to the end device.

To learn more about Cisco IOS DHCP server, visit:

http://cco.cisco.com/en/US/docs/ios/12_0t/12_0t1/feature/guide/Easyip2.html

NAT and PAT

To access the Internet directly from the branch office, Network Address Translation (NAT) or Port Address Translation (PAT) is needed to map the private addresses of the branch network to valid public addresses. When a packet comes to the router, NAT rewrites the source address in the IP header. The router tracks this translation. When return traffic comes back, the destination address will be rewritten to its original value. PAT adds the ability to rewrite port numbers, thereby increasing the number of times that a single public address can be used for translation. NAT and PAT were enabled to allow multiple hosts from the private branch network to access the Internet by using a single shared public IP address and various port numbers.

To learn more about NAT and PAT (also referred to as *NAT Overloading*), visit:

http://www.cisco.com/en/US/tech/tk648/tk361/technologies_tech_note09186a0080094831.shtml

Quality of Service

- [Classification and Marking, page 46](#)
- [Policing and Markdown, page 47](#)
- [Scheduling, page 47](#)
- [Shaping, page 48](#)
- [Scavenger Class QoS, page 48](#)
- [Security Services, page 48](#)

An enterprise branch must support a variety of user applications, and some applications are more sensitive than others to packet delay, loss, and jitter that exceed tolerable levels when multiple users share limited network resources. Business-critical applications tend to be sensitive to delays and packet loss, real-time applications have strict delay and jitter requirements, and other types of applications may impose additional requirements. QoS is a set of tools and techniques for managing network resources in order to provide different priorities to different applications or to guarantee them a certain level of performance.

For more information about QoS and the various tools available in Cisco IOS software see the *Enterprise QoS Solution Reference Network Design Guide* at:

http://www.cisco.com/en/US/docs/solutions/Enterprise/WAN_and_MAN/QoS_SRND/QoS-SRND-Book.html

QoS policies vary from one enterprise to another, as each policy reflects particular business and organizational objectives. To meet the business criteria outlined in the “[Medium Branch Design Considerations](#)” section on page 4, the Services Ready Medium Branch Network adopted a hierarchical QoS model that is configured to support eight classes of traffic flows. The eight-class model specifically includes voice, interactive video, call signaling, internetwork control, transactional data, bulk data, best effort, and scavenger classes, as shown in [Table 8](#). The designated classification conforms to the Cisco QoS Baseline and RFC 3246.

Table 8 QoS Eight-Class Model

Application	Layer 3 Classification			Layer 2 CoS/MPLS EXP
	IPP	PHB ¹	DSCP	
Internetwork control	6	CS6	48	6
Voice	5	EF	46	5
Interactive video	4	AF41, AF42	34, 36	4
Call signaling/ Critical Data	3	AF31, CS3	24, 25, 26	3
Transactional data	2	AF21, AF22	18, 20	2
Bulk data	1	AF11, AF12	10, 12	1
Scavenger	1	CS1	8	1
Best effort	0	0	0	0

1. PHB = per hop behavior.

Each class of traffic carries a specific service level requirement. For the eight classes selected, the requirements are as follows:

- Voice
 - Loss should be no more than 1 percent.
 - One-way latency (mouth-to-ear) should be no more than 150 ms.
 - Average one-way jitter should be targeted under 30 ms.
- Interactive Video
 - Loss should be no more than 1 percent.
 - One-way latency should be no more than 150 ms.

- Jitter should be no more than 30 ms.
 - Overprovision interactive video queues by 20 percent to accommodate bursts.
- Call Signaling/Critical Data
 - Voice control traffic requires 150 bps (plus Layer 2 overhead) per phone of guaranteed bandwidth. A higher rate may be required, depending on the call signaling protocol(s) in use.
 - Mission-critical data traffic must have an adequate bandwidth guarantee for the interactive foreground operations that it supports.
- Internetwork Control
 - IGP's are usually adequately protected with the Cisco IOS internal PAK_Priority mechanism; we recommend that EGP's such as BGP have an explicit class for IP routing with a minimal bandwidth guarantee.
- Transactional Data
 - Transaction data traffic should have an adequate bandwidth guarantee for the interactive, foreground operations it supports.
- Bulk Data
 - Bulk data traffic should have a moderate bandwidth guarantee, and should be constrained from dominating a link.
- Best Effort
 - Adequate bandwidth should be assigned to the best-effort class as a whole, because the majority of applications will default to this class; reserve at least 25 percent for best-effort traffic.
- Scavenger
 - Scavenger traffic should be assigned the lowest configurable queuing service; for instance, in Cisco IOS this would mean assigning a Class-Based Weighted Fair Queuing (CBWFQ) of 1 percent to the scavenger class.

Figure 32 shows allocation of bandwidth to the eight QoS classes. The Eight-Class QoS Model allocates bandwidth to the general traffic categories as follows:

- Real-time traffic (voice and interactive video): 28 percent
- Scavenger and bulk traffic: 7 percent
- Best effort traffic: 25 percent
- Critical data traffic: 25 percent
- Transactional Data and Internetwork traffic: 15%

Figure 32 Bandwidth Allocation for Eight-Class QoS Model

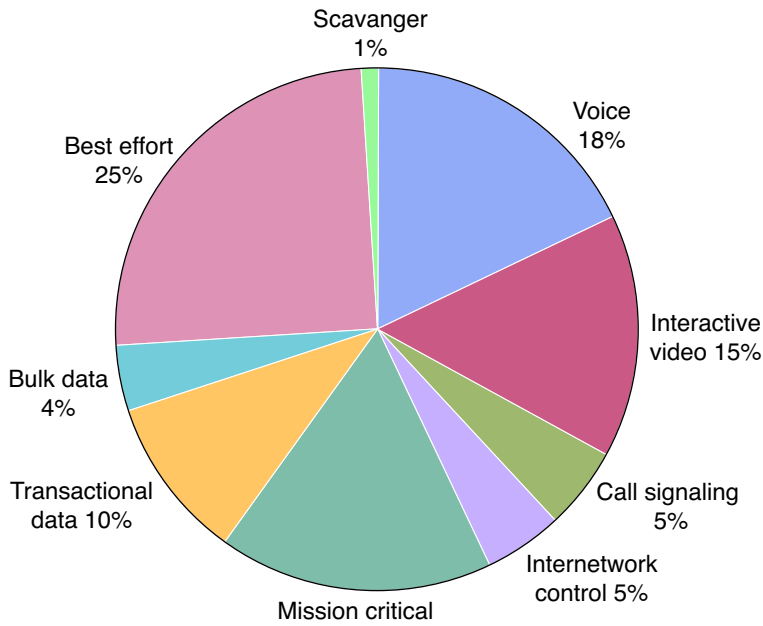

There are various ways to enable QoS in an enterprise branch network. The Eight-Class QoS policy is implemented in two logically different places in the network. A part of the policy is implemented at the access and distribution layers, and another part is implemented at the WAN edge layer. [Figure 33](#) and [Figure 34](#) shows summaries of QoS features that are part of the Services Ready Medium Branch Network and their different implementation points. This design conforms to the Differentiated Services (DiffServ) architecture, as defined in RFC 2475.

Figure 33 WAN Router

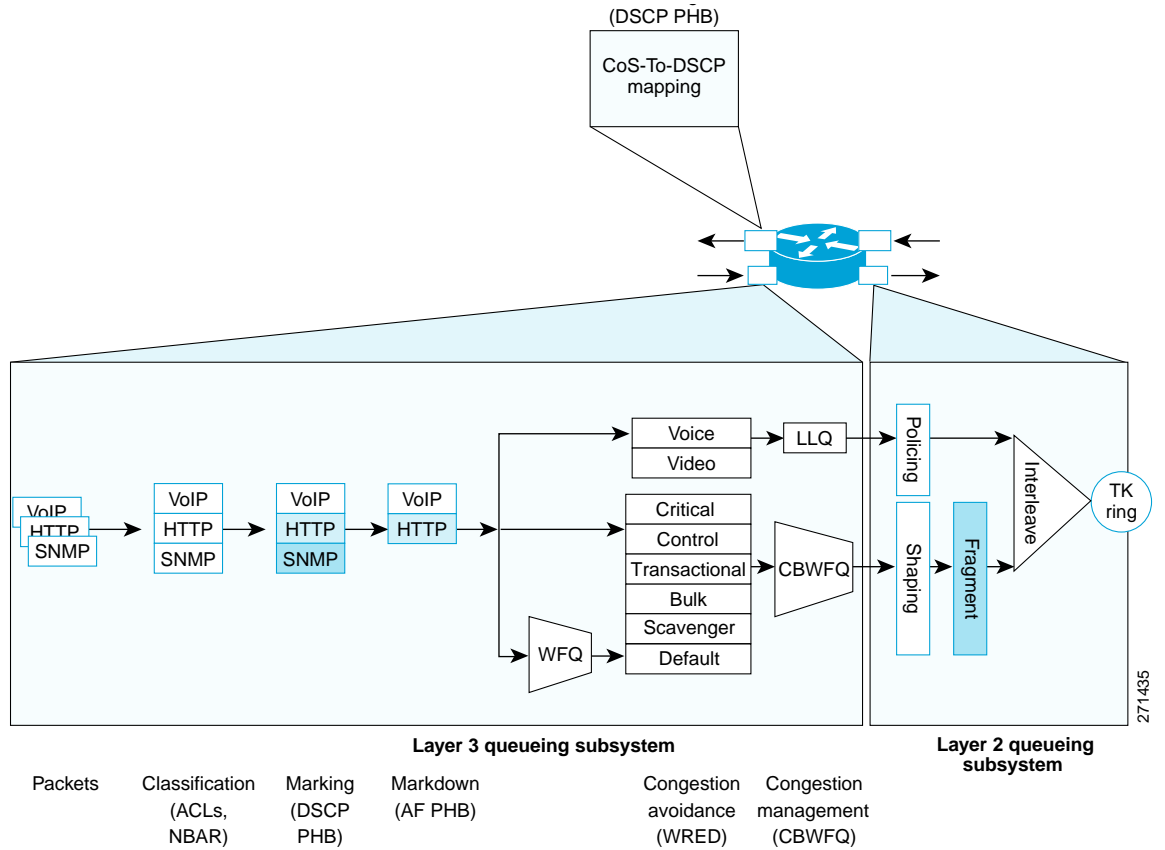
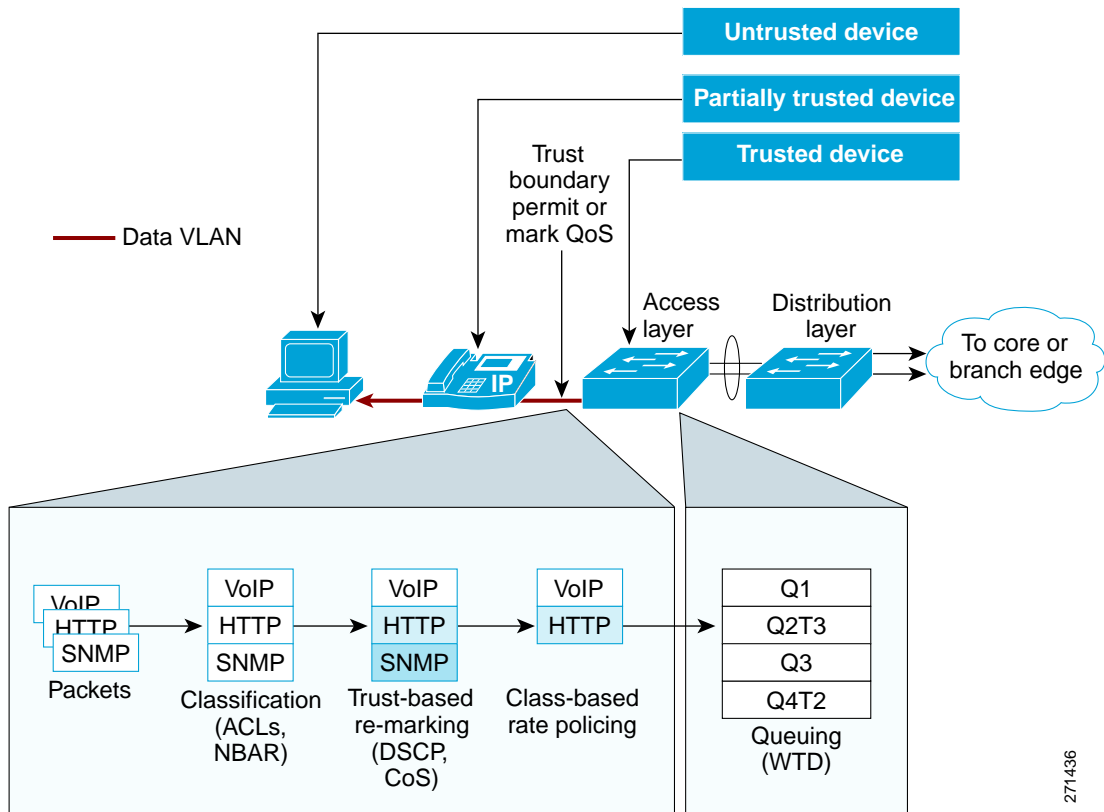

Figure 34 LAN Switch



271436

Regardless of the implementation point, the design incorporated a set of common QoS design principles. These principles are described in the following sections.

Classification and Marking

Classification identifies packets belonging to a certain traffic class, based on one or more TCP/IP header fields as defined in the Access Control List (ACL), or in application signatures via Network Based Application Recognition (NBAR). Marking tags the classified traffic by modifying either the 802.1Q/p class of service (CoS) Ethernet header field for incoming traffic or the DSCP per-hop behavior (PHB) header bits for outgoing traffic. Applications are classified and marked as close to their sources as technically and administratively feasible. Access layer switches remark all the packets coming from PC endpoints, servers, and so on, with appropriate CoS/DSCP values. Voice and signaling packets coming out of Cisco IP Phones are trusted, but all the packets coming from PCs attached to the IP Phones are re-marked. Figure 35 shows assignment of different traffic flows to corresponding DSCP PHB and 802.1Q/p CoS classes. In addition, the assignment of each class to the corresponding Catalyst 3560 queue is shown.

Figure 35 Traffic Flow to QoS Class Mapping

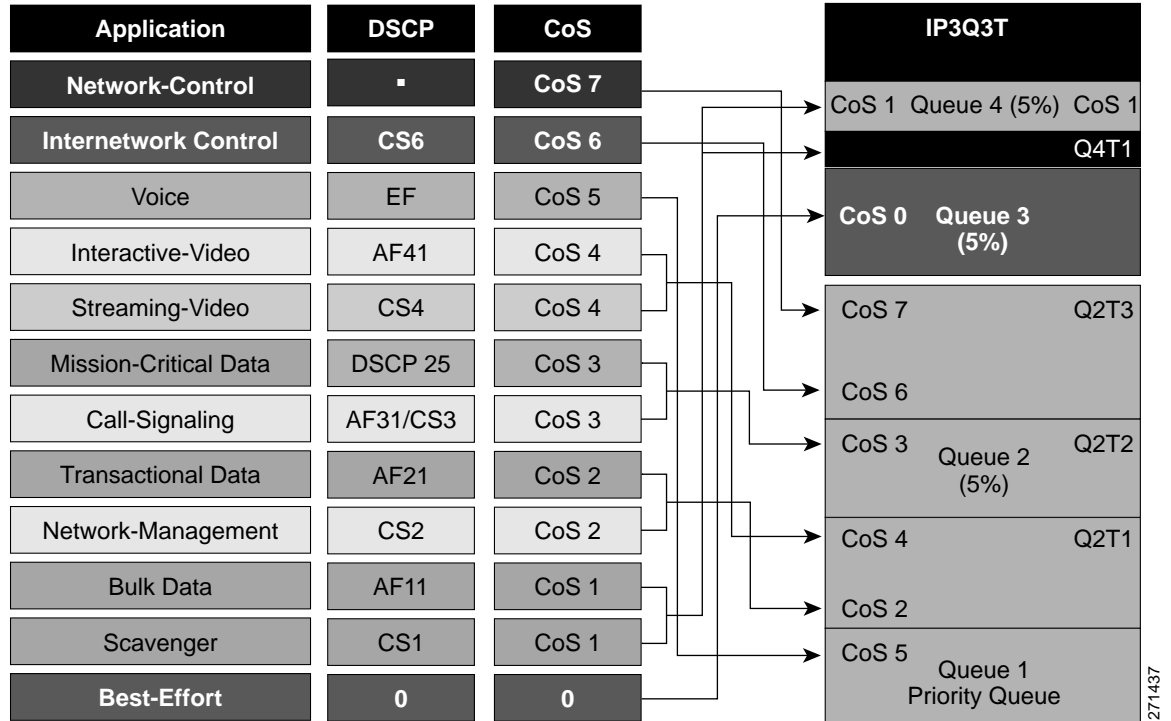

271437

Policing and Markdown

Policing determines whether packets are conforming to administratively defined traffic rates, and marks, re-marks, or drops nonconforming traffic flows. Excess traffic is marked down according to the Assured Forwarding PHB Group (RFC 2597) rules. Traffic flows are policed and marked down as close to their sources as possible. Traffic leaving access layer switches was rate limited. Policing is enabled on the outgoing WAN interface.

Scheduling

Scheduling determines how a frame or packet exits a device. The Weighted Random Early Detection (WRED) algorithm provides for congestion avoidance on network interfaces by providing buffer management and allowing TCP traffic to throttle back before buffers are exhausted. This helps avoid tail drops and global synchronization issues, thereby maximizing network utilization and TCP-based application performance.

Queuing techniques such as weighted fair queuing (WFQ), CBWFQ, and low latency queuing (LLQ) are necessary to ensure that critical applications are forwarded even during network congestion. Real-time applications such as voice or video that need to be forwarded with the least latency and jitter use LLQ. Non-delay-sensitive traffic can use CBWFQ. Best-effort data has several queues using WFQ.

Queuing comes into effect automatically only when the amount of traffic exceeds the available bandwidth.

Shaping

Shaping delays excess traffic that is above an administratively defined rate. It uses a buffer to hold packets when the data rate is higher than expected. Shaping was performed on the WAN interface.

Scavenger Class QoS

QoS can also provide network security by using scavenger class QoS. The scavenger class QoS strategy identifies known worms and attacks. Traffic patterns from that end user that are considered “unusual” or as “normal traffic but at an unusually high rate” are marked as scavenger class (CS1) in the DSCP field and allowed to pass through the switch. Through the use of the scavenger class, QoS can be used as a security mechanism to limit the arrival rate of any traffic that is destined for the firewall or Cisco IOS IPS configurations. The Services Ready Medium Branch Network also uses scavenger class QoS for excess traffic on the data VLAN.

Security Services

Security services help to protect the branch network from unauthorized, malicious, or inadvertent use of network resources. The challenge in designing the network is to find a balance between the need to keep networks open to support critical business requirements and the need to protect business-sensitive information. The Services Ready Medium Branch Network strikes this balance by using technology and best practices that provide protection against the most common security threats.

Cisco offers a large number of products, features, and recommendations for securing a network. This design blueprint focuses on security guidelines and security features for services that are integrated into the branch office router and branch office switch. For comprehensive coverage of the subject, see the *Enterprise Branch Security Design Guide* at:

http://www.cisco.com/en/US/docs/solutions/Enterprise/Branch/E_B_SDC1.html

Providing effective security starts with establishment of a security policy for the branch network. A security policy provides a set of rules by which people who have access to the network resources must abide. RFC 2196 Site Security Handbook provides a good starting point for development of a branch office security policy. In addition, SANS Institute (www.sans.org) provides guidelines for developing comprehensive security policies for enterprises of various sizes.

Security services for a medium branch office network are described in the following sections and shown in [Figure 36](#):

- [Infrastructure Protection, page 49](#)
- [Access Control, page 51](#)
- [Secure Connectivity, page 53](#)
- [Threat Protection, Detection, and Mitigation, page 60](#)

Figure 36 Security Services Building Blocks

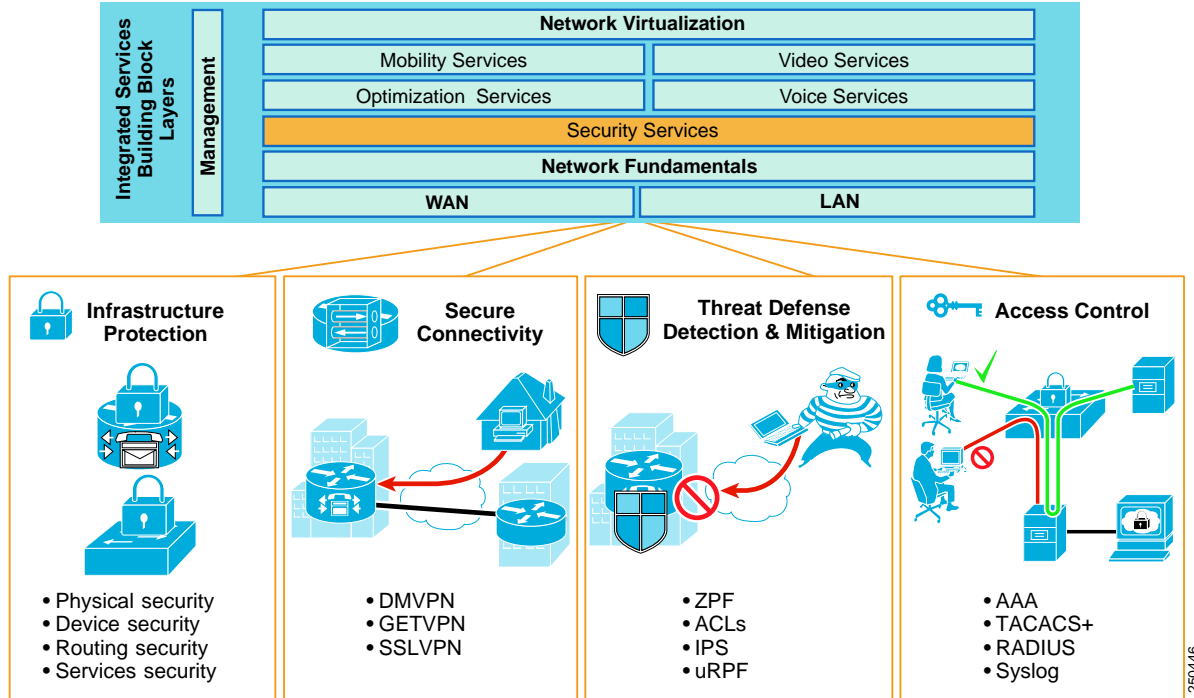

In addition to following the guidelines and implementing security features recommended in this guide, it is important to emphasize that providing security for the branch network is an ongoing activity. Security threats evolve, and vulnerabilities are uncovered almost daily. Therefore, it is critical for the branch network to undergo continuous monitoring, periodic security assessment, and policy review.

While technology can create high enough barriers to prevent security breaches, the most costly security violations tend to be caused by either low-tech methods or unauthorized employees. Therefore, it is also critical to provide physical security and to ensure that security procedures are enforced at every level in the enterprise.

Infrastructure Protection

Infrastructure protection provides proactive measures to protect the branch routers and switches from direct attacks and indirect misuse. Infrastructure protection assists in maintaining network service continuity and availability. To protect network devices, the following methods are used in the Services Ready Medium Branch Network:

- **Physical security:** Place routers and switches in a locked, temperature- and humidity-controlled room or cabinet accessible only by authorized administrators.
- **Device security:** Harden network devices.
 - **Securing unused ports:** Any ports not in use are disabled, autonegotiated trunking is turned off, and the ports are placed into the black hole VLAN.
 - **Enabling Secure Shell (SSH):** SSH is enabled and Telnet is disabled to prevent snooping and unauthorized access by unwanted parties. SSH is configured with five login retries.
 - **Enabling secure web access:** HTTPS access should be used for management applications.

- Enabling VTY, console, and AUX timeouts, and ACLs: Set all VTY, console, and AUX ports with timeouts to automatically drop any idle sessions after 300 seconds. ACLs are applied to restrict access to the network devices and permit only specific protocols for administrative and monitoring purposes.
- Providing banner message: It is a security best practice to provide a banner to inform unauthorized users that access to the device is restricted.
- Routing protocol security:
 - Configure protocol authentication: MD5 algorithm is used to authenticate routing protocol packets. In addition, RIPv2 has all interfaces, except for the primary, set to passive mode.
- Network services security:
 - Turning off unnecessary services: Turning off unnecessary services means disabling any known potentially hazardous interface features and any global services not specifically required in the network. [Table 9](#) lists services available on the branch router that should be disabled if not used.

Table 9 Router Services That Should Be Disabled If Unused

Feature	Description	Default	Action
Cisco Discovery Protocol (CDP)	Layer 2 device discovery protocol	Enabled	Disable
TCP small servers	TCP network services	Disabled	
UDP small servers	UDP network services	Disabled	
Finger	User lookup service	Disabled	
Identification service	Device identification service	Disabled	
BOOTP	Legacy service for obtaining IP addresses	Enabled	Disable
Autoloading	Autoloading of configuration from TFTP	Disabled	
Classless routing	Forwarding packets with no specific route to the best supernet route	Enabled	Disable unless required
HTTP server	Used for web-based configuration	Enabled	Disable and use HTTPS
HTTPS server	Used for web-based configuration	Enabled	Disable if not used
FTP server	Used to copy configuration files	Disabled	
DNS server	Name resolution	Enabled	Disable or enable explicit server if needed
PAD	Packet assembler/disassembler	Disabled	
IP source routing	Packet-specified routing	Enabled	Disable on all interfaces

Table 9 Router Services That Should Be Disabled If Unused (continued)

Feature	Description	Default	Action
Proxy ARP	Proxy for Layer 2 address resolution	Enabled	Disable on all interfaces
IP redirects	ICMP ¹ redirect message	Enabled	Disable on WAN interfaces
ICMP unreachable	Incorrect IP address notification	Enabled	Disable on WAN interfaces
Directed broadcast	Packet specified broadcast	Enabled	Disable on all interfaces
ICMP mask reply messages	Replies to subnet mask queries	Disabled	Disable on WAN interfaces
MOP	Maintenance Operation Protocol for loading Cisco IOS images	Disabled	

1. ICMP = Internet Control Message Protocol.

To simplify the steps for providing network device protection, the Services Ready Medium Branch Network used the AutoSecure feature of Cisco IOS software. It is a single interactive command that disables all nonessential system processes and services as previously described. In addition, it enables several services that improve security, including:

- Tuning of scheduler interval and allocation
- TCP syn wait time
- TCP keepalive messages
- ICMP unreachable messages
- Enables Cisco Express Forwarding (CEF)
- Provides antispoofing
- Blocks all IANA-reserved address blocks
- Blocks all private address blocks

To learn more about AutoSecure, visit:

http://www.cisco.com/warp/public/cc/pd/iosw/prodlit/cas11_ds.htm

Access Control

Access control is a mechanism for verifying user identity, restricting access to network resources, and auditing usage. Three independent security processes—authentication, authorization, and accounting—are used for this purpose. The processes perform the following functions:

- Provide a method for identifying users, verifying their identity, and granting/denying access to the network resources through mechanisms such as login and password or challenge and response.
- Provide a method for controlling access to network resources by authenticated users through mechanisms such as user groups, various access levels, privileges, or explicit user/group resource assignment (and vice versa).

- Provide a method for auditing the network to ensure compliance with security policies or to monitor attempts of unauthorized use.

Cisco offers several mechanisms to perform the authentication, authorization, and accounting processes independently as well as an integrated architectural framework that consistently enforces security policies across the entire network. The Services Ready Medium Branch Network used a mixture of independent mechanisms and an integrated framework to reinforce and expand access control coverage. Authentication Authorization Accounting (AAA) service is used as the integrated framework to perform the eponymous identity and access control processes.

When AAA is activated, the network device on which it is running verifies security information and reports user activity to the RADIUS or TACACS+ security server on the network. The Services Ready Medium Branch Network was validated with both RADIUS and TACACS+. The two servers provide the following functions:

- **RADIUS:** Distributed client/server system implemented through AAA that secures networks against unauthorized access. RADIUS clients run on routers and switches and send authentication requests to a central RADIUS server that contains all user authentication and network service access information.

To learn more about RADIUS, visit:

http://www.cisco.com/en/US/docs/ios/12_2/security/configuration/guide/scfrad.html

- **TACACS+:** Security application implemented through AAA that provides centralized validation of users attempting to gain access to a router or network access server. TACACS+ services are maintained in a database on a TACACS+ daemon running, typically, on a UNIX or Windows NT workstation. TACACS+ provides for separate and modular authentication, authorization, and accounting facilities.

To learn more about TACACS+, visit:

http://www.cisco.com/en/US/docs/ios/12_2/security/configuration/guide/scftplus.html

Authentication

Authentication identifies the user through a login and verifies the user's identity through a password (or challenge/response in case of a software process). Authentication is the first gate that must be crossed to gain access to the system. If the login is found, the user is identified. If the password matches, then the user's identity is verified. If the login is not found or the password does not match, then the user is denied access. The following measures were taken to provide authentication in the Services Ready Medium Branch Network:

- **Password management:** Password management ensures that only approved users can access a device or services within the network. Strong passwords that are at least 8 characters, combining letters, numbers, and symbols and avoiding dictionary words, numbers, or dates are recommended. Passwords should be changed frequently. The Services Ready Medium Branch Network uses Type 5 encryption for storing administrative passwords in the configuration file as well as the Cisco IOS password encryption feature. In addition, all devices mandate a minimum of an 8-character password length.
- **VTY, console, and AUX passwords:** All access mechanisms on all devices are guarded by administrative passwords.
- **AAA authentication:** A list of authentication methods that are applied to the various interfaces is created. The method list defines the types of authentication to be performed and the sequence in which they will be performed. All authentication methods, except for local, line password, and enable authentication, are defined through AAA.

Authorization

In the simplest terms, authorization defines the network resources accessible to an authenticated user. There are two orthogonal methods for implementing authorization. Either the user is associated with all resources accessible to that user, or a resource is associated with all users that have access to that resource. A user can have different privilege levels for a resource (for example, list, read, write, execute). To simplify management and speed up the authorization process, users are assigned to groups (for example, administrator). Group membership defines which resources can be accessed by the user. Temporal authorization provides a mechanism to grant count- or time-based access to specified resources. The following measures were taken to provide authorization in the Services Ready Medium Branch Network:

- AAA authorization: Assembles a set of attributes that describe what the user is authorized to perform. These attributes are compared to the information contained in a database for a given user, and the result is returned to AAA to determine the user's actual capabilities and restrictions. The database is located on a server at the central site. As with authentication, a named list of authorization methods is created and is applied to various interfaces.

Accounting

As the name implies, accounting tracks access by users to various resources. Accounting is used to audit the network to ensure full compliance with security policies or to identify security breaches. The following measures were taken to provide accounting in the Services Ready Medium Branch Network:

- Enabling logging: Access control of Simple Network Management Protocol (SNMP) and syslog on the router and switches is configured to ensure that there is a tracking mechanism when any unusual activity occurs. For more information about logging see the “[Management Services](#)” section on [page 63](#).
- AAA accounting: Provides a method for collecting and sending security server information used for auditing, and reporting, such as user identities, start and stop times, executed commands, and packet and byte counts. As with authentication and authorization, a named list of accounting methods is created and applied to various interfaces.

For more information about AAA, visit:

http://www.cisco.com/en/US/docs/ios/12_2/security/configuration/guide/scfaaa.html

Secure Connectivity

Secure connectivity protects against information theft or alteration of end-user data on public shared transport mediums. A Virtual Private Network (VPN) provides the means for securely and privately transmitting data over such a medium. There are two types of VPNs: provider-provisioned and enterprise-provisioned. The Frame Relay, Layer 3 VPN (L3VPN), and Layer 2 VPN (L2VPN) services described in the “[WAN Services](#)” section on [page 9](#) are examples of provider-provisioned VPNs. This section focuses on WAN-based VPN technologies in the context of a branch office, as shown in [Figure 37](#).

Table 10 *Typical VPNs Provisioned in a Medium Branch Office*

VPN Type	Advantages	Disadvantages	Appropriate for Branch
IPSec with direct encapsulation	<ul style="list-style-type: none"> • Multivendor interoperability 	<ul style="list-style-type: none"> • Limited support for mesh topology • No dynamic routing • No multicast • IP only • No QoS 	When interoperability with non-Cisco products is required
IPsec with VTI ¹ encapsulation	<ul style="list-style-type: none"> • QoS • Multicast • Dynamic routing • Lower overhead than GRE • Ease of use 	<ul style="list-style-type: none"> • Limited interoperability • IP only 	Small number of sites.
IPSec with GRE encapsulation	<ul style="list-style-type: none"> • Non-IP protocols • Multicast • QoS • Dynamic routing 	<ul style="list-style-type: none"> • Limited support for mesh topology • Overlay routing 	When non-IP protocols are required.
Easy VPN	<ul style="list-style-type: none"> • Simple configuration 	<ul style="list-style-type: none"> • No mesh topology • No dynamic routing • No multicast • IP-only 	Ease of management and simplicity of configuration are a priority.
DMVPN ²	<ul style="list-style-type: none"> • Multicast • Simpler configuration than IPsec+GRE • Small scale on-demand meshing • Easier to scale 	<ul style="list-style-type: none"> • Limited support for meshed topology • IP-only • Overlay routing • No spoke-to-spoke QoS 	<ul style="list-style-type: none"> • Internet-based primary WAN links. • Backup WAN link.

Table 10 *Typical VPNs Provisioned in a Medium Branch Office (continued)*

VPN Type	Advantages	Disadvantages	Appropriate for Branch
GETVPN	<ul style="list-style-type: none"> • Tunnel-less VPN • Full-mesh connectivity • Routing • Efficient multicast • Advanced QoS • Scalable 	<ul style="list-style-type: none"> • Public WAN deployments • IP only 	<ul style="list-style-type: none"> • Appropriate for most branch offices. • MPLS/IP WANs. • Traditional Layer 2 WANs that need added security.
SSLVPN	<ul style="list-style-type: none"> • Clientless solution • Ease of use 	<ul style="list-style-type: none"> • Limited support for application-level protocols • Lower performance than IPsec alternatives 	<ul style="list-style-type: none"> • Remote users connecting to the branch.

1. VTI = Virtual Tunnel Interface.

2. DMVPN = Dynamic Multipoint Virtual Private Network.

In addition to these general considerations, a VPN solution must meet the business criteria outlined in the “[Medium Branch Design Considerations](#)” section on page 4. Those requirements specify support for multicast and dynamic routing protocols. Because IPsec with direct encapsulation, IPsec with VTI, and Easy VPN do not support multicast and dynamic routing, they were excluded from branch office considerations. Moreover, IPsec with GRE encapsulation is a less general case of Dynamic Multipoint Virtual Private Network (DMVPN). Therefore, the only VPN solutions evaluated for the Services Ready Medium Branch Network are DMVPN, Group Encrypted Transport Virtual Private Network (GETVPN) and SSL VPN.

GETVPN is appropriate for the primary WAN link, and DMVPN is appropriate for the Internet backup link for all WAN deployment scenarios described in the “[WAN Services](#)” section on page 9. However, existing hub-and-spoke WAN designs may already have DMVPN deployed. Therefore, DMVPN was validated on the primary link for leased line, Frame Relay, and VPWS WAN services. It should be noted that leased-line, Frame Relay, and Virtual Private Wire Service (VPWS) offer a degree of data privacy by providing traffic isolation. However, it is common to add a VPN to improve overall security and to enable enterprises to meet regulatory requirements such as Health Insurance Portability and Accountability Act (HIPAA), Sarbanes-Oxley Act, and Payment Card Industry (PCI) security standards. In summary, the following VPN deployment scenarios were tested for the Services Ready Medium Branch Network:

- GETVPN on the primary link, DMVPN on the backup link, and SSL VPN for remote user access
- DMVPN on the primary link, DMVPN on the backup link, and SSL VPN for remote user access

Each VPN technology is described in more detail later in this section.

The foundation of a secure VPN is based on three independent security measures: data confidentiality, data integrity, and authentication. Each VPN solution listed in [Table 10](#) uses a different combination of technologies to provide these security measures. The following technologies are used in the Services Ready Medium Branch Network:

- Data Confidentiality: Protects data from unauthorized interception. There are two general mechanisms for providing confidentiality:

- Encryption: Reorders bits of the original message, making it incomprehensible to people not authorized to view the information. There are numerous encryption algorithms of various strengths. The following were used in the Services Ready Medium Branch Network:
 - Triple Data Encryption Standard (3DES): Symmetric encryption mechanism that uses three different keys to encrypt a message. 3DES was used with both DMVPN and GETVPN.
 - Advanced Encryption Standard (AES)-256: Symmetric encryption mechanism that uses 256-bit key for encryption. AES-256 was used with both DMVPN and GETVPN.
- Tunneling: Encapsulates original packet in a new packet and sends the composite packet over the network. The following mechanisms are used to provide tunneling:
 - Generic Routing Encapsulation (GRE): Encapsulates an original IP packet in a new IP packet whose source and destination become the two virtual endpoints of the GRE tunnel. The traffic in a GRE tunnel is not encrypted. However, GRE offers several advantages such as ability to carry both IP and non-IP traffic and the ability to support multicast. Therefore, GRE is typically placed inside an IPsec tunnel for greater security. This is the mechanism used by DMVPN.
 - IP Security (IPsec): IPsec is a framework for various security features. There are two main protocols within IPsec: tunnel mode protocol (also known as Authentication Header [AH]), and transport mode protocol (also known as Encapsulating Security Payload [ESP]). HA provides unencrypted tunneling and therefore was not used in the Services Ready Medium Branch. ESP tunneling provides both encryption and authentication. In addition, ESP encrypts the original IP header. Standalone ESP is the mechanism used by GETVPN.
- Data Integrity: Guarantees that no tampering or alteration of the data occurs while it travels between the source and destination. The following algorithms are used for both DMVPN and GETVPN:
 - Message Digest 5 (MD5): A 128-bit hash algorithm. A hashing key is produced on the original message, appended to the end, and then encrypted. The recipient recomputes the hash to detect any alterations.
 - Secure Hash Algorithm 1 (SHA-1): A 160-bit hash algorithm. SHA-1 works on the same principle as MD5.
- Authentication: Verifies the identity of both endpoints that are communicating. VPN can use a variety of methods to perform authentication, such as login and password, smart cards, or biometrics. Most typically, digital certificates are used. The services-ready method used the following VPN authentication method:
 - Preshared Key (PSK): A secret key that is shared between the endpoints using a secure channel. A PSK is entered into each peer manually, and is used to authenticate the peer. In the Services Ready Medium Branch Network, the secure channel for key exchange is provided by the following mechanism:
 - Diffie-Hellman Group 2 (DH2): 3DES and MD5 encryption and hashing algorithm with 1024-bit key

A secure communication channel between two endpoints is also referred to as a *security association* (SA). It is a security best practice to provide a lifetime limit for the SA. Typically, the lifetime is short enough to prevent attackers from gathering enough data to break the encryption ciphers. The lifetime data volume thus depends on effective bandwidth and the encryption algorithm. It is also important to frequently change encryption keys when using the preshared key infrastructure. For the Services Ready Medium Branch Network, both lifetimes are provided in [Table 11](#).

In addition to security measures, VPNs differ in the way they manage keys, provide point-to-point or multipoint communication, and allow for dynamic creation of VPN tunnels. The three VPNs used in the Services Ready Medium Branch Network offer the following functions:

- DMVPN is IPsec- and GRE-based VPN. It enables dynamic spoke-to-spoke tunnel creation in a traditional hub-and-spoke WAN design. DMVPN leverages multipoint GRE (mGRE) to establish multiple tunnel endpoints and to create an overlay non-broadcast multi-access (NBMA) network. While a traditional hub and spoke GRE configuration would require a separate tunnel between endpoints, mGRE allows multiple endpoints to have a single tunnel interface in the same subnet. Next Hop Resolution Protocol (NHRP) is used to provide tunnel-to-physical address lookup, facilitating dynamic configuration of GRE tunnels between endpoints. NHRP operates in a client/server configuration. NHRP Server typically runs on the hub, and each spoke router (NHRP Client) registers its tunnel-to-physical address mapping with the server. When a spoke wants to communicate on the NBMA mGRE subnet, it first sends a request to the NHRP Server to map a tunnel endpoint to a physical address. When the physical address is known, a GRE tunnel is established, and a regular routing process determines the path to the endpoint. Figure 38 shows DMVPN hub-and-spoke and spoke-to-spoke architecture.

Figure 38 DMVPN mGRE architecture

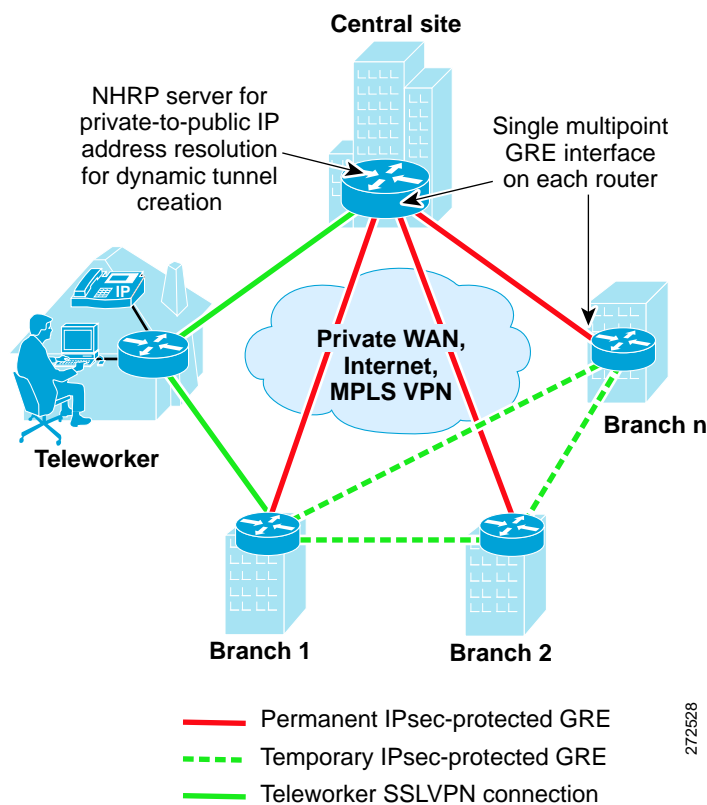

To learn more about DMVPN visit:

http://www.cisco.com/en/US/docs/ios/12_2t/12_2t13/feature/guide/ftgreips.html

- Group Encrypted Transport VPN (GETVPN) combines IPsec and Group Domain of Interpretation (GDOI) key server to encrypt traffic on a private WAN. Traditional VPN gateways directly authenticate each other and set up IPsec sessions that are private to the pair. This approach does not scale well when the network provides any-to-any connectivity or has large number of VPN gateways. GDOI server facilitates management and distribution of digital certificates or pre-shared cryptography keys. It authenticates group members and distributes keys and policies. GETVPN is a tunnelless VPN and therefore should be used in private WANs such as MPLS or traditional Layer 2 WANs. GETVPN can be used in conjunction with DMVPN or IPsec/GRE to simplify key

recurrence. Attackers can be either individuals external to the enterprise or someone within the organization. Internal attackers are much more difficult to spot and block because they have more information and more options for launching an attack. In addition, both types of attackers can use low-tech methods, such as social engineering, to gain unauthorized access. It is therefore critical to have a solid security policy for the branch office and to educate all users to follow the established security measures. Security policy was described in the “Security Services” section on page 48.

Services Ready Medium Branch Network uses the following security mechanisms to prevent external attacks:

- **Zone-based Policy Firewall (ZPF):** Prevents external threats and attacks. Firewalls provide stateful security and application inspection for each protocol entering or leaving a branch network. A stateful inspection firewall uses a combination of access control with application inspection to ensure that only approved responses get through the firewall. ZPF assigns the router interfaces to various zones and applies inspection policies to traffic flowing between the various zones. Inter-zone policies offer considerable flexibility and granularity, enabling different inspection policies for different host groups connected to the same router interface. An interface can be easily added or removed from a zone. Four security zones were defined for the Services Ready Medium Branch Network: demilitarized zone (DMZ), Public zone, VPN zone, and Private zone as shown in [Figure 41](#). The following traffic is inspected and permitted to pass:
 - From Private zone to Private zone, all traffic passes without any inspection.
 - From Private zone to Public zone HTTP, FTP, DNS, HTTPS, SSH, and ICMP traffic is inspected and allowed, but the rest of the traffic is blocked.
 - From Public zone to Private zone, no traffic is allowed.
 - From Public zone to DMZ zone, only HTTP, HTTPS, and DNS are allowed.
 - From Private zone to VPN zone, all traffic passes with inspection.
 - From VPN zone to Private zone, all traffic passes with inspection.

To learn more about Zone-based Policy Firewall, visit:

http://www.cisco.com/en/US/products/sw/secursw/ps1018/products_tech_note09186a00808bc994.shtml

Figure 41 Security Zones

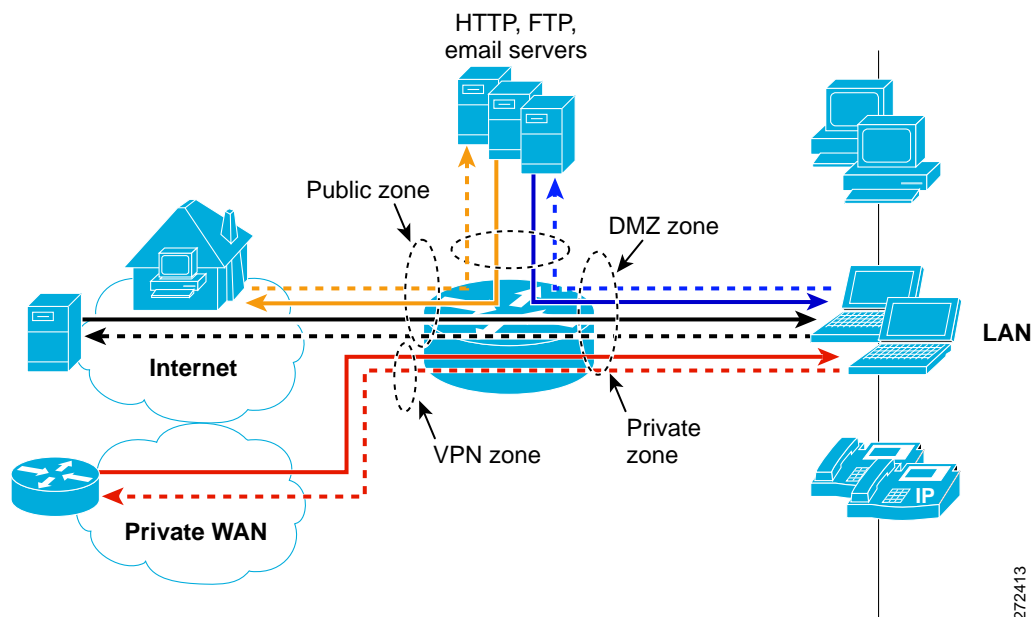

- Unicast Reverse Path Forwarding (uRPF): Leverages routing tables to validate source addresses that are expected to be seen on an interface. Packets are forwarded only if they match the router's best path to the source. This ensures that packets coming into an interface are from valid hosts that have a corresponding entry in the routing table. Packets with source addresses that cannot be reached via the input interface are dropped.

To learn more about uRPF, visit:

<http://www.cisco.com/web/about/security/intelligence/unicast-rpf.html>

The following security mechanisms are used to prevent internal threats and to control access to network resources in the Services Ready Medium Branch Network:

- Standard and extended access control lists (ACLs): Control whether a router permits or denies packets to pass, based on criteria in the packet header. Standard ACLs filter packets based on source IP address only. Extended ACLs filter packets on source and destination IP addresses, port numbers, and protocol type. ACLs are used extensively within the Services Ready Medium Branch Network to permit or deny access between the different firewall zones.
- Layer 2 security: Prevents various attacks or access violations that could be launched through the branch switches
 - 802.1x: Client-server-based access control and authentication protocol that restricts unauthorized devices from connecting to a LAN through publicly accessible ports. The authentication is provided by a RADIUS server.
 - Port Security: Switch port limits the number of MAC addresses that are able to connect to a switch, and ensures that only approved MAC addresses are able to access the switch. It prevents MAC address flooding and ensures that only approved users can log on to the network.
 - DHCP Snooping: Switch port forwards DHCP requests only from trusted access ports and drops all other types of DHCP traffic. DHCP snooping eliminates rogue devices from behaving as the DHCP server.

- Dynamic Address Resolution Protocol (ARP) Inspection (DAI): Maintains a binding table containing IP and MAC address associations dynamically populated using DHCP snooping. This feature ensures the integrity of user and default gateway information so that traffic cannot be captured. This feature mitigates ARP spoofing and ARP poisoning attacks.
- IP Source Guard: When a client receives a valid IP address from the DHCP server, or when a static IP source binding is configured by the user, a per-port and VLAN access control list (PVACL) is installed on the port. This process restricts the client IP traffic to the source IP addresses configured in the binding; any IP traffic with a source IP address except that in the IP source binding is filtered out. This filtering limits a host's ability to attack the network by claiming a neighbor host's IP address.
- Bridge Protocol Data Unit (BPDU) Guard: Prevents loops if another switch is attached to a PortFast port. When BPDU Guard is enabled on an interface, the interface is shut down if a BPDU is received on the interface. To assume the root bridge function, a device would be attached to the port and would run STP with a lower bridge priority than that of the current root bridge. If another device assumes the root bridge function in this way, it renders the network suboptimal. This is a simple form of a denial-of-service (DoS) attack on the network.

To detect and mitigate various external and internal attacks, the Services Ready Medium Branch Network uses the following mechanisms:

- Cisco Intrusion Prevention System (IPS): Monitors packets and sessions as they flow through the branch, and scans each packet to match any of the IPS signatures. When IPS detects suspicious activity, it can shunt the offending packets before network security can be compromised. When an IPS signature is matched, one or more of the following actions are taken:
 - An alarm is sent to a syslog server or a centralized management interface.
 - The packet is dropped.
 - The connection is reset.

The Services Ready Medium Branch Network is configured to take different actions depending on which attack signature is matched. An advanced signature set was used to identify various attacks. IPS is configured on all outside and inside interfaces. Traffic, regardless of whether it is a WAN link to the public or an internal LAN link, is inspected. See the “[System Testing](#)” chapter or page for the various attacks that were validated for the Services Ready Medium Branch Network.

- Network Based Application Recognition (NBAR): Recognizes certain type of attacks and drops packets involved in a denial-of-service attacks such as SQL Slammer, and worms such as CODE RED and NIMDA.

Management Services

Management services include activities related to configuration, monitoring, automation, and maintenance of a branch office network, as shown in [Figure 42](#).

Cisco Configuration Professional

Cisco Configuration Professional, shown in Figure 43, is a web-based device management tool embedded within the Cisco IOS software. Cisco Configuration Professional simplifies router, security, Unified Communications, wireless WAN, and basic LAN configuration through intelligent wizards. It enables faster configuration and monitoring of the branch router without requiring knowledge of the Cisco IOS command-line interface (CLI). In the Services Ready Medium Branch Network, Cisco Configuration Professional was used for monitoring only.

Figure 43 Cisco Configuration Professional

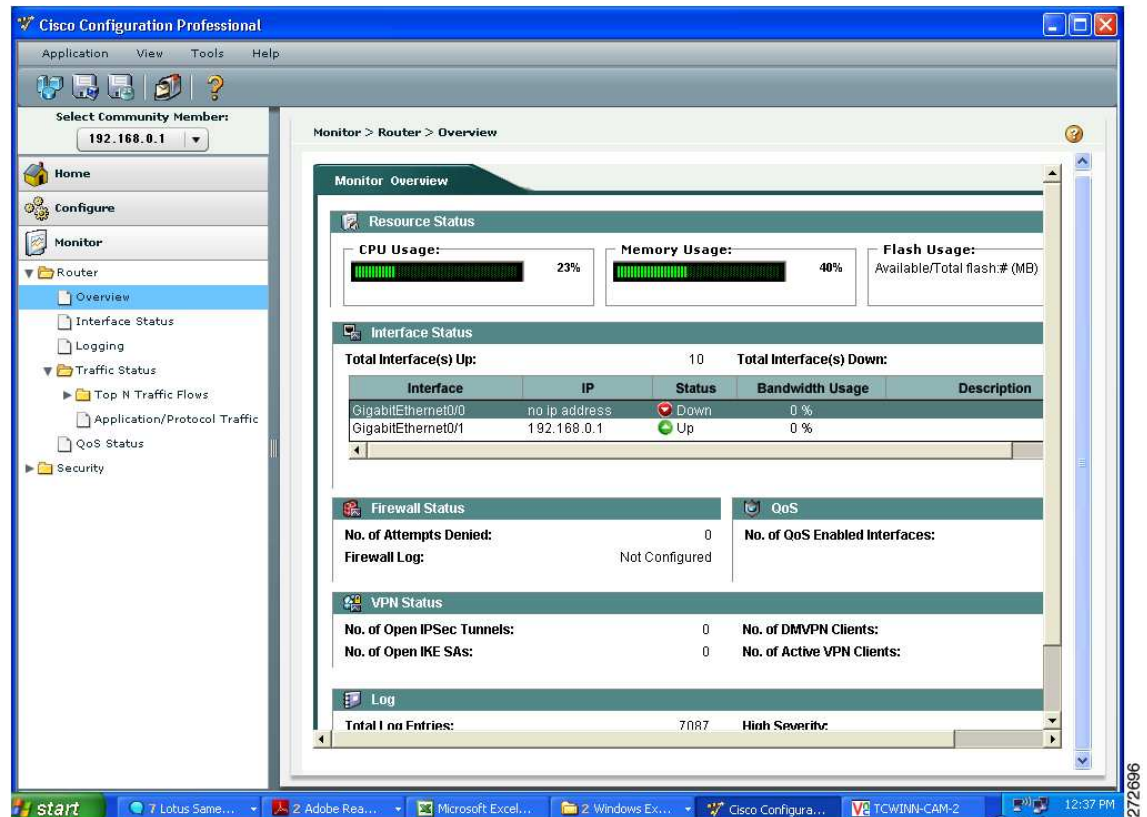

In monitor mode, Cisco Configuration Professional provides an overview of router status and performance metrics such as the Cisco IOS release number, interface status (up or down), and CPU and memory usage. The monitor mode also allows users to view the number of network access attempts that were denied by Cisco IOS Firewall, and provides easy access to the firewall log. Additionally, VPN status, such as the number of active IPsec tunnels, can be monitored.

For more information about Cisco Configuration Professional, visit:

http://www.cisco.com/en/US/prod/collateral/routers/ps9422/data_sheet_c78_462210.html

Simple Network Management Protocol

Simple Network Management Protocol (SNMP) provides a standardized framework and a common language for the monitoring and management of devices in a network. In the Services Ready Medium Branch Network, SNMP version 3 traps were enabled to log various events on the routers and switches.

To learn more about configuring SNMP visit:

http://www.cisco.com/en/US/docs/ios/12_2/configfun/configuration/guide/fcf014.html

Syslog

Syslog is a protocol for sending logging messages on a network. Various devices log status, events, alerts, and errors, using syslog components that forward the log messages to a syslog service. A syslog service simply accepts messages and stores them in files or prints them to a console. Syslog was used extensively in the Services Ready Medium Branch Network for security accounting and for monitoring the status of various devices.

To learn more about Cisco IOS software syslog messages, visit:

http://www.cisco.com/en/US/docs/ios/12_3/sem1/system/messages/123semv1.html

http://www.cisco.com/en/US/docs/ios/12_3/sem2/system/messages/123semv2.html

NetFlow

NetFlow version 9 technology is used to monitor and measure specific traffic flows and to provide an aggregate view of all network activity. With NetFlow, network administrators can view detailed time and application-specific usage of the network. This information is essential for network planning, security analysis, application optimization and delivery, and traffic engineering. A typical NetFlow record includes source and destination IP addresses, TCP/UDP port numbers, type of service (ToS), packet and byte counts, time stamps, input and output interfaces as shown in [Figure 44](#), TCP flags and routing information. NetFlow data is exported from the router to a centrally located NetFlow collection server for analysis. This typically consumes 1 to 5 percent of bandwidth. The Services Ready Medium Branch Network used Netflow version 9.

Figure 44 Data Captured by NetFlow

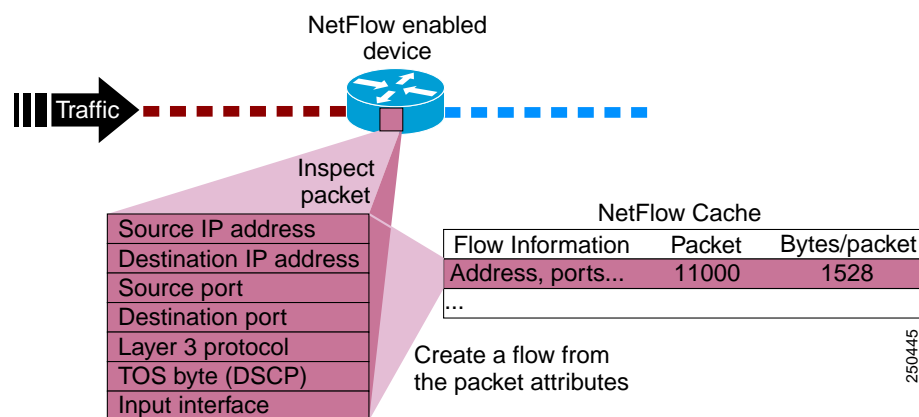

For more information about NetFlow and third-party NetFlow data analysis tools, visit:

http://www.cisco.com/en/US/prod/collateral/iosswrel/ps6537/ps6555/ps6601/prod_white_paper0900aecd80406232.html

Network Based Application Recognition

Network Based Application Recognition (NBAR) is a Cisco IOS classification engine that can recognize a wide variety of applications, including web-based applications and client-server applications that dynamically assign TCP or User Datagram Protocol (UDP) ports. After the application is recognized, the network can invoke specific services for the application. In the Services Ready Medium Branch Network, NBAR was used to support QoS features described in “[Quality of Service](#)” section on page 41. NBAR identifies and stops command worms, such as SQL Slammer, NIMDA, and Arctic, from propagating through the network.

To learn more about NBR, visit:

http://www.cisco.com/en/US/prod/collateral/iosswrel/ps6537/ps6558/ps6612/ps6653/prod_qas09186a00800a3ded_ps6616_Products_Q_and_A_Item.html

IP Service Level Agreement

The IP service level agreement (IP SLA) feature of Cisco IOS software is used to verify service guarantees, to increase network reliability by validating network performance, and to proactively identify network issues. In the Services Ready Medium Branch Network, IP SLAs were used to measure:

- End-to-end response time (delay) between the branch router and the central location router
- Packet delay variability (jitter) for traffic flowing between the branch and the central location

Both IP SLA metrics are critical to ensure high-quality voice services. To learn more about IP SLAs visit:

http://www.cisco.com/en/US/technologies/tk648/tk362/tk920/technologies_white_paper0900aecd8017f8c9_ps6602_Products_White_Paper.html

Network Time Protocol

Network Time Protocol (NTP) is used to synchronize clocks among network devices. This synchronization allows events to be correlated when system logs are created and when other time-specific events occur. All devices in the Services Ready Medium Branch Network used NTP to synchronize their clocks. The NTP server was hosted at the central site.

To learn more about NTP, visit:

http://www.cisco.com/en/US/tech/tk869/tk769/technologies_white_paper09186a0080117070.shtml

Cisco Configuration Engine

The Cisco Configuration Engine (CCE) automates installation and provisioning of Cisco devices during their initial deployment and in subsequent reconfigurations. It securely distributes software images and device configuration files to one or multiple devices on a local LAN or over the WAN. In the Services Ready Medium Network, a centrally hosted CCE server was used to distribute Cisco IOS images and device configuration files to the branch routers and switches. During the initial deployment, the primary benefit of the CCE is consistent Cisco IOS image and configuration distribution across multiple branch networks. Once the network becomes operational, the CCE provides a simple, secure, and fast way to

- T3 WAN interface with Frame Relay encapsulation, simultaneously active primary and backup WAN links, OSPF routing, GETVPN over primary and DMVPN over backup WAN links, and Cisco SRST with SIP configured IP phones and SIP trunking to central site.
- Two 24-port distribution switches configured in Cisco StackWise topology with 5 two-link EtherChannel trunks and DMZ VLAN on the access ports.
- A 48-port access switch with a two-link EtherChannel trunk and Data and Voice VLANs on the access ports

The sample CCE templates are intended to provide:

- Full and validated router and switch configurations for the Services Ready Medium Branch Network
- Alternative configurations of the various technologies of the Services Ready Medium Branch Network
- Starting points for customization of the Services Ready Medium Branch Network configuration

The Services Ready Medium Branch Network used CCE version 3.0 to deploy the branch router and switch Cisco IOS images and configurations. To learn more about CCE, visit:

http://www.cisco.com/en/US/prod/collateral/netmgtsw/ps6504/ps4617/data_sheet_c78-502925.html

Voice Services

The availability of higher bandwidth and more reliable QoS guarantees enable enterprises to combine voice and data on the same converged IP network. IP-based voice services offer new, business-relevant functionality and are more cost effective than traditional telephone services.

Today, branch offices have two fundamental options for converged telephony:

- Voice over IP (VoIP): Traditional telephony devices such as analog phones, faxes, PBXs, and public switched telephone network (PSTN) attached to an IP network. A voice-enabled router digitizes and packetizes the voice and signaling traffic from the traditional devices and transports the traffic over the IP network.
- IP Telephony: IP-based telephony devices connected to an IP network that natively digitize and packetize voice and signaling traffic. A voice-enabled router transports the traffic over the IP network.

IP telephony was the primary focus of the Services Ready Medium Branch Network. However, a small number of analog phones and fax machines were connected to the network and used for VoIP as well as traditional PSTN connectivity.

Voice services for a medium branch office network are described in the following sections and shown in Figure 46:

- [Voice Quality Considerations, page 70](#)
- [WAN Capacity Considerations, page 72](#)
- [IP Telephony, page 75](#)
- [Traditional Telephony, page 87](#)

- Delay Variability (jitter): Jitter is the difference in the end-to-end delay between packets. Cisco recommends a maximum jitter of less than 30 ms for high-quality voice.
- Packet loss: Packet loss is a relative ratio of packets successfully sent and received to the total number of packets transmitted. The amount of packet loss that can be tolerated is user-dependent; however, on average, packet loss should be kept to less than 1 percent to ensure high-quality voice service.

Table 12 summarizes packet propagation criteria that must be met to support high-quality voice.

Table 12 *Not-to-Exceed Packet Propagation Criteria for High-Quality Voice Service*

Propagation Factor	Not-to-exceed Value
Delay (Latency)	150 ms
Delay variability (Jitter)	30 ms
Packet Loss (Packet Drops)	1 percent

For more information about controlling voice quality, visit:

http://www.cisco.com/en/US/netsol/ns341/ns396/ns172/ns103/networking_solutions_white_paper09186a00801b1c5a.shtml

Another factor affecting voice quality is the codec used to digitize the voice signal. Cisco voice devices typically use the following two codecs:

- G.711: Provides encoding that does not perform any compression and requires 64 kb/s of bandwidth (not including overhead) for a single voice call. The mean opinion score (MOS), a metric used to measure voice quality, for G.711 is 4.1.
- G.729a: Provides encoding with compression and requires 8 kb/s of bandwidth (not including overhead) for a single voice call. Compression reduces the amount of required bandwidth, but affects the quality of the transmitted voice signal. However, the MOS score for G.729a is 3.9, which is a barely perceptible difference in comparison to G.711, and therefore the codec provides an acceptable tradeoff for the significant reduction in consumed bandwidth.

The selection of the appropriate codec depends on the desired level of voice quality, the amount of available bandwidth, and the number of concurrent voice calls that must be supported. In the Services Ready Medium Branch Network, the G.729a codec is used for voice calls that will traverse the WAN links because it will provide bandwidth savings on these lower-speed links. The G.711 codec is used for LAN calls. To compensate for the quality factors described previously, it is critical that QoS be enabled in the branch network. The “Quality of Service” section on page 41 provides detailed information on QoS implemented in the Services Ready Medium Branch Network. All voice traffic was given 18 percent of the available bandwidth and was assigned for low latency queuing (LLQ). Call signaling was combined with other mission-critical data and was assigned 20 percent of the available bandwidth.

Traffic shaping is required for multiple-access, nonbroadcast media such as Frame Relay, where the physical access speed varies between two endpoints and several branch sites are typically aggregated to a single router interface at the central site. Shaping at the branch router alleviates potential congestion when the central site oversubscribes bandwidth or when the branch WAN link allows bursting beyond the Frame Relay committed information rate (CIR). The Services Ready Medium Branch Network used traffic shaping to limit the traffic sent out on the WAN interfaces to a rate lower than the line rate. The specific settings for traffic shaping vary from implementation to implementation and depend on the central site router provisioning and the Frame Relay configuration. IP SLAs described in the “Management Services” section on page 63 ensured that the desired delay and jitter were maintained on the WAN link.

WAN Capacity Considerations

Three types of calls must be considered when provisioning the branch office for voice: PSTN (traditional), LAN (private exchange), and WAN (toll-bypass) calls. PSTN calls are needed for external communication, LAN calls are for intraoffice communication, and WAN calls enable communication with the rest of the enterprise. Knowing the number of PSTN calls and WAN calls helps to determine the number of voice lines and WAN bandwidth needed for the branch office. Traditionally, basic oversubscription ratios or Erlang traffic models have been used to determine the number of voice lines required for PSTN and WAN calling. Basic oversubscription ratios are typically based on call records collected from other existing offices of similar size and function, and applied to the new office. They equate the number of users to the number of PSTN and WAN calls required for calling. The business criteria outlined in the [Medium Branch Design Considerations, page 4](#) specified the following oversubscription ratios:

- 5:1 user-to-active call ratio
- 4:1 WAN-to-LAN call ratio
- 4:1 WAN-to-PSTN call ratio

[Table 13](#) lists the requirements of the number of active calls for three sample office sizes.

Table 13 Active Calls for Typical 50-, 75-, and 100-User Branch Offices, Using Oversubscription Ratios

Active Calls	50-User Branch	75-User Branch	100-User Branch
WAN	5	8	10
PSTN	3	4	5
LAN	3	4	5
Total calls	11	16	20

Alternatively, an Erlang traffic model can provide a more accurate method for determining the number of external voice lines (PSTN and WAN) required for a branch office. There are several variants of the Erlang model, depending on the intended telephone use in the branch office. The following example uses the Extended Erlang B to determine the number of voice lines required for the Services Ready Medium Branch Network.

The Extended Erlang B traffic model takes into account the additional traffic load caused by blocked callers that immediately try to call again if their calls are blocked. The four variables involved are recall factor, busy hour traffic (BHT), blocking, and lines:

- Recall factor: Percentage of calls that immediately retry if their calls are blocked.
- Busy hour traffic (BHT): Number of hours (in Erlangs) of call traffic during the busiest hour of operation of a telephone system.
- Blocking: Failure rate of calls because of an insufficient number of available lines. For example, 0.03 means three calls blocked per 100 calls attempted.
- Lines: Total number of external lines needed.



Note

An *Erlang* is a unit of measurement of voice traffic. Strictly speaking, an Erlang represents the continuous use of one voice path or line. In practice, it is used to describe the total traffic volume in one hour.

If an average user calls for 12 minutes during the busy hour, external calls account for 10 minutes of those calls (or 10 min/60 min/hr = 0.17 Erlang), half of blocked calls immediately retry, blocked calls are no more than 3 percent of total calls, there is a 4:1 WAN-to-LAN call ratio, and there is a 4:1 WAN-to-PSTN call ratio, the Extended Erlang B calculator at <http://www.erlang.com/calculator/exeb/> suggests the total number of external lines for 50-, 75-, and 100-user branch office as shown in Table 14.

Table 14 Active Calls for Typical 50-, 75-, and 100-User Branch Offices, Using Extended Erlang B Traffic Model

Active Calls	50-User Branch	75-User Branch	100-User Branch
Busy Hour Traffic (Erlangs)	9	13	18
WAN	10	14	18
PSTN	4	5	6
LAN	4	5	6
Total calls	18	24	30

The critical assumption in the Extended Erlang B model is the amount of BHT per user (0.17 Erlang in the preceding example), which varies between enterprises, and even between branch offices within an enterprise. Therefore, Table 14 is provided only as an example. The Services Ready Medium Branch Network used active call counts derived from the oversubscription ratios shown in Table 13.

Real-time Transport Protocol (RTP) is the primary protocol for transporting real-time traffic such as voice or interactive video. The minimum amount of bandwidth required to place a given number of calls over the WAN can be derived from the number of RTP streams. The size of each RTP stream depends on the WAN type, the associated encapsulations (Frame Relay, PPP, MLPP, Ethernet, IPsec, GRE), and the voice sampling rate. Figure 47 shows packet size for a G.729a RTP packet with DMVPN encapsulation. Figure 48 shows the packet size for G.729a RTP packet with GETVPN encapsulations.

Figure 47 RTP Packet for G.729a Codec with DMVPN Encapsulation

ESP Auth	ESP Pad	Voice Payload	RTP	UDP	IP	GRE	GRE IP	ESP IV	ESP	IPSecIP	Link Header
12	2-257	20	12	8	20	4	20	8	8	20	x
Bytes											

272664

Figure 48 RTP Packet for G.729a Codes with GETVPN Encapsulation

ESP Auth	ESP Pad	Voice Payload	RTP	UDP	IP	ESP IV	ESP	IP	Link Header
12	2-257	20	12	8	20	8	8	20	x
Bytes									

272665

An RTP packet contains 40 bytes of RTP and UDP header information. Because most information in these headers is identical (for example, the same source/destination IP address/UDP port numbers and the same RTP payload type), compressed RTP (cRTP) can be used to eliminate redundant header information in each frame. Using cRTP reduces the 40-byte header to only 2 or 4 bytes, allowing more calls to be placed over the same link speed. Table 15 shows sample bandwidth requirements for RTP and

cRTP streams with the various Services Ready Medium Branch Network WAN encapsulations. The Cisco Voice Codec Bandwidth Calculator that was used to calculate the necessary bandwidth requirements is available at:

<http://tools.cisco.com/Support/VBC/do/CodecCalc1.do>,

Although cRTP reduces the amount of required bandwidth, it is a CPU intensive process that may impact the overall performance of the router. Therefore, cRTP is appropriate only when voice traffic represents more than 33 percent of the load on the link, when the link uses a low bit-rate codec (such as G.729), and when no other real-time application (such as video conferencing) is using the same link.

Table 15 Bandwidth Requirement for a Single Call with Various WAN Encapsulation Methods

	Frame Relay, PPP, MLPP		Ethernet	
	RTP (kbps)	cRTP (kb/s)	RTP (kb/s)	cRTP (kb/s)
DMVPN	56	40	60	N/A
GETVPN	46	30	50	N/A

The Services Ready Medium Branch Network used cRTP to minimize bandwidth consumption only on the 4 T1 connections; other WAN connection types used RTP. However, it should be noted that the 4T1 link does not require cRTP to support up to 100 users with the oversubscription ratios provided previously. In the Services Ready Medium Branch Network, cRTP was validated for completeness and demonstration purposes only. The QoS model allocates 18 percent of bandwidth to voice traffic. Table 16 shows the amount of bandwidth required for voice communication and the total bandwidth that is required to support branch offices of 50, 75, and 100 users with various WAN encapsulation methods. The total number of active voice calls is derived from the oversubscription ratios shown in Table 13. In general, each call has two streams for audio traffic; one stream from caller to callee, and another stream in the reverse direction.

Table 16 Bandwidth Requirements for Voice Traffic and Total Bandwidth for a Services Ready Medium Branch Network with 50, 75, and 100 User Counts

	Frame Relay, PPP, MLPPP				Ethernet	
	RTP Voice (Mbps)	RTP Total (Mb/s)	cRTP Voice (Mp/s)	cRTP Total (Mb/s)	RTP Voice (Mb/s)	RTP Total (Mb/s)
50-User Services Ready Medium Network (5 simultaneous WAN calls)						
DMVPN	0.27	1.2	0.2	0.85	0.29	1.27
GETVPN	0.22	1.0	0.15	0.64	0.24	1.06
75-User Services Ready Medium Network (8 simultaneous WAN calls)						
DMVPN	0.44	1.9	0.31	1.36	0.47	2.04
GETVPN	0.36	1.56	0.23	1.02	0.39	1.7
100-User Services Ready Medium Network (10 simultaneous WAN calls)						
DMVPN	0.55	2.38	0.39	1.7	0.59	2.55
GETVPN	0.45	1.95	0.29	1.27	0.49	2.12

Table 16 shows that the following user counts are appropriate for the various WAN connection options of the Services Ready Medium Branch Network:

- T3/E3 line: Up to 100 users with RTP
- 4 T1 lines: Up to 100 users with RTP
- 1000BASE-LX/LH GigE shaped to 12 Mb/s: Up to 100 users with RTP

Besides considering provisioning of bandwidth for voice bearer traffic, you should consider bandwidth requirements for call control traffic. For centralized call control described below, the following calculations can be used to determine the amount of required bandwidth in a VPN network:

- SCCP Phone Traffic with VPN:

Bandwidth (bps) = 415 * (number of IP Phones and gateways in the branch)

- SIP Phone Traffic with VPN:

Bandwidth (bps) = 619 * (number of IP Phones and gateways in the branch)

A 100-user Services Ready Medium Branch Network requires less than 50 kb/s for SCCP phone traffic, and 75 kb/s for SIP phone traffic, which is well below the 5 percent maximum assumed in the preceding calculations and well below the 20 percent maximum allocated through the QoS mechanism.

For the local call control described below the following calculation can be used to determine the amount of required bandwidth in a VPN network:

Bandwidth (b/s) = 116 * (number of telephone lines)

A 100-user Services Ready Medium Branch Network requires less than 16 kb/s for H.323 or SIP control traffic, which is also well below the 5 percent maximum assumed in the above calculations and well below the 20 percent maximum allocated through the QoS mechanism.

In most cases, an Internet-based backup link (for example, xDSL) does not provide enough bandwidth and link quality to support voice traffic. Therefore, the Services Ready Medium Branch Network uses PSTN as the backup link for voice traffic.

To learn more about voice communication in a VPN network see the *Voice and Video Enabled IPsec VPN (V3PN) Design Guide* at:

http://www.cisco.com/en/US/docs/solutions/Enterprise/WAN_and_MAN/V3PN_SRND/V3PN_SRND.html

IP Telephony

- [Centralized Call Control, page 76](#)
- [Local Call Control, page 77](#)
- [Selecting a Call Control Model, page 78](#)
- [IP Phones, page 79](#)
- [Voice Gateway, page 79](#)
- [Call Admission Control, page 83](#)
- [Conferencing and Transcoding, page 85](#)
- [Music on Hold, page 86](#)
- [Dial Plan, page 86](#)
- [Voice Mail and Auto Attendant Services, page 87](#)

Table 17 **Trade-offs Between Centralized and Local Call Control Models**

Factor	Centralized Model	Local Model
WAN link characteristics	Needs more bandwidth and is more sensitive to link delay	Needs less bandwidth and is less sensitive to link delay
High availability	Impacted by WAN link failure	No WAN dependencies
Feature set	More features	Fewer features
Scalability	Scales better	Scales poorly
Management	Centralized	Per-branch office

When deciding between the two deployment models, you must consider the overall enterprise voice deployment and any existing voice systems already in use. The Services Ready Medium Branch Network was validated with both centralized call control using Cisco Unified CM with Cisco Unified SRST and with local call control using Cisco Unified CME.

IP Phones

Cisco IP Phones described in the “[Selecting Network Components](#)” section on page 3 can operate in either Skinny Call Control Protocol (SCCP) or Session Initiation Protocol (SIP) mode. The main trade-off between SCCP and SIP is in the functionality supported and third-party interoperability. SCCP is a Cisco proprietary protocol with a large number of Cisco voice products supporting its various features. SIP, on the other hand, is based on an open standard and has been adapted by a larger number of VoIP vendors. The Services Ready Medium Branch Network has been tested with both SIP and SCCP phones, with both the centralized call control model and the local call control model.

In addition to the IP Phones described previously, the Services Ready Medium Branch Network also uses Cisco IP Communicator, a software-based application that runs on a PC. The Cisco IP Communicator, shown in [Figure 52](#), only uses SCCP for call signaling.

Figure 52 Cisco IP Communicator



To learn more about the Cisco IP Communicator product, visit:

http://www.cisco.com/en/US/prod/collateral/voicesw/ps6788/phones/ps5475/product_data_sheet0900aec8064efe0.html

Voice Gateway

Both VoIP and IP telephony networks require a gateway to convert voice and signaling information between the traditional PSTN system and an IP-based system. The gateway must interpret PSTN analog or digital signaling to provide connectivity. A Cisco IOS voice gateway provides a full range of signaling options. Analog signaling and Basic Rate Interface (BRI)-based digital signaling provide PSTN

connectivity for branch offices with a relatively small number of users. Only T1 or E1 digital voice trunks support the required number of users in a medium branch office. Table 18 displays the various Cisco IOS digital signaling options that pertain to the Services Ready Medium Branch Network.

Table 18 Cisco IOS Software Support for High Density Digital Signaling Protocols

Signaling	Description	Typical Use
T1 CAS	Channel Associated Signaling	Used widely in North America to connect to the PSTN or PBXs. Several variations of this signaling exist, including T1 FXS, T1 FXO, and T1 E&M. T1 FXS and T1 FXO support loop start and ground start signaling. T1 E&M signaling supports delay dial, wink, and immediate dial.
T1 FGD	Feature Group D	The T1 CAS variations generally cannot convey caller ID, but T1 FGD can convey caller ID. It is used to connect to the PSTN where caller ID is required and where PRI is not an option. T1 FGD is an asymmetric protocol.
T1/E1 PRI	ISDN Primary Rate Interface	An ISDN connection to the PSTN carrying 23 (T1) or 30 (E1) simultaneous voice calls, introducing the terms $23B+D$ and $30B+D$. T1/E1 PRI uses the Q.931 ISDN specification. Calls are controlled via a dedicated signaling channel (D channel).
T1 PRI NFAS	Nonfacility Associated Signaling	A variation of PRI available only on T1 that uses a single D channel to control multiple spans of T1s with only B channels (voice calls).
E1 R2	Regional System 2 (R2) CAS protocol	Used in South America and Asia for PSTN connectivity. There are numerous country-specific variations of the R2 protocol.

The Services Ready Medium Branch Network used a T1 PRI trunk to connect the branch network to the PSTN. The T1 connection is provided by the local telephone company and runs to the nearest central office (CO) in the area. In future updates to this guide, some of the other options listed in Table 18 will be validated and documented. The following interface card was used to connect to the PSTN and to provide the T1 PRI trunk:

- 1 Port T1/E1 Multiflex Trunk Voice/WAN interface card (VWIC2-1MFT-T1/E), shown in Figure 53.

Figure 53 1 Port T1/E1 Multiflex Trunk Voice/WAN Interface Card



The VWIC2-1MFT-T1/E1 interface card provides up to 23 individual PSTN channels. Both oversubscription ratio and Extended Erlang B calculations, provided in [Table 13](#) and [Table 14](#) respectively, show that a typical medium branch office does not require more than 6 PSTN lines. Therefore, only a fractional T1 connection is necessary to meet the requirements of the Services Ready Medium Branch Network outlined in the “[Medium Branch Design Considerations](#)” section on [page 4](#). Consequently, only a fractional T1 line with 6 channels each were connected to the router. The router also provides connectivity for analog phones and faxes.

To learn more about the Multiflex Trunk Voice WAN Interface Card, visit:

http://www.cisco.com/en/US/prod/collateral/routers/ps5855/product_data_sheet0900aec8028d2db.html

Digital signal processor (DSP) technology provides voice compression, echo cancellation, tone generation, and voice packetization functions for servicing voice interfaces and converting voice signals for transport over IP networks. A digital PSTN voice port must have access to DSP resources in order to digitize and packetize the analog signal coming from the PSTN line. In the Services Ready Medium Branch Network, the DSP resources were provided by the router because the VWIC2-1MFT-T1/E1 card has no DSPs. The number of required DSP modules depends on the amount and type of voice traffic in the branch. [Table 19](#) shows the number of required packet voice DSP modules (PVDMs) for branch offices with various active call requirements. The number of PSTN calls corresponds to the number of estimated active calls calculated from oversubscription ratios, as shown in [Table 13](#). Transcoding, conferencing, and analog phone/fax connectivity are described in later sections. The DSP calculator is available at:

http://www.cisco.com/cgi-bin/Support/DSP/cisco_dsp_calc.pl.

Table 19 *DSP Requirements for Various Voice Configurations, Assuming G.711 Encoding and Fax Pass-through*

Configuration	3 PSTN calls, 4 analog devices, 1 transcoding sessions, 1 conference calls	4 PSTN calls, 4 analog devices, 2 transcoding sessions, 1 simultaneous conference calls	5 PSTN calls, 4 analog devices, 3 transcoding sessions, 2 simultaneous conference calls
Number of onboard DSPs	2	3	3
PVDMs	PVDM2-16 + PVDM2-8	PVDM2-32 + PVDM2-8	PVDM2-32 + PVDM2-8

The Services Ready Medium Branch Network uses 3 DSPs with the PVDM2-32 and PVDM2-8 modules. The PVDM2-32 and PVDM2-8 modules, which are similar to PVDM2-64 module shown in [Figure 54](#), support up to 4 G.711 channels or 20 channels for medium-complexity codecs, such as G.729a or Fax Relay.

Figure 54 64-Channel Packet Fax/Voice DSP Module

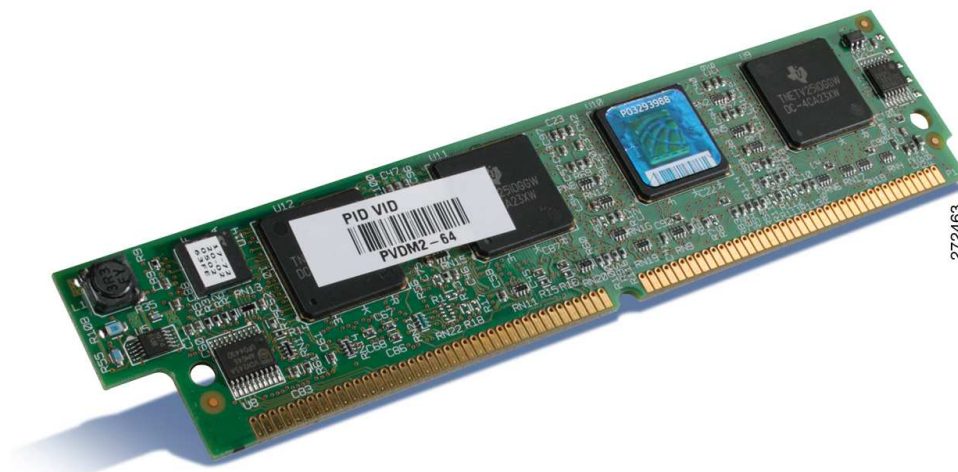

Besides physical connectivity and signal conversion, you must consider other PSTN services when configuring the voice gateway. The T1 PRI signaling mechanism that was selected for the Services Ready Medium Branch Network supports the following PSTN services:

- Direct Inward Dial (DID): Enables callers to dial directly to an extension without the assistance of an operator or automated call attendant. In the Services Ready Medium Branch Network, several users, the main office, and the PSTN voice mail access have DID numbers. Calls to other users in the office terminate on an automated attendant.
- Traditional fax services continue to be a widely used mechanism for document delivery. Physical integration of fax into the Services Ready Medium Branch Network is described in the [“Analog Device Connectivity” section on page 87](#). In addition to physical connectivity of fax machines, the voice gateway must support a mechanism for interoperability of analog fax with IP telephony networks.

In its original form, fax data is digital and is contained in High-Level Data Link Control (HDLC) frames. However, to transmit across a traditional PSTN, these digital HDLC frames are modulated onto an analog carrier. While this analog carrier is necessary for effective faxing in PSTN environments, it is not ideal for the type of digital transport used by IP packet networks. Therefore, specific transport methods have been devised for successful transport of fax transmissions over an IP infrastructure.

The two main methods for transporting fax over IP are pass-through and relay. Pass-through is the simplest method. It works by sampling and digitizing the analog fax signal just as a voice codec does for human speech. While there are a number of codecs available, pass-through always uses the G.711 codec for carrying fax information because it offers the least distortion of the analog fax signals. Fax pass-through works only with the call control protocols of H.323 and SIP. Because fax pass-through utilizes the call control protocol for its switchover, this is the only pass-through solution that can work with third-party devices.

Relay is the other main method for transporting fax over IP. Relay strips off the analog carrier from the fax signal, in a process known as *demodulation*, to expose the fax HDLC data frames. The pertinent information in these HDLC frames is then removed and efficiently packaged in a fax relay protocol to be transported to the gateway on the other side. After it is received on the other side, the fax information is pulled from the relay protocol, reconstructed into fax HDLC frames, and modulated on to an analog carrier for transmission to a fax machine.

Cisco supports two versions of Fax Relay, T.38 and Cisco Fax Relay. An ITU standard, T.38 allows Cisco gateways to interoperate with third-party devices that also support the T.38 specification. In most scenarios, T.38 Fax Relay uses the call control protocol to switch from voice mode to T.38 fax relay mode. Fax Relay mode, and more specifically T.38, is the preferred method for transporting fax traffic. The Services Ready Medium Branch Network used both T.38-based fax relay and fax pass-through.

Two VoIP-enabled endpoints must use a common protocol stack to perform speech coding, call setup, signaling, data transport, and other functions related to voice communication. To ensure its relevance and applicability, The Services Ready Medium Branch Network was validated with the following VoIP protocol stacks:

- **H.323:** Defines a suite of protocols, algorithms, and hardware specifications for audiovisual communication over IP-based network. The suite provides a complete protocol stack and defines precisely what is allowed and what is forbidden. H.323 includes speech coding algorithms such as G.711; RTP-based data transport; RTCP for controlling data channels; H.225 protocol for registration, admission, and status control; Q.931 call signaling protocol; and H.245 call control protocol.
- **Session Initiation Protocol (SIP):** Defines a protocol for setting up audiovisual connections over an IP network. Unlike H.323, which provides a complete protocol stack, SIP is a single, extensible module that has been designed to interwork with existing network-based applications. It is a text-based protocol modeled on HTTP.
- **Skinnny Client Control Protocol (SCCP):** Lightweight protocol used to set up calls between Cisco IP Phones and a voice gateway proxy (for example, Cisco Unified CME). The proxy communicates with the H.323 gateway, using H.225 and H.245 signaling, and the IP Phone using the SCCP protocol. The IP Phone requires less processing overhead because most of the H.323 processing resides in the proxy.

The choice between H.323 and SIP depends on the enterprise and is often based on feature requirements as well as interoperability with existing systems (for example, PBX, voicemail). In the Services Ready Medium Branch Network, the following four combinations of call control agent, IP Phone protocol, and gateway-to-gateway protocol were validated:

- Cisco Unified CME with SCCP endpoints and H.323 trunk
- Cisco Unified CME with SIP endpoints and SIP trunk
- Cisco Unified SRST with SCCP endpoints and H.323 trunk
- Cisco Unified SRST with SIP endpoints and SIP trunk

Call Admission Control

Call Admission Control (CAC) maintains high voice quality over an IP WAN by limiting the number of calls that are admitted. Traditional telephony circuits, in which physical channels limit the number of calls allowed to connect to the PSTN, do not have this requirement. When VoIP calls traverse an IP WAN, calls are packet streams and there are no physical limitations that control the number of calls admitted to the WAN link. An IP WAN link can easily be oversubscribed, and the voice quality of all connected calls can be degraded, as shown in [Figure 55](#).

Figure 55 Traditional Versus VoIP Call Admission Control

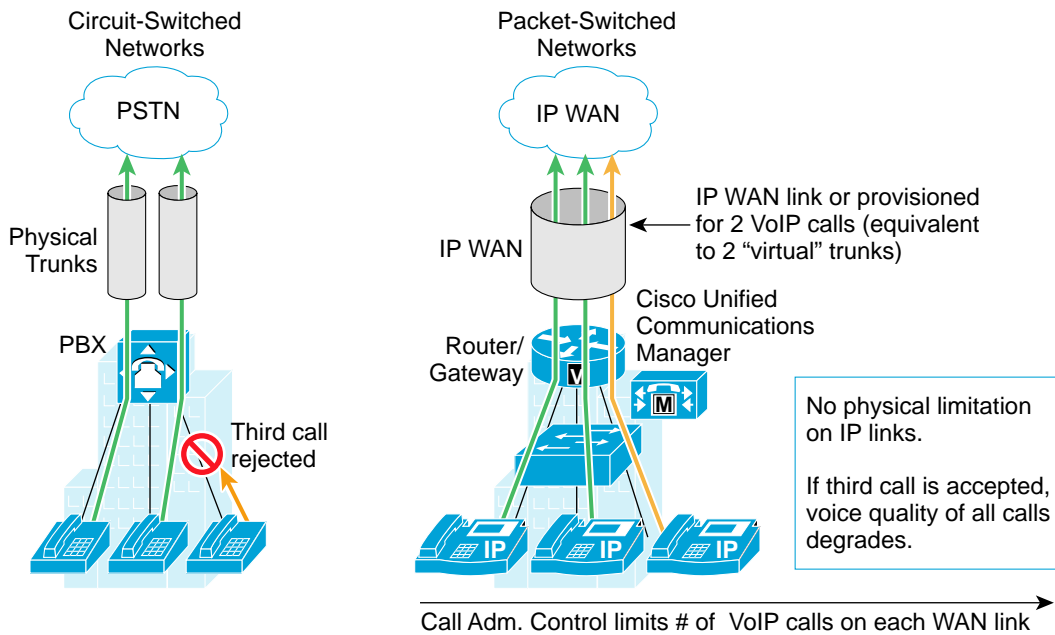

Resource Reservation Protocol (RSVP) is a mechanism for dynamically setting up end-to-end QoS across a heterogeneous network. A resource reservation is created by exchanging signaling messages between the source and destination devices that are processed by intermediate routers along the path. The signaling messages "reserve" bandwidth at the intermediate routers for each unidirectional data flow. RSVP can propagate RSVP requests across routers that do not support the protocol. There are two operational models for RSVP, as described below and shown in [Figure 56](#).

- **IntServ:** Controls resource reservation at both control and data planes. In the control plane, RSVP admits or denies the reservation request. In the data plane, it classifies the data packets, polices them based on the traffic description contained in the RSVP messages, and queues them in the appropriate queue.
- **IntServ/DiffServ:** Controls resource reservation at the control plane only. This means that the CAC function is separate from the scheduling and policing functions, which can be performed by the low latency queuing (LLQ) algorithm according to predefined class maps, policy maps, and service policies. With the IntServ/DiffServ model, it is therefore possible to add RSVP CAC to a network that is already using a differentiated services approach to QoS. RSVP admits or rejects calls, based on a preconfigured bandwidth amount, but the actual scheduling is based on the preexisting LLQ criteria such as the DSCP value of each packet.

272458

Figure 56 RSVP Operational Models: IntServ and IntServ/DiffServ

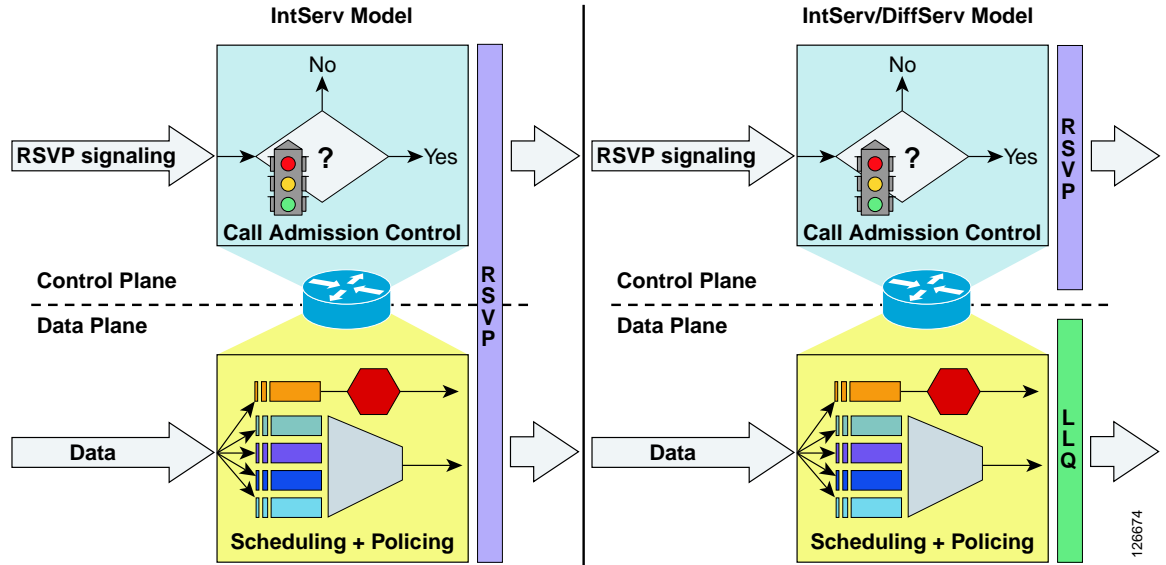

The Services Ready Medium Branch Network used the IntServ/DiffServ RSVP mechanism to control the number of calls placed on the network, but relied on the established QoS policy explained in the [“Quality of Service” section on page 41](#) to control actual packet scheduling. This model is appropriate for the Services Ready Medium Branch Network because all LLQ-destined traffic is controlled by RSVP.

At present, RSVP is supported only in the centralized call control model with Cisco Unified SRST. To simulate the function of RSVP for the local call control model with Cisco Unified CME, a simple maximum call limit was placed on the WAN voice gateway.

Conferencing and Transcoding

Conferencing joins multiple participants into a single call. The number of media streams connected to a conference corresponds to the number of participants. A conference bridge mixes the streams together and creates a unique output stream for each connected participant. The output stream for a given participant is the composite of the streams from all connected participants minus their own input stream. The conference bridge is controlled by Cisco Unified CM or Cisco Unified CME. A conference bridge is allocated from the onboard DSPs. The Services Ready Medium Branch Network was designed to support two simultaneous conferencing sessions. Cisco Unified CME provides conferencing locally through the branch router, while the centralized call control model leverages the conferencing functionality of the Cisco Unified CM in the central site.

Transcoding converts an input stream from one codec into an output stream that uses a different codec. It may also connect two streams that utilize the same codec but with a different sampling rate. Transcoding is typically used to convert between a G.711 voice stream and the low bit-rate compressed voice stream G.729a. The Services Ready Medium Branch Network used transcoding to support endpoints that are configured for G.711 only. This condition exists when G.729a is used in the system but there are devices that do not support this codec, or there is a device with G.729a support that may be configured to not use G.729a. The Services Ready Medium Branch Network was designed to support up to three simultaneous transcoding sessions.

The G.711 codec was used for LAN calls to maximize call quality and the G.729a coded was used for calls that traverse a WAN to maximize bandwidth efficiency. The G.729a codec is supported on all Cisco Unified IP Phone models and therefore G.711 to G.729a transcoding is not required.

Music on Hold

Music on hold (MOH) provides music to callers when their call is placed on hold, transferred, parked, or added to an ad-hoc conference. The integrated MOH feature allows both internal and external users to place users on hold with music streamed from a streaming source. There are two types of MOH transport mechanism: unicast and multicast. The Services Ready Medium Branch Network used unicast to transport MOH data in the local call control mode (Cisco Unified CME). In the case of centralized call processing, multicast is used to transport MOH data. Multicast MOH consists of streams that are sent from the MOH source to a multicast group IP address, to which endpoints requesting an MOH audio stream can join. A multicast MOH stream is a point-to-multipoint, one-way audio RTP stream between the MOH source and the multicast group IP address. Multicast MOH conserves system resources and bandwidth because it enables multiple users to use the same audio source stream.

In the case of SCCP phones, the multicast was enabled on the branch router. In the case of SIP phones, multicast was configured at the central Cisco Unified CM, and the branch router simply forwarded the traffic as it would any other multicast application.

In the Services Ready Medium Branch Network, the MOH source was an audio file stored on the branch router, except for the centralized deployment option with SIP phones.

Dial Plan

The dial plan is one of the key elements of an IP telephony system, and is an integral part of all call control agents. Generally, the dial plan is responsible for instructing the call control agent on how to route calls. Specifically, the dial plan in the Services Ready Medium Branch Network performs the following functions:

- Endpoint addressing: Reachability of internal destinations is provided by assigning directory numbers (DNs) to all endpoints (such as IP Phones, fax machines, and analog phones) and applications (such as voice mail systems, auto attendants, and conferencing systems).
- Path selection: A secondary path can be used when the primary path is not available. The secondary path is made by rerouting over the PSTN during an IP WAN failure.



Note Cisco Unified CME does not support path selection.

- Digit manipulation: In some cases, it is necessary to manipulate the dialed string before routing the call; for example, when rerouting over the PSTN, a call originally dialed using the access code, or when expanding an abbreviated code (such as 0 for the operator) to an extension.

Additional functions are possible and will be validated in the future update to this guide:

- Calling privileges: Different groups of devices can be assigned to different classes of service by granting or denying access to certain destinations. For example, lobby phones might be allowed to reach only internal and local PSTN destinations, but executive phones could have unrestricted PSTN access.
- Call coverage: Special groups of devices can be created to handle incoming calls for a certain service according to different rules (top-down, circular hunt, longest idle, or broadcast).

The automated alternate routing (AAR) feature enables Cisco Unified CM to establish an alternate path for the voice data when the preferred path between two endpoints within the same cluster runs out of available bandwidth, as determined by the locations mechanism for call admission control. If a phone in one branch calls a phone in another branch, and the available bandwidth for the WAN link between the branches is insufficient, then AAR reroutes the call through the PSTN.

Voice Mail and Auto Attendant Services

All voice mail in the Services Ready Medium Branch Network is stored locally in the branch for both centralized and distributed call control models. The Cisco Unity Express network module shown in [Figure 57](#) was used for voice mail services. Cisco Unity Express provides cost-effective voice and integrated messaging and automated attendant for enterprise branch offices with up to 240 users. The Cisco 3945 ISR used the Cisco Unity Express network module, shown in [Figure 57](#), while the Cisco 3925 ISR used the advanced integration module (AIM) form factor, as shown in [Figure 58](#).

Figure 57 Cisco Unity Express Network Module



Figure 58 Cisco Unity Express Advanced Integration Module



Traditional Telephony

In the Services Ready Medium Branch Network, traditional telephony is used to provide traditional fax services, emergency response, and call backup options as described in the following sections.

Analog Device Connectivity

There are various reasons to continue using some forms of traditional telephony in a branch office. For example, fax services continue to be widely used, and analog phones connected directly to a voice gateway can provide a backup of last resort. The Services Ready Medium Branch Network used the following voice interface card for connecting traditional voice devices into the network:

- 4-port FXS/DID Voice Interface Card (VIC-4FXS/DID)

There are four FXS ports on the VIC-4FXS/DID card shown in [Figure 59](#). The ports were used for connecting a mixture of analog phones and faxes.

Figure 59 *Four Port FXS/DID Voice Interface Card*



Emergency Services

Emergency services are of great importance in a proper deployment of a voice system. The Services Ready Medium Branch Network was validated with the 911 emergency network as deployed in Canada and the United States. The design and implementation described are adaptable to other locales. Please consult with your local telephony network provider for appropriate implementation of emergency call functionality.

In general, a local exchange carrier has a dedicated network for the 911 service. In the Services Ready Medium Branch Network, the T1 PRI trunk connected the branch to the 911 service managed by Public Safety Answering Point (PSAP). In this configuration, the voice gateway provides emergency response location (ERL) and emergency location identification (ELIN) number.



Note

Advanced Emergency Services with ERL and ELIN information are currently supported only with Cisco Unified SRST. Cisco Unified CME implements 911 services by forwarding the call to a PSTN without any additional information.

To learn more about Emergency Services see:

http://www.cisco.com/en/US/docs/voice_ip_comm/cucm/srnd/6x/e911.html

Optimization Services

This section covers the following optimization services topics:

- [Selecting a Cisco WAE Module, page 91](#)
- [Cisco WAAS General Design Considerations, page 92](#)
- [Cisco WAAS High-Availability and Rapid Recovery Considerations, page 93](#)
- [Cisco WAAS Security Considerations, page 93](#)
- [Cisco WAAS Management Considerations, page 94](#)

Limited bandwidth, high latency, packet drops, and frequent congestion limit the performance of client/server applications that communicate over the WAN. Because of these unfavorable WAN link characteristics, enterprises have traditionally opted to deploy distributed applications and enterprise middleware in the branch offices to ensure adequate performance. However, running applications in the branch offices increases management costs, complicates disaster recovery, and hampers regulatory compliance. Today, more and more enterprises are turning to WAN and application optimization technologies to deploy client/server applications over the WAN with a LAN-like performance.

The Cisco Wide Area Application Services (Cisco WAAS) technologies and products give enterprise branches LAN-like access to centrally hosted applications, servers, storage, and multimedia services. Cisco WAAS provides the enterprise branch with application delivery, acceleration, WAN optimization, and local service solutions to optimize performance of any TCP-based application in a WAN or metropolitan area network (MAN) environment. The Cisco WAAS software solution runs on the Cisco Wide Area Application Engine (Cisco WAE) family of hardware platforms. In general, there are three types of optimization services:

- WAN optimization: Provides mechanisms for improving performance of TCP based applications. Three techniques are widely used to optimize TCP applications:
 - Compression: Cisco WAAS uses a persistent version of the Lempel-Ziv (LZ) lossless compression algorithm.
 - TCP Optimization: Cisco WAAS uses an optimized version of TCP known as Transport Flow Optimization (TFO).
 - Caching: Cisco WAAS uses a data redundancy elimination (DRE) technique to cache duplicated data patterns.
- Application acceleration: Provides mechanisms for reducing “chattiness” of enterprise applications or protocols
 - Application based: Cisco WAAS provides adapters for optimizing specific applications (video, e-mail)
 - Protocol based: Cisco WAAS provides adapters for optimizing specific application layer protocols (SSL)
- Wide Area File Services: Provide faster access to files stored on a network file system.
 - Object caching: Cisco WAAS caches or pre-positions entire files and keeps the local copy synchronized to ensure accuracy.
 - Request prediction: Cisco WAAS inspects Common Internet File System (CIFS) and Network File System (NFS) messages and prefetches data by predicting follow-on requests.

Cisco WAAS offers different deployment options at the branch, as shown in [Figure 60](#).

Figure 60 Cisco WAAS Deployment Options

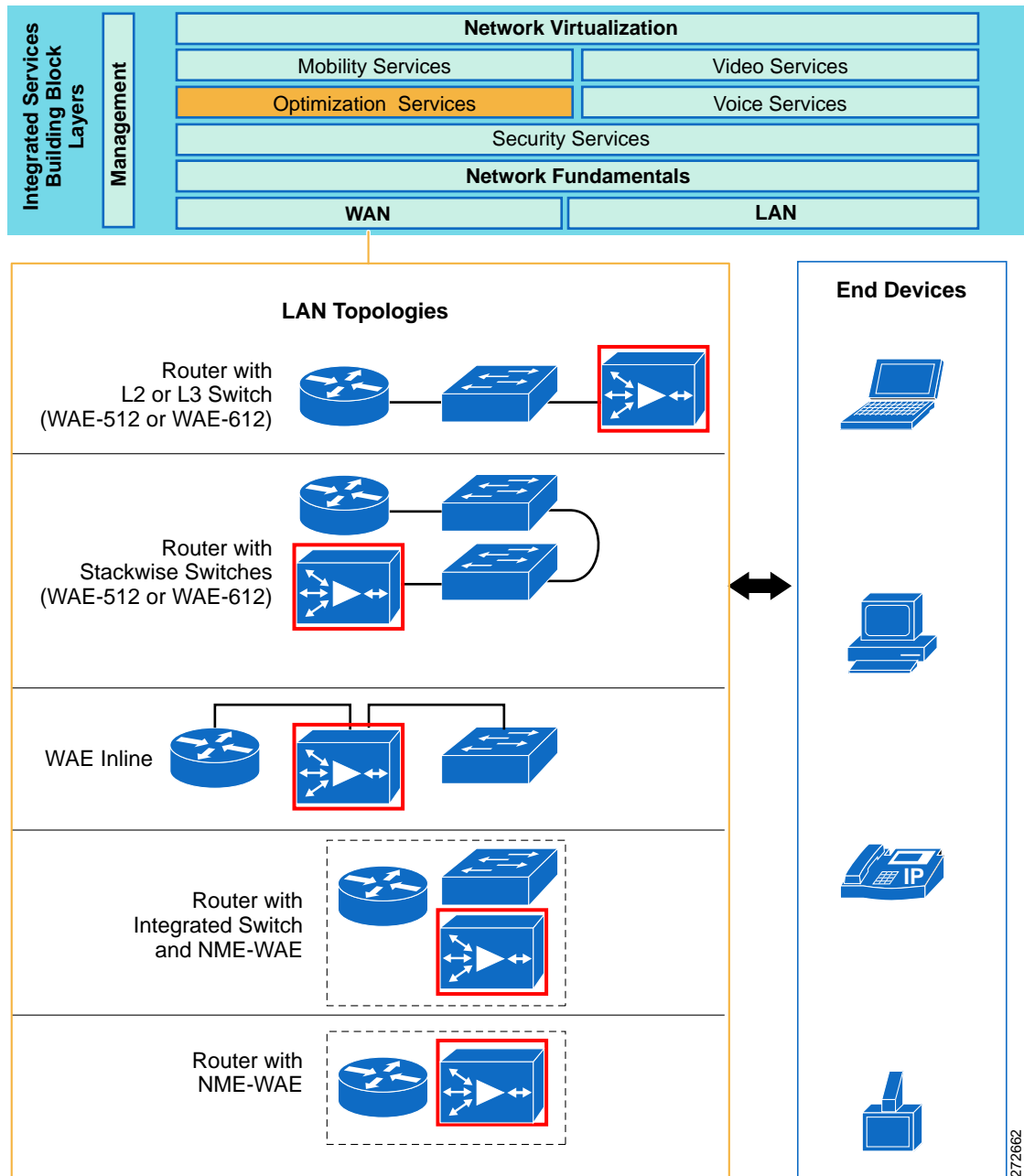

The Services Ready Medium Branch Network focuses on services that are integrated into the branch router. Designs featuring standalone Cisco WAE appliances are not considered in this guide. However, designs with standalone Cisco WAE appliances are equally viable and are described in the *Enterprise Branch Wide Area Application Services Design Guide* at:

<http://www.cisco.com/en/US/docs/solutions/Enterprise/Branch/WAASBr11.html>.

Moreover, the Services Ready Medium Branch Network features an integrated EtherSwitch service module; therefore, only the integrated Cisco WAE with the integrated switch, shown in Figure 60, was evaluated.

272662

Selecting a Cisco WAE Module

Cisco WAAS is a symmetric solution that requires one Cisco WAE device in the branch and another at the central site. This guide focuses on Cisco WAE deployment in the branch. Selection, design, and configuration of the central site Cisco WAE are not considered in this guide. For more information on Cisco WAAS central site deployment, see the *Cisco Enterprise Data Center Wide Area Application Services (Cisco WAAS) Design Guide* at:

http://www.cisco.com/en/US/docs/solutions/Enterprise/Data_Center/WAASDC11.html

Table 20 lists and compares three Cisco WAE network module models that can be deployed in the Cisco 3900 ISRs.

Table 20 Cisco WAE Feature Comparison

Cisco Device	Max Optimized TCP Connections	Max CIFS Sessions	Drive Capacity (GB)	RAM (GB)	Max Recommended WAN Links	Max Optimized Throughput (Mb/s)	Optimization
NME-WAE-302	250	N/A	80	0.5	4	90	LZS, TFO, DRE
NME-WAE-502	500	500	120	1	4	150	LZS, TFO, DRE, applications, and protocols
NME-WAE-522	750	750	160	2	8	200	LZS, TFO, DRE, applications, and protocols

Only the Cisco NME-WAE-522 network module supports enough concurrent TCP connections and WAN bandwidth to meet the needs of a 50- to 100-user branch office. Therefore, NME-WAE-522, shown in Figure 61, was the only module validated for the Services Ready Medium Branch Network. Two types of software licenses are available for the Cisco NME-WAE-522 network module:

- Transport license: Provides the WAN optimization features including Data Redundancy Elimination (DRE), Lempel-Ziv (LZ) compression, and Transport Flow Optimizations (TFO).
- Enterprise license: Includes the transport license functions plus application-specific accelerations such as Common Internet File System (CIFS) services and print services, disk encryption, and TCP Flow Agent for NetQoS integration.

The Enterprise license was used in the Services Ready Medium Branch Network.

- Static mode: Uses policy-based routing (PBR)

Cisco WCCP is the preferred mechanism for interception and redirection because it is easier to configure, supports high availability, and provides clustering capabilities. To meet the design criteria in the [“Medium Branch Design Considerations” section on page 4](#), the Services Ready Medium Branch Network used only Cisco WCCPv2. Cisco WCCP is a Cisco IOS software feature that enables routing platforms to transparently redirect traffic. It provides several configuration options for traffic handling and distribution to the two Cisco WAE engines in the Services Ready Medium Branch Network. The configuration involves:

- Traffic forwarding mechanism: Cisco WCCP traffic is forwarded to the Cisco WAE module using either GRE encapsulation or Layer 2 (L2) redirection. L2 redirection is more appropriate when Cisco WAAS is deployed as an external appliance connected to a switch; therefore, only GRE encapsulation was used in the Services Ready Medium Branch Network.
- Traffic redirection: Cisco WCCP uses service groups to redirect traffic for further processing to the appropriate Cisco WAE module. These service groups are determined by the web cache and configured for identification by Cisco WCCP. The Cisco WAAS TCP promiscuous mode uses Cisco WCCP service groups 61 and 62 for traffic redirection. Service group 61 is in the path of packet flow for one direction, and service group 62 is in the path of packet flow for the opposite direction.
- Intelligent traffic filtering: Application traffic policies (ATPs) are defined to optimize only specific types of application traffic. All other traffic is pass-through. The following traffic was optimized in the Services Ready Medium Branch Network:
 - HTTP
 - FTP
 - CIFS

The NME-WAE-522 network module has an internal interface through the router backplane and an external Fast/Gigabit Ethernet interface on the faceplate of the module. The internal interface is the recommended mode for deployment unless special considerations require the external interface. The Services Ready Medium Branch Network used only the internal interface.

None of the WAN deployment scenarios described in the [“WAN Services” section on page 9](#) required modification of the default Cisco WAAS TFO transmit/receive buffers.

Cisco WAAS High-Availability and Rapid Recovery Considerations

- Cisco WAAS offers several mechanisms to guarantee rapid error recovery: Cisco WAAS DRE cache is persistent and loosely synchronized, enabling quick recovery in the event of a reboot or software restart.
- Cisco WAAS Device Manager offers the ability to back up individual devices for fast restore onto a standby/replacement device.

Cisco WAAS Security Considerations

Zone-based Policy Firewall was configured to support Cisco WAAS traffic. The Cisco WAE network module was placed into the Private zone of the firewall. Traffic from and to Cisco WAAS was encrypted and decrypted before moving to and from the VPN zone.

Cisco WAAS Management Considerations

Cisco WAAS Central Manager was used to configure the two Cisco WAE network modules. See the [“System Implementation”](#) chapter on [page 1](#).

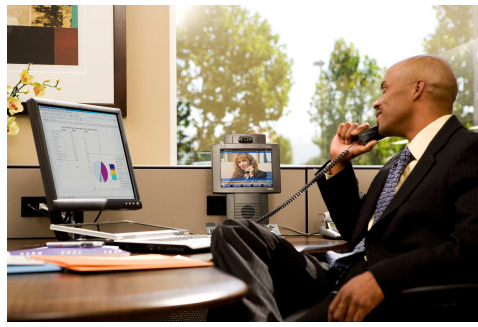

System Implementation

Revised: November 6, 2009

This section describes the information you need to configure the Cisco 3900 Series Integrated Services Routers Generation 2 (ISRs G2) branch routers, Catalyst 3560 switch, and EtherSwitch service module used in the Services Ready Medium Branch Network.



Note

Use the [Command Lookup Tool \(registered customers only\)](#) for more information on the commands used in this document.

The full configuration of the Cisco 3900 Series ISR that was used for validating the features described in this guide is provided in the [Services Ready Medium Branch Network Toolkit](#).

Contents

- [Network Topology, page 1](#)
- [WAN Services Implementation, page 4](#)
- [LAN Services Implementation, page 10](#)
- [Network Fundamental Services Implementation, page 25](#)
- [Security Services Implementation, page 43](#)
- [Voice Services Implementation, page 91](#)
- [Optimization Services Implementation, page 140](#)
- [Caveats, page 147](#)

Network Topology

[Figure 1](#) shows the components of the Services Ready Medium Branch Network test bed. The topology includes the following components:

Enterprise Headquarters

- Web servers
- File servers

- Print servers
- PC clients
- Cisco 7200 Series VXR routers
- Cisco Secure ACS
- Catalyst 3560 and Catalyst 6500 switches
- IP Phones
- Cisco Unified Communications Manager (Cisco Unified CM)
- Cisco Wide Area Application Engine (Cisco WAE) 512
- Cisco Configuration Engine server

Enterprise Branch

- Cisco 3925 and Cisco 3945 ISRs
- Cisco 3560 switches and EtherSwitch service module
- Cisco Unified IP Phones 7942G, 7945G, 7961G, 7962G, 7965G, 7971G, and 7985G
- Cisco Unified IP Conference Station 7936
- PC clients
- Demilitarized zone (DMZ) servers
- Analog telephones and faxes

Figure 1 Services Ready Medium Branch Network Test Bed

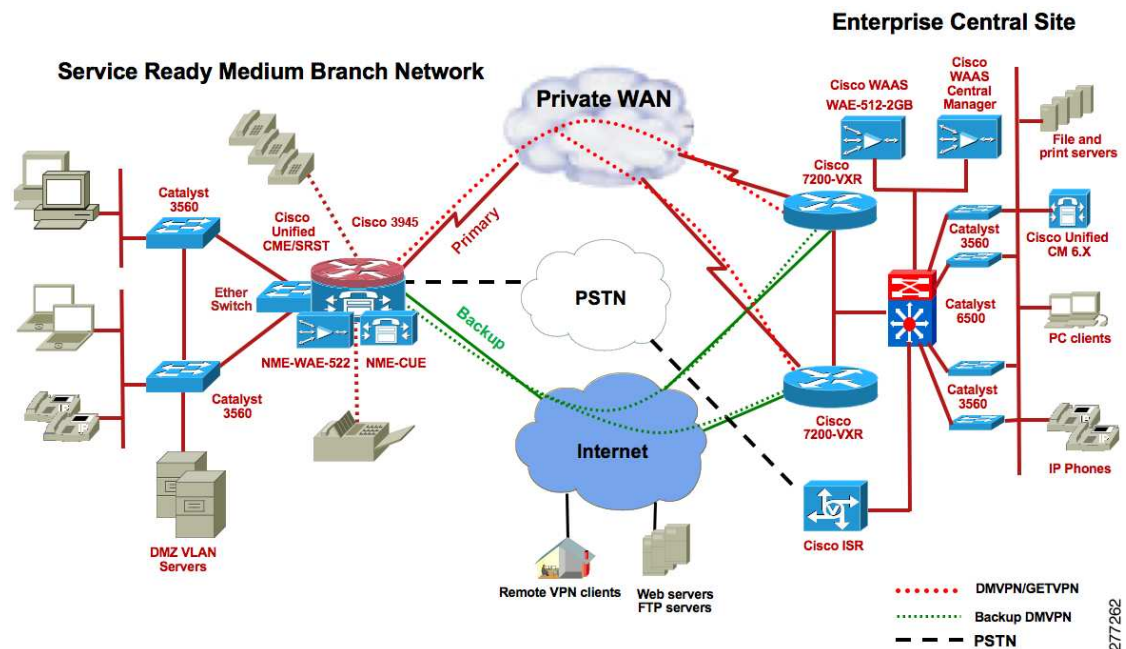

Figure 2 shows the detailed topology, interface assignment, and IP addressing scheme.

277262

Figure 2 Services Ready Medium Branch Network Topology

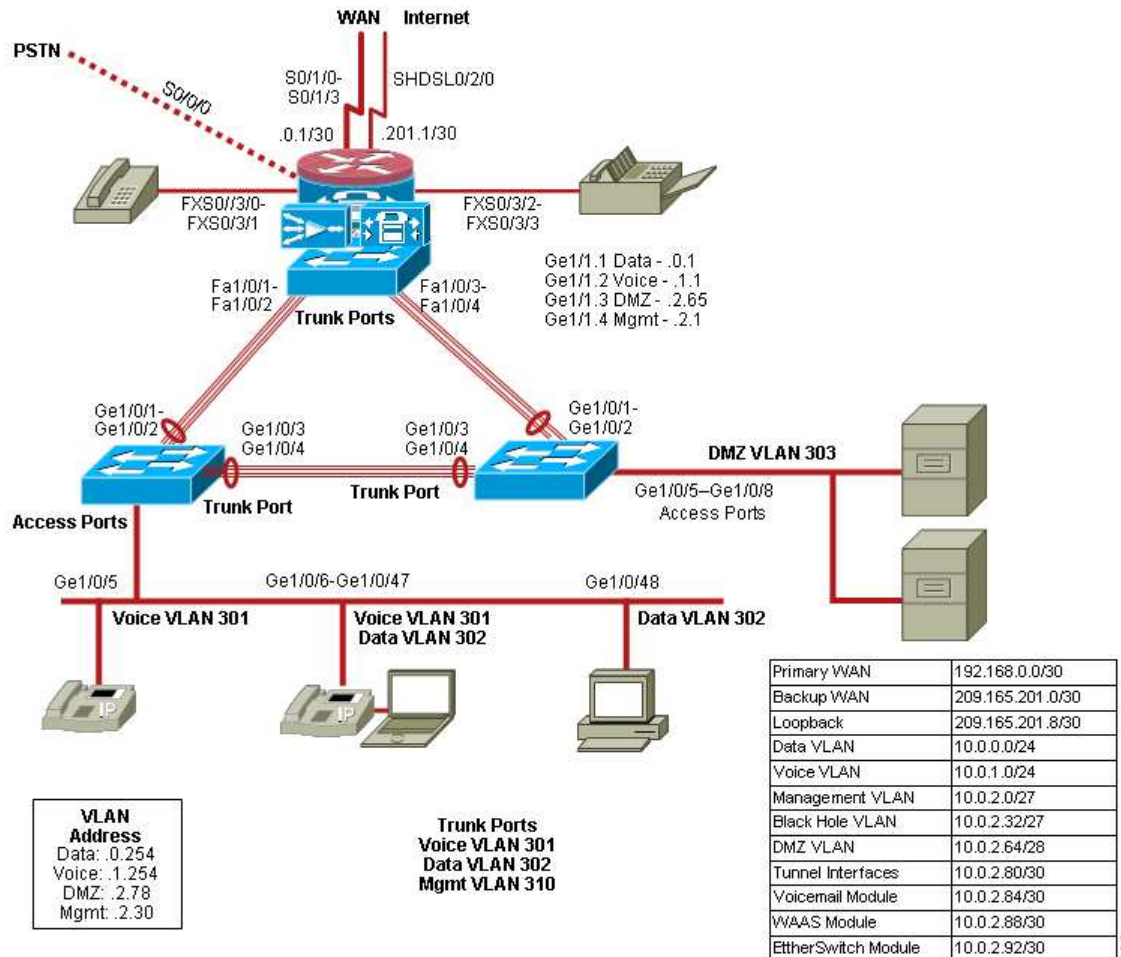

Figure 3 shows the high-speed WAN interface cards (HWICs), voice interface cards (VICs), voice WAN interface cards (VWICs), and network modules configuration on a Cisco 3945 router. WAN connectivity is provided by the 4-port high-speed interface card (HWIC-4T). A 1-port T3/E3 network module (NME-1T1/E1) would occupy a network module slot. A Cisco 3925 router, shown in Figure 4 was filled in the same way, except that a Cisco Unity Express Advanced Integration Module (AIM-CUE) was used instead of the network module (NME-CUE). Both Cisco 3945 and Cisco 3925 had an internal VPN module (AIM-VPN) that was placed into internal slot 0. In the Cisco 3925 configuration, the Cisco Unity Express AIM-CUE module was placed into internal slot 1.

Figure 3 Interface Card and Service Module Configuration on a Cisco 3945 Router

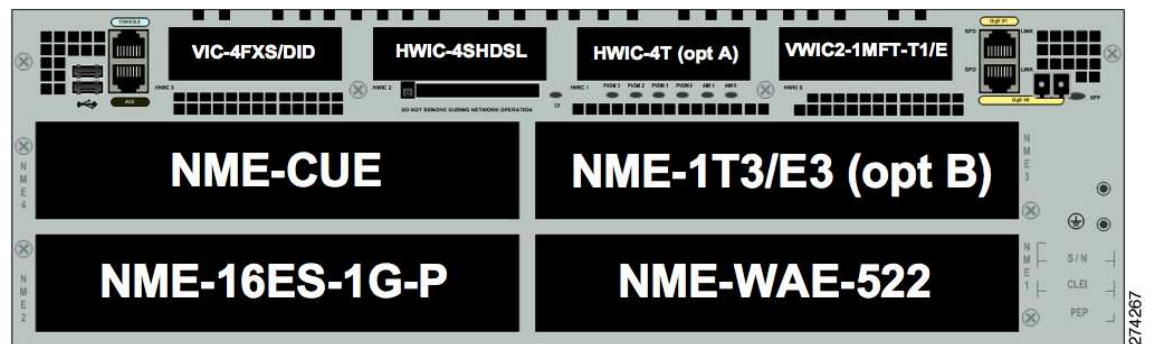
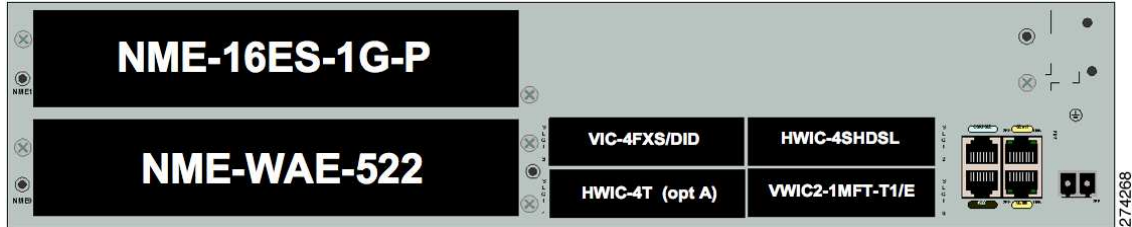

Figure 4 Interface Card and Service Module Configuration On a Cisco 3925



The access layer switch configuration in the following sections applies to both switches.

WAN Services Implementation

The following four configurations were tested for connecting WAN access lines to the nearest provider edge (PE) device of the service provider network:

- [Single-Port DS-3 Interface with Frame Relay Encapsulation, page 4](#)
- [Single-Port DS-3 Interface with Point-to-Point Encapsulation, page 5](#)
- [Multiport DS-1 Interface with Multilink Point-to-Point Encapsulation, page 6](#)
- [Multiport DS-1 Interface with Multilink Frame Relay Encapsulation, page 8](#)
- [Onboard Gigabit Ethernet Interface, page 9](#)

Single-Port DS-3 Interface with Frame Relay Encapsulation

A single-port clear-channel T3/E3 network module was used for this configuration. Traditional Frame Relay (FR) shaping was applied on the interface. Alternatively, QoS-based shaping as defined in the Eight-Class-V3PN-Edge-Shape service policy can be used. This example is shown in the “[Multiport DS-1 Interface with Multilink Frame Relay Encapsulation](#)” section on page 8.

```
Router(config)# card type t3 3 ! Declares network module in slot 3 operational in T3 mode
Router(config)# interface Serial3/0 ! Enters serial interface configuration mode
Router(config-if)# no ip address ! Disable IP processing on the serial interface
Router(config-if)# ip nbar protocol-discovery ! Enables NBAR to discover default protocols
and gather statistics
Router(config-if)# load-interval 30 ! Specifies interval for computing load statistics
Router(config-if)# dsu bandwidth 44210 ! Specifies maximum allowed bandwidth in Kbps for
the interface
Router(config-if)# max-reserved-bandwidth 100 ! Makes 100% of interface bandwidth
available for QoS reservations
Router(config-if)# encapsulation frame-relay IETF ! Enables Frame Relay IETF standard
Router(config-if)# interface Serial3/0.1 point-to-point ! Defines point-to-point Frame
Relay sub-interface for the primary link
Router(config-subif)# ip address 192.168.0.1 255.255.255.252 ! Specifies an IP address for
the sub-interface
Router(config-subif)# ip access-group BLOCK-TFTP in ! Applies ACL named "BLOCK-TFTP" on
incoming traffic
Router(config-subif)# ip access-group BLOCK-TFTP out ! Applies ACL named "BLOCK-TFTP" on
outgoing traffic
Router(config-subif)# ip nbar protocol-discovery ! Enables NBAR to discover default
protocols and gather statistics
Router(config-subif)# ip flow ingress ! Enables NetFlow accounting for incoming packets
Router(config-subif)# ip flow egress ! Enables NetFlow accounting for outgoing packets
```



```

Router(config-subif)# ip pim sparse-dense-mode ! Enables multicast in sparse-dense mode
Router(config-subif)# no ip mroute-cache ! Disables fast-switching of multicast packets
Router(config-subif)# snmp trap link-status ! Generates SNMP trap when link-status changes
Router(config-subif)# frame-relay interface-dlci 230 ! Defines Frame Relay DLCI for the
sub-interface
Router(config-fr-dlci)# class FR-SHAPING ! Assigns Frame Relay configuration map
"FR-SHAPING" for traffic shaping. The map-class is defined in QoS section
Router(config-fr-dlci)# exit

```

Apply the following command on the Serial3/0.1 subinterface after defining the *Public* security zone as shown in the Security section.

```

Router(config-subif)# zone-member security Public ! Adds sub-interface to firewall zone
called Public

```

Apply the following command on the Serial3 interface after defining the VPN-MAP crypto map as shown in the Security section if using GETVPN.

```

Router(config-fr-dlci)# crypto map VPN-MAP ! Applies crypto map "VPN-MAP" to the Frame
Relay DLCI

```

Verification of Single-Port DS-3 Interface with Frame Relay Encapsulation

To verify your Frame Relay single-port DS-3 interface configuration, enter and verify the output of the following command:

```

Router# show frame-relay pvc 230

PVC Statistics for interface Serial3/0 (Frame Relay DTE)

DLCI = 230, DLCI USAGE = LOCAL, PVC STATUS = ACTIVE, INTERFACE = Serial3/0.1

  input pkts 12487      output pkts 12470      in bytes 2441416
  out bytes 2441892    dropped pkts 0         in pkts dropped 0
  out pkts dropped 0   out bytes dropped 0
  in FECN pkts 0      in BECN pkts 0        out FECN pkts 0
  out BECN pkts 0     in DE pkts 0          out DE pkts 0
  out bcast pkts 12443  out bcast bytes 2438648
  5 minute input rate 0 bits/sec, 0 packets/sec
  5 minute output rate 0 bits/sec, 0 packets/sec
  pvc create time 4d03h, last time pvc status changed 4d03h
  cir 56000    bc 7000    be 0      byte limit 875  interval 125
  mincir 28000  byte increment 875  Adaptive Shaping none
  pkts 12235   bytes 2398060  pkts delayed 0      bytes delayed 0
  shaping inactive
  traffic shaping drops 0
  Queueing strategy: fifo
  Output queue 0/40, 0 drop, 0 dequeued
Router#

```

Single-Port DS-3 Interface with Point-to-Point Encapsulation

The following configuration for the T3/E3 network module uses the PPP Layer 2 encapsulation method.

```

Router(config)# card type t3 3 ! Declares network module in slot 3 operational in T3 mode
Router(config)# interface Serial3/0 ! Enters serial interface configuration mode
Router(config-if)# no ip address ! Disable IP processing on the serial interface
Router(config-if)# ip nbar protocol-discovery ! Enables NBAR to discover default protocols
and gather statistics
Router(config-if)# load-interval 30 ! Specifies interval for computing load statistics

```

```

Router(config-if)# dsu bandwidth 44210 ! Specifies maximum allowed bandwidth in Kbps for
the interface
Router(config-if)# max-reserved-bandwidth 100 ! Makes 100% of interface bandwidth
available for QoS reservations
Router(config-if)# encapsulation PPP ! Sets Layer 2 encapsulation to PPP
Router(config-if)# ip address 192.168.0.1 255.255.255.252 ! Specifies an IP address for
the sub-interface
Router(config-if)# ip access-group BLOCK-TFTP in ! Applies ACL named "BLOCK-TFTP" on
incoming traffic
Router(config-if)# ip access-group BLOCK-TFTP out ! Applies ACL named "BLOCK-TFTP" on
outgoing traffic
Router(config-if)# ip nbar protocol-discovery ! Enables NBAR to discover default protocols
and gather statistics
Router(config-if)# ip flow ingress ! Enables NetFlow accounting for incoming packets
Router(config-if)# ip flow egress ! Enables NetFlow accounting for outgoing packets
Router(config-if)# ip pim sparse-dense-mode ! Enables multicast in sparse-dense mode
Router(config-if)# no ip mroute-cache ! Disables fast-switching of multicast packets
Router(config-if)# snmp trap link-status ! Generates SNMP trap when link-status changes

```

Apply the following command on the Serial3 interface after defining the *EIGHT-CLASS-V3PN-EDGE-SHAPE* class as shown in the Security section.

```

Router(config-if)# service-policy output EIGHT-CLASS-V3PN-EDGE-SHAPE ! Applies QoS policy
to the interface in outgoing direction to provide preferential treatment for traffic

```

Apply the following command on the Serial3 interface after defining the *Public* security zone in the Security section.

```

Router(config-if)# zone-member security Public ! Adds interface to firewall zone called
Public

```

Apply the following command on the Serial3 interface after defining the *VPN-MAP* crypto map in the Security section if using GETVPN

```

Router(config-if)# crypto map VPN-MAP ! Applies crypto map "VPN-MAP" to the interface.

```

Multipoint DS-1 Interface with Multilink Point-to-Point Encapsulation

To support the multilink PPP configuration, four interfaces on the HWIC-4T were bundled together to form a single multilink bundle.

```

Router(config)# interface Multilink1 ! Enters multilink interface configuration mode
Router(config-if)# ip address 192.168.0.1 255.255.255.252 ! Specifies an IP address for
interface
Router(config-if)# ip access-group BLOCK-TFTP in ! Applies ACL named "BLOCK-TFTP" on
incoming traffic
Router(config-if)# ip access-group BLOCK-TFTP out ! Applies ACL named "BLOCK-TFTP" on
outgoing traffic
Router(config-if)# ip pim sparse-dense-mode ! Enables multicast in sparse-dense mode
Router(config-if)# no ip mroute-cache ! Disables fast-switching of multicast packets
Router(config-if)# ip nbar protocol-discovery ! Enables NBAR to discover default protocols
and gather statistics
Router(config-if)# load-interval 30 ! Specifies interval for computing load statistics
Router(config-if)# ip flow egress ! Enables NetFlow accounting for outgoing packets
Router(config-if)# ip flow ingress ! Enables NetFlow accounting for incoming packets
Router(config-if)# ppp multilink ! Enables Multilink PPP
Router(config-if)# ppp multilink group 1 ! Assigns interface to the multilink group 1
Router(config-if)# max-reserved-bandwidth 100 ! Makes 100% of interface bandwidth
available for QoS reservations
Router(config-if)# exit

```

```

Router(config)# interface Serial0/1/0 ! Enters serial interface configuration mode for
channel group 0
Router(config-if)# no ip address
Router(config-if)# encapsulation ppp ! Configures encapsulation type for interface as PPP
Router(config-if)# ppp multilink ! Enables Multilink PPP
Router(config-if)# ppp multilink group 1 ! Assigns interface to multilink group 1
Router(config-if)# max-reserved-bandwidth 100 ! Makes 100% of interface bandwidth
available for QoS reservations
Router(config-if)# no shutdown
Router(config-if)# interface Serial0/1/1 ! Enters serial interface configuration mode for
channel group 0
Router(config-if)# no ip address
Router(config-if)# encapsulation ppp ! Configures encapsulation type for interface as PPP
Router(config-if)# ppp multilink ! Enables Multilink PPP
Router(config-if)# ppp multilink group 1 ! Assigns interface to multilink group 1
Router(config-if)# max-reserved-bandwidth 100 ! Makes 100% of interface bandwidth
available for QoS reservations
Router(config-if)# no shutdown
Router(config-if)# interface Serial0/1/2 ! Enters serial interface configuration mode for
channel group 0
Router(config-if)# no ip address
Router(config-if)# encapsulation ppp ! Configures encapsulation type for interface as PPP
Router(config-if)# ppp multilink ! Enables Multilink PPP
Router(config-if)# ppp multilink group 1 ! Assigns interface to multilink group 1
Router(config-if)# max-reserved-bandwidth 100 ! Makes 100% of interface bandwidth
available for QoS reservations
Router(config-if)# no shutdown
Router(config-if)# interface Serial0/1/3 ! Enters serial interface configuration mode for
channel group 0
Router(config-if)# no ip address
Router(config-if)# encapsulation ppp ! Configures encapsulation type for interface as PPP
Router(config-if)# ppp multilink ! Enables Multilink PPP
Router(config-if)# ppp multilink group 1 ! Assigns interface to multilink group 1
Router(config-if)# max-reserved-bandwidth 100 ! Makes 100% of interface bandwidth
available for QoS reservations
Router(config-if)# no shutdown
Router(config-if)# exit

```

Apply the following command on the Multilink1 interface after defining the *EIGHT-CLASS-V3PN-EDGE-SHAPE* class as shown in the Security section.

```

Router(config-if)# service-policy output EIGHT-CLASS-V3PN-EDGE-SHAPE ! Applies QoS policy
to the interface in outgoing direction to provide preferential treatment for traffic

```

Apply the following command on the Multilink1 interface after defining the *Public* security zone as shown in the Security section.

```

Router(config-if)# zone-member security Public ! Adds interface to firewall zone called
Public

```

Apply the following command on the Multilink1 interface after defining the *VPN-MAP* crypto map as shown in the Security section if using GETVPN.

```

Router(config-if)# crypto map VPN-MAP ! Applies crypto map "VPN-MAP" to the interface

```

Verification of Multiport DS-1 Interface with Multilink PPP Encapsulation

To verify the multilink interface configuration, enter the **show ppp multilink** command to display the active serial interfaces bundled as part of PPP multilink.

```

Router# show ppp multilink

```

```

Multilink1

```

```

Bundle name: BRANCH
Remote Endpoint Discriminator: [1] ISP-1
Local Endpoint Discriminator: [1] Router
Bundle up for 2w2d, total bandwidth 8192, load 1/255
Receive buffer limit 48000 bytes, frag timeout 1000 ms
  0/0 fragments/bytes in reassembly list
  3 lost fragments, 4704524 reordered
  9/800 discarded fragments/bytes, 0 lost received
  0xE543EE received sequence, 0xE83A54 sent sequence
Member links: 4 active, 0 inactive (max not set, min not set)
  Se0/1/0, since 2w2d
  Se0/1/1, since 2w2d
  Se0/1/2, since 2w2d
  Se0/1/3, since 2w2d
No inactive multilink interfaces
Router#

```

Use the **show interface multilink** command to show the status of multilink.

```

Router1# show interface Multilink 1
Multilink1 is up, line protocol is up
  Hardware is multilink group interface
  Internet address is 192.168.0.1/30
  Backup interface ATM0/2/IMA0, failure delay 0 sec, secondary disable delay 0 sec,
  kickin load not set, kickout load not set
  MTU 1500 bytes, BW 8192 Kbit, DLY 100000 usec,
    reliability 255/255, txload 1/255, rxload 1/255
  Encapsulation PPP, LCP Open, multilink Open
  Open: IPCP, CDPCP, loopback not set
  Keepalive set (10 sec)
  DTR is pulsed for 2 seconds on reset
  Last input 00:00:21, output never, output hang never
  Last clearing of "show interface" counters 2w2d
  Input queue: 0/75/178/0 (size/max/drops/flushes); Total output drops: 791
  Queueing strategy: fifo
  Output queue: 0/40 (size/max)
  30 second input rate 0 bits/sec, 0 packets/sec
  30 second output rate 1000 bits/sec, 1 packets/sec
    5463859 packets input, 1356700636 bytes, 0 no buffer
    Received 0 broadcasts, 0 runts, 0 giants, 0 throttles
    12 input errors, 0 CRC, 1 frame, 0 overrun, 0 ignored, 8 abort
    5275968 packets output, 3619744669 bytes, 0 underruns
    0 output errors, 0 collisions, 1 interface resets
    0 output buffer failures, 0 output buffers swapped out
    0 carrier transitions
Router#

```

Multiport DS-1 Interface with Multilink Frame Relay Encapsulation

To support the multilink Frame Relay configuration, four interfaces on the HWIC-4T were bundled together to form a single multilink bundle.

```

Router(config)# interface MFR 1 ! Enters Frame Relay multilink interface configuration mode
Router(config-if)# encapsulation frame-relay ! Specifies Frame Relay encapsulation for the
interface
Router(config-if)# ip address 192.168.0.1 255.255.255.252 ! Specifies an IP address for
interface
Router(config-if)# ip access-group BLOCK-TFTP in ! Applies ACL named "BLOCK-TFTP" on
incoming traffic
Router(config-if)# ip access-group BLOCK-TFTP out ! Applies ACL named "BLOCK-TFTP" on
outgoing traffic

```

```

Router(config-if)# no ip mroute-cache ! Disables fast-switching of multicast packets
Router(config-if)# ip nbar protocol-discovery ! Enables NBAR to discover default protocols
and gather statistics
Router(config-if)# load-interval 30 ! Specifies interval for computing load statistics
Router(config-if)# ip flow egress ! Enables NetFlow accounting for outgoing packets
Router(config-if)# ip flow ingress ! Enables NetFlow accounting for incoming packets
Router(config-if)# max-reserved-bandwidth 100 ! Makes 100% of interface bandwidth
available for QoS reservations
Router(config-if)# end

Router(config)# interface Serial0/1/0 ! Enters serial interface configuration mode for
channel group 1
Router(config-if)# encapsulation frame-relay MFR 1 ! Assigns the link to MFR bundle with id
1
Router(config-if)# no shutdown
Router(config-if)# interface Serial0/1/1 ! Enters serial interface configuration mode for
channel group 1
Router(config-if)# encapsulation frame-relay MFR 1 ! Assigns the link to MFR bundle with id
1
Router(config-if)# no shutdown
Router(config-if)# interface Serial0/1/2 ! Enters serial interface configuration mode for
channel group 1
Router(config-if)# encapsulation frame-relay MFR 1 ! Assigns the link to MFR bundle with id
1
Router(config-if)# no shutdown
Router(config-if)# interface Serial0/1/3 ! Enters serial interface configuration mode for
channel group 1
Router(config-if)# encapsulation frame-relay MFR 1 ! Assigns the link to MFR bundle with id
1
Router(config-if)# end

```

Apply the following command on the MFR interface after defining the *EIGHT-CLASS-V3PN-EDGE-SHAPE* class as shown in the Security section.

```

Router(config-if)# service-policy output EIGHT-CLASS-V3PN-EDGE-SHAPE ! Applies QoS policy
to the interface in outgoing direction to provide preferential treatment for traffic

```

Apply the following command on the MFR interface after defining the *Public* security zone as shown in the Security section.

```

Router(config-if)# zone-member security Public ! Adds interface to firewall zone called
Public

```

Apply the following command on the MFR interface after defining the *VPN-MAP* crypto map as shown in the Security section if using GETVPN.

```

Router(config-if)# crypto map VPN-MAP ! Applies crypto map "VPN-MAP" to the interface

```

Onboard Gigabit Ethernet Interface

The onboard Gigabit Ethernet port was used for WAN connection with Ethernet encapsulation.



Note

When using the Small Form Pluggable (SFP) module that provides optical connectivity, the default media type for the interface must be changed to SFP.

```

Branch(config)# interface gigabitEthernet0/0! Enters the gigabit Ethernet interface
configuration mode

```

```

Branch(config-if)# ip address 192.168.0.1 255.255.255.252 ! Specifies an IP address for
interface
Branch(config-if)# ip access-group BLOCK-TFTP in ! Applies ACL named "BLOCK-TFTP" on
incoming traffic
Branch(config-if)# ip access-group BLOCK-TFTP out ! Applies ACL named "BLOCK-TFTP" on
outgoing traffic
Branch(config-subif)# ip nbar protocol-discovery ! Enables NBAR to discover default
protocols and gather statistics
Branch(config-if)# ip flow ingress ! Enables NetFlow accounting for incoming traffic
Branch(config-if)# ip flow egress ! Enables NetFlow accounting for outgoing traffic
Branch(config-if)# ip pim sparse-dense-mode ! Enables multicast in sparse-dense mode
Branch(config-if)# no ip mroute-cache ! Disables fast-switching of multicast packets
Branch(config-if)# load-interval 30 ! Specifies interval for computing load statistics
Branch(config-if)# max-reserved-bandwidth 100 ! Makes 100% of interface bandwidth
available for QoS reservations
Branch(config-if)# media-type sfp ! Sets the Ethernet connector to SFP module
Branch(config-if)# no shutdown
Branch(config-if)# end

```

Apply the following command on the Gigabit Ethernet interface after defining the *EIGHT-CLASS-V3PN-EDGE-SHAPE* class as shown in the Security section.

```

Router(config-if)# service-policy output EIGHT-CLASS-V3PN-EDGE-SHAPE ! Applies QoS policy
to the interface in outgoing direction to provide preferential treatment for traffic

```

Apply the following command on the Gigabit Ethernet interface after defining the *Public* security zone as shown in the Security section.

```

Router(config-if)# zone-member security Public ! Adds interface to firewall zone called
Public

```

Apply the following command on the Gigabit Ethernet interface after defining the *VPN-MAP* crypto map as shown in the Security section if using GETVPN.

```

Router(config-if)# crypto map VPN-MAP ! Applies crypto map "VPN-MAP" to the interface

```

LAN Services Implementation

The main design consideration in the branch office LAN design are high availability, scalability, security, and manageability. A multilayered LAN architecture addresses these criteria and makes it easier to troubleshoot network issues.

The Multilayered Branch LAN architecture can be divided into the following layers:

- **Edge Layer:** Provides WAN connectivity, routing, addressing, high availability, quality of service (QoS), security, management services, and an exit point to the rest of the network.
- **Distribution Layer:** Provides private VLANs and trunking.
- **Access Layer:** Provides connectivity and Power-over-Ethernet (PoE) to end user devices. Layer 2 security, authentication, private VLANs, and QoS are addressed at this layer.

Edge Layer

One of the onboard Gigabit Ethernet ports was connected to a distribution layer switch. The following are VLAN configurations were applied to create VLANs across the branch network:

- [Data VLAN, page 11](#)
- [Voice VLAN, page 11](#)

- [DMZ VLAN, page 12](#)
- [Management VLAN, page 12](#)

Enable the LAN facing the Gigabit Ethernet interface.

```
Branch(config)# interface GigabitEthernet0/1 ! Enters gigabit Ethernet sub-interface 2
configuration mode
Branch(config-subif)# no shutdown
```

Data VLAN

```
Branch(config)# interface GigabitEthernet2/0.1 ! Enters internal gigabit Ethernet
sub-interface 1 configuration mode
Branch(config-subif)# description Data-VLAN
Branch(config-subif)# encapsulation dot1Q 301 ! Defines IEEE 802.1Q VLAN encapsulation
type
Branch(config-subif)# ip address 10.0.0.1 255.255.255.0 ! Assigns IP address to the
interface
Branch(config-subif)# ip pim sparse-dense-mode ! Enables multicast in sparse-dense mode
```

Apply the following command on the Gigabit Ethernet subinterface after defining the *INPUT-POLICY* class as shown in the Security section.

```
Branch(config-subif)# service-policy input INPUT-POLICY ! Executes a policy "INPUT-POLICY"
on incoming traffic
```

Apply the following command on the Gigabit Ethernet subinterface after defining the *Private* security zone as shown in the Security section.

```
Branch(config-subif)# zone-member security Private ! Adds the subinterface to firewall
zone called Private
```

Apply the following command on the Gigabit Ethernet subinterface after defining the *IPS-ADVSET* ACL as shown in the Security section.

```
Branch(config-subif)# ip ips IPS-ADVSET out ! Enables IPS signature matching for traffic
flowing in outward direction
Branch(config-subif)# ip ips IPS-ADVSET in ! Enables IPS signature matching for traffic
flowing in inward direction
```

Voice VLAN

```
Branch(config)# interface GigabitEthernet2/0.2 ! Enters internal gigabit Ethernet
sub-interface 2 configuration mode
Branch(config-subif)# description Voice-VLAN
Branch(config-subif)# encapsulation dot1Q 302 ! Defines IEEE 802.1Q VLAN encapsulation
type
Branch(config-subif)# ip address 10.0.1.1 255.255.255.0 ! Assigns IP address to the
interface
Branch(config-subif)# ip pim sparse-dense-mode ! Enables multicast in sparse-dense mode
```

Apply the following command on the Gigabit Ethernet subinterface after defining the *INPUT-POLICY* class as shown in the Security section.

```
Branch(config-subif)# service-policy input INPUT-POLICY ! Executes a policy "INPUT-POLICY"
on incoming traffic
```

Apply the following command on the Gigabit Ethernet subinterface after defining the *Private* security zone as shown in the Security section.

```
Branch(config-subif)# zone-member security Private ! Adds the subinterface to firewall
zone called Private
```

DMZ VLAN

```
Branch(config-subif)# interface GigabitEthernet2/0.3 ! Enters internal gigabit Ethernet
sub-interface 3 configuration mode
Branch(config-subif)# description DMZ-VLAN
Branch(config-subif)# encapsulation dot1Q 303 ! Defines IEEE 802.1Q VLAN encapsulation
type
Branch(config-subif)# ip address 10.0.2.65 255.255.255.240 ! Assigns IP address to the
interface
Branch(config-subif)# ip pim sparse-dense-mode ! Enables multicast in sparse-dense mode
```

Apply the following command on the Gigabit Ethernet subinterface after defining the *INPUT-POLICY* class as shown in the Security section.

```
Branch(config-subif)# service-policy input INPUT-POLICY ! Executes a policy "INPUT-POLICY"
on incoming traffic
```

Apply the following command on the Gigabit Ethernet subinterface after defining the *DMZ* security zone as shown in the Security section.

```
Branch(config-subif)# zone-member security DMZ ! Adds the subinterface to firewall zone
called DMZ
```

Apply the following command on the Gigabit Ethernet subinterface after defining the *IPS-ADVSET* ACL as shown in the Security section.

```
Branch(config-subif)# ip ips IPS-ADVSET out ! Enables IPS signature matching for traffic
flowing in outward direction
Branch(config-subif)# ip ips IPS-ADVSET in ! Enables IPS signature matching for traffic
flowing in inward direction
```

Management VLAN

```
Branch(config-subif)# interface GigabitEthernet2/0.4 ! Enters internal gigabit Ethernet
sub-interface 4 configuration mode
Branch(config-subif)# description Management-VLAN
Branch(config-subif)# encapsulation dot1Q 310 ! Defines IEEE 802.1Q VLAN encapsulation
type
Branch(config-subif)# ip address 10.0.2.1 255.255.255.224 ! Assigns IP address to the
interface
Branch(config-subif)# ip pim sparse-dense-mode ! Enables multicast in sparse-dense mode
```

Apply the following command on the Gigabit Ethernet subinterface after defining the *INPUT-POLICY* class as shown in the Security section.

```
Branch(config-subif)# service-policy input INPUT-POLICY ! Executes a policy "INPUT-POLICY"
on incoming traffic
```

Apply the following command on the Gigabit Ethernet subinterface after defining the *Private* security zone as shown in the Security section.

```
Branch(config-subif)# zone-member security Private ! Adds the subinterface to firewall
zone called Private
```

Distribution Layer

- [Configuring EtherSwitch Service Module, page 13](#)
- [VLAN Trunking Protocol Implementation, page 13](#)

- [VLAN Implementation, page 14](#)
- [Spanning Tree Implementation, page 15](#)
- [Uplink to Router Implementation, page 15](#)
- [EtherChannel Implementation, page 15](#)
- [DOT1X Services, page 17](#)

Configuring EtherSwitch Service Module

The EtherSwitch service module is accessible from the router's command line. The Gigabit Ethernet link between the router and the switch requires IP addresses to be configured in order to session into the module.

```
Branch(config)#interface GigabitEthernet 1/0

Branch(config-if)#ip address 10.0.2.93 255.255.255.252 ! Assigns IP address to internal
Gigabit Ethernet link
Branch(config-if)#no shutdown
Branch(config-if)#exit
```

From the console, initiate a session with the EtherSwitch service module.

```
Branch# service-module gigabitEthernet 2/0 session
Trying 10.0.2.93, 2066 ... Open

    --- System Configuration Dialog ---

Would you like to enter the initial configuration dialog? [yes/no]: no

Would you like to terminate autoinstall? [yes]:
Switch> enable
Switch# configure terminal
Enter configuration commands, one per line. End with CNTL/Z.
Switch(config)# hostname Switch-Dist
```

VLAN Trunking Protocol Implementation

VLAN Trunking Protocol (VTP) is a client server protocol that reduces the overhead of network administration by propagating the VLAN information from the server to all the clients in a single VTP domain.

In the Services Ready Medium Branch Network, the EtherSwitch service module at the distribution layer was configured as the VTP server.

```
Switch-Dist(config)# vtp domain VTP-BRANCH ! Creates VTP domain with name "VTP-BRANCH"
Switch-Dist(config)# vtp mode server ! Sets the distribution switch to server VTP mode
```



Note

Always check the revision number of a new switch before bringing adding it to the network, regardless of whether the switch is going to operate in VTP client mode or operate in VTP server mode. To reset the revision number, do one of the following:

- Reboot the switch
or
- Temporarily change the domain name of the new switch and then change it back to its valid domain name.

VTP Verification

To verify your VTP configuration, enter the **show vtp status** command to display the VTP management status and other counters.

```
Switch# show vtp status
VTP Version                : 2
Configuration Revision     : 91
Maximum VLANs supported locally : 1005
Number of existing VLANs   : 5
VTP Operating Mode         : Server
VTP Domain Name            : VTP-BRANCH
VTP Pruning Mode           : Disabled
VTP V2 Mode                : Disabled
VTP Traps Generation       : Disabled
MD5 digest                 : 0x01 0x71 0x91 0x17 0x8C 0x59 0xE5 0x39
Configuration last modified by 10.0.1.254 at 7-29-08 17:23:15
Local updater ID is 10.0.1.254 on interface Vl10 (lowest numbered VLAN interface found)
Switch#
```

VLAN Implementation

VLAN is a logical segmentation of LAN into multiple-broadcast domain that allows a group of hosts to communicate as if they were on a single LAN even if they are not physically collocated. A Layer 3 device is required for communication between VLANs.

Five VLANs were defined: DATA, VOICE, DMZ, MANAGEMENT, and BLACKHOLE.

```
Switch-Dist(config)# vlan 301 ! Creates Data VLAN to vlan database
Switch-Dist(config-vlan)# name DATA
Switch-Dist(config-vlan)# exit
Switch-Dist(config)# vlan 302 ! Creates Voice VLAN to vlan database
Switch-Dist(config-vlan)# name VOICE
Switch-Dist(config-vlan)# exit
Switch-Dist(config) # vlan 303 ! Creates DMZ VLAN to vlan database
Switch-Dist(config-vlan)# name DMZ
Switch-Dist(config-vlan)# exit
Switch-Dist(config)# vlan 310 ! Creates management VLAN to vlan database
Switch-Dist(config-vlan)# name MANAGEMENT
Switch-Dist(config-vlan)# exit
Switch-Dist(config-vlan)# vlan 333 ! Creates black hole VLAN to vlan database
Switch-Dist(config-vlan)# name BLACKHOLE
Switch-Dist(config-vlan)# exit
Switch-Dist(config)# interface Vlan301 ! Enters Data VLAN configuration mode
Switch-Dist(config-if)# ip address 10.0.0.254 255.255.255.0 ! Specifies the IP address for
the SVI interface
Switch-Dist(config-if)# interface Vlan302 ! Enters Voice VLAN configuration mode
Switch-Dist(config-if)# ip address 10.0.1.0 254 255.255.255.0 ! Specifies the IP address
for the SVI interface
Switch-Dist(config-if)# interface Vlan303 ! Enters switch virtual interface (SVI)
configuration
Switch-Dist(config-if)# ip address 10.0.2.78 255.255.255.240 ! Specifies the IP address for
the SVI interface
Switch-Dist(config-if)# interface Vlan310 ! Enters Management VLAN interface configuration
mode
Switch-Dist(config-if)# ip address 10.0.2.30 255.255.255.224 ! Specifies the IP address for
the SVI interface
```

Spanning Tree Implementation

```
Switch-Dist(config)# spanning-tree mode pvst ! Enables Per-VLAN spanning-tree protocol
```

Spanning Tree Verification

To verify your Spanning Tree configuration, enter the **show spanning-tree summary** command to display the Spanning Tree mode enabled in the switch.

```
Switch# show spanning-tree summary
Switch is in pvst mode
Root bridge for: none
Extended system ID          is enabled
Portfast Default            is disabled
PortFast BPDU Guard Default is disabled
Portfast BPDU Filter Default is disabled
Loopguard Default          is disabled
EtherChannel misconfig guard is enabled
UplinkFast                  is disabled
BackboneFast                is disabled
Configured Pathcost method used is short
                             <Removed>
```

Uplink to Router Implementation

```
Switch-Dist(config)# interface g1/0/2 ! Enters gigabit Ethernet interface configuration
mode for internal link to the router
Switch-Dist(config-if)# description trunk to router
Switch-Dist(config-if)# switchport trunk encapsulation dot1q ! Tags outgoing frames with
IEEE 802.1Q trunk encapsulation format
Switch-Dist(config-if)# switchport trunk allowed vlan 301-303,310 ! Defines list of allowed
VLANs that can send traffic on the trunk.
Switch-Dist(config-if)# switchport mode trunk ! Enables the Ethernet port as VLAN trunk
Switch-Dist(config-if)# load-interval 30 ! Specifies interval for computing load
statistics
```

EtherChannel Implementation

EtherChannel supports the IEEE 802.3ad Link Aggregation Control Protocol (LACP) that has three EtherChannel modes:

- **On:** The link aggregation is forced to be formed without any LACP negotiation. In other words, the switch will neither send the LACP packet nor process any incoming LACP packet.
- **Passive:** The switch does not initiate the channel, but does understand incoming LACP packets. The peer (in the active state) initiates negotiation (by sending out an LACP packet) which is received and replied to, eventually forming the aggregation channel with the peer.
- **Active:** An aggregate link is formed, and it initiates the negotiation. The link aggregate will be formed if the other end is running in LACP active or passive mode. This is the recommended configuration.

EtherChannel was established between access layer Catalyst 3560 switches and the EtherSwitch service module using LACP.

```
Switch-Dist(config)# interface f1/0/1 ! Enters Fast Ethernet port 1 configuration mode
Switch-Dist(config-if)# description EtherChannel link-1 to access switch 1
Switch-Dist(config-if)# switchport trunk encapsulation dot1q ! Tags outgoing frames with
IEEE 802.1Q trunk encapsulation format
Switch-Dist(config-if)# switchport mode trunk ! Enables the Ethernet port as VLAN trunk
```

```

Switch-Dist(config-if)# load-interval 30 ! Specifies interval for computing load
statistics
Switch-Dist(config-if)# mls qos trust dscp ! Accept incoming DSCP markings
Switch-Dist(config-if)# channel-group 1 mode active ! Assigns the interface to EtherChannel
group 1 in LACP active mode
Creating a port-channel interface Port-channel 1
Switch-Dist(config-if)# interface f1/0/2 ! Enters Fast Ethernet port 2 configuration
Switch-Dist(config-if)# description EtherChannel link-2 to access switch 1
Switch-Dist(config-if)# switchport trunk encapsulation dot1q ! Tags outgoing frames with
IEEE 802.1Q trunk encapsulation format
Switch-Dist(config-if)# switchport mode trunk ! Enables the Ethernet port as VLAN trunk
Switch-Dist(config-if)# load-interval 30 ! Specifies interval for computing load
statistics
Switch-Dist(config-if)# mls qos trust dscp ! Accept incoming DSCP markings
Switch-Dist(config-if)# channel-group 1 mode active ! Assigns the interface to be
EtherChannel group 1 in LACP active mode
Switch-Dist(config-if)# interface Port-channel1 ! Enters EtherChannel specific
configuration
Switch-Dist(config-if)# switchport trunk encapsulation dot1q ! Tags outgoing frames with
IEEE 802.1Q trunk encapsulation format
Switch-Dist(config-if)# switchport mode trunk ! Enables the EtherChannel as VLAN trunk
Switch-Dist(config-if)# load-interval 30 ! Specifies interval for computing load
statistics

Switch-Dist(config)# interface f1/0/3 ! Enters fast Ethernet port 1 configuration mode
Switch-Dist(config-if)# description EtherChannel link-1 to access switch 2
Switch-Dist(config-if)# switchport trunk encapsulation dot1q ! Tags outgoing frames with
IEEE 802.1Q trunk encapsulation format
Switch-Dist(config-if)# switchport mode trunk ! Enables the Ethernet port as VLAN trunk
Switch-Dist(config-if)# load-interval 30 ! Specifies interval for computing load
statistics
Switch-Dist(config-if)# mls qos trust dscp ! Accept incoming DSCP markings
Switch-Dist(config-if)# channel-group 2 mode active ! Assigns the interface to EtherChannel
group 2 in LACP active mode
Creating a port-channel interface Port-channel 2
Switch-Dist(config-if)# interface f1/0/4 ! Enters fast Ethernet port 2 configuration
Switch-Dist(config-if)# description EtherChannel link-2 to access switch 2
Switch-Dist(config-if)# switchport trunk encapsulation dot1q ! Tags outgoing frames with
IEEE 802.1Q trunk encapsulation format
Switch-Dist(config-if)# switchport mode trunk ! Enables the Ethernet port as VLAN trunk
Switch-Dist(config-if)# load-interval 30 ! Specifies interval for computing load
statistics
Switch-Dist(config-if)# mls qos trust dscp ! Accept incoming DSCP markings
Switch-Dist(config-if)# channel-group 2 mode active ! Assigns the interface to be
EtherChannel group 2 in LACP active mode
Switch-Dist(config-if)# interface Port-channel2 ! Enters EtherChannel specific
configuration
Switch-Dist(config-if)# switchport trunk encapsulation dot1q ! Tags outgoing frames with
IEEE 802.1Q trunk encapsulation format
Switch-Dist(config-if)# switchport mode trunk ! Enables the EtherChannel as VLAN trunk
Switch-Dist(config-if)# load-interval 30 ! Specifies interval for computing load
statistics

```

EtherChannel Verification

To verify your cross-stack EtherChannel configuration, enter the following commands:

```

Switch-Dist# show etherchannel summary
Flags: D - down          P - in port-channel
       I - stand-alone s - suspended
       H - Hot-standby (LACP only)

```

```

R - Layer3      S - Layer2
U - in use     f - failed to allocate aggregator
u - unsuitable for bundling
w - waiting to be aggregated
d - default port

```

```

Number of channel-groups in use: 1
Number of aggregators:          1

```

Group	Port-channel	Protocol	Ports
1	Po1(SU)	LACP	Fa1/0/1(P) Fa1/0/2(P)
2	Po2(SU)	LACP	Fa1/0/3(P) Fa1/0/4(P)

```

Switch# show interface port-channel 1
Port-channell is up, line protocol is up (connected)
  Hardware is EtherChannel, address is 000d.2851.8d8b (bia 000d.2851.8d8b)
  MTU 1500 bytes, BW 2000000 Kbit, DLY 10 usec,
    reliability 255/255, txload 1/255, rxload 1/255
  Encapsulation ARPA, loopback not set
  Full-duplex, 1000Mb/s, link type is auto, media type is unknown
  Media-type configured as connector
  input flow-control is off, output flow-control is unsupported
  Members in this channel: Fa1/0/1 Fa1/0/2
  ARP type: ARPA, ARP Timeout 04:00:00
  Last input 00:00:01, output 00:00:00, output hang never
  Last clearing of "show interface" counters 6w6d
  Input queue: 0/75/0/0 (size/max/drops/flushes); Total output drops: 0
  Queueing strategy: fifo
  Output queue: 0/40 (size/max)
  30 second input rate 2000 bits/sec, 4 packets/sec
  30 second output rate 134000 bits/sec, 110 packets/sec
    136360555 packets input, 2314351511 bytes, 0 no buffer
    Received 18489892 broadcasts (0 multicast)
    0 runs, 0 giants, 0 throttles
    0 input errors, 0 CRC, 0 frame, 0 overrun, 0 ignored
    0 watchdog, 18243546 multicast, 0 pause input
    0 input packets with dribble condition detected
  535580165 packets output, 1770503169 bytes, 0 underruns
    0 output errors, 0 collisions, 0 interface resets
    0 babbles, 0 late collision, 0 deferred
    0 lost carrier, 0 no carrier, 0 PAUSE output
    0 output buffer failures, 0 output buffers swapped out

```

DOT1X Services

```

Switch-Dist(config)# aaa new-model ! Enables Authentication, Authorization and Accounting
services
Switch-Dist(config)# aaa authentication dot1x default group radius ! Specifies default
dot1x authentication to use RADIUS server database
Switch-Dist(config)# aaa session-id common ! Specifies to use the same session identifier
for all invocations of accounting services
Switch-Dist(config)# dot1x system-auth-control ! Enables IEEE 802.1x authentication
globally on the switch
Switch-Dist(config)# radius-server host 172.16.0.80 ! Specifies RADIUS server IP address
Switch-Dist(config)# radius-server key KEY-BR ! Specifies RADIUS server key as "KEY-BR"
for encrypting all communication with the RADIUS server
Switch-Dist(config)# int range f1/0/5 - 16 ! Enters configuration for range of gigabit
Ethernet ports
Switch-Dist(config-if-range)# dot1x port-control auto ! Enables dot1x authentication on
the port

```

```
Switch-Dist(config-if-range)# dot1x timeout server-timeout 60 ! Specifies time to wait for
a response from RADIUS server before retransmitting
```

The mapping for the CoS to DSCP values is shown in Figure 35 in the “Quality of Service” section on page 41.

```
Switch-Dist(config)# mls qos ! Enables QoS on the switch
Switch-Dist(config)# mls qos map policed-dscp 0 10 18 24 25 34 to 8 ! Defines Policed-DSCP
map which is used to mark down the packets with specified values to DSCP 8.
Switch-Dist(config)# mls qos map cos-dscp 0 8 16 24 32 46 48 56 ! Defines CoS-DSCP map for
preferential treatment
Switch-Dist(config)# mls qos srr-queue output cos-map queue 1 threshold 3 5 ! Maps the CoS
5 to egress queue 1 with threshold 3
Switch-Dist(config)# mls qos srr-queue output cos-map queue 2 threshold 1 2 4 ! Maps the
CoS 2 and CoS 4 to egress queue 2 with threshold 1
Switch-Dist(config)# mls qos srr-queue output cos-map queue 2 threshold 2 3 ! Maps the CoS
3 to egress queue 2 with threshold 2
Switch-Dist(config)# mls qos srr-queue output cos-map queue 2 threshold 3 6 7 ! Maps the
CoS 6 and CoS 7 to egress queue 2 with threshold 3
Switch-Dist(config)# mls qos srr-queue output cos-map queue 3 threshold 3 0 ! Maps the CoS
0 to egress queue 3 with threshold 3
Switch-Dist(config)# mls qos srr-queue output cos-map queue 4 threshold 3 1 ! Maps the CoS
1 to egress queue 4 with threshold 3
Switch-Dist(config)# mls qos srr-queue output dscp-map queue 1 threshold 3 46 ! Maps the
DSCP value 46 to egress queue 1 with threshold 3
Switch-Dist(config)# mls qos srr-queue output dscp-map queue 2 threshold 1 16 18 20 22 25
32 34 36 ! Maps the DSCP values 16, 18, 20, 22, 25, 32, 34 and 36 to egress queue 2 with
threshold 1
Switch-Dist(config)# mls qos srr-queue output dscp-map queue 2 threshold 1 38 ! Maps the
DSCP value 38 to egress queue 2 with threshold 1
Switch-Dist(config)# mls qos srr-queue output dscp-map queue 2 threshold 2 24 26 36 ! Maps
the DSCP values 24, 26, and 36 to egress queue 2 with threshold 2
Switch-Dist(config)# mls qos srr-queue output dscp-map queue 2 threshold 3 48 56 36 ! Maps
the DSCP values 36, 48, and 56 to egress queue 2 with threshold 3
Switch-Dist(config)# mls qos srr-queue output dscp-map queue 3 threshold 3 0 36 ! Maps the
DSCP values 0 and 36 to egress queue 3 with threshold 3
Switch-Dist(config)# mls qos srr-queue output dscp-map queue 4 threshold 1 8 36 ! Maps the
DSCP values 8 and 36 to egress queue 4 with threshold 1
Switch-Dist(config)# mls qos srr-queue output dscp-map queue 4 threshold 3 10 12 14 36 !
Maps the DSCP values 10, 12, 14, and 36 to egress queue 4 with threshold 3
Switch-Dist(config)# mls qos queue-set output 1 threshold 2 70 80 100 100 ! Defines the
weighed tail-drop thresholds for queue 2 to 70% for threshold 1 and 80% for threshold 2
Switch-Dist(config)# mls qos queue-set output 1 threshold 4 40 100 100 100 ! Defines the
weighed tail-drop thresholds for queue 4 to 40% for threshold 1 and 100% for threshold 2
```

The distribution layer switches are connected only to DMZ servers that should be collocated and physically secured. Therefore, all DSCP marking originating at DMZ servers is trusted.

```
Switch-Dist(config)# int range f1/0/5 - 16 ! Enters configuration for range of gigabit
Ethernet ports
Switch-Dist(config-if-range)# mls qos trust dscp ! Accept incoming DSCP markings
```

Access Layer

- VTP Implementation, page 19
- Spanning Tree Implementation, page 19
- EtherChannel Implementation, page 19
- DOT1X Services, page 20
- QoS Implementation, page 21

- [Assigning QoS to Switch Port, page 24](#)

VTP Implementation



Note

```
Switch-Access(config)# vtp domain VTP-BRANCH ! Creates VTP domain with name "VTP-BRANCH"
Switch-Access(config)# vtp mode client ! Sets the access switch to client VTP mode
```

Always check the revision number of a new switch before bringing adding it to the network, regardless of whether the switch is going to operate in VTP client mode or operate in VTP server mode. To reset the revision number, do one of the following:

- Reboot the switch
or
- Temporarily change the domain name of the new switch and then change it back to its valid domain name.

Spanning Tree Implementation

```
Switch-Access(config)# spanning-tree mode pvst ! Specifies the Per-VLAN spanning-tree protocol
```

EtherChannel Implementation

```
Switch-Access(config)# interface g1/0/1 ! Enters port 0 configuration mode
Switch-Access(config-if)# switchport trunk encapsulation dot1q ! Tags outgoing frames with IEEE 802.1Q trunk encapsulation format
Switch-Access(config-if)# switchport mode trunk ! Enables the Ethernet port as VLAN trunk
Switch-Access(config-if)# load-interval 30 ! Specifies interval for computing load statistics
Switch-Access(config-if)# channel-group 1 mode active! Assigns the interface to be EtherChannel EtherChannel group 1 in LACP active mode
Switch-Access(config-if)# interface g1/0/2 ! Enters port 1 configuration mode
Switch-Access(config-if)# switchport trunk encapsulation dot1q ! Tags outgoing frames with IEEE 802.1Q trunk encapsulation format
Switch-Access(config-if)# switchport mode trunk ! Enables the Ethernet port as VLAN trunk
Switch-Access(config-if)# load-interval 30 ! Specifies interval for computing load statistics
Switch-Access(config-if)# channel-group 1 mode active ! Assigns the interface to be EtherChannel EtherChannel group 1 in LACP active mode
Switch-Access(config-if)# exit
Switch-Access(config)# interface Port-channel1 ! Enters EtherChannel specific configuration mode
Switch-Access(config-if)# switchport trunk encapsulation dot1q ! Tags outgoing frames with IEEE 802.1Q trunk encapsulation format
Switch-Access(config-if)# switchport mode trunk ! Enables the EtherChannel as VLAN trunk
Switch-Access(config-if)# load-interval 30 ! Specifies interval for computing load statistics
Switch-Access(config-if)# exit

Switch-Access(config)# interface g1/0/3 ! Enters port 3 configuration mode
Switch-Access(config-if)# switchport trunk encapsulation dot1q ! Tags outgoing frames with IEEE 802.1Q trunk encapsulation format
Switch-Access(config-if)# switchport mode trunk ! Enables the Ethernet port as VLAN trunk
```



```

Switch-Access(config-if)# load-interval 30 ! Specifies interval for computing load
statistics
Switch-Access(config-if)# channel-group 2 mode active ! Assigns the interface to be
EtherChannel EtherChannel group 2 in LACP active mode
Switch-Access(config-if)# interface g1/0/4 ! Enters port 4 configuration mode
Switch-Access(config-if)# switchport trunk encapsulation dot1q ! Tags outgoing frames with
IEEE 802.1Q trunk encapsulation format
Switch-Access(config-if)# switchport mode trunk ! Enables the Ethernet port as VLAN trunk
Switch-Access(config-if)# load-interval 30 ! Specifies interval for computing load
statistics
Switch-Access(config-if)# channel-group 2 mode active ! Assigns the interface to be
EtherChannel EtherChannel group 2 in LACP active mode
Switch-Access(config-if)# exit
Switch-Access(config)# interface Port-channel2 ! Enters EtherChannel specific
configuration mode
Switch-Access(config-if)# switchport trunk encapsulation dot1q ! Tags outgoing frames with
IEEE 802.1Q trunk encapsulation format
Switch-Access(config-if)# switchport mode trunk ! Enables the EtherChannel as VLAN trunk
Switch-Access(config-if)# load-interval 30 ! Specifies interval for computing load
statistics
Switch-Access(config-if)# exit

```

VLAN Implementation

The following configuration was applied to all access ports connected to an IP Phone.

```

Switch-Access(config)# interface range g1/0/5 - 52 ! Enters configuration for range of
gigabit Ethernet ports
Switch-Access(config-if-range)# switchport mode access ! Sets the port to access mode
Switch-Access(config-if-range)# switch access vlan 301 ! Assigns the port to Data VLAN
Switch-Access(config-if-range)# switchport voice vlan 302 ! Assigns the port to Voice VLAN
Switch-Access(config-if-range)# srr-queue bandwidth share 1 70 25 5 ! Enables bandwidth
sharing for all output queues. Queue 1 is strict priority queue, queue 2 gets 70% of
bandwidth, queue 3 25% of bandwidth, and queue 4 5% of the bandwidth
Switch-Access(config-if-range)# srr-queue bandwidth shape 3 0 0 0 ! Specifies queue 2,3,4
to operate in shared mode.
Switch-Access(config-if-range)# priority-queue out ! Egress expedite queue is enabled.
This command will force SRR to ignore weight of queue 1 while calculating the bandwidth
ratio. This queue will be emptied before servicing other queues.
Switch-Access(config-if-range)# mls qos trust device cisco-phone ! Specifies the port to
trust the CoS/DSCP value if the CDP neighbor is Cisco IP Phone
Switch-Access(config-if-range)# spanning-tree portfast ! Sets the switch port to
forwarding state ignoring listening/learning state
Switch-Access(config-if-range)# load-interval 30 ! Specifies interval for computing load
statistics

```

DOT1X Services

```

Switch-Access(config)# aaa new-model ! Enables Authentication, Authorization and
Accounting services
Switch-Access(config)# aaa authentication dot1x default group radius ! Specifies default
dot1x authentication to use RADIUS server database
Switch-Access(config)# aaa session-id common ! Specifies to use the same session identifier
for all invocations of accounting services
Switch-Access(config)# dot1x system-auth-control ! Enables IEEE 802.1x authentication
globally on the switch
Switch-Access(config)# radius-server host 172.16.0.80 ! Specifies RADIUS server IP address

```



```
Switch-Access(config)# radius-server key KEY-BR ! Specifies RADIUS server key as "KEY-BR"
for encrypting all communication with the RADIUS server
Switch-Access(config)# int range g1/0/5 - 52! Enters configuration for the range of Gigabit
Ethernet ports
Switch-Access(config-if-range)# dot1x port-control auto ! Enables dot1x authentication on
the port
Switch-Access(config-if-range)# dot1x timeout server-timeout 60 ! Specifies time to wait
for a response from RADIUS server before retransmitting
```

DOT1X Services Verification

To verify your DOT1X services configuration, enter the following command:

```
Switch-Access# show dot1x interface g1/0/5
Supplicant MAC <Not Applicable>
  AuthSM State      = N/A
  BendSM State      = N/A
PortStatus          = N/A
MaxReq              = 2
MaxAuthReq          = 2
HostMode            = Single
PortControl         = Auto
QuietPeriod         = 60 Seconds
Re-authentication   = Disabled
ReAuthPeriod        = 3600 Seconds
ServerTimeout       = 60 Seconds
SuppTimeout         = 30 Seconds
TxPeriod            = 30 Seconds
Guest-Vlan          = 0
```

QoS Implementation

The mapping for the CoS to DSCP values is shown in [Figure 35](#) in the “Quality of Service” section on [page 41](#).

```
Switch-Access(config)# mls qos ! Enables QoS on the switch
Switch-Access(config)# mls qos map policed-dscp 0 10 18 24 25 34 to 8 ! Defines
Policed-DSCP map which is used to mark down the packets with specified values to DSCP 8.
Switch-Access(config)# mls qos map cos-dscp 0 8 16 24 32 46 48 56 ! Defines CoS-DSCP map
for preferential treatment
Switch-Access(config)# mls qos srr-queue output cos-map queue 1 threshold 3 5 ! Maps the
CoS 5 to egress queue 1 with threshold 3
Switch-Access(config)# mls qos srr-queue output cos-map queue 2 threshold 1 2 4 ! Maps the
CoS 2 and CoS 4 to egress queue 2 with threshold 1
Switch-Access(config)# mls qos srr-queue output cos-map queue 2 threshold 2 3 ! Maps the
CoS 3 to egress queue 2 with threshold 2
Switch-Access(config)# mls qos srr-queue output cos-map queue 2 threshold 3 6 7 ! Maps the
CoS 6 and CoS 7 to egress queue 2 with threshold 3
Switch-Access(config)# mls qos srr-queue output cos-map queue 3 threshold 3 0 ! Maps the
CoS 0 to egress queue 3 with threshold 3
Switch-Access(config)# mls qos srr-queue output cos-map queue 4 threshold 3 1 ! Maps the
CoS 1 to egress queue 4 with threshold 3
Switch-Access(config)# mls qos srr-queue output dscp-map queue 1 threshold 3 46 ! Maps the
DSCP value 46 to egress queue 1 with threshold 3
Switch-Access(config)# mls qos srr-queue output dscp-map queue 2 threshold 1 16 18 20 22
25 32 34 36 ! Maps the DSCP values 16, 18, 20, 22, 25, 32, 34 and 36 to egress queue 2 with
threshold 1
Switch-Access(config)# mls qos srr-queue output dscp-map queue 2 threshold 1 38 ! Maps the
DSCP value 38 to egress queue 2 with threshold 1
Switch-Access(config)# mls qos srr-queue output dscp-map queue 2 threshold 2 24 26 36 !
Maps the DSCP values 24, 26, and 36 to egress queue 2 with threshold 2
```

```

Switch-Access(config)# mls qos srr-queue output dscp-map queue 2 threshold 3 48 56 36 !
Maps the DSCP values 36, 48, and 56 to egress queue 2 with threshold 3
Switch-Access(config)# mls qos srr-queue output dscp-map queue 3 threshold 3 0 36 ! Maps
the DSCP values 0 and 36 to egress queue 3 with threshold 3
Switch-Access(config)# mls qos srr-queue output dscp-map queue 4 threshold 1 8 36 ! Maps
the DSCP values 8 and 36 to egress queue 4 with threshold 1
Switch-Access(config)# mls qos srr-queue output dscp-map queue 4 threshold 3 10 12 14 36
! Maps the DSCP values 10, 12,14, and 36 to egress queue 4 with threshold 3
Switch-Access(config)# mls qos queue-set output 1 threshold 2 70 80 100 100 ! Defines the
weighed tail-drop thresholds for queue 2 to 70% for threshold 1 and 80% for threshold 2
Switch-Access(config)# mls qos queue-set output 1 threshold 4 40 100 100 100 ! Defines the
weighed tail-drop thresholds for queue 4 to 40% for threshold 1 and 100% for threshold 2
Switch-Access(config)# ip access-list extended DVLAN-BULK-DATA ! Defines ACL to match Bulk
Data
Switch-Access(config-ext-nacl)# permit tcp any any eq 220 ! Match Internet Mail Access
Protocol v3 (IMAPv3)
Switch-Access(config-ext-nacl)# permit tcp any any eq 143 ! Match Internet Message Access
Protocol (IMAP)
Switch-Access(config-ext-nacl)# permit tcp any any eq smtp ! Match Simple Mail Transfer
Protocol
Switch-Access(config-ext-nacl)# ip access-list extended DVLAN-MISSION-CRITICAL-DATA !
Defines ACL to match Business Critical Data
Switch-Access(config-ext-nacl)# permit tcp any any eq www ! Match HTTP traffic for port 80
Switch-Access(config-ext-nacl)# permit tcp any any range 3200 3203 ! Match SAP traffic
Switch-Access(config-ext-nacl)# permit tcp any any eq 3600 ! Match SAP traffic
Switch-Access(config-ext-nacl)# permit tcp any any range 2000 2002 ! Match SCCP traffic
Switch-Access(config-ext-nacl)# permit udp any any eq isakmp ! Match Internet Security
Association and Key Management Protocol
Switch-Access(config-ext-nacl)# permit tcp any eq www any ! Match HTTP traffic coming from
source port 80
Switch-Access(config-ext-nacl)# ip access-list extended DVLAN-PC-VIDEO
! Defines ACL to match Video traffic
Switch-Access(config-ext-nacl)# permit udp any any range 16384 32767! Match traffic in the
given port range
Switch-Access(config-ext-nacl)# ip access-list extended DVLAN-TRANSACTIONAL-DATA
! Defines ACL to match Transactional Data
Switch-Access(config-ext-nacl)# permit tcp any any eq 1352 ! Match Lotus Notes traffic
Switch-Access(config-ext-nacl)# permit udp any any eq domain ! Match DNS traffic
Switch-Access(config-ext-nacl)# permit udp any any eq netbios-dgm ! Match NetBios traffic
Switch-Access(config-ext-nacl)# permit udp any any eq netbios-ns ! Match NetBios traffic
Switch-Access(config-ext-nacl)# permit udp any any eq netbios-ss ! Match NetBios traffic
Switch-Access(config-ext-nacl)# ip access-list extended VVLAN-ANY ! Defines ACL to match
Voice VLAN traffic
Switch-Access(config-ext-nacl)# permit ip 10.0.1.0 0.0.0.255 any
Switch-Access(config-ext-nacl)# ip access-list extended VVLAN-CALL-SIGNALING ! Defines ACL
to match voice signaling traffic
Switch-Access(config-ext-nacl)# permit udp 10.0.1.0 0.0.0.255 any
Switch-Access(config-ext-nacl)# permit tcp 10.0.1.0 0.0.0.255 any range 2000 2002
Switch-Access(config-ext-nacl)# ip access-list extended VVLAN-VOICE ! Defines ACL to match
voice traffic
Switch-Access(config-ext-nacl)# permit udp 10.0.1.0 0.0.0.255 any
Switch-Access(config-ext-nacl)# permit udp 10.0.1.0 0.0.0.255 any range 16384 32767
Switch-Access(config-ext-nacl)# class-map match-all DVLAN-TRANSACTIONAL-DATA ! Defines
class-map for Transactional Data
Switch-Access(config-cmap)# match access-group name DVLAN-TRANSACTIONAL-DATA ! Matches
traffic specified in DVLAN-TRANSACTIONAL-DATA ACL
Switch-Access(config-cmap)# class-map match-all DVLAN-PC-VIDEO ! Defines class-map for
Video traffic
Switch-Access(config-cmap)# match access-group name DVLAN-PC-VIDEO ! Matches traffic
specified in DVLAN-PC-VIDEO ACL
Switch-Access(config-cmap)# class-map match-all VVLAN-CALL-SIGNALING ! Defines class-map
for Voice signalling
Switch-Access(config-cmap)# match access-group name VVLAN-CALL-SIGNALING ! Matches traffic
specified in VVLAN-CAL-SIGNALING ACL

```

```

Switch-Access(config-cmap)# class-map match-all DVLAN-MISSION-CRITICAL-DATA
! Defines class-map for Business critical traffic
Switch-Access(config-cmap)# match access-group name DVLAN-MISSION-CRITICAL-DATA
! Matches traffic specified in DVLAN-MISSION_CRITICAL_DATA ACL
Switch-Access(config-cmap)# class-map match-all VVLAN-VOICE ! Defines class-map for voice
traffic
Switch-Access(config-cmap)# match access-group name VVLAN-VOICE ! Matches traffic
specified in VVLAN-VOICE ACL
Switch-Access(config-cmap)# class-map match-all VVLAN-ANY ! Defines class-map for voice
vlan traffic
Switch-Access(config-cmap)# match access-group name VVLAN-ANY ! Matches traffic specified
in VVLAN-ANY ACL
Switch-Access(config-cmap)# class-map match-all DVLAN-BULK-DATA ! Defines class-map for
Bulk traffic
Switch-Access(config-cmap)# match access-group name DVLAN-BULK-DATA ! Matches traffic
specified in DVLAN-BULK_DATA ACL
Switch-Access(config-cmap)# policy-map IPPHONE+PC-ADVANCED ! Defines Policy-map
Switch-Access(config-pmap-c)# class VVLAN-VOICE ! Matches traffic classified by VVLAN-VOICE
class-map
Switch-Access(config-pmap-c)# set dscp ef ! Set DSCP value to EF
Switch-Access(config-pmap-c)# police 6144000 61440 exceed-action drop ! Incoming traffic
will be policed to 6.2 Mbps with a 62 KB burst size and if the rate is exceeded packet
will be dropped
Switch-Access(config-pmap-c)# class VVLAN-CALL-SIGNALING ! Matches traffic classified by
VVLAN-VOICE class-map
Switch-Access(config-pmap-c)# set dscp cs3 ! Set DSCP value to CS3
Switch-Access(config-pmap-c)# police 1024000 10240 exceed-action policed-dscp-transmit
!Incoming traffic will be policed to 10.2 Mbps with a 10.2 KB burst size and if the rate
is exceeded packet will be marked down to Scavenger class (CS1)
Switch-Access(config-pmap-c)# class VVLAN-ANY ! Matches traffic classified by class-map
Switch-Access(config-pmap-c)# set dscp default ! Set DSCP value to 0
Switch-Access(config-pmap-c)# police 32000 8000 exceed-action policed-dscp-transmit !
Incoming traffic will be policed to 32 kbps with a 8 KB burst size and if the rate is
exceeded packet will be marked down to Scavenger class (CS1)
Switch-Access(config-pmap-c)# class DVLAN-PC-VIDEO ! Matches traffic classified by
class-map
Switch-Access(config-pmap-c)# set dscp af41 ! Set DSCP value to 0
Switch-Access(config-pmap-c)# police 1984000 19840 exceed-action policed-dscp-transmit
!Incoming traffic will be policed to 10.2 Mbps with a 10.2 KB burst size and if the rate
is exceeded packet will be marked down to Scavenger class (CS1)
Switch-Access(config-pmap-c)# class DVLAN-MISSION-CRITICAL-DATA ! Matches traffic
classified by class-map
Switch-Access(config-pmap-c)# set dscp 25 ! Set DSCP value to 25
Switch-Access(config-pmap-c)# police 12500000 125000 exceed-action policed-dscp-transmit
!Incoming traffic will be policed to 12.5 Mbps with a 125 KB burst size and if the rate is
exceeded packet will be marked down to Scavenger class (CS1)
Switch-Access(config-pmap-c)# class DVLAN-TRANSACTIONAL-DATA ! Matches traffic classified
by class-map
Switch-Access(config-pmap-c)# police 10000000 100000 exceed-action policed-dscp-transmit
!Incoming traffic will be policed to 10 Mbps with a 100 KB burst size and if the rate is
exceeded packet will be marked down to Scavenger class (CS1)
Switch-Access(config-pmap-c)# set dscp af21 ! Set DSCP value to AF21
Switch-Access(config-pmap-c)# class DVLAN-BULK-DATA ! Matches traffic classified by
class-map
Switch-Access(config-pmap-c)# set dscp af11 ! Set DSCP value to AF11
Switch-Access(config-pmap-c)# police 5000000 50000 exceed-action policed-dscp-transmit
!Incoming traffic will be policed to 5 Mbps with a 50 KB burst size and if the rate is
exceeded packet will be marked down to Scavenger class (CS1)
Switch-Access(config-pmap-c)# class class-default ! Defines default class
Switch-Access(config-pmap-c)# set dscp default ! Set DSCP value to 0
Switch-Access(config-pmap-c)# police 12500000 125000 exceed-action policed-dscp-transmit !
Incoming traffic will be policed to 12.5 Mbps with a 125 KB burst size and if the rate is
exceeded packet will be marked down to Scavenger class (CS1)

```

QoS Verification

To verify your QoS configuration, enter the **show mls qos** command to display whether QoS is enabled in the switch.

```
Switch-Access# show mls qos
QoS is enabled
QoS ip packet dscp rewrite is enabled

Switch-Access# show mls qos maps policed-dscp
Policed-dscp map:
  d1 : d2 0  1  2  3  4  5  6  7  8  9
-----
  0 :   08 01 02 03 04 05 06 07 08 09
  1 :   08 11 12 13 14 15 16 17 08 19
  2 :   20 21 22 23 08 08 26 27 28 29
  3 :   30 31 32 33 08 35 36 37 38 39
  4 :   40 41 42 43 44 45 46 47 48 49
  5 :   50 51 52 53 54 55 56 57 58 59
  6 :   60 61 62 63

Switch-Access# show mls qos maps cos-dscp
Cos-dscp map:
  cos:   0  1  2  3  4  5  6  7
-----
  dscp:  0  8 16 24 32 46 48 56
```

Assigning QoS to Switch Port

```
Switch-Access(config)# interface range g1/0/5 - 52 ! Enters configuration for the range of
Gigabit Ethernet ports
Switch-Access(config-if-range)# service-policy input IPPHONE+PC-ADVANCED ! Applies QoS
policy IPPHONE+PC-ADVANCED to the interface in input direction.
ignoring listening/learning state
```

Verification of Assigning QoS to Switch Port

To verify that QoS is being assigned to the switch port, enter the **show policy-map interface** to display the QoS policy and the related counters.

```
Switch-Access# show policy-map interface g1/0/3
GigabitEthernet1/0/3

Service-policy input: IPPHONE+PC-ADVANCED

Class-map: VVLAN-VOICE (match-all)
  0 packets, 0 bytes
  offered rate 0 bps, drop rate 0 bps
  Match: access-group name VVLAN-VOICE

Class-map: VVLAN-CALL-SIGNALING (match-all)
  0 packets, 0 bytes
  offered rate 0 bps, drop rate 0 bps
  Match: access-group name VVLAN-CALL-SIGNALING

Class-map: VVLAN-ANY (match-all)
  0 packets, 0 bytes
  offered rate 0 bps, drop rate 0 bps
  Match: access-group name VVLAN-ANY
```

```
Class-map: DVLAN-PC-VIDEO (match-all)
  0 packets, 0 bytes
    offered rate 0 bps, drop rate 0 bps
  Match: access-group name DVLAN-PC-VIDEO

Class-map: DVLAN-MISSION-CRITICAL-DATA (match-all)
  0 packets, 0 bytes
    offered rate 0 bps, drop rate 0 bps
  Match: access-group name DVLAN-MISSION-CRITICAL-DATA

Class-map: DVLAN-TRANSACTIONAL-DATA (match-all)
  0 packets, 0 bytes
    offered rate 0 bps, drop rate 0 bps
  Match: access-group name DVLAN-TRANSACTIONAL-DATA

Class-map: DVLAN-BULK-DATA (match-all)
  0 packets, 0 bytes
    offered rate 0 bps, drop rate 0 bps
  Match: access-group name DVLAN-BULK-DATA

Class-map: class-default (match-any)
  0 packets, 0 bytes
    offered rate 0 bps, drop rate 0 bps
  Match: any
    0 packets, 0 bytes
    rate 0 bps
```

Network Fundamental Services Implementation

- [Path Redundancy, page 25](#)
- [IP Addressing and IP Routing, page 27](#)

Path Redundancy

- [Redundant WAN Link, page 25](#)

Redundant WAN Link

Backup for any of the three access links is provided by using a Systematic High-Speed Digital Subscriber Line (SHDSL)-based inverse multiplexing over ATM (IMA) interface. The backup interface is connected to the closest PE device of the service provider network.

```
Router(config)# controller SHDSL 0/2/0 ! Enters controller configuration mode
Router(config-controller)# dsl-group 0 pairs 0, 1, 2 ima ! Creates an IMA bundle pairing
links 0-2
Router(config-controller-dsl-group)# ima group clock-mode itc ! Defines clock mode for the
IMA group. Sets the transmit clock for at least one link to be different from the other
links.
Router(config-controller-dsl-group)# shdsl annex A-B ! Specifies annex A/B of G.991.2
standard to be used on the controller
Router(config-controller-dsl-group)# shdsl rate auto ! Sets the controller rate
negotiation in auto mode
Router(config-controller-dsl-group)# end

Router(config)# interface ATM0/2/IMA0 ! Enters IMA interface configuration mode
```

```

Router(config-if)# bandwidth 4608 ! Sets the maximum allowed bandwidth in Kbps
Router(config-if)# load-interval 30 ! Specifies interval for computing load statistics
Router(config-if)# max-reserved-bandwidth 100 ! Makes 100 % of interface bandwidth
available for QoS reservations
Router(config-if)# exit

Router(config)# interface ATM0/2/IMA0.1 point-to-point ! Creates IMA point-to-point
sub-interface and specifies its parameters
Router(config-subif)# ip address 209.165.201.1 255.255.255.252 ! Assigns IP address to the
interface
Router(config-subif)# pvc 10/10 ! Creates a PVC and specifies its parameters
Router(config-if-atm-vc)# protocol ip 209.165.201.2 broadcast ! Enables broadcast
capability to perform reverse-arp on the ISP router
Router(config-if-atm-vc)# vbr-rt 2304 2304 ! Assigns VBR class of service and defines peak
and average cell rate
Router(config-if-atm-vc)# oam-pvc manage ! Enables end-to-end F5 OAM loopback cell
transmission and OAM management
Router(config-if-atm-vc)# encapsulation aal5mux ppp Virtual-Template10 ! Configures PPPoA
AAL5+MUX point-to-point encapsulation and associates it with Virtual-Template

Router(config)# interface Virtual-Template10 ! Enters Virtual Template configuration
Router(config-if)# bandwidth 4608 ! Sets the maximum allowed bandwidth in Kbps
Router(config-if)# ip unnumbered ATM0/2/IMA0.1 ! Reuses the IP address of the IMA
sub-interface
Router(config-if)# ip nbar protocol-discovery ! Enables NBAR to discover default protocols
and gather statistics
Router(config-if)# ip flow ingress ! Enables NetFlow accounting for incoming traffic
Router(config-if)# ip flow egress ! Enables NetFlow accounting for outgoing traffic
Router(config-if)# load-interval 30 ! Specifies interval for computing load statistics
Router(config-if)# max-reserved-bandwidth 100 ! Makes 100% of interface bandwidth
available for QoS reservations
Router(config-if)# end

```

Apply the following command on the Virtual Template interface after defining the *EIGHT-CLASS-V3PN-EDGE-SHAPE* class as shown in the Security section.

```

Router(config-if)# service-policy output EIGHT-CLASS-V3PN-EDGE-SHAPE ! Applies QoS policy
to the interface in outgoing direction to provide preferential treatment for traffic

```

Apply the following command on the Virtual Template interface after defining the *Public* security zone as shown in the Security section.

```

Router(config-if)# zone-member security Public ! Adds interface to firewall zone called
Public

```

Apply the following command on the Virtual Template interface after defining the *VPN-MAP* crypto map as shown in the Security section if using GETVPN.

```

Router(config-if)# crypto map VPN-MAP ! Applies crypto map "VPN-MAP" to the interface

```

Redundant WAN Link Verification

To verify the redundant WAN link configuration, enter the **show backup** command to display the backup interface and its status for each primary interface.

```

Router# show backup
Primary Interface   Secondary Interface   Status
-----
Multilink1         ATM0/2/IMA0          normal operation

```

IP Addressing and IP Routing

- [Routing Protocol Implementation, page 27](#)
- [Multicast Implementation, page 34](#)
- [DHCP Implementation, page 35](#)
- [NAT Implementation, page 35](#)
- [Quality of Service Implementation, page 36](#)

Routing Protocol Implementation

A branch office router is likely to use a single routing protocol. However, because a network may use EIGRP, OSPF, RIPv2, BGP or static routing, all of these protocols were independently validated. The following configurations are for each of the protocols. [Table 1](#) summarizes the subnets in the Services Ready Medium Branch Network.

Table 1 Subnet Assignment

Network	Address	Type
Primary WAN	192.168.0.0/30	Private
Backup WAN	209.165.201.0/30	Public
Loopback	209.165.201.8/30	Public
Data VLAN	10.0.0.0/24	Private
Voice VLAN	10.0.1.0/24	Private
Management VLAN	10.0.2.0/27	Private
Black Hole VLAN	10.0.2.32/27	Private
DMZ VLAN	10.0.2.64/28	Private
Tunnel Interfaces	10.0.2.80/30	Private
Voice Mail Module	10.0.2.84/30	Private
Cisco WAAS Module	10.0.2.88/30	Private
EtherSwitch Module	10.0.2.92/30	Private
Central Site Network	172.16.0.0/16	Private

The Services Ready Medium Branch Network provides direct access to the Internet through split tunneling. Various combinations of WAN services and VPN technologies lead to several different options for implementing the split tunnel mechanism. In WAN implementations where the network service provider is responsible for routing (for example, Layer 3 VPN [L3VPN]), split tunneling can be provided on the primary link and the backup link can be set to standby state. The implementation options vary slightly for GETVPN and DMVPN. In WAN implementations where the enterprise is responsible for routing, split tunneling can be provided on the backup link by maintaining it in an active state. Again, there is a slight variation between GETVPN and DMVPN implementations.

Active/Standby Primary/Backup WAN Links with DMVPN Implementation

The secondary WAN interface must be configured as the backup interface for the primary WAN link.

```
Router(config)# interface Multilink1 ! Enters multilink interface configuration mode
```



```
Router(config-if)# backup interface ATM0/2/IMA0 ! Specifies backup interface
Router(config-if)# exit
```

A loopback interface with a public address is used as the source interface for the DMVPN tunnel.

```
Router(config)# interface Loopback0 ! Enters loopback interface configuration mode
Router(config-if)# ip address 209.165.201.9 255.255.255.252 ! Specifies loopback subnet
Router(config-if)# exit
```

The “DMVPN Implementation” section on page 54 provides configuration for the tunnel interface. After the tunnel interface is defined, two routing processes are configured: one for the enterprise network, and another for the public network. The following sections provide implementations in which OSPF, EIGRP, and RIPv2 provide routing for enterprise traffic in which BGP is responsible for routing public traffic.

Enterprise Routing With OSPF

Enterprise networks are learned through the tunnel interface.

```
Router(config)# router ospf 1 ! Enables private network OSPF routing process
Router(config-router)# passive interface GigabitEthernet 2/0 ! Disables routing
advertisements on the LAN interface
Router(config-router)# router-id 10.0.0.1 ! Specifies the OSPF router ID
Router(config-router)# network 10.0.0.0 0.0.0.255 area 0 ! Advertises Data VLAN subnet in
backbone area
Router(config-router)# network 10.0.1.0 0.0.0.255 area 0 ! Advertises Voice VLAN subnet in
backbone area
Router(config-router)# network 10.0.2.0 0.0.0.31 area 0 ! Advertises Management VLAN
subnet in backbone area
Router(config-router)# network 10.0.2.64 0.0.0.15 area 0 ! Advertises DMZ VLAN subnet in
backbone area
Router(config-router)# network 10.0.2.80 0.0.0.3 area 0 ! Advertises Tunnel subnet in
backbone area
Router(config-router)# network 10.0.2.88 0.0.0.3 area 0 ! Advertises WAAS subnet in
backbone area
Router(config-router)# exit
```

Enterprise Routing with EIGRP

Enterprise networks are learned through the tunnel interface.

```
Router(config)# router eigrp 1 ! Enables private network EIGRP routing process
Router(config-router)# passive interface GigabitEthernet 2/0 ! Disables routing
advertisements on the LAN interface
Router(config-router)# no auto-summary ! Disable automatic route summarization
Router(config-router)# network 10.0.0.0 0.0.0.255 ! Advertises Data VLAN subnet
Router(config-router)# network 10.0.1.0 0.0.0.255 ! Advertises Voice VLAN subnet
Router(config-router)# network 10.0.2.0 0.0.0.31 ! Advertises Management VLAN subnet
Router(config-router)# network 10.0.2.64 0.0.0.15 ! Advertises DMZ VLAN subnet
Router(config-router)# network 10.0.2.80 0.0.0.3 ! Advertises Tunnel subnet
Router(config-router)# network 10.0.2.88 0.0.0.3 ! Advertises WAAS subnet
Router(config-router)# exit
```

Enterprise Routing with RIPv2

Enterprise networks are learned through the tunnel interface.

```
Router(config)# router rip ! Enables private network RIP routing process
Router(config-router)# passive interface GigabitEthernet 2/0 ! Disables routing
advertisements on the LAN interface
Router(config-router)# no auto-summary ! Disable automatic route summarization
Router(config-router)# version 2 ! Enable RIP version 2
Router(config-router)# network 10.0.0.0 ! Advertises all branch subnets
```



```
Router(config-router)# exit
```

Service Provider Routing with BGP

The BGP routing process is responsible for establishing the tunnel link by advertising the loopback network. In default BGP configuration, the router learns public routes advertised by the PE or ISP router. A Medium routing table would slow down the destination network lookup process. In general, network service providers should not advertise Internet routes to the branch network, but in case this happens, an access list is defined to exclude public routes.

```
Router(config)# access-list 20 permit 209.165.201.8 0.0.0.3 ! Permits Loopback network and blocks all others
Router(config)# router bgp 1 ! Enables public and loopback network BGP routing process
Router(config-router)# passive interface GigabitEthernet 2/0 ! Disables routing advertisements on the LAN interface
Router(config-router)# neighbor 192.168.0.2 remote-as 65015! Neighbor router IP for primary link that is in autonomous system 65015
Router(config-router)# neighbor 209.165.201.2 remote-as 65016! Neighbor router IP for backup link that is in autonomous system 65016
Router(config-router)# network 192.168.0.0 mask 255.255.255.252 ! Advertises primary WAN link subnet
Router(config-router)# network 209.165.201.0 mask 255.255.255.252 ! Advertises backup WAN link subnet
Router(config-router)# network 209.165.201.8 mask 255.255.255.252 ! Advertises Loopback subnet
Router(config-router)# distribute-list 20 in ! Block all routing updates except for Loopback network
Router(config-router)#exit
```

Finally, static routes are defined to direct traffic to the public network. When the primary link is active, it is used as the default route for all traffic. When the backup link is active, it is used as the default for all traffic.

```
Router(config)# ip route 0.0.0.0 0.0.0.0 192.168.0.2 ! Sets the primary WAN link as default for all traffic
Router(config)# ip route 0.0.0.0 0.0.0.0 209.165.201.2 ! Sets the backup WAN link as default for all traffic
```

Active/Standby Primary/Backup WAN Links with GETVPN on Primary Link and DMVPN on Backup Link Implementation

Because GETVPN is a tunnel-less protocol, it is used only on the primary WAN link. Because DMVPN is used for the backup link, the tunnel interface is needed only when the primary link fails. All enterprise network information is advertised over the primary link. Since this link also routes public traffic, it may insert public routes into the routing table. To prevent this situation, the following ACL is defined to allow only enterprise networks in the routing table.

```
Router(config)# access-list 10 permit 172.16.0.0 0.0.255.255 ! Permits all Enterprise networks
```

Enterprise Routing with OSPF

Enterprise networks are learned through the primary WAN interface.

```
Router(config)# router ospf 1 ! Enables private network OSPF routing process
Router(config-router)# passive interface GigabitEthernet 2/0 ! Disables routing advertisements on the LAN interface
Router(config-router)# router-id 10.0.0.1 ! Specifies the OSPF router ID
Router(config-router)# network 10.0.0.0 0.0.0.255 area 0 ! Advertises Data VLAN subnet in backbone area
```

```

Router(config-router)# network 10.0.1.0 0.0.0.255 area 0 ! Advertises Voice VLAN subnet in
backbone area
Router(config-router)# network 10.0.2.0 0.0.0.31 area 0 ! Advertises Management VLAN
subnet in backbone area
Router(config-router)# network 10.0.2.64 0.0.0.15 area 0 ! Advertises DMZ VLAN subnet in
backbone area
Router(config-router)# network 10.0.2.80 0.0.0.3 area 0 ! Advertises Tunnel subnet in
backbone area
Router(config-router)# network 10.0.2.88 0.0.0.3 area 0 ! Advertises WAAS subnet in
backbone area
Router(config-router)# network 192.168.0.0 0.0.0.3 area 0 ! Advertises primary WAN link
subnet in the backbone area
Router(config-router)# distribute-list 10 in ! Block all Internet routing updates
Router(config-router)# exit

```

Enterprise Routing with EIGRP

Enterprise networks are learned through the primary WAN interface.

```

Router(config)# router eigrp 1 ! Enables private network EIGRP routing process
Router(config-router)# passive interface GigabitEthernet 2/0 ! Disables routing
advertisements on the LAN interface
Router(config-router)# no auto-summary ! Disable automatic route summarization
Router(config-router)# network 10.0.0.0 0.0.0.255 ! Advertises Data VLAN subnet
Router(config-router)# network 10.0.1.0 0.0.0.255 ! Advertises Voice VLAN subnet
Router(config-router)# network 10.0.2.0 0.0.0.31 ! Advertises Management VLAN subnet
Router(config-router)# network 10.0.2.64 0.0.0.15 ! Advertises DMZ VLAN subnet
Router(config-router)# network 10.0.2.80 0.0.0.3 ! Advertises Tunnel subnet
Router(config-router)# network 10.0.2.88 0.0.0.3 ! Advertises WAAS subnet
Router(config-router)# network 192.168.0.0 0.0.0.3 ! Advertises primary WAN link subnet
Router(config-router)# distribute-list 10 in ! Block all Internet routing updates
Router(config-router)# exit

```

Enterprise Routing with RIPv2

Enterprise networks are learned through the primary WAN interface.

```

Router(config)# router rip ! Enables private network RIP routing process
Router(config-router)# passive interface GigabitEthernet 2/0 ! Disables routing
advertisements on the LAN interface
Router(config-router)# no auto-summary ! Disable automatic route summarization
Router(config-router)# version 2 ! Enable RIP version 2
Router(config-router)# network 10.0.0.0 ! Advertises all branch subnets
Router(config-router)# network 192.168.0.0 ! Advertises primary WAN link subnet
Router(config-router)# distribute-list 10 in ! Block all Internet routing updates
Router(config-router)# exit

```

Service Provider Routing with BGP

The BGP routing process is responsible for establishing the tunnel link by advertising the loopback network. In the default BGP configuration, the router learns public routes that are advertised by the ISP router. A Medium routing table would slow down the destination network lookup process. In general, network service providers should not advertise Internet routes to the branch network; an access list should be defined to exclude public routes.

```

Router(config)# access-list 20 permit 209.165.201.8 0.0.0.3 ! Permits Loopback network and
blocks all others

Router(config)# router bgp 1 ! Enables public and loopback network BGP routing process
Router(config-router)# passive interface GigabitEthernet 2/0 ! Disables routing
advertisements on the LAN interface
Router(config-router)# neighbor 209.165.201.2 remote-as 65016 ! Neighbor router IP for
backup link that is in autonomous system 65016

```

```

Router(config-router)# network 209.165.201.0 mask 255.255.255.252 ! Advertises backup WAN
link subnet
Router(config-router)# network 209.165.201.8 mask 255.255.255.252 ! Advertises Loopback
subnet
Router(config-router)# distribute-list 20 in ! Block all routing updates except for
Loopback network
Router(config-router)# exit

```

Finally, static routes are defined to direct traffic to the public network. When the primary link is active, it is used as the default for all traffic. When the backup link is active, it is used as the default for all traffic.

```

Router(config)# ip route 0.0.0.0 0.0.0.0 192.168.0.2 ! Sets the primary WAN link as
default for all traffic
Router(config)# ip route 0.0.0.0 0.0.0.0 209.165.201.2 ! Sets the backup WAN link as
default for all traffic

```

Active/Active Primary/Backup WAN Link with DMVPN Implementation

The primary function of the backup interface in the Services Ready Medium Branch Network is to provide an alternate path in case the primary link fails. When the primary WAN interface is operational, the backup interface is in standby mode. However, for purposes of split tunneling, the interface can be kept in active state and provide access to the Internet, because it is a direct connection.

Again, there are two routing processes, one for enterprise traffic and another for public traffic. The routing is similar to the Active/Standby configuration for DMVPN because BGP likely selects the primary interface as the lowest-cost path to the central site network. It automatically switches over the tunnel interface to the backup link when the primary fails. To prevent situations where the Internet has a lower cost path to the central site, static routes with different costs are defined for the central site loopback interface. The only other difference in configuration is the default route configuration. Non-enterprise traffic must be directed out over the backup link.

Enterprise Routing with OSPF

Enterprise networks are learned through the tunnel interface.

```

Router(config)# router ospf 1 ! Enables private network OSPF routing process
Router(config-router)# passive interface GigabitEthernet 2/0 ! Disables routing
advertisements on the LAN interface
Router(config-router)# router-id 10.0.0.1 ! Specifies the OSPF router ID
Router(config-router)# network 10.0.0.0 0.0.0.255 area 0 ! Advertises Data VLAN subnet in
backbone area
Router(config-router)# network 10.0.1.0 0.0.0.255 area 0 ! Advertises Voice VLAN subnet in
backbone area
Router(config-router)# network 10.0.2.0 0.0.0.31 area 0 ! Advertises Management VLAN
subnet in backbone area
Router(config-router)# network 10.0.2.64 0.0.0.15 area 0 ! Advertises DMZ VLAN subnet in
backbone area
Router(config-router)# network 10.0.2.80 0.0.0.3 area 0 ! Advertises Tunnel subnet in
backbone area
Router(config-router)# network 10.0.2.88 0.0.0.3 area 0 ! Advertises WAAS subnet in
backbone area
Router(config-router)# exit

```

Enterprise Routing with EIGRP

Enterprise networks are learned through the tunnel interface.

```

Router(config)# router eigrp 1 ! Enables private network EIGRP routing process
Router(config-router)# passive interface GigabitEthernet 2/0 ! Disables routing
advertisements on the LAN interface

```

```

Router(config-router)# no auto-summary ! Disable automatic route summarization
Router(config-router)# network 10.0.0.0 0.0.0.255 ! Advertises Data VLAN subnet
Router(config-router)# network 10.0.1.0 0.0.0.255 ! Advertises Voice VLAN subnet
Router(config-router)# network 10.0.2.0 0.0.0.31 ! Advertises Management VLAN subnet
Router(config-router)# network 10.0.2.64 0.0.0.15 ! Advertises DMZ VLAN subnet
Router(config-router)# network 10.0.2.80 0.0.0.3 ! Advertises Tunnel subnet
Router(config-router)# network 10.0.2.88 0.0.0.3 ! Advertises WAAS subnet
Router(config-router)# exit

```

Enterprise Routing with RIPv2

Enterprise networks are learned through the Tunnel interface.

```

Router(config)# router rip ! Enables private network RIP routing process
Router(config-router)# passive interface GigabitEthernet 2/0 ! Disables routing
advertisements on the LAN interface
Router(config-router)# no auto-summary ! Disable automatic route summarization
Router(config-router)# version 2 ! Enable RIP version 2
Router(config-router)# network 10.0.0.0 ! Advertises all branch subnets
Router(config-router)# exit

```

Service Provider Routing with BGP

The BGP routing process is responsible for establishing the tunnel link by advertising the loopback network. In the default BGP configuration, the router learns public routes that are advertised by the PE or ISP router. A Medium routing table would slow down the destination network lookup process. In general, network service providers should not advertise Internet routes to the branch network; an access list should be defined to exclude public routes.

```

Router(config)# access-list 20 permit 209.165.201.8 0.0.0.3 ! Permits Loopback network and
blocks all others

```

```

Router(config)# router bgp 1 ! Enables public and loopback network BGP routing process
Router(config-router)# passive interface GigabitEthernet 2/0 ! Disables routing
advertisements on the LAN interface
Router(config-router)# neighbor 192.168.0.2 remote-as 65015! Neighbor router IP for
primary link that is in autonomous system 65015
Router(config-router)# neighbor 209.165.201.2 remote-as 65016! Neighbor router IP for
backup link that is in autonomous system 65016
Router(config-router)# network 192.168.0.0 mask 255.255.255.252 ! Advertises primary WAN
link subnet
Router(config-router)# network 209.165.201.0 mask 255.255.255.252 ! Advertises backup WAN
link subnet
Router(config-router)# network 209.165.201.8 mask 255.255.255.252 ! Advertises Loopback
subnet
Router(config-router)# distribute-list 20 in ! Block all routing updates except for
Loopback network
Router(config-router)#exit

```

Finally, static routes are defined to direct traffic to the public network. When the primary link is active, it is used as the default for all traffic. When the backup link is active, it is used as the default for all traffic. In addition, static routes ensure that the central site loopback interface is routed over the primary link when it is in an active state.

```

Router(config)# ip route 0.0.0.0 0.0.0.0 192.168.0.2 250 ! Sets the primary WAN link as
default for all traffic with higher cost than the backup WAN link
Router(config)# ip route 0.0.0.0 0.0.0.0 209.165.201.2 ! Sets the backup WAN link as
default for all traffic with lower cost than the primary link
Router(config)# ip route 209.165.201.10 255.255.255.255 192.168.0.2 ! Sets the primary WAN
link as the preferred interface for reaching the central site Loopback interface
Router(config)# ip route 209.165.201.10 255.255.255.255 209.165.201.2 250 ! Sets the
backup WAN link as the preferred interface for reaching the central site Loopback
interface

```

Active/Active Primary/Backup WAN Links with GETVPN on Primary Link and DMVPN on Backup Link Implementation

As in the Active/Standby configuration with DMVPN, this implementation differs from the Active/Standby GETVPN and DMVPN implementation in the assignment of static routes for loopback network and public traffic.

```
Router(config)# access-list 10 permit 172.16.0.0 0.0.255.255 ! Permits all Enterprise networks
```

Enterprise Routing with OSPF

Enterprise networks are learned through the primary WAN interface.

```
Router(config)# router ospf 1 ! Enables private network OSPF routing process
Router(config-router)# passive interface GigabitEthernet 2/0 ! Disables routing advertisements on the LAN interface
Router(config-router)# router-id 10.0.0.1 ! Specifies the OSPF router ID
Router(config-router)# network 10.0.0.0 0.0.0.255 area 0 ! Advertises Data VLAN subnet in backbone area
Router(config-router)# network 10.0.1.0 0.0.0.255 area 0 ! Advertises Voice VLAN subnet in backbone area
Router(config-router)# network 10.0.2.0 0.0.0.31 area 0 ! Advertises Management VLAN subnet in backbone area
Router(config-router)# network 10.0.2.64 0.0.0.15 area 0 ! Advertises DMZ VLAN subnet in backbone area
Router(config-router)# network 10.0.2.80 0.0.0.3 area 0 ! Advertises Tunnel subnet in backbone area
Router(config-router)# network 10.0.2.88 0.0.0.3 area 0 ! Advertises WAAS subnet in backbone area
Router(config-router)# network 192.168.0.0 0.0.0.3 area 0 ! Advertises primary WAN link subnet in the backbone area
Router(config-router)# distribute-list 10 in ! Block all Internet routing updates
Router(config-router)# exit
```

Enterprise Routing with EIGRP

Enterprise networks are learned through the primary WAN interface.

```
Router(config)# router eigrp 1 ! Enables private network EIGRP routing process
Router(config-router)# passive interface GigabitEthernet 2/0 ! Disables routing advertisements on the LAN interface
Router(config-router)# no auto-summary ! Disable automatic route summarization
Router(config-router)# network 10.0.0.0 0.0.0.255 ! Advertises Data VLAN subnet
Router(config-router)# network 10.0.1.0 0.0.0.255 ! Advertises Voice VLAN subnet
Router(config-router)# network 10.0.2.0 0.0.0.31 ! Advertises Management VLAN subnet
Router(config-router)# network 10.0.2.64 0.0.0.15 ! Advertises DMZ VLAN subnet
Router(config-router)# network 10.0.2.80 0.0.0.3 ! Advertises Tunnel subnet
Router(config-router)# network 10.0.2.88 0.0.0.3 ! Advertises WAAS subnet
Router(config-router)# network 192.168.0.0 0.0.0.3 ! Advertises primary WAN link subnet
Router(config-router)# distribute-list 10 in ! Block all Internet routing updates
Router(config-router)# exit
```

Enterprise Routing with RIPv2

Enterprise networks are learned through the primary WAN interface.

```
Router(config)# router rip ! Enables private network RIP routing process
Router(config-router)# passive interface GigabitEthernet 2/0 ! Disables routing advertisements on the LAN interface
Router(config-router)# no auto-summary ! Disable automatic route summarization
Router(config-router)# version 2 ! Enable RIP version 2
Router(config-router)# network 10.0.0.0 ! Advertises all branch subnets
Router(config-router)# network 192.168.0.0 ! Advertises primary WAN link subnet
Router(config-router)# distribute-list 10 in ! Block all Internet routing updates
```

```
Router(config-router)# exit
```

Service Provider Routing with BGP

The BGP routing process is responsible for establishing the tunnel link by advertising the loopback network. In the default BGP configuration, the router learns public routes advertised by the ISP router. In general, network service providers should not advertise Internet routes to the branch network; an access list should be defined to exclude public routes.

```
Router(config)# access-list 20 permit 209.165.201.8 0.0.0.3 ! Permits Loopback network and blocks all others
```

```
Router(config)# router bgp 1 ! Enables public and loopback network BGP routing process
Router(config-router)# passive interface GigabitEthernet 2/0 ! Disables routing advertisements on the LAN interface
Router(config-router)# neighbor 209.165.201.2 remote-as 65016! Neighbor router IP for backup link that is in autonomous system 65016
Router(config-router)# network 209.165.201.0 mask 255.255.255.252 ! Advertises backup WAN link subnet
Router(config-router)# network 209.165.201.8 mask 255.255.255.252 ! Advertises Loopback subnet
Router(config-router)# distribute-list 20 in ! Block all routing updates except for Loopback network
Router(config-router)#exit
```

There is a possibility that the tunnel link has a lower cost to the central site than the primary WAN link. To prevent traffic from being sent over the tunnel link when the WAN link is available, the tunnel interface is defined as backup for the primary WAN interface.

```
Router(config)# interface Multilink1 ! Enters multilink interface configuration mode
Router(config-if)# backup interface Tunnell ! Specifies backup interface
Router(config-if)# exit
```

Finally, static routes are defined to direct traffic to the public network. When the primary link is active, it is used as the default for all route traffic. When the backup link is active, it is used as the default route for all traffic.

```
Router(config)# ip route 0.0.0.0 0.0.0.0 192.168.0.2 250 ! Sets the primary WAN link as default for all traffic with higher cost than backup WAN link
Router(config)# ip route 0.0.0.0 0.0.0.0 209.165.201.2 ! Sets the backup WAN link as default for all traffic with lower cost than primary WAN link
```

Multicast Implementation

Previous sections have shown how to apply multicast on each interface.

```
Router(config)# ip multicast-routing ! Enables multicast routing
```

Multicast Verification

To verify your multicast configuration, enter the following command:

```
Router# show ip pim neighbor
PIM Neighbor Table
Mode: B - Bidir Capable, DR - Designated Router, N - Default DR Priority,
      S - State Refresh Capable
Neighbor      Interface      Uptime/Expires   Ver   DR
Address
192.168.0.1   Multilink1     00:00:16/00:01:27 v2    1 / S P
Router#
```

DHCP Implementation

Addresses were dynamically assigned for the data and voice VLAN devices. The DMZ server used static addressing.

```
Router(config)# ip dhcp excluded-address 10.0.1.1 10.0.1.10 ! Specifies the addresses to
be excluded from DHCP
Router(config)# ip dhcp excluded-address 10.0.1.245 10.0.1.254 ! Specifies the addresses
to be excluded from DHCP
Router(config)# ip dhcp pool IP-PHONES ! Specifies DHCP pool for IP Phones
Router(dhcp-config)# network 10.0.1.0 255.255.255.0 ! Specifies the DHCP address range
Router(dhcp-config)# default-router 10.0.1.3 ! Specifies the default HSRP gateway
Router(dhcp-config)# option 150 ip 10.0.0.2 ! Specifies the default TFTP server
Router(dhcp-config)# lease 30 ! Sets the lease expiration to 1 month
Router(dhcp-config)# exit
Router(config)# ip dhcp excluded-address 10.0.0.1 10.0.0.30! Specifies the addresses to be
excluded from DHCP
Router(config)# ip dhcp excluded-address 10.0.0.245 10.0.0.254! Specifies the addresses to
be excluded from DHCP
Router(config)# ip dhcp pool PCS ! Specifies the DHCP pool for PCs
Router(dhcp-config)# network 10.0.0.0 255.255.255.0 ! Specifies the DHCP address range
Router(dhcp-config)# default-router 10.0.0.3 ! Specifies the default HSRP gateway
Router(dhcp-config)# exit
Router(config)# service dhcp ! Starts the DHCP server
```

DHCP Verification

To verify your DHCP configuration, enter the **show ip dhcp binding** command to display the IP address details leased by the DHCP server.

```
Router# show ip dhcp binding
Bindings from all pools not associated with VRF:
IP address          Client-ID/
                   Hardware address/
                   User name
10.0.1.26           0100.1e4a.a8e5.e1    Infinite          Automatic
10.0.1.29           0100.5060.0387.20    Infinite          Automatic
Router#
```

NAT Implementation

```
Router(config)# ip access-list standard NAT-BRANCH ! Defines extended ACL for translation
Router(config-ext-nacl)# permit 10.0.0.0 0.0.0.255
Router(config-ext-nacl)# exit
Router(config)# ip nat translation tcp-timeout 300 ! Specifies timeout value for TCP ports
Router(config)# ip nat inside source list NAT-BRANCH interface ATM0/2/IMA0.1 overload !
Enables NAT for traffic that matches the ACL (Inside local) and translates the source
address to specified interface address (Inside global) on the backup interface
Router(config)# interface GigabitEthernet2/0.1 ! Enters gigabit Ethernet configuration
mode
Router(config-subif)# ip nat inside ! Specifies the interface as connected to inside
network
Router(config-subif)# exit
Router(config)# interface ATM0/2/IMA0.1 ! Enters backup interface configuration mode
Router(config-if)# ip nat outside ! Specifies the interface as connected to outside
network
Router(config-if)# exit
```

NAT Verification

To verify your NAT configuration, enter the following command:

```
Router# show ip nat translations
Pro Inside global      Inside local      Outside local      Outside global
tcp 22

10.0.0.15: 2140        10.0.0.15: 2140    201.165.201.1:2000  201.165.201.1:2000
Router#
```

Quality of Service Implementation

Quality of service (QoS) identifies business-critical traffic and ensures that appropriate bandwidth and network resources are allocated according to a classification scheme. QoS includes classification of different traffic types, marking specific fields in Layer 2 or Layer 3 headers, prioritizing the traffic based on the marked field, and dropping unwanted traffic.

Eight-Class QoS was configured to match traffic, based on the NBAR protocol classification or using Layer 2 or Layer 3 header information. A different level of service is provided for the matched traffic. The QoS scheme also checks for any unwanted traffic and drops it if matches are found in the incoming traffic from the LAN. A parent policy-map is configured to shape the outgoing traffic to a specified rate (as per the service provider), and a child policy-map is applied to the shaping queue.

```
Router(config)# ip access-list extended ACL-FTP ! Defines extended ACL to identify traffic
from a local FTP server
Router(config-ext-nacl)# permit ip host 10.0.0.4 any
Router(config-ext-nacl)#exit
!Defines two extended access lists (101 and 102) to classify PCs running enterprise
applications
Router(config)# access-list 101 permit ip host 10.0.0.5 host 172.16.0.30
Router(config)# access-list 101 permit ip host 10.0.0.6 host 172.16.0.30
Router(config)# access-list 102 permit ip host 10.0.0.7 any
Router(config)# access-list 102 permit ip host 10.0.0.8 any
Router(config)# access-list 102 permit ip host 10.0.0.9 any
Router(config)# access-list 102 permit ip host 10.0.0.10 any
Router(config)# ip nbar port-map custom-02 udp 1434 ! Customizes NBAR protocol to match
UDP port 1434 used by the SQL Slammer and Sapphire worms
Router(config)# ip nbar port-map custom-03 tcp 5554 9996 ! Customizes NBAR protocol to
match TCP ports 5554 and 9996 used by the Sasser worm
Router(config)# ip nbar port-map custom-04 tcp 445 ! Customize NBAR protocol to match TCP
port 445 used by Microsoft SMB protocol for file sharing
Router(config)# class-map match-all SQL-SLAMMER ! Defines Class map for Sql-Slammer
traffic
Router(config-cmap)# match protocol custom-02 ! Matches traffic with port number in
custom-02
Router(config-cmap)# match packet length min 404 max 404 ! Matches traffic with packet
length 404 bytes
Router(config-cmap)# exit
Router(config)# class-map match-any WORMS ! Defines class map for unwanted traffic
Router(config-cmap)# match protocol http url "*.ida*" ! Matches HTTP traffic with the
specific string in the URL
Router(config-cmap)# match protocol http url "*cmd.exe*" ! Matches HTTP traffic with the
specific string in the URL
Router(config-cmap)# match protocol http url "*root.exe*" ! Matches HTTP traffic with the
specific string in the URL
Router(config-cmap)# match protocol http url "*readme.eml*" ! Matches HTTP traffic with
the specific string in the URL
Router(config-cmap)# match class-map SQL-SLAMMER ! Matches SQL-Slammer worm signature
Router(config-cmap)# match protocol custom-03 ! Matches Sasser worm signature
Router(config-cmap)# exit
```



```
Router(config)# class-map match-any VOICE ! Defines class map for Voice traffic
Router(config-cmap)# match ip dscp ef ! Matches traffic with DSCP set to EF
Router(config-cmap)# exit
Router(config)# class-map match-all INTERACTIVE-VIDEO ! Defines class map for interactive
video traffic
Router(config-cmap)# match ip dscp af41 af42 ! Matches traffic with DSCP set to AF41 or
AF42
Router(config-cmap)# exit
Router(config)# class-map match-all SCAVENGER ! Defines class map for Scavenger traffic
Router(config-cmap)# match ip dscp cs1 ! Matches traffic with DSCP set to cs1
Router(config-cmap)# exit
Router(config)# class-map match-any MISSION-CRITICAL ! Defines classmap for mission
critical traffic
Router(config-cmap)# match ip dscp cs3 ! Matches traffic with DSCP set to CS3
Router(config-cmap)# match ip dscp af31 ! Matches traffic with DSCP set to AF31
Router(config-cmap)# match access-group 101 ! Matches ip traffic in ACL 101
Router(config-cmap)# match ip dscp 25 ! Matches traffic with DSCP set to 25
Router(config-cmap)# match protocol http ! Matches HTTP traffic
Router(config-cmap)# exit
Router(config)# class-map match-any INTERNETWORK-CONTROL ! Defines class map for routing
control traffic
Router(config-cmap)# match ip dscp cs6 ! Matches traffic with DSCP set to CS6
Router(config-cmap)# exit
Router(config)# class-map match-any TRANSACTIONAL-DATA ! Defines class map for
transactional data traffic
Router(config-cmap)# match ip dscp af21 af22 ! Matches traffic with DSCP set to AF21 or
AF22
Router(config-cmap)# match access-group 102 ! Matches ip traffic in ACL
Router(config-cmap)# match protocol custom-04 ! Matches traffic with port number mentioned
in custom-04
Router(config-cmap)# exit
Router(config)# class-map match-any BULK-DATA ! Defines Class map for bulk traffic
Router(config-cmap)# match ip dscp af11 af12 ! Matches traffic with DSCP set to AF11 or
AF12
Router(config-cmap)# match protocol ftp ! Matches FTP traffic
Router(config-cmap)# match access-group name ACL-FTP ! Matches ip traffic in ACL-FTP ACL
Router(config-cmap)# exit

Router(config)# policy-map EIGHT-CLASS-V3PN-EDGE ! Defines child policy map
Router(config-pmap)# class VOICE ! Matches traffic classified by VOICE class-map
Router(config-pmap-c)# priority % 18 ! Specifies guaranteed bandwidth of 14 % of interface
bandwidth
Router(config-pmap-c)# class INTERACTIVE-VIDEO ! Matches traffic classified by
INTERACTIVE-VIDEO class-map
Router(config-pmap-c)# priority % 10 ! Specifies guaranteed bandwidth of 6% of interface
bandwidth
Router(config-pmap-c)# class MISSION-CRITICAL ! Matches traffic classified
byMISSION-CRITICAL class-map
Router(config-pmap-c)# bandwidth % 25 ! Specifies a minimum bandwidth of 25% of interface
bandwidth
Router(config-pmap-c)# random-detect ! Specifies to drop TCP packet randomly to avoid tail
drop
Router(config-pmap-c)# class INTERNETWORK-CONTROL ! Matches traffic classified by
INTERNETWORK-CONTROL class-map
Router(config-pmap-c)# bandwidth % 3 ! Specifies a minimum bandwidth of 3% of interface
bandwidth
Router(config-pmap-c)# class TRANSACTIONAL-DATA ! Matches traffic classified by
TRANSACTIONAL-DATA class-map
Router(config-pmap-c)# bandwidth % 12 ! Specifies a minimum bandwidth of 18% of interface
bandwidth
Router(config-pmap-c)# random-detect ! Specifies to drop TCP packet randomly to avoid tail
drop
Router(config-pmap-c)# class BULK-DATA ! Matches traffic classified by BULK-DATA class map
```

```

Router(config-pmap-c)# bandwidth % 5 ! Specifies a minimum bandwidth of 5% of interface
bandwidth
Router(config-pmap-c)# class SCAVENGER ! Matches traffic classified by SCAVENGER class map
Router(config-pmap-c)# bandwidth % 2 ! Specifies a minimum bandwidth of 2% of interface
bandwidth
Router(config-pmap-c)# class class-default ! Defines default class
Router(config-pmap-c)# bandwidth % 25 ! Specifies a minimum bandwidth of 25% of interface
bandwidth
Router(config-pmap-c)# random-detect ! Specifies to drop TCP packet randomly to avoid tail
drop
Router(config-pmap-c)# exit
Router(config-pmap)# exit

```

After creating the following two policy maps, apply them on WAN interfaces as described in the DS-3, DS-1, and Gigabit Ethernet interface configuration section.

```

Router(config)# policy-map EIGHT-CLASS-V3PN-EDGE-SHAPE ! Defines parent policy map for
Primary interface
Router(config-pmap)# class class-default ! Matches all traffic
Router(config-pmap-c)# shape average 6912000 ! Outgoing traffic was shaped at a rate of
6.9 Mbps
Router(config-pmap-c)# service-policy EIGHT-CLASS-V3PN-EDGE ! Attaches traffic policy to
shaping queue.
Router(config-pmap-c)# exit
Router(config-pmap)# exit
Router(config)# policy-map EIGHT-CLASS-V3PN-EDGE-BACKUP ! Defines parent policy map for
Backup interface
Router(config-pmap)# class class-default ! Matches all traffic
Router(config-pmap-c)# shape average 4608000 ! Outgoing traffic was shaped at a rate of
4.6 Mbps
Router(config-pmap-c)# service-policy EIGHT-CLASS-V3PN-EDGE ! Attaches traffic policy to
shaping queue.
Router(config-pmap-c)# exit
Router(config)# map-class frame-relay FR-SHAPING ! Defines a map-class for Frame Relay
traffic shaping
Router(config-map-class)# frame-relay cir 24000000 ! Sets average rate to 24 Mbps
Router(config-map-class)# frame-relay bc 120000 ! Sets committed burst size to 120 Kb
Router(config-map-class)# frame-relay mincir 24000000 ! Sets the minimum guaranteed rate
it should drop in case of congestion to 24 Mbps
Router(config-map-class)# frame-relay adaptive-shaping becn ! Enables to adjust the
shaping rate in response to backward congestion notification
Router(config-map-class)# service-policy output EIGHT-CLASS-V3PN-EDGE-SHAPE ! Attaches
traffic policy to Frame Relay shaping queue.
Router(config-map-class)# exit
Router(config)# policy-map INPUT-POLICY ! Defines Policy map for LAN interface
Router(config-pmap)# class WORMS ! Matches HTTP traffic with Virus
Router(config-pmap-c)# drop ! Drop the traffic
Router(config-pmap-c)# class class-default ! Matches all traffic
Router(config-pmap-c)# exit
Router(config-pmap)# exit
Router(config)#

```

Quality of Service Verification

To verify your QoS configuration, enter the **show policy-map interface** command to display the QoS policy and related traffic counters on each interface.

```

Router# show policy-map interface
GigabitEthernet2/0.1

Service-policy input: INPUT-POLICY

Class-map: WORMS (match-any)

```

```

9 packets, 594 bytes
30 second offered rate 0 bps, drop rate 0 bps
Match: protocol http url "*.ida*"
  0 packets, 0 bytes
  30 second rate 0 bps
Match: protocol http url "*cmd.exe*"
  0 packets, 0 bytes
  30 second rate 0 bps
Match: protocol http url "*root.exe*"
  0 packets, 0 bytes
  30 second rate 0 bps
Match: protocol http url "*readme.eml*"
  0 packets, 0 bytes
  30 second rate 0 bps
Match: class-map match-all SQL-SLAMMER
  0 packets, 0 bytes
  30 second rate 0 bps
  Match: protocol custom-02
  Match: packet length min 404 max 404
Match: protocol custom-03
  9 packets, 594 bytes
  30 second rate 0 bps
drop

Class-map: class-default (match-any)
  103593411 packets, 6980776240 bytes
  30 second offered rate 0 bps, drop rate 0 bps
  Match: any
  QoS Set
  dscp cos
  Packets marked 103593416
GigabitEthernet2/0.2

Service-policy input: INPUT-POLICY

Class-map: WORMS (match-any)
  0 packets, 0 bytes
  30 second offered rate 0 bps, drop rate 0 bps
  Match: protocol http url "*.ida*"
    0 packets, 0 bytes
    30 second rate 0 bps
  Match: protocol http url "*cmd.exe*"
    0 packets, 0 bytes
    30 second rate 0 bps
  Match: protocol http url "*root.exe*"
    0 packets, 0 bytes
    30 second rate 0 bps
  Match: protocol http url "*readme.eml*"
    0 packets, 0 bytes
    30 second rate 0 bps
  Match: class-map match-all SQL-SLAMMER
    0 packets, 0 bytes
    30 second rate 0 bps
    Match: protocol custom-02
    Match: packet length min 404 max 404
  Match: protocol custom-03
    0 packets, 0 bytes
    30 second rate 0 bps
  drop

Class-map: class-default (match-any)
  3350613 packets, 212885188 bytes
  30 second offered rate 0 bps, drop rate 0 bps
  Match: any

```

```

QoS Set
  dscp cos
    Packets marked 3350613
GigabitEthernet2/0.3

Service-policy input: INPUT-POLICY

Class-map: WORMS (match-any)
  0 packets, 0 bytes
  30 second offered rate 0 bps, drop rate 0 bps
  Match: protocol http url "*.ida*"
    0 packets, 0 bytes
    30 second rate 0 bps
  Match: protocol http url "*cmd.exe*"
    0 packets, 0 bytes
    30 second rate 0 bps
  Match: protocol http url "*root.exe*"
    0 packets, 0 bytes
    30 second rate 0 bps
  Match: protocol http url "*readme.eml*"
    0 packets, 0 bytes
    30 second rate 0 bps
  Match: class-map match-all SQL-SLAMMER
    0 packets, 0 bytes
    30 second rate 0 bps
  Match: protocol custom-02
  Match: packet length min 404 max 404
  Match: protocol custom-03
    0 packets, 0 bytes
    30 second rate 0 bps
  drop

Class-map: class-default (match-any)
  3266743 packets, 201900728 bytes
  30 second offered rate 0 bps, drop rate 0 bps
  Match: any
  QoS Set
    dscp cos
      Packets marked 3266743
GigabitEthernet0/0/0

Service-policy output: EIGHT-CLASS-V3PN-EDGE-SHAPE

Class-map: class-default (match-any)
  86921887 packets, 11420188514 bytes
  30 second offered rate 1000 bps, drop rate 0 bps
  Match: any
  Traffic Shaping
    Target/Average   Byte   Sustain   Excess   Interval   Increment
      Rate           Limit  bits/int  bits/int  (ms)      (bytes)
    6912000/6912000  43200  172800   172800   25        21600

    Adapt Queue     Packets  Bytes    Packets  Bytes    Shaping
    Active Depth    -        85141012 2709383642 0        0        Delayed  Active
    -              0        85141012 2709383642 0        0        no

Service-policy : EIGHT-CLASS-V3PN-EDGE

Class-map: VOICE (match-any)
  1781 packets, 206488 bytes
  30 second offered rate 0 bps, drop rate 0 bps
  Match: ip dscp ef (46)
    0 packets, 0 bytes
    30 second rate 0 bps

```

```

Queueing
  Strict Priority
  Output Queue: Conversation 136
  Bandwidth 14 ( %)
  Bandwidth 967 (kbps) Burst 24175 (Bytes)
  (pkts matched/bytes matched) 0/0
  (total drops/bytes drops) 0/0

Class-map: INTERACTIVE-VIDEO (match-all)
  0 packets, 0 bytes
  30 second offered rate 0 bps, drop rate 0 bps
  Match: ip dscp af41 (34) af42 (36)
  Queueing
    Strict Priority
    Output Queue: Conversation 136
    Bandwidth 6 ( %)
    Bandwidth 414 (kbps) Burst 10350 (Bytes)
    (pkts matched/bytes matched) 0/0
    (total drops/bytes drops) 0/0

Class-map: MISSION-CRITICAL (match-any)
  1181375 packets, 148873894 bytes
  30 second offered rate 0 bps, drop rate 0 bps
  Match: ip dscp cs3 (24)
    1181375 packets, 148873894 bytes
    30 second rate 0 bps
  Match: ip dscp af31 (26)
    0 packets, 0 bytes
    30 second rate 0 bps
  Match: access-group 101
    0 packets, 0 bytes
    30 second rate 0 bps
  Match: ip dscp 25
    0 packets, 0 bytes
    30 second rate 0 bps
  Match: protocol http
    0 packets, 0 bytes
    30 second rate 0 bps
  Queueing
    Output Queue: Conversation 137
    Bandwidth 25 ( %)
    Bandwidth 1728 (kbps)
    (pkts matched/bytes matched) 0/0
  (depth/total drops/no-buffer drops) 0/0/0
    exponential weight: 9
    mean queue depth: 0

class      Transmitted      Random drop      Tail drop      Minimum Maximum Mark
          pkts/bytes      pkts/bytes      pkts/bytes      thresh  thresh  prob
0          0/0              0/0              0/0              20     40     1/10
1          0/0              0/0              0/0              22     40     1/10
2          0/0              0/0              0/0              24     40     1/10
3 1181305/148866418  0/0              0/0              26     40     1/10
4          0/0              0/0              0/0              28     40     1/10
5          0/0              0/0              0/0              30     40     1/10
6          0/0              0/0              0/0              32     40     1/10
7          0/0              0/0              0/0              34     40     1/10
rsvp      0/0              0/0              0/0              36     40     1/10

Class-map: INTERNETWORK-CONTROL (match-any)
  1245619 packets, 176240010 bytes
  30 second offered rate 0 bps, drop rate 0 bps
  Match: ip dscp cs6 (48)

```

```

1245619 packets, 176240010 bytes
30 second rate 0 bps
Queueing
  Output Queue: Conversation 138
  Bandwidth 3 ( %)
  Bandwidth 207 (kbps)Max Threshold 64 (packets)
  (pkts matched/bytes matched) 0/0
(depth/total drops/no-buffer drops) 0/0/0

Class-map: TRANSACTIONAL-DATA (match-any)
8833287 packets, 1254893912 bytes
30 second offered rate 1000 bps, drop rate 0 bps
Match: ip dscp af21 (18) af22 (20)
8833286 packets, 1254893912 bytes
30 second rate 1000 bps
Match: access-group 102
0 packets, 0 bytes
30 second rate 0 bps
Match: protocol custom-04
0 packets, 0 bytes
30 second rate 0 bps
Queueing
  Output Queue: Conversation 139
  Bandwidth 18 ( %)
  Bandwidth 1244 (kbps)
  (pkts matched/bytes matched) 0/0
(depth/total drops/no-buffer drops) 0/0/0
  exponential weight: 9
  mean queue depth: 0

```

class	Transmitted pkts/bytes	Random drop pkts/bytes	Tail drop pkts/bytes	Minimum thresh	Maximum thresh	Mark prob
0	0/0	0/0	0/0	20	40	1/10
1	0/0	0/0	0/0	22	40	1/10
2	8833254/1254889504	0/0	0/0	24	40	1/10
3	0/0	0/0	0/0	26	40	1/10
4	0/0	0/0	0/0	28	40	1/10
5	0/0	0/0	0/0	30	40	1/10
6	0/0	0/0	0/0	32	40	1/10
7	0/0	0/0	0/0	34	40	1/10
rsvp	0/0	0/0	0/0	36	40	1/10

```

Class-map: BULK-DATA (match-any)
0 packets, 0 bytes
30 second offered rate 0 bps, drop rate 0 bps
Match: ip dscp af11 (10) af12 (12)
0 packets, 0 bytes
30 second rate 0 bps
Match: protocol ftp
0 packets, 0 bytes
30 second rate 0 bps
Match: access-group name aclftp
0 packets, 0 bytes
30 second rate 0 bps
Queueing
  Output Queue: Conversation 140
  Bandwidth 5 ( %)
  Bandwidth 345 (kbps)Max Threshold 64 (packets)
  (pkts matched/bytes matched) 0/0
(depth/total drops/no-buffer drops) 0/0/0

Class-map: SCAVENGER (match-all)
0 packets, 0 bytes

```

```

30 second offered rate 0 bps, drop rate 0 bps
Match: ip dscp cs1 (8)
Queueing
  Output Queue: Conversation 141
  Bandwidth 2 ( %)
  Bandwidth 138 (kbps)Max Threshold 64 (packets)
  (pkts matched/bytes matched) 0/0
(depth/total drops/no-buffer drops) 0/0/0

Class-map: class-default (match-any)
  75659826 packets, 9839974210 bytes
  30 second offered rate 0 bps, drop rate 0 bps
Match: any
Queueing
  Output Queue: Conversation 142
  Bandwidth 25 ( %)
  Bandwidth 1728 (kbps)
  (pkts matched/bytes matched) 0/0
(depth/total drops/no-buffer drops) 0/0/0
  exponential weight: 9
  mean queue depth: 0

```

class	Transmitted pkts/bytes	Random drop pkts/bytes	Tail drop pkts/bytes	Minimum thresh	Maximum thresh	Mark prob
0	73879122/9719111088	0/0	0/0	20	40	1/10
1	0/0	0/0	0/0	22	40	1/10
2	18/14796	0/0	0/0	24	40	1/10
3	0/0	0/0	0/0	26	40	1/10
4	0/0	0/0	0/0	28	40	1/10
5	0/0	0/0	0/0	30	40	1/10
6	0/0	0/0	0/0	32	40	1/10
7	0/0	0/0	0/0	34	40	1/10
rsvp	0/0	0/0	0/0	36	40	1/10

Virtual-Template10

Service-policy output: EIGHT-CLASS-V3PN-EDGE-BACKUP

Service policy content is displayed for cloned interfaces only such as vaccess and sessions

Security Services Implementation

- [Infrastructure Protection Implementation, page 43](#)
- [Access Control Implementation, page 51](#)
- [Secure Connectivity Implementation, page 52](#)
- [Threat Defense Detection and Mitigation Implementation, page 58](#)

Infrastructure Protection Implementation

- [Securing Unused Ports, page 44](#)
- [Turning Off Unused Services, page 44](#)
- [Routing Protocol Security, page 50](#)
- [Additional Services Measures, page 51](#)

Securing Unused Ports

The following is an example of securing an unused port. The example applies both to the access switch and the distribution layer switch.

```
Switch(config)# interface g1/0/4 ! Enters configuration mode for the specified port
Switch(config-if)# switchport mode access ! Assign the port to access mode
Switch(config-if)# switchport access vlan 333 ! Assign the unused port to Black Hole VLAN
Switch(config-if)# exit
```

Turning Off Unused Services

To improve the overall security of the network, the Cisco IOS devices must be secured from infrastructure attack. As a security best practice, disable any unused services because these unused services are only rarely used for legitimate purposes and can be used to launch a denial of service (DoS) attack. The following example disables the unused services.

```
Router(config)# no service pad ! Disable PAD service
Router(config)# no service udp-small-servers ! Disable UDP small server
Router(config)# no service tcp-small-servers ! Disable TCP small server
Router(config)# no ip bootp server ! Disable BOOTP server
Router(config)# no cdp run ! Disable Cisco Discover Protocol service
Router(config)# no ip source-route ! Disable source routing
Router(config)# no ip classless ! Disable forwarding of packets for unrecognized subnets
Router(config)# no ip http server ! Disable HTTP server
Router(config)# no ip http secure-server ! Disable HTTPS server
Router(config)# no ip domain-lookup ! Disable DNS server
Router(config) # interface Multilink1 ! Enters interface configuration mode
Router(config-if)# no cdp enable ! Disable Cisco discovery protocol on the interface
Router(config-if)# no ip redirects ! Disable ICMP redirect message
Router(config-if)# no ip proxy-arp ! Disable Proxy ARP
Router(config-if)# no ip unreachable ! Disable ICMP unreachable error message
Router(config-if)# no ip directed-broadcast ! Disable directed broadcasts
Router(config-if)# no ip mask-reply ! Disable ICMP mask reply messages
```

The unused services can also be disabled by running Cisco AutoSecure.

```
Router# auto secure
--- AutoSecure Configuration ---

*** AutoSecure configuration enhances the security of
the router, but it will not make it absolutely resistant
to all security attacks ***

AutoSecure will modify the configuration of your device.
All configuration changes will be shown. For a detailed
explanation of how the configuration changes enhance security
and any possible side effects, please refer to Cisco.com for
Autosecure documentation.
At any prompt you may enter '?' for help.
Use ctrl-c to abort this session at any prompt.

Gathering information about the router for AutoSecure

Is this router connected to internet? [no]: yes
Enter the number of interfaces facing the internet [1]: 3
Controller Timeslots D-Channel Configurable modes Status
T1 0/0/0 24 23 pri/channelized Administratively up
T1 0/0/1 24 23 pri/channelized Administratively up Administratively up
```

Interface	IP-Address	OK?	Method	Status	Protocol
GigabitEthernet0/1	unassigned	YES	NVRAM	up	up
GigabitEthernet2/0.1	10.0.0.1	YES	NVRAM	up	up
GigabitEthernet2/0.2	10.0.1.1	YES	NVRAM	up	up
GigabitEthernet2/0.3	10.0.2.65	YES	NVRAM	up	up
GigabitEthernet2/0.4	10.0.2.1	YES	NVRAM	up	up
Serial0/0/0:0	unassigned	YES	unset	down	down
Serial0/0/0:1	unassigned	YES	unset	down	down
Serial0/0/0:2	unassigned	YES	unset	down	down
Serial0/0/0:3	unassigned	YES	unset	down	down
Serial0/0/0:4	unassigned	YES	unset	down	down
Serial0/0/0:5	unassigned	YES	unset	down	down
Serial0/0/0:6	unassigned	YES	unset	down	down
Serial0/0/0:7	unassigned	YES	unset	down	down
Serial0/0/0:8	unassigned	YES	unset	down	down
Serial0/0/0:9	unassigned	YES	unset	down	down
Serial0/0/0:10	unassigned	YES	unset	down	down
Serial0/0/0:11	unassigned	YES	unset	down	down
Serial0/0/0:12	unassigned	YES	unset	down	down
Serial0/0/0:13	unassigned	YES	unset	down	down
Serial0/0/0:14	unassigned	YES	unset	down	down
Serial0/0/0:15	unassigned	YES	unset	down	down
Serial0/0/0:16	unassigned	YES	unset	down	down
Serial0/0/0:17	unassigned	YES	unset	down	down
Serial0/0/0:18	unassigned	YES	unset	down	down
Serial0/0/0:19	unassigned	YES	unset	down	down
Serial0/0/0:20	unassigned	YES	unset	down	down
Serial0/0/0:21	unassigned	YES	unset	down	down
Serial0/0/0:22	unassigned	YES	unset	down	down
Serial0/0/0:23	unassigned	YES	NVRAM	up	up
Serial0/1/0	unassigned	YES	NVRAM	up	up
Serial0/1/1	unassigned	YES	NVRAM	up	up
Serial0/1/2	unassigned	YES	NVRAM	up	up
Serial0/1/3	unassigned	YES	NVRAM	up	up
ATM0/2/IMA0	unassigned	YES	NVRAM	standby mode	down
ATM0/2/IMA0.1	209.165.201.1	YES	NVRAM	standby mode	down
In1/0	10.0.2.85	YES	NVRAM	up	up
Integrated-Service-Engine1/0	10.0.2.89	YES	NVRAM	administratively down	down
Multilink1	192.168.0.1	YES	NVRAM	up	up
Virtual-Access1	unassigned	YES	unset	up	up
Virtual-Access2	unassigned	YES	unset	down	down
Virtual-Template10	209.165.201.1	YES	TFTP	down	down
Loopback0	209.165.201.9	YES	NVRAM	up	up
Tunnel1	10.0.2.81	YES	NVRAM	up	up

Enter the interface name that is facing the internet: **Multilink1**

Enter the interface name that is facing the internet: **ATM0/2/IMA0.1**

Enter the interface name that is facing the internet: **Loopback0**

Securing Management plane services...

Disabling service finger

Disabling service pad

Disabling udp & tcp small servers

Enabling service password encryption

Enabling service tcp-keepalives-in

Enabling service tcp-keepalives-out

Disabling the cdp protocol

Disabling the bootp server

Disabling the http server

Disabling the finger service
 Disabling source routing
 Disabling gratuitous arp

Is SNMP used to manage the router? [yes/no]: **no**
 Disabling SNMP

Here is a sample Security Banner to be shown
 at every access to device. Modify it to suit your
 enterprise requirements.

Authorized Access only
 This system is the property of So-&So-Enterprise.
 UNAUTHORIZED ACCESS TO THIS DEVICE IS PROHIBITED.
 You must have explicit permission to access this
 device. All activities performed on this device
 are logged. Any violations of access policy will result
 in disciplinary action.

Enter the security banner {Put the banner between
 k and k, where k is any character}:
 k Unauthorised access to this device is prohibited k
 Enable secret is either not configured or
 is the same as enable password
 Enter the new enable secret:
 Confirm the enable secret :
 Enter the new enable password:
 Confirm the enable password:
 Configuring AAA local authentication
 Configuring Console, Aux and VTY lines for
 local authentication, exec-timeout, and transport
 Securing device against Login Attacks
 Configure the following parameters

Blocking Period when Login Attack detected: **5**

Maximum Login failures with the device: **5**

Maximum time period for crossing the failed login attempts: **5**

Configure SSH server? [yes]: **yes**
 Enter hostname: **Branch**
 Enter the domain-name: **example.com**

Configuring interface specific AutoSecure services
 Disabling the following ip services on all interfaces:

no ip redirects
 no ip proxy-arp
 no ip unreachable
 no ip directed-broadcast
 no ip mask-reply
 Disabling mop on Ethernet interfaces

Securing Forwarding plane services...

Enabling CEF (This might impact the memory requirements for your platform)
 Enabling unicast rpf on all interfaces connected
 to internet

```
Configure CBAC Firewall feature? [yes/no]: no
Tcp intercept feature is used prevent tcp syn attack
on the servers in the network. Create autosec_tcp_intercept_list
to form the list of servers to which the tcp traffic is to
be observed
```

```
Enable tcp intercept feature? [yes/no]: no
```

```
This is the configuration generated:
```

```
no service finger
no service pad
no service udp-small-servers
no service tcp-small-servers
service password-encryption
service tcp-keepalives-in
service tcp-keepalives-out
no cdp run
no ip bootp server
no ip http server
no ip finger
no ip source-route
no ip gratuitous-arps
no ip identd
no snmp-server
banner motd ^C Unauthorised access to this device is prohibited ^C
security passwords min-length 6
security authentication failure rate 10 log
enable secret 5 $1$2gLN$RpNwkFyfJdCjXkMDxY3PI1
enable password 7 011F07065802150C2E
aaa new-model
aaa authentication login local_auth local
line con 0
  login authentication local_auth
  exec-timeout 5 0
  transport output telnet
line aux 0
  login authentication local_auth
  exec-timeout 10 0
  transport output telnet
line vty 0 4
  login authentication local_auth
  transport input telnet
line tty 1
  login authentication local_auth
  exec-timeout 15 0
line tty 66
  login authentication local_auth
  exec-timeout 15 0
line tty 130
  login authentication local_auth
  exec-timeout 15 0
login block-for 5 attempts 5 within 5
ip domain-name example.com
crypto key generate rsa general-keys modulus 1024
ip ssh time-out 60
ip ssh authentication-retries 2
```

```
line vty 0 4
  transport input ssh telnet
service timestamps debug datetime msec localtime show-timezone
service timestamps log datetime msec localtime show-timezone
logging facility local2
logging trap debugging
service sequence-numbers
logging console critical
logging buffered
interface GigabitEthernet0/0
  no ip redirects
  no ip proxy-arp
  no ip unreachable
  no ip directed-broadcast
  no ip mask-reply
  no mop enabled
interface GigabitEthernet0/1
  no ip redirects
  no ip proxy-arp
  no ip unreachable
  no ip directed-broadcast
  no ip mask-reply
  no mop enabled
interface GigabitEthernet2/0.1
  no ip redirects
  no ip proxy-arp
  no ip unreachable
  no ip directed-broadcast
  no ip mask-reply
interface GigabitEthernet2/0.2
  no ip redirects
  no ip proxy-arp
  no ip unreachable
  no ip directed-broadcast
  no ip mask-reply
interface GigabitEthernet2/0.3
  no ip redirects
  no ip proxy-arp
  no ip unreachable
  no ip directed-broadcast
  no ip mask-reply
interface Serial0/0/0
  no ip redirects
  no ip proxy-arp
  no ip unreachable
  no ip directed-broadcast
  no ip mask-reply
interface Serial0/1/1
  no ip redirects
  no ip proxy-arp
  no ip unreachable
  no ip directed-broadcast
  no ip mask-reply
interface Serial0/1/2
  no ip redirects
  no ip proxy-arp
  no ip unreachable
  no ip directed-broadcast
  no ip mask-reply
```

```

interface Serial0/1/3
  no ip redirects
  no ip proxy-arp
  no ip unreachable
  no ip directed-broadcast
  no ip mask-reply
interface Serial0/0/0:23
  no ip redirects
  no ip proxy-arp
  no ip unreachable
  no ip directed-broadcast
  no ip mask-reply
interface ATM0/2/IMA0
  no ip redirects
  no ip proxy-arp
  no ip unreachable
  no ip directed-broadcast
  no ip mask-reply
interface ATM0/2/IMA0.1
  no ip redirects
  no ip proxy-arp
  no ip unreachable
  no ip directed-broadcast
  no ip mask-reply
interface Integrated-Service-Engine1/0
  no ip redirects
  no ip proxy-arp
  no ip unreachable
  no ip directed-broadcast
  no ip mask-reply
  no mop enabled
interface Integrated-Service-Engine2/0
  no ip redirects
  no ip proxy-arp
  no ip unreachable
  no ip directed-broadcast
  no ip mask-reply
  no mop enabled
ip cef
access-list 100 permit udp any any eq bootpc
interface ATM0/3/IMA0.1
  ip verify unicast source reachable-via rx allow-default 100
!
end

```

Apply this configuration to running-config? [yes]: **yes**

Applying the config generated to running-config
The name for the keys will be: Router.example.com

```

percent The key modulus size is 1024 bits
percent Generating 1024 bit RSA keys, keys will be non-exportable...[OK]

```

```

Router#
092165: Sep 23 03:03:32.096 PDT: percentAUTOSEC-1-MODIFIED: AutoSecure configuration has
been Modified on this device
Router#

```

Routing Protocol Security

Apply an authentication mechanism to all the WAN interfaces.

OSPF

```
Router(config)# interface Tunnel 1 ! Enters tunnel interface configuration mode
Router(config-line)# ip ospf authentication message-digest ! Enables MD5 routing protocol
authentication
Router(config-line)# ip ospf message-digest-key 100 md5 c1$k0SyS ! Sets key and password
for MD5
Router(config)# exit
Router(config)# interface Multilink1 ! Enters serial interface configuration mode
Router(config-line)# ip ospf authentication message-digest ! Enables MD5 routing protocol
authentication
Router(config-line)# ip ospf message-digest-key 100 md5 c1$k0SyS ! Sets key and password
for MD5
Router(config)# exit
```

EIGRP

```
Router(config)# key chain EIGRP-KEY ! Creates chain of keys
Router(config-keychain)# key 1 ! Creates a key
Router(config-keychain-key)# key-string c1$k0SyS ! Sets the key value
Router(config-keychain-key)# exit
Router(config-keychain)# exit

Router(config)# interface Tunnel 1 ! Enters tunnel interface configuration mode
Router(config-line)# ip authentication mode eigrp 100 md5 ! Enables MD5 routing protocol
authentication
Router(config-line)# ip authentication key-chain eigrp 100 EIGRP-KEY ! Sets key and
password for MD5
Router(config)# exit
Router(config)# interface Multilink1 ! Enters serial interface configuration mode
Router(config-line)# ip authentication mode eigrp 100 md5 ! Enables MD5 routing protocol
authentication
Router(config-line)# ip authentication key-chain eigrp 100 EIGRP-KEY ! Sets key and
password for MD5
Router(config)# exit
```

RIPv2

```
Router(config)# key chain RIP-KEY ! Creates chain of keys
Router(config-keychain)# key 1 ! Creates a key
Router(config-keychain-key)# key-string c1$k0SyS ! Sets the key value
Router(config-keychain-key)# exit
Router(config-keychain)# exit

Router(config)# interface Tunnel 1 ! Enters tunnel interface configuration mode
Router(config-line)# ip rip authentication mode md5 ! Enables MD5 routing protocol
authentication
Router(config-line)# ip rip authentication key-chain RIP-KEY ! Sets key and password for
MD5
Router(config)# exit
Router(config)# interface Multilink1 ! Enters serial interface configuration mode
Router(config-line)# ip rip authentication mode md5 ! Enables MD5 routing protocol
authentication
Router(config-line)# ip rip authentication key-chain RIP-KEY ! Sets key and password for
MD5
```

```
Router(config)# exit
```

Additional Services Measures

```
Router(config)# line vty 0 4 ! Specifies VTY line specific parameters
Router(config-line)# transport input ssh ! Allows only SSH connection
Router(config)# exit
Router(config)# ip http secure-server ! Enables HTTPS service
Router(config)# ip http authentication aaa login-authentication default ! Specifies to use
AAA database for HTTP login
```

Verification of Additional Services Measures

To verify your additional services configuration, enter the following command.

```
Router# show ip ssh
SSH Enabled - version 1.99
Authentication timeout: 120 secs; Authentication retries: 3
```

Access Control Implementation

Authentication, Authorization, and Accounting (AAA) is an architectural framework for consistently configuring a set of independent security functions. It provides a modular way of performing authentication, authorization, and accounting using a protocol such as RADIUS or TACACS.

In the branch architecture, AAA is the primary method for access control, using RADIUS as the protocol for communication between network devices and the AAA server.

```
Router(config)# aaa new-model ! Enables Authentication, Authorization and Accounting
services
Router(config)# aaa group server radius AAA-BRANCH ! Specifies the RADIUS server group
Router(config-sg-radius)# server 172.16.0.80 auth-port 1645 acct-port 1646 ! Specifies the
RADIUS server ip address
Router(config-sg-radius)# aaa authentication login default group radius local ! Specifies
default login authentication to use RADIUS server database
Router(config-sg-radius)# aaa authentication login VPN-AUTH-LIST group radius local !
Specifies SSL VPN login authentication to use RADIUS server database
Router(config)# aaa session-id common ! Specifies the use of the same session identifier
for all invocations of accounting services
Router(config)# radius-server key BRANCH-KEY ! Specifies RADIUS server key
```

Password Management

```
Router(config)# security passwords min-length 8 ! Sets minimum length of passwords to 8
characters
Router(config)# service password-encryption ! Enables Cisco IOS to encrypt all password in
configuration file
Router(config)# enable password level 7 C1$k0SyS ! Enables configuration password with
privilege level 7
Router(config)# enable secret level 5 C1$k0SyS ! Enables configuration password stored
with MD5 encryption with privilege level 5
Router(config)# security authentication failure rate 10 log ! Allows up to 10 unsuccessful
login attempts with a syslog entry for attempts that exceed the threshold
Router(config)# username admin password C1$k0SyS ! Sets login password
```

```
Switch-Dist(config)# service password-encryption ! Enables Cisco IOS to encrypt all
password in configuration file
```

```
Switch-Dist(config)# enable secret level 5 C1$k0SyS ! Enables configuration password
stored with MD5 encryption with privilege level 5
```

```
Switch-Access(config)# service password-encryption ! Enables Cisco IOS to encrypt all
password in configuration file
```

```
Switch-Access(config)# enable secret level 5 C1$k0SyS ! Enables configuration password
stored with MD5 encryption with privilege level 5
```

Secure Connectivity Implementation

- [GETVPN Key Server, page 53](#)
- [DMVPN Implementation, page 54](#)
- [SSL VPN Implementation, page 56](#)

Group Encrypted Transport Virtual Private Networks (GETVPN) eliminates the need for tunnels across the WAN. By removing the need for point-to-point tunnels, meshed networks can scale better while maintaining network-intelligence features that are critical to voice and video quality, such as QoS, routing, and multicast. GETVPN offers a new standards-based IPsec security model that is based on the concept of “trusted” group members. Trusted member routers use a common security methodology that is independent of any point-to-point IPsec tunnel relationship.

GET-based networks can be used in a variety of WAN environments, including IP and Multiprotocol Label Switching (MPLS). MPLS VPNs that use this encryption technology are highly scalable, manageable, and cost-effective, and they meet government-mandated encryption requirements. The flexible nature of GET allows security-conscious enterprises either to manage their own network security over a service provider WAN service or to offload encryption services to their providers. GET simplifies securing large Layer 2 or MPLS networks that require partial or full-mesh connectivity.

In the Services Ready Medium Branch Foundation, GETVPN encryption was used on the primary WAN link.

```
Router(config)# crypto isakmp policy 1 ! Identifies the policy to create and enters
isakmp configuration mode
Router(config-isakmp)# encryption 3des ! Specifies the 3-DES encryption algorithm
Router(config-isakmp)# authentication pre-share ! Specifies authentication with preshared
keys
Router(config-isakmp)# hash md5 ! Specifies hash algorithm as MD5
Router(config-isakmp)# group 2 ! Specifies the 1024-bit Diffie-Hellman group
Router(config-isakmp)# lifetime 28800 ! Specifies the lifetime of IKE security association
Router(config-isakmp)# crypto isakmp key VPN-KEY address 209.165.201.10! Specifies static
key for the ISAKMP negotiation with peer device using remote peer Loopback address
Router(config)# crypto isakmp keepalive 30 ! Enables keepalives between peers with
specified interval
Router(config)# crypto gdoi group GET-GROUP ! Enters GDOI group configuration mode.
Router(config-gdoi-group)# identity number 1357924680 ! Sets GDOI group number
Router(config-gdoi-group)# server address ipv4 209.165.201.10! Specifies GDOI key server
address
Router(config-gdoi-group)# crypto map VPN-MAP local-address Loopback0 ! Specifies the
interface to be used by the crypto map for the IPSEC traffic
Router(config)# crypto map VPN-MAP 1 gdoi ! Enters crypto map configuration mode and
creates or modifies a crypto map entry.
Router(config-crypto-map)# set group GET-GROUP ! Associates the GDOI group to the crypto
map.
Router(config-crypto-map)# qos pre-classify ! Enables QoS on VPN tunnel interface
Router(config-crypto-map)# exit
```

Apply the *VPN-MAP* on all WAN interfaces and subinterfaces.

```
Router(config-fr-dlci)# crypto map VPN-MAP
```

or

```
Router(config-if)# crypto map VPN-MAP
```

GETVPN Key Server

The key server was configured at the central location.

```
KEY-SERVER(config)# crypto isakmp policy 1 ! Defines an IKE policy
KEY-SERVER(config-isakmp)# encryption 3des ! Specifies 3-DES encryption algorithm
KEY-SERVER(config-isakmp)# authentication pre-share ! Specifies authentication with
preshared keys
KEY-SERVER(config-isakmp)# group 2 ! Specifies the 1024-bit Diffie-Hellman group
KEY-SERVER(config-isakmp)# lifetime 28800 ! Specifies the lifetime of IKE security
association
KEY-SERVER(config)# crypto ipsec transform-set GET-GROUP esp-aes 256 esp-sha-hmac
! Defines a IPsec transform set with ESP encapsulation and AES 256 bit encryption
KEY-SERVER(cfg-crypto-trans)# crypto ipsec profile GET-VPN ! Defines a profile and enters
IPSEC configuration mode
KEY-SERVER(ipsec-profile)# set security-association lifetime seconds 86400 ! Specifies
security association lifetime
KEY-SERVER(ipsec-profile)# set transform-set GET-GROUP ! Specifies which transform sets
can be used with the crypto map entry.
KEY-SERVER(ipsec-profile)# crypto gdoi group GET-GROUP ! Identifies a GDOI group and
enters GDOI group configuration mode
KEY-SERVER(config-gdoi-group)# identity number 1357924680 ! Sets GDOI group number
KEY-SERVER(config-gdoi-group)# server local ! Specified GDOI key server as local and
enters its configuration
KEY-SERVER(gdoi-local-server)# rekey address ipv4 REKEY-ADDRESS ! Defines destination
information for rekey messages as defined in the REKEY-ADDRESS ACL
KEY-SERVER(gdoi-local-server)# rekey lifetime seconds 300 ! Limits the number of seconds
that any one encryption key should be used
KEY-SERVER(gdoi-local-server)# rekey retransmit 10 number 2 ! Specifies the number of
times the rekey message is retransmitted
KEY-SERVER(gdoi-local-server)# rekey authentication mypubkey rsa REKEY-RSA ! Specifies the
keys to be used for a rekey to GDOI group members
KEY-SERVER(gdoi-local-server)# sa ipsec 1 ! Specifies the IPsec SA policy information to
be used for a GDOI group and enters GDOI SA IPsec configuration mode
KEY-SERVER(gdoi-sa-ipsec)# profile GET-VPN ! Defines the IPsec SA policy for a GDOI group
KEY-SERVER (gdoi-sa-ipsec)# match address ipv4 SA-ACL ! Specifies an IP extended access
list for a GDOI registration.
KEY-SERVER (gdoi-sa-ipsec)# replay counter window-size 64 ! Specifies the window-size for
the replay counter
KEY-SERVER (config)# ip access-list extended REKEY-ADDRESS ! Defines an extended
access-list and enters acl mode
KEY-SERVER (config-ext-nacl)# permit udp host host 209.165.201.10 eq 848 host 239.1.100.1
eq 248 ! Permits packets from a specific address to register with the Key-Server at its
multicast address
KEY-SERVER (config)# ip access-list extended SA-ACL ! Defines an extended access-list and
enters acl mode
KEY-SERVER(config-ext-nacl)# permit ip 10.0.0.0 0.0.0.255 172.16.0.0 0.0.255.255
! Permits traffic from branch subnets to central site subnets and vice versa
KEY-SERVER(config-ext-nacl)# permit ip 10.0.1.0 0.0.0.255 172.16.0.0 0.0.255.255
KEY-SERVER(config-ext-nacl)# permit ip 10.0.2.0 0.0.0.31 172.16.0.0 0.0.255.255
KEY-SERVER(config-ext-nacl)# permit ip 172.16.0.0 0.0.255.255 10.0.0.0 0.0.0.255
KEY-SERVER(config-ext-nacl)# permit ip 172.16.0.0 0.0.255.255 10.0.1.0 0.0.0.255
KEY-SERVER(config-ext-nacl)# permit ip 172.16.0.0 0.0.255.255 10.0.2.0 0.0.0.31
```

DMVPN Implementation

Dynamic Multipoint Virtual Private Network (DMVPN) is useful for building scalable IPsec VPNs. DMVPN uses a centralized architecture to provide easier implementation and management for deployment that requires granular access control for diverse users including teleworkers and mobile workers.

Cisco DMVPN allows branch locations to communicate directly with each other over the public WAN or Internet, such as when using Voice over IP (VoIP) between two branch offices, but does not require a permanent VPN connection between sites. In the Services Ready Medium Branch Network, DMVPN was tested on both the primary WAN link and the backup WAN link depending on whether the tunnel interface is active.

```

Router(config)# crypto isakmp policy 1 ! Defines IKE policy
Router(config-isakmp)# encr 3des ! Specifies the encryption mode as 3DES
Router(config-isakmp)# hash md5 ! Specifies hash algorithm as MD5
Router(config-isakmp)# authentication pre-share ! Specifies authentication with pre-shared
keys
Router(config-isakmp)# group 2 ! Specifies 1024-bit Diffie-Hellman group
Router(config-isakmp)# lifetime 28800 ! Specifies the lifetime of IKE security association
Router(config)# crypto isakmp key VPN-KEY address 209.165.201.10 ! Defines the preshared
key to be used for authentication
Router(config)# crypto isakmp keepalive 30 ! Enables keepalives between peers with
specified interval
Router(config)# crypto ipsec transform-set DM-GROUP esp-3des esp-md5-hmac
! Specifies IPsec transform set with ESP encapsulation and AES 256 bit encryption
Router(cfg-crypto-trans)# exit
Router(config)# crypto ipsec profile DM-VPN ! Defines IPsec Profile
Router(ipsec-profile)# set security-association lifetime seconds 86400 ! Specifies the
amount of time for SA to be active
Router(ipsec-profile)# set transform-set DM-GROUP ! Specifies the IPsec transform set for
encrypting traffic
Router(ipsec-profile)# exit
Router(config)# interface Tunnel 1 ! Enters tunnel interface configuration mode
Router(config-if)# ip address 10.0.2.81 255.255.255.252 ! Specifies tunnel interface IP
address
Router(config-if)# ip mtu 1416 ! Sets the MTU size to 1416 bytes
Router(config-if)# tunnel source Loopback 0 ! Specifies the source address to be used for
tunnel packets
Router(config-if)# ip nbar protocol-discovery ! Enables NBAR protocol discovery
Router(config-if)# ip flow ingress ! Enables Netflow accounting on incoming traffic
Router(config-if)# ip flow egress ! Enables Netflow accounting on outgoing traffic
Router(config-if)# ip nhrp authentication KEY-BR ! Specifies authentication string
Router(config-if)# ip nhrp map 172.16.0.10 209.165.201.10 ! Specifies central site Tunnel
address to Tunnel source mapping
Router(config-if)# ip nhrp map multicast 209.165.201.10 ! Enables Broadcast/Multicast
support for Tunnel source address
Router(config-if)# ip nhrp network-id 100000 ! Specifies network identifier for this NBMA
network
Router(config-if)# ip nhrp holdtime 300 ! Specifies the time the NHRP address will be
advertised as valid
Router(config-if)# ip nhrp nhs 172.16.0.10 ! Specifies next hop server as the Tunnel
interface
Router(config-if)# load-interval 30 ! Specifies the interval for computing load statistics
Router(config-if)# qos pre-classify ! Enables QoS on VPN tunnel interface
Router(config-if)# tunnel mode gre multipoint ! Specifies the tunnel mode as multipoint
GRE
Router(config-if)# tunnel key 100000 ! Specifies the tunnel key
Router(config-if)# tunnel protection ipsec profile DM-VPN ! Associate IPsec profile with
tunnel interface

```

Apply the following command on the Tunnel interface after defining VPN security zone.

```
Router(config-if)# zone-member security VPN ! Adds this interface to firewall zone called VPN
```

DMVPN Verification

To verify your DMVPN configuration, enter the following commands:

```
Router# show crypto ipsec sa
```

```
interface: Tunnell
  Crypto map tag: Tunnell-head-0, local addr 209.165.201.9

protected vrf: (none)
local ident (addr/mask/prot/port): (209.165.201.9/255.255.255.255/47/0)
remote ident (addr/mask/prot/port): (209.165.201.10/255.255.255.255/47/0)
current_peer 209.165.201.10 port 500
  PERMIT, flags={origin_is_acl,}
  #pkts encaps: 13642629, #pkts encrypt: 13642629, #pkts digest: 13642629
  #pkts decaps: 16147685, #pkts decrypt: 16147685, #pkts verify: 16147685
  #pkts compressed: 0, #pkts decompressed: 0
  #pkts not compressed: 0, #pkts compr. failed: 0
  #pkts not decompressed: 0, #pkts decompress failed: 0
  #send errors 1, #recv errors 5522

local crypto endpt.: 209.165.201.9, remote crypto endpt.: 209.165.201.10
path mtu 1514, ip mtu 1514, ip mtu idb Loopback0
current outbound spi: 0x6523EA4E(1696852558)

inbound esp sas:
  spi: 0x2DD40AB3(768871091)
    transform: esp-3des esp-md5-hmac ,
    in use settings ={Tunnel, }
    conn id: 11125, flow_id: AIM-VPN/SSL-3:125, crypto map: Tunnell-head-0
    sa timing: remaining key lifetime (k/sec): (4435361/55246)
    IV size: 8 bytes
    replay detection support: Y
    Status: ACTIVE

inbound ah sas:

inbound pcp sas:

outbound esp sas:
  spi: 0x6523EA4E(1696852558)
    transform: esp-3des esp-md5-hmac ,
    in use settings ={Tunnel, }
    conn id: 11126, flow_id: AIM-VPN/SSL-3:126, crypto map: Tunnell-head-0
    sa timing: remaining key lifetime (k/sec): (4419430/55246)
    IV size: 8 bytes
    replay detection support: Y
    Status: ACTIVE

outbound ah sas:

outbound pcp sas:
```

```
Router# show crypto isakmp sa
```

```
IPv4 Crypto ISAKMP SA
dst          src          state          conn-id slot status
209.165.201.9 209.165.201.10 QM_IDLE          21440  0 ACTIVE
```

SSL VPN Implementation

Secure Socket Layer Virtual Private Network (SSL VPN) is used to connect remote office users directly to the branch and provide them access to resources in the DMZ VLAN. They are also able to place calls using PC soft phones.

```
Router(config)#crypto pki trustpoint SSLVPN ! Defines a PKI certificate trust point
Router(ca-trustpoint)# enrollment selfsigned ! Specifies this router as self-signed root
certificate authority
Router(ca-trustpoint)# serial-number ! Specifies that the routers serial number should be
in the certificate request
Router(ca-trustpoint)# revocation-check none ! Disable certificate status check
Router(ca-trustpoint)# rsa-keypair CERT-KEY ! Specified RSA key pair
Router(ca-trustpoint)#exit
Router(config)#crypto pki certificate chain SSLVPN ! Enters certificate configuration mode
Router(config-cert-chain)# certificate self-signed 01 ! Manually enters self-signed
certificate
```

There can be only one self-signed PKI certificate per router. AutoSecure, described in the Infrastructure Protection Implementation section, creates a self-signed certificate for the router while configuring SSH access. If AutoSecure was enabled on the router, then the next step is not necessary. However, if AutoSecure was not enabled, the above command will request a self-signed PKI certificate. To learn about creating self-signed certificates, visit:

http://www.cisco.com/en/US/prod/collateral/iosswrel/ps6537/ps6586/ps6657/white_paper_c07-372106.html

Enter the certificate in hexadecimal representation....

```
Router(config-pubkey)# 308201F2 3082019C A0030201 02020101 300D0609 2A864886 F70D0101
04050030
Router(config-pubkey)# 42314030 12060355 0405130B 46545831 31343841 36433030 2A06092A
864886F7
Router(config-pubkey)# 0D010902 161D4B69 76752D33 3832352D 42722D31 2E796F75 72646F6D
61696E2E
Router(config-pubkey)# 636F6D30 1E170D30 38303231 33323232 3131345A 170D3230 30313031
30303030
Router(config-pubkey)# 30305A30 42314030 12060355 0405130B 46545831 31343841 36433030
2A06092A
Router(config-pubkey)# 864886F7 0D010902 161D4B69 76752D33 3832352D 42722D31 2E796F75
72646F6D
Router(config-pubkey)# 61696E2E 636F6D30 5C300D06 092A8648 86F70D01 01010500 034B0030
48024100
Router(config-pubkey)# A699E60C 8EBCF9EA B3142412 FDEE1150 BF25E671 0FBF5E3E 323ABFEB
FFC9790D
Router(config-pubkey)# D5D10D76 7639A04A DDD45FA3 F82E6EFE 2F14C046 E05C0488 433CD054
44E97E61
Router(config-pubkey)# 02030100 01A37D30 7B300F06 03551D13 0101FF04 05300301 01FF3028
0603551D
Router(config-pubkey)# 11042130 1F821D4B 6976752D 33383235 2D42722D 312E796F 7572646F
6D61696E
Router(config-pubkey)# 2E636F6D 301F0603 551D2304 18301680 14E94478 E4EE44CD 8277D8E9
B12EBC6D
Router(config-pubkey)# ABC165DC D8301D06 03551D0E 04160414 E94478E4 EE44CD82 77D8E9B1
2EBC6D
Router(config-pubkey)# C165DCD8 300D0609 2A864886 F70D0101 04050003 41001086 6FDC6C2E
735E9A99
Router(config-pubkey)# 764F874B 03F10F55 31414E96 A0901C04 D172E2B1 AF990499 5404A7B8
94543832
Router(config-pubkey)# 5B5C0389 C543C76F 49E70F1D CCBCECE3 A9B346CF D561
Router(config-pubkey)# quit
Router(config-cert-chain)# exit
```

Add the following rules to the firewall access control list (ACL) definitions.

```

Router(config)# ip access-list extended publicSelfInRule20Acl ! Enters Public to IOS zone
ACL definition
Router(config-ext-nacl)# permit tcp any host 209.165.201.15 ! Public address of SSLVPN
gateway 1
Router(config-ext-nacl)# permit tcp any host 209.165.201.17 ! Public address of SSLVPN
gateway 2
Router(config-ext-nacl)# permit tcp any host 209.165.201.20 eq www ! Public address of DMZ
server
Router(config-ext-nacl)# permit tcp any host 209.165.201.21 eq www ! Public address of DMZ
server
Router(config-ext-nacl)# permit tcp any host 209.165.201.22 eq www ! Public address of DMZ
server
Router(config-ext-nacl)# permit ip 192.168.0.0 0.0.0.252 ! Central site network
Router(config-ext-nacl)# permit ip 209.165.201.0 0.0.0.252 ! Central site network
Router(config-ext-nacl)# exit
Router(config)#

Router(config)# ip access-list extended publicDMZInRule20Acl ! Enters Public to DMZ zone
ACL definition
Router(config-ext-nacl)# permit tcp any host 209.165.201.16 ! Public address of SSLVPN
gateway 1
Router(config-ext-nacl)# permit tcp any host 209.165.201.17 ! Public address of SSLVPN
gateway 2
Router(config-ext-nacl)# permit tcp any host 209.165.201.20 eq www ! Public address of DMZ
server
Router(config-ext-nacl)# permit tcp any host 209.165.201.21 eq www ! Public address of DMZ
server
Router(config-ext-nacl)# permit tcp any host 209.165.201.22 eq www ! Public address of DMZ
server
Router(config-ext-nacl)# exit

Router(config)# ip local pool SSLVPN-Address-Pool 10.0.0.70 10.0.2.79 ! Defines pool of
addresses for VPN clients

Router(config)# webvpn gateway SSLVPN-GATEWAY-1 ! Enters webvpn gateway configuration mode
Router(config-webvpn-gateway)# ip address 209.165.201.15 port 443 ! Assigns public IP for
the gateway
Router(config-webvpn-gateway)# http-redirect port 80 ! Configures HTTP traffic to be
carried as HTTPS
Router(config-webvpn-gateway)# ssl trustpoint SSLVPN ! Assigns PKI certificate trust point
Router(config-webvpn-gateway)# inservice ! Starts the SSLVPN process
Router(config-webvpn-gateway)# exit

Router(config)# webvpn gateway SSLVPN-GATEWAY-2
Router(config-webvpn-gateway)# ip address 209.165.201.17 port 443 ! Assigns public IP for
the gateway
Router(config-webvpn-gateway)# http-redirect port 80 ! Configures HTTP traffic to be
carried as HTTPS
Router(config-webvpn-gateway)# ssl trustpoint SSLVPN ! Assigns PKI certificate trust point
Router(config-webvpn-gateway)# inservice ! Starts the SSLVPN process
Router(config-webvpn-gateway)# exit

Router(config)# webvpn install svc flash:sslclient-win-1.1.4.176.pkg ! Installs Cisco
AnyConnect VPN package

Router(config-webvpn-context)# webvpn context SSLVPN-GW-WEB ! Enters webvpn context
configuration mode
Router(config-webvpn-context)# secondary-color white ! Configures login portal
Router(config-webvpn-context)# title-color #FF9900 ! Configures login portal
Router(config-webvpn-context)# text-color black ! Configures login portal
Router(config-webvpn-context)# ssl encryption rc4-md5 ! Configures RC4-MD5 SSL encryption
Router(config-webvpn-context)# ssl authenticate verify all ! Performs user authentication

```

```

Router(config-webvpn-context)# url-list "WEB-SERVERS" ! Configures list of URLs in DMZ
that the user can access
Router(config-webvpn-url)# heading "Web Servers" ! Configures display properties for web
servers
Router(config-webvpn-url)#url-text "Server1" url-value "http://10.0.2.65/index.html"
Router(config-webvpn-url)# url-text "Server2" url-value "http://10.0.2.66/index.html"
Router(config-webvpn-url)# url-text "Server3" url-value "http://10.0.2.67/index.html"

Router(config-webvpn-url)#policy group SSLVPN-POLICY-WEB ! Defines policy for DMZ web
servers
Router(config-webvpn-group)# url-list "WEB-SERVERS" ! Associates policy with URL list
Router(config-webvpn-group)# functions svc-enabled ! Enables use of tunnel mode
Router(config-webvpn-group)# mask-urls ! Obfuscates sensitive URLs
Router(config-webvpn-group)# svc address-pool "SSLVPN-Address-Pool" ! Assigns local
addresses
Router(config-webvpn-group)# svc keep-client-installed ! Maintains Cisco AnyConnect VPN
client software installations on the connecting PCs
Router(config-webvpn-group)# default-group-policy SSLVPN-POLICY-WEB ! Associates SSLVPN
context with this group policy
Router(config-webvpn-context)# aaa authentication list VPN-AUTH-LIST ! Configures AAA for
SSLVPN users
Router(config-webvpn-context)# gateway SSLVPN-GATEWAY-1 ! Assigns gateway to this SSLVPN
context
Router(config-webvpn-context)# inservice ! Starts the SSLVPN policy
Router(config-webvpn-context)# exit

```

The following example illustrates a second SSL VPN context.

```

Router(config-webvpn)# webvpn context SSLVPN-GW-APP ! Enters webvpn context configuration
mode
Router(config-webvpn-context)# ssl encryption rc4-md5 ! Configures RC4-MD5 SSL encryption
Router(config-webvpn-context)# ssl authenticate verify all ! Performs user authentication
Router(config-webvpn-context)# url-list "APP-SERVERS" ! Associates policy with URL list
Router(config-webvpn-url)# heading "Application Servers" ! Configures display properties
for application servers
Router(config-webvpn-url)# url-text "Server1" url-value "http://10.0.2.65/index.html"
Router(config-webvpn-url)# url-text "Server2" url-value "http://10.0.2.66/index.html"
Router(config-webvpn-url)# url-text "Server3" url-value "http://10.0.2.67/index.html"
Router(config-webvpn-url)# policy group SSLVPN-POLICY-APP
Router(config-webvpn-group)# url-list "APP-SERVERS" ! Associates policy with URL list
Router(config-webvpn-group)# default-group-policy SSLVPN-POLICY-APP ! Associates SSLVPN
context with this group policy
Router(config-webvpn-context)# aaa authentication list VPN-AUTH-LIST ! Configures AAA for
SSLVPN users
Router(config-webvpn-context)# gateway SSLVPN-GATEWAY-2 ! Assigns gateway to this SSLVPN
context
Router(config-webvpn-context)# inservice ! Starts the SSLVPN policy
Router(config-webvpn-context)# exit
Router(config)#

```

Threat Defense Detection and Mitigation Implementation

- [Zone-based Policy Firewall Implementation, page 59](#)
- [Cisco IOS IPS Implementation, page 71](#)
- [Layer 2 Security, page 72](#)

Zone-based Policy Firewall Implementation

Zone-based Policy Firewall (ZPF) offers assignment of traffic into secure zones for multiple-interface routers. It changes the firewall configuration from interface-based classic Context-Based Access Control (CBAC) model to a more flexible zone-based configuration.

Interfaces are assigned to different zones, and inspection policies are applied to traffic moving between zones. As the inspection policies are zone based rather than interface based, different policies can be applied to traffic from and to the same interface.

There are four zones in the Services Ready Medium Branch Network: Private (LAN), Public (WAN), VPN, and DMZ. Inspection policies were applied for the following zone pairs:

- Traffic originated from Private to Public
- Traffic originated from Private to DMZ
- Traffic originated from Public to Private
- Traffic originated from Public to DMZ
- Traffic originated from router to Private
- Traffic originated from Private to router
- Traffic originated from Private to VPN
- Traffic originated from VPN to Private

```
Router(config)# parameter-map type inspect publicPrivateOutParamMap ! Defines a
parameter-map for traffic from Public to Private zone
Router(config-profile)# max-incomplete low 6000 ! Specifies minimum number of half-open
session before IOS stops removing sessions
Router(config-profile)# max-incomplete high 10000 ! Specifies maximum number of half-open
session after which IOS starts removing sessions
Router(config-profile)# one-minute low 18000 ! Specifies minimum number of half-open
session in one minute before IOS stops removing sessions
Router(config-profile)# one-minute high 20000 ! Specifies maximum number of half-open
session in one minute after which IOS starts removing sessions
Router(config-profile)# udp idle-time 10 ! Specifies maximum length of time for which UDP
inspect information is maintained
Router(config-profile)# icmp idle-time 5 ! Specifies maximum length of time for which ICMP
inspect information is maintained
Router(config-profile)# tcp max-incomplete host 7000 block-time 0 ! Specifies the maximum
number of half-open TCP sessions to the same destination before IOS starts removing
sessions
Router(config-profile)# exit
Router(config)# ip access-list extended privatePublicOutRule10Acl ! Defines ACL for
traffic from IOS to Private zone
Router(config-ext-nacl)# permit 10.0.0.0 0.0.0.255 ! Permits all data VLAN traffic
Router(config-ext-nacl)# permit 10.0.1.0 0.0.0.255 ! Permits all voice VLAN traffic
Router(config-ext-nacl)# exit

Router(config)# ip access-list extended publicPrivateOutRule10Acl ! Defines ACL for
traffic from Public zone to Private zone
Router(config-ext-nacl)# permit ip 172.16.0.0 0.0.255.255 10.0.0.0 0.0.0.255 ! Permits
central site traffic to Data VLAN
Router(config-ext-nacl)# permit ip 172.16.0.0 0.0.255.255 10.0.1.0 0.0.0.255 ! Permits
central site traffic to Voice VLAN
Router(config-ext-nacl)# permit ip 172.16.0.0 0.0.255.255 10.0.2.0 0.0.0.31 ! Permits
central site traffic to Managment VLAN
Router(config-ext-nacl)# permit ip host 239.1.100.1 any ! Permits key server multicast
address
Router(config-ext-nacl)# permit ip host 209.165.201.10 any ! Permits key server
Router(config-ext-nacl)# exit
```



```

Router(config)# class-map type inspect match-all FROM-SELF-CMAP ! Defines class map for
traffic from IOS to Private zone
Router(config-cmap)# match access-group name selfPrivateRule10 ! Matches traffic in
specified ACL
Router(config-cmap)# exit
Router(config)# class-map type inspect match-any TO-SELF-CMAP ! Defines class map for
traffic from Private
Router(config-cmap)# match access-group name selfPrivateRule10 ! Matches traffic in
specified ACL
Router(config-cmap)# exit
Router(config)# class-map type inspect match-any privateDMZOutRule10Protocols ! Defines
class map for protocols from Private to DMZ zone
Router(config-cmap)# match protocol http ! Matches HTTP traffic
Router(config-cmap)# match protocol https ! Matches Secure HTTP traffic
Router(config-cmap)# match protocol dns ! Matches DNS traffic
Router(config-cmap)# match protocol ssh ! Matches Secure Shell traffic
Router(config-cmap)# exit
Router(config)# class-map type inspect match-any privatePublicOutRule10 ! Defines class
map for traffic from Private to Public zone
Router(config-cmap)# match access-group name publicPrivateOutRule10Acl ! Matches traffic
in specified ACL
Router(config-cmap)# exit
Router(config)# class-map type inspect match-any SELF-SERVICE-CMAP ! Defines class map for
protocols originating from IOS
Router(config-cmap)# match protocol tcp ! Matches TCP traffic
Router(config-cmap)# match protocol udp ! Matches UDP traffic
Router(config-cmap)# match protocol icmp ! Matches ICMP traffic
Router(config-cmap)# match protocol h323 ! Matches H323 traffic
Router(config-cmap)# match protocol echo ! Matches ICMP echo traffic
Router(config-cmap)# exit
Router(config-cmap)# class-map type inspect match-any publicDMZOutRule10Protocols
! Defines class map for protocols from Public to DMZ zone
Router(config-cmap)# match protocol http ! Matches HTTP traffic
Router(config-cmap)# match protocol https ! Matches Secure HTTP traffic
Router(config-cmap)# match protocol dns ! Matches DNS traffic
Router(config-cmap)# match protocol ssh ! Matches Secure Shell traffic
Router(config-cmap)# exit

Router(config)# policy-map type inspect publicDMZOutFwPolicy ! Defines inspect policy for
Public to DMZ zone
Router(config-pmap)# class type inspect publicDMZOutRule10Protocols ! Matches traffic
classified by specified class-map
Router(config-pmap-c)# inspect publicPrivateOutParamMap ! Enables packet inspection
according to the Public to Private zone parameter map definition
Router(config-pmap-c)# exit
Router(config-pmap)# class class-default ! Matches all other traffic
Router(config-pmap-c)# drop log ! Drops the traffic
Router(config-pmap-c)# exit
Router(config-pmap)# exit

Router(config)# policy-map type inspect privateSelfOutFwPolicy ! Defines inspect policy
for Private to IOS zone
Router(config-pmap)# class type inspect SELF-SERVICE-MAP ! Matches traffic classified to
IOS parameter map definition
Router(config-pmap-c)# pass ! Passes the traffic
Router(config-pmap-c)# exit
Router(config-pmap)# class class-default ! Matches all other traffic
Router(config-pmap-c)# drop ! Drops the traffic
Router(config-pmap-c)# exit
Router(config-pmap)# exit

Router(config)# policy-map type inspect selfPrivateOutFwPolicy ! Defines inspect policy
for IOS to Private zone

```



```

Router(config-pmap)# class type inspect SELF-SERVICE-MAP ! Matches from IOS parameter map
definition
Router(config-pmap-c)# pass ! Passes the traffic
Router(config-pmap-c)# exit
Router(config-pmap)# class class-default ! Matches all other traffic
Router(config-pmap-c)# drop ! Drops the traffic
Router(config-pmap-c)# exit
Router(config-pmap)# exit

Router(config)# policy-map type inspect privatePublicOutFwPolicy ! Defines inspect policy
for Private to Public zone
Router(config-pmap)# class type inspect privatePublicOutRule10 ! Matches traffic
classified by specified class-map
Router(config-pmap-c)# inspect publicPrivateOutParamMap ! Enables packet inspection
according to the Public to Private zone parameter map definition percent. No specific
protocol configured in class privatePublicOutRule10 for inspection. All protocols will be
inspected
Router(config-pmap-c)# exit
Router(config-pmap)# class class-default ! Matches all other traffic
Router(config-pmap-c)# drop ! Drops the traffic
Router(config-pmap-c)# exit
Router(config-pmap)# exit

Router(config)# policy-map type inspect privateDMZOutFwPolicy ! Defines inspect policy for
Private to DMZ zone
Router(config-pmap)# class type inspect privateDMZOutRule10Protocols ! Matches traffic
classified by specified class-map
Router(config-pmap-c)# inspect publicPrivateOutParamMap ! Enables packet inspection
according to the Public to Private zone parameter map definition
Router(config-pmap-c)# exit
Router(config-pmap-c)# class class-default ! Matches all other traffic
Router(config-pmap-c)# drop log ! Drops the traffic
Router(config-pmap-c)# exit
Router(config-pmap)# exit

Router(config)# zone security Public ! Define Security Zone named Public
Router(config-sec-zone)# description Public Internet Connection
Router(config-sec-zone)# exit

```

Apply *Public* security zone on the WAN interface or subinterface as described in WAN interface configuration sections.

```

Router(config)# zone security Private ! Define Security Zone named Private
Router(config-sec-zone)# description Customer Private Network
Router(config-sec-zone)# exit
Router(config)# zone security DMZ ! Define Security Zone named DMZ
Router(config-sec-zone)# description Customer DMZ Network
Router(config-sec-zone)# exit

```

Apply *Private* and *DMZ* security zones on the LAN interface or subinterface as described in VLAN interface configuration sections.

```

Router(config)# zone-pair security privatePublicOut source Private destination Public !
Define zone-pair for Private to Public traffic
Router(config-sec-zone-pair)# description Outbound Firewall Policy from Private to Public
Router(config-sec-zone-pair)# service-policy type inspect privatePublicOutFwPolicy ! Apply
firewall policy for zone-pair
Router(config-sec-zone-pair)# exit

Router(config)# zone-pair security publicDMZOut source Public destination DMZ ! Define
zone-pair for Public to DMZ traffic
Router(config-sec-zone-pair)# description Outbound Firewall Policy from Public to DMZ
Router(config-sec-zone-pair)# service-policy type inspect publicDMZOutFwPolicy ! Apply
firewall policy for zone-pair

```

```

Router(config-sec-zone-pair)# exit

Router(config)# zone-pair security privateDMZOut source Private destination DMZ ! Define
zone-pair for Private to DMZ traffic
Router(config-sec-zone-pair)# description Outbound Firewall Policy from Private to DMZ

Router(config-sec-zone-pair)# service-policy type inspect privateDMZOutFwPolicy ! Apply
firewall policy for zone-pair
Router(config-sec-zone-pair)# exit

Router(config)# zone-pair security privateSelf source Private destination self ! Define
zone-pair for Private to IOS traffic
Router(config-sec-zone-pair)# service-policy type inspect privateSelfOutFwPolicy ! Apply
firewall policy for zone-pair
Router(config-sec-zone-pair)# exit

Router(config)# zone-pair security selfPrivate source self destination Private ! Define
zone-pair for IOS to Private traffic
Router(config-sec-zone-pair)# service-policy type inspect selfPrivateOutFwPolicy ! Apply
firewall policy for zone-pair
Router(config-sec-zone-pair)# exit

```

Zone-based Policy Firewall Verification

To verify your zone-based firewall configuration, enter the following commands:

```

Router# show policy-map type inspect zone-pair
Zone-pair: publicPrivateOut

Service-policy inspect : publicPrivateOutFwPolicy

Class-map: publicPrivateOutRule10 (match-any)
Match: access-group name publicPrivateOutRule10Acl
  0 packets, 0 bytes
  30 second rate 0 bps
Match: class-map match-any publicPrivateOutRule10Protocols
  160728 packets, 5222722 bytes
  30 second rate 0 bps
Match: protocol http
  0 packets, 0 bytes
  30 second rate 0 bps
Match: protocol https
  23 packets, 1196 bytes
  30 second rate 0 bps
Match: protocol dns
  0 packets, 0 bytes
  30 second rate 0 bps
Match: protocol ssh
  0 packets, 0 bytes
  30 second rate 0 bps
Match: protocol icmp
  81876 packets, 2947880 bytes
  30 second rate 0 bps
Match: protocol ftp
  0 packets, 0 bytes
  30 second rate 0 bps
Match: protocol tcp
  78575 packets, 2251480 bytes
  30 second rate 0 bps
Match: protocol udp
  246 packets, 22166 bytes
  30 second rate 0 bps

```

```
Match: protocol bgp
  0 packets, 0 bytes
  30 second rate 0 bps
Match: protocol smtp
  0 packets, 0 bytes
  30 second rate 0 bps
Inspect
Packet inspection statistics [process switch:fast switch]
tcp packets: [77702:1346327]
udp packets: [2:0]
icmp packets: [18235:7]

Session creations since subsystem startup or last reset 95910
Current session counts (estab/half-open/terminating) [0:0:0]
Maxever session counts (estab/half-open/terminating) [14:101:1]
Last session created 08:55:49
Last statistic reset never
Last session creation rate 0
Maxever session creation rate 15120
Last half-open session total 0

Class-map: class-default (match-any)
  Match: any
  Drop
    0 packets, 0 bytes
Zone-pair: publicDMZOut

Service-policy inspect : publicDMZOutFwPolicy

Class-map: publicDMZOutRule10Protocols (match-any)
  Match: protocol http
    0 packets, 0 bytes
    30 second rate 0 bps
  Match: protocol https
    0 packets, 0 bytes
    30 second rate 0 bps
  Match: protocol dns
    0 packets, 0 bytes
    30 second rate 0 bps
  Match: protocol ssh
    0 packets, 0 bytes
    30 second rate 0 bps
  Match: protocol bgp
    0 packets, 0 bytes
    30 second rate 0 bps
  Match: protocol icmp
    0 packets, 0 bytes
    30 second rate 0 bps
  Match: access-group name DMZPublicOutRuleAcl20
    0 packets, 0 bytes
    30 second rate 0 bps
Inspect
  Session creations since subsystem startup or last reset 0
  Current session counts (estab/half-open/terminating) [0:0:0]
  Maxever session counts (estab/half-open/terminating) [0:0:0]
  Last session created never
  Last statistic reset never
  Last session creation rate 0
  Maxever session creation rate 0
  Last half-open session total 0

Class-map: class-default (match-any)
  Match: any
  Drop
```

```

    0 packets, 0 bytes
Zone-pair: privateDMZOut

Service-policy inspect : privateDMZOutFwPolicy

Class-map: privateDMZOutRule10Protocols (match-any)
  Match: protocol http
    0 packets, 0 bytes
    30 second rate 0 bps
  Match: protocol https
    0 packets, 0 bytes
    30 second rate 0 bps
  Match: protocol dns
    0 packets, 0 bytes
    30 second rate 0 bps
  Match: protocol ssh
    0 packets, 0 bytes
    30 second rate 0 bps
Inspect
  Session creations since subsystem startup or last reset 0
  Current session counts (estab/half-open/terminating) [0:0:0]
  Maxever session counts (estab/half-open/terminating) [0:0:0]
  Last session created never
  Last statistic reset never
  Last session creation rate 0
  Maxever session creation rate 0
  Last half-open session total 0

Class-map: class-default (match-any)
  Match: any
  Drop
    0 packets, 0 bytes
Zone-pair: vpnPrivateIn

Service-policy inspect : vpnPrivateInFwPolicy

Class-map: vpnPrivateInRule10 (match-any)
  Match: access-group name vpnPrivateInRule10Acl
    4314 packets, 109136 bytes
    30 second rate 0 bps
Inspect
  Packet inspection statistics [process switch:fast switch]
  tcp packets: [229:3495]
  udp packets: [10:6177032]
  icmp packets: [0:31]

  Session creations since subsystem startup or last reset 271
  Current session counts (estab/half-open/terminating) [0:0:0]
  Maxever session counts (estab/half-open/terminating) [2:11:1]
  Last session created 5d08h
  Last statistic reset never
  Last session creation rate 0
  Maxever session creation rate 10
  Last half-open session total 0

Class-map: class-default (match-any)
  Match: any
  Drop
    0 packets, 0 bytes
Zone-pair: vpnPrivateOut

Service-policy inspect : vpnPrivateOutFwPolicy

Class-map: vpnPrivateOutRule10 (match-any)

```

```
Match: access-group name vpnPrivateOutRule10Acl
      6356447 packets, 231662957 bytes
      30 second rate 0 bps
Inspect
  Packet inspection statistics [process switch:fast switch]
  tcp packets: [9061:117338799]
  udp packets: [1761:2253]
  icmp packets: [0:6176836]
  ftp packets: [0:11]
  tftp packets: [160:6]
  tftp-data packets: [1600:1756]
  skinny packets: [2867:62498341]

  Session creations since subsystem startup or last reset 6356113
  Current session counts (estab/half-open/terminating) [5:0:0]
  Maxever session counts (estab/half-open/terminating) [193:22:97]
  Last session created 00:00:48
  Last statistic reset never
  Last session creation rate 0
  Maxever session creation rate 22400
  Last half-open session total 0

Class-map: class-default (match-any)
  Match: any
  Drop
    0 packets, 0 bytes
Zone-pair: publicSelfOut

Service-policy inspect : publicSelfOutFwPolicy

Class-map: publicSelfOutRule20 (match-any)
  Match: access-group name publicSelfOutRule20Acl
    255 packets, 39396 bytes
    30 second rate 0 bps
  Match: protocol tcp
    17229 packets, 735614 bytes
    30 second rate 0 bps
  Match: protocol udp
    89136 packets, 6774336 bytes
    30 second rate 0 bps
  Match: protocol icmp
    5 packets, 400 bytes
    30 second rate 0 bps
Inspect
  Packet inspection statistics [process switch:fast switch]
  tcp packets: [457182:0]
  udp packets: [179870:0]
  icmp packets: [43:0]

  Session creations since subsystem startup or last reset 89587
  Current session counts (estab/half-open/terminating) [1:0:0]
  Maxever session counts (estab/half-open/terminating) [4:4:1]
  Last session created 00:00:45
  Last statistic reset never
  Last session creation rate 1
  Maxever session creation rate 6
  Last half-open session total 0

Class-map: CRYPTO-CMAP (match-all)
  Match: access-group 123
  Pass
    81354612 packets, 8078747532 bytes

Class-map: class-default (match-any)
```

```

Match: any
Drop (default action)
  0 packets, 0 bytes
Zone-pair: publicSelfIn

Service-policy inspect : publicSelfInFwPolicy

Class-map: publicSelfInRule20 (match-any)
Match: access-group name publicSelfInRule20Acl
  279 packets, 35460 bytes
  30 second rate 0 bps
Match: protocol tcp
  0 packets, 0 bytes
  30 second rate 0 bps
Match: protocol udp
  0 packets, 0 bytes
  30 second rate 0 bps
Match: protocol icmp
  0 packets, 0 bytes
  30 second rate 0 bps
Inspect
  Packet inspection statistics [process switch:fast switch]
  udp packets: [919:0]
  icmp packets: [111:0]

  Session creations since subsystem startup or last reset 279
  Current session counts (estab/half-open/terminating) [0:0:0]
  Maxever session counts (estab/half-open/terminating) [1:2:0]
  Last session created 21:40:08
  Last statistic reset never
  Last session creation rate 0
  Maxever session creation rate 74
  Last half-open session total 0

Class-map: CRYPTO-CMAP (match-all)
Match: access-group 123
Pass
  0 packets, 0 bytes

Class-map: class-default (match-any)
Match: any
Drop (default action)
  0 packets, 0 bytes
Zone-pair: DMZPublicOut

Service-policy inspect : publicDMZOutFwPolicy

Class-map: publicDMZOutRule10Protocols (match-any)
Match: protocol http
  0 packets, 0 bytes
  30 second rate 0 bps
Match: protocol https
  0 packets, 0 bytes
  30 second rate 0 bps
Match: protocol dns
  0 packets, 0 bytes
  30 second rate 0 bps
Match: protocol ssh
  0 packets, 0 bytes
  30 second rate 0 bps
Match: protocol bgp
  0 packets, 0 bytes
  30 second rate 0 bps
Match: protocol icmp

```

```

    0 packets, 0 bytes
    30 second rate 0 bps
Match: access-group name DMZPublicOutRuleAcl20
    0 packets, 0 bytes
    30 second rate 0 bps
Inspect
  Session creations since subsystem startup or last reset 0
  Current session counts (estab/half-open/terminating) [0:0:0]
  Maxever session counts (estab/half-open/terminating) [0:0:0]
  Last session created never
  Last statistic reset never
  Last session creation rate 0
  Maxever session creation rate 0
  Last half-open session total 0

Class-map: class-default (match-any)
  Match: any
  Drop
    0 packets, 0 bytes

Zone-pair: selfprivate

Service-policy inspect : selfFwPolicy

Class-map: SELF-CMAP (match-any)
  Match: access-group name SELF-ACL
    24257448 packets, 1807595033 bytes
    30 second rate 1000 bps
  Pass
    24257448 packets, 1807595033 bytes

Class-map: class-default (match-any)
  Match: any
  Drop
    0 packets, 0 bytes
Zone-pair: vpnself

Service-policy inspect : selfFwPolicy

Class-map: SELF-CMAP (match-any)
  Match: access-group name SELF-ACL
    545089 packets, 17426918 bytes
    30 second rate 0 bps
  Pass
    545089 packets, 17426918 bytes

Class-map: class-default (match-any)
  Match: any
  Drop
    0 packets, 0 bytes
Zone-pair: selfvpn

Service-policy inspect : selfFwPolicy

Class-map: SELF-CMAP (match-any)
  Match: access-group name SELF-ACL
    1088484 packets, 28319861 bytes
    30 second rate 0 bps
  Pass
    1088484 packets, 28319861 bytes

Class-map: class-default (match-any)
  Match: any
  Drop

```

```

    0 packets, 0 bytes
Router#

```

DMVPN uses Virtual Tunnel Interface (VTI) for IPsec VPN connectivity. When the DMVPN interface is assigned to a security zone, traffic routing to and from other interfaces in the router are subjected to zone-to-zone firewall policy.

If the DMVPN interface is assigned to the same security zone as another interface (for example, Gigabit Ethernet 0/0), traffic moving between hosts on the DMVPN and hosts connected to Gigabit Ethernet 0/0 will pass freely with no policy application.

In the Services Ready Medium Branch Network, the tunnel interface is assigned to the VPN security zone. Additional inspection policies were applied.

```

Router(config)# ip access-list extended publicSelfInRule20Acl ! Defines ACL for Public to
IOS zone traffic
Router(config-ext-nacl)# permit udp any eq isakmp host 209.165.201.9 eq isakmp ! Matches
ISAKMP traffic
Router(config-ext-nacl)# exit

Router(config)# ip access-list extended publicSelfOutRule20Acl ! Defines ACL for IOS to
Public zone traffic
Router(config-ext-nacl)# permit udp host 22.0.14.253 eq isakmp any eq isakmp ! Matches
ISAKMP traffic
Router(config-ext-nacl)# permit ip 192.168.0.0 0.0.0.252 ! Central site network
Router(config-ext-nacl)# permit ip 209.165.201.0 0.0.0.252 ! Central site network
Router(config-ext-nacl)# exit

Router(config)# ip access-list extended vpnPrivateInRule10Acl ! Defines ACL for VPN to
Private zone traffic
Router(config-ext-nacl)# permit ip any any ! Matches all traffic
Router(config-ext-nacl)# exit

Router(config)# ip access-list extended vpnPrivateOutRule10Acl ! Defines ACL for Private
to VPN zone traffic
Router(config-ext-nacl)# permit ip any any ! Matches all traffic
Router(config-ext-nacl)# exit

Router(config)# ip access-list extended NON-TCP-ACL ! Defines ACL for WAAS GRE tunnel
Router(config-ext-nacl)# permit gre host 10.0.2.90 host 10.0.2.89
Router(config-ext-nacl)# exit

Router(config)# ip access-list extended DMZPublicOutRuleAcl120 ! Defines ACL for DMZ to
Public zone traffic
Router(config-ext-nacl)# permit tcp host 10.0.2.70 eq www any ! DMZ server
Router(config-ext-nacl)# permit tcp host 10.0.2.71 eq www any ! DMZ server
Router(config-ext-nacl)# permit tcp host 10.0.2.72 eq www any ! DMZ server

Router(config-ext-nacl)# exit

Router(config)# access-list 123 permit esp any any ! Matches IPsec ESP traffic
Router(config)# ip access-list extended SELF-ACL ! Defines ACL for IOS traffic
Router(config-ext-nacl)# permit tcp any any ! Matches TCP
Router(config-ext-nacl)# permit gre any any ! Matches GRE
Router(config-ext-nacl)# permit ip any any ! Matches IP
Router(config-ext-nacl)# exit

Router(config)# class-map type inspect match-any vpnPrivateInRule10 ! Defines class-map
for VPN to Private zone traffic
Router(config-cmap)# match access-group name vpnPrivateInRule10Acl ! Matches traffic
specified in ACL
Router(config-cmap)# exit

```



```

Router(config)# class-map type inspect match-all CRYPTO-MAP ! Defines class-map for
matching VPN traffic
Router(config-cmap)# match access-group 123 ! Matches traffic specified in ACL
Router(config-cmap)# exit

Router(config)# class-map type inspect match-any publicSelfInRule20 ! Defines class-map
for matching Public to IOS zone traffic
Router(config-cmap)# match access-group name publicSelfInRule20Acl ! Matches traffic
specified in ACL
Router(config-cmap)# match protocol tcp ! Matches TCP traffic
Router(config-cmap)# match protocol udp ! Matches UDP traffic
Router(config-cmap)# match protocol icmp ! Matches ICMP traffic
Router(config-cmap)# exit

Router(config)# class-map type inspect match-any vpnPrivateOutRule10 ! Defines class-map
for Private to VPN zone traffic
Router(config-cmap)# match access-group name vpnPrivateOutRule10Acl ! Matches traffic
specified in ACL
Router(config-cmap)# exit

Router(config)# class-map type inspect match-any publicSelfOutRule20 ! Defines class-map
for matching IOS to Public zone traffic
Router(config-cmap)# match access-group name publicSelfOutRule20Acl ! Matches traffic
specified in ACL
Router(config-cmap)# match protocol tcp ! Matches TCP traffic
Router(config-cmap)# match protocol udp ! Matches UDP traffic
Router(config-cmap)# match protocol icmp ! Matches ICMP traffic
Router(config-cmap)# exit

Router(config)# class-map type inspect match-any publicDMZOutRule10Protocols
! Defines class-map for matching DMZ to Public zone traffic
Router(config-cmap)# match protocol http ! Matches HTTP traffic
Router(config-cmap)# match protocol https ! Matches Secure HTTP traffic
Router(config-cmap)# match protocol dns ! Matches DNS traffic
Router(config-cmap)# match protocol ssh ! Matches Secure Shell traffic
Router(config-cmap)# match protocol bgp ! Matches BGP traffic
Router(config-cmap)# match protocol icmp ! Matches ICMP traffic
Router(config-cmap)# match access-group name DMZPublicOutRuleAcl120 ! Matches traffic
specified in ACL
Router(config-cmap)# exit

Router(config)# policy-map type inspect publicSelfInFwPolicy ! Defines inspect policy for
Public to IOS zone
Router(config-pmap)# class type inspect publicSelfInRule20 ! Matches traffic classified by
specified class-map
Router(config-pmap-c)# inspect ! Enables packet inspection
Router(config-pmap-c)# exit
Router(config-pmap)# class type inspect CRYPTO-CMAP ! Matches traffic classified by
specified class-map
Router(config-pmap-c)# pass ! Passes traffic
Router(config-pmap-c)# exit
Router(config-pmap)# class class-default ! Matches all other traffic
Router(config-pmap-c)# drop log ! Drops traffic
Router(config-pmap-c)# exit
Router(config-pmap)# exit

Router(config)# policy-map type inspect publicDMZOutFwPolicy ! Defines policy for DMZ to
Public zone
Router(config-pmap)# class type inspect publicDMZOutRule10Protocols ! Matches
traffic classified by specified class-map
Router(config-pmap-c)# inspect publicPrivateOutParamMap ! Enables inspection for Public to
Private zone traffic
Router(config-pmap-c)# exit
Router(config-pmap)# class class-default ! Matches all other traffic
Router(config-pmap-c)# drop log ! Drops traffic

```

```

Router(config-pmap-c)# exit
Router(config-pmap)# exit

Router(config)# policy-map type inspect vpnPrivateInFwPolicy ! Defines policy for VPN to
Private zone traffic
Router(config-pmap)# class type inspect vpnPrivateInRule10 ! Matches
traffic classified by specified class-map
Router(config-pmap-c)# inspect ! Enables packet inspection percent. No specific protocol
configured in class vpnPrivateInRule10 for inspection. All protocols will be inspected
Router(config-pmap-c)# exit
Router(config-pmap)# class class-default ! Matches all other traffic
Router(config-pmap-c)# drop log ! Drops traffic
Router(config-pmap-c)# exit
Router(config-pmap)# exit

Router(config)# policy-map type inspect publicSelfOutFwPolicy ! Defines policy for IOS to
Public zone traffic
Router(config-pmap)# class type inspect publicSelfOutRule20 ! Matches traffic classified
by specified class-map
Router(config-pmap-c)# inspect ! Enables packet inspection
Router(config-pmap-c)# exit
Router(config-pmap)# class type inspect CRYPTO-CMAP ! Matches traffic classified by
specified class-map
Router(config-pmap-c)# pass ! Pass the traffic
Router(config-pmap-c)# exit
Router(config-pmap)# class class-default ! Matches all other traffic
Router(config-pmap-c)# drop log ! Drops the traffic
Router(config-pmap-c)# exit
Router(config-pmap)# exit

Router(config)# policy-map type inspect vpnPrivateOutFwPolicy ! Defines policy for Private
to VPN zone traffic
Router(config-pmap)# class type inspect vpnPrivateOutRule10 ! Matches traffic classified
by specified class-map
Router(config-pmap-c)# inspect ! Enables packet inspection
percentNo specific protocol configured in class vpnPrivateOutRule10 for inspection. All
protocols will be inspected
Router(config-pmap-c)# exit
Router(config-pmap)# class class-default ! Matches all other traffic
Router(config-pmap-c)# drop log ! Drops traffic
Router(config-pmap-c)# exit
Router(config-pmap)# exit

Router(config)# zone security VPN ! Define VPN Zone name
Router(config-sec-zone)# description customer VPN Network
Router(config-sec-zone)# exit

Router(config)# zone-pair security vpnPrivateIn source VPN destination Private ! Define
zone-pair for VPN to Private zone traffic
Router(config-sec-zone-pair)# service-policy type inspect vpnPrivateInFwPolicy ! Apply
firewall policy for zone-pair
Router(config-sec-zone-pair)# exit

Router(config)# zone-pair security vpnPrivateOut source Private destination VPN ! Define
zone-pair for Private to VPN zone traffic
Router(config-sec-zone-pair)# service-policy type inspect vpnPrivateOutFwPolicy ! Apply
firewall policy for zone-pair
Router(config-sec-zone-pair)# exit

Router(config)# zone-pair security publicSelfOut source self destination Public ! Define
zone-pair for IOS to Public zone traffic
Router(config-sec-zone-pair)# service-policy type inspect publicSelfOutFwPolicy ! Apply
firewall policy for zone-pair
Router(config-sec-zone-pair)# exit

```

```

Router(config)# zone-pair security publicSelfIn source Public destination self ! Define
zone-pair for Public to IOS zone traffic
Router(config-sec-zone-pair)# service-policy type inspect publicSelfInFwPolicy ! Apply
firewall policy for zone-pair
Router(config-sec-zone-pair)# exit

Router(config)# zone-pair security DMZPublicOut source DMZ destination Public ! Define
zone-pair to for DMZ to Public zone traffic
Router(config-sec-zone-pair)# service-policy type inspect publicDMZOutFwPolicy
Router(config-sec-zone-pair)# exit

Router(config)# interface Tunnel 1 ! Enters Tunnel interface configuration mode
Router(config-if)# zone-member security VPN ! Assign a zone to the interface
Router(config-if)# exit

```

Cisco IOS IPS Implementation

The Cisco IOS IPS acts as an inline intrusion detection sensor, watching packets and sessions as they flow through the router and scanning each packet to match any of the Cisco IOS IPS signatures. When Cisco IOS IPS detects suspicious activity, it responds before network security can be compromised and logs the event through Cisco IOS syslog messages or Security Device Event Exchange (SDEE).

In the Services Ready Medium Branch Foundation, IPS inspection was enabled on the DATA VLAN in both directions. All types of traffic were inspected using advanced signature set stored in the flash memory.

```

Router# mkdir flash:ips5 ! Creates the folder in flash for saving the signature files
Router(config)# config t
Router(config)# ip ips config location flash:/ips5/ retries 1 ! Specifies the location to
save the signature file
Router(config)# ip ips deny-action ips-interface ! Changes the default behavior of the ACL
filters that are created for the deny actions.
Router(config)# ip ips notify SDEE ! Enables SDEE event notification on a router
Router(config)# ip ips name IPS-ADVSET ! Defines an IOS IPS rule

Router(config)# ip ips signature-category ! Allows the fine tuning of signature parameters
on the basis of signature category
Router (config-ips-category)# category all ! Specifies the signature category to be used
for multiple aignature actions or conditions
Router(config-ips-category-action)# retired true ! Retires all the signatures in the "all"
category
Router(config-ips-category-action)# category ios_ips advanced ! Enables advanced signature
set
Router (config-ips-category-action)# retired false ! Enables the signatures in the IOS_IPS
category
Router(config-ips-category-action)# end
Router(config)# copy tftp://<ipaddr>/IOS-S341-CLI.pkg idconf ! Loads the signature package
(IOS-S341-CLI.pkg) to the specified location in ip ips config location

```

Cisco IOS IPS Verification

To verify your Cisco IOS IPS configuration, enter the following command:

```

Router# show ip ips statistics
Interfaces configured for ips 2
Session creations since subsystem startup or last reset 0
Current session counts (estab/half-open/terminating) [0:0:0]
Maxever session counts (estab/half-open/terminating) [0:0:0]
Last session created never
Last statistic reset never
TCP reassembly statistics

```

```

received 0 packets out-of-order; dropped 0
peak memory usage 0 KB; current usage: 0 KB
peak queue length 0

```

Access Control List Implementation

Access control list (ACL) configuration is a basic filtering process that can be used to control access network based on source or source/destination combination.

In Services Ready Medium Branch Network, ACLs entries are used to block TFTP traffic between certain endpoints. This is only an illustrative example.

```

Router(config)# ip access-list extended BLOCK-TFTP ! Specifies an Extended named ACL
Router(config-ext-nacl)# deny udp 172.16.10.0 0.0.0.255 eq tftp 10.0.0.0 0.0.0.255 eq tftp
! Deny TFTP traffic from specific source to specific destination
Router(config-ext-nacl)# deny udp 172.16.20.0 0.0.0.255 eq tftp 10.0.0.0 0.0.0.255 eq tftp
Router(config-ext-nacl)# deny udp 172.16.30.0 0.0.0.255 eq tftp 10.0.0.0 0.0.0.255 eq tftp

```

uRPF Implementation

The uRPF feature is automatically implemented when using AutoSecure. For the sake of completeness, the full configuration is provided.

```

Router(config)# access-list 103 permit udp any any eq bootpc ! Specifies ACL that permits bootpc traffic

```

Each WAN interface was configured to support uRPF filtering.

```

Router(config)# interface Multilink1 ! Enters Multilink interface configuration mode
Router(config-if)# ip verify unicast source reachable-via rx allow-default 103 ! Enables uRPF filtering
Router(config-if)# exit

Router(config)# interface ATM0/2/0.1 point-to-point ! Enters backup interface configuration mode
Router(config-if)# ip verify unicast source reachable-via rx allow-default 103 ! Enables uRPF filtering
Router(config-if)# exit

```

Layer 2 Security

- [Port Security Implementation, page 72](#)
- [Dynamic ARP Inspection Implementation, page 73](#)
- [IP Source Guard Implementation, page 75](#)
- [DHCP Snooping Implementation, page 75](#)
- [BPDU Guard Implementation, page 76](#)

Port Security Implementation

Following port security configuration was applied to both the distribution and access layer switches.

```

Switch-Dist(config)# interface range f1/0/5 - 16 ! Enters configuration for range of gigabit Ethernet ports
Switch-Dist(config-if-range)# switchport port-security ! Enables port security in this port

```

```

Switch-Dist(config-if-range)# switchport port-security maximum 2 ! Specifies to allow
traffic from maximum 2 mac-address as source address
Switch-Dist(config-if-range)# switchport port-security aging type inactivity ! Specifies
to age out the dynamically learned mac address if no traffic for specified period
Switch-Dist(config-if-range)# switchport port-security aging time 2 ! Specifies to age out
the dynamically learned mac-address after 2 minutes
Switch-Dist(config-if-range)# switchport port-security violation restrict ! Specifies the
port to drop packet from non secure mac address and send a trap

Switch-Access(config)# interface range g1/0/5 - 52 ! Enters configuration for range of
Gigabit Ethernet
Switch-Access(config-if-range)# switchport port-security ! Enables port security in this
port
Switch-Access(config-if-range)# switchport port-security maximum 2 ! Specifies to allow
traffic from maximum 2 mac-address as source address
Switch-Access(config-if-range)# switchport port-security aging type inactivity ! Specifies
to age out the dynamically learned mac address if no traffic for specified period
Switch-Access(config-if-range)# switchport port-security aging time 2 ! Specifies to age
out the dynamically learned mac-address after 2 minutes
Switch-Access(config-if-range)# switchport port-security violation restrict ! Specifies
the port to drop packet from non secure mac address and send a trap

```

Port Security Verification

To verify your port security configuration, enter the following command:

```

Switch-Access# show port-security interface g1/0/5
Port Security           : Enabled
Port Status             : Secure-up
Violation Mode          : Restrict
Aging Time              : 2 mins
Aging Type              : Inactivity
SecureStatic Address Aging : Disabled
Maximum MAC Addresses   : 2
Total MAC Addresses     : 0
Configured MAC Addresses : 0
Sticky MAC Addresses    : 0
Last Source Address:Vlan : 0000.0000.0000:0
Security Violation Count : 0
Switch-Access#

```

Dynamic ARP Inspection Implementation

Following command demonstrates how to apply dynamic Address Resolution Protocol (ARP) inspection excluding specified hosts.

```

Switch-Dist(config)# arp access-list STATIC-HOSTS ! Defines ARP access-list for hosts that
will be allowed to ARP packets
Switch-Dist(config-arp-nacl)# permit ip host 10.0.0.5 mac any
Switch-Dist(config-arp-nacl)# permit ip host 10.0.0.6 mac any
Switch-Dist(config-arp-nacl)# permit ip host 10.0.0.7 mac any
Switch-Dist(config-arp-nacl)# permit ip host 10.0.0.8 mac any
Switch-Dist(config-arp-nacl)# permit ip host 10.0.0.9 mac any
Switch-Dist(config-arp-nacl)# permit ip host 10.0.0.10 mac any
Switch-Dist(config-arp-nacl)# exit
Switch-Dist(config)# ip arp inspection vlan 301-303 ! Enables ARP inspection on specified
VLANs
Switch-Dist(config)# ip arp inspection validate dst-mac ! Specifies to perform a check
destination-MAC and Target MAC to be same on ARP packet
Switch-Dist(config)# ip arp inspection log-buffer entries 100 ! Enable the dynamic ARP
inspection log buffer to hold 100 entries

```

```

Switch-Dist(config)# ip arp inspection log-buffer logs 1 interval 100 ! Enables every log
entry to generate a system message every 100 seconds
Switch-Dist(config)# ip arp inspection filter STATIC-HOSTS vlan 301-303 ! Applies ARP ACL
to specified VLANs
Switch-Dist(config)# errdisable recovery cause arp-inspection ! Enable error recovery for
Dynamic ARP inspection error-disabled state.
Switch-Dist(config)# interface range Port-Channel 1 - 2 ! Enters EtherChannel
configuration mode
Switch-Dist(config-if)# ip arp inspection trust ! Disable ARP inspection
Switch-Dist(config)# interface range f1/0/1 - 4 ! Enters Fast Ethernet configuration mode
Switch-Dist(config-if)# ip arp inspection trust ! Disables ARP inspection
Switch-Dist(config)# interface g1/0/2 ! Enters gigabit Ethernet configuration mode
Switch-Dist(config-if)# ip arp inspection trust ! Disables ARP inspection

Switch-Access(config)# arp access-list STATIC-HOSTS ! Defines ARP access-list for hosts
that will be allowed to ARP packets
Switch-Access(config-arp-nacl)# permit ip host 10.0.0.5 mac any
Switch-Access(config-arp-nacl)# permit ip host 10.0.0.6 mac any
Switch-Access(config-arp-nacl)# permit ip host 10.0.0.7 mac any
Switch-Access(config-arp-nacl)# permit ip host 10.0.0.8 mac any
Switch-Access(config-arp-nacl)# permit ip host 10.0.0.9 mac any
Switch-Access(config-arp-nacl)# permit ip host 10.0.0.10 mac any
Switch-Access(config-arp-nacl)# exit
Switch-Access(config)# ip arp inspection vlan 301-302 ! Enables ARP inspection on
specified VLANs
Switch-Access(config)# ip arp inspection validate dst-mac ! Specifies to perform a check
destination-MAC and Target MAC to be same on ARP packet
Switch-Access(config)# ip arp inspection log-buffer entries 100 ! Enable the dynamic ARP
inspection log buffer to hold 100 entries
Switch-Access(config)# ip arp inspection log-buffer logs 1 interval 100 ! Enables every
log entry to generate a system message every 100 seconds
Switch-Access(config)# ip arp inspection filter STATIC-HOSTS vlan 301-303 ! Applies ARP
ACL to specified VLANs
Switch-Access(config)# errdisable recovery cause arp-inspection ! Enable error recovery
for Dynamic ARP inspection error-disabled state.
Switch-Access(config)# interface range Port-Channel 1 - 2 ! Enters EtherChannel
configuration mode
Switch-Access(config-if)# ip arp inspection trust ! Disables ARP inspection
Switch-Access(config)# interface range g1/0/1 - 4 ! Enters gigabit Ethernet configuration
mode
Switch-Access(config-if)# ip arp inspection trust ! Disables ARP inspection

```

Dynamic ARP Inspection Verification

To verify your dynamic ARP inspection configuration, enter the following command:

```
Switch-Access# show ip arp inspection vlan 301
```

```

Source Mac Validation      : Disabled
Destination Mac Validation : Enabled
IP Address Validation      : Disabled

```

Vlan	Configuration	Operation	ACL Match	Static ACL
301	Enabled	Active	static-host	No

Vlan	ACL Logging	DHCP Logging
301	Deny	Deny

```
Switch-Access#
```

IP Source Guard Implementation

The following source guard configuration was applied to both the distribution and access layer switches.

```
Switch-Dist(config)# ip source binding 0030.94C2.9A40 vlan 303 10.0.2.65 interface f1/0/5
! Specifies MAC to IP binding for statically assigned DMZ server address
Switch-Dist(config)# ip source binding 0030.94C2.9A41 vlan 303 10.0.2.66 interface f1/0/6
! Specifies MAC to IP binding for statically assigned DMZ server address
Switch-Dist(config)# ip source binding 0030.94C2.9A41 vlan 303 10.0.2.66 interface f1/0/7
! Specifies MAC to IP binding for statically assigned DMZ server address
Switch-Dist(config)# ip source binding 0030.94C2.9A41 vlan 303 10.0.2.66 interface f1/0/8
! Specifies MAC to IP binding for statically assigned DMZ server address
Switch-Dist(config)# ip source binding 0030.94C2.9A42 vlan 303 10.0.2.67 interface f1/0/9
! Specifies MAC to IP binding for statically assigned DMZ server address
Switch-Dist(config)# ip source binding 0030.94C2.9A43 vlan 303 10.0.2.68 interface f1/0/10
! Specifies MAC to IP binding for statically assigned DMZ server address
Switch-Dist(config)# ip source binding 0030.94C2.9A44 vlan 303 10.0.2.69 interface f1/0/11
! Specifies MAC to IP binding for statically assigned DMZ server address
Switch-Dist(config)# ip source binding 0030.94C2.9A45 vlan 303 10.0.2.70 interface f1/0/12
! Specifies MAC to IP binding for statically assigned DMZ server address
Switch-Dist(config)# ip source binding 0030.94C2.9A46 vlan 303 10.0.2.71 interface f1/0/13
! Specifies MAC to IP binding for statically assigned DMZ server address
Switch-Dist(config)# ip source binding 0030.94C2.9A47 vlan 303 10.0.2.72 interface f1/0/14
! Specifies MAC to IP binding for statically assigned DMZ server address
Switch-Dist(config)# ip source binding 0030.94C2.9A48 vlan 303 10.0.2.73 interface f1/0/15
! Specifies MAC to IP binding for statically assigned DMZ server address
Switch-Dist(config)# ip source binding 0030.94C2.9A49 vlan 303 10.0.2.74 interface f1/0/16
! Specifies MAC to IP binding for statically assigned DMZ server address
Switch-Access(config)# interface range f1/0/5 - 16 ! Enters Fast Ethernet configuration
mode
Switch-Access(config-if-range)# ip verify source port-security ! Specifies to check the
binding table and allow traffic only if it matches an entry
Switch-Access(config)# interface range g1/0/5 - 52 ! Enters gigabit Ethernet configuration
mode
Switch-Access(config-if-range)# ip verify source port-security ! Specifies to check the
binding table and allow traffic only if it matches an entry
```

DHCP Snooping Implementation

```
Switch-Dist(config)# ip dhcp snooping ! Enables DHCP snooping globally on the switch
Switch-Dist(config)# ip dhcp snooping vlan 301-303 ! Enables DHCP snooping for specified
VLANs
Switch-Dist (config)# interface range Port-Channel 1 - 2 ! Enters EtherChannel
configuration mode
Switch-Dist(config-if)# ip dhcp snooping trust ! Disable ARP inspection on EtherChannel
Switch-Dist(config)# interface range f1/0/1 - 4 ! Enters Fast Ethernet configuration mode
Switch-Dist(config-if)# ip dhcp snooping trust ! Disables DHCP snooping
Switch-Dist(config)# interface g1/0/2 ! Enters gigabit Ethernet configuration mode
Switch-Dist(config-if)# ip dhcp snooping trust ! Disables DHCP snooping

Switch-Access(config)# ip dhcp snooping ! Enables DHCP snooping globally on the switch
Switch-Access(config)# ip dhcp snooping vlan 301-302 ! Enables DHCP snooping for specified
VLANs
Switch-Access(config)# interface Port-Channel1 ! Enters EtherChannel configuration mode
Switch-Access(config-if)# ip dhcp snooping trust ! Disables DHCP snooping
Switch-Access(config)# interface range Port-Channel 1 - 2 ! Enters EtherChannel
configuration mode
Switch-Access(config-if)# ip dhcp snooping trust ! Disables DHCP snooping
Switch-Access(config)# interface range g1/0/1 - 4 ! Enters gigabit Ethernet configuration
mode
Switch-Access(config-if)# ip dhcp snooping trust ! Disables DHCP snooping
```

DHCP Snooping Verification

To verify your Dynamic Host Configuration Protocol (DHCP) snooping configuration, enter the following command.

```
Switch-Access# show ip dhcp snooping
Switch DHCP snooping is enabled
DHCP snooping is configured on following VLANs:
301-303
Insertion of option 82 is enabled
```

BPDU Guard Implementation

The following is an example for configuring port security on all trunk ports.

```
Switch-Dist(config-if)# interface range Port-channel 1 - 2 ! Enters Ether channel
configuration mode
Switch-Dist(config-if-range)# spanning-tree bpduguard disable ! Disables BPDU guard
Switch-Dist(config)# interface range g1/0/2 ! Enters gigabit Ethernet configuration mode
Switch-Dist(config-if)# spanning-tree bpduguard enable ! Enables BPDU guard
Switch-Dist(config)# interface range f1/0/5 - 16 ! Enters Fast Ethernet configuration mode
Switch-Dist(config-if)# spanning-tree bpduguard enable ! Enables BPDU guard
Switch-Access(config-if)# interface Port-channel 1 !Enters EtherChannel configuration
mode
Switch-Access(config-if)# spanning-tree bpduguard disable ! Disables BPDU guard
Switch-Access(config)# interface range g1/0/5 - 52 ! Enters gigabit Ethernet configuration
mode
Switch-Access(config-if)# spanning-tree bpduguard enable ! Enables BPDU guard
```

Management Services Implementation

- [NetFlow Implementation, page 76](#)
- [SNMP Implementation, page 77](#)
- [NTP Implementation, page 78](#)
- [IP SLA Implementation, page 79](#)
- [Syslog Implementation, page 80](#)
- [Cisco Configuration Professional Implementation, page 80](#)
- [Cisco Configuration Engine Implementation, page 85](#)

NetFlow Implementation

Cisco IOS NetFlow efficiently collects and measure data as it enters specific router interface. This data can be used for network traffic accounting and network planning.

NetFlow can be configured to collect data for top flows, and the data can be used for further analysis.

```
Router(config)# ip flow-top-talkers ! Enabled NetFlow to capture traffic statistics for
top flows
Router(config-flow-top-talkers)# top 5 ! Specifies the maximum number of top talkers
Router(config-flow-top-talkers)# sort-by packets ! Specifies to sort top talkers by number
of bytes
Router(config-flow-top-talkers)# cache-timeout 100 ! Specifies the time up to which top
talkers statistics collected
Router(config-flow-top-talkers)# exit
```



```
Router(config)# exit
```

NetFlow Verification

To verify your NetFlow configuration, enter the following command:

```
Router# show ip flow top-talkers
```

```
SrcIf          SrcIPAddress  DstIf          DstIPAddress  Pr SrcP DstP  Pkts
Mul            10.0.0.22     Local          10.0.0.8      2F 0000 0000   28
Mul            10.0.0.27     Local          10.0.0.10     32 AAB6 2992   28
Tul            172.16.0.10   Null           224.0.0.10    58 0000 0000   27
3 of 5 top talkers shown. 3 flows processed.
```

```
Router#
```

SNMP Implementation

Simple Network Management Protocol (SNMP) is an application layer protocol which facilitates the exchange of management information between a network device and an SNMP server. This information can be used for network management and troubleshooting.

SNMP is enabled to send traps for specific events that will be used for troubleshooting. Two SNMP communities with different privileges were configured.

```
Router(config)# ip access-list standard Full ! List of clients with full access to SNMP agent
Router(config-std-nacl)# permit host 172.16.4.5
Router(config-std-nacl)# exit
Router(config)# ip access-list standard Browse ! List of clients with browse access to SNMP agent
Router(config-std-nacl)# permit host 10.0.0.6
Router(config-std-nacl)# exit
Router(config)# snmp-server community RW-ACCESS rw Full ! Enables SNMP community with Read/Write access to server
Router(config)# snmp-server community RO-ACCESS ro Browse ! Enables SNMP community with Read-Only access to server
Router(config)# snmp-server enable traps snmp authentication linkdown linkup coldstart warmstart ! Enables notification for various router events
Router(config)# snmp-server enable traps eigrp ! Enables EIGRP notification
Router(config)# snmp-server enable traps flash insertion removal ! Enables Flash Insertion/Removal notification
Router(config)# snmp-server enable traps envmon ! Enables Environmental monitor notification
Router(config)# snmp-server enable traps bgp ! Enables BGP protocol notification
Router(config)# snmp-server enable traps memory bufferpeak ! Enables Memory buffer peak notification
Router(config)# snmp-server enable traps hsrp ! Enables HSRP notification
Router(config)# snmp-server enable traps ospf state-change ! Enables OSPF protocol state-change notification
Router(config)# snmp-server enable traps ospf errors ! Enables OSPF error notification
Router(config)# snmp-server enable traps ospf retransmit ! Enables OSPF LSA retransmit notification
Router(config)# snmp-server enable traps ospf lsa ! Enables OSPF LSA notification
Router(config)# snmp-server enable traps ospf cisco-specific state-change nssa-trans-change ! Enables OSPF NSSA state change notification
Router(config)# snmp-server enable traps ospf cisco-specific state-change shamlink interface-old ! Enables OSPF replaced interface shamlink notification
```

```

Router(config)# snmp-server enable traps ospf cisco-specific state-change shamlink
neighbor ! Enables OSPF neighbor shamlink transition notification
Router(config)# snmp-server enable traps ospf cisco-specific errors ! Enables OSPF
nonvirtual interface mismatch error notification
Router(config)# snmp-server enable traps ospf cisco-specific retransmit ! Enables OSPF
retransmit error notification
Router(config)# snmp-server enable traps ospf cisco-specific lsa ! Enables OSPF LSA
notification
Router(config)# snmp-server enable traps cpu threshold ! Enables CPU threshold violation
notification
Router(config)#

```

NTP Implementation

Network Time Protocol (NTP) is used to synchronize the time in local devices to a radio clock or atomic clock attached to the time server. Synchronized time in all the network devices is helpful for troubleshooting and understanding logging messages.

```

Router(config)# ntp authenticate ! Enables NTP authentication
Router(config)# ntp authentication-key 1234 md5 NTP-KEY ! Specifies authentication key and
Password
Router(config)# ntp trusted-key 1234 ! Specifies the key number to be used for
authentication
Router(config)# ntp server 172.16.0.60 key 1234 ! Specifies central site NTP server
address and key

```

```

Switch-Dist (config)# ntp authenticate ! Enables NTP authentication
Switch-Dist (config)# ntp authentication-key 1234 md5 NTP-KEY ! Specifies authentication
key and Password
Switch-Dist (config)# ntp trusted-key 1234 ! Specifies the key number to be used for
authentication
Switch-Dist (config)# ntp server 172.16.0.60 key 1234 ! Specifies central site NTP server
address and key

```

```

Switch-Access (config)# ntp authenticate ! Enables NTP authentication
Switch-Access (config)# ntp authentication-key 1234 md5 NTP-KEY ! Specifies authentication
key and Password
Switch-Access (config)# ntp trusted-key 1234 ! Specifies the key number to be used for
authentication
Switch-Access (config)# ntp server 172.16.0.60 key 1234 ! Specifies central site NTP
server address and key

```

Set time zone and daylight saving for a specific time zone. The following example uses U.S. Pacific Standard Time zone.

```

Router(config)# clock timezone pst -8 ! Sets the time zone
Router(config)# clock summer-time pdt recurring ! Sets daylight savings time
Switch-Dist(config)# clock timezone pst -8 ! Sets the time zone
Switch-Dist(config)# clock summer-time pdt recurring ! Sets daylight savings time

```

```

Switch-Access(config)# clock timezone pst -8 ! Sets the time zone
Switch-Access(config)# clock summer-time pdt recurring ! Sets daylight savings time

```

NTP Verification

To verify your NTP configuration, enter the following command:

```

Router# show ntp status
Clock is synchronized, stratum 4, reference is 10.66.66.11
nominal freq is 250.0000 Hz, actual freq is 249.9966 Hz, precision is 2**18
reference time is CC70BD86.5EFBE4E6 (02:16:54.371 PDT Tue Sep 9 2008)
clock offset is -0.0255 msec, root delay is 0.79 msec

```

```
root dispersion is 0.11 msec, peer dispersion is 0.05 msec
Router#
```

IP SLA Implementation

An IP Service Level Agreement (SLA) is a management tool running on Cisco IOS software that can be used to analyze IP service levels for IP applications and services in order to increase the network productivity and to reduce the frequency of network outages.

In the Services Ready Medium Branch Network architecture, the User Datagram Protocol (UDP)-echo operation is used to test end-to-end connectivity and response time, and UDP jitter is used to measure packet variability.

```
Router(config)# ip sla 10 ! Configures IP SLA operation with specified ID
Router(config-ip-sla)# udp-echo 209.165.201.10 65535 source-ip 209.165.201.9 source-port
65000 ! Performs UDP echo operation between two Loopback Interfaces
Router(config-ip-sla-udp)# frequency 30 ! Sets the rate at which a specified IP SLA
operation repeats
Router(config)# ip sla 20 ! Configures IP SLA operation with specified ID
Router(config-ip-sla-udp)# udp-jitter 209.165.201.10 65535 source-ip 209.165.201.9
source-port 65000 ! Performs UDP jitter operation between two Loopback Interfaces
Router(config-ip-sla-jitter)# frequency 30 ! Sets the rate at which a specified IP SLA
operation repeats

Router(config-ip-sla-udp)# exit
Router(config)# ip sla schedule 10 start-time now life forever ! Starts the IP SLA
operation now and runs it indefinitely
Router(config)# ip sla schedule 20 start-time now life forever ! Starts the IP SLA
operation now and runs it indefinitely
```

IP SLA Verification

To verify your IP SLA configuration, enter the following command:

```
Router# show ip sla statistics

Round Trip Time (RTT) for      Index 10
      Latest RTT: NoConnection/Busy/Timeout
Latest operation start time: *22:45:46.259 pst Mon Feb 2 2009
Latest operation return code: No connection
Number of successes: 0
Number of failures: 3
Operation time to live: Forever

Round Trip Time (RTT) for      Index 20
      Latest RTT: 0 milliseconds
Latest operation start time: *20:22:59.119 pst Mon Feb 2 2009
Latest operation return code: Socket bind error
RTT Values:
      Number Of RTT: 0                RTT Min/Avg/Max: 0/0/0 milliseconds
Latency one-way time:
      Number of Latency one-way Samples: 0
      Source to Destination Latency one way Min/Avg/Max: 0/0/0 milliseconds
      Destination to Source Latency one way Min/Avg/Max: 0/0/0 milliseconds
Jitter Time:
      Number of SD Jitter Samples: 0
      Number of DS Jitter Samples: 0
      Source to Destination Jitter Min/Avg/Max: 0/0/0 milliseconds
```

```

    Destination to Source Jitter Min/Avg/Max: 0/0/0 milliseconds
Packet Loss Values:
    Loss Source to Destination: 0          Loss Destination to Source: 0
    Out Of Sequence: 0          Tail Drop: 0
    Packet Late Arrival: 0      Packet Skipped: 0
Voice Score Values:
    Calculated Planning Impairment Factor (ICPIF): 0
    Mean Opinion Score (MOS): 0
Number of successes: 0
Number of failures: 4
Operation time to live: Forever

```

Syslog Implementation

Apply following commands to enable syslog logging.

```

Router(config)# service timestamps log datetime msec localtime show-timezone ! Instructs
the system to timestamp syslog messages
Router(config)# logging 172.16.0.90 ! Identifies syslog server
Router(config)# logging trap notifications ! Log notice messages and above
Router(config)# logging facility local2 ! Specifies the facility level used by the syslog
messages
Router(config)# logging buffered 4096 ! Sets size of internal log buffer

Switch-Access(config)# service timestamps log datetime msec localtime show-timezone !
Instructs the system to timestamp syslog messages
Switch-Access (config)# logging 172.16.0.90 ! Identifies syslog server
Switch-Access (config)# logging trap notifications ! Log notice messages and above
Switch-Access (config)# logging facility local2 ! Specifies the facility level used by the
syslog messages
Switch-Access (config)# logging buffered 4096 ! Sets size of internal log buffer

Switch-Dist(config)# service timestamps log datetime msec localtime show-timezone !
Instructs the system to timestamp syslog messages
Switch-Dist (config)# logging 172.16.0.90 ! Identifies syslog server
Switch-Dist (config)# logging trap notifications ! Log notice messages and above

```

Cisco Configuration Professional Implementation

Monitoring of the Services Ready Medium Branch Network was done with the Cisco Configuration Professional in monitor mode. Cisco Configuration Professional provides an overview of router status and performance metrics without having to use the Cisco IOS command-line interface. [Figure 5](#) shows the monitor overview, which includes information such as CPU and memory usage, interface status, firewall status, and VPN status.

Figure 5 Cisco Configuration Professional Monitor Overview

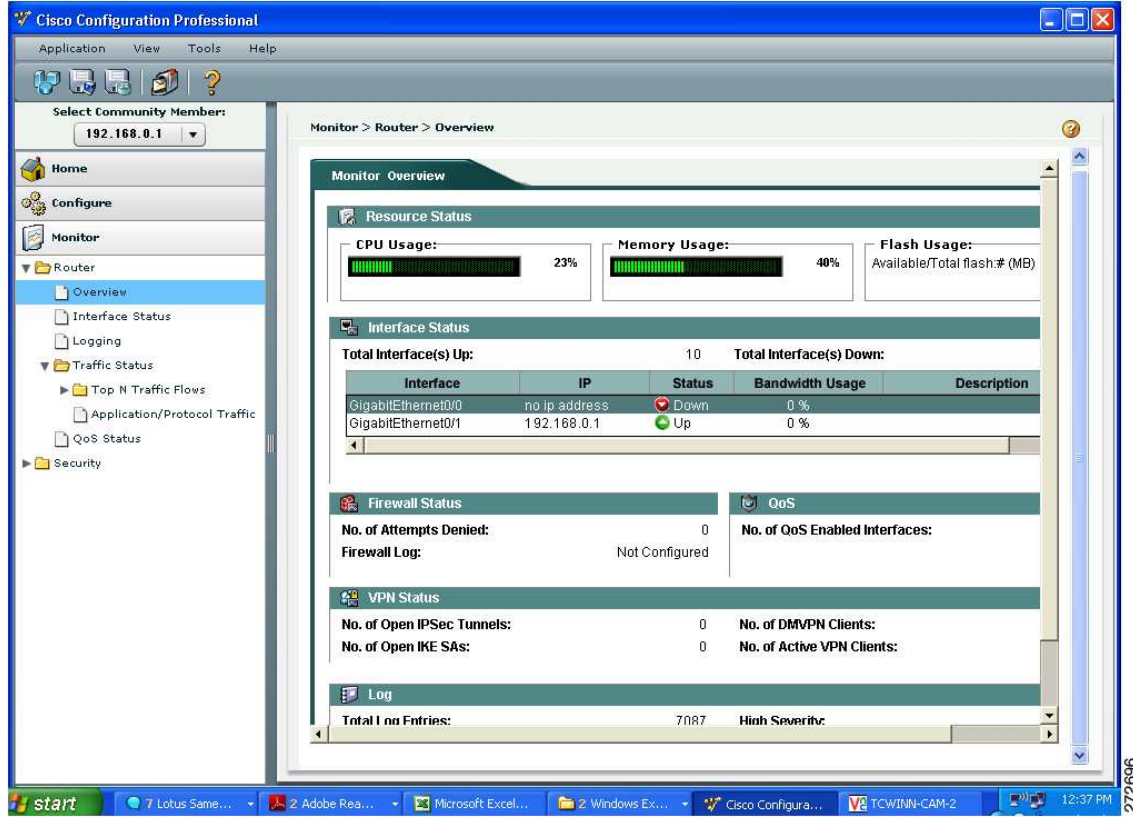

272696

Figure 6 shows the interface status for the Gigabit Ethernet interface, which includes packets in and packets out, and bandwidth usage.

Figure 6 Cisco Configuration Professional Gigabit Ethernet Interface Status

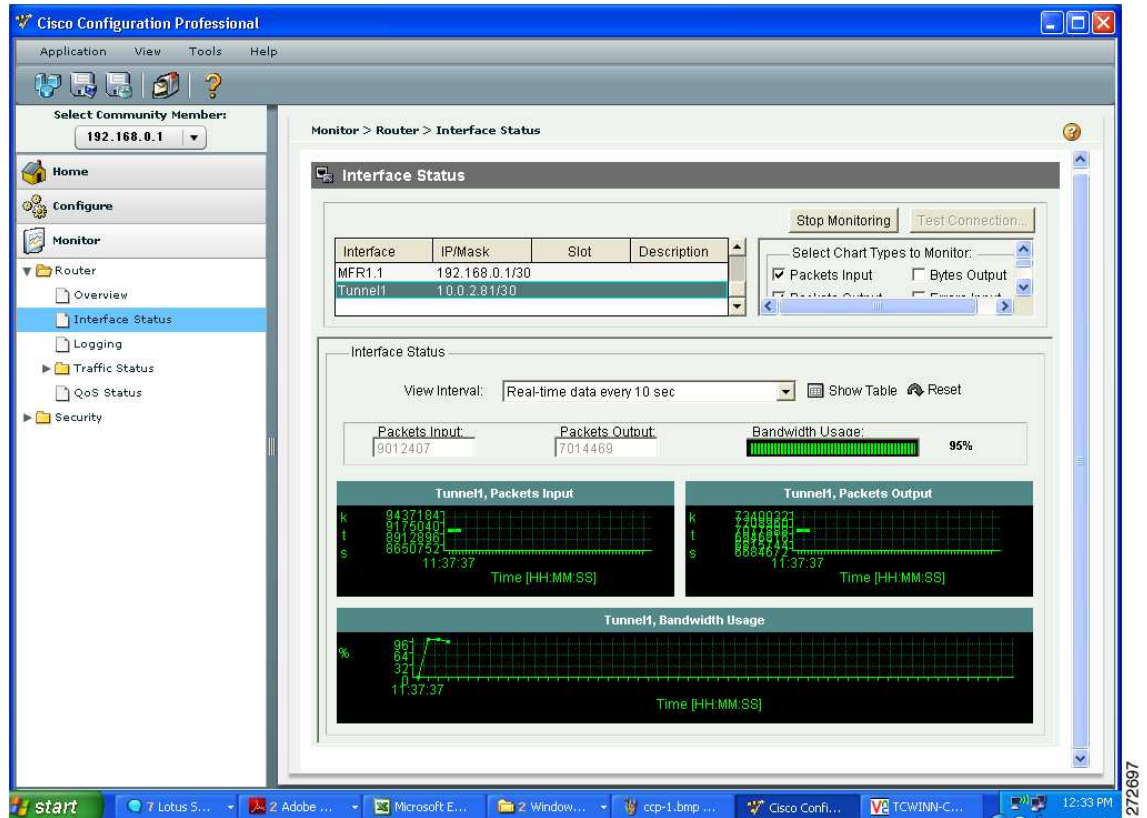

272697

Figure 7 shows the interface status for the tunnel interface.

Figure 7 Cisco Configuration Professional Tunnel Interface Status

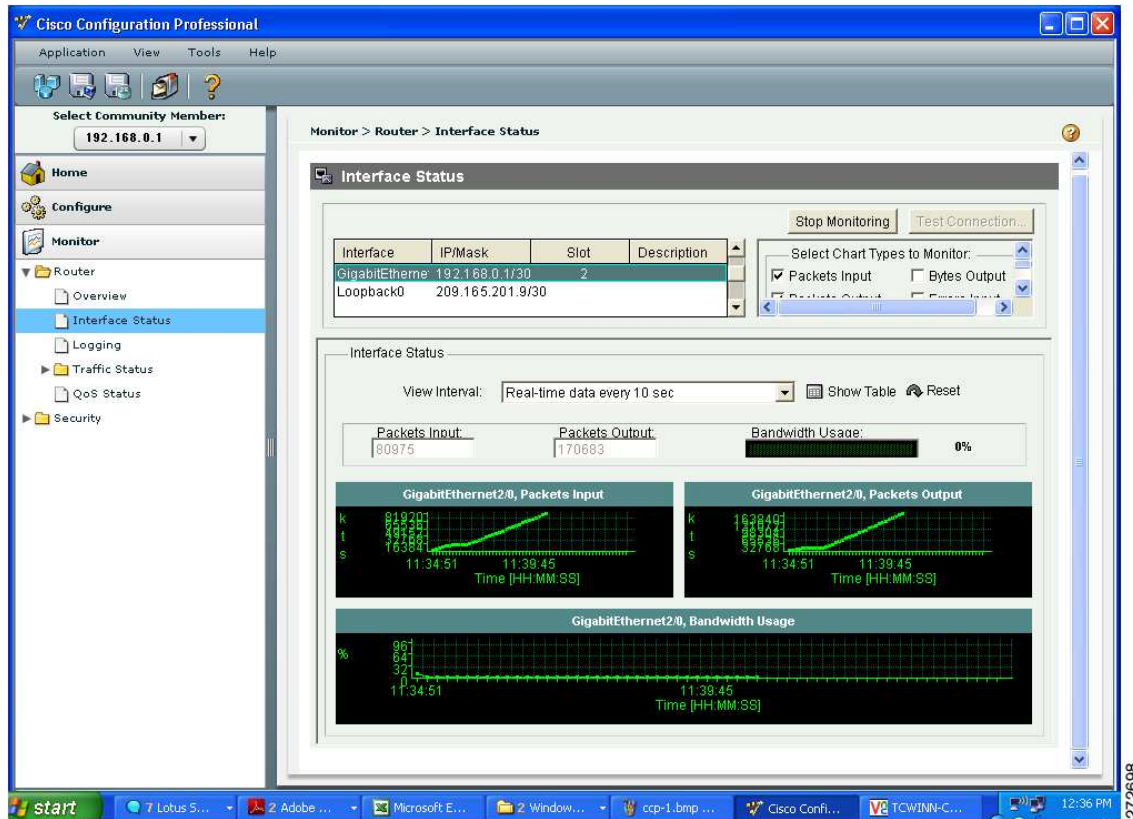

272698

Figure 8 shows the VPN status for the DMVPN tunnel, which includes encapsulation and decapsulation packets and send and receive error packets.

Figure 8 Cisco Configuration Professional VPN Status

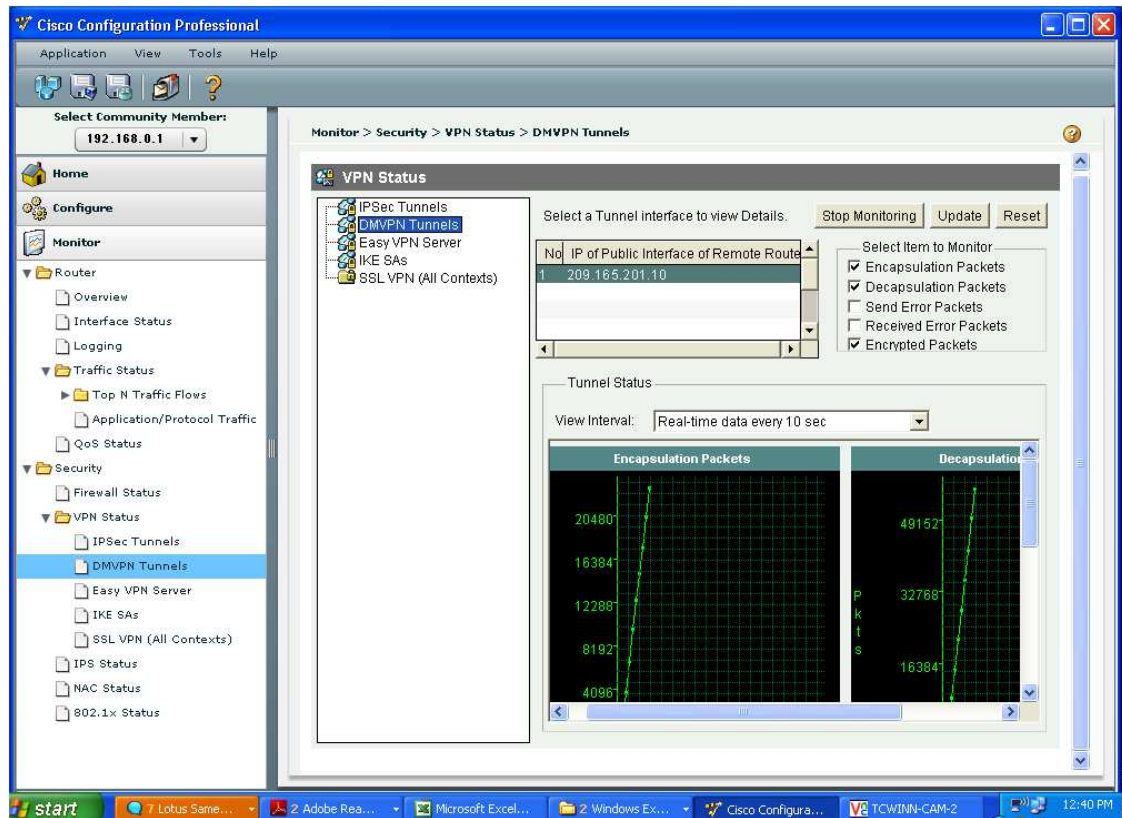
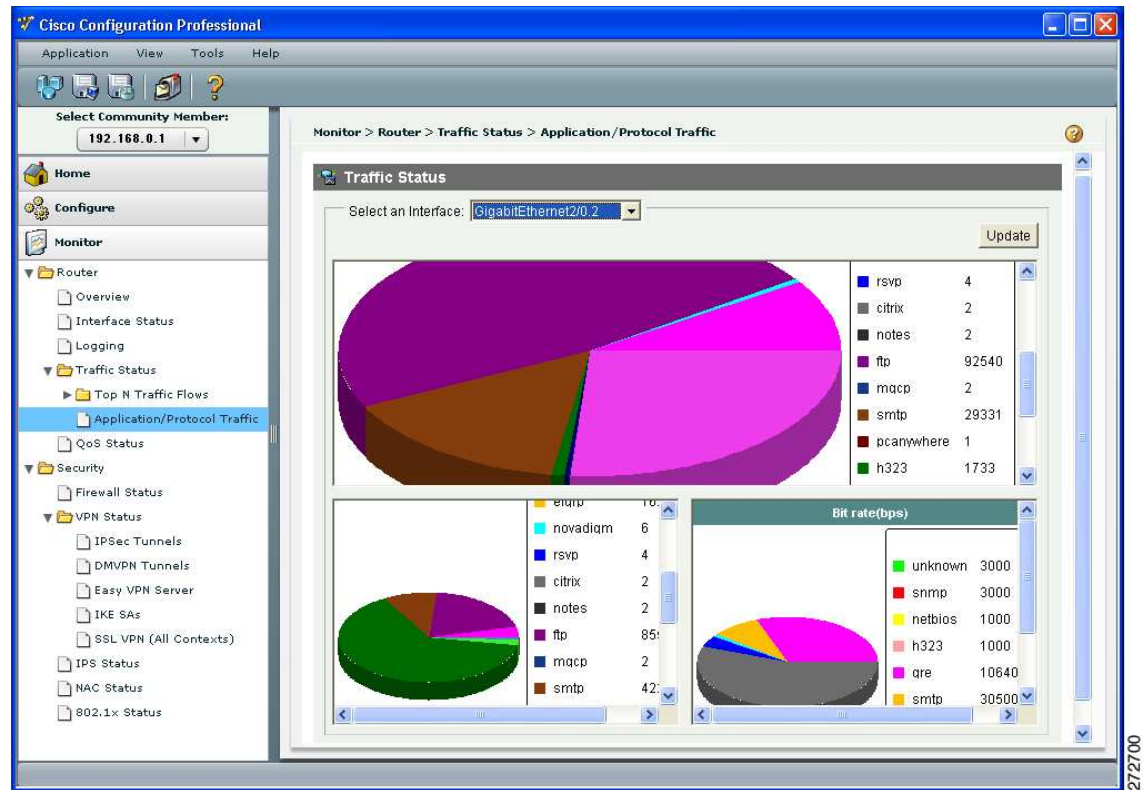

Figure 9 shows the interface traffic analysis.

Figure 9 Cisco Configuration Professional Traffic Analysis



Cisco Configuration Engine Implementation

There are several steps required to enable deployment with the Cisco Configuration Engine. First, *bootstrap configuration* must be applied to each device. The bootstrap configuration is either preloaded or obtained from a centrally hosted DHCP server through option 150. In the Services Ready Medium Branch Network, both routers and all switches were preloaded with the following bootstrap configuration.

```
Router(config)# cns trusted-server all-agents cce.example.com ! Specifies trusted server
for CNS agent
Router(config)# cns id hardware-serial ! Identifies this devices by its serial number to
CCE
Router(config)# cns id hardware-serial event ! Identifies this devices by its serial
number to CCE event logging component
Router(config)# cns event cce.example.com ! Enables event agent
Router(config)# cns config initial cce.example.com 80 ! Initiates an initial configuration
on CCE server port 80
Router(config)# cns config partial cce.example.com 80 ! Initiates an incremental
configuration on CCE server port 80
Router(config)# cns exec 80 ! Enables CNS agent

Switch-Access(config)# cns trusted-server all-agents cce.example.com ! Specifies trusted
server for CNS agent
Switch-Access(config)# cns id hardware-serial ! Identifies this devices by its serial
number to CCE
```

```

Switch-Access(config)# cns id hardware-serial event ! Identifies this devices by its
serial number to CCE event logging component
Switch-Access(config)# cns event cce.example.com ! Enables event agent
Switch-Access(config)# cns config initial cce.example.com 80 ! Initiates an initial
configuration on CCE server port 80
Switch-Access(config)# cns config partial cce.example.com 80 ! Initiates an incremental
configuration on CCE server port 80
Switch-Access(config)# cns exec 80 ! Enables CNS agent

Switch-Dist(config)# cns trusted-server all-agents cce.example.com ! Specifies trusted
server for CNS agent
Switch-Dist(config)# cns id hardware-serial ! Identifies this devices by its serial number
to CCE
Switch-Dist(config)# cns id hardware-serial event ! Identifies this devices by its serial
number to CCE event logging component
Switch-Dist(config)# cns event cce.example.com ! Enables event agent
Switch-Dist(config)# cns config initial cce.example.com 80 ! Initiates an initial
configuration on CCE server port 80
Switch-Dist(config)# cns config partial cce.example.com 80 ! Initiates an incremental
configuration on CCE server port 80
Switch-Dist(config)# cns exec 80 ! Enables CNS agent

```

Secondly, the device CNS ID must be entered into the CCE server prior to powering on of branch devices. Each device CNS is associated with Cisco IOS image to be loaded onto the device and a configuration toolkit. The Services Ready Medium Branch Network provides following 10 CCE toolkits:

- **Configuration for zero-touch deployment with Cisco Configuration Engine**
 - Bootstrap Configuration for routers and switches
- **Router**
 - Gigabit Ethernet WAN interface, active primary and standby backup WAN links, OSPF routing, DMVPN over primary and backup WAN links, and Cisco Unified CME with SCCP configured IP Phones and H.323 trunking to the central site.
 - Four T1 WAN interface bundle with MLPPP encapsulation, active primary and standby backup WAN links, EIGRP routing, GETVPN over primary and DMVPN over backup WAN links, and Cisco Unified CME with SIP configured IP Phones and SIP trunking to central site.
 - Four T1 WAN interface bundle with MLFR encapsulation, simultaneously active primary and backup WAN links, EIGRP routing, DMVPN over primary and backup WAN links, and Cisco Unified SRST with SCCP configured IP Phones and H.323 trunking to central site.
 - T3 WAN interface with Frame Relay encapsulation, simultaneously active primary and backup WAN links, OSPF routing, GETVPN over primary and DMVPN over backup WAN links, and Cisco Unified SRST with SIP configured IP Phones and SIP trunking to central site.
- **Distribution Switches**
 - A 16-port EtherSwitch service module with 2 two-link EtherChannel trunks and DMZ VLAN on access ports.
- **Access Switches**
 - A 48-port access switch with a two-link EtherChannel trunk and Data and Voice VLANs on access ports.

Downloading and Using the Configuration Toolkit

Download the templates from the following location:

- [Configuration Templates for Services Ready Large Branch Network](#)

To use the configuration templates for manual configurations, download them to a TFTP server that is accessible from the routers and switches. To use the configuration templates with Cisco Configuration Engine (CCE) 3.0, complete the following steps:

- Step 1** Log in to CCE and navigate to **Tools > Template Manager**.
- Step 2** In the Template Manager window, shown in [Figure 10](#), click **Add Template**. The Template Engine window appears.

Figure 10 CCE Template Manager

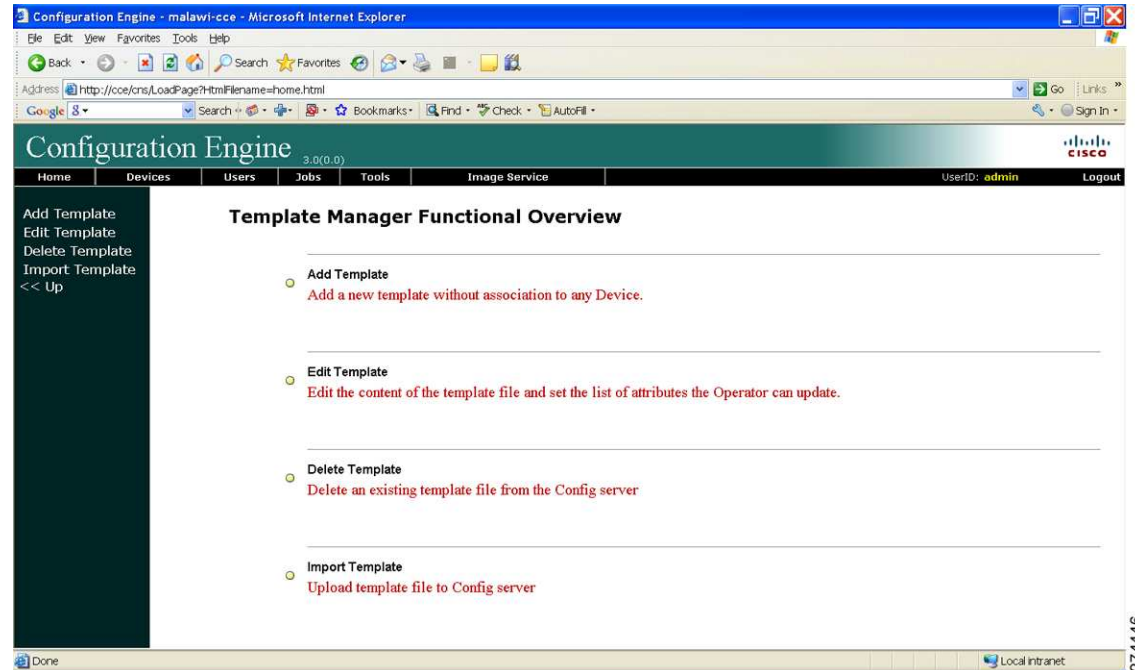

- Step 3** In the Template Engine window, shown in [Figure 11](#), choose the best template engine for your specific environment, and then click **Next**. The CCE Configuration Editor window appears.

Figure 11 CCE Template Engine

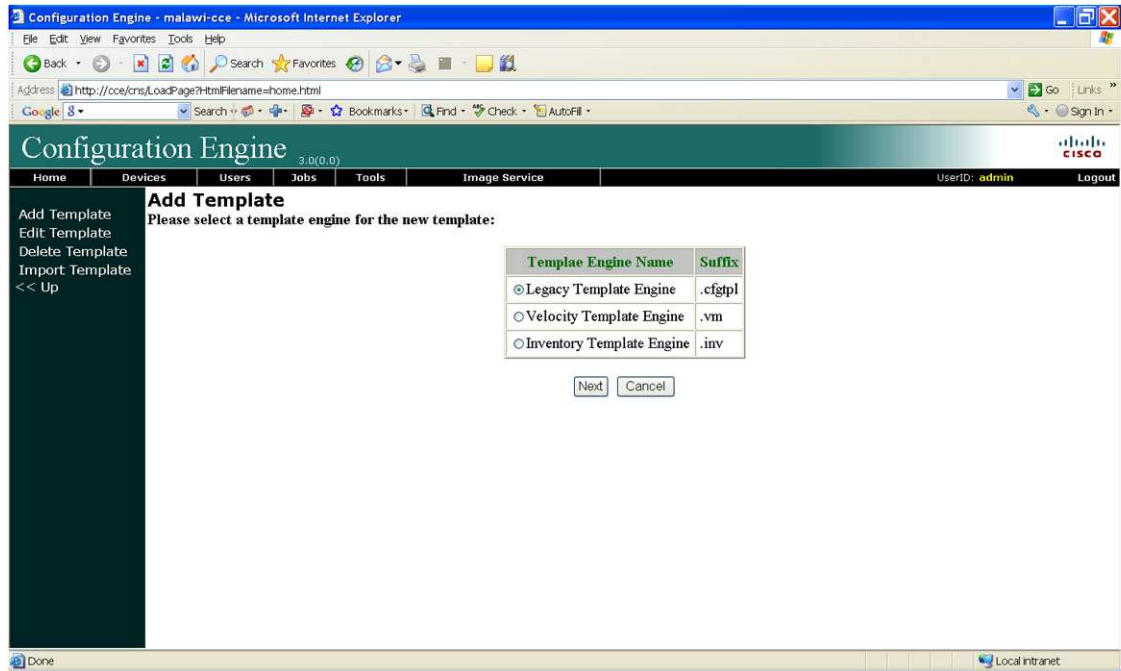

- Step 4** From the list of configuration templates, copy the configuration template that best meets your needs from one of the above listed configuration templates and paste it into the CCE Configuration Editor, shown in Figure 12.

Figure 12 CCE Configuration Editor

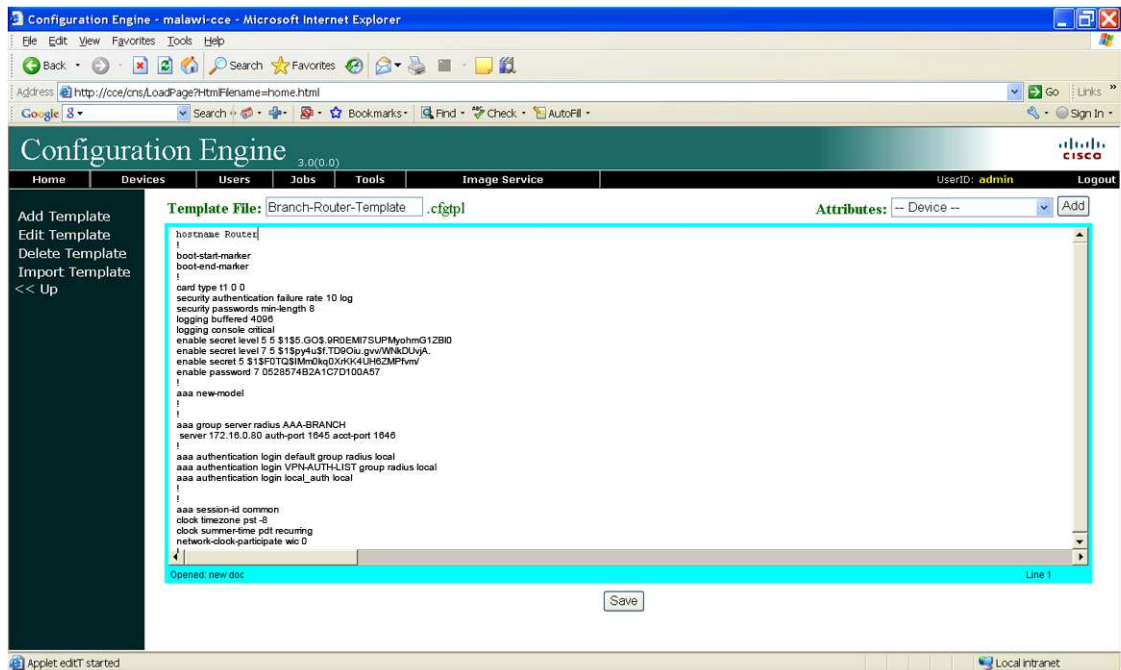

- Step 5** Customize the configuration to meet the needs of your specific environment. After editing the configuration, name and save the configuration.

Step 6 Navigate to the Device Manager window, shown in [Figure 13](#), and click **Add Device**.

Figure 13 CCE Device Manager

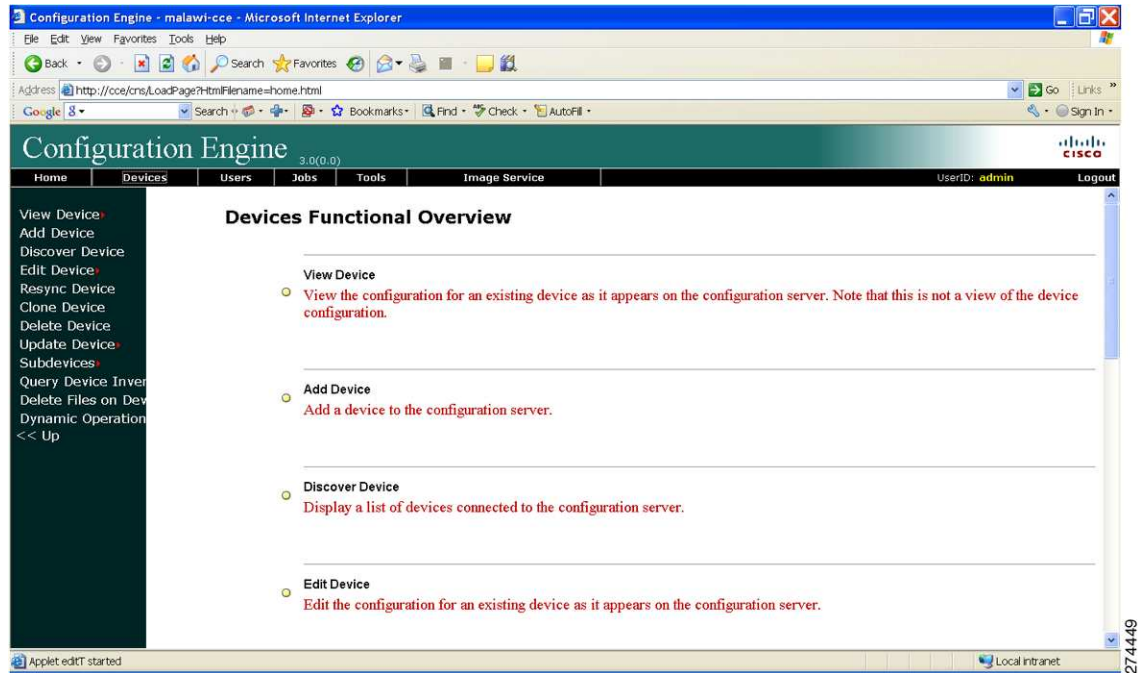

Step 7 In the Create Device Editor window, shown in [Figure 14](#), assign a Device Name, a Unique ID that corresponds to the configuration name specified in [Step 5](#), and a Device Type. Click **Next**. The Device Group Selector window appears.

Figure 14 CCE Create Device Editor

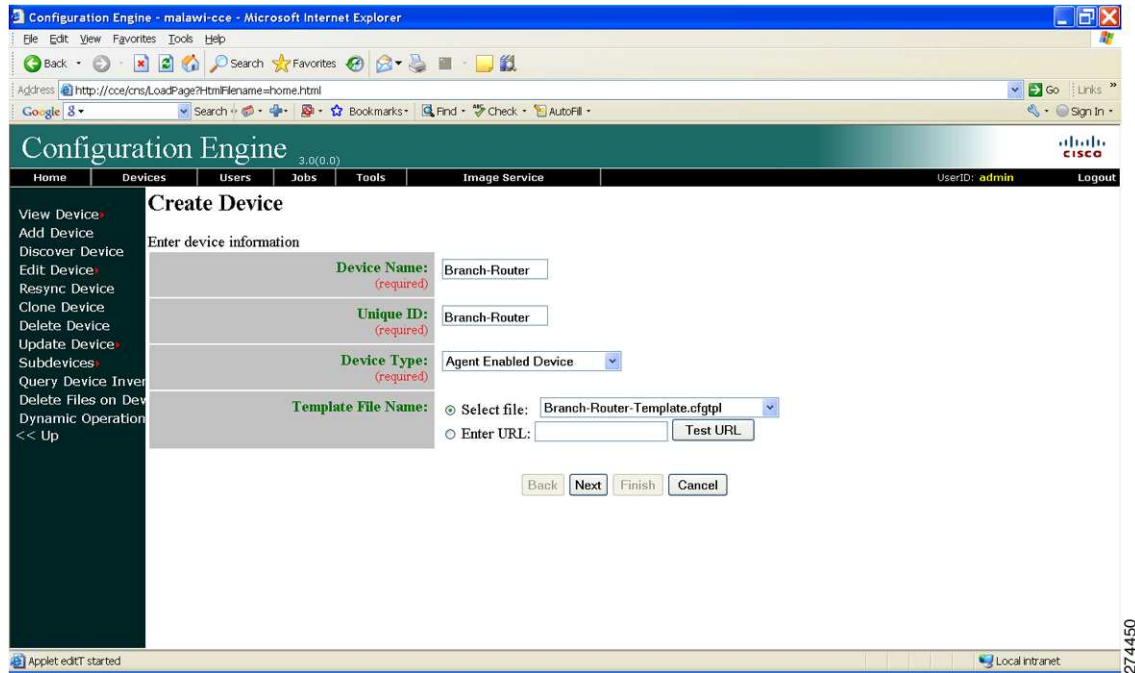

- Step 8** Choose group membership as shown in Figure 15. CCE supports management of devices as groups. See the CCE documentation for details on how to manage devices as a group. Click **Next**. The Device Group Selector window appears.

Figure 15 CCE Device Group Selector

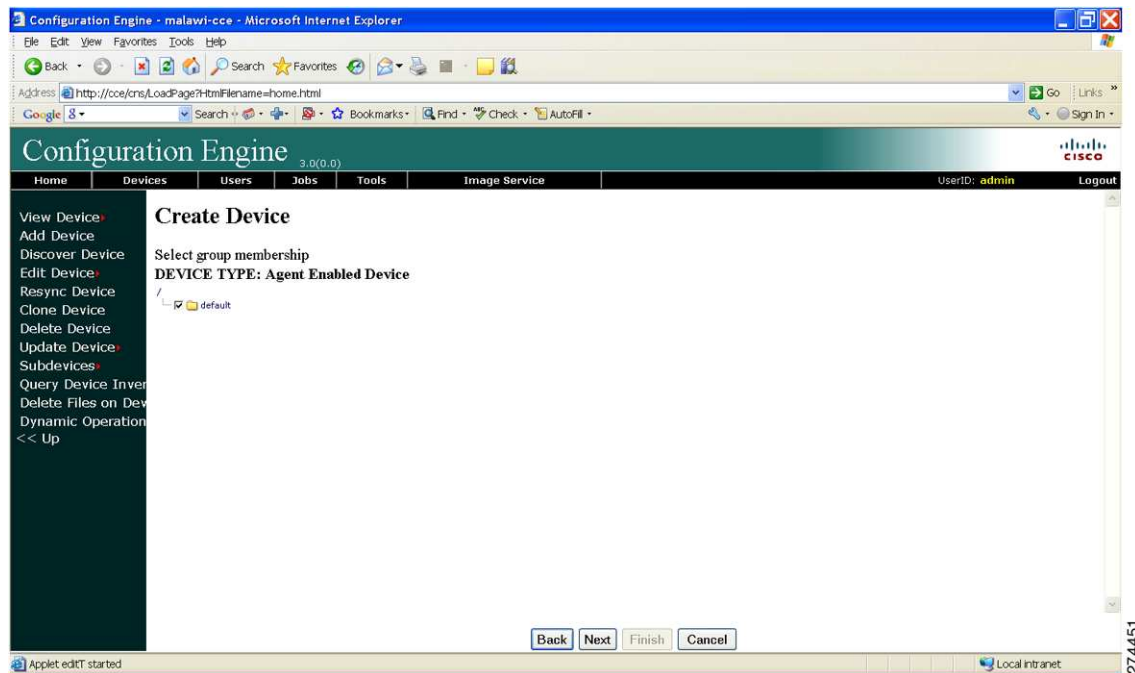

- Step 9** In the Device Identification Assignment window, shown in [Figure 16](#), enter the Event ID, Config ID, and Image ID (CCE supports the ability to distribute Cisco IOS software images; see the CCE documentation for additional information) for the Device Type. Click **Finish**.

**Note**

These IDs must match the identification provided in the device Bootstrap Configuration.

Figure 16 CCE Device Identification Assignment

- Step 10** Repeat this procedure for all routers and switches.

Voice Services Implementation

- [PRI-Trunk and FXS Port Implementation, page 92](#)
- [Cisco Unified CME with SCCP Endpoints Implementation, page 93](#)
- [Cisco Unified CME with SIP Endpoints Implementation, page 110](#)
- [Cisco Unified SRST with SCCP Endpoints Implementation, page 116](#)
- [Cisco Unified SRST with SIP Endpoints Implementation, page 128](#)

This section describes the implementation of two scenarios for voice services:

- Distributed infrastructure and branch endpoints are controlled by Cisco Unified Communications Manager Express (Cisco Unified CME). Local branch voice mail is provided through Cisco Unity Express access.
- Centralized call control with Cisco Unified Communications Manager (Cisco Unified CM). Cisco Unified Survivable Remote Site Telephony (Cisco Unified SRST) is configured in case of WAN failure.

The following high-level steps must be performed for each telephony service:

1. Configure voice connectivity.
2. Perform telephony service setup.
3. Install IP Phones.
4. Configure voice gateway.
5. Configure dial plan.
6. Set up transcoding and conferencing.
7. Implement Music on Hold.
8. Integrate voice mail.
9. Configure emergency services.

PRI-Trunk and FXS Port Implementation

A 12- channel T1 PRI trunk was used to connect the router to the public switched telephone network (PSTN).

```
Router(config)# card type t1 0 ! Declares network module in slot 0 operational in T1 mode
Router(config)# isdn switch-type primary-4ess ! Acts as Primary 4ESS switch interface to
the PSTN network
Router(config)# network-clock-participate wic 0 ! Enables MFT card to synchronize with NTP
server
Router(config)# controller T1 0/0/0 ! Enters T1 controller configuration mode
Router(config-controller)# pri-group timeslots 1-12 ! Configures Non-facility associated
signaling for first 12 channels of the T1 link
Router(config-controller)# exit
```

The following configuration applies to analog Foreign Exchange Service (FXS) ports.

```
Router(config)# voice-port0/3/0 ! Enters voice port configuration mode
Router(config-voiceport)# station-id name ANALOG-1 ! Assigns a name for the voice port
Router(config-voiceport)# exit

Router(config)# voice-port0/3/1! Enters voice port configuration mode
Router(config-voiceport)# station-id name ANALOG-2 ! Assigns a name for the voice port
Router(config-voiceport)# exit

Router(config)# voice-port0/3/2 ! Enters voice port configuration mode
Router(config-voiceport)# station-id name ANALOG-3 ! Assigns a name for the voice port
Router(config-voiceport)# exit

Router(config)# voice-port0/3/3 ! Enters voice port configuration mode
Router(config-voiceport)# station-id name ANALOG-4 ! Assigns a name for the voice port
Router(config-voiceport)# exit
```

In the Services Ready Medium Branch network 4xT1, the serial interface utilizes compressed RTP to place calls over the WAN. There are several ways to configure cRTP. In the following implantation, cRTP is configured on the QoS class map:

```
Router(config)# policy-map EIGHT-CLASS-V3PN-EDGE ! Defines child policy map
Router(config-pmap)# class VOICE ! Matches traffic classified by VOICE class-map
Router(config-pmap-c)# compress header ip rtp ! Enables cRTP compression
Router(config-pmap-c)# exit
```

The Services Ready Medium Branch Networks has been tested with both SIP- and SCCP-enabled phones. Each phone type requires a different configuration. To implement SCCP-based phones, follow the SCCP instructions in the “Cisco Unified CME with SCCP Endpoints Implementation” section on page 93. To implement SIP-based phones, follow SIP instructions in the “Cisco Unified CME with SIP Endpoints Implementation” section on page 110.

To implement the various voice services described in the following sections, several resources are necessary at the central site. Table 2 lists these resources and the associated IP addresses that are used in the implementation instructions.

Table 2 Central Site Resources Required for Voice Implementation

Resource	IP Address
NTP Server	172.16.0.60
Cisco Call Manager	172.16.200.10
Message Wait Indicator Server	172.16.0.110
Music on Hold Multicast Group	239.1.1.1

Cisco Unified CME with SCCP Endpoints Implementation

- Cisco Unified CME with SCCP Endpoints: Telephony Service Setup, page 93
- Cisco Unified CME with SCCP Endpoints: IP Phone Installation and Configuration, page 95
- Cisco Unified CME with SCCP Endpoints: H.323 Voice Gateway Implementation, page 97
- Cisco Unified CME with SCCP Endpoints: Dial Plan Implementation, page 97
- Cisco Unified CME with SCCP Endpoints: CAC Implementation, page 98
- Cisco Unified CME with SCCP Endpoints: Transcoding and Conferencing Implementation, page 98
- Cisco Unified CME with SCCP Endpoints: Music on Hold Implementation, page 100
- Cisco Unified CME with SCCP Endpoints: Voice Mail and Auto Attendant Integration, page 100
- Cisco Unified CME with SCCP Endpoints: Emergency Services Implementation, page 107
- Cisco Unified CME with SCCP Endpoints Verification, page 108

Cisco Unified CME with SCCP Endpoints: Telephony Service Setup

The Cisco IOS software provides an automated mechanism for configuring IP telephony services.

```
Router(config)# telephony-service setup ! Enters into Unified CME start setup mode
```

```
--- Cisco IOS Telephony Services Setup ---
```

```
Do you want to setup DHCP service for your IP Phones? [yes/no]: no
```

```
Do you want to start telephony-service setup? [yes/no]: yes
```

```
Configuring Cisco IOS Telephony Services :
```

```
Enter the IP source address for Cisco IOS Telephony Services :10.0.1.2
```

```
Enter the Skinny Port for Cisco IOS Telephony Services : [2000]:
```

```
How many IP Phones do you want to configure : [0]: 75 ! User configurable number of phones up to maximum of 240 on 3900 ISRs
```

```
Do you want dual-line extensions assigned to phones? [yes/no]: yes
```

```
What Language do you want on IP Phones :
```

```

0 English
1 French
2 German
3 Russian
4 Spanish
5 Italian
6 Dutch
7 Norwegian
8 Portuguese
9 Danish
10 Swedish
11 Japanese
[0]: ! Maintains default English language
Which Call Progress tone set do you want on IP Phones :
0 United States
1 France
2 Germany
3 Russia
4 Spain
5 Italy
6 Netherlands
7 Norway
8 Portugal
9 UK
10 Denmark
11 Switzerland
12 Sweden
13 Austria
14 Canada
15 Japan
[0]: ! Maintains default United States call progress tone
What is the first extension number you want to configure : 5001

Do you have Direct-Inward-Dial service for all your phones? [yes/no]: yes
Enter the full E.164 number for the first phone :4085555001 ! Assigns DID number

Do you want to forward calls to a voice message service? [yes/no]: yes
Enter extension or pilot number of the voice message service:5444
Call forward No Answer Timeout : [18]: ! Maintains default value of 18 seconds.
Possible values are from 5 to 60000 seconds

Do you wish to change any of the above information? [yes/no]: no
CNF-FILES: Clock is not set or synchronized,
           retaining old versionStamps

---- Setup completed config ----

Router(config)#
*Sep 10 05:37:10.207: percentLINK-3-UPDOWN: Interface ephone_dsp DN 1.2, changed state to
up
*Sep 10 05:37:10.207: percentLINK-3-UPDOWN: Interface ephone_dsp DN 2.1, changed state to
up
*Sep 10 05:37:10.207: percentLINK-3-UPDOWN: Interface ephone_dsp DN 2.2, changed state to
up
*Sep 10 05:37:10.207: percentLINK-3-UPDOWN: Interface ephone_dsp DN 3.1, changed state to
up
*Sep 10 05:37:10.207: percentLINK-3-UPDOWN: Interface ephone_dsp DN 3.2, changed state to
up
*Sep 10 05:37:10.207: percentLINK-3-UPDOWN: Interface ephone_dsp DN 4.1, changed state to
up
*Sep 10 05:37:10.207: percentLINK-3-UPDOWN: Interface ephone_dsp DN 4.2, changed state to
up

```

Cisco Unified CME with SCCP Endpoints: IP Phone Installation and Configuration

In the Services Ready Medium Branch Network, IP Phones are installed by simply connecting them to ports on the access layer switches. Because all the ports offer Power-over-Ethernet, no additional power cables are necessary. After they are installed, the phones are configured with the default configuration that was generated during the telephony setup in the previous section. However, if the IP Phone firmware needs to be upgraded in the future, enter the following commands.



Note

The following configuration is not required with the Cisco IOS software image used for the Services Ready Medium Branch Network validation.

```
Router(config)# telephony-service ! Enters telephony configuration mode
Router(config-telephony)# load 7960-7940 P00308000900 ! Loads telephony SCCP firmware
files for 7960 to 7940 phones
Router(config-telephony)# load 7942 SCCP42.8-3-2S ! Loads telephony SCCP firmware files
for 7942 phones
Router(config-telephony)# load 7962 SCCP62.8-3-2S ! Loads telephony SCCP firmware files
for 7962 phones
Router(config-telephony)# load 7965 SCCP65.8-3-2S ! Loads telephony SCCP firmware files
for 7965 phones
Router(config-telephony)# load 7971 SCCP71.8-3-2S ! Loads telephony SCCP firmware files
for 7971 phones
Router(config-telephony)# load 7985 cmterm_7985.4-1-6-0 ! Loads telephony SCCP firmware
for 7985 video phone
```

Apply the following command after defining the new ephone type.

```
Router(config-telephony)# load 7937 cmterm_7937.1-2-1-0 ! Loads telephony SCCP firmware
files for 7937 conference station
```

```
Router(config-telephony)# create cnf-files ! Builds XML configuration file for SCCP phones
Router(config-telephony)# exit
```

This guide provides Cisco IOS software commands for setting up IP Phones. Alternatively, a graphical user interface (GUI) allows the configuration of directory numbers through a web interface. To set up the web configuration tool, use the following instructions to enable the services on the router:

```
Router(config)# ip http server ! Enables HTTP server
Router(config)# ip http path flash: ! Specifies location of HTTP files in IOS
Router(config)# telephony-service ! Enters telephony configuration mode
Router(config-telephony)# web admin system name admin password c1$k0SyS ! Defines username
and password for system administrator
Router(config-telephony)# dn-webedit ! Enables ability to configure directory numbers
Router(config-telephony)# time-webedit ! Enables ability to configure phone time
Router(config-telephony)# exit
```

```
Router(config)# telephony-service ! Enters telephony configuration mode
Router(config-telephony)# max-ephones 100 ! Sets the maximum number of phones that can
register with Cisco CME
Router(config-telephony)# max-dn 200! Sets the maximum number of directory numbers (two
for each phone)
Router(config-telephony)# ip source-address 10.0.1.2 port 2000 secondary 10.0.1.1 ! Sets
IP address used for phone registration and secondary router for backup
Router(config-telephony)# time-zone 5 ! Sets time zone to Pacific Standard/Daylight Time
Router(config-telephony)# no auto-reg-ephone ! Disables registration of unconfigured
phones
Router(config-telephony)# voicemail 5444 ! Defines number for speed dialing voicemail from
phone
Router(config-telephony)# system message Your current options ! Message displayed on IP
Phones
```

```

Router(config-telphony)# secondary-dialtone 9 ! Provides dial tone for PSTN calls
Router(config-telphony)# transfer-system full-blind ! Transfers calls without consultation
Router(config-telphony)# transfer-pattern 9..... ! Allows transfers for all calls
originating from PSTN
Router(config-telphony)# transfer-pattern 4..... ! Allows transfers for all calls
originating in area code starting with "4"
Router(config-telphony)# call-forward pattern .T ! Allows call forwarding for all calls
Router(config-telephony)# exit

Router(config)# ephone-template 1 ! Defines ephone configuration template tag
Router(config-ephone-template)# softkeys hold Join Newcall Resume Select ! Softkey display
when the connected party is on hold
Router(config-ephone-template)# softkeys idle ConfList Join Newcall Pickup Redial !
Softkey display when the phone is idle
Router(config-ephone-template)# softkeys seized Redial Endcall Cfdall Pickup Callback
Meetme ! Softkey display when caller is attempting to call but has not been connected yet
Router(config-ephone-template)# softkeys connected Trnsfer Hold Confrn Endcall ! Softkey
display when connection to remote point has been established
Router(config-ephone-template)# exit

```

Apply the following configuration to all IP Phones 1 to 100. Set the unique DN number and assign the desired extension to each phone.

```

Router(config)# ephone-dn 1 dual-line ! Enters directory number configuration mode
Router(config-ephone-dn)# number 5001 ! Configures phone (or extension) number for this
directory number
Router(config-ephone-dn)# call-forward busy 5444 ! Forwards call for a busy extension to
voicemail
Router(config-ephone-dn)# call-forward noan 5444 timeout 10 ! Forwards call for an
extension that does not answer to voicemail after 10 seconds of ringing
Router(config-ephone-dn)# exit

Router(config)# ephone 1! Enters phone configuration mode
Router(config-ephone)# ephone-template 1 ! Associates phone with configuration template
Router(config-ephone)# button 1:1 ! Associates phone with directory number 1:2, 1:3, etc.
Router(config-ephone)# exit

```

To configure soft phone, use the following example.

```

Router(config)# ephone 120! Enters phone configuration mode
Router(config-ephone)# type CIPC ! Specifies that this is softphone
Router(config-ephone)# ephone-template 1 ! Associates phone with configuration template
Router(config-ephone)# button 1:120 ! Associates phone with directory number 1:2, 1:3,
etc.
Router(config-ephone)# exit

```

In Cisco IOS 12.4(20)T and later, apply the following configuration to define a conference station.

```

Router(config)# ephone-type 7937 ! Enters ephone-type template configuration mode
Router(config-ephone-type)# device-id 431 ! Specifies 7937 conference station device id
Router(config-ephone-type)# device-type 7937 ! Specifies device type
Router(config-ephone-type)# device-name 7936 Conference Station ! Assigns name to the
device type
Router(config-ephone-type)# num-buttons 1 ! Number of line buttons supported
Router(config-ephone-type)# num-presentations 6 ! Number of call presentations lines
Router(config-ephone-type)# exit

Router(config)# ephone-dn 110 dual-line ! Enters directory number configuration
Router(config-ephone-dn)# number 5110 ! Configures extension (or phone) number for this
directory number
Router(config-ephone-dn)# name Engineering Conference Room ! Associates a name with this
directory number
Router(config-ephone-dn)# exit

```

```
Router(config)# ephone 110! Enters phone configuration mode
Router(config-ephone)# button 1:110 ! Associates phone with directory number
Router(config-ephone)# exit
```

Generate the configuration file.

```
Router(config)# telephony-service ! Enters telephony configuration mode
Router(config-telephony)# create cnf-files ! Builds XML configuration file for SCCP phones
Router(config-telephony)# reset all ! Reloads the phone configuration
Router(config-telephony)# exit
```

Cisco Unified CME with SCCP Endpoints: H.323 Voice Gateway Implementation

The following configuration enables VoIP on the network and sets up H.323 dial peers between the branch gateway and the destination telephone networks.

```
Router(config)# voice service voip ! Enters voice service configuration mode
Router(config-voi-srv)# allow-connections h323 to h323 ! Enables calls h323 endpoint to
h323 endpoint
Router(config-voi-srv)# allow-connections h323 to SIP ! Enables calls from h323 endpoint
to SIP endpoint
Router(config-voi-srv)# exit
```

Cisco Unified CME with SCCP Endpoints: Dial Plan Implementation

Ten dial peers were defined for the Services Ready Medium Branch Network: central site, local calls, two 911 emergency services dial peers, voice mail, auto attendant, long distance, international calling, and fax pass-through or fax relay. Voice mail and emergency services dial peers are described in the “Cisco Unified CME with SIP Endpoints: Voice Mail and Auto Attendant Integration” section on page 115.

```
Router(config)# dial-peer voice 1 voip ! Enters dial peer to central site configuration
mode
Router(config-dial-peer)# dtmf-relay h245-alphanumeric ! Specifies H.245 alphanumeric
method for relaying dual tone multifrequency tones
Router(config-dial-peer)# destination-pattern 408..... ! Specifies area code prefix for
central site dial peer
Router(config-dial-peer)# session target ipv4:172.16.200.10 ! Specifies central site dial
peer address
Router(config-peer)# exit
```

```
Router(config)# dial-peer voice 2 pots ! Enters dial peer for local area calls
configuration mode
Router(config-dial-peer)# destination-pattern 9..... ! Specifies area code prefix for
central site dial peer
Router(config-dial-peer)# direct-inward-dial ! Enables DID numbers
Router(config-dial-peer)# port 0/0/0:23 ! Specifies outgoing/incoming interface for calls
Router(config-peer)# exit
```

```
Router(config)# dial-peer voice 3 pots ! Enters dial peer for long distance calls
configuration mode
Router(config-dial-peer)# destination-pattern 91..... ! Specifies area code prefix
for central site dial peer
Router(config-dial-peer)# prefix 1 ! Prefix that the system adds automatically to the dial
string
Router(config-dial-peer)# direct-inward-dial ! Enables DID numbers
Router(config-dial-peer)# port 0/0/0:23 ! Specifies outgoing/incoming interface for calls
Router(config-peer)# exit
```

```

Router(config)# dial-peer voice 4 pots ! Enters dial peer for international calls
configuration mode
Router(config-dial-peer)# destination-pattern 9011T ! Specifies area code prefix for
central site dial peer
Router(config-dial-peer)# prefix 011 ! Prefix that the system adds automatically to the
dial string
Router(config-dial-peer)# direct-inward-dial ! Enables DID numbers
Router(config-dial-peer)# port 0/0/0:23 ! Specifies outgoing/incoming interface for calls
Router(config-peer)# exit

```

When calls over the WAN exceed the maximum allocated bandwidth, they are redirected to PSTN.

```

Router(config)# dial-peer voice 15 pots ! Enters dial peer for PSTN bypass configuration
mode
Router(config-dial-peer)# destination-pattern 408..... ! Specifies destination pattern
Router(config-dial-peer)# port 0/0/23 ! Specifies outgoing/incoming interface for calls
Router(config-dial-peer)# preference 1 ! Sets the dial peer preference order
Router(config-dial-peer)# prefix 408 ! Prefix that the system adds automatically to the
dial string

```

If you are using fax pass-through, apply the following configuration.

```

Router(config)# dial-peer voice 6 voip ! Enters dial peer for fax passthrough
configuration mode
Router(config-dial-peer)# destination-pattern 4085555333 ! Specifies local number of fax
machine
Router(config-dial-peer)# session target ipv4:172.16.200.10 ! Specifies central site dial
peer address
Router(config-dial-peer)# fax protocol pass-through g711ulaw ! Configures fax passthrough
with G.711 codec
Router(config-peer)# exit

```

If you are using fax relay, apply the following configuration.

```

Router(config)# dial-peer voice 7 voip ! Enters dial peer for fax relay configuration mode
Router(config-dial-peer)# destination-pattern 4085555333 ! Specifies local number of fax
machine
Router(config-dial-peer)# session target ipv4:172.16.200.10 ! Specifies central site dial
peer address
Router(config-dial-peer)# fax-relay ecm disable ! Disables fax relay ECM
Router(config-dial-peer)# fax rate 9600 ! Selects fax transmission rate
Router(config-dial-peer)# fax protocol t38 ! Sets the T.38 fax relay protocol
Router(config-dial-peer)# codec g711ulaw ! Configures fax relay with G.711 codec
Router(config-peer)# exit

```

Cisco Unified CME with SCCP Endpoints: CAC Implementation

RSVP is not supported with Cisco Unified CME. A limited workaround is possible by setting a limit on the number of voice calls that can be placed over the WAN.

```

Router(config)# dial-peer voice 1 voip ! Enters dial peer to central site configuration
mode
Router(config-dial-peer)# max-con 36 ! Sets the maximum number of WAN based calls to 36
Router(config-dial-peer)# exit

```

Cisco Unified CME with SCCP Endpoints: Transcoding and Conferencing Implementation

Transcoding compresses and decompresses voice streams to match endpoint-device capabilities.

Transcoding is required when an incoming voice stream is digitized and compressed (by means of a codec) to save bandwidth and the local device does not support that type of compression.

```

Router(config)# telephony-service ! Enters telephony configuration mode
Router(config-telphony)# sdspfarm units 4! Specifies number of DSP farms that can register
with SCCP server
Router(config-telphony)# sdspfarm transcode sessions 5 ! Specifies maximum number of
simultaneous transcoding sessions
Router(config-telphony)# sdspfarm tag 2 CONFERENCE ! Creates DSP farm profile
Router(config-telphony)# sdspfarm tag 3 TRANSCODE ! Creates DSP farm profile
Router(config-telphony)# conference hardware ! Configures CME for multiparty conferencing
Router(config-telphony)# exit

Router(config)# voice-card 0 ! Enters DSP farm configuration mode
Router(config-voicecard)# dsp services dspfarm ! Enables DSP services
Router(config-voicecard)# exit
Router(config)# sccp local GigabitEthernet2/0.2 ! Sets the interface for conferencing and
transcoding to register with CME
Router(config)# sccp ccm 10.0.1.1 identifier 1 version 5.0.1 ! Associates conferencing and
transcoding with CME
Router(config)# sccp ! Enables SCCP globally
Router(config)# sccp ccm group 1 ! Creates SCCP group and enters SCCP configuration mode
Router(config-sccp-ccm)# associate ccm 1 priority 1 ! Associates SCCP group 1 with CME
Router(config-sccp-ccm)# associate profile 2 register CONFERENCE ! Associates DSP farm
profile with with a SCCP group
Router(config-sccp-ccm)# associate profile 3 register TRANSCODE ! Associates DSP farm
profile with with a SCCP group
Router(config-sccp-ccm)# exit

Router(config)# dspfarm profile 2 transcode ! Enters DSP farm profile configuration mode
Router(config-dspfarm-profile)# codec g711ulaw ! Specifies codec supported by DSP farm
Router(config-dspfarm-profile)# codec g711alaw ! Specifies codec supported by DSP farm
Router(config-dspfarm-profile)# codec g729ar8 ! Specifies codec supported by DSP farm
Router(config-dspfarm-profile)# codec g729abr8 ! Specifies codec supported by DSP farm
Router(config-dspfarm-profile)# codec g729r8 ! Specifies codec supported by DSP farm
Router(config-dspfarm-profile)# codec pass-through ! Specifies codec supported by DSP farm
Router(config-dspfarm-profile)# maximum sessions 5 ! Specifies maximum number of
simultaneous sessions supported by this profile
Router(config-dspfarm-profile)# associate application sccp ! Associates SCCP with this DSP
farm profile
Router(config-dspfarm-profile)# no shutdown
Router(config-dspfarm-profile)# exit

Router(config)# dspfarm profile 3 conference ! Enters DSP farm profile configuration mode
Router(config-dspfarm-profile)# codec g711ulaw ! Specifies codec supported by DSP farm
Router(config-dspfarm-profile)# codec g711alaw ! Specifies codec supported by DSP farm
Router(config-dspfarm-profile)# codec g729ar8 ! Specifies codec supported by DSP farm
Router(config-dspfarm-profile)# codec g729abr8 ! Specifies codec supported by DSP farm
Router(config-dspfarm-profile)# codec g729r8 ! Specifies codec supported by DSP farm
Router(config-dspfarm-profile)# codec g729br8 ! Specifies codec supported by DSP farm
Router(config-dspfarm-profile)# maximum sessions 3 ! Specifies maximum number of
simultaneous sessions supported by this profile
Router(config-dspfarm-profile)# associate application sccp ! Associates SCCP with this DSP
farm profile
Router(config-dspfarm-profile)# no shutdown
Router(config-dspfarm-profile)# exit

Router(config)# ephone-dn 241 dual-line ! Enters directory number configuration mode
Router(config-ephone-dn)# number 5555 ! Associates telephone extension with this directory
number
Router(config-ephone-dn)# conference ad-hoc ! Configures ad-hoc conferencing
Router(config-ephone-dn)# no huntstop ! Continues call hunting if line is unavailable
Router(config-ephone-dn)# exit

Router(config)# ephone-dn 242 dual-line ! Enters directory number configuration mode
Router(config-ephone-dn)# number 5555 ! Associates telephone extension with this directory
number

```



```

Router(config-ephone-dn)# conference ad-hoc ! Configures ad-hoc conferencing
Router(config-ephone-dn)# no huntstop ! Continues call hunting if line is unavailable
Router(config-ephone-dn)# preference 1 ! Sets dial peer preference order
Router(config-ephone-dn)# exit

Router(config)# ephone-dn 243 dual-line ! Enters directory number configuration mode
Router(config-ephone-dn)# number 5555 ! Associates telephone extension with this directory
number
Router(config-ephone-dn)# conference ad-hoc ! Configures ad-hoc conferencing
Router(config-ephone-dn)# huntstop ! Stop hunting for lines, all conferencing lines are
occupied
Router(config-ephone-dn)# preference 2 ! Sets dial peer preference order
Router(config-ephone-dn)# exit

Router(config)# ephone-dn 244 dual-line ! Enters directory number configuration mode
Router(config-ephone-dn)# number 5666 ! Associates telephone extension with this directory
number
Router(config-ephone-dn)# conference meetme ! Configures meet me conferencing
Router(config-ephone-dn)# no huntstop ! Continues call hunting if line is unavailable
Router(config-ephone-dn)# exit

Router(config)# ephone-dn 245 dual-line ! Enters directory number configuration mode
Router(config-ephone-dn)# number 5666 ! Associates telephone extension with this directory
number
Router(config-ephone-dn)# conference meetme ! Configures meet me conferencing
Router(config-ephone-dn)# no huntstop ! Continues call hunting if line is unavailable
Router(config-ephone-dn)# preference 1 ! Sets dial peer preference order
Router(config-ephone-dn)# exit

Router(config)# ephone-dn 246 dual-line ! Enters directory number configuration mode
Router(config-ephone-dn)# number 5666 ! Associates telephone extension with this directory
number
Router(config-ephone-dn)# conference meetme ! Configures meet me conferencing
Router(config-ephone-dn)# huntstop ! Stop hunting for lines, all conferencing lines are
occupied
Router(config-ephone-dn)# preference 2 ! Sets dial peer preference order
Router(config-ephone-dn)# exit

```

Cisco Unified CME with SCCP Endpoints: Music on Hold Implementation

Music on Hold (MOH) is an audio stream that is played to PSTN and VoIP G.711 or G.729 callers who are placed on hold by phones in a Cisco Unified Communications Manager Express (Cisco Unified CME) system. This audio stream is intended to reassure callers that they are still connected to their calls.

```

Router(config)# telephony-service ! Enters telephony configuration mode
Router(config-telephony)# moh music-on-hold.au ! Specifies music on hold file
Router(config-telephony)# exit

```

Cisco Unified CME with SCCP Endpoints: Voice Mail and Auto Attendant Integration

Voice mail is provided by the Cisco Unity Express service module either in the Advanced Integration Module (AIM) form factor or the Network Module (NME) form factor. The AIM module requires the following configuration.

To configure the NME, substitute *Integrated-Service-Engine 2/0* for *Service-Engine 0/1*

```

Router(config)# interface Service-Engine 0/1 ! Enters Cisco Unity Express configuration
mode

```



```

Router(config-if)# ip address 10.0.2.86 255.255.255.252 ! Assigns ip address to the
service engine router interface
Router(config-if)# service-module ip address 10.0.2.85 255.255.255.252 ! Assigns IP
address to service module internal interface
Router(config-if)# service-module ip default-gateway 10.0.2.86 ! Assigns default gateway
for the service module
Router(config-if)# zone-member security Private ! Assigns Cisco Unity Express to private
security zone
Router(config-if)# no shutdown
Router(config-if)# exit
Router(config)# ip route 10.0.2.884 255.255.255.252 Service-Engine 0/1 ! Adds a static
route entry to direct traffic to the module

```

Cisco Unity Express uses SIP as its signaling protocol and requires a SIP dial peer.

```

Router(config)# dial-peer voice 7 voip ! Enters dial peer for voicemail configuration mode
Router(config-dial-peer)# destination-pattern 5444 ! Specifies mailbox extension
Router(config-dial-peer)# session target ipv4:10.0.1.85 ! Specifies voicemail address
Router(config-dial-peer)# session protocol sipv2! Enables SIP for voicemail communication
Router(config-dial-peer)# codec g711ulaw ! Specifies codec for voicemail messages
Router(config-dial-peer)# b2bua ! Enables SIP to SCCP forwarding
Router(config-dial-peer)# dtmf-relay sip-notify! Specifies DTMF relay method
Router(config-dial-peer)# no vad ! Disables voice activity detection
Router(config-peer)# exit

```

```

Router(config)# dial-peer voice 9 voip ! Enters dial peer for Auto Attendant configuration
mode
Router(config-dial-peer)# destination-pattern 5000 ! Specifies mailbox extension
Router(config-dial-peer)# session target ipv4:10.0.2.85 ! Specifies voicemail address
Router(config-dial-peer)# session protocol sipv2 ! Enables SIP for voicemail communication
Router(config-dial-peer)# codec g711ulaw ! Specifies codec for voicemail messages
Router(config-dial-peer)# b2bua ! Enables SIP to SCCP forwarding
Router(config-dial-peer)# dtmf-relay sip-notify ! Specifies DTMF relay method
Router(config-dial-peer)# no vad ! Disables voice activity detection
Router(config-peer)# exit

```

The following configuration turns on the message wait indicator.

```

Router(config)# ephone-dn 19 ! Enters directory number configuration mode
Router(config-ephone-dn)# number 8000.... ! Phone number for placing MWI notification call
Router(config-ephone-dn)# mwi on ! When call placed to this DN turn MWI on

Router(config-ephone-dn)# ephone-dn 20 ! Enters directory number configuration mode
Router(config-ephone-dn)# number 8001.... ! Phone number for placing MWI notificztion call
Router(config-ephone-dn)# mwi off ! When call placed to this DN turn MWI off

```

Additional Cisco Unified CME configuration is performed through a Web-based user interface as shown in Figure 17 through Figure 22. Figure 17 shows the login prompt window.

Figure 17 Cisco Unified CME Login Prompt

The screenshot shows a web browser window titled "Cisco Unity Express Initialization Wizard - Microsoft Internet Explorer". The address bar shows the URL: `http://10.0.2.85/Web/Ink/Wizard.do?vizAction=INIT`. The page header includes the Cisco logo and the text "Cisco Unified Communications Express" with the tagline "Discover all that is possible on the Internet." Below the header, the page is titled "Cisco Unity Express Initialization Wizard". A "Steps" sidebar on the left lists five steps: 1. CallManager Express Login (selected), 2. Import CME Users, 3. Defaults, 4. Call Handling, and 5. Commit. The main content area is titled "CallManager Express Login" and contains the following text: "Enter the details of the CallManager Express that Cisco Unity Express will connect to. The user name and password will be used to authenticate while retrieving information from the CallManager Express." Below this text are five input fields: "Hostname *" with the value "10.0.1.2", "Web User Name *" with the value "admin", "Web Password *" with masked characters, "XML User Name", and "XML Password". A red asterisk note at the bottom left states "* indicates a mandatory field". At the bottom right of the form area are buttons for "Back", "Next", "Finish", "Cancel", and "Help". The browser status bar at the bottom shows "Done" and "Local intranet". A vertical number "250781" is visible on the right edge of the browser window.

Figure 18 shows the Cisco Unified CME import users window.

Figure 18 Importing Cisco Unified CME Users

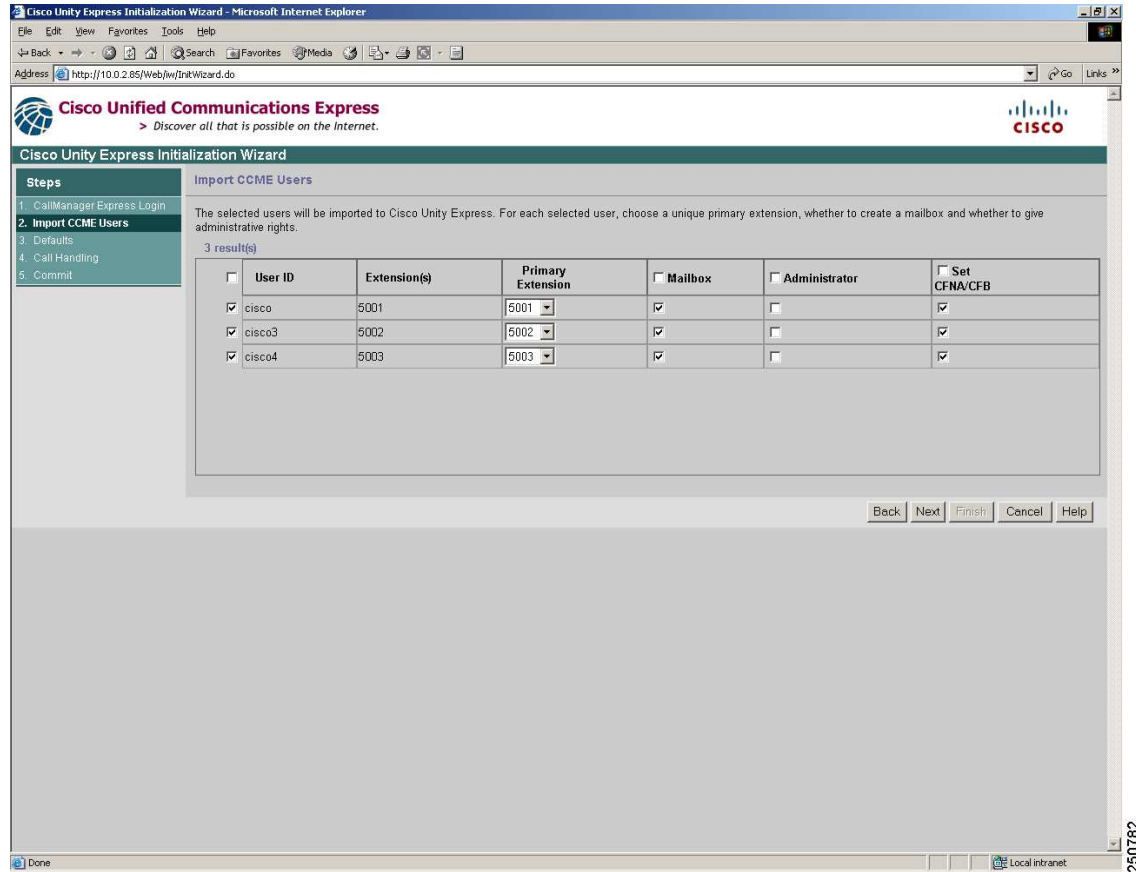

250782

Figure 19 shows the Cisco Unified CME defaults window.

Figure 19 Configuring Mailbox Defaults

The screenshot displays the 'Cisco Unity Express Initialization Wizard' in a Microsoft Internet Explorer browser window. The address bar shows 'http://10.0.2.85/Web/IntrNWizard.do'. The page title is 'Cisco Unity Express Initialization Wizard' and the Cisco logo is visible in the top right. A 'Steps' sidebar on the left lists: 1. CallManager Express Login, 2. Import CME Users, 3. Defaults (selected), 4. Call Handling, and 5. Commit. The main content area is titled 'Defaults' and contains the following configuration options:

- System Default Language:** English (United States) (dropdown menu)
- Password & PIN options:**
 - Generate random password
 - Blank password
 - Generate random PIN
 - Blank PIN
- Mailbox Defaults:**
 - Mailbox Size *: 775 seconds
 - Maximum Caller Message Size *: 240 seconds
 - Message Expiry Time *: 30 days

A red asterisk note at the bottom left states: '* indicates a mandatory field'. At the bottom right, there are navigation buttons: Back, Next, Finish, Cancel, and Help. The status bar at the bottom shows 'Done' and 'Local intranet'. A vertical number '250783' is visible on the right edge of the browser window.

Figure 20 shows the call handling configuration window.

Figure 20 **Configuring Call Handling**

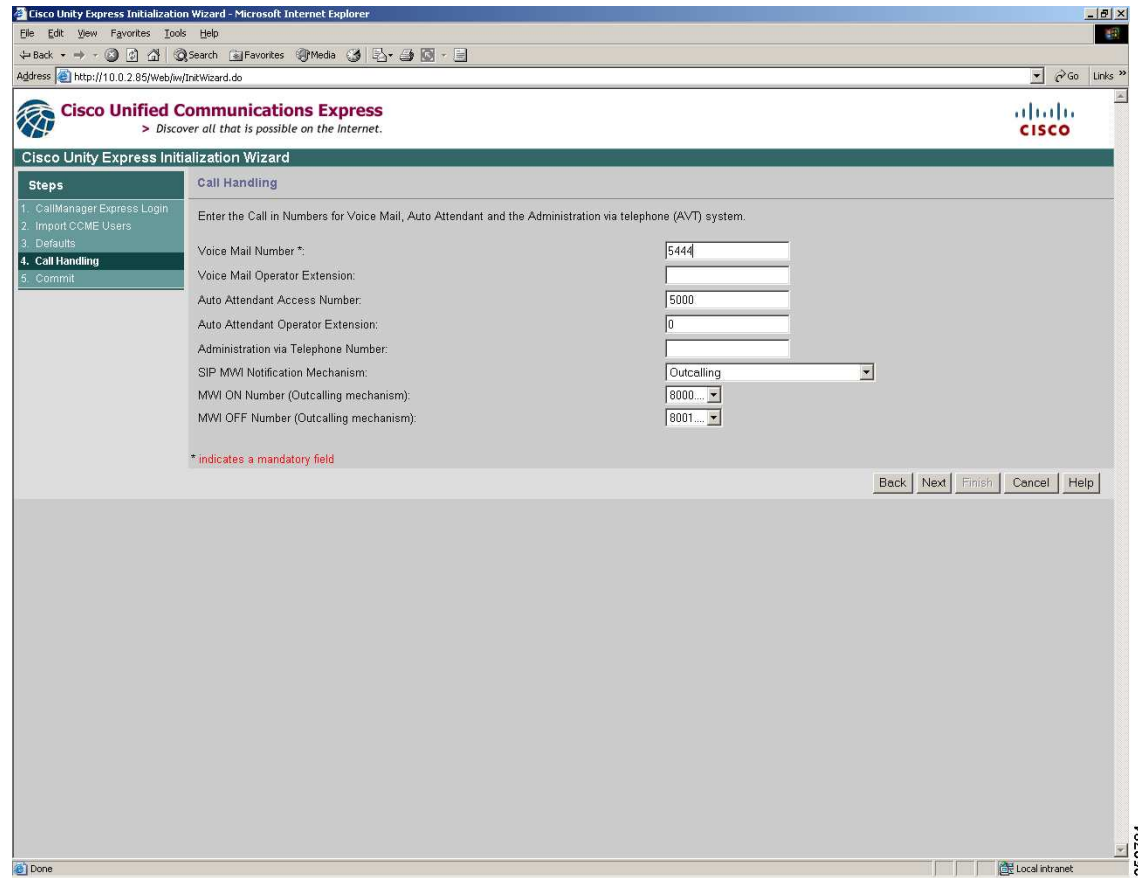

250784

Figure 21 shows the Cisco Unified CME configuration verification window.

Figure 21 Verifying Configuration

Cisco Unity Express Initialization Wizard

Steps

1. CallManager Express Login
2. Import CCME Users
3. Defaults
4. Call Handling
5. **Commit**

Commit

You have chosen to set/add:

Maximum Caller Message Size:	240
Message Expiry Time:	30
Voice Mail Number:	5444
Auto Attendant Access Number:	
Voice Mail Operator Extension:	
Auto Attendant Operator Extension:	0
Administration via Telephone Number:	
SIP MWI Notification Mechanism:	Outcalling
MWI On Number:	8000....
MWI Off Number:	8001....

Click on Finish to commit the initialization. **Note:** This operation is not reversible.

Finally, save to startup configuration (will take a few minutes more).

Back Next Finish Cancel Help

Done Local intranet

250785

Figure 22 shows the Cisco Unified CME configuration status window.

Figure 22 **Reviewing Configuration Status**

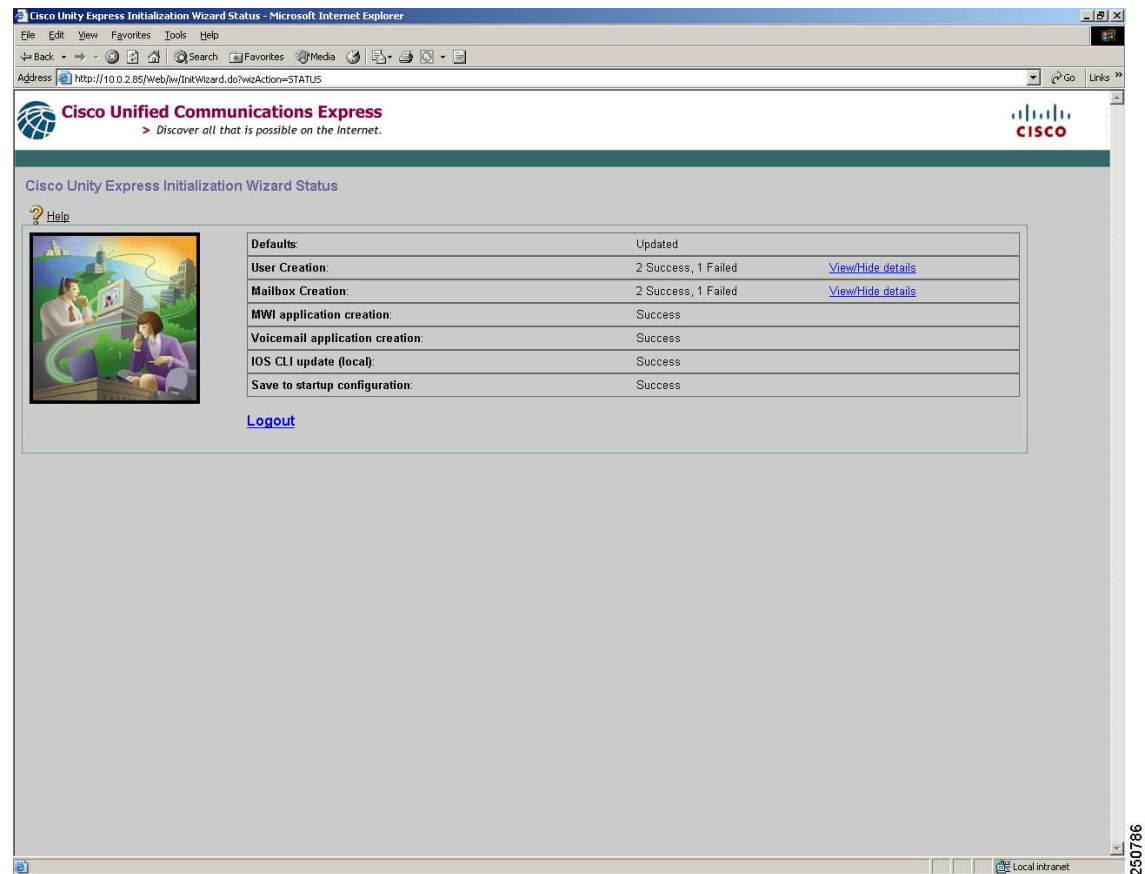

Cisco Unified CME with SCCP Endpoints: Emergency Services Implementation

The following is the implementation of emergency number calling for North America. The PRI trunk is used for placing emergency calls.

```
Router(config)# dial-peer voice 10 pots ! Enters dial peer for emergency calls
configuration mode
Router(config-dial-peer)# destination-pattern 911 ! Specifies North America emergency
number
Router(config-dial-peer)# direct-inward-dial ! Enables DID numbers
Router(config-dial-peer)# port 0/0/0:23 ! Specifies outgoing/incoming interface for calls
Router(config-peer)# exit
```

```
Router(config)# dial-peer voice 11 pots ! Enters dial peer for local area calls
configuration mode
Router(config-dial-peer)# destination-pattern 9911 ! Specifies area code prefix for
central site dial peer
Router(config-dial-peer)# prefix 911 ! Prefix that the system adds automatically to the
dial string
Router(config-dial-peer)# direct-inward-dial ! Enables DID numbers
Router(config-dial-peer)# port 0/0/0:23 ! Specifies outgoing/incoming interface for calls
Router(config-peer)# exit
```

Cisco Unified CME with SCCP Endpoints Verification

```
Router(config)# show ephone phone-load
DeviceName          CurrentPhoneload    PreviousPhoneload    LastReset
=====
SEP796000060053    SCCP41.8-3-2S      SCCP41.8-3-2S        Initialized
SEP796000060052    SCCP41.8-3-2S      SCCP41.8-3-2S        Initialized
SEP796000060051    SCCP41.8-3-2S      SCCP41.8-3-2S        Initialized
SEP796000060050    SCCP41.8-3-2S      SCCP41.8-3-2S        Initialized
SEP796000060049    SCCP41.8-3-2S      SCCP41.8-3-2S        Initialized
SEP796000060059    SCCP41.8-3-2S      SCCP41.8-3-2S        Initialized
SEP796000060058    SCCP41.8-3-2S      SCCP41.8-3-2S        Initialized
SEP796000060057    SCCP41.8-3-2S      SCCP41.8-3-2S        Initialized
SEP796000060056    SCCP41.8-3-2S      SCCP41.8-3-2S        Initialized
SEP796000060055    SCCP41.8-3-2S      SCCP41.8-3-2S        Initialized
SEP796000060054    SCCP41.8-3-2S      SCCP41.8-3-2S        Initialized
SEP796000060063    SCCP41.8-3-2S      SCCP41.8-3-2S        Initialized
SEP796000060062    SCCP41.8-3-2S      SCCP41.8-3-2S        Initialized
SEP796000060061    SCCP41.8-3-2S      SCCP41.8-3-2S        Initialized
SEP796000060060    SCCP41.8-3-2S      SCCP41.8-3-2S        Initialized
SEP796000060042    SCCP41.8-3-2S      SCCP41.8-3-2S        Initialized
SEP796000060041    SCCP41.8-3-2S      SCCP41.8-3-2S        Initialized
SEP796000060040    SCCP41.8-3-2S      SCCP41.8-3-2S        Initialized
SEP796000060043    SCCP41.8-3-2S      SCCP41.8-3-2S        Initialized
SEP796000060044    SCCP41.8-3-2S      SCCP41.8-3-2S        Initialized
SEP796000060045    SCCP41.8-3-2S      SCCP41.8-3-2S        Initialized
SEP796000060046    SCCP41.8-3-2S      SCCP41.8-3-2S        Initialized
SEP796000060047    SCCP41.8-3-2S      SCCP41.8-3-2S        Initialized
SEP796000060048    SCCP41.8-3-2S      SCCP41.8-3-2S        Initialized
SEP796000060086    SCCP41.8-3-2S      SCCP41.8-3-2S        Initialized
```

```
Router# show telephony-service ephone-template
ephone-template 1
softkeys hold Join Newcall Resume Select
softkeys idle ConfList Join Newcall Pickup Redial RmLstC
softkeys seized Redial Endcall Cfdall Pickup Callback Meetme
softkeys connected Trnsfer Hold Confrn Endcall
conference drop-mode never
conference add-mode all
conference admin: No
max-calls-per-button 8
busy-trigger-per-button 0
privacy default
Always send media packets to this router: No
Preferred codec: g711ulaw
keepalive 30 auxiliary 30
User Locale: US
Network Locale: US
```

```
Router# show ephone
```

```
ephone-1[0] Mac:001C.58FB.7640 TCP socket:[7] activeLine:0 REGISTERED in SCCP ver 12/9
mediaActive:0 offhook:0 ringing:0 reset:0 reset_sent:0 paging 0 debug:0 caps:12
IP:10.0.1.11 53063 7965 keepalive 126205 max_line 6
button 1: dn 1 number 5001 CH1 IDLE CH2 IDLE
Preferred Codec: g722-64
```

```
ephone-2[1] Mac:001E.4AF1.38D4 TCP socket:[-1] activeLine:0 UNREGISTERED
mediaActive:0 offhook:0 ringing:0 reset:0 reset_sent:0 paging 0 debug:0 caps:7
IP:0.0.0.0 0 Unknown 0 keepalive 0 max_line 0
```



```
Preferred Codec: g711ulaw
```

```
ephone-3[2] Mac:001C.58F9.BD38 TCP socket:[2] activeLine:0 REGISTERED in SCCP ver 12/9
mediaActive:0 offhook:0 ringing:0 reset:0 reset_sent:0 paging 0 debug:0 caps:12
IP: 10.0.1.12 51579 7962 keepalive 126880 max_line 6
button 1: dn 2 number 5002 CH1 IDLE CH2 IDLE
Preferred Codec: g711ulaw
```

```
Router# show telephony-service ephone
Number of Configured ephones 75 (Registered 75)
ephone 1
Device Security Mode: Non-Secure
mac-address 001C.58FB.7640
type 7965
button 1:1
keepalive 30 auxiliary 30
max-calls-per-button 8
busy-trigger-per-button 0
ephone-template 1
Always send media packets to this router: No
Preferred codec: g711ulaw
conference drop-mode never
conference add-mode all
conference admin: No
privacy: Yes
privacy button: No
user-locale US
network-locale US
```

```
Router# show telephony-service
CONFIG (Version=4.1(0))
=====
Version 4.1(0)
Cisco Unified Communications Manager Express
For on-line documentation please see:
www.cisco.com/univercd/cc/td/doc/product/access/ip_ph/ip_ks/index.htm
```

```
ip source-address 192.168.0.1 port 2000
max-ephones 120
max-dn 200
max-conferences 3
dspfarm units 4
dspfarm transcode sessions 3
conference software
hunt-group report delay 1 hours
hunt-group logout DND
max-redirect 5
cnf-file location: system:
cnf-file option: PER-PHONE-TYPE
network-locale[0] US (This is the default network locale for this box)
network-locale[1] US
network-locale[2] US
network-locale[3] US
network-locale[4] US
user-locale[0] US (This is the default user locale for this box)
user-locale[1] US
user-locale[2] US
user-locale[3] US
user-locale[4] US
srst mode auto-provision is OFF
srst ephone template is 0
srst dn template is 0
```

```

srst dn line mode is single
time-format 12
date-format mm-dd-yy
timezone 0 Greenwich Standard Time
no transfer-pattern is configured, transfer is restricted to local SCCP phones only.
keepalive 30 auxiliary 30
timeout interdigit 10
timeout busy 10
timeout ringing 180
timeout ringin-callerid 8
timeout night-service-bell 12
caller-id name-only: enable
web admin system name Admin
web admin customer name Customer
edit DN through Web: disabled.
edit TIME through web: disabled.
Log (table parameters):
    max-size: 150
    retain-timer: 15
transfer-system full-consult
local directory service: enabled.
Extension-assigner tag-type ephone-tag.

```

Cisco Unified CME with SIP Endpoints Implementation

- [Cisco Unified CME with SIP Endpoints: Telephony Service Setup, page 110](#)
- [Cisco Unified CME with SIP Endpoints: IP Phone Installation and Configuration, page 111](#)
- [Cisco Unified CME with SIP Endpoints: SIP Voice Gateway Implementation, page 112](#)
- [Cisco Unified CME with SIP Endpoints: Dial Plan Implementation, page 112](#)
- [Cisco Unified CME with SIP Endpoints: CAC Implementation, page 114](#)
- [Cisco Unified CME with SIP Endpoints: Transcoding Implementation, page 114](#)
- [Cisco Unified CME with SIP Endpoints: Music on Hold Implementation, page 114](#)
- [Cisco Unified CME with SIP Endpoints: Voice Mail and Auto Attendant Integration, page 115](#)
- [Cisco Unified CME with SIP Endpoints: Emergency Services Implementation, page 116](#)

Cisco Unified CME with SIP Endpoints: Telephony Service Setup

Configure the SIP gateway at the branch router.

```

Router(config)# voice service voip ! Enters voice service configuration mode
Router(config-voi-srv)# allow-connections SIP to SIP ! Enables calls from SIP endpoint to
SIP endpoint
Router(config-voi-srv)# sip ! Enters SIP configuration mode
Router(config-voi-sip)# registrar server expires max 120 min 60 ! Sets the SIP Phone
keepalive. The phone will check every 2 minutes whether it is registered with Cisco CME
in case the router lost its registration information during reboot
Router(config-voi-sip)# bind control source-interface GigabitEthernet2/0.2 ! Specifies SIP
to Voice VLAN binding
Router(config-voi-sip)# bind media source-interface GigabitEthernet2/0.2 ! Specifies SIP
to Voice VLAN binding
Router(config-voi-sip)# exit
Router(config-voi-srv)# exit

```

Cisco Unified CME with SIP Endpoints: IP Phone Installation and Configuration

In the Services Ready Medium Branch Network, IP Phones are installed by simply connecting them to ports on the access layer switches. Because all the ports offer Power over Ethernet, no additional power cables are necessary. Once installed, phones are configured with the default configuration generated during the Cisco Unified CME installation. However, if IP Phone firmware needs to be upgraded in the future, issue the following commands.



Note

The following configuration is not required with the Cisco IOS software image used for the Services Ready Medium Branch Network validation.

```
Router(config)# voice register global ! Enters voice register configuration mode
Router(config-register-global)# mode cme ! Enables cme mode in the register
Router(config-register-global)# load 7960-7940 POS3-08-3-00 ! Loads SIP firmware files for
7960-7940 phones
Router(config-register-global)# load 7961 SIP61.8-3-2S ! Loads SIP firmware files for 7961
phone
Router(config-register-global)# load 7962 SIP62.8-3-2S ! Loads SIP firmware files for 7962
phone
Router(config-register-global)# load 7965 SIP65.8-3-2S ! Loads SIP firmware files for 7965
phone
Router(config-register-global)# load 7971 SIP71.8-3-2S ! Loads SIP firmware files for 7971
phone

Router(config-register-global)# create profile ! Generates provisioning file
Router(config-register-global)# exit
```

To configure Cisco Unified CME with SIP endpoints from the command line, apply the following configuration.

```
Router(config)# voice register global ! Enters voice configuration mode
Router(config-register-global)# mode cme ! Enables CME mode in the register
Router(config-register-global)# max-pool 100 ! Sets the maximum number of SIP Phones
Router(config-register-global)# max-dn 200 ! Sets the maximum number of directory numbers
(two for each phone)
Router(config-register-global)# source-address 10.0.1.2 port 2000 ! Sets IP address used
for phone registration
Router(config-register-global)# dst auto-adjust ! Enables automatic adjustment of Daylight
Savings Time
Router(config-register-global)# timezone 5 ! Sets time zone to Pacific Standard/Daylight
Time
Router(config-register-global)# voicemail 5444 ! Defines number for speed dialing
voicemail from phone
Router(config-register-global)# ntp-server 172.16.0.60 ! Synchronizes clock on the phones
with the specified NTP server
Router(config-register-global)# exit
Router(config)# telephony-service ! Enters telephony configuration mode
Router(config-telphony)# secondary-dialtone 9 ! Provides dial tone for PSTN calls
Router(config-telphony)# exit
```

Apply the following configuration to all IP Phones 1 to 100. Set a unique DN number and assign the desired extension to each phone.

```
Router(config)# voice register dn 1 ! Enters directory configuration mode
Router(config-register-dn)# number 5001! Configures extension number for this directory
number
Router(config-register-dn)# call-forward b2bua busy 5444 ! Forwards calls for a busy
extension to voicemail
Router(config-register-dn)# call-forward b2bua noan 5444 timeout 10 ! Forwards calls for a
no answer extension to voicemail after 10 seconds of running
```

```
Router(config-register-dn)# call-forward b2bua mailbox 5444 ! Designates a mailbox at the
end of call forward chainingRouter(config-register-dn)# mwi ! Configures Voicemail indicator
Router(config-register-dn)# exit
```

```
Router(config)# voice register pool 1 ! Enters voice register pool configuration mode
Router(config-register-pool)# id mac 00E1.CB13.0395 ! Explicitly identifies the phone
Router(config-register-pool)# type 7960 ! Defines phone type for the SIP phone being
configured. Other types are 7942, 7945, 7961, 7962, 7965, 7971
Router(config-register-pool)# number 1 dn 1! Associates phone 1 with directory number 1
Router(config-register-pool)# exit
```

Generate a configuration file.

```
Router(config)# voice register global ! Enters voice register configuration mode
Router(config-register-global)# create profile ! Generates provisioning file
Router(config-register-global)# reset ! Reboots the SIP phone
Router(config-register-global)# exit
```

Cisco Unified CME with SIP Endpoints: SIP Voice Gateway Implementation

The SIP voice gateway is responsible for connecting the branch VoIP network to the PSTN and to the central site telephony network. The following configuration enables VoIP on the network and sets up SIP dial peers between the branch gateway and the destination telephone networks. IP Phones are configured for SIP signaling.

```
Router(config)# voice service voip ! Enters voice service configuration mode
Router(config-voi-srv)# allow-connections SIP to h323 ! Enables calls from SIP endpoint
to h323 endpoint
Router(config-voi-srv)# allow-connections SIP to SIP ! Enables calls between SIP endpoints
```

Cisco Unified CME with SIP Endpoints: Dial Plan Implementation

Ten dial peers were defined for the Services Ready Medium Branch Network: central site, local calls, two 911 emergency services dial peers, voicemail, Auto Attendant, long distance, international calling, and fax pass-through or fax relay. Voice mail, Auto Attendant, and emergency services dial peers are described in the [“Cisco Unified CME with SIP Endpoints: Voice Mail and Auto Attendant Integration”](#) section on page 115 and [“Cisco Unified CME with SIP Endpoints: Emergency Services Implementation”](#) section on page 116.

To provide automatic dialing without pressing the dial button, apply the following dial plan configuration.

```
Router(config)# voice register dialplan 1 ! Enters dial plan configuration mode
Router(config-register-dialplan)# type 7940-7960-others ! Specifies all phones
Router(config-register-dialplan)# pattern 1 9..... ! Matches outbound PSTN traffic
Router(config-register-dialplan)# pattern 1 4..... ! Matches central site traffic
Router(config-register-dialplan)# exit

Router(config)# voice register pool 1 ! Enters register configuration mode
Router(config-register-pool)# dialplan 1 ! Assigns dial plan to phones
Router(config-register-pool)# exit ! Assigns dial plan to phones

Router(config)# dial-peer voice 1 voip ! Enters dial peer to central site configuration
mode
Router(config-dial-peer)# session protocol sipv2 ! Enables SIP for voicemail communication
Router(config-dial-peer)# dtmf-relay rtp-nte ! Specifies Network Time Protocol method for
relaying pressed digit tones
Router(config-dial-peer)# destination-pattern 408..... ! Specifies area code prefix for
central site dial peer
Router(config-dial-peer)# session target ipv4:172.16.200.10 ! Specifies central site dial
peer address
```

```

Router(config-dial-peer)# no vad ! Disables voice activity detection
Router(config-peer)# exit

Router(config)# dial-peer voice 2 pots ! Enters dial peer for local area calls
configuration mode
Router(config-dial-peer)# destination-pattern 9..... ! Specifies area code prefix for
central site dial peer
Router(config-dial-peer)# direct-inward-dial ! Enables DID numbers
Router(config-dial-peer)# port 0/0/0:23 ! Specifies outgoing/incoming interface for calls
Router(config-peer)# exit

Router(config)# dial-peer voice 3 pots ! Enters dial peer for long distance calls
configuration mode
Router(config-dial-peer)# destination-pattern 91..... ! Specifies area code prefix
for central site dial peer
Router(config-dial-peer)# prefix 1 ! Prefix that the system adds automatically to the dial
string
Router(config-dial-peer)# direct-inward-dial ! Enables DID numbers
Router(config-dial-peer)# port 0/0/0:23 ! Specifies outgoing/incoming interface for calls
Router(config-peer)# exit

Router(config)# dial-peer voice 4 pots ! Enters dial peer for international calls
configuration mode
Router(config-dial-peer)# destination-pattern 9011T ! Specifies area code prefix for
central site dial peer
Router(config-dial-peer)# prefix 011 ! Prefix that the system adds automatically to the
dial string
Router(config-dial-peer)# direct-inward-dial ! Enables DID numbers
Router(config-dial-peer)# port 0/0/0:23 ! Specifies outgoing/incoming interface for calls
Router(config-peer)# exit

```

When calls over the WAN exceed the maximum allocated bandwidth, they are redirected to PSTN.

```

Router(config)# dial-peer voice 15 pots ! Enters dial peer for PSTN bypass configuration
mode
Router(config-dial-peer)# destination-pattern 408..... ! Specifies destination pattern
Router(config-dial-peer)# port 0/0/23 ! Specifies outgoing/incoming interface for calls
Router(config-dial-peer)# preference 1 ! Sets the dial peer preference order
Router(config-dial-peer)# prefix 408 ! Prefix that the system adds automatically to the
dial string

```

If you are using fax pass-through, apply the following configuration.

```

Router(config)# dial-peer voice 6 voip ! Enters dial peer for fax passthrough
configuration mode
Router(config-dial-peer)# session protocol sipv2 ! Enables SIP for voicemail communication
Router(config-dial-peer)# destination-pattern 4085555333 ! Specifies local number of fax
machine
Router(config-dial-peer)# session target ipv4:172.16.200.10 ! Specifies central site dial
peer address
Router(config-dial-peer)# fax protocol pass-through g711ulaw ! Configures fax passthrough
with G.711 codec
Router(config-peer)# exit

```

If you are using fax relay, apply the following configuration.

```

Router(config)# dial-peer voice 7 voip ! Enters dial peer for fax relay configuration mode
Router(config-dial-peer)# session protocol sipv2 ! Enables SIP for voicemail communication
Router(config-dial-peer)# destination-pattern 4085555333 ! Specifies local number of fax
machine
Router(config-dial-peer)# session target ipv4:172.16.200.10 ! Specifies central site dial
peer address
Router(config-dial-peer)# fax-relay ecm disable ! Disables fax relay ECM
Router(config-dial-peer)# fax rate 9600 ! Selects fax transmission rate
Router(config-dial-peer)# fax protocol t38 ! Sets the T.38 fax relay protocol

```

```
Router(config-dial-peer)# codec g711ulaw ! Configures fax relay with G.711 codec
Router(config-peer)# exit
```

Cisco Unified CME with SIP Endpoints: CAC Implementation

Resource Reservation Protocol (RSVP) is not supported with Cisco Unified CME. A limited workaround is possible by setting a limit on the number of voice calls that can be placed over the WAN.

```
Router(config)# dial-peer voice 1 voip ! Enters dial peer to central site configuration mode
Router(config-dial-peer)# max-con 36 ! Sets the maximum number of WAN based calls to 36
Router(config-dial-peer)# exit
```

Cisco Unified CME with SIP Endpoints: Transcoding Implementation

Transcoding compresses and decompresses voice streams to match end device capabilities. Transcoding is required when an incoming voice stream is digitized and compressed (by means of a codec) to save bandwidth and the local device does not support that type of compression. Conferencing is not supported with SIP and Cisco Unified CME.

```
Router(config)# telephony-service ! Enters telephony configuration mode
Router(config-telephony)# max-ephones 100 ! Sets the maximum number of phones that can register with Cisco CME
Router(config-telephony)# max-dn 100 ! Sets the maximum number of directory numbers (two for each phone)
Router(config-telephony)# sdspfarm units 4 ! Specifies number of DSP farms that can register with SCCP server
Router(config-telephony)# sdspfarm transcode sessions 5 ! Specifies maximum number of simultaneous transcoding sessions
Router(config-telephony)# sdspfarm tag 3 TRANSCODE ! Creates DSP farm profile
Router(config-telephony)# exit

Router(config)# voice-card 0 ! Enters DSP farm configuration mode
Router(config-voicecard)# dsp services dspfarm ! Enables DSP services
Router(config-voicecard)# exit

Router(config)# dspfarm profile 3 ! Enters DSP farm profile configuration mode
Router(config-dspfarm-profile)# codec g711ulaw ! Specifies codec supported by DSP farm
Router(config-dspfarm-profile)# codec g711alaw ! Specifies codec supported by DSP farm
Router(config-dspfarm-profile)# codec g729ar8 ! Specifies codec supported by DSP farm
Router(config-dspfarm-profile)# codec g729abr8 ! Specifies codec supported by DSP farm
Router(config-dspfarm-profile)# codec g729r8 ! Specifies codec supported by DSP farm
Router(config-dspfarm-profile)# codec pass-through ! Specifies codec supported by DSP farm
Router(config-dspfarm-profile)# maximum sessions 5 ! Specifies maximum number of simultaneous sessions supported by this profile
Router(config-dspfarm-profile)# no shutdown
Router(config-dspfarm-profile)# exit
```

Cisco Unified CME with SIP Endpoints: Music on Hold Implementation

MOH is an audio stream that is played to PSTN and VoIP G.711 or G.729 callers who are placed on hold by phones in a Cisco Unified CME system. This audio stream is intended to reassure callers that they are still connected to their calls.

```
Router(config)# telephony-service ! Enters telephony configuration mode
Router(config-telephony)# moh music-on-hold.au ! Specifies music on hold file
Router(config-telephony)# exit
```

Cisco Unified CME with SIP Endpoints: Voice Mail and Auto Attendant Integration

Voice mail is provided by the Cisco Unity Express service module either in the Advanced Integration Module (AIM) form factor or the Network Module (NME) form factor. The AIM module requires the following configuration. To configure the NME, substitute *Integrated-Service-Engine 2/0* for *Service-Engine 0/1*.

```
Router(config)# interface Service-Engine 0/1 ! Enters Cisco Unity Express configuration mode
Router(config-if)# ip address 10.0.2.86 255.255.255.252 ! Assigns ip address to the service engine router interface
Router(config-if)# service-module ip address 10.0.2.85 255.255.255.252 ! Assigns IP address to service module internal interface
Router(config-if)# service-module ip default-gateway 10.0.2.86 ! Assigns default gateway for the service module
Router(config-if)# no shutdown
Router(config-if)# exit
Router(config)# ip route 10.0.2.84 255.255.255.252 Service-Engine 0/1 ! Adds a static route entry to direct traffic to the module
```

Configure a dial peer for voice mail, because Cisco Unity Express uses SIP as its signaling protocol.

```
Router(config)# dial-peer voice 8 voip ! Enters dial peer for voicemail configuration mode
Router(config-dial-peer)# destination-pattern 5444 ! Specifies mailbox extension
Router(config-dial-peer)# session target ipv4:10.0.2.85 ! Specifies voicemail address
Router(config-dial-peer)# session protocol sipv2! Enables SIP for voicemail communication
Router(config-dial-peer)# codec g711ulaw ! Specifies codec for voicemail messages
Router(config-dial-peer)# b2bua ! Enables SIP to SCCP forwarding
Router(config-dial-peer)# dtmf-relay sip-notify ! Specifies DTMF relay method
Router(config-dial-peer)# no vad ! Disables voice activity detection
Router(config-peer)# exit
```

```
Router(config)# dial-peer voice 9 voip ! Enters dial peer for autoattendant configuration mode
Router(config-dial-peer)# destination-pattern 5000 ! Specifies mailbox extension
Router(config-dial-peer)# session target ipv4:10.0.2.85 ! Specifies voicemail address
Router(config-dial-peer)# session protocol sipv2! Enables SIP for voicemail communication
Router(config-dial-peer)# codec g711ulaw ! Specifies codec for voicemail messages
Router(config-dial-peer)# b2bua ! Enables SIP to SCCP forwarding
Router(config-dial-peer)# dtmf-relay sip-notify! Specifies DTMF relay method
Router(config-dial-peer)# no vad ! Disables voice activity detection
Router(config-peer)# exit
```

```
Router(config)# sip-ua ! Enters SIP user agent configuration mode
Router(config-sip-ua)# mwi-server ipv4:172.16.0.110 expires 3600 port 5060 transport udp ! Sets Cisco Unified Manager address for providing message wait indicator
Router(config-voi-sip)# exit
```

```
Router# service-module Service-Engine 0/1 session ! Sessions into the CUE service module
```

```
CUE(config)# ccn application voicemail ! Enters voicemail configuration mode
CUE(config-application)# description "Cisco Voicemail" ! Sets user friendly name for voicemail application
CUE(config-application)# maxsessions 4 ! Sets maximum number of users concurrently listening to voicemail
CUE(config-application)# exit
```

```
CUE(config)# ccn trigger sip phonenumber 5444 ! Assigns number that will trigger voicemail
CUE(config-trigger)# application voicemail ! Assigns voicemail to the call trigger
CUE(config-trigger)# enabled ! Turns the trigger on
CUE(config-trigger)# maxsessions 4 ! Sets maximum number of users concurrently listening to voicemail
CUE(config-trigger)# exit
```



```
CUE(config)# exit
```

Create user mailboxes. Repeat the following steps for all users.

```
CUE# username John create ! Creates mailbox for user John
CUE# configure terminal
CUE(config)# username John phonenumber 5001 ! Assigns mailbox for John to extension
CUE(config)# exit

CUE# configure terminal
CUE(config)# voice mailbox owner John ! Enters configuration mode for voicemail mailbox
CUE(config-mailbox)# description "John's Mailbox" ! Sets user friendly description
CUE(config-mailbox)# enable ! Turns the mailbox on
CUE(config-mailbox)# expiration time 14 ! Sets expiration time for voicemail to two weeks
CUE(config-mailbox)# mailboxsize 600 ! Sets voicemail box size to 10 minutes of messages
CUE(config-mailbox)# messagesize 120 ! Sets maximum message size to 2 minutes
CUE(config-mailbox)# exit
```

Cisco Unified CME with SIP Endpoints: Emergency Services Implementation

The following is the implementation of emergency number calling for North America. The PRI trunk is used for placing emergency calls.

```
Router(config)# dial-peer voice 10 pots ! Enters dial peer for emergency calls
configuration mode
Router(config-dial-peer)# destination-pattern 911 ! Specifies North America emergency
number
Router(config-dial-peer)# direct-inward-dial ! Enables DID numbers
Router(config-dial-peer)# port 0/0/0:23 ! Specifies outgoing/incoming interface for calls
Router(config-peer)# exit

Router(config)# dial-peer voice 11 pots ! Enters dial peer for local area calls
configuration mode
Router(config-dial-peer)# destination-pattern 9911 ! Specifies area code prefix for
central site dial peer
Router(config-dial-peer)# prefix 911 ! Prefix that the system adds automatically to the
dial string
Router(config-dial-peer)# direct-inward-dial ! Enables DID numbers
Router(config-dial-peer)# port 0/0/0:23 ! Specifies outgoing/incoming interface for calls
Router(config-peer)# exit
```

Cisco Unified SRST with SCCP Endpoints Implementation

- [Cisco Unified SRST with SCCP Endpoints: Telephony Service Setup, page 117](#)
- [Cisco Unified SRST with SCCP Endpoints: IP Phone Installation and Configuration, page 118](#)
- [Cisco Unified SRST with SCCP Endpoints: H.323 Voice Gateway Implementation, page 119](#)
- [Cisco Unified SRST with SCCP Endpoints: Dial Plan Implementation, page 121](#)
- [Cisco Unified SRST with SCCP Endpoints: RSVP Implementation, page 123](#)
- [Cisco Unified SRST with SCCP Endpoints: Transcoding and Conferencing Implementation, page 124](#)
- [Cisco Unified SRST with SCCP Endpoints: Music on Hold Implementation, page 126](#)
- [Cisco Unified SRST with SCCP Endpoints: Voice Mail and Auto Attendant Integration, page 126](#)
- [Cisco Unified SRST with SCCP Endpoints: Emergency Services Implementation, page 127](#)

Cisco Unified SRST provides Cisco Unified CM with fallback support for Cisco IP Phones that are attached to a Cisco router on a branch network. Cisco Unified SRST enables routers to provide call-handling support for Cisco IP Phones when they lose connection to a remote primary, secondary, or tertiary Cisco Unified CM, or when WAN connection is operationally down.

Cisco Unified SRST with SCCP Endpoints: Telephony Service Setup

Configure Cisco Unified SRST at the central site Cisco Unified CM as shown in [Figure 23](#). The Cisco Unified SRST reference name is used in configuring the Cisco Unified SRST device pool as shown in [Figure 24](#).

Figure 23 Cisco Unified SRST Configuration in Cisco Unified CM

SOLUTIONS-UNITY
SRST Reference Configuration - Microsoft Internet Explorer

File Edit View Favorites Tools Help

Back Forward Stop Refresh Home Search Favorites Media Print

https://172.16.200.10/ccmadmin/srstSave.do

Cisco Unified CallManager Administration
For Cisco Unified Communications Solutions

Navigation Cisco Unified CMAdmin

System Call Routing Media Resources Voice Mail Device Application User Management Bulk Administration Help

SRST Reference Configuration Related Links

Save Delete Copy Reset Add New

Status
Update successful

SRST Reference Information

Name* BRANCH-SRST

Port* 2000

IP Address* 10.0.1.2

SIP Network/IP Address 10.0.1.2

SIP Port* 5060

SRST Certificate Provider Port* 2445

Is SRST Secure?

Save Delete Copy Reset Add New

*- indicates required item.

261035

Figure 24 Cisco Unified SRST Device Pool Configuration in Cisco Unified CM

The screenshot shows the Cisco Unified CM Administration web interface. The browser title is "Device Pool Configuration - Microsoft Internet Explorer". The address bar shows the URL: <https://172.16.200.10/ccmadmin/devicePoolEdit.do?key=6288511a-ee4d-d12b-f518-110d95eb9952>. The page title is "Device Pool Configuration".

Status: Status: Ready

Device Pool Information: Device Pool: BRANCH-POOL (7 members**)

Device Pool Settings:

- Device Pool Name*: BRANCH-POOL
- Cisco Unified Communications Manager Group*: Default
- Calling Search Space for Auto-registration: < None >
- Reverted Call Focus Priority: Default

Roaming Sensitive Settings:

- Date/Time Group*: CMLocal
- Region*: BRANCH
- Media Resource Group List: BRANCH
- Location: Branch
- Network Locale: United States
- SRST Reference*: BRANCH-SRST
- Connection Monitor Duration***:
- Single Button Barge*: Default
- Join Across Lines*: Default
- Physical Location: < None >
- Device Mobility Group: < None >

Device Mobility Related Information**:**

- Device Mobility Calling Search Space: < None >
- AAR Calling Search Space: < None >
- AAR Group: < None >

Buttons: Save, Delete, Copy, Reset, Add New

Footer: * indicates required item.

Configure the Cisco Unified SRST fallback mode at the branch router.

```
Router(config)# call-manager-fallback ! Enters call manager fallback configuration mode
Router(config-cm-fallback)# ip source-address 10.0.1.2 port 2000 ! Sets IP address for
phone registration
Router(config-cm-fallback)# max-dn 200 dual-line ! Sets the maximum number of directory
numbers and configures dual channel
Router(config-cm-fallback)# max-ephones 100 ! Sets the maximum number of IP Phones
Router(config-cm-fallback)# exit
```

Cisco Unified SRST with SCCP Endpoints: IP Phone Installation and Configuration

In the Services Ready Medium Branch Network, IP Phones are installed by simply connecting them to ports on the access layer switches. Because all the ports offer Power over Ethernet, no additional power cables are necessary. After installation, the phones are configured with a default configuration generated during the telephony setup in the previous section.

```
Router(config)# clock timezone PST -8 ! Sets the timezone for display on IP Phones
Router(config)# call-manager-fallback ! Enters call manager fallback configuration mode
Router(config-cm-fallback)# user-locale US ! Sets the language for display on IP Phones
Router(config-cm-fallback)# system message primary Your current options ! Sets message for
display on IP Phones
Router(config-cm-fallback)# secondary-dialtone 9 ! Provides dial tone for PSTN calls
Router(config-cm-fallback)# call-forward busy 5444 ! Forwards busy calls to voicemail
Router(config-cm-fallback)# call-forward noan 5444 timeout 10 ! Forwards busy calls to
voicemail after 10 minutes of ringing
```

```

Router(config-cm-fallback)# dialplan-pattern 1 408555.... extension-length 4 ! Creates
dialplan pattern that expands extension numbers to full E.164 numbers
Router(config-cm-fallback)# transfer-system full-blind ! Transfers calls without
consultation
Router(config-cm-fallback)# transfer-pattern 9.....! Allows transfers for all calls
originating from PSTN
Router(config-cm-fallback)# transfer-pattern 4.....! Allows transfers for all calls
originating in area code starting with "4"
Router(config-cm-fallback)# transfer-system full-consult ! Consults call before transfer
on second line
Router(config-cm-fallback)# call-forward pattern .T ! Allows call forwarding for all calls

Router(config-cm-fallback)# exit

```

Cisco Unified SRST with SCCP Endpoints: H.323 Voice Gateway Implementation

The following configuration enables VoIP on the network and sets up H.323 dial peers between the branch gateway and the destination telephone network, as shown in [Figure 25](#), [Figure 26](#), and [Figure 27](#).

Figure 25 H.323 Gateway Cisco Unified CM Configuration

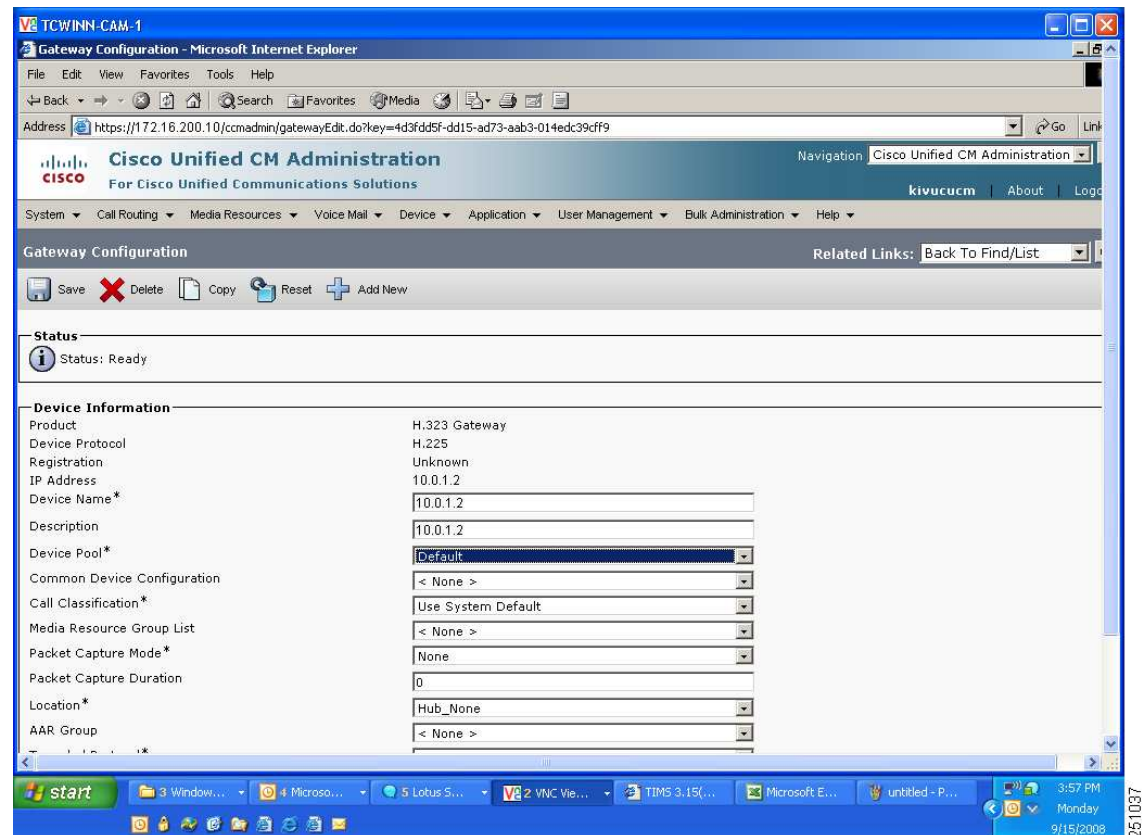

251037

Figure 26 H.323 Gateway Cisco Unified CM Configuration 2?

The screenshot displays the Cisco Unified CM Administration interface for Gateway Configuration. The browser window title is "TCWINN-CAM-1" and the address bar shows the URL: <https://172.16.200.10/ccmadmin/gatewayEdit.do?key=4d3fdd5f-dd15-ad73-aab3-014edc39cff9>. The page header includes the Cisco logo and "Cisco Unified CM Administration For Cisco Unified Communications Solutions". A navigation menu is visible at the top right, and a system menu is at the top left. The main content area is titled "Gateway Configuration" and includes a "Related Links" section with a "Back To Find/List" link. Below this, there are several configuration sections:

- Gateway Configuration:**
 - Buttons: Save, Delete, Copy, Reset, Add New
 - AAR Group: < None >
 - Tunneled Protocol*: None
 - Signaling Port*: 1720
 - Media Termination Point Required:
 - Retry Video Call As Audio:
 - Wait for Far End H.245 Terminal Capability Set:
 - Path Replacement Support:
 - Transmit UTF-8 for Calling Party Name:
 - SRTP Allowed: (Note: When this flag is checked, IPSec needs to be configured in the network to provide end to end security. Failure to do so will expose keys and other information.)
- Multilevel Precedence and Preemption (MLPP) Information:**
 - MLPP Domain: < None >
 - MLPP Indication: Not available on this device
 - MLPP Preemption: Not available on this device
- Call Routing Information - Inbound Calls:**
 - Significant Digits*: All
 - Calling Search Space: BRANCH

261038

Figure 27 H.323 Gateway Cisco Unified CM Configuration for Cisco Unified SRST Mode

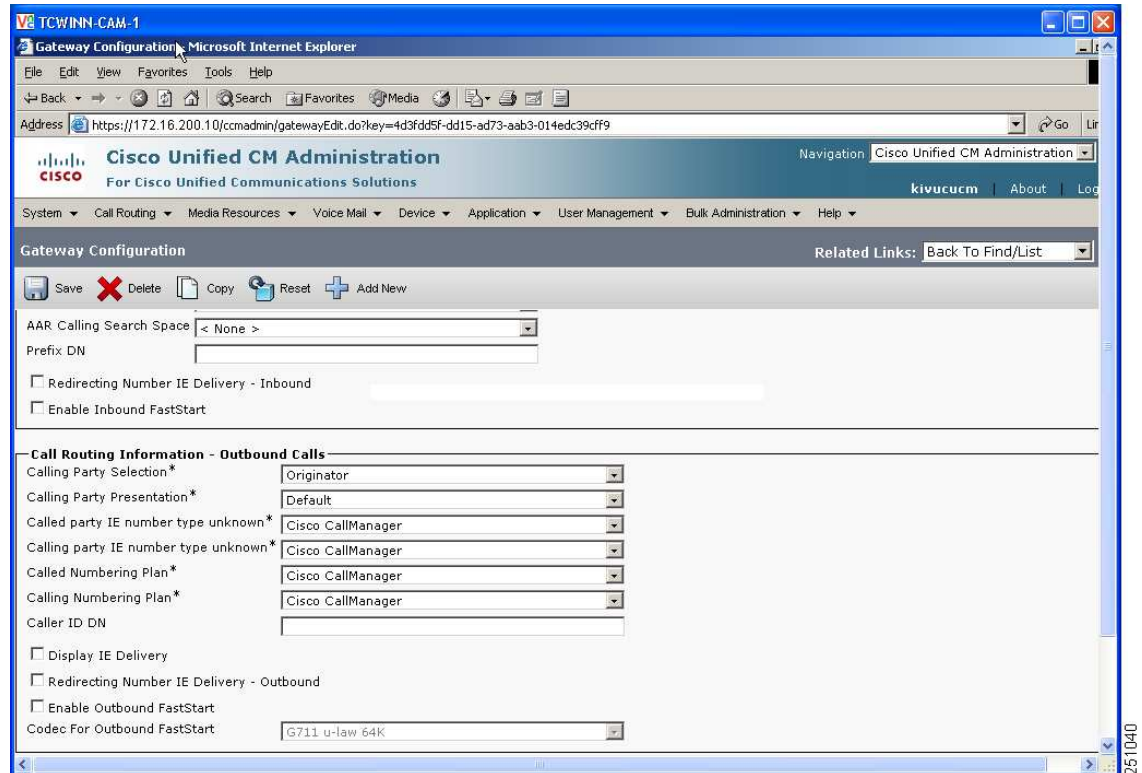

Cisco Unified SRST with SCCP Endpoints: Dial Plan Implementation

Twelve dial peers were defined for the Services Ready Medium Branch Network:

- Central site WAN
- Central site PSTN
- Local calls
- Four 911 emergency services dial peers
- Voice mail
- Auto Attendant
- Long distance
- International calling
- Fax pass through or fax relay

Voice mail and emergency services dial peers are described in the “Cisco Unified SRST with SCCP Endpoints: Voice Mail and Auto Attendant Integration” section on page 126 and the “Cisco Unified SRST with SCCP Endpoints: Emergency Services Implementation” section on page 127.

```
Router(config)# dial-peer voice 1 pots ! Enters dial peer for central site calls
Router(config-dial-peer)# destination-pattern 5.... ! Specifies area code prefix for
central site dial peer
Router(config-dial-peer)# prefix 1408555 ! Prefix that the system adds automatically to
the dial string
```

```

Router(config-dial-peer)# incoming called-number .T ! Associates dial peer with any
incoming number
Router(config-dial-peer)# direct-inward-dial ! Enables DID numbers
Router(config-dial-peer)# port 0/0/0:23 ! Specifies outgoing/incoming interface for calls
Router(config-peer)# exit

```

When calls over the WAN exceed the maximum allocated bandwidth, they are redirected to PSTN.

```

Router(config)# dial-peer voice 15 pots ! Enters dial peer for PSTN bypass configuration
mode
Router(config-dial-peer)# destination-pattern 408..... ! Specifies destination pattern
Router(config-dial-peer)# port 0/0/23 ! Specifies outgoing/incoming interface for calls
Router(config-dial-peer)# preference 1 ! Sets the dial peer preference order
Router(config-dial-peer)# prefix 408 ! Prefix that the system adds automatically to the
dial string
Router(config-dial-peer)# exit

```

```

Router(config)# dial-peer voice 2 voip ! Enters dial peer to central site configuration
mode
Router(config-dial-peer)# dtmf-relay h245-alphanumeric ! Specifies H.245 method for
relaying pressed digit tones
Router(config-dial-peer)# destination-pattern 408..... ! Specifies area code prefix for
central site dial peer
Router(config-dial-peer)# session target ipv4:172.16.200.10 ! Specifies central site dial
peer address
Router(config-peer)# exit

```

```

Router(config)# dial-peer voice 3 pots ! Enters dial peer for local area calls
configuration mode
Router(config-dial-peer)# destination-pattern 9..... ! Specifies area code prefix for
central site dial peer
Router(config-dial-peer)# direct-inward-dial ! Enables DID numbers
Router(config-dial-peer)# port 0/0/0:23 ! Specifies outgoing/incoming interface for calls
Router(config-peer)# exit

```

```

Router(config)# dial-peer voice 4 pots ! Enters dial peer for long distance calls
configuration mode
Router(config-dial-peer)# destination-pattern 91..... ! Specifies area code prefix
for central site dial peer
Router(config-dial-peer)# prefix 1 ! Prefix that the system adds automatically to the dial
string
Router(config-dial-peer)# direct-inward-dial ! Enables DID numbers
Router(config-dial-peer)# port 0/0/0:23 ! Specifies outgoing/incoming interface for calls
Router(config-peer)# exit

```

```

Router(config)# dial-peer voice 5 pots ! Enters dial peer for international calls
configuration mode
Router(config-dial-peer)# destination-pattern 9011T ! Specifies area code prefix for
central site dial peer
Router(config-dial-peer)# prefix 011 ! Prefix that the system adds automatically to the
dial string
Router(config-dial-peer)# direct-inward-dial ! Enables DID numbers
Router(config-dial-peer)# port 0/0/0:23 ! Specifies outgoing/incoming interface for calls
Router(config-peer)# exit

```

If using fax pass-through, apply the following configuration.

```

Router(config)# dial-peer voice 6 voip ! Enters dial peer for fax passthrough
configuration mode
Router(config-dial-peer)# destination-pattern 4085555333 ! Specifies local number of fax
machine
Router(config-dial-peer)# session target ipv4:172.16.200.10 ! Specifies central site dial
peer address

```



```
Router(config-dial-peer)# fax protocol pass-through g711ulaw ! Configures fax passthrough
with G.711 codec
Router(config-peer)# exit
```

If using fax relay, apply the following configuration.

```
Router(config)# dial-peer voice 7 voip ! Enters dial peer for fax relay configuration mode
Router(config-dial-peer)# destination-pattern 4085555333 ! Specifies local number of fax
machine
Router(config-dial-peer)# session target ipv4:172.16.200.10 ! Specifies central site dial
peer address
Router(config-dial-peer)# fax-relay ecm disable ! Disables fax relay ECM
Router(config-dial-peer)# fax rate 9600 ! Selects fax transmission rate
Router(config-dial-peer)# fax protocol t38 ! Sets the T.38 fax relay protocol
Router(config-dial-peer)# codec g711ulaw ! Configures fax relay with G.711 codec
Router(config-peer)# exit
```

Cisco Unified SRST with SCCP Endpoints: RSVP Implementation

The following implementation applies to Cisco Unified SRST branch voice deployments. Use the following commands on the tunnel interface for DMVPN, WAN primary, and on the WAN interface for GETVPN.



Note

On the four T1 WAN links, the maximum bandwidth that can be managed by RSVP is 4550 kbps.

```
Router(config)# interface Tunnel 1 ! Enters tunnel interface configuration mode
Router(config-if)# ip rsvp bandwidth 8112 ! Sets maximum allowed bandwidth for voice (see
Table 20) plus video (512 kb/s)
Router(config-if)# ip rsvp data-packet classification none ! Turns off per-packet data
processing
Router(config-if)# ip rsvp resource-provider none ! Specifies no resource provider for the
traffic flows
Router(config-if)# ip rsvp policy local identity RSVP-VOICE ! Creates RSVP policy for
voice
Router(config-rsvp-local-policy)# maximum bandwidth group 7600 ! Sets maximum bandwidth for
voice
Router(config-rsvp-local-policy)# forward all ! Forwards all traffic for this policy
Router(config-rsvp-local-policy)# exit
Router(config-if)# ip rsvp policy local identity RSVP-VIDEO ! Creates RSVP policy for
video
Router(config-rsvp-local-policy)# maximum bandwidth group 512 ! Sets maximum bandwidth for
video
Router(config-rsvp-local-policy)# forward all ! Forwards all traffic for this policy
Router(config-rsvp-local-policy)# exit
Router(config-if)# ip rsvp policy local default ! Default policy for traffic that does not
matchin above identifiers
Router(config-if)# exit

Router(config)# ip rsvp policy identity RSVP-VIDEO policy-locator .*VideoStream.*
! Creates a policy for matching video traffic
Router(config)# ip rsvp policy identity RSVP-VOICE policy-locator .*AudioStream.*
! Creates a policy for matching voice traffic
Router(config)# ip rsvp policy preempt ! Enables preempting of lower reservation by higher
reservation
```

The RSVP policy must be applied on the voice VLAN interface.

```
Branch(config)# interface GigabitEthernet2/0.2 ! Enters gigabit Ethernet sub-interface 2
configuration mode
Router(config-if)# ip rsvp bandwidth ! Enables RSVP on the interface
```

```
Router(config-if)# exit
```

Cisco Unified SRST with SCCP Endpoints: Transcoding and Conferencing Implementation

Transcoding compresses and decompresses voice streams to match end device capabilities. Transcoding is required when an incoming voice stream is digitized and compressed (by means of a codec) to save bandwidth and the local device does not support that type of compression.

```
Router(config)# call-manager-fallback ! Enters call manager fallback configuration mode
Router(config-cm-fallback)# max-conferences 3 ! Specifies the maximum number of
simultaneous conferences
Router(config-cm-fallback)# exit

Router(config)# voice-card 0 ! Enters DSP farm configuration mode
Router(config-voicecard)# dsp services dspfarm ! Enables DSP services
Router(config-voicecard)# exit
Router(config)# sccp local GigabitEthernet2/0.2 ! Sets the interface for conferencing and
transcoding to register with CME
Router(config)# sccp ccm 10.0.1.2 identifier 1 version 5.0.1 ! Associates conferencing
and transcoding with CME
Router(config)# sccp ! Enables SCCP globally
Router(config)# sccp ccm group 1 ! Creates SCCP group and enters SCCP configuration mode
Router(config-sccp-ccm)# associate ccm 1 priority 1 ! Associates SCCP group 1 with CME
Router(config-sccp-ccm)# associate profile 3 register CONFERENCE ! Associates DSP farm
profile with with a SCCP group
Router(config-sccp-ccm)# associate profile 2 register TRANSCODE ! Associates DSP farm
profile with with a SCCP group
Router(config-sccp-ccm)# exit

Router(config)# dspfarm profile 2 transcode ! Enters DSP farm profile configuration mode
Router(config-dspfarm-profile)# codec g711ulaw ! Specifies codec supported by DSP farm
Router(config-dspfarm-profile)# codec g711alaw ! Specifies codec supported by DSP farm
Router(config-dspfarm-profile)# codec g729ar8 ! Specifies codec supported by DSP farm
Router(config-dspfarm-profile)# codec g729abr8 ! Specifies codec supported by DSP farm
Router(config-dspfarm-profile)# codec g729r8 ! Specifies codec supported by DSP farm
Router(config-dspfarm-profile)# codec pass-through ! Specifies codec supported by DSP farm
Router(config-dspfarm-profile)# maximum sessions 5 ! Specifies maximum number of
simultaneous sessions supported by this profile
Router(config-dspfarm-profile)# associate application sccp ! Associates SCCP with this DSP
farm profile
Router(config-dspfarm-profile)# no shutdown
Router(config-dspfarm-profile)# exit

Router(config)# dspfarm profile 3 conference ! Enters DSP farm profile configuration mode
Router(config-dspfarm-profile)# codec g711ulaw ! Specifies codec supported by DSP farm
Router(config-dspfarm-profile)# codec g711alaw ! Specifies codec supported by DSP farm
Router(config-dspfarm-profile)# codec g729ar8 ! Specifies codec supported by DSP farm
Router(config-dspfarm-profile)# codec g729abr8 ! Specifies codec supported by DSP farm
Router(config-dspfarm-profile)# codec g729r8 ! Specifies codec supported by DSP farm
Router(config-dspfarm-profile)# codec g729br8 ! Specifies codec supported by DSP farm
Router(config-dspfarm-profile)# maximum sessions 3 ! Specifies maximum number of
simultaneous sessions supported by this profile
Router(config-dspfarm-profile)# associate application sccp ! Associates SCCP with this DSP
farm profile
Router(config-dspfarm-profile)# no shutdown
Router(config-dspfarm-profile)# exit
```

Transcoding and conferencing are configured on the remote Cisco Unified CM as shown in [Figure 28](#) and [Figure 29](#).

Figure 28 Transcoding Configuration for Cisco Unified SRST Mode

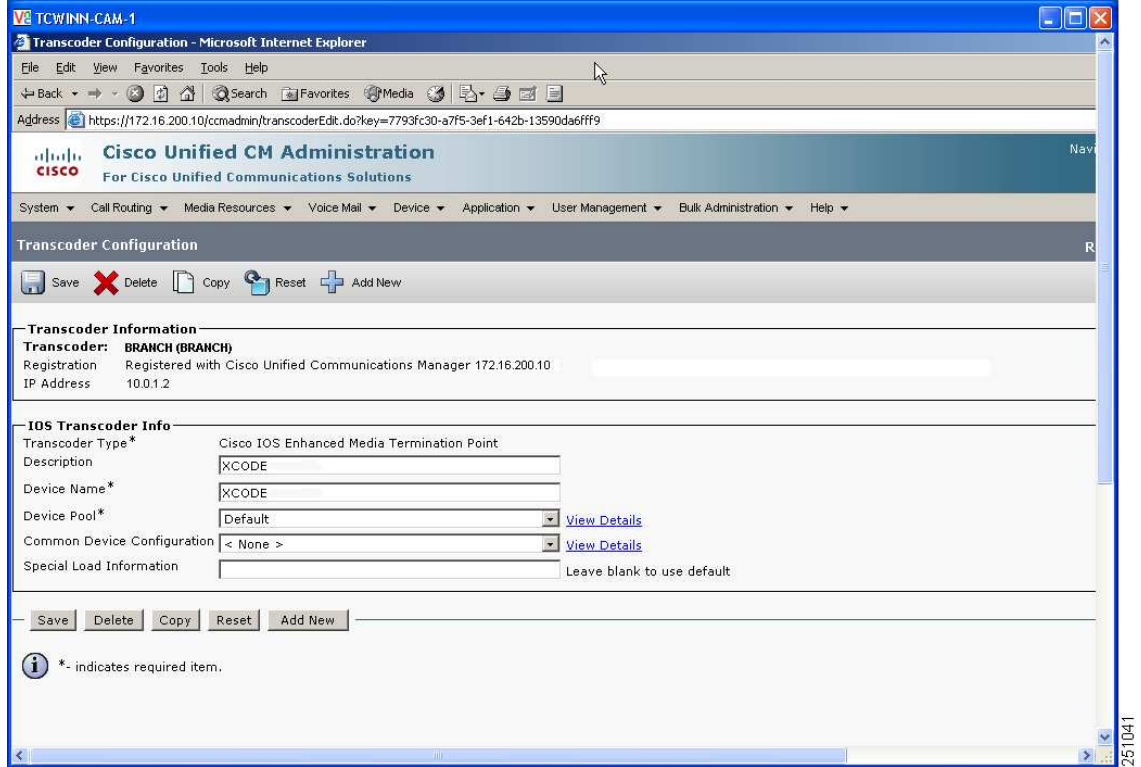

251041

Figure 29 Conferencing Configuration for Cisco Unified SRST Mode

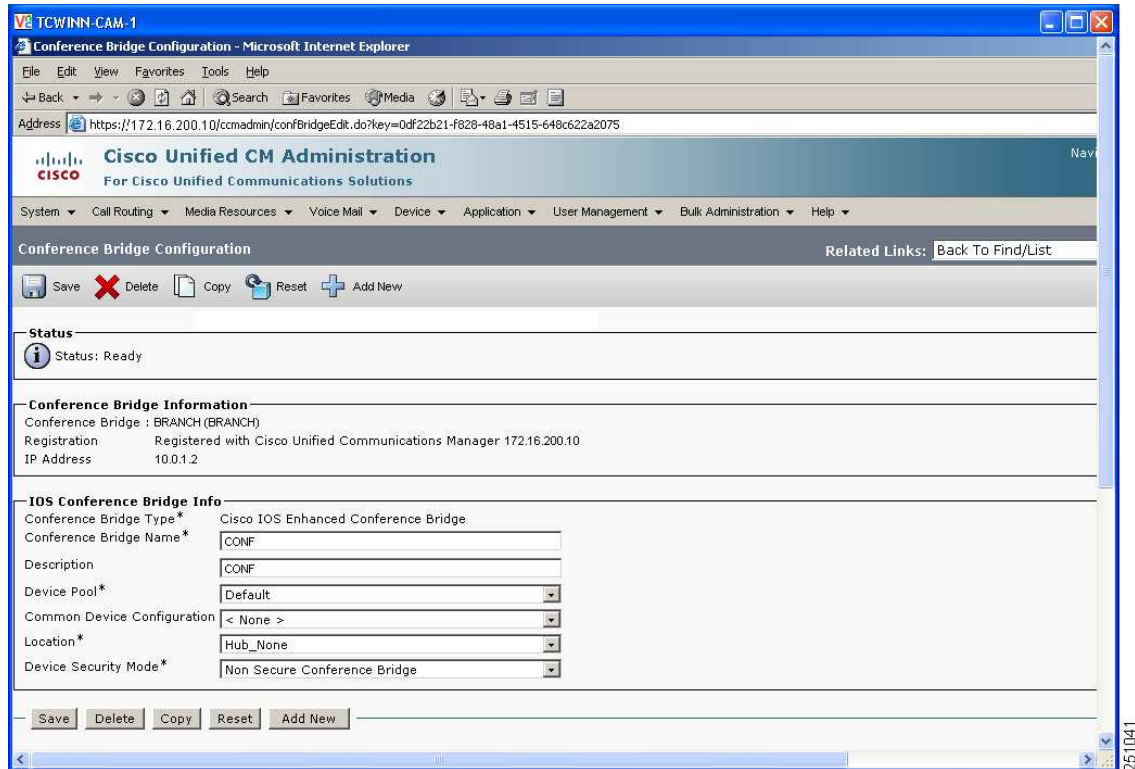

Cisco Unified SRST with SCCP Endpoints: Music on Hold Implementation

Music on hold (MOH) is an audio stream that is played to PSTN and VoIP G.711 or G.729 callers who are placed on hold by phones in a Cisco Unified CME system. This audio stream is intended to reassure callers that they are still connected to their calls.

```
Router(config)# call-manager-fallback ! Enters call manager fallback configuration mode
Router(config-cm-fallback)# moh music-on-hold.au ! Specifies music on hold file
Router(config-cm-fallback)# multicast moh 239.1.1.1 port 16384 ! Uses multicast for MoH
Router(config-cm-fallback)# exit
```

Cisco Unified SRST with SCCP Endpoints: Voice Mail and Auto Attendant Integration

Voice mail is provided by the Cisco Unity Express service module either in the Advanced Integration Module (AIM) form factor or the Network Module (NME) form factor. The AIM module requires the following configuration. To configure the NME, substitute *Integrated-Service-Engine 2/0* for *Service-Engine 0/1*.

```
Router(config)# interface service-engine 0/1 ! Enters Cisco Unity Express configuration mode
Router(config-if)# ip address 10.0.2.86 255.255.255.252 ! Assigns ip address to the service engine router interface
Router(config-if)# service-module ip address 10.0.2.85 255.255.255.252 ! Assigns IP address to service module internal interface
Router(config-if)# service-module ip default-gateway 10.0.2.86 ! Assigns default gateway for the service module
Router(config-if)# zone-member security Private ! Assigns Cisco Unity Express to private security zone
Router(config-if)# no shutdown
Router(config-if)# exit
```

```
Router(config)# ip route 10.0.2.84 255.255.255.252 Service-Engine 0/1 ! Adds a static
route entry to direct traffic to the module
```

Configure a dial peer for voice mail because Cisco Unity Express uses SIP as its signaling protocol.

```
Router(config)# dial-peer voice 8 voip ! Enters dial peer for voicemail configuration mode
Router(config-dial-peer)# destination-pattern 5444 ! Specifies mailbox extension
Router(config-dial-peer)# session target ipv4:10.0.2.85 ! Specifies voicemail address
Router(config-dial-peer)# session protocol sipv2! Enables SIP for voicemail communication
Router(config-dial-peer)# codec g711ulaw ! Specifies codec for voicemail messages
Router(config-dial-peer)# b2bua ! Enables SIP to SCCP forwarding
Router(config-dial-peer)# dtmf-relay sip-notify! Specifies DTMF relay method
Router(config-dial-peer)# no vad ! Disables voice activity detection
Router(config-peer)# exit
```

```
Router(config)# dial-peer voice 9 voip ! Enters dial peer for autoattendant configuration
mode
Router(config-dial-peer)# destination-pattern 5000 ! Specifies mailbox extension
Router(config-dial-peer)# session target ipv4:10.0.2.85 ! Specifies voicemail address
Router(config-dial-peer)# session protocol sipv2! Enables SIP for voicemail communication
Router(config-dial-peer)# codec g711ulaw ! Specifies codec for voicemail messages
Router(config-dial-peer)# b2bua ! Enables SIP to SCCP forwarding
Router(config-dial-peer)# dtmf-relay sip-notify! Specifies DTMF relay method
Router(config-dial-peer)# no vad ! Disables voice activity detection
Router(config-peer)# exit
```

The local Cisco Unity Express software must be registered with the Cisco Unified CM software at the central site. The following reference provides implementation details:

http://cisco.com/en/US/products/sw/voicesw/ps5520/products_configuration_example09186a0080289ef0.shtml

Additional Cisco Unity Express configuration is performed through a web-based user interface, as shown in [Figure 17](#) through [Figure 22](#).

Cisco Unified SRST with SCCP Endpoints: Emergency Services Implementation

The following provides implementation of emergency number calling for North America. The PRI trunk is used to place emergency calls. Each 911 call is selectively routed to the closest Public Safety Answering Point (PSAP), based on the caller's location. In addition, the caller's phone number and address automatically display on a terminal at the PSAP. The PSAP can quickly dispatch emergency help, even if the caller is unable to communicate the caller's location. Also, if the caller disconnects prematurely, the PSAP has the information it needs to contact the 911 caller.

```
Router(config)# voice emergency response location 1 ! Enters emergency response
configuration mode
Router(cfg-emrgncy-resp-location)# elin 1 4085555150 ! Specifies ELIN number provided by
PSAP
Router(cfg-emrgncy-resp-location)# name Bdlg 22, Floor 2 ! Internal location name
Router(cfg-emrgncy-resp-location)# subnet 1 10.0.1.0 255.255.255.0 ! Assigns Voice VLAN
subnet as origination of the emergency call
Router(cfg-emrgncy-resp-location)# subnet 2 10.0.4.0 255.255.255.0 ! Assigns backup Voice
VLAN subnet as origination of the emergency call
Router(cfg-emrgncy-resp-location)# exit

Router(config)# dial-peer voice 10 pots ! Enters dial peer for emergency calls
configuration mode
Router(config-dial-peer)# emergency response zone ! Replaces local extension with ELIN
number
Router(config-dial-peer)# destination-pattern 911 ! Specifies North America emergency
number
Router(config-dial-peer)# direct-inward-dial ! Enables DID numbers
```

```

Router(config-dial-peer)# port 0/0/0:23 ! Specifies outgoing/incoming interface for calls
Router(config-peer)# exit

Router(config)# dial-peer voice 11 pots ! Enters dial peer for local area calls
configuration mode
Router(config-dial-peer)# emergency response zone ! Replaces local extension with ELIN
number
Router(config-dial-peer)# destination-pattern 9911 ! Specifies area code prefix for
central site dial peer
Router(config-dial-peer)# prefix 911 ! Prefix that the system adds automatically to the
dial string
Router(config-dial-peer)# direct-inward-dial ! Enables DID numbers
Router(config-dial-peer)# port 0/0/0:23 ! Specifies outgoing/incoming interface for calls
Router(config-peer)# exit

Router(config)# dial-peer voice 12 pots ! Enters dial peer for ELIN callback configuration
mode
Router(config-dial-peer)# incoming called-number 4085555150 ! Specifies ELIN number
Router(config-dial-peer)# direct-inward-dial ! Enables DID numbers
Router(config-dial-peer)# emergency response callback ! Identifies the ELIN dial peer
Router(config-peer)# exit

Router(config)# dial-peer voice 13 pots ! Enters dial peer for ELIN callback configuration
mode
Router(config-dial-peer)# incoming called-number 4085555150 ! Specifies ELIN number
Router(config-dial-peer)# direct-inward-dial ! Enables DID numbers
Router(config-dial-peer)# emergency response callback ! Identifies the ELIN dial peer
Router(config-peer)# exit

```

Cisco Unified SRST with SIP Endpoints Implementation

- [Cisco Unified SRST with SIP Endpoints: Telephony Service Setup, page 128](#)
- [Cisco Unified SRST with SIP Endpoints: Cisco Unified SRST Fallback Mode at the Branch Router, page 130](#)
- [Cisco Unified SRST with SIP Endpoints: IP Phone Installation and Configuration, page 131](#)
- [Cisco Unified SRST with SIP Endpoints: SIP Voice Gateway Implementation, page 131](#)
- [Cisco Unified SRST with SIP Endpoints: Dial Plan Implementation, page 133](#)
- [Cisco Unified SRST with SIP Endpoints: RSVP Implementation, page 135](#)
- [Cisco Unified SRST with SIP Endpoints: Transcoding and Conferencing Implementation, page 135](#)
- [Cisco Unified SRST with SIP Endpoints: Music on Hold Implementation, page 138](#)
- [Cisco Unified SRST with SIP Endpoints: Voice Mail and Auto Attendant Integration, page 138](#)
- [Cisco Unified SRST with SIP Endpoints: Emergency Services Implementation, page 139](#)

Cisco Unified SRST provides Cisco Unified CM with fallback support for Cisco IP Phones that are attached to a Cisco router on a branch network. Cisco Unified SRST enables routers to provide call-handling support for Cisco IP Phones when they lose connection to a remote primary, secondary, or tertiary Cisco Unified CM, or when WAN connection is operationally down.

Cisco Unified SRST with SIP Endpoints: Telephony Service Setup

Configure the Cisco Unified SRST at Cisco Unified CM of the central site, as shown in [Figure 30](#). The Cisco Unified SRST reference name is used in configuring Cisco Unified SRST device pools as shown in [Figure 31](#).

Figure 30 Cisco Unified SRST Configuration in Cisco Unified CM

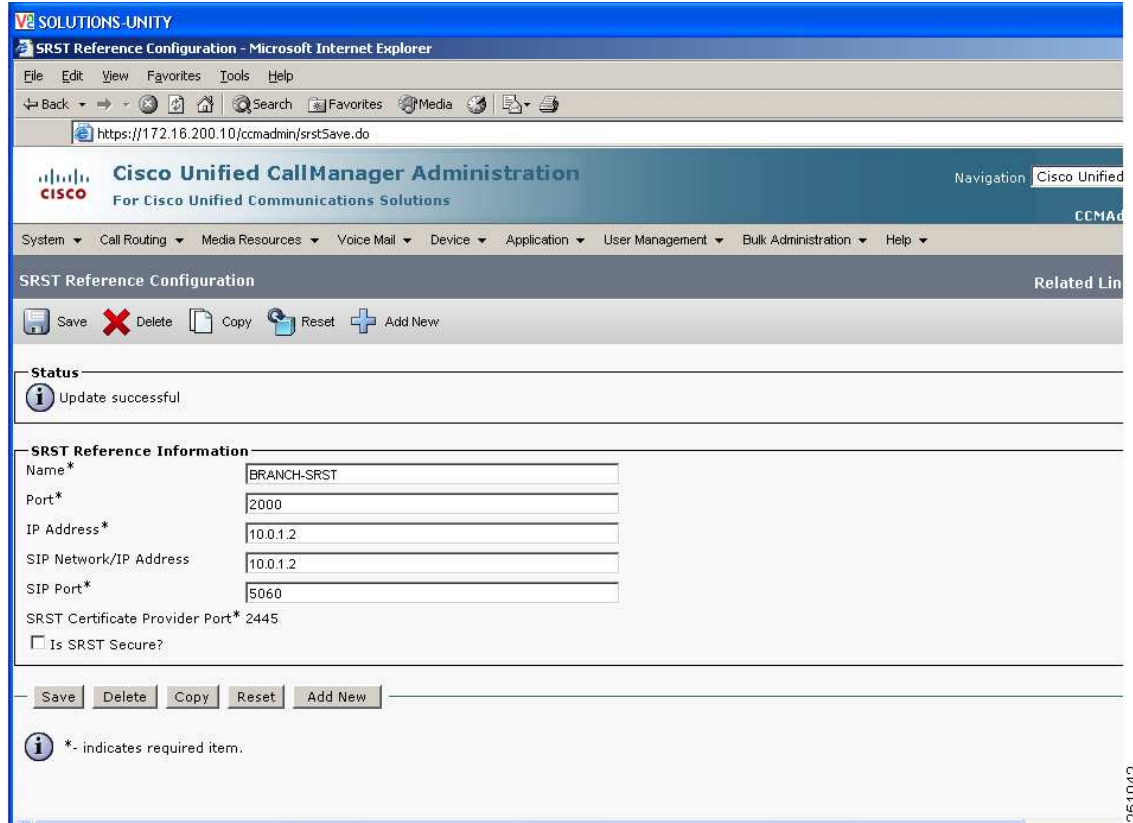

251042

Figure 31 Cisco Unified SRST Device Pool Configuration in Cisco Unified CM

The screenshot shows the Cisco Unified CM Administration web interface for configuring a Device Pool. The browser title is "Device Pool Configuration - Microsoft Internet Explorer". The address bar shows the URL: `https://172.16.200.10/ccmadmin/devicePoolEdit.do?key=5288511a-eedd-d12b-f518-110df5ed8962`. The page title is "Cisco Unified CM Administration" with the subtitle "For Cisco Unified Communications Solutions".

The navigation menu includes: System, Call Routing, Media Resources, Voice Mail, Device, Application, User Management, Bulk Administration, and Help. The current page is "Device Pool Configuration" with a "Related Links" dropdown set to "Back To Find/List".

At the top, there are buttons for Save, Delete, Copy, Reset, and Add New. The "Status" section shows "Status: Ready".

The "Device Pool Information" section shows "Device Pool: BRANCH-POOL (7 members)**".

The "Device Pool Settings" section includes:

- Device Pool Name*: BRANCH-POOL
- Cisco Unified Communications Manager Group*: Default
- Calling Search Space for Auto-registration: < None >
- Reverted Call Focus Priority: Default

The "Roaming Sensitive Settings" section includes:

- Date/Time Group*: CMLocal
- Region*: BRANCH
- Media Resource Group List: BRANCH
- Location: Branch
- Network Locale: United States
- SRST Reference*: BRANCH-SRST
- Connection Monitor Duration***: (empty)
- Single Button Barge*: Default
- Join Across Lines*: Default
- Physical Location: < None >
- Device Mobility Group: < None >

The "Device Mobility Related Information****" section includes:

- Device Mobility Calling Search Space: < None >
- AAR Calling Search Space: < None >
- AAR Group: < None >

At the bottom, there are buttons for Save, Delete, Copy, Reset, and Add New. A note indicates: "* - indicates required item." The status bar shows "Done" and "Local intranet".

Cisco Unified SRST with SIP Endpoints: Cisco Unified SRST Fallback Mode at the Branch Router

```
Router(config)# voice register global ! Enters voice configuration mode
Router(config-register-global)# max-pool 100 ! Sets the maximum number of SIP Phones
Router(config-register-global)# max-dn 200 ! Sets the maximum number of directory numbers
(two for each phone)
Router(config-register-global)# system message Your current options ! Sets message for
display on IP Phones
Router(config-register-global)# dialplan-pattern 1 4085555... extension-length 4 ! Creates
dialplan pattern that expands extension numbers to full E.164 numbers
Router(config-register-global)# exit
```

```
Router(config)# voice register pool 1 ! Enters voice register pool configuration mode
Router(config-register-pool)# id network 10.0.1.0 255.255.255.0 ! Identifies Voice VLAN
with SIP Phones
Router(config-register-pool)# proxy 172.16.0.20 preference 1 monitor probe icmp-ping !
Defines remote proxy dialpeer and method to monitor the state of the peer
Router(config-register-pool)# call-forward b2bua busy 5444 ! Forwards busy calls to
voicemail
Router(config-register-pool)# call-forward b2bua noan 5444 timeout 10 ! Forwards busy
calls to voicemail after 10 minutes of ringing
Router(config-register-pool)# codec g711ulaw ! Sets the codec for local calls
Router(config-register-pool)# exit
```

Cisco Unified SRST with SIP Endpoints: IP Phone Installation and Configuration

In Cisco Unified SRST mode, the Cisco Unified CM controls IP Phone firmware installation and configuration.

Cisco Unified SRST with SIP Endpoints: SIP Voice Gateway Implementation

The following configuration enables VoIP on the network and sets up SIP dial peers between the branch gateway and the destination telephone networks, as shown in [Figure 32](#), [Figure 33](#), and [Figure 34](#).

Figure 32 SIP Trunk Cisco Unified CM Configuration (1 of 3)

The screenshot displays the Cisco Unified CM Administration web interface for configuring a SIP Trunk. The browser window shows the URL: `https://172.16.200.10/ccmadmin/trunkEdit.do?key=e9e2ebaa-7272-cfc8-7634-2ca63ff64db`. The page title is "Trunk Configuration - Microsoft Internet Explorer".

The main content area is titled "Trunk Configuration" and includes a "Status" section showing "Status: Ready". Below this is the "Device Information" section, which contains the following fields and values:

Product:	SIP Trunk
Device Protocol:	SIP
Device Name*	10.0.1.2
Description:	
Device Pool*	Default
Common Device Configuration:	< None >
Call Classification*:	Use System Default
Media Resource Group List:	< None >
Location*:	Hub_None
AAR Group:	< None >
Packet Capture Mode*:	None
Packet Capture Duration:	0

At the bottom of the form, there are two checkboxes: "Media Termination Point Required" (unchecked) and "Retrv Viden Call as Audin" (checked).

Figure 33 SIP Trunk Cisco Unified CM Configuration (2 of 3)

The screenshot displays the Cisco Unified CM Administration web interface in Microsoft Internet Explorer. The browser address bar shows the URL: `https://172.16.200.10/ccmadmin/trunkEdit.do?key=e9e2ebaa-7272-cfc8-7634-2ca63ff6f4db`. The page title is "Trunk Configuration - Microsoft Internet Explorer".

The navigation menu includes: System, Call Routing, Media Resources, Voice Mail, Device, Application, User Management, Bulk Administration, and a dropdown menu. The current page is "Trunk Configuration".

Below the navigation menu, there are buttons for "Save", "Delete", "Reset", and "Add New". A "Related Links" section contains a link for "Back To Find/List".

The configuration is divided into several sections:

- Multilevel Precedence and Preemption (MLPP) Information:** MLPP Domain is set to "< None >".
- Call Routing Information:**
 - Inbound Calls:**
 - Significant Digits*: All
 - Connected Line ID Presentation*: Default
 - Connected Name Presentation*: Default
 - Calling Search Space: BRANCH
 - AAR Calling Search Space: < None >
 - Prefix DN: (empty field)
 - Redirecting Diversion Header Delivery - Inbound
 - Outbound Calls:**
 - Calling Party Selection*: Originator
 - Calling Line ID Presentation*: Default
 - Calling Name Presentation*: Default

The page number "261045" is visible in the bottom right corner of the browser window.

Figure 34 SIP Trunk Cisco Unified CM Configuration (3 of 3)

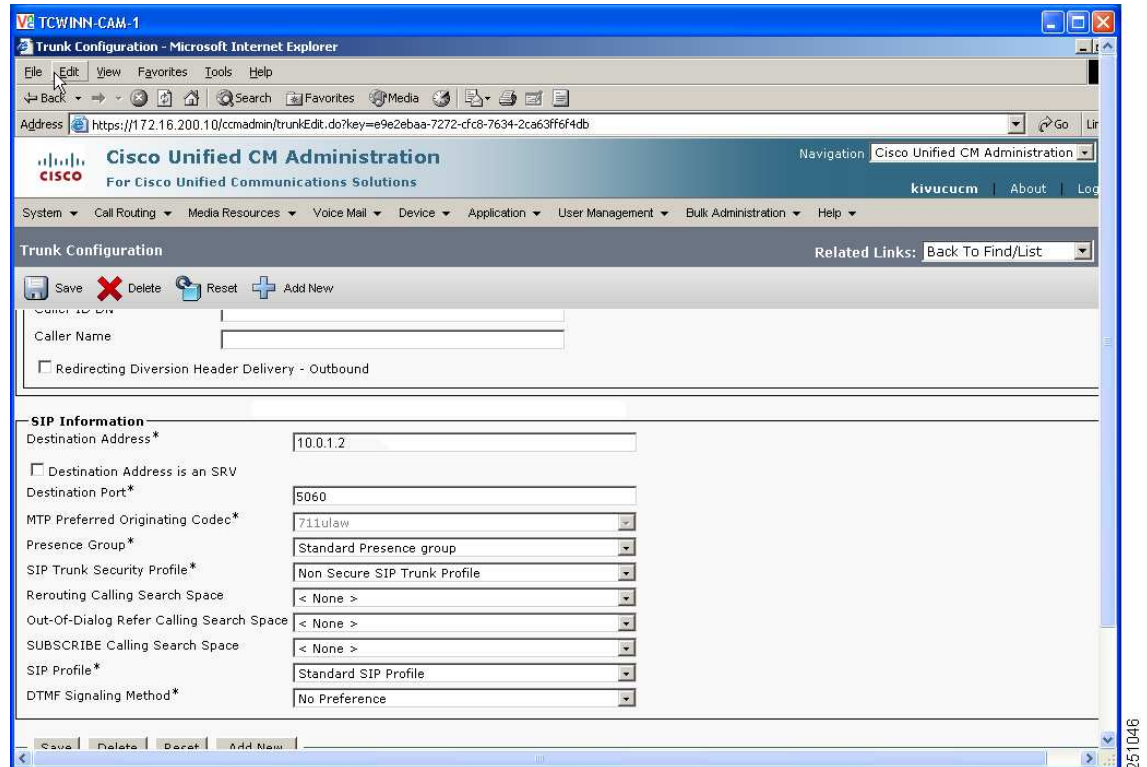

Cisco Unified SRST with SIP Endpoints: Dial Plan Implementation

Twelve dial peers were defined for the Services Ready Medium Branch Network: central site WAN, central site PSTN, local calls, four 911 emergency services dial peers, voice mail, auto attendant, long distance, international calling and fax pass-through or fax relay. Voice mail, auto attendant and emergency services dial peers are described in the “Cisco Unified SRST with SIP Endpoints: Voice Mail and Auto Attendant Integration” section on page 138 and in the “Cisco Unified SRST with SIP Endpoints: Emergency Services Implementation” section on page 139.

```
Router(config)# dial-peer voice 1 pots ! Enters dial peer for central site calls
Router(config-dial-peer)# destination-pattern 5.... ! Specifies area code prefix for
central site dial peer
Router(config-dial-peer)# prefix 1408555 ! Prefix that the system adds automatically to
the dial string
Router(config-dial-peer)# incoming called-number .T ! Associates dial peer with any
incoming number
Router(config-dial-peer)# direct-inward-dial ! Enables DID numbers
Router(config-dial-peer)# port 0/0/0:23 ! Specifies outgoing/incoming interface for calls
Router(config-peer)# exit
```

```
Router(config)# dial-peer voice 2 voip ! Enters dial peer to central site configuration
mode
Router(config-dial-peer)# session protocol sipv2! Enables SIP for voicemail communication
Router(config-dial-peer)# dtmf-relay rtp-nte ! Specifies Network Time Protocol method for
relaying pressed digit tones
Router(config-dial-peer)# destination-pattern 408..... ! Specifies area code prefix for
central site dial peer
Router(config-dial-peer)# session target ipv4:172.16.200.10 ! Specifies central site dial
peer address
```

```

Router(config-dial-peer)# no vad ! Disables voice activity detection
Router(config-peer)# exit

Router(config)# dial-peer voice 3 pots ! Enters dial peer for local area calls
configuration mode
Router(config-dial-peer)# destination-pattern 9..... ! Specifies area code prefix for
central site dial peer
Router(config-dial-peer)# direct-inward-dial ! Enables DID numbers
Router(config-dial-peer)# port 0/0/0:23 ! Specifies outgoing/incoming interface for calls
Router(config-peer)# exit

Router(config)# dial-peer voice 4 pots ! Enters dial peer for long distance calls
configuration mode
Router(config-dial-peer)# destination-pattern 91..... ! Specifies area code prefix
for central site dial peer
Router(config-dial-peer)# prefix 1 ! Prefix that the system adds automatically to the dial
string
Router(config-dial-peer)# direct-inward-dial ! Enables DID numbers
Router(config-dial-peer)# port 0/0/0:23 ! Specifies outgoing/incoming interface for calls
Router(config-peer)# exit

Router(config)# dial-peer voice 5 pots ! Enters dial peer for international calls
configuration mode
Router(config-dial-peer)# destination-pattern 9011T ! Specifies area code prefix for
central site dial peer
Router(config-dial-peer)# prefix 011 ! Prefix that the system adds automatically to the
dial string
Router(config-dial-peer)# direct-inward-dial ! Enables DID numbers
Router(config-dial-peer)# port 0/0/0:23 ! Specifies outgoing/incoming interface for calls
Router(config-peer)# exit

```

When calls over the WAN exceed the maximum allocated bandwidth, they are redirected to PSTN.

```

Router(config)# dial-peer voice 15 pots ! Enters dial peer for PSTN bypass configuration
mode
Router(config-dial-peer)# destination-pattern 408..... ! Specifies destination pattern
Router(config-dial-peer)# port 0/0/23 ! Specifies outgoing/incoming interface for calls
Router(config-dial-peer)# preference 1 ! Sets the dial peer preference order
Router(config-dial-peer)# prefix 408 ! Prefix that the system adds automatically to the
dial string

```

If using fax pass-through, apply the following configuration.

```

Router(config)# dial-peer voice 6 voip ! Enters dial peer for fax passthrough
configuration mode
Router(config-dial-peer)# session protocol sipv2! Enables SIP for voicemail communication
Router(config-dial-peer)# destination-pattern 4085555333 ! Specifies local number of fax
machine
Router(config-dial-peer)# session target ipv4:172.16.200.10 ! Specifies central site dial
peer address
Router(config-dial-peer)# fax protocol pass-through g711ulaw ! Configures fax passthrough
with G.711 codec
Router(config-peer)# exit

```

If using fax relay, apply the following configuration.

```

Router(config)# dial-peer voice 7 voip ! Enters dial peer for fax relay configuration mode
Router(config-dial-peer)# session protocol sipv2! Enables SIP for voicemail communication
Router(config-dial-peer)# destination-pattern 4085555333 ! Specifies local number of fax
machine
Router(config-dial-peer)# session target ipv4:172.16.200.10 ! Specifies central site dial
peer address
Router(config-dial-peer)# fax-relay ecm disable ! Disables fax relay ECM
Router(config-dial-peer)# fax rate 9600 ! Selects fax transmission rate
Router(config-dial-peer)# fax protocol t38 ! Sets the T.38 fax relay protocol

```

```
Router(config-dial-peer)# codec g711ulaw ! Configures fax relay with G.711 codec
Router(config-peer)# exit
```

Cisco Unified SRST with SIP Endpoints: RSVP Implementation

The following implementation applies to Cisco Unified SRST branch voice deployments. Apply the following commands on the tunnel interface for DMVPN, WAN primary, and for the WAN interface for GETVPN.

```
Router(config)# interface Tunnel 1 ! Enters tunnel interface configuration mode
Router(config-if)# ip rsvp bandwidth 8112 ! Sets maximum allowed bandwidth for voice (see
Table 18) plus video (512 Mbps)
Router(config-if)# ip rsvp data-packet classification none ! Turns off per-packet data
processing
Router(config-if)# ip rsvp resource-provider none ! Specifies no resource provider for the
traffic flows
Router(config-if)# ip rsvp policy local identity RSVP-VOICE ! Creates RSVP policy for
voice
Router(config-rsvp-local-policy)# maximum bandwidth group 7600 ! Sets maximum bandwidth for
voice
Router(config-rsvp-local-policy)# forward all ! Forwards all traffic for this policy
Router(config-rsvp-local-policy)# exit
Router(config-if)# ip rsvp policy local identity RSVP-VIDEO ! Creates RSVP policy for
video
Router(config-rsvp-local-policy)# maximum bandwidth group 512 ! Sets maximum bandwidth for
video
Router(config-rsvp-local-policy)# forward all ! Forwards all traffic for this policy
Router(config-rsvp-local-policy)# exit
Router(config-if)# ip rsvp policy local default ! Default policy for traffic that does not
matchin above identifiers
Router(config-if)# exit

Router(config)# ip rsvp policy identity RSVP-VIDEO policy-locator .*VideoStream.* !
Creates a policy for matching video traffic
Router(config)# ip rsvp policy identity RSVP-VOICE policy-locator .*AudioStream.* !
Creates a policy for matching voice traffic
Router(config)# ip rsvp policy preempt ! Enables preempting of lower reservation by higher
reservation
```

The RSVP policy must be applied on the voice VLAN interface.

```
Branch(config)# interface GigabitEthernet2/0.2 ! Enters gigabit Ethernet sub-interface 2
configuration mode
Router(config-if)# ip rsvp bandwidth ! Enables RSVP on the interface
Router(config-if)# exit
```

Cisco Unified SRST with SIP Endpoints: Transcoding and Conferencing Implementation

Transcoding compresses and decompresses voice streams to match end device capabilities. Transcoding is required when an incoming voice stream is digitized and compressed (by means of a codec) to save bandwidth and the local device does not support that type of compression. Transcoding and conferencing are configured on the Cisco Call Manager of the central site, as shown in [Figure 35](#) and [Figure 36](#).

```
Router(config)# voice-card 0 ! Enters DSP farm configuration mode
Router(config-voicecard)# dsp services dspfarm ! Enables DSP services
Router(config-voicecard)# exit
Router(config)# sccp local GigabitEthernet2/0.2 ! Sets the interface for conferencing and
transcoding to register with CME
Router(config)# sccp ccm 10.0.1.2 identifier 1 version 5.0.1 ! Associates conferencing
and transcoding with CME
```

```

Router(config)# sccp ! Enables SCCP globally
Router(config)# sccp ccm group 1 ! Creates SCCP group and enters SCCP configuration mode
Router(config-sccp-ccm)# associate ccm 1 priority 1 ! Associates SCCP group 1 with CME
Router(config-sccp-ccm)# associate ccm 2 priority 2 ! Associates SCCP group 2 with CME
Router(config-sccp-ccm)# associate profile 3 register CONFERENCE ! Associates DSP farm
profile with with a SCCP group
Router(config-sccp-ccm)# associate profile 2 register TRANSCODE ! Associates DSP farm
profile with with a SCCP group
Router(config-sccp-ccm)# exit

Router(config)# dspfarm profile 2 transcode ! Enters DSP farm profile configuration mode
Router(config-dspfarm-profile)# codec g711ulaw ! Specifies codec supported by DSP farm
Router(config-dspfarm-profile)# codec g711alaw ! Specifies codec supported by DSP farm
Router(config-dspfarm-profile)# codec g729ar8 ! Specifies codec supported by DSP farm
Router(config-dspfarm-profile)# codec g729abr8 ! Specifies codec supported by DSP farm
Router(config-dspfarm-profile)# codec g729r8 ! Specifies codec supported by DSP farm
Router(config-dspfarm-profile)# codec pass-through ! Specifies codec supported by DSP farm
Router(config-dspfarm-profile)# maximum sessions 5 ! Specifies maximum number of
simultaneous sessions supported by this profile
Router(config-dspfarm-profile)# associate application sccp ! Associates SCCP with this DSP
farm profile
Router(config-dspfarm-profile)# no shutdown
Router(config-dspfarm-profile)# exit

Router(config)# dspfarm profile 3 conference ! Enters DSP farm profile configuration mode
Router(config-dspfarm-profile)# codec g711ulaw ! Specifies codec supported by DSP farm
Router(config-dspfarm-profile)# codec g711alaw ! Specifies codec supported by DSP farm
Router(config-dspfarm-profile)# codec g729ar8 ! Specifies codec supported by DSP farm
Router(config-dspfarm-profile)# codec g729abr8 ! Specifies codec supported by DSP farm
Router(config-dspfarm-profile)# codec g729r8 ! Specifies codec supported by DSP farm
Router(config-dspfarm-profile)# codec g729br8 ! Specifies codec supported by DSP farm
Router(config-dspfarm-profile)# maximum sessions 3 ! Specifies maximum number of
simultaneous sessions supported by this profile
Router(config-dspfarm-profile)# associate application sccp ! Associates SCCP with this DSP
farm profile
Router(config-dspfarm-profile)# no shutdown
Router(config-dspfarm-profile)# exit

```

Figure 35 Transcoding Configuration for Cisco Unified SRST Mode

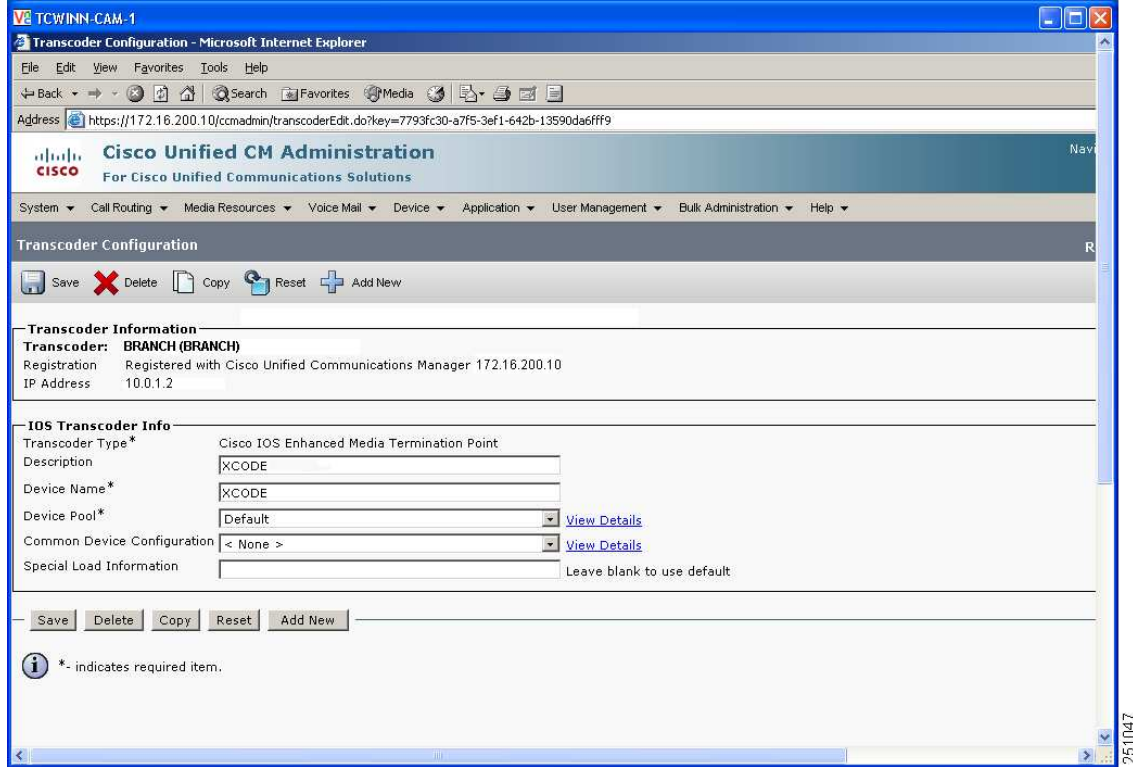
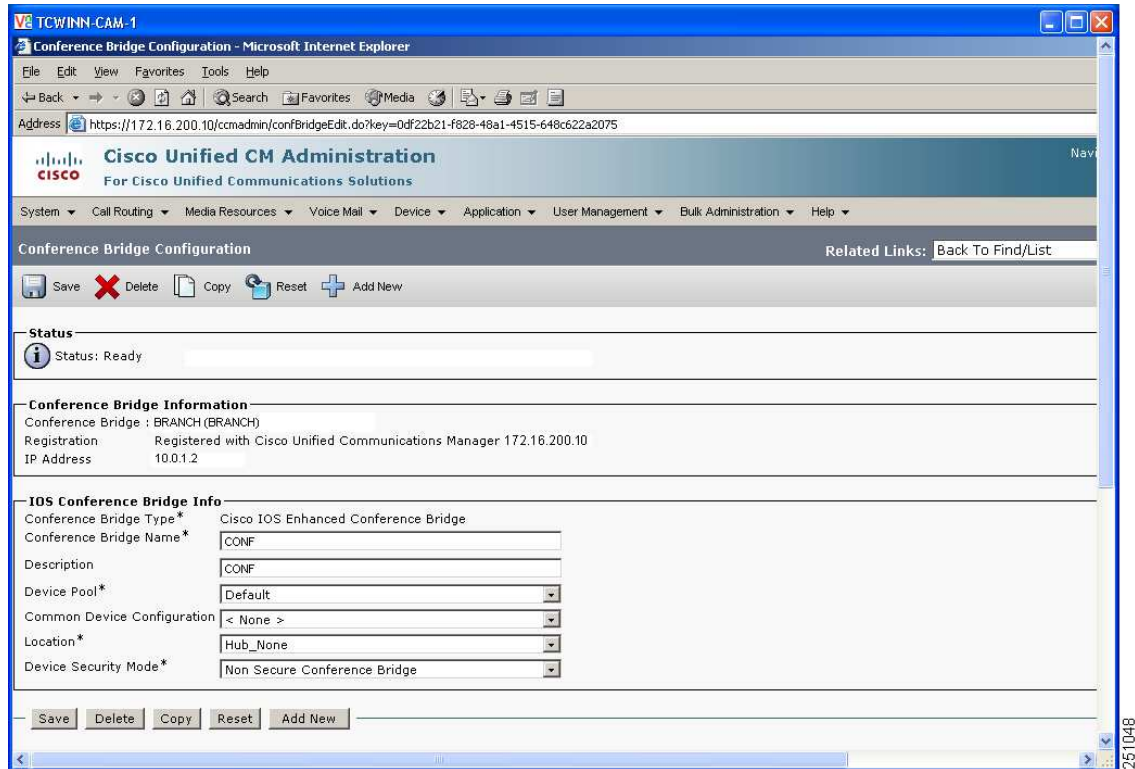

Figure 36 Conferencing Configuration for Cisco Unified SRST Mode



Cisco Unified SRST with SIP Endpoints: Music on Hold Implementation

Music on hold (MOH) is implemented at the Unified Call Manager at the central site. Please see the following instructions to implement MOH in Cisco Unified CM:

http://www.cisco.com/en/US/docs/voice_ip_comm/cucm/admin/6_1_1/ccmfeat/fsmoh.html

Cisco Unified SRST with SIP Endpoints: Voice Mail and Auto Attendant Integration

Voice mail is provided by the Cisco Unity Express service module either in the Advanced Integration Module (AIM) form factor or the Network Module (NME) form factor. The AIM module requires the following configuration. To configure the NME, substitute *Integrated-Service-Engine 2/0* for *Service-Engine 0/1*.

```
Router(config)# interface Service-Engine 0/1 ! Enters Cisco Unity Express configuration mode
Router(config-if)# ip address 10.0.2.86 255.255.255.252 ! Assigns IP address to the service engine router interface
Router(config-if)# service-module ip address 10.0.2.85 255.255.255.252 ! Assigns IP address to service module internal interface
Router(config-if)# service-module ip default-gateway 10.0.2.86 ! Assigns default gateway for the service module
Router(config-if)# zone-member security Private ! Assigns Cisco Unity Express to private security zone
Router(config-if)# no shutdown
Router(config-if)# exit
Router(config)# ip route 10.0.2.84 255.255.255.252 Service-Engine 0/1 ! Adds a static route entry to direct traffic to the module
```

Configure a dial peer for voice mail, because Cisco Unity Express uses SIP as its signaling protocol.

```
Router(config)# dial-peer voice 8 voip ! Enters dial peer for voicemail configuration mode
Router(config-dial-peer)# destination-pattern 5444 ! Specifies mailbox extension
Router(config-dial-peer)# session target ipv4:10.0.2.85 ! Specifies voicemail address
Router(config-dial-peer)# session protocol sipv2! Enables SIP for voicemail communication
Router(config-dial-peer)# codec g711ulaw ! Specifies codec for voicemail messages
Router(config-dial-peer)# b2bua ! Enables SIP to SCCP forwarding
Router(config-dial-peer)# dtmf-relay sip-notify! Specifies DTMF relay method
Router(config-dial-peer)# no vad ! Disables voice activity detection
Router(config-peer)# exit
```

```
Router(config)# dial-peer voice 9 voip ! Enters dial peer for autoattendant configuration mode
Router(config-dial-peer)# destination-pattern 5000 ! Specifies mailbox extension
Router(config-dial-peer)# session target ipv4:10.0.2.85 ! Specifies voicemail address
Router(config-dial-peer)# session protocol sipv2! Enables SIP for voicemail communication
Router(config-dial-peer)# codec g711ulaw ! Specifies codec for voicemail messages
Router(config-dial-peer)# b2bua ! Enables SIP to SCCP forwarding
Router(config-dial-peer)# dtmf-relay sip-notify! Specifies DTMF relay method
Router(config-dial-peer)# no vad ! Disables voice activity detection
Router(config-peer)# exit
```

The local Cisco Unity Express software must be registered with Cisco Unified CM software at the central site. The following reference provides implementation details:

http://cisco.com/en/US/products/sw/voicesw/ps5520/products_configuration_example09186a0080289ef0.shtml

Additional Cisco Unity Express configuration is performed through a web-based user interface, as shown in [Figure 17](#) through [Figure 22](#).

Cisco Unified SRST with SIP Endpoints: Emergency Services Implementation

The following example implements emergency number calling for North America. The PRI trunk is used for placing emergency calls. Each 911 call is selectively routed to the closest PSAP based on the caller's location. In addition, the caller's phone number and address automatically display on a terminal at the PSAP. The PSAP can quickly dispatch emergency help, even if the caller is unable to communicate the caller's location. Also, if the caller disconnects prematurely, the PSAP has the information it needs to contact the 911 caller.

```
Router(config)# voice emergency response location 1 ! Enters emergency response configuration mode
Router(cfg-emrgncy-resp-location)# elin 1 4085555150 ! Specifies ELIN number provided by PSAP
Router(cfg-emrgncy-resp-location)# subnet 1 10.0.1.0 255.255.255.0 ! Assigns Voice VLAN subnet as origination of the emergency call
Router(cfg-emrgncy-resp-location)# subnet 2 10.0.4.0 255.255.255.0 ! Assigns backup Voice VLAN subnet as origination of the emergency call

Router(cfg-emrgncy-resp-location)# exit

Router(config)# dial-peer voice 10 pots ! Enters dial peer for emergency calls configuration mode
Router(config-dial-peer)# emergency response zone ! Replaces local extension with ELIN number
Router(config-dial-peer)# destination-pattern 911 ! Specifies North America emergency number
Router(config-dial-peer)# direct-inward-dial ! Enables DID numbers
Router(config-dial-peer)# port 0/0/0:23 ! Specifies outgoing/incoming interface for calls
Router(config-peer)# exit
```

```

Router(config)# dial-peer voice 11 pots ! Enters dial peer for local area calls
configuration mode
Router(config-dial-peer)# emergency response zone ! Replaces local extension with ELIN
number
Router(config-dial-peer)# destination-pattern 9911 ! Specifies area code prefix for
central site dial peer
Router(config-dial-peer)# prefix 911 ! Prefix that the system adds automatically to the
dial string
Router(config-dial-peer)# direct-inward-dial ! Enables DID numbers
Router(config-dial-peer)# port 0/0/0:23 ! Specifies outgoing/incoming interface for calls
Router(config-peer)# exit

Router(config)# dial-peer voice 12 pots ! Enters dial peer for ELIN callback configuration
mode
Router(config-dial-peer)# incoming called-number 4085555150 ! Specifies ELIN number
Router(config-dial-peer)# direct-inward-dial ! Enables DID numbers
Router(config-dial-peer)# emergency response callback ! Identifies the ELIN dial peer
Router(config-peer)# exit

Router(config)# dial-peer voice 13 pots ! Enters dial peer for ELIN callback configuration
mode
Router(config-dial-peer)# incoming called-number 4085555150 ! Specifies ELIN number
Router(config-dial-peer)# direct-inward-dial ! Enables DID numbers
Router(config-dial-peer)# emergency response callback ! Identifies the ELIN dial peer
Router(config-peer)# exit

```

Optimization Services Implementation

- [Cisco WAAS Implementation, page 140](#)
- [Router and Cisco WAE Module Configuration, page 141](#)
- [Additional Cisco WAE–Application Accelerator Configuration, page 142](#)
- [Cisco WAE–Central Manager Implementation, page 145](#)

Cisco WAAS Implementation

In the Services Ready Medium Branch Network, the Cisco NME-WAE-522 network module was used to optimize the Common Internet File System (CIFS), FTP, and HTTP traffic.

Two types of configuration are applied to devices that run Cisco Wide Area Application Services (Cisco WAAS):

- Router and Cisco WAE module configuration
- Central manager configuration

After the router and module configurations are complete, the Cisco Wide Area Application Engine (Cisco WAE) module can be registered with the central manager. Registration with the central manager requires that all router configuration steps be complete, and that the Cisco WAE be able to connect to the central manager. After the Cisco WAE has been registered and activated with the central manager, all additional configuration options can be set through the central manager device groups.

The central manager configuration provides the remaining configuration for the entire Cisco WAAS deployment. The central manager configuration options can be applied at the device or device group level. To simplify the deployment and management of the Cisco WAAS solution, the Services Ready Medium Branch Network uses device groups as the primary central manager configuration method.

Router and Cisco WAE Module Configuration

The router provides Cisco Web Cache Communication Protocol (Cisco WCCP) interception points for Cisco WAAS. Cisco WCCP redirection allows the router to redirect traffic to Cisco WAAS for optimization. Various methods of interception and redirection are supported by routers and switches. Redirection methods depend on the speed requirements and the router or switch platform. This deployment uses both generic router encapsulation (GRE) redirection and Layer 2 (L2) redirection.

The loopback interface on the router is essential for identifying the router ID. Although any IP address can be used to identify the router ID, the loopback interface is preferred over the physical interfaces. Loopback interfaces are always available, and there are no physical ties to them. Other routing protocols also use loopback interfaces as the preferred method for naming the router ID. If the IP address is tied to a specific physical interface, and the physical interface fails, then the IP address becomes unavailable, causing unexpected problems for the Cisco WCCP groups.

The Cisco WCCPv2 services 61 and 62, also known as *TCP promiscuous mode services*, allow the Cisco WCCP to transparently intercept and redirect traffic to the Cisco WAE module. Service 61 redirects ingress traffic, and service 62 redirects egress traffic. Services 61 and 62 are both needed to redirect bidirectional traffic flow. Passwords should be assigned to Cisco WCCP groups to prevent rogue traffic interception and redirection.

```
Branch(config)# ip wccp 61 ! Enables WCCP services
Branch(config)# ip wccp 62 ! Enables WCCP services
Branch(config)# ip inspect WAAS enable ! Enables inspection of packets coming from WAE
Branch(config)# interface Integrated-Service-Engine 1/0 ! Enters WAE module configuration mode
Branch(config-if)# ip address 10.0.2.90 255.255.255.252 ! Assigns IP address to the backplane interface
Branch(config-if)# ip wccp redirect exclude in ! Excludes packets received on this interface from redirection to prevent a traffic loop
Branch(config-if)# zone-member security Private ! Assigns the interface to a private zone
Branch(config-if)# service-module ip address 10.0.2.89 255.255.255.252 ! Assigns IP address to service module internal interface
Branch(config-if)# service-module ip default-gateway 10.0.2.90 ! Assigns default gateway for the service module
Branch(config-if)# no keepalive ! Disables keep alive for the interface
Branch(config-if)# exit
Router(config)# ip route 10.0.2.88 255.255.255.252 Integrated-Service-Engine 1/0 ! Adds a static route entry to direct traffic to the module
```

Apply WCCP redirection on WAN, Tunnel, and LAN interfaces

```
Branch(config)# interface Serial3/0.1 point-to-point ! Enters Tunnel interface configuration mode
Branch(config)# ip wccp 62 redirect in ! Enables WCCP redirection on the WAN interface

Branch(config)# interface Tunnel1 ! Enters Tunnel interface configuration mode
Branch(config)# ip wccp 62 redirect in ! Enables WCCP redirection on the Tunnel interface

Branch(config)# interface GigabitEthernet2/0.1 ! Enters Tunnel interface configuration mode
Branch(config)# ip wccp 61 redirect in ! Enables WCCP redirection on the Tunnel interface
```

Configurations for LAN, WAN, and tunnel interfaces are provided in the “WAN Services Implementation” section on page 4, the “LAN Services Implementation” section on page 10, and the “Security Services Implementation” section on page 43.

Additional Cisco WAE–Application Accelerator Configuration

Additional commands are necessary to complete the Cisco WAE implementation.

```
Router(config)# service-module integrated-Service-Engine 1/0 session ! Sessions into the
WAE service module
Trying 10.0.2.90, 2066 ... Open
```

Cisco Wide Area Application Engine Console

```
Username: admin
Password:
System Initialization Finished.
WAE(config)# device mode application-accelerator ! Sets the WAE module to application
acceleration mode (the default)
WAE(config)# primary-interface GigabitEthernet 1/0 ! Sets the primary interface for
traffic interception and delivery
WAE(config)# ip name-server 172.16.0.70 ! Assigns central site DNS server for the module
WAE(config)# ntp server 172.16.0.60! Assigns central site NTP server for the module
WAE(config)# central-manager address 172.16.100.1 ! Assigns the Central Manager for the
module
WAE(config)# wccp router-list 1 10.0.2.90 ! Adds the router to the WCCPv2 router list
WAE(config)# wccp tcp-promiscuous router-list-num 1 ! Enables TCP promiscuous mode to
accept all traffic on the router's primary interface
```

The Cisco WCCP configuration for TCP promiscuous mode services 61 and 62 succeeded. The Cisco WCCP configuration for TCP promiscuous mode services succeeded. Remember to configure Cisco WCCP services 61 and 62 on the corresponding router.

```
WAE(config)# wccp version 2 ! Enables WCCP version 2
WAE(config)# cms enable ! Initializes the local database and connects to the central
manager
```

The following traffic interception policies can be automatically configured from the Cisco WAE central manager. The CLI version of these policies is provided for demonstration purposes and as a starting point for customization.

```
WAE(config)# policy-engine application name File-Transfer ! Creates a new application name
for FTP traffic
WAE(config)# policy-engine application name WEB ! Creates a new application name for HTTP
traffic
WAE(config)# policy-engine application name WAFS ! Creates a new application name for file
system traffic
WAE(config)# policy-engine application classifier FTP-Control ! Creates application
classifier for FTP control traffic
WAE(config-app-cls)# match dst port eq 21 ! Matches traffic with destination port 21
WAE(config-app-cls)# exit
WAE(config-pol-eng-app)# exit
WAE(config)# policy-engine application classifier FTP-Data ! Creates application
classifier for FTP data traffic
WAE(config-app-cls)# match dst port eq 20 ! Matches traffic with destination port 20
WAE(config-app-cls)# exit
WAE(config-pol-eng-app)# exit
WAE(config)# policy-engine application classifier HTTP ! Creates application classifier
for HTTP traffic
WAE(config-app-cls)# match dst port eq 80 ! Matches traffic with destination port 80
WAE(config-app-cls)# match dst port eq 8080 ! Matches traffic with destination port 8080
WAE(config-app-cls)# match dst port eq 8000 ! Matches traffic with destination port 8000
WAE(config-app-cls)# match dst port eq 8001 ! Matches traffic with destination port 8001
WAE(config-app-cls)# match dst port eq 3128 ! Matches traffic with destination port 3128
WAE(config-app-cls)# exit
```

```

WAE(config-pol-eng-app)# exit
WAE(config)# policy-engine application classifier CIFS ! Creates application classifier
for CIFS traffic
WAE(config-app-cls)# match dst port eq 139 ! Matches traffic with destination port as 139
WAE(config-app-cls)# match dst port eq 445 ! Matches traffic with destination port as 445
WAE(config-app-cls)# exit
WAE(config-pol-eng-app)# exit
WAE(config)# policy-engine application map basic name File-Transfer classifier FTP-Control
action pass-through ! Assigns FTP application to a classifier and specifies the action to
be taken for matching FTP control traffic
WAE(config)# policy-engine application map basic name File-Transfer classifier FTP-Data
action optimize full ! Assigns FTP application to a classifier and specifies the action to
be taken for matching FTP data traffic
WAE(config)# policy-engine application map basic name Web classifier HTTP action optimize
full ! Assigns HTTP application to a classifier and specifies the action to be taken for
matching HTTP traffic
WAE(config)# policy-engine application map basic name WAFS classifier CIFS action optimize
full accelerate cifs-adaptor ! Assigns WAFS application to a classifier and specifies the
action to be taken for matching CIFS traffic. Uses CIFS specific application adaptor
WAE(config)# policy-engine application map adaptor WAFS transport name WAFS All action
optimize full ! Assigns WAFS application to a classifier and specifies the action to be
taken for matching CIFS traffic

```

Activating the Application Accelerators

For security purposes, Cisco WAEs that are being added to the Cisco WAAS network need to be approved by the Cisco WAAS network administrator. This security feature prevents unauthorized devices from joining the Cisco WAAS network. This section provides steps for activating all the inactive devices.

To activate the devices, from the Cisco WAAS Central Manager window, choose **Devices > Devices**.

1. In the taskbar, click the **Activate All Inactive WAEs** icon, shown in the red box in [Figure 37](#), to activate the two inactive Cisco WAEs.

Figure 37 **Devices Window**



2. The Activate All Inactive WAE window appears, as shown in [Figure 38](#). By default, the **Create a new location for each inactive WAE** option is chosen.

Figure 38 **Activating Inactive Cisco WAEs**

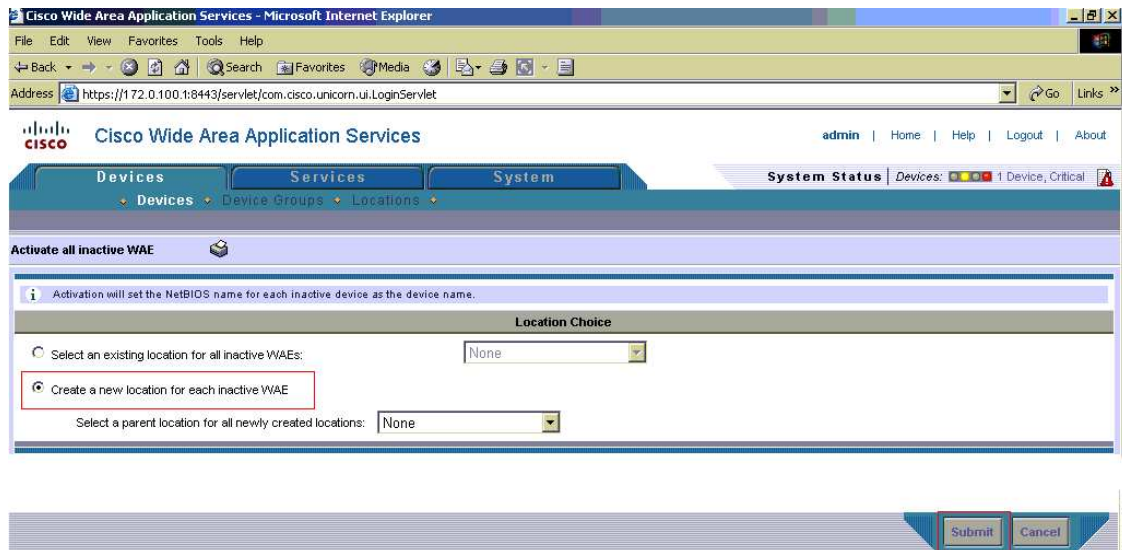

3. Click **Submit** at the bottom of the page.

4. When a Transaction Warning dialog box appears, click **OK**, and then click **Submit**. The current state of the core and edge Cisco WAEs is now listed as pending instead of inactive, as shown in the red box in the middle of [Figure 39](#). Notice in the red box at the top of the [Figure 39](#) that the system status has changed to orange, with two devices reporting Major.

Figure 39 **Pending Devices**

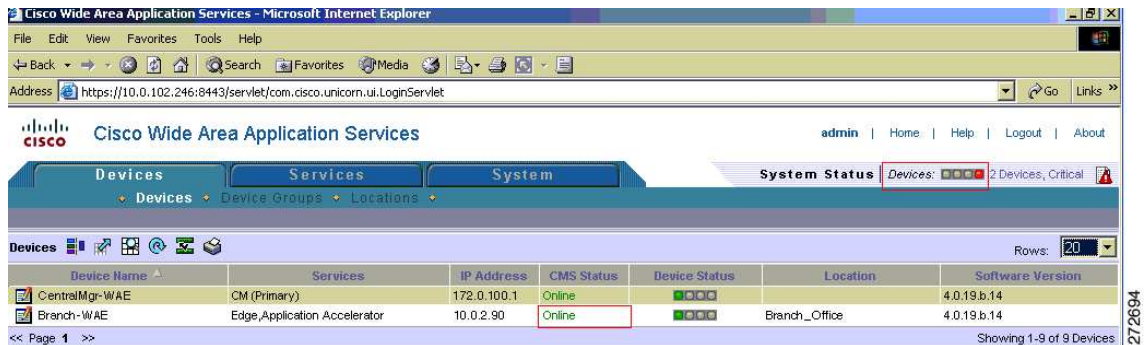

5. After a few minutes, all devices show Online in the Status column, as shown in [Figure 40](#).

Figure 40 Online Devices

Device Name	Services	IP Address	CMS Status	Device Status	Location	Software Version
CentralMgr-WAE	CM (Primary)	172.0.100.1	Online	●●●●		4.0.19.b.14
Branch-WAE	Edge, Application Accelerator	10.0.2.90	Online	●●●●	Branch_Office	4.0.19.b.14

Cisco WAE–Central Manager Implementation

The central manager is the management component of Cisco WAAS. The central manager provides a GUI for configuration, monitoring, and management of multiple branch-office and data center Cisco WAEs. The central manager can scale to support thousands of Cisco WAE devices for large-scale deployments. The central manager must be used in order to make configuration changes through the web interface. If the central manager fails, the Cisco WAEs continue to function; however, changes cannot be made using the web pages on the central manager until the central manager comes back online.

The Cisco WAEs need to connect to the central manager at the initial setup. The registration process adds the Cisco WAE to the central manager and initializes the local Cisco WAE database. When disk encryption on the Cisco WAE is enabled, the central manager must be available to distribute the encryption key if the Cisco WAE reboots.

Centralized reporting can be obtained from the central manager. Individually, the Cisco WAEs provide basic statistics through the CLI and local-device GUI. Systemwide application statistics are available from the central manager GUI. Detailed reports such as total traffic reduction, application mix, and pass-through traffic are available from the central manager GUI.

```

WAE-CM(config)# device mode central-manager ! Sets the WAE device to central manager mode.
The device is set to application acceleration by default
WAE-CM(config)# primary-interface GigabitEthernet 1/0 ! Sets the primary interface for
traffic interception and delivery
WAE-CM(config)# interface GigabitEthernet 1/0 ! Enters gigabit Ethernet configuration mode
for the specified port
WAE-CM(config-if)# ip address 172.16.100.1 255.255.255.0 ! Assigns IP address for the
interface
WAE-CM(config-if)# no shutdown
The interface was up.
WAE-CM(config-if)# exit
WAE-CM(config)# ip default-gateway 192.168.0.2 ! Assigns default gateway for the central
manager
WAE-CM(config)# ntp server 172.16.0.60 ! Assigns NTP server for the central manager
WAE-CM(config)# cms enable ! Starts centralized management service

```

Verify that the Cisco WAAS central manager process has successfully started by using an Internet Explorer browser to go to the following URL to start the Cisco WAAS Central Manager GUI shown in Figure 41:

https://cm_server_ip_or_host_name:8443

Figure 41 Cisco WAAS Central Manager GUI

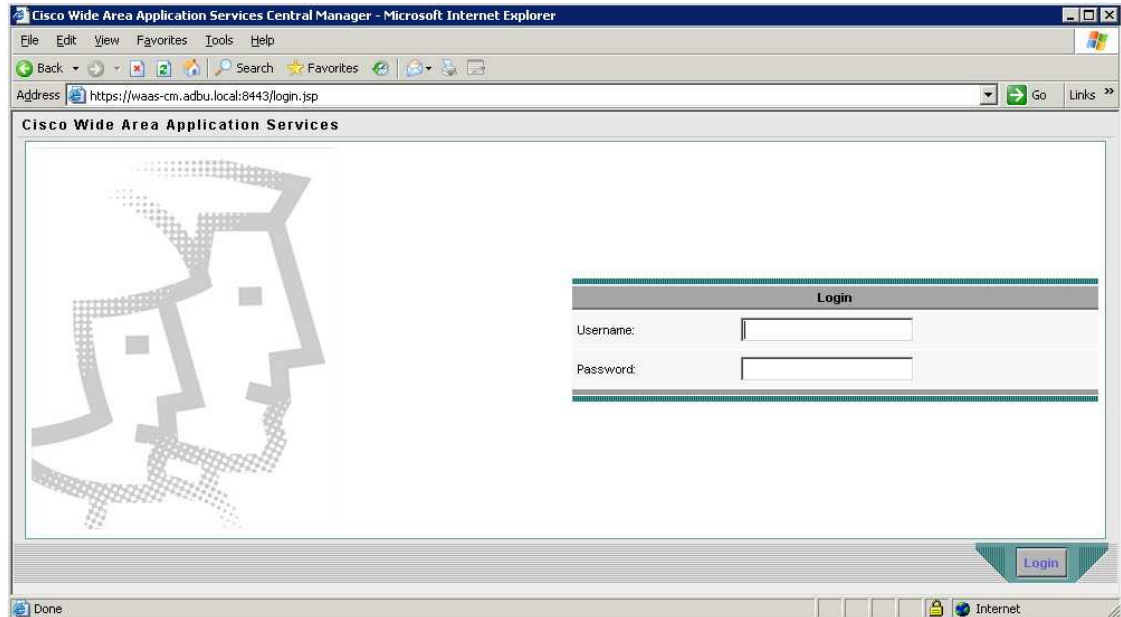

- Log in using the following default credentials:
 Username: admin
 Password: default
 The Devices window shown in [Figure 42](#) appears.

Figure 42 Devices Window



For ease of use and to start collecting statistics earlier, you need to change a few parameters. In the following steps, you extend the central manager session timeout interval and modify the intervals by which the Cisco WAAS central manager or Cisco WAE pulls or pushes data to and from the Cisco WAAS Central Manager.

- Choose **System > Configuration**. The Config Properties window shown in [Figure 43](#) appears.

Figure 43 Config Properties Window

Property Name	Value	Description
cdm.session.timeout	120	Session timeout for Central Manager GUI in minutes
DeviceGroup.overlap	true	Allow Devices to be in Multiple Device Groups
System.datafeed.pollRate	300	The configuration poll interval from WAE to CM in seconds. Recommend not setting below default 300
System.device.recovery.key	default	Device identity recovery key
System.guiServer.fqdn	IP Address	Choose between IP Address and FQDN to launch the Device GUI
System.healthmonitor.collectRate	60	The collect/send rate in seconds for device health/status monitor. If rate is set to 0 HealthMonitor will not collect
System.icm.enable	true	Allow configuration changes made on device to propagate to Central Manager
System.monitoring.collectRate	60	The rate at which WAE collects and sends monitoring reports to Central Manager in seconds
System.monitoring.dailyConsolidationHour	1	The hour at which CM consolidates hourly and daily monitoring records
System.monitoring.enable	true	Enable WAE statistics monitoring
System.monitoring.monthlyConsolidationFrequency	14	How frequently (in days) the Central Manager consolidates daily monitoring records into monthly records
System.monitoring.recordLimitDays	1825	The maximum number of days of monitoring data to maintain in the system
System.print.driverFtpTimeout	600	The maximum wait time to FTP files of a driver. If the FTP does not finish within this setting, the process will fail
System.rpc.timeout.syncGuiOperation	50	Timeout in seconds for GUI sync operations, CM to device connection.

3. Choose **ALL** from the Rows drop-down list shown in the red box in Figure 43.
4. Click the **Edit** icon next to the parameter to change each of the parameters in the red boxes 2 to 5 in Figure 43 to the following values:
 - cdm.session.timeout: 100
 - System.datafeed.pollRate: 60
 - System.healthmonitor.collectRate: 30
 - System.monitoring.collectRate: 60

Caveats

- Zone-based firewall does not support inspection of SIP and SCCP in releases earlier than Cisco IOS Release 12.4(20)T. See DDTs CSCsm79679.
- Zone-based firewall does not support stateful switchover.
- Message waiting indicator (MWI) does not work during router failover.
- Cisco Unified CME does not work with HSRP.
- Cisco web Cache Communication Protocol (Cisco WCCP) version 2 is not Virtual Routing and Forwarding (VRF) aware and does not work if multiple VRF interfaces (VRF-lite) are configured on the customer edge (CE) router.
- Call preservation is not supported during HSRP. Only local IP Phone calls may be preserved.
- Traffic shaping is not supported over virtual access interfaces with PPP over ATM. See DDTs CSCsm77478.
- VRF-aware IP SLA is not supported in releases earlier than Cisco IOS Release 12.4(20)T.

- Bidirectional Forwarding Detection (BFD) is supported only on Gigabit Ethernet interfaces. Support for additional WAN encapsulations such as Frame Relay and PPP is planned for future releases.
- GETVPN is not VRF aware in releases earlier than Cisco IOS Release 12.4(20)T.
- When registered to Cisco Unified CME, the Cisco Unified IP Conference Station 7936 running firmware version 1.1 continues to display message prompts such as “hold” and “enter number” after the call has ended. See DDTS CSCsm61235.

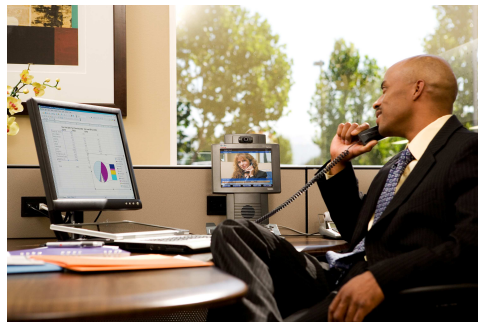

Configuration Verification

Revised: November 6, 2009

This chapter describes the **show** commands that you can use to display and verify your configuration.



Note

For more information see the following command references:

[Cisco IOS Debug Command Reference](#)
[Cisco IOS IP Addressing Services Command Reference](#)
[Cisco IOS IP Application Services Command Reference](#)
[Cisco IOS IP Multicast Command Reference](#)
[Cisco IOS IP Routing Protocols Command Reference](#)
[Cisco IOS LAN Switching Command Reference](#)
[Cisco IOS NetFlow Command Reference](#)
[Cisco IOS Quality of Service Solutions Command Reference](#)
[Cisco IOS Security Command Reference](#)
[Cisco IOS Voice Command Reference](#)
[Cisco IOS Master Command List, Release 12.4T](#)

Use the [Command Lookup Tool](#) (registered customers only) for more information on the commands used in this document.

Contents

- [General Configuration Verification, page 2](#)
- [QoS Verification, page 3](#)
- [Routing Verification, page 3](#)
- [Security Verification, page 4](#)
- [Voice Verification, page 5](#)
- [Cisco Unity Express Verification, page 7](#)
- [Cisco Wide Area Application Services Verification, page 7](#)

General Configuration Verification

- **show adjacency summary**

This command displays a summary of Cisco Express Forwarding (CEF) adjacency information.
- **show clock**

This command displays the time and date from the system software clock.
- **show interfaces status**

This command displays the interface status or a list of interfaces in an error-disabled state on LAN ports only.
- **show interfaces summary**

This command displays a summary of statistics for one interface or for all interfaces that are configured on a networking device.
- **show ip cache flow**

This command displays a summary of the NetFlow accounting statistics.
- **show ip flow export**

This command displays the status and the statistics for NetFlow accounting data export, including the main cache and all other enabled caches.
- **show ip wccp**

This command displays global statistics related to Cisco Web Cache Communication Protocol (Cisco WCCP).
- **show logging**

This command displays the state of system logging (syslog) and the contents of the standard system logging buffer.
- **show memory dead**

This command displays statistics on memory allocated by processes that have terminated.
- **show memory debug leaks**

This command displays detected memory leaks.
- **show memory free**

This command displays statistics about free memory when Cisco IOS software or Cisco IOS Software Modularity images are running.
- **show mls qos interface policers**

This command displays all the policers configured on the interface, their settings, and the number of policers unassigned.
- **show ntp status**

This command displays statistics for the Network Time Protocol (NTP) server.
- **show processes cpu**

This command displays detailed CPU utilization statistics (CPU use per process) when Cisco IOS software or Cisco IOS Software Modularity images are running.

- **show processes memory**

This command shows the amount of memory used by each system process in Cisco IOS software or Cisco IOS Software Modularity images.

- **show spanning-tree**

This command displays Spanning Tree information for the specified Spanning Tree instances.

QoS Verification

- **show class-map**

This command displays all class maps and their matching criteria.

- **show ip nbar protocol-discovery**

This command displays the statistics gathered by the Network Based Application Recognition (NBAR) protocol discovery feature.

- **show mls qos**

This command displays multilayer switching (MLS) quality of service (QoS) information.

- **show mls qos interface**

This command displays QoS information for the specified interface.

- **show mls qos maps**

This command displays information about the QoS mapping.

- **show policy-map**

This command displays the configurations of all classes for a specified service policy map or all classes for all existing policy maps.

- **show policy-map interface**

This command displays the statistics and the configurations of the input and output policies that are attached to an interface.

Routing Verification

- **show bfd neighbors**

This command displays a line-by-line listing of existing Bidirectional Forwarding Detection (BFD) adjacencies.

- **show ip bgp**

This command displays entries in the Border Gateway Protocol (BGP) routing table.

- **show ip bgp neighbors**

This command displays information about BGP and TCP connections to neighbors.

- **show ip bgp summary**

This command displays the status of all BGP connections.

- **show ip dhcp binding**

This command displays address bindings on the Cisco IOS DHCP server.

- **show ip dhcp server statistics**
This command displays Cisco IOS DHCP server statistics.
- **show ip eigrp neighbors**
This command displays neighbors discovered by Enhanced Interior Gateway Routing Protocol (EIGRP).
- **show ip mroute active**
This command displays the contents of the multicast routing (mroute) table. Displays the rate that active sources are sending to multicast groups, in kilobits per second.
- **show ip mroute count**
This command displays the contents of the multicast routing (mroute) table. Displays statistics about the group and source, including number of packets, packets per second, average packet size, and bytes per second.
- **show ip nat translations**
This command displays active Network Address Translations (NATs).
- **show ip nat statistics**
This command displays NAT statistics.
- **show ip ospf neighbors**
This command displays Open Shortest Path First (OSPF)–neighbor information on a per-interface basis.
- **show ip route**
This command displays the current state of the routing table.

Security Verification

- **show crypto engine accelerator statistics**
This command displays a summary of the configuration information for the crypto accelerator.
- **show crypto engine connections active**
This command displays a summary of the configuration information for the crypto engine connections.
- **show crypto gdoi**
This command displays information about a Group Domain of Interpretation (GDOI) configuration.
- **show crypto gdoi ipsec sa**
This command displays information about the IPsec security association (SA) for all group members.
- **show crypto ipsec sa**
This command displays the settings used by current SAs.
- **show crypto isakmp sa**
This command displays current Internet Key Exchange (IKE) SAs.
- **show crypto session**
This command displays status information for active crypto sessions.

- **show ip ips interfaces**
This command displays the Cisco IOS Intrusion Prevention System (IPS) interface configuration.
- **show ip ips sessions**
This command displays the Cisco IOS IPS session-related information.
- **show ip ips signatures**
This command displays the Cisco IOS IPS signature information, such as which signatures are disabled and marked for deletion.
- **show ip ips statistics**
This command displays the Cisco IOS IPS information such as the number of packets audited and the number of alarms sent.
- **show policy-map type inspect**
This command displays a specified policy map.
- **show policy-map type inspect zone-pair**
This command displays the runtime inspect type policy map statistics and other information such as sessions existing on a specified zone pair.
- **show standby**
This command displays Hot Standby Router Protocol (HSRP) information.
- **show webvpn gateway**
This command displays the status of a Secure Socket Layer (SSL) Virtual Private Network (VPN) gateway.
- **show webvpn context**
This command displays the operational status and configuration parameters for SSL VPN context configurations.
- **show webvpn session context**
This command displays a list of active SSL VPN user sessions for only the named context.
- **show webvpn session user**
This command displays detailed information about the named SSL VPN user session.
- **show webvpn stats**
This command displays SSL VPN application and network statistics.
- **show zone-pair security**
This command displays the source zone, destination zone, and policy attached to the zone pair.
- **show zone security**
This command displays information about the security zone, including the name and description.

Voice Verification

- **show call active voice brief**
This command displays a truncated version of call information for voice calls in progress.

- **show call-manager-fallback all**

This command displays the Cisco Unified Communications Manager fallback configuration and statistics.
- **show dial-peer voice summary**

This command displays a short summary of information for each voice dial peer.
- **show dspfarm**

This command displays digital signal processor (DSP) farm-service information such as operational status and DSP resource allocation for transcoding and conferencing.
- **show dspfarm dsp all**

This command displays DSP-farm DSP global information.
- **show ephone offhook**

This command displays information and packet counts for the phones that are currently off hook.
- **show ephone registered**

This command displays the status of registered phones.
- **show ephone summary**

This command displays brief information about Cisco IP Phones.
- **show rtpspi call**

This command displays Real-time Transport Protocol (RTP) service provider interface active call details.
- **show sccp all**

This command displays all Skinny Client Control Protocol (SCCP) global information, such as administrative and operational status.
- **show sccp connections summary**

This command displays a summary of the number of sessions and connections based on the service type under the SCCP application.
- **show sip-ua status registrar**

This command displays status for the SIP user agent (UA) registrar clients.
- **show telephony-service all**

This command displays detailed configuration for phones, voice ports, and dial peers in a Cisco Unified Communications Manager Express (Cisco Unified CME) system.
- **show voice call status**

This command displays the status of active calls.
- **show voice call summary**

This command displays the current settings and state of voice ports on the Cisco router, regardless of port activity.
- **show voice dsp**

This command displays the current status or selective statistics of DSP voice channels.
- **show voice port summary**

This command displays a summary of configuration information for all voice ports.

- **show voice register all**
This command displays all Session Initiation Protocol (SIP) Cisco Unified Survivable Remote Site Telephony (Cisco Unified SRST) and Cisco Unified CME configurations and register information.
- **show voip rtp connections**
This command displays (RTP) named event packets.

Cisco Unity Express Verification

- **show ccn application**
This command displays the currently configured applications.
- **show ccn engine**
This command display details of the configured Cisco Unity Express software engine.
- **show ccn subsystem jtapi**
This command display the JTAPI subsystem parameters.
- **show ccn subsystem sip**
This command display the SIP subsystem parameters.
- **show system language installed**
This command displays the languages that are available for use.
- **show voicemail configuration**
This command displays the configured From address for outgoing e-mail.
- **show voicemail detail**
This command displays the details for a general delivery mailbox or a subscriber with the name value.
- **show voicemail limits**
This command displays default values for all mailboxes.
- **show voicemail mailboxes**
This command displays all configured mailboxes and their current storage status.
- **show voicemail messages future**
This command displays all messages scheduled for future delivery.
- **show voicemail users**
This command lists all the local voice-mail subscribers.

Cisco Wide Area Application Services Verification

- **show cifs auto-discovery**
This command displays Common Internet File System (CIFS) autodiscovery status and run-time data.

- **show cifs cache**
This command displays CIFS cache information.
- **show cifs connectivity peers**
This command displays run-time information on edge-core connectivity and a list of connected cores.
- **show cifs sessions count**
This command displays run-time information on active CIFS sessions and the number of pending CIFS requests.
- **show cifs sessions list**
This command displays run-time information on active CIFS sessions and a list of connected CIFS sessions.
- **show device-mode**
This command displays the configured or current device mode of a Cisco Wide Area Application Services (WAAS) device.
- **show disks details**
This command displays detailed SMART disk monitoring information for Cisco WAAS device disks.
- **show egress-methods**
This command displays the egress method that is configured and that is being used on a particular Cisco WAE.
- **show policy-engine status**
This command displays high-level information about a Cisco Wide Area Application Engine (Cisco WAE): Cisco WAE's policy engine.
- **show policy-engine application classifier**
This command displays information about the specified application classifier.
- **show statistics cifs**
This command displays the CIFS statistics information.
- **show statistics dre**
This command displays data redundancy elimination (DRE) general statistics for a Cisco WAE.
- **show statistics tfo**
This command displays TFO statistics for a Cisco WAE.
- **show tfo auto-discovery**
This command displays TFO auto discovery statistics for a Cisco WAE.
- **show tfo status**
This command displays global Traffic Flow Optimization (TFO) status information for a Cisco WAE.
- **show tfo connections**
This command displays Traffic Flow Optimization (TFO) connection information for a Cisco WAE.
- **show tfo connections summary**
This command displays a summary list of TFO connections for a Cisco WAE.

- **show wccp**
This command displays Cisco Web Cache Communication Protocol (Cisco WCCP) information for a Cisco WAE.
- **show wccp gre**
This command displays Cisco WCCP generic routing encapsulation (GRE) packet-related information
- **show wccp routers**
This command displays routers seen and not seen by this Cisco WAE.
- **show wccp status**
This command displays the version of Cisco WCCP that is enabled and running.

Additional Command Reference Documentation

See the following command references for more information:

- [Cisco IOS Configuration Fundamentals Command Reference](#)
- [Cisco IOS IP Addressing Services Command Reference](#)
- [Cisco IOS IP Application Services Command Reference](#)
- [Cisco IOS IP Multicast Command Reference](#)
- [Cisco IOS IP Routing Protocols Command Reference](#)
- [Cisco IOS LAN Switching Command Reference](#)
- [Cisco IOS NetFlow Command Reference](#)
- [Cisco IOS Quality of Service Solutions Command Reference](#)
- [Cisco IOS Security Command Reference](#)

The [Output Interpreter Tool \(registered customers only\)](#) (OIT) supports certain **show** commands. Use the OIT to view an analysis of the **show** command output.

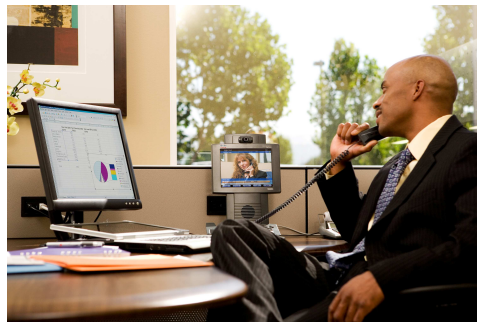

Troubleshooting

Revised: November 6, 2009

This chapter describes the **debug** commands you can use to troubleshoot your configuration.

The OIT [Output Interpreter Tool](#) (registered customers only) supports certain **show** commands. Use the OIT to view an analysis of **show** command output.



Note

See the [Important Information on Debug Commands](#) before you use **debug** commands.

See the [Cisco IOS Debug Command Reference](#) for more information.

Contents

- [Baseline Troubleshooting Commands, page 1](#)
- [Voice Troubleshooting Commands, page 2](#)
- [Cisco WAAS Troubleshooting Commands, page 2](#)

Baseline Troubleshooting Commands

- **debug aaa authentication**
- **debug bgp all events**
- **debug crypto gdoi**
- **debug crypto isakmp**
- **debug frame-relay events**
- **debug frame-relay lmi**
- **debug frame-relay packet**
- **debug h225 events**
- **debug ip inspect detailed**
- **debug ip inspect policy detailed**
- **debug ip ips category**

- `debug ip ips detailed`
- `debug ip ips function-trace`
- `debug ip ips idconf`
- `debug ppp multilink data`
- `debug ppp multilink events`
- `debug radius authentication`
- `debug qos cce`
- `debug qos events`
- `debug qos stats`

Voice Troubleshooting Commands

- `debug ephone detail`
- `debug sccp errors`
- `debug sccp events`
- `debug sccp keepalive`
- `debug sccp packets`
- `debug voice ccapi inout`
- `debug voice confmsp`
- `debug voice dsmp`
- `debug voice xcodemsp`
- `debug voip dialpeer`

Cisco WAAS Troubleshooting Commands

- `debug wccp events`
- `debug wccp error`

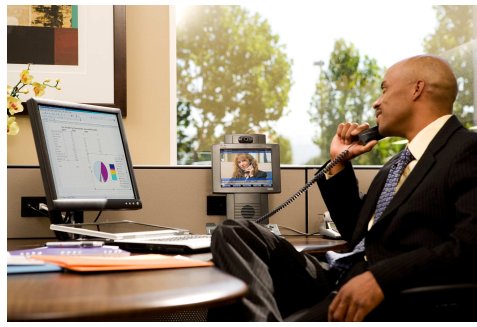

System Testing

Revised: November 6, 2009

This chapter describes the tests performed on the Services Ready Medium Branch Network.

Contents

- [Test Result Summary, page 1](#)
- [Test Setups, page 5](#)

Test Result Summary

Table 1 lists the test cases and their results.

Table 1 **Test Cases and Results**

Test Case	Result
DS3 Primary WAN Connections for Cisco 3900 Series Medium Branch	Passed
Gigabit Ethernet Primary WAN Connection for Cisco 3900 Series Medium Branch	Passed
MLPPP Primary WAN Connection for Cisco 3900 Series Medium Branch	Passed
MLFR Primary WAN Connection for Cisco 3900 Series Medium Branch	Passed
SHDSL IMA Secondary WAN Connection for Cisco 3900 Series Medium Branch	Passed
Interface Removal and Addition to SHDSL IMA Interface	Passed
Layer 2 Access Layer Switch	Passed
L2 Security–802.1x Authentication on the Access Layer Switch	Passed
L2 Security–DHCP Snooping and Dynamic ARP Inspection on Access Layer Switch	Passed
L2 Security–Port Security on the Access Layer Switch	Passed
L2 Security–IP Source Guard on the Access Layer Switch	Passed
L2 Security–BPDU Guard on the Access Layer Switch	Passed
QoS on the LAN	Passed
WAN Edge QoS–8 Class QoS Model	Passed

Table 1 **Test Cases and Results**

Test Case	Result
LLQ for Voice and Interactive Video Traffic	Passed
CBWFQ and WRED for Data Traffic	Passed
Traffic Shaping on Different WAN Links	Passed
DSCP/CoS Marking Incoming/Returning Traffic from WAN to LAN	Passed
Modification and Deletion of ACLs Defined with Class Map match access-group Command	Passed
Unconfigure and Reconfigure QoS	Passed
Unconfigure QoS, Reload Router, and Reconfigure QoS	Passed
BGP Routing on the Branch	Passed
OSPF Routing as IGP Between Branch and Headquarters Network	Passed
EIGRP Routing as IGP Between the Branch Router and the Headquarters Router	Passed
Traffic Measurement Using NetFlow When QoS is Enabled on the Branch Router	Passed
NBAR Classification with QoS	Passed
Modify Match Protocol Statements and Bandwidth Percentage	Passed
100 ACLs	Passed
NTP in the Branch Router	Passed
Branch Router as a DHCP Server	Passed
IP SLA VoIP UDP Jitter Codec G.711 u-law (Branch to HQ)	Passed
IP SLA VoIP UDP Jitter Codec G.729A u-law (Branch to HQ)	Passed
IP SLA ICMP Echo (Branch to HQ)	Passed
IPsec Site-to-Site VPN Using DMVPN	Passed
IPsec Using GETVPN	Passed
GETVPN Unicast Rekeying	Passed
GETVPN Multicast Rekeying	Passed
IPsec DMVPN with Prefragmentation	Passed
IPsec DMVPN and IGP	Passed
DMVPN Backup for MPLS Network (Branch to HQ)	Passed
DMVPN Backup for MPLS Network (Branch to Branch)	Passed
DMVPN Backup for MPLS Network Using BFD (Branch to HQ)	Passed
DMVPN Backup for MPLS Network Using BFD (Branch to Branch)	Passed
DMVPN Backup for MPLS Network Using BFD IGP as OSPF (Branch to Branch)	Passed
DMVPN Backup for MPLS Network Using EBGp (Branch to HQ)	Passed
DMVPN with QoS	Passed
GETVPN with QoS	Passed
DMVPN with QoS and NBAR	Passed
GETVPN with QoS and NBAR	Passed
DMVPN/GETVPN with QoS, NBAR, and NetFlow	Passed

Table 1 **Test Cases and Results**

Test Case	Result
Zone-based Policy Firewall Configuration on the Branch Router	Passed
NAT and PAT Configuration on the Branch Router	Passed
NAT, QoS, and NetFlow on the Branch	Passed
ZPF, QoS, and NetFlow on the Branch	Passed
ZPF, QoS, NBAR, and NetFlow on the Branch	Passed
ZPF, QoS, NBAR, NAT, and NetFlow on the Branch	Passed
ZPF with DMVPN	Passed
ZPF with GETVPN	Passed
IPsec, ZPF, QoS, NBAR, NAT, and NetFlow on the Branch	Passed
DDOS Prevention Using Cisco IOS IPS	Passed
Cisco IOS IPS with Background Data Traffic	Passed
ZPF with NAT and Cisco IOS IPS	Passed
IPsec, ZPF, QoS, NBAR, NAT, Cisco IOS IPS, and NetFlow on the Branch	Passed
Remote Users Using WebVPN (SSL VPN)	Passed
Remote Users Using WebVPN (SSL VPN) Full Tunnel	Passed
Complete Baseline Test	Passed
EtherChannel Uplink from Access Layer Switch	Passed
EIGRP Subsecond Convergence During Primary WAN Failure	Passed
OSPF Subsecond Convergence During Primary WAN Failure	Passed
IPsec over Backup SHDSL WAN Link	Passed
ZPF, NAT, and IPsec over Backup SHDSL WAN Link	Passed
IPsec, ZPF, QoS, NBAR, and NetFlow on Both Primary and Secondary Link, and NAT on the Secondary Link	Passed
Multicast with Security and QoS Features	Passed
Enable SNMP on the UUTs for Management and Monitoring	Passed
Enable SYSLOG on the UUT for Management and Monitoring	Passed
Using Cisco CCP for Configuration and Monitoring of the UUTs	Passed
Cisco WCCP Redirection	Passed
Cisco WAE Automatic Discovery to Identify WAE Appliances	Passed
Cisco WAE Optimization Feature (TFO)	Passed
Cisco WAAS, Cisco IOS Zone-based Firewall, and Cisco IOS IPS Interoperability	Passed
Cisco WAAS with NBAR	Passed
Cisco WAAS with CIFS	Passed
Cisco WAE with Data Redundancy Elimination	Passed
Negative Test Case for DRE	Passed
SCCP Phone Registration to Cisco Unified CME	Passed

Table 1 **Test Cases and Results**

Test Case	Result
SIP Phone Registration to Cisco Unified CME	Passed
SCCP Local Calls	Passed
SIP Local Calls	Passed
PSTN Calls	Passed
Branch to Headquarters Calls over the WAN with a SIP Trunk	Passed
Branch to Headquarters Calls over the WAN with an H.323 trunk	Passed
Supplementary Services with Cisco Unified CME	Passed
Supplementary Services Between Phones in the Branch, Headquarters, and PSTN	Passed
Call Conference in the Branch Cisco Unified CME	Passed
Call Forward to Voice Mail	Passed
Video Call Between Branch and Headquarters	Passed
T.38 Fax Between Branch and Headquarters	Passed
IP SLA VoIP UDP Jitter Codec g711ulaw (Branch to HQ)	Passed
Remote Phones on the Cisco Unified CME	Passed
Cisco Unified CME with WAN Failure Scenario to Headquarters	Passed
Cisco Unified CME with IPsec over the WAN	Passed
Cisco Unified CME with QoS and NBAR	Passed
Cisco Unified CME with ZPF	Passed
Cisco Unified CME Remote Phones with ZPF	Passed
Cisco Unified CME Failover with Secondary Cisco Unified CME	Passed
Baseline Features Plus Cisco Unified CME	Passed
SCCP Phone Registration to Cisco Unified CM	Passed
SIP Phone Registration to Cisco Unified CM	Passed
SIP Local Calls	Passed
SCCP Local Calls	Passed
PSTN Calls with SIP Gateway	Passed
PSTN Calls with H.323 Gateway	Passed
Branch to Headquarters Calls over the WAN	Passed
Supplementary Services Between Phones in Branch, Headquarters, and PSTN	Passed
Call Conference in the Branch	Passed
Call Forward to Voice Mail	Passed
Phone Registration During Cisco Unified Survivable Remote Site Telephony (Cisco Unified SRST)	Passed
Local and PSTN Calls in Cisco Unified SRST Mode	Passed
Supplementary Services in Cisco Unified SRST Mode	Passed
Call Forward to Voice Mail in Cisco Unified SRST Mode	Passed

Table 1 Test Cases and Results

Test Case	Result
Call Conference in Cisco Unified SRST Mode	Passed
Branch to Headquarters Calls with IPsec over the WAN	Passed
Branch to Headquarters Voice and Video Calls with QoS and NBAR	Passed
Branch to Headquarters Voice and Video calls with ZPF	Passed
Baseline Features Plus Cisco Unified CM	Passed
RSVP Agent in SRST Router–HQ to Branch Call with Phones Registered to Cisco Unified CM	Passed
RSVP Agent with Application ID in SRST Router–HQ to Branch Call with Phones Registered to Cisco Unified CM	Passed
RSVP Agent–HQ to Branch Call with H.323 Trunk	Passed
Baseline Performance Test	Passed
Baseline Plus Voice Performance Test with Cisco Unified CME	Passed
Baseline Plus Voice Performance Test with Cisco Unified CM and Cisco Unified SRST	Passed
Baseline Plus Voice Plus Cisco WAAS Performance Test	Passed

Test Setups

The test cases described in this section use the test setups shown in Figure 1 through Figure 4, in addition to test setups shown in the other figures referenced in the specific test case.

Figure 1 Private WAN, Cisco Unified CME Mode

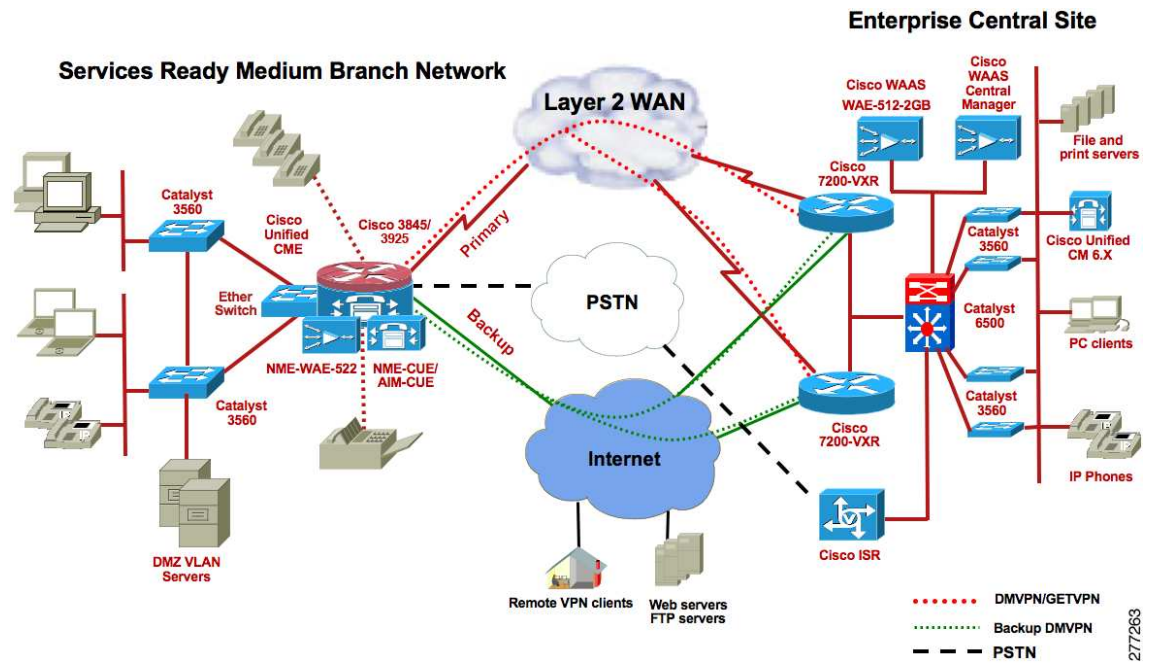

277263

Figure 2 Private WAN, Cisco Unified SRST Mode

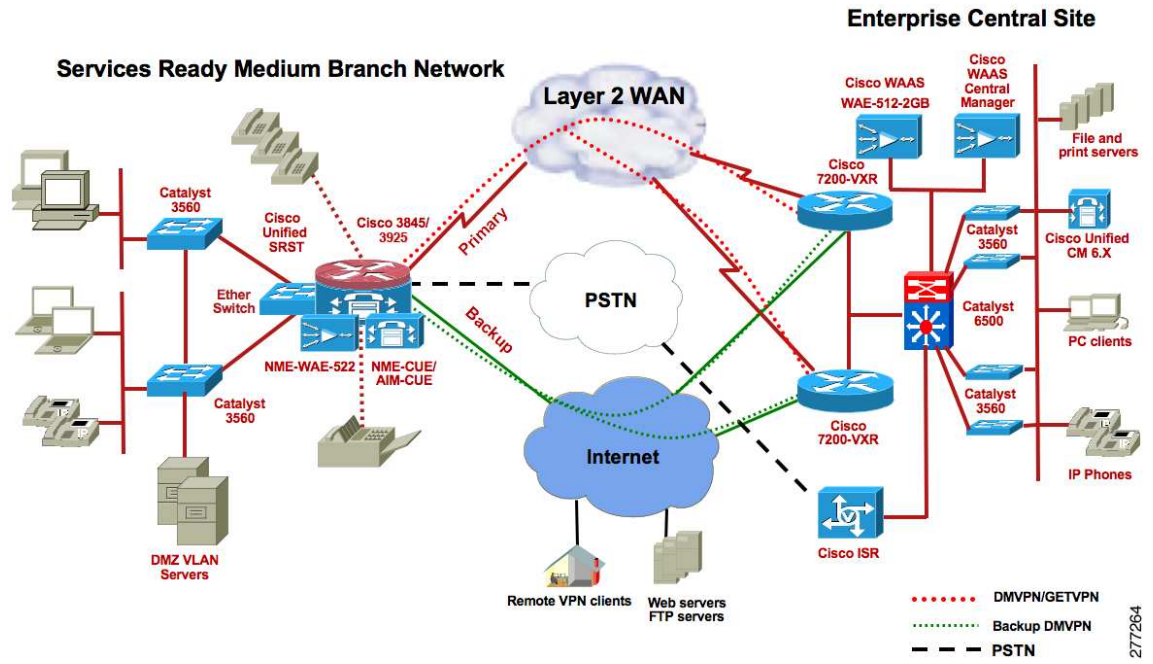

Figure 3 MPLS WAN, Cisco Unified CME Mode

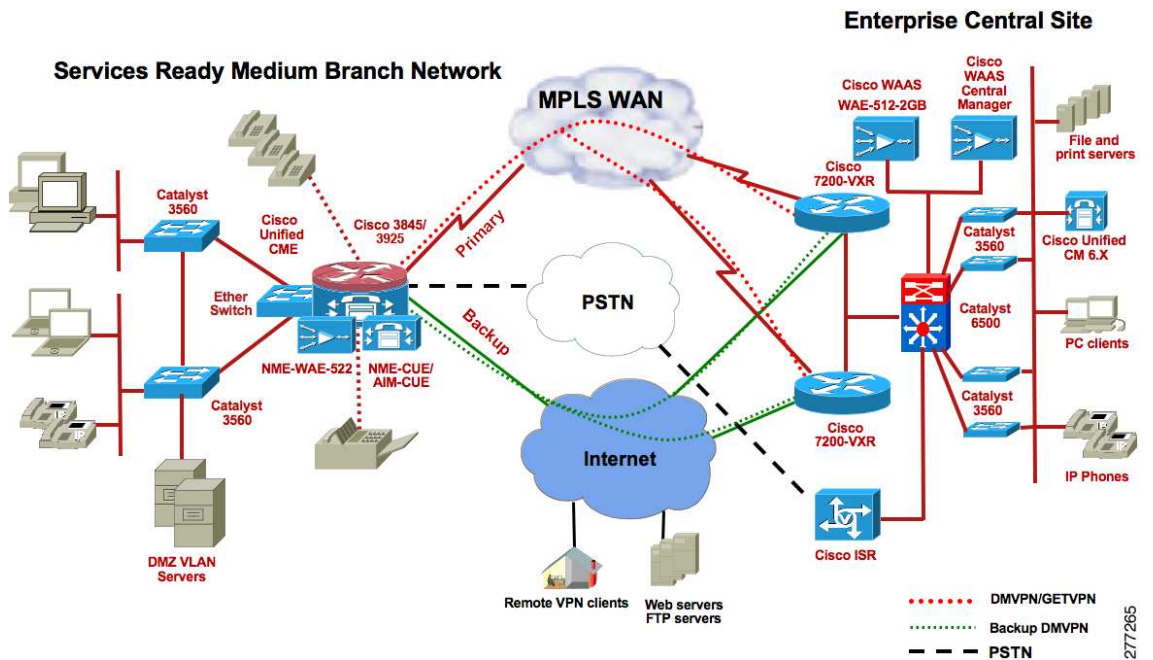
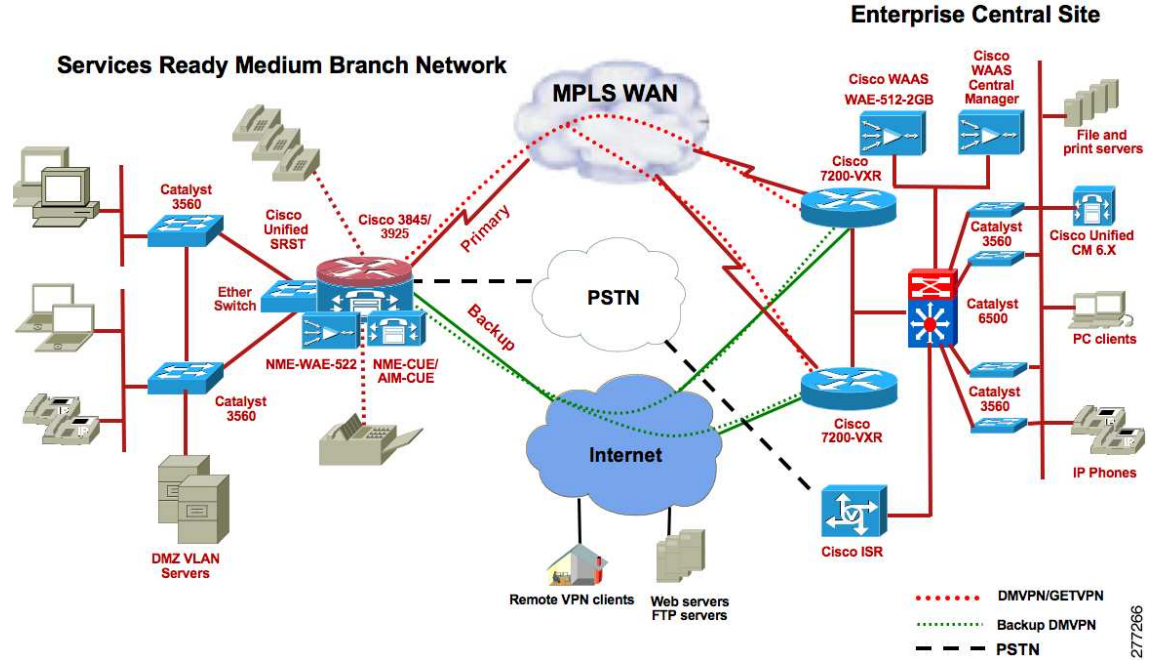

Figure 4 MPLS WAN, Cisco Unified SRST Mode



277266

Traffic Profile

The following traffic profile was used to represent typical traffic in a large enterprise branch network.

HTTP Traffic—75 percent

- 16 KB object size representing large HTML files containing images (10 URLs)
- 4 KB object size representing transactional data (10 URLs)

FTP Traffic—10 percent

- 1 MB file size

SMTP Traffic—10 percent

- 4 KB fixed object size

DNZ Traffic—5 percent

- 89 byte object size

Test Cases

This section contains the following test cases:

- [WAN Connectivity Test Cases, page 9](#)
- [Network Services Test Cases, page 13](#)
- [High Availability Test Cases, page 74](#)
- [Network Management Test Cases, page 88](#)

- [WAN Optimization Test Cases, page 89](#)
- [Cisco Unified CME Test Cases, page 93](#)
- [Cisco Unified SRST Test Cases, page 108](#)
- [Performance Test Cases, page 124](#)

WAN Connectivity Test Cases

DS3 Primary WAN Connections for Cisco 3900 Series Medium Branch

Description	Set up a DS3 (T3) private WAN connection between the branch Cisco ISR and headend router
Test Setup	Figure 1 on page 5, Private WAN, Cisco Unified CME Mode
Procedure	<ol style="list-style-type: none">1. Install an NM-1T3/E3 card into the branch Integrated Services Router (ISR).2. Configure the card as T3 on both branch and headend routers.3. Connect the card using a T3 coaxial cable.4. Configure the IP address on both routers.5. Make sure that the IP addresses belong to the same segment and have the same subnet mask.6. Ping both routers.7. Send T3 line rate HTTP and FTP bidirectional traffic, with 75% HTTP and 25% FTP, and measure the branch Cisco ISR CPU utilization.
Pass/Fail Criteria	The T3 link and line protocol should come up on both routers. The ping should be 100% successful. T3 line rate should be achieved, and branch Cisco ISR CPU should be less than 75%.
Result	Passed

Gigabit Ethernet Primary WAN Connection for Cisco 3900 Series Medium Branch

Description	Set up a Gigabit Ethernet private WAN connection between the branch Cisco ISR and the headend router
Test Setup	Figure 1 on page 5, Private WAN, Cisco Unified CME Mode
Procedure	<ol style="list-style-type: none">1. Install an HWIC-1GE-SFP card into one of the HWIC slots on the branch Cisco ISR.2. Connect to the GE port on the headend router using multimode fiber.3. Configure the IP address and both routers.4. Make sure that the IP addresses belong to the same segment and have the same subnet mask.5. Ping both routers.6. Send 100-Mb/s bidirectional HTTP and FTP traffic (50 Mb/s in each direction), with 75% HTTP and 25% FTP.7. Measure the branch Cisco ISR CPU utilization.
Pass/Fail Criteria	The GE link and line protocol should come up on both routers. The ping should be 100% successful. 100-Mb/s throughput should be achieved, and the branch Cisco ISR CPU should be less than 75%.
Result	Passed

MLPPP Primary WAN Connection for Cisco 3900 Series Medium Branch

Description	Set up an MLPPP primary WAN connection between the branch Cisco ISR and the headend router
Test Setup	Figure 1 on page 5, Private WAN, Cisco Unified CME Mode
Procedure	<ol style="list-style-type: none">1. Install an HWIC-4T card into one of the HWIC slots on the branch Cisco ISR.2. Connect the card to the headend using Smart Serial cables. If you are using an HWIC-4T, configure the four serial ports with a clock rate of 2048000 Hz.3. Enable PPP encapsulation. Bundle all the four serial interfaces into an MLPPP link.4. Configure an IP address on the multilink interface of each router, make sure that the IP addresses belong to the same segment and have the same subnet mask.5. Ping both routers.6. Send 90 percent of line rate of bidirectional HTTP and FTP traffic, with 75% HTTP and 25% FTP. Measure branch Cisco ISR CPU.

Pass/Fail Criteria The MLPPP link and line protocol should come up on both branch and headend routers. The ping should be 100% successful. The required throughput should be achieved, and the branch Cisco ISR CPU should be less than 75%.

Result Passed

MLFR Primary WAN Connection for Cisco 3900 Series Medium Branch

Description Set up an MLFR primary WAN connection between the branch Cisco ISR and the headend router

Test Setup [Figure 1 on page 5, Private WAN, Cisco Unified CME Mode](#)

Procedure

1. Install an HWIC-4T card into one of the HWIC slots on the branch Cisco ISR.
2. Connect to the headend using Smart Serial cables.
3. If you are using an HWIC-4T, configure the four serial ports with a clock rate of 2048000 Hz.
4. Enable Frame Relay encapsulation.
5. Configure four Frame Relay point-to-point subinterfaces with DLCIs, and bundle all four serial interfaces into an MLFR link.
6. Configure an IP address on the multilink interface of each router. Make sure that the IP addresses belong to the same segment and have the same subnet mask.
7. Ping both routers.
8. Send 90 percent of line rate of bidirectional HTTP and FTP traffic, with 75% HTTP and 25% FTP. Measure branch Cisco ISR CPU.

Pass/Fail Criteria The MLFR link and line protocol should come up on both branch and headend routers. The ping should be 100% successful. The required throughput should be achieved, and the branch Cisco ISR CPU should be less than 75%.

Result Passed

SHDSL IMA Secondary WAN Connection for Cisco 3900 Series Medium Branch

Description Set up an SHDSL IMA WAN connection between the branch Cisco ISR and the DSLAM

Test Setup [Figure 1 on page 5, Private WAN, Cisco Unified CME Mode](#)

Procedure	<ol style="list-style-type: none"> 1. Install an HWIC-4SHDSL card into one of the HWIC slots on the branch Cisco ISR. 2. Connect to the ISP DSLAM. 3. Configure IMA with two ports to achieve a bandwidth of 4608 kb/s. 4. Configure a PVC with AAL5SNAP encapsulation. 5. Configure the IP address on the ATM IMA interface. Verify the connection by pinging the DSLAM IP address. 6. Send line rate bidirectional HTTP and FTP traffic over the interface.
Pass/Fail Criteria	The ATM link and line protocol should come up. The ping should be 100% successful. Close to line rate should be achieved for HTTP and FTP traffic, and the router CPU should be less than 75%.
Result	Passed

Interface Removal and Addition to SHDSL IMA Interface

Description	Set up an SHDSL IMA WAN connection between the branch Cisco ISR and the ISP router (or DSLAM). Remove interfaces from the IMA group, and add the interfaces back to the IMA group while the traffic is traversing the IMA link.
Test Setup	Figure 1 on page 5, Private WAN, Cisco Unified CME Mode
Procedure	<ol style="list-style-type: none"> 1. Install an HWIC-4SHDSL card into one of the HWIC slots on the branch Cisco ISR. 2. Connect to the ISP DSLAM or router. 3. Configure IMA with two ports to achieve a bandwidth of 4608 kb/s. 4. Configure a PVC with a AAL5SNAP encapsulation. 5. Configure the IP address on the ATM IMA interface. address belongs Verify the connection by pinging the DSLAM IP address. 6. Send line rate bidirectional HTTP and FTP traffic over the interface. 7. Shut down one of the ports of the IMA group. 8. After 2 minutes, restart the port.
Pass/Fail Criteria	<p>The ATM link and line protocol should come up. The ping should be 100% successful. Close to line rate should be achieved for HTTP and FTP traffic, and the router CPU should be less than 75%.</p> <p>The IMA link should not go down when one of the ports of the IMA group goes down, and all the traffic should be carried over just one port. When the port is brought back up using the no shutdown command, the traffic should be carried over both the links equally.</p>
Result	Passed

Network Services Test Cases

Layer 2 Access Layer Switch

Description	Set up Catalyst 3560 switches as access layer switches
Test Setup	Figure 1 on page 5, Private WAN, Cisco Unified CME Mode , or Figure 2 on page 6, Private WAN, Cisco Unified SRST Mode , or Figure 3 on page 6, MPLS WAN, Cisco Unified CME Mode , or Figure 4 on page 7, MPLS WAN, Cisco Unified SRST Mode
Procedure	<ol style="list-style-type: none">1. Configure Catalyst 3560 switches in Layer 2 mode.2. Define VLANs for voice, data, management, and DMZ.3. Enable RSPT for subsecond switchover in case of master distribution switch failure.4. Do not enable Layer 3 routing on the access layer switches.
Pass/Fail Criteria	Layer 2 voice, data, management, and DMZ VLANs should come up. During master distribution switch failure, Layer 2 convergence should happen within a second.
Result	Passed

L2 Security–802.1x Authentication on the Access Layer Switch

Description	Set up to verify 802.1x authentication on one of the access switches
Test Setup	Figure 1 on page 5, Private WAN, Cisco Unified CME Mode , or Figure 2 on page 6, Private WAN, Cisco Unified SRST Mode , or Figure 3 on page 6, MPLS WAN, Cisco Unified CME Mode , or Figure 4 on page 7, MPLS WAN, Cisco Unified SRST Mode

Procedure	<ol style="list-style-type: none"> 1. Configure DHCP snooping on the switch. 2. Configure a trunk port connecting the access switch to the distribution switch and router as the trusted port. Configure all other ports as non-trusted ports. 3. Configure the router as the DHCP server. 4. Add a Windows DHCP server and connect it to one of the non-trusted ports of the switch. 5. Configure DAI for VLAN (x,y). 6. Assign all the switch ports to either x or y VLAN. 7. Configure the DHCP scope in the DHCP servers to assign IP addresses to x and y VLANs. 8. Connect phones and PCs to the switch ports. 9. Place all IP Phones in VLAN x and PCs in VLAN y.
Pass/Fail Criteria	<p>The IP Phones and PCs should obtain IP addresses from the DHCP server on the router and not from the Windows DHCP server, because the Windows server is connected to a non-trusted port.</p> <p>DAI should build dynamic entries (ACLs) with IP addresses (obtained through DHCP) and corresponding MAC addresses for the phones and PCs.</p> <p>If a laptop with a statically configured IP address (in the y VLAN) is connected to a switch port associated to the y VLAN, the DAI should prevent the laptop from obtaining network connectivity; that is, it builds a deny ACL for this laptop.</p>
Result	Passed

L2 Security–DHCP Snooping and Dynamic ARP Inspection on Access Layer Switch

Description	Set up to verify DHCP snooping and Dynamic ARP inspection on one of the access switches
Test Setup	Figure 1 on page 5, Private WAN, Cisco Unified CME Mode , or Figure 2 on page 6, Private WAN, Cisco Unified SRST Mode , or Figure 3 on page 6, MPLS WAN, Cisco Unified CME Mode , or Figure 4 on page 7, MPLS WAN, Cisco Unified SRST Mode

Procedure	<ol style="list-style-type: none">1. Configure 802.1x port authentication on several of the switch ports along with DHCP snooping and DAI.2. Configure AAA on the switch.3. Configure the IP address of the RADIUS server.4. Set up the EtherSwitch module as a NAS by providing its IP address in the Cisco Secure ACS server located in HQ.5. Install a self-signed certificate on the ACS server.6. Configure EAP-PEAP MSCHAPV2 authentication on the ACS server.7. Download the ACS certificate onto one of the PCs that is running Windows XP and that is located in the branch office.8. Install the certificate on the PC.9. Configure the PC for EAP-PEAP MSCHAPV2 authentication.10. Connect the IP Phone to the switch port on which 802.1x authentication is enabled.11. Connect the PC to the switch port of the IP Phone.12. Connect another PC that does not have the ACS certificate installed to another switch port on which 802.1x port authentication is enabled.
Pass/Fail Criteria	<p>The traffic should be distributed 2:1 between the primary and secondary router.</p> <p>The standby router should take over control after the primary router is power cycled.</p> <p>When power returns to the primary router, it should take over control from the standby router after waiting for the preemption time to expire.</p>
Result	Passed

L2 Security—Port Security on the Access Layer Switch

Description	Set up to verify port security on one of the access switches
Test Setup	Figure 1 on page 5, Private WAN, Cisco Unified CME Mode , or Figure 2 on page 6, Private WAN, Cisco Unified SRST Mode , or Figure 3 on page 6, MPLS WAN, Cisco Unified CME Mode , or Figure 4 on page 7, MPLS WAN, Cisco Unified SRST Mode
Procedure	<ol style="list-style-type: none">1. Configure the port security feature on one of the switch ports of the access switch to allow only one MAC address.2. Configure the port security aging timer to be 2 seconds, and configure the port security violation policy to Restrict.3. Connect a laptop to the switch port.4. After the laptop gets an IP address through DHCP, disconnect the laptop and connect a different laptop to the same switch port.

Pass/Fail Criteria	<p>When the laptop is connected to the switch port, it should get an IP address through DHCP. The switch should populate the laptop's MAC address and port information into a port security table.</p> <p>When another laptop with a different MAC address is connected to the same port, a port security violation error should be displayed on the console of the switch, and the new laptop should not be provided with an IP address.</p>
Result	Passed

L2 Security—IP Source Guard on the Access Layer Switch

Description	Set up to verify IP source guard on one of the access switches
Test Setup	<p>Figure 1 on page 5, Private WAN, Cisco Unified CME Mode, or Figure 2 on page 6, Private WAN, Cisco Unified SRST Mode, or Figure 3 on page 6, MPLS WAN, Cisco Unified CME Mode, or Figure 4 on page 7, MPLS WAN, Cisco Unified SRST Mode</p>
Procedure	<ol style="list-style-type: none"> 1. Configure IP source guard on the switch ports. 2. Connect a traffic generator to the switch port on which the IP source guard is configured, and send line rate traffic to HQ. 3. Obtain the IP address of the traffic generator, using DHCP before sending the traffic. 4. After sending traffic for about 15 minutes, change the source MAC address of the traffic generator connected to the switch port, and observe the behavior.
Pass/Fail Criteria	<p>The traffic from the traffic generator should be successfully allowed from the switch port and should reach the traffic generator at HQ.</p> <p>The IP source guard feature validates the source MAC address of the host that is connected to the switch port on which the IP source guard is enabled. It associates the host MAC address to the IP address obtained through DHCP. Once the traffic generator MAC address is changed, traffic should be dropped and not be allowed to pass from the switch port.</p>
Result	Passed

L2 Security–BPDU Guard on the Access Layer Switch

Description	Set up to verify BPDU guard on one of the access layer switches
Test Setup	Figure 1 on page 5, Private WAN, Cisco Unified CME Mode , or Figure 2 on page 6, Private WAN, Cisco Unified SRST Mode , or Figure 3 on page 6, MPLS WAN, Cisco Unified CME Mode , or Figure 4 on page 7, MPLS WAN, Cisco Unified SRST Mode
Procedure	<ol style="list-style-type: none">1. Configure Spanning Tree PortFast with the BPDU guard on the switch port that is connected to PC and phones.2. Remove the PC or phone from one of the ports where BPDU guard is enabled, and connect another switch.
Pass/Fail Criteria	The phones and PC ports should be operational and able to send traffic normally after enabling BPDU guard. The port shut down after connecting the switch.
Result	Passed

QoS on the LAN

Description	Enable conditionally trusted IP Phone and PC and scavenger-class traffic (Advanced) Model Configuration on the Catalyst 3560 switches
Test Setup	Figure 35 on page 47, Traffic Flow to QoS Class Mapping Figure 34 on page 46, LAN Switch

Procedure

1. Enable QoS on the access layer switch. Re-mark all the packets coming from PC endpoints, servers, and so on, with appropriate CoS or DSCP values. Trust the voice and signaling packets coming out of Cisco IP Phones, but re-mark all the packets coming from PCs attached to the IP Phones. Use Ethereal to verify proper packet marking.
2. Enable MLS QoS on the Catalyst switches.
3. Configure CoS to DSCP mapping to map CoS 5 to DSCP EF.
4. Re-mark excess data VLAN traffic marked 0, AF11, AF21, CS3, DSCP 25, and AF41 to scavenger class (CS1).
5. Define class maps for voice VLAN, voice signaling, interactive video, transactional data, mission-critical data, bulk data, and default (best effort).
6. Define policy maps and mark voice traffic to DSCP 46 (EF), voice signaling traffic to DSCP 24 (CS3), interactive video to DSCP 34 (AF41), mission-critical traffic to DSCP 25 (CS3), transactional data traffic to DSCP 18 (AF21), bulk data to DSCP 10 (AF11), and default to DSCP 0.
7. Configure policing (rate limiting) for each class.
8. Configure Catalyst switch egress queue in 1P3Q3T mode, that is, set up Q1 as the priority queue to carry all voice traffic, and set up the rest of the three queues in shared-bandwidth mode. Assign Q2 for mission-critical data traffic, Q3 for best-effort traffic, and Q4 for scavenger and bulk traffic. Configure shared weights of 70, 25, and 5 for Q2, Q3, and Q4, respectively.
9. Configure Weighted Tail Drop (WTD) thresholds per queue as shown in [Figure 35](#). For Q2 set the first threshold to 70% and the second threshold to 80%. For Q4, set the first threshold to 40% and the second threshold to 100%.
10. Verify, using the following **show** commands:
show mls qos
show mls qos map
show mls qos interface
show mls qos interface policers
show class-map
show policy-map
show policy interface

Pass/Fail Criteria

Voice and data packets should be properly marked by the switches.

Excess traffic should be re-marked to scavenger class and dropped if the scavenger class limit is also exceeded.

Queuing should be engaged only during congestion.

Each traffic type should be properly queued based on the queue assignments.

Result

Passed

WAN Edge QoS—8 Class QoS Model

Description Enable 8-class hierarchical QoS on the primary WAN interface

Test Setup

```
class-map match-all VOICE
match ip dscp ef ! VoIP
class-map match-all INTERACTIVE-VIDEO
match ip dscp af41 af42 ! Interactive Video
class-map match-any CALL-SIGNALING
match ip dscp cs3 ! Old Call Signaling
match ip dscp af31 ! New Call Signaling
class-map match-any INTERNETWORK-CONTROL
match ip dscp cs6 ! IP Routing
match access-group name IKE ! References ISAKMP ACL
class-map match-all TRANSACTIONAL-DATA
match ip dscp af21 af22 ! Transactional Data
class-map match-all BULK-DATA
match ip dscp af11 af12 ! Bulk Data
class-map match-all SCAVENGER
match ip dscp cs1 ! Scavenger
!
```

Procedure

1. Configure class maps for voice, voice signaling, interactive video, mission-critical data, transactional data, internetwork control, bulk/scavenger data, and best-effort data.
2. Match voice, based on a DSCP value of 46, and also based on IP address/port number using ACLs. Port numbers range from 16384 to 32768.
3. Match voice signaling, based on a DSCP of CS3, and also based on IP address/port number using ACLs. Use port number range 2000 to 2002 for SCCP, 1720 for H.323, and 5060 to 5062 for SIP.
4. Match interactive video-based on a DSCP value of 34, and also based on IP address/port number using ACLs. Use port number range 16384 to 32768.
5. Match mission-critical data traffic-based on a DSCP value of 25, and also based on IP address/port number using ACLs.
6. Match transactional data traffic, based on a DSCP value of 18, and also based on IP address/port number using ACLs.
7. Match internetwork control traffic, based on a DSCP value of 48, and also based on IP address/port number using ACLs.
8. Match bulk/scavenger traffic, based on a DSCP value of 8, and also based on IP address/port number using ACLs.
9. Match best-effort traffic, based on a DSCP value of 0, and also based on IP address/port number using ACLs.
10. Verify whether packets are matched to the correct class map, using the **show policy-map interface** command.

Pass/Fail Criteria

Incoming traffic from the LAN interface of the router should be properly classified, based on the DSCP/CoS values present in the packet.

Result

Passed

LLQ for Voice and Interactive Video Traffic

Description	Enable LLQ for RTP traffic, which includes voice and video
Test Setup	<pre> policy-map EIGHT-CLASS-V3PN-EDGE class VOICE priority percent 18 ! VoIP gets 18% LLQ class INTERACTIVE-VIDEO priority percent 15 ! IP/VC gets 15% LLQ </pre>
Procedure	<ol style="list-style-type: none"> 1. Configure strict priority queuing for voice and video traffic not exceeding 33% of the configured bandwidth. 2. Drop excess RTP traffic during link congestion. 3. Make voice and video calls, and also send background HTTP traffic. 4. Verify using show ip policy-map interface command.
Pass/Fail Criteria	<p>RTP and data packets should be Cisco Express Forwarding switched.</p> <p>Voice traffic and video traffic should always be given priority, even during congestion, and they should not be dropped, provided they do not exceed their allocated bandwidth.</p>
Result	Passed

CBWFQ and WRED for Data Traffic

Description	Configure CBWFQ for various types of data traffic, allocate bandwidth for each category, and configure WRED for congestion management
Test Setup	<pre> class INTERNETWORK-CONTROL bandwidth percent 5 ! Control Plane provisioning class MISSION-CRITICAL bandwidth percent 22 ! Mission-Critical-Data provisioning queue-limit 18 ! Optional: Anti-Replay tuning class TRANSACTIONAL-DATA bandwidth percent 10 ! Transactional-Data provisioning queue-limit 18 ! Optional: Anti-Replay tuning class BULK-DATA bandwidth percent 4 ! Bulk-Data provisioning queue-limit 3 class SCAVENGER bandwidth percent 1 ! Scavenger class is throttled queue-limit 1 ! Optional: Anti-Replay tuning class class-default bandwidth percent 25 ! Best Effort needs BW guarantee queue-limit 16 ! Optional: Anti-Replay Tuning </pre>

Procedure	<ol style="list-style-type: none"> 1. Allocate A% of bandwidth for mission-critical traffic, B% of bandwidth for transactional data traffic, C% for internetwork control traffic, D% for bulk/scavenger traffic, and the remaining bandwidth for best-effort traffic. 2. Configure DSCP-based WRED for mission-critical, transactional, and best-effort traffic. Retain default thresholds, and drop probabilities for WRED. 3. Send voice, video, and data traffic, and oversubscribe the bandwidth with data traffic. <p>The following data traffic types are mandatory:</p> <ul style="list-style-type: none"> • HTTP • HTTPS • FTP • ICMP • DNS <p>The following data traffic types are optional and based on availability of tools:</p> <ul style="list-style-type: none"> • CIFS • SMTP • POP3 • Citrix
Pass/Fail Criteria	Voice traffic and video traffic should always be given priority, even during congestion, and they should not be dropped, provided they do not exceed their allocated bandwidth. Excess data traffic not conforming to the allocated bandwidth should be dropped based on WRED and DSCP. WRED should minimize tail drops for high-priority traffic.
Result	Passed

Traffic Shaping on Different WAN Links

Description	Enable traffic shaping on the WAN interface as part of the hierarchical QoS configuration
Test Setup	Figure 1 on page 5, Private WAN, Cisco Unified CME Mode , or Figure 2 on page 6, Private WAN, Cisco Unified SRST Mode , or Figure 3 on page 6, MPLS WAN, Cisco Unified CME Mode , or Figure 4 on page 7, MPLS WAN, Cisco Unified SRST Mode
Procedure	<ol style="list-style-type: none"> 1. Configure traffic shaping on the WAN links to shape the egress traffic to 95% of the available bandwidth. 2. Send voice and data traffic to oversubscribe bandwidth.

Pass/Fail Criteria The egress traffic should be shaped to an average of 95% of the total available bandwidth.

Result Passed

DSCP/CoS Marking Incoming/Returning Traffic from WAN to LAN

Description Re-mark ingress traffic to the router coming from the WAN and going to the LAN

Test Setup [Figure 1 on page 5, Private WAN, Cisco Unified CME Mode](#), or [Figure 2 on page 6, Private WAN, Cisco Unified SRST Mode](#), or [Figure 3 on page 6, MPLS WAN, Cisco Unified CME Mode](#), or [Figure 4 on page 7, MPLS WAN, Cisco Unified SRST Mode](#)

Procedure

1. Configure DSCP to CoS mapping for the various ingress traffic types from the WAN. The marking should match the DSCP value of similar or the same type of traffic egressing the WAN interface.
2. Verify using the **show policy-map interface** command and using the Ethereal packet sniffer on the LAN.

Pass/Fail Criteria The ingress traffic should be properly marked.

Result Passed

Modification and Deletion of ACLs Defined with Class Map match access-group Command

Description Modify or delete ACLs defined under class-map configuration mode using **match access-group** statements

Test Setup [Figure 1 on page 5, Private WAN, Cisco Unified CME Mode](#), or [Figure 2 on page 6, Private WAN, Cisco Unified SRST Mode](#), or [Figure 3 on page 6, MPLS WAN, Cisco Unified CME Mode](#), or [Figure 4 on page 7, MPLS WAN, Cisco Unified SRST Mode](#)

Procedure

1. Change ACLs' source and destination IP addresses.
2. Change ACLs' source and destination ports.
3. Delete ACLs.
4. Save configuration.
5. Run traffic while making the changes.

Pass/Fail Criteria The ACL changes or deletions should not have no adverse impact on the router such as tracebacks, memory leaks, or a crash. The changes should be properly handled and applied to the traffic stream.

Result Passed

Unconfigure and Reconfigure QoS

Description Remove QoS configuration, and reapply QoS configuration

Test Setup [Figure 1 on page 5, Private WAN, Cisco Unified CME Mode](#), or [Figure 2 on page 6, Private WAN, Cisco Unified SRST Mode](#), or [Figure 3 on page 6, MPLS WAN, Cisco Unified CME Mode](#), or [Figure 4 on page 7, MPLS WAN, Cisco Unified SRST Mode](#)

Procedure

1. Remove QoS configuration.
2. Reapply QoS configuration.

Pass/Fail Criteria There should be no adverse impact on the router such as tracebacks, memory leaks, or a crash.

Result Passed

Unconfigure QoS, Reload Router, and Reconfigure QoS

Description Remove QoS configuration, and reapply QoS configuration after router reload

Test Setup [Figure 1 on page 5, Private WAN, Cisco Unified CME Mode](#), or [Figure 2 on page 6, Private WAN, Cisco Unified SRST Mode](#), or [Figure 3 on page 6, MPLS WAN, Cisco Unified CME Mode](#), or [Figure 4 on page 7, MPLS WAN, Cisco Unified SRST Mode](#)

Procedure

1. Remove the entire hierarchical QoS configuration from the branch router.
2. Reload the router.
3. Reapply the configuration to the branch router while running traffic.

Pass/Fail Criteria There should be no adverse impact on the router such as tracebacks, memory leaks, or a crash.

Result Passed

BGP Routing on the Branch

Description	Configure BGP routing to the ISP
Test Setup	Figure 1 on page 5, Private WAN, Cisco Unified CME Mode, or Figure 2 on page 6, Private WAN, Cisco Unified SRST Mode, or Figure 3 on page 6, MPLS WAN, Cisco Unified CME Mode, or Figure 4 on page 7, MPLS WAN, Cisco Unified SRST Mode
Procedure	<ol style="list-style-type: none"> 1. Configure External BGP (eBGP) on the branch router on the secondary WAN interface. 2. Inject a default route and a limited set of required routes, using a route filter, into the branch Interior Gateway Protocol (IGP) from the ISP. 3. Disable synchronization in the BGP configuration. 4. Advertise only the outside address of the branch to the ISP. 5. Do not advertise any inside addresses (LAN) of the branch router to the ISP. 6. Verify by pinging the headend router.
Pass/Fail Criteria	<p>BGP should come up between the branch and the ISP. The default route and all other routes injected from the ISP should be visible in the branch router's Routing Information Base (RIB).</p> <p>Ping should be successful between the branch and headend router.</p>
Result	Passed

OSPF Routing as IGP Between Branch and Headquarters Network

Description	Enable OSPF between the branch router and headend router, and advertise each other's LAN addresses
Test Setup	Figure 1 on page 5, Private WAN, Cisco Unified CME Mode, or Figure 2 on page 6, Private WAN, Cisco Unified SRST Mode, or Figure 3 on page 6, MPLS WAN, Cisco Unified CME Mode, or Figure 4 on page 7, MPLS WAN, Cisco Unified SRST Mode

Procedure	<ol style="list-style-type: none">1. Configure OSPF routing between the branch router and the headend router.2. Advertise all the LAN addresses attached to the branch and the LAN addresses attached to the headend so that the headend router can see the branch network and vice versa.3. Redistribute connected and static routes in the branch and headend into OSPF.4. Verify by OSPF adjacency, using the show ip ospf neighbors command.5. Verify by pinging from the branch LAN to the headend LAN and vice versa.
Pass/Fail Criteria	OSPF adjacency should be established between the branch router and the headend router.
Result	Passed

EIGRP Routing as IGP Between the Branch Router and the Headquarters Router

Description	Enable EIGRP between the branch router and headend router and advertise each other's LAN addresses
Test Setup	Figure 1 on page 5, Private WAN, Cisco Unified CME Mode , or Figure 2 on page 6, Private WAN, Cisco Unified SRST Mode , or Figure 3 on page 6, MPLS WAN, Cisco Unified CME Mode , or Figure 4 on page 7, MPLS WAN, Cisco Unified SRST Mode
Procedure	<ol style="list-style-type: none">1. Configure EIGRP routing between the branch router and the headend router.2. Advertise all the LAN addresses attached to the branch and the headend so that the headend router can see the branch network and vice versa.3. Redistribute connected and static routes in the branch and headend into EIGRP.4. Verify by EIGRP adjacency, using the show ip eigrp neighbors command.5. Verify by pinging from the branch LAN to the headend LAN and vice versa.
Pass/Fail Criteria	EIGRP adjacency should be established between the branch router and the headend router. Ping should be 100% successful.
Result	Passed

Traffic Measurement Using NetFlow When QoS is Enabled on the Branch Router

Description	Enable NetFlow on the branch router
Test Setup	Figure 1 on page 5, Private WAN, Cisco Unified CME Mode , or Figure 2 on page 6, Private WAN, Cisco Unified SRST Mode , or Figure 3 on page 6, MPLS WAN, Cisco Unified CME Mode , or Figure 4 on page 7, MPLS WAN, Cisco Unified SRST Mode
Procedure	<ol style="list-style-type: none">1. Configure NetFlow version 5 or version 9 for both ingress and egress traffic on the WAN and LAN interfaces of the branch router.2. Send bidirectional HTTP, FTP, and voice traffic between the branch and the headend router.3. Collect protocol distribution charts, interface statistics, and QoS statistics.4. Export the statistics to a network analysis module (NAM) located at the enterprise headquarters.
Pass/Fail Criteria	NetFlow should collect the statistics and export it to the NAM. The collected statistics should be within performance requirements.
Result	Passed

NBAR Classification with QoS

Description	Enable NBAR protocol discovery and classification. With the help of QoS, provide bandwidth guarantees for certain traffic flows, and drop certain distributed denial of service (DDoS) traffic such as SQL slammer and worms such as CODE RED, NIMDA, and so on.
Test Setup	<pre> ip nbar port-map custom-02 udp 1434 ! SQL Slammer custom PDLM ip nbar port-map custom-03 tcp 5554 9996 ! Sasser custom PDLM class-map match-all SQL-SLAMMER match protocol custom-02 ! Matches the SQL Slammer PDLM match packet length min 404 max 404 ! Matches the packet length (376+28) ! class-map match-any WORMS match protocol http url "*.ida*" ! CodeRed match protocol http url "*cmd.exe*" ! CodeRed match protocol http url "*root.exe*" ! CodeRed match protocol http url "*readme.eml*" ! NIMDA match class-map SQL-SLAMMER ! SQL Slammer class-map match protocol custom-03 ! Sasser custom PDLM ! policy-map WORM-DROP class WORMS drop ! Drops all known worms ! interface GigabitEthernet0/0.1 description DATA VLAN SUBNET encapsulation dot1Q 301 ip address 10.0.0.1 255.255.255.0 service-policy input WORM-DROP ! Drops known worms (DVLAN only) ! </pre>
Procedure	<ol style="list-style-type: none"> 1. Configure NBAR protocol discovery on the interfaces, and match protocol statements in the QoS policy map. <ul style="list-style-type: none"> • Mark HTTP traffic to a certain URL, such as <code>http://example.com</code> as mission critical. • Mark all other HTTP traffic as best effort. • Limit bulk traffic such as FTP. • Mark all voice traffic as critical. 2. Provide bandwidth guarantees by specifying bandwidth percentage in the QoS policy map configuration for different classes of traffic. <ul style="list-style-type: none"> • For mission-critical traffic, provide X% bandwidth. • For voice traffic, provide Y% bandwidth. • For transactional traffic, provide Z% bandwidth. • For all other traffic, provide the remaining bandwidth. 3. Measure the various traffic flows, using NBAR. 4. Send HTTP, FTP, and voice traffic.

Pass/Fail Criteria NBAR should properly classify the different protocols and provide bandwidth guarantees based on the policy map configuration. NBAR should provide the percentage breakdown of various protocols traversing the LAN and WAN links. NBAR should drop worm packets.

Result Passed

Modify Match Protocol Statements and Bandwidth Percentage

Description Modify “match protocol” statements and bandwidth percentage in the policy map configuration

Test Setup [Figure 1 on page 5, Private WAN, Cisco Unified CME Mode](#), or [Figure 2 on page 6, Private WAN, Cisco Unified SRST Mode](#), or [Figure 3 on page 6, MPLS WAN, Cisco Unified CME Mode](#), or [Figure 4 on page 7, MPLS WAN, Cisco Unified SRST Mode](#)

Procedure Modify the match protocol statements in the NBAR configuration by adding more protocols, changing the existing HTTP URL, and modifying the percentage bandwidth allocated for each traffic class over a live network

Pass/Fail Criteria Changes should not cause any abnormal behavior in the branch router such as tracebacks, memory leaks, or crashes. Changes should be applied to traffic.

Result Passed

100 ACLs

Description Configure about 100 ACLs on the branch router

Test Setup [Figure 1 on page 5, Private WAN, Cisco Unified CME Mode](#), or [Figure 2 on page 6, Private WAN, Cisco Unified SRST Mode](#), or [Figure 3 on page 6, MPLS WAN, Cisco Unified CME Mode](#), or [Figure 4 on page 7, MPLS WAN, Cisco Unified SRST Mode](#)

Procedure

1. Configure about 100 ACLs, either dummy ACLs or ACLs matching certain hosts or networks.
2. At the end of the list configure a **permit ip any any** statement.
3. Configure the ACL on the primary and secondary WAN interface.
4. Send data traffic.

Pass/Fail Criteria If a packet does not match any of the statements in the list, the packet should match the **permit ip any any** statement at the end of the list and be allowed to pass through. If the packet matches any statement in the last, appropriate action such as permit or deny should be taken, depending on what is configured in the ACL statement.

Result Passed

NTP in the Branch Router

Description NTP in the branch router

Test Setup [Figure 1 on page 5, Private WAN, Cisco Unified CME Mode](#), or [Figure 2 on page 6, Private WAN, Cisco Unified SRST Mode](#), or [Figure 3 on page 6, MPLS WAN, Cisco Unified CME Mode](#), or [Figure 4 on page 7, MPLS WAN, Cisco Unified SRST Mode](#)

Procedure

1. Configure NTP in the branch to source the clock from an NTP server in the network. The NTP server could be local to the branch, or it could be located in either the headquarters or the service provider premises.
2. Configure Message Digest 5 (MD5) authentication for NTP.
3. Verify, using the **show ntp status** command.

Pass/Fail Criteria NTP should be sourced from the NTP server after successful authentication.

Result Passed

Branch Router as a DHCP Server

Description Branch router as a DHCP server

Test Setup [Figure 1 on page 5, Private WAN, Cisco Unified CME Mode](#), or [Figure 2 on page 6, Private WAN, Cisco Unified SRST Mode](#), or [Figure 3 on page 6, MPLS WAN, Cisco Unified CME Mode](#), or [Figure 4 on page 7, MPLS WAN, Cisco Unified SRST Mode](#)

Procedure

1. Configure a DHCP server on the branch router to provide IP addresses for DHCP clients such as IP Phones and PCs.
2. Verify, using the **show ip dhcp binding** and **show ip dhcp server statistics** commands.

Pass/Fail Criteria The DHCP server on the router should be able to provide IP addresses to the clients using DHCP.

Result Passed

IP SLA VoIP UDP Jitter Codec G.711 u-law (Branch to HQ)

Description	Set up for verification of the service level agreement (SLA) for VoIP UDP jitter SLA																		
Test Setup	Figure 1 on page 5, Private WAN, Cisco Unified CME Mode																		
Procedure	<ol style="list-style-type: none"> 1. Enable the IP SLA responder on the HQ router. 2. Configure a basic type of VoIP UDP jitter operation on the branch router. 3. Configure any available options, such as codec G.711 u-law for a VoIP UDP jitter SLAs operation type. 4. Configure any threshold conditions, if required. 5. Schedule the operation to run, and then allow the operation to run for enough time to gather statistics. 6. Display and interpret the results of the operation, using Cisco IOS CLI or using an NMS system using SNMP. 																		
Pass/Fail Criteria	<p>To view and interpret the results of an IP SLA operation, use the show ip sla monitor statistics command, and check that the boundaries are within limits. For example,</p> <table> <thead> <tr> <th>ICPIF Range</th> <th>MOS</th> <th>Quality</th> </tr> </thead> <tbody> <tr> <td>0–3</td> <td>5</td> <td>Best</td> </tr> <tr> <td>4–13</td> <td>4</td> <td>High</td> </tr> <tr> <td>14–23</td> <td>3</td> <td>Medium</td> </tr> <tr> <td>24–33</td> <td>2</td> <td>Low</td> </tr> <tr> <td>34–43</td> <td>1</td> <td>Poor</td> </tr> </tbody> </table>	ICPIF Range	MOS	Quality	0–3	5	Best	4–13	4	High	14–23	3	Medium	24–33	2	Low	34–43	1	Poor
ICPIF Range	MOS	Quality																	
0–3	5	Best																	
4–13	4	High																	
14–23	3	Medium																	
24–33	2	Low																	
34–43	1	Poor																	
Result	Passed																		

IP SLA VoIP UDP Jitter Codec G.729A u-law (Branch to HQ)

Description	Set up verification of the service level agreement (SLA) for VoIP UDP jitter SLA
Test Setup	Figure 1 on page 5, Private WAN, Cisco Unified CME Mode

- Procedure**
1. Enable the IP SLA responder on the HQ router.
 2. Configure a basic type of VoIP UDP jitter operation on the branch router.
 3. Configure any available options, such as codec G.729A u-law for a VoIP UDP jitter SLA operation type.
 4. Configure any threshold conditions, if required.
 5. Schedule the operation to run, and then allow the operation to run for enough time to gather statistics.
 6. Display and interpret the results of the operation, using Cisco IOS CLI or using an NMS system using SNMP.

Pass/Fail Criteria To view and interpret the results of an IP SLA operation, use the **show ip sla monitor statistics** command and check that the boundaries are within limits. For example,

ICPIF Range MOS Quality

0–3	5	Best
4–13	4	High
14–23	3	Medium
24–33	2	Low
34–43	1	Poor

Result Passed

IP SLA ICMP Echo (Branch to HQ)

Description Set up verification of the service level agreement (SLA) for ICMP echo

Test Setup [Figure 1 on page 5, Private WAN, Cisco Unified CME Mode](#)

- Procedure**
1. Enable the IP SLA responder on the HQ router.
 2. Configure ICMP echo operation type on the branch router.
 3. Configure any options available for SLAs operation type.
 4. Configure any threshold conditions, if required.
 5. Schedule the operation to run, and then allow the operation run for enough time to gather statistics.
 6. Display and interpret the results of the operation, using Cisco IOS CLI or using an NMS system using SNMP. For example

```
ip sla monitor 6
type echo protocol ipIcmpEcho 192.168.0.2 source-ipaddr
192.168.0.1
frequency 300!
ip sla monitor schedule 6 life forever start-time now
```

Pass/Fail Criteria To view and interpret the results of an IP SLA operation, use the **show ip sla monitor 6** command to verify details, and report any significant delay issues.

Result Passed

IPsec Site-to-Site VPN Using DMVPN

Description Setup an IPsec site-to-site VPN between the branch router and the headend router, using DMVPN.

Test Setup [Figure 1 on page 5, Private WAN, Cisco Unified CME Mode](#), or [Figure 2 on page 6, Private WAN, Cisco Unified SRST Mode](#), or [Figure 3 on page 6, MPLS WAN, Cisco Unified CME Mode](#), or [Figure 4 on page 7, MPLS WAN, Cisco Unified SRST Mode](#)

Procedure

1. Install the AIM-VPN/SSL-3 module on the motherboard of the branch router.
2. Configure the headend router as a DMVPN hub and Next Hop Resolution Protocol (NHRP) server with multipoint GRE.
3. Configure the branch router as a spoke with multipoint GRE.
4. Configure ISAKMP policy preshared authentication with 3-DES encryption for the keys.
5. Configure ISAKMP SA lifetime to be 3600.
6. Configure transform set with 3-DES, ESP-SHA, DH Group 2 and preshared keys.
7. Configure IPsec SA lifetime to be 86400.
8. Configure tunnel protection for the DMVPN tunnel interface.
9. Add the DMVPN tunnel interface network address to the IGP configuration.
10. Verify IPsec connectivity, using the following **show** commands:
 - **show crypto isakmp sa**
 - **show crypto ipsec sa**
 - **show crypto engine connections active**
11. Send a sweep ping from a host connected to the branch data VLAN to a host connected to the headquarters data VLAN.
12. Verify whether the ping traffic gets encrypted; use the **show crypto engine accelerator statistics** command.

Pass/Fail Criteria	ISAKMP and IPsec sessions should be established. The DMVPN tunnel line protocol should come up. Routing tables at both the branch and headquarters routers should be updated. Ping should be 100% successful. Ping traffic should be encrypted.
Result	Passed
IPsec Using GETVPN	
Description	Set up an IPsec VPN between the branch router and the headend router, using GETVPN
Test Setup	Figure 3 on page 6, MPLS WAN, Cisco Unified CME Mode , or Figure 4 on page 7, MPLS WAN, Cisco Unified SRST Mode
Procedure	<ol style="list-style-type: none">1. Install the AIM-VPN/SSL-3 module on the motherboard of the branch router.2. Set up a GDOI key server for GETVPN in headquarters. The key server can be a Cisco 2900 series ISR platform.3. Configure the key server to send unicast rekeys.4. Configure the network segments associated with branch and headquarters LANs for encryption, using an ACL. Associate the ACL to the GDOI SA.5. Configure AES 256-bit encryption for IPsec.6. Configure a rekey timeout of 10800 seconds.7. Configure antireplay protection.8. Configure the branch routers and the headend routers as group members.9. Configure the GDOI crypto map on the primary WAN interface of the branch router and the headend router.10. Configure the TCP maximum segment size (MSS) to 1360 bytes on the router interfaces.11. Register the group members to the key server.12. Send a sweep ping from a host connected to the branch data VLAN to a host connected to the headquarters data VLAN.13. Verify whether the ping traffic gets encrypted; use the show crypto engine accelerator statistics command.14. Verify GETVPN, using the following show commands:<ul style="list-style-type: none">• show crypto isakmp sa• show crypto ipsec sa• show crypto engine connections active

Pass/Fail Criteria

Group members should be registered to the key server.

The key server should successfully push the IPsec SA ACL and rekey the ACL to the group members.

The routing tables at both the branch and head quarters routers should be updated.

Ping should be 100% successful.

Ping traffic should be encrypted.

Result Passed

GETVPN Unicast Rekeying

Description GETVPN unicast rekeying

Test Setup [Figure 3 on page 6, MPLS WAN, Cisco Unified CME Mode](#), or [Figure 4 on page 7, MPLS WAN, Cisco Unified SRST Mode](#)

Procedure

1. Set up a GDOI key server for GETVPN in the headquarters. The key server can be a Cisco 2900 series ISR platform.
2. Configure the key server to send unicast rekeys.
3. Configure the network segments associated with the branch and headquarters LANs for encryption, using an ACL. Associate the ACL to the GDOI SA.
4. Configure AES 256-bit encryption for IPsec.
5. Configure a rekey timeout of 10800 seconds.
6. Configure the branch router(s) and the headend router (s) as group members.
7. Configure the GDOI crypto map on the primary WAN interface of the branch router and headend router.
8. Register the group members to the key server.
9. Verify rekeying functionality.
10. Use the **show crypto isakmp sa** command to verify.

Pass/Fail Criteria

Group members should be registered to the key server.

The key server should be able to successfully push the ACL for unicast rekeying to the group members.

After the rekey timeout, the key server should send new keys to the group members. For some time, both old keys and new keys should be present in group members. The new key should take over after a certain amount of time, usually within a minute.

Result Passed

GETVPN Multicast Rekeying

Description	GETVPN multicast rekeying
Test Setup	Figure 3 on page 6, MPLS WAN, Cisco Unified CME Mode , or Figure 4 on page 7, MPLS WAN, Cisco Unified SRST Mode
Procedure	<ol style="list-style-type: none">1. Set up a GDOI key server for GETVPN in the headquarters. The key server can be a Cisco 2900 series ISR platform.2. Configure the key server to send multicast rekeys, with unicast rekeys as a backup mechanism.3. Define an ACL for multicast rekeying in the key server, and use the 239.x.x.x multicast group for rekeying.4. Configure PIM sparse mode (PIM-SM) on the key server and all the group members.5. Configure the headend router as the rendezvous point (RP).6. Configure the network segments associated with the branch and headquarters LANs for encryption, using an ACL. Associate the ACL to the GDOI SA.7. Configure AES 256-bit encryption for IPsec.8. Configure a rekey timeout of 10800 seconds.9. Configure the branch router(s) and the headend router(s) as group members.10. Configure the GDOI crypto map on the primary WAN interface of the branch router and the headend router.11. Register the group members to the key server.12. Verify rekeying functionality.13. Use the show crypto isakmp sa command to verify.
Pass/Fail Criteria	<p>Group members should be registered to the key server.</p> <p>The key server should be able to successfully push the ACL for multicast rekeying to the group members.</p> <p>Group members should register to the 239.x.x.x multicast group successfully.</p> <p>After the rekey timeout, the key server should send new keys to the multicast group. For some time, both old keys and new keys should be present in group members, and the new key should take over after a certain amount of time, usually within a minute.</p>
Result	Passed

IPsec DMVPN with Prefragmentation

Description	IPsec DMVPN with prefragmentation
Test Setup	Figure 1 on page 5, Private WAN, Cisco Unified CME Mode, or Figure 2 on page 6, Private WAN, Cisco Unified SRST Mode, or Figure 3 on page 6, MPLS WAN, Cisco Unified CME Mode, or Figure 4 on page 7, MPLS WAN, Cisco Unified SRST Mode
Procedure	<ol style="list-style-type: none"> 1. Configure IPsec VPN between the branch and headquarters with a tunnel MTU of 1000 bytes. 2. Enable prefragmentation. 3. Send voice and data traffic through the IPsec VPN tunnel.
Pass/Fail Criteria	The IPsec packets that are larger than 1000 bytes should be fragmented.
Result	Passed

IPsec DMVPN and IGP

Description	IPsec DMVPN and IGP
Test Setup	Figure 1 on page 5, Private WAN, Cisco Unified CME Mode, or Figure 2 on page 6, Private WAN, Cisco Unified SRST Mode, or Figure 3 on page 6, MPLS WAN, Cisco Unified CME Mode, or Figure 4 on page 7, MPLS WAN, Cisco Unified SRST Mode
Procedure	<ol style="list-style-type: none"> 1. Bring down the IPsec tunnel between the branch and the headquarters router. 2. Verify whether the routing table is updated at both the branch and headquarters routers. 3. After 3 minutes, bring up the IPsec tunnel between the branch and headquarters routers. 4. Verify whether the routing table is updated at both the branch and headquarters routers.
Pass/Fail Criteria	<p>When the IPsec tunnel goes down, the routing tables at both the branch and headquarters are updated. At the branch, the headquarters becomes unreachable, and the routes should be removed from the routing table. Similarly, at the headquarters, the branch becomes unreachable, and routes should be removed from the routing table.</p> <p>When the tunnel comes back up, the routes at both the branch and headquarters should reappear.</p>
Result	Passed

DMVPN Backup for MPLS Network (Branch to HQ)

Description	DMVPN backup on medium branch using static floating route (Spoke-to-HQ)
Test Setup	Figure 1 on page 5, Private WAN, Cisco Unified CME Mode , or Figure 2 on page 6, Private WAN, Cisco Unified SRST Mode , or Figure 3 on page 6, MPLS WAN, Cisco Unified CME Mode , or Figure 4 on page 7, MPLS WAN, Cisco Unified SRST Mode
Procedure	<ol style="list-style-type: none">1. On the medium branch Cisco 2951 router, configure the serial interface on the branch that connects to the Internet Cloud router for frame-relay.2. Configure the static route in the branch router to reach to HQ with higher administrative distance (for example, 240).3. Redistribute the static route into the IGP on the branch router.4. Make sure that the entire traffic flow is going through the MPLS network when the branch WAN is up and running.5. Shut down the WAN and verify that the IP traffic flows to HQ using the Internet Cloud.
Pass/Fail Criteria	Verify that you can reach HQ from the branch when the primary WAN is down.
Result	Passed

DMVPN Backup for MPLS Network (Branch to Branch)

Description	DMVPN backup on medium branch using static floating route (Spoke-to-Spoke)
Test Setup	Figure 1 on page 5, Private WAN, Cisco Unified CME Mode , or Figure 2 on page 6, Private WAN, Cisco Unified SRST Mode , or Figure 3 on page 6, MPLS WAN, Cisco Unified CME Mode , or Figure 4 on page 7, MPLS WAN, Cisco Unified SRST Mode

Procedure	<ol style="list-style-type: none"> 1. On the medium branch Cisco 2951 router, configure the serial interface on the branch that connects to the Internet Cloud router for frame-relay. 2. Configure the static route in the branch router to reach to HQ with higher administrative distance (for example, 240). 3. Redistribute the static route into the IGP on the branch router. 4. Make sure that the entire traffic is going through the MPLS network when the branch WAN is up and running. 5. Shut down the WAN and verify that IP traffic flows to HQ through the Internet Cloud. 6. Verify that from small branch running DMVPN that you can reach the medium branch when the WAN link is down. 7. Check the DMVPN hub for the NHRP database for all the spoke addresses (registered branch address). 8. Verify that a dynamic tunnel has been created between the medium branch and the small branch.
Pass/Fail Criteria	Verify that you can reach HQ and the small branch from the medium branch when the primary WAN is down.
Result	Passed

DMVPN Backup for MPLS Network Using BFD (Branch to HQ)

Description	DMVPN backup with BFD using EIGRP as IGP (Branch to HQ)
Test Setup	Figure 1 on page 5, Private WAN, Cisco Unified CME Mode , or Figure 2 on page 6, Private WAN, Cisco Unified SRST Mode , or Figure 3 on page 6, MPLS WAN, Cisco Unified CME Mode , or Figure 4 on page 7, MPLS WAN, Cisco Unified SRST Mode

Procedure	<ol style="list-style-type: none">1. Configure the primary WAN interface and secondary WAN interface on the branch router.2. Configure the secondary WAN interface as a Frame Relay interface that accesses the Internet.3. Configure DMVPN on the branch router.4. Configure the secondary WAN to be a higher cost route than the primary WAN so that primary WAN is always the preferred route.5. Configure BFD on the primary WAN interface of the branch router and the primary WAN interface of the head-end router with a BFD interval of 50 ms, min_rx of 50 ms, and a BFD multiplier of 5.6. Configure BFD on the secondary WAN interface.7. Enable BFD for all interfaces in the EIGRP routing process.8. Verify whether BFD is up and running by issuing show bfd neighbor command9. Send HTTP and voice traffic between the branch and HQ.10. Bring down the primary WAN interface by either disconnecting the cable or shutting down the link on the head-end side.11. After about three minutes, bring up the primary WAN interface.
Pass/Fail Criteria	<p>Verify that, when the primary WAN fails, EIGRP reconvergence occurs within a second because of BFD.</p> <p>Verify that all the traffic is routed through the secondary WAN interface.</p> <p>Verify that voice and HTTP sessions are maintained during reconvergence.</p> <p>Verify that, when the primary WAN comes up after three minutes, the traffic is routed over the primary WAN interface.</p>
Result	Passed

DMVPN Backup for MPLS Network Using BFD (Branch to Branch)

Description	DMVPN backup with BFD using EIGRP as IGP (Branch to Branch)
Test Setup	Figure 1 on page 5, Private WAN, Cisco Unified CME Mode , or Figure 2 on page 6, Private WAN, Cisco Unified SRST Mode , or Figure 3 on page 6, MPLS WAN, Cisco Unified CME Mode , or Figure 4 on page 7, MPLS WAN, Cisco Unified SRST Mode

Procedure	<ol style="list-style-type: none"> 1. Configure the primary WAN interface and secondary WAN interface on the branch router. 2. Configure the secondary WAN interface as a Frame Relay interface that assesses the Internet. 3. Configure DMVPN on the branch router. 4. Configure the secondary WAN to be a higher cost route than the primary WAN so that primary WAN is always the preferred route. 5. Configure BFD on the primary WAN interface of the branch router and the primary WAN interface of the head-end router with BFD interval of 50 ms, min_rx of 50 ms, and a BFD multiplier of 5. 6. Configure BFD on the secondary WAN interface. 7. Enable BFD for all interfaces in the EIGRP routing process. 8. Verify whether BFD is up and running by issuing show bfd neighbor command. 9. Send HTTP and voice traffic between the branch and HQ. 10. Bring down the primary WAN interface by either disconnecting the cable or shutting down the link on the head-end side. 11. After about three minutes, bring up the primary WAN interface.
Pass/Fail Criteria	<p>Verify that, when the primary WAN fails, EIGRP reconvergence occurs within a second because of BFD.</p> <p>Verify that all the traffic is routed through the secondary WAN interface.</p> <p>Verify that voice and HTTP sessions are maintained during reconvergence.</p> <p>Verify that, when the primary WAN comes up after three minutes, the traffic is routed over the primary WAN interface.</p>
Result	Passed

DMVPN Backup for MPLS Network Using BFD IGP as OSPF (Branch to Branch)

Description	DMVPN backup with BFD using OSPF as IGP (Branch to Branch)
Test Setup	<p>Figure 1 on page 5, Private WAN, Cisco Unified CME Mode, or</p> <p>Figure 2 on page 6, Private WAN, Cisco Unified SRST Mode, or</p> <p>Figure 3 on page 6, MPLS WAN, Cisco Unified CME Mode, or</p> <p>Figure 4 on page 7, MPLS WAN, Cisco Unified SRST Mode</p>

Procedure	<ol style="list-style-type: none"> 1. Configure the primary WAN interface and secondary WAN interface on the branch router. 2. Configure the secondary WAN interface as a Frame Relay interface that assesses the Internet. 3. Configure DMVPN on the branch router. 4. Configure the secondary WAN to be a higher cost route than the primary WAN so that primary WAN is always the preferred route. 5. Configure BFD on the primary WAN interface of the branch router and the primary WAN interface of the head-end router with BFD interval of 50 ms, min_rx of 50 ms, and a BFD multiplier of 5. 6. Configure BFD on the secondary WAN interface. 7. Enable BFD for all interfaces in the EIGRP routing process. 8. Verify whether BFD is up and running by issuing show bfd neighbor command. 9. Send HTTP and voice traffic between the branch and HQ. 10. Bring down the primary WAN interface by either disconnecting the cable or shutting down the link on the head-end side. 11. After about three minutes, bring up the primary WAN interface.
Pass/Fail Criteria	<p>Verify that, when the primary WAN fails, EIGRP reconvergence occurs within a second because of BFD.</p> <p>Verify that all the traffic is routed through the secondary WAN interface.</p> <p>Verify that voice and HTTP sessions are maintained during reconvergence.</p> <p>Verify that, when the primary WAN comes up after three minutes, the traffic is routed over the primary WAN interface.</p>
Result	Passed

DMVPN Backup for MPLS Network Using EBG (Branch to HQ)

Description	DMVPN backup for MPLS using EBG
Test Setup	Figure 1 on page 5, Private WAN, Cisco Unified CME Mode , or Figure 2 on page 6, Private WAN, Cisco Unified SRST Mode , or Figure 3 on page 6, MPLS WAN, Cisco Unified CME Mode , or Figure 4 on page 7, MPLS WAN, Cisco Unified SRST Mode

Procedure	<ol style="list-style-type: none"> 1. Configure the primary WAN interface and backup WAN interface on the branch router. 2. Configure the secondary WAN interface as a Frame Relay interface that assesses the Internet. 3. Configure DMVPN on the branch router. 4. Configure EBGP peers with the Internet router on the branch router. Under normal conditions, when the primary WAN is up and running, the backup DMVPN is dormant. 5. Shut down the primary WAN interface. The backup interface should come up and the EBGP peers become activated. Finally, the DMVPN should come up. 6. Send 2 Mb/s of traffic from the backup interface (DMVPN is up) and check the QoS status and various queues. 7. Send HTTP and Voice traffic between the branch and HQ 8. After about three minutes, bring up the primary WAN interface
Pass/Fail Criteria	<p>Verify that, when the primary WAN fails, the backup DMVPN comes up.</p> <p>Verify that voice and HTTP sessions pass through.</p> <p>Check for appropriate QoS Queues.</p> <p>When the primary comes up after three minutes, verify that the traffic is routed over the primary WAN interface.</p>
Result	Passed
DMVPN with QoS	
Description	DMVPN with QoS
Test Setup	<p>Figure 1 on page 5, Private WAN, Cisco Unified CME Mode, or</p> <p>Figure 2 on page 6, Private WAN, Cisco Unified SRST Mode, or</p> <p>Figure 3 on page 6, MPLS WAN, Cisco Unified CME Mode, or</p> <p>Figure 4 on page 7, MPLS WAN, Cisco Unified SRST Mode</p>
Procedure	<ol style="list-style-type: none"> 1. Configure the 8-class QoS model as explained in the QoS test cases. 2. Configure DMVPN with the qos pre-classify command to classify IPsec packets before encryption. 3. Send voice and data traffic, and verify whether traffic going through the DMVPN tunnel gets the correct QoS treatment, such as voice put in strict priority queue with proper bandwidth percentages applied.
Pass/Fail Criteria	The IPsec packets should get the correct QoS treatment.
Result	Passed

GETVPN with QoS

Description	GETVPN with QoS
Test Setup	Figure 1 on page 5, Private WAN, Cisco Unified CME Mode , or Figure 2 on page 6, Private WAN, Cisco Unified SRST Mode , or Figure 3 on page 6, MPLS WAN, Cisco Unified CME Mode , or Figure 4 on page 7, MPLS WAN, Cisco Unified SRST Mode
Procedure	<ol style="list-style-type: none">1. Configure the 8-class QoS model as explained in the QoS test cases.2. Configure GETVPN with the qos pre-classify command to classify IPsec packets before encryption.3. Send voice traffic and data traffic, and verify whether traffic going through the GETVPN gets the correct QoS treatment, such as voice put in strict priority queue with proper bandwidth percentages applied.
Pass/Fail Criteria	The IPsec packets should get the correct QoS treatment.
Result	Passed

DMVPN with QoS and NBAR

Description	DMVPN with QoS and NBAR
Test Setup	Figure 1 on page 5, Private WAN, Cisco Unified CME Mode , or Figure 2 on page 6, Private WAN, Cisco Unified SRST Mode , or Figure 3 on page 6, MPLS WAN, Cisco Unified CME Mode , or Figure 4 on page 7, MPLS WAN, Cisco Unified SRST Mode
Procedure	<ol style="list-style-type: none">1. Configure the 8-class QoS model as explained in the QoS test cases.2. Configure NBAR with the custom ip nbar port-map and ip nbar protocol-discovery commands as in the NBAR test case.3. Configure DMVPN with the qos pre-classify command to classify IPsec packets before encryption.4. Send voice and data (HTTP, FTP, and ICMP) traffic, and verify whether traffic going through the DMVPN tunnel gets the correct NBAR and QoS treatment, such as voice put in the strict priority queue with the proper bandwidth percentages applied.
Pass/Fail Criteria	QoS and NBAR classification and bandwidth guarantees should be given to the voice and data traffic egressing the WAN interface before encryption.
Result	Passed

GETVPN with QoS and NBAR

Description	GETVPN with QoS and NBAR
Test Setup	Figure 1 on page 5, Private WAN, Cisco Unified CME Mode or Figure 2 on page 6, Private WAN, Cisco Unified SRST Mode or Figure 3 on page 6, MPLS WAN, Cisco Unified CME Mode or Figure 4 on page 7, MPLS WAN, Cisco Unified SRST Mode
Procedure	<ol style="list-style-type: none"> 1. Configure the 8-class QoS model as explained in the QoS test cases. 2. Configure NBAR with the custom ip nbar port-map and ip nbar protocol-discovery commands as in the NBAR test case. 3. Configure GETVPN with the qos pre-classify command to classify IPsec packets before encryption. 4. Send voice and data (HTTP, FTP, and ICMP) traffic and verify whether traffic going through the IPsec tunnel gets the correct NBAR and QoS treatment, such as voice put in the strict priority queue with the proper bandwidth percentages applied.
Pass/Fail Criteria	QoS and NBAR classification and bandwidth guarantees should be given to the voice and data traffic egressing the WAN interface before encryption.
Result	Passed

DMVPN/GETVPN with QoS, NBAR, and NetFlow

Description	DMVPN/GETVPN with QoS, NBAR and NetFlow
Test Setup	Figure 1 on page 5, Private WAN, Cisco Unified CME Mode, or Figure 2 on page 6, Private WAN, Cisco Unified SRST Mode, or Figure 3 on page 6, MPLS WAN, Cisco Unified CME Mode, or Figure 4 on page 7, MPLS WAN, Cisco Unified SRST Mode

Procedure	<ol style="list-style-type: none">1. Configure the 8-class QoS model as explained in the QoS test cases.2. Configure NBAR with custom ip nbar port-map and ip nbar protocol-discovery commands as in the NBAR test case.3. Configure NetFlow version 5 or version 9 for both ingress and egress traffic on the WAN and LAN interfaces of the branch router.4. Configure IPsec with the qos pre-classify command to classify IPsec packets before encryption.5. Send voice and data (HTTP, FTP, and ICMP) traffic, and verify whether traffic going through the IPsec tunnel gets the correct NBAR and QoS treatment, such as voice put in the strict priority queue with the proper bandwidth percentages applied.6. Collect protocol distribution charts, interface statistics, and QoS statistics. Export the statistics to a NAM at the enterprise headquarters.
Pass/Fail Criteria	QoS and NBAR classification and bandwidth guarantees should be given to the voice and data traffic egressing the WAN interface before encryption NetFlow should collect the statistics and export them to the NAM, and the collected statistics should be within performance requirements.
Result	Passed

Zone-based Policy Firewall Configuration on the Branch Router

Description Configure Zone-based Policy Firewall (ZPF) with three zones: Public, Private, and DMZ

Test Setup

```

class-map type inspect match-any publicPrivateOutRule10Protocols
match protocol http
match protocol https
match protocol dns
match protocol ssh
match protocol icmp
match protocol ftp
exit
class-map type inspect match-any publicDMZOutRule10Protocols
match protocol http
match protocol https
match protocol dns
exit
class-map type inspect match-all publicPrivateOutRule10
match access-group name publicPrivateOutRule10Acl
match class-map publicPrivateOutRule10Protocols
exit

ip access-list extended publicPrivateOutRule10Acl
permit ip 172.16.0.0 0.0.0.255 any
exit

policy-map type inspect publicPrivateOutFwPolicy
class type inspect publicPrivateOutRule10
inspect publicPrivateOutParamMap
class class-default
drop log
exit
policy-map type inspect publicDMZOutFwPolicy
class type inspect publicDMZOutRule10Protocols
inspect publicPrivateOutParamMap
class class-default
drop log
exit

parameter-map type inspect publicPrivateOutParamMap
alert on
audit-trail on
dns-timeout 5
icmp idle-time 10
max-incomplete low 2000
max-incomplete high 3000
one-minute low 2000
one-minute high 3000
tcp finwait-time 5
tcp idle-time 3600
tcp max-incomplete host 50 block-time 0
tcp synwait-time 30
udp idle-time 30

```

**Test Setup
(continued)**

```
zone security Public
description Public Internet Connection
exit

zone security Private
description Customer Private Network
exit

interface Serial0/1/0:0.500
zone-member security Public
exit

interface Serial0/1/1:0.500
zone-member security Private
exit

interface FastEthernet0/0
zone-member security Private
exit

zone-pair security publicPrivateOut source Private destination
Public
description Outbound Firewall Policy from Private to Public
service-policy type inspect publicPrivateOutFwPolicy
exit
zone-pair security publicDMZOut source Public destination DMZ
description Outbound Firewall Policy from Public to DMZ
service-policy type inspect publicDMZOutFwPolicy
exit
```

Procedure

1. Create the firewall policy.
Referring to the test setup, the steps for creating zone-based policy firewall are outlined below.
2. Create the class maps to classify network traffic.
3. Create the policy map (firewall policy).
4. Create the Inspect Parameter-Map.
5. Create the security zones: Public, Private, and DMZ.
6. Assign the interfaces to the security zones (zone membership).
7. Assign the primary WAN interfaces to the Private zone.
8. Assign the voice and data VLANs to the Private zone.
9. Assign the DMZ VLAN to the DMZ zone.
10. Assign secondary WAN interface to Public zone.
11. Create the zone pairs in the test setup, and assign a policy map (firewall policy).
12. Send various kinds of traffic, such as HTTP, HTTPS, DNS, FTP, and ICMP, between the zones.

Pass/Fail Criteria

From Private zone to Private zone all traffic should be passed without any inspection.

From Private zone to Public zone, HTTP, FTP, DNS, HTTPS, SSH, and ICMP traffic should be inspected and allowed, and the rest of the traffic should be blocked.

From Public zone to Private zone, no traffic should be allowed.

From Public zone to DMZ zone, only HTTP, FTP, and DNS should be allowed.

Result Passed

NAT and PAT Configuration on the Branch Router

Description Configure NAT and PAT for traffic going out to the Internet

Test Setup [Figure 1 on page 5, Private WAN, Cisco Unified CME Mode](#), or [Figure 2 on page 6, Private WAN, Cisco Unified SRST Mode](#), or [Figure 3 on page 6, MPLS WAN, Cisco Unified CME Mode](#), or [Figure 4 on page 7, MPLS WAN, Cisco Unified SRST Mode](#)

Procedure

1. Configure static NAT translations for certain hosts on the data VLAN, using an address pool.
2. For the rest of the hosts, configure PAT by using the **overload** command in the NAT configuration.
3. Configure the secondary WAN interface as the interface connecting to the Internet through the ISP.
4. Configure the LAN as NAT inside, and configure the secondary WAN interface as NAT outside.
5. Send HTTP, HTTPS, ICMP, DNS, and SSH traffic from clients on the LAN to the Internet.
6. Verify translations and statistics using the **show ip nat translations** and **show ip nat statistics** commands.

Pass/Fail Criteria

The inside address should be translated to the outside global address when the traffic from the LAN is going out to the Internet. The return traffic from the Internet to the LAN should always be directed to the outside global address of the inside hosts.

Result Passed

NAT, QoS, and NetFlow on the Branch

Description	Configure NAT and QoS on the branch
Test Setup	Figure 1 on page 5, Private WAN, Cisco Unified CME Mode , or Figure 2 on page 6, Private WAN, Cisco Unified SRST Mode , or Figure 3 on page 6, MPLS WAN, Cisco Unified CME Mode , or Figure 4 on page 7, MPLS WAN, Cisco Unified SRST Mode
Procedure	<ol style="list-style-type: none">1. Configure static NAT translations for certain hosts on the data VLAN using an address pool and for the rest of the hosts configure PAT by using the overload command in the NAT configuration.2. Configure the secondary WAN interface as the interface connecting to the Internet through the ISP.3. Configure 8-class H-QoS on the secondary WAN interface.4. Mark all the traffic going out to the Internet as best-effort traffic.5. Configure traffic shaping to 95% of the available WAN bandwidth.6. Configure NetFlow on the secondary WAN interface for ingress and egress traffic.7. Collect traffic statistics and distribution charts, and export the statistics to a NAM, using either v5 or v9 NetFlow.8. Send HTTP, HTTPS, ICMP, DNS and SSH traffic from clients on the LAN to the Internet.9. Verify translations and statistics, using the show ip nat translations and show ip nat statistics commands.10. Verify QoS, using the show policy-map interface command.11. Verify NetFlow, using the show ip flow command.
Pass/Fail Criteria	<p>The inside address should be translated to the outside global address when the traffic from the LAN is going out to the Internet. The return traffic from the Internet to the LAN should always be directed to the outside global address of the inside hosts.</p> <p>All the Internet traffic should be marked as best effort.</p> <p>Traffic should be shaped to 95% of the WAN bandwidth.</p> <p>The NetFlow statistics collected should be within performance requirements.</p>
Result	Passed

ZPF, QoS, and NetFlow on the Branch

Description	Configure ZPF, QoS, and NetFlow on the branch router
Test Setup	Figure 1 on page 5, Private WAN, Cisco Unified CME Mode , or Figure 2 on page 6, Private WAN, Cisco Unified SRST Mode , or Figure 3 on page 6, MPLS WAN, Cisco Unified CME Mode , or Figure 4 on page 7, MPLS WAN, Cisco Unified SRST Mode
Procedure	<ol style="list-style-type: none">1. Configure ZPF as explained in the Zone-based Policy Firewall Configuration on the Branch Router test case procedure.2. Configure the secondary WAN interface as the interface connecting to the Internet through the ISP.3. Assign the primary WAN interface to the Private zone.4. Assign the secondary WAN interface to the Public zone.5. Assign the voice VLAN and data VLAN interfaces to the Private zone.6. Configure 8-class hierarchical QoS on both the primary and secondary WAN interfaces.7. Mark all the traffic going out to the Internet as best-effort traffic.8. Configure traffic shaping to 95% of the available WAN bandwidth.9. Configure NetFlow on the WAN and LAN interfaces for ingress and egress traffic.10. Collect traffic statistics and distribution charts, and export the statistics to a NAM, using NetFlow version 5 or version 9.11. Send HTTP, HTTPS, ICMP, DNS, and SSH traffic from clients on the LAN to the Internet.12. Send bidirectional HTTP, HTTPS, and FTP traffic between the branch and headquarters.13. Ping one of the clients on the LAN from the ISP.14. Verify translations and statistics, using the show ip nat translations and show ip nat statistics command.15. Verify QoS, using the show policy-map interface command.16. Verify NetFlow, using the show ip flow command.

Pass/Fail Criteria	<p>Traffic from the branch to headquarters should not be inspected.</p> <p>Traffic from the branch to the Internet should be inspected.</p> <p>QoS should be applied to the traffic, and ZPF should have no adverse effect on the QoS.</p> <p>All the Internet traffic should be marked as best effort.</p> <p>Traffic should be shaped to 95% of the WAN bandwidth.</p> <p>The NetFlow statistics collected should be within performance requirements.</p> <p>The ping should fail.</p>
Result	Passed

ZPF, QoS, NBAR, and NetFlow on the Branch

Description	Configure ZPF, QoS, NBAR, and NetFlow on the branch router
Test Setup	Figure 1 on page 5, Private WAN, Cisco Unified CME Mode , or Figure 2 on page 6, Private WAN, Cisco Unified SRST Mode , or Figure 3 on page 6, MPLS WAN, Cisco Unified CME Mode , or Figure 4 on page 7, MPLS WAN, Cisco Unified SRST Mode

Procedure	<ol style="list-style-type: none">1. Configure ZPF as explained in the Zone-based Policy Firewall Configuration on the Branch Router test case procedure.2. Configure the secondary WAN interface as the interface connecting to the Internet through the ISP.3. Assign the primary WAN interface to the Private zone.4. Assign the secondary WAN interface to the Public zone.5. Assign the voice VLAN and data VLAN interfaces to the Private zone.6. Configure 8-class hierarchical QoS on both primary and secondary WAN interfaces.7. Mark all the traffic going out to the Internet as best-effort traffic.8. Configure traffic shaping to 95% of the available WAN bandwidth.9. Configure NBAR as in the NBAR Classification with QoS test case.10. Configure NetFlow on the WAN and LAN interfaces for ingress and egress traffic.11. Collect traffic statistics and distribution charts, and export the statistics to a NAM, using NetFlow version 5 or version 9.12. Send HTTP, HTTPS, ICMP, DNS, and SSH traffic from clients on the LAN to the Internet.13. Send bidirectional HTTP, HTTPS, and FTP traffic between the branch and headquarters.14. Ping one of the clients on the LAN from the ISP.15. Verify translations and statistics using the show ip nat translations and show ip nat statistics commands.16. Verify QoS, using the show policy-map interface command.17. Verify NetFlow, using the show ip flow command.
Pass/Fail Criteria	<p>Traffic from the branch to headquarters should not be inspected.</p> <p>Traffic from the branch to the Internet should be inspected.</p> <p>QoS should be applied to the traffic, and ZPF should have no adverse effect on the QoS.</p> <p>All the Internet traffic should be marked as best effort.</p> <p>Traffic should be shaped to 95% of the WAN bandwidth.</p> <p>NBAR should provide bandwidth guarantees to different flows and should detect and stop worms such as NIMDA and CODE RED.</p> <p>The NetFlow statistics collected should be within performance requirements.</p> <p>The ping should fail.</p>
Result	Passed

ZPF, QoS, NBAR, NAT, and NetFlow on the Branch

Description	Configure ZPF, QoS, NBAR, and NetFlow on the branch router
Test Setup	Figure 1 on page 5, Private WAN, Cisco Unified CME Mode , or Figure 2 on page 6, Private WAN, Cisco Unified SRST Mode , or Figure 3 on page 6, MPLS WAN, Cisco Unified CME Mode , or Figure 4 on page 7, MPLS WAN, Cisco Unified SRST Mode
Procedure	<ol style="list-style-type: none">1. Configure ZPF as explained in the Zone-based Policy Firewall Configuration on the Branch Router test case procedure.2. Configure the secondary WAN interface as the interface connecting to the Internet through the ISP.3. Assign the primary WAN interface to the Private zone.4. Assign the secondary WAN interface to the Public zone.5. Assign the voice VLAN and data VLAN interfaces to the Private zone.6. Configure static NAT translations for certain hosts on the data VLAN using an address pool. For the rest of the hosts, configure PAT by using the overload keyword in the ip nat inside source command in the NAT configuration.7. Configure the data VLAN as NAT inside, and configure the secondary WAN interface as NAT outside.8. Configure 8-class hierarchical QoS on both primary and secondary WAN interfaces.9. Mark all the traffic going out to the Internet as best-effort traffic.10. Configure traffic shaping to 95% of the available WAN bandwidth.11. Configure NBAR as in the NBAR Classification with QoS test case.12. Configure NetFlow on the WAN and LAN interfaces for ingress and egress traffic.13. Collect traffic statistics and distribution charts, and export the statistics to a NAM, using NetFlow version 5 or version 9.14. Send HTTP, HTTPS, ICMP, DNS, and SSH traffic from clients on the LAN to the Internet.15. Send bidirectional HTTP, HTTPS, and FTP traffic between the branch and headquarters.16. Ping one of the clients on the LAN from the ISP.17. Verify translations and statistics, using the show ip nat translations and show ip nat statistics commands.18. Verify QoS, using the show policy-map interface command.19. Verify NetFlow, using the show ip flow command.

Pass/Fail Criteria	<p>Traffic from the branch to headquarters should not be inspected.</p> <p>Traffic from the branch to the Internet should be inspected.</p> <p>Inside addresses should be translated to outside global addresses when the traffic from the LAN is going out to the Internet. The return traffic from the Internet to the LAN should always be directed to the outside global address of the inside hosts.</p> <p>QoS should be applied to the traffic, and ZPF should not have any adverse effect on the QoS.</p> <p>All the Internet traffic should be marked as best effort.</p> <p>Traffic should be shaped to 95% of the WAN bandwidth.</p> <p>NBAR should provide bandwidth guarantees to different flows and should detect and stop worms such as NIMDA and CODE RED.</p> <p>The NetFlow statistics collected should be within performance requirements.</p> <p>The ping should fail.</p>
Result	Passed
ZPF with DMVPN	
Description	Configure ZPF with DMVPN on the primary WAN interface connecting the branch and headquarters
Test Setup	<p>Figure 1 on page 5, Private WAN, Cisco Unified CME Mode, or</p> <p>Figure 2 on page 6, Private WAN, Cisco Unified SRST Mode, or</p> <p>Figure 3 on page 6, MPLS WAN, Cisco Unified CME Mode, or</p> <p>Figure 4 on page 7, MPLS WAN, Cisco Unified SRST Mode</p>
Procedure	<ol style="list-style-type: none"> 1. Configure ZPF as explained in the Zone-based Policy Firewall Configuration on the Branch Router test case procedure. 2. Configure the secondary WAN interface as the interface connecting to the Internet through the ISP. 3. Assign the primary WAN interface to the Private zone. 4. Assign the DMVPN tunnel interface over the primary WAN to the Private zone. 5. Assign the voice VLAN and data VLAN interfaces to the Private zone. 6. Assign the secondary WAN interface to the Public zone. 7. Configure firewall policy for the Private zone to the Public zone, the Private zone to the DMZ zone, and the Public zone to the DMZ zone. 8. Send bidirectional HTTP, HTTPS, and FTP traffic between the branch and headquarters.

Pass/Fail Criteria ZPF should have no adverse impact on DMVPN.
Traffic between the branch and headquarters over the primary WAN interface should be encrypted.

Result Passed

ZPF with GETVPN

Description Configure ZPF with GETVPN connecting the branch and headquarters

Test Setup [Figure 3 on page 6, MPLS WAN, Cisco Unified CME Mode](#), or [Figure 4 on page 7, MPLS WAN, Cisco Unified SRST Mode](#)

Procedure

1. Configure ZPF as explained in the [Zone-based Policy Firewall Configuration on the Branch Router](#) test case procedure.
2. Assign the primary WAN interface to the Public zone.
3. Assign the voice VLAN and data VLAN interfaces to the Private zone.
4. Configure GETVPN as in the [IPsec Using GETVPN](#) test case procedure.
5. Send bidirectional HTTP, HTTPS, and FTP traffic between the branch and headquarters.

Pass/Fail Criteria Traffic between the branch and headquarters should be encrypted.
ZPF should have no effect on the traffic between the branch and headquarters.

Result Passed

IPsec, ZPF, QoS, NBAR, NAT, and NetFlow on the Branch

Description Configure ZPF, QoS, NBAR, and NetFlow on the branch router

Test Setup [Figure 1 on page 5, Private WAN, Cisco Unified CME Mode](#), or [Figure 2 on page 6, Private WAN, Cisco Unified SRST Mode](#), or [Figure 3 on page 6, MPLS WAN, Cisco Unified CME Mode](#), or [Figure 4 on page 7, MPLS WAN, Cisco Unified SRST Mode](#)

Procedure

1. Configure IPsec VPN, using either DMVPN or GETVPN on the primary WAN interface.
2. Configure ZPF as explained in the [Zone-based Policy Firewall Configuration on the Branch Router](#) test case procedure.
3. Configure the secondary WAN interface as the interface connecting to the Internet through the ISP.
4. Assign the primary WAN interface to the Private zone.
5. Assign the secondary WAN interface to the Public zone.
6. Assign the voice VLAN and data VLAN interfaces to the Private zone.
7. Configure static NAT translations for certain hosts on the data VLAN, using an address pool. For the rest of the hosts, configure PAT by using the **overload** command in the NAT configuration.
8. Configure the data VLAN as NAT inside, and configure the secondary WAN interface as NAT outside.
9. Configure 8-class hierarchical QoS on both the primary and secondary WAN interfaces.
10. Mark all the traffic going out to the Internet as best-effort traffic.
11. Configure traffic shaping to 95% of the available WAN bandwidth.
12. Configure NBAR as in the [NBAR Classification with QoS](#) test case.
13. Configure NetFlow on the WAN and LAN interfaces for ingress and egress traffic.
14. Collect traffic statistics and distribution charts, and export the statistics to a NAM using NetFlow version 5 or version 9.
15. Send HTTP, HTTPS, ICMP, DNS, and SSH traffic from clients on the LAN to the Internet.
16. Send bidirectional HTTP, HTTPS, and FTP traffic between the branch and headquarters.
17. Ping one of the clients on the LAN from the ISP.
18. Verify translations and statistics, using the **show ip nat translations** and **show ip nat statistics** commands.
19. Verify QoS, using the **show policy-map interface** command.
20. Verify NetFlow, using the **show ip flow** command.

Procedure

1. Configure IPsec VPN, using either DMVPN or GETVPN on the primary WAN interface.
2. Configure ZPF as explained in the [Zone-based Policy Firewall Configuration on the Branch Router](#) test case procedure.
3. Configure the secondary WAN interface as the interface connecting to the Internet through the ISP.
4. Assign the primary WAN interface to the Private zone.
5. Assign the secondary WAN interface to the Public zone.
6. Assign the voice VLAN and data VLAN interfaces to the Private zone.
7. Configure static NAT translations for certain hosts on the data VLAN, using an address pool. For the rest of the hosts, configure PAT by using the **overload** command in the NAT configuration.
8. Configure the data VLAN as NAT inside, and configure the secondary WAN interface as NAT outside.
9. Configure 8-class hierarchical QoS on both the primary and secondary WAN interfaces.
10. Mark all the traffic going out to the Internet as best-effort traffic.
11. Configure traffic shaping to 95% of the available WAN bandwidth.
12. Configure NBAR as in the [NBAR Classification with QoS](#) test case.
13. Configure NetFlow on the WAN and LAN interfaces for ingress and egress traffic.
14. Collect traffic statistics and distribution charts, and export the statistics to a NAM using NetFlow version 5 or version 9.
15. Send HTTP, HTTPS, ICMP, DNS, and SSH traffic from clients on the LAN to the Internet.
16. Send bidirectional HTTP, HTTPS, and FTP traffic between the branch and headquarters.
17. Ping one of the clients on the LAN from the ISP.
18. Verify translations and statistics, using the **show ip nat translations** and **show ip nat statistics** commands.
19. Verify QoS, using the **show policy-map interface** command.
20. Verify NetFlow, using the **show ip flow** command.

Procedure

1. Configure IPsec VPN, using either DMVPN or GETVPN on the primary WAN interface.
2. Configure ZPF as explained in the [Zone-based Policy Firewall Configuration on the Branch Router](#) test case procedure.
3. Configure the secondary WAN interface as the interface connecting to the Internet through the ISP.
4. Assign the primary WAN interface to the Private zone.
5. Assign the secondary WAN interface to the Public zone.
6. Assign the voice VLAN and data VLAN interfaces to the Private zone.
7. Configure static NAT translations for certain hosts on the data VLAN, using an address pool. For the rest of the hosts, configure PAT by using the **overload** command in the NAT configuration.
8. Configure the data VLAN as NAT inside, and configure the secondary WAN interface as NAT outside.
9. Configure 8-class hierarchical QoS on both the primary and secondary WAN interfaces.
10. Mark all the traffic going out to the Internet as best-effort traffic.
11. Configure traffic shaping to 95% of the available WAN bandwidth.
12. Configure NBAR as in the [NBAR Classification with QoS](#) test case.
13. Configure NetFlow on the WAN and LAN interfaces for ingress and egress traffic.
14. Collect traffic statistics and distribution charts, and export the statistics to a NAM using NetFlow version 5 or version 9.
15. Send HTTP, HTTPS, ICMP, DNS, and SSH traffic from clients on the LAN to the Internet.
16. Send bidirectional HTTP, HTTPS, and FTP traffic between the branch and headquarters.
17. Ping one of the clients on the LAN from the ISP.
18. Verify translations and statistics, using the **show ip nat translations** and **show ip nat statistics** commands.
19. Verify QoS, using the **show policy-map interface** command.
20. Verify NetFlow, using the **show ip flow** command.

Pass/Fail Criteria	<p>Traffic from the branch to headquarters should be encrypted.</p> <p>Traffic from the branch to headquarters should not be inspected.</p> <p>Traffic from the branch to the Internet should be inspected.</p> <p>Inside addresses should be translated to outside global addresses when the traffic from the LAN is going out to the Internet. The return traffic from the Internet to the LAN should always be directed to the outside global address of the inside hosts.</p> <p>QoS should be applied to the traffic, and ZPF should not have any adverse effect on the QoS.</p> <p>All the Internet traffic should be marked as best-effort.</p> <p>Traffic should be shaped to 95% of the WAN bandwidth.</p> <p>NBAR should provide bandwidth guarantees to different flows and should detect and stop worms such as NIMDA and CODE RED.</p> <p>The NetFlow statistics collected should be within performance requirements.</p> <p>The ping should fail.</p>
Result	Passed

DDOS Prevention Using Cisco IOS IPS

Description Configure Cisco IOS IPS with IDCONF v5.0 in the branch router to prevent denial-of-service attacks

Test Setup

```
ip ips config location flash:/ips5/ retries 1
ip ips name IPS-ADVSET
!
ip ips signature-category
  category all
  retired true
  category ios_ips advanced
  retired false
!
crypto key pubkey-chain rsa
  named-key realm signature
  key-string
    30820122 300D0609 2A864886 F70D0101 01050003 82010F00 3082010A
02820101
    00C19E93 A8AF124A D6CC7A24 5097A975 206BE3A2 06FBA13F 6F12CB5B
4E441F16
    17E630D5 C02AC252 912BE27F 37FDD9C8 11FC7AF7 DCDD81D9 43CDABC3
6007D128
    B199ABCB D34ED0F9 085FADC1 359C189E F30AF10A C0EFB624 7E0764BF
3E53053E
    5B2146A9 D7A5EDE3 0298AF03 DED7A5B8 9479039D 20F30663 9AC64B93
C0112A35
    FE3F0C87 89BCB7BB 994AE74C FA9E481D F65875D6 85EAF974 6D9CC8E3
F0B08B85
    50437722 FFBE85B9 5E4189FF CC189CB9 69C46F9C A84DFBA5 7A0AF99E
AD768C36
    006CF498 079F88F8 A3B3FB1F 9FB7B3CB 5539E1D1 9693CCBB 551F78D2
892356AE
    2F56D826 8918EF3C 80CA4F4D 87BFCA3B BFF668E9 689782A5 CF31CB6E
B4B094D3
    F3020301 0001
  quit
!
interface GigabitEthernet0/1.2
  description Data-VLAN
  encapsulation dot1Q 301
  ip address 10.0.0.1 255.255.255.0
  ip ips IPS-ADVSET in
  ip ips IPS-ADVSET out
!
```

Procedure	<ol style="list-style-type: none">1. Download the latest IPS signature pack from: http://www.cisco.com/cgi-bin/tablebuild.pl/ios-v5sigup to the router flash.2. Configure Cisco IOS IPS with IDCONF v5.0 on the router.3. Enable the advanced category signature set.4. Configure Cisco IOS IPS for both directions of traffic on the data VLAN and WAN interfaces.5. Enable syslog on the router and log the syslog messages to a syslog server located in the branch.6. Launch DDOS attacks from a PC attached to the branch router data VLAN to a server at the headquarters.7. Verify whether the attacks are detected by Cisco IOS IPS and whether the alert messages are logged to the syslog server.
Pass/Fail Criteria	<p>The attacks should be detected by Cisco IOS IPS, and appropriate signatures should be triggered.</p> <p>Actions such as warning, dropping the packets, or dropping the session should be taken based on a particular signature configuration.</p> <p>The alert messages related to the attack should be logged to a syslog server.</p>
Result	Passed

Cisco IOS IPS with Background Data Traffic

Description	Configure Cisco IOS IPS with IDCONF v5.0 in the branch router to prevent denial-of-service attacks
Test Setup	Figure 1 on page 5, Private WAN, Cisco Unified CME Mode , or Figure 2 on page 6, Private WAN, Cisco Unified SRST Mode , or Figure 3 on page 6, MPLS WAN, Cisco Unified CME Mode , or Figure 4 on page 7, MPLS WAN, Cisco Unified SRST Mode

Procedure	<ol style="list-style-type: none">1. Download the latest IPS signature pack from: http://www.cisco.com/cgi-bin/tablebuild.pl/ios-v5sigup to the router flash.2. Configure Cisco IOS IPS with IDCONF v5.0 on the router.3. Enable advanced category signature set.4. Configure Cisco IOS IPS for both directions of traffic on the data VLAN and WAN interfaces.5. Enable syslog on the router, and log the syslog messages to a syslog server located in the branch.6. Send HTTP, HTTPS, and FTP traffic between the branch and headquarters.7. Launch DDOS attacks from a PC attached to the branch router data VLAN to a server at the headquarters.8. Verify whether the attacks are detected by Cisco IOS IPS and whether the alert messages, logged to the syslog server.
Pass/Fail Criteria	<p>The attacks should be detected by Cisco IOS IPS, and appropriate signatures should be triggered.</p> <p>Actions such as warning, dropping the packets, or dropping the session should be taken based on a particular signature configuration.</p> <p>The alert messages related to the attack should be logged to a syslog server.</p>
Result	Passed

ZPF with NAT and Cisco IOS IPS

Description	Configure ZPF with NAT and Cisco IOS IPS on the branch router
Test Setup	Figure 1 on page 5, Private WAN, Cisco Unified CME Mode , or Figure 2 on page 6, Private WAN, Cisco Unified SRST Mode , or Figure 3 on page 6, MPLS WAN, Cisco Unified CME Mode , or Figure 4 on page 7, MPLS WAN, Cisco Unified SRST Mode

Procedure

1. Configure ZPF as explained in the [Zone-based Policy Firewall Configuration on the Branch Router](#) test case procedure
2. Configure the secondary WAN interface as the interface connecting to the Internet through the ISP.
3. Assign the primary WAN interface to the Private zone.
4. Assign the secondary WAN interface to the Public zone.
5. Assign the voice VLAN and data VLAN interfaces to the Private zone.
6. Configure static NAT translations for certain hosts on the data VLAN, using an address pool. For the rest of the hosts, configure PAT by using the **overload** command in the NAT configuration.
7. Configure the data VLAN as NAT inside, and configure the secondary WAN interface as NAT outside.
8. Download the latest Cisco IOS IPS signature pack from: <http://www.cisco.com/cgi-bin/tablebuild.pl/ios-v5sigup> to the router flash.
9. Configure Cisco IOS IPS with IDCONF v5.0 on the router.
10. Enable advanced category signature set.
11. Configure Cisco IOS IPS for both directions of traffic on the data and DMZ VLAN and WAN interfaces.
12. Enable syslog on the router, and log the syslog messages to a syslog server located at the branch.
13. Send HTTP, HTTPS, and FTP traffic between the branch and headquarters.
14. Send HTTP, FTP, and DNS traffic between the branch and the Internet.
15. Launch DDOS attacks from a PC attached to the branch router data VLAN to a server located at the headquarters.
16. Launch threats from a host in the Internet to the DMZ servers.
17. Verify whether the attacks are detected by Cisco IOS IPS and whether the alert messages are logged to the syslog server.

Pass/Fail Criteria	<p>Traffic from the branch to headquarters should not be inspected.</p> <p>Traffic from the branch to Internet should be inspected.</p> <p>Inside addresses should be translated to outside global addresses when the traffic from the LAN is going out to the Internet. The return traffic from the Internet to the LAN should always be directed to the outside global address of the inside hosts.</p> <p>The attacks should be detected by Cisco IOS IPS, and appropriate signatures should be triggered.</p> <p>Actions such as warning, dropping the packets or dropping the session, or blocking the host should be taken based on a particular signature configuration.</p> <p>The alert messages related to the attack should be logged to a syslog server.</p>
---------------------------	--

Result	Passed
---------------	--------

IPsec, ZPF, QoS, NBAR, NAT, Cisco IOS IPS, and NetFlow on the Branch

Description	Configure ZPF, QoS, NBAR, NAT, Cisco IOS IPS, and NetFlow on the branch router
Test Setup	<p>Figure 1 on page 5, Private WAN, Cisco Unified CME Mode, or</p> <p>Figure 2 on page 6, Private WAN, Cisco Unified SRST Mode, or</p> <p>Figure 3 on page 6, MPLS WAN, Cisco Unified CME Mode, or</p> <p>Figure 4 on page 7, MPLS WAN, Cisco Unified SRST Mode</p>
Procedure	<ol style="list-style-type: none"> 1. Configure IPsec VPN using either DMVPN or GETVPN on the primary WAN interface. 2. Configure ZPF as explained in the Zone-based Policy Firewall Configuration on the Branch Router test case procedure. 3. Configure the secondary WAN interface as the interface connecting to the Internet through the ISP. 4. Assign the primary WAN interface to the Private zone. 5. Assign the secondary WAN interface to the Public zone. 6. Assign the voice VLAN and data VLAN interfaces to the Private zone. 7. Configure static NAT translations for certain hosts on the data VLAN, using an address pool. For the rest of the hosts, configure PAT by using the overload command in the NAT configuration. 8. Configure the data VLAN as NAT inside, and configure the secondary WAN interface as NAT outside. 9. Configure Cisco IOS IPS with IDCONF v5.0 on the router. 10. Enable advanced category signature set. 11. Configure Cisco IOS IPS for both directions of traffic on the data and DMZ VLAN and WAN interfaces.

- Procedure (continued)**
12. Enable syslog on the router and log the syslog messages to a syslog server at the branch.
 13. Configure 8-class hierarchical QoS on both primary and secondary WAN interfaces.
 14. Mark all the traffic going out to the Internet as best-effort traffic.
 15. Configure traffic shaping to 95% of the available WAN bandwidth.
 16. Configure NBAR as in the [NBAR Classification with QoS](#) test case.
 17. Configure NetFlow on the WAN and LAN interfaces for ingress and egress traffic.
 18. Collect traffic statistics and distribution charts, and export the statistics to a NAM, using NetFlow version 5 or version 9.
 19. Send HTTP, HTTPS, ICMP, DNS, and SSH traffic from clients on the LAN to the Internet.
 20. Send bidirectional HTTP, HTTPS, and FTP traffic between the branch and headquarters.
 21. Ping one of the clients on the LAN from the ISP.
 22. Launch DDOS attacks from a PC attached the branch router data VLAN to a server located at the headquarters.
 23. Launch threats from a host in the Internet to the DMZ servers.
 24. Verify translations and statistics, using the **show ip nat translations** and **show ip nat statistics** commands.
 25. Verify whether the attacks are detected by Cisco IOS IPS and whether the alert messages are logged to the syslog server.
 26. Verify QoS, using the **show policy-map interface** command.
 27. Verify NetFlow, using **show ip flow** command.

Pass/Fail Criteria

All traffic should be Cisco Express Forwarding switched.

Traffic from the branch to headquarters should be encrypted.

Traffic from the branch to headquarters should not be inspected.

Traffic from the branch to the Internet should be inspected.

Inside addresses should be translated to the outside global address when the traffic from the LAN is going out to the Internet. The return traffic from the Internet to the LAN should always be directed to the outside global address of the inside hosts.

QoS should be applied to the traffic, and ZPF should not have any adverse effect on the QoS.

All the Internet traffic should be marked as best-effort.

Traffic should be shaped to 95% of the WAN bandwidth.

The attacks should be detected by Cisco IOS IPS, and appropriate signatures should be triggered.

Actions such as warning, dropping the packets or dropping the session, blocking host should be taken based on a particular signature configuration.

The alert messages related to the attack should be logged to a syslog server.

NBAR should provide bandwidth guarantees to different flows and should detect and stop worms such as NIMDA and CODE RED.

NetFlow statistics collected should be within performance requirements.

The ping should fail.

Result

Passed

Remote Users Using WebVPN (SSL VPN)

Description Configure WebVPN in clientless mode

Test Setup

```
gateway gw-1
  ip address 209.165.201.17 port 443
  ssl trustpoint SSLVPN
  inservice
webvpn context con-1
url-list "u1"
  heading "u1-h1"
  url-text "Intranet" url-value "http://example.com"
  url-text "Intranet2" url-value "example.com"
!
policy group p1
  url-list "u1"
default-group-policy p1
gateway gw-1 domain one
  inservice

webvpn context cifs
  title "CIFS CONTEXT"
  ssl encryption
  ssl authenticate verify all
!
nbns-list cifs
  nbns-server 10.0.0.2 master
!
policy group cifs
  nbns-list "cifs"
  functions file-access
  functions file-browse
  functions file-entry
!
policy group cifs'
default-group-policy cifs
gateway gw-1 domain cifs
  inservice
```

Procedure	<ol style="list-style-type: none">1. Configure AAA RADIUS authentication.2. Configure a trust point with a persistent self-signed certificate.3. Configure the WebVPN gateway with an IP address, and associate the trust point to the gateway. Enable the WebVPN service.4. Configure the WebVPN context, and define the URL list and the port list in the context.5. Configure WebVPN for clientless access with support for intranet web-based applications and Windows File Sharing Common Internet File System (CIFS).6. Configure the WebVPN policy, and associate the context and gateway to the policy. Enable WebVPN policy.7. Connect from a remote user from the Internet, using a web browser (Microsoft Internet Explorer 6.0) to the WebVPN gateway.8. Access web-based applications and shared drives on the intranet.9. Use either the Cisco IOS CLI or CCP to configure WebVPN.10. Verify WebVPN functionality, by using the following show commands or by monitoring through CCP:<ul style="list-style-type: none">• show webvpn gateway• show webvpn context• show webvpn session context• show webvpn session user• show webvpn stats
Pass/Fail Criteria	<p>All traffic should be Cisco Express Forwarding switched.</p> <p>The remote user should be able to connect to the WebVPN gateway by just using only a web browser, without running any Java applet or application.</p> <p>The remote user should be able to access branch intranet web-based applications and Windows shared drives.</p> <p>All the SSL VPN traffic should be accelerated by the hardware encryption engine AIM-VPN/SSL-3 module.</p>
Result	Passed

Remote Users Using WebVPN (SSL VPN) Full Tunnel

Description Configure WebVPN in SVC or full tunnel access mode

Test Setup

```
ip local pool svc 10.0.0.21 10.0.0.30
!
webvpn gateway ssl-vpn
  ip address 209.165.201.17 port 443
  ssl trustpoint golden-tp
  inservice
!
webvpn context Default_context
  ssl trustpoint
  ssl authenticate verify all
  inservice
!
webvpn context sslvpn
  ssl trustpoint
  ssl authenticate verify all
  inservice
!
policy group default
  functions svc-enabled
  svc address-pool "svc"
  svc keep-client-installed
  svc split include 10.0.0.0 255.255.255.0
default-group-policy default
gateway ssl-vpn
inservice
```

Procedure	<p>Note Tunneling Client (also known as Thick Client or Full Tunneling): A larger client (generally around 500K max) is delivered to the end user. The applications that can be accessed are very similar to those available via IPsec VPN. This client is delivered via a web page (the device to which the user is connecting) and never needs to be manually distributed or installed.</p> <p>The Cisco SSL VPN client (SVC) client configuration requires:</p> <ul style="list-style-type: none"> • Configuration of an address pool (very similar to IPsec VPN). • The address pool to be called in the policy group. • Turning on SVC with tunnel mode enabled. <ol style="list-style-type: none"> 1. Configure AAA RADIUS authentication. 2. Configure an IP address pool for SVC. 3. Configure a trust point with persistent self-signed certificate. 4. Configure the WebVPN gateway with an IP address, and associate the trust point to the gateway. Enable the WebVPN service. 5. Configure the WebVPN context. 6. Configure the WebVPN policy, and associate the context and gateway to the policy. Enable WebVPN policy. 7. Associate the address pool in the WebVPN policy. 8. Turn on SVC with tunnel mode enabled. 9. From the remote PC, download the SVC client software and connect. 10. Access web-based applications and shared drives in the intranet. 11. Use either the Cisco IOS CLI or CCP to configure WebVPN. 12. Verify WebVPN functionality, using the following show commands or by monitoring through CCP: <ul style="list-style-type: none"> • show webvpn gateway • show webvpn context • show webvpn session context • show webvpn session user • show webvpn stats
Pass/Fail Criteria	<p>All traffic should be Cisco Express Forwarding switched.</p> <p>The remote user should be able to connect to the WebVPN gateway, using the SVC client application.</p> <p>The remote user should be able to access branch intranet web-based applications and Windows shared drives.</p> <p>All the SSL VPN traffic should be accelerated by the hardware encryption engine AIM-VPN/SSL-3 module.</p>
Result	Passed

Complete Baseline Test

Description

Enable all the baseline services in the branch and headend routers. The baseline features include BGP routing, OSPF/EIGRP routing, IPsec using DMVPN or GETVPN, ZPF, NAT, IPS, QoS, NBAR, ACL, NetFlow, DHCP, AAA RADIUS server, NTP, syslog, SNMP, WebVPN, PIM-v2, and IGMP v2.

Configure L2 and L3 switching on the access and distribution layer switches.

Enable QoS on the L3 distribution switches.

Test Setup

Figure 1 on page 5, Private WAN, Cisco Unified CME Mode, or Figure 2 on page 6, Private WAN, Cisco Unified SRST Mode, or Figure 3 on page 6, MPLS WAN, Cisco Unified CME Mode, or Figure 4 on page 7, MPLS WAN, Cisco Unified SRST Mode

Procedure

1. Configure L2 switching with RSTP on the Catalyst 3560 switches. Verify, using the **show spanning tree** command.
2. Configure voice, data, and DMZ VLANs.
3. Configure Catalyst QoS on the Catalyst 3560 switch.
4. Configure BGP routing. Verify whether the default route is injected into the branch router, using the **show ip route** and **show ip bgp summary** commands.
5. Configure OSPF/EIGRP routing as the IGP. Verify the neighbor relationship between headquarters and branch routers, using the **show ip ospf neighbors** or **show ip eigrp neighbors** command. Verify the routes using the **show ip route** command.
6. Configure IPsec (DMVPN/GETVPN) over the primary and secondary WAN interfaces. Verify, using the **show crypto engine connections active** and **show crypto session** commands.
7. Configure ZPF with voice VLAN, data VLAN, and primary WAN in the Private zone, DMZ VLAN in the DMZ zone, secondary WAN in the Public zone, and IPsec tunnel in the VPN zone. Verify, using the **show policy-map type inspect** command.
8. Configure the 8-class QoS model with the **qos pre-classify** command. Verify, using the **show policy-map interface** command.
9. Configure NBAR to provide bandwidth guarantees to different protocols such as HTTP, HTTPS, FTP, DNS, SSH, and ICMP. Verify, using the **show ip nbar protocol-discovery** command.
10. Configure NAT to translate the addresses of hosts in the data VLAN when accessing the Internet through the secondary WAN interface. Verify, using the **show ip nat translations** command.
11. Configure IPS to prevent DDOS attacks, slackware, malware, worms, and so on, against the branch/headquarters clients and servers. Send alert messages to a syslog server.

- Procedure (continued)**
12. Configure NetFlow on all the interfaces, and export the statistics to a NAM in headquarters. Verify NetFlow statistics, using the **show ip flow** command.
 13. Configure NTP in the branch router, and authenticate the NTP server using MD5 authentication. Verify, using the **show ntp status** command.
 14. Configure the DHCP server on the branch router to provide dynamic IP addresses to clients in the voice, data, and DMZ VLANs. Verify, using the **show ip dhcp bindings** command.
 15. Configure AAA to authenticate and authorize users using a RADIUS server located in the headquarters.
 16. Configure SNMP to collect traps.
 17. Configure WebVPN in clientless mode, and have at least five remote users access the branch web-based applications and Windows File Sharing from the Internet.
 18. Configure an IPTV server in the headquarters to stream 300 kb/s video using multicast. Set up the headquarters router as an RP, and configure PIM-SM on branch and headend routers.
 19. Send HTTP, HTTPS, DNS, SSH, ICMP, and CIFS traffic between the branch and headquarters.
 20. Send HTTP, FTP, DNS, and SSH traffic between the branch and the Internet.
 21. Send HTTP traffic between the Internet and the DMZ.
 22. Join four clients to the multicast group to receive IPTV video streams.
 23. Launch threats from hosts on the branch LAN to servers on the headquarters.

Pass/Fail Criteria

All traffic should be Cisco Express Forwarding switched.

The Catalyst switch should properly mark the traffic and put it in appropriate queues.

Traffic from the branch to headquarters should be encrypted.

Traffic from the branch to headquarters should not be inspected.

Traffic from the branch to the Internet should be inspected.

Inside addresses should be translated to outside global addresses when the traffic from the LAN is going out to the Internet. The return traffic from the Internet to the LAN should always be directed to the outside global address of the inside hosts.

QoS should be applied to the traffic, and ZPF should not have any adverse effect on the QoS.

All Internet traffic should be marked as best effort.

Traffic should be shaped to 95% of the WAN bandwidth.

The attacks should be detected by Cisco IOS IPS, and appropriate signatures should be triggered.

Actions such as warning, dropping the packets or dropping the session, or blocking the host should be taken based on a particular signature configuration.

The alert messages related to the attack should be logged to a syslog server.

NBAR should provide bandwidth guarantees to different flows and should detect and stop worms such as NIMDA and CODE RED.

Remote users should be able to access the branch intranet web-based applications and shared Windows network drives. The WebVPN traffic should be accelerated by the AIM-VPN/SSL-3 module.

The NetFlow statistics should be collected and exported, and they should be within performance requirements.

The router should be able to source the clock from the NTP server after successful authentication.

The DHCP server on the router should provide IP addresses to the clients on the LAN.

AAA should be able to authenticate users using a RADIUS server.

Result

Passed

High Availability Test Cases

EtherChannel Uplink from Access Layer Switch

Description	Set up a EtherChannel connection between access layer switch(es) and distribution layer switch
Test Setup	Connect two ports between access layer switch(es) and distribution layer switch
Procedure	<ol style="list-style-type: none"> 1. Bundle two Gigabit Ethernet uplinks on the Catalyst 3560 switches into an LACP EtherChannel, and connect each of the ports to different distribution switches, which are stacked together as shown in the test setup. 2. Send LAN traffic between the access and distribution switches. 3. Bring down one of the links in the EtherChannel bundle; after about 30 seconds, bring up the link again.
Pass/Fail Criteria	The two Gigabit Ethernet bundle EtherChannel link should behave as one 2-Gigabit Ethernet link. The LAN traffic between the access and distribution switches should be load balanced between the two Gigabit Ethernet links in the EtherChannel. When one of the Gigabit Ethernet links goes down, the EtherChannel should stay up, and there should be no impact on the LAN traffic. All the traffic should now be carried by just one Gigabit Ethernet link. When the other Gigabit Ethernet link comes up, load balancing should resume.
Result	Passed

EIGRP Subsecond Convergence During Primary WAN Failure

Description	Enable BFD for EIGRP subsecond convergence during primary WAN failure
Test Setup	Figure 1 on page 5, Private WAN, Cisco Unified CME Mode or Figure 2 on page 6, Private WAN, Cisco Unified SRST Mode or Figure 3 on page 6, MPLS WAN, Cisco Unified CME Mode or Figure 4 on page 7, MPLS WAN, Cisco Unified SRST Mode

Procedure	<ol style="list-style-type: none">1. Set up a primary WAN interface and a secondary WAN interface on the branch router.2. Set up a secondary WAN interface to be an SHDSL IMA interface.3. Configure the secondary WAN to be a higher cost route than the primary WAN so that the primary WAN is always preferred.4. Configure BFD on the primary WAN interface of the branch router. Configure the primary WAN interface of the headend router with a BFD interval of 50 ms, a min_rx of 50 ms, and a BFD multiplier of 5.5. Configure BFD on the secondary WAN interface.6. Enable BFD for all interfaces in the EIGRP routing process.7. Verify whether BFD is up by entering the show bfd neighbor command.8. Send HTTP and voice traffic between the branch and headquarters.9. Bring down the primary WAN interface by either pulling out the cable or shutting down the link on the headend side.10. After about 3 minutes, bring up the primary WAN interface.
Pass/Fail Criteria	<p>When the primary WAN fails, EIGRP reconvergence should occur within a second because of BFD, and all the traffic should be routed through the secondary WAN interface.</p> <p>Voice and HTTP sessions should be maintained during reconvergence.</p> <p>When the primary WAN comes up after 3 minutes, the traffic should be routed over the primary WAN interface.</p>
Result	<p>Passed on Gigabit Ethernet interfaces.</p> <p>BFD is supported only on Gigabit Ethernet interfaces. Support for additional WAN encapsulations such as Frame Relay and PPP is planned for future releases.</p>

OSPF Subsecond Convergence During Primary WAN Failure

Description	Enable BFD for OSPF subsecond convergence during primary WAN failure
Test Setup	Figure 1 on page 5, Private WAN, Cisco Unified CME Mode , or Figure 2 on page 6, Private WAN, Cisco Unified SRST Mode , or Figure 3 on page 6, MPLS WAN, Cisco Unified CME Mode , or Figure 4 on page 7, MPLS WAN, Cisco Unified SRST Mode

Procedure	<ol style="list-style-type: none"> 1. Set up a primary WAN interface and a secondary WAN interface on the branch router. 2. Set up a secondary WAN interface to be an SHDSL IMA interface. 3. Configure the secondary WAN to be a higher cost route than the primary WAN, using the OSPF ip ospf cost command, so that the primary WAN is always preferred. 4. Configure BFD on the primary WAN interface of the branch router and the primary WAN interface of the headend router with a BFD interval of 50 ms, a min_rx of 50 ms, and a BFD multiplier of 5. 5. Configure BFD on the secondary WAN interface. 6. Enable BFD for all interfaces in the OSPF routing process. 7. Verify whether BFD is up by entering the show bfd neighbor command. 8. Send HTTP and voice traffic between the branch and headquarters. 9. Bring down the primary WAN interface by either pulling out the cable or shutting down the link on the headend side. 10. After about 3 minutes bring up the primary WAN interface.
Pass/Fail Criteria	<p>When the primary WAN fails, OSPF reconvergence should occur within a second because of BFD, and all the traffic should be routed through the secondary WAN interface.</p> <p>Voice and HTTP sessions should be maintained during reconvergence.</p> <p>When the primary WAN comes up after 3 minutes, the traffic should be routed over the primary WAN interface.</p>
Result	<p>Passed on on Gigabit Ethernet interfaces</p> <p>BFD is supported only on Gigabit Ethernet interfaces. Support for additional WAN encapsulations such as Frame Relay and PPP is planned for future releases.</p>

IPsec over Backup SHDSL WAN Link

Description	Encryption over backup link between the branch and headquarters
Test Setup	Figure 1 on page 5, Private WAN, Cisco Unified CME Mode , or Figure 2 on page 6, Private WAN, Cisco Unified SRST Mode , or Figure 3 on page 6, MPLS WAN, Cisco Unified CME Mode , or Figure 4 on page 7, MPLS WAN, Cisco Unified SRST Mode

Procedure

1. Set up a primary WAN interface and a secondary WAN interface on the branch router.
2. Set up the secondary WAN interface to be an SHDSL IMA interface.
3. Configure the secondary WAN to be a higher cost route than the primary WAN, using the OSPF **ip ospf cost** command, so that the primary WAN is always preferred.
4. Configure BFD on the primary WAN interface of the branch router and the primary WAN interface of the headend router with a BFD interval of 50 ms, a min_rx of 50 ms, and a BFD multiplier of 5.
5. Configure BFD on the secondary WAN interface.
6. Enable BFD for all interfaces in the OSPF routing process.
7. Verify whether BFD is up by entering the **show bfd neighbor** command.
8. Configure one of the IPsec types, that is, IPsec DMVPN or GETVPN, on both the primary and secondary WAN interfaces between the branch and headquarters.
9. Send HTTP, FTP, and ICMP traffic between the branch and headquarters.
10. Bring down the primary WAN interface by either pulling out the cable or shutting down the link on the headend side.
11. After about 3 minutes bring up the primary WAN interface.

Pass/Fail Criteria

When the primary WAN fails, OSPF reconvergence should occur within a second because of BFD.

All the traffic should be sent through the IPsec tunnel over the secondary WAN interface.

HTTP, FTP, and ICMP sessions should be maintained during the switchover and switchback.

When the primary WAN comes up after 3 minutes, the traffic should be routed over the primary WAN interface IPsec tunnel.

No router tracebacks, memory leaks, or crashes should be observed.

All the traffic should be Cisco Express Forwarding switched.

Result

Passed on Gigabit Ethernet interfaces.

BFD is supported only on Gigabit Ethernet interfaces. Support for additional WAN encapsulations such as Frame Relay and PPP is planned for future releases.

ZPF, NAT, and IPsec over Backup SHDSL WAN Link**Description**

ZPF, NAT, and IPsec over backup SHDSL WAN link

Test Setup

[Figure 1 on page 5, Private WAN, Cisco Unified CME Mode](#), or [Figure 2 on page 6, Private WAN, Cisco Unified SRST Mode](#), or [Figure 3 on page 6, MPLS WAN, Cisco Unified CME Mode](#), or [Figure 4 on page 7, MPLS WAN, Cisco Unified SRST Mode](#)

Procedure

1. Set up a primary WAN interface and a secondary WAN interface on the branch router.
2. Set up a secondary WAN interface to be an SHDSL IMA interface.
3. Configure the secondary WAN to be a higher cost route than the primary WAN, using the OSPF **ip ospf cost** command, so that the primary WAN is always preferred.
4. Configure BFD on the primary WAN interface of the branch router and the primary WAN interface of the headend router with a BFD interval of 50 ms, a min_rx of 50 ms, and a BFD multiplier of 5.
5. Configure BFD on the secondary WAN interface.
6. Enable BFD for all interfaces in the OSPF routing process.
7. Verify whether BFD is up by entering the **show bfd neighbor** command.
8. Configure one of the IPsec types, that is, IPsec DMVPN or GETVPN, on both the primary and secondary WAN interfaces between the branch and headquarters.
9. Configure ZPF as explained in the [Zone-based Policy Firewall Configuration on the Branch Router](#) test case procedure.
10. Configure the secondary WAN interface as the interface connecting to the Internet through the ISP.
11. Assign the primary WAN interface to the Private zone.
12. Assign the secondary WAN interface to the Public zone.
13. Assign the voice VLAN and data VLAN interfaces to the Private zone.
14. If you are using DMVPN, assign the tunnel interface to the VPN zone.
15. Define a firewall policy between the VPN zone and the Public zone.
16. Define a firewall policy between the VPN zone and the Private zone.
17. Configure static NAT translations for certain hosts on the data VLAN using an address pool. For the rest of the hosts, configure PAT by using the **overload** command in the NAT configuration.
18. Configure the data VLAN as NAT inside, and configure the secondary WAN interface as NAT outside.
19. Send HTTP, FTP, and ICMP traffic between the branch and headquarters.
20. Send HTTP, FTP, DNS, and ICMP traffic between PCs on the branch data VLAN to the Internet.
21. Verify translations and statistics, using the **show ip nat translations** and **show ip nat statistics** commands.
22. Bring down the primary WAN interface by either pulling the cable out or shutting down the link on the headend side.
23. After about 3 minutes bring up the primary WAN interface.

Pass/Fail Criteria	<p>When the primary WAN fails, OSPF reconvergence should occur within a second because of BFD.</p> <p>ZPF should inspect all traffic going out of the secondary WAN interface.</p> <p>All the traffic between the branch and headquarters should be sent through the IPsec tunnel over the secondary WAN interface.</p> <p>Inside addresses should be translated to outside global addresses when the traffic from the LAN is going out to the Internet. The return traffic from the Internet to the LAN should always be directed to the outside global addresses of the inside hosts.</p> <p>HTTP, FTP, and ICMP sessions should be maintained during the switchover and switchback.</p> <p>When the primary comes up after 3 minutes, the traffic should be routed over the primary WAN interface IPsec tunnel.</p> <p>No router tracebacks, memory leaks, or crashes should be observed.</p> <p>All the traffic should be Cisco Express Forwarding switched.</p>
Result	<p>Passed on Gigabit Ethernet interfaces.</p> <p>BFD is supported only on Gigabit Ethernet interfaces. Support for additional WAN encapsulations such as Frame Relay and PPP is planned for future releases.</p>
IPsec, ZPF, QoS, NBAR, and NetFlow on Both Primary and Secondary Link, and NAT on the Secondary Link	
Description	ZPF, NAT, and IPsec over backup SHDSL WAN link
Test Setup	<p>Figure 1 on page 5, Private WAN, Cisco Unified CME Mode, or</p> <p>Figure 2 on page 6, Private WAN, Cisco Unified SRST Mode, or</p> <p>Figure 3 on page 6, MPLS WAN, Cisco Unified CME Mode, or</p> <p>Figure 4 on page 7, MPLS WAN, Cisco Unified SRST Mode</p>

Procedure

1. Set up a primary WAN interface and a secondary WAN interface on the branch router.
2. Set up the secondary WAN interface to be an SHDSL IMA interface.
3. Configure the secondary WAN to be a higher cost route than the primary WAN, using the OSPF **ip ospf cost** command, so that the primary WAN is always preferred.
4. Configure BFD on the primary WAN interface of the branch router and the primary WAN interface of the headend router with a BFD interval of 50 ms, a min_rx of 50 ms and a BFD multiplier of 5.
5. Configure BFD on the secondary WAN interface.
6. Enable BFD for all interfaces in the OSPF routing process.
7. Verify whether BFD is up by entering the **show bfd neighbor** command.
8. Configure one of the IPsec types, that is, DMVPN or GETVPN, on both the primary and secondary WAN interfaces between the branch and headquarters.
9. Configure ZPF as explained in the [Zone-based Policy Firewall Configuration on the Branch Router](#) test case procedure.
10. Configure the secondary WAN interface as the interface connecting to the Internet through the ISP.
11. Assign the primary WAN interface to the Private zone.
12. Assign the secondary WAN interface to the Public zone.
13. Assign the voice VLAN and data VLAN interfaces to the Private zone.
14. If you are using DMVPN, assign the tunnel interface to the VPN zone.
15. Define a firewall policy between the VPN zone and the Public zone.
16. Define a firewall policy between the VPN zone and the Private zone.
17. Configure static NAT translations for certain hosts on the data VLAN, using an address pool. For the rest of the hosts, configure PAT by using the **overload** command in the NAT configuration.
18. Configure the data VLAN as NAT inside, and configure the secondary WAN interface as NAT outside.
19. Configure Cisco IOS IPS with IDCONF v5.0 on the router.
20. Enable advanced category signature set.
21. Configure Cisco IOS IPS for both directions of traffic on the data and DMZ VLAN and WAN interfaces.
22. Enable syslog on the router, and log the syslog messages to a syslog server located in the branch.
23. Configure 8-class hierarchical QoS on both the primary and secondary WAN interfaces.
24. Mark all the traffic going out to the Internet as best-effort traffic.
25. Configure traffic shaping to 95% of the available WAN bandwidth.
26. Configure NBAR as in the [NBAR Classification with QoS](#) test case.

**Procedure
(continued)**

27. Configure NetFlow on the WAN and LAN interfaces for ingress and egress traffic.
28. Collect traffic statistics and distribution charts, and export the statistics to a NAM, using NetFlow version 5 or version 9.
29. Send HTTP, FTP, and ICMP traffic between the branch and headquarters.
30. Send HTTP, FTP, DNS, and ICMP traffic between PCs on the branch, and configure NetFlow on the WAN and LAN interfaces for ingress and egress traffic.
31. Verify translations and statistics, using the **show ip nat translations** and **show ip nat statistics** commands.
32. Launch DDOS attacks from a PC attached to the branch router data VLAN to a server located in the headquarters.
33. Launch threats from a host in the Internet to the DMZ servers.
34. Verify translations and statistics, using the **show ip nat translations** and **show ip nat statistics** commands.
35. Verify whether the attacks are detected by Cisco IOS IPS and the alert messages logged to the syslog server.
36. Verify QoS, using the **show policy-map interface** command.
37. Verify NetFlow, using the **show ip flow** command.
38. Bring down the primary WAN interface by either pulling out the cable or shutting down the link on the headend side.
39. After about 3 minutes bring up the primary WAN interface.

Pass/Fail Criteria

When the primary WAN fails, OSPF reconvergence should occur within a second because of BFD.

ZPF should inspect all traffic going out the secondary WAN interface.

All the traffic between the branch and headquarters should be sent through the IPsec tunnel over the secondary WAN interface.

Inside addresses should be translated to outside global addresses when the traffic from the LAN is going out to the Internet. The return traffic from the Internet to the LAN should always be directed to the outside global address of the inside hosts.

HTTP, FTP, and ICMP sessions should be maintained during the switchover and switchback.

QoS should be applied to the traffic, and ZPF should not have any adverse effect on the QoS.

All the Internet traffic should be marked as best effort.

Traffic should be shaped to 95% of the WAN bandwidth.

Since the secondary WAN link bandwidth is less than the primary WAN bandwidth, only conforming high-priority traffic, such as voice traffic or mission-critical traffic, should be carried over the secondary WAN link. The rest should be dropped.

The attacks should be detected by Cisco IOS IPS, and appropriate signatures should be triggered.

Actions such as warning, dropping the packets or dropping the session, or blocking the host should be taken based on a particular signature configuration.

The alert messages related to the attack should be logged to a syslog server.

NBAR should provide bandwidth guarantees to different flows and should detect and stop worms such as NIMDA and CODE RED.

NetFlow statistics collected should be within performance requirements.

When the primary comes up after 3 minutes, the traffic should be routed over the primary WAN interface IPsec tunnel.

No router tracebacks, memory leaks, or crashes should be observed.

All the traffic should be Cisco Express Forwarding switched.

Result

Passed on Gigabit Ethernet interfaces.

BFD is supported only on Gigabit Ethernet interfaces. Support for additional WAN encapsulations such as Frame Relay and PPP is planned for future releases.

Multicast with Security and QoS Features

Description Configure multicast PIM-v2 sparse mode on the branch and headend routers to send/receive multicast traffic

Test Setup [Figure 1 on page 5, Private WAN, Cisco Unified CME Mode](#), or [Figure 2 on page 6, Private WAN, Cisco Unified SRST Mode](#), or [Figure 3 on page 6, MPLS WAN, Cisco Unified CME Mode](#), or [Figure 4 on page 7, MPLS WAN, Cisco Unified SRST Mode](#)

Procedure

1. Set up a primary WAN interface and a secondary WAN interface on the branch router.
2. Set up the secondary WAN interface to be an SHDSL IMA interface.
3. Configure secondary WAN to be a higher cost route than the primary WAN, using the OSPF **ip ospf cost** command, so that the primary WAN is always preferred.
4. Configure BFD on the primary WAN interface of the branch router and the primary WAN interface of the headend router with a BFD interval of 50 ms, a min_rx of 50 ms, and a BFD multiplier of 5.
5. Configure BFD on the secondary WAN interface.
6. Enable BFD for all interfaces in the OSPF routing process.
7. Verify whether BFD is up by entering the **show bfd neighbor** command.
8. Configure an IPTV server on the headend to stream a 300-kb/s stream to a multicast group 239.10.x.x.
9. Configure the headend router as an RP, and configure PIM-SM on both the headend and branch routers.
10. Configure IGMP v2 on the access and distribution switches.
11. Configure one of the IPsec types, that is, DMVPN or GETVPN, on both the primary and secondary WAN interface between the branch and headquarters.
12. Configure ZPF as explained in the [Zone-based Policy Firewall Configuration on the Branch Router](#) test case procedure.
13. Configure the secondary WAN interface as the interface connecting to the Internet through the ISP.
14. Assign the primary WAN interface to the Private zone.
15. Assign the secondary WAN interface to the Public zone.
16. Assign the voice VLAN and data VLAN interfaces to the Private zone.
17. If you are using DMVPN, assign the tunnel interface to the VPN zone.
18. Define a firewall policy between the VPN zone and the Public zone.
19. Define a firewall policy between the VPN zone and the Private zone.
20. Configure static NAT translations for certain hosts on the data VLAN, using an address pool. For the rest of the hosts, configure PAT by using the **overload** command in the NAT configuration.
21. Configure the data VLAN as NAT inside, and configure the secondary WAN interface as NAT outside.
22. Configure Cisco IOS IPS with IDCONF v5.0 on the router.
23. Enable advanced category signature set.
24. Configure Cisco IOS IPS for both directions of traffic on the data and DMZ VLAN and WAN interfaces.
25. Enable syslog on the router, and log the syslog messages to a syslog server located in the branch.

**Procedure
(continued)**

26. Configure 8-class hierarchical QoS on both the primary and secondary WAN interfaces.
 27. Mark all the traffic going out to the Internet as best-effort traffic.
 28. Configure traffic shaping to 95% of the available WAN bandwidth.
 29. Configure NBAR as in the [NBAR Classification with QoS](#) test case.
 30. Configure NetFlow on the WAN and LAN interfaces for ingress and egress traffic.
 31. Collect traffic statistics and distribution charts, and export the statistics to a NAM, using NetFlow version 5 or version 9.
 32. Send HTTP, FTP, and ICMP traffic between the branch and headquarters.
 33. Send HTTP, FTP, DNS, and ICMP traffic between PCs on the branch data VLAN to the Internet.
 34. Four clients in the branch join the multicast group 239.10.x.x to view the IPTV video stream.
 35. Verify translations and statistics, using the **show ip nat translations** and **show ip nat statistics** commands.
 36. Launch DDOS attacks from a PC attached the branch router data VLAN to a server located in the headquarters.
 37. Launch threats from a host in the Internet to the DMZ servers.
 38. Verify translations and statistics, using the **show ip nat translations** and **show ip nat statistics** commands.
 39. Verify whether the attacks are detected by Cisco IOS IPS and whether the alert messages are logged to the syslog server.
 40. Verify QoS, using the **show policy-map interface** command.
 41. Verify NetFlow, using the **show ip flow** command.
 42. Verify multicast traffic, using the **show ip mroute active** and **show ip mroute count** commands.
 43. Bring down the primary WAN interface by either pulling out the cable or shutting down the link on the headend side.
 44. After about 3 minutes, bring up the primary WAN interface.
- Note** IPTV clients leave the group after 5 minutes.

Pass/Fail Criteria

When the primary WAN fails, OSPF reconvergence should occur within a second because of BFD.

ZPF should inspect all traffic going out of the secondary WAN interface.

All the traffic between the branch and headquarters should be sent through the IPsec tunnel over the secondary WAN interface.

Inside addresses should be translated to outside global addresses when the traffic from the LAN is going out to the Internet. The return traffic from the Internet to the LAN should always be directed to the outside global address of the inside hosts.

HTTP, FTP, and ICMP sessions should be maintained during the switchover and switchback.

QoS should be applied to the traffic, and ZPF should not have any adverse effect on the QoS.

All the Internet traffic should be marked as best-effort.

Traffic should be shaped to 95% of the WAN bandwidth.

Since the secondary WAN link bandwidth is less than the primary WAN bandwidth, only conforming high-priority traffic, such as voice traffic or mission-critical traffic, should be carried over the secondary WAN link. The rest should be dropped.

The attacks should be detected by Cisco IOS IPS, and appropriate signatures should be triggered.

Actions such as warning, dropping the packets or dropping the session, or blocking the host should be taken based on a particular signature configuration.

The alert messages related to the attack should be logged to a syslog server.

NBAR should provide bandwidth guarantees to different flows and should detect and stop worms such as NIMDA and CODE RED.

The multicast join should be successful, and IPTV clients should be able to view the IPTV video stream.

Even when multiple clients join the multicast group, only one stream should be coming from the headend to the branch.

The multicast clients should continue to receive the video stream during primary WAN link failure.

NetFlow statistics collected should be within performance requirements.

When the primary comes up after 3 minutes, the traffic should be routed over the primary WAN interface IPsec tunnel.

No router tracebacks, memory leaks, or crashes should be observed.

The multicast stream should cease from the headend to the branch when all the clients leave the multicast group.

All the traffic should be Cisco Express Forwarding switched.

Result	Passed on Gigabit Ethernet interfaces. BFD is supported only on Gigabit Ethernet interfaces. Support for additional WAN encapsulations such as Frame Relay and PPP is planned for future releases.
---------------	---

Network Management Test Cases

Enable SNMP on the UUTs for Management and Monitoring

Description	Network management using SNMP
Test Setup	Figure 2 on page 6, Private WAN, Cisco Unified SRST Mode
Procedure	<p>Enable SNMP on the Units Under Test (UUTs) as follows:</p> <ol style="list-style-type: none"> 1. Define read-only and read-write community strings, using the snmp-server community command. 2. Enable SNMP traps, using the snmp-server enable traps command. 3. Enable traps related to link status in the interface, using the snmp trap link-status command, <p>After enabling the UUTs for SNMP read-only and read-write access, poll an OID using the snmpget command on a UNIX box (for example, poll for the iftable to get a list of the interfaces on the router).</p>
Pass/Fail Criteria	If an SNMP trap-listener is configured, you should be able to see the traps sent by the UUT. You can simulate a link flap by entering a shutdown command, and then entering a no shutdown command. Configure the address of the management station, using the snmp-server host command.
Result	Passed

Enable SYSLOG on the UUT for Management and Monitoring

Description	Syslog for management and monitoring
Test Setup	Figure 2 on page 6, Private WAN, Cisco Unified SRST Mode
Procedure	<ol style="list-style-type: none"> 1. Enable syslog on the UUTs, using the logging command in global configuration mode, and redirect it to a syslog server. 2. Enable syslog using the logging host and logging facility local5 commands accordingly.
Pass/Fail Criteria	Syslog messages from the router should be sent to the syslog server; messages can be verified by comparing time stamps.
Result	Passed

Using Cisco CCP for Configuration and Monitoring of the UUTs

Description	Using CCP for router configuration and management
Test Setup	Figure 2 on page 6, Private WAN, Cisco Unified SRST Mode
Procedure	<ol style="list-style-type: none"> 1. Enter the ip http server command on the UUT. CCP can reside on the flash memory or on the PC connected to the network. 2. Use the CCP GUI to configure and monitor the UUT. You can use the CCP GUI to configure most features, including firewall and VPN.
Pass/Fail Criteria	Log on to the UUTs using CCP, and use the GUI to configure and monitor the UUT and interfaces.
Result	Passed

WAN Optimization Test Cases

Cisco WCCP Redirection

Description	Cisco WCCP redirection of TCP traffic to NME
Test Setup	Figure 2 on page 6, Private WAN, Cisco Unified SRST Mode
Procedure	<ol style="list-style-type: none"> 1. Enable Cisco WCCP redirection on the UUT for redirecting TCP flows to the Cisco WAE module using these commands: <ul style="list-style-type: none"> ip wccp version 2 ip wccp 61 ip wccp 62 2. On the WAN interface, enter the ip wccp redirect-out command to redirect all the TCP traffic exiting the WAN interface to the Cisco WAE module in the UUT. Enable Cisco WCCP on the Cisco WAE, using the wccp version 2 and wccp router-list commands. 3. Use the show wccp command to verify the status on the NME, and use the show ip wccp status command on the router.
Pass/Fail Criteria	Use the show ip wccp command to verify Cisco WCCP redirection.
Result	Passed

Cisco WAE Automatic Discovery to Identify WAE Appliances

Description	Verify automatic Cisco WAE appliance discovery with TCP traffic
Test Setup	Figure 2 on page 6, Private WAN, Cisco Unified SRST Mode

Procedure	<ol style="list-style-type: none"> 1. Enable Cisco WCCP on the router and on the NME as mentioned in the Cisco WCCP Redirection test case. 2. Enable Cisco WCCP redirection on the UUT to redirect TCP traffic to the NM. 3. Initiate a Telnet session or TCP-based service from the branch to the headquarters. This service should be able to start the autodiscovery of the Cisco WAE appliances.
------------------	---

Pass/Fail Criteria	Cisco WAE devices in the branch network should be able to automatically discover the Cisco WAE appliance in the headquarters when the TCP traffic flows are redirected to the NM, using TCP options.
---------------------------	--

Result	Passed
---------------	--------

Cisco WAE Optimization Feature (TFO)

Description	Verify that the TFO feature is working for TCP traffic between the branch and headquarters with and without introducing delay
--------------------	---

Test Setup	Figure 2 on page 6, Private WAN, Cisco Unified SRST Mode
-------------------	--

Procedure	<ol style="list-style-type: none"> 1. Set up Cisco WCCP redirection and enable the TFO feature on the Cisco WAE module on the UUT as mentioned in the previous WAN Optimization test cases. 2. Send stateful TCP traffic from the branch to headquarters, and monitor whether the traffic is being optimized. 3. Use the show statistics tfo command to check the statistics on the NME-WAE. 4. Enable delay, using the PMOD router on the headquarters network, and run the traffic again. Measure the flow optimization, and compare the two statistics (with and without delay).
------------------	--

Pass/Fail Criteria	TCP traffic should be redirected to the Cisco WAE module and optimized successfully. Use show commands on the Cisco WAE module to verify the optimization.
---------------------------	---

Result	Passed
---------------	--------

Cisco WAAS, Cisco IOS Zone-based Firewall, and Cisco IOS IPS Interoperability

Description	Cisco WAAS with security feature interoperability
--------------------	---

Test Setup	Figure 2 on page 6, Private WAN, Cisco Unified SRST Mode
-------------------	--

Procedure	<ol style="list-style-type: none">1. Configure Cisco WCCP redirection so that the TCP flows are redirected to the Cisco WAE module on the UUT as mentioned in the previous test cases.2. Configure zone-based firewall as described in the previous test cases.3. Configure Cisco IOS Intrusion Prevention as described in the previous test cases.4. Send stateful TCP traffic from the branch network on the UUT to the headquarters data network.5. Monitor the traffic, using show commands.
------------------	---

Pass/Fail Criteria	Verify that the TCP traffic is being optimized with all other Cisco IOS features being executed by using show commands listed in the “Cisco Wide Area Application Services Verification” section on page 7.
---------------------------	--

Result	Passed
---------------	--------

Cisco WAAS with NBAR

Description	Interoperability between NBAR and Cisco WAAS
--------------------	--

Test Setup	Figure 2 on page 6, Private WAN, Cisco Unified SRST Mode
-------------------	--

Procedure	<ol style="list-style-type: none">1. Set up NBAR on the UUT as described in previous test cases. NBAR policies are to mark traffic before it hits the Cisco WAE.2. Pass TCP/UDP traffic from the branch to the headquarters network.3. Verify that the NBAR policies are executed on the traffic flows and that Cisco WAAS optimizes the traffic flows.
------------------	---

Pass/Fail Criteria	Traffic from the branch to headquarters should be optimized, and the NBAR functionality should be verified.
---------------------------	---

Result	Passed
---------------	--------

Cisco WAAS with CIFS

Description	Verify the CIFS feature on the Cisco WAAS
--------------------	---

Test Setup	Figure 2 on page 6, Private WAN, Cisco Unified SRST Mode
-------------------	--

- Procedure**
1. Enable the CIFS feature on the Cisco WAE NM in the UUT and on the appliance in the headquarters.
Clients on the LAN can safely overcome protocol-specific performance limitations such as latency, data transfer, and bandwidth consumption. With Cisco WAAS acceleration, remote office users receive LAN-like access to centralized file server data, and with disconnected mode of operation, remote users retain continuous ability to read files during periods of prolonged disconnection.
 2. Use the CIFS_BM benchmark tool to test CIFS optimization and measure the latency and delay in ms.

Pass/Fail Criteria CIFS caching should produce LAN-like access to file server data with low speed or delayed WAN links.

Result Passed

Cisco WAE with Data Redundancy Elimination

Description Verify the DRE feature on Cisco WAAS

Test Setup [Figure 2 on page 6, Private WAN, Cisco Unified SRST Mode](#)

- Procedure**
1. Enable the DRE feature on the Cisco WAE NM on the UUT in the branch and also on the appliance in the headquarters.
 2. Pass TCP traffic from the branch to headquarters like FTP traffic with redundant data so that the directory is built up with hashes on the storage.
 3. Use the **show statistics dre** command to check the DRE cache hit and miss.
 4. You can also monitor the DRE feature using the Central Manager GUI.

Pass/Fail Criteria The DRE feature is supposed to reduce the amount of traffic traversing the WAN. You can validate the DRE feature by passing similar traffic multiple times and checking the WAN bandwidth usage.

Result Passed

Negative Test Case for DRE

Description Negative test case for DRE, reload the UUT on the branch network

Test Setup [Figure 2 on page 6, Private WAN, Cisco Unified SRST Mode](#)

Procedure	<ol style="list-style-type: none"> 1. In the Cisco WAE with Data Redundancy Elimination test case, we verified that the DRE is working, and after sending traffic for a while, verified that the database is built up on both ends. Reload the UUT or reload the NME WAE on the branch network. 2. The database should be flushed and rebuilt on both sides. 3. Verify using show commands on both sides.
Pass/Fail Criteria	The existing database should be flushed and rebuilt when the UUT is reloaded on the branch or headquarters side.
Result	Passed

Cisco Unified CME Test Cases

SCCP Phone Registration to Cisco Unified CME

Description	Register SCCP phones to the Cisco Unified CME
Test Setup	Figure 1 on page 5, Private WAN, Cisco Unified CME Mode , or Figure 3 on page 6, MPLS WAN, Cisco Unified CME Mode
Procedure	<ol style="list-style-type: none"> 1. Configure Cisco Unified CME on the branch router with the Cisco Unified CME address belonging to the voice VLAN segment. 2. For the Cisco 3945 branch, configure the maximum ephones to be 100 phones. 3. For the Cisco 3925 branch, configure the maximum ephones to be 60 phones. 4. Configure dual lines and auto-registration for each of the phones. 5. Configure a TFTP server on the branch router for the phones to download the firmware. 6. Configure a DHCP server on the branch router to provide IP addresses for Cisco IP Phone endpoints. 7. Register SCCP phones to Cisco Unified CME. Register multiple phone types such as 7960, 7962, 7965, 7971, 7975, 7985, and 7936 phones. 8. Verify the configuration, using the show telephony-service and show ephone registered commands.
Pass/Fail Criteria	All the phones should successfully register to the Cisco Unified CME.
Result	Passed

SIP Phone Registration to Cisco Unified CME

Description	Register SIP phones to Cisco Unified CME
Test Setup	Figure 1 on page 5, Private WAN, Cisco Unified CME Mode , or Figure 3 on page 6, MPLS WAN, Cisco Unified CME Mode
Procedure	<ol style="list-style-type: none"> 1. Configure Cisco Unified CME on the branch router with the Cisco Unified CME address belonging to the voice VLAN segment. 2. For the Cisco 3945 branch, configure the maximum ephones to be 100 phones. 3. For the Cisco 3925 branch, configure the maximum ephones to be 60 phones. 4. Configure dual lines and auto-registration for each of the phones. 5. Configure a TFTP server on the branch router for the phones to download the firmware. 6. Configure a DHCP server on the branch router to provide IP addresses for the Cisco IP Phone endpoints. 7. Register SIP phones to Cisco Unified CME. Register multiple phone types such as 7960, 7962, 7965, 7971, 7975, 7985, and 7936 phones. 8. Verify the configuration, using the show voice register command.
Pass/Fail Criteria	All the phones should successfully register to the Cisco Unified CME.
Result	Passed
SCCP Local Calls	
Description	Make calls between the SCCP phones registered to the Cisco Unified CME
Test Setup	Figure 1 on page 5, Private WAN, Cisco Unified CME Mode , or Figure 3 on page 6, MPLS WAN, Cisco Unified CME Mode
Procedure	<ol style="list-style-type: none"> 1. Make a call between two phones registered to the Cisco Unified CME. 2. Verify ringback tone when the phone is ringing. 3. Verify the voice path, and pass DTMF digits between the phones.
Pass/Fail Criteria	Voice call should be successful with 100% path confirmation. DTMF digit passing should successful.
Result	Passed

SIP Local Calls

Description	Make calls between the SIP phones registered to the Cisco Unified CME
Test Setup	Figure 1 on page 5, Private WAN, Cisco Unified CME Mode or Figure 3 on page 6, MPLS WAN, Cisco Unified CME Mode
Procedure	<ol style="list-style-type: none">1. Make a call between two phones registered to the Cisco Unified CME.2. Verify the ringback tone when the phone is ringing.3. Verify the voice path, and pass DTMF digits between the phones.
Pass/Fail Criteria	The voice call should be successful with 100% path confirmation. DTMF digit passing should be successful.
Result	Passed

PSTN Calls

Description	Make calls between the IP Phones registered to Cisco Unified CME to PSTN
Test Setup	Figure 1 on page 5, Private WAN, Cisco Unified CME Mode , or Figure 3 on page 6, MPLS WAN, Cisco Unified CME Mode
Procedure	<ol style="list-style-type: none">1. Configure a PRI trunk to the PSTN on the branch router.2. Configure voice translation rules to translate incoming calls from the PSTN.3. Make a call from a PSTN phone to the branch IP Phone.4. Verify the ringback tone when the phone is ringing.5. Verify the voice path, and pass DTMF digits.6. Verify for both SCCP and SIP phones.
Pass/Fail Criteria	Voice call should be successful with 100% path confirmation. DTMF digit passing should be successful.
Result	Passed

Branch to Headquarters Calls over the WAN with a SIP Trunk

Description	Make calls between the IP Phones registered to Cisco Unified CME in the branch and IP Phones registered to Cisco Unified CM in the headquarters
Test Setup	Figure 1 on page 5, Private WAN, Cisco Unified CME Mode , or Figure 3 on page 6, MPLS WAN, Cisco Unified CME Mode

Procedure	<ol style="list-style-type: none">1. Configure a SIP trunk over the WAN interface between Cisco Unified CME and Cisco Unified CM.2. Configure voice class with G.729 and G.711 as the codec options, with the first choice being G.729, and the second choice being G.711.3. Configure RFC 2833 for DTMF relay.4. Associate the voice class to the SIP trunk dial peer.5. Make a call from an IP Phone in the branch to the IP Phone in the headquarters.6. Verify the ringback tone when the phone is ringing.7. Verify the voice path, and pass DTMF digits.8. Verify for both SCCP and SIP phones.
------------------	--

Pass/Fail Criteria	Voice call should be successful with 100% path confirmation. DTMF digit passing should be successful.
---------------------------	--

Result	Passed
---------------	--------

Branch to Headquarters Calls over the WAN with an H.323 trunk

Description	Make calls between the IP Phones registered to Cisco Unified CME in the branch and IP Phones registered to Cisco Unified CM in the headquarters
--------------------	---

Test Setup	Figure 1 on page 5, Private WAN, Cisco Unified CME Mode , or Figure 3 on page 6, MPLS WAN, Cisco Unified CME Mode
-------------------	--

Procedure	<ol style="list-style-type: none">1. Configure an H.323 trunk over the WAN interface between Cisco Unified CME and Cisco Unified CM.2. Configure voice class with G.729 and G.711 as the codec options, with the first choice being G.729, and the second choice being G.711.3. Configure RFC 2833 DTMF relay.4. Associate the voice class to the H.323 dial peer.5. Make a call from an IP Phone in the branch to the IP Phone in the headquarters.6. Verify the ringback tone when the phone is ringing.7. Verify the voice path, and pass DTMF digits.8. Verify for both SCCP and SIP Phones.
------------------	---

Pass/Fail Criteria	Voice call should be successful with 100% path confirmation. DTMF digit passing should be successful.
---------------------------	--

Result	Passed
---------------	--------

Supplementary Services with Cisco Unified CME

Description	Test the various supplementary features in Cisco Unified CME with all the phones local to the branch
Test Setup	Figure 1 on page 5, Private WAN, Cisco Unified CME Mode , or Figure 3 on page 6, MPLS WAN, Cisco Unified CME Mode
Procedure	<ol style="list-style-type: none">1. Configure transfer system full-consult on the Cisco Unified CME.2. Configure music on hold (MOH) to source from a file in flash memory.3. Verify call transfer full consult between phones A, B, and C, with C being the transferrer; that is, make a call from phone A to phone B, and transfer the call to phone C.4. Verify MOH on phone A during call transfer.5. Configure transfer system full-blind on the Cisco Unified CME.6. Verify call transfer full-blind between phones A, B, and C with C being the transferrer, that is, make a call from phone A to phone B, and transfer the call to phone C.7. Verify MOH on phone A during call transfer.8. Configure call forward functionality by configuring forward-to numbers under the ephone-dns.9. Verify call forward no answer to another ephone extension.10. Verify call forward all to another ephone extension.
Pass/Fail Criteria	Voice call should be successful with 100% path confirmation. Call transfer full-consult should be successful. Call transfer full-blind should be successful. Call forward no answer should be successful. Call forward all should be successful. MOH should be heard.
Result	Passed

Supplementary Services Between Phones in the Branch, Headquarters, and PSTN

Description	Test the various supplementary features between phones in the branch registered to Cisco Unified CME, phones registered to Cisco Unified CM, and PSTN phones
Test Setup	Figure 1 on page 5, Private WAN, Cisco Unified CME Mode , or Figure 3 on page 6, MPLS WAN, Cisco Unified CME Mode

Procedure	<ol style="list-style-type: none"> 1. Configure transfer system full-consult on the Cisco Unified CME. 2. Configure MOH to source from a file in flash memory. 3. Configure multicast MOH. 4. Verify call transfer full-consult between phones A, B, and C with C being the transferrer; that is, make a call from phone A to phone B, and transfer the call to phone C. Phone A is located in headquarters, Phone B is located in the branch, and Phone C is in the PSTN. 5. Verify MOH on phone A during call transfer. 6. Configure transfer system full-blind on the Cisco Unified CME. 7. Verify call transfer full-blind between phones A, B, and C with C being the transferrer; that is, make a call from phone A to phone B, and transfer the call to phone C. 8. Verify MOH on phone A during call transfer. 9. Configure call forward functionality for Cisco Unified CME phones by configuring forward-to numbers under the ephone-dns. 10. Verify call forward no answer to another ephone extension. 11. Verify call forward all to another ephone extension.
------------------	--

Pass/Fail Criteria	<p>Voice call should be successful with 100% path confirmation.</p> <p>Call transfer full-consult should be successful.</p> <p>Call transfer full-blind should be successful.</p> <p>Call forward no answer should be successful.</p> <p>Call forward all should be successful.</p> <p>MOH should be heard.</p>
---------------------------	---

Result	Passed
---------------	--------

Call Conference in the Branch Cisco Unified CME

Description	Test a three-party conference with the branch IP Phone as the conference initiator
Test Setup	Figure 1 on page 5, Private WAN, Cisco Unified CME Mode , or Figure 3 on page 6, MPLS WAN, Cisco Unified CME Mode
Procedure	<ol style="list-style-type: none"> 1. Make a three-party conference between a branch phone, a headquarters phone, and a PSTN phone, with the branch phone as the conference initiator.
Pass/Fail Criteria	Conference call should be successful.
Result	Passed

Call Forward to Voice Mail

Description	Test call forward to Cisco Unity Express with transcoding on the Cisco Unified CME
Test Setup	Figure 1 on page 5, Private WAN, Cisco Unified CME Mode , or Figure 3 on page 6, MPLS WAN, Cisco Unified CME Mode
Procedure	<ol style="list-style-type: none">1. Configure call forward on no answer or busy to voice mail on the ephone DNs of the IP Phones on the branch.2. Set up Cisco Unity Express as the voice mail system.3. Configure DSP farm on the branch router for Cisco Unified CME transcoding to transcode G.729 codec to G.711-ulaw codec.4. Make a call from the headquarters phone to the branch phone that uses the G.729 codec.5. Make a branch phone busy.6. Verify whether the call was forwarded to voice mail.7. Verify whether the MWI appears on the branch phone.8. Retrieve the voice mail from Cisco Unity Express by dialing the voice mail from the branch phone.9. Verify whether the MWI disappears once the message is heard.
Pass/Fail Criteria	<p>The call should be forwarded to voice mail.</p> <p>Cisco Unified CME transcoding resources should be invoked when the call is forwarded to voice mail, because Cisco Unity Express supports only the G.711u-law codec.</p> <p>The MWI light should appear when the message is left in Cisco Unity Express and should disappear once the message is retrieved.</p>
Result	Passed

Video Call Between Branch and Headquarters

Description	Test a video call between the branch and headquarters using either Cisco Unified Video Advantage or the Cisco Unified IP Phone 7985G.
Test Setup	Figure 1 on page 5, Private WAN, Cisco Unified CME Mode , or Figure 3 on page 6, MPLS WAN, Cisco Unified CME Mode

Procedure	<ol style="list-style-type: none"> 1. Make a video call between the branch phone and the headquarters phone using either Cisco Unified Video Advantage or the Cisco Unified IP Phone 7985G with H.263 for the video and G.711u-law codec for the voice. 2. Test Hold and Resume on the Cisco Unified CME phone. 3. Test mute. 4. Verify the voice and video path.
------------------	---

Pass/Fail Criteria	<p>The voice and video path confirmation should be 100%.</p> <p>When the Cisco Unified CME phone puts the call on hold, the headquarters phone should hear MOH.</p> <p>When the Cisco Unified CME phone mutes the call, the headquarters phone should not hear anything, and the video should freeze.</p>
---------------------------	---

Result	Passed
---------------	--------

T.38 Fax Between Branch and Headquarters

Description	Test T.38 fax between the branch and headquarters
Test Setup	Figure 1 on page 5, Private WAN, Cisco Unified CME Mode , or Figure 3 on page 6, MPLS WAN, Cisco Unified CME Mode
Procedure	<ol style="list-style-type: none"> 1. Configure T.38 fax on the branch router and T.38 fax the Cisco Unified CM. 2. Using a fax machine in the branch, send a multipage fax to a fax machine in the headquarters.
Pass/Fail Criteria	The fax should be received properly on the headquarters fax machine.
Result	Passed

IP SLA VoIP UDP Jitter Codec g711ulaw (Branch to HQ)

Description	VoIP UDP Jitter IP SLA codec g711ulaw
Test Setup	Figure 1 on page 5, Private WAN, Cisco Unified CME Mode , or Figure 3 on page 6, MPLS WAN, Cisco Unified CME Mode

- Procedure**
1. Enable the IP SLA responder on the HQ router.
 2. Configure the basic VoIP UDP Jitter operation type on the branch router.
 3. Configure any options available, such as codec g711ulaw, for the VoIP UDP Jitter SLAs operation type.
 4. Configure the threshold conditions, if required.
 5. Schedule the operation to run and let the operation run for enough of a period of time to gather statistics.
 6. Display and interpret the results of the operation using either the Cisco IOS CLI or an NMS system with SNMP.

Pass/Fail Criteria To view and interpret the operational results of an IP SLA, use the **show ip sla monitor statistics** command to check the boundaries the limits, for example:

ICPIF Range	MOS	Quality
0–3	5	Best
4–13	4	High
14–23	3	Medium
24–33	2	Low
34–43	1	Poor

Result Passed

Remote Phones on the Cisco Unified CME

Description Test remote phone support in the Cisco Unified CME

Test Setup [Figure 1 on page 5, Private WAN, Cisco Unified CME Mode](#) or [Figure 3 on page 6, MPLS WAN, Cisco Unified CME Mode](#)

- Procedure**
1. Register a remote phone to the Cisco Unified CME through the Internet; that is, the remote phone is located in the remote teleworker's home office.
 2. Configure the G.729 codec for remote phones.
 3. Configure the media termination point (MTP) option on the Cisco Unified CME to terminate and originate RTP packets from and to the remote phone.
 4. Configure DSP farm assist for the remote phone to transcode G.729 calls to G.711 calls.
 5. Make a call from the remote phone to a branch IP Phone.
 6. Verify the ringback tone when the phone is ringing.
 7. Verify the voice path and also pass DTMF digits.

Pass/Fail Criteria The ringback tone should be heard.
 The voice path confirmation should be 100%.
 DTMF digit passing should be successful.

Result Passed

Cisco Unified CME with WAN Failure Scenario to Headquarters

Description Test the Cisco Unified CME functionality to the headquarters during WAN failure

Test Setup [Figure 1 on page 5, Private WAN, Cisco Unified CME Mode](#), or
[Figure 3 on page 6, MPLS WAN, Cisco Unified CME Mode](#)

Procedure 1. Make a call between a branch IP Phone and a headquarters IP Phone.
 2. Make a call between a branch IP Phone and a PSTN phone.
 3. Make a call between two branch IP Phones.
 4. Bring down the WAN interface of the router.

Pass/Fail Criteria During WAN failure the call between the branch IP Phone and the headquarters IP Phone should be dropped; however, the call between the IP Phone and the PSTN phone and the call between the two IP Phones in the branch should be sustained.

Result Passed

Cisco Unified CME with IPsec over the WAN

Description Test Cisco Unified CME functionality with IPsec over the WAN

Test Setup [Figure 1 on page 5, Private WAN, Cisco Unified CME Mode](#), or
[Figure 3 on page 6, MPLS WAN, Cisco Unified CME Mode](#)

Procedure 1. Configure IPsec over the WAN, and test with all types of IPsec.
 2. Make a video call from a branch IP Phone to a headquarters IP Phone.
 3. Verify ringback.
 4. Verify whether signaling, voice, and video packets are encrypted and decrypted properly.
 5. Verify voice and video path, and pass DTMF digits.

Pass/Fail Criteria Signaling, voice, and video packets should be encrypted and decrypted properly.

 The ringback tone should be heard when the remote phone rings.

 The voice and video path confirmation should be 100%.

 DTMF digit passing should be successful.

Result Passed

Cisco Unified CME with QoS and NBAR

Description Test Cisco Unified CME functionality with QoS and NBAR applied to signaling and RTP packets

Test Setup [Figure 1 on page 5, Private WAN, Cisco Unified CME Mode](#), or
[Figure 3 on page 6, MPLS WAN, Cisco Unified CME Mode](#)

Procedure

1. Configure the 8-class QoS model over the primary WAN interface.
2. Configure LLQ for voice and video traffic and allocate X% and Y% of the bandwidth for voice and video, but make sure not to exceed 33% of the total bandwidth.
3. Configure 1P3Q3T on the Catalyst switch, and trust the COS value coming from the Cisco IP Phones.
4. Configure a DSCP value of CS3 on the SIP/H.323 dial peer to give priority to signaling traffic.
5. Make voice and video calls from branch IP Phones to headquarters IP Phones.
6. Verify whether the IP Phone marks the voice traffic with a DSCP value of EF.
7. Verify whether the Catalyst switch marks the video packets with a DSCP value of AF41.
8. Verify whether call signaling, voice, and video traffic are classified properly and put in priority queue.
9. Send more voice and video traffic to exceed the allocated bandwidth, and verify whether voice and video traffic is dropped.

Pass/Fail Criteria

The IP Phone should mark the voice traffic with DSCP value of EF.
 The IP Phone should mark SCCP signaling traffic with DSCP value of CS3.
 The Catalyst switch should trust the COS value marked by IP Phone.
 Catalyst switch should remark the video traffic to AF41.
 QoS on the router should properly classify signaling, voice, and video packets, based on their DSCP value.
 Voice and video should get strict priority queuing treatment; that is, adhering voice and video traffic should be sent out first, and exceeding voice and video traffic should be dropped.

Result Passed

Cisco Unified CME with ZPF

Description Test Cisco Unified CME functionality with ZPF

Test Setup [Figure 1 on page 5, Private WAN, Cisco Unified CME Mode](#), or [Figure 3 on page 6, MPLS WAN, Cisco Unified CME Mode](#)

Procedure

1. Configure ZPF, with data and voice VLANs in the Private zone and with WAN interface in the Public zone.
2. Configure a policy to inspect router-generated SIP, H.323, and RTP traffic from system-defined self-zone to Public zone, and vice versa.
3. Configure access lists to allow calls originated in headquarters through the firewall.
4. Make a voice call from a branch IP Phone to a headquarters IP Phone.
5. Verify the ringback tone.
6. Verify the voice path and pass DTMF digits.

Pass/Fail Criteria

ZPF should inspect call signaling and RTP packets and open holes for the return traffic.
 The ringback tone should be heard.
 The voice path confirmation should be 100%.
 DTMF digit passing should be successful.

Result Passed

Cisco Unified CME Remote Phones with ZPF

Description Test Cisco Unified CME remote phone support with ZPF

Test Setup [Figure 1 on page 5, Private WAN, Cisco Unified CME Mode](#), or [Figure 3 on page 6, MPLS WAN, Cisco Unified CME Mode](#)

Procedure	<ol style="list-style-type: none">1. Configure ZPF, with data and voice VLANs in the Private zone and WAN interface in the Public zone.2. Configure a policy to inspect router generated SIP, H.323, and RTP traffic from system-defined self-zone to Public zone, and vice versa.3. Configure a policy to inspect SCCP traffic for the remote phone.4. Configure an access list to allow incoming SCCP and RTP traffic from a remote phone to the Cisco Unified CME.5. Configure MTP on the Cisco Unified CME.6. Configure DSP farm assist for the remote phone.7. Configure an access list to allow calls originated in headquarters through the firewall.8. Make a voice call from a remote IP Phone to a branch IP Phone.9. Verify the ringback tone.10. Verify the voice path and pass DTMF digits.11. When the call is verified, transfer the call, using full-consult transfer, to a headquarters, with the branch phone being the transferrer. Commit the transfer.12. Verify whether the transfer completes.13. Verify whether the voice path between the remote phone and the headquarters phone is set up.14. Verify DTMF digit passing.
Pass/Fail Criteria	<p>ZPF should open holes for SCCP traffic for remote phone registration.</p> <p>ZPF should inspect call signaling and RTP packets and open holes for the return traffic.</p> <p>The ringback tone should be heard.</p> <p>The voice path confirmation should be 100%.</p> <p>DTMF digit passing should be successful.</p> <p>Transfer should be successful.</p>
Result	Passed

Cisco Unified CME Failover with Secondary Cisco Unified CME

Description	Test Cisco Unified CME failover to a secondary Cisco Unified CME
Test Setup	Figure 1 on page 5, Private WAN, Cisco Unified CME Mode , or Figure 3 on page 6, MPLS WAN, Cisco Unified CME Mode

Procedure	<ol style="list-style-type: none"> 1. Set up Cisco Unified CMEs on two branch routers; make one of the routers the primary Cisco Unified CME, and make the other the secondary. 2. Register all the phones to the primary Cisco Unified CME. 3. Verify in the phone network configuration whether both Cisco Unified CMEs exist. 4. Make a call between the branch IP Phone and the headquarters IP Phone. 5. Make a call between the branch IP Phone and another branch IP Phone. 6. Bring down the primary Cisco Unified CME by reloading that router. 7. Verify whether all the phones register to the secondary Cisco Unified CME. 8. Verify the status of active calls. 9. Verify MWI status of phones with active voice mail. 10. Verify whether the phones fall back to the primary Cisco Unified CME when it comes back up.
------------------	---

Pass/Fail Criteria	<p>When the primary Cisco Unified CME fails, all the phones with no active calls should immediately register to the secondary Cisco Unified CME.</p> <p>For phones with active calls over the WAN to headquarters or the PSTN, those calls should be dropped. The phones should immediately register to the secondary Cisco Unified CME.</p> <p>For phones with active calls local to the branch, those calls should be sustained. When those calls complete, those phones should register to the secondary Cisco Unified CME.</p> <p>Phones with active voice mail should lose their MWI.</p> <p>When the primary Cisco Unified CME comes up, all the phones should register to primary Cisco Unified CME.</p>
---------------------------	---

Result	Passed
---------------	--------

Baseline Features Plus Cisco Unified CME

Description	Test baseline features plus Cisco Unified CME
Test Setup	Figure 1 on page 5, Private WAN, Cisco Unified CME Mode , or Figure 3 on page 6, MPLS WAN, Cisco Unified CME Mode

Procedure

1. Enable all baseline features as described in the [Complete Baseline Test](#) test case.
2. Configure a primary Cisco Unified CME and a secondary Unified CME.
3. Register all the phones to the primary Cisco Unified CME.
4. Make voice and video calls between branch IP Phones and headquarters IP Phones.
 - a. Verify the ringback tone, verify the voice and video path, and pass DTMF digits.
5. Make voice calls between branch IP Phones and PSTN phones.
 - a. Verify the ringback tone, verify the voice path, and pass DTMF digits.
6. Make voice calls between branch IP Phones.
 - a. Verify the ringback tone, verify the voice path, and pass DTMF digits.
7. Make a 4-party conference call with a branch IP Phone, a branch FXS phone, a headquarters IP Phone, and a PSTN phone as the conference participants.
 - a. Verify that when the conference initiator leaves the conference, all the parties are dropped.
8. Make a call from a headquarters IP Phone to a branch IP Phone, which is busy.
 - a. Verify whether the headquarters IP Phone is able to leave voice mail.
 - b. Verify whether Cisco Unified CME transcoding is invoked.
 - c. Verify whether the branch phone receives an MWI.
9. Retrieve voice mail from branch IP Phones.
 - a. Verify whether MWI changes status once the voice mail messages are retrieved.
10. Make a call from a remote Cisco Unified CME phone to a branch IP Phone.
 - a. Verify the ringback tone, verify the voice path, and pass DTMF digits.
11. Verify supplementary services.

Pass/Fail Criteria	<p>The voice and video path confirmation should be 100%.</p> <p>Cisco Unified CME transcoding gets invoked for call transfers to voice mail, with the calling party being in headquarters.</p> <p>DSP farm assist gets invoked for remote phones.</p> <p>The MWI light should turn on when voice mail messages are left and should turn off when the voice mail messages are retrieved.</p> <p>The conference call should be successful.</p> <p>Supplementary services such as call transfer and call forward should be successful.</p>
Result	Passed

Cisco Unified SRST Test Cases

SCCP Phone Registration to Cisco Unified CM

Description	Register IP Phones in the branch to the Cisco Unified CM located in the headquarters using SCCP
Test Setup	Figure 2 on page 6, Private WAN, Cisco Unified SRST Mode , or Figure 4 on page 7, MPLS WAN, Cisco Unified SRST Mode
Procedure	<ol style="list-style-type: none"> 1. For the Cisco 3945 branch, register 240 phones to Cisco Unified CM. 2. For the Cisco 3925 branch register 160 phones to Cisco Unified CM. 3. Use Cisco Unified CM bulk registration utility to register all the phones. 4. Configure regions in Cisco Unified CM for each branch. 5. Configure dual lines for each phone. 6. Configure the TFTP server as the Cisco Unified CM in the branch router that is used to download the firmware. 7. Configure a DHCP server on the branch router to provide IP addresses to IP Phone endpoints. 8. Register SCCP phones to Cisco Unified CM. Register multiple phone types such as 7960, 7962, 7965, 7971, 7975, 7985, and 7936 phones.
Pass/Fail Criteria	All the phones should successfully register to the Cisco Unified CM.
Result	Passed

SIP Phone Registration to Cisco Unified CM

Description	Register IP Phones in the branch to the Cisco Unified Communications Manager, located in the headquarters using SIP
Test Setup	Figure 2 on page 6, Private WAN, Cisco Unified SRST Mode , or Figure 4 on page 7, MPLS WAN, Cisco Unified SRST Mode
Procedure	<ol style="list-style-type: none">1. For the Cisco 3945 branch, register 240 phones to Cisco Unified CM.2. For the Cisco 3925 branch, register 160 phones to Cisco Unified CM.3. Use the Cisco Unified CM bulk registration utility to register all the phones.4. Configure regions in the Cisco Unified CM for each branch.5. Configure dual lines for each of the phones.6. Configure a TFTP server as the Cisco Unified Communications Manager in the branch router for the phones to download the firmware.7. Configure a DHCP server on the branch router to provide IP addresses to IP Phone endpoints.8. Register SIP phones to Cisco Unified CM. Register multiple phone types such as 7960, 7962, 7965, 7971, 7975, 7985, and 7936 phones.
Pass/Fail Criteria	All the phones should successfully register to the Cisco Unified CM.
Result	Passed

SIP Local Calls

Description	Make calls between the SIP phones registered to the Cisco Unified CM
Test Setup	Figure 2 on page 6, Private WAN, Cisco Unified SRST Mode , or Figure 4 on page 7, MPLS WAN, Cisco Unified SRST Mode
Procedure	<ol style="list-style-type: none">1. Make a call between two phones registered to the Cisco Unified CM.2. Verify the ringback tone when the phone is ringing.3. Verify the voice path, and pass DTMF digits between the phones.
Pass/Fail Criteria	The voice calls should be successful with 100% path confirmation. DTMF digit passing should be successful.
Result	Passed

SCCP Local Calls

Description	Make calls between the SCCP phones registered to the Cisco Unified CM.
Test Setup	Figure 2 on page 6, Private WAN, Cisco Unified SRST Mode , or Figure 4 on page 7, MPLS WAN, Cisco Unified SRST Mode
Procedure	<ol style="list-style-type: none">1. Make a call between two phones registered to the Cisco Unified CM.2. Verify the ringback tone when the phone is ringing.3. Verify the voice path, and pass DTMF digits between the phones.
Pass/Fail Criteria	The voice call should be successful with 100% path confirmation. DTMF digit passing should be successful.
Result	Passed

PSTN Calls with SIP Gateway

Description	Make calls between the IP Phones registered to Cisco Unified CM and PSTN phones
Test Setup	Figure 2 on page 6, Private WAN, Cisco Unified SRST Mode , or Figure 4 on page 7, MPLS WAN, Cisco Unified SRST Mode
Procedure	<ol style="list-style-type: none">1. Configure a PRI trunk to the PSTN on the branch router.2. Configure voice translation rules to translate incoming calls from the PSTN.3. Configure a SIP trunk between the branch router and Cisco Unified CM.4. Register the branch router as a SIP gateway in Cisco Unified CM.5. Configure an autoattendant in Cisco Unified CM that includes route lists, route groups, and route pattern.6. Make a call from a PSTN phone to the branch IP Phone.7. Verify the ringback tone when the phone is ringing.8. Verify the voice path, and pass DTMF digits.
Pass/Fail Criteria	The voice call should be successful with 100% path confirmation. DTMF digit passing should be successful.
Result	Passed

PSTN Calls with H.323 Gateway

Description	Make calls between the IP Phones registered to Cisco Unified CM to PSTN
Test Setup	Figure 2 on page 6, Private WAN, Cisco Unified SRST Mode , or Figure 4 on page 7, MPLS WAN, Cisco Unified SRST Mode
Procedure	<ol style="list-style-type: none">1. Configure a PRI trunk to the PSTN on the branch router.2. Configure voice translation rules to translate incoming calls from the PSTN.3. Configure an H.323 trunk between the branch router and Cisco Unified CM.4. Register the branch router as an H.323 gateway in Cisco Unified CM.5. Configure a autoattendant in Cisco Unified CM that includes route lists, route groups, and route pattern.6. Make a call from a PSTN phone to the branch IP Phone.7. Verify the ringback tone when the phone is ringing.8. Verify the voice path, and pass DTMF digits.
Pass/Fail Criteria	The voice call should be successful with 100% path confirmation. DTMF digit passing should be successful.
Result	Passed

Branch to Headquarters Calls over the WAN

Description	Make calls between the branch IP Phones registered to Cisco Unified CM and IP Phones registered to Cisco Unified CM in the headquarters
Test Setup	Figure 2 on page 6, Private WAN, Cisco Unified SRST Mode , or Figure 4 on page 7, MPLS WAN, Cisco Unified SRST Mode
Procedure	<ol style="list-style-type: none">1. Make a call from an IP Phone in the branch to the IP Phone in the headquarters.2. Verify the ringback tone when the phone is ringing.3. Verify the voice path, and pass DTMF digits.4. Verify for both SCCP and SIP Phones.
Pass/Fail Criteria	The voice call should be successful with 100% path confirmation. DTMF digit passing should be successful.
Result	Passed

Supplementary Services Between Phones in Branch, Headquarters, and PSTN

Description	Test the various supplementary features between phones in the branch registered to Cisco Unified CM, phones in headquarters registered to Cisco Unified CM, and PSTN phones
Test Setup	Figure 2 on page 6, Private WAN, Cisco Unified SRST Mode , or Figure 4 on page 7, MPLS WAN, Cisco Unified SRST Mode
Procedure	<ol style="list-style-type: none"> 1. Configure the branch router as a SIP gateway. 2. Configure multicast MOH on Cisco Unified CM. 3. Enable PIM-SM on the branch router and headend router, with the headend router as the RP. 4. Verify call transfer full-consult between phones A (located in headquarters), B (located in the branch), and C (on the PSTN) with C being the transferrer; that is, make a call from phone A to phone B, and transfer the call to phone C. 5. Verify MOH on phone A during call transfer. 6. Configure call forward functionality for IP Phones by configuring forward-to numbers in the phone configuration in Cisco Unified CM. 7. Verify call forward no answer to another IP Phone extension. 8. Verify call forward all to another IP Phone extension.
Pass/Fail Criteria	<p>The voice call should be successful with 100% path confirmation.</p> <p>Call transfer full-consult should be successful.</p> <p>Call forward no answer should be successful.</p> <p>Call forward all should be successful.</p> <p>MOH should be heard.</p>
Result	Passed

Call Conference in the Branch

Description	Test a three-party conference with the branch IP Phone as the conference initiator
Test Setup	Figure 2 on page 6, Private WAN, Cisco Unified SRST Mode , or Figure 4 on page 7, MPLS WAN, Cisco Unified SRST Mode

- Procedure**
1. Configure DSP farm conferencing on the branch router to utilize the DSP resources in the branch router for conferencing.
 2. Configure a media resources group for conference in the Cisco Unified CM.
 3. Add the branch router DSP farm resource to the media resource group.
 4. Register the DSP farm to the Cisco Unified CM.
 5. Make a three-party conference between a branch phone, headquarters phone, and a PSTN phone, with the branch phone as the conference initiator.
 6. Verify whether DSP farm conferencing resources is utilized, using the **show dspfarm** and **show sccp connections** commands.

Pass/Fail Criteria

Conference call should be successful.

The DSP farm resources on the branch router should be utilized for conferencing.

When the conference initiator drops the call, all the parties should drop out of the conference.

Result Passed

Call Forward to Voice Mail

Description Test call forward to Cisco Unity Express with DSP farm transcoding

Test Setup [Figure 2 on page 6, Private WAN, Cisco Unified SRST Mode](#), or [Figure 4 on page 7, MPLS WAN, Cisco Unified SRST Mode](#)

Procedure	<ol style="list-style-type: none"> 1. Set up Cisco Unity Express on the branch router and register Cisco Unity Express to Cisco Unified CM using JTAPI. 2. Configure CTI ports on Cisco Unified CM. 3. Configure call forward on no answer or busy to voice mail in the device, phone configuration in Cisco Unified CM. 4. Configure DSP farm transcoding on the branch router to transcode G.729 codec to G.711ulaw codec. 5. Configure a media resource group for transcoder in Cisco Unified CM, and add the branch DSP farm transcoding resource to the media resource group. 6. Make a call from the headquarters phone to the branch phone using the G.729 codec. 7. Make the branch phone busy. 8. Verify whether the call was forwarded to voice mail. 9. Verify whether MWI appears on the branch phone when the voice mail is left. 10. Retrieve the voice mail from the Cisco Unity Express by dialing the voice mail from the branch phone. 11. Verify whether the MWI disappears when the message is heard.
Pass/Fail Criteria	<p>The call should be forwarded to voice mail.</p> <p>The DSP farm transcoding resources should be invoked when the call is forwarded to voice mail, since Cisco Unity Express supports only the G.711u-law codec.</p> <p>The MWI light should appear when the message is left in Cisco Unity Express and should disappear when the message is retrieved.</p>
Result	Passed

Phone Registration During Cisco Unified Survivable Remote Site Telephony (Cisco Unified SRST)

Description	Test IP Phone registrations during Cisco Unified SRST mode
Test Setup	Figure 2 on page 6, Private WAN, Cisco Unified SRST Mode , or Figure 4 on page 7, MPLS WAN, Cisco Unified SRST Mode

Procedure	<ol style="list-style-type: none">1. Initially register all the branch phones to Cisco Unified CM.2. Configure Cisco Unified SRST in the branch router.3. Configure Cisco Unified SRST in Cisco Unified CM as the branch router.4. Make calls between branch phones and headquarters phones, local calls, and calls from the branch to the PSTN.5. Bring down the WAN interface or bring down Cisco Unified CM by shutting it down.6. Verify the state of active calls during WAN/Cisco Unified CM failure.7. Verify whether all the phones register to Cisco Unified SRST.8. Bring up the Cisco Unified CM after about 10 minutes, and verify whether all the phones register to Cisco Unified Communications Manager.
Pass/Fail Criteria	<p>Phones with no active calls should immediately register to Cisco Unified SRST.</p> <p>Phones with active calls to headquarters should drop the call and register to Cisco Unified SRST.</p> <p>Local calls and calls to the PSTN should be sustained. When the call completes, those phones should register to Cisco Unified SRST.</p> <p>All the phones should immediately register to Cisco Unified CM when it comes up.</p>
Result	Passed

Local and PSTN Calls in Cisco Unified SRST Mode

Description	Test local and PSTN calls in Cisco Unified SRST mode
Test Setup	Figure 2 on page 6, Private WAN, Cisco Unified SRST Mode , or Figure 4 on page 7, MPLS WAN, Cisco Unified SRST Mode
Procedure	<ol style="list-style-type: none">1. Configure MOH to source audio files from flash memory.2. Make locals calls, and make calls to the PSTN.3. Verify the ringback tone.4. Verify the voice path, and pass DTMF digits.5. Place local calls on hold for 30 seconds, and then resume the call.6. Place PSTN calls on hold for 30 seconds, and then resume the call.

Pass/Fail Criteria	The ringback tone should be heard. The voice path confirmation should be 100%. DMTF digit passing should be successful. Local call hold/resume should be successful. PSTN call hold/resume should be successful. Locals call should hear tone on hold. PSTN callers should hear music on hold.
Result	Passed

Supplementary Services in Cisco Unified SRST Mode

Description	Test supplementary services such as call transfers and call forwards in Cisco Unified SRST mode
Test Setup	Figure 2 on page 6, Private WAN, Cisco Unified SRST Mode , or Figure 4 on page 7, MPLS WAN, Cisco Unified SRST Mode
Procedure	<ol style="list-style-type: none">1. Configure transfer system full-consult on the Cisco Unified SRST.2. Configure MOH to source from a file in flash memory.3. Configure Multicast MOH.4. Verify call transfer full-consult between phones A, B, and C with C being the transferrer; that is, make a call from phone A to phone B, and transfer the call to phone C. Phone C and phone B are located in the branch, and phone A is in the PSTN.5. Make a call from phone A to phone B, and transfer the call to phone C.6. Verify MOH on phone A during call transfer.7. Configure transfer system full-blind on the Cisco Unified SRST.8. Verify call transfer full-blind between phones A, B, and C, with C being the transferer; that is, make a call from phone A to phone C, and transfer the call to phone B.9. Verify MOH on phone A during call transfer.10. Configure call forward functionality for the Cisco Unified SRST phones.11. Verify call forward no answer to another ephone extension.12. Verify call forward all to another ephone extension.

Pass/Fail Criteria The voice call should be successful with 100% path confirmation.
 Call transfer full-consult should be successful.
 Call forward no answer should be successful.
 Call forward all should be successful.
 MOH should be heard.

Result Passed

Call Forward to Voice Mail in Cisco Unified SRST Mode

Description Test call forward to Cisco Unity Express with transcoding on the Cisco Unified CME

Test Setup [Figure 1 on page 5, Private WAN, Cisco Unified CME Mode](#), or [Figure 3 on page 6, MPLS WAN, Cisco Unified CME Mode](#)

Procedure

1. Configure call forward on no answer or busy to voice mail in Cisco Unified Communications Manager phone configuration.
2. Go to Cisco Unified SRST mode.
3. Set up Cisco Unity Express as the voice mail system.
4. Make a call from the PSTN phone to a busy branch phone.
5. Verify whether the call was forwarded to voice mail.
6. Verify whether MWI appears on the branch phone.
7. Retrieve the voice mail from Cisco Unity Express by dialing the voice mail from the branch phone.
8. Verify whether the MWI disappears when the message is heard.

Pass/Fail Criteria The call should be forwarded to voice mail.
 The MWI light should appear when the message is left in Cisco Unity Express and should disappear when the message is retrieved.

Result Passed

Call Conference in Cisco Unified SRST Mode

Description Test a three-party conference with the branch IP Phone as the conference initiator

Test Setup [Figure 2 on page 6, Private WAN, Cisco Unified SRST Mode](#) or [Figure 4 on page 7, MPLS WAN, Cisco Unified SRST Mode](#)

Procedure

1. Make a three-party conference call between two branch phones and a PSTN phone, with one of the branch phones as the conference initiator.

Pass/Fail Criteria The conference call should be successful.

Result Passed

Branch to Headquarters Calls with IPsec over the WAN

Description Test branch to headquarters calls with IPsec over the WAN

Test Setup [Figure 2 on page 6, Private WAN, Cisco Unified SRST Mode](#), or [Figure 4 on page 7, MPLS WAN, Cisco Unified SRST Mode](#)

Procedure

1. Configure IPsec over the WAN, and test with all types of IPsec.
2. Register the branch phones to the Cisco Unified Communications Manager.
3. Make a video call from a branch IP Phone to a headquarters IP Phone.
4. Verify the ringback tone.
5. Verify whether signaling, voice, and video packets are encrypted and decrypted properly.
6. Verify voice and video path, and pass DTMF digits.

Pass/Fail Criteria Signaling, voice, and video packets should be encrypted and decrypted properly.
The ringback tone should be heard when the remote phone rings.
The voice and video path confirmation should be 100%.
DTMF digit passing should be successful.

Result Passed

Branch to Headquarters Voice and Video Calls with QoS and NBAR

Description Test branch to headquarters voice and video calls with QoS and NBAR applied to signaling and RTP packets

Test Setup [Figure 2 on page 6, Private WAN, Cisco Unified SRST Mode](#), or [Figure 4 on page 7, MPLS WAN, Cisco Unified SRST Mode](#)

Procedure

1. Configure the 8-class QoS Model over the primary WAN interface.
2. Configure LLQ for voice and video traffic, and allocate X% and Y% of the bandwidth for voice and video, but make sure not to exceed 33% of the total bandwidth.
3. Configure 1P3Q3T on the Catalyst switch, and trust the CoS value coming from the Cisco IP Phones.
4. Configure a DSCP value of CS3 on the SIP/H.323 dial peer to give priority to signaling traffic.
5. Register the branch phones to the Cisco Unified Communications Manager.
6. Make voice and video calls from branch IP Phones to headquarters IP Phones.
7. Verify whether the IP Phone marks the voice traffic with a DSCP value of EF.
8. Verify whether the Catalyst switch marks the video packets with a DSCP value of AF41.
9. Verify whether call signaling, voice, and video traffic is classified properly and put in priority queue.
10. Send more voice and video traffic to exceed the allocated bandwidth, and verify whether voice and video traffic is dropped.

Pass/Fail Criteria

The IP Phone should mark the voice traffic with a DSCP value of EF.
The IP Phone should mark SCCP signaling traffic with a DSCP value of CS3.
The Catalyst switch should trust the COS value marked by the IP Phone.
The Catalyst switch should re-mark the video traffic to AF41.
QoS on the router should properly classify signaling, voice, and video packets, based on their DSCP values.
Voice and video traffic should receive strict priority queuing treatment; that is, adhering voice and video traffic should be sent out first, and exceeding voice and video traffic should be dropped.

Result

Passed

Branch to Headquarters Voice and Video calls with ZPF**Description**

Test Cisco Unified CME functionality with ZPF

Test Setup

[Figure 2 on page 6, Private WAN, Cisco Unified SRST Mode](#), or [Figure 4 on page 7, MPLS WAN, Cisco Unified SRST Mode](#)

Procedure	<ol style="list-style-type: none">1. Configure ZPF with data and voice VLANs in the Private zone and WAN interface in the Public zone.2. In the Private-Public zone policy, add statements to inspect SCCP and SIP signaling the traffic from the phones, and add access lists to all incoming calls to the branch from headquarters.3. Make a voice call from a branch IP Phone to a headquarters IP Phone.4. Verify the ringback tone.5. Verify the voice path, and pass DTMF digits.
Pass/Fail Criteria	<p>ZPF should inspect call signaling and dynamically open holes for RTP packets.</p> <p>The ringback tone should be heard.</p> <p>The voice path confirmation should be 100%.</p> <p>DTMF digit passing should be successful.</p>
Result	Passed

Baseline Features Plus Cisco Unified CM

Description	Test baseline features plus Cisco Unified Communications Manager
Test Setup	Figure 1 on page 5, Private WAN, Cisco Unified CME Mode , or Figure 3 on page 6, MPLS WAN, Cisco Unified CME Mode

Procedure

1. Enable all baseline features as described in the [Complete Baseline Test](#) test case.
2. Register all the phones to the primary Cisco Unified Communications Manager.
3. Register all DSP farm transcoding and conferencing resources to Cisco Unified Communications Manager.
4. Make voice and video calls between branch IP Phones and headquarters IP Phones.
 - a. Verify the ringback tone, verify the voice/video path, and pass DTMF digits.
5. Make voice calls between branch IP Phones and PSTN phones.
 - a. Verify the ringback tone, verify the voice path, and pass DTMF digits.
6. Make voice calls between branch IP Phones.
 - a. Verify the ringback tone, verify the voice path, and pass DTMF digits.
7. Make a four-party conference call with a branch IP Phone, a branch FXS phone, a headquarters IP Phone and a PSTN phone as the conference participants.
 - a. Verify that when the conference initiator leaves the conference, all the parties are dropped.
 - b. Verify whether DSP farm conferencing resources are utilized.
8. Make a call from a headquarters IP Phone to a branch IP Phone that is busy.
 - a. Verify whether the headquarters IP Phone is able to leave voice mail.
 - b. Verify whether DSP farm transcoding gets invoked.
 - c. Verify whether the branch phone receives an MWI.
9. Retrieve the voice mail messages from the branch IP Phones.
 - a. Verify that MWI changes status when the voice mail messages are retrieved.
10. Verify supplementary services.

Pass/Fail Criteria

Voice and video path confirmation should be 100%.

DSP farm transcoding is invoked for call transfers to voice mail when the calling party is in headquarters.

The MWI light should turn on when voice mail messages are left and should turn off when the voice mail messages are retrieved.

Conference call should be successful.

Supplementary services such as call transfers and call forwards should be successful.

Result

Passed

RSVP Agent in SRST Router–HQ to Branch Call with Phones Registered to Cisco Unified CM

Description	Test calls between the IP Phones in the HQ to phones registered in the branch in centralized call control deployment scenario with RSVP agent enabled in HQ and WAN router
Test Setup	Figure 1 on page 5, Private WAN, Cisco Unified CME Mode or Figure 3 on page 6, MPLS WAN, Cisco Unified CME Mode
Procedure	<ol style="list-style-type: none"> 1. Enable SCCP and configure transcoder/MTP profile with RSVP and coded pass-through in SRST branch router and WAN router in HQ. 2. Register both the transcoder and MTP to Cisco Unified CM. 3. Configure HQ and branch phones in different locations. 4. Configure RSVP policy as mandatory for voice and video calls in Cisco Unified CM. 5. Make a voice call from the HQ phone to a branch phone. 6. Make a video call from the HQ phone to a branch phone. 7. Make multiple voice calls from the HQ to the branch, so that the voice bandwidth is consumed. 8. Make a new voice call.
Pass/Fail Criteria	<p>Verify that an RSVP reservation is made and that both voice and video calls are successful.</p> <p>Verify the voice path and pass DTMF.</p> <p>Verify that both SCCP and SIP Phones work properly.</p> <p>Verify RSVP reservation fails and the call is not successful when the bandwidth is consumed.</p>
Result	Passed

RSVP Agent with Application ID in SRST Router–HQ to Branch Call with Phones Registered to Cisco Unified CM

Description	Make calls between the IP Phones registered to Cisco Unified CM in the HQ and IP Phones registered to Cisco Unified CME in the branch with RSVP agent configured
Test Setup	Figure 1 on page 5, Private WAN, Cisco Unified CME Mode or Figure 3 on page 6, MPLS WAN, Cisco Unified CME Mode

Procedure	<ol style="list-style-type: none">1. Enable SCCP and configure transcoder/MTP profile with RSVP and coded pass-through in SRST branch router and WAN router in HQ.2. Configure the RSVP application ID for voice and video calls and specify the bandwidth to be 384 for video.3. Register both the transcoder and MTP to Cisco Unified CM.4. Configure HQ and branch phones in different locations.5. Configure RSVP policy as mandatory for voice and video calls in Cisco Unified CM.6. Make a voice call from the HQ phone to a branch phone.7. Make a video call from the HQ phone to a branch phone.
Pass/Fail Criteria	<p>Verify that an RSVP reservation is made and that both voice and video calls are successful.</p> <p>Verify that the second video call fails because the bandwidth is configured in application ID for video.</p> <p>Verify the voice path and pass DTMF.</p> <p>Verify that both SCCP and SIP phones work properly.</p> <p>Verify that RSVP reservation fails and that the call is not successful when the bandwidth is consumed.</p>
Result	Passed

RSVP Agent–HQ to Branch Call with H.323 Trunk

Description	Make calls between the IP Phones in HQ to phones registered in the branch in centralized call control deployment scenario with RSVP agent enabled and with application ID in HQ and WAN router
Test Setup	Figure 1 on page 5, Private WAN, Cisco Unified CME Mode or Figure 3 on page 6, MPLS WAN, Cisco Unified CME Mode

Procedure	<ol style="list-style-type: none"> 1. Configure H.323 trunk over the WAN interface between Cisco Unified CME and Cisco Unified CM 2. Enable SCCP and configure transcoder/MTP profile with RSVP and coded pass-through in SRST branch router and WAN router in HQ. 3. Register both the transcoder and MTP to Cisco Unified CM. 4. Configure RSVP policy as mandatory for voice and video calls in Cisco Unified CM. 5. Configure voice class with G.729 and G.711 as the codec options, with the first choice being G.729 and second choice being G.711. 6. Associate the voice class to the H.323 dial peer. 7. Make a voice call from the HQ phone to a branch phone. 8. Make a video call from the HQ phone to a branch phone. 9. Make multiple voice calls from the HQ to the branch so that the voice bandwidth is consumed, and then make a new voice call.
Pass/Fail Criteria	<p>Verify that an RSVP reservation is made and that both voice and video calls are successful.</p> <p>Verify the voice path and pass DTMF.</p> <p>Verify that both SCCP and SIP phones work properly.</p> <p>Verify that the RSVP reservation fails and the call is not successful when the bandwidth is consumed.</p>
Result	Passed

Performance Test Cases

Baseline Performance Test

Description	<p>Enable all the baseline services in the branch and headend routers. The baseline features include BGP routing, OSPF/EIGRP routing, IPsec using DMVPN or GETVPN, ZPF, NAT, IPS, QoS, NBAR, ACL, NetFlow, DHCP, AAA RADIUS server, NTP, syslog, SNMP, PIM-v2, and IGMP v2.</p> <p>Configure L2 and L3 switching on the access and distribution layer switches.</p>
Test Setup	<p>Figure 1 on page 5, Private WAN, Cisco Unified CME Mode, or Figure 2 on page 6, Private WAN, Cisco Unified SRST Mode, or Figure 3 on page 6, MPLS WAN, Cisco Unified CME Mode, or Figure 4 on page 7, MPLS WAN, Cisco Unified SRST Mode</p>

Procedure

1. Before the start of the test, measure the CPU utilization and memory utilization of the router.
2. Use the following traffic profile.
 - HTTP: 75% of the traffic
 - FTP: 10% of the traffic
 - SMTP: 10% of the traffic
 - DNS: 5% of the traffic

For HTTP, use two different object sizes:

- 16-KB object size for large html files (10 URLs)
- 4-KB object size for transactional type data

For FTP, use a 1-MB file size.

For SMTP, use a 4-KB fixed object size.

For DNS, use 89 bytes.

3. Start the traffic to achieve line rate on the primary WAN interface.
4. Record the router performance metrics such as CPU, processor and I/O memory utilization, and LAN/WAN throughput.
5. Do not generate any threats to the router during the performance test.
6. Start adding the features incrementally and measure performance. Take at least five measurements, 3 minutes apart, before turning on the next feature.
7. When all the features are added, check whether the router CPU utilization is less than or equal to 75% with line rate traffic. If it is greater than the 75%, tune the traffic to reach 75% CPU utilization, with a tolerance of +/- 2%.
8. At 75% CPU utilization, take performance readings of the router every 3 minutes for a duration of 1 hour.
9. Stop all traffic at the end of the hour. Wait for about 30 minutes, and take router memory readings. Use the **show memory debug leaks** command to determine whether there were any memory leaks during the test.
10. Collect the following performance readings:
 - Router CPU utilization at 5 seconds, 1 minute, and 5 minutes, using the **show proc cpu** command
 - Router memory, using the **show mem free** and **show proc mem** commands
 - Interface statistics, using the **show interface summary** command
 - Cisco Express Forwarding switching statistics, using the **show interfaces stats** command

- Procedure (continued)** 11. Also record the following feature-specific measurements:
- QoS: **show policy-map interface** command
 - IPsec: **show crypto engine connections active** command
 - ZPF: **show policy-map type inspect** command
 - NAT: **show ip nat statistics** command
 - NetFlow: **show ip cache flow** command
 - Multicast: **show ip mroute count** command
 - NBAR: **show ip nbar protocol-discovery** command
 - IPS: **show ip ips statistics** command

Pass/Fail Criteria There are no router tracebacks.
 There are no router memory leaks.
 There are no router crashes.
 Most of the traffic should be Cisco Express Forwarding switched.

Result Passed

Baseline Plus Voice Performance Test with Cisco Unified CME

Description Enable all the baseline services in the branch and headend routers. The baseline features include BGP routing, OSPF/EIGRP routing, IPsec using DMVPN or GETVPN, ZPF, NAT, IPS, QoS, NBAR, ACL, NetFlow, DHCP, AAA RADIUS server, NTP, syslog, SNMP, PIM-v2, and IGMP v2.

Configure L2 and L3 switching on the access and distribution layer switches.

Enable QoS on the L3 distribution switches.

Enable Cisco Unified CME on the branch router.

Measure the performance of the branch router in terms of CPU utilization, throughput of WAN and LAN interfaces, and processor and IO memory consumption.

Test Setup [Figure 1 on page 5, Private WAN, Cisco Unified CME Mode](#), or [Figure 2 on page 6, Private WAN, Cisco Unified SRST Mode](#), or [Figure 3 on page 6, MPLS WAN, Cisco Unified CME Mode](#), or [Figure 4 on page 7, MPLS WAN, Cisco Unified SRST Mode](#)

Procedure

1. Before the start of the test, measure the CPU utilization and memory utilization of the router.
2. Register 100 phones to Cisco Unified CME on the Cisco 3945 platform.
3. Register 60 phones to Cisco Unified CME on the Cisco 3925 platform.
4. Configure dual lines for all the phones.
5. Use the following voice traffic profiles:
 - For T3 WAN bandwidth or Gigabit Ethernet WAN rate limited to 50 Mb/s
 - On the Cisco 3945 platform:
 - 9 voice calls over WAN with G.711u-law codec
 - 2 384k H.263 video calls over WAN
 - 3 calls with transcoding (DSP farm assist)
 - 2 three-party conferences
 - 6 calls to PSTN over PRI
 - 40 local calls
 - On the Cisco 3925 platform:
 - 6 voice calls over WAN with G.711u-law codec
 - 1 384k H.263 video call over WAN
 - 2 calls with transcoding
 - 1 three-party conference
 - 12 calls to PSTN over PRI
 - 26 local calls
 - For 4 T1 or 8-Mb/s bandwidth:
 - On the Cisco 3945 platform:
 - 10 voice calls over the WAN with G.729r8 codec
 - 1 384-KB video call over the WAN
 - 2 transcoding sessions
 - 1 three-party conference
 - 40 local calls
 - On the Cisco 3925 platform:
 - 6 voice calls over the WAN with G.729r8 codec
 - 1 384-KB video call over the WAN
 - 2 transcoding sessions
 - 1 three-party conference
 - 40 local calls
 - Call duration of voice and video calls is 180 seconds with intercall delay of 10 seconds.
 - Call duration for conferences is 10 minutes.

Procedure (continued)	<p>6. Use the following data traffic profile:</p> <ul style="list-style-type: none"> • HTTP: 75% of the traffic • FTP: 10% of the traffic • SMTP: 10% of the traffic • DNS: 5% of the traffic <p>For HTTP, use two different object sizes:</p> <ul style="list-style-type: none"> • 16-KB object size for large HTML files (10 URLs) • 4-KB object size for transactional type data (10 URLs) <p>For FTP, use a 1-MB file size.</p> <p>For SMTP, use 4-KB fixed object size.</p> <p>For DNS, use 89 bytes.</p> <p>7. Start all the voice and video calls. When the calls have stabilized, take a couple of CPU measurements 3 minutes apart. Stop all the voice and video traffic.</p> <p>8. Start the data traffic and take a CPU utilization measurement after stabilization. The CPU utilization measurement should be very close to 75% as measured in the baseline performance test.</p> <p>9. Adjust the data traffic throughput to accommodate all the voice and video traffic, while maintaining 75% CPU utilization. When the router has stabilized, take performance readings for about 1 hour, and stop all the traffic. Wait for about 30 minutes to record the memory readings.</p> <p>10. In addition to the metrics mentioned in the Baseline Performance Test, collect the following metrics:</p> <ul style="list-style-type: none"> • Calls-per-second rate • Voice and video call completion rate • Throughput in bits per second
Pass/Fail Criteria	<p>There are no router tracebacks.</p> <p>There are no router memory leaks.</p> <p>There are no router crashes.</p> <p>Most of the traffic should be Cisco Express Forwarding switched.</p>
Result	Passed

Baseline Plus Voice Performance Test with Cisco Unified CM and Cisco Unified SRST**Description**

Enable all the baseline services in the branch and headend routers. The baseline features include BGP routing, OSPF/EIGRP routing, IPsec using DMVPN or GETVPN, ZPF, NAT, IPS, QoS, NBAR, ACL, NetFlow, DHCP, AAA Radius server, NTP, syslog, SNMP, PIM-v2, and IGMP v2.

Configure L2 and L3 switching on the access and distribution layer switches.

Enable QoS on the L3 distribution switches.

Enable Cisco Unified SRST on the branch router.

Measure the performance of the branch router in terms of CPU utilization, throughput of WAN and LAN interfaces, and processor and IO memory consumption.

Test Setup

[Figure 1 on page 5, Private WAN, Cisco Unified CME Mode](#), or [Figure 2 on page 6, Private WAN, Cisco Unified SRST Mode](#), or [Figure 3 on page 6, MPLS WAN, Cisco Unified CME Mode](#), or [Figure 4 on page 7, MPLS WAN, Cisco Unified SRST Mode](#)

Procedure

1. Before the start of the test, measure the CPU utilization and memory utilization of the router.
2. Register 240 phones to Cisco Unified CM for the Cisco 3945 branch.
3. Register 160 phones to Cisco Unified CM for the Cisco 3925 branch.
4. Configure dual lines for all the phones.
5. Use the following voice traffic profiles.
 - For T3 WAN bandwidth or Gigabit Ethernet WAN rate limited to 50 Mb/s.
 - On Cisco 3945 platform:
 - 9 voice calls over WAN with G.711u-law codec
 - 2 384-KB H.263 video calls over WAN
 - 4 calls with transcoding (DSP farm assist)
 - 2 three-party conferences
 - 12 calls to PSTN over PRI
 - 40 local calls
 - On the Cisco 3925 platform:
 - 6 voice calls over WAN with G.711u-law codec
 - 1 384-KB H.263 video call over WAN
 - 2 calls with transcoding
 - 1 three-party conference
 - 6 calls to PSTN over PRI
 - 26 local calls
 - For 4 T1 or 8-Mb/s bandwidth:
 - On the Cisco 3945 platform:
 - 10 voice calls over the WAN with G.729r8 codec
 - 1 384-KB video call over the WAN
 - 2 transcoding sessions
 - 1 three-party conference
 - 40 local calls
 - On the Cisco 3925 platform:
 - 6 voice calls over the WAN with G.729r8 codec
 - 1 384-KB video call over the WAN
 - 2 transcoding sessions
 - 1 three-party conference
 - 40 local calls
 - Call duration of voice and video calls is 180 seconds with intercall delay of 10 seconds.

- Procedure (continued)**
- Call duration for conferences is 10 minutes.
6. Use the following data traffic profile:
 - HTTP: 75% of the traffic
 - FTP: 10% of the traffic
 - SMTP: 10% of the traffic
 - DNS: 5% of the traffic

For HTTP, use two different object sizes:

 - 16-KB object size for large HTML files (10 URLs)
 - 4-KB object size for transactional type data (10 URLs)

For FTP, use a 1-MB file size.

For SMTP, use 4-KB fixed object size.

For DNS, use 89 bytes.
 7. Start all the voice and video calls. When the calls have stabilized, take a couple of CPU utilization measurements 3 minutes apart. Stop all the voice and video traffic.
 8. Start the data traffic, and take CPU utilization measurement after stabilization. The CPU utilization measurement should be very close to 75% as measured in the baseline performance test.
 9. Adjust the data traffic throughput to accommodate all the voice and video traffic, while maintaining 75% CPU utilization. When the router has stabilized, take performance readings for about 1 hour and stop all the traffic. Wait for about 30 minutes to record the memory readings.
 10. In addition to the metrics mentioned in the [Baseline Performance Test](#), collect the following metrics:
 - Calls per second rate
 - Voice and video call completion rate
 - Throughput in bits per second

Pass/Fail Criteria

There are no router tracebacks.

There are no router memory leaks.

There are no router crashes.

Most of the traffic should be Cisco Express Forwarding switched.

Result

Passed

Baseline Plus Voice Plus Cisco WAAS Performance Test

Description	<p>Enable all the baseline services in the branch and headend routers. The baseline features include BGP routing, OSPF/EIGRP routing, IPsec using DMVPN or GETVPN, ZPF, NAT, IPS, QoS, NBAR, ACL, NetFlow, DHCP, AAA RADIUS server, NTP, syslog, SNMP, PIM-v2, and IGMP v2.</p> <p>Configure L2 and L3 switching on the access and distribution layer switches.</p> <p>Enable QoS on the L3 distribution switches.</p> <p>Enable Cisco Unified SRST on the branch router.</p> <p>Enable Cisco WCCPv2 and Cisco WCCP 61 and 62 on the branch router.</p> <p>Set up the Cisco WAAS module to do WAN optimization.</p> <p>Measure the performance of the branch router in terms of CPU utilization, throughput of WAN and LAN interfaces, and processor and IO memory consumption.</p>
Test Setup	<p>Figure 1 on page 5, Private WAN, Cisco Unified CME Mode, or Figure 2 on page 6, Private WAN, Cisco Unified SRST Mode, or Figure 3 on page 6, MPLS WAN, Cisco Unified CME Mode, or Figure 4 on page 7, MPLS WAN, Cisco Unified SRST Mode</p>
Procedure	<ol style="list-style-type: none">1. Before the start of the test, measure the CPU utilization and memory utilization of the router.2. Initially disable WAN optimization.3. Start the data traffic, and take a CPU utilization measurement after stabilization. The CPU utilization measurement should be very close to 75% as measured in the baseline performance test.4. Enable the WAN optimization, and run the baseline performance test again. Measure the CPU utilization. Since Cisco WAAS optimizes the TCP traffic, the CPU utilization may be lower than 75%. Record CPU measurements. Stop the data traffic.5. Start all the voice and video calls. When the calls have stabilized, take a couple of CPU utilization measurements 3 minutes apart. Stop all the voice and video traffic.6. Adjust the data traffic throughput to accommodate all the voice and video traffic, while maintaining 75% CPU utilization. When the router has stabilized, take performance readings for about 1 hour, and stop all the traffic. Wait for about 30 minutes to record the memory readings.7. In addition to the metrics mentioned in the Baseline Plus Voice Performance Test with Cisco Unified CME, collect the following metrics:<ul style="list-style-type: none">• TFO statistics in the Cisco WAAS module• DRE statistics in the Cisco WAAS module

Pass/Fail Criteria	<p>There are no router tracebacks.</p> <p>There are no router memory leaks.</p> <p>There are no router crashes.</p> <p>Most of the traffic should be Cisco Express Forwarding switched.</p> <p>The system throughput achieved should be higher than in the Baseline Plus Voice Performance Test with Cisco Unified CME or the Baseline Plus Voice Performance Test with Cisco Unified CM and Cisco Unified SRST.</p>
Result	Passed

