



Compute Node Overview

This chapter contains the following topics:

- [Cisco UCS X410c M7 Compute Node Overview, on page 1](#)
- [Local Console, on page 6](#)
- [Front Mezzanine Options, on page 7](#)
- [mLOM and Rear Mezzanine Slot Support, on page 8](#)
- [System Health States, on page 9](#)
- [Interpreting LEDs, on page 10](#)
- [Optional Hardware Configuration, on page 12](#)

Cisco UCS X410c M7 Compute Node Overview

The Cisco UCS X410c M7 Compute Node (UCSX-410C-M7) is a two-slot compute node that supports four CPU sockets for 4th Generation Intel® Xeon® Scalable Processors. Each compute node is exactly four CPUs. Less than four CPUs is an unsupported configuration.

The overall compute node consists of two distinct subnodes, a primary and a secondary.

- The primary contains two CPUs (1 and 2), two heatsinks, and half of the DIMMs. All additional hardware components and supported functionality are supported through the primary, including the front and rear mezzanine hardware options, rear mezzanine bridge card, front panel, KVM, management console, and status LEDs.
- The secondary contains two additional CPUs (3 and 4), two heatsinks, and the other half of the DIMMs. The secondary also contains a power adapter, which ensures that the electrical power is shared and distributed between the primary and secondary. The power adapter is not a customer-serviceable part.

Each Cisco UCS X410c M7 compute node supports the following:

- Up to 16 T of system memory as 64 DDR5 DIMMs, up to 4800 MHz with 1DPC, 4400 MHz with 2DPC. Thirty-two DDR5 DIMMs are supported on the primary, and 32 DIMMs are supported on the secondary.
- 16 DIMMs per CPU, 8 channels per CPU socket, 2 DIMMs per channel. Memory Mirroring and RAS is supported.
- Supported memory can be populated as 16 GB, 32 GB, 64 GB, 128 GB, or 256 GB DDR5 DIMMs.
- One front mezzanine module which can support any of the following:

- A front storage module, which supports multiple different storage device configurations:
 - All SAS/SATA configuration consisting of up to six SAS/SATA SSDs with an integrated RAID controller (HWRAID) in slots 1 through 6.
 - All NVMe configuration consisting of up to six U.2 NVMe Gen4 (x4 PCIe) SSDs in slots 1 through 6.
 - A mixed storage configuration consisting of up to six SAS/SATA or up to four NVMe drives is supported. In this configuration, U.2 NVMe drives are supported in slots 1 through 4 only. U.3 NVMe drives can be used in slots 1 through 6.

For additional information, see [Front Mezzanine Options, on page 7](#).

- 1 modular LAN on motherboard (mLOM) module or virtual interface card (VIC) supporting a maximum of 200G of aggregate traffic, 100G to each fabric, through a Cisco 5th Gen 100G mLOM/VIC. For more information, see [mLOM and Rear Mezzanine Slot Support, on page 8](#).
- 1 rear mezzanine module (UCSX-V4-PCIME or UCSX-ME-V5Q50G).
- A boot-optimized mini-storage module. Two versions of mini-storage exist:
 - One version supports up to two M.2 SATA drives of up to 960GB each. This version supports an optional hardware RAID controller (RAID1).
 - One version supports up to two M.2 NVMe drives of up to 960GB each that are directly attached to CPU 1. This version does not support an optional RAID controller. This option will be available after initial release of the compute node.

Two options of mini-storage exist, one supporting up to two M.2 SATA drives with a RAID controller (UCSX-M2-HWRD-FPS), and one supporting up to two M.2 NVMe drives direct attached to CPU1 through a Passthrough controller (UCSX-M2-PT-FPN).

- Local console connectivity through a USB Type-C connector.
- Connection with a paired UCS PCIe module, such as the Cisco UCS X440p PCIe node, to support GPU offload and acceleration. For more information, see the [Optional Hardware Configuration, on page 12](#).
- Up to 4 UCS X410c M7 compute nodes can be installed in a Cisco UCS X9508 modular system.

Compute Node Identification

Each Cisco UCS X410c M7 compute node features a node identification tag at the lower right corner of the primary node.

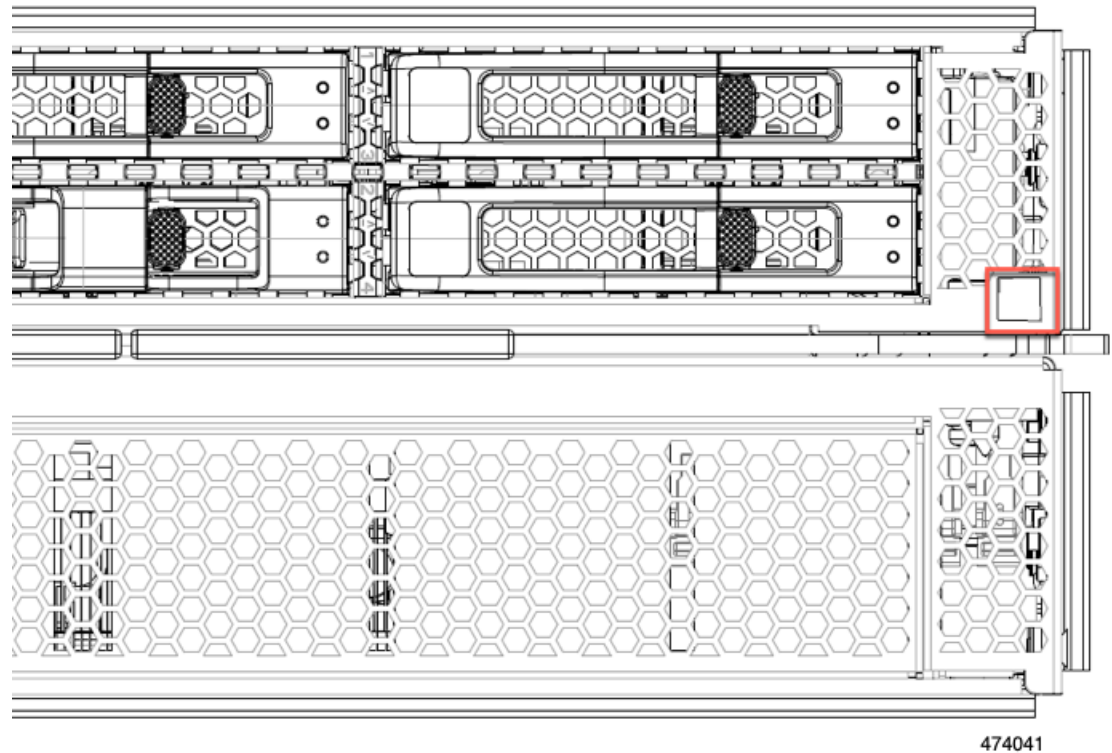

The node identification tag is a QR code that contains information that uniquely identifies the product, such as:

- The Cisco product identifier (PID) or virtual identifier (VID)
- The product serial number

The product identification tag applies to the entire compute node, both the primary and secondary.

You will find it helpful to scan the QR code so that the information is available if you need to contact Cisco personnel.

Compute Node Front Panel

The Cisco UCS X410c M7 front panel contains system LEDs that provide visual indicators for how the overall compute node is operating. An external connector is also supported.

Compute Node Front Panel

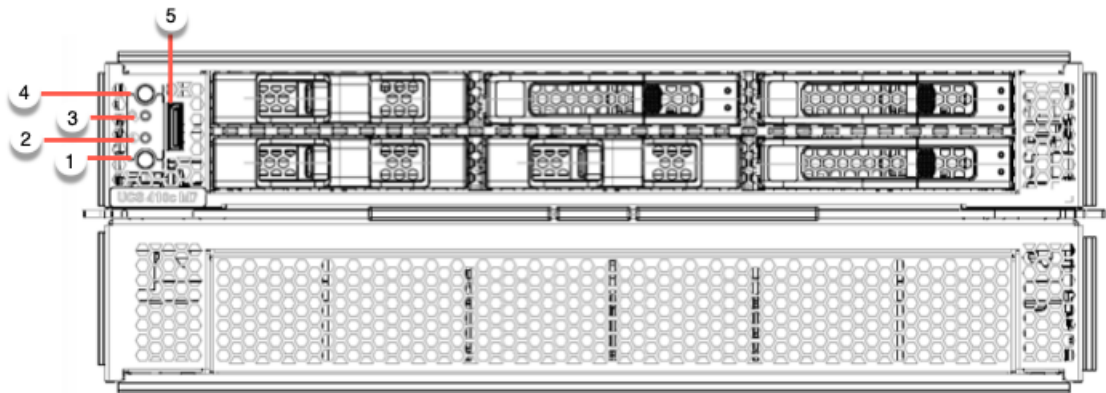

474002

<p>1</p>	<p>Power LED and Power Switch</p> <p>The LED provides a visual indicator about whether the compute node is on or off.</p> <ul style="list-style-type: none"> • Steady green indicates the compute node is on. • Steady Amber indicates the compute node is in Standby power mode. • Off or dark indicates that the compute node is not powered on. <p>The switch is a push button that can power off or power on the compute node. See Front Panel Buttons, on page 5.</p>	<p>2</p>	<p>System Activity LED</p> <p>The LED blinks to show whether data or network traffic is written to or read from the compute node. If no traffic is detected, the LED is dark.</p> <p>The LED is updated every 10 seconds.</p>
<p>3</p>	<p>System Health LED</p> <p>A multifunction LED that indicates the state of the compute node.</p> <ul style="list-style-type: none"> • Steady green indicates the compute node successfully booted to runtime and is in normal operating state. • Steady amber indicates that the compute node successfully booted but is in a degraded runtime state. • Blinking amber indicates that the compute node is in a critical state, which requires attention. 	<p>4</p>	<p>Locator LED/Switch</p> <p>The LED provides a visual indicator that glows solid blue to identify a specific compute node.</p> <p>The switch is a push button that toggles the Indicator LED on or off. See Front Panel Buttons, on page 5.</p>

5	External Optical Connector (Oculink) that supports local console functionality.		
---	---	--	--

Front Panel Buttons

The front panel has some buttons that are also LEDs. See [Compute Node Front Panel, on page 3](#).

- The front panel Power button is a multi-function button that controls system power for the compute node.
 - Immediate power up: Quickly pressing and releasing the button, but not holding it down, causes a powered down compute node to power up.
 - Immediate power down: Pressing the button and holding it down 7 seconds or longer before releasing it causes a powered-up compute node to immediately power down.
 - Graceful power down: Quickly pressing and releasing the button, but not holding it down, causes a powered-up compute node to power down in an orderly fashion.
- The front panel Locator button is a toggle that controls the Locator LED. Quickly pressing the button, but not holding it down, toggles the locator LED on (when it glows a steady blue) or off (when it is dark). The LED can also be dark if the compute node is not receiving power.

For more information, see [Interpreting LEDs, on page 10](#).

Drive Bays

Each Cisco UCS X410c M7 compute node has a front mezzanine slot that can support local storage drives of different types and quantities of 2.5-inch SAS, SATA, or NVMe drives. A drive blank panel (UCSC-BBLKD-M7) must cover all empty drive bays.

Drive bays are numbered sequentially from 1 through 6 as shown.

Figure 1: Front Loading Drives

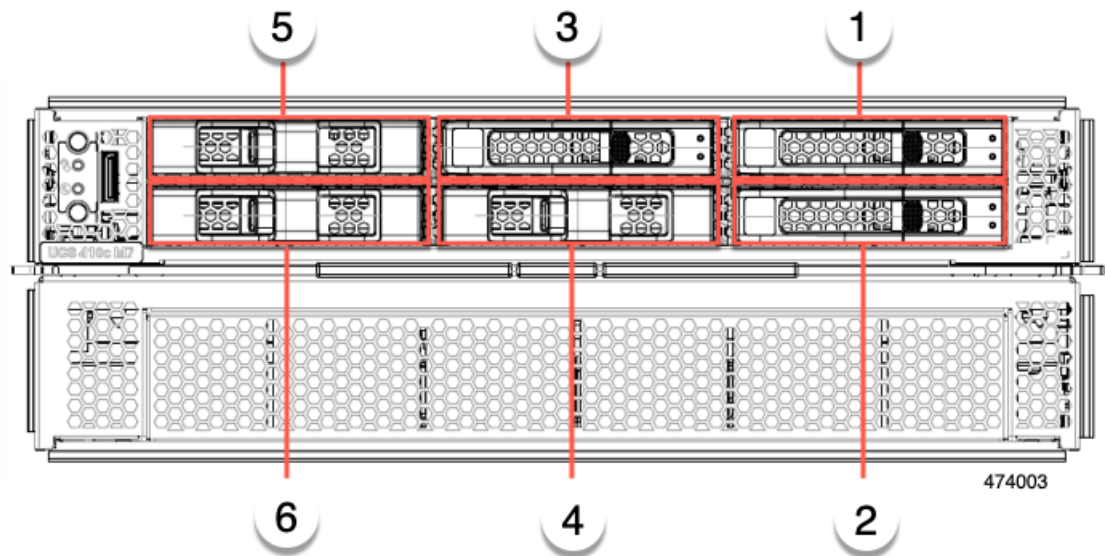

Drive Front Panels

The front drives are installed in the front mezzanine slot of the compute node. SAS/SATA and NVMe drives are supported.

Compute Node Front Panel with SAS/SATA Drives

The compute node front panel contains the front mezzanine module, which can support a maximum of 6 SAS/SATA drives. The drives have additional LEDs that provide visual indicators about each drive's status.

Figure 2: Drive LEDs

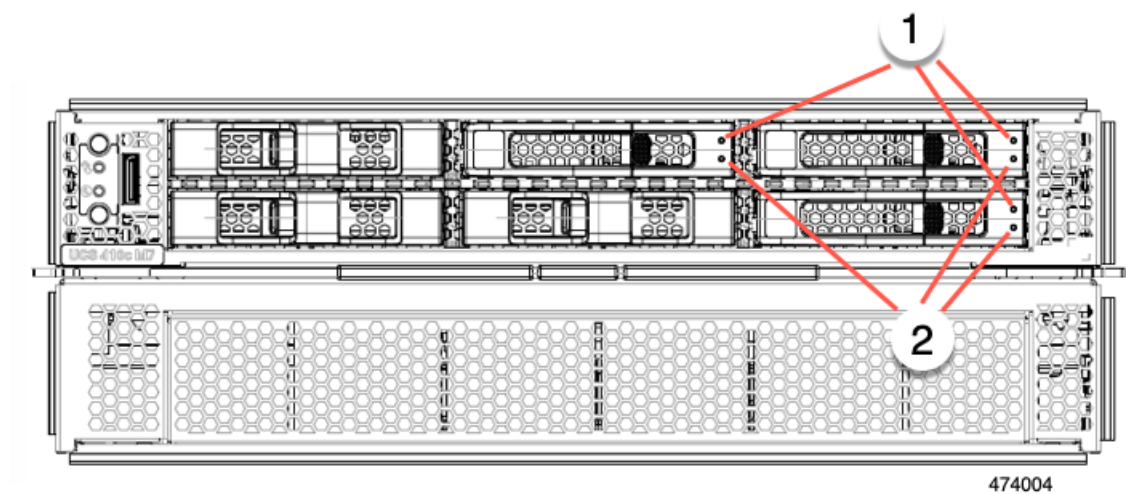

1	Drive Health LED	2	Drive Activity LED
---	------------------	---	--------------------

Compute Node Front Panel with NVMe Drives

The compute node front panel contains the front mezzanine module, which can support a maximum of six 2.5-inch NVMe drives.

Local Console

The local console connector is a horizontal oriented OcuLink on the compute node faceplate.

The connector allows a direct connection to a compute node to allow operating system installation directly rather than remotely.

The connector terminates to a KVM dongle cable (UCSX-C-DEBUGCBL) that provides a connection into a Cisco UCS compute node. The cable provides connection to the following:

- VGA connector for a monitor
- Host Serial Port
- USB port connector for a keyboard and mouse

With this cable, you can create a direct connection to the operating system and the BIOS running on a compute node. A KVM cable can be ordered separately and it doesn't come with compute node's accessory kit.

Figure 3: KVM Cable for Compute Nodes

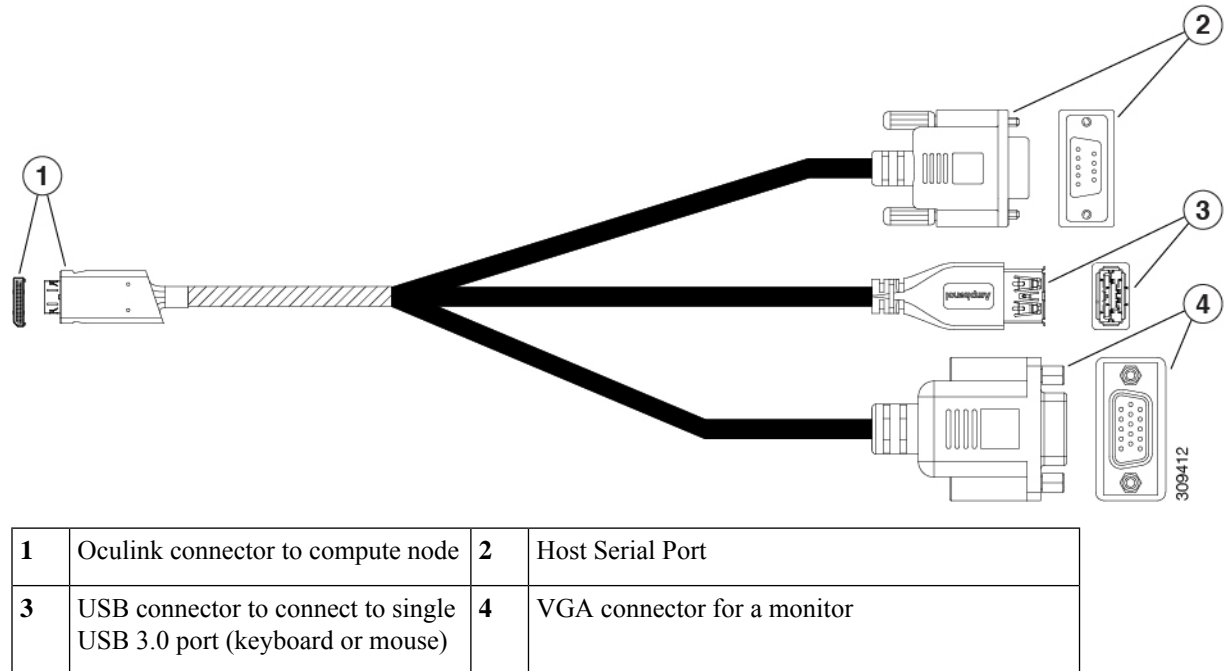

Front Mezzanine Options

The Cisco UCS X410c M7 Compute Node supports front mezzanine module storage through SAS/SATA or NVMe SSDs. For more information, see [Storage Options, on page 7](#).

Storage Options

The compute node supports the following local storage options in the front mezzanine module.

Cisco UCS X410c Passthrough Module

The compute node supports the Cisco FlexStorage NVMe passthrough controller, which is a passthrough controller for NVMe drives only. This module supports:

- Support up to six NVME SSDs in slots 1 through 6
- PCIe Gen3 and Gen4, x24 total lanes, partitioned as six x4 lanes
- Drive hot plug is supported
- Virtual RAID on CPU (VROC) is not supported, so RAID across NVME SSDs is not supported

Cisco UCS X410c RAID Module

This storage option supports:

- Support up to six 6 SAS/SATA SSDs, or
- Up to four or six NVME SSDs as:
 - U.2 NVMe in slots 1 through 4, direct connected to CPU1 at PCIe Gen4 x4
 - U.3 NVMe drives in slots 1 to 6 connected to the RAID controller at PCIe Gen4 x 1 and configurable with HW RAID.
- PCIe Gen3 and Gen4, x8 lanes
- Drive hot plug is supported
- RAID support depends on the type of drives and how they are configured in the RAID:
 - RAID across U.2 NVME SSDs is not supported.
 - RAID is not supported in a mixture of SAS/SATA and U.3 NVMe drives in the same RAID group.
 - The following RAID levels are supported across SAS/SATA and U.3 NVMe SSDs when the RAID group is either all SAS/SATA drives or all U.3 NVMe drives: RAID0, 1, 5, 6, 00, 10, 50, and 60.

Storage-Free Option

If no front storage drives are required, Cisco offers a storage-free configuration consisting of a blank front mezzanine faceplate for the primary.

mLOM and Rear Mezzanine Slot Support

The following rear mezzanine and modular LAN on motherboard (mLOM) modules and virtual interface cards (VICs) are supported.

The following mLOM VICs are supported.

- Cisco UCS VIC 15420 mLOM (UCSX- ML-V5Q50G) which supports:
 - Quad-Port 25G mLOM.
 - Occupies the compute node's modular LAN on motherboard (mLOM) slot.
 - Enables up to 50 Gbps of unified fabric connectivity to each of the chassis intelligent fabric modules (IFMs) for 100 Gbps connectivity per compute node.
- Cisco UCS VIC 15231 mLOM (UCSX-ML-V5D200G), which supports:
 - x16 PCIe Gen 4 host interface to UCS X410c M7 compute node
 - Two or four KR interfaces that connect to Cisco UCS X Series Intelligent Fabric Modules (IFMs):
 - Two 100G KR interfaces connecting to the UCSX 100G Intelligent Fabric Module (UCSX-I-9108-100G)
 - Four 25G KR interfaces connecting to the Cisco UCSX 9108 25G Intelligent Fabric Module (UCSX-I-9108-25G)

The following modular network mezzanine cards are supported.

- Cisco UCS VIC 15422 (UCSX-ME-V5Q50G) which supports:
 - Four 25G KR interfaces.
 - Can occupy the compute node's mezzanine slot at the bottom rear of the chassis.
 - An included bridge card extends this VIC's 2x 50 Gbps of network connections through IFM connectors, bringing the total bandwidth to 100 Gbps per fabric (for a total of 200 Gbps per compute node).
- Cisco UCS PCI Mezz card for X-Fabric (UCSX-V4-PCIME) provides connectivity for Cisco UCS PCIe Nodes, such as the Cisco UCS X440p PCIe Node, which supports GPU offload and acceleration when a compute node is paired with the PCIe node.



Note Although not an mLOM or rear mezzanine card, the UCS VIC 15000 bridge connector (UCSX-V5-BRIDGE-D) is required to connect the Cisco VIC 15420 mLOM and Cisco VIC 15422 rear mezzanine card on the compute node.

System Health States

The compute node's front panel has a System Health LED, which is a visual indicator that shows whether the compute node is operating in a normal runtime state (the LED glows steady green). If the System Health LED shows anything other than solid green, the compute node is not operating normally, and it requires attention.



The following System Health LED states indicate that the compute node is not operating normally.

System Health LED Color	Compute Node State	Conditions
Solid Amber	Degraded	<ul style="list-style-type: none"> • Power supply redundancy lost • Intelligent Fabric Module (IFM) redundancy lost • Mismatched processors in the system. This condition might prevent the system from booting. • Faulty processor in a dual processor system. This condition might prevent the system from booting. • Memory RAS failure if memory is configured for RAS • Failed drive in a compute node configured for RAID

System Health LED Color	Compute Node State	Conditions
Blinking Amber	Critical	<ul style="list-style-type: none"> • Boot failure • Fatal processor or bus errors detected • Fatal uncorrectable memory error detected • Lost both IFMs • Lost both drives • Excessive thermal conditions

Interpreting LEDs

Table 1: Compute Node LEDs

LED	Color	Description
Compute Node Power (callout 1 on the Chassis Front Panel) 	Off	Power off.
	Green	Normal operation.
	Amber	Standby.
Compute Node Activity (callout 2 on the Chassis Front Panel) 	Off	None of the network links are up.
	Green	At least one network link is up.
Compute Node Health (callout 3 on the Chassis Front Panel) 	Off	Power off.
	Green	Normal operation.
	Amber	Degraded operation.
	Blinking Amber	Critical error.

LED	Color	Description
Compute Node Locator LED and button (callout 4 on the Chassis Front Panel)	Off	Locator not enabled.
	Blinking Blue 1 Hz	Locates a selected compute node—If the LED is not blinking, the compute node is not selected. You can initiate the LED in UCS Intersight or by pressing the button, which toggles the LED on and off.

Table 2: Drive LEDs, SAS/SATA





Activity/Presence LED 	Status/Fault LED 	Description
Off	Off	Drive not present or drive powered off
On (glowing solid green)	Off	Drive present, but no activity or drive is a hot spare
Blinking green, 4HZ	Off	Drive present and drive activity
Blinking green, 4HZ	Blinking amber, 4HZ	Drive Locate indicator or drive prepared for physical removal
On (glowing solid green)	On (glowing solid amber)	Failed or faulty drive
Blinking green, 1HZ	Blinking amber, 1HZ	Drive rebuild or copyback operation in progress
On (glowing solid green)	Two 4HZ amber blinks with a 1/2 second pause	Predict Failure Analysis (PFA)

Table 3: Drive LEDs, NVMe (VMD Disabled)

Activity/Presence LED 	Status/Fault LED 	Description
Off	Off	Drive not present or drive powered off
On (glowing solid green)	Off	Drive present, but no activity
Blinking green, 4HZ	Off	Drive present and drive activity
N/A	N/A	Drive Locate indicator or drive prepared for physical removal
N/A	N/A	Failed or faulty drive





Activity/Presence LED 	Status/Fault LED 	Description
N/A	N/A	Drive Rebuild

Table 4: Drive LEDs, NVMe (VMD Enabled)

Activity/Presence LED 	Status/Fault LED 	Description
Off	Off	Drive not present or drive powered off
On (glowing solid green)	Off	Drive present, but no activity
Blinking green, 4HZ	Off	Drive present and drive activity
Blinking green, 4HZ	Blinking amber, 4HZ	Drive Locate indicator or drive prepared for physical removal
N/A	N/A	Failed or faulty drive
N/A	N/A	Drive Rebuild

Optional Hardware Configuration

The Cisco UCS X410c M7 compute node can be installed in a Cisco UCS X9508 Server Chassis either as a standalone compute node or with the following optional hardware configuration.

Cisco UCS X440p PCIe Node

As an option, the compute node can be paired with a full-slot GPU acceleration hardware module in the Cisco UCS X9508 Server Chassis. This option is supported through the Cisco X440p PCIe node. For information about this option, see the [Cisco UCS X440p PCIe Node Installation and Service Guide](#).



Note When the compute node is paired with the Cisco UCS X440p PCIe node, the Cisco UCS PCI Mezz card for X-Fabric Connectivity (UCSX-V4-PCIME-D) is required. The UCS VIC bridge connector is required with the mezzanine card to connect the UCS X-Series compute nodes to Cisco UCS X Series IFMs. The bridge connector card installs on the compute node.



Caution When the compute node is installed in the same Cisco UCS X9508 chassis as the Cisco UCS X440p PCIe node, the compute node must be installed to the slots immediately to the right of the PCIe node. For more information, see [Compute Node Installation Guidelines and Limitations](#).