

FlashStack Data Center with Citrix XenDesktop 7.15 and VMware vSphere 6.7 U1 with Cisco UCS Manager 4.0 for 6000 Seats

Deployment Guide for a 6000 Seat Virtual Desktop Infrastructure built on Cisco UCS B200 M5 and Cisco UCS Manager 3.2 with Pure Storage FlashArray//X70 R2 Array, Citrix XenDesktop 7.15 LTSR and VMware vSphere 6.7U1 Hypervisor Platform

Published: May 21, 2019

Updated: February 10, 2020



About the Cisco Validated Design Program

The Cisco Validated Design (CVD) program consists of systems and solutions designed, tested, and documented to facilitate faster, more reliable, and more predictable customer deployments. For more information, go to:

<http://www.cisco.com/go/designzone>.

ALL DESIGNS, SPECIFICATIONS, STATEMENTS, INFORMATION, AND RECOMMENDATIONS (COLLECTIVELY, "DESIGNS") IN THIS MANUAL ARE PRESENTED "AS IS," WITH ALL FAULTS. CISCO AND ITS SUPPLIERS DISCLAIM ALL WARRANTIES, INCLUDING, WITHOUT LIMITATION, THE WARRANTY OF MERCHANTABILITY, FITNESS FOR A PARTICULAR PURPOSE AND NON-INFRINGEMENT OR ARISING FROM A COURSE OF DEALING, USAGE, OR TRADE PRACTICE. IN NO EVENT SHALL CISCO OR ITS SUPPLIERS BE LIABLE FOR ANY INDIRECT, SPECIAL, CONSEQUENTIAL, OR INCIDENTAL DAMAGES, INCLUDING, WITHOUT LIMITATION, LOST PROFITS OR LOSS OR DAMAGE TO DATA ARISING OUT OF THE USE OR INABILITY TO USE THE DESIGNS, EVEN IF CISCO OR ITS SUPPLIERS HAVE BEEN ADVISED OF THE POSSIBILITY OF SUCH DAMAGES.

THE DESIGNS ARE SUBJECT TO CHANGE WITHOUT NOTICE. USERS ARE SOLELY RESPONSIBLE FOR THEIR APPLICATION OF THE DESIGNS. THE DESIGNS DO NOT CONSTITUTE THE TECHNICAL OR OTHER PROFESSIONAL ADVICE OF CISCO, ITS SUPPLIERS OR PARTNERS. USERS SHOULD CONSULT THEIR OWN TECHNICAL ADVISORS BEFORE IMPLEMENTING THE DESIGNS. RESULTS MAY VARY DEPENDING ON FACTORS NOT TESTED BY CISCO.

CCDE, CCENT, Cisco Eos, Cisco Lumin, Cisco Nexus, Cisco StadiumVision, Cisco TelePresence, Cisco WebEx, the Cisco logo, DCE, and Welcome to the Human Network are trademarks; Changing the Way We Work, Live, Play, and Learn and Cisco Store are service marks; and Access Registrar, Aironet, AsyncOS, Bringing the Meeting To You, Catalyst, CCDA, CCDP, CCIE, CCIP, CCNA, CCNP, CCSP, CCVP, Cisco, the Cisco Certified Internetwork Expert logo, Cisco IOS, Cisco Press, Cisco Systems, Cisco Systems Capital, the Cisco Systems logo, Cisco Unified Computing System (Cisco UCS), Cisco UCS B-Series Blade Servers, Cisco UCS C-Series Rack Servers, Cisco UCS S-Series Storage Servers, Cisco UCS Manager, Cisco UCS Management Software, Cisco Unified Fabric, Cisco Application Centric Infrastructure, Cisco Nexus 9000 Series, Cisco Nexus 7000 Series, Cisco Prime Data Center Network Manager, Cisco NX-OS Software, Cisco MDS Series, Cisco Unity, Collaboration Without Limitation, EtherFast, EtherSwitch, Event Center, Fast Step, Follow Me Browsing, FormShare, GigaDrive, HomeLink, Internet Quotient, IOS, iPhone, iQuick Study, LightStream, Linksys, MediaTone, MeetingPlace, MeetingPlace Chime Sound, MGX, Networkers, Networking Academy, Network Registrar, PCNow, PIX, PowerPanels, ProConnect, ScriptShare, SenderBase, SMARTnet, Spectrum Expert, StackWise, The Fastest Way to Increase Your Internet Quotient, TransPath, WebEx, and the WebEx logo are registered trademarks of Cisco Systems, Inc. and/or its affiliates in the United States and certain other countries.

All other trademarks mentioned in this document or website are the property of their respective owners. The use of the word partner does not imply a partnership relationship between Cisco and any other company. (0809R)

© 2020 Cisco Systems, Inc. All rights reserved.

Table of Contents

Executive Summary	9
Solution Overview	10
Introduction.....	10
Audience	10
Purpose of this Document.....	10
What's New?	10
Solution Summary.....	12
Cisco Desktop Virtualization Solutions: Data Center	15
The Evolving Workplace.....	15
Cisco Desktop Virtualization Focus	16
Simplified.....	16
Secure	16
Scalable	16
Savings and Success.....	17
Physical Topology.....	17
Compute Connectivity.....	17
Network Connectivity	18
Fibre Channel Storage Connectivity.....	19
End-to-End Physical Connectivity.....	19
High Scale Mixed Desktop Workload Solution Reference Architecture.....	22
What is FlashStack?.....	24
FlashStack Solution Benefits.....	25
What's New in this FlashStack Release.....	26
Configuration Guidelines.....	27
Solution Components	28
Cisco Unified Computing System	28
Cisco Unified Computing System Components	28
Cisco UCS Fabric Interconnect.....	29
Cisco UCS B200 M5 Blade Server	30
Main Features	32
Cisco UCS VIC1340 Converged Network Adapter.....	32
Cisco Switching.....	33
Cisco Nexus 93180YC-FX Switches.....	33
Cisco MDS 9132T 32-Gbps Fiber Channel Switch	35
Hypervisor	37
VMware vSphere 6.7.....	37

VMware vSphere Client	37
VMware ESXi 6.7 Hypervisor	38
Desktop Broker	39
Citrix XenDesktop 7.15	39
Citrix Provisioning Services 7.15	43
Benefits for Citrix XenApp and Other Server Farm Administrators	43
Benefits for Desktop Administrators	43
Citrix Provisioning Services Solution.....	44
Citrix Provisioning Services Infrastructure	44
Purity for FlashArray (Purity//FA 5)	45
FlashArray//X Specifications.....	45
Evergreen™ Storage	46
Pure1®	47
Pure1 Manage	48
Pure1 Analyze	48
Pure1 Support.....	48
Pure1 META.....	48
Architecture and Design Considerations for Desktop Virtualization	49
Understanding Applications and Data	50
Project Planning and Solution Sizing Sample Questions.....	50
Hypervisor Selection.....	51
Storage Considerations	51
Boot From SAN	51
Pure Storage FlashArray Considerations.....	51
Port Connectivity	52
Oversubscription	52
Topology	52
VMware Virtual Volumes Considerations.....	52
Pure Storage FlashArray Best Practices for VMware vSphere.....	53
Citrix XenDesktop Design Fundamentals	54
Machine Catalogs.....	54
Delivery Groups.....	54
Citrix Provisioning Services	55
Example XenDesktop Deployments	57
Distributed Components Configuration.....	57
Multiple Site Configuration.....	58
Citrix Cloud Services.....	59

Designing a XenDesktop Environment for a Mixed Workload.....	59
Deployment Hardware and Software	61
Products Deployed	61
Software Revisions	63
Logical Architecture	64
Configuration Guidelines	64
VLANs	64
VSANs.....	65
Solution Configuration.....	66
Solution Cabling.....	66
Cisco Unified Computing System Base Configuration	68
Cisco UCS Manager Software Version 4.0(2b)	68
Configure Fabric Interconnects at Console	68
Configure Fabric Interconnects for a Cluster Setup	68
Configure Base Cisco Unified Computing System	70
Synchronize Cisco UCSM to NTP	71
Configure Global Policies	72
Fabric Ports: Discrete versus Port Channel Mode.....	73
Set Fabric Interconnects to Fibre Channel End Host Mode	74
Create Uplink Port Channels to Cisco Nexus Switches	79
Configure IP, UUID, Server, MAC, WWNN, and WWPN Pools.....	84
Set Jumbo Frames in both the Cisco Fabric Interconnect	90
Create Host Firmware Package	91
Create Server Pool Policy	92
Create Network Control Policy for Cisco Discovery Protocol.....	94
Create Power Control Policy	95
Create Server BIOS Policy	96
Configure Maintenance Policy.....	97
Create vNIC Templates.....	98
Create vHBA Templates.....	100
Create Server Boot Policy for SAN Boot.....	102
Configure and Create a Service Profile Template	108
Create Service Profile Template	108
Create Service Profiles from Template and Associate to Servers.....	116
Configure Cisco Nexus 93180YC-FX Switches.....	118
Configure Global Settings for Cisco Nexus A and Cisco Nexus B	118
Configure VLANs for Cisco Nexus A and Cisco Nexus B Switches	119

Virtual Port Channel (vPC) Summary for Data and Storage Network	119
Cisco Nexus 93180YC-FX Switch Cabling Details	119
Cisco UCS Fabric Interconnect 6332-16UP Cabling	120
Create vPC Peer-Link Between the Two Nexus Switches	121
Create vPC Configuration Between Nexus 93180YC-FX and Fabric Interconnects.....	122
Cisco MDS 9132T 32-Gbps FC Switch Configuration	125
Pure Storage FlashArray//X70 R2 to MDS SAN Fabric Connectivity	126
Configure Feature for MDS Switch A and MDS Switch B.....	127
Configure VSANs for MDS Switch A and MDS Switch B.....	127
Create and Configure Fiber Channel Zoning.....	129
Create Device Aliases for Fiber Channel Zoning.....	129
Create Zoning	130
Configure Pure Storage FlashArray//X70 R2	131
Configure Host	132
Configure Volume	133
Install and Configure VMware ESXi 6.7.....	135
Download Cisco Custom Image for ESXi 6.7 Update 1	135
Install VMware vSphere ESXi 6.7	135
Set Up Management Networking for ESXi Hosts.....	136
Update Cisco VIC Drivers for ESXi	137
VMware Clusters	138
Building the Virtual Machines and Environment for Workload Testing.....	139
Software Infrastructure Configuration.....	139
Preparing the Master Targets.....	140
Install and Configure XenDesktop and XenApp	141
Prerequisites	141
Install XenDesktop Delivery Controller, Citrix Licensing, and StoreFront	142
Install Citrix License Server	143
Install Citrix Licenses	147
Install the XenDesktop.....	148
Additional XenDesktop Controller Configuration.....	154
Configure the XenDesktop Site.....	158
Configure the XenDesktop Site Hosting Connection.....	162
Configure the XenDesktop Site Administrators	170
Install and Configure StoreFront.....	172
Additional StoreFront Configuration.....	185
Install and Configure Citrix Provisioning Server 7.15.....	187

Install Additional PVS Servers.....	205
Install XenDesktop Virtual Desktop Agents	215
Install the Citrix Provisioning Server Target Device Software	223
Create Citrix Provisioning Server vDisks	226
Provision Virtual Desktop Machines	234
Citrix Provisioning Services Streamed VMSetup Wizard	234
Citrix Machine Creation Services	251
Create Delivery Groups.....	257
Citrix XenDesktop Policies and Profile Management	262
Configure Citrix XenDesktop Policies	262
Configuring User Profile Management	263
Install and Configure NVIDIA P6 Card.....	265
Physical Installation of P6 Card into Cisco UCS B200 M5 Server.....	265
Install an NVIDIA GPU Card in the Front of the Server	266
Install an NVIDIA GPU Card in the Rear of the Server	268
Install the NVIDIA VMware VIB Driver	270
Configure a Virtual Machine with a vGPU.....	272
Install the GPU Drivers Inside Windows Virtual Machine.....	275
Configure NVIDIA Grid License Server on Virtual Machine.....	278
Cisco Intersight Cloud Based Management.....	279
Test Setup, Configuration, and Load Recommendation.....	281
Cisco UCS Test Configuration for Single Blade Scalability	281
Cisco UCS Configuration for Full Scale Testing.....	285
Hardware and Software Components.....	286
Test Methodology and Success Criteria	288
Test Procedure.....	288
Pre-Test Setup for Single and Multi-Blade Testing	288
Test Run Protocol.....	288
Success Criteria.....	289
VSImax 4.1.x Description	290
Server-Side Response Time Measurements	291
Single-Server Recommended Maximum Workload	294
Test Results	295
Single-Server Recommended Maximum Workload Testing.....	295
Single-Server Recommended Maximum Workload for HSD with 270 Users	295
Single-Server Recommended Maximum Workload for HVD Non-Persistent with 205 Users	298
Single-Server Recommended Maximum Workload for HVD Persistent with 205 Users.....	301

Cluster Recommended Maximum Workload Testing	304
Cluster Workload Testing with 1900 HSD Users	304
Cluster Workload Testing with 2050 Non-Persistent Desktop Users	308
Cluster Workload Testing with 2050 Persistent Desktop Users	311
Full Scale Mixed Workload Testing with 6000 Users.....	315
Pure Storage FlashArray//X70 R2 Storage System Graph for 6000 Users Mixed Workload Test	323
Summary	325
Get More Business Value with Services	325
About the Authors.....	326
Acknowledgements	326
References	327
Cisco UCS B-Series Servers	327
Cisco UCS Manager Configuration Guides.....	327
Cisco UCS Virtual Interface Cards.....	327
Cisco Nexus Switching References.....	327
Cisco MDS 9000 Service Switch References	327
VMware References	328
Citrix References	328
Login VSI Documentation	328
Pure Storage Reference Documents.....	328
Appendix.....	329
Ethernet Network Configuration.....	329
Cisco Nexus 93180YC-FX-A Configuration	329
Cisco Nexus 93180YC-FX-B Configuration	341
No System Default Switchport Shutdown Fibre Channel Network Configuration	353
Cisco MDS 9132T 32-Gbps-A Configuration.....	353
Cisco MDS 9132T 32-Gbps-B Configuration.....	425
Full Scale 6000 Mixed-User Performance Chart with Boot and LoginVSI Knowledge Worker Workload Test	502
HSD Server Performance Monitor Data for Eight HSD Server Cluster: 6000 Users Mixed Scale Testing	503
Persistent HVD Server Performance Monitor Data for Eleven Sample HVD Server cluster: 6000 Users Mixed Scale Testing.....	509
Non-persistent HVD Server Performance Monitor Data for Eleven HVD Server Cluster: 6000 Users Mixed Scale Testing...	515

Executive Summary

Cisco Validated Designs include systems and solutions that are designed, tested, and documented to facilitate and improve customer deployments. These designs incorporate a wide range of technologies and products into a portfolio of solutions that have been developed to address the business needs of customers. Cisco, Pure and Citrix have partner to deliver this document, which serves as a specific step-by-step guide for implementing this solution. This Cisco Validated Design provides an efficient architectural design that is based on customer requirements. The solution that follows is a validated approach for deploying Cisco, Pure, VMware and Citrix technologies as a shared, high performance, resilient, virtual desktop infrastructure.

This document provides a reference architecture and design guide for up to a 6000-seat mixed workload end user computing environment on FlashStack Data Center with Cisco UCS and Pure Storage® FlashArray//X70 R2 with 100 percent DirectFlash Modules and DirectFlash Software. The solution includes Citrix XenDesktop server-based Hosted Shared Desktop Windows Sever 2016 sessions, Citrix XenDesktop persistent Microsoft Windows 10 virtual desktops and Citrix XenDesktop non-persistent Microsoft Windows 10 virtual desktops on VMware vSphere 6.7U1.

The solution is a predesigned, best-practice data center architecture built on the FlashStack reference architecture. The FlashStack Data Center used in this validation includes Cisco Unified Computing System (Cisco UCS), the Cisco Nexus® 9000 family of switches, Cisco MDS 9000 family of Fibre Channel (FC) switches and Pure All-NVMe FlashArray//X system.

This solution is 100 percent virtualized on fifth generation Cisco UCS B200 M5 blade servers, booting VMware vSphere 6.7 Update 1 through FC SAN from the FlashArray//X70 R2 storage array. The virtual desktops are powered using Citrix Provisioning Server 7.15 LTSR and Citrix XenApp/XenDesktop 7.15 LTSR, with a mix of Windows Server 2016 hosted shared desktops (1900), pooled/non-persistent hosted virtual Windows 10 desktops (2050), provisioned with Citrix Provisioning Service, and persistent hosted virtual Windows 10 desktops provisioned with Citrix Machine Creation Services (2050) to support the user population and provisioned on the Pure Storage FlashArray//X70 R2 storage array. Where applicable the document provides best practice recommendations and sizing guidelines for customer deployment of this solution.

This solution delivers the design for a 6000-user payload with 6 fewer blade servers than previous 6000 seat solutions on fourth generation Cisco UCS Blade Servers making it more efficient and cost effective in the data center due to increased solution density. Further rack efficiencies were gained from a storage standpoint as all 6000 users were hosted on a single 3U FlashArray//X70 R2 storage array while previous large-scale FlashStack Cisco Validated Designs with VDI used a Pure Storage 3U base chassis along with a 2U expansion shelf.

The solution is fully capable of supporting hardware accelerated graphics workloads. The Cisco UCS B200 M5 server supports up to two NVIDIA P6 cards for high density, high-performance graphics workload support. See our Cisco Graphics White Paper for details about integrating NVIDIA GPU with Citrix XenDesktop.

This solution provides an outstanding virtual desktop end-user experience as measured by the Login VSI 4.1.32.1 Knowledge Worker workload running in benchmark mode, along with the 6000-seat solution providing a large-scale building block that can be replicated to confidently scale-out to tens of thousands of users.

Solution Overview

Introduction

The current industry trend in data center design is towards shared infrastructures. By using virtualization along with pre-validated IT platforms, enterprise customers have embarked on the journey to the cloud by moving away from application silos and toward shared infrastructure that can be quickly deployed, thereby increasing agility and reducing costs. Cisco, Pure Storage, Citrix and VMware have partnered to deliver this Cisco Validated Design, which uses best of breed storage, server and network components to serve as the foundation for desktop virtualization workloads, enabling efficient architectural designs that can be quickly and confidently deployed.

Audience

The audience for this document includes, but is not limited to; sales engineers, field consultants, professional services, IT managers, partner engineers, and customers who want to take advantage of an infrastructure built to deliver IT efficiency and enable IT innovation.

Purpose of this Document

This document provides a step-by-step design, configuration and implementation guide for the Cisco Validated Design for a large-scale XenDesktop 7.15 mixed workload solution with Pure Storage FlashArray//X array, Cisco UCS Blade Servers, Cisco Nexus 9000 series Ethernet switches and Cisco MDS 9100 series Multilayer Fibre channel switches.

What's New?

This is the first Citrix XenDesktop 7.15 Virtual Client Compute (VCC) deployment Cisco Validated Design with Cisco UCS 5th generation servers and Pure X-Series system.

It incorporates the following features:

- Cisco UCS B200 M5 blade servers with Intel Xeon Scalable Family processor and 2666 MHz memory
- Validation of Cisco Nexus 9000 with Pure Storage FlashArray//X system
- Validation of Cisco MDS 9100 with Pure Storage FlashArray//X system
- Support for the Cisco UCS 4.0(2b) release and Cisco UCS B200-M5 servers
- Support for the latest release of Pure Storage FlashArray//X70 R2 hardware and Purity//FA v5.1.7
- A Fibre Channel storage design supporting SAN LUNs
- Cisco UCS Inband KVM Access
- Cisco UCS vMedia client for vSphere Installation
- Cisco UCS Firmware Auto Sync Server policy
- VMware vSphere 6.7 U1 Hypervisor
- Citrix XenDesktop 7.15 LTSR CU3 Server 2016 RDS hosted shared virtual desktops

- Citrix XenDesktop 7.15 LTSR CU3 non-persistent hosted virtual Windows 10 desktops provisioned with Citrix Provisioning Services
- Citrix XenDesktop 7.15 LTSR CU3 persistent full clones hosted virtual Windows 10 desktops provisioned with Citrix Machine Creation Services

The data center market segment is shifting toward heavily virtualized private, hybrid and public cloud computing models running on industry-standard systems. These environments require uniform design points that can be repeated for ease of management and scalability.

These factors have led to the need for predesigned computing, networking and storage building blocks optimized to lower the initial design cost, simplify management, and enable horizontal scalability and high levels of utilization.

The use cases include:

- Enterprise Data Center
- Service Provider Data Center
- Large Commercial Data Center

Solution Summary

FlashStack provides a jointly supported solution by Cisco and Pure Storage. Bringing a carefully validated architecture built on superior compute, world class networking, and the leading innovations in all flash storage.



The portfolio of validated offerings from FlashStack includes but is not limited to the following:

- Consistent performance: FlashStack provides higher, more consistent performance than disk-based solutions and delivers a converged infrastructure based on all-flash that provides non-disruptive upgrades and scalability.
- Cost savings: FlashStack uses less power, cooling, and data center space when compared to legacy disk/hybrid storage. It provides industry-leading storage data reduction and exceptional storage density.
- Simplicity: FlashStack requires low ongoing maintenance and reduces operational overhead. It also scales simply and smoothly in step with business requirements.
- Deployment choices: It is available as a custom-built single unit from FlashStack partners, but organizations can also deploy using equipment from multiple sources, including equipment they already own.
- Unique business model: The Pure Storage Evergreen Storage Model enables companies to keep their storage investments forever, which means no more forklift upgrades and no more downtime.
- Mission-critical resiliency: FlashStack offers best in class performance by providing active-active resiliency, no single point of failure, and non-disruptive operations, enabling organizations to maximize productivity.
- Support choices: Focused, high-quality single-number reach for FlashStack support is available from FlashStack Authorized Support Partners. Single-number support is also available directly from Cisco Systems as part of the Cisco Solution Support for Data Center offering. Support for FlashStack components

is also available from Cisco, VMware, and Pure Storage individually and leverages TSANet for resolution of support queries between vendors.

This Cisco Validated Design prescribes a defined set of hardware and software that serves as an integrated foundation for both Citrix XenDesktop Microsoft Windows 10 virtual desktops and Citrix XenApp server desktop sessions based on Microsoft Server 2016.

The mixed workload solution includes Pure Storage FlashArray//X®, Cisco Nexus® and MDS networking, the Cisco Unified Computing System (Cisco UCS®), Citrix XenDesktop and VMware vSphere® software in a single package. The design is space optimized such that the network, compute, and storage required can be housed in one data center rack. Switch port density enables the networking components to accommodate multiple compute and storage configurations of this kind.

The infrastructure is deployed to provide Fibre Channel-booted hosts with block-level access to shared storage. The reference architecture reinforces the "wire-once" strategy, because as additional storage is added to the architecture, no re-cabling is required from the hosts to the Cisco UCS fabric interconnect.

The combination of technologies from Cisco Systems, Inc., Pure Storage Inc. and Citrix Systems Inc. produced a highly efficient, robust and affordable desktop virtualization solution for a hosted virtual desktop and hosted shared desktop mixed deployment supporting different use cases. Key components of this solution include the following:

- More power, same size. Cisco UCS B200 M5 half-width blade with dual 18-core 2.3 GHz Intel® Xeon® Scalable Family Gold (6140) processors and 768 GB of memory for Citrix XenDesktop hosts supports more virtual desktop workloads than the previously released generation processors on the same hardware. The Intel 18-core 2.3 GHz Intel® Xeon® Gold Scalable Family (6140) processors used in this study provided a balance between increased per-blade capacity and cost.
- Fewer servers. Because of the increased compute power in the Cisco UCS B200 M5 servers, we supported the 6000-seat design with 16 percent fewer servers compared to previous generation Cisco UCS B200 M4s.
- Fault-tolerance with high availability built into the design. The various designs are based on using one Unified Computing System chassis with multiple Cisco UCS B200 M5 blades for virtualized desktop and infrastructure workloads. The design provides N+1 server fault tolerance for hosted virtual desktops, hosted shared desktops and infrastructure services.
- Stress-tested to the limits during aggressive boot scenario. The servers hosting Hosted Shared Desktop sessions and VDI shared and statically assigned desktop environment booted and registered with the Citrix Delivery Controllers within 20 minutes, providing our customers with an extremely fast, reliable cold-start desktop virtualization system.
- Stress-tested to the limits during simulated login storms. All 6000 simulated users logged in and started running workloads up to steady state in 48-minutes without overwhelming the processors, exhausting memory or exhausting the storage subsystems, providing customers with a desktop virtualization system that can easily handle the most demanding login and startup storms.
- Ultra-condensed computing for the data center. The rack space required to support the system is less than a single 42U rack, conserving valuable data center floor space.
- All Virtualized: This Cisco Validated Design (CVD) presents a validated design that is 100 percent virtualized on VMware ESXi 6.7. All of the virtual desktops, user data, profiles, and supporting infrastructure components, including Active Directory, SQL Servers, Citrix XenDesktop components, XenDesktop VDI desktops and XenApp servers were hosted as virtual machines. This provides customers with complete

flexibility for maintenance and capacity additions because the entire system runs on the FlashStack converged infrastructure with stateless Cisco UCS Blade servers and Pure FC storage.

- Cisco maintains industry leadership with the new Cisco UCS Manager 4.0(2b) software that simplifies scaling, guarantees consistency, and eases maintenance. Cisco's ongoing development efforts with Cisco UCS Manager (UCSM), Cisco UCS Central, and Cisco UCS Director insure that customer environments are consistent locally, across Cisco UCS Domains and across the globe, our software suite offers increasingly simplified operational and deployment management and it continues to widen the span of control for customer organizations' subject matter experts in compute, storage and network.
- Our 40G unified fabric story gets additional validation on Cisco UCS 6300 Series Fabric Interconnects as Cisco runs more challenging workload testing, while maintaining unsurpassed user response times.
- Cisco SAN architectural benefit of the next-generation 32-Gbps fabric switches address the requirement for highly scalable, virtualized, intelligent SAN infrastructure in current-generation data center environments.
- Pure All-NVMe FlashArray//X70 R2 storage array provides industry-leading storage solutions that efficiently handle the most demanding I/O bursts (for example, login storms), profile management, and user data management, deliver simple and flexible business continuance, and help reduce storage cost per desktop.
- Pure All-NVMe FlashArray//X70 R2 storage array provides a simple to understand storage architecture for hosting all user data components (virtual machines, profiles, user data) on the same storage array.
- Pure Storage software enables to seamlessly add, upgrade or remove capacity and/or controllers from the infrastructure to meet the needs of the virtual desktops transparently.
- Pure Storage Management UI for VMware vSphere hypervisor has deep integrations with vSphere, providing easy-button automation for key storage tasks such as storage repository provisioning, storage resize, directly from vCenter.
- Citrix XenDesktop and XenApp Advantage. XenApp and XenDesktop are virtualization solutions that give IT control of virtual machines, applications, licensing, and security while providing anywhere access for any device.

XenApp and XenDesktop provides the following:

- End users to run applications and desktops independently of the device's operating system and interface.
- Administrators to manage the network and control access from selected devices or from all devices.
- Administrators to manage an entire network from a single data center.
- XenApp and XenDesktop share a unified architecture called FlexCast Management Architecture (FMA). FMA's key features are the ability to run multiple versions of XenApp or XenDesktop from a single Site and integrated provisioning.
- Optimized to achieve the best possible performance and scale. For hosted shared desktop sessions, the best performance was achieved when the number of vCPUs assigned to the VMware 7 RDS virtual machines did not exceed the number of hyper-threaded (logical) cores available on the server. In other words, maximum performance is obtained when not overcommitting the CPU resources for the virtual machines running virtualized RDS systems.
- Provisioning desktop machines made easy. Citrix provides two core provisioning methods for XenDesktop and XenApp virtual machines: Citrix Provisioning Services for pooled virtual desktops and XenApp virtual

servers and Citrix Machine Creation Services for pooled or persistent virtual desktops. This paper provides guidance on how to use each method and documents the performance of each technology.

Cisco Desktop Virtualization Solutions: Data Center

The Evolving Workplace

Today's IT departments are facing a rapidly evolving workplace environment. The workforce is becoming increasingly diverse and geographically dispersed, including offshore contractors, distributed call center operations, knowledge and task workers, partners, consultants, and executives connecting from locations around the world at all times.

This workforce is also increasingly mobile, conducting business in traditional offices, conference rooms across the enterprise campus, home offices, on the road, in hotels, and at the local coffee shop. This workforce wants to use a growing array of client computing and mobile devices that they can choose based on personal preference. These trends are increasing pressure on IT to ensure protection of corporate data and prevent data leakage or loss through any combination of user, endpoint device, and desktop access scenarios (Figure 1).

These challenges are compounded by desktop refresh cycles to accommodate aging PCs and bounded local storage and migration to new operating systems, specifically Microsoft Windows 10 and productivity tools, specifically Microsoft Office 2016.

Figure 1 Cisco Data Center Partner Collaboration

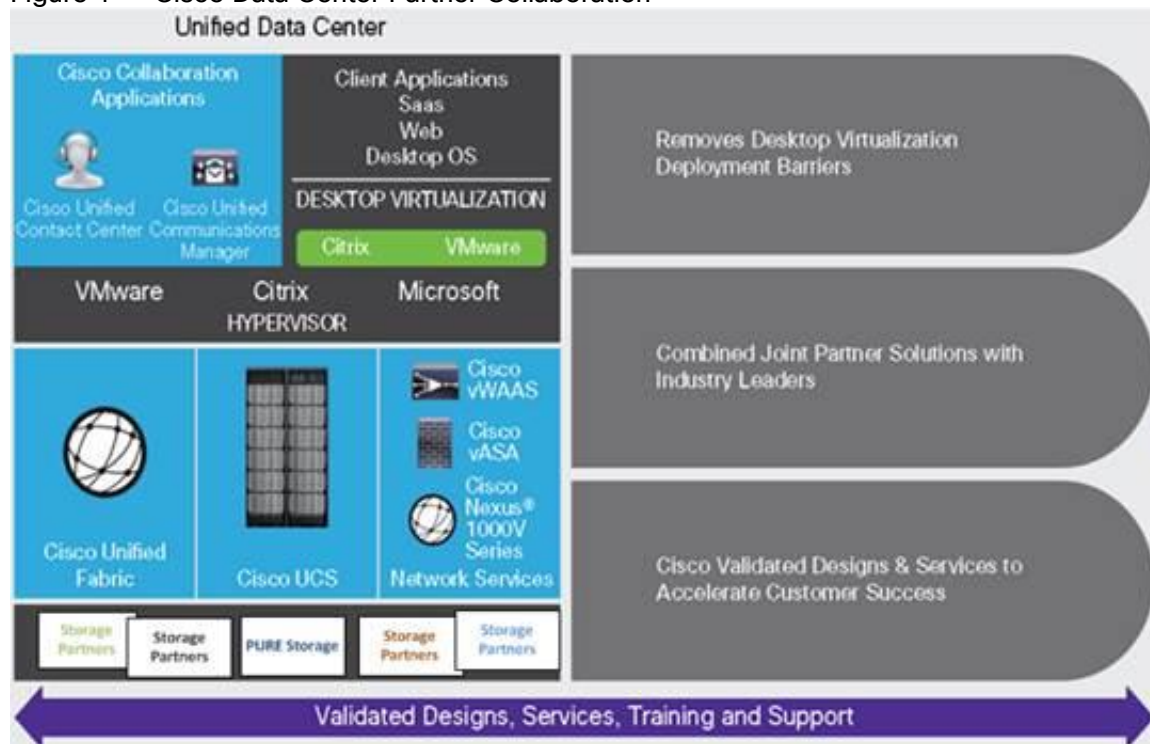

Some of the key drivers for desktop virtualization are increased data security and reduced TCO through increased control and reduced management costs.

Cisco Desktop Virtualization Focus

Cisco focuses on three key elements to deliver the best desktop virtualization data center infrastructure: simplification, security, and scalability. The software combined with platform modularity provides a simplified, secure, and scalable desktop virtualization platform.

Simplified

Cisco UCS provides a radical new approach to industry-standard computing and provides the core of the data center infrastructure for desktop virtualization. Among the many features and benefits of Cisco UCS are the drastic reduction in the number of servers needed and in the number of cables used per server, and the capability to rapidly deploy or re-provision servers through Cisco UCS service profiles. With fewer servers and cables to manage and with streamlined server and virtual desktop provisioning, operations are significantly simplified. Thousands of desktops can be provisioned in minutes with Cisco UCS Manager Service Profiles and Cisco storage partners' storage-based cloning. This approach accelerates the time to productivity for end users, improves business agility, and allows IT resources to be allocated to other tasks.

Cisco UCS Manager automates many mundane, error-prone data center operations such as configuration and provisioning of server, network, and storage access infrastructure. In addition, Cisco UCS B-Series Blade Servers and C-Series Rack Servers with large memory footprints enable high desktop density that helps reduce server infrastructure requirements.

Simplification also leads to more successful desktop virtualization implementation. Cisco and its technology partners like VMware Technologies, Citrix Systems and Pure Storage have developed integrated, validated architectures, including predefined converged architecture infrastructure packages such as FlashStack. Cisco Desktop Virtualization Solutions have been tested with VMware vSphere, Citrix XenDesktop.

Secure

Although virtual desktops are inherently more secure than their physical predecessors, they introduce new security challenges. Mission-critical web and application servers using a common infrastructure such as virtual desktops are now at a higher risk for security threats. Inter-virtual machine traffic now poses an important security consideration that IT managers need to address, especially in dynamic environments in which virtual machines, using VMware vMotion, move across the server infrastructure.

Desktop virtualization, therefore, significantly increases the need for virtual machine-level awareness of policy and security, especially given the dynamic and fluid nature of virtual machine mobility across an extended computing infrastructure. The ease with which new virtual desktops can proliferate magnifies the importance of a virtualization-aware network and security infrastructure. Cisco data center infrastructure (Cisco UCS and Cisco Nexus Family solutions) for desktop virtualization provides strong data center, network, and desktop security, with comprehensive security from the desktop to the hypervisor. Security is enhanced with segmentation of virtual desktops, virtual machine-aware policies and administration, and network security across the LAN and WAN infrastructure.

Scalable

Growth of a desktop virtualization solution is all but inevitable, so a solution must be able to scale, and scale predictably, with that growth. The Cisco Desktop Virtualization Solutions built on FlashStack Data Center infrastructure supports high virtual-desktop density (desktops per server), and additional servers and storage scale with near-linear performance. FlashStack Data Center provides a flexible platform for growth and improves business agility. Cisco UCS Manager Service Profiles allow on-demand desktop provisioning and make it just as easy to deploy dozens of desktops as it is to deploy thousands of desktops.

Cisco UCS servers provide near-linear performance and scale. Cisco UCS implements the patented Cisco Extended Memory Technology to offer large memory footprints with fewer sockets (with scalability to up to 1 terabyte (TB) of memory with 2- and 4-socket servers). Using unified fabric technology as a building block, Cisco UCS server aggregate bandwidth can scale to up to 80 Gbps per server, and the northbound Cisco UCS fabric interconnect can output 2 terabits per second (Tbps) at line rate, helping prevent desktop virtualization I/O and memory bottlenecks. Cisco UCS, with its high-performance, low-latency unified fabric-based networking architecture, supports high volumes of virtual desktop traffic, including high-resolution video and communications traffic. In addition, Cisco storage partner Pure, helps maintain data availability and optimal performance during boot and login storms as part of the Cisco Desktop Virtualization Solutions. Recent Cisco Validated Designs for end user computing based on FlashStack solutions have demonstrated scalability and performance, with up to 6000 desktops up and running in 20 minutes.

FlashStack data center provides an excellent platform for growth, with transparent scaling of server, network, and storage resources to support desktop virtualization, data center applications, and cloud computing.

Savings and Success

The simplified, secure, scalable Cisco data center infrastructure for desktop virtualization solutions saves time and money compared to alternative approaches. Cisco UCS enables faster payback and ongoing savings (better ROI and lower TCO) and provides the industry's greatest virtual desktop density per server, reducing both capital expenditures (CapEx) and operating expenses (OpEx). The Cisco UCS architecture and Cisco Unified Fabric also enables much lower network infrastructure costs, with fewer cables per server and fewer ports required. In addition, storage tiering and deduplication technologies decrease storage costs, reducing desktop storage needs by up to 50 percent.

The simplified deployment of Cisco UCS for desktop virtualization accelerates the time to productivity and enhances business agility. IT staff and end users are more productive more quickly, and the business can respond to new opportunities quickly by deploying virtual desktops whenever and wherever they are needed. The high-performance Cisco systems and network deliver a near-native end-user experience, allowing users to be productive anytime and anywhere.

The ultimate measure of desktop virtualization for any organization is its efficiency and effectiveness in both the near term and the long term. The Cisco Desktop Virtualization Solutions are very efficient, allowing rapid deployment, requiring fewer devices and cables, and reducing costs. The solutions are also very effective, providing the services that end users need on their devices of choice while improving IT operations, control, and data security. Success is bolstered through Cisco's best-in-class partnerships with leaders in virtualization and storage, and through tested and validated designs and services to help customers throughout the solution lifecycle. Long-term success is enabled through the use of Cisco's scalable, flexible, and secure architecture as the platform for desktop virtualization.

Physical Topology

Compute Connectivity

Each compute chassis in the design is redundantly connected to the managing fabric interconnects with at least two ports per IOM. Ethernet traffic from the upstream network and Fibre Channel frames coming from the FlashArray are converged within the fabric interconnect to be both Ethernet and Fibre Channel over Ethernet and transmitted to the UCS servers through the IOM. These IOM connections from the Cisco UCS Fabric Interconnects to the IOMs are automatically configured as port channels by specifying a Chassis/FEX Discovery Policy within UCSM.

Each rack server in the design is redundantly connected to the managing fabric interconnects with at least one port to each FI. Ethernet traffic from the upstream network and Fibre Channel frames coming from the FlashArray are converged within the fabric interconnect to be both Ethernet and Fibre Channel over Ethernet and transmitted to the UCS server.

These connections from the UCS 6454 Fabric Interconnect to the 2208XP IOM hosted within the chassis are shown in Figure 2.

Figure 2 Compute Connectivity

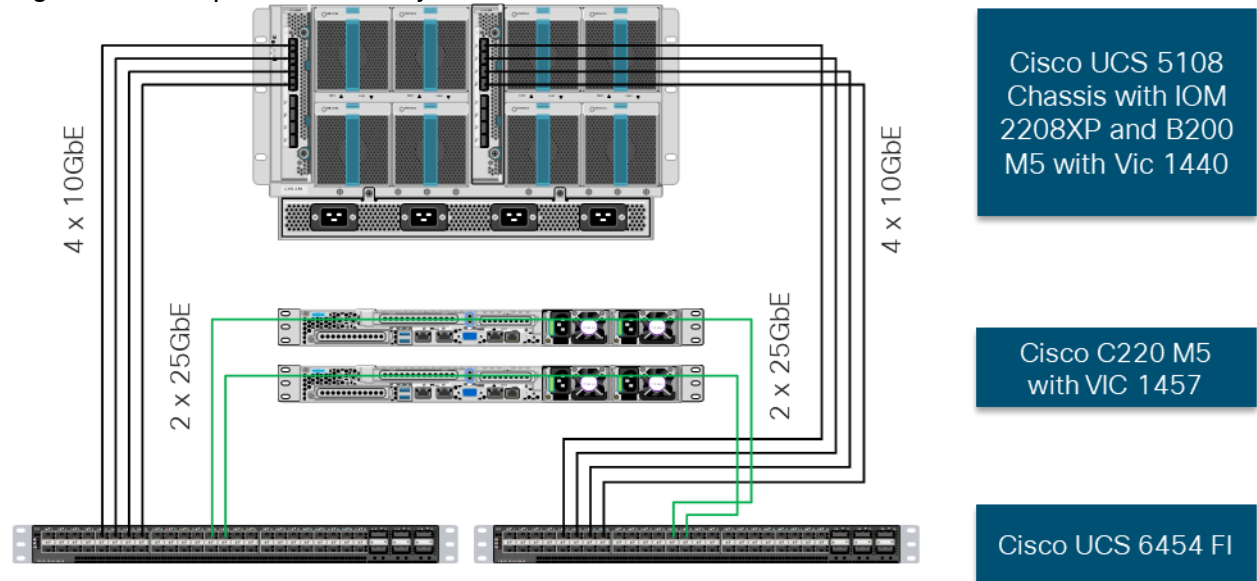

The 2208XP IOM are shown with 4x10Gbps ports to deliver an aggregate of 80Gbps to the chassis, full population of the 2208XP IOM can support 8x10Gbps ports, allowing for an aggregate of 160Gbps to the chassis.

Network Connectivity

The Layer 2 network connection to each Fabric Interconnect is implemented as Virtual Port Channels (vPC) from the upstream Nexus Switches. In the switching environment, the vPC provides the following benefits:

- Allows a single device to use a Port Channel across two upstream devices
- Eliminates Spanning Tree Protocol blocked ports and use all available uplink bandwidth
- Provides a loop-free topology
- Provides fast convergence if either one of the physical links or a device fails
- Helps ensure high availability of the network

The upstream network switches can connect to the Cisco UCS 6454 Fabric Interconnects using 10G, 25G, 40G, or 100G port speeds. In this design, the 100G ports from the 40/100G ports on the 6454 (1/49-54) were used for the virtual port channels. In the iSCSI design, this would also transport the storage traffic between the Cisco UCS servers and the FlashArray//X R2

Figure 3 Network Connectivity

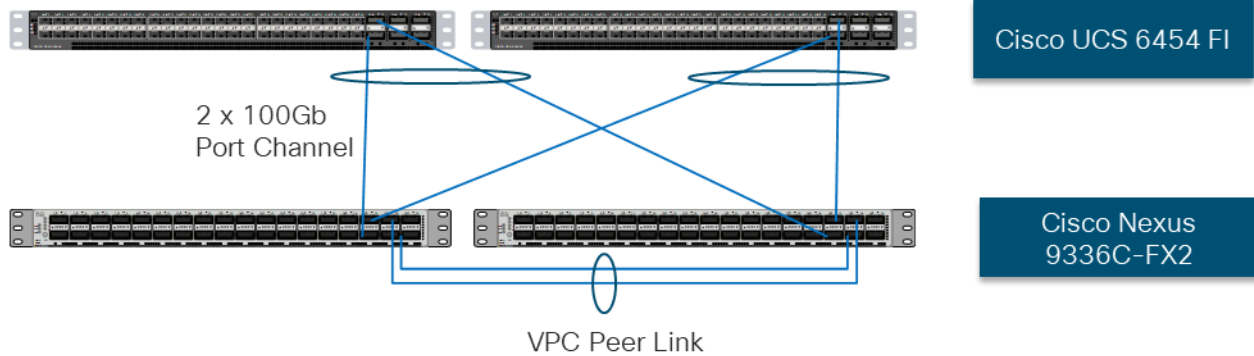

Fibre Channel Storage Connectivity

The FlashArray//X70 R2 platform is connected through both MDS 9132Ts to their respective Fabric Interconnects in a traditional air-gapped A/B fabric design. The Fabric Interconnects are configured in N-Port Virtualization (NPV) mode, known as FC end host mode in UCSM. The MDS has N-Port ID Virtualization (NPIV) enabled. This allows F-port channels to be used between the Fabric Interconnect and the MDS, providing the following benefits:

- Increased aggregate bandwidth between the fabric interconnect and the MDS
- Load balancing across the FC uplinks
- High availability in the event of a failure of one or more uplinks

Figure 4 Fibre Channel Storage Connectivity

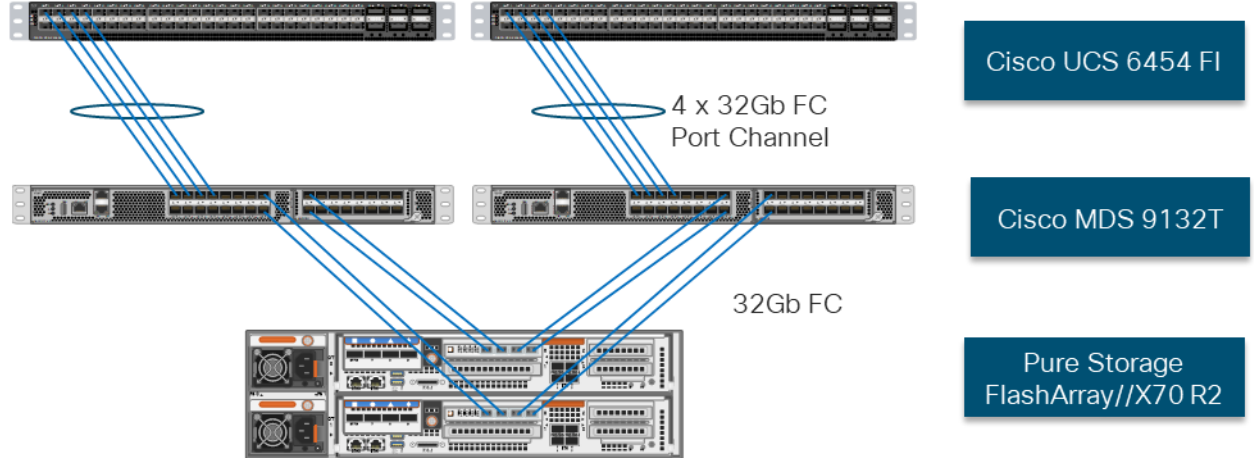

End-to-End Physical Connectivity

FC End-to-End Data Path

The FC end to end path in the design is a traditional air-gapped fabric with identical data path through each fabric as detailed below:

- Each Cisco UCS Server is equipped with a VIC 1400 Series adapter
- In the Cisco B200 M5 server, a VIC 1440 provides 2x10Gbps to IOM A and 2x10Gbps to IOM B through the Cisco UCS Chassis 5108 chassis backplane

- In the Cisco C220 M5 server, a VIC 1457 is used with 2x 25Gbps connections to FI-A and 2x5Gbps FI-B for a total of 4x25Gbps of uplink bandwidth
- Each IOM is connected to its respective Cisco UCS 6454 Fabric Interconnect using a port-channel for 4-8 links
- Each Cisco UCS 6454 FI connects to the MDS 9132T for the respective SAN fabric using an F-Port channel
- The Pure Storage FlashArray//X70 R2 is connected to both MDS 9132T switches to provide redundant paths through both fabrics

Figure 5 FC End-to-End Data Path

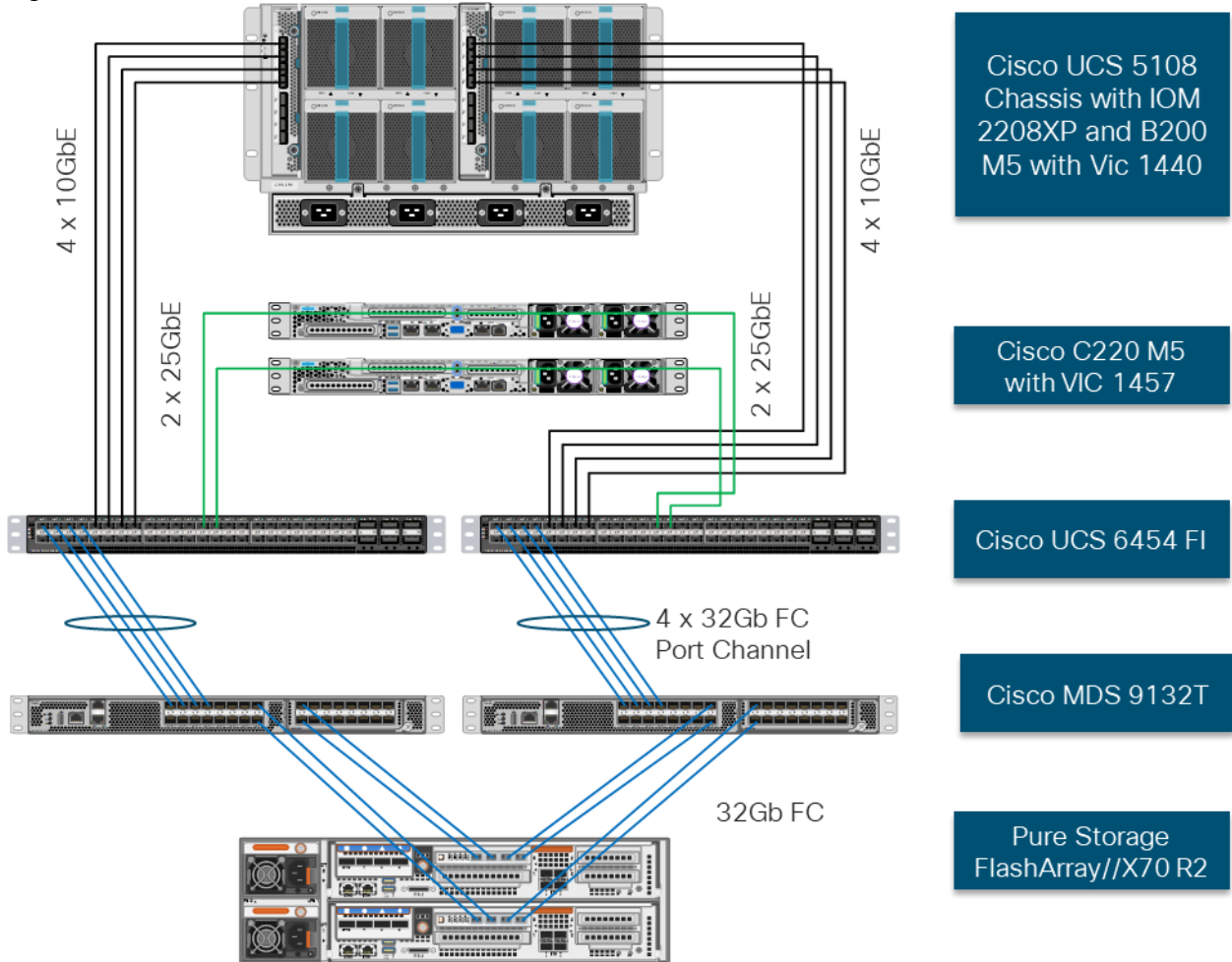

The components of this integrated architecture shown in Figure 5 are:

- Cisco Nexus 9336C-FX2 - 10/25/40/100Gb capable, LAN connectivity to the UCS compute resources
- Cisco UCS 6454 Fabric Interconnect - Unified management of UCS compute, and the compute's access to storage and networks
- Cisco UCS B200 M5 - High powered blade server, optimized for virtual computing
- Cisco UCS C220 M5 - High powered rack server, optimized for virtual computing

- Cisco MDS 9132T – 32Gbps Fibre Channel connectivity within the architecture, as well as interfacing to resources present in an existing data center
- Pure Storage FlashArray//X70 R2

iSCSI End-to-End Data Path

The iSCSI end-to-end data path presented in the design leverages the Nexus 9336C-FX2 networking switches to carry storage traffic.

- Each Cisco UCS Server is equipped with a VIC 1400 series adapter
- In the Cisco UCS B200 M5 server this is accomplished using the VIC 1440 with 20Gb to IOM A and 20Gbps to IOM B through the Cisco UCS Chassis 5108 chassis backplane
- In the Cisco UCS C220 M5 server this is accomplished with the VIC 1457 with 4x 10/25Gbps connection
- Each IOM is connected to its respective Cisco UCS 6454 Fabric Interconnect using a port-channel for 4-8 links
- Each Cisco UCS C-Series Server is attached through a 25Gb port to each Cisco UCS 6454 FI
- Each Cisco UCS 6454 FI connects to the Nexus 9336C-FX2 through 2x 100Gbps virtual port channels
- Each controller on the Pure FlashArray//X70 R2 is connected to each Nexus 9336C-FX2 switch through 2x 40Gbps connections to provide redundant paths

Figure 6 iSCSI End-to-End Data Path

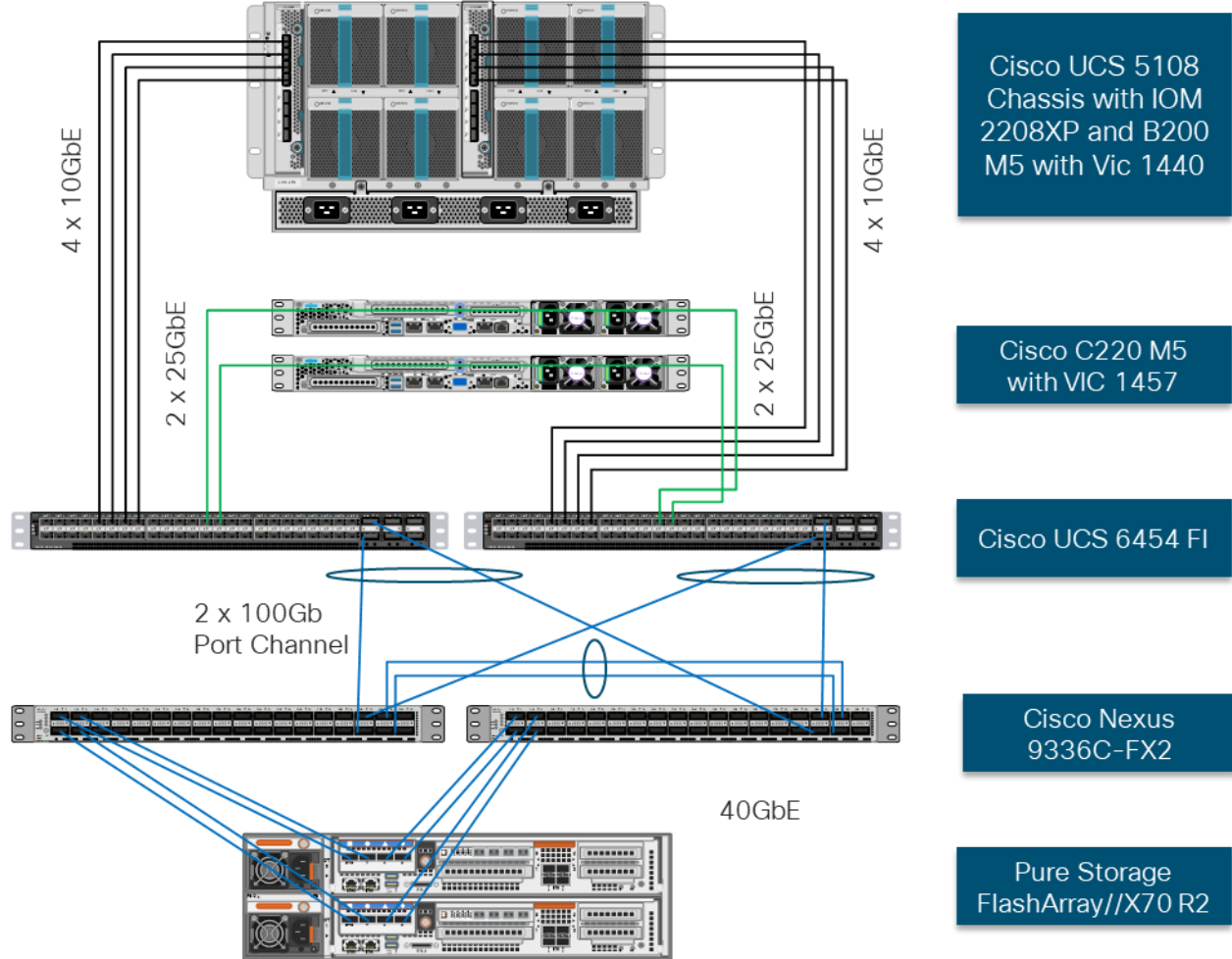

The components of this integrated architecture shown in Figure 6 are:

- Cisco Nexus 9336C-FX2 – 10/25/40/100Gb capable, LAN connectivity to the UCS compute resources and Pure Storage resource.
- Cisco UCS 6454 Fabric Interconnect – Unified management of UCS compute, and the compute’s access to storage and networks.
- Cisco UCS B200 M5 – High powered blade server, optimized for virtual computing.
- Cisco UCS C220 M5 – High powered rack server, optimized for virtual computing
- Pure Storage FlashArray//X70 R2

High Scale Mixed Desktop Workload Solution Reference Architecture

Figure 7 illustrates the FlashStack System architecture used in this Validated Design to support very high scale mixed desktop user workload. It follows Cisco configuration requirements to deliver highly available and scalable architecture.

Figure 7 FlashStack Solution Reference Architecture

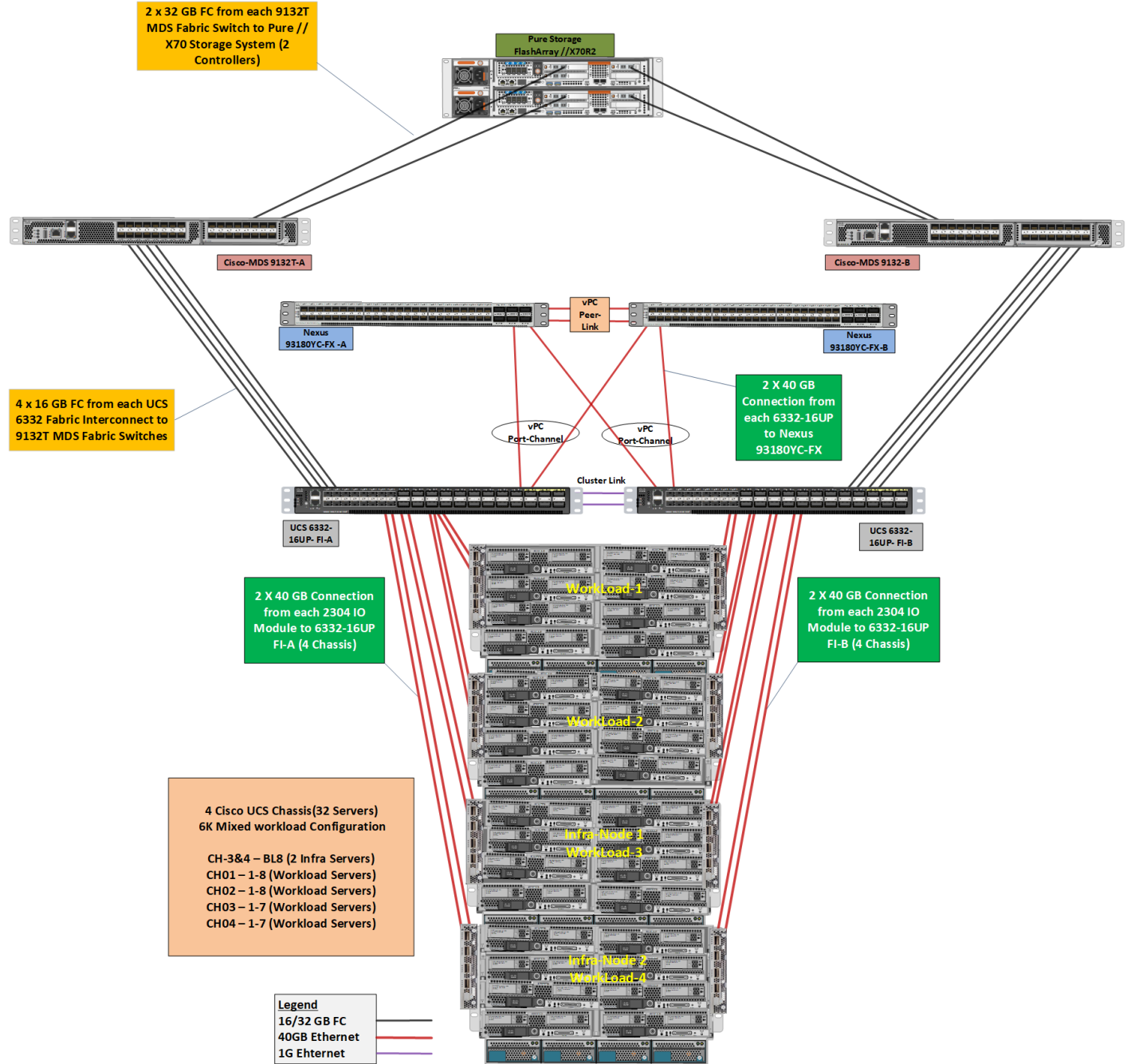

The reference hardware configuration includes:

- Two Cisco Nexus 93180YC-FX switches
- Two Cisco MDS 9132T 32-Gbps Fibre Channel switches
- Two Cisco UCS 6332-16UP Fabric Interconnects
- Four Cisco UCS 5108 Blade Chassis
- Two Cisco UCS B200 M5 Blade Servers (2 Server hosting Infrastructure virtual machines)

- Thirty Cisco UCS B200 M5 Blade Servers (for workload)
- One Pure Storage FlashArray//X70 R2 with All-NVMe DirectFlash Modules

For desktop virtualization, the deployment includes Citrix XenDesktop 7.15 LTSR CU3 running on VMware vSphere 6.7 Update 1.

The design is intended to provide a large-scale building block for XenDesktop mixed workloads consisting of RDS Windows Server 2016 hosted shared desktop sessions and Windows 10 non-persistent and persistent hosted desktops in the following ratio:

- 1900 Random Hosted Shared Windows 2016 user sessions with office 2016 (PVS)
- 2050 Random Pooled Windows 10 Hosted Virtual Desktops with office 2016 (PVS)
- 2050 Static Full Copy Windows 10 Hosted Virtual Desktops with office 2016 (MCS)

The data provided in this document will allow our customers to adjust the mix of HSD and HVD desktops to suit their environment. For example, additional blade servers and chassis can be deployed to increase compute capacity, additional disk shelves can be deployed to improve I/O capability and throughput, and special hardware or software features can be added to introduce new features. This document guides you through the detailed steps for deploying the base architecture. This procedure explains everything from physical cabling to network, compute and storage device configurations.

What is FlashStack?

The [FlashStack](#) platform, developed by Cisco and Pure Storage, is a flexible, integrated infrastructure solution that delivers pre-validated storage, networking, and server technologies. Cisco and Pure Storage have carefully validated and verified the FlashStack solution architecture and its many use cases while creating a portfolio of detailed documentation, information, and references to assist customers in transforming their data centers to this shared infrastructure model.

FlashStack is a best practice data center architecture that includes the following components:

- Cisco Unified Computing System
- Cisco Nexus Switches
- Cisco MDS Switches
- Pure Storage FlashArray

Figure 8 FlashStack Systems Components

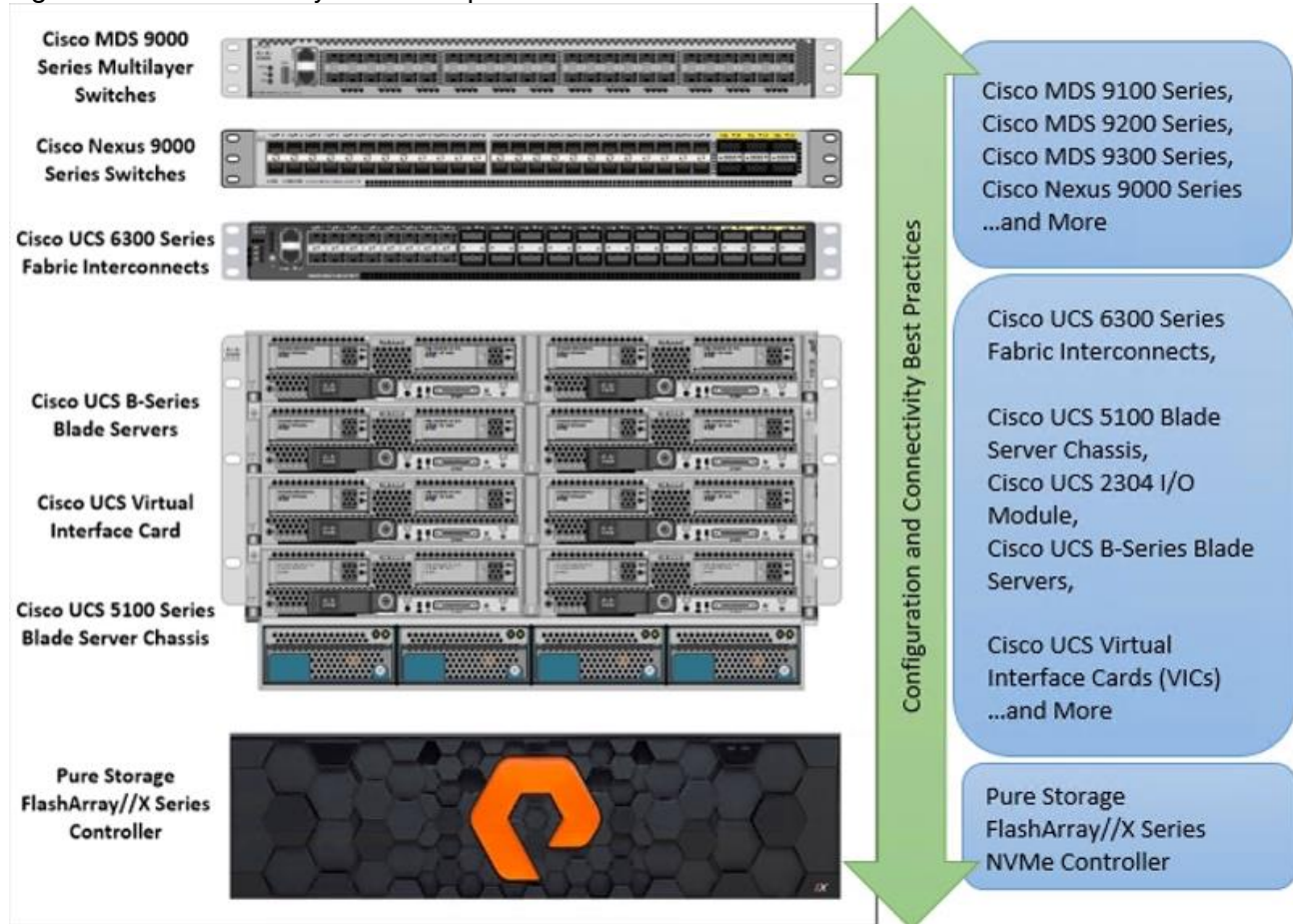

As shown in Figure 8, these components are connected and configured according to best practices of both Cisco and Pure Storage and provide the ideal platform for running a variety of enterprise database workloads with confidence. FlashStack can scale up for greater performance and capacity (adding compute, network, or storage resources individually as needed), or it can scale out for environments that require multiple consistent deployments.

The reference architecture covered in this document leverages the Pure Storage FlashArray//X70 R2 Controller with NVMe based DirectFlash modules for Storage, Cisco UCS B200 M5 Blade Server for Compute, Cisco Nexus 9000, and Cisco MDS 9100 Series for the switching element and Cisco Fabric Interconnects 6300 Series for System Management. As shown in Figure 8, FlashStack Architecture can maintain consistency at scale. Each of the component families shown in (Cisco UCS, Cisco Nexus, Cisco MDS, Cisco FI and Pure Storage) offers platform and resource options to scale the infrastructure up or down, while supporting the same features and functionality that are required under the configuration and connectivity best practices of FlashStack.

FlashStack Solution Benefits

FlashStack provides a jointly supported solution by Cisco and Pure Storage. Bringing a carefully validated architecture built on superior compute, world-class networking, and the leading innovations in all flash storage. The portfolio of validated offerings from FlashStack includes but is not limited to the following:

- Consistent Performance and Scalability
 - Consistent sub-millisecond latency with 100 percent NVMe enterprise flash storage

- Consolidate hundreds of enterprise-class applications in a single rack
- Scalability through a design for hundreds of discrete servers and thousands of virtual machines, and the capability to scale I/O bandwidth to match demand without disruption
- Repeatable growth through multiple FlashStack CI deployments
- Operational Simplicity
 - Fully tested, validated, and documented for rapid deployment
 - Reduced management complexity
 - No storage tuning or tiers necessary
 - 3x better data reduction without any performance impact
- Lowest TCO
 - Dramatic savings in power, cooling and space with Cisco UCS and 100 percent Flash
 - Industry leading data reduction
 - Free FlashArray controller upgrades every three years with Forever Flash™
- Mission Critical and Enterprise Grade Resiliency
 - Highly available architecture with no single point of failure
 - Non-disruptive operations with no downtime
 - Upgrade and expand without downtime or performance loss
 - Native data protection: snapshots and replication

Cisco and Pure Storage have also built a robust and experienced support team focused on FlashStack solutions, from customer account and technical sales representatives to professional services and technical support engineers. The support alliance between Pure Storage and Cisco gives customers and channel services partners direct access to technical experts who collaborate with cross vendors and have access to shared lab resources to resolve potential issues.

What's New in this FlashStack Release

This CVD of the FlashStack release introduces new hardware with the Pure Storage FlashArray//X, that is 100 percent NVMe enterprise class all-flash array along with Cisco UCS B200 M5 Blade Servers featuring the Intel Xeon Scalable Family of CPUs. This is the second Oracle RAC Database deployment Cisco Validated Design with Pure Storage. It incorporates the following features:

- Pure Storage FlashArray//X70 R2
- Cisco [9132T](#) 32-Gbps MDS Fibre Channel Switch
- VMware vSphere 6.7 U1 and Citrix XenDesktop 7.15 LTSR Cumulative Update 3 (CU3)

Configuration Guidelines

This Cisco Validated Design provides details for deploying a fully redundant, highly available 6000 seat mixed workload virtual desktop solution with VMware on a FlashStack Data Center architecture. Configuration guidelines are provided that refer the reader to which redundant component is being configured with each step. For example, storage controller 01 and storage controller 02 are used to identify the two Pure Storage FlashArray//X70 R2 controllers that are provisioned with this document, Cisco Nexus A or Cisco Nexus B identifies the pair of Cisco Nexus switches that are configured, and Cisco MDS A or Cisco MDS B identifies the pair of Cisco MDS switches that are configured. The pair of Cisco UCS 6332-16UP Fabric Interconnects are similarly configured as FI-A and FI-B.

Additionally, this document details the steps for provisioning multiple Cisco UCS hosts, and these are identified sequentially: VM-Host-Infra-01, VM-Host-Infra-02, VM-Host-RDSH-01, VM-Host-VDI-01 and so on. Finally, to indicate that you should include information pertinent to your environment in a given step, <text> appears as part of the command structure.

Solution Components

This section describes the components used in the solution outlined in this solution.

Cisco Unified Computing System

Cisco UCS Manager (UCSM) provides unified, embedded management of all software and hardware components of the Cisco Unified Computing System™ (Cisco UCS) through an intuitive GUI, a CLI, and an XML API. The manager provides a unified management domain with centralized management capabilities and can control multiple chassis and thousands of virtual machines.

Cisco UCS is a next-generation data center platform that unites computing, networking, and storage access. The platform, optimized for virtual environments, is designed using open industry-standard technologies and aims to reduce total cost of ownership (TCO) and increase business agility. The system integrates a low-latency, lossless 40 Gigabit Ethernet unified network fabric with enterprise-class, x86-architecture servers. It is an integrated, scalable, multi-chassis platform in which all resources participate in a unified management domain.

Cisco Unified Computing System Components

The main components of Cisco UCS are:

- **Compute:** The system is based on an entirely new class of computing system that incorporates blade servers based on Intel® Xeon® Scalable Family processors.
- **Network:** The system is integrated on a low-latency, lossless, 40-Gbps unified network fabric. This network foundation consolidates LANs, SANs, and high-performance computing (HPC) networks, which are separate networks today. The unified fabric lowers costs by reducing the number of network adapters, switches, and cables needed, and by decreasing the power and cooling requirements.
- **Virtualization:** The system unleashes the full potential of virtualization by enhancing the scalability, performance, and operational control of virtual environments. Cisco security, policy enforcement, and diagnostic features are now extended into virtualized environments to better support changing business and IT requirements.
- **Storage access:** The system provides consolidated access to local storage, SAN storage, and network-attached storage (NAS) over the unified fabric. With storage access unified, Cisco UCS can access storage over Ethernet, Fibre Channel, Fibre Channel over Ethernet (FCoE), and Small Computer System Interface over IP (iSCSI) protocols. This capability provides customers with choice for storage access and investment protection. In addition, server administrators can pre-assign storage-access policies for system connectivity to storage resources, simplifying storage connectivity and management and helping increase productivity.
- **Management:** Cisco UCS uniquely integrates all system components, enabling the entire solution to be managed as a single entity by Cisco UCS Manager. Cisco UCS Manager has an intuitive GUI, a CLI, and a robust API for managing all system configuration processes and operations.

Figure 9 Cisco Data Center Overview

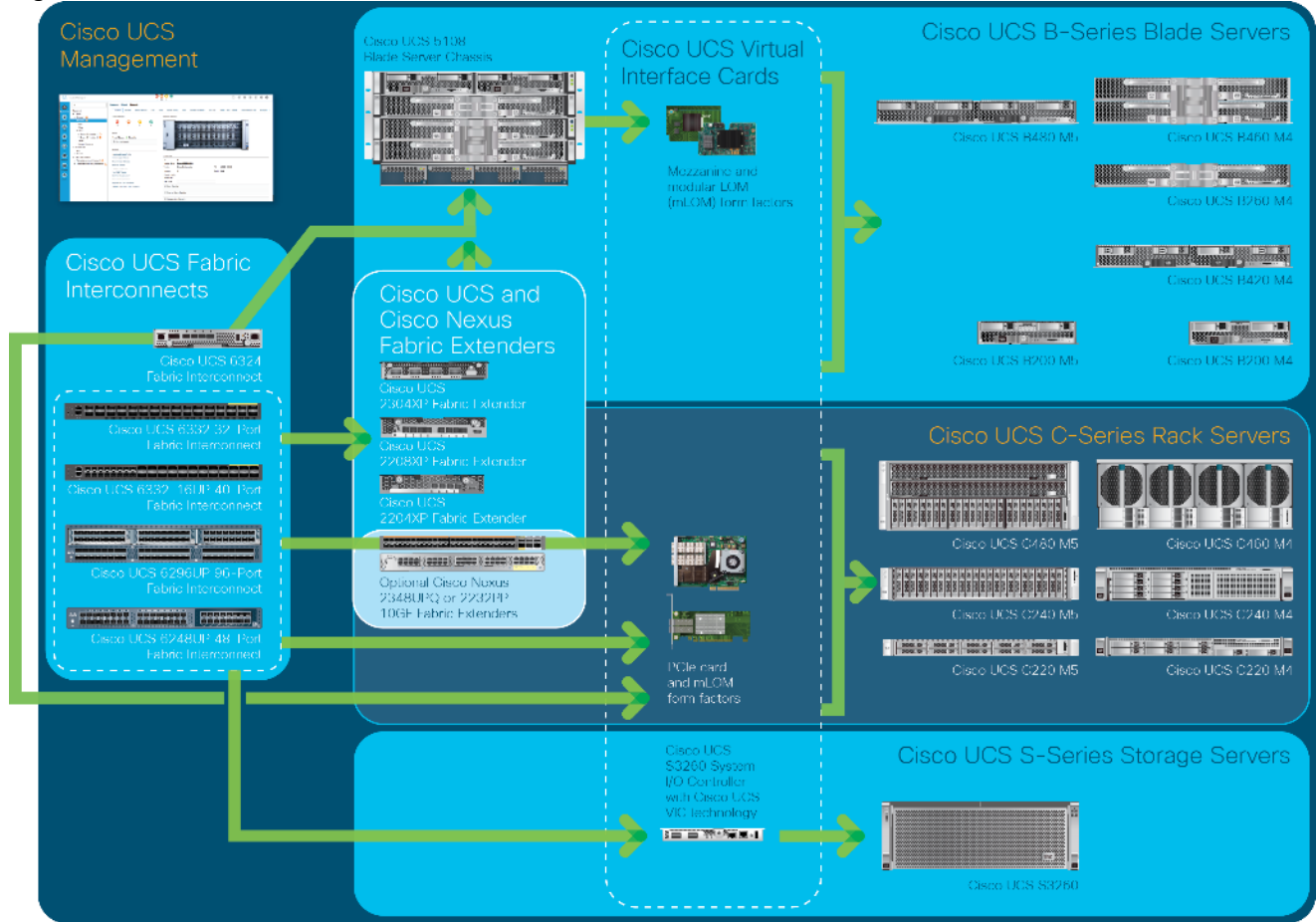

Cisco UCS is designed to deliver:

- Reduced TCO and increased business agility
- Increased IT staff productivity through just-in-time provisioning and mobility support
- A cohesive, integrated system that unifies the technology in the data center; the system is managed, serviced, and tested as a whole
- Scalability through a design for hundreds of discrete servers and thousands of virtual machines and the capability to scale I/O bandwidth to match demand
- Industry standards supported by a partner ecosystem of industry leaders

Cisco UCS Manager provides unified, embedded management of all software and hardware components of the Cisco Unified Computing System across multiple chassis, rack servers, and thousands of virtual machines. Cisco UCS Manager manages Cisco UCS as a single entity through an intuitive GUI, a CLI, or an XML API for comprehensive access to all Cisco UCS Manager Functions.

Cisco UCS Fabric Interconnect

The Cisco UCS 6300 Series Fabric Interconnects are a core part of Cisco UCS, providing both network connectivity and management capabilities for the system. The Cisco UCS 6300 Series offers line-rate, low-latency, lossless 40 Gigabit Ethernet, FCoE, and Fibre Channel functions.

The fabric interconnects provide the management and communication backbone for the Cisco UCS B-Series Blade Servers and Cisco UCS 5100 Series Blade Server Chassis. All chassis, and therefore all blades, attached to the fabric interconnects become part of a single, highly available management domain. In addition, by supporting unified fabric, the Cisco UCS 6300 Series provides both LAN and SAN connectivity for all blades in the domain.

For networking, the Cisco UCS 6300 Series uses a cut-through architecture, supporting deterministic, low-latency, line-rate 40 Gigabit Ethernet on all ports, 2.4 plus terabit (Tb) switching capacity, and 320 Gbps of bandwidth per chassis IOM, independent of packet size and enabled services. The product series supports Cisco low-latency, lossless, 40 Gigabit Ethernet unified network fabric capabilities, increasing the reliability, efficiency, and scalability of Ethernet networks. The fabric interconnects support multiple traffic classes over a lossless Ethernet fabric, from the blade server through the interconnect. Significant TCO savings come from an FCoE-optimized server design in which network interface cards (NICs), host bus adapters (HBAs), cables, and switches can be consolidated.

Figure 10 Cisco UCS 6300 Series Fabric Interconnect - 6332-16UP

Front View



Rear View



Cisco UCS B200 M5 Blade Server

The Cisco UCS B200 M5 Blade Server (Figure 11 and Figure 12) is a density-optimized, half-width blade server that supports two CPU sockets for Intel Xeon processor 6140 Gold series CPUs and up to 24 DDR4 DIMMs. It supports one modular LAN-on-motherboard (LOM) dedicated slot for a Cisco virtual interface card (VIC) and one mezzanine adapter. In additions, the Cisco UCS B200 M5 supports an optional storage module that accommodates up to two SAS or SATA hard disk drives (HDDs) or solid-state disk (SSD) drives. You can install up to eight Cisco UCS B200 M5 servers in a chassis, mixing them with other models of Cisco UCS blade servers in the chassis if desired.

Figure 11 Cisco UCS B200 M5 Front View



Figure 12 Cisco UCS B200 M5 Back View

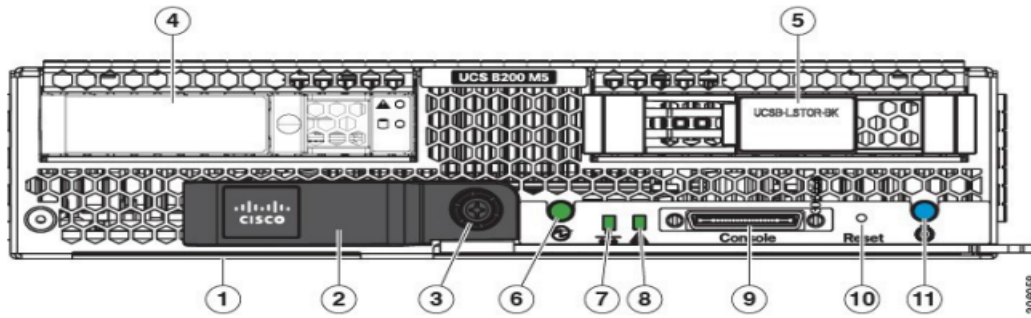

1	Asset pull tag Each server has a plastic tag that pulls out of the front panel. The tag contains the server serial number as well as the product ID (PID) and version ID (VID). The tag also allows you to add your own asset tracking label without interfering with the intended air flow.	7	Network link status
2	Blade ejector handle	8	Blade health LED
3	Ejector captive screw	9	Console connector¹
4	Drive bay 1	10	Reset button access
5	Drive bay 2	11	Locator button and LED
6	Power button and LED		

Notes:

1. A KVM I/O Cable plugs into the console connector, it can be ordered as a spare. The KVM I/O Cable is included with every Cisco UCS 5100 Series blade server chassis accessory kit

Cisco UCS combines Cisco UCS B-Series Blade Servers and C-Series Rack Servers with networking and storage access into a single converged system with simplified management, greater cost efficiency and agility, and increased visibility and control. The Cisco UCS B200 M5 Blade Server is one of the newest servers in the Cisco UCS portfolio.

The Cisco UCS B200 M5 delivers performance, flexibility, and optimization for data centers and remote sites. This enterprise-class server offers market-leading performance, versatility, and density without compromise for workloads ranging from web infrastructure to distributed databases. The Cisco UCS B200 M5 can quickly deploy stateless physical and virtual workloads with the programmable ease of use of the Cisco UCS Manager software and simplified server access with Cisco® Single Connect technology. Based on the Intel Xeon processor 6140 Gold product family, it offers up to 3 TB of memory using 128GB DIMMs, up to two disk drives, and up to 320 Gbps of I/O throughput. The Cisco UCS B200 M5 offers exceptional levels of performance, flexibility, and I/O throughput to run your most demanding applications.

In addition, Cisco UCS has the architectural advantage of not having to power and cool excess switches, NICs, and HBAs in each blade server chassis. With a larger power budget per blade server, it provides uncompromised expandability and capabilities, as in the new Cisco UCS B200 M5 server with its leading memory-slot capacity and drive capacity.

The Cisco UCS B200 M5 provides:

- Latest Intel® Xeon® Scalable processors with up to 28 cores per socket
- Up to 24 DDR4 DIMMs for improved performance
- Intel 3D XPoint-ready support, with built-in support for next-generation nonvolatile memory technology

- Two GPUs
- Two Small-Form-Factor (SFF) drives
- Two Secure Digital (SD) cards or M.2 SATA drives
- Up to 80 Gbps of I/O throughput

Main Features

The Cisco UCS B200 M5 server is a half-width blade. Up to eight servers can reside in the 6-Rack-Unit (6RU) Cisco UCS 5108 Blade Server Chassis, offering one of the highest densities of servers per rack unit of blade chassis in the industry. You can configure the Cisco UCS B200 M5 to meet your local storage requirements without having to buy, power, and cool components that you do not need.

The Cisco UCS B200 M5 provides these main features:

- Up to two Intel Xeon Scalable CPUs with up to 28 cores per CPU
- 24 DIMM slots for industry-standard DDR4 memory at speeds up to 2666 MHz, with up to 3 TB of total memory when using 128-GB DIMMs
- Modular LAN On Motherboard (mLOM) card with Cisco UCS Virtual Interface Card (VIC) 1340, a 2-port, 40 Gigabit Ethernet, Fibre Channel over Ethernet (FCoE)-capable mLOM mezzanine adapter
- Optional rear mezzanine VIC with two 40-Gbps unified I/O ports or two sets of 4 x 10-Gbps unified I/O ports, delivering 80 Gbps to the server; adapts to either 10- or 40-Gbps fabric connections
- Two optional, hot-pluggable, hard-disk drives (HDDs), solid-state drives (SSDs), or NVMe 2.5-inch drives with a choice of enterprise-class RAID or pass-through controllers
- Cisco FlexStorage local drive storage subsystem, which provides flexible boot and local storage capabilities and allows you to boot from dual, mirrored SD cards
- Support for up to two optional GPUs
- Support for up to one rear storage mezzanine card

For more information about Cisco UCS B200 M5, see the [Cisco UCS B200 M5 Blade Server Specsheet](#).

Table 1 Ordering Information

Part Number	Description
UCSB-B200-M5	UCS B200 M5 Blade w/o CPU, mem, HDD, mezz
UCSB-B200-M5-U	UCS B200 M5 Blade w/o CPU, mem, HDD, mezz (UPG)
UCSB-B200-M5-CH	UCS B200 M5 Blade w/o CPU, mem, HDD, mezz, Drive bays, HS

Cisco UCS VIC1340 Converged Network Adapter

The Cisco UCS Virtual Interface Card (VIC) 1340 (Figure 13) is a 2-port 40-Gbps Ethernet or dual 4 x 10-Gbps Ethernet, Fibre Channel over Ethernet (FCoE)-capable modular LAN on motherboard (mLOM) designed exclusively for the M5 generation of Cisco UCS B-Series Blade Servers. When used in combination with an optional port expander, the Cisco UCS VIC 1340 capabilities is enabled for two ports of 40-Gbps Ethernet.

The Cisco UCS VIC 1340 enables a policy-based, stateless, agile server infrastructure that can present over 256 PCIe standards-compliant interfaces to the host that can be dynamically configured as either network interface cards (NICs) or host bus adapters (HBAs). In addition, the Cisco UCS VIC 1340 supports Cisco® Data Center Virtual Machine Fabric Extender (VM-FEX) technology, which extends the Cisco UCS fabric interconnect ports to virtual machines, simplifying server virtualization deployment and management.

Figure 13 Cisco UCS VIC 1340

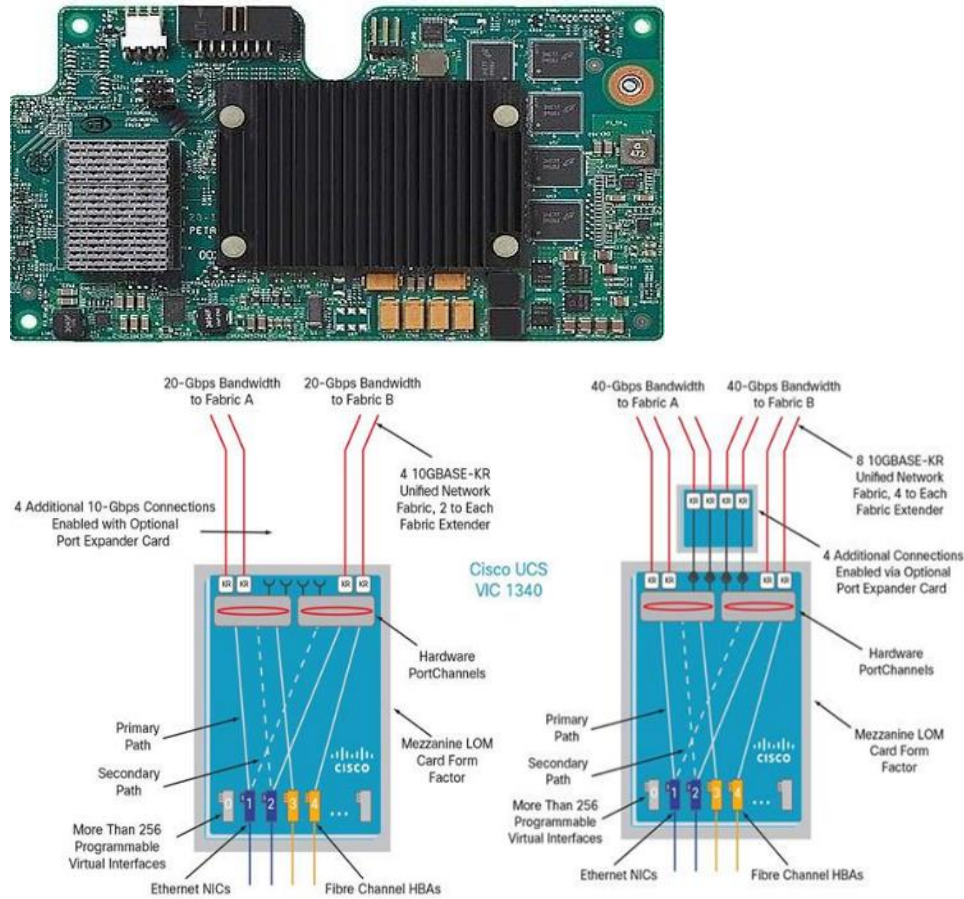

Figure 13 illustrates the Cisco UCS VIC 1340 Virtual Interface Cards Deployed in the Cisco UCS B-Series B200 M5 Blade Servers.

Cisco Switching

Cisco Nexus 93180YC-FX Switches

The 93180YC-EX Switch provides a flexible line-rate Layer 2 and Layer 3 feature set in a compact form factor. Designed with Cisco Cloud Scale technology, it supports highly scalable cloud architectures. With the option to operate in Cisco NX-OS or Application Centric Infrastructure (ACI) mode, it can be deployed across enterprise, service provider, and Web 2.0 data centers.

- Architectural Flexibility
 - Includes top-of-rack or middle-of-row fiber-based server access connectivity for traditional and leaf-spine architectures

- Leaf node support for Cisco ACI architecture is provided in the roadmap
- Increase scale and simplify management through Cisco Nexus 2000 Fabric Extender support
- Feature Rich
 - Enhanced Cisco NX-OS Software is designed for performance, resiliency, scalability, manageability, and programmability
 - ACI-ready infrastructure helps users take advantage of automated policy-based systems management
 - Virtual Extensible LAN (VXLAN) routing provides network services
 - Rich traffic flow telemetry with line-rate data collection
 - Real-time buffer utilization per port and per queue, for monitoring traffic micro-bursts and application traffic patterns
- Highly Available and Efficient Design
 - High-density, non-blocking architecture
 - Easily deployed into either a hot-aisle and cold-aisle configuration
 - Redundant, hot-swappable power supplies and fan trays
- Simplified Operations
 - Power-On Auto Provisioning (POAP) support allows for simplified software upgrades and configuration file installation
 - An intelligent API offers switch management through remote procedure calls (RPCs, JSON, or XML) over a HTTP/HTTPS infrastructure
 - Python Scripting for programmatic access to the switch command-line interface (CLI)
 - Hot and cold patching, and online diagnostics
- Investment Protection

A Cisco 40 Gb [bidirectional transceiver](#) allows reuse of an existing 10 Gigabit Ethernet multimode cabling plant for 40 Gigabit Ethernet Support for 1 Gb and 10 Gb access connectivity for data centers migrating access switching infrastructure to faster speed. The following is supported:

- 1.8 Tbps of bandwidth in a 1 RU form factor
- 48 fixed 1/10/25-Gbps SFP+ ports
- 6 fixed 40/100-Gbps QSFP+ for uplink connectivity
- Latency of less than 2 microseconds
- Front-to-back or back-to-front airflow configurations
- 1+1 redundant hot-swappable 80 Plus Platinum-certified power supplies
- Hot swappable 3+1 redundant fan trays

Figure 14 Cisco Nexus 93180YC-EX Switch

Cisco MDS 9132T 32-Gbps Fiber Channel Switch

The next-generation Cisco® MDS 9132T 32-Gbps 32-Port Fibre Channel Switch (Figure 15) provides high-speed Fibre Channel connectivity from the server rack to the SAN core. It empowers small, midsize, and large enterprises that are rapidly deploying cloud-scale applications using extremely dense virtualized servers, providing the dual benefits of greater bandwidth and consolidation.

Small-scale SAN architectures can be built from the foundation using this low-cost, low-power, non-blocking, line-rate, and low-latency, bi-directional airflow capable, fixed standalone SAN switch connecting both storage and host ports.

Medium-size to large-scale SAN architectures built with SAN core directors can expand 32-Gbps connectivity to the server rack using these switches either in switch mode or Network Port Virtualization (NPV) mode.

Additionally, investing in this switch for the lower-speed (4- or 8- or 16-Gbps) server rack gives you the option to upgrade to 32-Gbps server connectivity in the future using the 32-Gbps Host Bus Adapter (HBA) that are available today. The Cisco® MDS 9132T 32-Gbps 32-Port Fibre Channel switch also provides unmatched flexibility through a unique port expansion module (Figure 16) that provides a robust cost-effective, field swappable, port upgrade option.

This switch also offers state-of-the-art SAN analytics and telemetry capabilities that have been built into this next-generation hardware platform. This new state-of-the-art technology couples the next-generation port ASIC with a fully dedicated Network Processing Unit designed to complete analytics calculations in real time. The telemetry data extracted from the inspection of the frame headers are calculated on board (within the switch) and, using an industry-leading open format, can be streamed to any analytics-visualization platform. This switch also includes a dedicated 10/100/1000BASE-T telemetry port to maximize data delivery to any telemetry receiver including Cisco Data Center Network Manager.

Figure 15 Cisco 9132T 32-Gbps MDS Fibre Channel Switch**Figure 16 Cisco MDS 9132T 32-Gbps 16-Port Fibre Channel Port Expansion Module**

- Features
 - High performance: MDS 9132T architecture, with chip-integrated nonblocking arbitration, provides consistent 32-Gbps low-latency performance across all traffic conditions for every Fibre Channel port on the switch.

- Capital Expenditure (CapEx) savings: The 32-Gbps ports allow users to deploy them on existing 16- or 8-Gbps transceivers, reducing initial CapEx with an option to upgrade to 32-Gbps transceivers and adapters in the future.
- High availability: MDS 9132T switches continue to provide the same outstanding availability and reliability as the previous-generation Cisco MDS 9000 Family switches by providing optional redundancy on all major components such as the power supply and fan. Dual power supplies also facilitate redundant power grids.
- Pay-as-you-grow: The MDS 9132T Fibre Channel switch provides an option to deploy as few as eight 32-Gbps Fibre Channel ports in the entry-level variant, which can grow by 8 ports to 16 ports, and thereafter with a port expansion module with sixteen 32-Gbps ports, to up to 32 ports. This approach results in lower initial investment and power consumption for entry-level configurations of up to 16 ports compared to a fully loaded switch. Upgrading through an expansion module also reduces the overhead of managing multiple instances of port activation licenses on the switch. This unique combination of port upgrade options allow four possible configurations of 8 ports, 16 ports, 24 ports and 32 ports.
- Next-generation Application-Specific Integrated Circuit (ASIC): The MDS 9132T Fibre Channel switch is powered by the same high-performance 32-Gbps Cisco ASIC with an integrated network processor that powers the Cisco MDS 9700 48-Port 32-Gbps Fibre Channel Switching Module. Among all the advanced features that this ASIC enables, one of the most notable is inspection of Fibre Channel and Small Computer System Interface (SCSI) headers at wire speed on every flow in the smallest form-factor Fibre Channel switch without the need for any external taps or appliances. The recorded flows can be analyzed on the switch and also exported using a dedicated 10/100/1000BASE-T port for telemetry and analytics purposes.
- Intelligent network services: Slow-drain detection and isolation, VSAN technology, Access Control Lists (ACLs) for hardware-based intelligent frame processing, smartzoning and fabric wide Quality of Service (QoS) enable migration from SAN islands to enterprise wide storage networks. Traffic encryption is optionally available to meet stringent security requirements.
- Sophisticated diagnostics: The MDS 9132T provides intelligent diagnostics tools such as Inter-Switch Link (ISL) diagnostics, read diagnostic parameters, protocol decoding, network analysis tools, and integrated Cisco Call Home capability for greater reliability, faster problem resolution, and reduced service costs.
- Virtual machine awareness: The MDS 9132T provides visibility into all virtual machines logged into the fabric. This feature is available through HBAs capable of priority tagging the Virtual Machine Identifier (VMID) on every FC frame. Virtual machine awareness can be extended to intelligent fabric services such as analytics[1] to visualize performance of every flow originating from each virtual machine in the fabric.
- Programmable fabric: The MDS 9132T provides powerful Representational State Transfer (REST) and Cisco NX-API capabilities to enable flexible and rapid programming of utilities for the SAN as well as polling point-in-time telemetry data from any external tool.
- Single-pane management: The MDS 9132T can be provisioned, managed, monitored, and troubleshoot using Cisco Data Center Network Manager (DCNM), which currently manages the entire suite of Cisco data center products.
- Self-contained advanced anticounterfeiting technology: The MDS 9132T uses on-board hardware that protects the entire system from malicious attacks by securing access to critical components such as the bootloader, system image loader and Joint Test Action Group (JTAG) interface.

Hypervisor

This Cisco Validated Design includes VMware vSphere 6.7 Update 1.

VMware vSphere 6.7

VMware provides virtualization software. VMware's enterprise software hypervisors for servers VMware vSphere ESX, vSphere ESXi, and vSphere—are bare-metal hypervisors that run directly on server hardware without requiring an additional underlying operating system. VMware vCenter Server for vSphere provides central management and complete control and visibility into clusters, hosts, virtual machines, storage, networking, and other critical elements of your virtual infrastructure.

VMware vSphere 6.7 introduces many enhancements to vSphere Hypervisor, VMware virtual machines, vCenter Server, virtual storage, and virtual networking, further extending the core capabilities of the vSphere platform.

Now VMware announced vSphere 6.7, which is one of the most feature rich releases of vSphere in quite some time. The vCenter Server Appliance is taking charge in this release with several new features which we'll cover in this blog article. For starters, the installer has gotten an overhaul with a new modern look and feel. Users of both Linux and Mac will also be ecstatic since the installer is now supported on those platforms along with Microsoft Windows. If that wasn't enough, the vCenter Server Appliance now has features that are exclusive such as:

- Migration
- Improved Appliance Management
- VMware Update Manager
- Native High Availability
- Built-in Backup / Restore

VMware vSphere Client

With VMware vSphere 6.7, a fully supported version of the HTML5-based vSphere Client that will run alongside the vSphere Web Client. The vSphere Client is built into vCenter Server 6.7 (both Windows and Appliance) and is enabled by default. While the HTML-5 based vSphere Client does not have full feature parity, the team has prioritized many of the day-to-day tasks of administrators and continue to seek feedback on items that will enable customers to use it full time. The vSphere Web Client continues to be accessible through "http://<vcenter_fqdn>/vsphere-client" while the vSphere Client is reachable through "http://<vcenter_fqdn>/ui". VMware is periodically updating the vSphere Client outside of the normal vCenter Server release cycle. To make sure it is easy and simple for customers to stay up to date the vSphere Client will be able to be updated without any effects to the rest of vCenter Server.

Some of the benefits of the new vSphere Client:

- Clean, consistent UI built on VMware's new Clarity UI standards (to be adopted across our portfolio)
- Built on HTML5 so it is truly a cross-browser and cross-platform application
- No browser plugins to install/manage
- Integrated into vCenter Server for 6.7 and fully supported
- Fully supports Enhanced Linked Mode

- Users of the Fling have been extremely positive about its performance

VMware ESXi 6.7 Hypervisor

VMware vSphere 6.7 introduces the following new features in the hypervisor:

- Scalability Improvements
 - ESXi 6.7 dramatically increases the scalability of the platform. With vSphere Hypervisor 6.0, clusters can scale to as many as 64 hosts, up from 32 in previous releases. With 64 hosts in a cluster, vSphere 6.0 can support 8000 virtual machines in a single cluster. This capability enables greater consolidation ratios, more efficient use of VMware vSphere Distributed Resource Scheduler (DRS), and fewer clusters that must be separately managed. Each vSphere Hypervisor 6.7 instance can support up to 480 logical CPUs, 12 terabytes (TB) of RAM, and 1024 virtual machines. By using the newest hardware advances, ESXi 6.7 enables the virtualization of applications that previously had been thought to be non-virtualizable.
- ESXi 6.7 Security Enhancements
 - Account management: ESXi 6.7 enables management of local accounts on the ESXi server using new ESXi CLI commands. The capability to add, list, remove, and modify accounts across all hosts in a cluster can be centrally managed using a vCenter Server system. Previously, the account and permission management functions for ESXi hosts were available only for direct host connections. The setup, removal, and listing of local permissions on ESXi servers can also be centrally managed.
 - Account lockout: ESXi Host Advanced System Settings have two new options for the management of failed local account login attempts and account lockout duration. These parameters affect Secure Shell (SSH) and vSphere Web Services connections, but not ESXi direct console user interface (DCUI) or console shell access.
 - Password complexity rules: In previous versions of ESXi, password complexity changes had to be made by manually editing the `/etc/pam.d/passwd` file on each ESXi host. In vSphere 6.0, an entry in Host Advanced System Settings enables changes to be centrally managed for all hosts in a cluster.
 - Improved auditability of ESXi administrator actions: Prior to vSphere 6.0, actions at the vCenter Server level by a named user appeared in ESXi logs with the vpxuser username: for example, `[user=vpxuser]`. In vSphere 6.7, all actions at the vCenter Server level for an ESXi server appear in the ESXi logs with the vCenter Server username: for example, `[user=vpxuser: DOMAIN\User]`. This approach provides a better audit trail for actions run on a vCenter Server instance that conducted corresponding tasks on the ESXi hosts.
 - Flexible lockdown modes: Prior to vSphere 6.7, only one lockdown mode was available. Feedback from customers indicated that this lockdown mode was inflexible in some use cases. With vSphere 6.7, two lockdown modes are available:
 - In normal lockdown mode, DCUI access is not stopped, and users on the DCUI access list can access the DCUI.
 - In strict lockdown mode, the DCUI is stopped.
 - Exception users: vSphere 6.0 offers a new function called exception users. Exception users are local accounts or Microsoft Active Directory accounts with permissions defined locally on the host to which these users have host access. These exception users are not recommended for general user accounts, but they are recommended for use by third-party applications—for service accounts, for example—that need host access when either normal or strict lockdown mode is enabled. Per-

- missions on these accounts should be set to the bare minimum required for the application to perform its task and with an account that needs only read-only permissions on the ESXi host.
- Smart card authentication to DCUI: This function is for U.S. federal customers only. It enables DCUI login access using a Common Access Card (CAC) and Personal Identity Verification (PIV). The ESXi host must be part of an Active Directory domain.

Desktop Broker

This Cisco Validated Design includes Citrix XenDesktop 7.15 LTSR.

Citrix XenDesktop 7.15

Enterprise IT organizations are tasked with the challenge of provisioning Microsoft Windows apps and desktops while managing cost, centralizing control, and enforcing the corporate security policy. Deploying Windows apps to users in any location, regardless of the device type and available network bandwidth, enables a mobile workforce that can improve productivity. With Citrix XenDesktop 7.15, IT can effectively control app and desktop provisioning while securing data assets and lowering capital and operating expenses.

The XenDesktop 7.15 release offers these benefits:

- Comprehensive virtual desktop delivery for any use case. The XenDesktop 7.15 release incorporates the full power of XenApp, delivering full desktops or just applications to users. Administrators can deploy both XenApp published applications and desktops (to maximize IT control at low cost) or personalized VDI desktops (with simplified image management) from the same management console. Citrix XenDesktop 7.15 leverages common policies and cohesive tools to govern both infrastructure resources and user access.
- Simplified support and choice of BYO (Bring Your Own) devices. XenDesktop 7.15 brings thousands of corporate Microsoft Windows-based applications to mobile devices with a native-touch experience and optimized performance. HDX technologies create a “high definition” user experience, even for graphics intensive design and engineering applications.
- Lower cost and complexity of application and desktop management. XenDesktop 7.15 helps IT organizations take advantage of agile and cost-effective cloud offerings, allowing the virtualized infrastructure to flex and meet seasonal demands or the need for sudden capacity changes. IT organizations can deploy XenDesktop application and desktop workloads to private or public clouds.
- Protection of sensitive information through centralization. XenDesktop decreases the risk of corporate data loss, enabling access while securing intellectual property and centralizing applications since assets reside in the data center.
- Virtual Delivery Agent improvements. Universal print server and driver enhancements and support for the HDX 3D Pro graphics acceleration for Windows 10 are key additions in XenDesktop 7.15.
- Improved high-definition user experience. XenDesktop 7.15 continues the evolutionary display protocol leadership with enhanced Thinwire display remoting protocol and Framehawk support for HDX 3D Pro.

Citrix XenApp and XenDesktop are application and desktop virtualization solutions built on a unified architecture so they're simple to manage and flexible enough to meet the needs of all your organization's users. XenApp and XenDesktop have a common set of management tools that simplify and automate IT tasks. You use the same architecture and management tools to manage public, private, and hybrid cloud deployments as you do for on premises deployments.

Citrix XenApp delivers:

- XenApp published apps, also known as server-based hosted applications: These are applications hosted from Microsoft Windows servers to any type of device, including Windows PCs, Macs, smartphones, and tablets. Some XenApp editions include technologies that further optimize the experience of using Windows applications on a mobile device by automatically translating native mobile-device display, navigation, and controls to Windows applications; enhancing performance over mobile networks; and enabling developers to optimize any custom Windows application for any mobile environment.
- XenApp published desktops, also known as server-hosted desktops: These are inexpensive, locked-down Windows virtual desktops hosted from Windows server operating systems. They are well suited for users, such as call center employees, who perform a standard set of tasks.
- Virtual machine-hosted apps: These are applications hosted from machines running Windows desktop operating systems for applications that can't be hosted in a server environment.
- Windows applications delivered with Microsoft App-V: These applications use the same management tools that you use for the rest of your XenApp deployment.
- Citrix XenDesktop: Includes significant enhancements to help customers deliver Windows apps and desktops as mobile services while addressing management complexity and associated costs. Enhancements in this release include:
- Unified product architecture for XenApp and XenDesktop: The FlexCast Management Architecture (FMA). This release supplies a single set of administrative interfaces to deliver both hosted-shared applications (RDS) and complete virtual desktops (VDI). Unlike earlier releases that separately provisioned Citrix XenApp and XenDesktop farms, the XenDesktop 7.15 release allows administrators to deploy a single infrastructure and use a consistent set of tools to manage mixed application and desktop workloads.
- Support for extending deployments to the cloud. This release provides the ability for hybrid cloud provisioning from Microsoft Azure, Amazon Web Services (AWS) or any Cloud Platform-powered public or private cloud. Cloud deployments are configured, managed, and monitored through the same administrative consoles as deployments on traditional on-premises infrastructure.

Citrix XenDesktop delivers:

- VDI desktops: These virtual desktops each run a Microsoft Windows desktop operating system rather than running in a shared, server-based environment. They can provide users with their own desktops that they can fully personalize.
- Hosted physical desktops: This solution is well suited for providing secure access to powerful physical machines, such as blade servers, from within your data center.
- Remote PC access: This solution allows users to log in to their physical Windows PC from anywhere over a secure XenDesktop connection.
- Server VDI: This solution is designed to provide hosted desktops in multitenant, cloud environments.
- Capabilities that allow users to continue to use their virtual desktops: These capabilities let users continue to work while not connected to your network.

This product release includes the following new and enhanced features:



Some XenDesktop editions include the features available in XenApp.

Zones

Deployments that span widely-dispersed locations connected by a WAN can face challenges due to network latency and reliability. Configuring zones can help users in remote regions connect to local resources without forcing connections to traverse large segments of the WAN. Using zones allows effective Site management from a single Citrix Studio console, Citrix Director, and the Site database. This saves the costs of deploying, staffing, licensing, and maintaining additional Sites containing separate databases in remote locations.

Zones can be helpful in deployments of all sizes. You can use zones to keep applications and desktops closer to end users, which improves performance.

For more information, see the [Zones](#) article.

Improved Database Flow and Configuration

When you configure the databases during Site creation, you can now specify separate locations for the Site, Logging, and Monitoring databases. Later, you can specify different locations for all three databases. In previous releases, all three databases were created at the same address, and you could not specify a different address for the Site database later.

You can now add more Delivery Controllers when you create a Site, as well as later. In previous releases, you could add more Controllers only after you created the Site.

For more information, see the [Databases](#) and [Controllers](#) articles.

Application Limits

Configure application limits to help manage application use. For example, you can use application limits to manage the number of users accessing an application simultaneously. Similarly, application limits can be used to manage the number of simultaneous instances of resource-intensive applications, this can help maintain server performance and prevent deterioration in service.

For more information, see the [Manage applications](#) article.

Multiple Notifications before Machine Updates or Scheduled Restarts

You can now choose to repeat a notification message that is sent to affected machines before the following types of actions begin:

- Updating machines in a Machine Catalog using a new master image
- Restarting machines in a Delivery Group according to a configured schedule

If you indicate that the first message should be sent to each affected machine 15 minutes before the update or restart begins, you can also specify that the message is repeated every five minutes until the update/restart begins.

For more information, see the [Manage Machine Catalogs](#) and [Manage Delivery Groups](#) articles.

API Support for Managing Session Roaming

By default, sessions roam between client devices with the user. When the user launches a session and then moves to another device, the same session is used, and applications are available on both devices. The applications follow, regardless of the device or whether current sessions exist. Similarly, printers and other resources assigned to the application follow.

 You can now use the PowerShell SDK to tailor session roaming. This was an experimental feature in the previous release.

For more information, see the [Sessions](#) article.

API Support for Provisioning Virtual Machines from Hypervisor Templates

When using the PowerShell SDK to create or update a Machine Catalog, you can now select a template from other hypervisor connections. This is in addition to the currently-available choices of virtual machine images and snapshots.

Support for New and Additional Platforms

 See the [System requirements](#) article for full support information. Information about support for third-party product versions is updated periodically.

By default, SQL Server 2014 SP2 Express is installed when installing the Controller, if an existing supported SQL Server installation is not detected.

You can install Studio or VDAs for Windows Desktop OS on machines running Windows 10.

You can create connections to Microsoft Azure virtualization resources.

Figure 17 Logical Architecture of Citrix XenDesktop

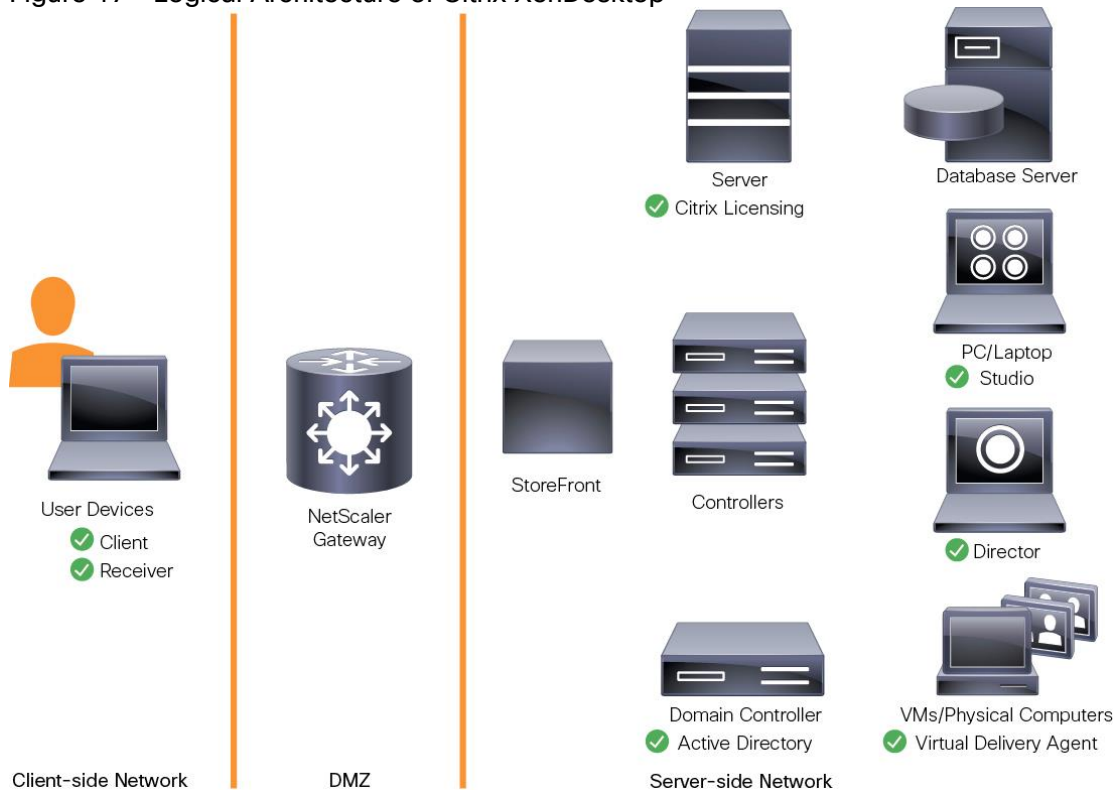

Citrix Provisioning Services 7.15

Most enterprises struggle to keep up with the proliferation and management of computers in their environments. Each computer, whether it is a desktop PC, a server in a data center, or a kiosk-type device, must be managed as an individual entity. The benefits of distributed processing come at the cost of distributed management. It costs time and money to set up, update, support, and ultimately decommission each computer. The initial cost of the machine is often dwarfed by operating costs.

Citrix PVS takes a very different approach from traditional imaging solutions by fundamentally changing the relationship between hardware and the software that runs on it. By streaming a single shared disk image (vDisk) rather than copying images to individual machines, PVS enables organizations to reduce the number of disk images that they manage, even as the number of machines continues to grow, simultaneously providing the efficiency of centralized management and the benefits of distributed processing.

In addition, because machines are streaming disk data dynamically and in real time from a single shared image, machine image consistency is essentially ensured. At the same time, the configuration, applications, and even the OS of large pools of machines can be completely changed in the time it takes the machines to reboot.

Using PVS, any vDisk can be configured in standard-image mode. A vDisk in standard-image mode allows many computers to boot from it simultaneously, greatly reducing the number of images that must be maintained and the amount of storage that is required. The vDisk is in read-only format, and the image cannot be changed by target devices.

Benefits for Citrix XenApp and Other Server Farm Administrators

If you manage a pool of servers that work as a farm, such as Citrix XenApp servers or web servers, maintaining a uniform patch level on your servers can be difficult and time consuming. With traditional imaging solutions, you start with a clean golden master image, but as soon as a server is built with the master image, you must patch that individual server along with all the other individual servers. Rolling out patches to individual servers in your farm is not only inefficient, but the results can also be unreliable. Patches often fail on an individual server, and you may not realize you have a problem until users start complaining or the server has an outage. After that happens, getting the server resynchronized with the rest of the farm can be challenging, and sometimes a full reimaging of the machine is required.

With Citrix PVS, patch management for server farms is simple and reliable. You start by managing your golden image, and you continue to manage that single golden image. All patching is performed in one place and then streamed to your servers when they boot. Server build consistency is assured because all your servers use a single shared copy of the disk image. If a server becomes corrupted, simply reboot it, and it is instantly back to the known good state of your master image. Upgrades are extremely fast to implement. After you have your updated image ready for production, you simply assign the new image version to the servers and reboot them. You can deploy the new image to any number of servers in the time it takes them to reboot. Just as important, rollback can be performed in the same way, so problems with new images do not need to take your servers or your users out of commission for an extended period of time.

Benefits for Desktop Administrators

Because Citrix PVS is part of Citrix XenDesktop, desktop administrators can use PVS's streaming technology to simplify, consolidate, and reduce the costs of both physical and virtual desktop delivery. Many organizations are beginning to explore desktop virtualization. Although virtualization addresses many of IT's needs for consolidation and simplified management, deploying it also requires the deployment of supporting infrastructure. Without PVS, storage costs can make desktop virtualization too costly for the IT budget. However, with PVS, IT can reduce the amount of storage required for VDI by as much as 90 percent. And with a single image to manage instead of

hundreds or thousands of desktops, PVS significantly reduces the cost, effort, and complexity for desktop administration.

Different types of workers across the enterprise need different types of desktops. Some require simplicity and standardization, and others require high performance and personalization. XenDesktop can meet these requirements in a single solution using Citrix FlexCast delivery technology. With FlexCast, IT can deliver every type of virtual desktop, each specifically tailored to meet the performance, security, and flexibility requirements of each individual user.

Not all desktops applications can be supported by virtual desktops. For these scenarios, IT can still reap the benefits of consolidation and single-image management. Desktop images are stored and managed centrally in the data center and streamed to physical desktops on demand. This model works particularly well for standardized desktops such as those in lab and training environments and call centers and thin-client devices used to access virtual desktops.

Citrix Provisioning Services Solution

Citrix PVS streaming technology allows computers to be provisioned and re-provisioned in real time from a single shared disk image. With this approach, administrators can completely eliminate the need to manage and patch individual systems. Instead, all image management is performed on the master image. The local hard drive of each system can be used for runtime data caching or, in some scenarios, removed from the system entirely, which reduces power use, system failure rate, and security risk.

The PVS solution's infrastructure is based on software-streaming technology. After PVS components are installed and configured, a vDisk is created from a device's hard drive by taking a snapshot of the OS and application image and then storing that image as a vDisk file on the network. A device used for this process is referred to as a master target device. The devices that use the vDisks are called target devices. vDisks can exist on a PVS, file share, or in larger deployments, on a storage system with which PVS can communicate (iSCSI, SAN, network-attached storage [NAS], and Common Internet File System [CIFS]). vDisks can be assigned to a single target device in private-image mode, or to multiple target devices in standard-image mode.

Citrix Provisioning Services Infrastructure

The Citrix PVS infrastructure design directly relates to administrative roles within a PVS farm. The PVS administrator role determines which components that an administrator can manage or view in the console.

A PVS farm contains several components. Figure 18 provides a high-level view of a basic PVS infrastructure and shows how PVS components might appear within that implementation.

Figure 18 Logical Architecture of Citrix Provisioning Services

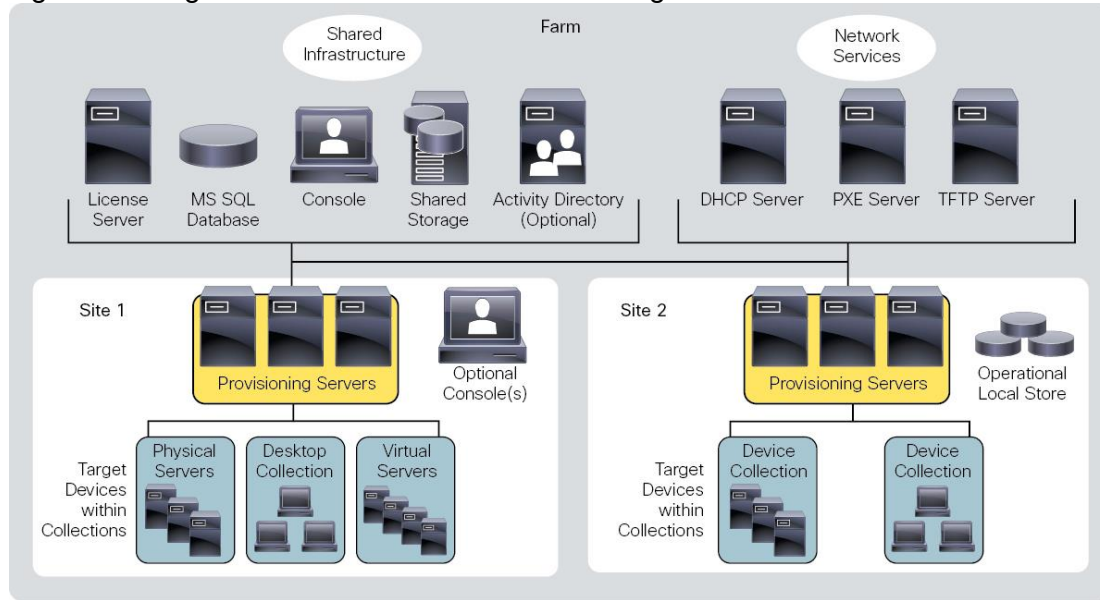

The following new features are available with Provisioning Services 7.15:

- Linux streaming
- XenServer proxy using PVS-Accelerator

Purity for FlashArray (Purity//FA 5)

At the heart of every FlashArray is Purity Operating Environment software. Purity//FA5 implements advanced data reduction, storage management, and flash management features, enabling organizations to enjoy Tier 1 data services for all workloads, proven 99.9999% availability over two years (inclusive of maintenance and generational upgrades), completely non-disruptive operations, 2X better data reduction versus alternative all-flash solutions, and – with FlashArray//X – the power and efficiency of DirectFlash™. Moreover, Purity includes enterprise-grade data security, comprehensive data protection options, and complete business continuity through ActiveCluster multi-site stretch cluster. All these features are included with every array.

FlashArray//X Specifications

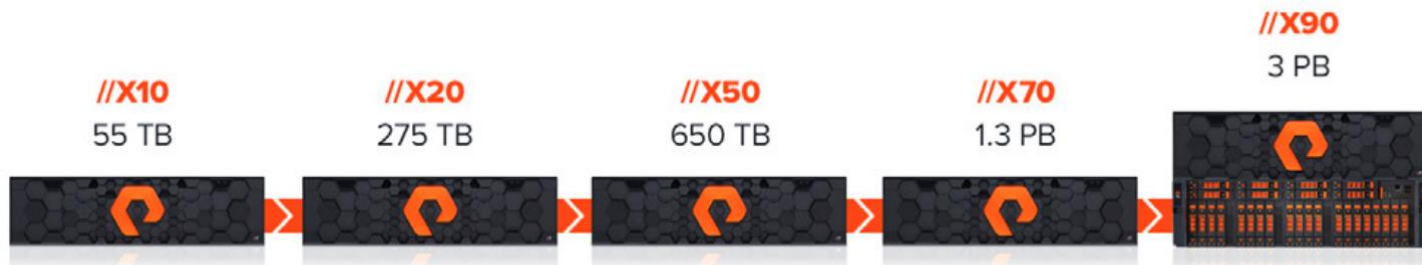

	CAPACITY	PHYSICAL	//X CONNECTIVITY
//X10	Up to 55 TB / 53.5 TiB effective capacity** Up to 20 TB / 18.6 TiB raw capacity	3U 490 – 600 Watts (nominal – peak) 95 lbs (43.1 kg) fully loaded 5.12" x 18.94" x 29.72" chassis	Onboard Ports (per controller) <ul style="list-style-type: none"> • 2 x 1/10/25 Gb Ethernet • 2 x 1/10/25 Gb Ethernet Replication • 2 x 1Gb Management Ports Host I/O Cards (3 slots/controller) <ul style="list-style-type: none"> • 2-port 10GBase-T Ethernet • 2-port 1/10/25 Gb Ethernet • 2-port 40 Gb Ethernet • 2 Port 50Gb Ethernet (NVMe-oF Ready)*** • 2-port 16/32 Gb Fibre Channel (NVMe-oF Ready) • 4-port 16/32 Gb Fibre Channel (NVMe-oF Ready)
//X20	Up to 275 TB / 251.8 TiB effective capacity** Up to 87 TB / 80.3 TiB raw capacity††	3U 620 – 688 Watts (nominal – peak) 95 lbs (43.1 kg) fully loaded 5.12" x 18.94" x 29.72" chassis	
//X50	Up to 650 TB / 602.8 TiB effective capacity** Up to 183 TB / 171 TiB raw capacity†	3U 620 – 760 Watts (nominal – peak) 95 lbs (43.1 kg) fully loaded 5.12" x 18.94" x 29.72" chassis	
//X70	Up to 1.3 PB / 1238.5 TiB effective capacity** Up to 366 TB / 320.1 TiB raw capacity†	3U 915 – 1345 Watts (nominal – peak) 97 lbs (44.0 kg) fully loaded 5.12" x 18.94" x 29.72" chassis	
//X90	Up to 3 PB / 3003.1 TiB effective capacity** Up to 878 TB / 768.3 TiB raw capacity†	3U – 6U 1100 – 1570 Watts (nominal – peak) 97 lbs (44 kg) fully loaded 5.12" x 18.94" x 29.72" chassis	
DIRECT FLASH SHELF	Up to 1.9 PB effective capacity** Up to 512 TB / 448.2 TiB raw capacity	3U 460 - 500 Watts (nominal – peak) 87.7 lbs (39.8kg) fully loaded 5.12" x 18.94" x 29.72" chassis	

* Stated //X specifications are applicable to //X R2 versions.

** Effective capacity assumes HA, RAID, and metadata overhead, GB-to-GiB conversion, and includes the benefit of data reduction with always-on inline deduplication, compression, and pattern removal. Average data reduction is calculated at 5-to-1 and does not include thin provisioning or snapshots.

*** FlashArray //X currently supports NVMe-oF through RoCEv2 with a roadmap for FC-NVMe and TCP-NVMe.

Evergreen™ Storage

Customers can deploy storage once and enjoy a subscription to continuous innovation through Pure's Evergreen Storage ownership model: expand and improve performance, capacity, density, and/or features for 10 years or more – all without downtime, performance impact, or data migrations. Pure has disrupted the industry's 3-5-year rip-and-replace cycle by engineering compatibility for future technologies right into its products, notably with the NVMe-Ready Guarantee for //M and online upgrade from any //M to //X.

7 YEARS OF NON-DISRUPTIVE **EVERGREEN** IMPROVEMENTS

176x

Capacity Increase

146x

Density Increase

13x

IOPs

5x

Throughput

7

HW Generations

\$0

Wasted Investment

FA-320, FA-420,
FA-450



2012-14

//M50



2015

//M70



2016

//X70



2017

//X90



2018

Pure1®

Pure1, our cloud-based management, analytics, and support platform, expands the self-managing, plug-n-play design of Pure all-flash arrays with the machine learning predictive analytics and continuous scanning of Pure1 Meta™ to enable an effortless, worry-free data platform.

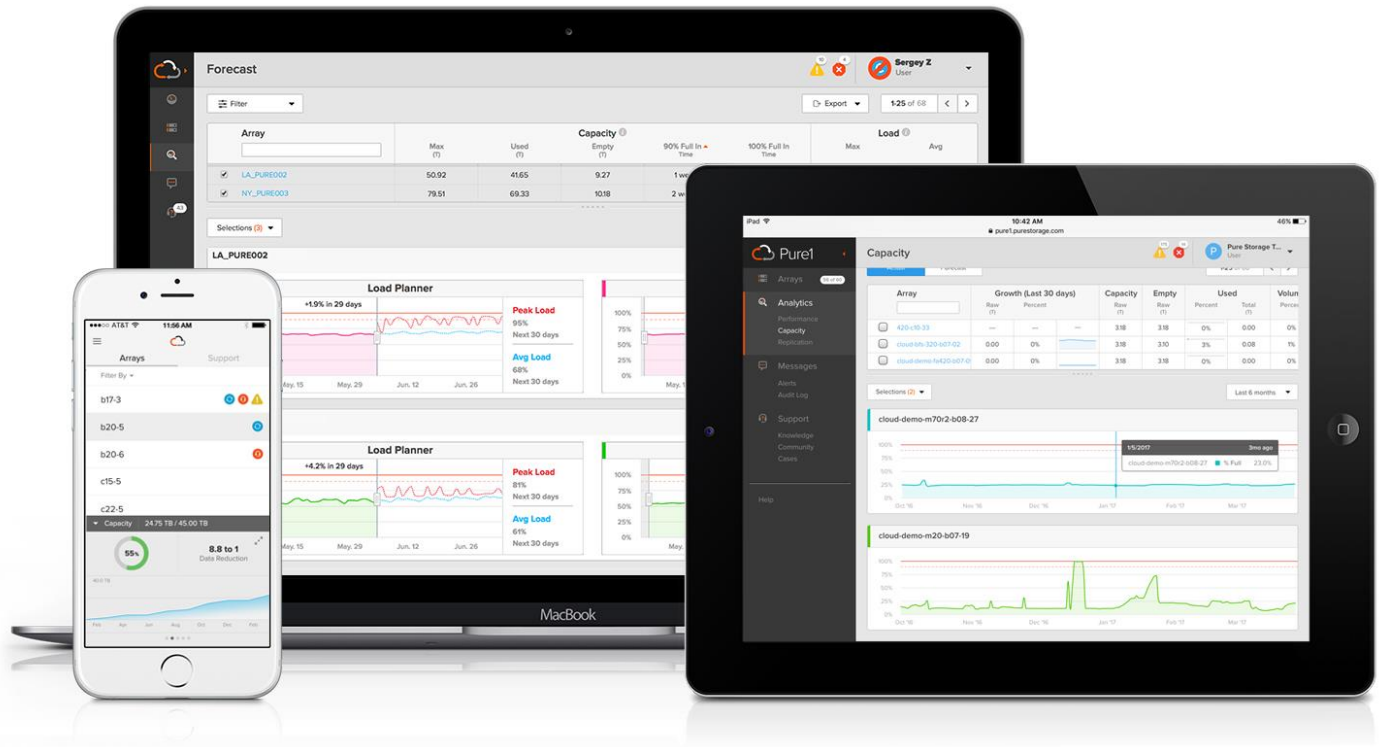

Pure1 Manage

In the Cloud IT operating model, installing and deploying management software is an oxymoron: you simply login. Pure1 Manage is SaaS-based, allowing you to manage your array from any browser or from the Pure1 Mobile App – with nothing extra to purchase, deploy, or maintain. From a single dashboard you can manage all your arrays, with full visibility on the health and performance of your storage.

Pure1 Analyze

Pure1 Analyze delivers true performance forecasting – giving customers complete visibility into the performance and capacity needs of their arrays – now and in the future. Performance forecasting enables intelligent consolidation and unprecedented workload optimization.

Pure1 Support

Pure combines an ultra-proactive support team with the predictive intelligence of Pure1 Meta to deliver unrivaled support that's a key component in our proven FlashArray 99.9999% availability. Customers are often surprised and delighted when we fix issues they did not even know existed.

Pure1 META

The foundation of Pure1 services, Pure1 Meta is global intelligence built from a massive collection of storage array health and performance data. By continuously scanning call-home telemetry from Pure's installed base, Pure1 Meta uses machine learning predictive analytics to help resolve potential issues and optimize workloads. The result is both a white glove customer support experience and breakthrough capabilities like accurate performance forecasting.

Meta is always expanding and refining what it knows about array performance and health, moving the Data Platform toward a future of self-driving storage.

Architecture and Design Considerations for Desktop Virtualization

There are many reasons to consider a virtual desktop solution such as an ever growing and diverse base of user devices, complexity in management of traditional desktops, security, and even Bring Your Own Device (BYOD) to work programs. The first step in designing a virtual desktop solution is to understand the user community and the type of tasks that are required to successfully execute their role. The following user classifications are provided:

- Knowledge Workers today do not just work in their offices all day – they attend meetings, visit branch offices, work from home, and even coffee shops. These anywhere workers expect access to all of their same applications and data wherever they are.
- External Contractors are increasingly part of your everyday business. They need access to certain portions of your applications and data, yet administrators still have little control over the devices they use and the locations they work from. Consequently, IT is stuck making trade-offs on the cost of providing these workers a device vs. the security risk of allowing them access from their own devices.
- Task Workers perform a set of well-defined tasks. These workers access a small set of applications and have limited requirements from their PCs. However, since these workers are interacting with your customers, partners, and employees, they have access to your most critical data.
- Mobile Workers need access to their virtual desktop from everywhere, regardless of their ability to connect to a network. In addition, these workers expect the ability to personalize their PCs, by installing their own applications and storing their own data, such as photos and music, on these devices.
- Shared Workstation users are often found in state-of-the-art university and business computer labs, conference rooms or training centers. Shared workstation environments have the constant requirement to re-provision desktops with the latest operating systems and applications as the needs of the organization change, tops the list.

After the user classifications have been identified and the business requirements for each user classification have been defined, it becomes essential to evaluate the types of virtual desktops that are needed based on user requirements. There are essentially five potential desktops environments for each user:

- Traditional PC: A traditional PC is what typically constitutes a desktop environment: physical device with a locally installed operating system.
- Hosted Shared Desktop: A hosted, server-based desktop is a desktop where the user interacts through a delivery protocol. With hosted, server-based desktops, a single installed instance of a server operating system, such as Microsoft Windows Server 2016, is shared by multiple users simultaneously. Each user receives a desktop "session" and works in an isolated memory space. Remoted Desktop Server Hosted Server sessions: A hosted virtual desktop is a virtual desktop running on a virtualization layer (ESX). The user does not work with and sit in front of the desktop, but instead the user interacts through a delivery protocol.
- Published Applications: Published applications run entirely on the Citrix XenApp server virtual machines and the user interacts through a delivery protocol. With published applications, a single installed instance of an application, such as Microsoft Office, is shared by multiple users simultaneously. Each user receives an application "session" and works in an isolated memory space.
- Streamed Applications: Streamed desktops and applications run entirely on the user's local client device and are sent from a server on demand. The user interacts with the application or desktop directly, but the resources may only available while they are connected to the network.

- Local Virtual Desktop: A local virtual desktop is a desktop running entirely on the user's local device and continues to operate when disconnected from the network. In this case, the user's local device is used as a type 1 hypervisor and is synced with the data center when the device is connected to the network.
- For the purposes of the validation represented in this document, both XenDesktop Hosted Virtual Desktops and XenApp Hosted Shared Desktop server sessions were validated. Each of the sections provides some fundamental design decisions for this environment.

Understanding Applications and Data

When the desktop user groups and sub-groups have been identified, the next task is to catalog group application and data requirements. This can be one of the most time-consuming processes in the VDI planning exercise but is essential for the VDI project's success. If the applications and data are not identified and co-located, performance will be negatively affected.

The process of analyzing the variety of application and data pairs for an organization will likely be complicated by the inclusion cloud applications, for example, Salesforce.com. This application and data analysis is beyond the scope of this Cisco Validated Design but should not be omitted from the planning process. There are a variety of third-party tools available to assist organizations with this crucial exercise.

Project Planning and Solution Sizing Sample Questions

Now that user groups, their applications and their data requirements are understood, some key project and solution sizing questions may be considered.

General project questions should be addressed at the outset, including:

- Has a VDI pilot plan been created based on the business analysis of the desktop groups, applications and data?
- Is there infrastructure and budget in place to run the pilot program?
- Are the required skill sets to execute the VDI project available? Can we hire or contract for them?
- Do we have end user experience performance metrics identified for each desktop sub-group?
- How will we measure success or failure?
- What is the future implication of success or failure?

Below is a short, non-exhaustive list of sizing questions that should be addressed for each user sub-group:

- What is the desktop OS planned? Windows 8 or Windows 10?
- 32 bit or 64 bit desktop OS?
- How many virtual desktops will be deployed in the pilot? In production? All Windows 8/10?
- How much memory per target desktop group desktop?
- Are there any rich media, Flash, or graphics-intensive workloads?
- Are there any applications installed? What application delivery methods will be used, Installed, Streamed, Layered, Hosted, or Local?
- What is the desktop OS planned for RDS Server Roles? Windows server 2012 or Server 2016?

- What is the hypervisor for the solution?
- What is the storage configuration in the existing environment?
- Are there sufficient IOPS available for the write-intensive VDI workload?
- Will there be storage dedicated and tuned for VDI service?
- Is there a voice component to the desktop?
- Is anti-virus a part of the image?
- What is the SQL server version for database? SQL server 2012 or 2016?
- Is user profile management (for example, non-roaming profile based) part of the solution?
- What is the fault tolerance, failover, disaster recovery plan?
- Are there additional desktop sub-group specific questions?

Hypervisor Selection

VMware vSphere has been identified the hypervisor for both RDS Hosted Sessions and VDI based desktops:

- VMware vSphere: VMware vSphere comprises the management infrastructure or virtual center server software and the hypervisor software that virtualizes the hardware resources on the servers. It offers features like Distributed Resource Scheduler, vMotion, high availability, Storage vMotion, VMFS, and a multi-pathing storage layer. More information on vSphere can be obtained at the [VMware web site](#).



For this CVD, the hypervisor used was VMware ESXi 6.7 Update 1.



Server OS and Desktop OS Machines configured in this CVD to support Hosted Shared Desktops (HSD) shared sessions and Hosted Virtual Desktops (both non-persistent and persistent).

Storage Considerations

Boot From SAN

When utilizing UCS Server technology it is recommended to configure Boot from SAN and store the boot partitions on remote storage, this enabled architects and administrators to take full advantage of the stateless nature of service profiles for hardware flexibility across lifecycle management of server hardware generational changes, Operating Systems/Hypervisors and overall portability of server identity. Boot from SAN also removes the need to populate local server storage creating more administrative overhead.

Pure Storage FlashArray Considerations

Make sure Each FlashArray Controller is connected to BOTH storage fabrics (A/B).

Within Purity, it's best practice to map Hosts to Host Groups and then Host Groups to Volumes, this ensures the Volume is presented on the same LUN ID to all hosts and allows for simplified management of ESXi Clusters across multiple nodes.

How big should a Volume be? With the Purity Operating Environment, we remove the complexities of aggregates, RAID groups, and so on. When managing storage, you just create a volume based on the size required, availability and performance are taken care of through RAID-HD and DirectFlash Software. As an administrator you can create 1 10TB volume or 10 1TB Volumes and their performance/availability will be the same, so instead of creating volumes for availability or performance you can think about recoverability, manageability and administrative considerations. For example, what data do I want to present to this application or what data do I want to store together so I can replicate it to another site/system/cloud, and so on.

Port Connectivity

10/25/40GbE connectivity support – while both 10 and 25 Gbps is provided through 2 onboard NICs on each FlashArray controller if any more interfaces are required or if 40GbE connectivity is also required then make sure there is provision for additional NICs have been included in the original FlashArray BOM.

16/32Gb Fiber Channel support (N-2 support) – Pure Storage offer up to 32Gb FC support on the latest FlashArray//X series arrays. Always make sure the correct number of HBAs and the speed of SFPs are included in the original FlashArray BOM.

Oversubscription

To reduce the impact of an outage or maintenance scheduled downtime it is good practice when designing fabrics to provide oversubscription of bandwidth, this enables a similar performance profile during component failure and protects workloads from being impacted by a reduced number of paths during a component failure or maintenance event. Oversubscription can be achieved by increasing the number of physically cabled connections between storage and compute. These connections can then be utilized to deliver performance and reduced latency to the underlying workloads running on the solution.

Topology

When configuring your SAN, it's important to remember that the more hops you have, the more latency you will see. For best performance, the ideal topology is a "Flat Fabric" where the FlashArray is only one hop away from any applications being hosted on it. For iSCSI, we recommend that you do not add routing to your storage LAN.

VMware Virtual Volumes Considerations

When configuring a Pure Storage FlashArray with Virtual Volumes, the FlashArray will only be able to provide the VASA Service to an individual vCenter at this time. vCenters that are in Enhanced Linked Mode will be able to communicate with the same FlashArray, however vCenters that are not in Enhanced Linked Mode cannot both use VVols on the same FlashArray. Should multiple vCenters need to use the same FlashArray for VVols, they should be configured in Enhanced Linked Mode.

Ensure that the Config VVol is either part of an existing FlashArray Protection Group, Storage Policy that includes snapshots or manual snapshots of the Config VVol are taken. This will help with the virtual machine recovery process if the virtual machine is deleted.

Keep in mind that there are some FlashArray limits on Volume Connections per Host, Volume Count and Snapshot Count. For more information about FlashArray limits, review the following:

https://support.purestorage.com/FlashArray/PurityFA/General_Troubleshooting/Pure_Storage_FlashArray_Limits

When a Storage Policy is applied to a VVol virtual machine, the Volumes associated with that virtual machine are added to the designated protection group when applying the policy to the virtual machine. Should replication be part of the policy, be mindful of the number of virtual machines using that storage policy and replication group. A high number of virtual machines with high change rate could cause replication to miss its schedule due to increases replication bandwidth and time needed to complete the scheduled snapshot. Pure Storage recommends VVol virtual machines that have Storage Policies applied be balanced between protection groups. Currently Pure Storage recommends 20 to 30 virtual machines per Storage Policy Replication Group.

Pure Storage FlashArray Best Practices for VMware vSphere

The following Pure Storage best practices for VMware vSphere should be followed as part of a design:

- For hosts earlier than 6.0 Patch 5 or 6.5 Update 1, Configure Round Robin and an I/O Operations Limit of 1 for every FlashArray device. This is no longer needed for later versions of ESXi. The best way to do this is to create an ESXi SATP Rule on every host (below). This will make sure all devices are set automatically.

```
esxcli storage nmp satp rule add -s "VMW_SATP_ALUA" -V "PURE" -M "FlashArray" -P
"VMW_PSP_RR" -O "iops=1"
```

- For iSCSI, disable DelayedAck and set the Login Timeout to 30 seconds. Jumbo Frames are optional.
- In vSphere 6.x, if hosts have any VMFS-5 volumes, change EnableBlockDelete to enabled. If it is all VMFS-6, this change is not needed.
- For VMFS-5, Run UNMAP frequently.
- For VMFS-6, keep automatic UNMAP enabled.
- When using vSphere Replication and/or when you have ESXi hosts running EFI-enabled virtual machines set the ESXi parameter Disk.DiskMaxIOSize to 4 MB.
- DataMover.HardwareAcceleratedMove, DataMover.HardwareAcceleratedInIt, and VMFS3.HardwareAcceleratedLocking should all be enabled.
- Ensure all ESXi hosts are connected to both FlashArray controllers. Ideally at least two paths to each. Aim for total redundancy.
- Install VMware tools whenever possible.
- Queue depths should be left at the default. Changing queue depths on the ESXi host is considered to be a tweak and should only be examined if a performance problem (high latency) is observed.
- When mounting snapshots, use the ESXi resignature option and avoid force-mounting.
- Configure Host Groups on the FlashArray identically to clusters in vSphere. For example, if a cluster has four hosts in it, create a corresponding Host Group on the relevant FlashArray with exactly those four hosts—no more, no less.
- Use Paravirtual SCSI adapters for virtual machines whenever possible.
- Atomic Test and Set (ATS) is required on all Pure Storage volumes. This is a default configuration and no changes should normally be needed.
- UseATSForHBOOnVMFS5 should be enabled. This was introduced in vSphere 5.5 U2 and is enabled by default. It is NOT required though.

For more information about the VMware vSphere Pure Storage FlashArray Best Practices, refer to:

[Web Guide: FlashArray® VMware Best Practices](#)

Citrix XenDesktop Design Fundamentals

An ever growing and diverse base of user devices, complexity in management of traditional desktops, security, and even Bring Your Own (BYO) device to work programs are prime reasons for moving to a virtual desktop solution.

Citrix XenDesktop 7.15 integrates Hosted Shared and VDI desktop virtualization technologies into a unified architecture that enables a scalable, simple, efficient, and manageable solution for delivering Windows applications and desktops as a service.

Users can select applications from an easy-to-use “store” that is accessible from tablets, smartphones, PCs, Macs, and thin clients. XenDesktop delivers a native touch-optimized experience with HDX high-definition performance, even over mobile networks.

Machine Catalogs

Collections of identical virtual machines or physical computers are managed as a single entity called a Machine Catalog. In this CVD, virtual machine provisioning relies on Citrix Provisioning Services to make sure that the machines in the catalog are consistent. In this CVD, machines in the Machine Catalog are configured to run either a Windows Server OS (for RDS hosted shared desktops) or a Windows Desktop OS (for hosted pooled VDI desktops).

Delivery Groups

To deliver desktops and applications to users, you create a Machine Catalog and then allocate machines from the catalog to users by creating Delivery Groups. Delivery Groups provide desktops, applications, or a combination of desktops and applications to users. Creating a Delivery Group is a flexible way of allocating machines and applications to users. In a Delivery Group, you can:

- Use machines from multiple catalogs
- Allocate a user to multiple machines
- Allocate multiple users to one machine

As part of the creation process, you specify the following Delivery Group properties:

- Users, groups, and applications allocated to Delivery Groups
- Desktop settings to match users' needs
- Desktop power management options

Figure 19 illustrates how users access desktops and applications through machine catalogs and delivery groups.



The Server OS and Desktop OS Machines configured in this CVD support the hosted shared desktops and hosted virtual desktops (both non-persistent and persistent).

Figure 19 Access Desktops and Applications through Machine Catalogs and Delivery Groups

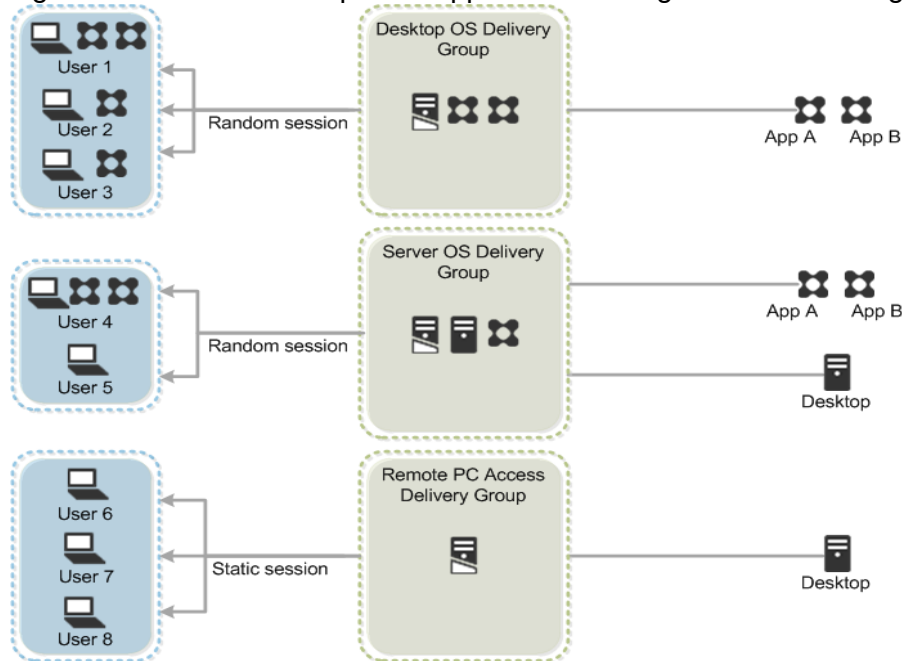

Citrix Provisioning Services

Citrix XenDesktop 7.15 can be deployed with or without Citrix Provisioning Services (PVS). The advantage of using Citrix PVS is that it allows virtual machines to be provisioned and re-provisioned in real-time from a single shared-disk image. In this way administrators can completely eliminate the need to manage and patch individual systems and reduce the number of disk images that they manage, even as the number of machines continues to grow, simultaneously providing the efficiencies of a centralized management with the benefits of distributed processing.

The Provisioning Services solution’s infrastructure is based on software-streaming technology. After installing and configuring Provisioning Services components, a single shared disk image (vDisk) is created from a device’s hard drive by taking a snapshot of the OS and application image, and then storing that image as a vDisk file on the network. A device that is used during the vDisk creation process is the Master target device. Devices or virtual machines that use the created vDisks are called target devices.

When a target device is turned on, it is set to boot from the network and to communicate with a Provisioning Server. Unlike thin-client technology, processing takes place on the target device.

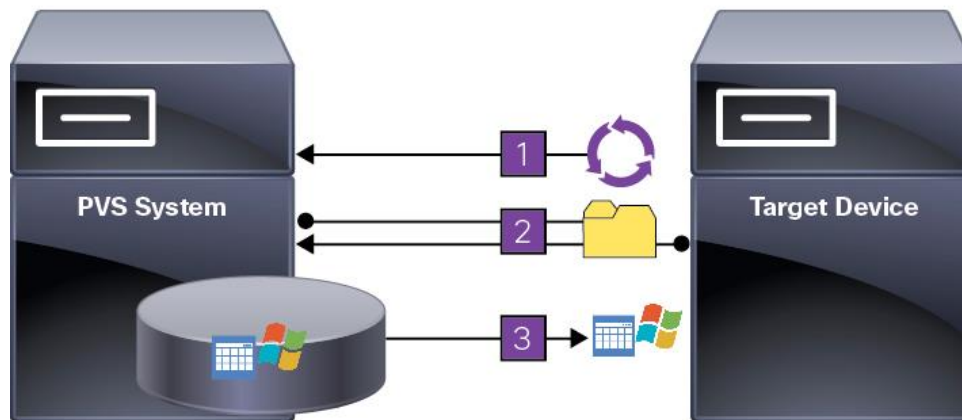
Figure 20 Citrix Provisioning Services Functionality

The target device downloads the boot file from a Provisioning Server (Step 2) and boots. Based on the boot configuration settings, the appropriate vDisk is mounted on the Provisioning Server (Step 3). The vDisk software is then streamed to the target device as needed, appearing as a regular hard drive to the system.

Instead of immediately pulling all the vDisk contents down to the target device (as with traditional imaging solutions), the data is brought across the network in real-time as needed. This approach allows a target device to get a completely new operating system and set of software in the time it takes to reboot. This approach dramatically decreases the amount of network bandwidth required and making it possible to support a larger number of target devices on a network without impacting performance

Citrix PVS can create desktops as Pooled or Private:

- Pooled Desktop: A pooled virtual desktop uses Citrix PVS to stream a standard desktop image to multiple desktop instances upon boot.
- Private Desktop: A private desktop is a single desktop assigned to one distinct user.

The alternative to Citrix Provisioning Services for pooled desktop deployments is Citrix Machine Creation Services (MCS), which is integrated with the XenDesktop Studio console.

Locating the PVS Write Cache

When considering a PVS deployment, there are some design decisions that need to be made regarding the write cache for the target devices that leverage provisioning services. The write cache is a cache of all data that the target device has written. If data is written to the PVS vDisk in a caching mode, the data is not written back to the base vDisk. Instead, it is written to a write cache file in one of the following locations:

- Cache on device hard drive. Write cache exists as a file in NTFS format, located on the target-device's hard drive. This option frees up the Provisioning Server since it does not have to process write requests and does not have the finite limitation of RAM.
- Cache on device hard drive persisted. (Experimental Phase) This is the same as "Cache on device hard drive", except that the cache persists. At this time, this method is an experimental feature only, and is only supported for NT6.1 or later (Windows 10 and Windows 2008 R2 and later). This method also requires a different bootstrap.
- Cache in device RAM. Write cache can exist as a temporary file in the target device's RAM. This provides the fastest method of disk access since memory access is always faster than disk access.

- Cache in device RAM with overflow on hard disk. This method uses VHDX differencing format and is only available for Windows 10 and Server 2008 R2 and later. When RAM is zero, the target device write cache is only written to the local disk. When RAM is not zero, the target device write cache is written to RAM first. When RAM is full, the least recently used block of data is written to the local differencing disk to accommodate newer data on RAM. The amount of RAM specified is the non-paged kernel memory that the target device will consume.
- Cache on a server. Write cache can exist as a temporary file on a Provisioning Server. In this configuration, all writes are handled by the Provisioning Server, which can increase disk I/O and network traffic. For additional security, the Provisioning Server can be configured to encrypt write cache files. Since the write-cache file persists on the hard drive between reboots, encrypted data provides data protection in the event a hard drive is stolen.
- Cache on server persisted. This cache option allows for the saved changes between reboots. Using this option, a rebooted target device is able to retrieve changes made from previous sessions that differ from the read only vDisk image. If a vDisk is set to this method of caching, each target device that accesses the vDisk automatically has a device-specific, writable disk file created. Any changes made to the vDisk image are written to that file, which is not automatically deleted upon shutdown.



In this CVD, Provisioning Server 7.15 was used to manage Pooled/Non-Persistent VDI Machines and XenApp RDS Machines with “Cache in device RAM with Overflow on Hard Disk” for each virtual machine. This design enables good scalability to many thousands of desktops. Provisioning Server 7.15 was used for Active Directory machine account creation and management as well as for streaming the shared disk to the hypervisor hosts.

Example XenDesktop Deployments

Two examples of typical XenDesktop deployments are as follows:

- A distributed components configuration
- A multiple site configuration

Since XenApp and XenDesktop 7.15 are based on a unified architecture, combined they can deliver a combination of Hosted Shared Desktops (HSDs, using a Server OS machine) and Hosted Virtual Desktops (HVDs, using a Desktop OS).

Distributed Components Configuration

You can distribute the components of your deployment among a greater number of servers or provide greater scalability and failover by increasing the number of controllers in your site. You can install management consoles on separate computers to manage the deployment remotely. A distributed deployment is necessary for an infrastructure based on remote access through NetScaler Gateway (formerly called Access Gateway).

Figure 21 shows an example of a distributed components configuration. A simplified version of this configuration is often deployed for an initial proof-of-concept (POC) deployment. The CVD described in this document deploys Citrix XenDesktop in a configuration that resembles this distributed components configuration shown. Two Cisco UCS B200M5 blade servers host the required infrastructure services (AD, DNS, DHCP, License Server, SQL, Citrix XenDesktop management, and StoreFront servers).

Figure 21 Example of a Distributed Components Configuration



Multiple Site Configuration

If you have multiple regional sites, you can use Citrix NetScaler to direct user connections to the most appropriate site and StoreFront to deliver desktops and applications to users.

In Figure 22 depicting multiple sites, a site was created in two data centers. Having two sites globally, rather than just one, minimizes the amount of unnecessary WAN traffic.

Figure 22 Multiple Sites

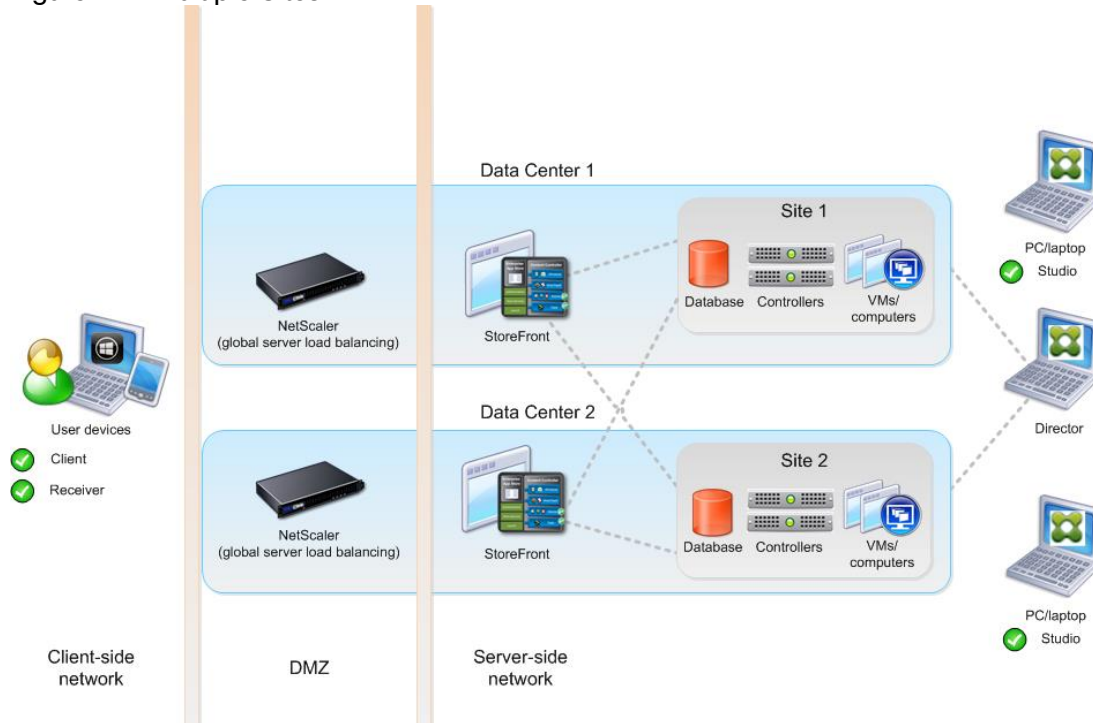

You can use StoreFront to aggregate resources from multiple sites to provide users with a single point of access with NetScaler. A separate Studio console is required to manage each site; sites cannot be managed as a single entity. You can use Director to support users across sites.

Citrix NetScaler accelerates application performance, load balances servers, increases security, and optimizes the user experience. In this example, two NetScalers are used to provide a high availability configuration. The NetScalers are configured for Global Server Load Balancing and positioned in the DMZ to provide a multi-site, fault-tolerant solution.

Citrix Cloud Services

Easily deliver the Citrix portfolio of products as a service. Citrix Cloud services simplify the delivery and management of Citrix technologies extending existing on-premises software deployments and creating hybrid workspace services.

- Fast: Deploy apps and desktops, or complete secure digital workspaces in hours, not weeks.
- Adaptable: Choose to deploy on any cloud or virtual infrastructure – or a hybrid of both.
- Secure: Keep all proprietary information for your apps, desktops, and data under your control.
- Simple: Implement a fully-integrated Citrix portfolio through a single-management plane to simplify administration

Designing a XenDesktop Environment for a Mixed Workload

With Citrix XenDesktop 7.15, the method you choose to provide applications or desktops to users depends on the types of applications and desktops you are hosting and available system resources, as well as the types of users and user experience you want to provide.

<p>Server OS machines</p>	<p>You want: Inexpensive server-based delivery to minimize the cost of delivering applications to a large number of users, while providing a secure, high-definition user experience.</p> <p>Your users: Perform well-defined tasks and do not require personalization or offline access to applications. Users may include task workers such as call center operators and retail workers, or users that share workstations.</p> <p>Application types: Any application.</p>
<p>Desktop OS machines</p>	<p>You want: A client-based application delivery solution that is secure, provides centralized management, and supports a large number of users per host server (or hypervisor), while providing users with applications that display seamlessly in high-definition.</p> <p>Your users: Are internal, external contractors, third-party collaborators, and other provisional team members. Users do not require off-line access to hosted applications.</p> <p>Application types: Applications that might not work well with other applications or might interact with the operating system, such as .NET framework. These types of applications are ideal for hosting on virtual machines.</p> <p>Applications running on older operating systems such as Windows XP or Windows Vista, and older architectures, such as 32-bit or 16-bit. By isolating each application on its own virtual machine, if one machine fails, it does not impact other users.</p>
<p>Remote PC Access</p>	<p>You want: Employees with secure remote access to a physical computer without using a VPN. For example, the user may be accessing their physical desktop PC from home or through a public WIFI hotspot. Depending upon the location, you may want to restrict the ability to print or copy and paste outside of the desktop. This method enables BYO device support without migrating desktop images into the data center.</p> <p>Your users: Employees or contractors that have the option to work from home but need access to specific software or data on their corporate desktops to perform their jobs remotely.</p> <p>Host: The same as Desktop OS machines.</p> <p>Application types: Applications that are delivered from an office computer and display seamlessly in high definition on the remote user's device.</p>

For the Cisco Validated Design described in this document, a mix of Windows Server 2016 based Hosted Shared Desktop sessions (RDS) and Windows 10 Hosted Virtual desktops (Statically assigned Persistent and Random Pooled) were configured and tested.

Deployment Hardware and Software

Products Deployed

The architecture deployed is highly modular. While each customer's environment might vary in its exact configuration, the reference architecture contained in this document once built, can easily be scaled as requirements and demands change. This includes scaling both up (adding additional resources within a Cisco UCS Domain) and out (adding additional Cisco UCS Domains and Pure Storage FlashArrays).

The FlashStack Data Center solution includes Cisco networking, Cisco UCS and Pure Storage FlashArray //X, which efficiently fit into a single data center rack, including the access layer network switches.

This CVD details the deployment of 6000 users for a mixed Citrix XenDesktop desktop workload featuring the following software:

- VMware vSphere ESXi 6.7 Update 1 Hypervisor
- Microsoft SQL Server 2016
- Microsoft Windows Server 2016 and Windows 10 64-bit virtual machine Operating Systems
- Citrix XenApp 7.15 LTSR CU3 Hosted Shared Virtual Desktops (HSD) with PVS write cache on FC storage
- Citrix XenDesktop 7.15 LTSR CU3 Non-Persistent Hosted Virtual Desktops (HVD) with PVS write cache on FC storage
- Citrix XenDesktop 7.15 LTSR CU3 Persistent Hosted Virtual Desktops (HVD) provisioned with MCS and stored on FC storage
- Citrix Provisioning Server 7.15 LTSR CU3
- Citrix User Profile Manager 7.15 LTSR CU3
- Citrix StoreFront 7.15 LTSR CU3

0 details the physical hardware and cabling deployed to enable this solution.

Figure 23 Virtual Desktop Workload Reference Architecture for the 6000 Seat on Citrix XenDesktop 7.15 LTSR on FlashStack

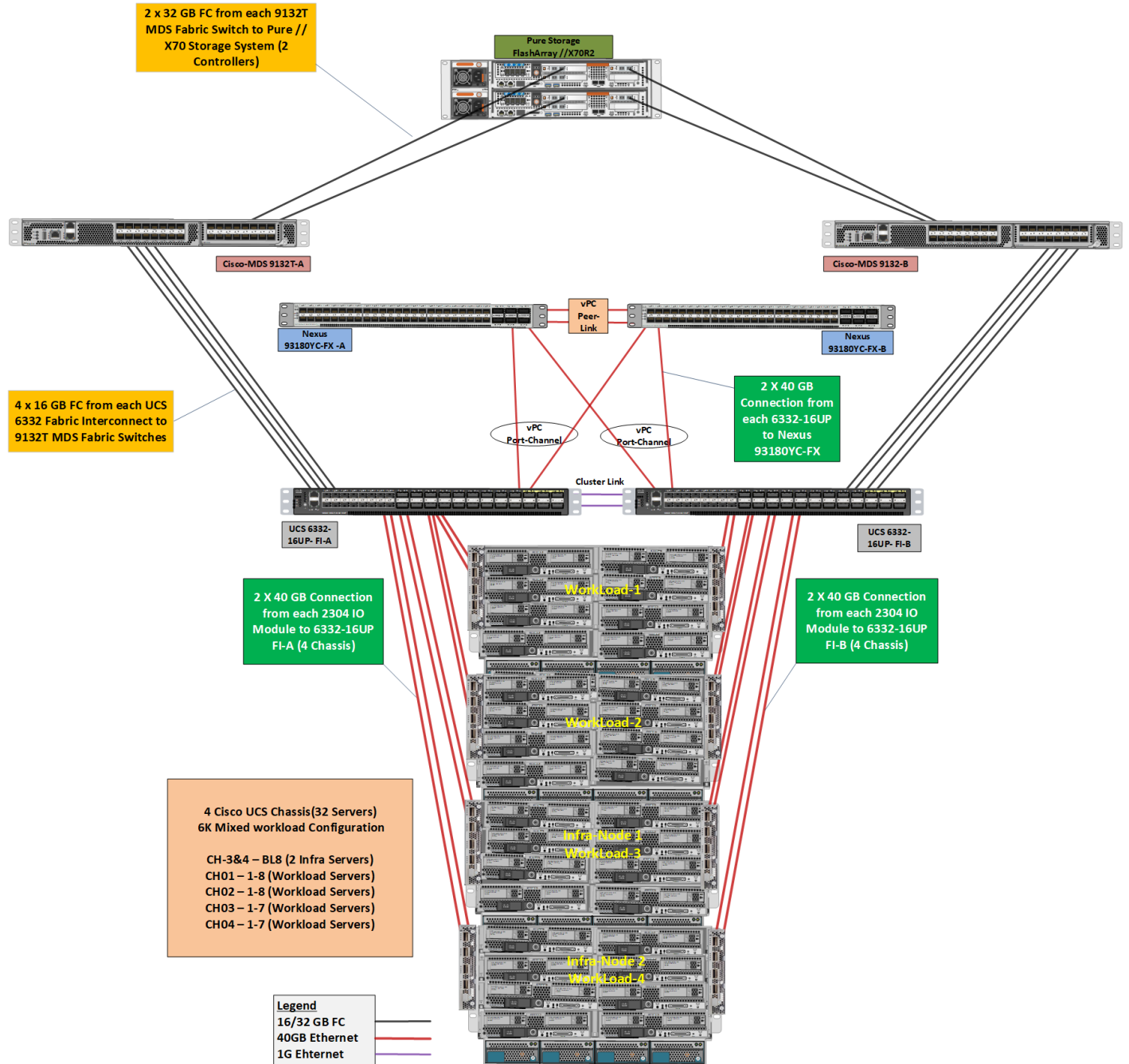

The solution contains the following hardware as shown in Figure 23.

- Two Cisco Nexus 93180YC-FX Layer 2 Access Switches
- Two Cisco MDS 9132T 32-Gbps 16Gb Fibre Channel Switches
- Four Cisco UCS 5108 Blade Server Chassis with two Cisco UCS-IOM-2304 IO Modules

- Two Cisco UCS B200 M5 Blade Servers with Intel Xeon Silver 4114 2.20-GHz 10-core processors, 192GB 2400MHz RAM, and one Cisco VIC1340 mezzanine card for the hosted infrastructure, providing N+1 server fault tolerance
- Eight Cisco UCS B200 M5 Blade Servers with Intel Xeon Gold 6140 2.30-GHz 18-core processors, 768GB 2666MHz RAM, and one Cisco VIC1340 mezzanine card for the Hosted Shared Desktop workload, providing N+1 server fault tolerance at the workload cluster level
- Eleven Cisco UCS B200 M5 Blade Servers with Intel Xeon Gold 6140 2.30-GHz 18-core processors, 768GB 2666MHz RAM, and one Cisco VIC1340 mezzanine card for the Random Pooled desktops workload, providing N+1 server fault tolerance at the workload cluster level
- Eleven Cisco UCS B200 M5 Blade Servers with Intel Xeon Gold 6140 2.30-GHz 18-core processors, 768GB 2666MHz RAM, and one Cisco VIC1340 mezzanine card for the Static (Full Clones) desktops workload, providing N+1 server fault tolerance at the workload cluster level
- Pure Storage FlashArray//X70 R2 with dual redundant controllers, with Twenty 1.92TB DirectFlash NVMe drives



The LoginVSI Test infrastructure is not a part of this solution. The Pure FlashArray//X70 R2 configuration is detailed later in this document.

Software Revisions

Table 2 lists the software versions of the primary products installed in the environment.

Table 2 Software and Firmware Versions

Vendor	Product / Component	Version / Build / Code
Cisco	UCS Component Firmware	4.0(2b) bundle release
Cisco	UCS Manager	4.0(2b) bundle release
Cisco	UCS B200 M5 Blades	4.0(2b) bundle release
Cisco	VIC 1340	4.3(2a)
VMware	vCenter Server Appliance	6.7.0.20000
VMware	vSphere ESXi 6.7 Update 1	6.7.0.10302608
Citrix	XenApp VDA	7.15.3000.488
Citrix	XenDesktop VDA	7.15.3000.488
Citrix	XenDesktop Controller	7.15.3000.488
Citrix	Provisioning Services	7.15.9.11
Citrix	StoreFront Services	3.12.3000.488
Pure Storage	FlashArray//X70 R2	Purity//FA v5.1.7

Logical Architecture

The logical architecture of the validated solution which is designed to support up to 6000 users within a single 42u rack containing 32 blades in 4 chassis, with physical redundancy for the blade servers for each workload type is illustrated in Figure 24.

Figure 24 Logical Architecture Overview

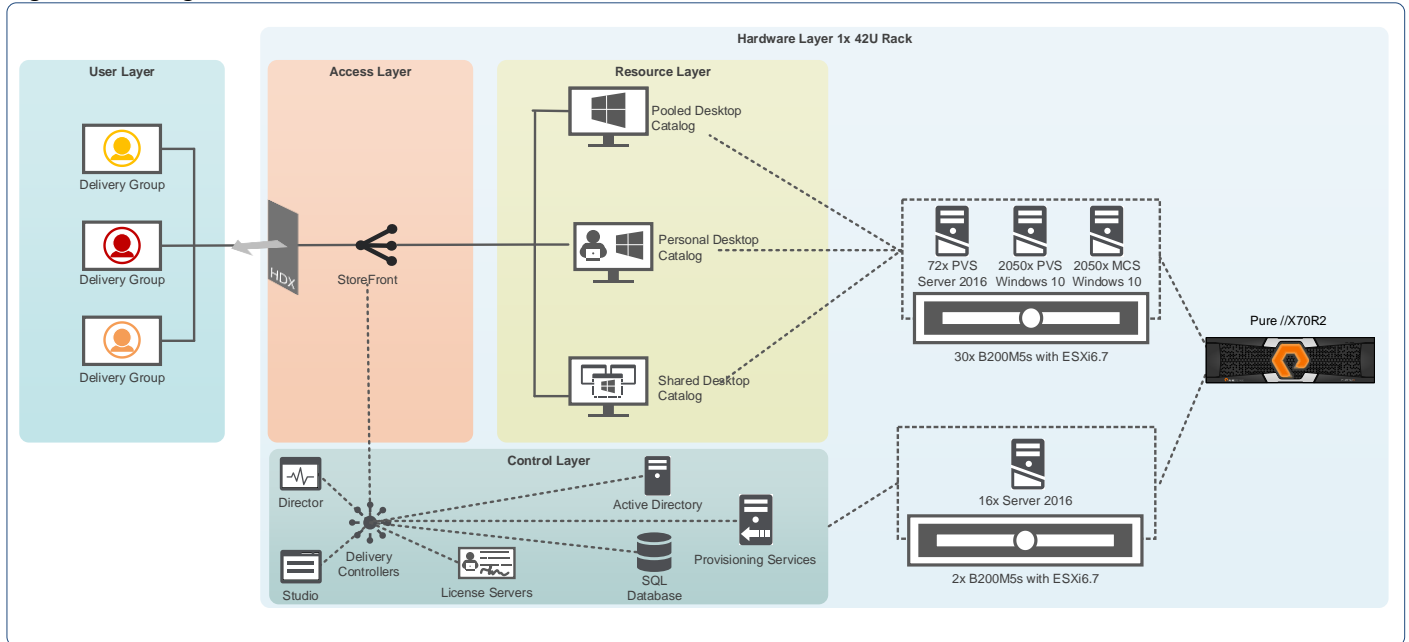

Configuration Guidelines

The Citrix XenDesktop solution described in this document provides details for configuring a fully redundant, highly-available configuration. Configuration guidelines are provided that refer to which redundant component is being configured with each step, whether that be A or B. For example, Nexus A and Nexus B identify the pair of Cisco Nexus switches that are configured. The Cisco UCS Fabric Interconnects are configured similarly.



This document is intended to allow the reader to configure the Citrix XenDesktop 7.15 customer environment as a stand-alone solution.

VLANs

The VLAN configuration recommended for the environment includes a total of six VLANs as outlined in Table 3 .

Table 3 VLANs Configured in this Study

VLAN Name	VLAN ID	VLAN Purpose
Default	1	Native VLAN
In-Band-Mgmt	70	In-Band management interfaces
Infra-Mgmt	71	Infrastructure Virtual Machines

VLAN Name	VLAN ID	VLAN Purpose
VCC/VM-Network	72	RDSH, Persistent and Non-Persistent
vMotion	73	VMware vMotion
OOB-Mgmt	164	Out of Band management interfaces

VSANs

Two virtual SANs configured for communications and fault tolerance in this design as outlined in Table 4 .

Table 4 VSANs Configured in this Study

VSAN Name	VSAN ID	Purpose
VSAN 100	100	VSAN for Primary SAN communication
VSAN 101	101	VSAN for Secondary SAN communication

Solution Configuration

This section details the configuration and tuning that was performed on the individual components to produce a complete, validated solution.

Solution Cabling

The following sections detail the physical connectivity configuration of the FlashStack 6000 seat mixed workload Citrix XenDesktop environment.

The information provided in this section is a reference for cabling the physical equipment in this Cisco Validated Design environment. To simplify cabling requirements, the tables include both local and remote device and port locations.

The tables in this section contain the details for the prescribed and supported configuration of the Pure Storage FlashArray//X70 R2 storage array to the Cisco 6332-16UP Fabric Interconnects through Cisco MDS 9132T 32-Gbps FC switches.



This document assumes that out-of-band management ports are plugged into an existing management infrastructure at the deployment site. These interfaces will be used in various configuration steps.



Be sure to follow the cabling directions in this section. Failure to do so will result in necessary changes to the deployment procedures that follow because specific port locations are mentioned.

Figure 25 shows a cabling diagram for a configuration using the Cisco Nexus 9000, Cisco MDS 9100 Series, and Pure Storage FlashArray//X70 R2 array.

Figure 25 FlashStack 6000 Seat Cabling Diagram

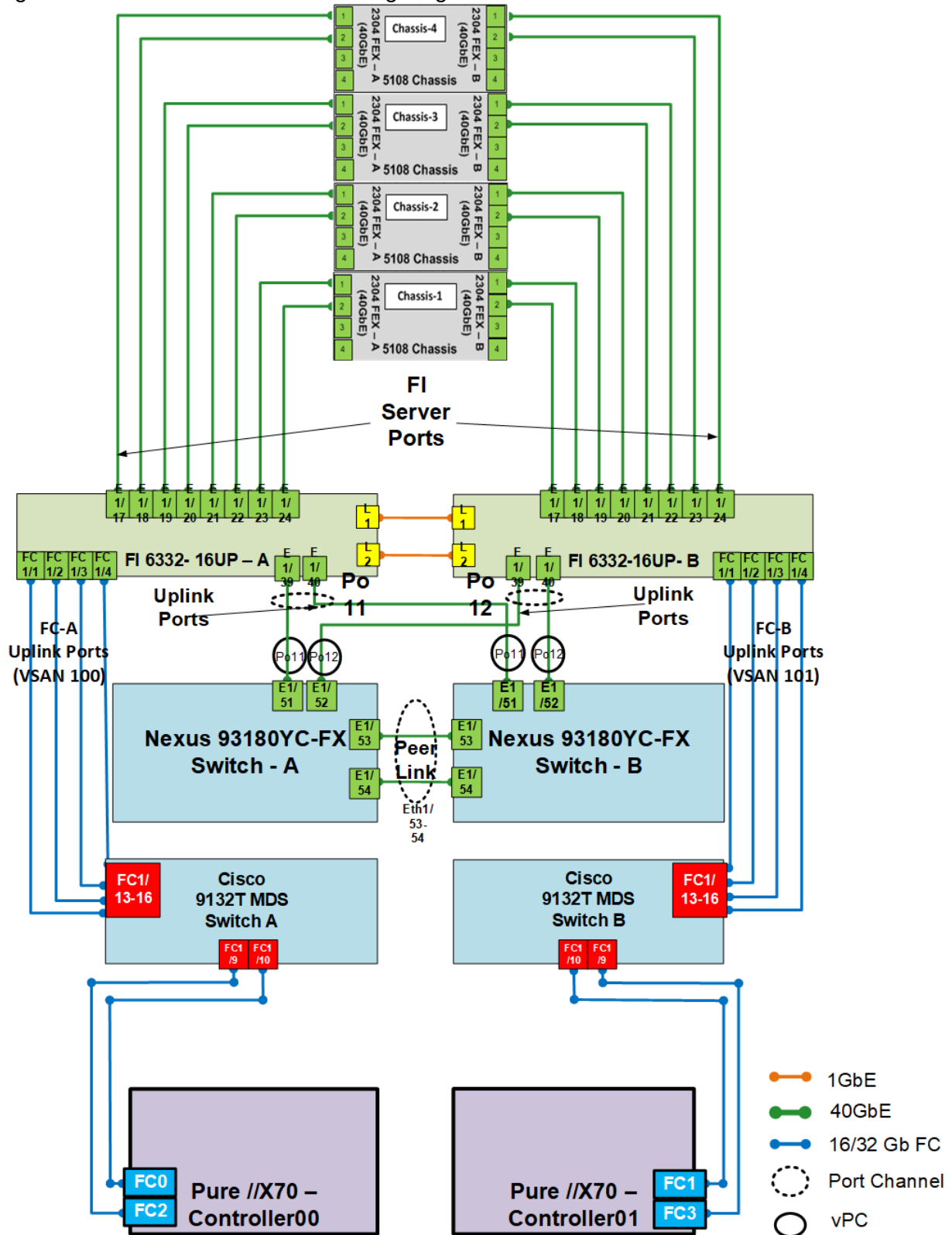

Cisco Unified Computing System Base Configuration

This section details the Cisco UCS configuration that was done as part of the infrastructure build out. The racking, power, and installation of the chassis are described in the [Cisco UCS Manager Getting Started Guide](#), and it is beyond the scope of this document. For more information about each step, refer to the following document, [Cisco UCS Manager - Configuration Guides](#).

Cisco UCS Manager Software Version 4.0(2b)

This document assumes you are using Cisco UCS Manager Software version 4.0(2b). To upgrade the Cisco UCS Manager software and the Cisco UCS 6332-16UP Fabric Interconnect software to a higher version of the firmware,) refer to [Cisco UCS Manager Install and Upgrade Guides](#).

Configure Fabric Interconnects at Console

To configure the fabric Interconnects, follow these steps:

1. Connect a console cable to the console port on what will become the primary fabric interconnect.
2. If the fabric interconnect was previously deployed and you want to erase it to redeploy, follow these steps:
 - a. Login with the existing user name and password.

```
# connect local-mgmt
# erase config
# yes (to confirm)
```
3. After the fabric interconnect restarts, the out-of-box first time installation prompt appears, type “console” and press Enter.
4. Follow the [Initial Configuration](#) steps as outlined in [Cisco UCS Manager Getting Started Guide](#). When configured, Login to UCSM IP Address through Web interface to perform base Cisco UCS configuration.

Configure Fabric Interconnects for a Cluster Setup

To configure the Cisco UCS Fabric Interconnects, follow these steps:

1. Verify the following physical connections on the fabric interconnect:
 - The management Ethernet port (mgmt0) is connected to an external hub, switch, or router
 - The L1 ports on both fabric interconnects are directly connected to each other
 - The L2 ports on both fabric interconnects are directly connected to each other
2. Connect to the console port on the first Fabric Interconnect.
3. Review the settings on the console. Answer yes to Apply and Save the configuration.
4. Wait for the login prompt to make sure the configuration has been saved to Fabric Interconnect A.
5. Connect the console port on the second Fabric Interconnect, configure secondary FI.

Figure 26 Initial Setup of Cisco UCS Manager on Primary Fabric Interconnect

```

Enter the configuration method. (console/gui) ? console

Enter the setup mode; setup newly or restore from backup. (setup/restore) ? setup

You have chosen to setup a new Fabric interconnect. Continue? (y/n): y

Enforce strong password? (y/n) [y]: n

Enter the password for "admin":
Confirm the password for "admin":

Is this Fabric interconnect part of a cluster(select 'no' for standalone)? (yes/no) [n]: yes

Enter the switch fabric (A/B) []: A

Enter the system name: VCC-AAD17

Physical Switch Mgmt0 IP address : 10.29.164.246

Physical Switch Mgmt0 IPv4 netmask : 255.255.255.0

IPv4 address of the default gateway : 10.29.164.1

Cluster IPv4 address : 10.29.164.245

Configure the DNS Server IP address? (yes/no) [n]:

Configure the default domain name? (yes/no) [n]:

Join centralized management environment (UCS Central)? (yes/no) [n]:

Following configurations will be applied:

Switch Fabric=A
System Name=VCC-AAD17
Enforced Strong Password=no
Physical Switch Mgmt0 IP Address=10.29.164.246
Physical Switch Mgmt0 IP Netmask=255.255.255.0
Default Gateway=10.29.164.1
Ipv6 value=0

Cluster Enabled=yes
Cluster IP Address=10.29.164.245
NOTE: Cluster IP will be configured only after both Fabric Interconnects are initialized.
      UCSM will be functional only after peer FI is configured in clustering mode.

Apply and save the configuration (select 'no' if you want to re-enter)? (yes/no): yes
Applying configuration. Please wait.

Configuration file - Ok

Cisco UCS 6300 Series Fabric Interconnect
VCC-AAD17-A login: █

```

Figure 27 Initial Setup of Cisco UCS Manager on Secondary Fabric Interconnect

```

Enter the configuration method. (console/gui) ? console

Installer has detected the presence of a peer Fabric interconnect. This Fabric interconnect will be added to the cluster. Continue (y/n) ? y

Enter the admin password of the peer Fabric interconnect:
Connecting to peer Fabric interconnect... done
Retrieving config from peer Fabric interconnect... done
Peer Fabric interconnect Mgmt0 IPv4 Address: 10.29.164.246
Peer Fabric interconnect Mgmt0 IPv4 Netmask: 255.255.255.0
Cluster IPv4 address      : 10.29.164.245

Peer FI is IPv4 Cluster enabled. Please Provide Local Fabric Interconnect Mgmt0 IPv4 Address

Physical Switch Mgmt0 IP address : 10.29.164.247

Apply and save the configuration (select 'no' if you want to re-enter)? (yes/no): yes
Applying configuration. Please wait.

Fri Feb 16 18:53:15 UTC 2018
Configuration file - Ok

Cisco UCS 6300 Series Fabric Interconnect
VCC-AAD17-B login: █

```

6. To log into the Cisco Unified Computing System (Cisco UCS) environment, follow these steps:
 - a. Open a web browser and navigate to the Cisco UCS Fabric Interconnect cluster address configured above.
 - b. Click the Launch UCS Manager link to download the Cisco UCS Manager software. If prompted, accept the security certificates.

Figure 28 Cisco UCS Manager Web Interface

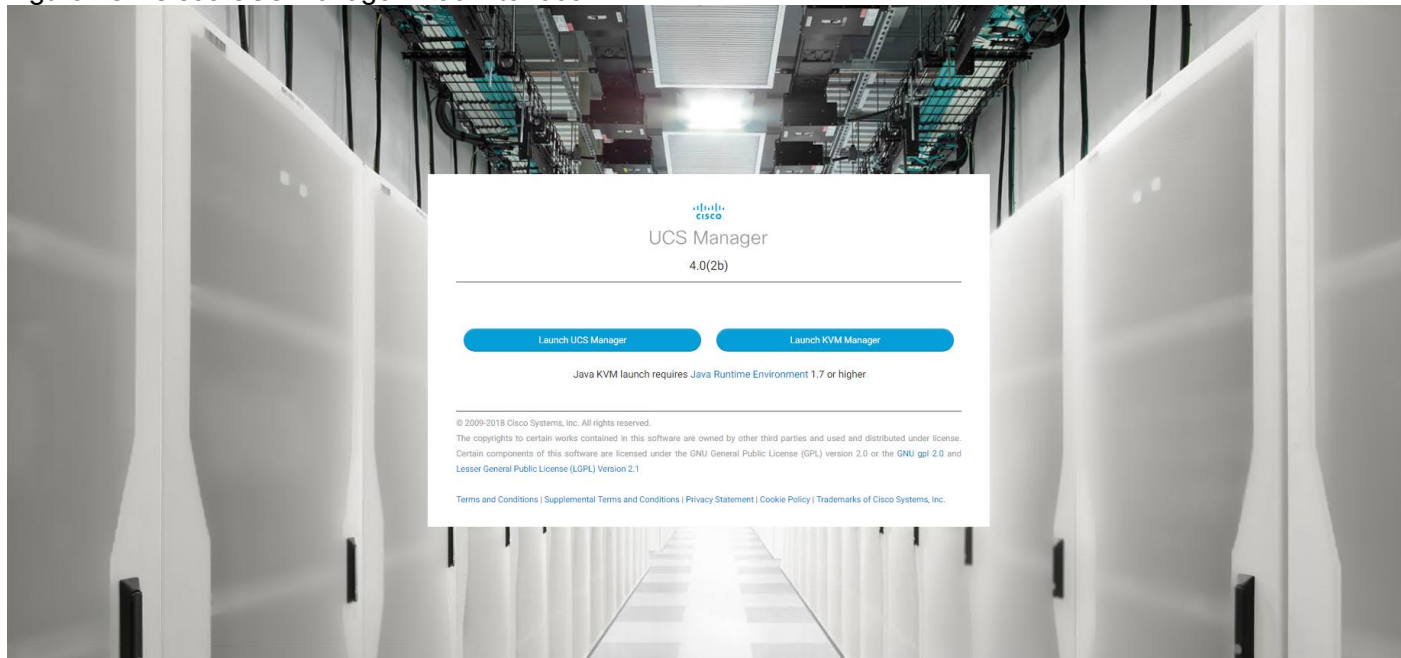

7. When prompted, enter the user name and password enter the password. Click “Log In” to login to Cisco UCS Manager.

Figure 29 Cisco UCS Manager Web Interface after Login

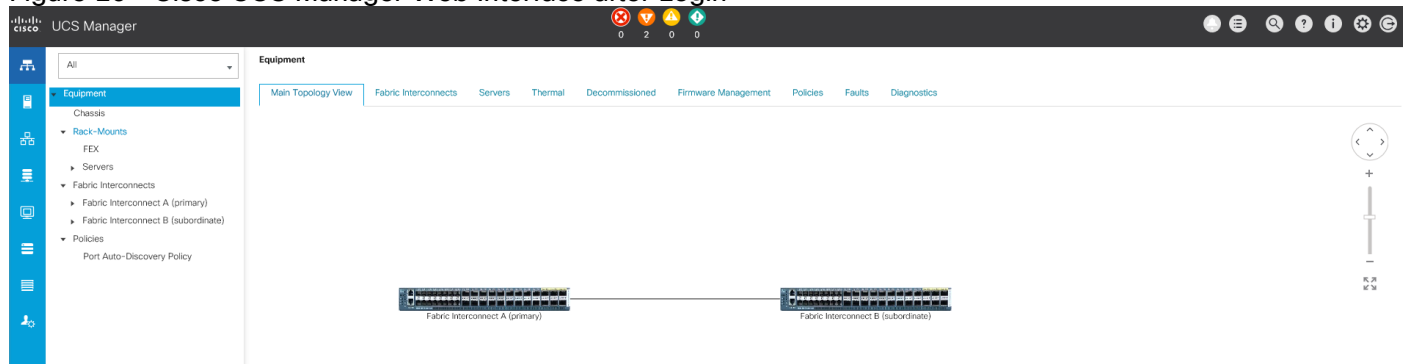

Configure Base Cisco Unified Computing System

The following are the high-level steps involved for a Cisco UCS configuration:

- Configure Fabric Interconnects for a Cluster Setup
- Set Fabric Interconnects to Fibre Channel End Host Mode

- Synchronize Cisco UCS to NTP
- Configure Fabric Interconnects for Chassis and Blade Discovery
 - Configure Global Policies
 - Configure Server Ports
- Configure LAN and SAN on Cisco UCS Manager
 - Configure Ethernet LAN Uplink Ports
 - Create Uplink Port Channels to Cisco Nexus Switches
 - Configure FC SAN Uplink Ports
 - Configure VLAN
 - Configure VSAN
- Configure IP, UUID, Server, MAC, WWNN and WWPN Pools
 - IP Pool Creation
 - UUID Suffix Pool Creation
 - Server Pool Creation
 - MAC Pool Creation
- WWNN and WWPN Pool Creation
- Set Jumbo Frames in both the Cisco Fabric Interconnect
- Configure Server BIOS Policy
- Create Adapter Policy
- Configure Update Default Maintenance Policy
- Configure vNIC and vHBA Template
- Create Server Boot Policy for SAN Boot

Details for each step are discussed in the following sections.

Synchronize Cisco UCSM to NTP

To synchronize the Cisco UCS environment to the NTP server, follow these steps:

1. In Cisco UCS Manager, in the navigation pane, click the Admin tab.
2. Select All > Time zone Management.
3. In the Properties pane, select the appropriate time zone in the Time zone menu.
4. Click Save Changes and then click OK.

5. Click Add NTP Server.
6. Enter the NTP server IP address and click OK.
7. Click OK to finish.
8. Click Save Changes.

Figure 30 Synchronize Cisco UCS Manager to NTP

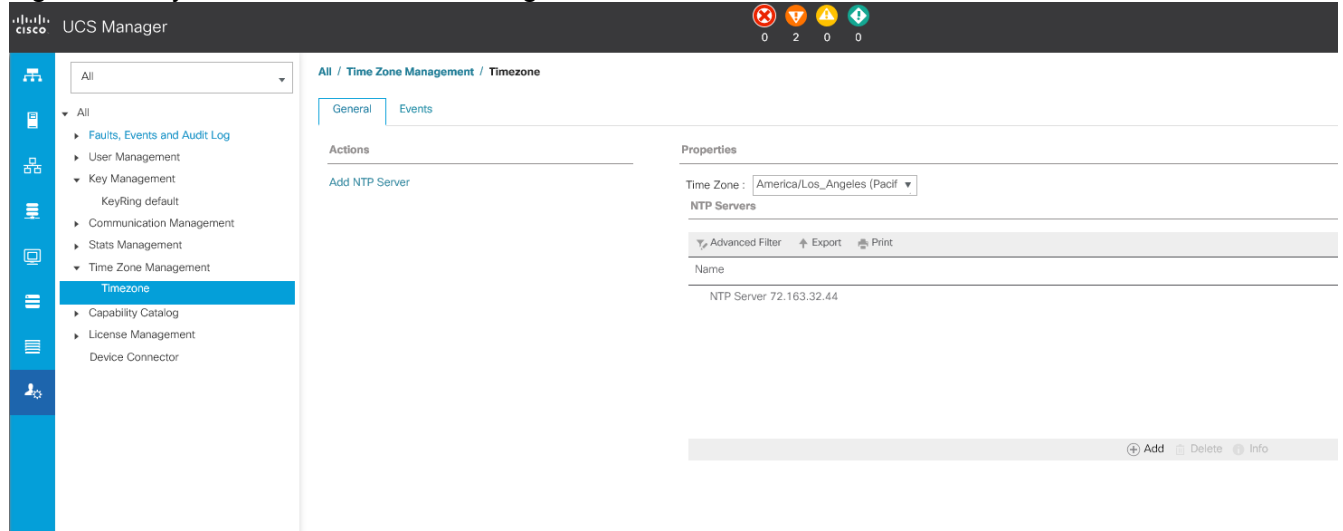

9. Configure Fabric Interconnects for Chassis and Blade Discovery

Cisco UCS 6332-16UP Fabric Interconnects are configured for redundancy. It provides resiliency in case of failures. The first step is to establish connectivity between blades and Fabric Interconnects.

Configure Global Policies

The chassis discovery policy determines how the system reacts when you add a new chassis. We recommend using the platform max value as shown. Using platform max helps ensure that Cisco UCS Manager uses the maximum number of IOM uplinks available.

To configure global policies, follow these steps:

1. In Cisco UCS Manager; Go to Equipment > Policies (right pane) > Global Policies > Chassis/FEX Discovery Policies. As shown in the screenshot below, select Action as “Platform Max” from the drop-down list and set Link Grouping to Port Channel.
2. Click Save Changes.
3. Click OK.

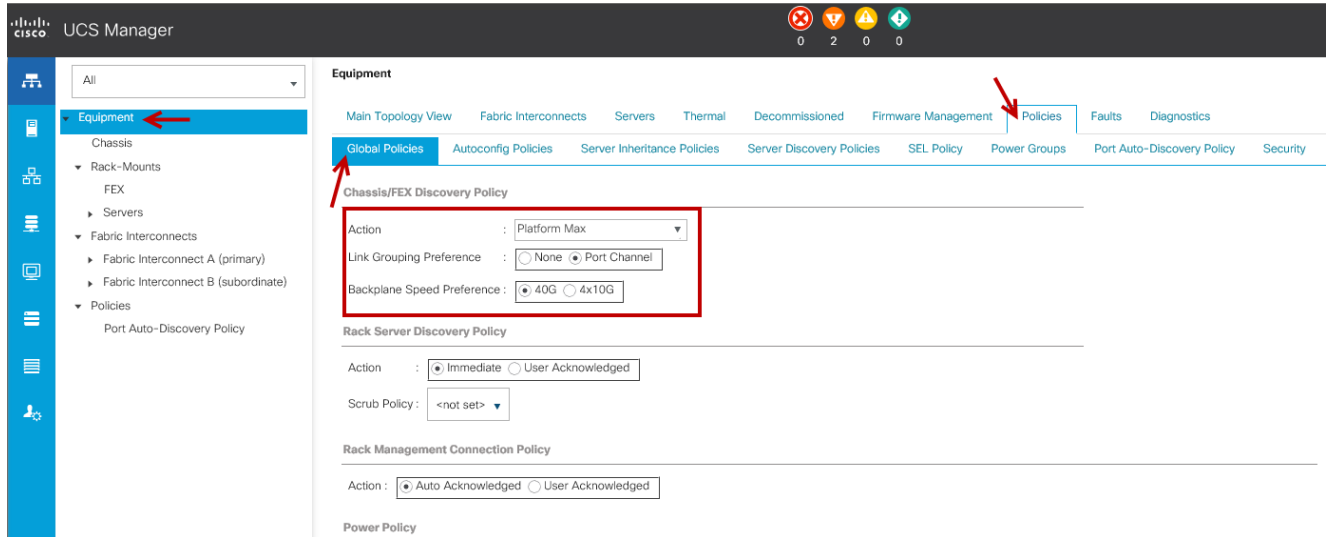

Fabric Ports: Discrete versus Port Channel Mode

Figure 31 illustrates the advantage of Discrete Vs Port-Channel mode in UCSM.

Figure 31 Port Channel versus Discrete Mode

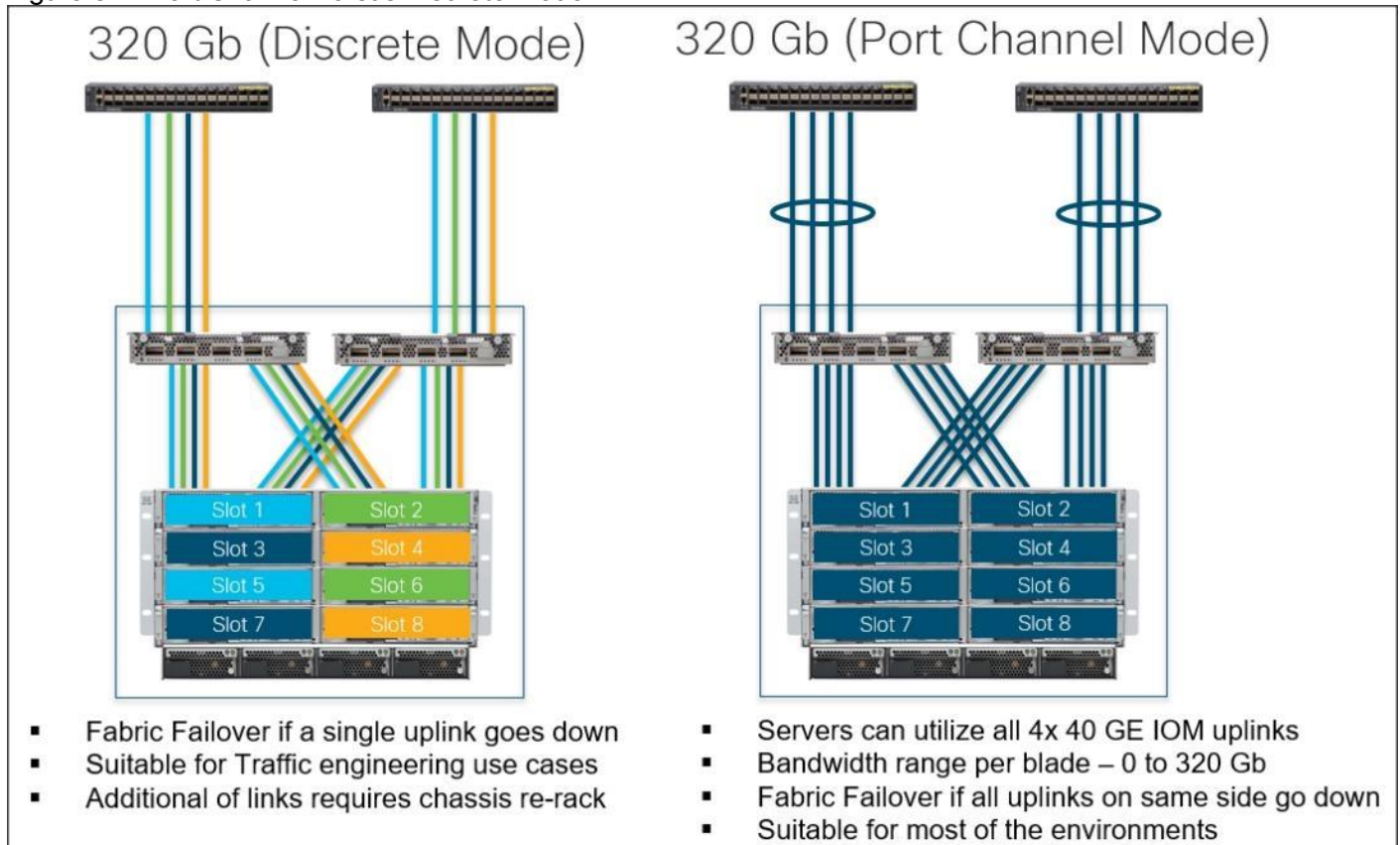

Set Fabric Interconnects to Fibre Channel End Host Mode

In order to configure FC Uplink ports connected to Cisco UCS MDS 9132T 32-Gbps FC switch set the Fabric Interconnects to the Fibre Channel End Host Mode. Verify that Fabric Interconnects are operating in “FC End-Host Mode.”

The screenshot displays the Cisco UCS Manager interface. On the left, the navigation pane shows the path: Fabric Interconnects > Fabric Interconnect A (primary) > Set FC End-Host Mode. The 'Set FC End-Host Mode' option is highlighted with a red box. A red arrow points from this option to the 'Actions' pane on the right. The right pane shows the 'Fabric Interconnects / Fabric Interconnect A (primary)' configuration page. The 'General' tab is selected, and the 'Fault Summary' section shows three status indicators (0) and a list of operational modes including 'Operable', 'OK', and 'End Host'.



Fabric Interconnect automatically reboot if switched operational mode; perform this task on one FI first, wait for FI to come up and follow the same on second FI.

Configure FC SAN Uplink Ports

To configure Fibre Channel Uplink ports, follow these steps:

1. Go to Equipment > Fabric Interconnects > Fabric Interconnect A > General tab > Actions pane, click Configure Unified ports.

2. Click Yes to confirm in the pop-up window.
3. Move the slider to the right.
4. Click OK.

 Ports to the right of the slider will become FC ports. For our study, we configured the first six ports on the FI as FC Uplink ports.

 Applying this configuration will cause the immediate reboot of Fabric Interconnect and/or Expansion Module(s).

Configure Unified Ports

The position of the slider determines the type of the ports. All the ports to the left of the slider are Fibre Channel ports (Purple), while the ports to the right are Ethernet ports (Blue).
Instructions

Port	Transport	If Role or Port Channel Membership	Desired If Role
Port 1	ether	Unconfigured	FC Uplink
Port 2	ether	Unconfigured	FC Uplink
Port 3	ether	Unconfigured	FC Uplink
Port 4	ether	Unconfigured	FC Uplink
Port 5	ether	Unconfigured	FC Uplink
Port 6	ether	Unconfigured	FC Uplink
Port 7	ether	Unconfigured	
Port 8	ether	Unconfigured	
Port 9	ether	Unconfigured	
Port 10	ether	Unconfigured	
Port 11	ether	Unconfigured	
Port 12	ether	Unconfigured	
Port 13	ether	Unconfigured	
Port 14	ether	Unconfigured	
Port 15	ether	Unconfigured	
Port 16	ether	Unconfigured	

OK Cancel

5. Click Yes to apply the changes.
6. After the FI reboot, your FC Ports configuration will look like Figure 32.
7. Follow the same steps on Fabric Interconnect B.

Figure 32 FC Uplink Ports on Fabric Interconnect A

UCS Manager

Equipment / Fabric Interconnects / Fabric Interconnect A (primary) / Fixed Module / FC Ports

FC Ports

Slot	Port ID	WWPN	If Role	If Type	Overall Status	Admin State
1	1	20:01:00:DE:FB:92:8D:00	Network	Physical	Up	Enabled
1	2	20:02:00:DE:FB:92:8D:00	Network	Physical	Up	Enabled
1	3	20:03:00:DE:FB:92:8D:00	Network	Physical	Up	Enabled
1	4	20:04:00:DE:FB:92:8D:00	Network	Physical	Up	Enabled
1	5	20:05:00:DE:FB:92:8D:00	Network	Physical	Stp Not Present	Enabled
1	6	20:06:00:DE:FB:92:8D:00	Network	Physical	Stp Not Present	Enabled

Configure Server Ports

Configure the server ports to initiate chassis and blade discovery. To configure server ports, follow these steps:

1. Go to Equipment > Fabric Interconnects > Fabric Interconnect A > Fixed Module > Ethernet Ports.

- Select the ports (for this solution ports are 17-24) which are connected to the Cisco IO Modules of the two B-Series 5108 Chassis.
- Right-click and select “Configure as Server Port.”

Figure 33 Configure Server Port on Cisco UCS Manager Fabric Interconnect for Chassis/Server Discovery

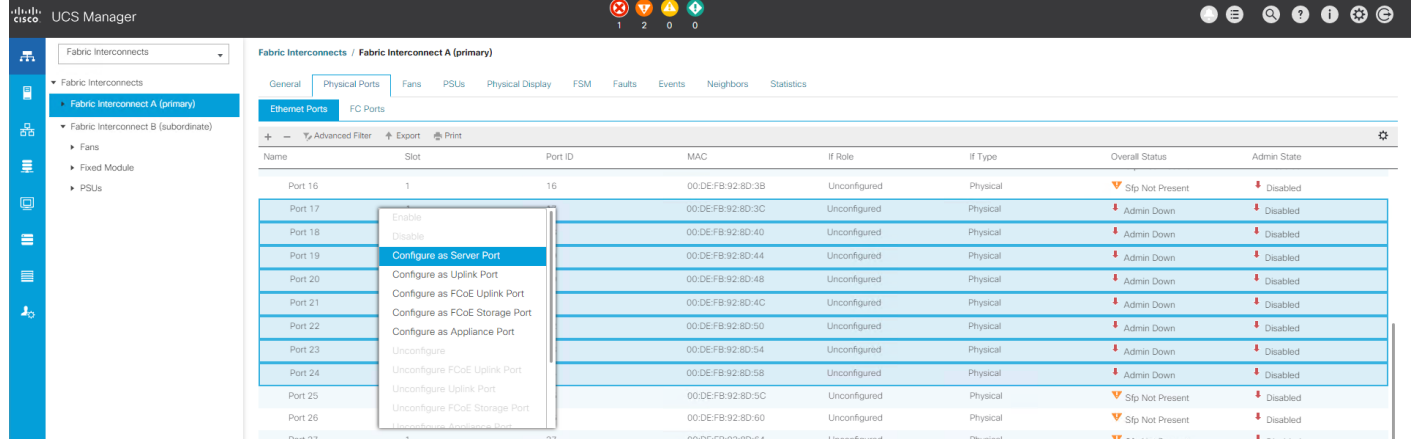

- Click Yes to confirm and click OK.
- Perform the same steps to configure “Server Port” on Fabric Interconnect B.

When configured, the server port will look like Figure 34 on both Fabric Interconnects.

Figure 34 Server Ports on Fabric Interconnect A

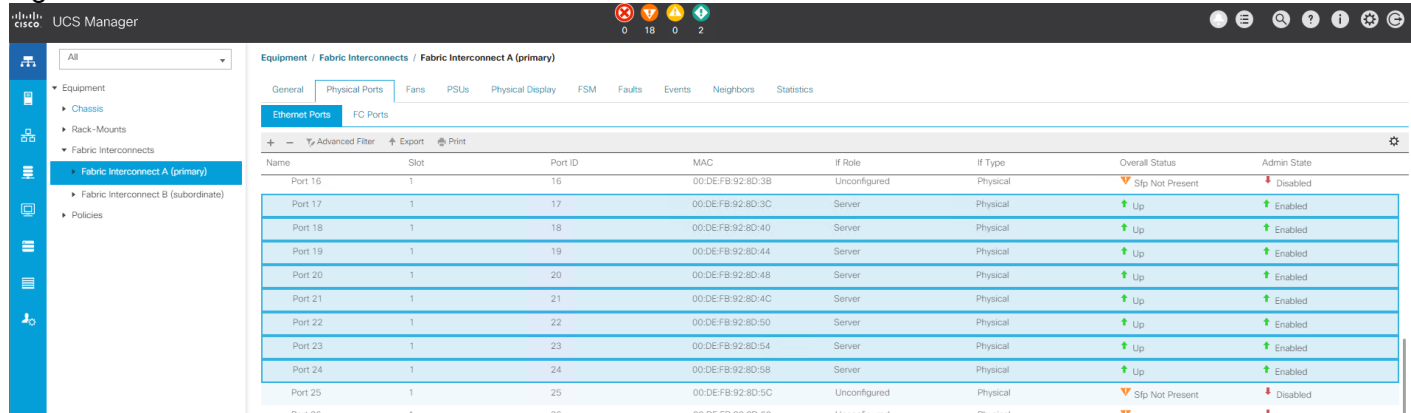

- After configuring Server Ports, acknowledge both the Chassis. Go to Equipment > Chassis > Chassis 1 > General > Actions > select “Acknowledge Chassis”. Similarly, acknowledge the chassis 2-4.
- After acknowledging both the chassis, re-acknowledge all the servers placed in the chassis. Go to Equipment > Chassis 1 > Servers > Server 1 > General > Actions > select Server Maintenance > select option “Re-acknowledge” and click OK. Repeat this process to re-acknowledge all eight Servers.
- When the acknowledgement of the Servers is completed, verify the Port-channel of Internal LAN. Go to the LAN tab > Internal LAN > Internal Fabric A > Port Channels as shown in Figure 35.

Figure 35 Internal LAN Port Channels

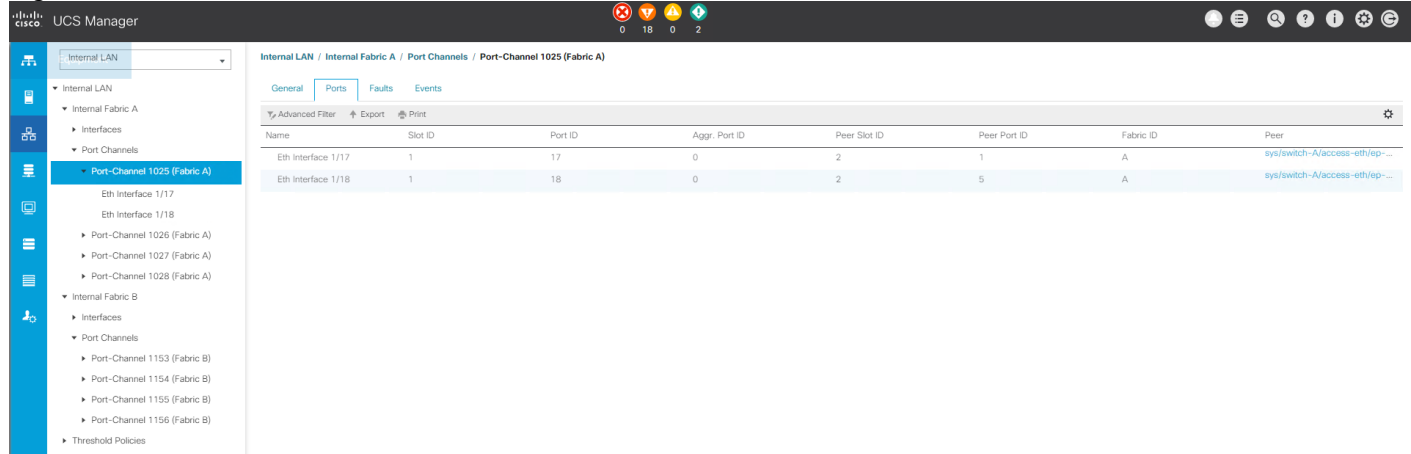

Configure Ethernet LAN Uplink Ports

To configure network ports that are used to uplink the Fabric Interconnects to the Cisco Nexus switches, follow these steps:

1. In Cisco UCS Manager, in the navigation pane, click the Equipment tab.
2. Select Equipment > Fabric Interconnects > Fabric Interconnect A > Fixed Module.
3. Expand Ethernet Ports.
4. Select ports (for this solution ports are 39-40) that are connected to the Nexus switches, right-click them, and select Configure as Network Port.

Figure 36 Network Uplink Port Configuration on Fabric Interconnect Configuration

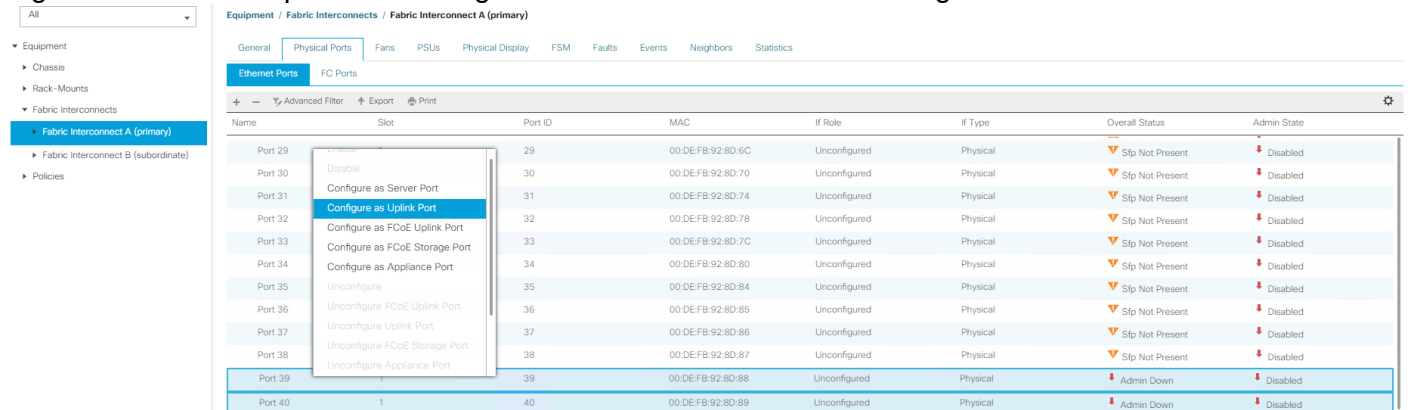

5. Click Yes to confirm ports and click OK.
6. Verify the Ports connected to Cisco A Nexus upstream switches are now configured as network ports.
7. Repeat steps 1-6 for Fabric Interconnect B. The screenshot below shows the network uplink ports for Fabric A.

Figure 37 Network Uplink Port on Fabric Interconnect

The screenshot shows the Cisco UCS Manager interface for Fabric Interconnect B (subordinate). The 'Physical Ports' tab is active, displaying a table of Ethernet Ports. The table has the following columns: Name, Slot, Port ID, MAC, If Role, If Type, Overall Status, and Admin State. The data is as follows:

Name	Slot	Port ID	MAC	If Role	If Type	Overall Status	Admin State
Port 16	1	16	00:DE:FB:90:A4:63	Unconfigured	Physical	Sfp Not Present	Disabled
Port 17	1	17	00:DE:FB:90:A4:64	Server	Physical	Up	Enabled
Port 18	1	18	00:DE:FB:90:A4:68	Server	Physical	Up	Enabled
Port 19	1	19	00:DE:FB:90:A4:6C	Server	Physical	Up	Enabled
Port 20	1	20	00:DE:FB:90:A4:70	Server	Physical	Up	Enabled
Port 21	1	21	00:DE:FB:90:A4:74	Server	Physical	Up	Enabled
Port 22	1	22	00:DE:FB:90:A4:78	Server	Physical	Up	Enabled
Port 23	1	23	00:DE:FB:90:A4:7C	Server	Physical	Up	Enabled
Port 24	1	24	00:DE:FB:90:A4:80	Server	Physical	Up	Enabled
Port 25	1	25	00:DE:FB:90:A4:84	Unconfigured	Physical	Sfp Not Present	Disabled
Port 26	1	26	00:DE:FB:90:A4:88	Unconfigured	Physical	Sfp Not Present	Disabled
Port 27	1	27	00:DE:FB:90:A4:8C	Unconfigured	Physical	Sfp Not Present	Disabled
Port 28	1	28	00:DE:FB:90:A4:90	Unconfigured	Physical	Sfp Not Present	Disabled
Port 29	1	29	00:DE:FB:90:A4:94	Unconfigured	Physical	Sfp Not Present	Disabled
Port 30	1	30	00:DE:FB:90:A4:98	Unconfigured	Physical	Sfp Not Present	Disabled
Port 31	1	31	00:DE:FB:90:A4:9C	Unconfigured	Physical	Sfp Not Present	Disabled
Port 32	1	32	00:DE:FB:90:A4:A0	Unconfigured	Physical	Sfp Not Present	Disabled
Port 33	1	33	00:DE:FB:90:A4:A4	Unconfigured	Physical	Sfp Not Present	Disabled
Port 34	1	34	00:DE:FB:90:A4:A8	Unconfigured	Physical	Sfp Not Present	Disabled
Port 35	1	35	00:DE:FB:90:A4:AC	Unconfigured	Physical	Sfp Not Present	Disabled
Port 36	1	36	00:DE:FB:90:A4:AD	Unconfigured	Physical	Sfp Not Present	Disabled
Port 37	1	37	00:DE:FB:90:A4:AE	Unconfigured	Physical	Sfp Not Present	Disabled
Port 38	1	38	00:DE:FB:90:A4:AF	Unconfigured	Physical	Sfp Not Present	Disabled
Port 39	1	39	00:DE:FB:90:A4:B0	Network	Physical	Up	Enabled
Port 40	1	40	00:DE:FB:90:A4:B1	Network	Physical	Up	Enabled

You have now created two uplink ports on each Fabric Interconnect as shown above. These ports will be used to create Virtual Port Channel in the next section.

Create Uplink Port Channels to Cisco Nexus Switches

In this procedure, two port channels were created; one from Fabric A to both Cisco Nexus 93180YC-FX switches and one from Fabric B to both Cisco Nexus 93180YC-FX switches. To configure the necessary port channels in the Cisco UCS environment, follow these steps:

1. In Cisco UCS Manager, click the LAN tab in the navigation pane.
2. Under LAN > LAN Cloud, expand node Fabric A tree:
 - a. Right-click Port Channels.
 - b. Select Create Port Channel.
 - c. Enter 11 as the unique ID of the port channel.



3. Enter name of the port channel.
4. Click Next.
5. Select Ethernet ports 39-40 for the port channel.
6. Click Finish.
7. Repeat steps 1-6 for the Port Channel configuration on FI-B.

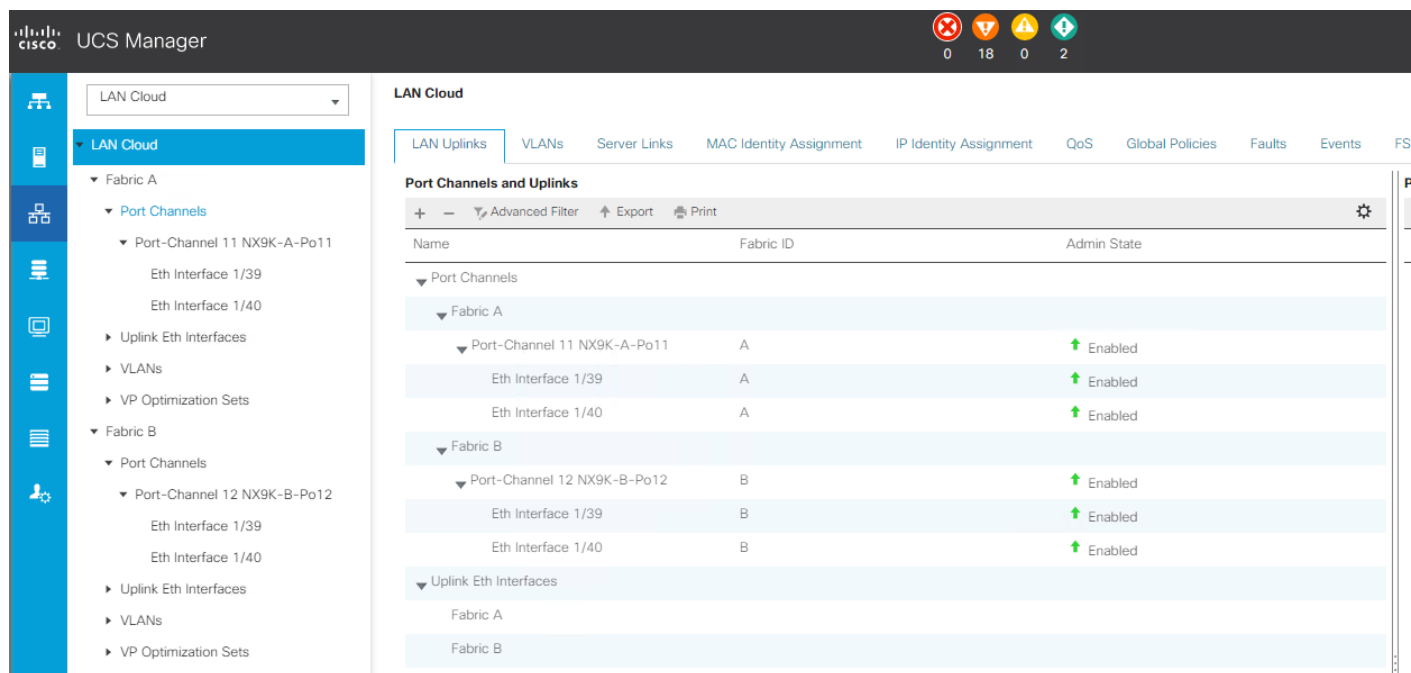

Configure VLAN

To configure the necessary virtual local area networks (VLANs) for the Cisco UCS environment, follow these steps:

1. In Cisco UCS Manager, click the LAN tab in the navigation pane.
2. Select LAN > LAN Cloud.
3. Right-click VLANs.

4. Select Create VLANs.
5. Enter Public_Traffic as the name of the VLAN to be used for Public Network Traffic.
6. Keep the Common/Global option selected for the scope of the VLAN.
7. Enter 134 as the ID of the VLAN ID.
8. Keep the Sharing Type as None.

Create VLANs ? X

VLAN Name/Prefix :

Multicast Policy Name : [Create Multicast Policy](#)

Common/Global
 Fabric A
 Fabric B
 Both Fabrics Configured Differently

You are creating global VLANs that map to the same VLAN IDs in all available fabrics.
 Enter the range of VLAN IDs.(e.g. " 2009-2019" , " 29,35,40-45" , " 23" , " 23,34-45")

VLAN IDs :

Sharing Type : None Primary Isolated Community

9. Repeat steps 1-8 to create required VLANs. Figure 38 shows the VLANs configured for this solution.

Figure 38 VLANs Configured for this Solution

Name	ID	Type	Transport	Native	VLAN Sharing
VLAN default (1)	1	Lan	Ether	Yes	None
VLAN InBand-Mgmt (70)	70	Lan	Ether	No	None
VLAN Infra-Mgmt (71)	71	Lan	Ether	No	None
VLAN Launcher (76)	76	Lan	Ether	No	None
VLAN VM-Network (72)	72	Lan	Ether	No	None
VLAN vMotion (73)	73	Lan	Ether	No	None

IMPORTANT! Create both VLANs with global across both fabric interconnects. This makes sure the VLAN identity is maintained across the fabric interconnects in case of a NIC failover.

Configure VSAN

To configure the necessary virtual storage area networks (VSANs) for the Cisco UCS environment, follow these steps:

1. In Cisco UCS Manager, click the SAN tab in the navigation pane.

2. Select SAN > SAN Cloud.
3. Under VSANs, right-click VSANs.
4. Select Create VSANs.
5. Enter the name of the VSAN.
6. Enter VSAN ID and FCoE VLAN ID.
7. Click OK.



In this solution, we created two VSANs; VSAN-A 100 and VSAN-B 101 for SAN Boot and Storage Access.

8. Select Fabric A for the scope of the VSAN:
 - a. Enter 100 as the ID of the VSAN.
 - b. Click OK and then click OK again.
9. Repeat steps 1-8 to create the VSANs necessary for this solution.

VSAN 100 and 101 are configured as shown below:

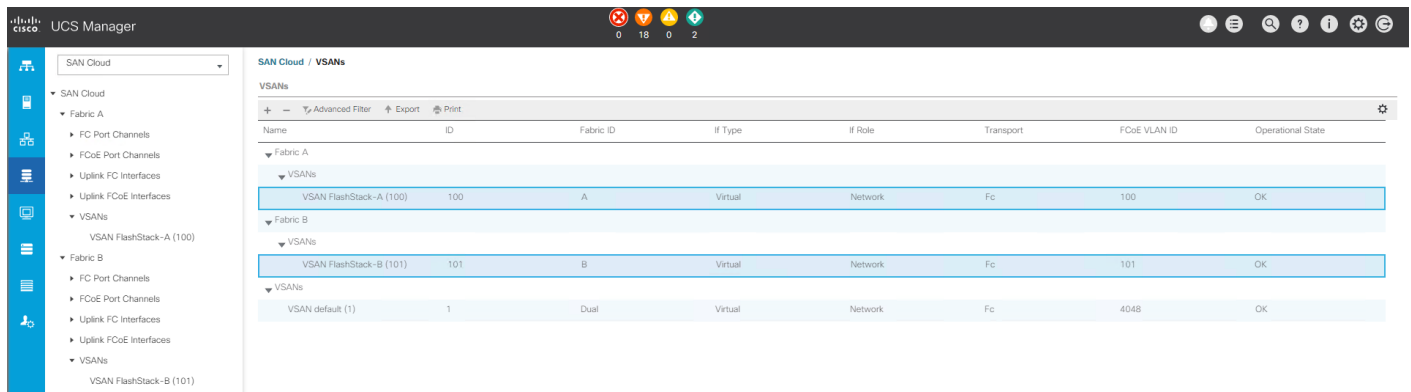
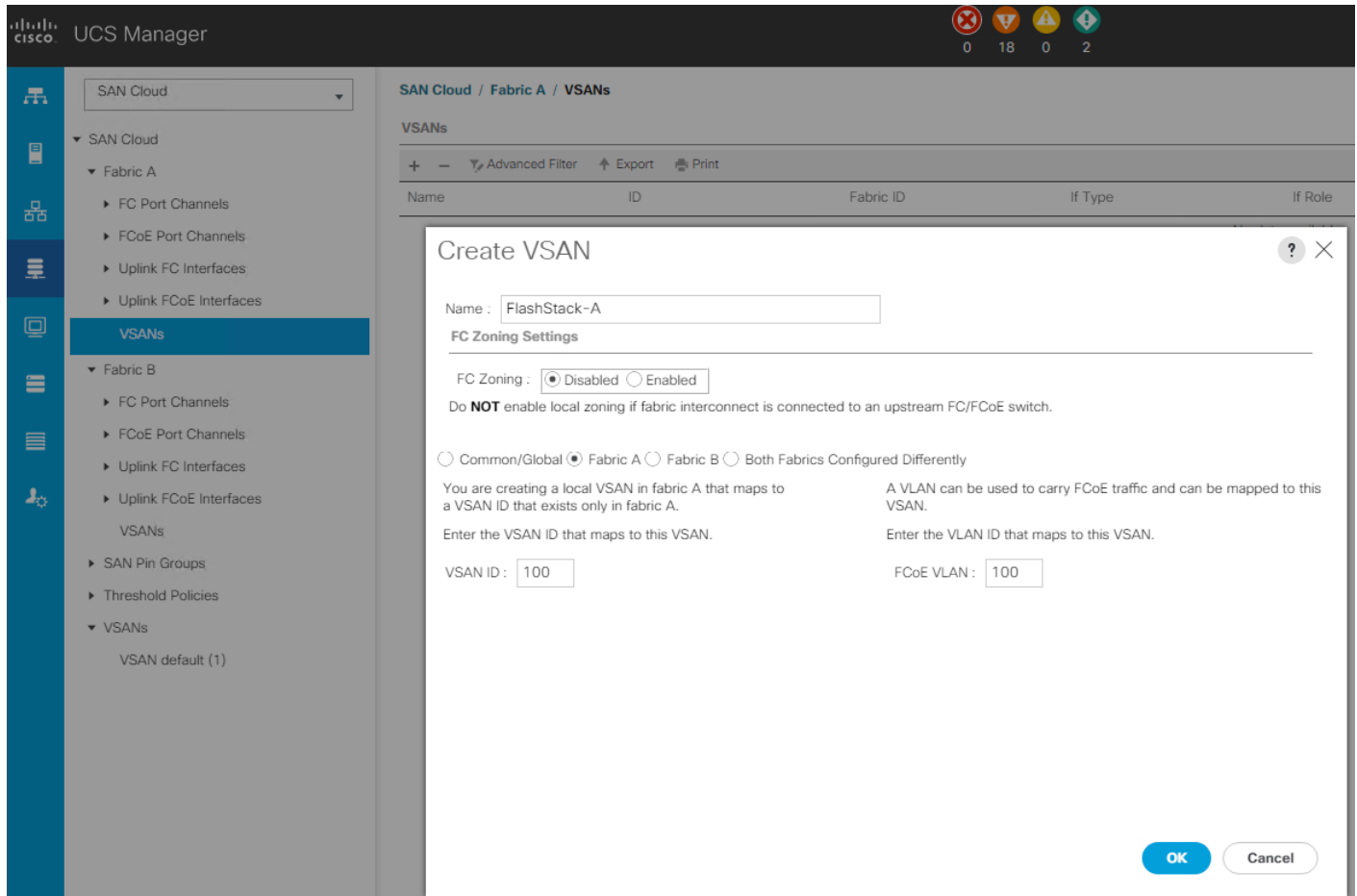

Create New Sub-Organization

To configure the necessary Sub-Organization for the Cisco UCS environment, follow these steps:

1. In Cisco UCS Manager, click the Servers tab in the navigation pane.
2. Select root > Sub-Organization.
3. Right-click Sub-Organization.
4. Enter the name of the Sub-Organization.

5. Click OK.

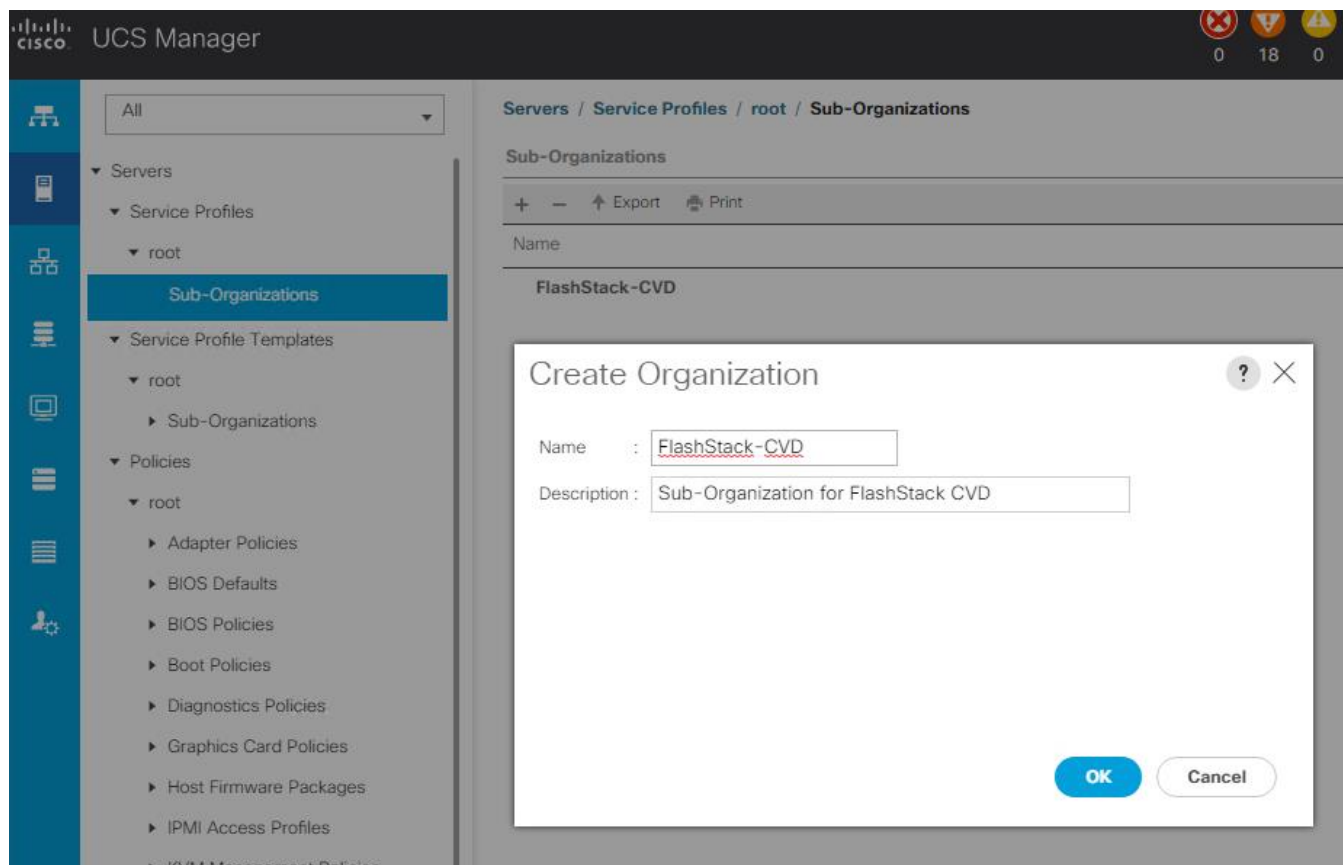

You will create pools and policies required for this solution under the newly created “FlashStack-CVD” sub-organization.

Configure IP, UUID, Server, MAC, WWNN, and WWPN Pools

IP Pool Creation

An IP address pool on the out of band management network must be created to facilitate KVM access to each compute node in the Cisco UCS domain. To create a block of IP addresses for server KVM access in the Cisco UCS environment, follow these steps:

1. In Cisco UCS Manager, in the navigation pane, click the LAN tab.
2. Select Pools > root > Sub-Organizations > FlashStack-CVD > IP Pools > click Create IP Pool.
3. Select option Sequential to assign IP in sequential order then click Next.

Create IP Pool

1 Define Name and Description

2 Add IPv4 Blocks

3 Add IPv6 Blocks

Name : FlashStack-KVMPool

Description :

Assignment Order : Default Sequential

4. Click Add IPv4 Block.

5. Enter the starting IP address of the block and the number of IP addresses required, and the subnet and gateway information as shown below.

Create IP Pool

1 Define Name and Description

2 Add IPv4 Blocks

3 Add IPv6 Blocks

Create Block of IPv4 Addresses

From : 10.29.164.166

Size : 32

Subnet Mask : 255.255.255.0

Primary DNS : 0.0.0.0

Default Gateway : 10.29.164.1

Secondary DNS : 0.0.0.0

OK Cancel

+ Add - Delete

UUID Suffix Pool Creation

To configure the necessary universally unique identifier (UUID) suffix pool for the Cisco UCS environment, follow these steps:

1. In Cisco UCS Manager, click the Servers tab in the navigation pane.
2. Select Pools > root > Sub-Organization > FlashStack-CVD
3. Right-click UUID Suffix Pools and then select Create UUID Suffix Pool.
4. Enter the name of the UUID name.
5. Optional: Enter a description for the UUID pool.
6. Keep the prefix at the derived option and select Sequential in as Assignment Order then click Next.

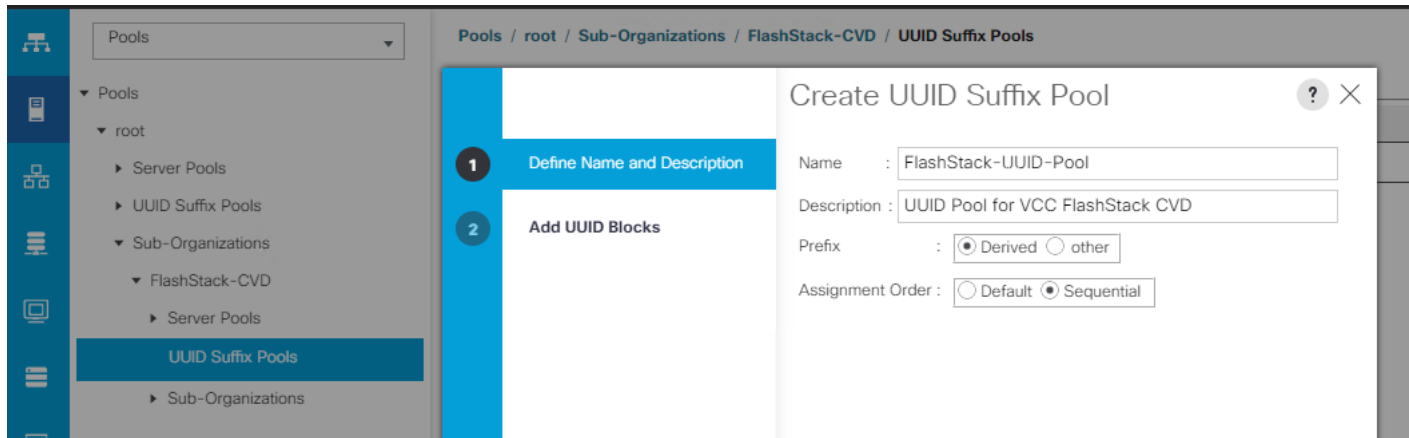

7. Click Add to add a block of UUIDs.
8. Create a starting point UUID as per your environment.
9. Specify a size for the UUID block that is sufficient to support the available blade or server resources.

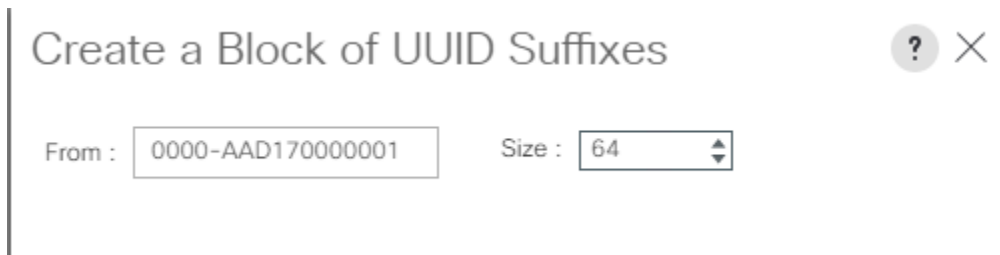

Server Pool Creation

To configure the necessary server pool for the Cisco UCS environment, follow these steps:



Consider creating unique server pools to achieve the granularity that is required in your environment.

1. In Cisco UCS Manager, click the Servers tab in the navigation pane.
2. Select Pools > root > Sub-Organization > FlashStack-CVD > right-click Server Pools > Select Create Server Pool.
3. Enter name of the server pool.
4. Optional: Enter a description for the server pool then click Next.

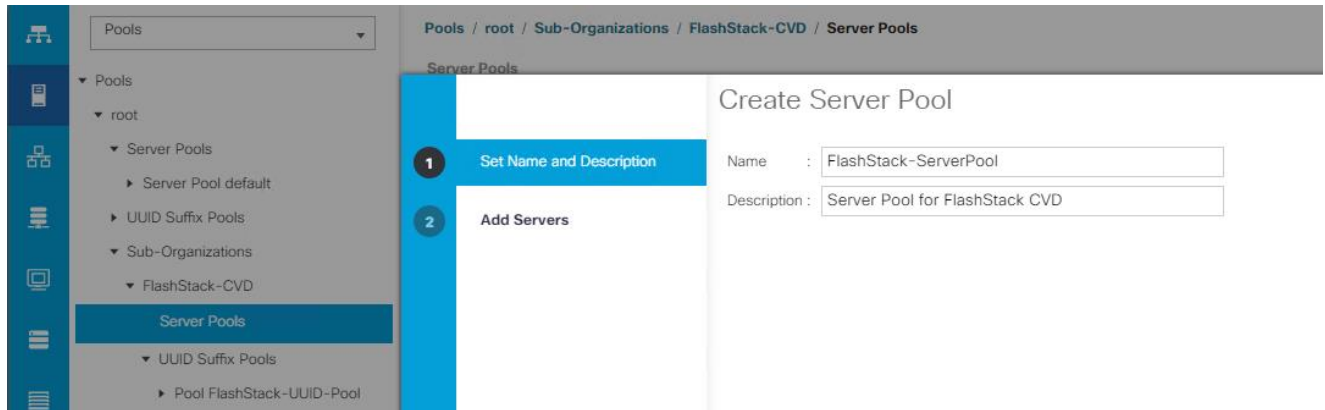

5. Select servers to be used for the deployment and click > to add them to the server pool. In our case we added thirty servers in this server pool.
6. Click Finish and then click OK.

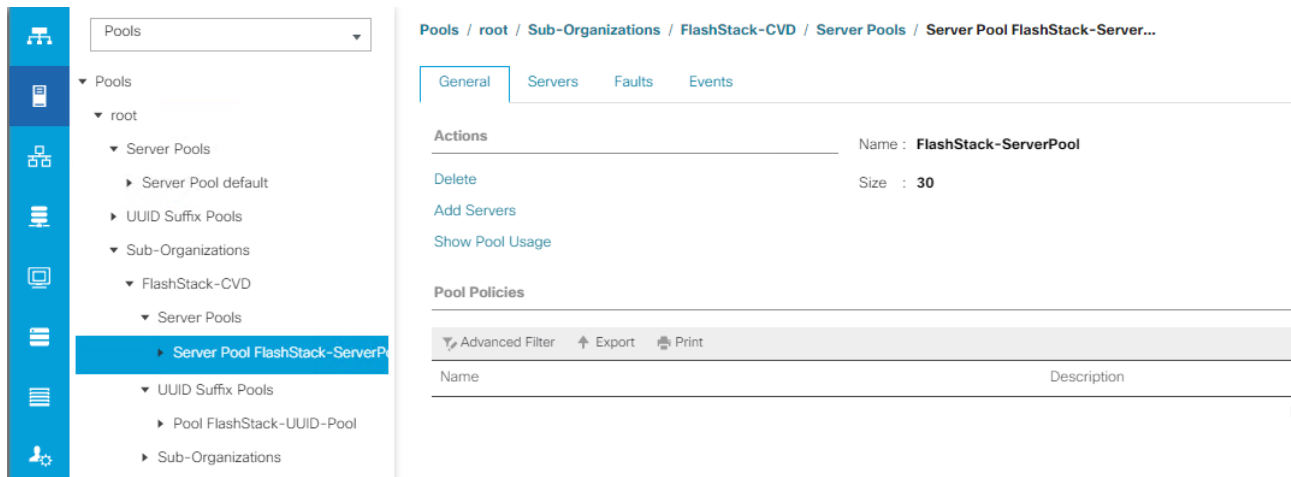

MAC Pool Creation

To configure the necessary MAC address pools for the Cisco UCS environment, follow these steps:

1. In Cisco UCS Manager, click the LAN tab in the navigation pane.
2. Select Pools > root > Sub-Organization > FlashStack > right-click MAC Pools under the root organization.
3. Select Create MAC Pool to create the MAC address pool.
4. Enter name for MAC pool. Select Assignment Order as "Sequential."
5. Enter the seed MAC address and provide the number of MAC addresses to be provisioned.
6. Click OK and then click Finish.
7. In the confirmation message, click OK.

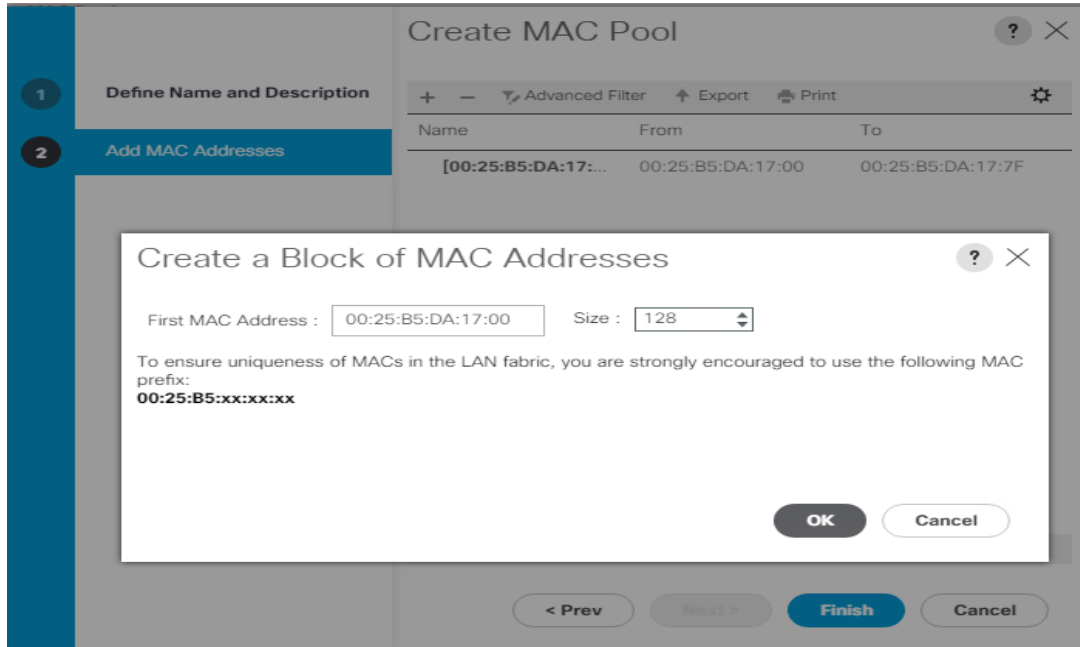

8. Create MAC Pool B and assign unique MAC Addresses as shown below.

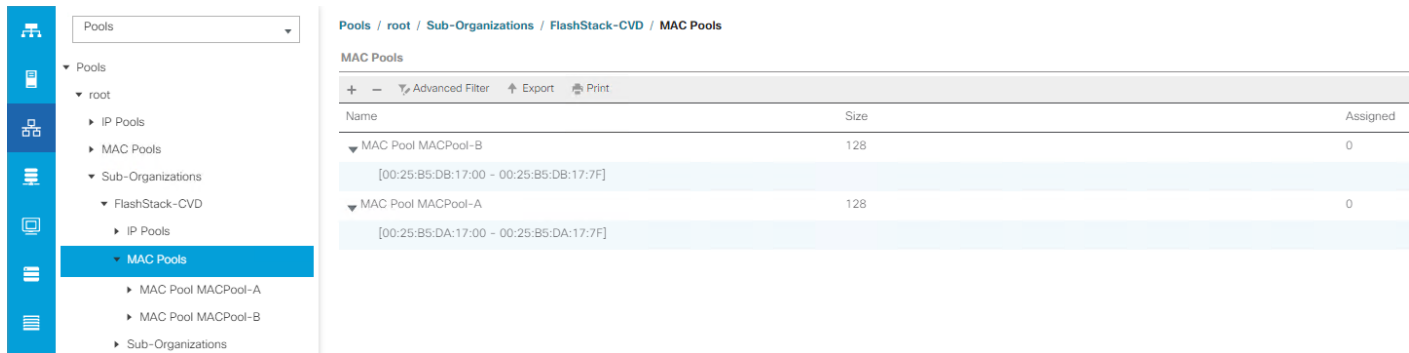

WWNN and WWPN Pool Creation

To configure the necessary WWNN pools for the Cisco UCS environment, follow these steps:

1. In Cisco UCS Manager, click the SAN tab in the navigation pane.
2. Select Pools > Root > Sub-Organization > FlashStack-CVD > WWNN Pools > right-click WWNN Pools > select Create WWNN Pool.
3. Assign name and Assignment Order as sequential.
4. Click Next and then click Add to add block of Ports.
5. Enter Block for WWN and size of WWNN Pool as shown below.

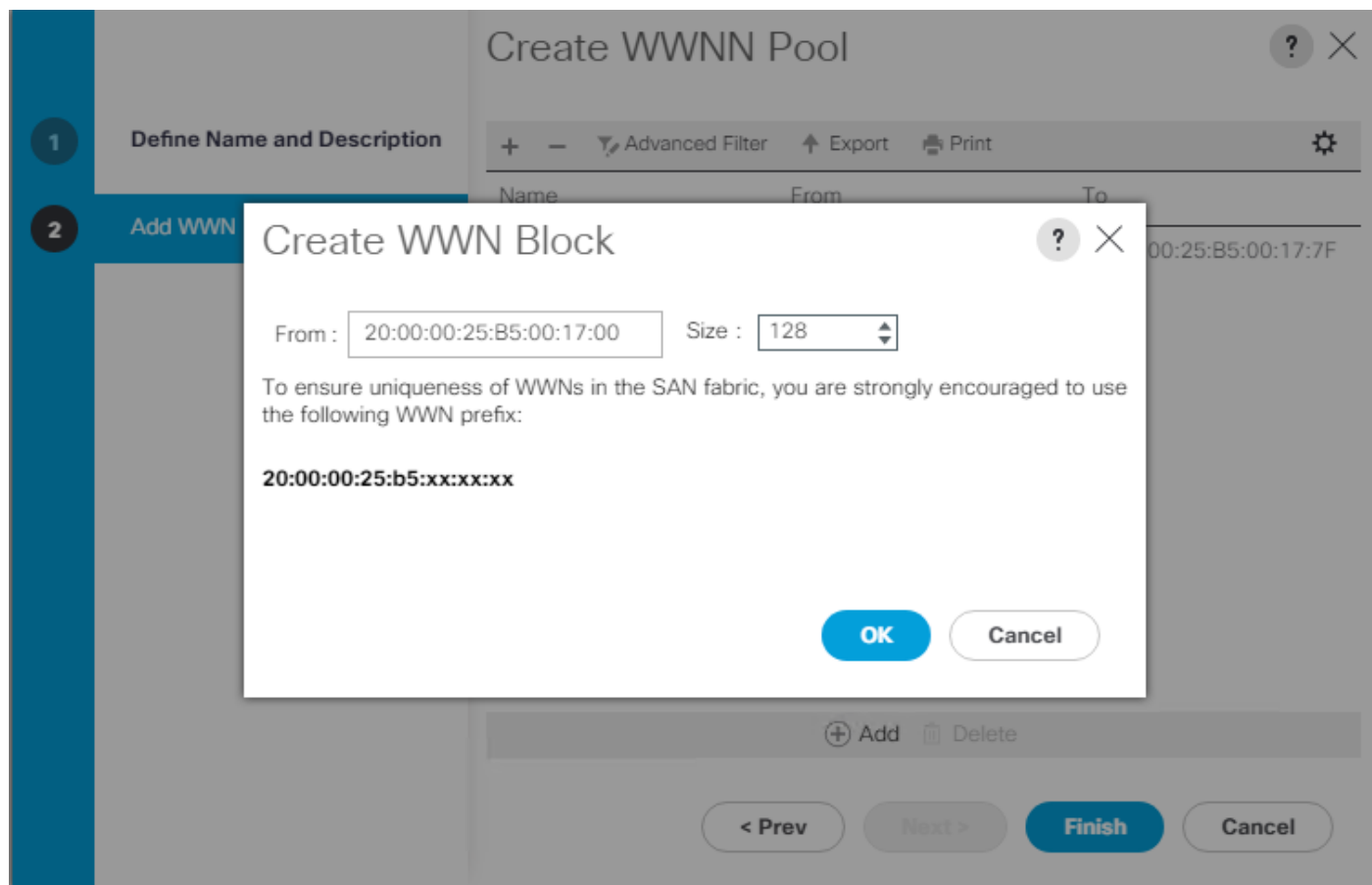

6. Click OK and then click Finish.

To configure the necessary WWPN pools for the Cisco UCS environment, follow these steps:



We created two WWPN as WWPN-A Pool and WWPN-B as World Wide Port Name as shown below. These WWNN and WWPN entries will be used to access storage through SAN configuration.

1. In Cisco UCS Manager, click the SAN tab in the navigation pane.
2. Select Pools > Root > WWPN Pools > right-click WWPN Pools > select Create WWPN Pool.
3. Assign name and Assignment Order as sequential.
4. Click Next and then click Add to add block of Ports.
5. Enter Block for WWN and size.
6. Click OK and then click Finish.

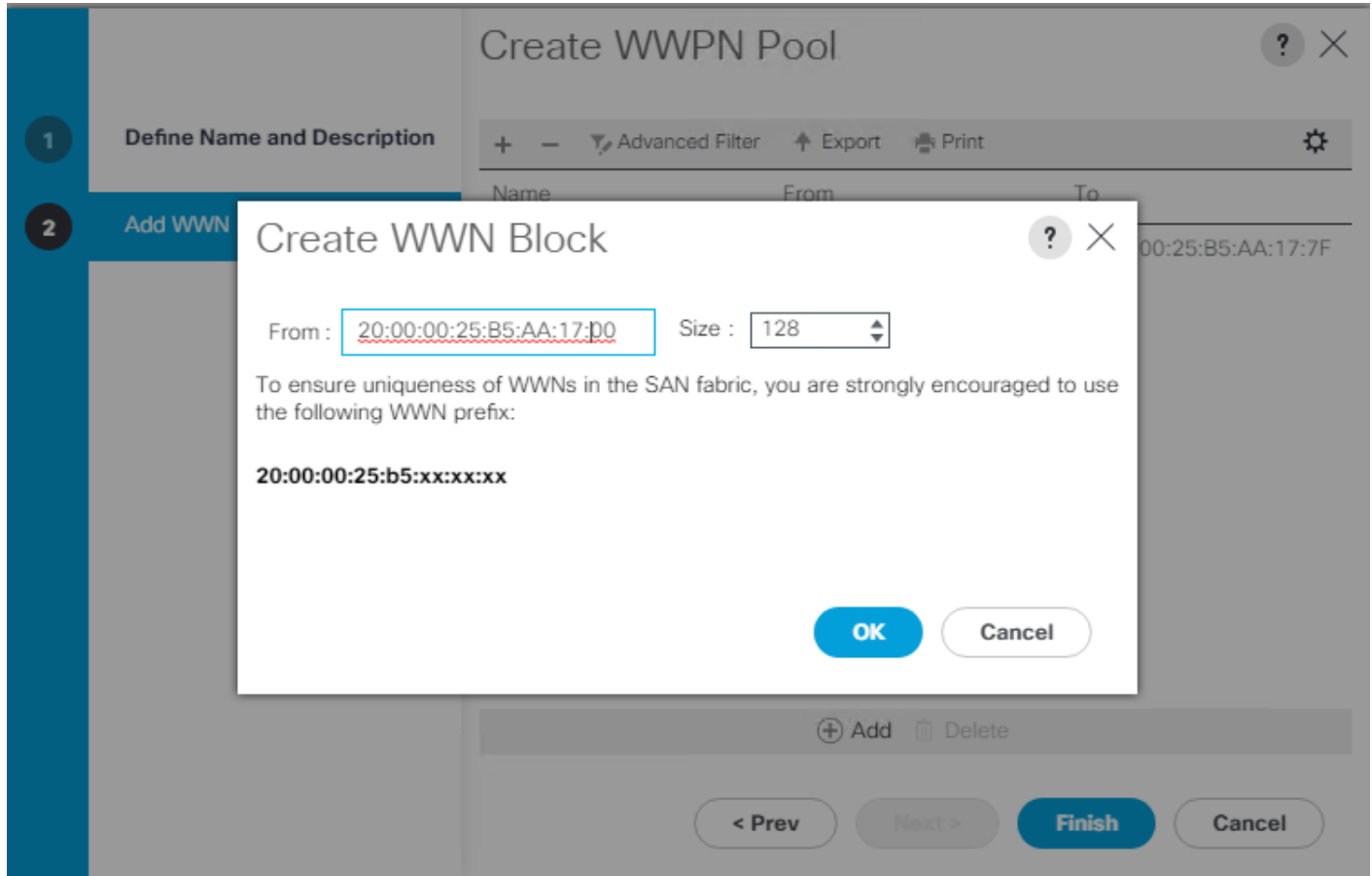

7. Configure WWPN-Bs Pool as well and assign the unique block IDs as shown below.

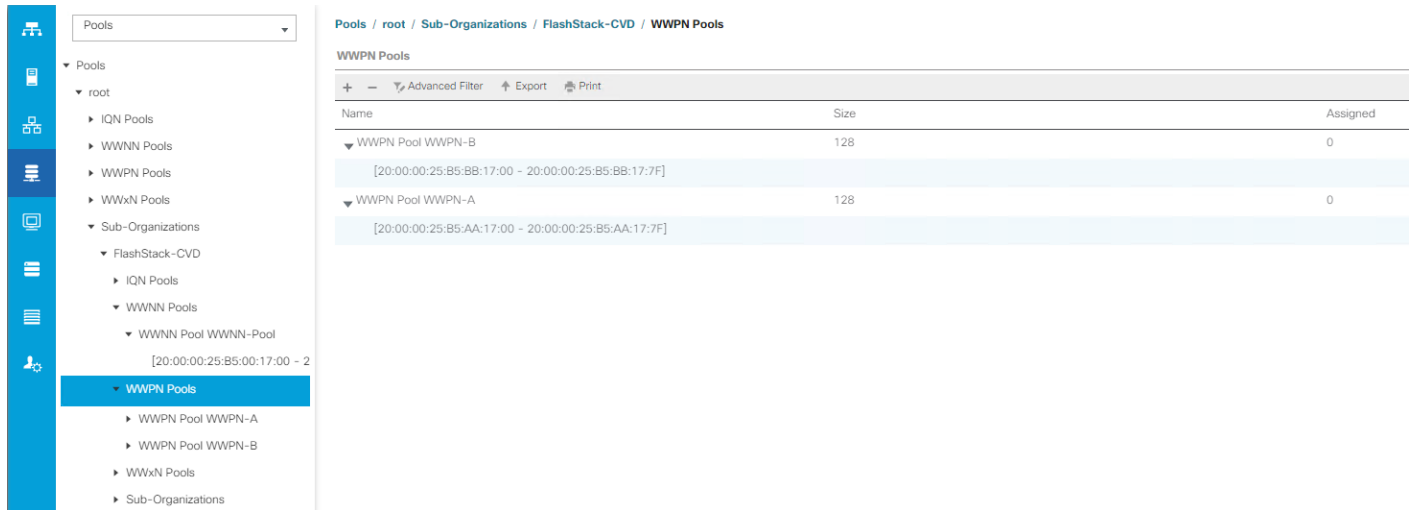

Set Jumbo Frames in both the Cisco Fabric Interconnect

To configure jumbo frames and enable quality of service in the Cisco UCS fabric, follow these steps:

1. In Cisco UCS Manager, click the LAN tab in the navigation pane.

2. Select LAN > LAN Cloud > QoS System Class.
3. In the right pane, click the General tab.
4. On the Best Effort row, enter 9216 in the box under the MTU column.
5. Click Save Changes.
6. Click OK.

The screenshot shows the Cisco UCS Manager interface for configuring a QoS System Class. The left navigation pane is set to 'LAN Cloud' > 'QoS System Class'. The main panel shows the 'General' tab with a table of QoS classes. The 'Best Effort' class is highlighted with a red box, showing an MTU of 9216.

Priority	Enabled	CoS	Packet Drop	Weight	Weight (%)	MTU	Multicast Optimized
Platinum	<input type="checkbox"/>	5	<input type="checkbox"/>	10	N/A	normal	<input type="checkbox"/>
Gold	<input type="checkbox"/>	4	<input checked="" type="checkbox"/>	9	N/A	normal	<input type="checkbox"/>
Silver	<input type="checkbox"/>	2	<input checked="" type="checkbox"/>	8	N/A	normal	<input type="checkbox"/>
Bronze	<input type="checkbox"/>	1	<input checked="" type="checkbox"/>	7	N/A	normal	<input type="checkbox"/>
Best Effort	<input checked="" type="checkbox"/>	Any	<input checked="" type="checkbox"/>	5	50	9216	<input type="checkbox"/>
Fibre Channel	<input checked="" type="checkbox"/>	3	<input type="checkbox"/>	5	50	fc	N/A

Create Host Firmware Package

Firmware management policies allow the administrator to select the corresponding packages for a given server configuration. These policies often include packages for adapter, BIOS, board controller, FC adapters, host bus adapter (HBA) option ROM, and storage controller properties.

To create a firmware management policy for a given server configuration in the Cisco UCS environment, follow these steps:

1. In Cisco UCS Manager, click the Servers tab in the navigation pane.
2. Select root > Sub-Organization > FlashStack-CVD > Host Firmware Packages.
3. Right-click Host Firmware Packages.
4. Select Create Host Firmware Package.
5. Enter name of the host firmware package.
6. Leave Simple selected.
7. Select the version 4.0(2b) for both the Blade Package.
8. Click OK to create the host firmware package.

Create Host Firmware Package

Name :

Description :

How would you like to configure the Host Firmware Package?

Simple Advanced

Blade Package :

Rack Package :

Service Pack :

Create Server Pool Policy

Create Server Pools Policy

Creating the server pool policy requires you to create the Server Pool Policy and Server Pool Qualification Policy.

To create a Server Pools Policy, follow these steps:

1. In Cisco UCS Manager, click the Servers tab in the navigation pane.
2. Select Pools > root > Sub-Organization > FlashStack-CVD > Server Pools.
3. Right-click Server Pools Select Create Server Pools Policy; Enter Policy name.
4. Select server from left pane to add as pooled server.



In our case, we created two server pools policies. For the “VCC-CVD01” policy, we added Servers as Chassis 1 Slot 1-8 and Chassis 3 Slot 1-8 and for the “VCC-CVD02” policy, we added Chassis 2 Slot 1-8 and Chassis 4 Slot 1-8.

Pools

- ▼ Pools
 - ▼ root
 - ▼ Server Pools
 - Server Pool default
 - ▶ UUID Suffix Pools
 - ▼ Sub-Organizations
 - ▼ FlashStack-CVD
 - ▼ Server Pools
 - ▶ Server Pool VCC-CVD01
 - ▶ Server Pool VCC-CVD02
 - ▼ UUID Suffix Pools
 - ▶ Pool FlashStack-UUID-Pool
 - ▶ Sub-Organizations

Pools / root / Sub-Organizations / FlashStack-CVD / Server Pools

Server Pools

+ - Advanced Filter ↑ Export Print

Name	Size	Assigned
▶ Server Pool VCC-CVD01	16	16
▶ Server Pool VCC-CVD02	16	16

Create Server Pool Policy Qualifications

To create a Server Pool Policy Qualification Policy complete following steps:

1. In Cisco UCS Manager, click the Servers tab in the navigation pane.
2. Select Pools > root > Sub-Organization > FlashStack-CVD > Server Pool Policy Qualification.
3. Right-click Server Pools Select Create Server Pool Policy Qualification; Enter Policy name.

4. Select Chassis/Server Qualification from left pane to add in Qualifications.
5. Click Add or OK to either Add more servers to existing policy to Finish creation of Policy.

Create Server Pool Policy Qualification

Naming

Name :

Description :

This server pool policy qualification will apply to new or re-discovered servers. Existing servers are not qualified until they are re-discovered

Actions

- Create Adapter Qualifications
- Create Chassis/Server Qualifications**
- Create Memory Qualifications
- Create CPU/Cores Qualifications
- Create Storage Qualifications
- Create Server PID Qualifications
- Create Power Group Qualifications
- Create Rack Qualifications

Qualifications

+ - Advanced Filter Export Print

Name	Max	Model	From	To	Architec...	Speed	Stepping	Power G...
Chassis id range [1 - 1]			1	1				

+ Add Delete Info



In our case, we created two server pools policies. For the “VCC-CVD01” policy, we added Servers as Chassis 1 Slot 1-8 and Chassis 3 Slot 1-8 and for the “VCC-CVD02” policy, we added Chassis 2 Slot 1-8 and Chassis 4 Slot 1-8.

Policies / root / Sub-Organizations / FlashStack-CVD / Server Pool Policy Qualifications

Server Pool Policy Qualifications

+ - Advanced Filter Export Print

Name	Max	Model	From	To
▼ VCC-CVD01-Qual				
Chassis id range [1 - 1]			1	1
Chassis id range [3 - 3]			3	3
▼ VCC-CVD02-Qual				
Chassis id range [2 - 2]			2	2
Chassis id range [4 - 4]			4	4

To create a Server Pool Policy, follow these steps:

1. In Cisco UCS Manager, click the Servers tab in the navigation pane.
2. Select Pools > root > Sub-Organization > FlashStack-CVD > Server Pool Policies.
3. Right-click Server Pool Policies and Select Create Server Pool Policy; Enter Policy name.

4. Select Target Pool and Qualification from the drop-down list.
5. Click OK.

Create Server Pool Policy ? ×

Name :

Description :

Target Pool :

Qualification :



We created two Server Pool Policies to associate with the Service Profile Templates “VCC-CVD01” and “VCC-CVD02” as described in this section.

Create Network Control Policy for Cisco Discovery Protocol

To create a network control policy that enables Cisco Discovery Protocol (CDP) on virtual network ports, follow these steps:

1. In Cisco UCS Manager, click the LAN tab in the navigation pane.
2. Select Policies > root > Sub-Organization > FlashStack-CVD > Network Control Policies.
3. Right-click Network Control Policies.
4. Select Create Network Control Policy.
5. Enter policy name.
6. Select the Enabled option for “CDP.”
7. Click OK to create the network control policy.

Create Network Control Policy ? ×

Name :

Description :

CDP : Disabled Enabled

MAC Register Mode : Only Native Vlan All Host Vlans

Action on Uplink Fail : Link Down Warning

MAC Security

Forge : Allow Deny

LLDP

Create Power Control Policy

To create a power control policy for the Cisco UCS environment, follow these steps:

1. In Cisco UCS Manager, click the Servers tab in the navigation pane.
2. Select Policies > root > Sub-Organization > FlashStack-CVD > Power Control Policies.
3. Right-click Power Control Policies.
4. Select Create Power Control Policy.
5. Select Fan Speed Policy as “Max Power.”
6. Enter NoPowerCap as the power control policy name.
7. Change the power capping setting to No Cap.
8. Click OK to create the power control policy.

Create Power Control Policy



Name :

Description :

Fan Speed Policy :

Power Capping

If you choose **cap**, the server is allocated a certain amount of power based on its priority within its power group. Priority values range from 1 to 10, with 1 being the highest priority. If you choose **no-cap**, the server is exempt from all power capping.

No Cap cap

Cisco UCS Manager only enforces power capping when the servers in a power group require more power than is currently available. With sufficient power, all servers run at full capacity regardless of their priority.

Create Server BIOS Policy

To create a server BIOS policy for the Cisco UCS environment, follow these steps:

1. In Cisco UCS Manager, click the Servers tab in the navigation pane.
2. Select Policies > root > Sub-Organization > FlashStack-CVD > BIOS Policies.
3. Right-click BIOS Policies.
4. Select Create BIOS Policy.
5. Enter B200-M5-BIOS as the BIOS policy name.
6. Leave all BIOS setting as "Platform Default."

Policies / root / Sub-Organizations / FlashStack-CVD / BIOS Policies / B200-M5-BIOS

Main Advanced Boot Options Server Management Events

Actions

Delete
Show Policy Usage
Use Global

Properties

Name	:	B200-M5-BIOS
Description	:	<input type="text"/>
Owner	:	Local
Reboot on BIOS Settings Change	:	<input checked="" type="checkbox"/>

Configure Maintenance Policy

To update the default Maintenance Policy, follow these steps:

1. In Cisco UCS Manager, click the Servers tab in the navigation pane.
2. Select Policies > root > Sub-Organization > FlashStack-CVD > Maintenance Policies.
3. Right-click Maintenance Policies to create a new policy.
4. Enter name for Maintenance Policy
5. Change the Reboot Policy to User Ack.
6. Click Save Changes.
7. Click OK to accept the change.

Policies / root / Sub-Organizations / FlashStack-CVD / Maintenance Policies / UserAck

General Events

Actions	Properties
Delete	Name : UserAck
Show Policy Usage	Description : <input type="text"/>
Use Global	Owner : Local
	Soft Shutdown Timer : 150 Secs <input type="text"/>
	Storage Config. Deployment Policy : <input type="radio"/> Immediate <input checked="" type="radio"/> User Ack
	Reboot Policy : <input type="radio"/> Immediate <input checked="" type="radio"/> User Ack <input type="radio"/> Timer Automatic
	<input checked="" type="checkbox"/> On Next Boot (Apply pending changes at next reboot.)

Create vNIC Templates

To create multiple virtual network interface card (vNIC) templates for the Cisco UCS environment, follow these steps:

1. In Cisco UCS Manager, click the LAN tab in the navigation pane.
2. Select Policies > root > Sub-Organization > FlashStack-CVD > vNIC Template.
3. Right-click vNIC Templates.
4. Select Create vNIC Template.
5. Enter name for vNIC template.
6. Keep Fabric A selected. Do not select the Enable Failover checkbox.
7. For Redundancy Type, Select "Primary Template."
8. Select Updating Template as the Template Type.
9. Under VLANs, select the checkboxes for desired VLANs to add as part of the vNIC Template.
10. Set Native-VLAN as the native VLAN.
11. For MTU, enter 9000.
12. In the MAC Pool list, select MAC Pool configure for Fabric A.
13. In the Network Control Policy list, select CDP_Enabled.
14. Click OK to create the vNIC template.

Create vNIC Template



If **VM** is selected, a port profile by the same name will be created.
 If a port profile of the same name exists, and updating template is selected, it will be overwritten

Template Type : Initial Template Updating Template

VLANs VLAN Groups

Advanced Filter Export Print

Select	Name	Native VLAN
<input checked="" type="checkbox"/>	default	<input checked="" type="radio"/>
<input checked="" type="checkbox"/>	InBand-Mgmt	<input type="radio"/>
<input checked="" type="checkbox"/>	Infra-Mgmt	<input type="radio"/>
<input checked="" type="checkbox"/>	Launcher	<input type="radio"/>
<input checked="" type="checkbox"/>	VM-Network	<input type="radio"/>
<input checked="" type="checkbox"/>	vMotion	<input type="radio"/>

Create VLAN

CDN Source : vNIC Name User Defined

MTU : 9000

MAC Pool : MACPool-A(128/128)

QoS Policy : <not set>

Network Control Policy : CDP_Enabled

Pin Group : <not set>

Stats Threshold Policy : default

Connection Policies

OK

Cancel

15. Repeat steps 1-14 to create a vNIC Template for Fabric B. For Peer redundancy Template Select "vNIC-Template-A" created in the previous step.

Create vNIC Template ? X

Name : vNIC-Template-B

Description :

Fabric ID : Fabric A Fabric B Enable Failover

Redundancy

Redundancy Type : No Redundancy Primary Template Secondary Template

Peer Redundancy Template : vNIC-Template-A ▼

Target

Adapter
 VM

Warning

If **VM** is selected, a port profile by the same name will be created.
If a port profile of the same name exists, and updating template is selected, it will be overwritten

Template Type : Initial Template Updating Template

VLANs | VLAN Groups

Advanced Filter | Export | Print ⚙

Select	Name	Native VLAN
<input checked="" type="checkbox"/>	default	<input checked="" type="radio"/>
<input checked="" type="checkbox"/>	InBand-Mgmt	<input type="radio"/>
<input checked="" type="checkbox"/>	Infra-Mgmt	<input type="radio"/>
<input checked="" type="checkbox"/>	Launcher	<input type="radio"/>

16. Verify that vNIC-Template-A Peer Redundancy Template is set to “vNIC-Template-B.”

Create vHBA Templates

To create multiple virtual host bus adapter (vHBA) templates for the Cisco UCS environment, follow these steps:

1. In Cisco UCS Manager, click the SAN tab in the navigation pane.
2. Select Policies > root > Sub-Organization > FlashStack-CVD > vHBA Template.

3. Right-click vHBA Templates.
4. Select Create vHBA Template.
5. Enter vHBA-A as the vHBA template name.
6. Keep Fabric A selected.
7. Select VSAN created for Fabric A from the drop-down list.
8. Change to Updating Template.
9. For Max Data Field keep 2048.
10. Select WWPN Pool for Fabric A (created earlier) for our WWPN Pool.
11. Leave the remaining fields as is.
12. Click OK.

Create vHBA Template



Name : vHBA-A

Description :

Fabric ID : A B

Redundancy

Redundancy Type : No Redundancy Primary Template Secondary Template

Select VSAN : FlashStack-A [Create VSAN](#)

Template Type : Initial Template Updating Template

Max Data Field Size : 2048

WWPN Pool : WWPN-A(128/128)

QoS Policy : <not set>

Pin Group : <not set>

Stats Threshold Policy : default

OK

Cancel

13. Repeat steps 1-12 to create a vHBA Template for Fabric B.

Create Server Boot Policy for SAN Boot

All Cisco UCS B200 M5 Blade Servers for workload and the two Infrastructure servers were set to boot from SAN for this Cisco Validated Design as part of the Service Profile template. The benefits of booting from SAN are numerous; disaster recovery, lower cooling and power requirements for each server since a local drive is not required, and better performance, to name just a few.



We strongly recommend using “Boot from SAN” to realize the full benefits of Cisco UCS stateless computing features, such as service profile mobility.

This process applies to a Cisco UCS environment in which the storage SAN ports are configured as explained in the following section.



A Local disk configuration for the Cisco UCS is necessary if the servers in the environments have a local disk.

To configure Local disk policy, follow these steps:

1. Go to tab Servers > Policies > root > Sub-Organization > FlashStack-CVD > right-click Local Disk Configuration Policy > Enter “SAN-Boot” as the local disk configuration policy name and change the mode to “No Local Storage.”
2. Click OK to create the policy.

Create Local Disk Configuration Policy ? X

Name :

Description :

Mode :

FlexFlash

FlexFlash State : Disable Enable

If **FlexFlash State** is disabled, SD cards will become unavailable immediately.
Please ensure SD cards are not in use before disabling the FlexFlash State.

FlexFlash RAID Reporting State : Disable Enable

As shown in the screenshot below, the Pure Storage FlashArray have eight active FC connections that pair with the Cisco MDS 9132T 32-Gbps switches. Two FC ports are connected to Cisco MDS-A and the other Two FC ports are connected to Cisco MDS-B Switches. All FC ports are 32 Gb/s. The SAN Ports CT0.FC0, CT0.FC2, of Pure Storage FlashArray Controller 0, are connected to Cisco MDS Switch A and CT1.FC1, CT1.FC3 are connected to Cisco MDS Switch B.

Array Ports							
Port	Name	Speed	Fallover	Port	Name	Speed	Fallover
CT0.FC0	52:4A:93:75:DD:91:0A:00	32 Gb/s		CT1.FC0	52:4A:93:75:DD:91:0A:10	0	
CT0.FC1	52:4A:93:75:DD:91:0A:01	0		CT1.FC1	52:4A:93:75:DD:91:0A:11	32 Gb/s	
CT0.FC2	52:4A:93:75:DD:91:0A:02	32 Gb/s		CT1.FC2	52:4A:93:75:DD:91:0A:12	0	
CT0.FC3	52:4A:93:75:DD:91:0A:03	0		CT1.FC3	52:4A:93:75:DD:91:0A:13	32 Gb/s	
CT0.FC8	52:4A:93:75:DD:91:0A:06	0		CT1.FC8	52:4A:93:75:DD:91:0A:16	0	
CT0.FC9	52:4A:93:75:DD:91:0A:07	0		CT1.FC9	52:4A:93:75:DD:91:0A:17	0	

Create SAN Policy A

The SAN-A boot policy configures the SAN Primary's primary-target to be port CT0.FC2 on the Pure Storage cluster and SAN Primary's secondary-target to be port CT1.FC2 on the Pure Storage cluster. Similarly, the SAN Secondary's primary-target should be port CT1.FC3 on the Pure Storage cluster and SAN Secondary's secondary-target should be port CT0.FC3 on the Pure Storage cluster.

Log into the storage controller and verify all the port information is correct. This information can be found in the Pure Storage GUI under System > Connections > Target Ports.

You have to create a SAN Primary (hba0) and a SAN Secondary (hba1) in SAN-A Boot Policy by entering WWPN of Pure Storage FC Ports as explained in the following section.

To create Boot Policies for the Cisco UCS environments, follow these steps:

1. Go to Cisco UCS Manager and then go to Servers > Policies > root > Sub Organization > FlashStack-CVD > Boot Policies. Right-click and select Create Boot Policy.
2. Enter SAN-A as the name of the boot policy.
3. Expand the Local Devices drop-down list and Choose Add CD/DVD. Expand the vHBAs drop-down list and Choose Add SAN Boot.



The SAN boot paths and targets will include primary and secondary options in order to maximize resiliency and number of paths.

4. In the Add SAN Boot dialog box, select Type as "Primary" and name vHBA as "hba0". Click OK to add SAN Boot.

Add SAN Boot ? X

vHBA :

Type : Primary Secondary Any

5. Select add SAN Boot Target to enter WWPN address of storage port. Keep 1 as the value for Boot Target LUN. Enter the WWPN for FC port CT0.FC0 of Pure Storage and add SAN Boot Primary Target.

Add SAN Boot Target



Boot Target LUN :

Boot Target WWPN :

Type : Primary Secondary

6. Add secondary SAN Boot target into same hba0, enter the boot target LUN as 1 and WWPN for FC port CT1.FC0 of Pure Storage, and add SAN Boot Secondary Target.

Add SAN Boot Target



Boot Target LUN :

Boot Target WWPN :

Type : Primary Secondary

7. From the vHBA drop-down list and choose Add SAN Boot. In the Add SAN Boot dialog box, enter " hba1" in the vHBA field. Click OK to SAN Boot, then choose Add SAN Boot Target.

Add SAN Boot



vHBA :

Type : Primary Secondary Any

8. Keep 1 as the value for the Boot Target LUN. Enter the WWPN for FC port CT1.FC1 of Pure Storage and add SAN Boot Primary Target.

Add SAN Boot Target



Boot Target LUN :

Boot Target WWPN :

Type : Primary Secondary

9. Add a secondary SAN Boot target into same vHBA1 and enter the boot target LUN as 1 and WWPN for FC port CT0.FC1 of Pure Storage and add SAN Boot Secondary Target.

Add SAN Boot Target



Boot Target LUN :

Boot Target WWPN :

Type : Primary Secondary

10. After creating the FC boot policies, you can view the boot order in the Cisco UCS Manager GUI. To view the boot order, navigate to Servers > Policies > Boot Policies. Click Boot Policy SAN-Boot-A to view the boot order in the right pane of the Cisco UCS Manager as shown below:

Name	Order	vNIC/vHBA/iSCSI vN...	Type	WWN	LUN Name
▼ Boot Policy SAN-A					
Remote CD/D...	1				
▼ San					
▼ SAN Primary					
	2	vHBA0	Primary		
SAN Ta...			Primary	52:4A:93:75:DD:91:0A:00	1
SAN Ta...			Secondary	52:4A:93:75:DD:91:0A:10	1
▼ SAN Seco...					
		vHBA1	Secondary		
SAN Ta...			Primary	52:4A:93:75:DD:91:0A:11	1
SAN Ta...			Secondary	52:4A:93:75:DD:91:0A:01	1

Create SAN Policy B

The SAN-B boot policy configures the SAN Primary's primary-target to be port CT0.FC6 on the Pure Storage cluster and SAN Primary's secondary-target to be port CT1.FC6 on the Pure Storage cluster. Similarly, the SAN Secondary's primary-target should be port CT1.FC7 on the Pure Storage cluster and SAN Secondary's secondary-target should be port CT0.FC7 on the Pure Storage cluster.

Log into the storage controller and verify all the port information is correct. This information can be found in the Pure Storage GUI under System > Connections > Target Ports.

You have to create SAN Primary (vHBA0) and SAN Secondary (vHBA1) in SAN-B Boot Policy by entering WWPN of Pure Storage FC Ports as explained in the following section.

To create boot policies for the Cisco UCS environments, follow these steps:

1. Go to UCS Manager and then go to tab Servers > Policies > root > Sub Organization > FlashStack-CVD > Boot Policies.
2. Right-click and select Create Boot Policy. Enter SAN-B as the name of the boot policy.
3. Expand the Local Devices drop-down list and Choose Add CD/DVD. Expand the vHBAs drop-down list and choose Add SAN Boot.



The SAN boot paths and targets include primary and secondary options in order to maximize resiliency and number of paths.

- In the Add SAN Boot dialog box, select Type as "Primary" and name vHBA as "vHBA0". Click OK to add SAN Boot.

Add SAN Boot ? X

vHBA :

Type : Primary Secondary Any

- Select Add SAN Boot Target to enter WWPN address of storage port. Keep 1 as the value for Boot Target LUN. Enter the WWPN for FC port CT0.FC2 of Pure Storage and add SAN Boot Primary Target.

Add SAN Boot Target ? X

Boot Target LUN :

Boot Target WWPN :

Type : Primary Secondary

- Add the secondary SAN Boot target into the same hba0; enter boot target LUN as 1 and WWPN for FC port CT1.FC2 of Pure Storage and add SAN Boot Secondary Target.

Add SAN Boot Target ? X

Boot Target LUN :

Boot Target WWPN :

Type : Primary Secondary

- From the vHBA drop-down list, choose Add SAN Boot. In the Add SAN Boot dialog box, enter " hba1" in the vHBA field. Click OK to SAN Boot, then choose Add SAN Boot Target.

Add SAN Boot



vHBA :

Type : Primary Secondary Any

8. Keep 1 as the value for Boot Target LUN. Enter the WWPN for FC port CT1.FC3 of Pure Storage and Add SAN Boot Primary Target.

Add SAN Boot Target



Boot Target LUN :

Boot Target WWPN :

Type : Primary Secondary

9. Add secondary SAN Boot target into same hba1 and enter boot target LUN as 1 and WWPN for FC port CT0.FC3 of Pure Storage and add SAN Boot Secondary Target.

Add SAN Boot Target



Boot Target LUN :

Boot Target WWPN :

Type : Primary Secondary

10. After creating the FC boot policies, you can view the boot order in the Cisco UCS Manager GUI. To view the boot order, navigate to Servers > Policies > Boot Policies. Click Boot Policy SAN-Boot-B to view the boot order in the right pane of the Cisco UCS Manager as shown below:

Policies / root / Sub-Organizations / FlashStack-CVD / Boot Policies

Boot Policies | Events

+ - Advanced Filter Export Print

Name	Order	vNIC/vHBA/iSCSI vNIC	Type	WWN	LUN Name
▶ Boot Policy SAN-A					
▼ Boot Policy SAN-B					
Remote CD/DVD	1				
▼ San	2				
▼ SAN Primary		vHBA0	Primary		
SAN Targ...			Primary	52:4A:93:75:DD:91:0A:02	1
SAN Targ...			Secondary	52:4A:93:75:DD:91:0A:12	1
▼ SAN Second...		vHBA1	Secondary		
SAN Targ...			Primary	52:4A:93:75:DD:91:0A:13	1
SAN Targ...			Secondary	52:4A:93:75:DD:91:0A:03	1



For this solution, we created two Boot Policy as “SAN-A” and “SAN-B”. For thirty-two Cisco UCS B200 M5 blade servers, you will assign the first 16 Service Profiles with SAN-A to the first 16 servers and the remaining 16 Service Profiles with SAN-B to the remaining 16 servers as explained in the following section.

Configure and Create a Service Profile Template

Service profile templates enable policy based server management that helps ensure consistent server resource provisioning suitable to meet predefined workload needs.

You will create two Service Profile templates; the first Service profile template “VCC-CVD01” uses the boot policy “SAN-A” and the second Service profile template “VCC-CVD02” uses the boot policy “SAN-B” to utilize all the FC ports from Pure Storage for high-availability in case any FC links go down.

You will create the first VCC-CVD01 as explained in the following section.

Create Service Profile Template

To create a service profile template, follow these steps:

1. In the Cisco UCS Manager, go to Servers > Service Profile Templates > root Sub Organization > FlashStack-CVD > and right-click to “Create Service Profile Template” as shown below.
2. Enter the Service Profile Template name, select the UUID Pool that was created earlier, and click Next.

Create Service Profile Template

You must enter a name for the service profile template and specify the template type. You can also specify how a UUID will be assigned to this template and enter a description.

Name :

The template will be created in the following organization. Its name must be unique within this organization.
Where : **org-root/org-FlashStack-CVD**

The template will be created in the following organization. Its name must be unique within this organization.

Type : Initial Template Updating Template

Specify how the UUID will be assigned to the server associated with the service generated by this template.
UUID

UUID Assignment:

The UUID will be assigned from the selected pool.
The available/total UUIDs are displayed after the pool name.

3. Select Local Disk Configuration Policy to SAN-Boot as No Local Storage.

Create Service Profile Template

Optionally specify or create a Storage Profile, and select a local disk configuration policy.

Specific Storage Profile Storage Profile Policy **Local Disk Configuration Policy**

Local Storage:

[Create Local Disk Configuration Policy](#)

Mode : **Any Configuration**
Protect Configuration : **Yes**

If **Protect Configuration** is set, the local disk configuration is preserved if the service profile is disassociated with the server. In that case, a configuration error will be raised when a new service profile is associated with that server if the local disk configuration in that profile is different.

FlexFlash

FlexFlash State : **Disable**

If **FlexFlash State** is disabled, SD cards will become unavailable immediately.
Please ensure SD cards are not in use before disabling the FlexFlash State.

FlexFlash RAID Reporting State : **Disable**

4. In the networking window, select Expert and click Add to create vNICs. Add one or more vNICs that the server should use to connect to the LAN.
5. Now there are two vNIC in the create vNIC menu; you provided a name to the first vNIC as "eth0" and the second vNIC as "eth1."
6. Select vNIC-Template-A for the vNIC Template and select VMware for the Adapter Policy as shown below.

Create vNIC



Name :

Use vNIC Template :

Redundancy Pair :

Peer Name :

vNIC Template :

[Create vNIC Template](#)

Adapter Performance Profile

Adapter Policy :

[Create Ethernet Adapter Policy](#)

7. Select vNIC-Template-B for the vNIC Template, created with the name eth1. Select VMware for the vNIC “eth1” for the Adapter Policy.



eth0 and eth1 vNICs are created so that the servers can connect to the LAN.

8. When the vNICs are created, you need to create vHBAs. Click Next.
9. In the SAN Connectivity menu, select “Expert” to configure as SAN connectivity. Select WWNN (World Wide Node Name) pool, which you created previously. Click “Add” to add vHBAs.

10. The following four HBAs were created:

- vHBA0 using vHBA Template vHBA-A
- vHBA1 using vHBA Template vHBA-B
- vHBA2 using vHBA Template vHBA-A
- vHBA3 using vHBA Template vHBA-B

Figure 39 vHBA0

Create vHBA



Name : vHBA0

Use vHBA Template :

Redundancy Pair :

Peer Name :

vHBA Template : vHBA-A ▼

[Create vHBA Template](#)

Adapter Performance Profile

Adapter Policy : VMWare ▼

[Create Fibre Channel Adapter Policy](#)

Figure 40 vHBA1

Modify vHBA



Name : vHBA1

Use vHBA Template :

[Create vHBA Template](#)

vHBA Template : vHBA-B ▼

Adapter Performance Profile

Adapter Policy : VMWare ▼

[Create Fibre Channel Adapter Policy](#)

Figure 41 All vHBAs

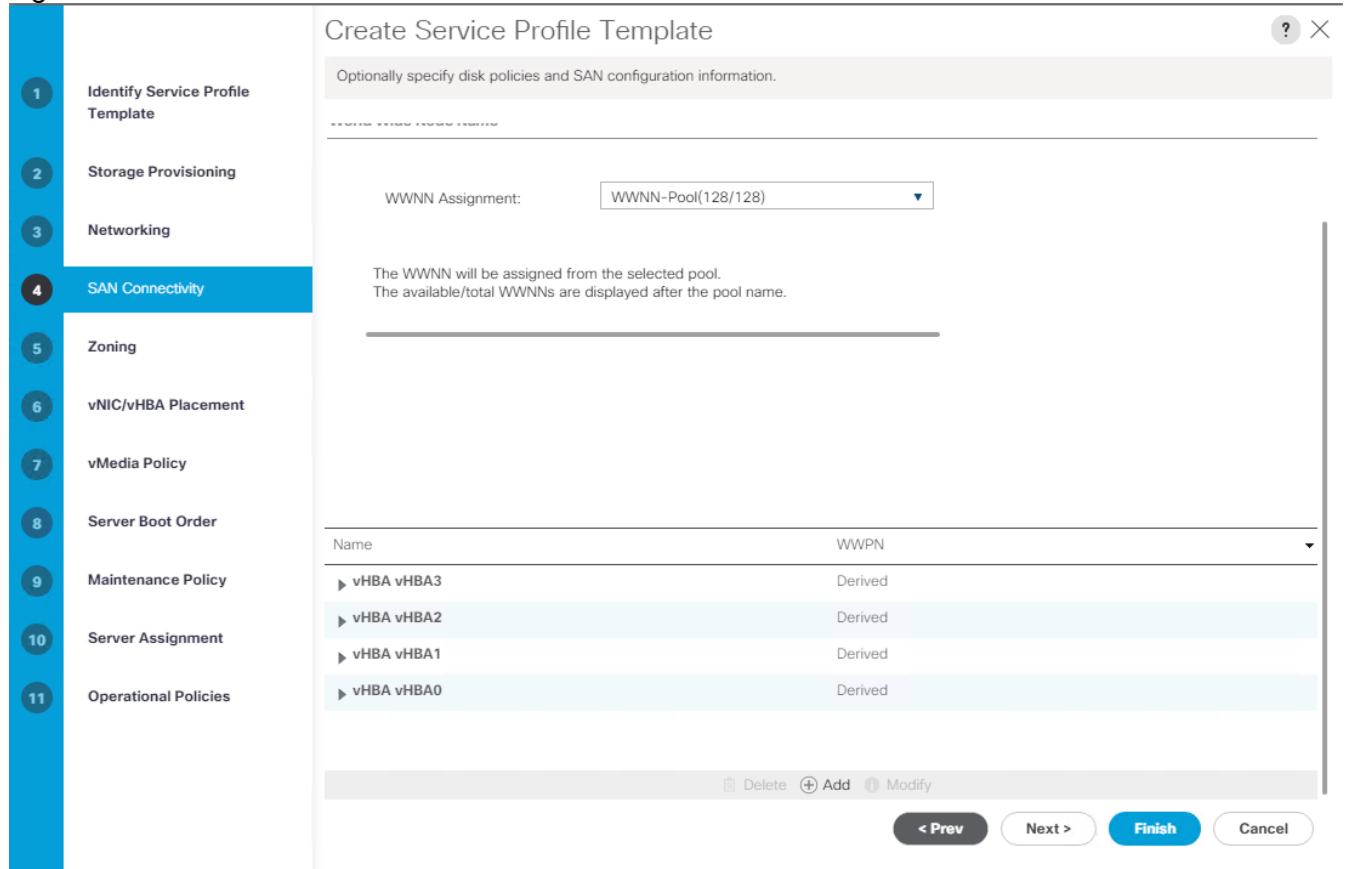

11. Skip zoning; for this FlashStack Configuration, the Cisco MDS 9132T 32-Gbps is used for zoning.

12. Select the default option as Let System Perform Placement in the Placement Selection menu.

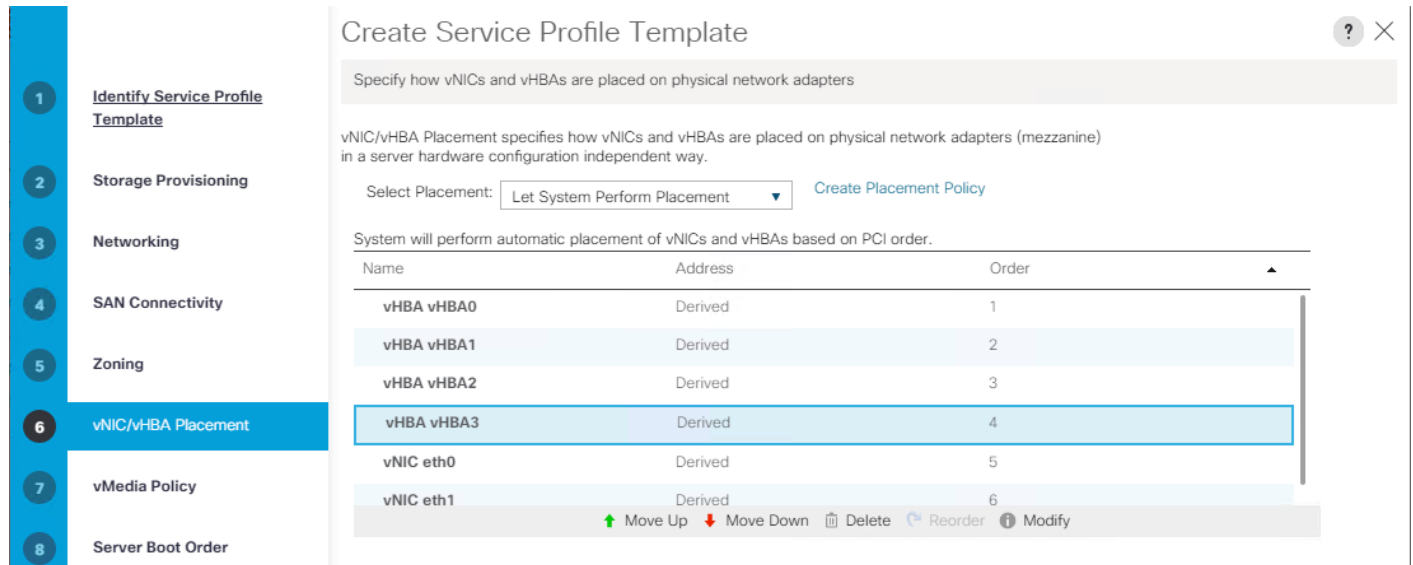

13. For the Server Boot Policy, select "SAN-A" as Boot Policy which you created earlier.

Create Service Profile Template

Optionally specify the boot policy for this service profile template.

Select a boot policy.

Boot Policy: [Create Boot Policy](#)

Name : **SAN-A**
 Description :
 Reboot on Boot Order Change : **No**
 Enforce vNIC/vHBA/iSCSI Name : **Yes**
 Boot Mode : **Legacy**

WARNINGS:
 The type (primary/secondary) does not indicate a boot order presence.
 The effective order of boot devices within the same device class (LAN/Storage/iSCSI) is determined by PCIe bus scan order.
 If **Enforce vNIC/vHBA/iSCSI Name** is selected and the vNIC/vHBA/iSCSI does not exist, a config error will be reported.
 If it is not selected, the vNICs/vHBAs are selected if they exist, otherwise the vNIC/vHBA with the lowest PCIe bus scan order is used.

Boot Order

Name	Order	vNIC/vH...	Type	WWN	LUN Name	Slot Num...	Boot Name	Boot Path	Description
▼ San	2								
▶ SAN Primary		vHBA0	Primary						
▶ SAN Second...		vHBA1	Secondary						
Remote CD/DVD	1								

[Create ICSI vNIC](#) [Set ICSI Boot Parameters](#) [Set UEFI Boot Parameters](#)

< Prev Next > **Finish** Cancel

The default setting was retained for the remaining maintenance and assignment policies in the configuration. However, they may vary from site-to-site depending on workloads, best practices, and policies. For example, we created a maintenance policy, BIOS policy, Power Policy, as detailed below.

14. Select UserAck maintenance policy, which requires user acknowledgement prior rebooting server when making changes to policy or pool configuration tied to a service profile.

Create Service Profile Template

Specify how disruptive changes such as reboots, network interruptions, and firmware upgrades should be applied to the server associated with this service profile.

⊖ Maintenance Policy

Select a maintenance policy to include with this service profile or create a new maintenance policy that will be accessible to all service profiles.

Maintenance Policy: [Create Maintenance Policy](#)

Name : **UserAck**
 Description :
 Soft Shutdown Timer : **150 Secs**
 Storage Config. Deployment Policy : **User Ack**
 Reboot Policy : **User Ack**

< Prev Next > **Finish** Cancel

15. Select Server Pool policy to automatically assign service profile to a server that meets the requirement for server qualification based on the pool configuration.
16. On the same page; you can configure “Host firmware Package Policy” which helps to keep the firmware in sync when associated to server.

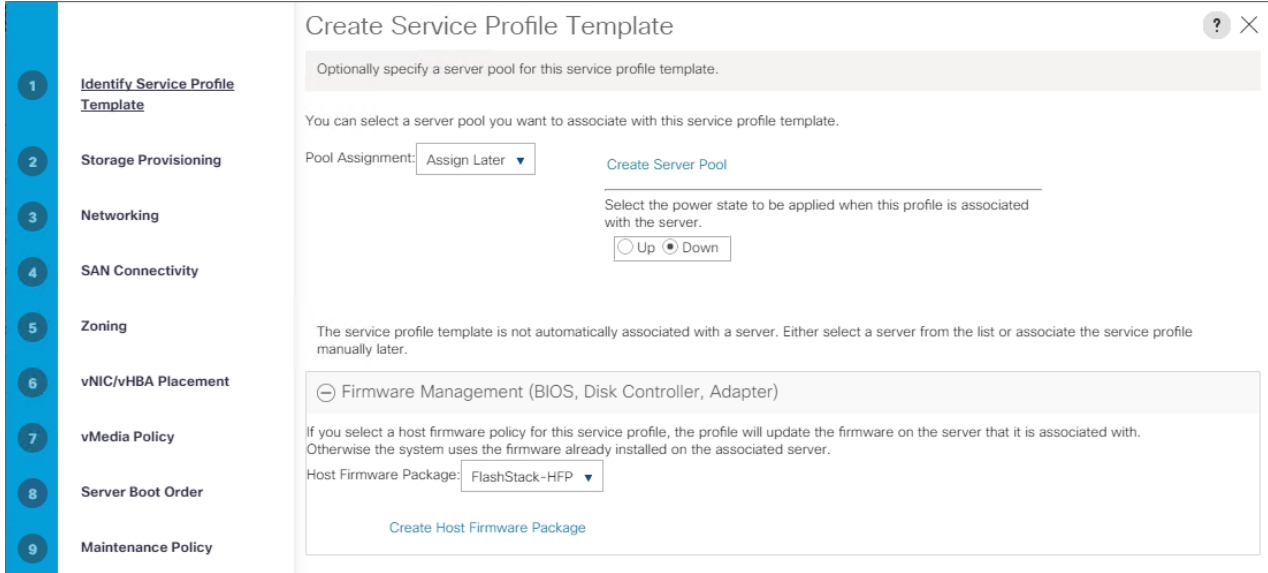

17. On the Operational Policy page, we configured BIOS policy for B200 M5 blade server, Power Control Policy with “NoPowerCap” for maximum performance and Graphics Card Policy for B200 M5 server configured with NVidia P6 GPU card.

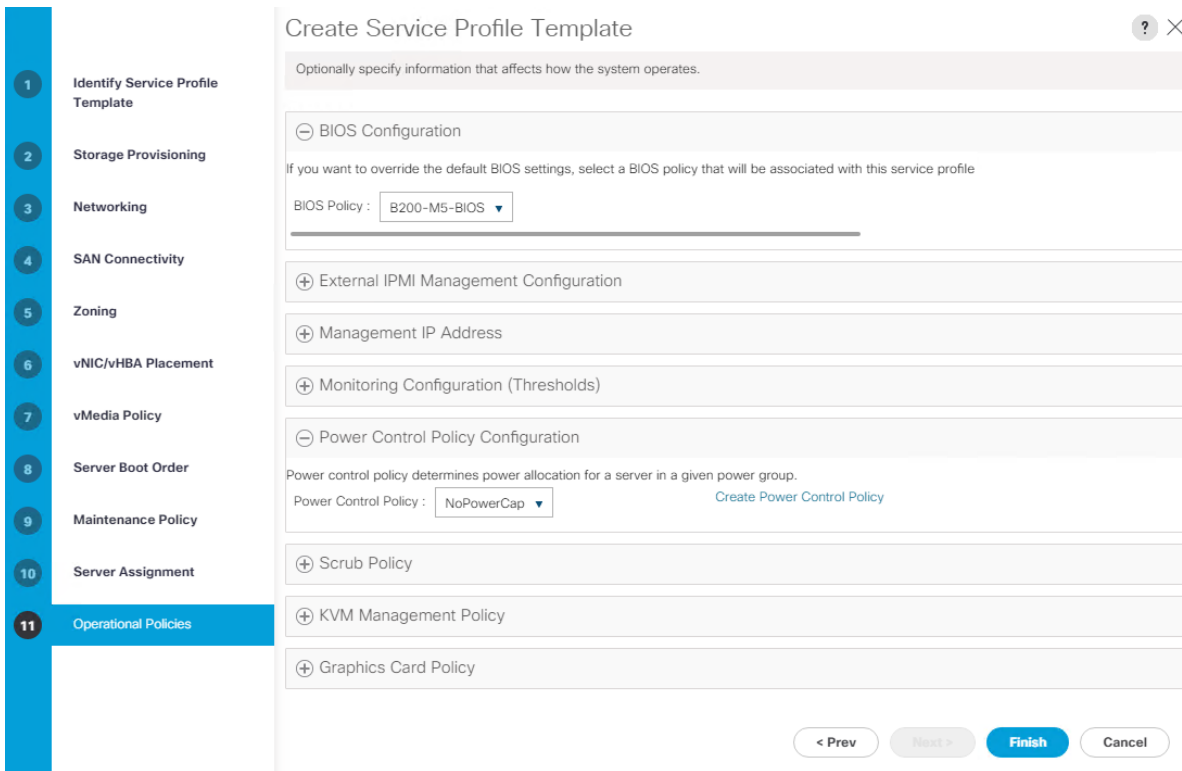

18. Click Next and then click Finish to create service profile template as “VCC-CVD01.”

Clone Service Profile Template

To clone the Service Profile template, follow these steps:

1. In the service profile template VCC-CVD02, modify the Boot Policy as “SAN-B” to use all the remaining FC paths of storage for high availability.

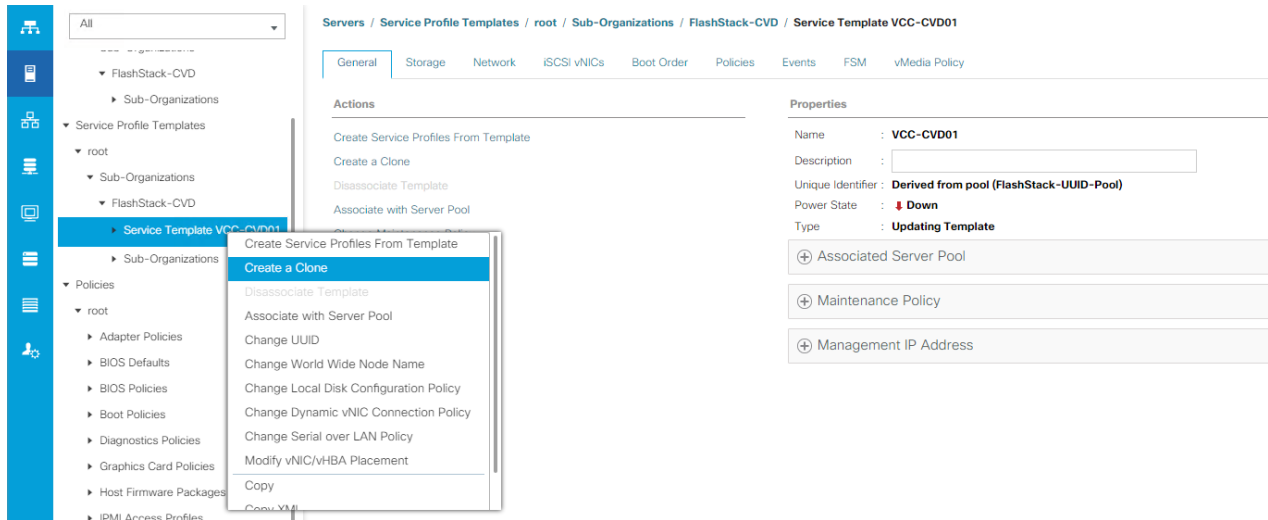

2. Enter name to create Clone from existing Service Profile template. Click OK.

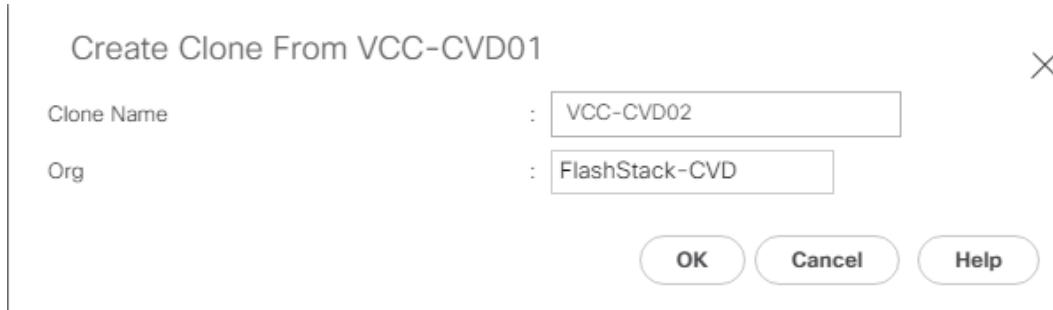

This VCC-CVD02 service profile template will be used to create the remaining sixteen service profiles for VCC workload and Infrastructure server02.

3. To change boot order from SAN-A to SAN-B for VCC-CVD02, click Cloned Service Profile template > Select Boot Order tab. Click Modify Boot Policy.

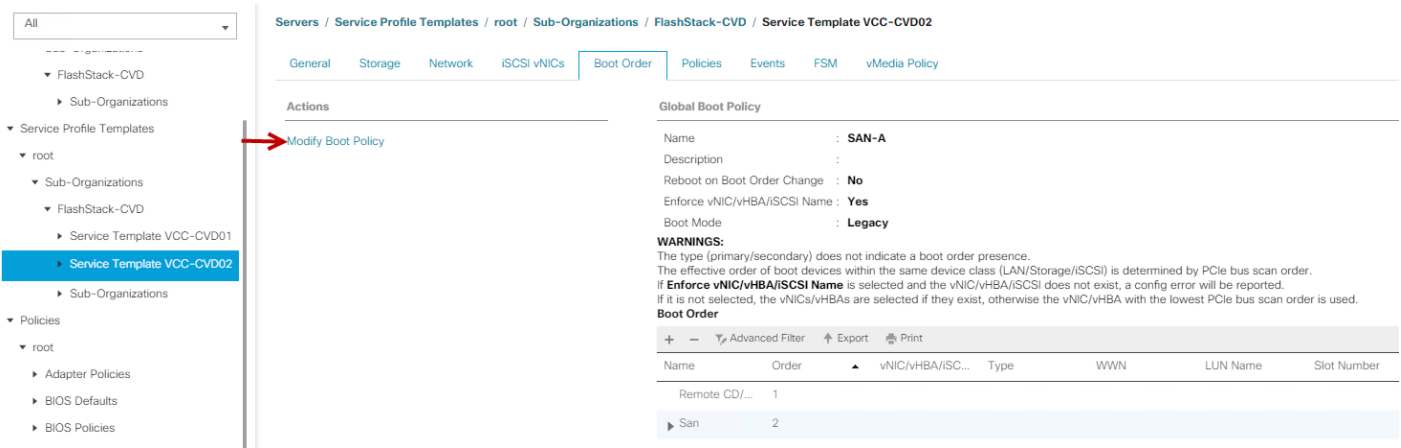

4. From the drop-down list select “SAN-B” as Boot Policy, click OK.

Modify Boot Policy

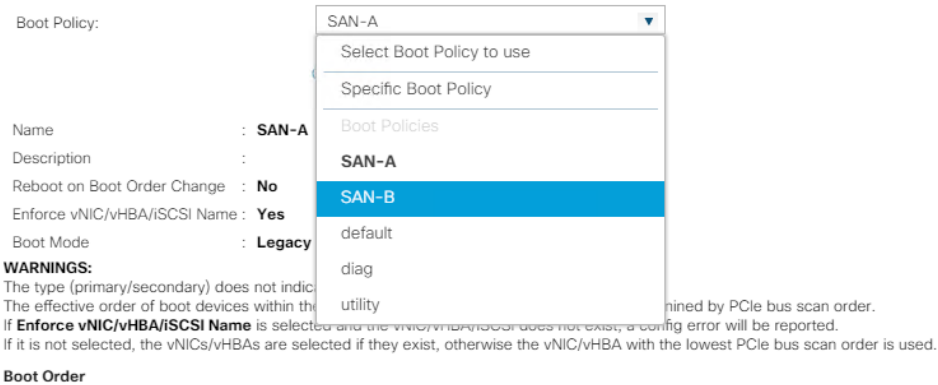

You have now created the Service Profile template “VCC-CVD01” and “VCC-CVD02” with each having four vHBAs and two vNICs.

Create Service Profiles from Template and Associate to Servers

Create Service Profiles from Template

You will create sixteen Service profiles from the VCC-CVD01 template and sixteen Service profiles from the VCC-CVD02 template as explained in the following sections.

For the first fifteen workload Nodes and Infrastructure Node 01, you will create sixteen Service Profiles from Template “VCC-CVD01.” The remaining fifteen workload Nodes and Infrastructure Node 02, will require creating another sixteen Service Profiles from Template “VCC-CVD02.”

To create first four Service Profiles from Template, follow these steps:

1. Go to tab Servers > Service Profiles > root > Sub-Organization > FlashStack-CVD and right-click “Create Service Profiles from Template.”

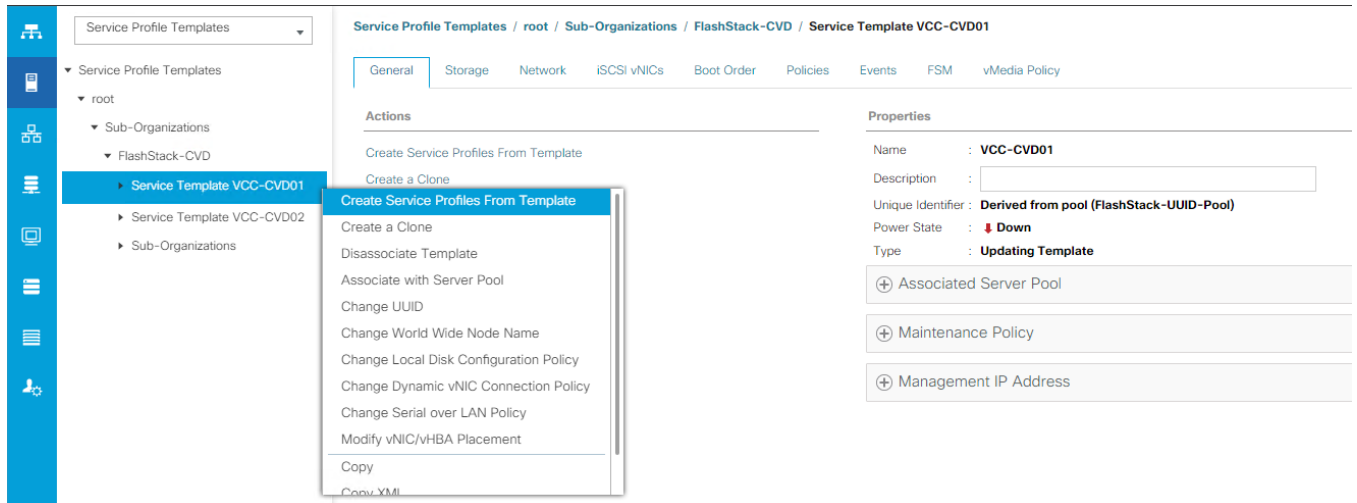

2. Select "VCC-CVD01" for the Service profile template which you created earlier and name the service profile "VCC-WLHostX." To create four service profiles, enter 16 for the Number of Instances, as 16 as shown below. This process will create service profiles "VCC-WLHOST1", "VCC-WLHOST2", and "VCC-WLHOST16."

Create Service Profiles From Template ? X

Naming Prefix :

Name Suffix Starting Number :

Number of Instances :

3. Create the remaining four Service Profiles "VCC-WLHOST17", "VCC-WLHOST18", and "VCC-WLHOST32" from Template "VCC-CVD02."

When the service profiles are created, the association of Service Profile starts automatically to servers based on the Server Pool Policies.

Service Profile association can be verified in Cisco UCS Manager > Servers > Service Profiles. Different tabs can provide details on Service profile association based on Server Pools Policy, Service Profile Template to which Service Profile is tied to, and so on.

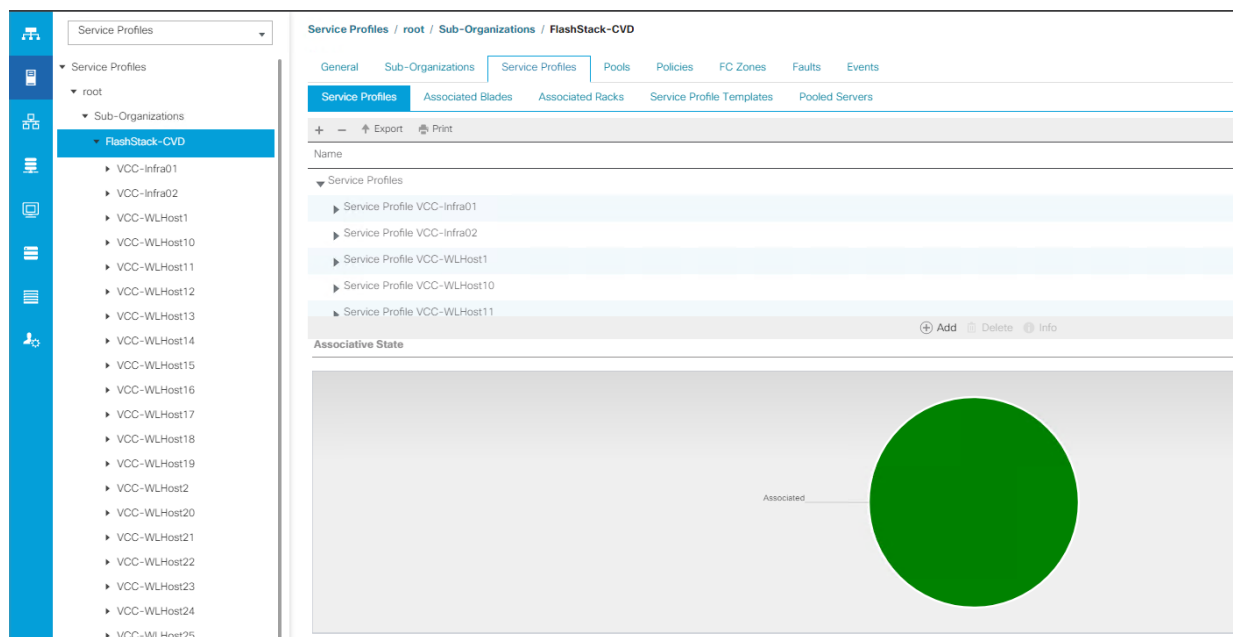

Configure Cisco Nexus 93180YC-FX Switches

The following section details the steps for the Nexus 93180YC-FX switch configuration. The details of “show run” output are listed in the Appendix.

Configure Global Settings for Cisco Nexus A and Cisco Nexus B

To set global configuration, follow these steps on both the Nexus switches:

1. Log in as admin user into the Nexus Switch A and run the following commands to set global configurations and jumbo frames in QoS:

```

conf terminal

policy-map type network-qos jumbo

class type network-qos class-default

mtu 9216

exit

class type network-qos class-fcoe

pause no-drop

mtu 2158

exit

exit

system qos

service-policy type network-qos jumbo

```

```
exit

copy run start
```

2. Log in as admin user into the Nexus Switch B and run the same above commands to set global configurations and jumbo frames in QoS.

Configure VLANs for Cisco Nexus A and Cisco Nexus B Switches

To create the necessary virtual local area networks (VLANs), follow these steps on both Nexus switches. We created VLAN 70, 71, 72, 73 and 76. The details of the “show run” output are listed in the Appendix.

1. Log in as admin user into the Nexus Switch A.
2. Create VLAN 70:

```
config terminal

VLAN 70

name InBand-Mgmt

no shutdown

exit

copy running-config startup-config

exit
```

3. Log in as admin user into the Nexus Switch B and create VLANs

Virtual Port Channel (vPC) Summary for Data and Storage Network

In the Cisco Nexus 93180YC-FX switch topology, a single vPC feature is enabled to provide HA, faster convergence in the event of a failure, and greater throughput. Cisco Nexus 93180YC-FX vPC configurations with the vPC domains and corresponding vPC names and IDs for Oracle Database Servers is listed in Table 5 .

Table 5 vPC Summary

vPC Domain	vPC Name	vPC ID
70	Peer-Link	1
70	vPC Port-Channel to FI	11
70	vPC Port-Channel to FI	12

As listed in Table 5 , a single vPC domain with Domain ID 70 is created across two Cisco Nexus 93180YC-FX member switches to define vPC members to carry specific VLAN network traffic. In this topology, we defined a total number of 3 vPCs:

- vPC ID 1 is defined as Peer link communication between two Nexus switches in Fabric A and B.
- vPC IDs 11 and 12 are defined for traffic from Cisco UCS fabric interconnects.

Cisco Nexus 93180YC-FX Switch Cabling Details

The following tables list the cabling information.

Table 6 Cisco Nexus 93180YC-FX-A Cabling Information

Local Device	Local Port	Connection	Remote Device	Remote Port
Cisco Nexus 93180YC-FX Switch A	Eth1/51	40GbE	Cisco UCS fabric interconnect A	Eth1/39
	Eth1/52	40GbE	Cisco UCS fabric interconnect B	Eth1/39
	Eth1/53	40GbE	Cisco Nexus 93180YC-FX B	Eth1/53
	Eth1/54	40GbE	Cisco Nexus 93180YC-FX B	Eth1/54
	MGMT0	GbE	GbE management switch	Any

Table 7 Cisco Nexus 93180YC-FX-B Cabling Information

Local Device	Local Port	Connection	Remote Device	Remote Port
Cisco Nexus 93180YC-FX Switch B	Eth1/51	40GbE	Cisco UCS fabric interconnect A	Eth1/40
	Eth1/52	40GbE	Cisco UCS fabric interconnect B	Eth1/40
	Eth1/53	40GbE	Cisco Nexus 93180YC-FX A	Eth1/53
	Eth1/54	40GbE	Cisco Nexus 93180YC-FX	Eth1/54
	MGMT0	GbE	GbE management switch	Any

Cisco UCS Fabric Interconnect 6332-16UP Cabling

The following tables list the FI 6332-16UP cabling information.

Table 8 Cisco UCS Fabric Interconnect (FI) A Cabling Information

Local Device	Local Port	Connection	Remote Device	Remote Port
Cisco UCS FI-6332-16UP-A	FC 1/1	16G FC	Cisco MDS 9132T 32-Gbps-A	FC 1/13
	FC 1/2	16G FC	Cisco MDS 9132T 32-Gbps-A	FC 1/14
	FC 1/3	16G FC	Cisco MDS 9132T 32-Gbps-A	FC 1/15
	FC ¼	16G FC	Cisco MDS 9132T 32-Gbps-A	FC 1/16
	Eth1/17-24	40GbE	UCS 5108 Chassis IOM-A Chassis 1-4	IO Module Port1-2
	Eth1/39	40GbE	Cisco Nexus 93180YC-FX Switch A	Eth1/51

Local Device	Local Port	Connection	Remote Device	Remote Port
	Eth1/40	40GbE	Cisco Nexus 93180YC-FX Switch B	Eth1/51
	Mgmt 0	1GbE	Management Switch	Any
	L1	1GbE	Cisco UCS FI - A	L1
	L2	1GbE	Cisco UCS FI - B	L2

Table 9 Cisco UCS Fabric Interconnect (FI) B Cabling Information

Local Device	Local Port	Connection	Remote Device	Remote Port
Cisco UCS FI-6332-16UP-B	FC 1/1	16G FC	Cisco MDS 9132T 32-Gbps-B	FC 1/13
	FC 1/2	16G FC	Cisco MDS 9132T 32-Gbps-B	FC 1/14
	FC 1/3	16G FC	Cisco MDS 9132T 32-Gbps-B	FC 1/15
	FC 1/4	16G FC	Cisco MDS 9132T 32-Gbps-B	FC 1/16
	Eth1/17-24	40GbE	UCS 5108 Chassis IOM-B Chassis 1-4	IO Module Port1-2
	Eth1/39	40GbE	Cisco Nexus 93180YC-FX Switch A	Eth1/52
	Eth1/40	40GbE	Cisco Nexus 93180YC-FX Switch B	Eth1/52
	Mgmt 0	1GbE	Management Switch	Any
	L1	1GbE	Cisco UCS FI - A	L1
	L2	1GbE	Cisco UCS FI - B	L2

Create vPC Peer-Link Between the Two Nexus Switches

To create the vPC Peer-Link, follow these steps:

1. Log in as “admin” user into the Nexus Switch A.



For vPC 1 as Peer-link, we used interfaces 53-54 for Peer-Link. You may choose the appropriate number of ports for your needs.

To create the necessary port channels between devices, follow these steps on both Nexus Switches:

```
config terminal
```

```

feature vpc
feature lacp
vpc domain 1
peer-keepalive destination 10.29.164.234 source 10.29.164.233
exit
interface port-channel 70
description VPC peer-link
switchport mode trunk
switchport trunk allowed VLAN 1,70-73,76
spanning-tree port type network
vpc peer-link
exit
interface Ethernet1/53
description vPC-PeerLink
switchport mode trunk
switchport trunk allowed VLAN 1, 70-73,76
channel-group 70 mode active
no shutdown
exit
interface Ethernet1/54
description vPC-PeerLink
switchport mode trunk
switchport trunk allowed VLAN 1, 70-73,76
channel-group 70 mode active
no shutdown
exit

```

2. Log in as admin user into the Nexus Switch B and repeat the above steps to configure second nexus switch.



Make sure to change peer-keepalive destination and source IP address appropriately for Nexus Switch B.

Create vPC Configuration Between Nexus 93180YC-FX and Fabric Interconnects

Create and configure vPC 11 and 12 for data network between the Nexus switches and Fabric Interconnects.

To create the necessary port channels between devices, follow these steps on both Nexus Switches:

1. Log in as admin user into Nexus Switch A and enter the following:

```
config Terminal
interface port-channel11
description FI-A-Uplink
switchport mode trunk
switchport trunk allowed VLAN 1,70-73,76
spanning-tree port type edge trunk
vpc 11
no shutdown
exit
interface port-channel12
description FI-B-Uplink
switchport mode trunk
switchport trunk allowed VLAN 1,70-73,76
spanning-tree port type edge trunk
vpc 12
no shutdown
exit
interface Ethernet1/51
description FI-A-Uplink
switch mode trunk
switchport trunk allowed vlan 1,70-73,76
spanning-tree port type edge trunk
mtu 9216
channel-group 11 mode active
no shutdown
exit
interface Ethernet1/52
description FI-B-Uplink
switch mode trunk
switchport trunk allowed vlan 1,70-73,76
spanning-tree port type edge trunk
```

```
mtu 9216
channel-group 12 mode active
no shutdown
exit
copy running-config startup-config
```

2. Log in as admin user into the Nexus Switch B and complete the following for the second switch configuration:

```
config Terminal
interface port-channel11
description FI-A-Uplink
switchport mode trunk
switchport trunk allowed VLAN 1,70-73,76
spanning-tree port type edge trunk
vpc 11
no shutdown
exit
interface port-channel12
description FI-B-Uplink
switchport mode trunk
switchport trunk allowed VLAN 1,70-73,76
spanning-tree port type edge trunk
vpc 12
no shutdown
exit
interface Ethernet1/51
description FI-A-Uplink
switch mode trunk
switchport trunk allowed vlan 1,70-73,76
spanning-tree port type edge trunk
mtu 9216
channel-group 11 mode active
no shutdown
exit
```

```

interface Ethernet1/52
description FI-B-Uplink
switch mode trunk
switchport trunk allowed vlan 1,70-73,76
spanning-tree port type edge trunk
mtu 9216
channel-group 12 mode active
no shutdown
exit
copy running-config startup-config
    
```

Verify All vPC Status is Up on Both Cisco Nexus Switches

Figure 42 shows the verification of the vPC status on both Cisco Nexus Switches.

Figure 42 vPC Description for Cisco Nexus Switch A and B

```

AAD17-NX9K-A# sh vpc brief
Legend:
      (*) - local vPC is down, forwarding via vPC peer-link
vPC domain id          : 70
Peer status            : peer adjacency formed ok
vPC keep-alive status  : peer is alive
Configuration consistency status : success
Per-vlan consistency status : success
Type-2 consistency status : success
vPC role               : primary
Number of vPCs configured : 4
Peer Gateway           : Disabled
Dual-active excluded VLANs : -
Graceful Consistency Check : Enabled
Auto-recovery status   : Disabled
Delay-restore status   : Timer is off.(timeout = 30s)
Delay-restore SVI status : Timer is off.(timeout = 10s)
Operational Layer3 Peer-router : Disabled

vPC Peer-link status
-----
id  Port  Status Active vlans
--  --
1   Po70  up     1,70-76

vPC status
-----
Id  Port  Status Consistency Reason          Active vlans
--  --
11  Po11  up     success  success          1,70-76
12  Po12  up     success  success          1,70-76
13  Po13  up     success  success          1,70-76
14  Po14  up     success  success          1,70-76
    
```

```

AAD17-NX9K-B# sh vpc brief
Legend:
      (*) - local vPC is down, forwarding via vPC peer-link
vPC domain id          : 70
Peer status            : peer adjacency formed ok
vPC keep-alive status  : peer is alive
Configuration consistency status : success
Per-vlan consistency status : success
Type-2 consistency status : success
vPC role               : secondary
Number of vPCs configured : 4
Peer Gateway           : Disabled
Dual-active excluded VLANs : -
Graceful Consistency Check : Enabled
Auto-recovery status   : Disabled
Delay-restore status   : Timer is off.(timeout = 30s)
Delay-restore SVI status : Timer is off.(timeout = 10s)
Operational Layer3 Peer-router : Disabled

vPC Peer-link status
-----
id  Port  Status Active vlans
--  --
1   Po70  up     1,70-76

vPC status
-----
Id  Port  Status Consistency Reason          Active vlans
--  --
11  Po11  up     success  success          1,70-76
12  Po12  up     success  success          1,70-76
13  Po13  up     success  success          1,70-76
14  Po14  up     success  success          1,70-76
    
```

Cisco MDS 9132T 32-Gbps FC Switch Configuration

Figure 40 illustrates the cable connectivity between the Cisco MDS 9132T 32-Gbps switch and the Cisco 6332 Fabric Interconnects and Pure Storage FlashArray//X70 R2 storage.

 We used four 16Gb FC connections from each Fabric Interconnect to each MDS switch and two 32Gb FC connections from each Pure Storage FlashArray//X70 R2 array controller to each MDS switch.

Table 10 Cisco MDS 9132T-A Cabling Information

Local Device	Local Port	Connection	Remote Device	Remote Port
--------------	------------	------------	---------------	-------------

Local Device	Local Port	Connection	Remote Device	Remote Port
Cisco MDS 9132T-A	FC1/9	32Gb FC	Pure Storage FlashArray//X70 R2 Controller 00	FC2
	FC1/10	32Gb FC	Pure Storage FlashArray//X70 R2 Controller 00	FC0
	FC1/13	16Gb FC	Cisco 6332-16UP Fabric Interconnect-A	FC1/1
	FC1/14	16Gb FC	Cisco 6332-16UP Fabric Interconnect-A	FC1/2
	FC1/15	16Gb FC	Cisco 6332-16UP Fabric Interconnect-A	FC1/3
	FC1/16	16Gb FC	Cisco 6332-16UP Fabric Interconnect-A	FC1/4

Table 11 Cisco MDS 9132T-B Cabling Information

Local Device	Local Port	Connection	Remote Device	Remote Port
Cisco MDS 9132T-B	FC1/9	32Gb FC	Pure Storage FlashArray//X70 R2 Controller 01	FC3
	FC1/10	32Gb FC	Pure Storage FlashArray//X70 R2 Controller 01	FC1
	FC1/13	16Gb FC	Cisco 6332-16UP Fabric Interconnect-B	FC1/1
	FC1/14	16Gb FC	Cisco 6332-16UP Fabric Interconnect-B	FC1/2
	FC1/15	16Gb FC	Cisco 6332-16UP Fabric Interconnect-B	FC1/3
	FC1/16	16Gb FC	Cisco 6332-16UP Fabric Interconnect-B	FC1/4

Pure Storage FlashArray//X70 R2 to MDS SAN Fabric Connectivity

Pure Storage FlashArray//X70 R2 to MDS A and B Switches using VSAN 100 for Fabric A and VSAN 101 Configured for Fabric B

In this solution, two ports (ports FC1/9 and FC1/10) of MDS Switch A and two ports (ports FC1/9 and FC1/10) of MDS Switch B connected to Pure Storage System as shown in Table 12. All ports connected to the Pure Storage Array carry 32 Gb/s FC Traffic.

Table 12 MDS 9132T 32-Gbps switch Port Connection to Pure Storage System

Local Device	Local Port	Connection	Remote Device	Remote Port
MDS Switch A	FC1/9	32Gb FC	Pure Storage FlashArray//X70 R2 Controller 00	CT0.FC0

	FC1/10	32Gb FC	Pure Storage FlashArray//X70 R2 Controller 00	CT0.FC2
MDS Switch B	FC1/9	32Gb FC	Pure Storage FlashArray//X70 R2 Controller 01	CT1.FC1
	FC1/10	32Gb FC	Pure Storage FlashArray//X70 R2 Controller 01	CT1.FC3

Configure Feature for MDS Switch A and MDS Switch B

To set feature on MDS Switches, follow these steps on both MDS switches:

1. Log in as admin user into MDS Switch A:

```
config terminal
feature npiv
feature telnet
switchname FlashStack-MDS-A
copy running-config startup-config
```

2. Log in as admin user into MDS Switch B. Repeat the steps above on MDS Switch B.

Configure VSANs for MDS Switch A and MDS Switch B

To create VSANs, follow these steps on both MDS switches:

1. Log in as admin user into MDS Switch A. Create VSAN 100 for Storage Traffic:

```
config terminal
VSAN database
vsan 100
vsan 100 interface fc 1/9-16
exit
interface fc 1/9-16
switchport trunk allowed vsan 100
switchport trunk mode off
port-license acquire
no shutdown
exit
copy running-config startup-config
```

2. Log in as admin user into MDS Switch B. Create VSAN 101 for Storage:

```

config terminal
VSAN database
vsan 101
vsan 101 interface fc 1/9-16
exit
interface fc 1/9-16
switchport trunk allowed vsan 101
switchport trunk mode off
port-license acquire
no shutdown
exit
copy running-config startup-config
    
```

Add FC Uplink Ports to Corresponding VSAN on Fabric Interconnect

To add the FC Ports to the corresponding VSAN, follow these steps:

1. In Cisco UCS Manager, in the Equipment tab, select Fabric Interconnects > Fabric Interconnect A > Fixed Module > FC Ports.
2. Select FC Port 1, drop-down list for VSAN, and select VSAN 100.

Figure 43 VSAN Assignment on FC Uplink Ports to MDS Switch

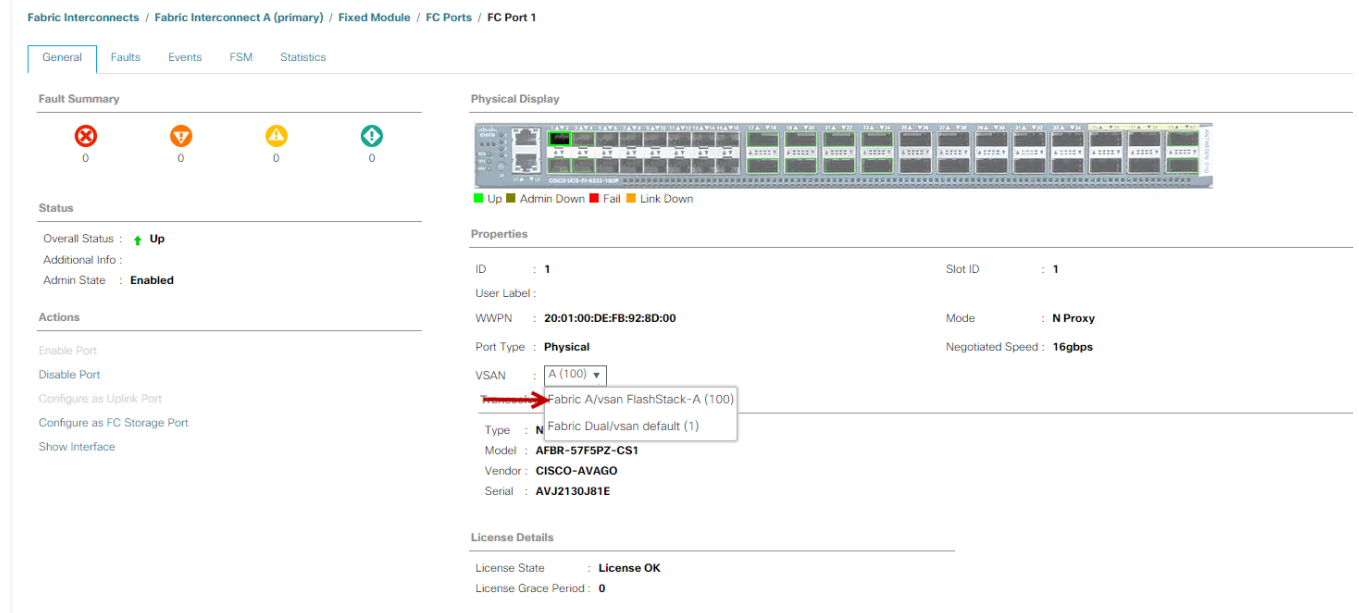

3. Repeat these steps to Add FC Port 1-4 to VSAN 100 on Fabric A and FC Port 1-4 to VSAN 101 on Fabric B.

Create and Configure Fiber Channel Zoning

This procedure sets up the Fibre Channel connections between the Cisco MDS 9132T 32-Gbps switches, the Cisco UCS Fabric Interconnects, and the Pure Storage FlashArray systems.



Before you configure the zoning details, decide how many paths are needed for each LUN and extract the WWPN numbers for each of the HBAs from each server. We used 4 HBAs for each Server. Two HBAs (HBA0 and HBA2) are connected to MDS Switch-A and other two HBAs (HBA1 and HBA3) are connected to MDS Switch-B.

To create and configure the fiber channel zoning, follow these steps:

1. Log into the Cisco UCS Manager > Equipment > Chassis > Servers and select the desired server. Click the Inventory tab and then click the HBA's tab to get the WWPN of HBA's as shown in the screenshot below:

Name	vHBA	Vendor	Model	Operability	WWPN	Original WWPN
HBA 1	vHBA0	Cisco Systems Inc	UCSB-MLOM-40G-03	Operable	20:00:00:25:B5:AA:17:1C	00:00:00:00:00:00:00:00
HBA 2	vHBA1	Cisco Systems Inc	UCSB-MLOM-40G-03	Operable	20:00:00:25:B5:BB:17:1C	00:00:00:00:00:00:00:00
HBA 3	vHBA2	Cisco Systems Inc	UCSB-MLOM-40G-03	Operable	20:00:00:25:B5:AA:17:1D	00:00:00:00:00:00:00:00
HBA 4	vHBA3	Cisco Systems Inc	UCSB-MLOM-40G-03	Operable	20:00:00:25:B5:BB:17:1D	00:00:00:00:00:00:00:00

2. Connect to the Pure Storage System and extract the WWPN of FC Ports connected to the Cisco MDS Switches. We have connected 8 FC ports from Pure Storage System to Cisco MDS Switches. FC ports CT0.FC2, CT1.FC2, CT0.FC3, CT1.FC3 are connected to MDS Switch-A and similarly FC ports CT0.FC6, CT1.FC6, CT0.FC7, CT1.FC7 are connected to MDS Switch-B.

Port	Name	Speed	Fallover	Port	Name	Speed	Fallover
CT0.FC0	52-4A:93:75:DD:910A:00	0		CT1.FC0	52-4A:93:75:DD:910A:10	0	
CT0.FC1	52-4A:93:75:DD:910A:01	0		CT1.FC1	52-4A:93:75:DD:910A:11	0	
CT0.FC2	52-4A:93:75:DD:910A:02	16 Gb/s		CT1.FC2	52-4A:93:75:DD:910A:12	16 Gb/s	
CT0.FC3	52-4A:93:75:DD:910A:03	16 Gb/s		CT1.FC3	52-4A:93:75:DD:910A:13	16 Gb/s	
CT0.FC6	52-4A:93:75:DD:910A:06	16 Gb/s		CT1.FC6	52-4A:93:75:DD:910A:16	16 Gb/s	
CT0.FC7	52-4A:93:75:DD:910A:07	16 Gb/s		CT1.FC7	52-4A:93:75:DD:910A:17	16 Gb/s	

Create Device Aliases for Fiber Channel Zoning

Cisco MDS Switch A

To configure device aliases and zones for the SAN boot paths as well as the datapaths of MDS switch A, follow these steps. The Appendix section regarding MDS 9132T 32-Gbps switch provides detailed information about the “show run” configuration.

1. Log in as admin user and run the following commands:

```

conf t
device-alias database
device-alias name VCC-WLHost01-HBA0 pwwn 20:00:00:25:B5:AA:17:00
device-alias name VCC-WLHost01-HBA2 pwwn 20:00:00:25:B5:AA:17:01
device-alias name FLASHSTACK-X-CT0-FC0 pwwn 52:4a:93:75:dd:91:0a:00
device-alias name FLASHSTACK-X-CT0-FC2 pwwn 52:4a:93:75:dd:91:0a:02
device-alias name FLASHSTACK-X-CT1-FC1 pwwn 52:4a:93:75:dd:91:0a:11
device-alias name FLASHSTACK-X-CT1-FC3 pwwn 52:4a:93:75:dd:91:0a:13

```

Cisco MDS Switch B

To configure device aliases and zones for the SAN boot paths as well as datapaths of MDS switch B, follow these steps:

1. Log in as admin user and run the following commands:

```

conf t
device-alias database
device-alias name VCC-WLHost01-HBA1 pwwn 20:00:00:25:B5:AA:17:00
device-alias name VCC-WLHost01-HBA3 pwwn 20:00:00:25:B5:AA:17:01
device-alias name FLASHSTACK-X-CT0-FC1 pwwn 52:4a:93:75:dd:91:0a:01
device-alias name FLASHSTACK-X-CT0-FC3 pwwn 52:4a:93:75:dd:91:0a:03
device-alias name FLASHSTACK-X-CT1-FC0 pwwn 52:4a:93:75:dd:91:0a:10
device-alias name FLASHSTACK-X-CT1-FC2 pwwn 52:4a:93:75:dd:91:0a:12

```

Create Zoning

Cisco MDS Switch A

To configure zones for the MDS switch A, follow these steps:

1. Create a zone for each service profile.
2. Login as admin user and create the zone as shown below:

```

conf t
zone name FlaskStack-VCC-CVD-WLHost01 vsan 100
member pwwn 52:4a:93:75:dd:91:0a:00
member pwwn 52:4a:93:75:dd:91:0a:02
member pwwn 52:4a:93:75:dd:91:0a:11
member pwwn 52:4a:93:75:dd:91:0a:13

```

```

member pwnn 20:00:00:25:B5:AA:17:00
member pwnn 20:00:00:25:B5:AA:17:01
conf t
zoneset name FlashStack-VCC-CVD vsan 100
member FlaskStack-VCC-CVD-WLHost01

```

3. After the zone for the Cisco UCS service profile has been created, create the zone set and add the necessary members:

```

conf t
zoneset name FlashStack-VCC-CVD vsan 100
member FlaskStack-VCC-CVD-WLHost01

```

4. Activate the zone set by running following commands:

```

zoneset activate name FlashStack-VCC-CVD vsan 100
exit
copy running-config startup-config

```

Configure Pure Storage FlashArray//X70 R2

The design goal of the reference architecture is to best represent a real-world environment as closely as possible. The approach included the features of Cisco UCS to rapidly deploy stateless servers and use Pure Storage FlashArray's boot LUNs to provision the O.S on top of Cisco UCS. Zoning was performed on the Cisco MDS 9132T 32-Gbps switches to enable the initiators discover the targets during boot process.

A Service Profile was created within Cisco UCS Manager to deploy the thirty-two servers quickly with a standard configuration. SAN boot volumes for these servers were hosted on the same Pure Storage FlashArray//X70 R2. Once the stateless servers were provisioned, following process was performed to enable Rapid deployment of thirty-two nodes.

Each Server node has dedicated single LUN to install operating system and all the thirty-two server node was booted off SAN. For this solution, we have installed vSphere ESXi 6.7 U1 Cisco Custom ISO on this LUNs to create thirty node based Citrix XenDesktop 7.15 LTSR CU3 solution.

Using logical servers that are disassociated from the physical hardware removes many limiting constraints around how servers are provisioned. Cisco UCS Service Profiles contain values for a server's property settings, including virtual network interface cards (vNICs), MAC addresses, boot policies, firmware policies, fabric connectivity, external management, and HA information. The service profiles represent all the attributes of a logical server in Cisco UCS model. By abstracting these settings from the physical server into a Cisco Service Profile, the Service Profile can then be deployed to any physical compute hardware within the Cisco UCS domain. Furthermore, Service Profiles can, at any time, be migrated from one physical server to another. Furthermore, Cisco is the only hardware provider to offer a truly unified management platform, with Cisco UCS Service Profiles and hardware abstraction capabilities extending to both blade and rack servers.

In addition to the service profiles, the use of Pure Storage's FlashArray's with SAN boot policy provides the following benefits:

- Scalability - Rapid deployment of new servers to the environment in a very few steps.
- Manageability - Enables seamless hardware maintenance and upgrades without any restrictions. This is a huge benefit in comparison to another appliance model like Exadata.
- Flexibility - Easy to repurpose physical servers for different applications and services as needed.
- Availability - Hardware failures are not impactful and critical. In rare case of a server failure, it is easier to associate the logical service profile to another healthy physical server to reduce the impact.

Configure Host

Before using a volume (LUN) on a host, the host has to be defined on Pure Storage FlashArray. To set up a host follow these steps:

1. Log into FlashArray dashboard.
2. In the PURE GUI, go to Storage tab.
3. Under Hosts option in the left frame, click the + sign to create a host.
4. Enter the name of the host or select Create Multiple and click Create. This will create a Host entry(s) under the Hosts category.

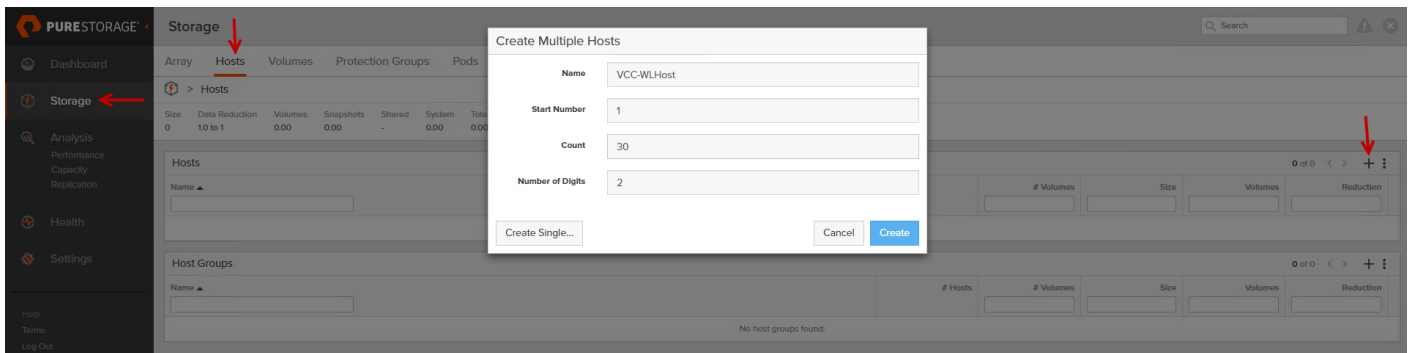

5. To update the host with the connectivity information by providing the Fibre Channel WWNs or iSCSI IQNs, click the Host that was created.
6. In the host context, click the Host Ports tab and click the settings button and select "Configure Fibre Channel WWNs" which will display a window with the available WWNs in the left side.

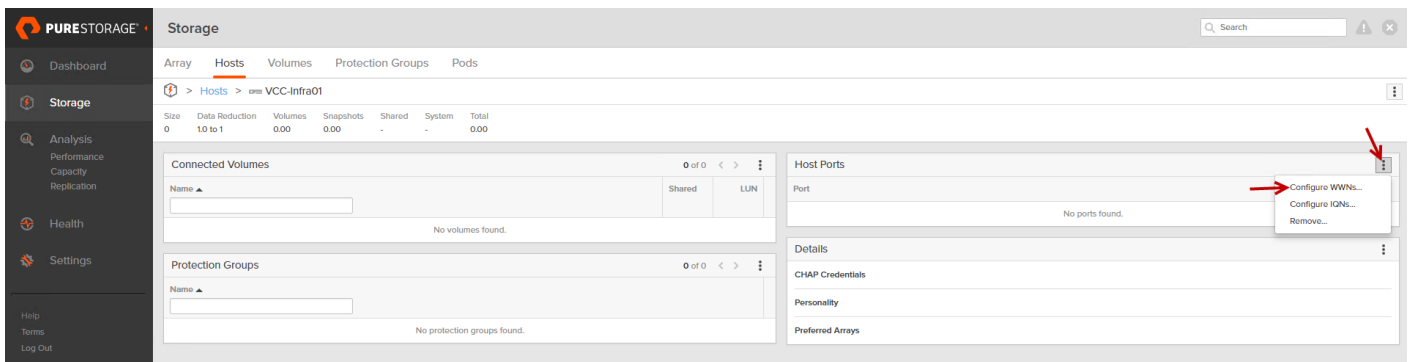

7. Select the list of WWNs that belongs to the host in the next window and click “Confirm.”

 Make sure the zoning has been setup to include the WWNs details of the initiators along with the target, without which the SAN boot will not work.

 WWNs will appear only if the appropriate FC connections were made and the zones were setup on the underlying FC switch.

Configure Volume

To configure a volume, follow these steps:

1. Go to the Storage tab > Volumes > and click the + sign to “Create Volume.”

2. Provide the name of the volume, size, choose the size type (KB, MB, GB, TB, PB) and click Create to create the volume. Example creating 32 SAB boot Volume for 32 B200 M5 server configured in this solution.

- Two for Infrastructure and remaining thirty Servers for Citrix XenDesktop workload test.

Create Multiple Volumes ✕

Container

Name

Provisioned Size G ▾

Start Number

Count

Number of Digits

Create Single...
Cancel
Create

- Attach the volume to a host by going to the “Connected Hosts and Host Groups” tab under the volume context menu.

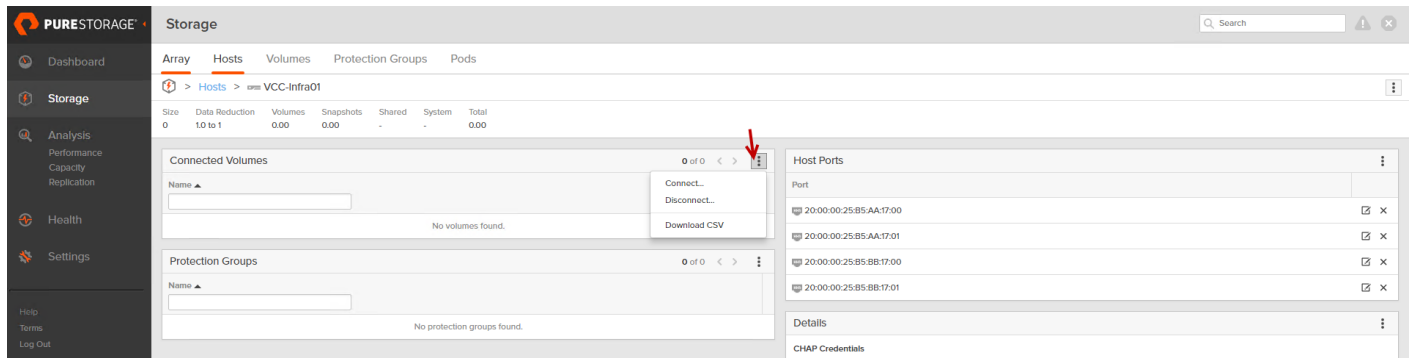

- Select Connect; In the Connect Volumes to Host wizard select SAN-BootXX volume, click Connect.

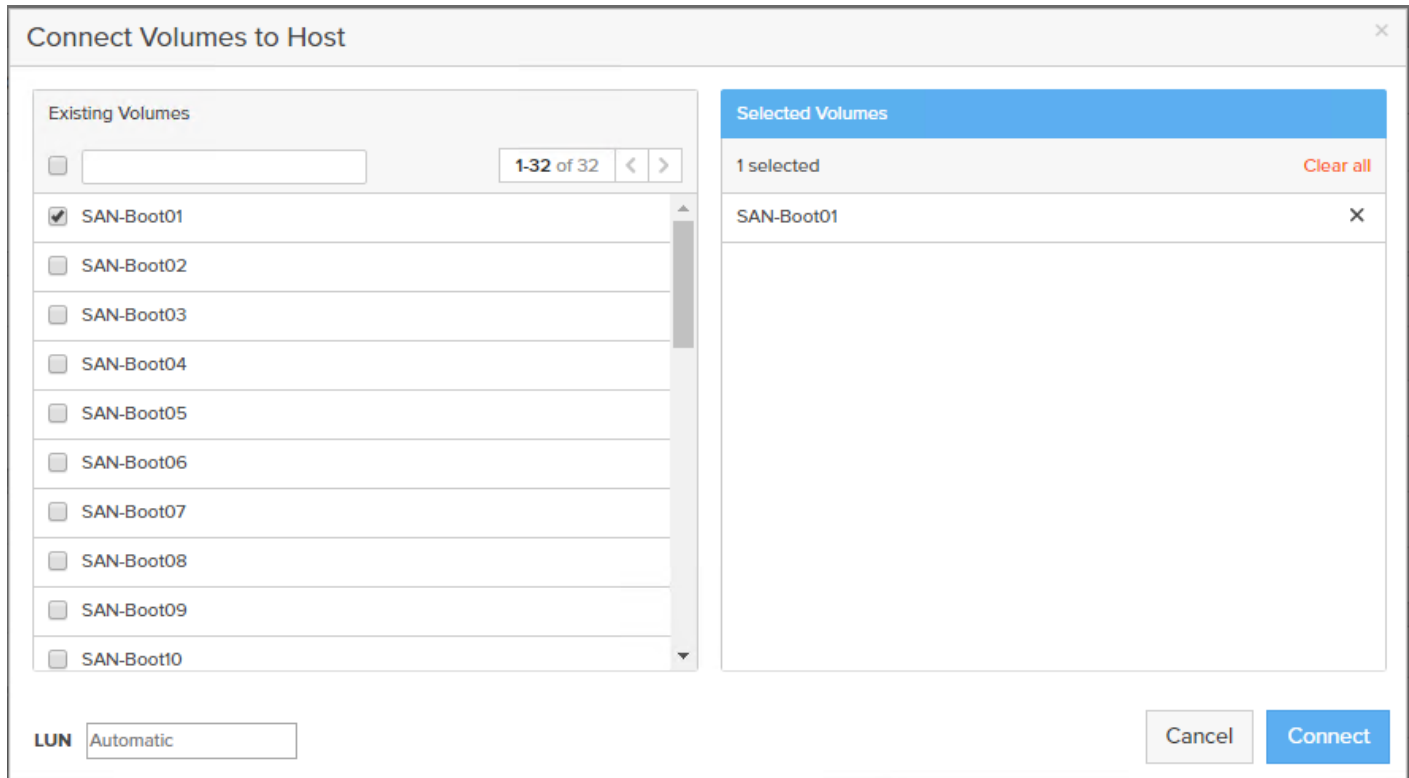

Make sure the SAN Boot Volumes has the LUN ID “1” since this is important while configuring Boot from SAN. You will also configure the LUN ID as “1” when configuring Boot from SAN policy in Cisco UCS Manager.

More LUNs can be connected by adding a connection to existing or new volume(s) to an existing node.

Install and Configure VMware ESXi 6.7

This section explains how to install VMware ESXi 6.7 Update1 in an environment.

There are several methods to install ESXi in a VMware environment. These procedures focus on how to use the built-in keyboard, video, mouse (KVM) console and virtual media features in Cisco UCS Manager to map remote installation media to individual servers and install ESXi on boot logical unit number (LUN). Upon completion of steps outlined here, ESXi hosts will be booted from their corresponding SAN Boot LUNs.

Download Cisco Custom Image for ESXi 6.7 Update 1

To download the Cisco Custom Image for ESXi 6.7 Update 1, from the [VMware vSphere Hypervisor 6.7 U1](#) page click the “Custom ISOs” tab.

Install VMware vSphere ESXi 6.7

In order to install VMware vSphere ESXi hypervisor on Cisco UCS Server, follow these steps:

1. In the Cisco UCS Manager navigation pane, click the Equipment tab.
2. Under Equipment > Chassis > Chassis 1 > Server 1.

3. Right-click Server 1 and select KVM Console.

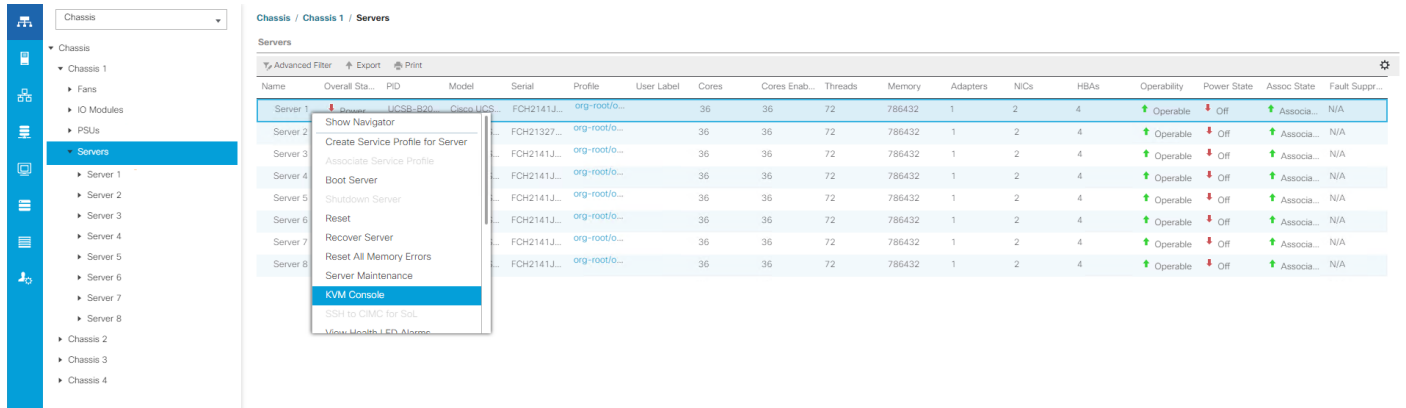

4. Click Activate Virtual Devices, mount ESXi ISO image.

5. Follow the prompts to complete installing VMware vSphere ESXi hypervisor.

6. When selecting a storage device to install ESXi, select Remote LUN provisioned through Pure Storage Administrative console and access through FC connection.

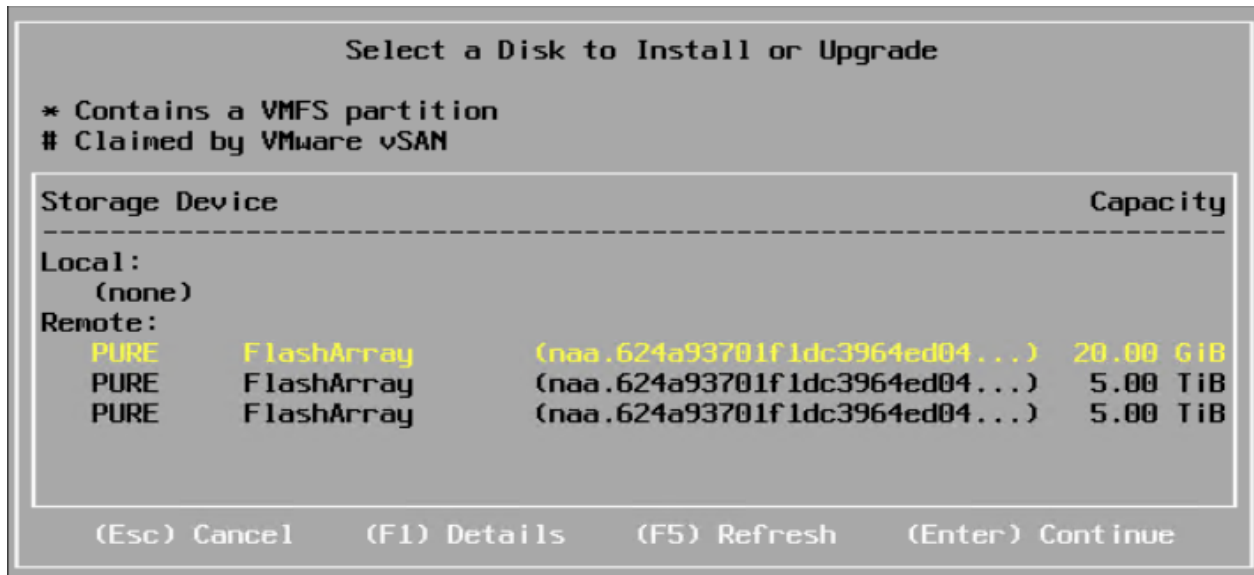

Set Up Management Networking for ESXi Hosts

Adding a management network for each VMware host is necessary for managing the host and connection to vCenter Server. Please select the IP address that can communicate with existing or new vCenter Server.

To configure the ESXi host with access to the management network, follow these steps:

1. After the server has finished rebooting, press F2 to enter in to configuration wizard for ESXi Hypervisor.
2. Log in as root and enter the corresponding password.
3. Select the "Configure the Management Network" option and press Enter.

4. Select the VLAN (Optional) option and press Enter. Enter the VLAN In-Band management ID and press Enter.
5. From the Configure Management Network menu, select "IP Configuration" and press Enter.
6. Select "Set Static IP Address and Network Configuration" option by using the space bar. Enter the IP address to manage the first ESXi host. Enter the subnet mask for the first ESXi host. Enter the default gateway for the first ESXi host. Press Enter to accept the changes to the IP configuration.
7. IPv6 Configuration was set to automatic.
8. Select the DNS Configuration option and press Enter.
9. Enter the IP address of the primary and secondary DNS server. Enter Hostname
10. Enter DNS Suffixes.
11. Since the IP address is assigned manually, the DNS information must also be entered manually.



The steps provided varies based on the configuration. Please make the necessary changes according to your configuration.

Figure 44 Sample ESXi Configure Management Network

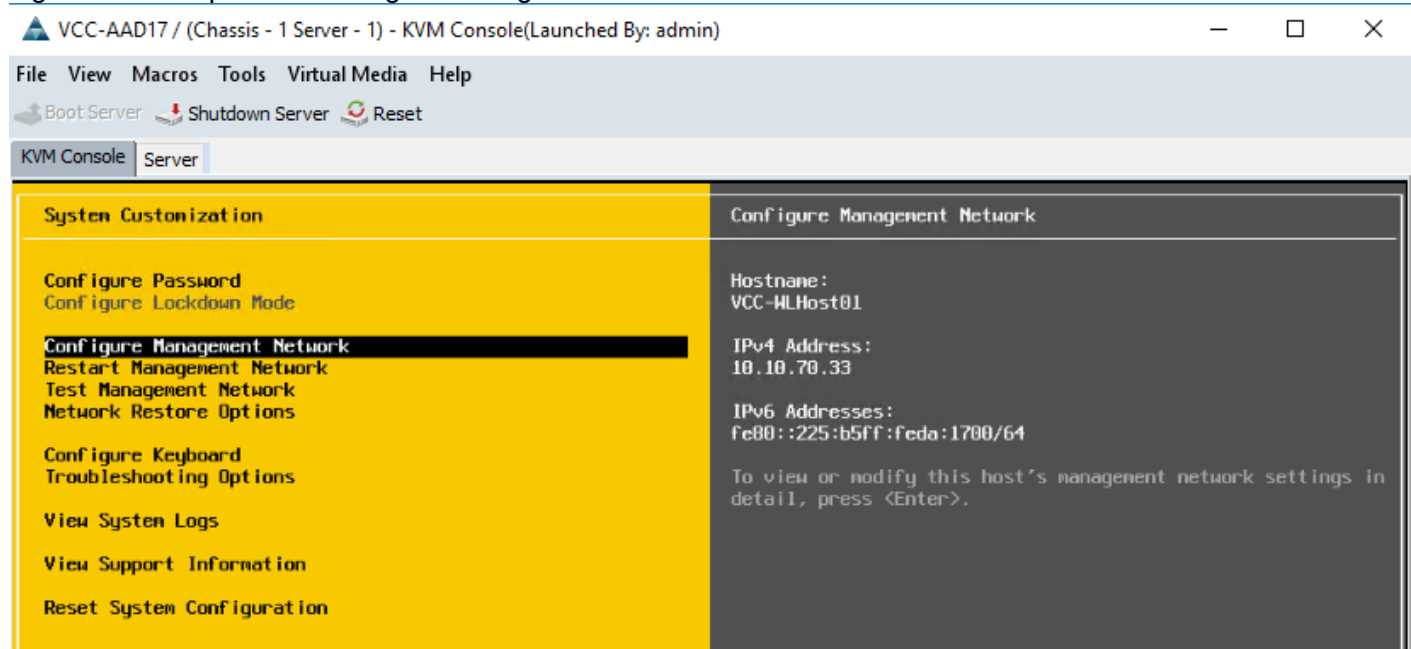

Update Cisco VIC Drivers for ESXi

When ESXi is installed from Cisco Custom ISO you might have to update Cisco VIC drivers for VMware ESXi Hypervisor to match current [Cisco Hardware and Software Interoperability Matrix](#).



In this Validated Design the following drivers were used:

- VMW-ESX-6.7.0-nenic-1.0.26.0
- VMW-ESX-6.7.0-nfnic-4.0.0.20

1. Log into your VMware Account to download required drivers for FNIC and NENIC as per the recommendation.
2. Enable SSH on ESXi to run following commands:

```
esxcli software vib update -d /path/offline-bundle.zip
```

VMware Clusters

The following VMware Clusters were configured in two vCenters to support the solution and testing environment:

- VCSA01
- VDI Cluster: Pure Storage FlashArray//X70 R2 with Cisco UCS
 - Infrastructure Cluster: Infrastructure virtual machines (vCenter, Active Directory, DNS, DHCP, SQL Server, XenDesktop Controllers, Provisioning Servers, and other common services).
 - HSD: XenApp Hosted Shared Desktop virtual machines (Windows Server 2016 streamed with PVS).
 - HVD Non-Persistent: XenDesktop Hosted Virtual Desktop virtual machines (Windows 10 64-bit non-persistent virtual desktops streamed with PVS).
 - HVD Persistent: XenDesktop Hosted Virtual Desktop virtual machines (Windows 10 64-bit persistent virtual desktops).
- VCSA02
- VSI Launchers Cluster
 - Launcher Cluster: Login VSI Cluster (The Login VSI launcher infrastructure was connected using the same set of switches but hosted on separate SAN storage and servers)

Figure 45 VMware vSphere WebUI Reporting Cluster Configuration for this Study

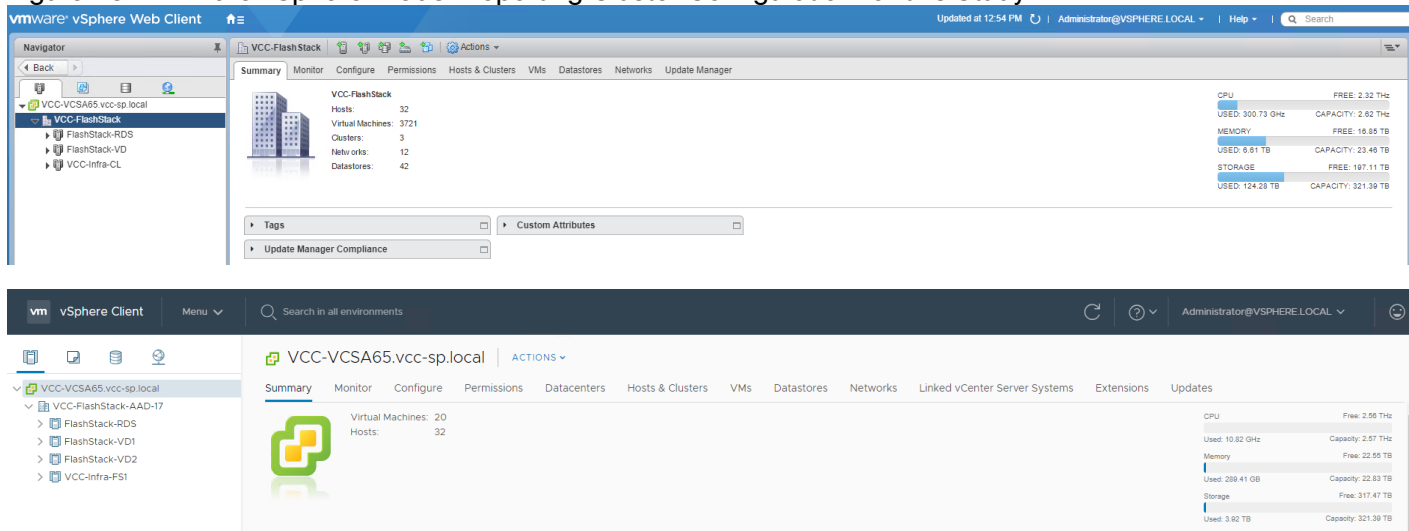

ESXi Side-Channel-Aware Scheduler, which is disabled by default, was not enabled to mitigate the Concurrent-context attack vector of CVE-2018-3646. The scheduler can be enabled on an individual ESXi host through the advanced configuration option `hyperthreadingMitigation`. Enabling this scheduler may impose a non-trivial performance impact. During the Cisco evaluation, as

much as a 20 percent drop in desktop density could be seen.

For more information related the mitigation impact, refer to the VMware KB [55806](#) and [55636](#).

The warning message in vSphere Web Client related to the mitigation can be suppressed (see below).

 This host is potentially vulnerable to issues described in CVE-2018-3646, please refer to <https://kb.vmware.com/s/article/55636> for details and VMware recommendations. KB 55636

[Suppress Warning](#)

Building the Virtual Machines and Environment for Workload Testing

Software Infrastructure Configuration

This section explains how to configure the software infrastructure components that comprise this solution.

Install and configure the infrastructure virtual machines by following the process provided in Table 13 .

Table 13 Test Infrastructure Virtual Machine Configuration

Configuration	Citrix XenDesktop Controllers Virtual Machines	Citrix Provisioning Servers Virtual Machines
Operating system	Microsoft Windows Server 2016	Microsoft Windows Server 2016
Virtual CPU amount	6	8
Memory amount	8 GB	16 GB
Network	VMXNET3 Infra	VMXNET3 VCC
Disk-1 (OS) size	40 GB	40 GB
Configuration	Microsoft Active Directory DCs Virtual Machines	vCenter Server Appliance Virtual Machine
Operating system	Microsoft Windows Server 2016	VCSA - SUSE Linux
Virtual CPU amount	2	16
Memory amount	4 GB	32 GB
Network	VMXNET3 Infra	VMXNET3 Mgmt
Disk size	40 GB	599 GB (across 12 VMDKs)
Configuration	Microsoft SQL Server Virtual Machine	Citrix StoreFront Controller Virtual Machine
Operating system	Microsoft Windows Server 2016	Microsoft Windows Server 2016

	Microsoft SQL Server 2012 SP1	
Virtual CPU amount	6	4
Memory amount	24GB	8 GB
Network	VMXNET3 Infra	VMXNET3 Infra
Disk-1 (OS) size	40 GB	40 GB
Disk-2 size	100 GB SQL Databases\Logs	-

Preparing the Master Targets

This section provides guidance regarding creating the golden (or master) images for the environment. Virtual machines for the master targets must first be installed with the software components needed to build the golden images. Additionally, all available patches as of February 2019 for the Microsoft operating systems, SQL server and Microsoft Office 2016 were installed.

Meltdown and Specter vulnerability mitigation was verified with InSpecter (Rel#8) as shown in Figure 46.

Figure 46 Specter and Meltdown Mitigation Status

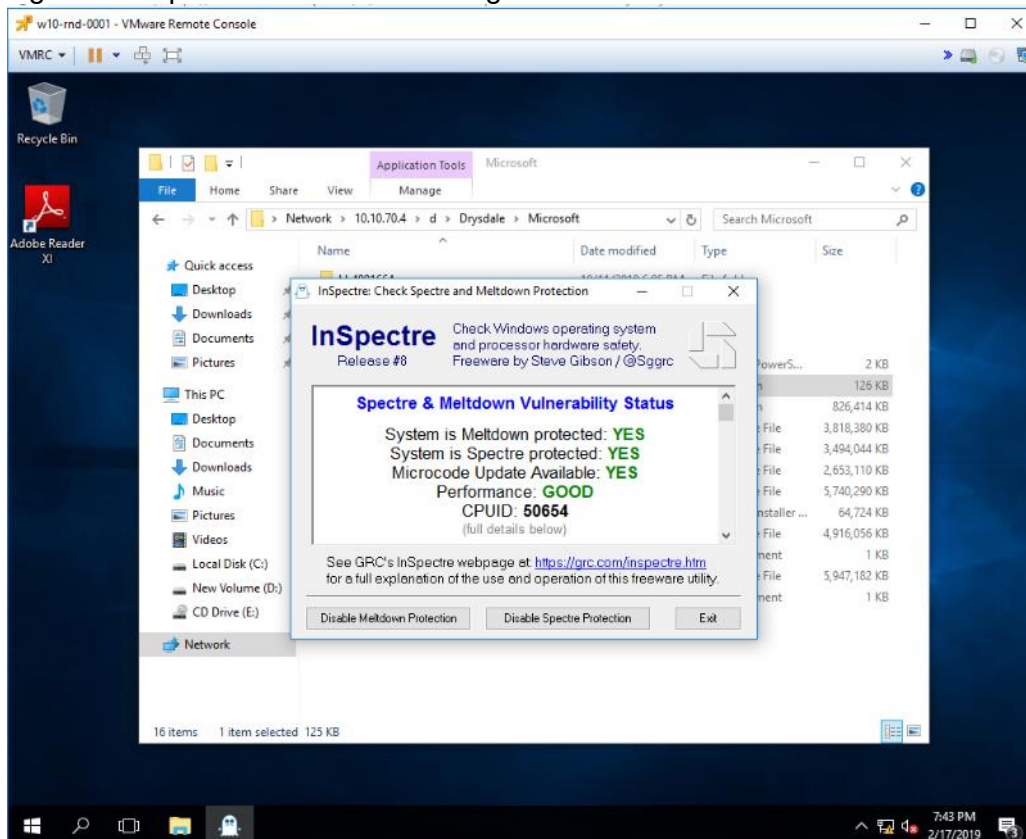

To prepare the master virtual machines for the Hosted Virtual Desktops (HVDs) and Hosted Shared Desktops (HSDs), there are three major steps: installing the PVS Target Device x64 software, installing the Virtual Delivery Agents (VDAs), and installing application software.



For this CVD, the images contain the basics needed to run the Login VSI workload.

The master target Hosted Virtual Desktop (HVD) and Hosted Shared Desktop (HSD) virtual machines were configured as detailed in Table 14

Table 14 HVD and HSD Virtual Machines Configurations

Configuration	HVD Virtual Machines	HSD Virtual Machines
Operating system	Microsoft Windows 10 64-bit	Microsoft Windows Server 2016
Virtual CPU amount	2	9
Memory amount	2 GB reserve for all guest memory	24 GB reserve for all guest memory
Network	VMXNET3 VCC	VMXNET3 VCC
Citrix PVS vDisk size	24 GB (dynamic)	40 GB (dynamic)
Full Clone Disk Size	100 GB	
Citrix PVS write cache Disk size	6 GB	30 GB
Citrix PVS write cache RAM cache size	64 MB	1024 MB
Additional software used for testing	Microsoft Office 2016 Login VSI 4.1.32 (Knowledge Worker Workload)	Microsoft Office 2016 Login VSI 4.1.32 (Knowledge Worker Workload)

Install and Configure XenDesktop and XenApp

This section explains the installation of the core components of the XenDesktop/XenApp 7.15 system. This CVD installs two XenDesktop Delivery Controllers to support both hosted shared desktops (HSD), non-persistent hosted virtual desktops (HVD), and persistent hosted virtual desktops (HVD).

Prerequisites

Citrix recommends that you use Secure HTTP (HTTPS) and a digital certificate to protect vSphere communications. Citrix recommends that you use a digital certificate issued by a certificate authority (CA) according to your organization's security policy. Otherwise, if the security policy allows, use the VMware-installed self-signed certificate.

To install vCenter Server self-signed Certificate, follow these steps:

1. Add the FQDN of the computer running vCenter Server to the hosts file on that server, located at System-Root/WINDOWS/system32/Drivers/etc/. This step is required only if the FQDN of the computer running vCenter Server is not already present in DNS.
2. Open Internet Explorer and enter the address of the computer running vCenter Server (for example, https://FQDN as the URL).
3. Accept the security warnings.
4. Click the Certificate Error in the Security Status bar and select View certificates.
5. Click Install certificate, select Local Machine, and then click Next.
6. Select Place all certificates in the following store and then click Browse.
7. Select Show physical stores.
8. Select Trusted People.

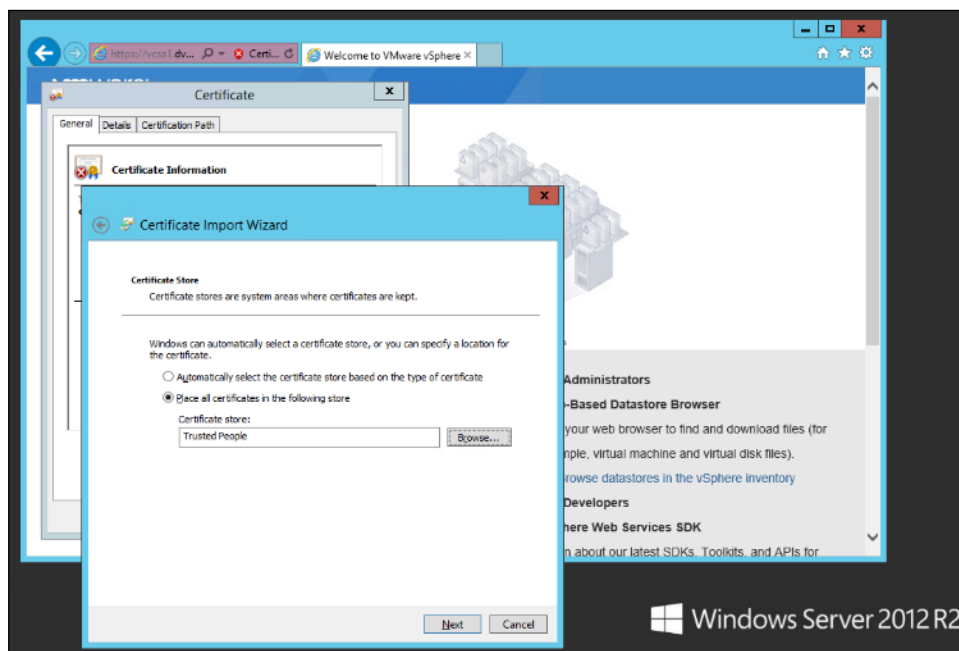

9. Click Next and then click Finish.
10. Repeat steps 1–9 on all Delivery Controllers and Provisioning Servers.

Install XenDesktop Delivery Controller, Citrix Licensing, and StoreFront

The process of installing the XenDesktop Delivery Controller also installs other key XenDesktop software components, including Studio, which is used to create and manage infrastructure components, and Director, which is used to monitor performance and troubleshoot problems.



Dedicated StoreFront and License servers should be implemented for large scale deployments.

Install Citrix License Server

To install the Citrix License Server, follow these steps:

1. To begin the installation, connect to the first Citrix License server and launch the installer from the Citrix XenDesktop 7.15 ISO.
2. Click Start.

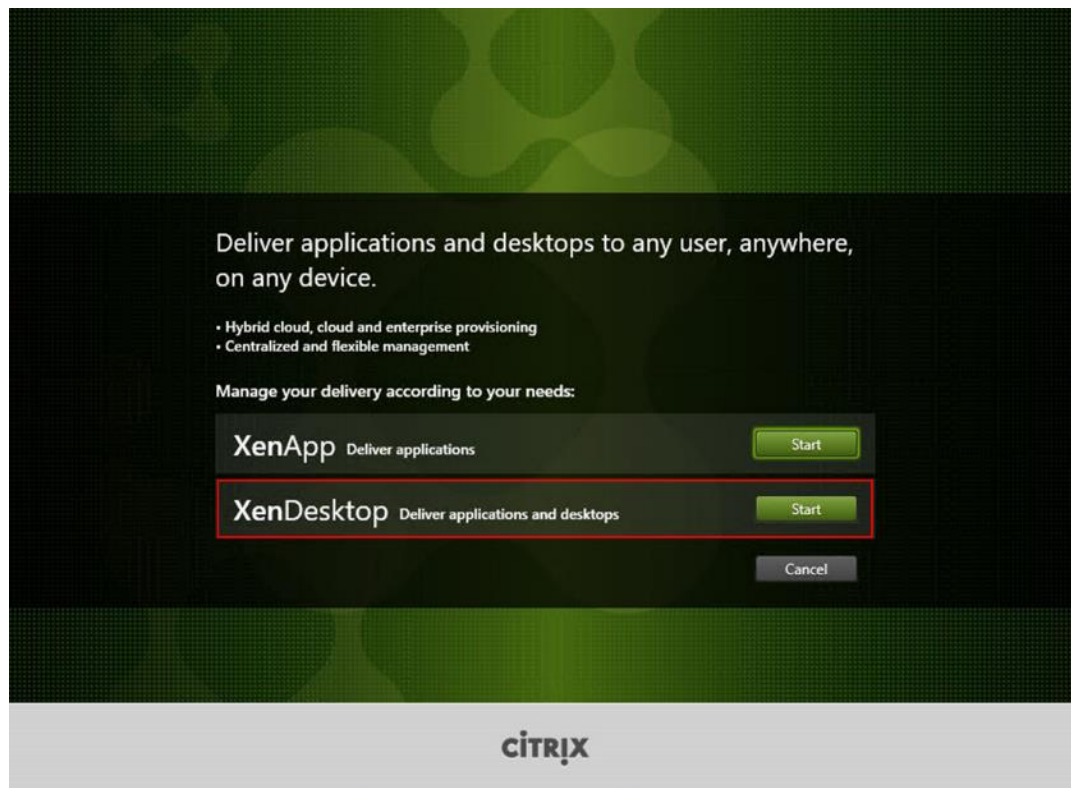

3. Click "Extend Deployment – Citrix License Server."

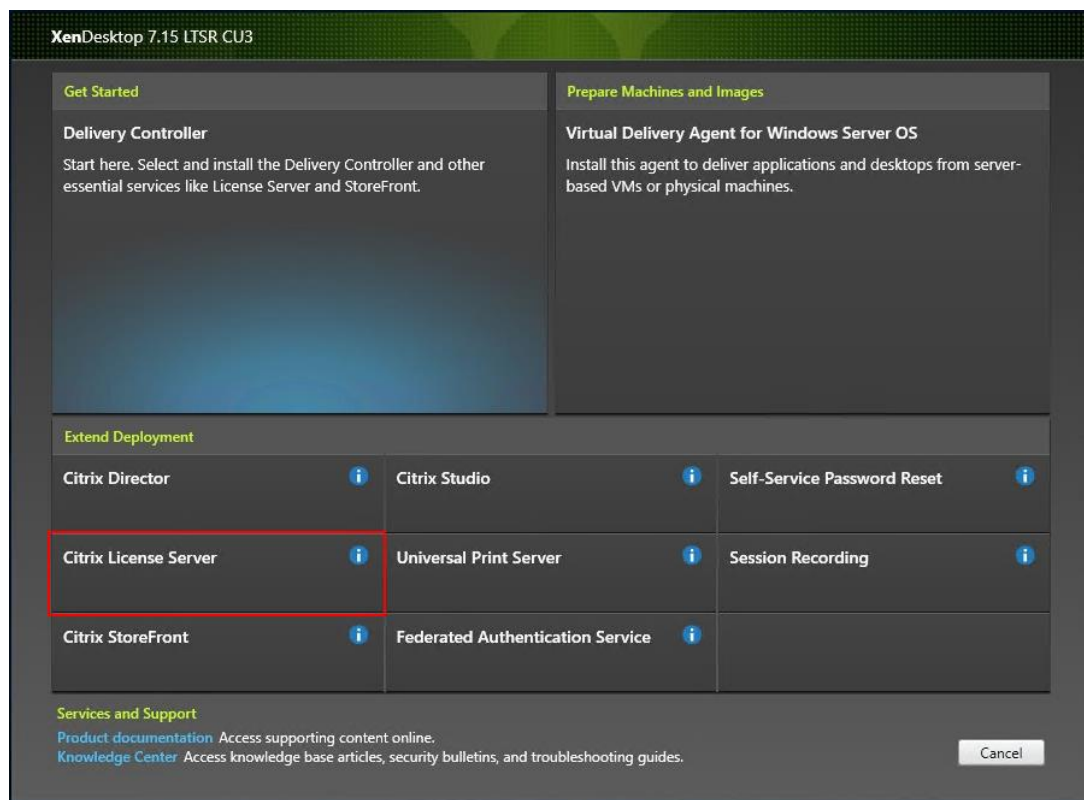

4. Read the Citrix License Agreement.
5. If acceptable, indicate your acceptance of the license by selecting the “I have read, understand, and accept the terms of the license agreement” radio button.
6. Click Next.

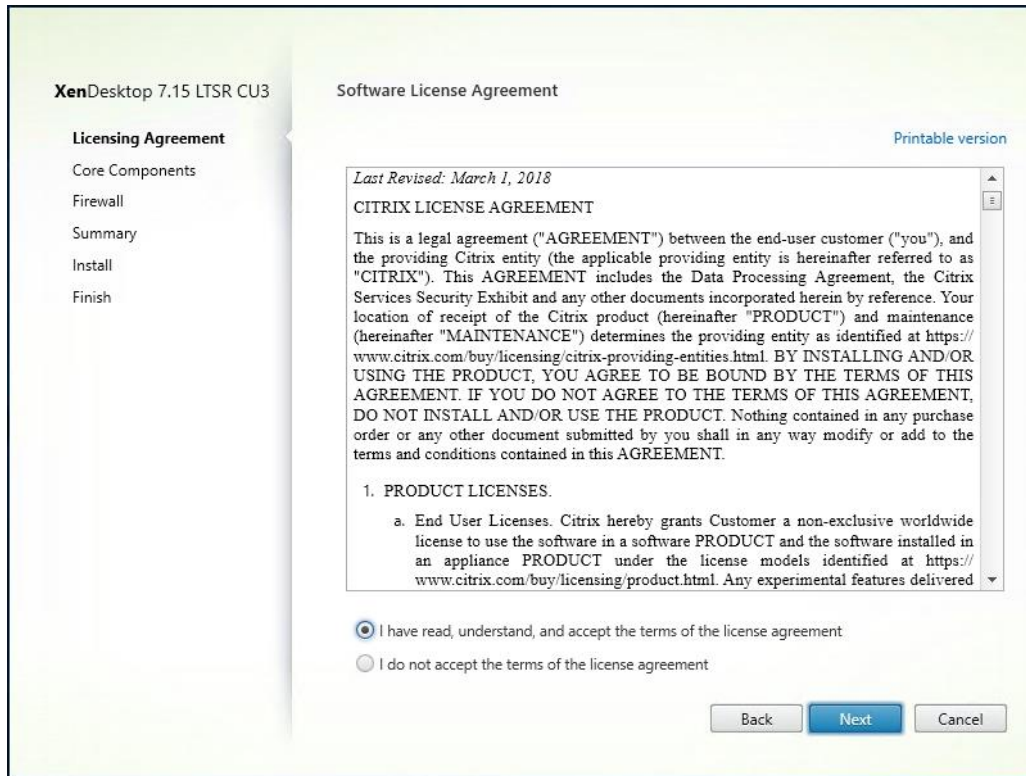

7. Click Next.

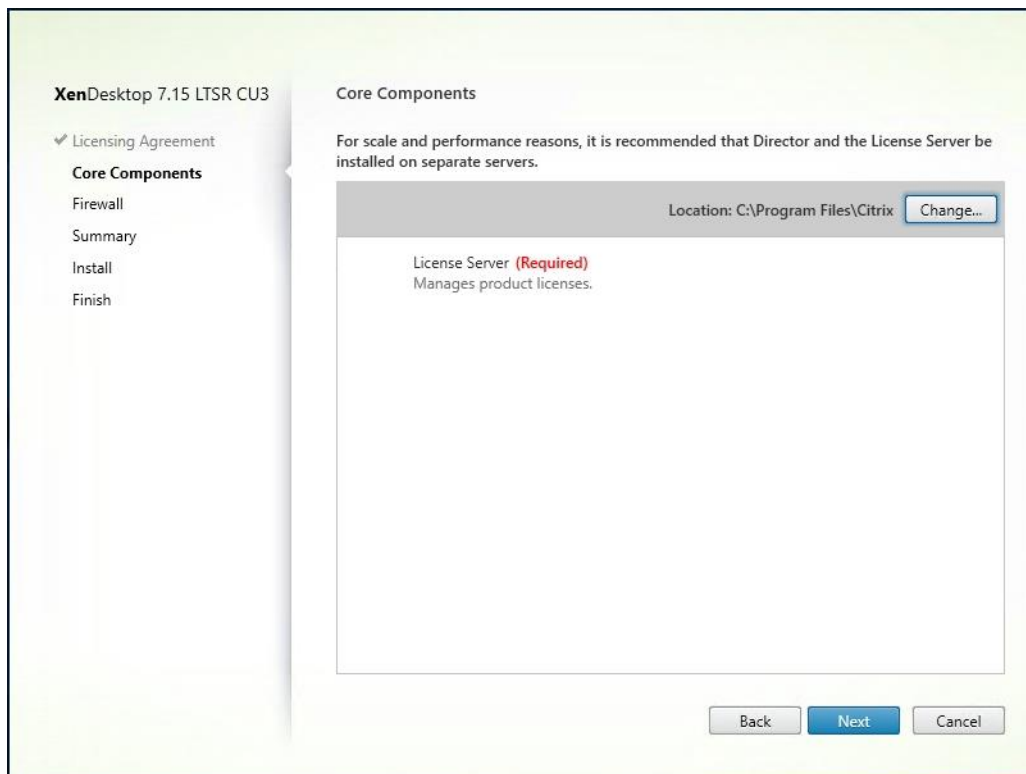

8. Select the default ports and automatically configured firewall rules.

9. Click Next.

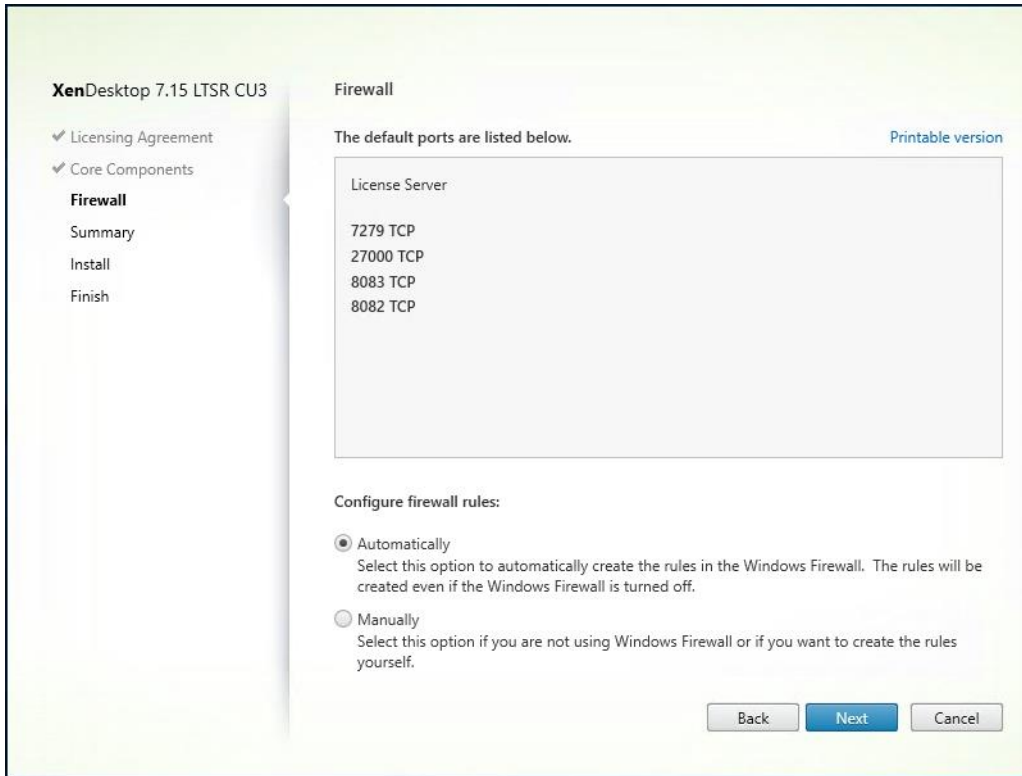

10. Click Install.

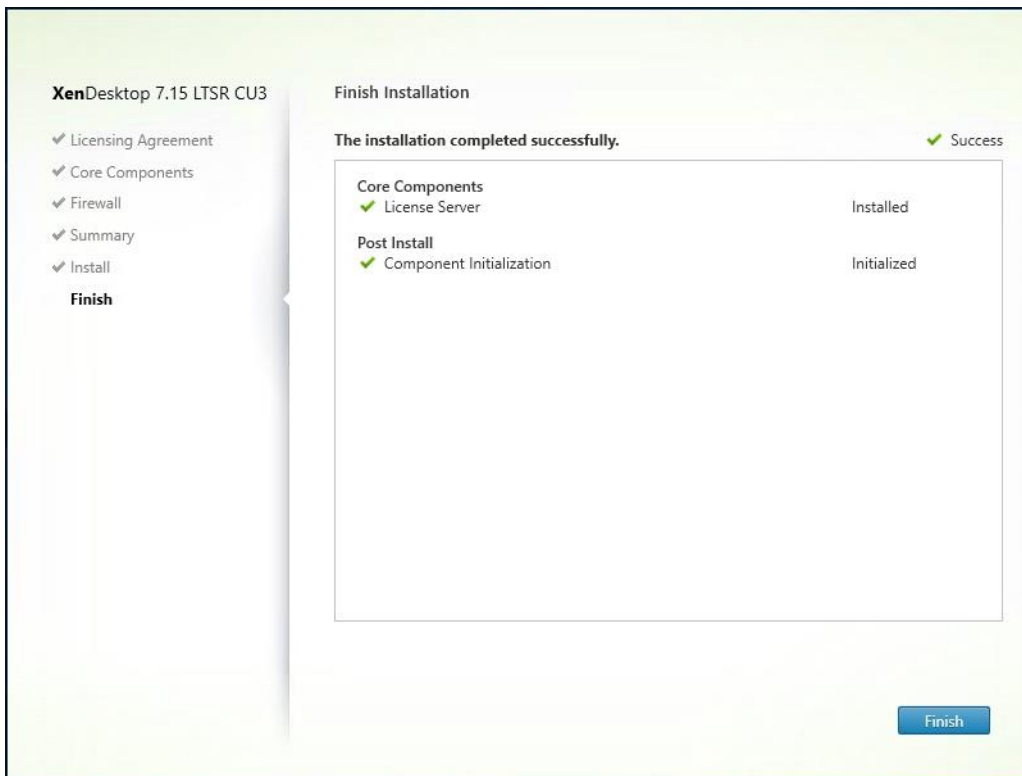

11. Click Finish to complete the installation.

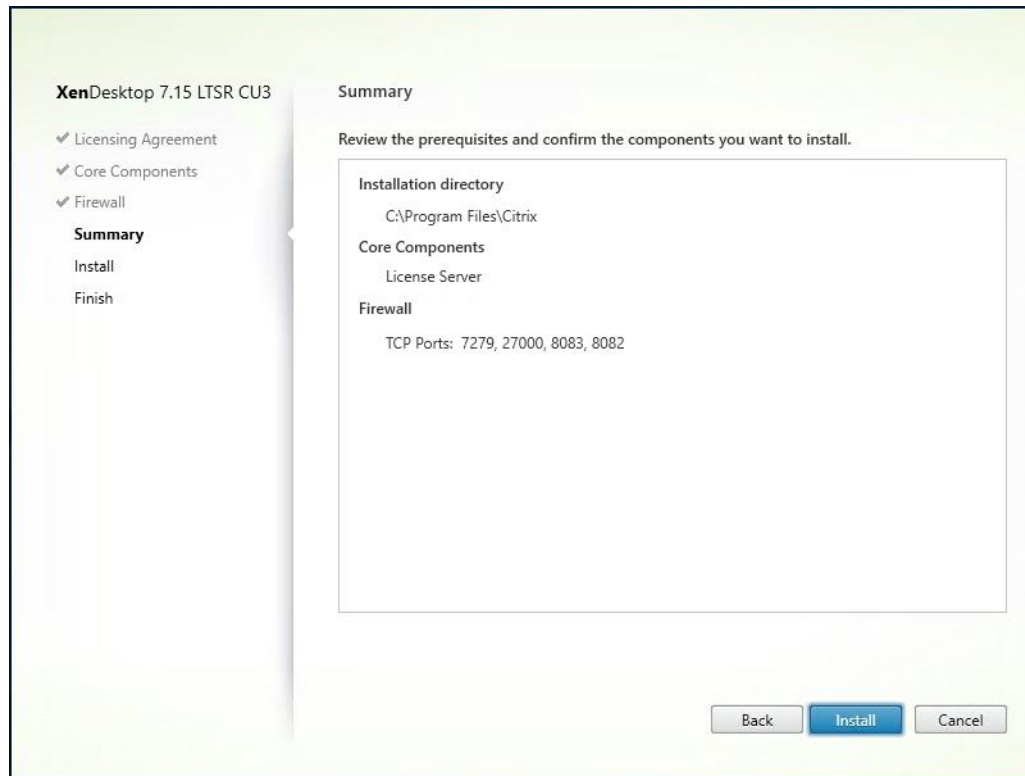

Install Citrix Licenses

To install the Citrix Licenses, follow these steps:

1. Copy the license files to the default location (C:\Program Files (x86)\Citrix\Licensing\ MyFiles) on the license server.

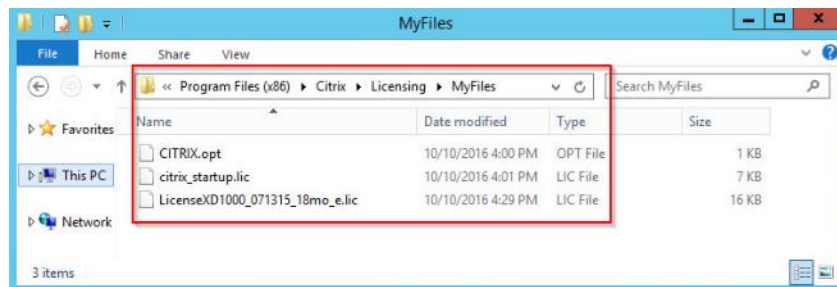

2. Restart the server or Citrix licensing services so that the licenses are activated.
3. Run the application Citrix License Administration Console.



4. Confirm that the license files have been read and enabled correctly.

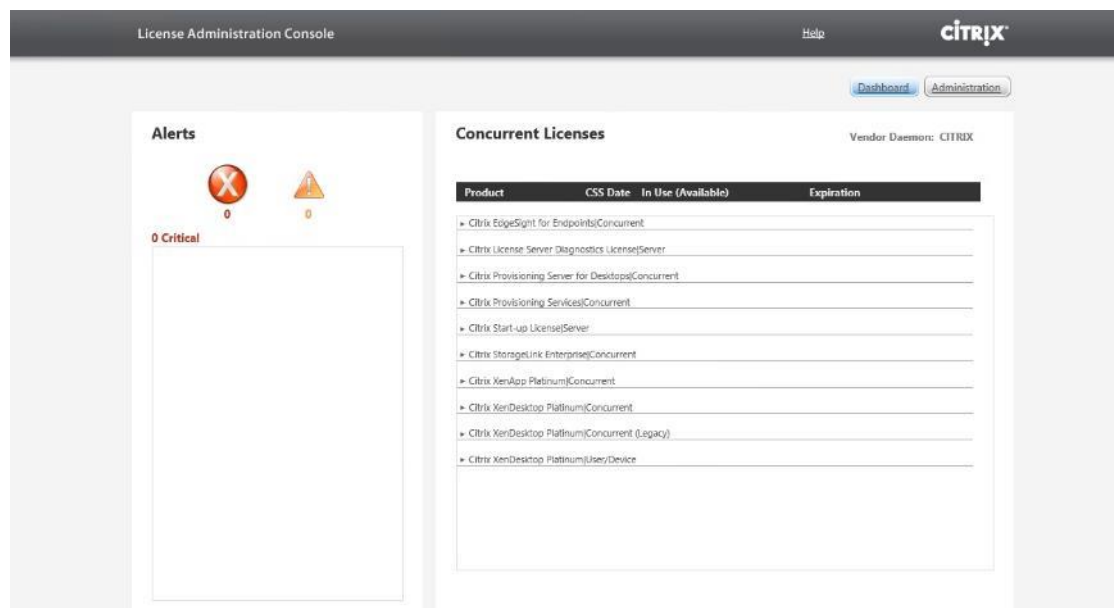

Install the XenDesktop

To begin the installation, connect to the first XenDesktop server and launch the installer from the Citrix XenDesktop 7.15ISO, and follow these steps:

1. Click Start.

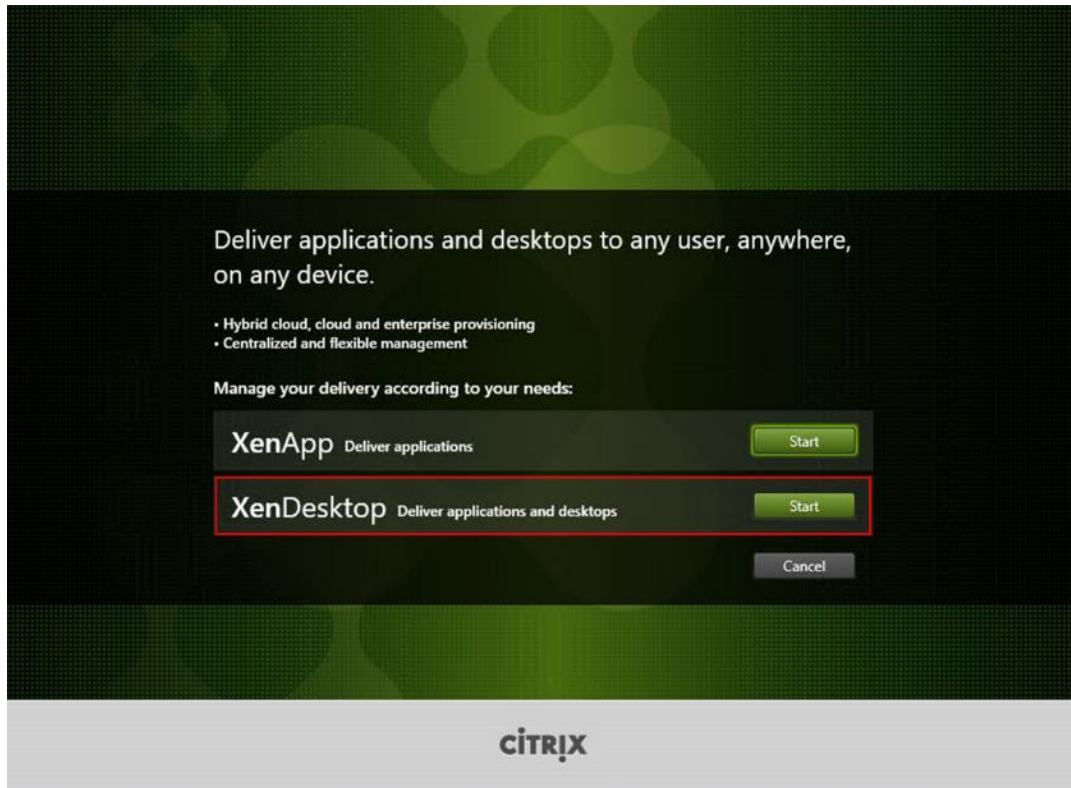

The installation wizard presents a menu with three subsections.

2. Click "Get Started - Delivery Controller."

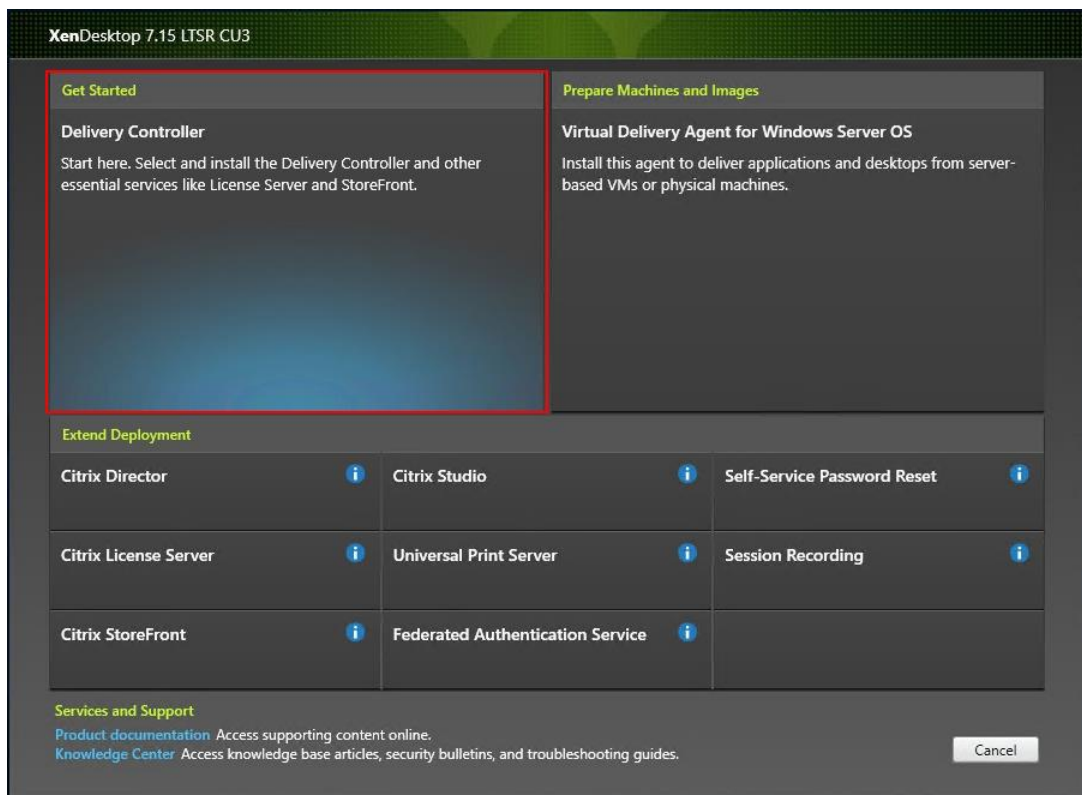

3. Read the Citrix License Agreement.
4. If acceptable, indicate your acceptance of the license by selecting the “I have read, understand, and accept the terms of the license agreement” radio button.
5. Click Next.

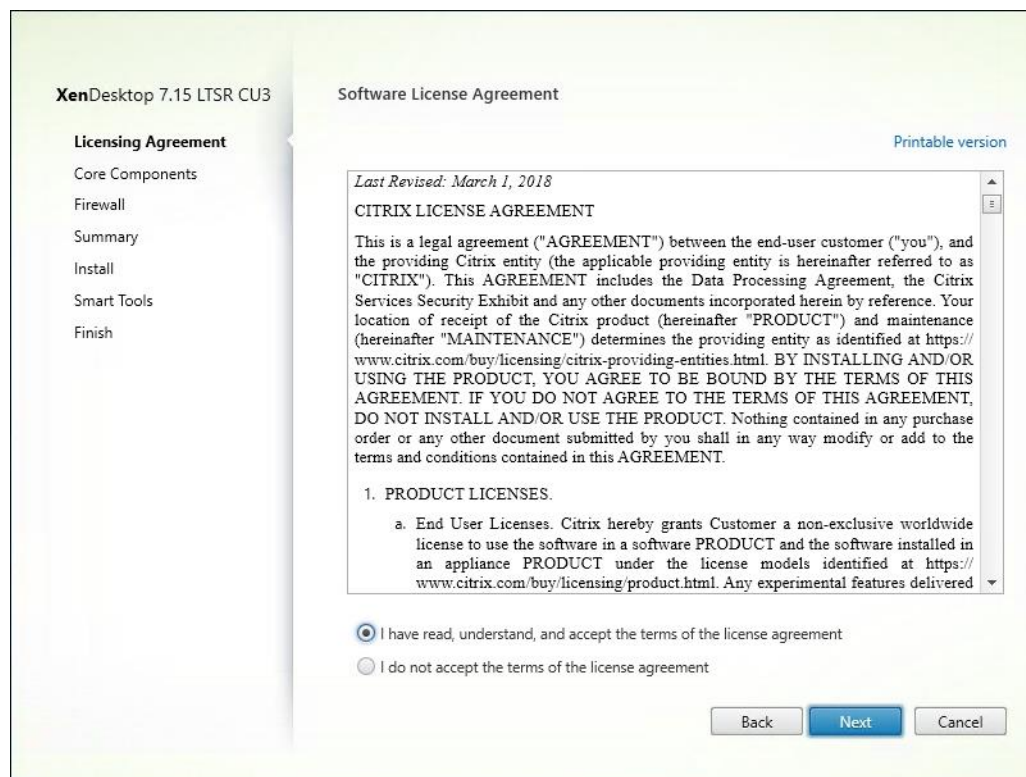

6. Select the components to be installed on the first Delivery Controller Server:
 - Delivery Controller
 - Studio
 - Director
7. Click Next.

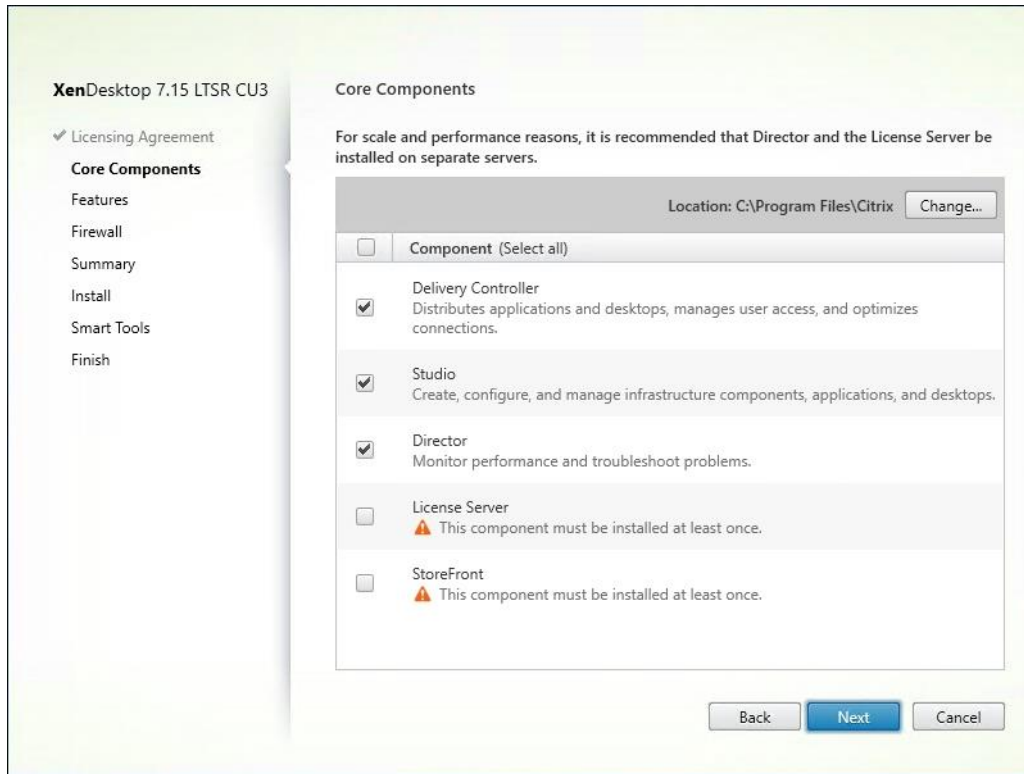

8. Since a dedicated SQL Server will be used to Store the Database, leave "Install Microsoft SQL Server 2012 SP1 Express" unchecked.
9. Click Next.

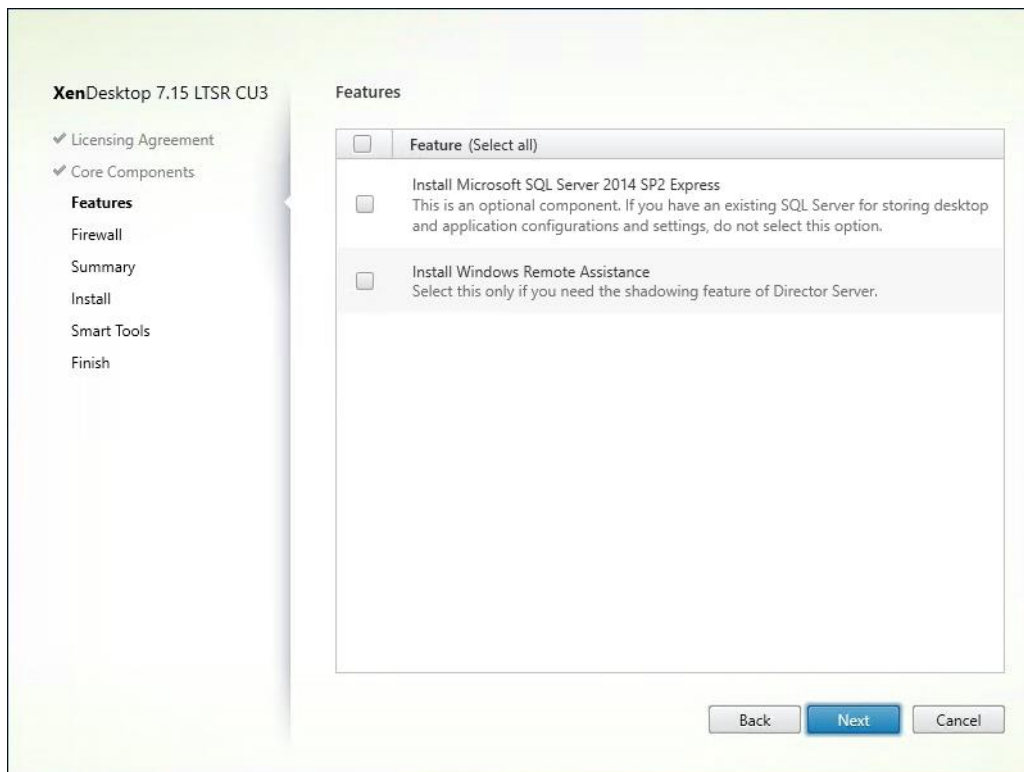

10. Select the default ports and automatically configured firewall rules.

11. Click Next.

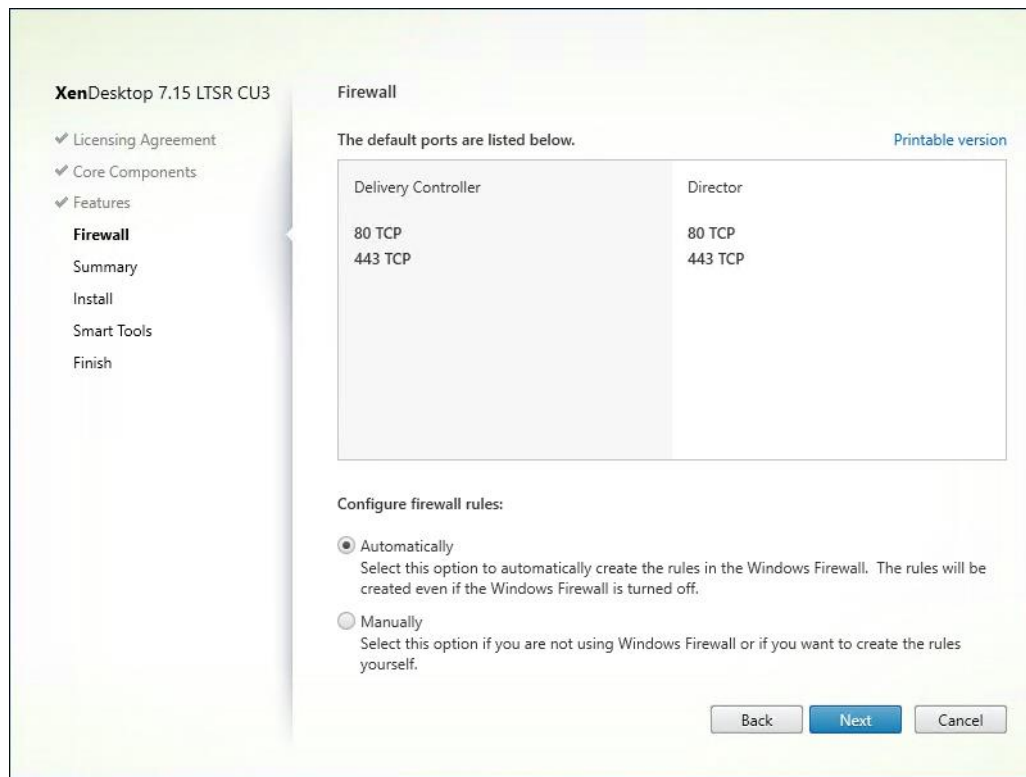

12. Click Install to begin the installation.

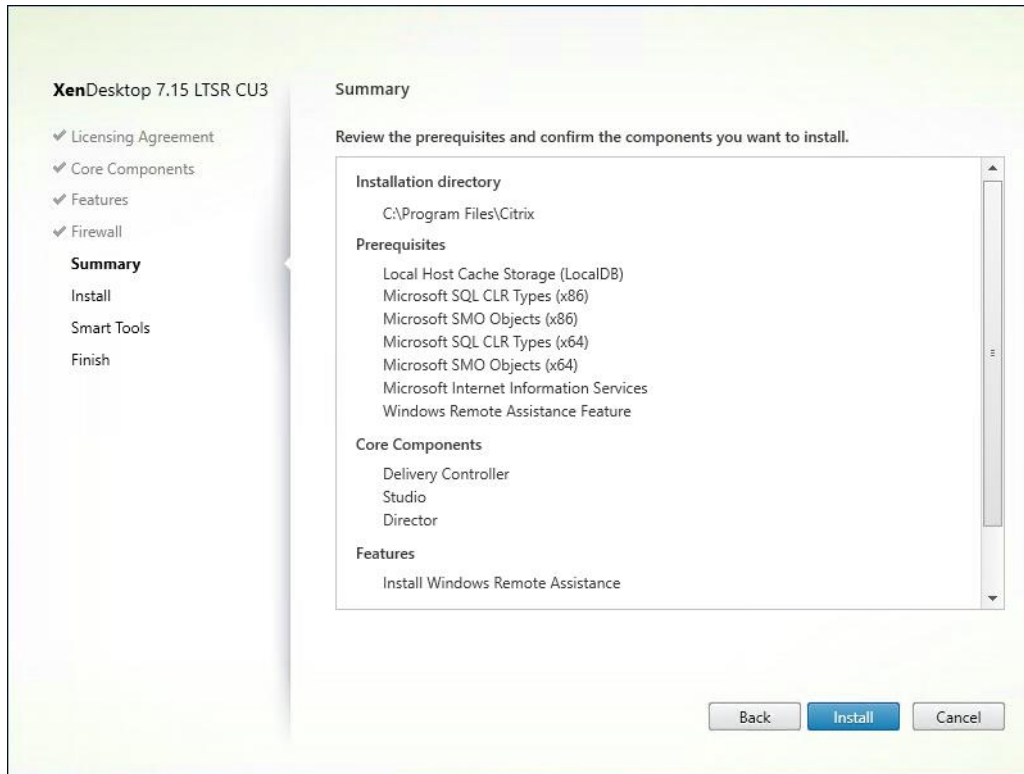

13. (Optional) Configure Smart Tools/Call Home participation.

14. Click Next.

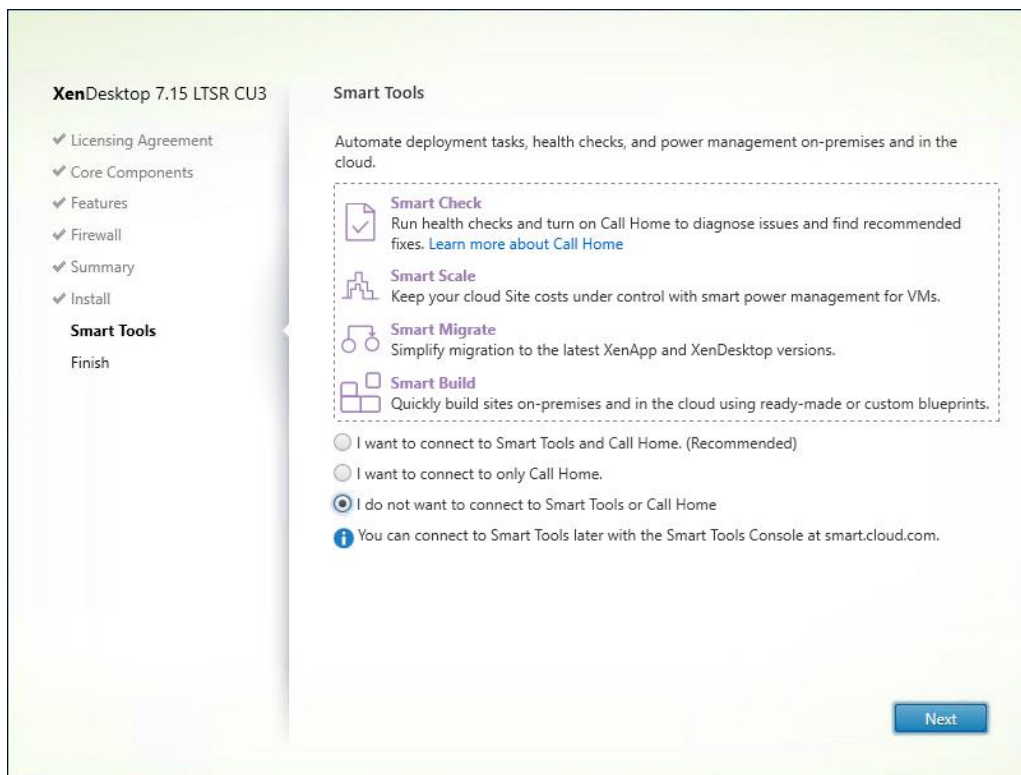

15. Click Finish to complete the installation.

16. (Optional) Check Launch Studio to launch Citrix Studio Console.

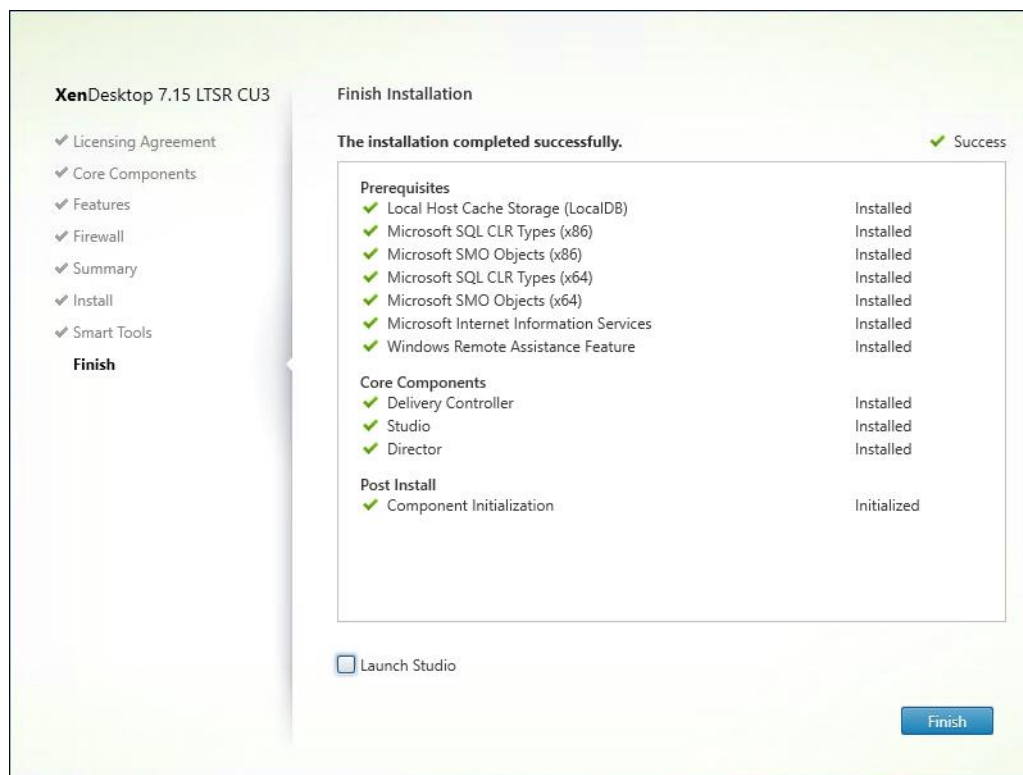

Additional XenDesktop Controller Configuration

After the first controller is completely configured and the Site is operational, you can add additional controllers. In this CVD, we created two Delivery Controllers.

To configure additional XenDesktop controllers, follow these steps:

1. To begin the installation of the second Delivery Controller, connect to the second XenDesktop server and launch the installer from the Citrix XenDesktop 7.15ISO.
2. Click Start.

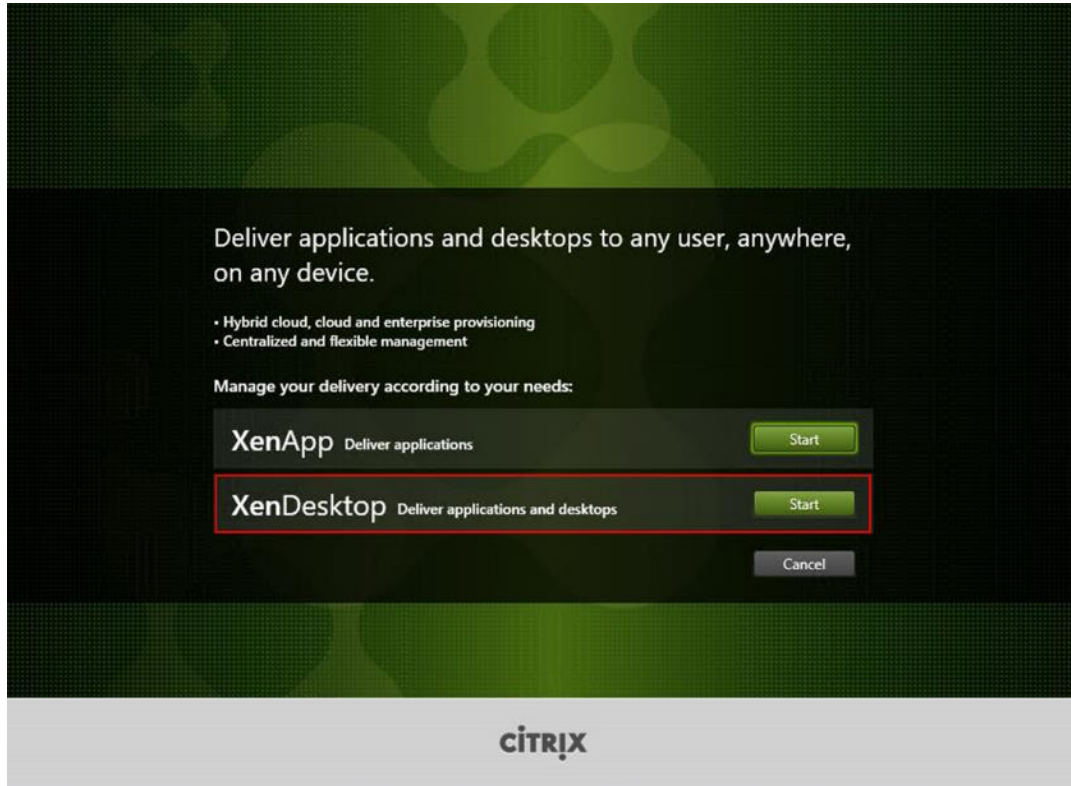

3. Click Delivery Controller.

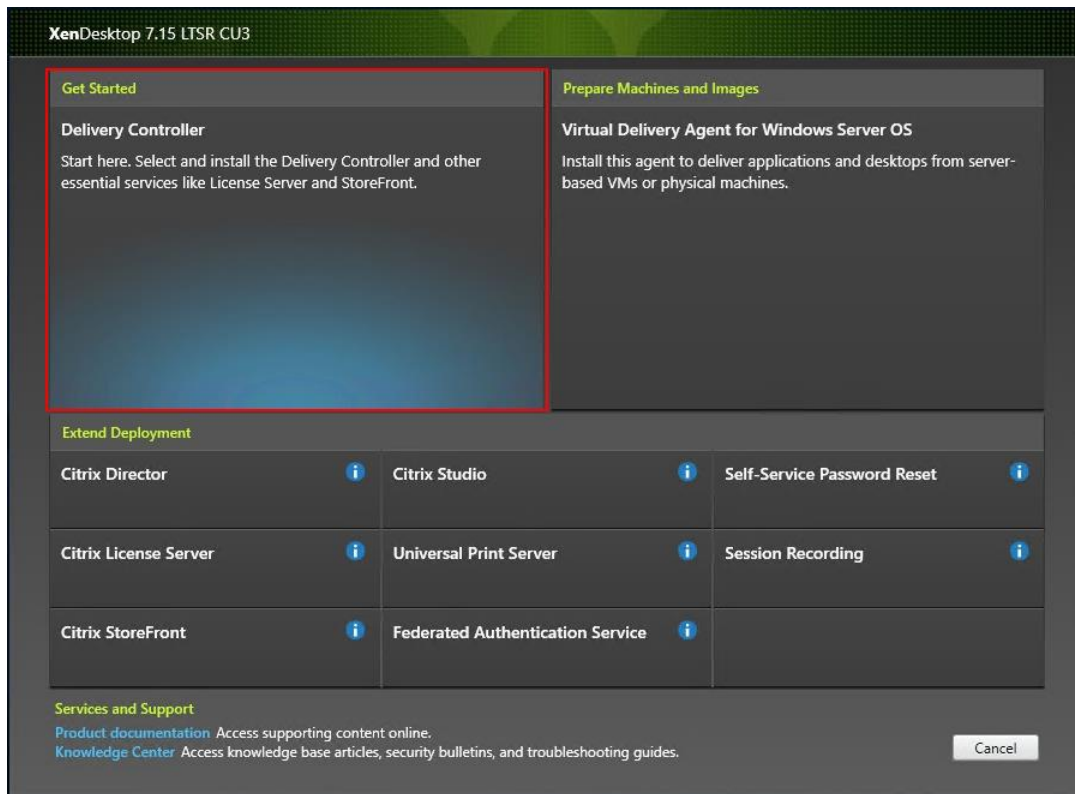

- Repeat the same steps used to install the first Delivery Controller, including the step of importing an SSL certificate for HTTPS between the controller and vSphere.
- Review the Summary configuration.
- Click Install.

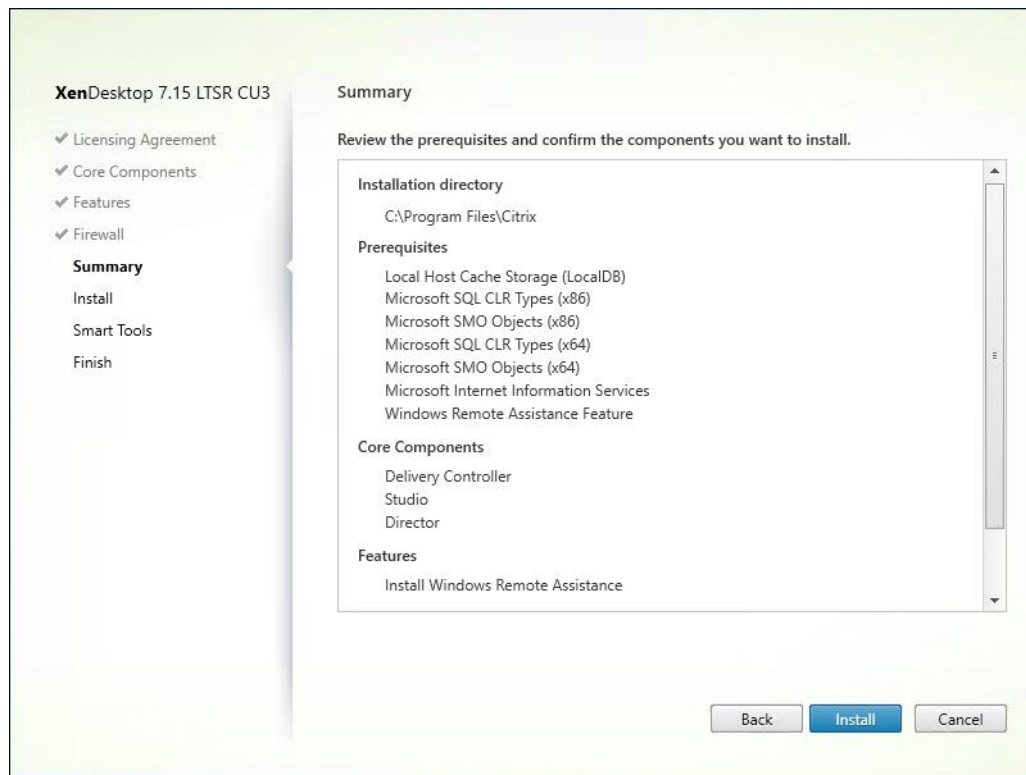

- (Optional) Configure Smart Tools/Call Home participation.
- Click Next.

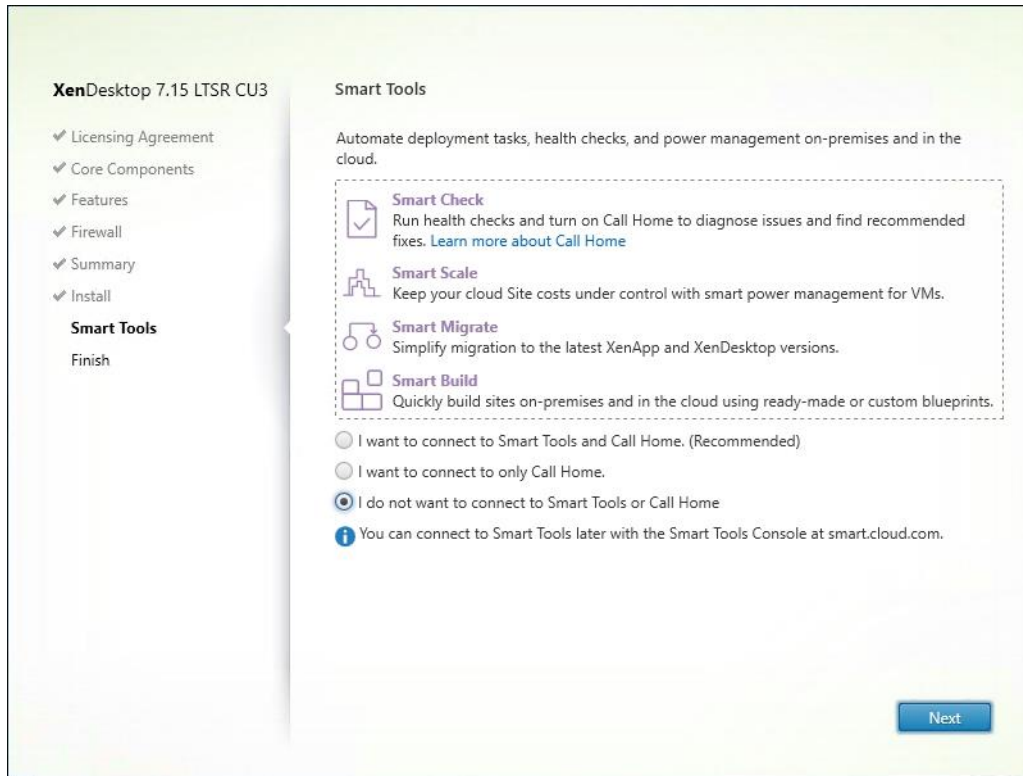

9. Verify the components installed successfully.

10. Click Finish.

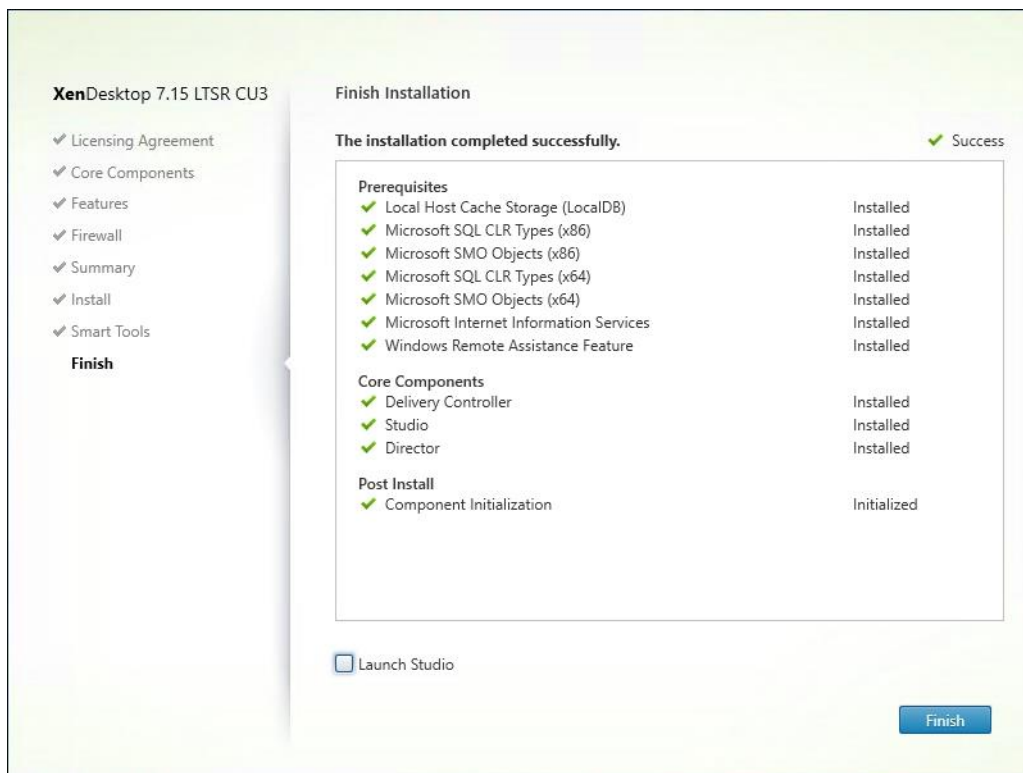

Configure the XenDesktop Site

Citrix Studio is a management console that allows you to create and manage infrastructure and resources to deliver desktops and applications. Replacing Desktop Studio from earlier releases, it provides wizards to set up your environment, create workloads to host applications and desktops, and assign applications and desktops to users.

Citrix Studio launches automatically after the XenDesktop Delivery Controller installation, or if necessary, it can be launched manually. Studio is used to create a Site, which is the core XenDesktop 7.15 environment consisting of the Delivery Controller and the Database.

To configure XenDesktop, follow these steps:

1. From Citrix Studio, click Deliver applications and desktops to your users.

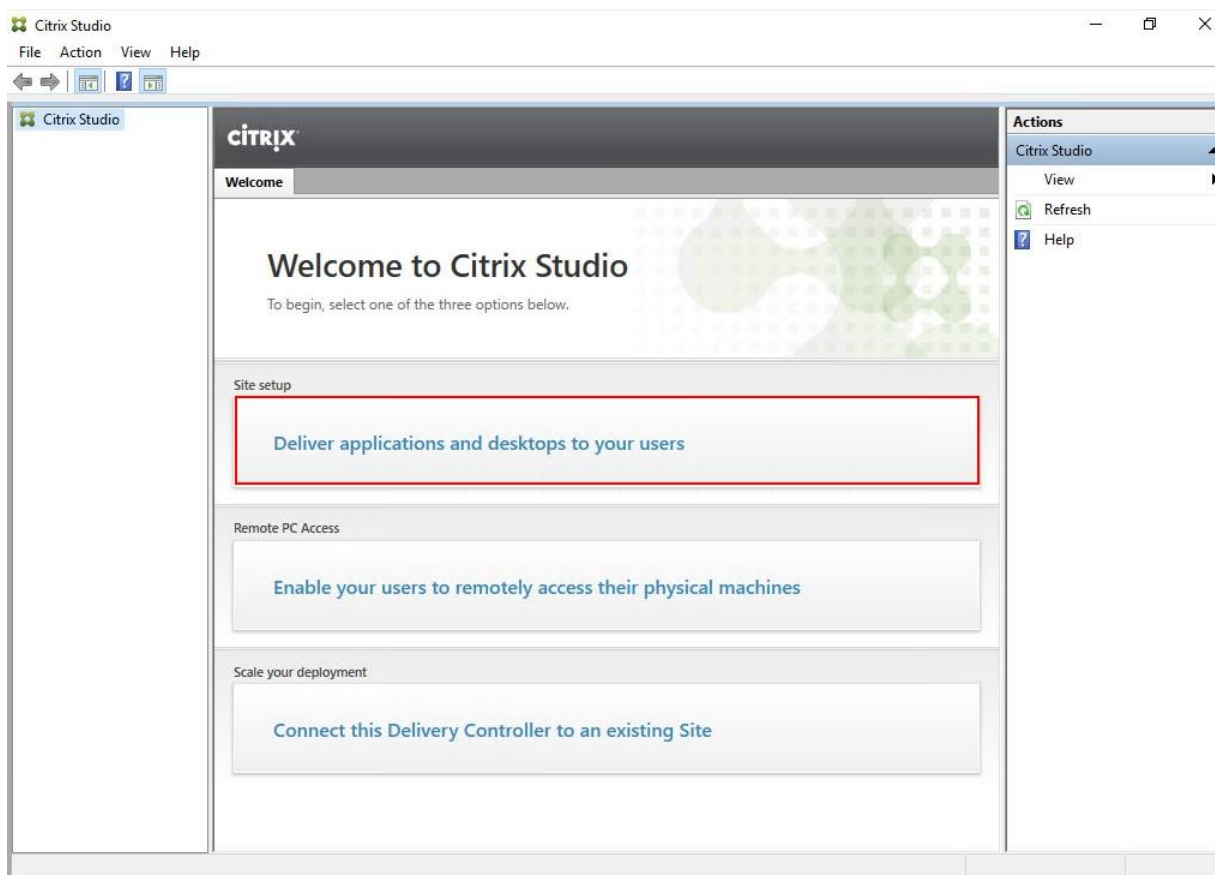

2. Select the "An empty, unconfigured Site" radio button.
3. Enter a site name.
4. Click Next.

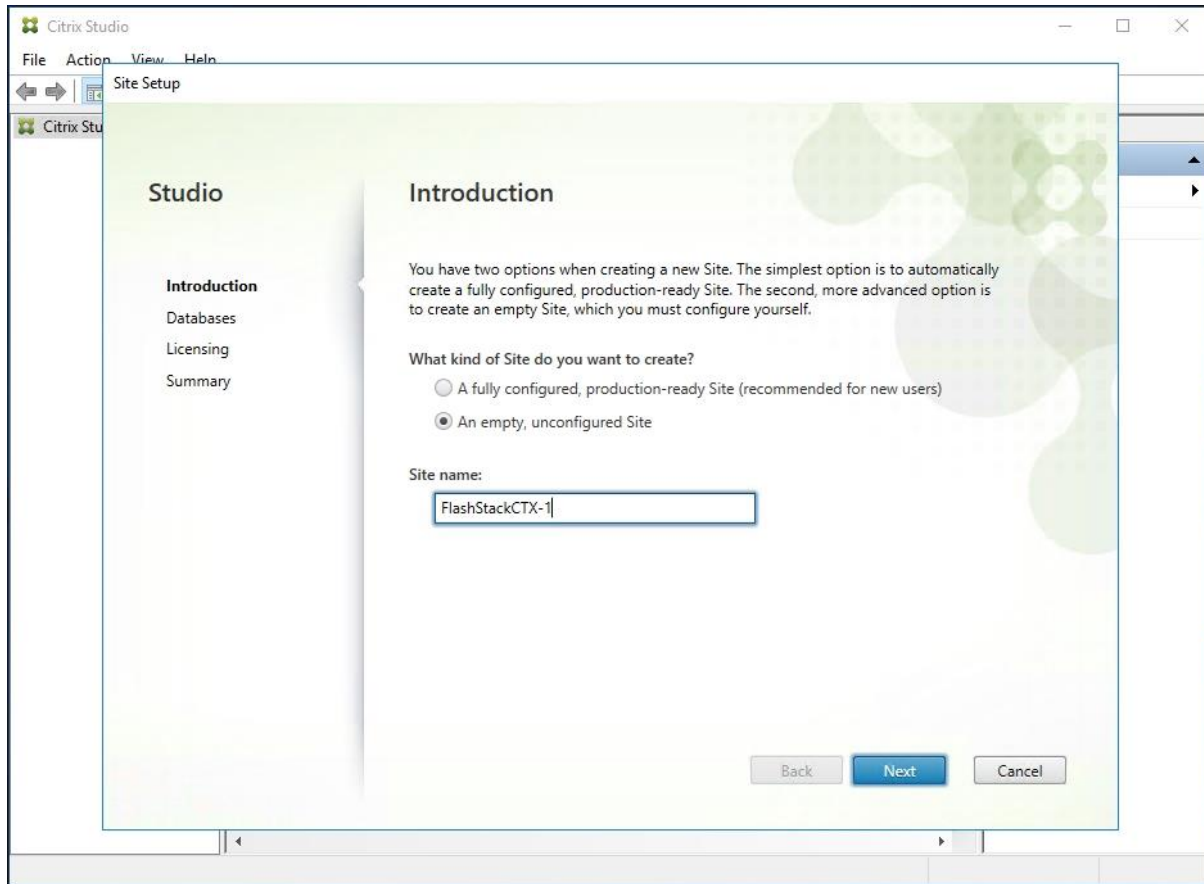

5. Provide the Database Server Locations for each data type and click Next.

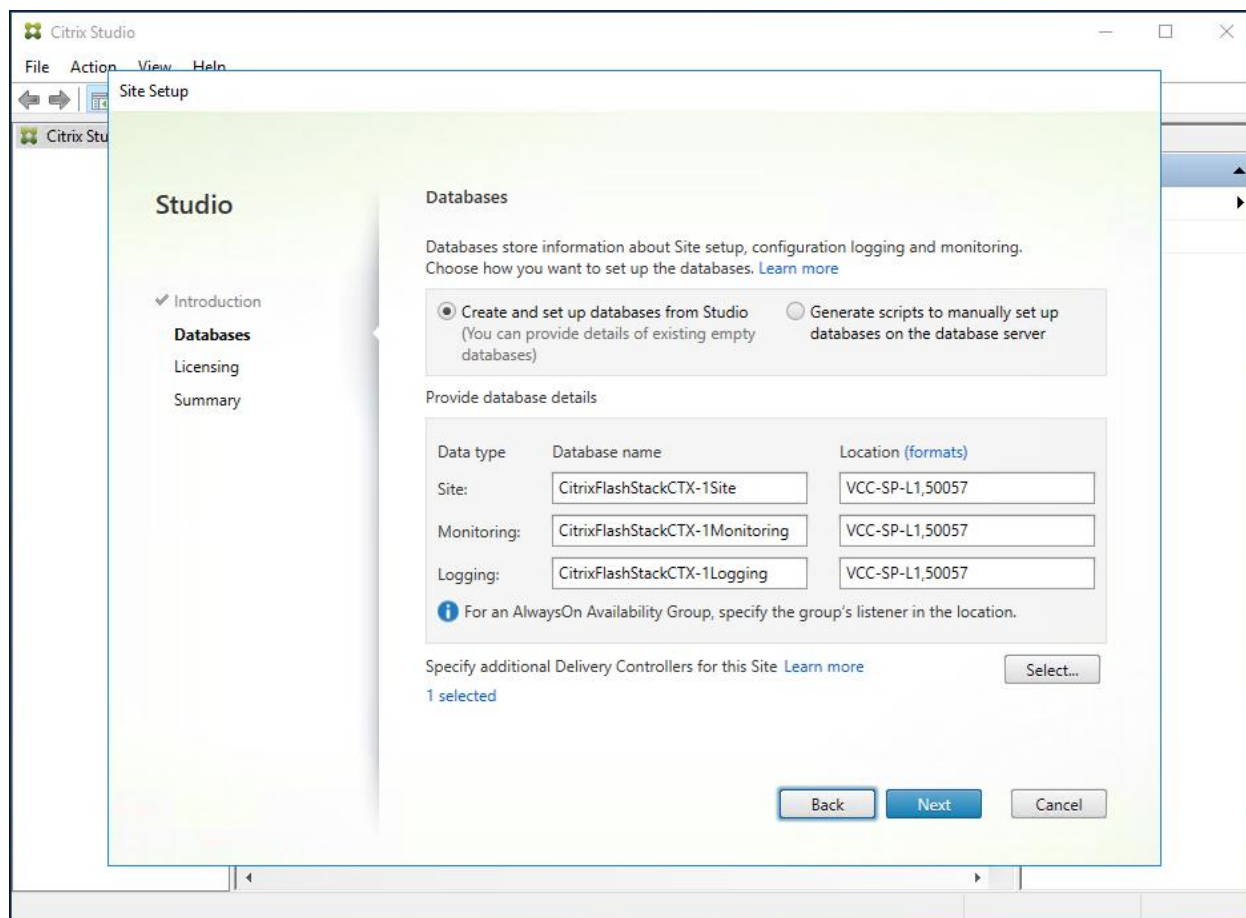

For an AlwaysOn Availability Group, use the group's listener DNS name.

6. Click Select to specify additional controllers (Optional at this time. Additional controllers can be added later).
7. Click Next.
8. Provide the FQDN of the license server.
9. Click Connect to validate and retrieve any licenses from the server.



If no licenses are available, you can use the 30-day free trial or activate a license file.

10. Select the appropriate product edition using the license radio button.
11. Click Next.

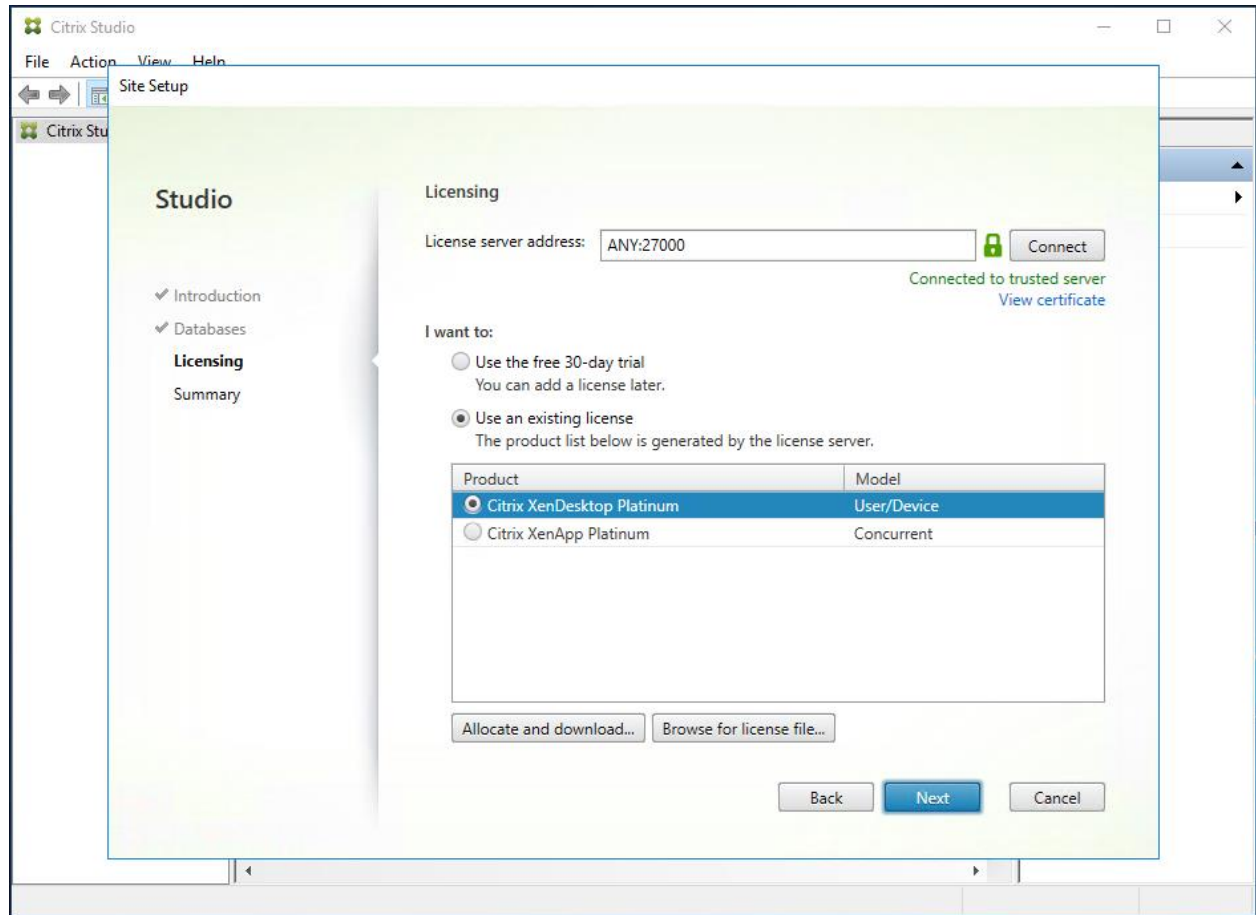

12. Verify information on the Summary page.

13. Click Finish.

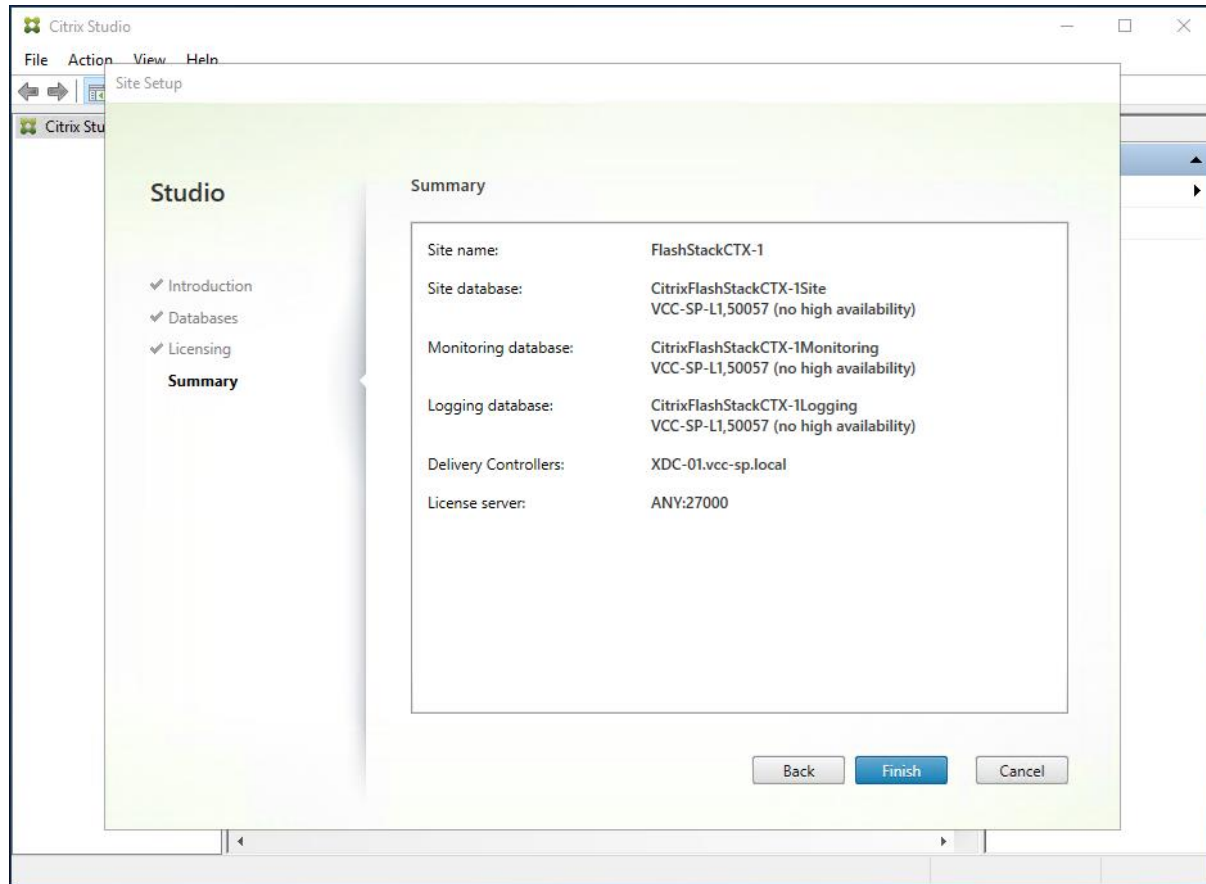

Configure the XenDesktop Site Hosting Connection

To configure the XenDesktop site hosting connection, follow these steps:

1. From Configuration > Hosting in Studio, click Add Connection and Resources in the right pane.

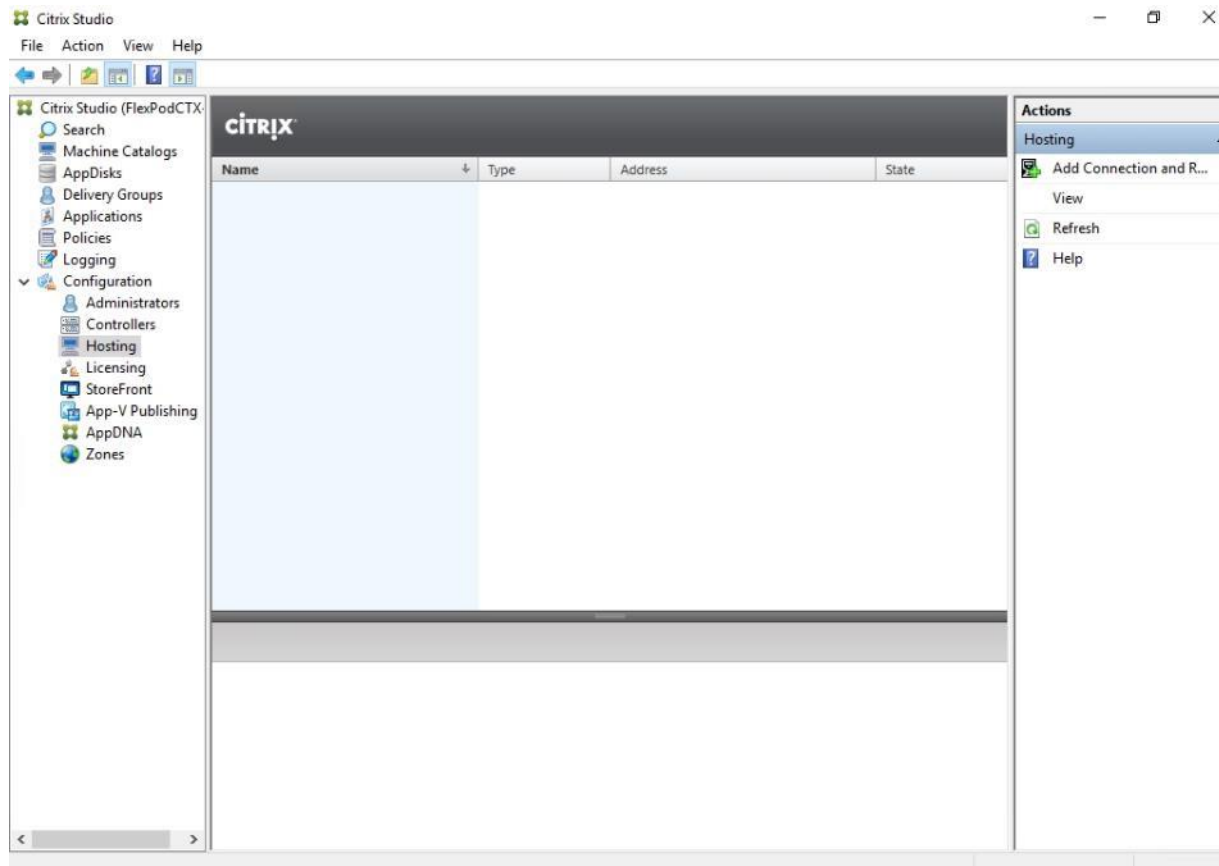

2. Select the Connection type of VMware vSphere®.
3. Enter the FQDN of the vCenter server (in Server_FQDN/sdk format).
4. Enter the username (in domain\username format) for the vSphere account.
5. Provide the password for the vSphere account.
6. Provide a connection name.
7. Check Studio Tools radio button required to support desktop provisioning task by this connection.
8. Click Next.

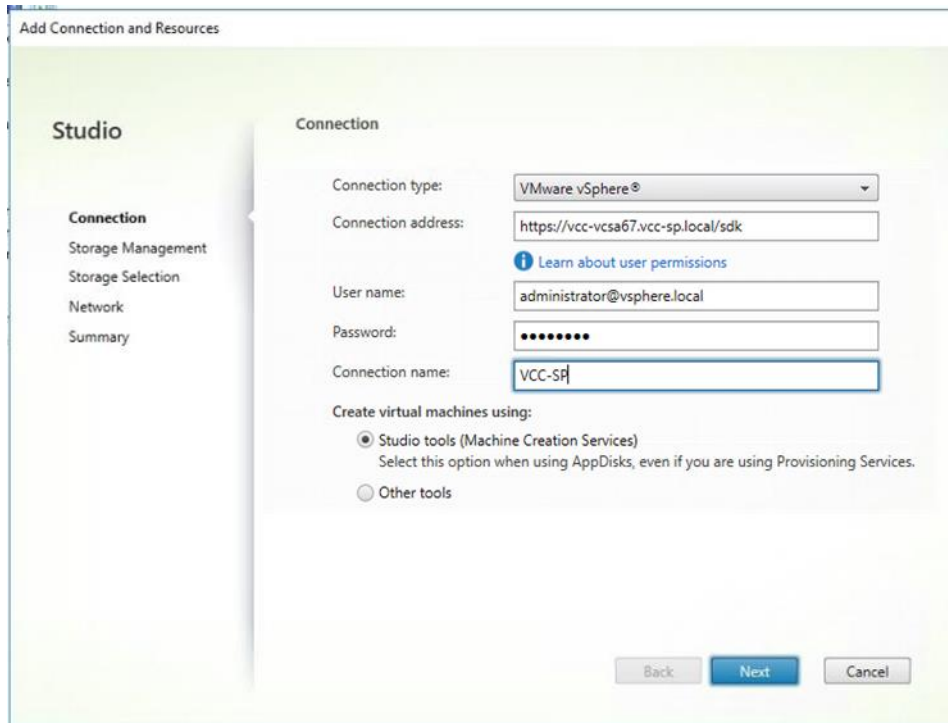

9. Accept the certificate and click OK to trust the hypervisor connection.

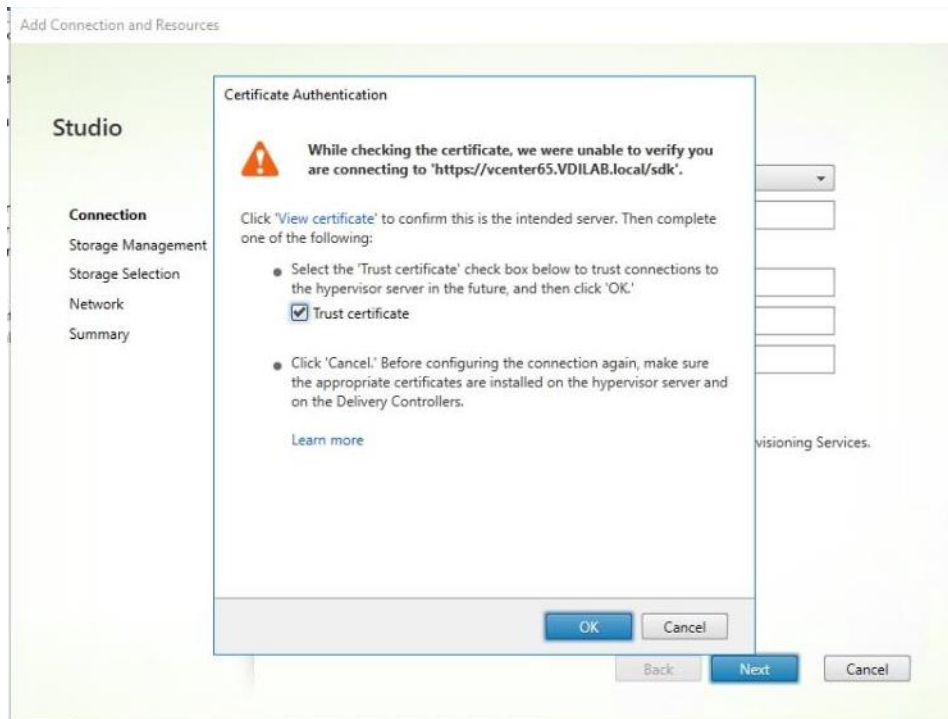

10. Select Cluster that will be used by this connection.

11. Check Use storage shared by hypervisors radio button.

12. Click Next.

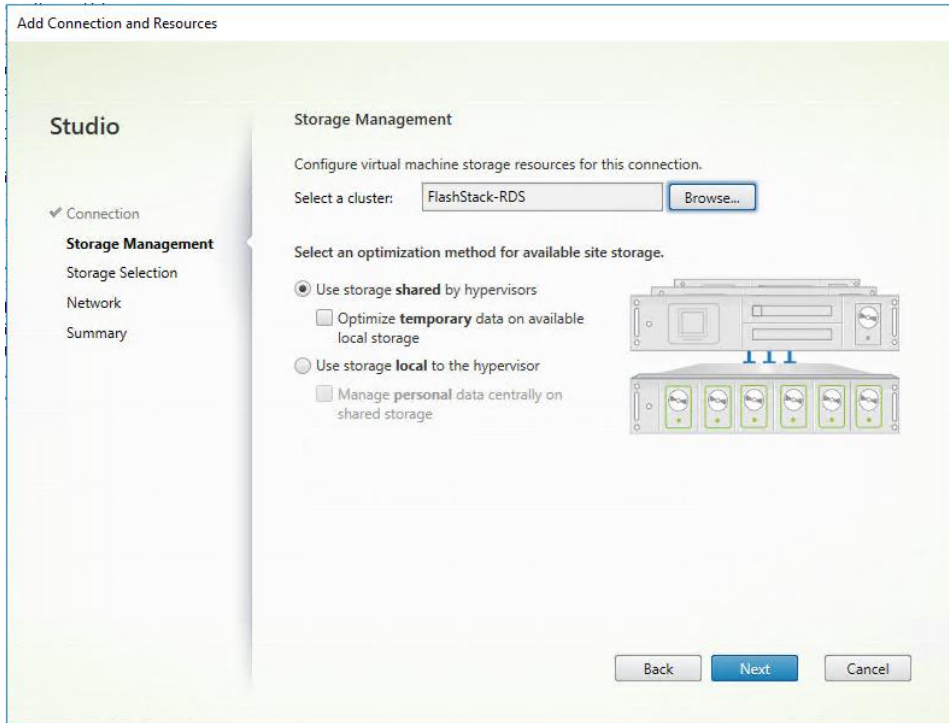

13. Make Storage selection to be used by this connection, use all provisioned for desktops datastores.

14. Click Next.

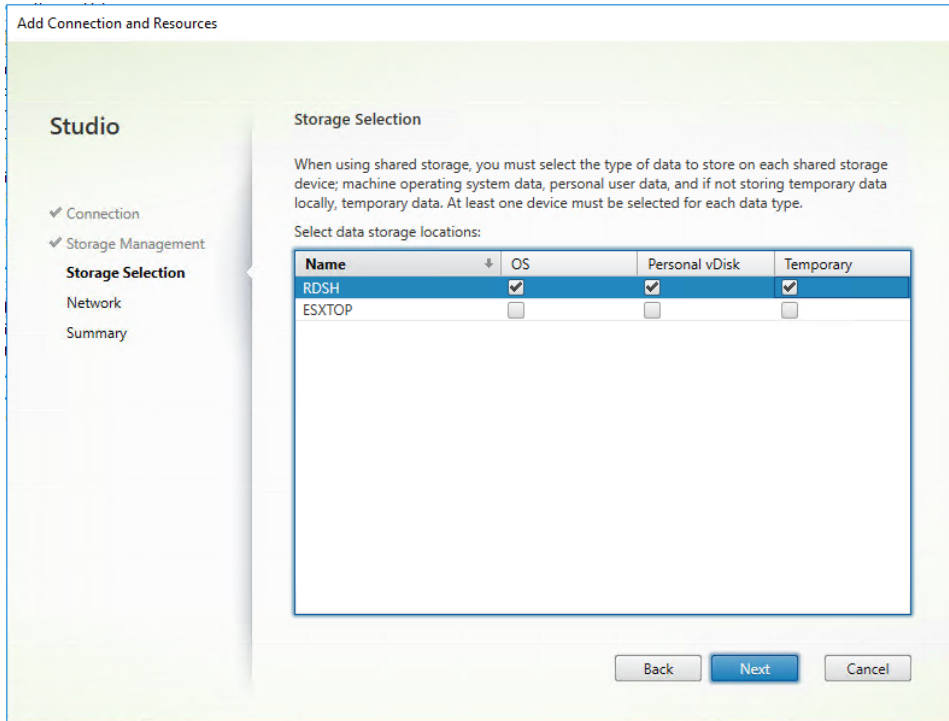

15. Make Network selection to be used by this connection.

16. Click Next.

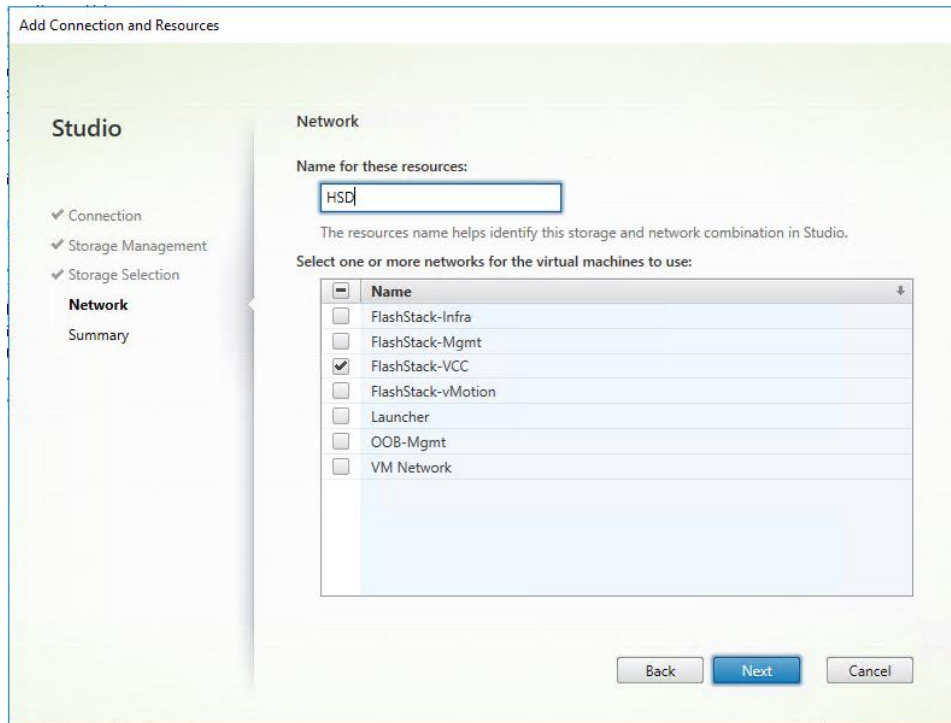

17. Review Site configuration Summary and click Finish.

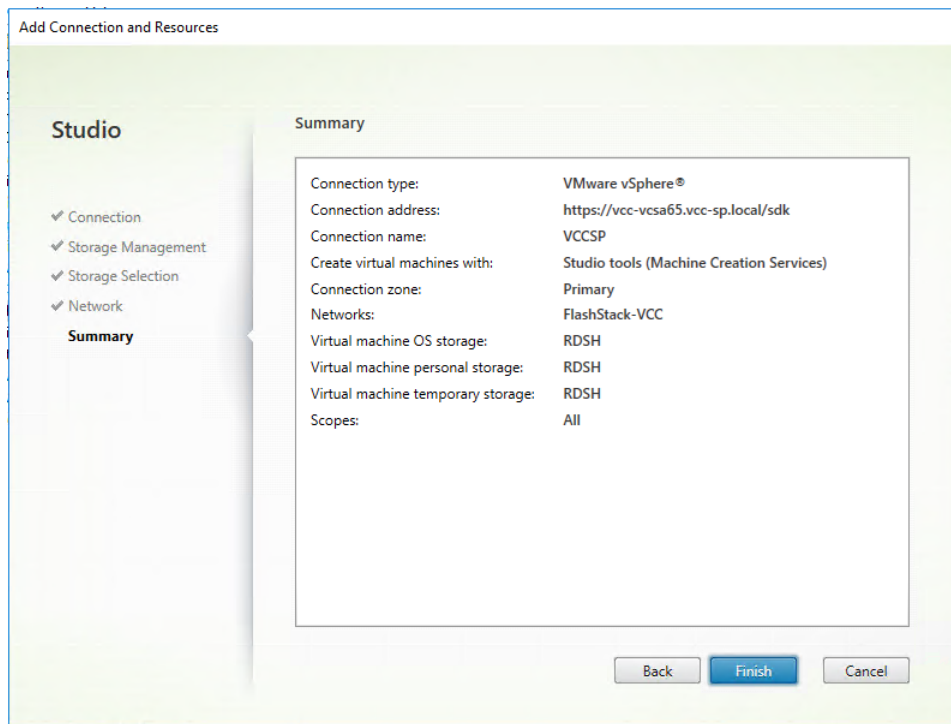

Add Resources to the Site Hosting Connection

To add resources to the additional vcenter clusters, follow these steps:

1. From Configuration > Hosting in Studio click Add Connection and Resources.

2. Select Use an existing Connection, use connection previously created for FlashStack environment.
3. Click Next.

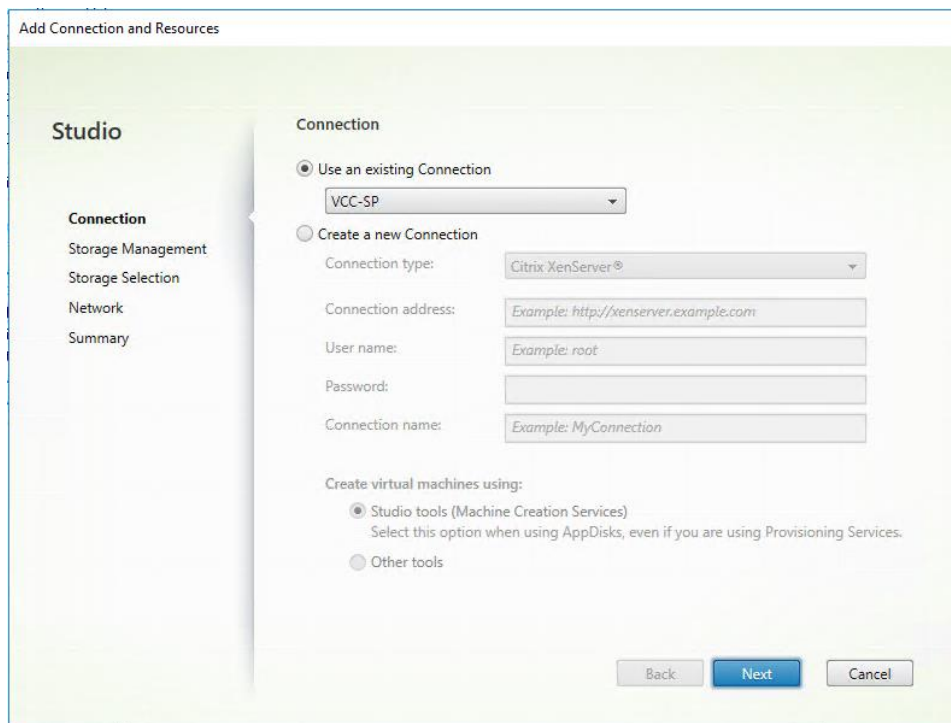

4. Select Cluster you adding to this connection.
5. Check Use storage shared by hypervisors radio button.
6. Click Next.

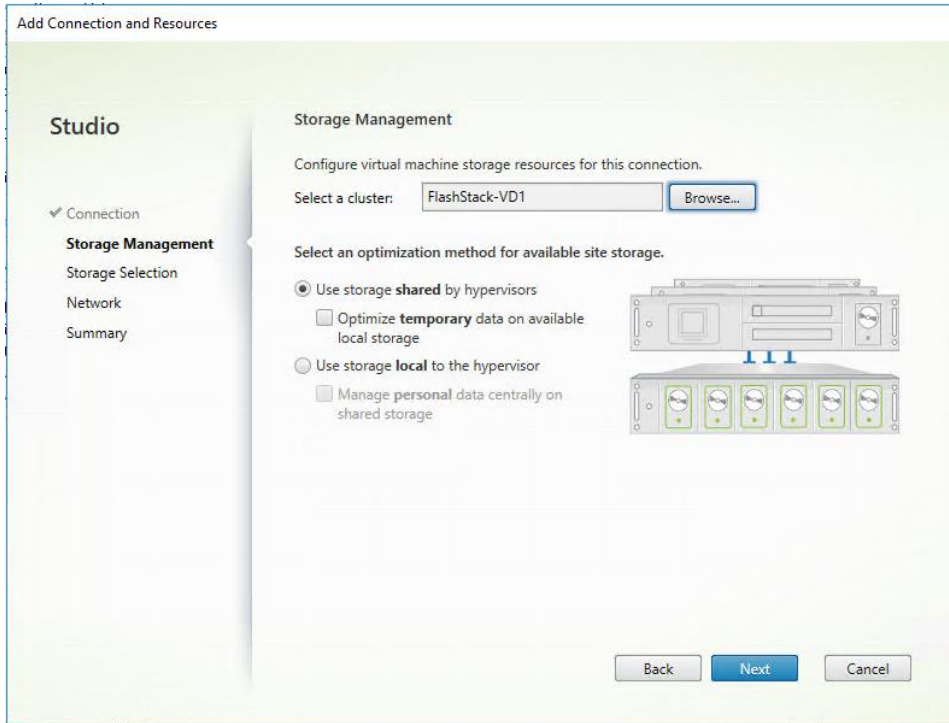

7. Select the Storage selection to be used by this connection, use all provisioned for desktops FC datastores.

8. Click Next.

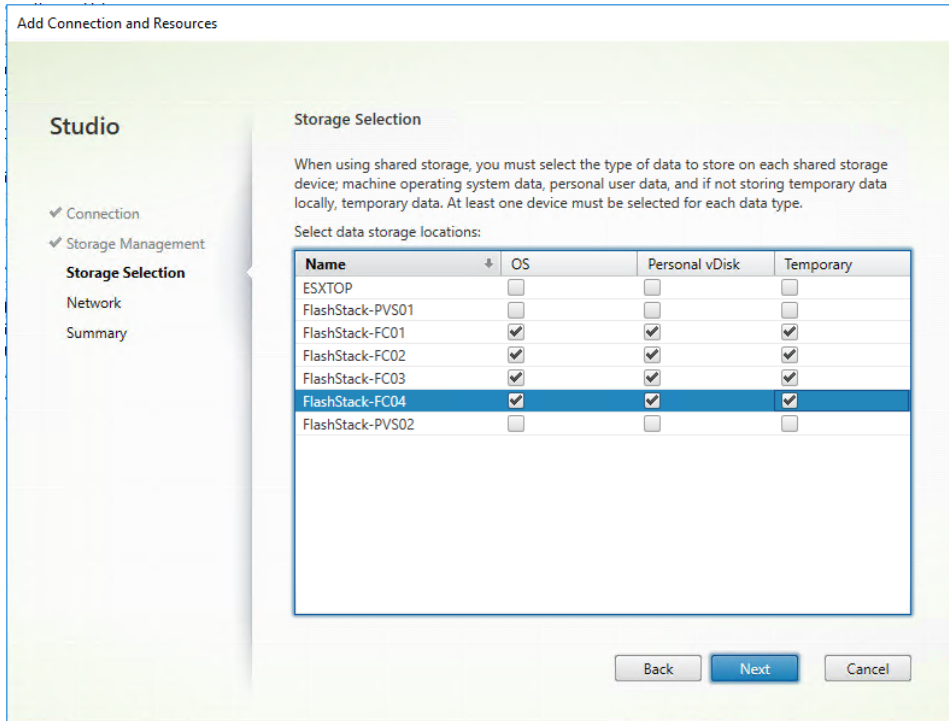

9. Select the Network selection to be used by this connection.

10. Click Next.

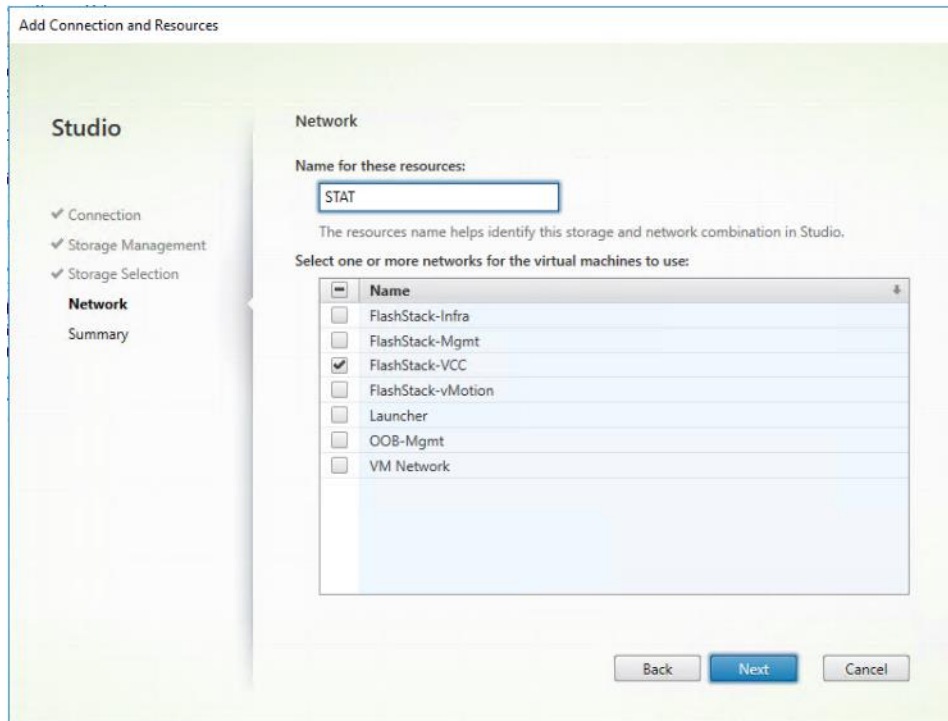

11. Review the Site configuration Summary and click Finish.

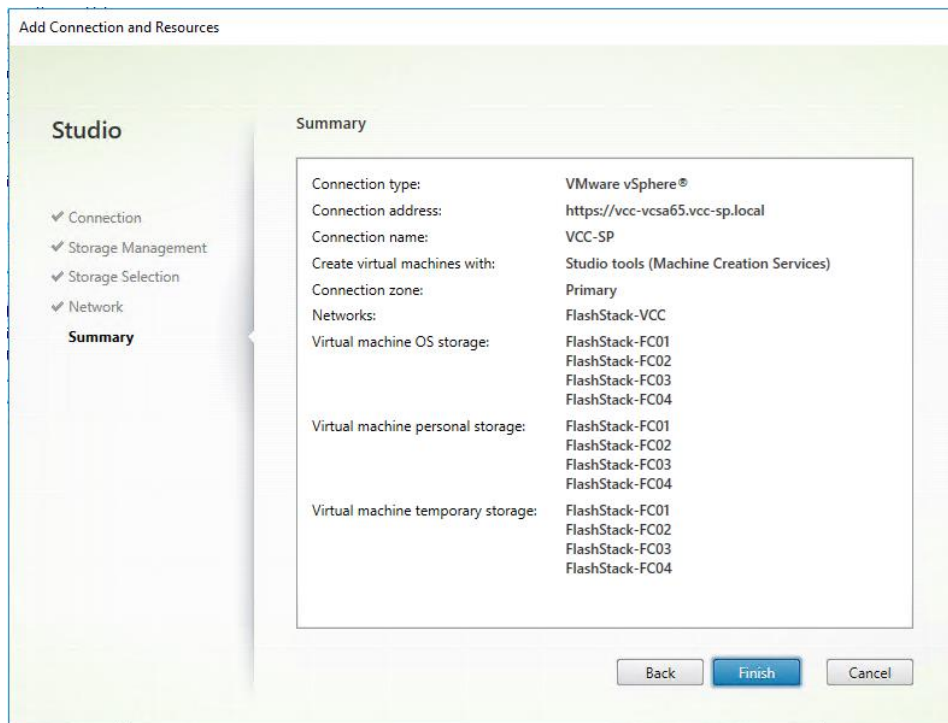

12. Repeat steps 1-11 to add all additional clusters.

Figure 47 FlashStack Hosting Connection in Studio with Three Clusters

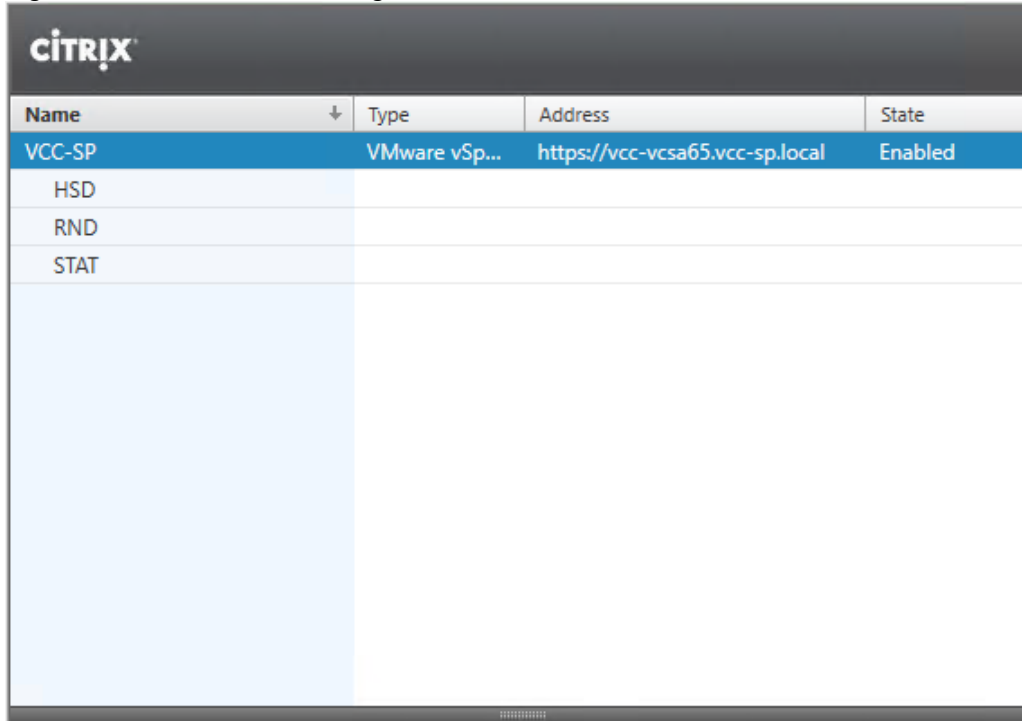

Name	Type	Address	State
VCC-SP	VMware vSp...	https://vcc-vcasa65.vcc-sp.local	Enabled
HSD			
RND			
STAT			

Configure the XenDesktop Site Administrators

To configure the XenDesktop site administrators, follow these steps:

1. Connect to the XenDesktop server and open Citrix Studio Management console.
2. From the Configuration menu, right-click Administrator and select Create Administrator from the drop-down list.

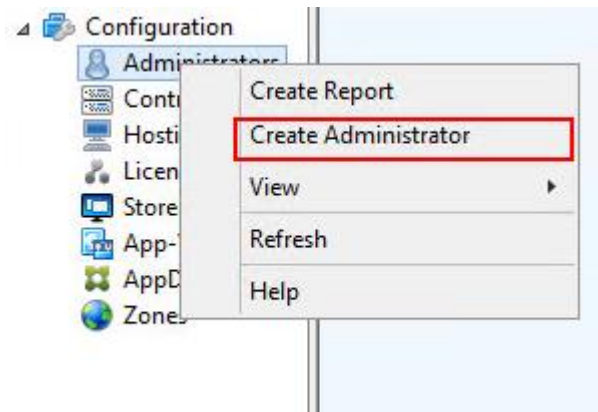

3. Select/Create appropriate scope and click Next.

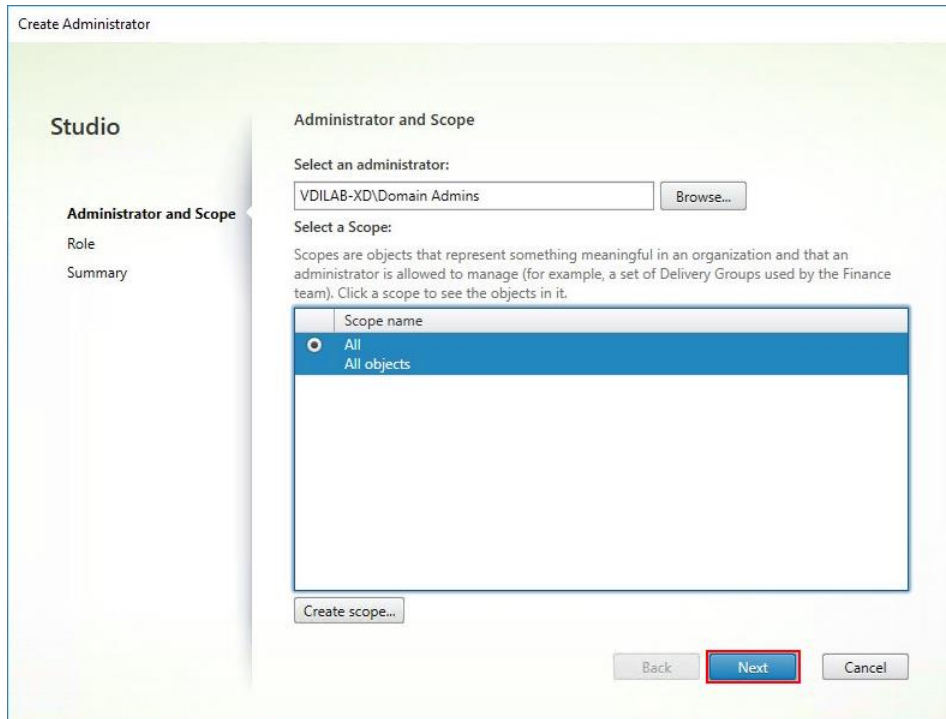

4. Select an appropriate Role.

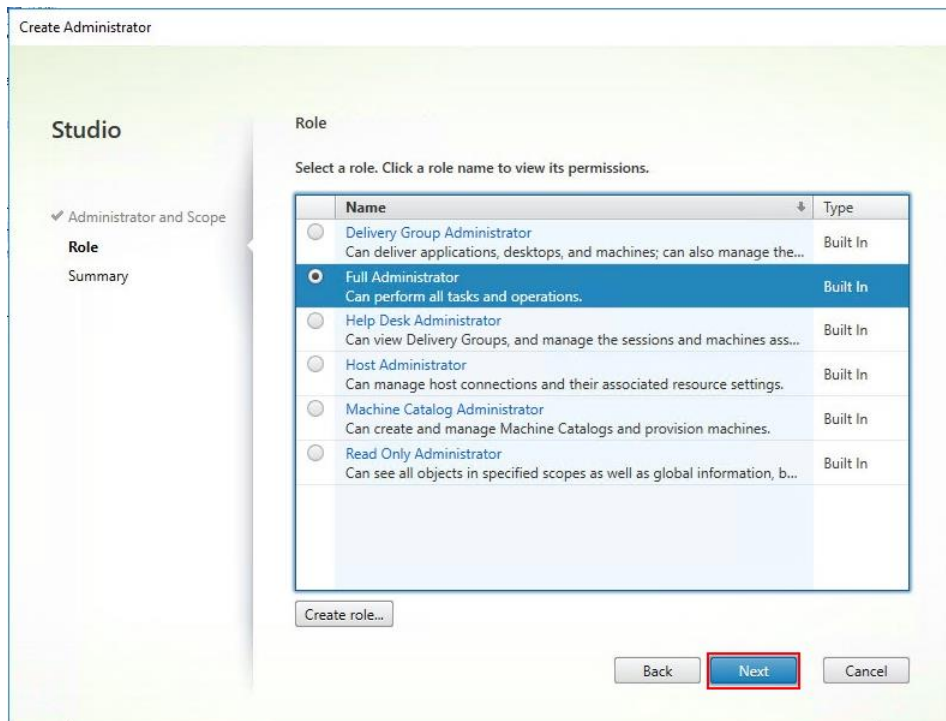

5. Review the Summary, check Enable administrator and click Finish.

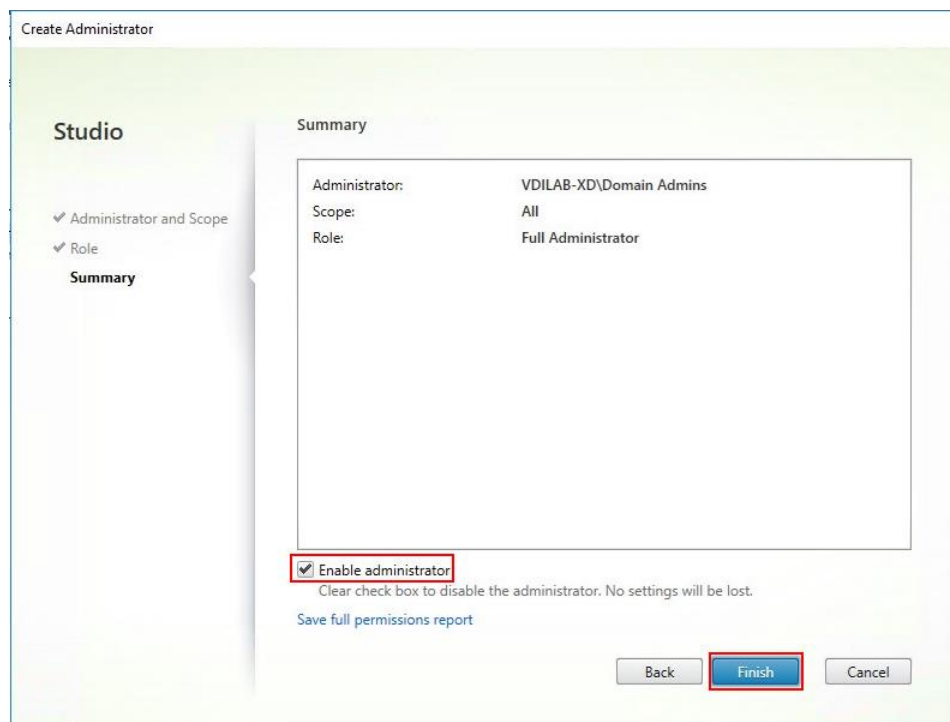

Install and Configure StoreFront

Citrix StoreFront stores aggregate desktops and applications from XenDesktop sites, making resources readily available to users. In this CVD, we created two StoreFront servers on dedicated virtual machines.

To install and configure StoreFront, follow these steps:

1. To begin the installation of the StoreFront, connect to the first StoreFront server and launch the installer from the Citrix XenDesktop 7.15 ISO.
2. Click Start.

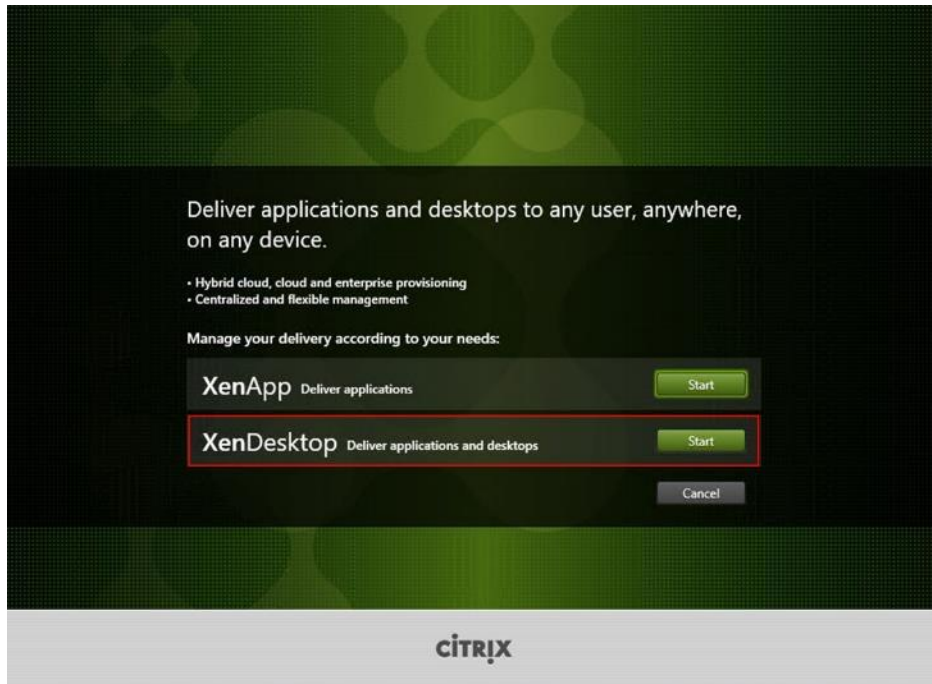

3. Click Extend Deployment Citrix StoreFront.

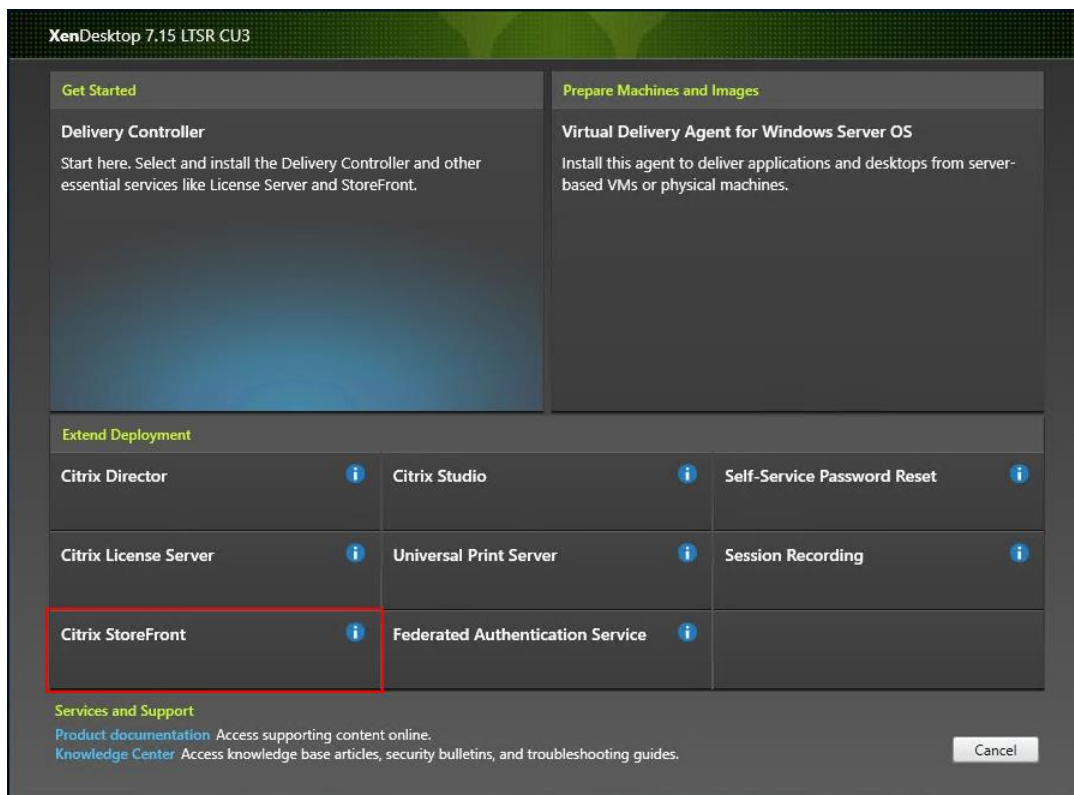

4. If acceptable, indicate your acceptance of the license by selecting the “I have read, understand, and accept the terms of the license agreement” radio button.

5. Click Next.

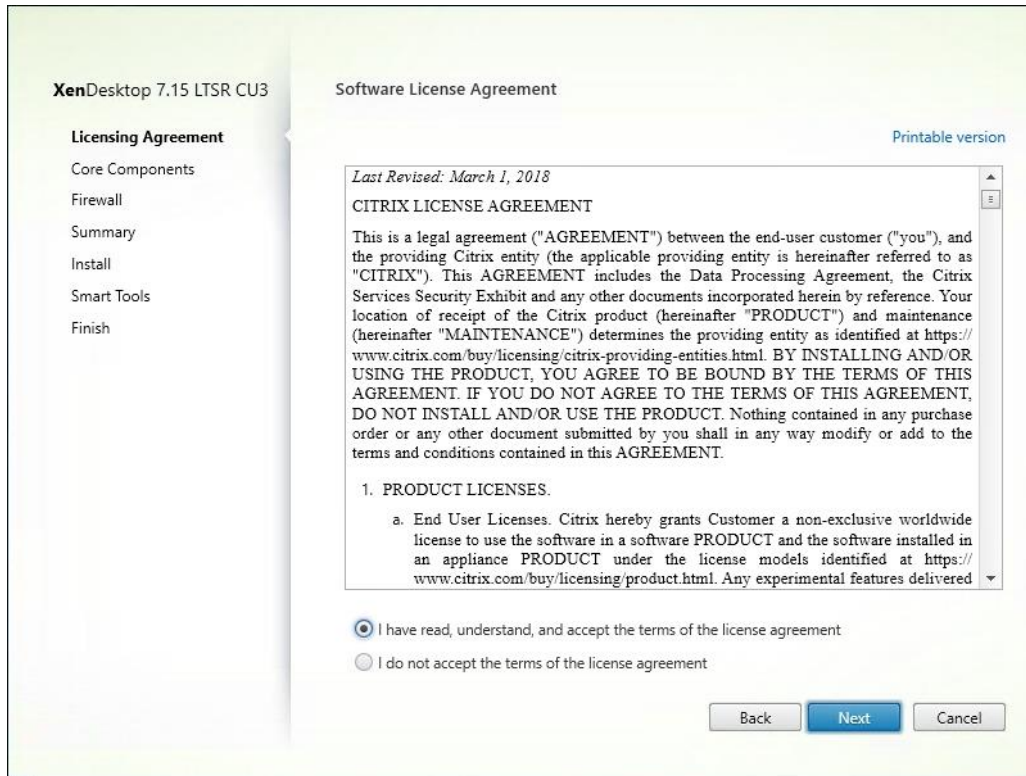

6. Click Next.

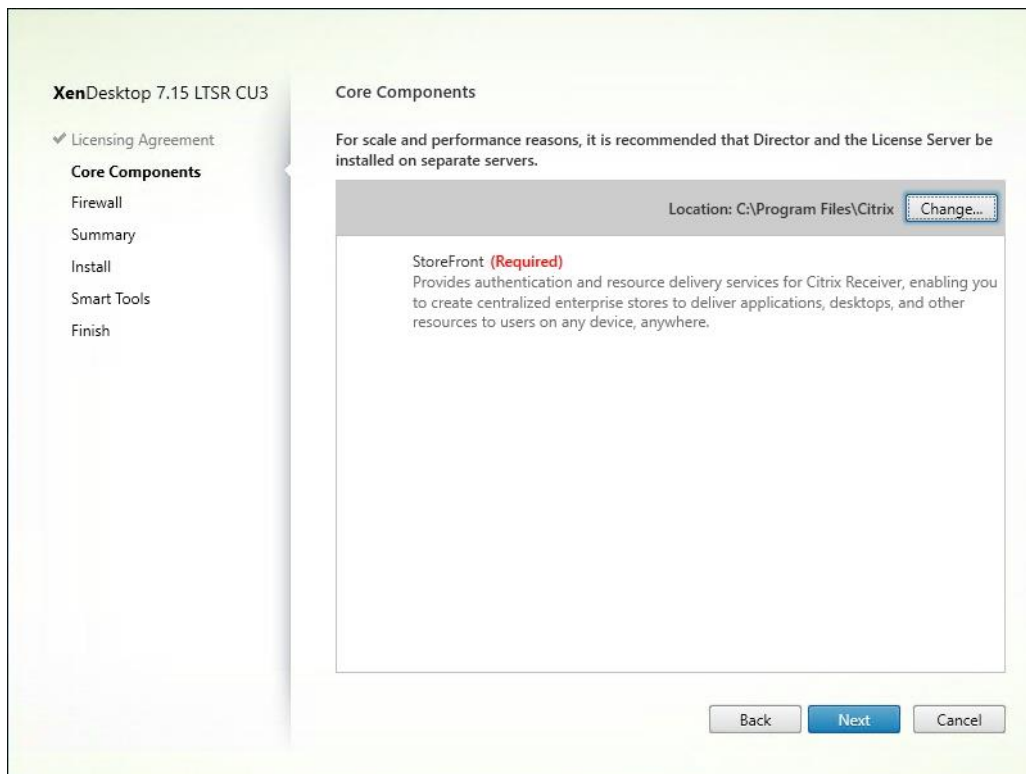

7. Select the default ports and automatically configured firewall rules.

8. Click Next.

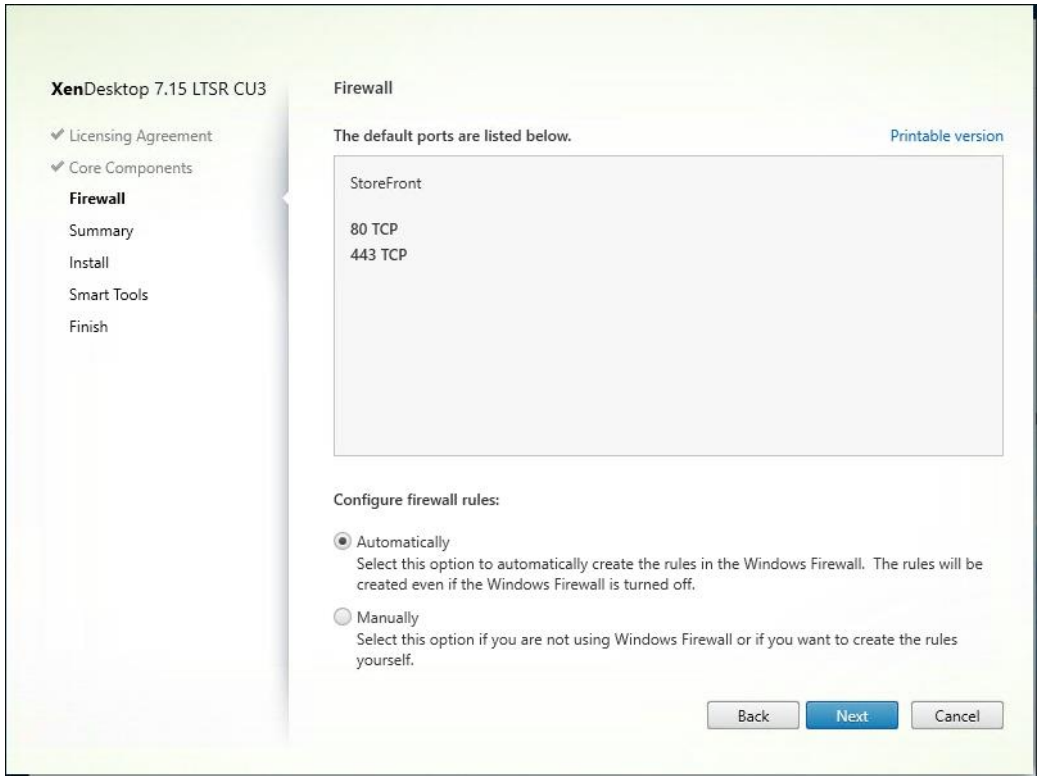

9. Click Install.

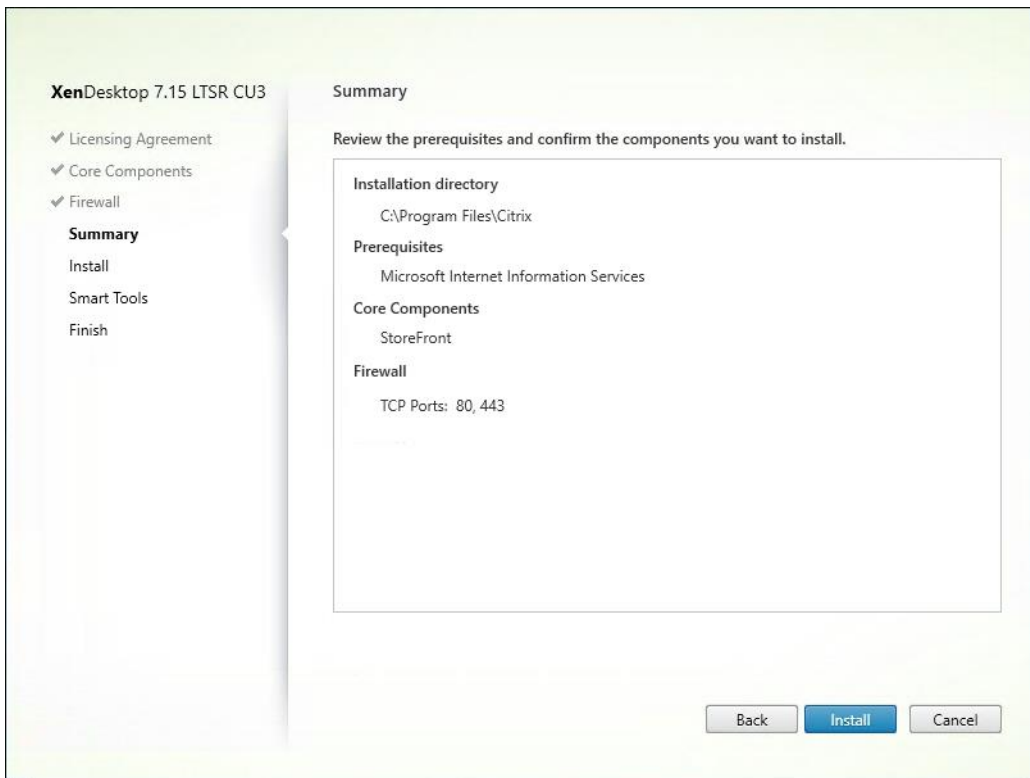

10. (Optional) Click “I want to participate in Call Home.”

11. Click Next.

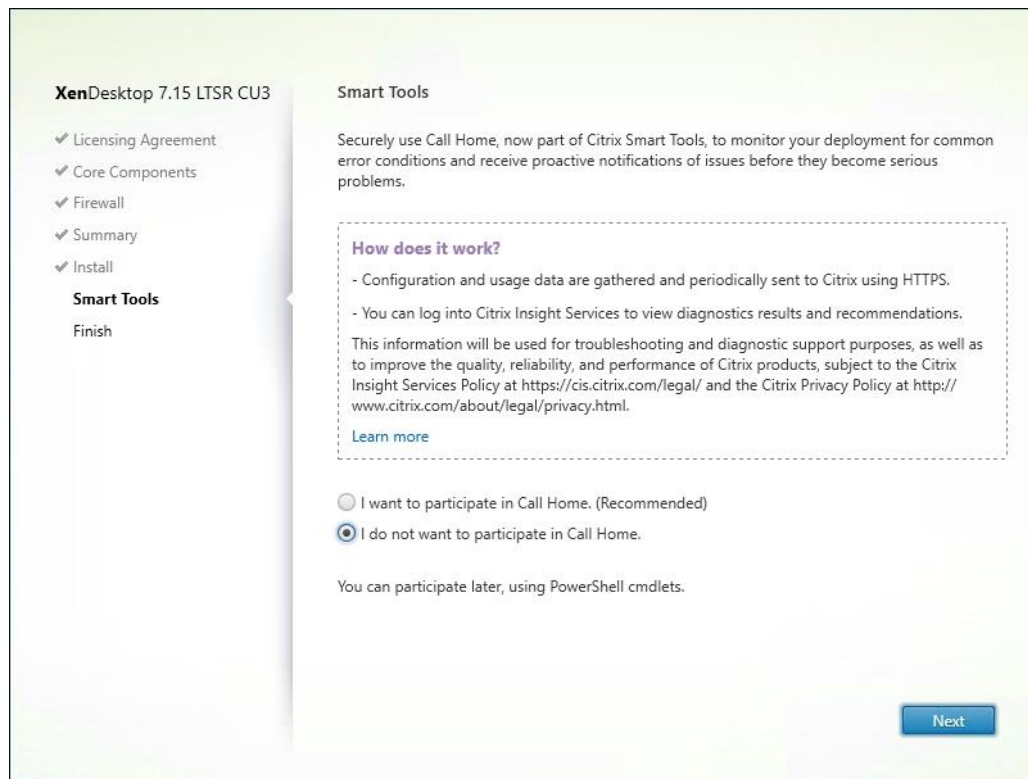

12. Check “Open the StoreFront Management Console.”

13. Click Finish.

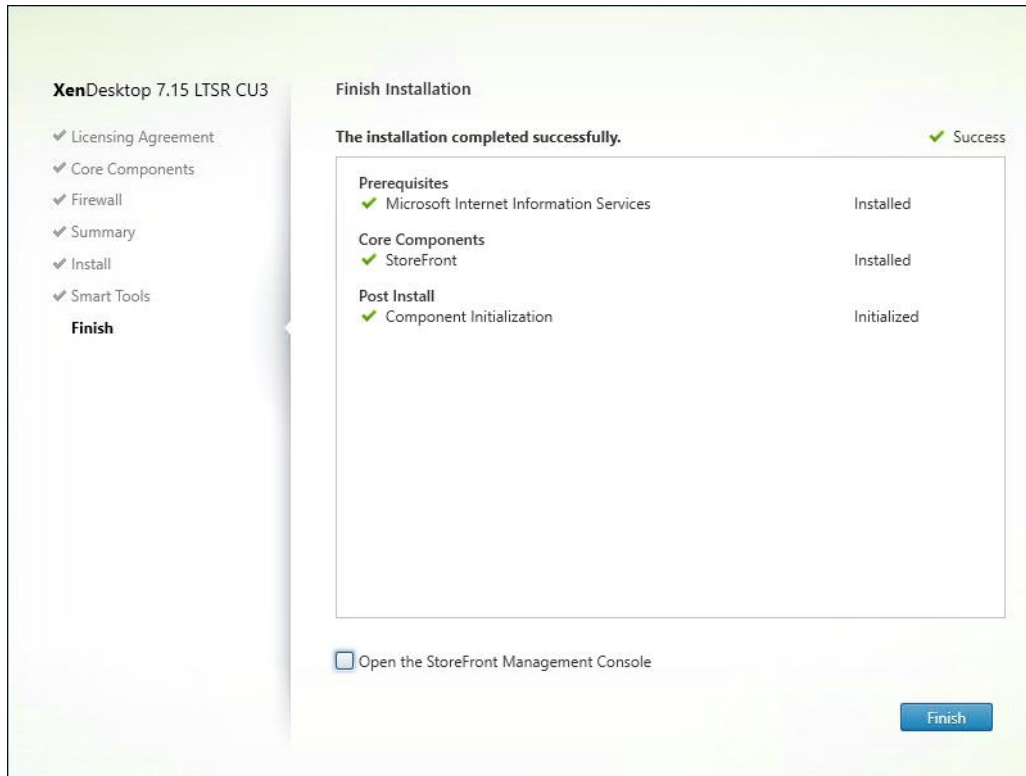

14. Click Create a new deployment.

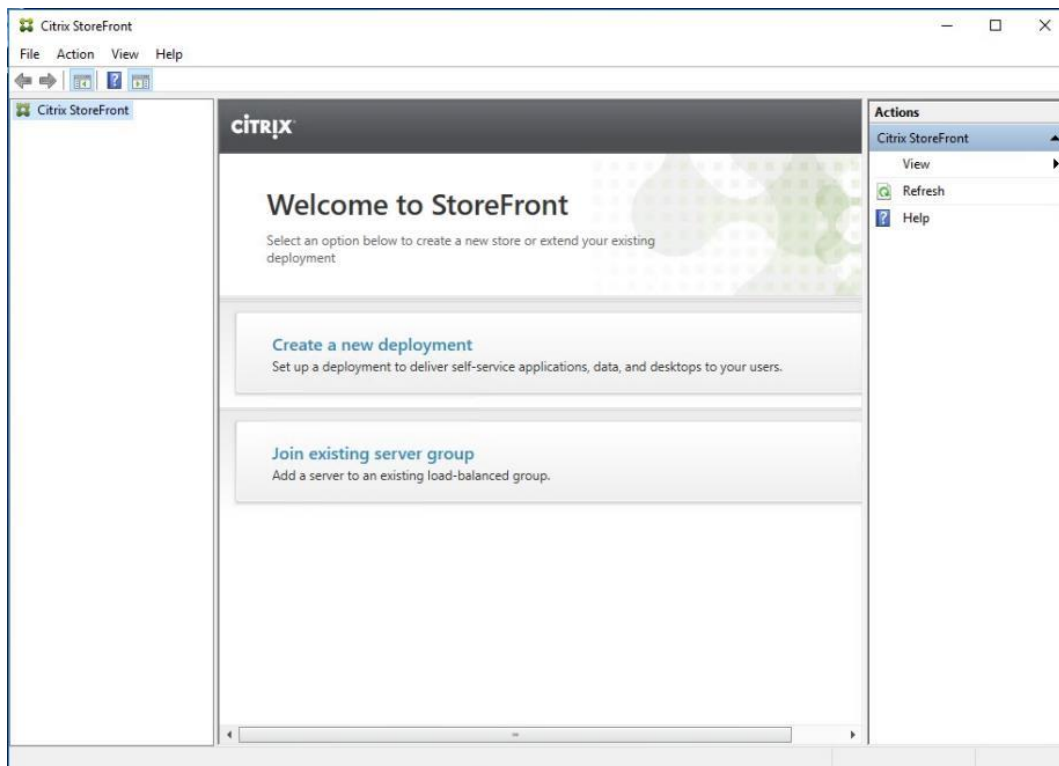

15. Specify the URL of the StoreFront server.



For a multiple server deployment use the load balancing environment in the Base URL box.

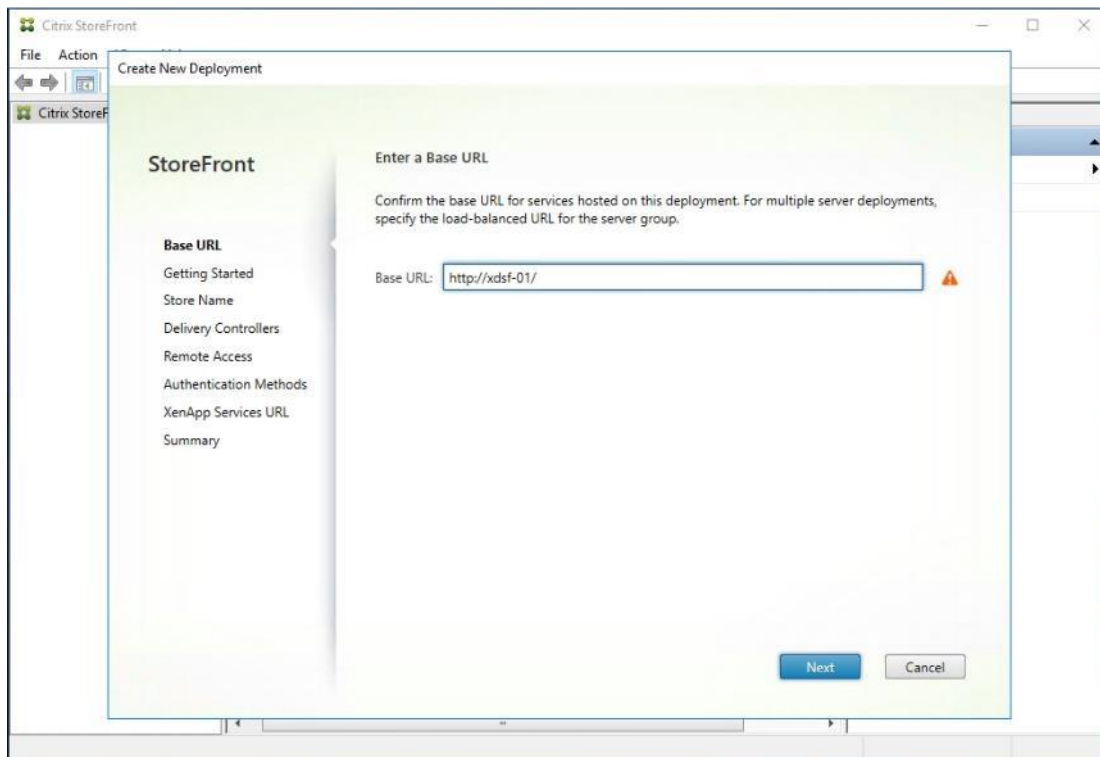

16. Click Next.

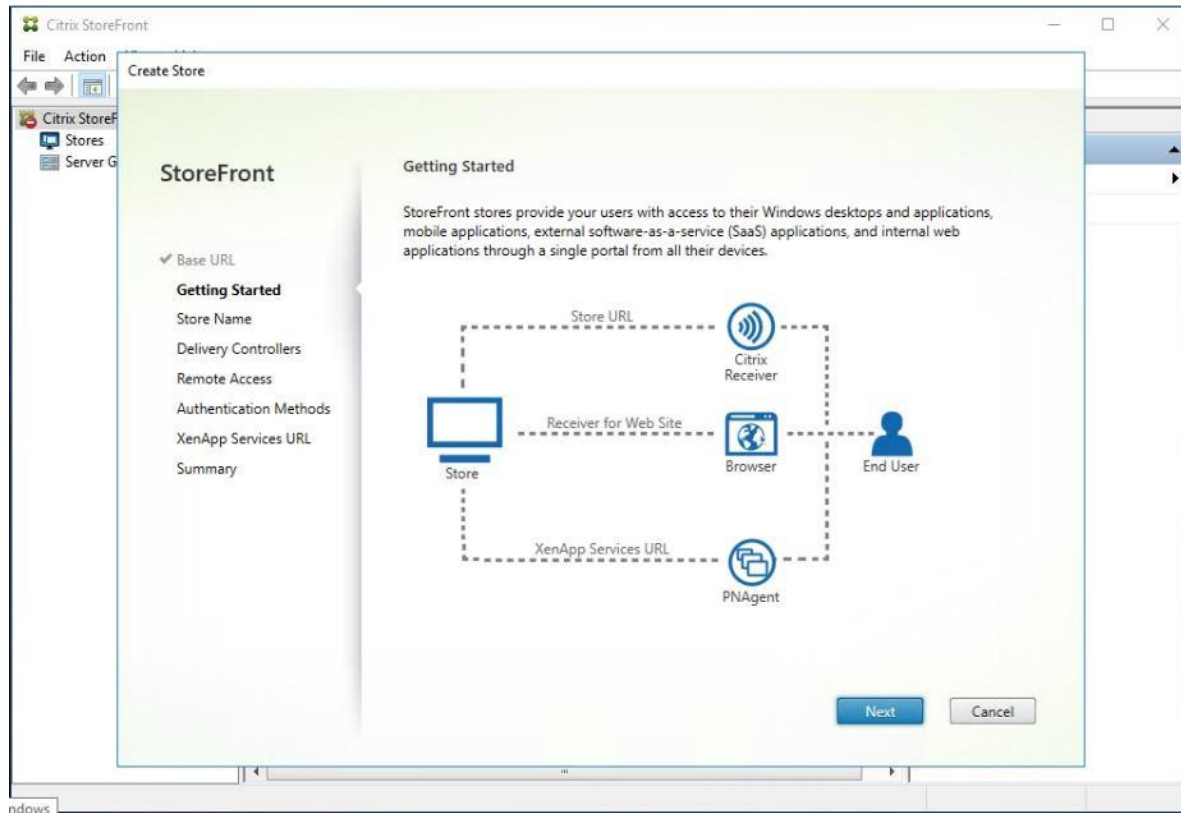

17. Specify a name for your store.

18. Click Next.

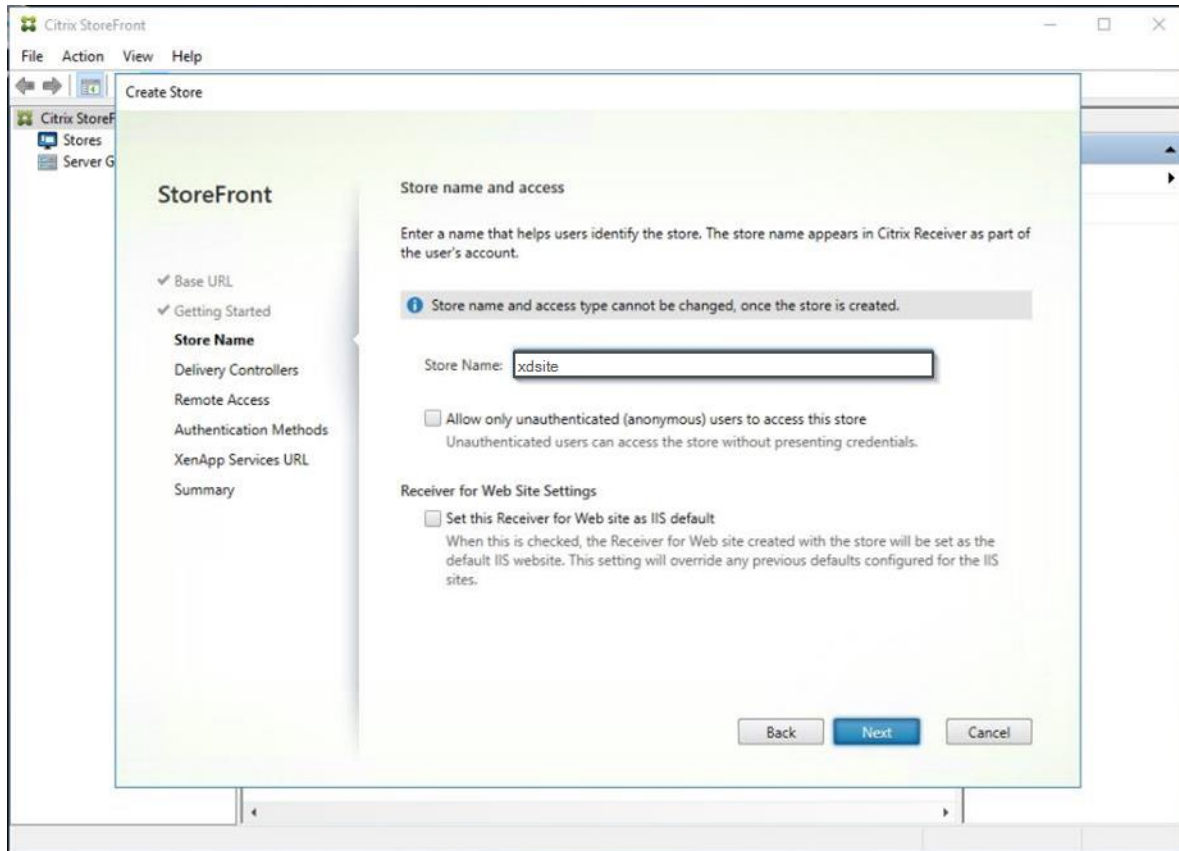

19. Add the required Delivery Controllers to the store.

20. Click Next.

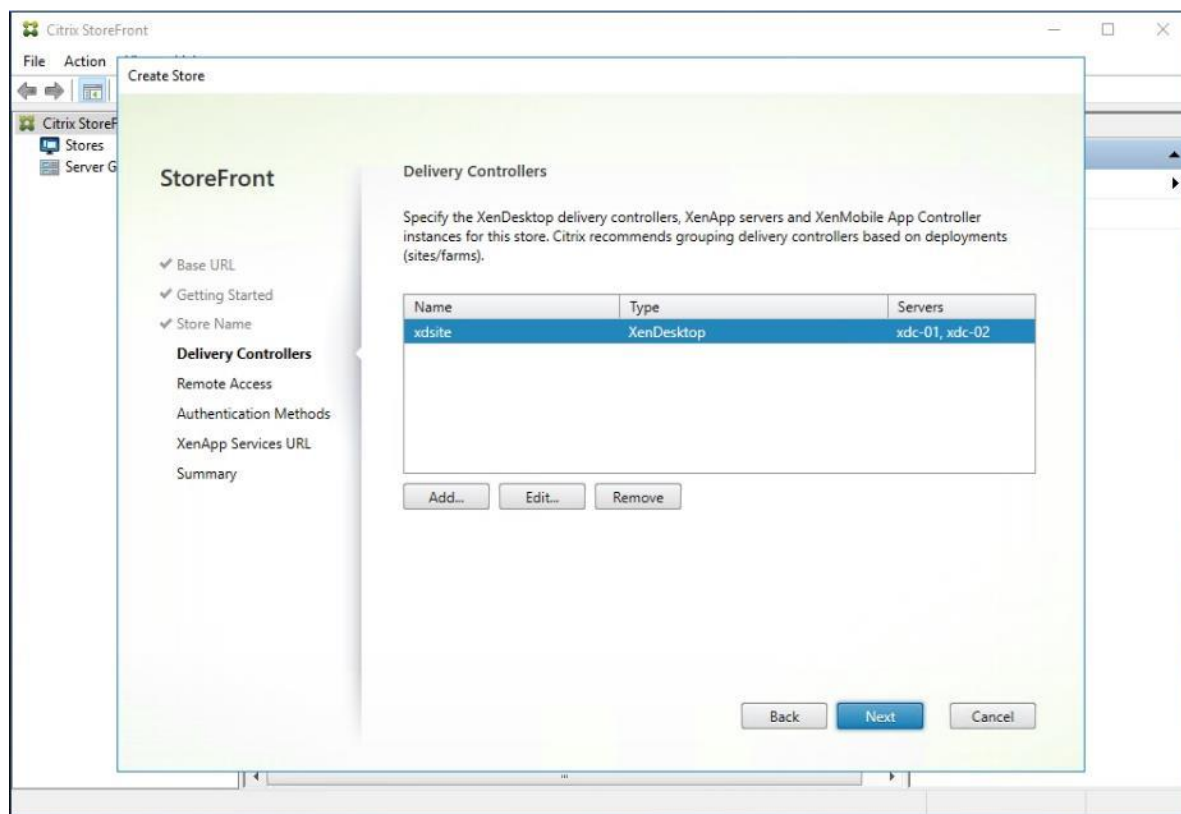

21. Specify how connecting users can access the resources, in this environment only local users on the internal network are able to access the store.

22. Click Next.

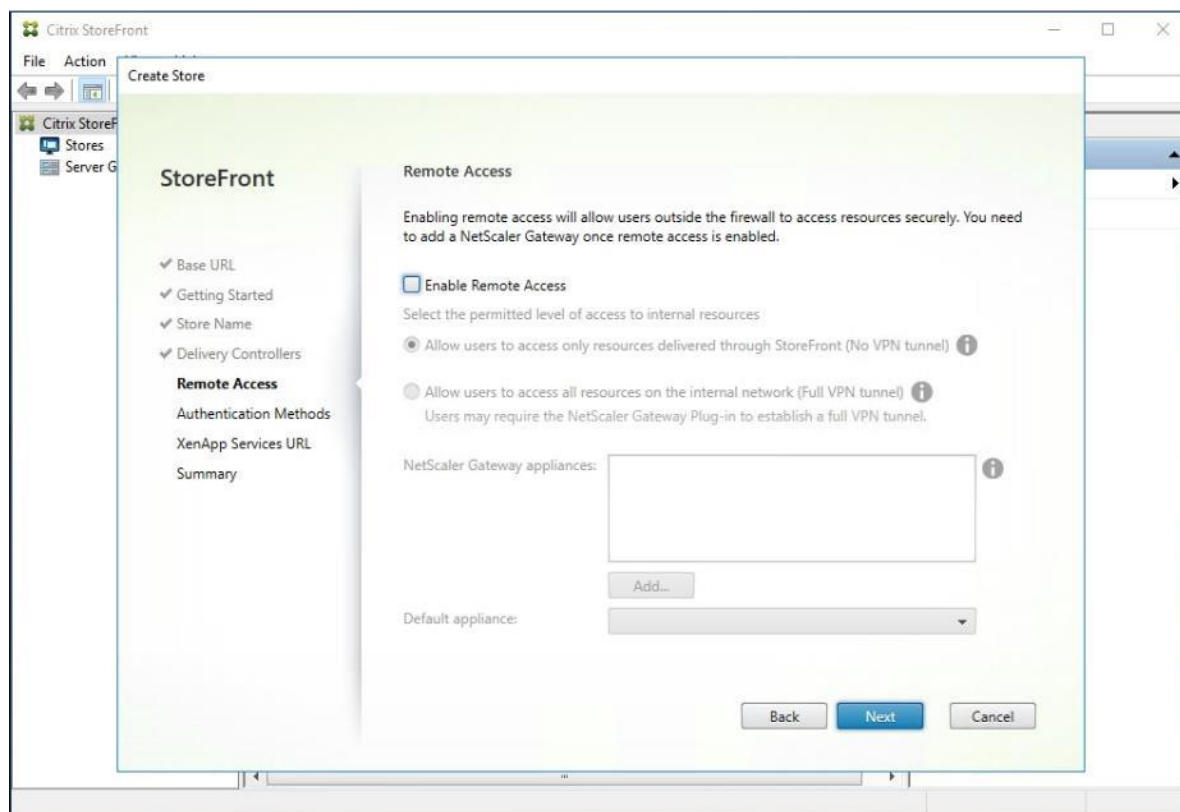

23. On the "Authentication Methods" page, select the methods your users will use to authenticate to the store. The following methods were configured in this deployment:

- Username and password: Users enter their credentials and are authenticated when they access their stores.
- Domain passthrough: Users authenticate to their domain-joined Windows computers and their credentials are used to log them on automatically when they access their stores.

24. Click Next.

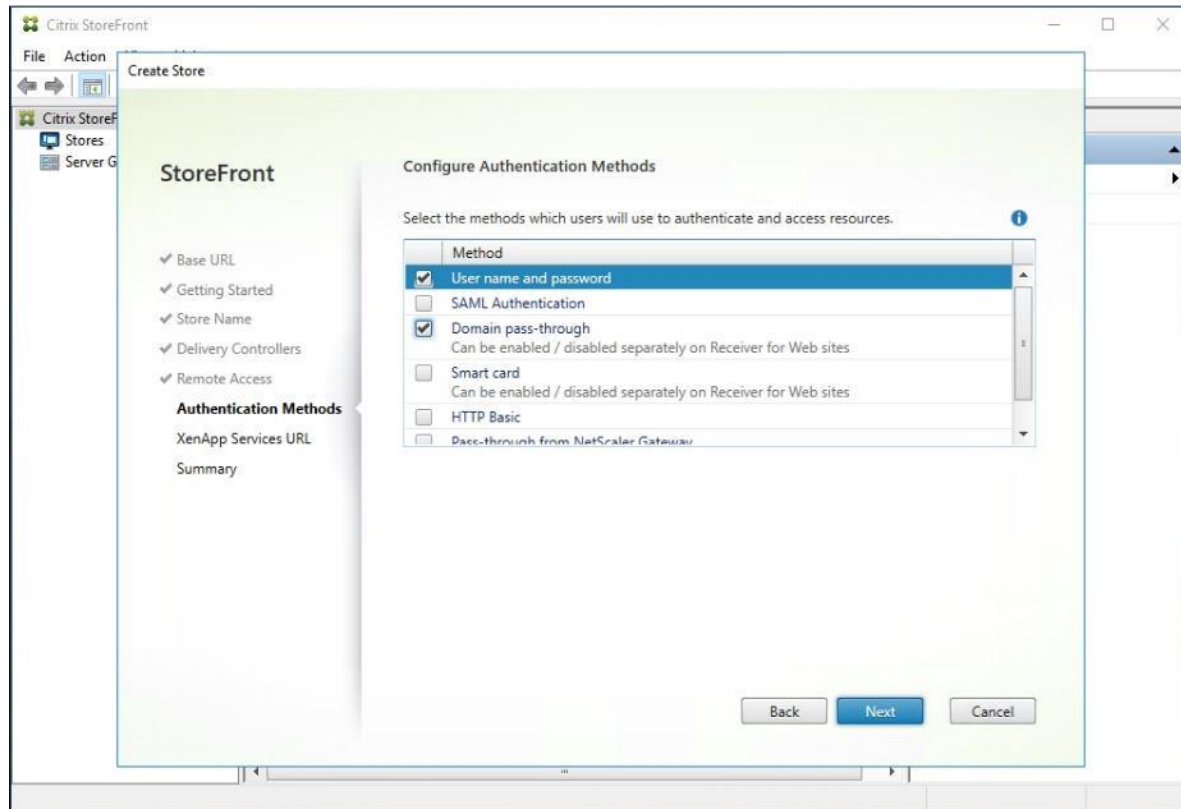

25. Configure the XenApp Service URL for users who use PNAgent to access the applications and desktops.

26. Click Create.

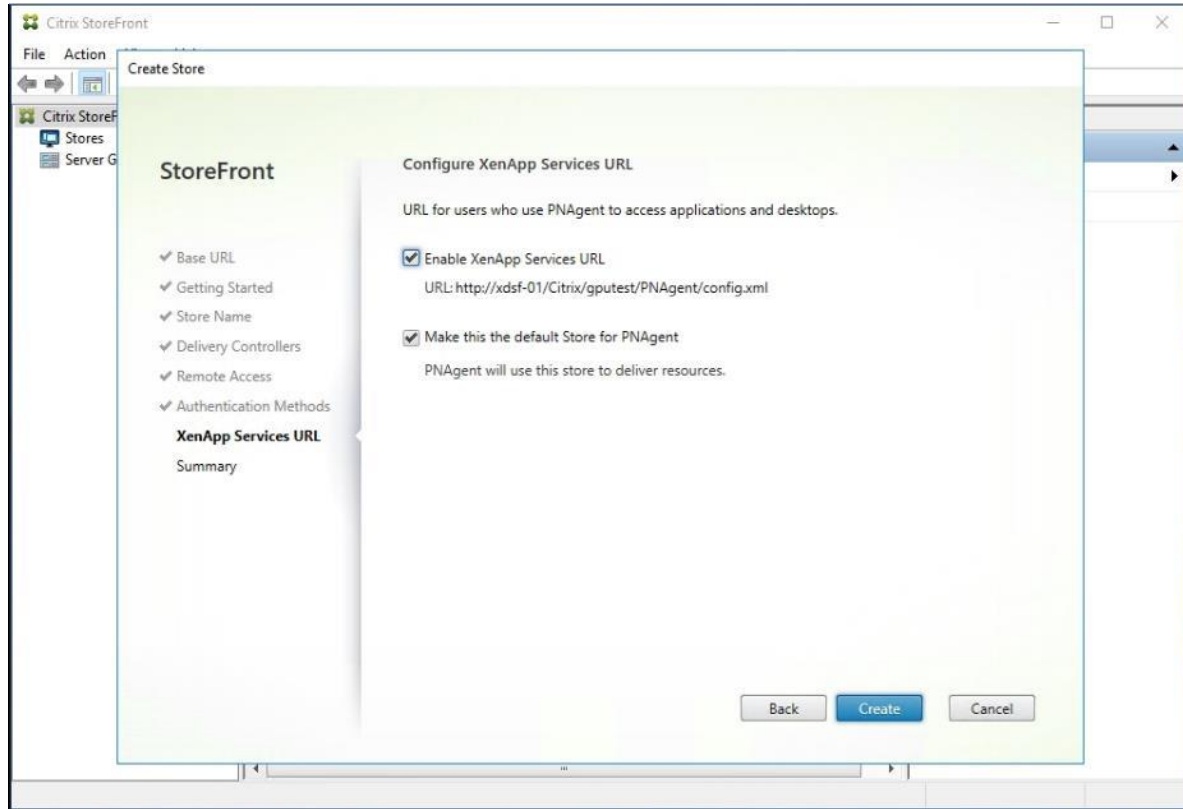

27. After creating the store click Finish.

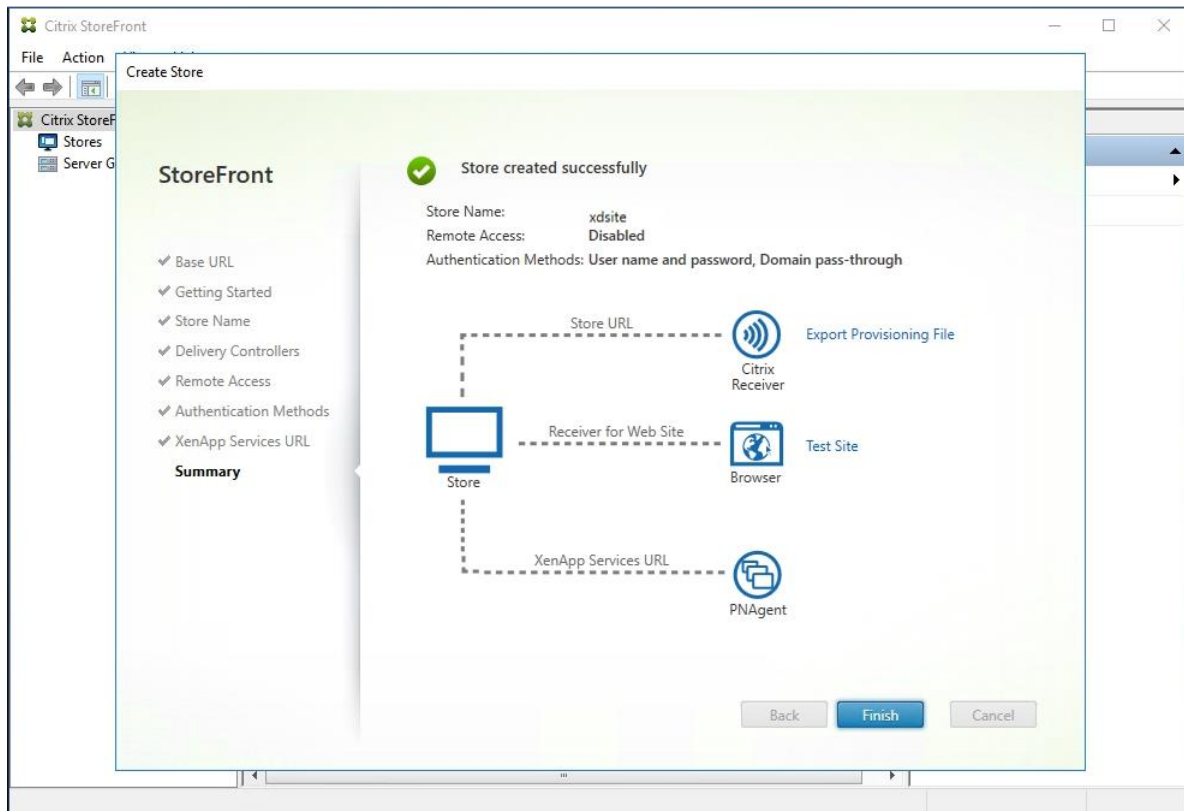

Additional StoreFront Configuration

After the first StoreFront server is completely configured and the Store is operational, you can add additional servers.

To configure additional StoreFront server, follow these steps:

1. To install the second StoreFront, use the same installation steps outlined above.
2. On the first StoreFront controller select Add Server from the Actions pane Select Server Group from the menu.
3. Connect to the first StoreFront server
4. To add the second server and generate the authorization information that allows the additional StoreFront server to join the server group, select Add Server from Actions pane in the Server Group.

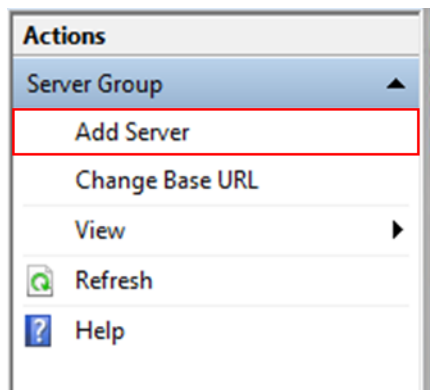

5. Copy the authorization code

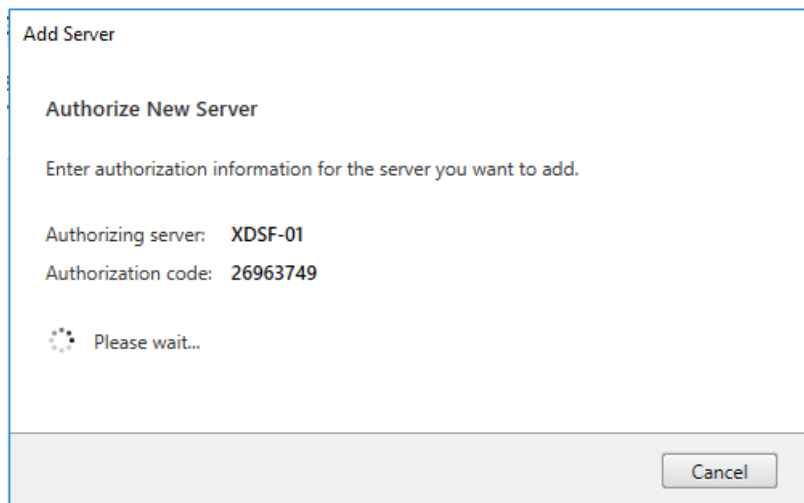

6. From the StoreFront Console on the second server select "Join existing server group."

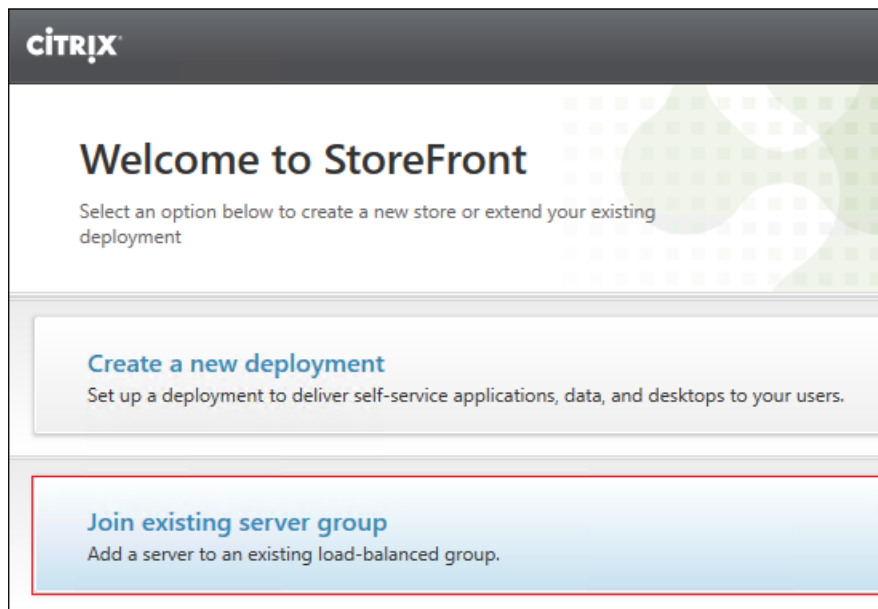

7. In the Join Server Group dialog, enter the name of the first Storefront server and paste the Authorization code into the Join Server Group dialog.
8. Click Join.

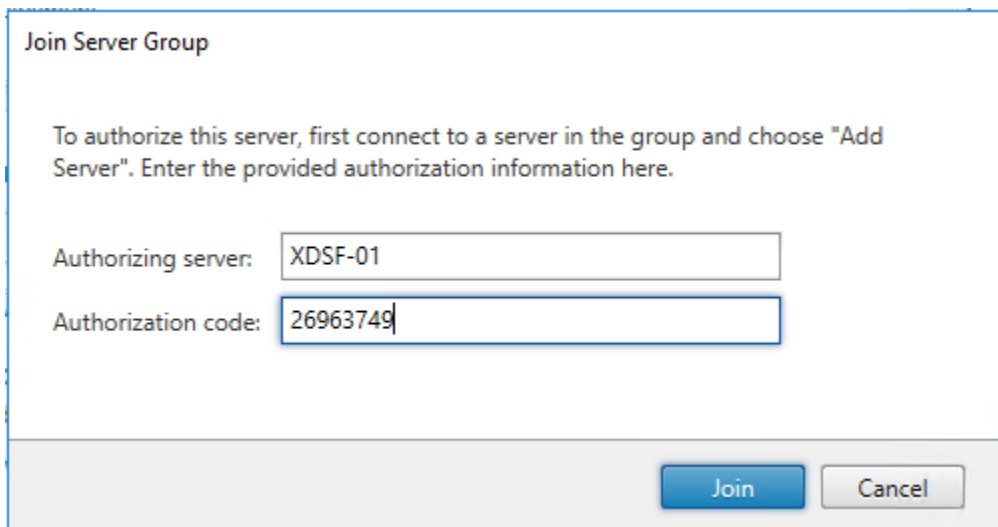

9. A message appears when the second server has joined successfully.
10. Click OK.

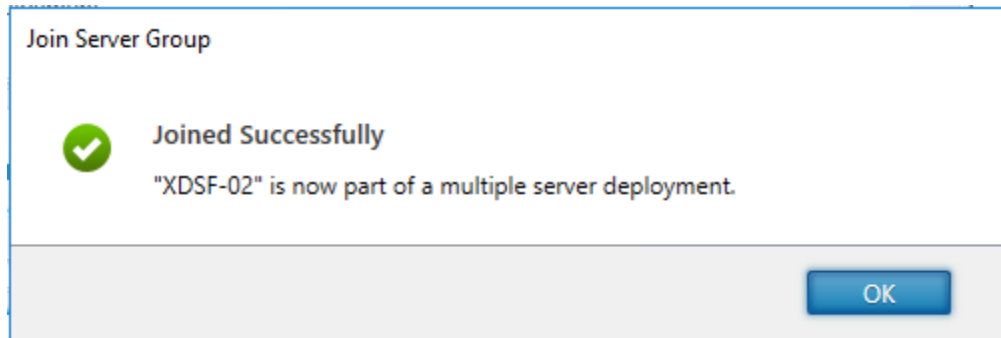

The second StoreFront is now in the Server Group.

Install and Configure Citrix Provisioning Server 7.15

In most implementations, there is a single vDisk providing the standard image for multiple target devices. Thousands of target devices can use a single vDisk shared across multiple Provisioning Services (PVS) servers in the same farm, simplifying virtual desktop management. This section describes the installation and configuration tasks required to create a PVS implementation.

The PVS server can have many stored vDisks, and each vDisk can be several gigabytes in size. Your streaming performance and manageability can be improved using a RAID array, SAN, or NAS. PVS software and hardware requirements are available in the Provisioning Services 7.15 document.

Prerequisites

Set the following Scope Options on the DHCP server hosting the PVS target machines (for example, VDI, RDS).

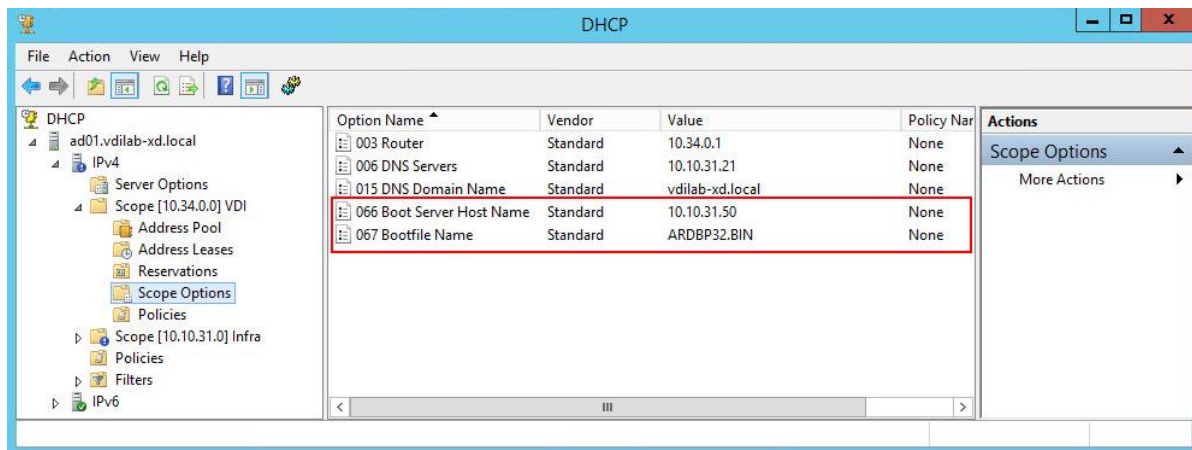

The boot server IP was configured for Load Balancing by NetScaler VPX to support high availability of the TFTP service.

To Configure TFTP Load Balancing, follow these steps:

1. Create a Virtual IP for TFTP Load Balancing.

IPs

IPV4s (3) | IPV6s (1)

Add Edit Delete Statistics Action Search

	IP Address	State	Type	Mode	ARP	ICMP	Virtual Server	Traffic Domain
		ENABLED	NetScaler IP	Active	ENABLED	ENABLED	-N/A-	0
		ENABLED	Subnet IP	Active	ENABLED	ENABLED	-N/A-	0
	10.10.31.50	ENABLED	Virtual IP	Active	ENABLED	ENABLED	ENABLED	0

2. Configure the servers that are running TFTP (your Provisioning Servers).

Servers

Add Edit Delete Action Search

	Name	State	IP Address / Domain	Traffic Domain
	pvs-1	ENABLED	10.34.0.11	0
	pvs-2	ENABLED	10.34.0.12	0

3. Define the TFTP service for the servers (Monitor used: udp-ecv).

Services

Services (2) | Auto Detected Services (0) | Internal Services (8)

Add Edit Delete Statistics Action Search

	Name	State	IP Address/Domain Name	Port	Protocol	Max Clients	Max Requests	Cache Type
	pvs1_tftp	UP	10.34.0.11	69	TFTP	0	0	SERVER
	pvs2_tftp	UP	10.34.0.12	69	TFTP	0	0	SERVER

4. Configure TFTP for load balancing.

Virtual Servers

Add Edit Delete Enable Disable Statistics Action Search

	Name	State	Effective State	IP Address	Port	Protocol	Method	Persistence	% Health
	PVSTFTP-LB	UP	UP	10.10.31.50	69	TFTP	LEASTCONNECTION	NONE	100.00% 2 UP/0 DOWN

As a Citrix best practice cited in this [CTX article](#), apply the following registry setting both the PVS servers and target machines:

```
HKEY_LOCAL_MACHINE\SYSTEM\CurrentControlSet\Services\TCPIP\Parameters\  
Key: "DisableTaskOffload" (dword)  
Value: "1"
```

Only one MS SQL database is associated with a farm. You can choose to install the Provisioning Services database software on an existing SQL database, if that machine can communicate with all Provisioning Servers within the farm, or with a new SQL Express database machine, created using the SQL Express software that is free from Microsoft.

The following databases are supported: Microsoft SQL Server 2008 SP3 through 2016 (x86, x64, and Express editions). Microsoft SQL 2016 was installed separately for this CVD.

 **High availability will be available for the databases once added to the SQL AlwaysOn Availability Group**
[CTX201203](#)

To install and configure Citrix Provisioning Service 7.15, follow these steps:

1. Insert the Citrix Provisioning Services 7.15 ISO and let AutoRun launch the installer.
2. Click the Console Installation button.

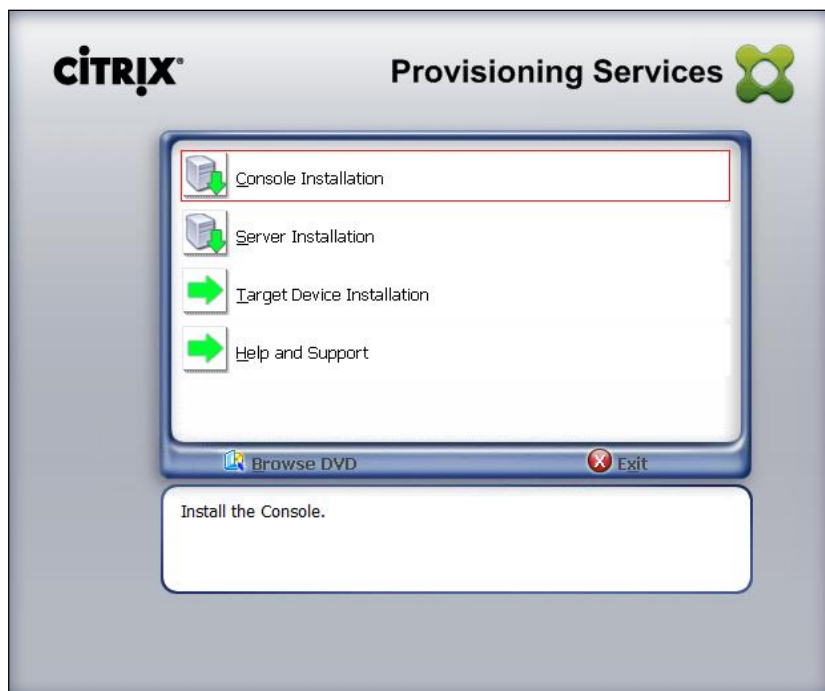

3. Click Install to install the required prerequisites.

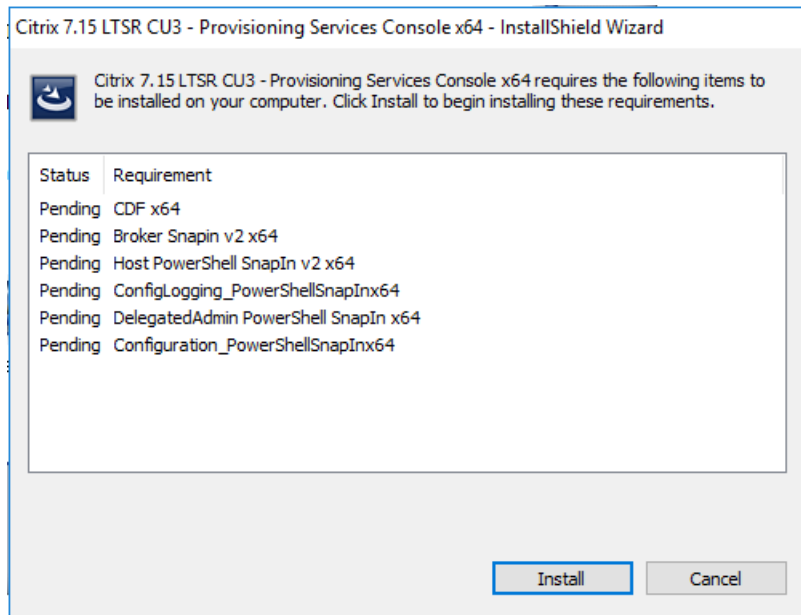

4. Click Next to start the console installation.

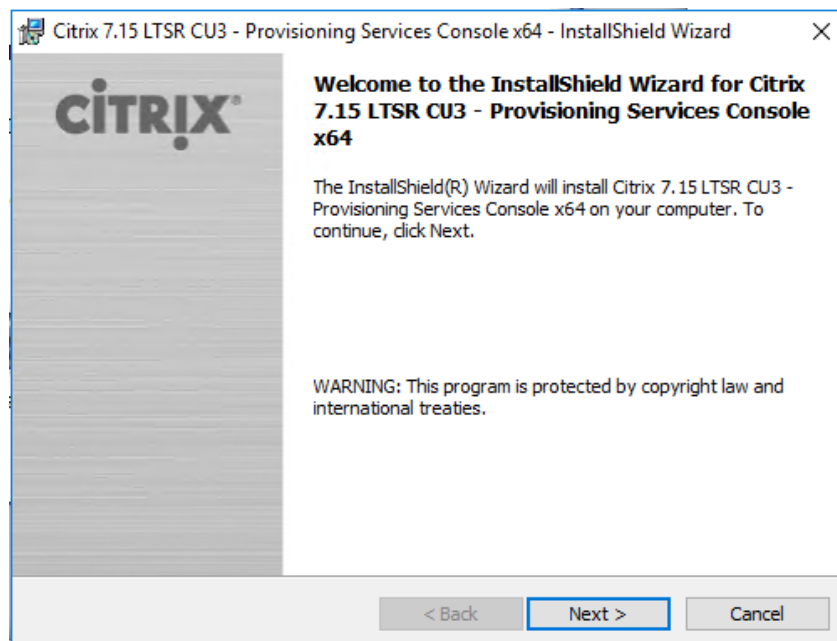

5. Read the Citrix License Agreement.

6. If acceptable, select the radio button labeled "I accept the terms in the license agreement."

7. Click Next.

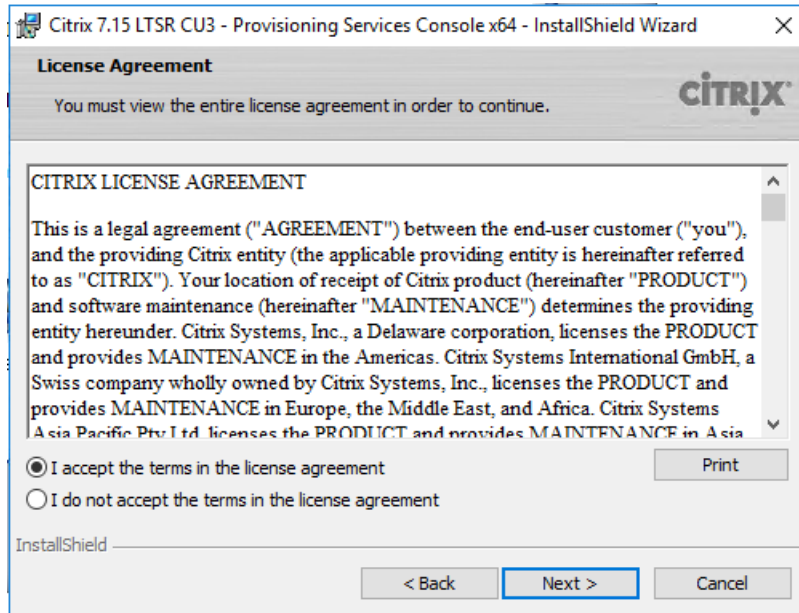

8. Optionally provide User Name and Organization.

9. Click Next.

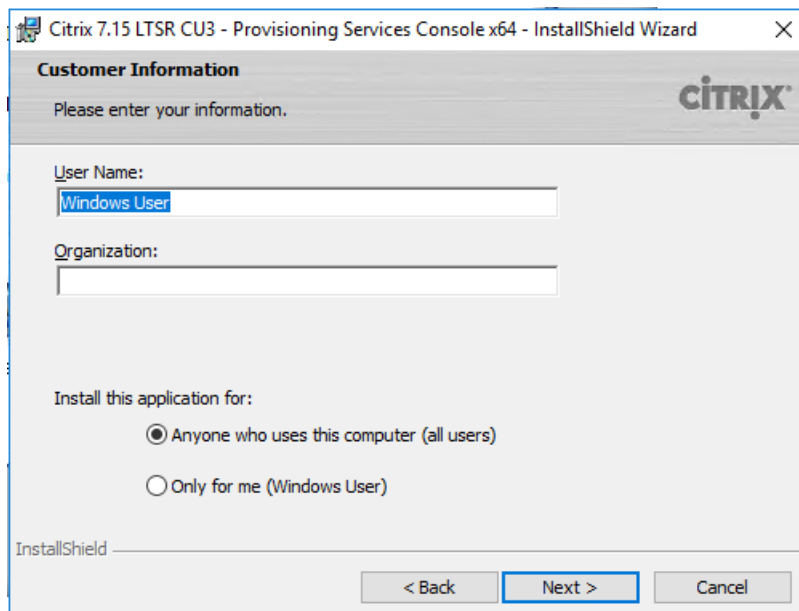

10. Accept the default path.

11. Click Next.

12. Click Install to start the console installation.

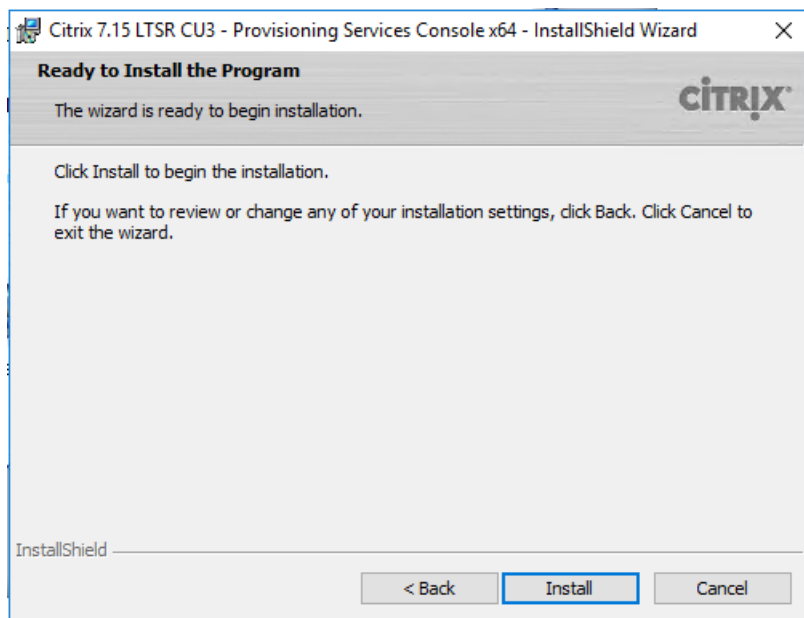

13. Click Finish after successful installation.

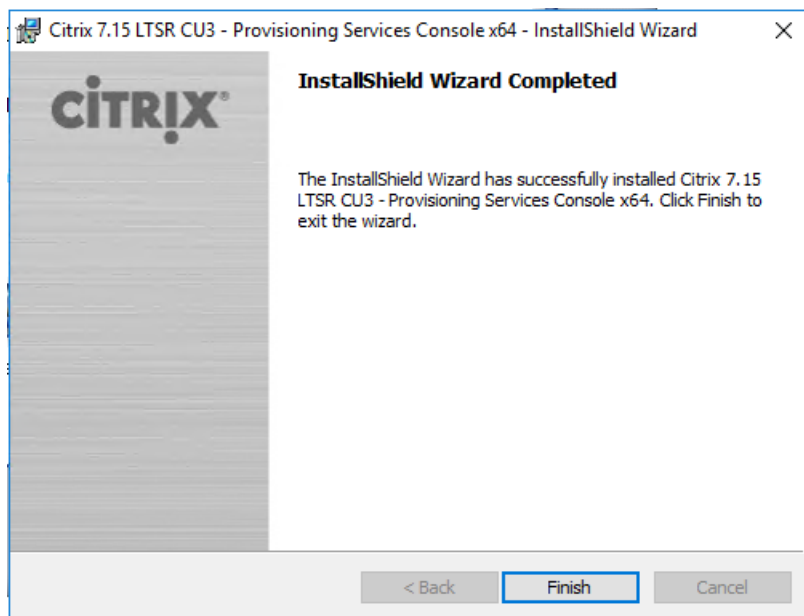

14. From the main installation screen, select Server Installation.

15. The installation wizard will check to resolve dependencies and then begin the PVS server installation process.

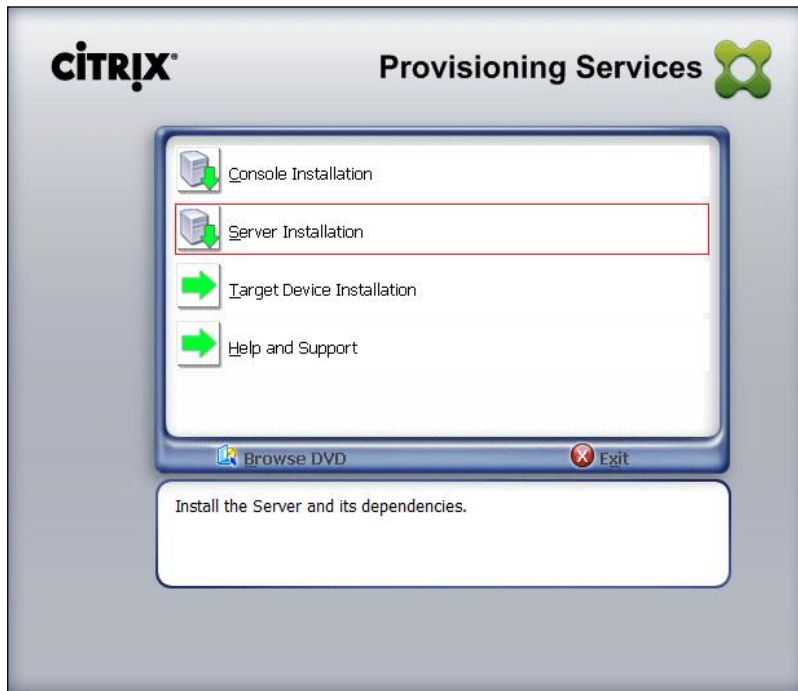

16. Click Install on the prerequisites dialog.

17. Click Yes when prompted to install the SQL Native Client.

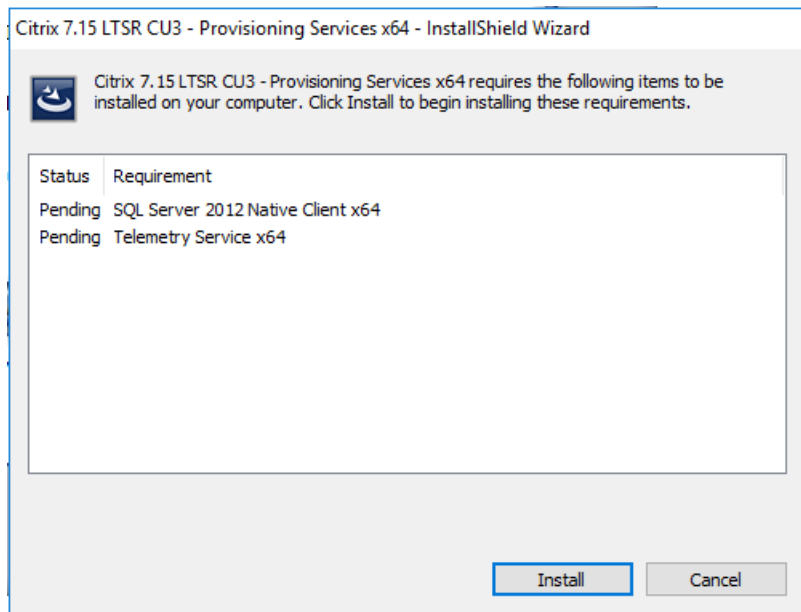

18. Click Next when the Installation wizard starts.

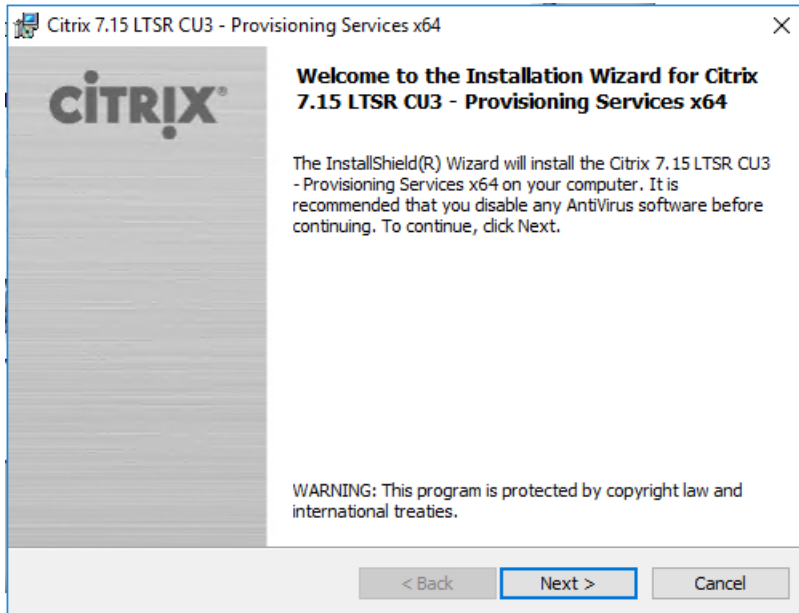

19. Review the license agreement terms.

20. If acceptable, select the radio button labeled "I accept the terms in the license agreement."

21. Click Next.

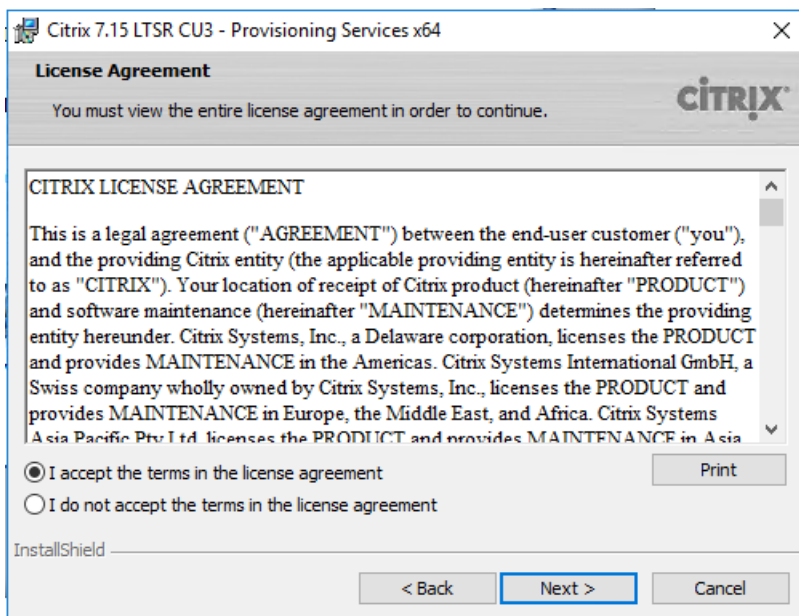

22. Provide User Name and Organization information. Select who will see the application.

23. Click Next.

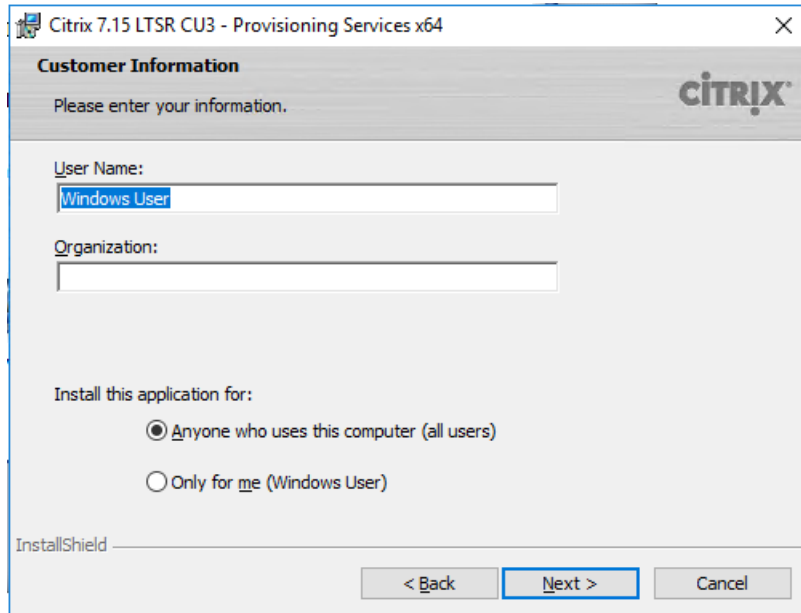

24. Accept the default installation location.

25. Click Next.

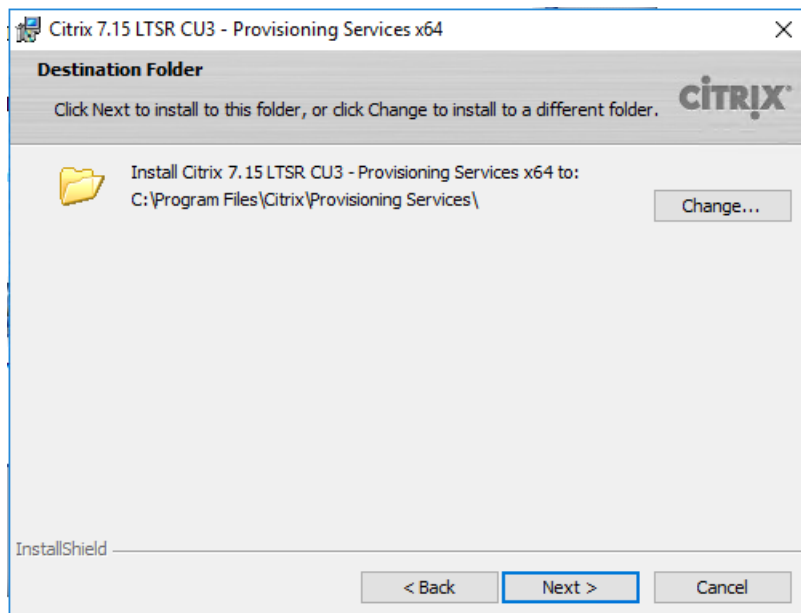

26. Click Install to begin the installation.

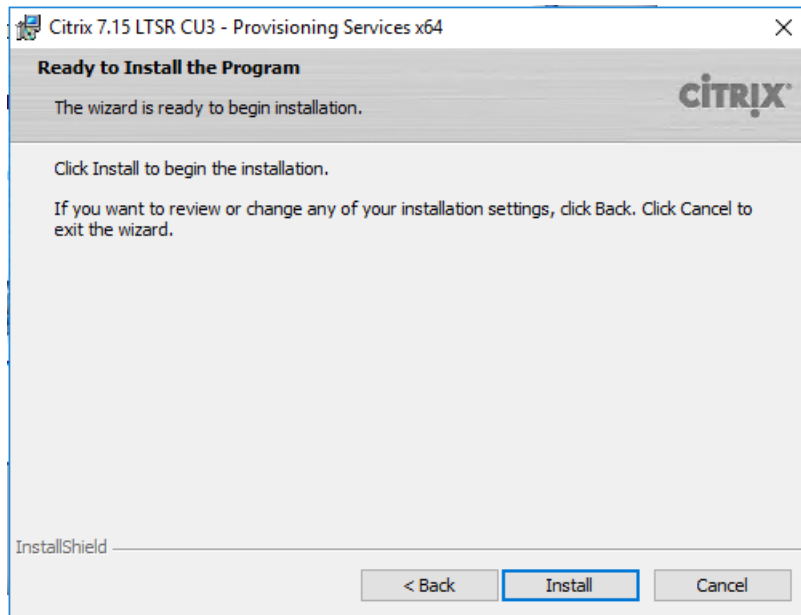

27. Click Finish when the install is complete.

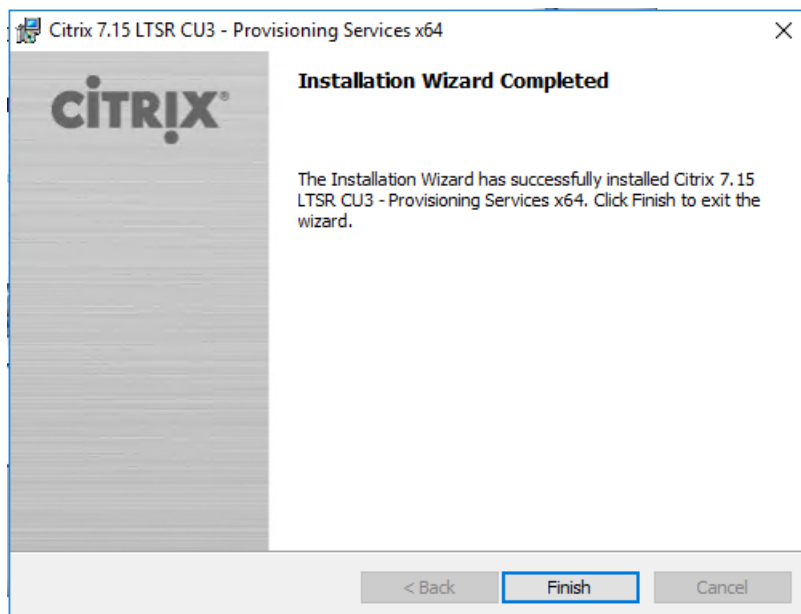

28. The PVS Configuration Wizard starts automatically.

29. Click Next.

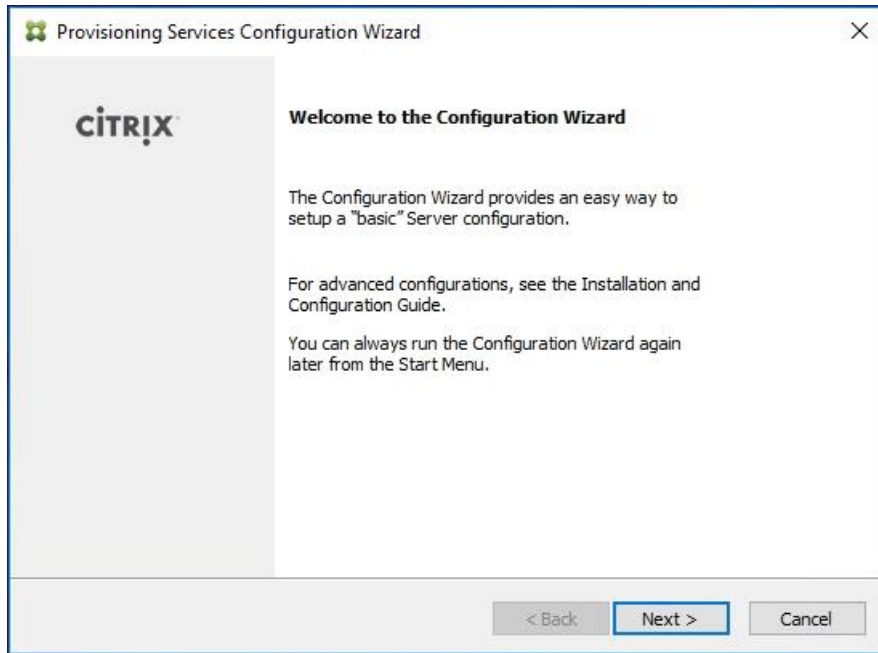

30. Since the PVS server is not the DHCP server for the environment, select the radio button labeled, "The service that runs on another computer."

31. Click Next.

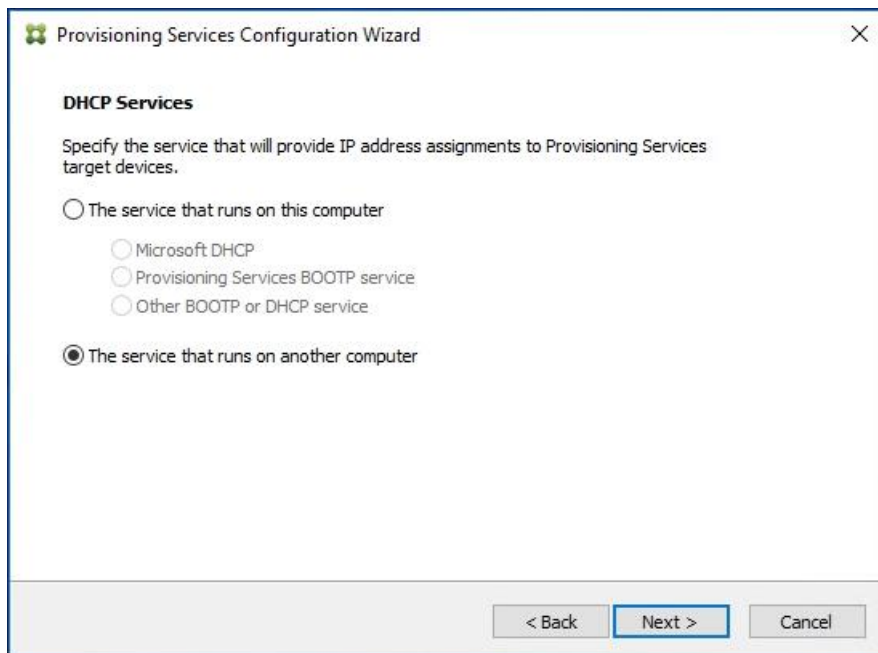

32. Since DHCP boot options 66 and 67 are used for TFTP services, select the radio button labeled, "The service that runs on another computer."

33. Click Next.

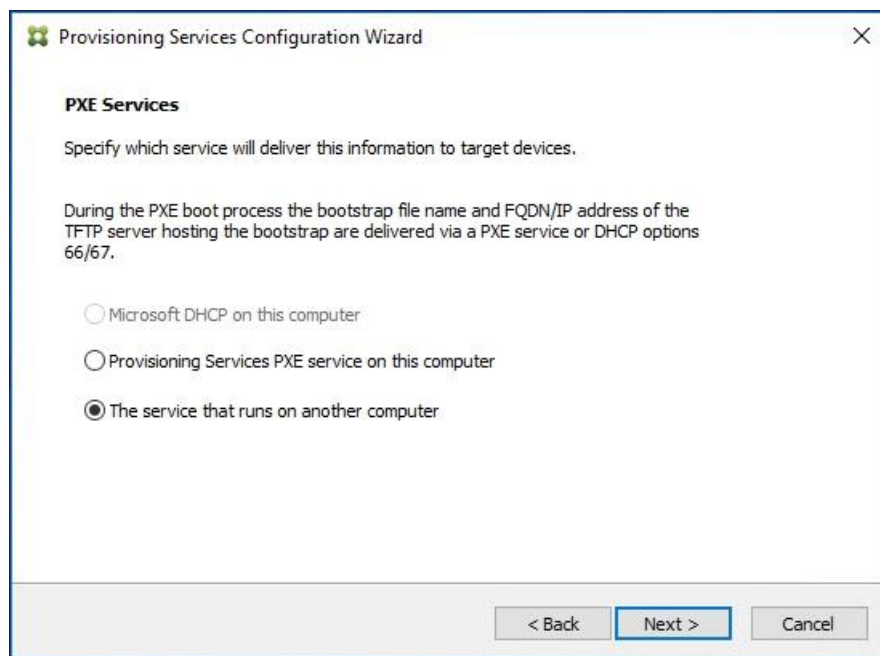

34. Since this is the first server in the farm, select the radio button labeled, "Create farm."

35. Click Next.

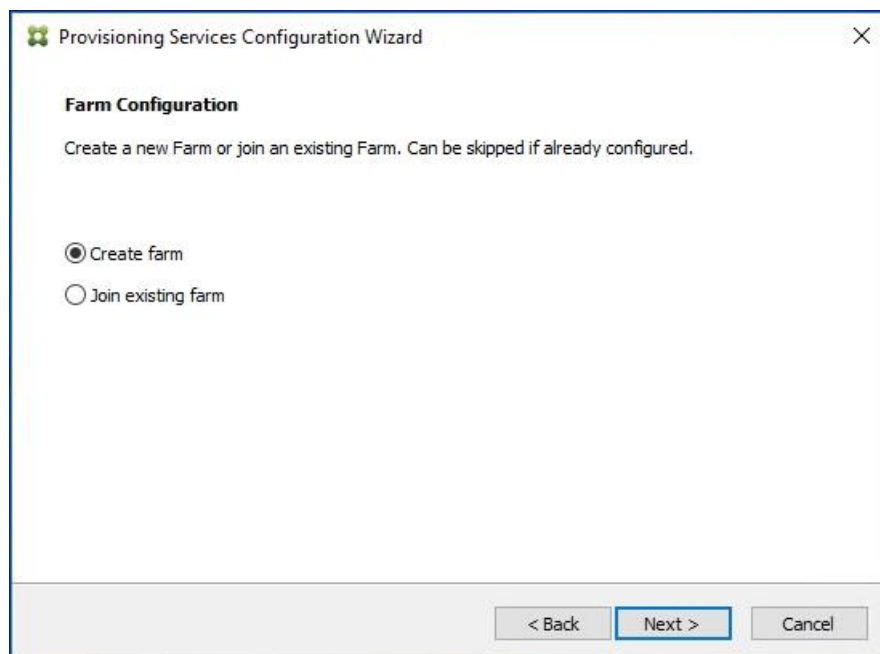

36. Enter the FQDN of the SQL server.

37. Click Next.

The screenshot shows the 'Database Server' step of the Provisioning Services Configuration Wizard. The title bar reads 'Provisioning Services Configuration Wizard'. The main heading is 'Database Server' with the instruction 'Enter the Server and Instance names.' Below this, there are four input fields: 'Server name' (containing 'VCCSQL-01'), 'Instance name' (containing 'VCC'), 'Optional TCP port' (empty), and 'Optional TCP port' (empty). There are two 'Browse...' buttons, one next to the 'Server name' field and one next to the 'Optional TCP port' field. Below the input fields are two checkboxes: 'Enable MultiSubnetFailover for SQL Server Always On' (unchecked) and 'Specify database mirror failover partner' (unchecked). Under the second checkbox, there are three more input fields: 'Server name', 'Instance name', and 'Optional TCP port', all of which are disabled. At the bottom of the wizard, there are three buttons: '< Back', 'Next >', and 'Cancel'.

38. Provide the Database, Farm, Site, and Collection name.

39. Click Next.

The screenshot shows the 'New Farm' step of the Provisioning Services Configuration Wizard. The title bar reads 'Provisioning Services Configuration Wizard'. The main heading is 'New Farm' with the instruction 'Enter the new Database and Farm names.' Below this, there are four input fields: 'Database name' (a dropdown menu showing 'FlashStack'), 'Farm name' (containing 'VCC'), 'Site name' (containing 'CTX-ADD17'), and 'Collection name' (containing 'W10'). There are two radio buttons: 'Use Active Directory groups for security' (selected) and 'Use Windows groups for security' (unselected). Below the radio buttons is a dropdown menu for 'Farm Administrator group' showing 'vcc-sp.local/Users/Domain Users'. At the bottom of the wizard, there are three buttons: '< Back', 'Next >', and 'Cancel'.

40. Provide the vDisk Store details.

41. Click Next.

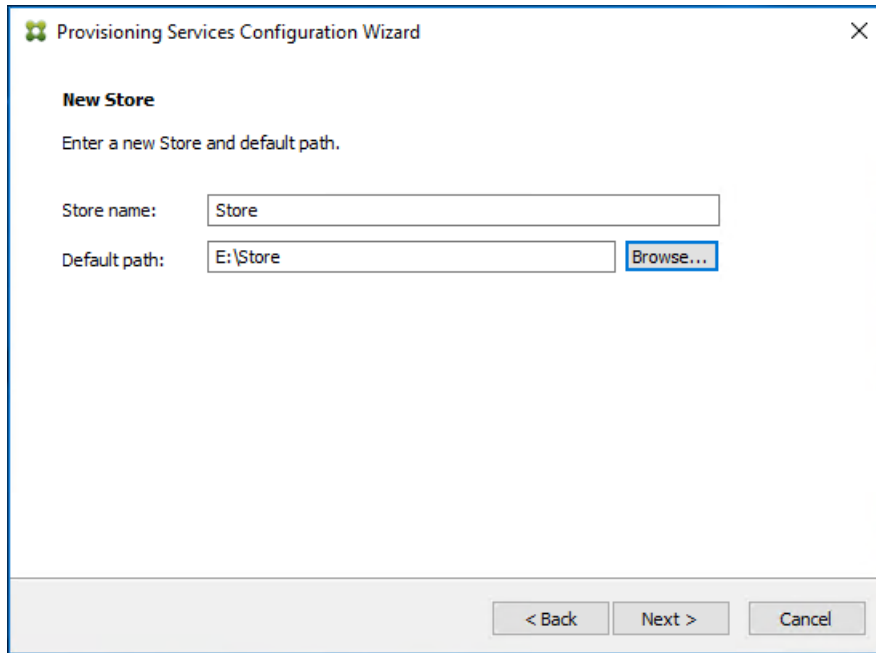

For large scale PVS environment, it is recommended to create the share using support for CIFS/SMB3 on an enterprise ready File Server.

- 42. Provide the FQDN of the license server.
- 43. Optionally, provide a port number if changed on the license server.
- 44. Click Next.

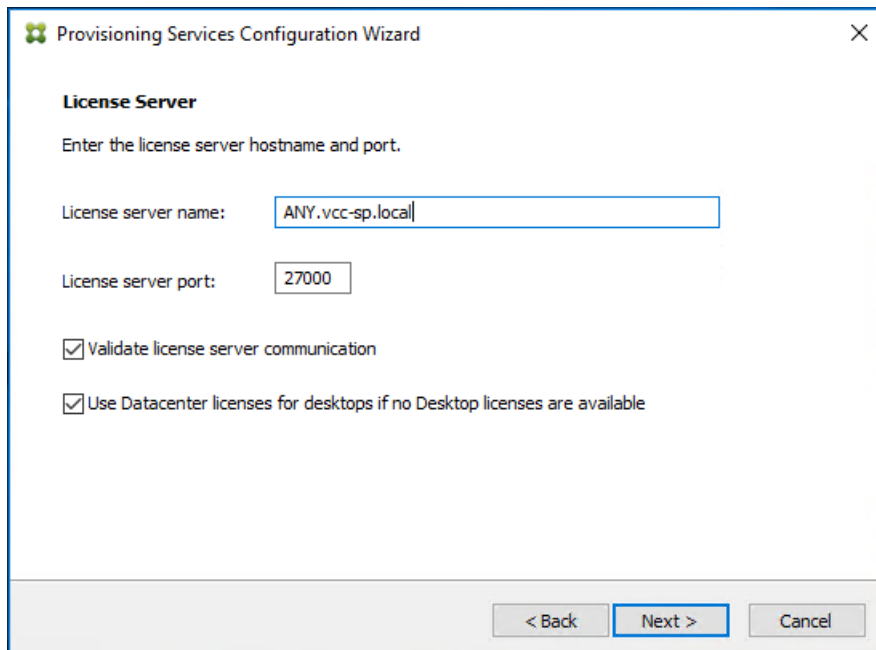



If an Active Directory service account is not already setup for the PVS servers, create that account prior to clicking Next on this dialog.

45. Select the Specified user account radio button.
46. Complete the User name, Domain, Password, and Confirm password fields, using the PVS account information created earlier.
47. Click Next.

Provisioning Services Configuration Wizard

User account

The Stream and Soap Services will run under a user account. Please select what user account you will use.

Note: The database will be configured for access from this account.

Network service account

Specified user account

User name:

Domain:

Password:

Confirm password:

< Back Next > Cancel

48. Set the Days between password updates to 7.



This will vary per environment. “7 days” for the configuration was appropriate for testing purposes.

49. Click Next.

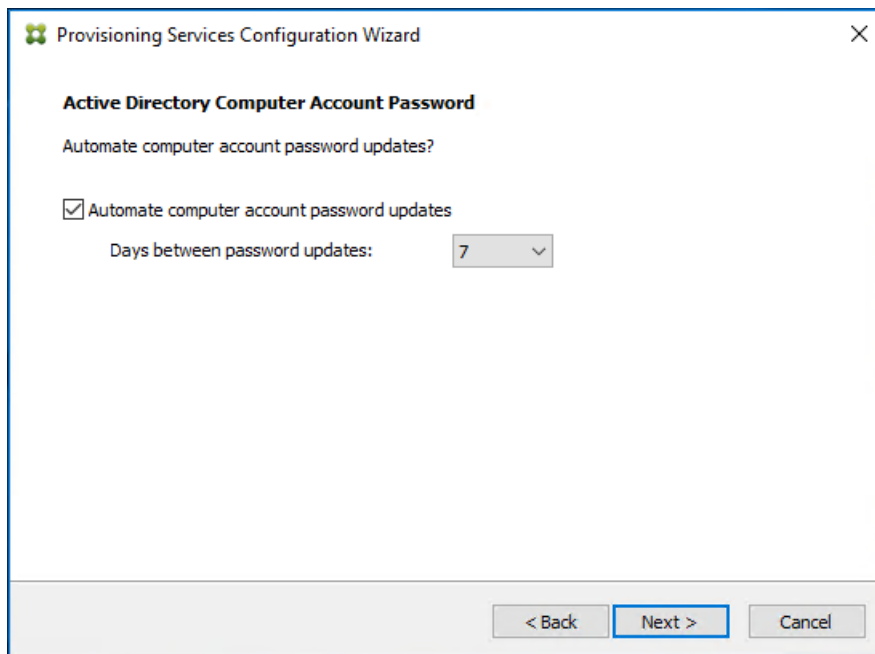

50. Keep the defaults for the network cards.

51. Click Next.

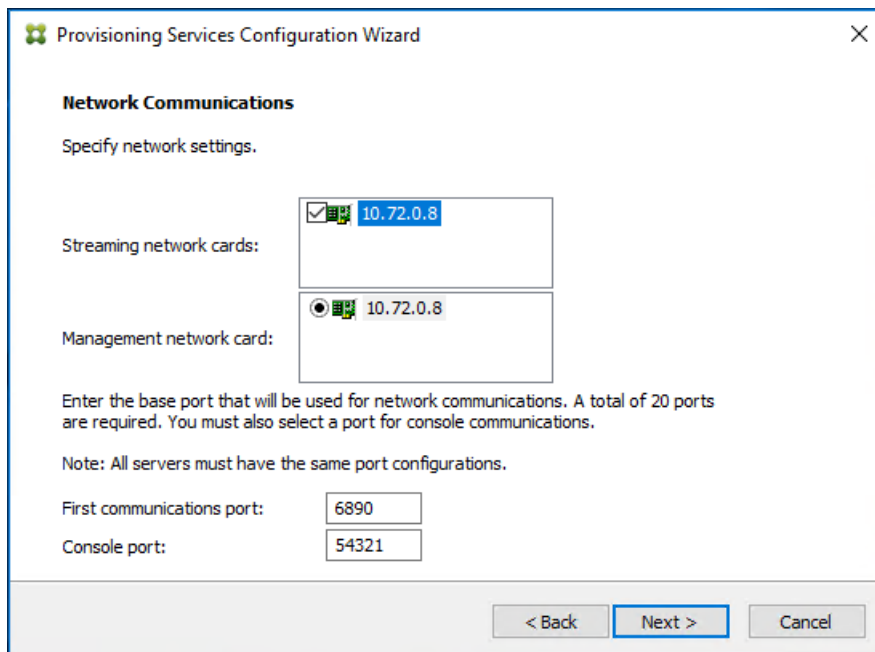

52. Select Use the Provisioning Services TFTP service checkbox.

53. Click Next.

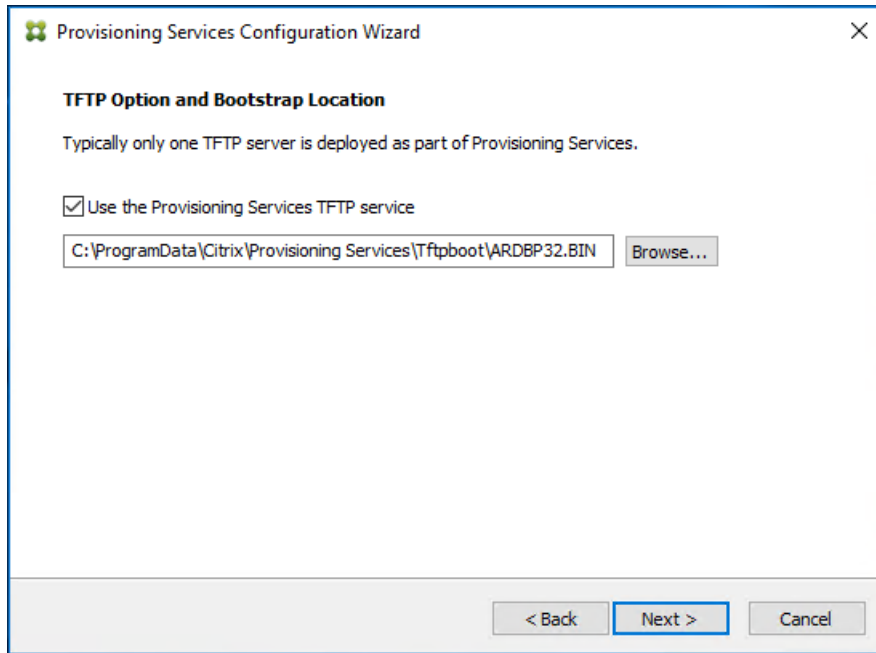

54. Make sure that the IP Addresses for all PVS servers are listed in the Stream Servers Boot List.

55. Click Next.

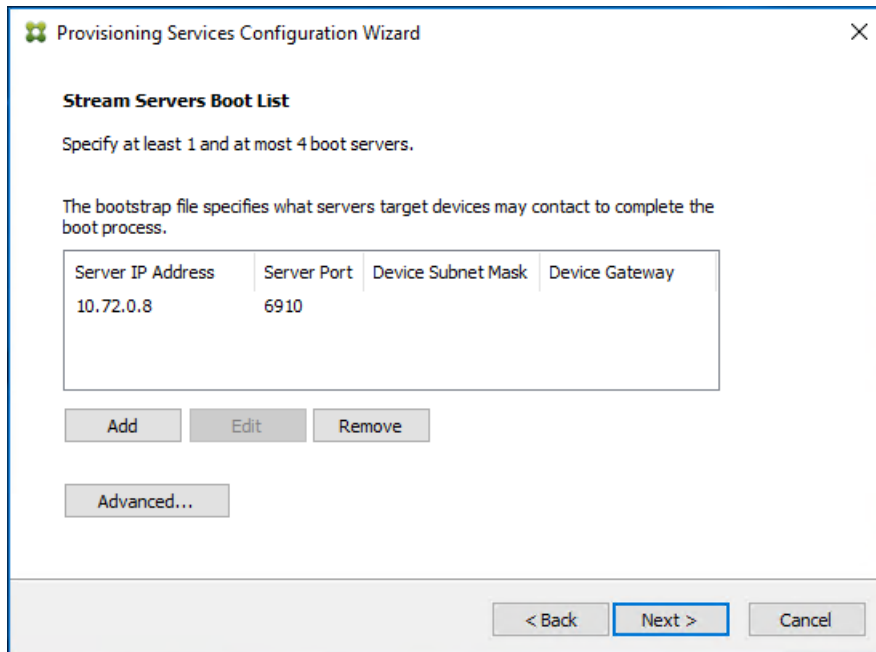

56. If Soap Server is used, provide details.

57. Click Next.

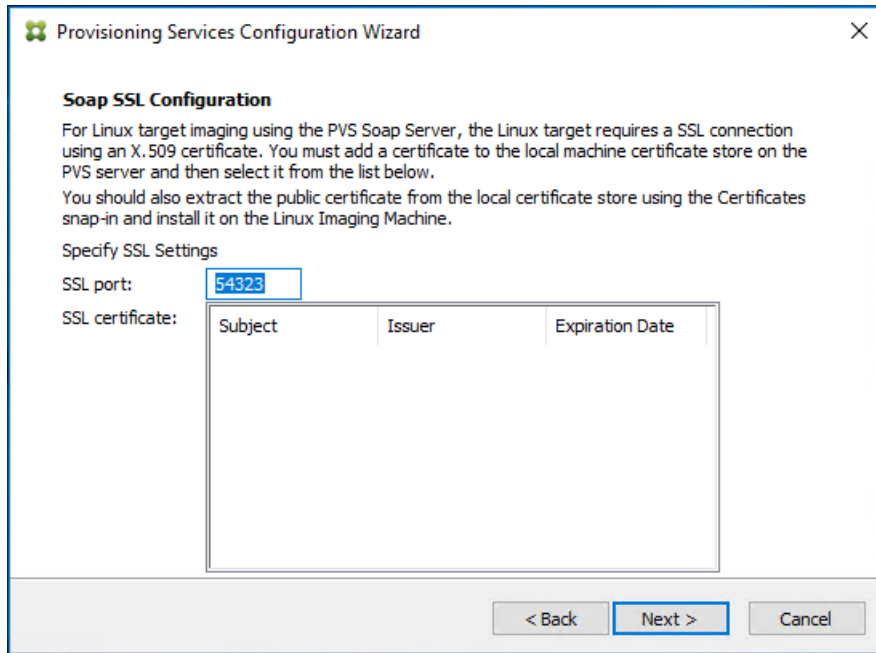

Provisioning Services Configuration Wizard

Soap SSL Configuration

For Linux target imaging using the PVS Soap Server, the Linux target requires a SSL connection using an X.509 certificate. You must add a certificate to the local machine certificate store on the PVS server and then select it from the list below.

You should also extract the public certificate from the local certificate store using the Certificates snap-in and install it on the Linux Imaging Machine.

Specify SSL Settings

SSL port:

SSL certificate:

Subject	Issuer	Expiration Date
---------	--------	-----------------

< Back Next > Cancel

58. If desired fill in Problem Report Configuration.

59. Click Next.

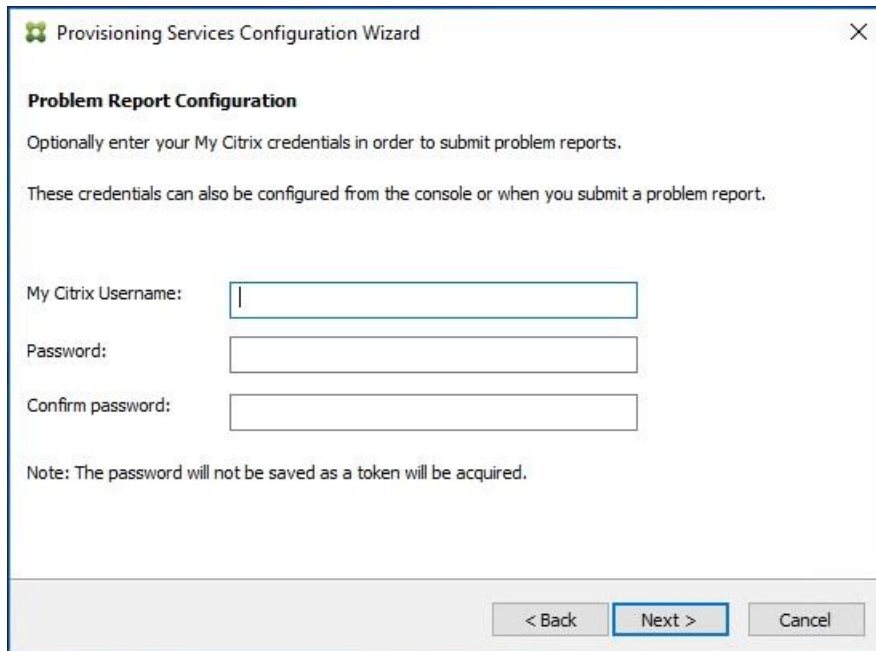

Provisioning Services Configuration Wizard

Problem Report Configuration

Optionally enter your My Citrix credentials in order to submit problem reports.

These credentials can also be configured from the console or when you submit a problem report.

My Citrix Username:

Password:

Confirm password:

Note: The password will not be saved as a token will be acquired.

< Back Next > Cancel

60. Click Finish to start the installation.

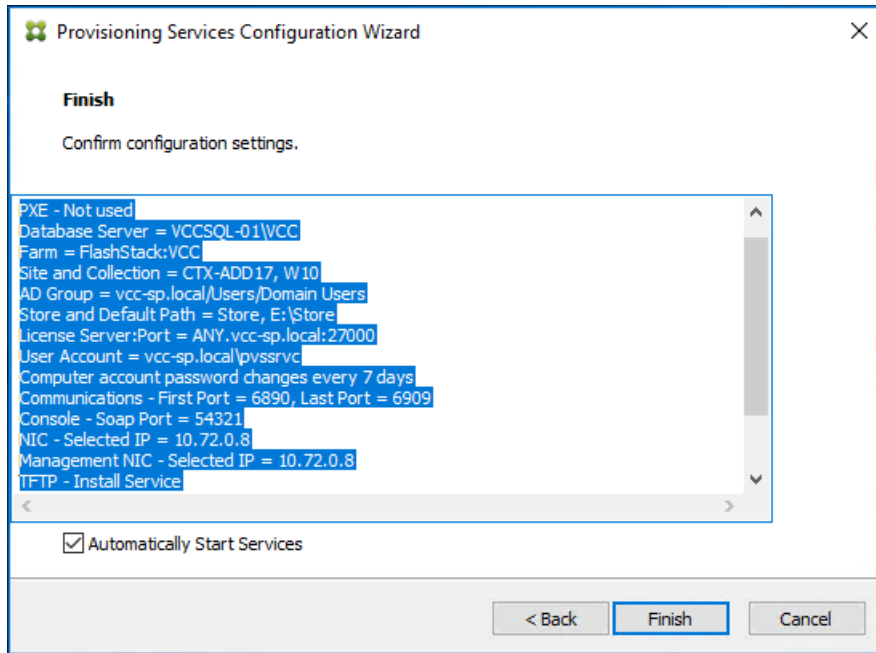

61. When the installation is completed, click Done.

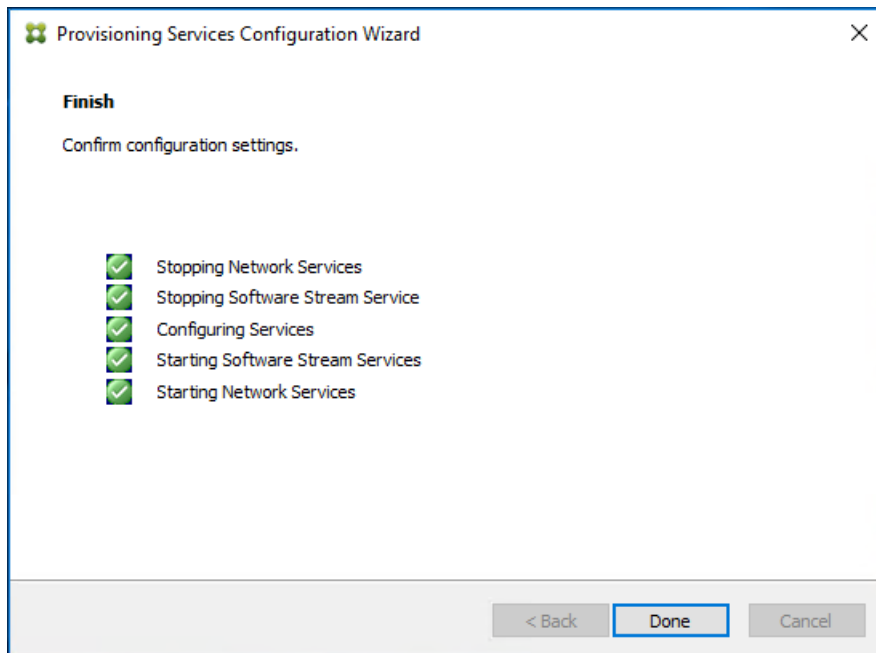

Install Additional PVS Servers

Complete the installation steps on the additional PVS servers up to the configuration step where it asks to Create or Join a farm. In this CVD, we repeated the procedure to add a total of three PVS servers. To install additional PVS servers, follow these steps:

1. On the Farm Configuration dialog, select “Join existing farm.”
2. Click Next.

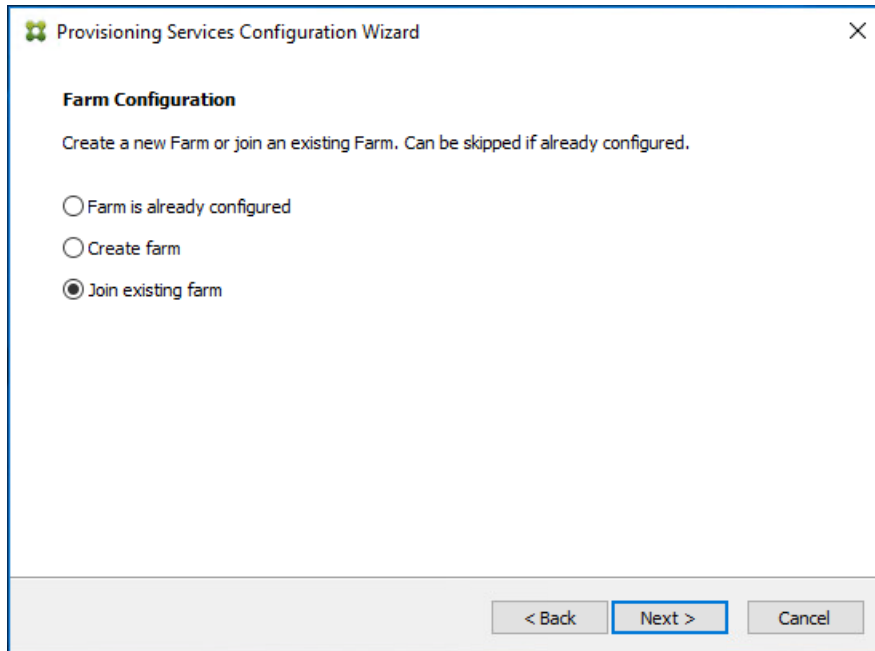

3. Provide the FQDN of the SQL Server.
4. Click Next.

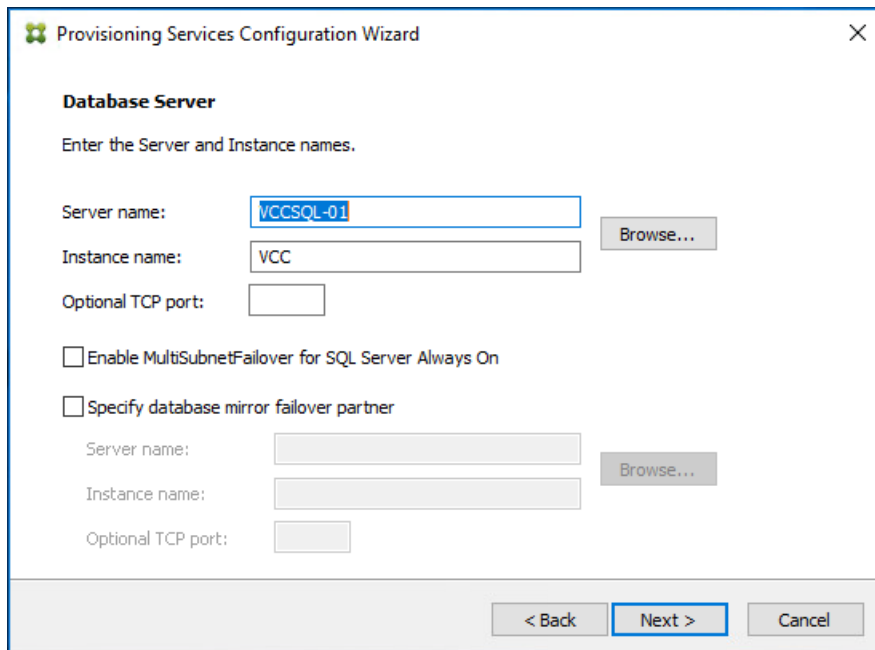

5. Accept the Farm Name.
6. Click Next.

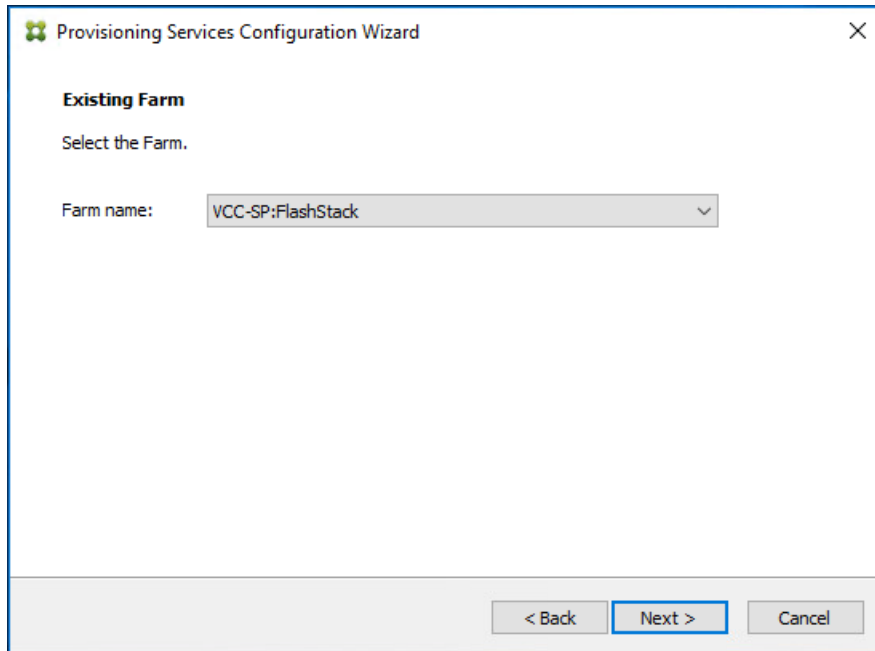

7. Accept the Existing Site.

8. Click Next.

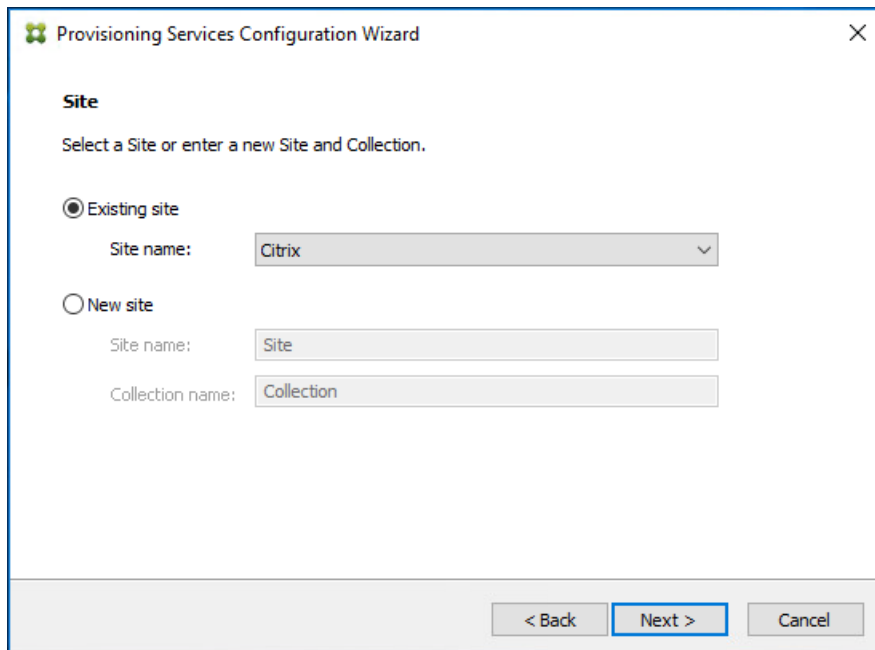

9. Accept the existing vDisk store.

10. Click Next.

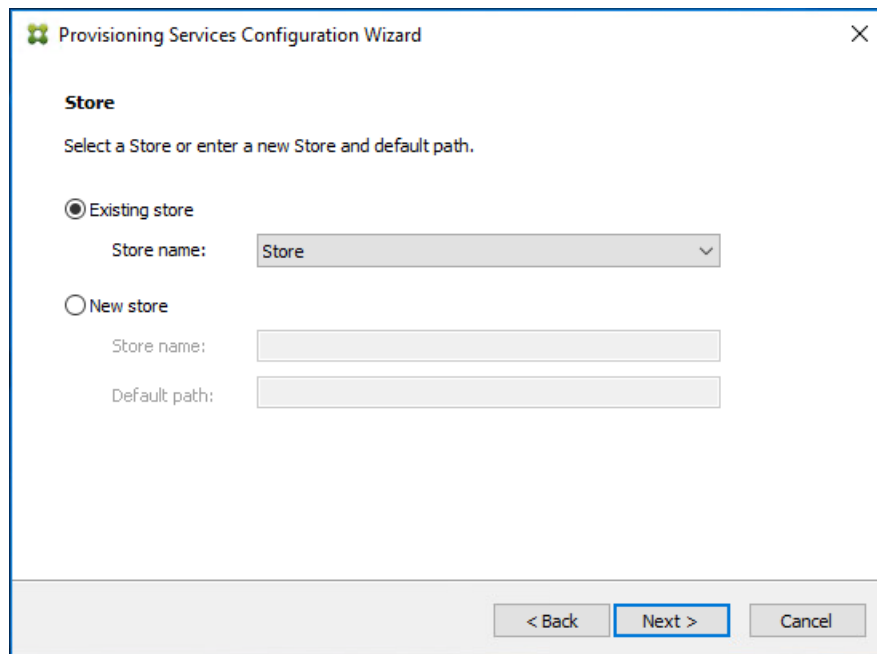

11. Provide the FQDN of the license server.
12. Optionally, provide a port number if changed on the license server.
13. Click Next.

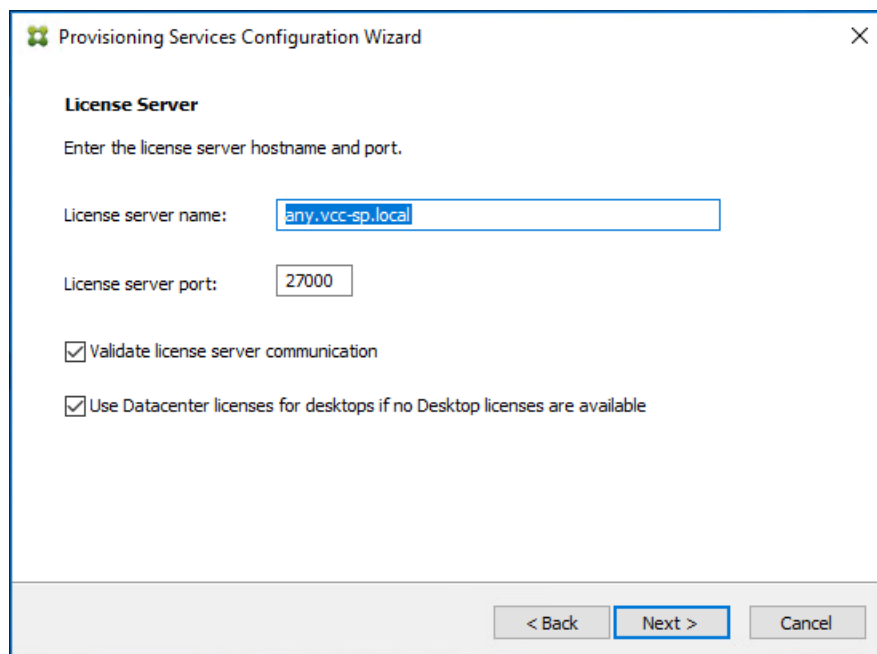

14. Provide the PVS service account information.
15. Click Next.

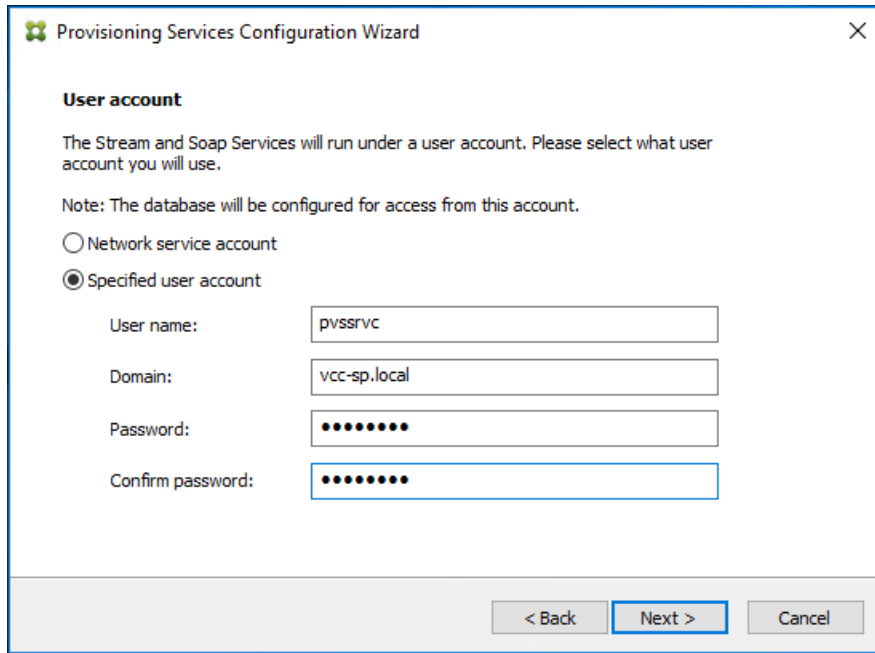

16. Set the Days between password updates to 7.

17. Click Next.

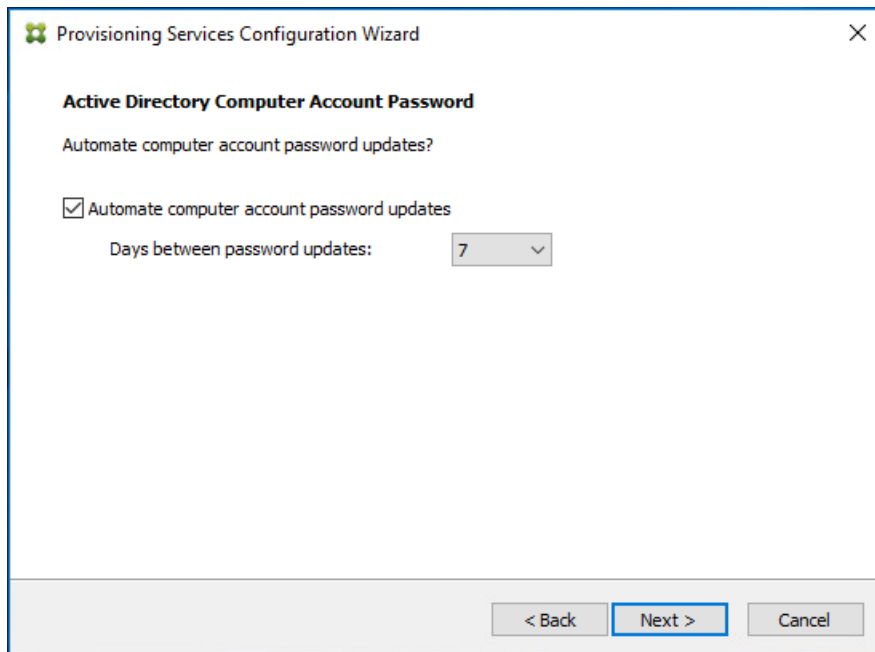

18. Accept the network card settings.

19. Click Next.

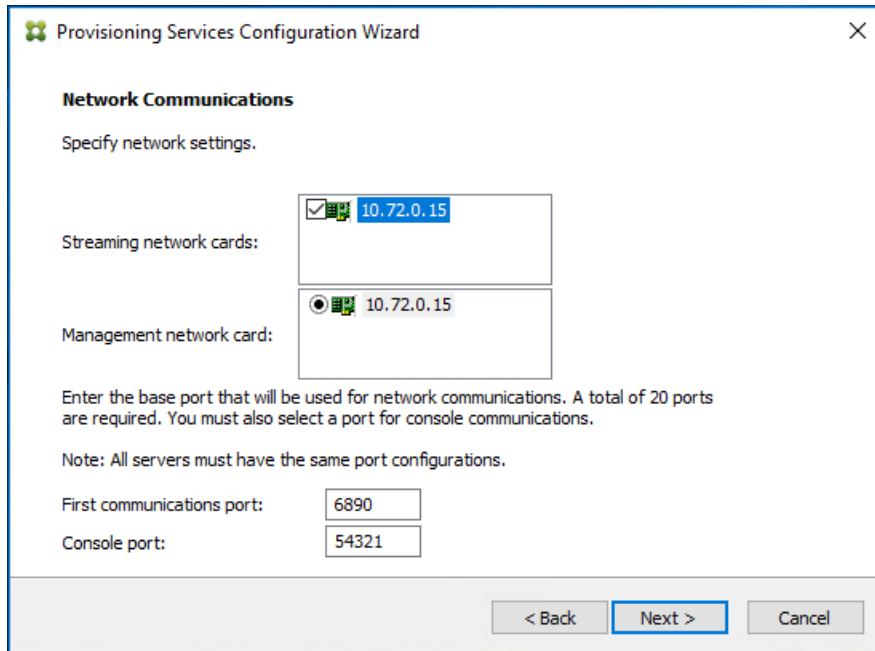

20. Select Use the Provisioning Services TFTP service checkbox.

21. Click Next.

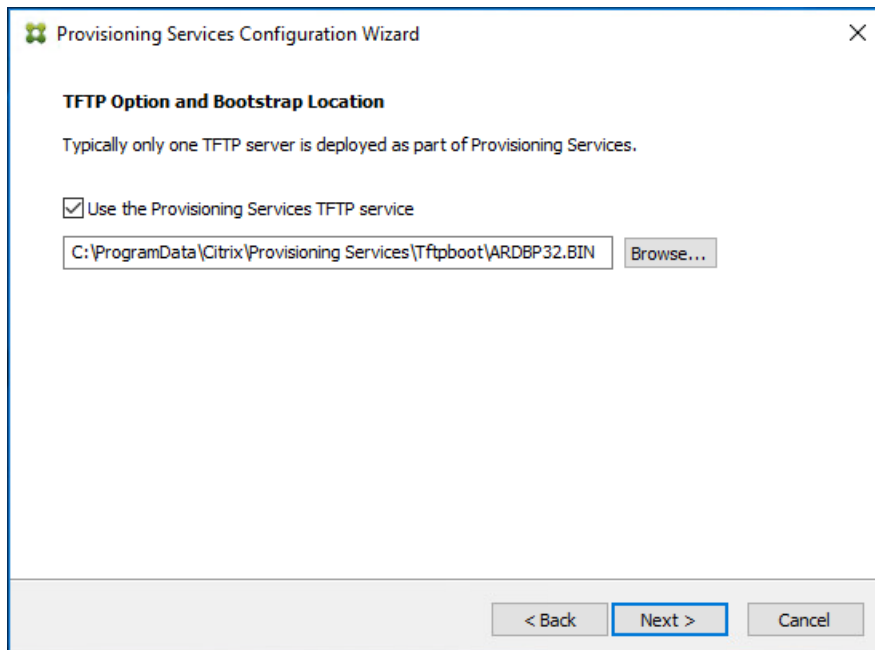

22. Make sure that the IP Addresses for all PVS servers are listed in the Stream Servers Boot List.

23. Click Next.

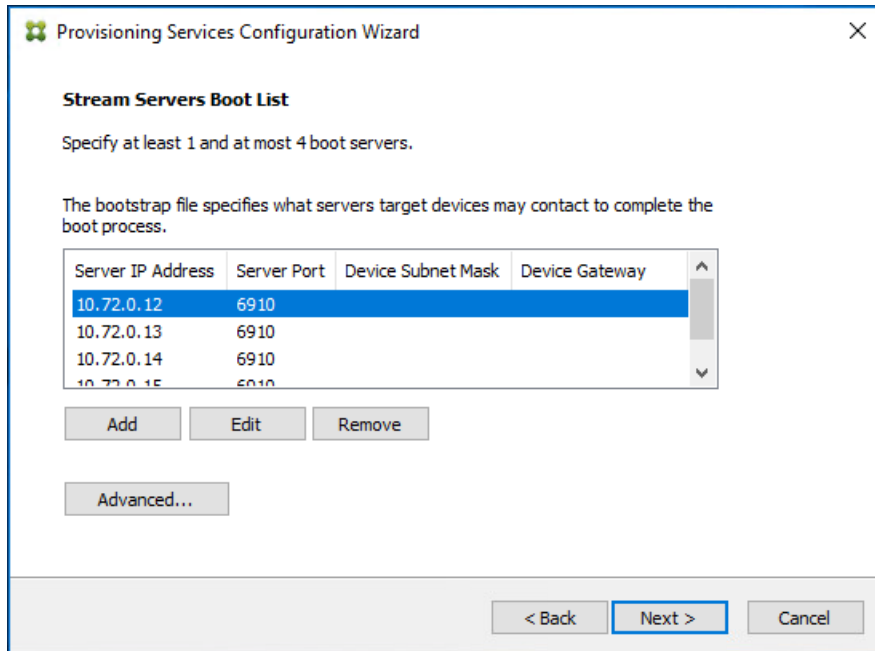

24. If Soap Server is used, provide details.

25. Click Next.

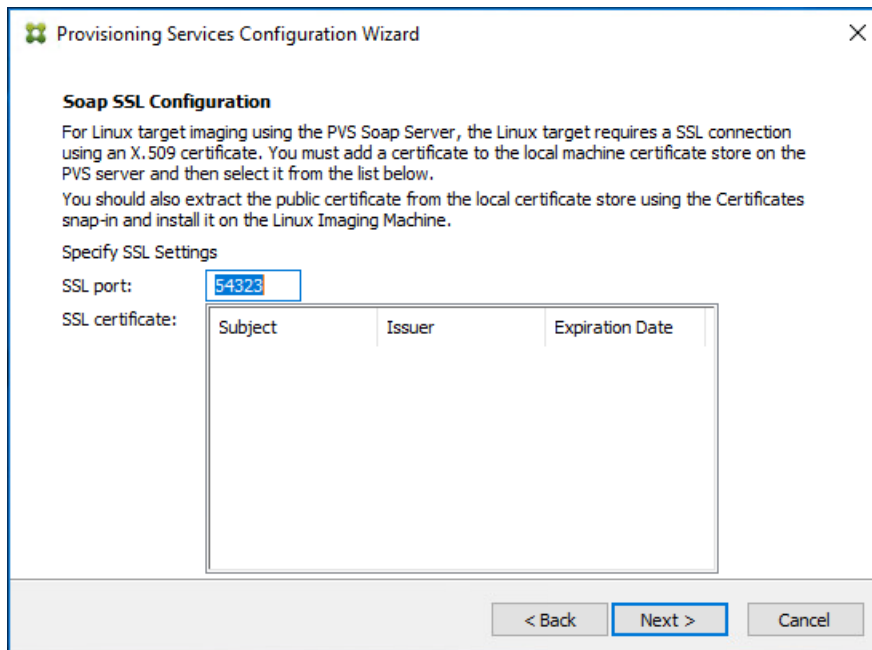

26. If desired fill in Problem Report Configuration.

27. Click Next.

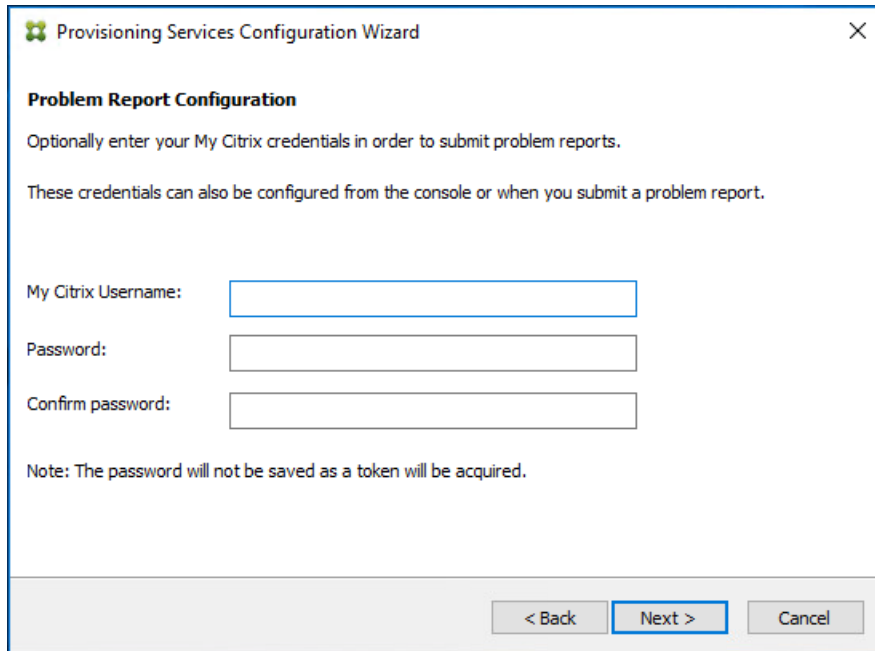

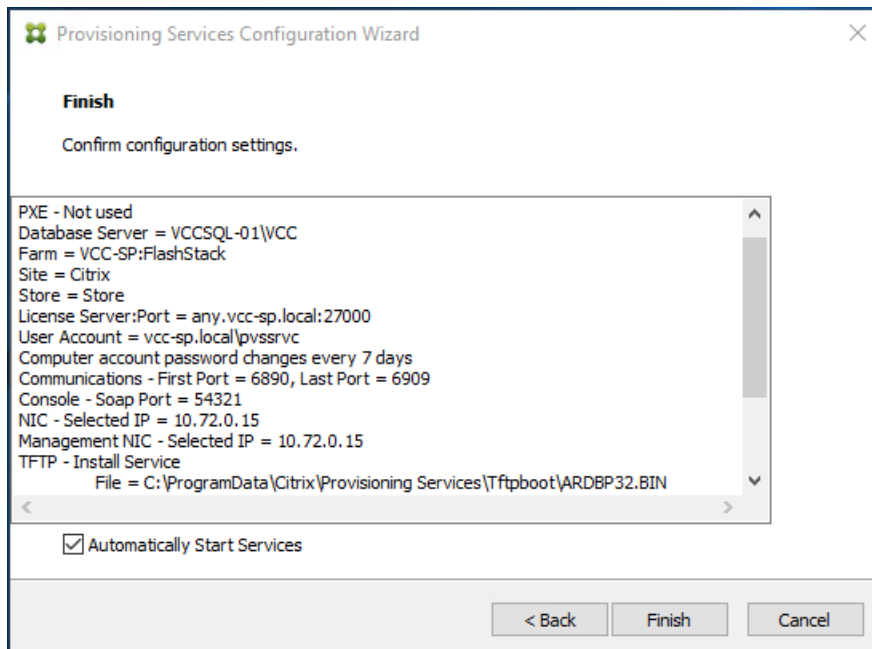

28. Click Finish to start the installation process.

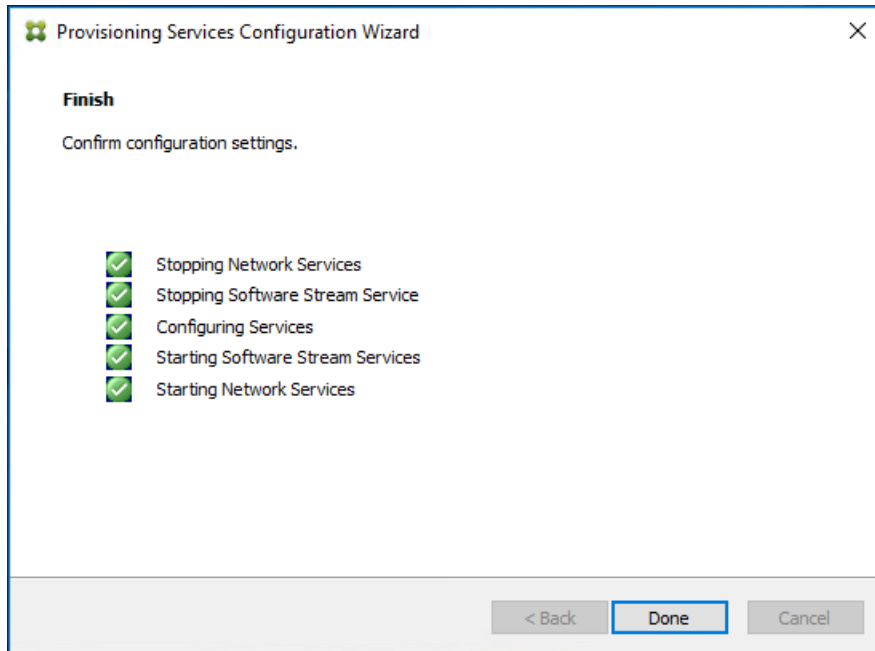

29. Click Done when the installation finishes.



 You can optionally install the Provisioning Services console on the second PVS server following the procedure in the section Installing Provisioning Services.

 After completing the steps to install the three additional PVS servers, launch the Provisioning Services Console to verify that the PVS Servers and Stores are configured and that DHCP boot options are defined.

30. Launch Provisioning Services Console and select Connect to Farm.

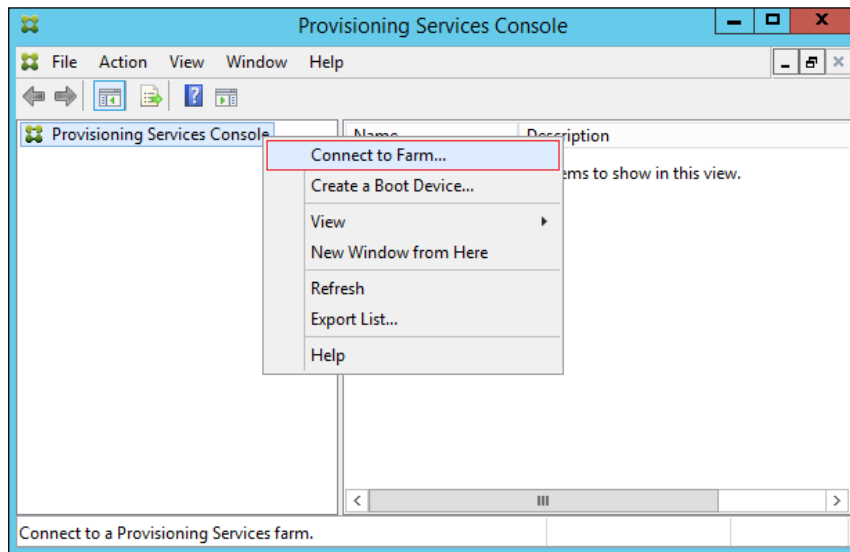

31. Enter localhost for the PVS1 server.

32. Click Connect.

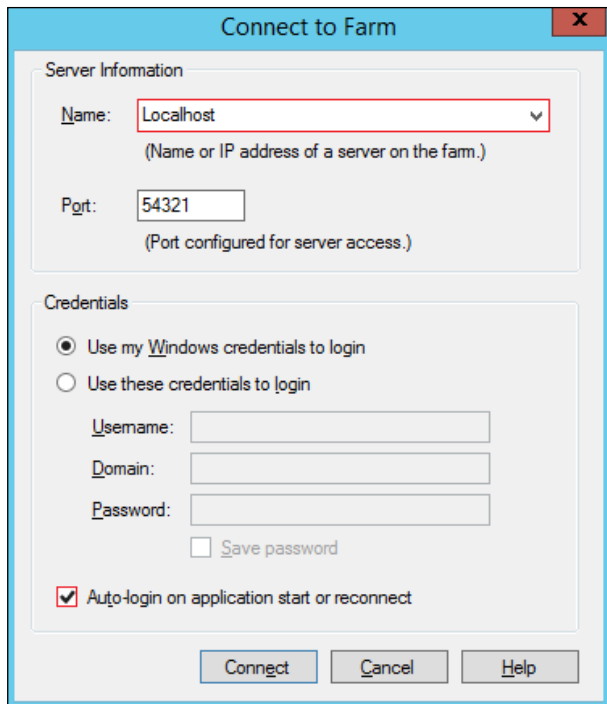

33. Select Store Properties from the drop-down list.

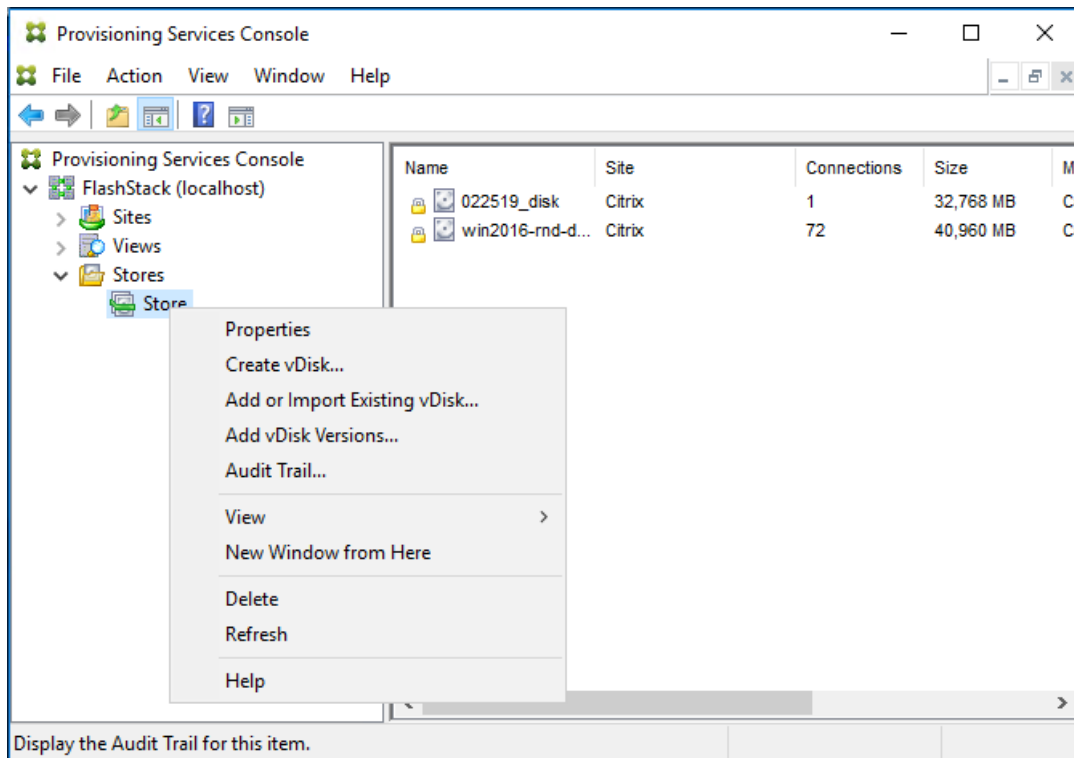

34. In the Store Properties dialog, add the Default store path to the list of Default write cache paths.

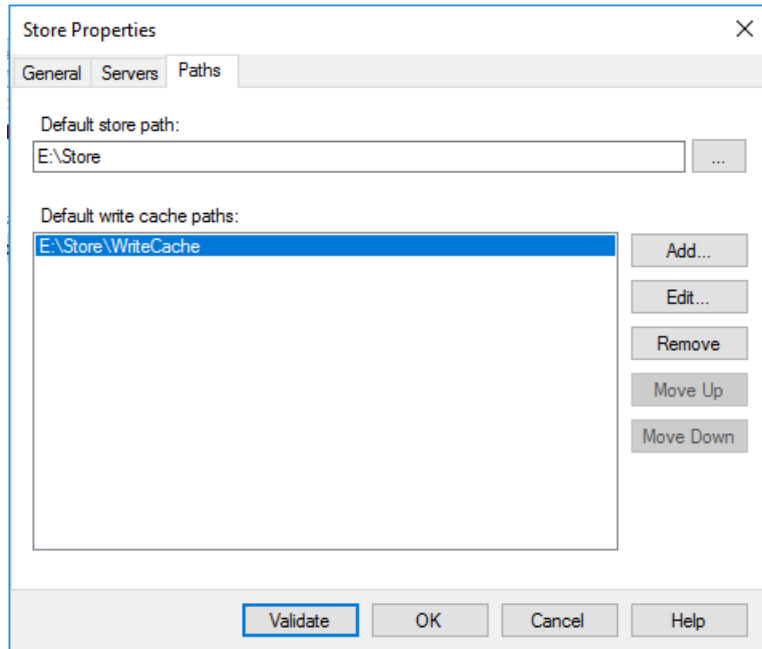

35. Click Validate. If the validation is successful, click Close and then click OK to continue.

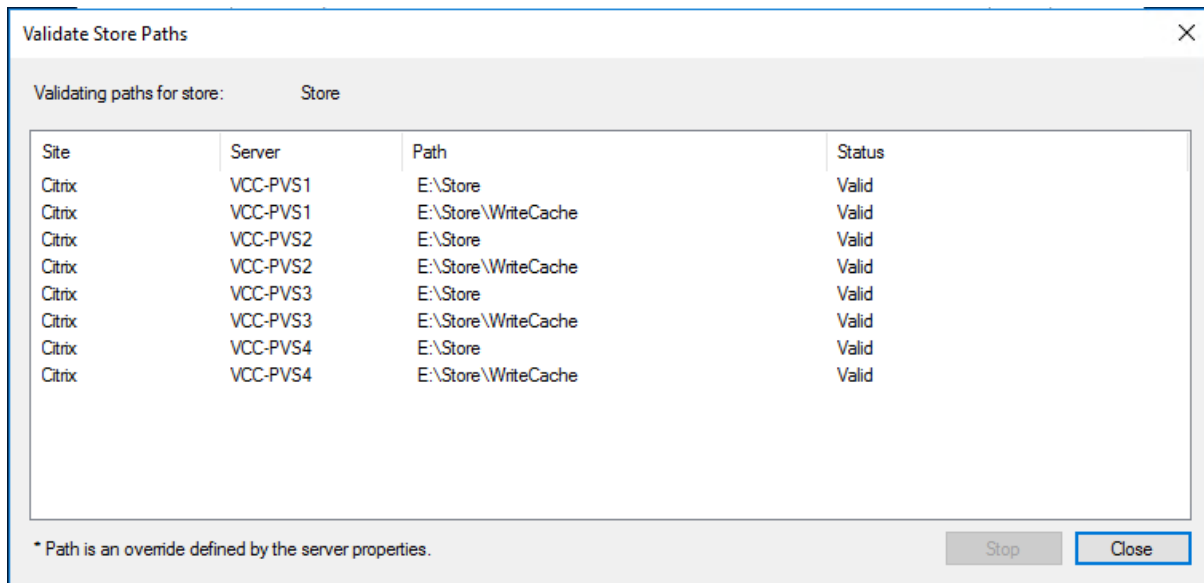

Install XenDesktop Virtual Desktop Agents

Virtual Delivery Agents (VDAs) are installed on the server and workstation operating systems and enable connections for desktops and apps. The following procedure was used to install VDAs for both HVD and HSD environments.

By default, when you install the Virtual Delivery Agent, Citrix User Profile Management is installed silently on master images. (Using profile management as a profile solution is optional but was used for this CVD and is described in a later section.)

To install XenDesktop Virtual Desktop Agents, follow these steps:

1. Launch the XenDesktop installer from the XenDesktop 7.15 ISO.
2. Click Start on the Welcome Screen.

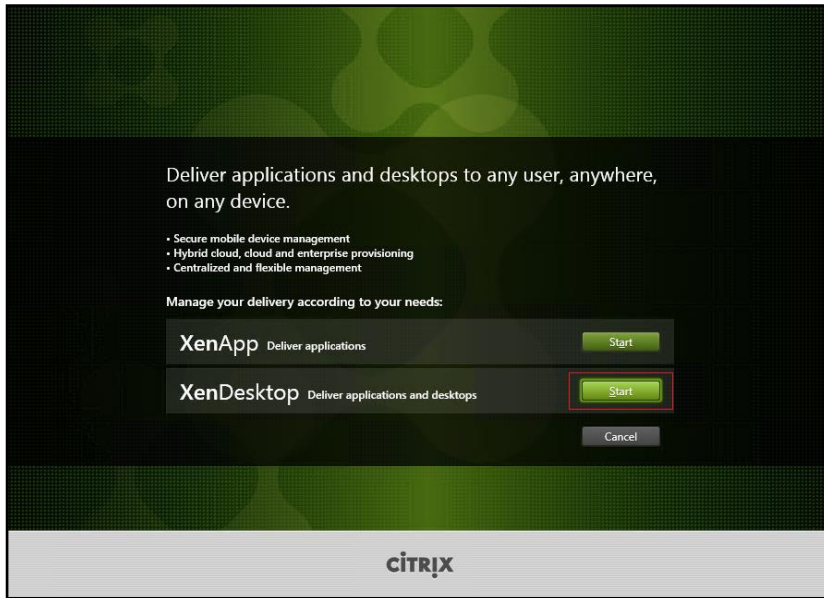

3. To install the VDA for the Hosted Virtual Desktops (VDI), select Virtual Delivery Agent for Windows Desktop OS.

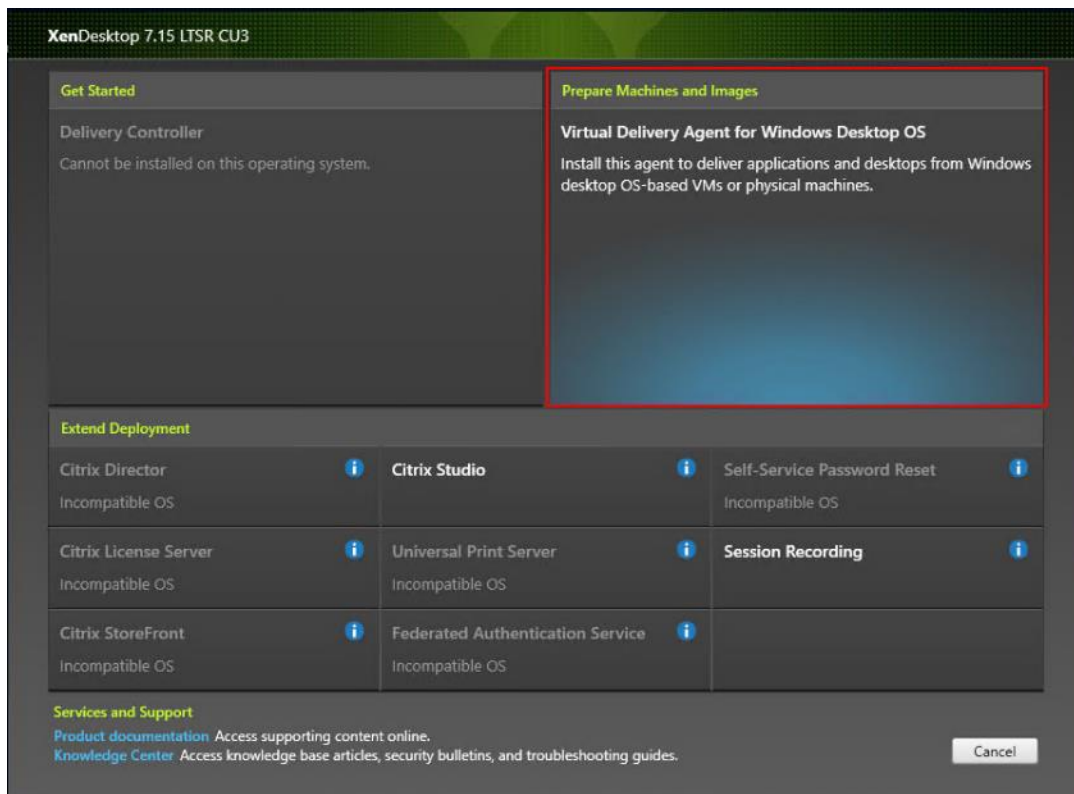

4. After the VDA is installed for Hosted Virtual Desktops, repeat the procedure to install the VDA for Hosted Shared Desktops (RDS). In this case, select Virtual Delivery Agent for Windows Server OS and follow the same basic steps.

Virtual Delivery Agent for Windows Server OS
Install this agent to deliver applications and desktops from server-based VMs or physical machines.

5. Select "Create a Master Image."
6. Click Next.

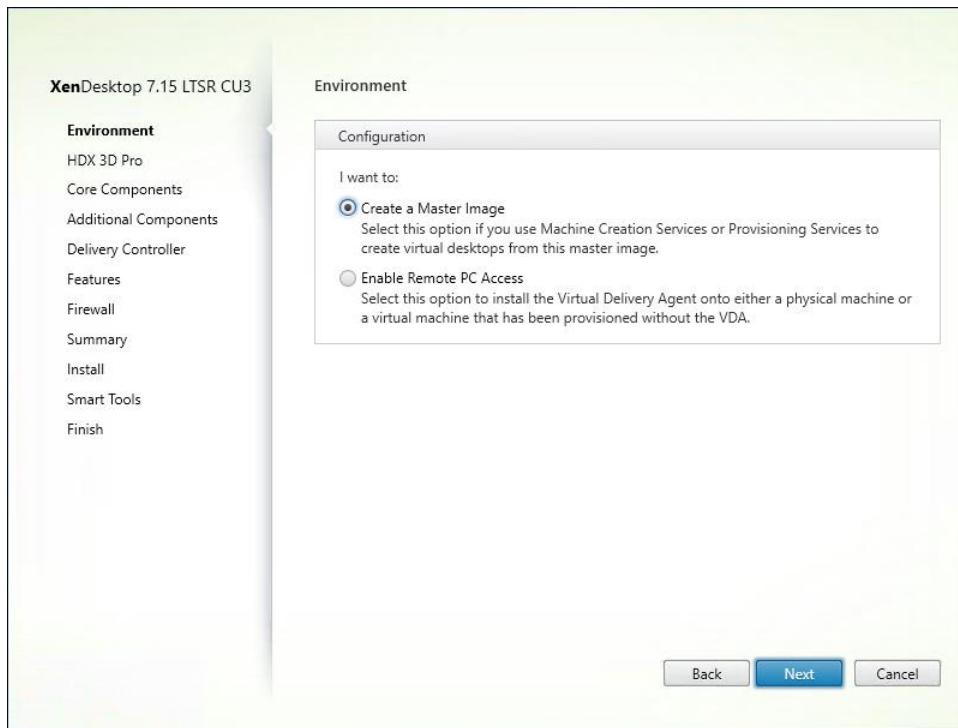

7. For the VDI vDisk, select "No, install the standard VDA."



Select Yes, install in HDX 3D Pro Mode if the virtual machine will be used with vGPU. For more information, go to section [Configure VM with vGPU](#).

8. Click Next.

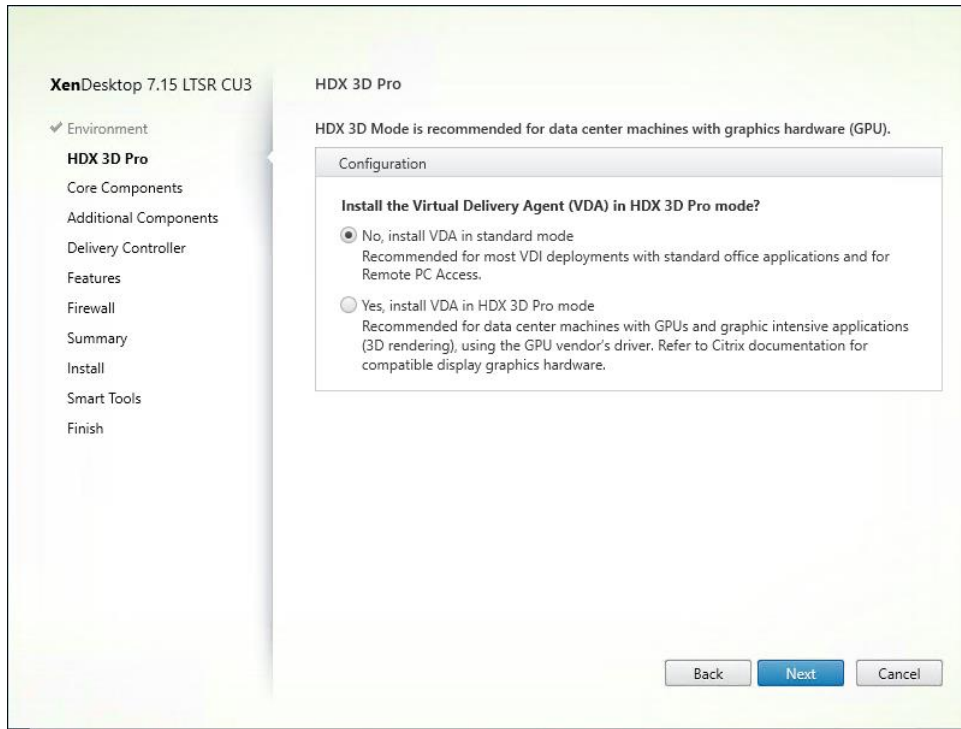

9. Optional: Do not select Citrix Receiver.

10. Click Next.

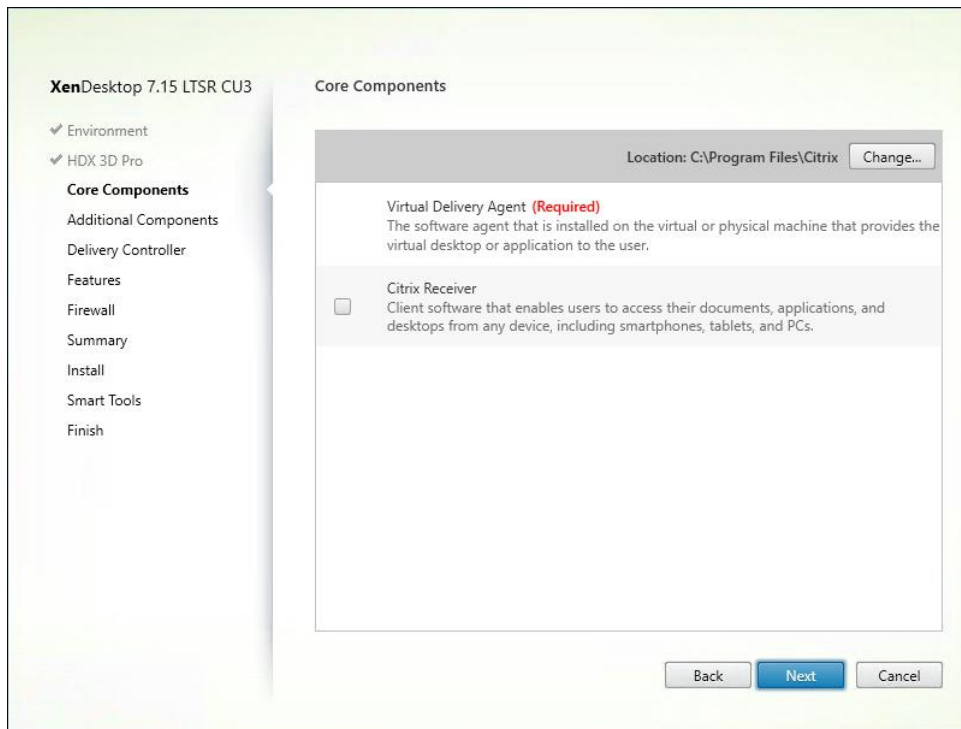

11. Select the additional components required for your image. In this design, only UPM and MCS components were installed on the image.



Deselect Citrix Machine Identity Service when building a master image for use with Citrix Provisioning Services.

12. Click Next

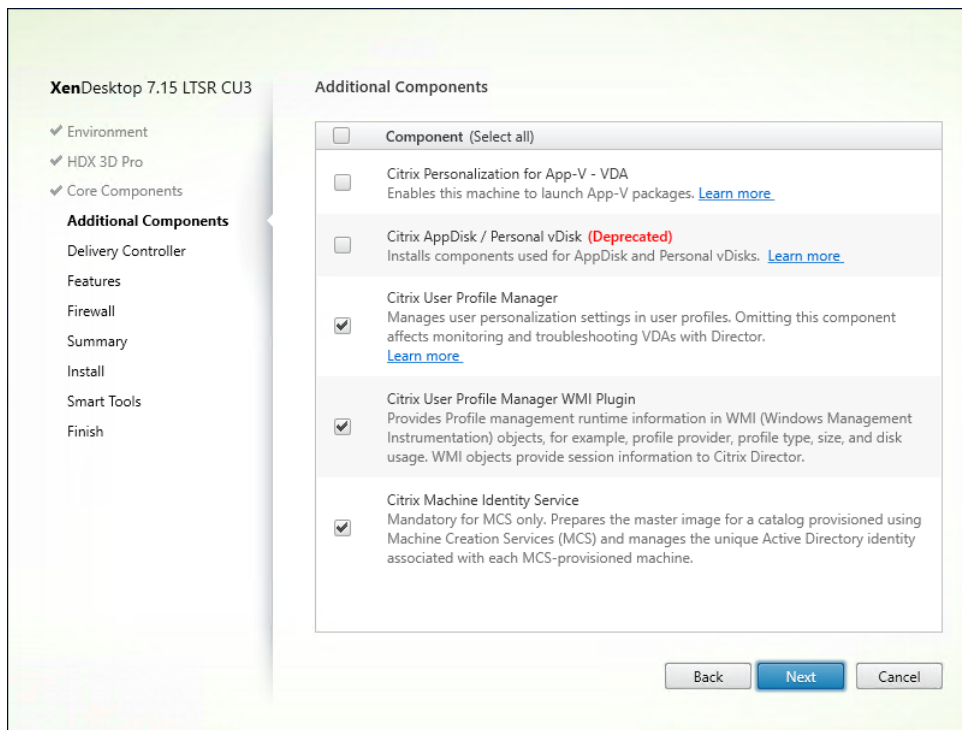

13. Do not configure Delivery Controllers at this time.

14. Click Next.

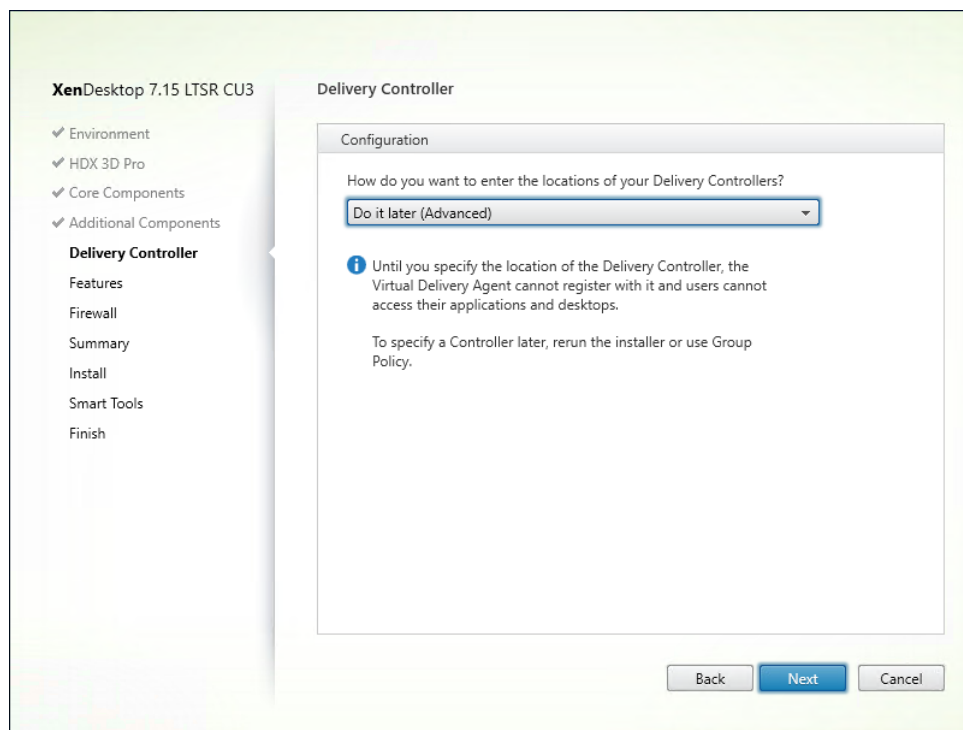

15. Accept the default features.

16. Click Next.

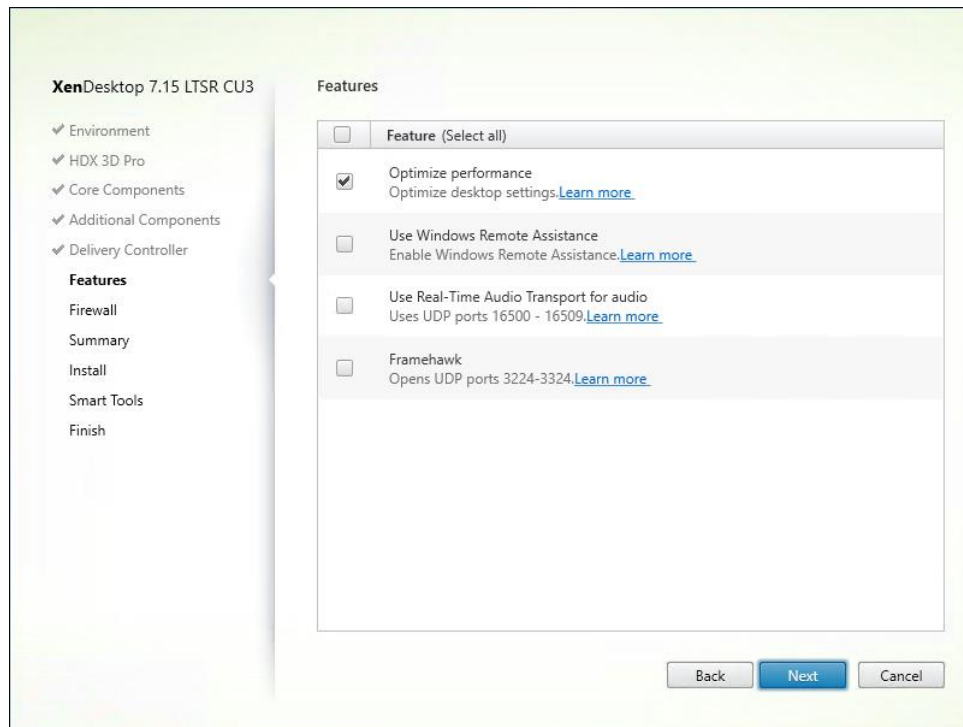

17. Allow the firewall rules to be configured Automatically.

18. Click Next.

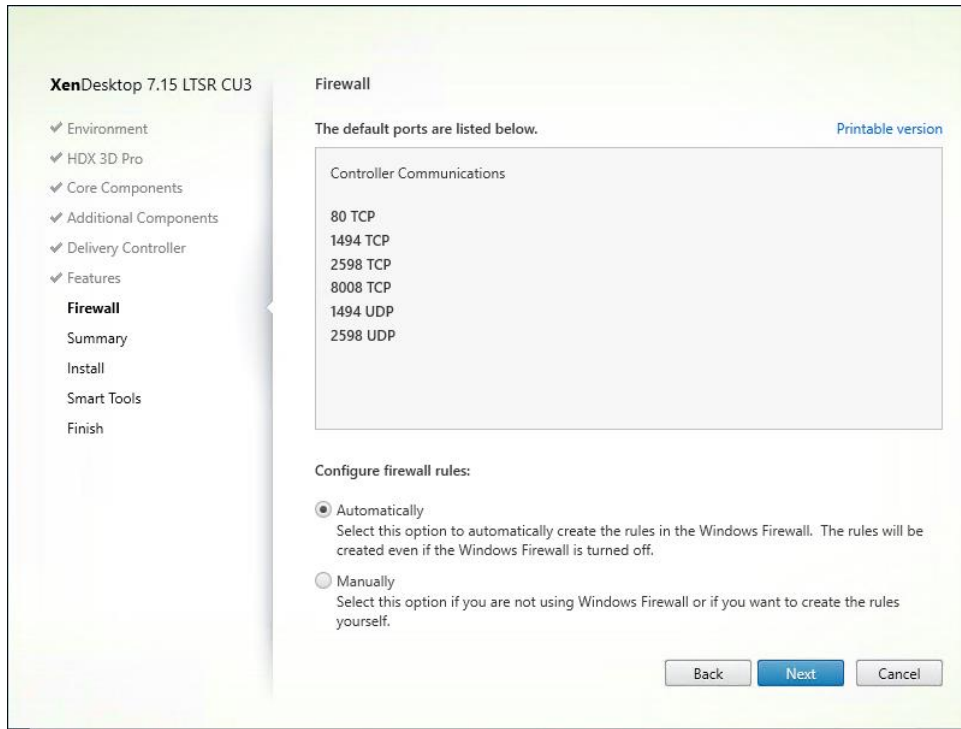

19. Verify the Summary and click Install.

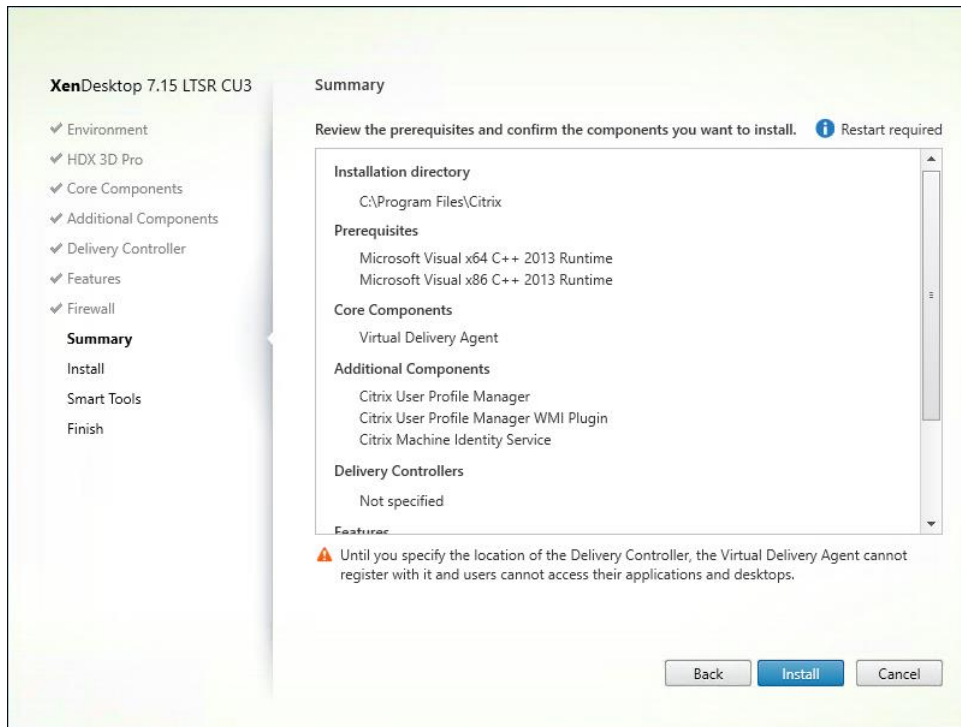

The machine will reboot automatically during installation.

20. (Optional) Configure Smart Tools/Call Home participation.

21. Click Next.

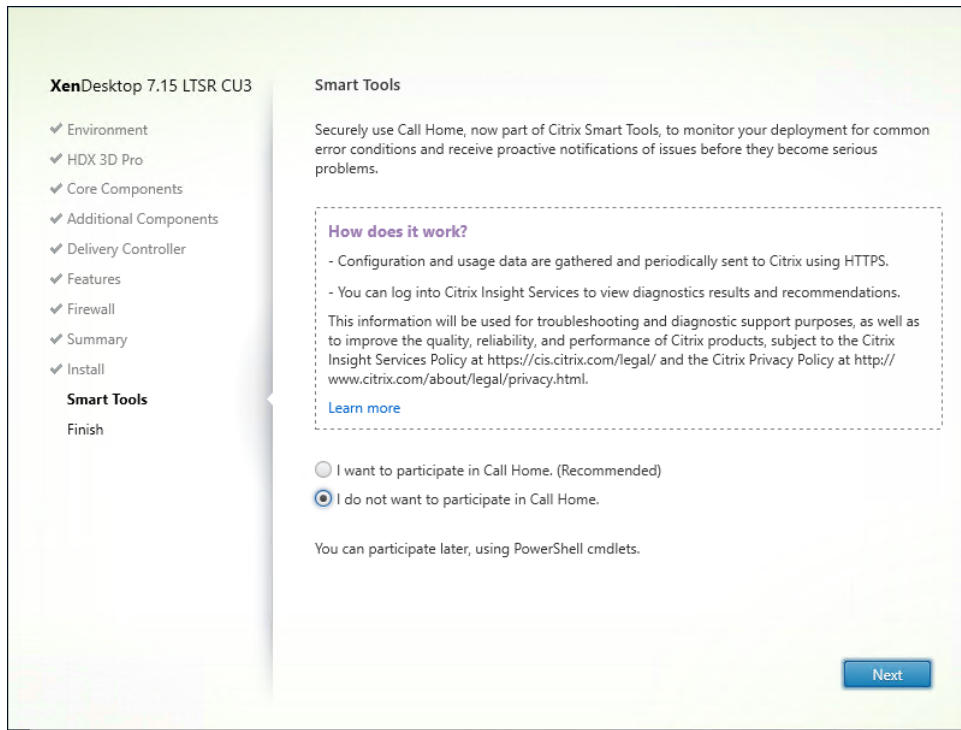

22. Check “Restart Machine.”

23. Click Finish and the machine will reboot automatically.

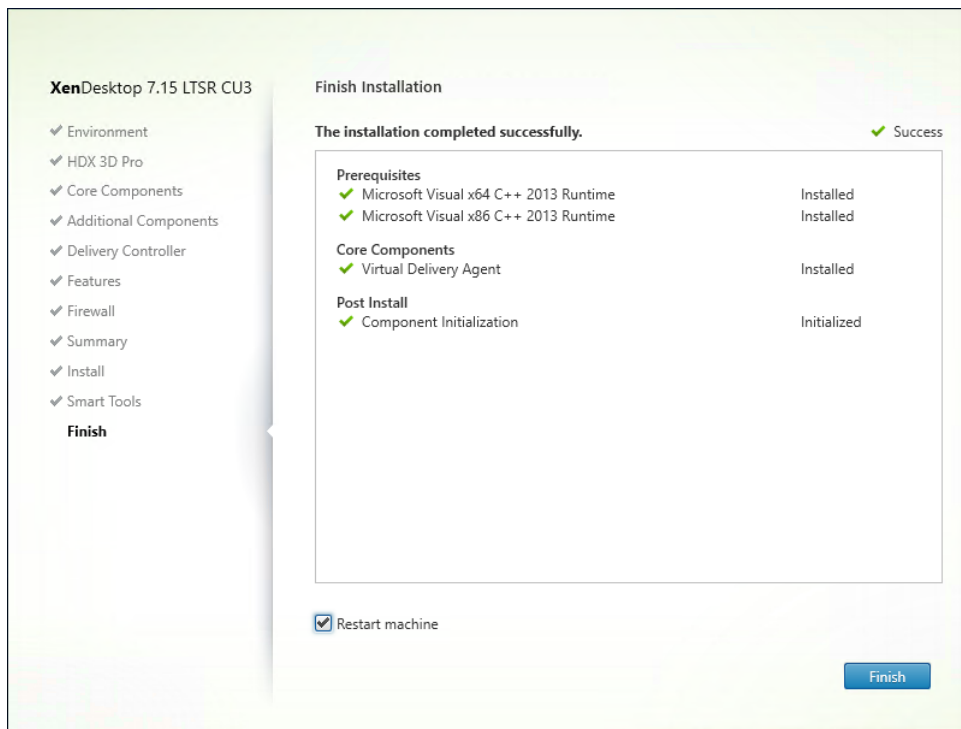

Install the Citrix Provisioning Server Target Device Software

The Master Target Device refers to the target device from which a hard disk image is built and stored on a vDisk. Provisioning Services then streams the contents of the vDisk created to other target devices. This procedure installs the PVS Target Device software that is used to build the RDS and VDI golden images.

To install the Citrix Provisioning Server Target Device software, follow these steps:



The instructions below explain the installation procedure to configure a vDisk for VDI desktops. When you have completed these installation steps, repeat the procedure to configure a vDisk for RDS.

1. Launch the PVS installer from the Provisioning Services 7.15 LTSR CU3 ISO.
2. Click the Target Device Installation button.

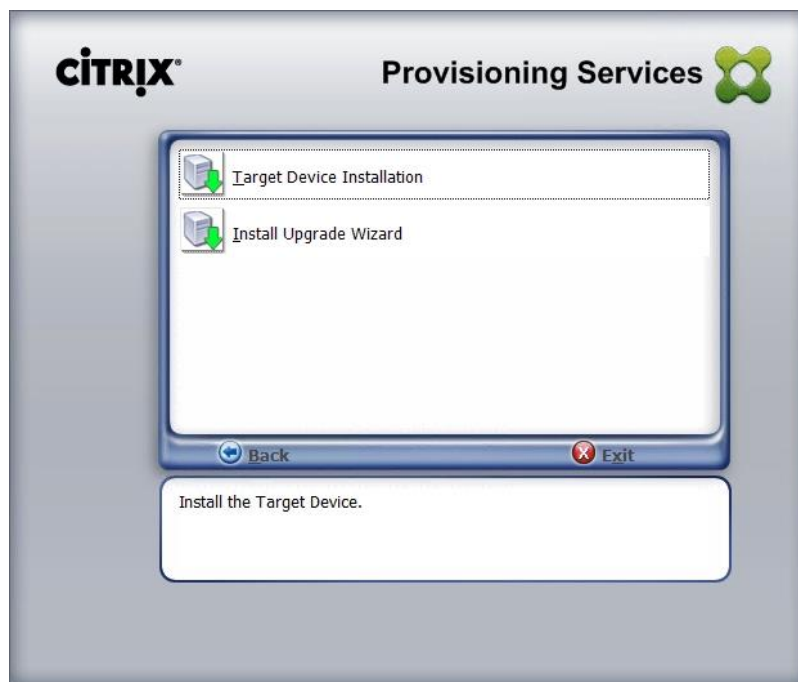

The installation wizard will check to resolve dependencies and then begin the PVS target device installation process.

3. Click Next.

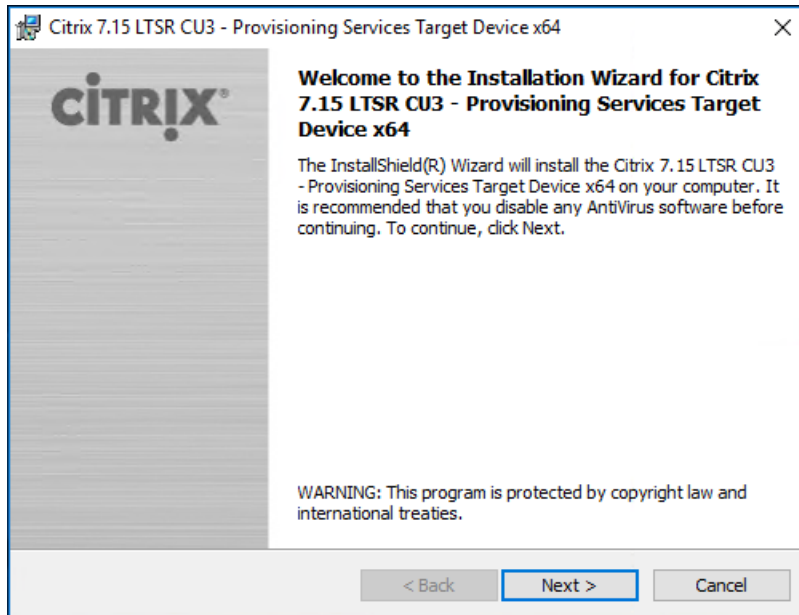

4. Indicate your acceptance of the license by selecting the "I have read, understand, and accept the terms of the license agreement" radio button.
5. Click Next.

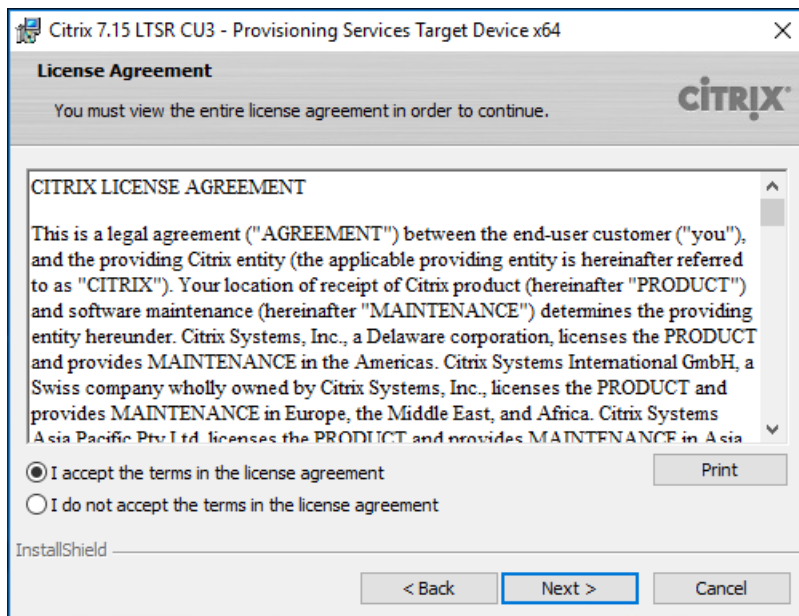

6. Optionally, provide the Customer information.
7. Click Next.

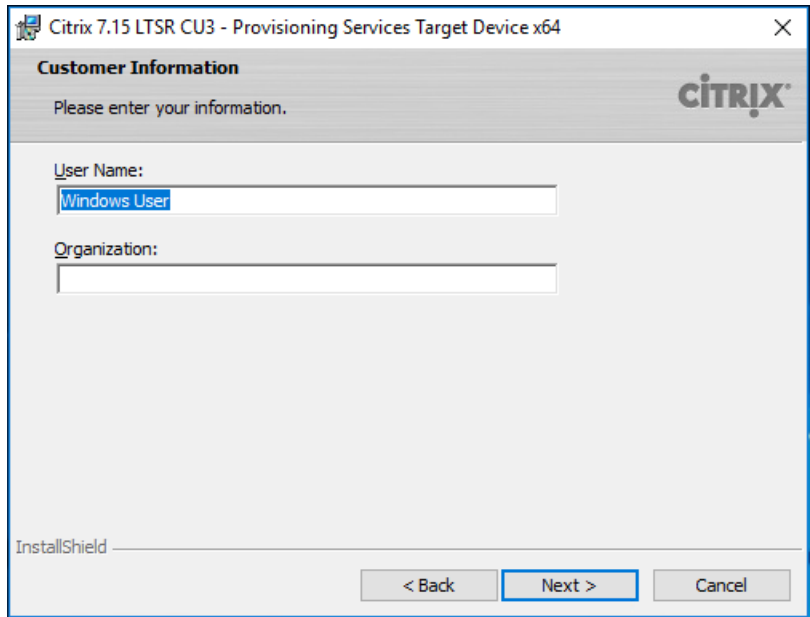

8. Accept the default installation path.

9. Click Next.

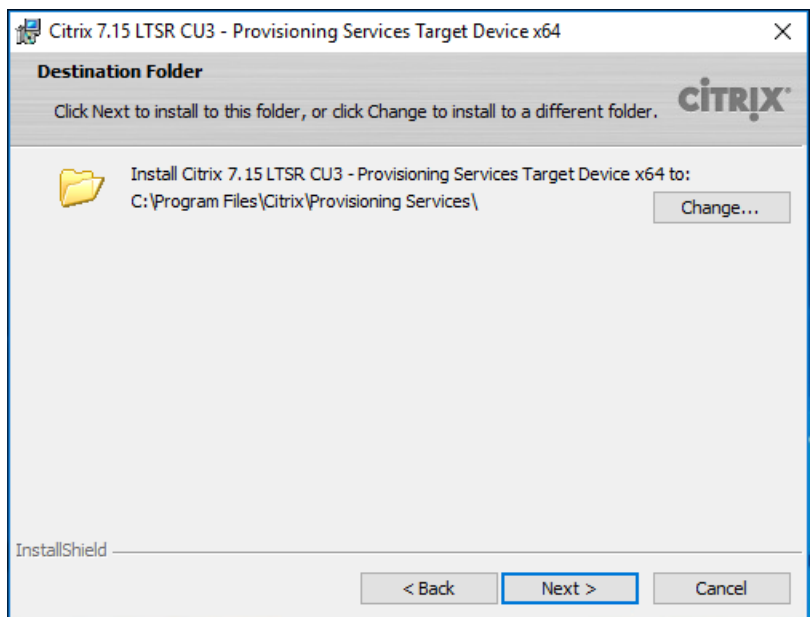

10. Click Install.

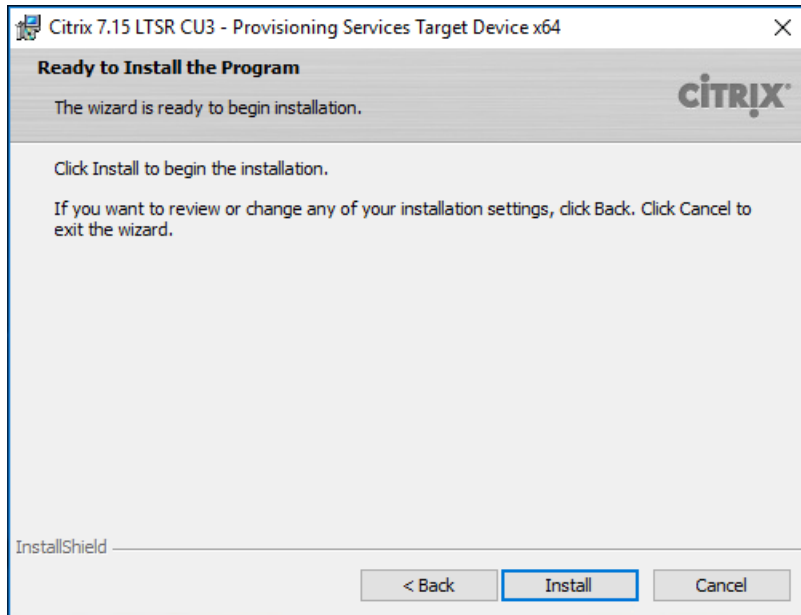

11. Deselect the checkbox to launch the Imaging Wizard and click Finish.

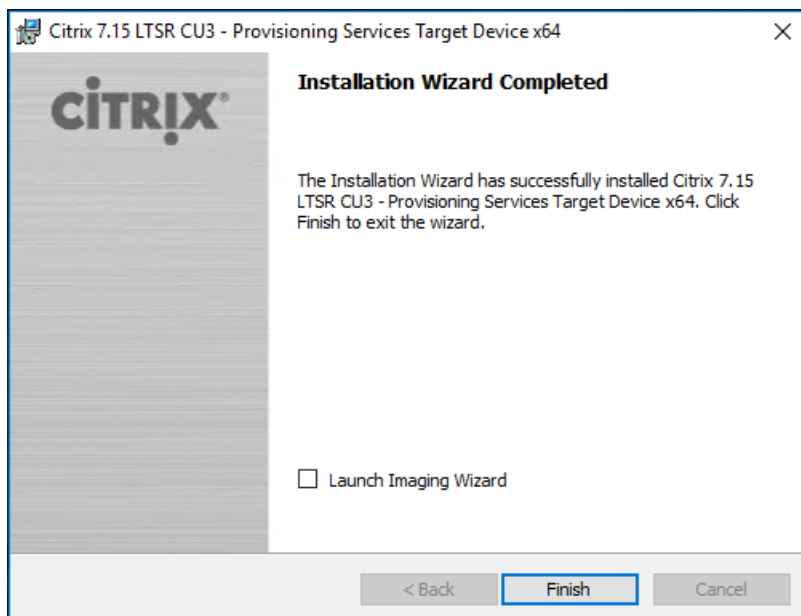

12. Click Yes to reboot the machine.

Create Citrix Provisioning Server vDisks

The PVS Imaging Wizard automatically creates a base vDisk image from the master target device. To create the Citrix Provisioning Server vDisks, follow these steps:



The instructions below describe the process of creating a vDisk for VDI desktops. When you have completed these steps, repeat the procedure to build a vDisk for RDS.

1. The PVS Imaging Wizard's Welcome page appears.

2. Click Next.

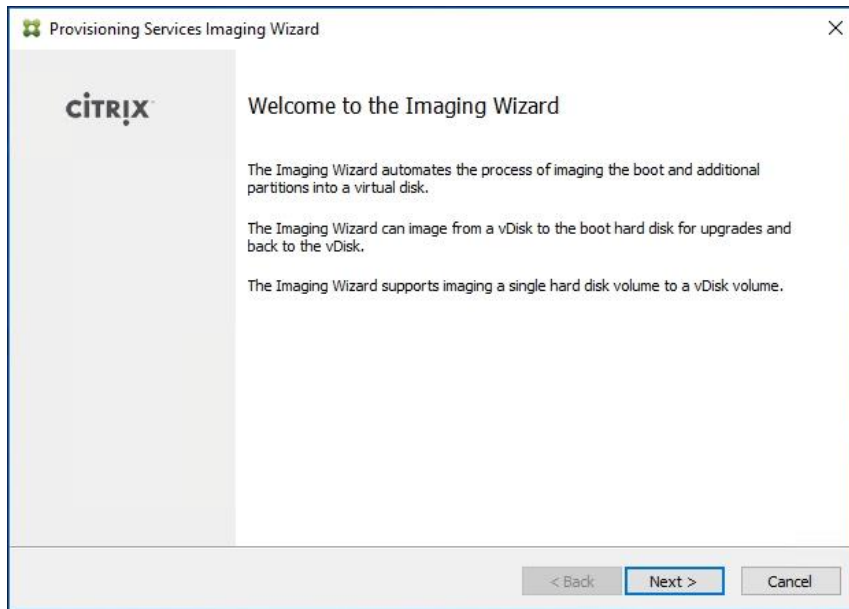

3. The Connect to Farm page appears. Enter the name or IP address of a Provisioning Server within the farm to connect to and the port to use to make that connection.
4. Use the Windows credentials (default) or enter different credentials.
5. Click Next.

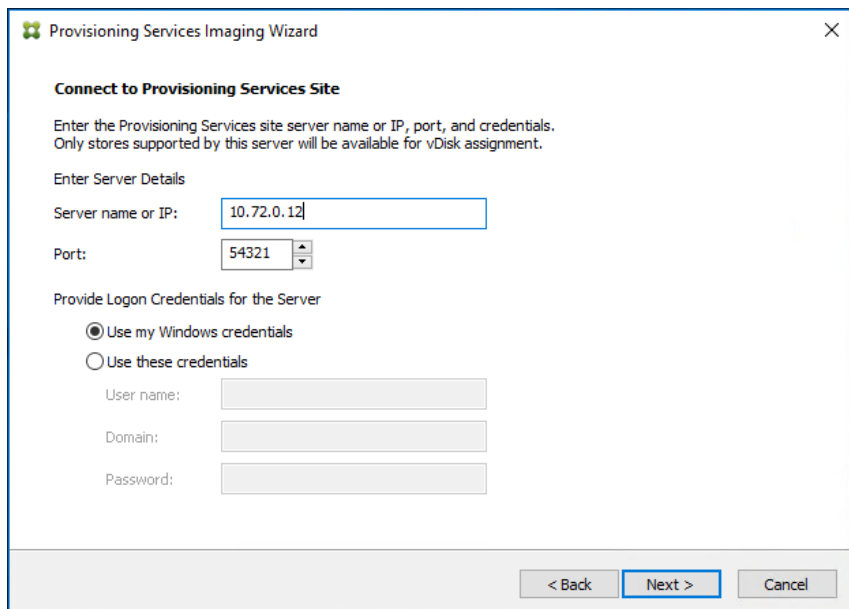

6. Select Create new vDisk.
7. Click Next.

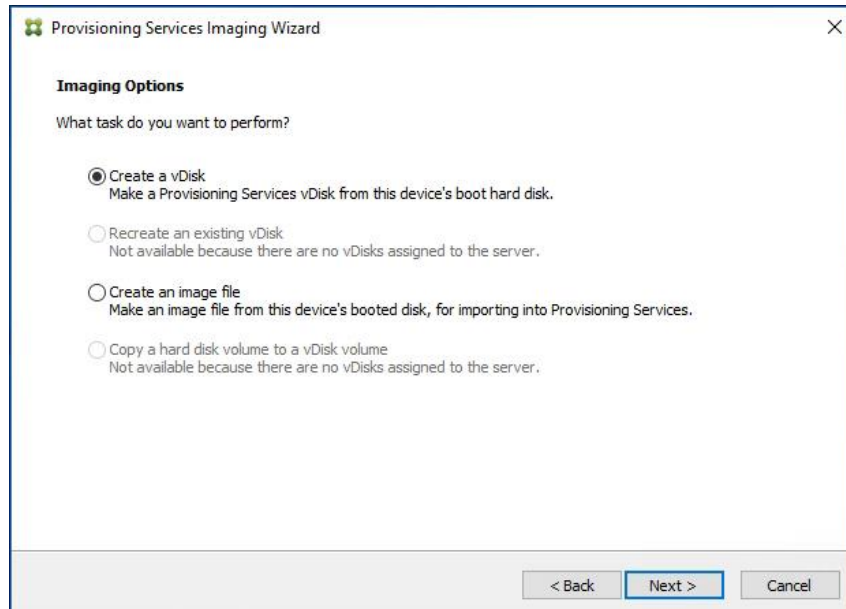

8. The Add Target Device page appears.
9. Select the Target Device Name, the MAC address associated with one of the NICs that was selected when the target device software was installed on the master target device, and the Collection to which you are adding the device.
10. Click Next.

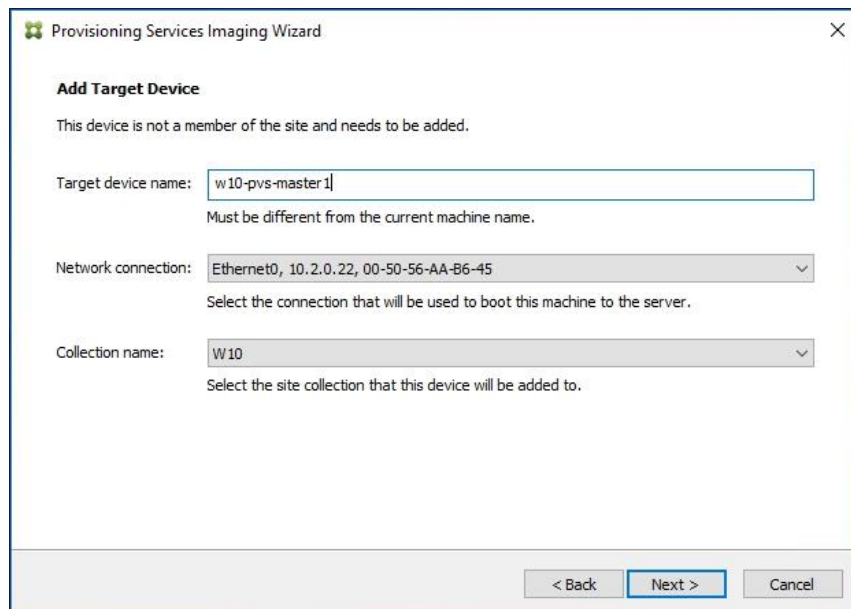

11. The New vDisk dialog displays. Enter the name of the vDisk.
12. Select the Store where the vDisk will reside. Select the vDisk type, either Fixed or Dynamic, from the drop-down list.



This CVD used Dynamic rather than Fixed vDisks.

13. Click Next.

The screenshot shows the 'Provisioning Services Imaging Wizard' window. The title bar reads 'Provisioning Services Imaging Wizard'. The main heading is 'New vDisk'. Below the heading, it says 'The new vDisk will be created in the store you select.' There are three input fields: 'vDisk name:' with the text 'win10-pvs', 'Store name:' with a dropdown menu showing 'Store - 474.1 GB Free' and 'Supported by Server: CTPVPS-1', and 'vDisk type:' with a dropdown menu showing 'Dynamic (recommended)'. At the bottom, there are three radio buttons: 'VHDX' (selected), 'VHD', and 'None'. At the bottom right, there are three buttons: '< Back', 'Next >' (highlighted with a blue border), and 'Cancel'.

14. On the Microsoft Volume Licensing page, select the volume license option to use for target devices. For this CVD, volume licensing is not used, so the None button is selected.

15. Click Next.

The screenshot shows the 'Provisioning Services Imaging Wizard' window. The title bar reads 'Provisioning Services Imaging Wizard'. The main heading is 'Microsoft Volume Licensing'. Below the heading, it says 'Choose whether the vDisk is to be configured for Microsoft KMS or MAK volume license management.' There are three radio buttons: 'None' (selected), 'Key Management Service (KMS)', and 'Multiple Activation Key (MAK)'. At the bottom right, there are three buttons: '< Back', 'Next >' (highlighted with a blue border), and 'Cancel'.

16. Select Image entire boot disk on the Configure Image Volumes page.

17. Click Next.

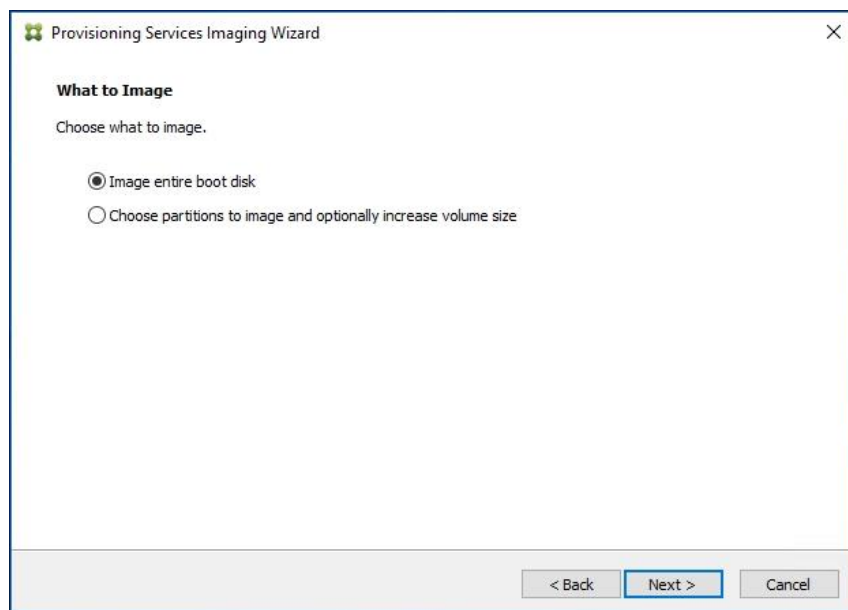

18. Select Optimize for hard disk again for Provisioning Services before imaging on the Optimize Hard Disk for Provisioning Services.

19. Click Next.

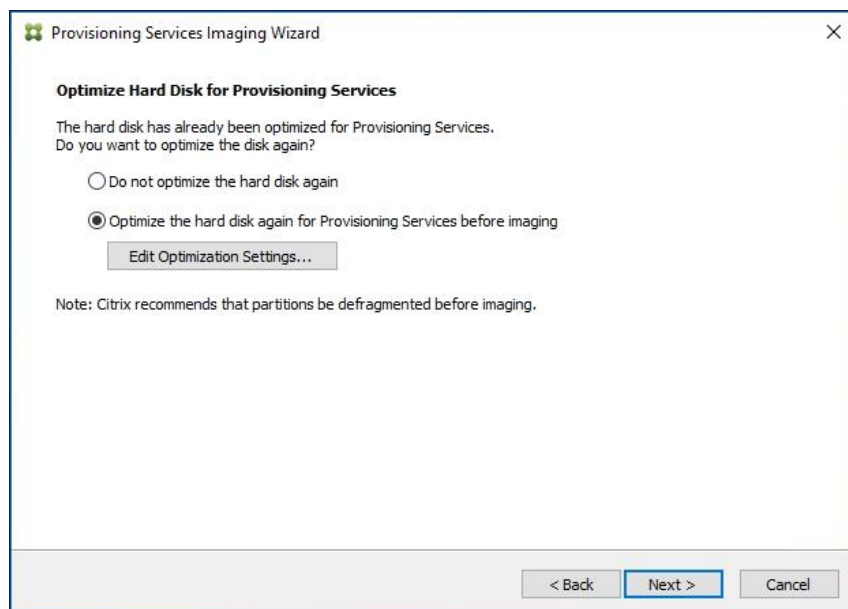

20. Select Create on the Summary page.

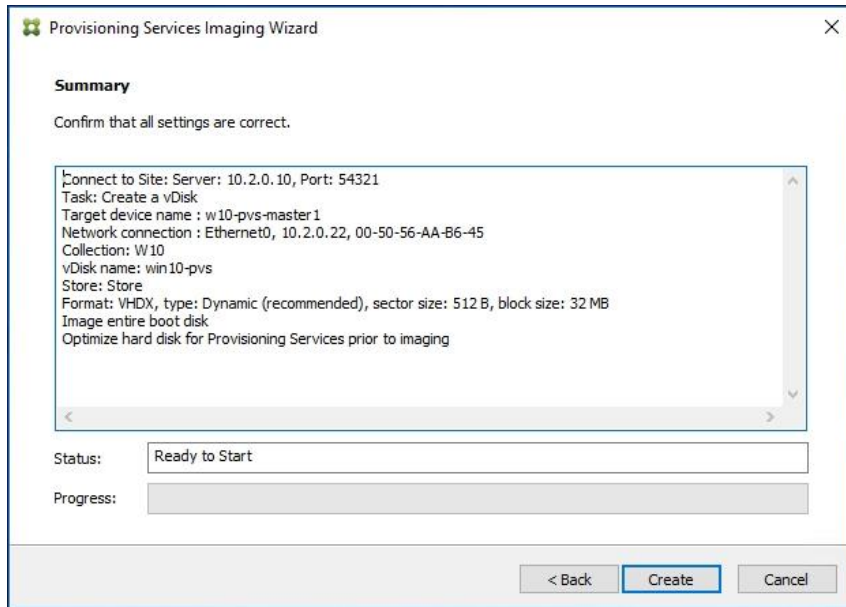

21. Review the configuration and click Continue.

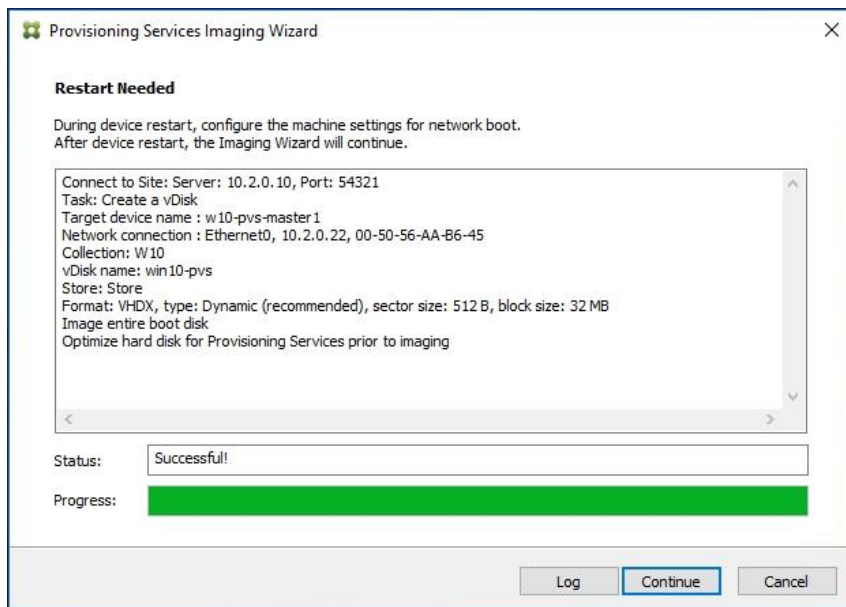

22. When prompted, click No to shut down the machine.

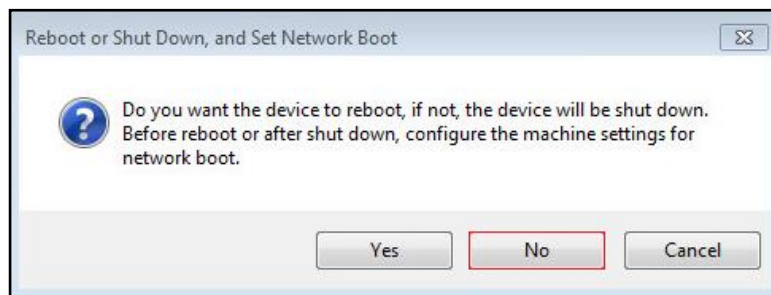

23. Edit the VM settings and select Force BIOS Setup under Boot Options.

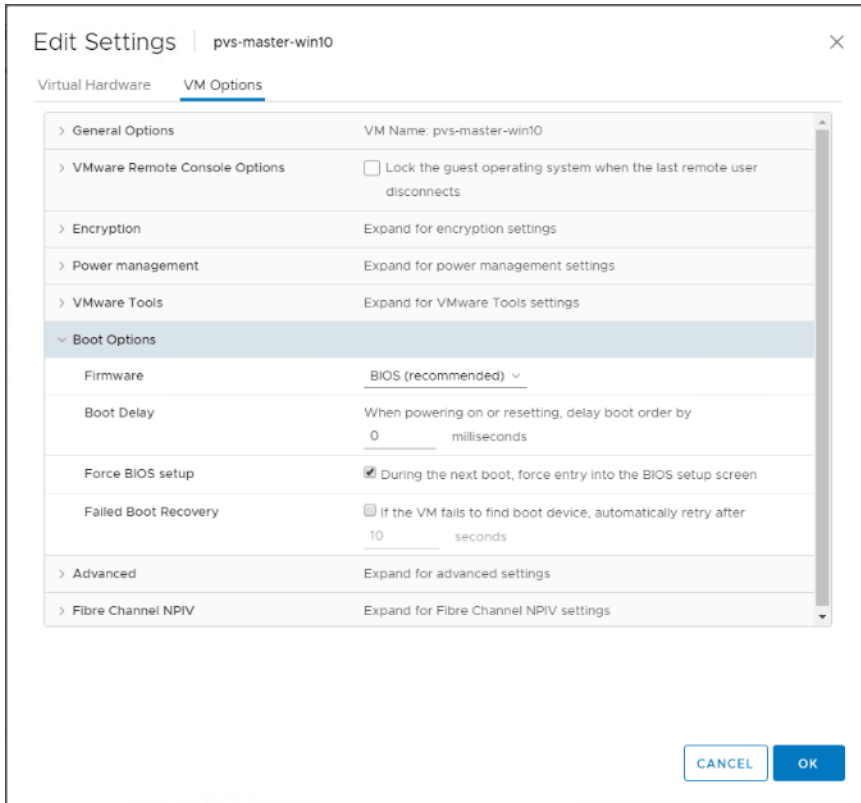

24. Configure the BIOS/VM settings for PXE/network boot, putting Network boot from VMware VMXNET3 at the top of the boot device list.

25. Select Exit Saving Changes.

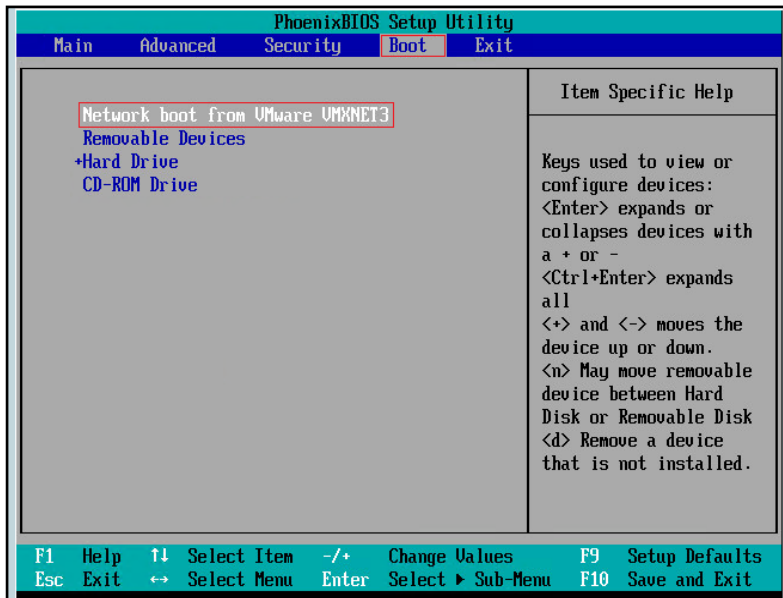



After restarting the virtual machine, log into the HVD or HSD master target. The PVS imaging process begins, copying the contents of the C: drive to the PVS vDisk located on the server.

26. If prompted to Restart, select Restart Later.

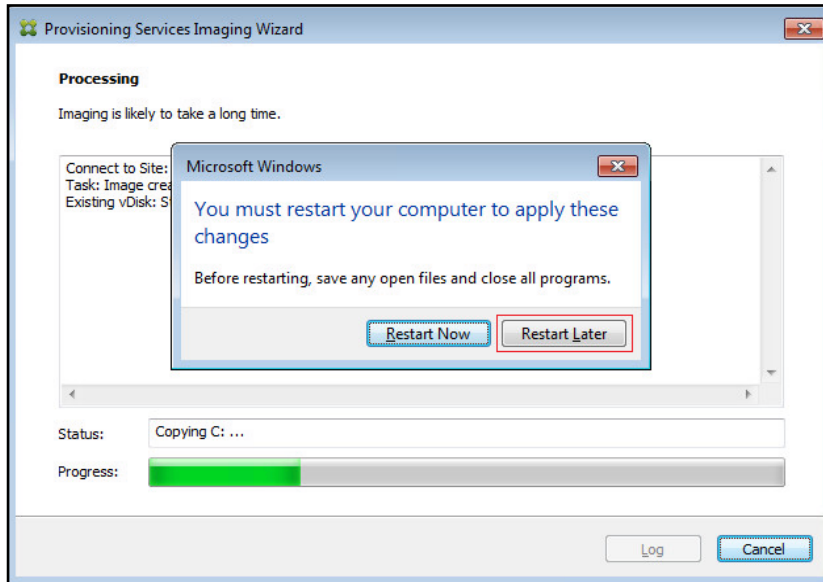

27. A message is displayed when the conversion is complete, click Done.

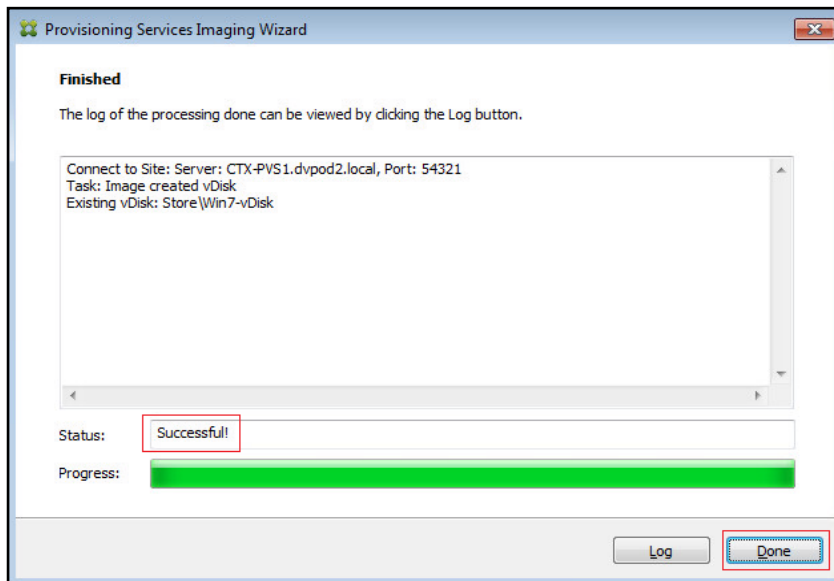

28. Shutdown the virtual machine used as the VDI or RDS master target.

29. Connect to the PVS server and validate that the vDisk image is available in the Store.

30. Right-click the newly created vDisk and select Properties.

31. On the vDisk Properties dialog, change Access mode to “Standard Image (multi-device, read-only access).”

32. Set the Cache Type to “Cache in device RAM with overflow on hard disk.”

33. Set Maximum RAM size (MBs): 128 for HVD and set 2048 MB for HSD vDisk.

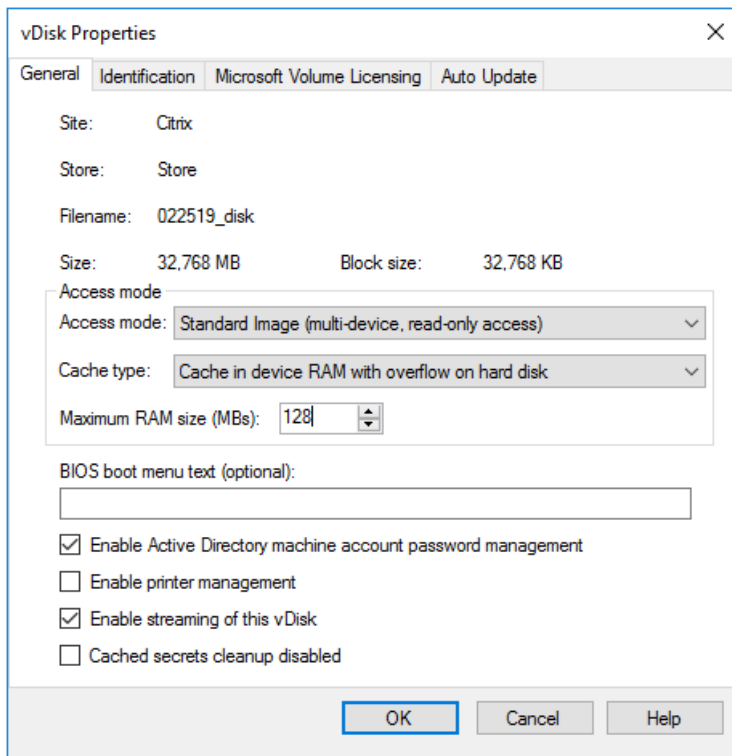

34. Click OK



Repeat this procedure to create vDisks for both the Hosted VDI Desktops (using the Windows 10 OS image) and the Hosted Shared Desktops (using the Windows Server 2016 image).

Provision Virtual Desktop Machines

Citrix Provisioning Services Streamed VMSetup Wizard

To create PVS streamed virtual desktop machines, follow these steps:

1. Create a Master Target Virtual Machines:

HVD Master Target VM Parameters	HSD Master Target VM Parameters
---------------------------------	---------------------------------

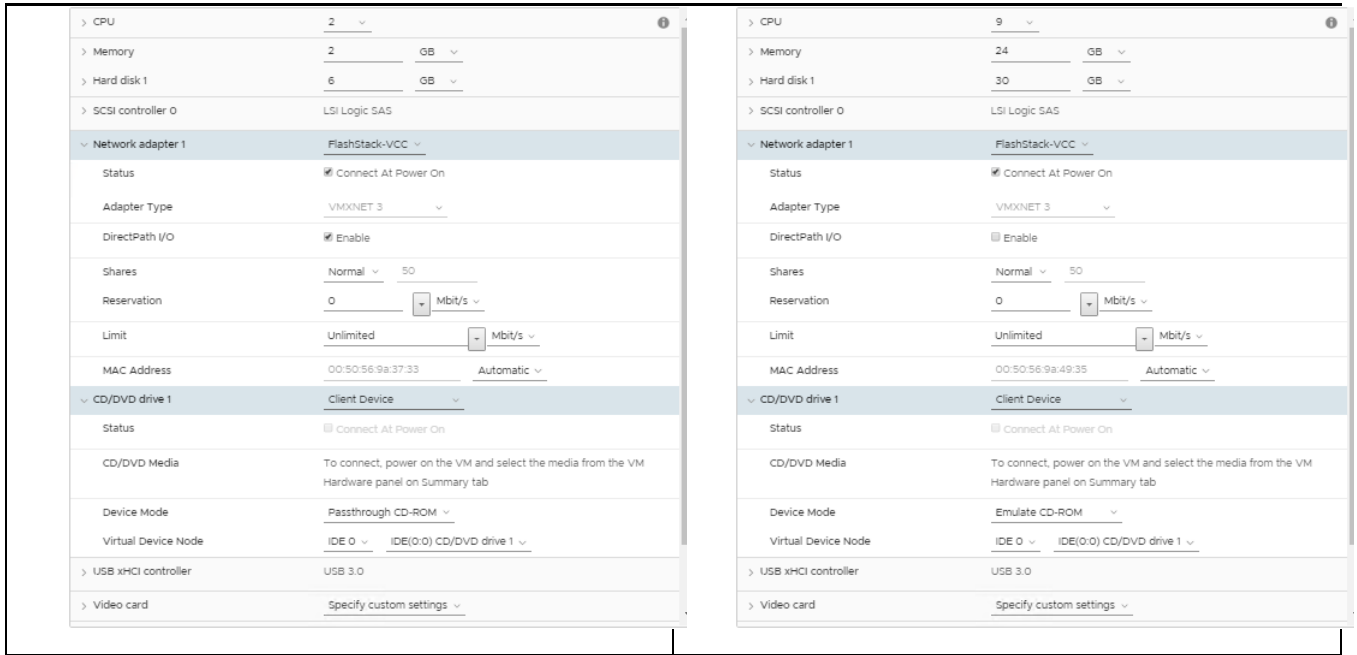

Master Target Virtual Machine Hard disk will be used as write cache disk. It has to be formatted prior to template conversion.

- a. Select the Master Target VM from the vSphere Client.
- b. Click the virtual machine go to Actions -> Clone and select Clone to Template...

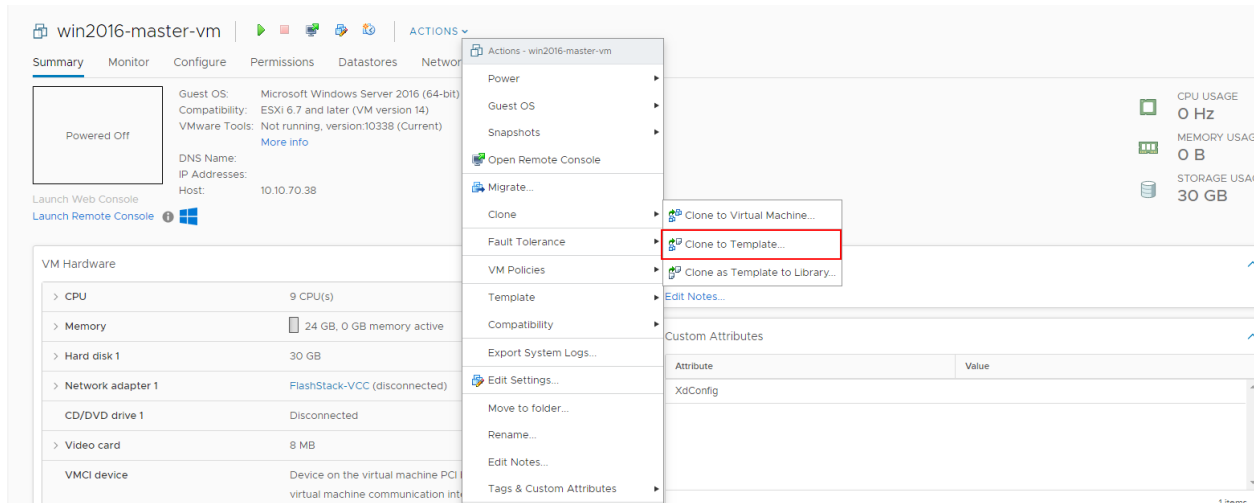

- c. Name the cloned VM Desktop-Template.

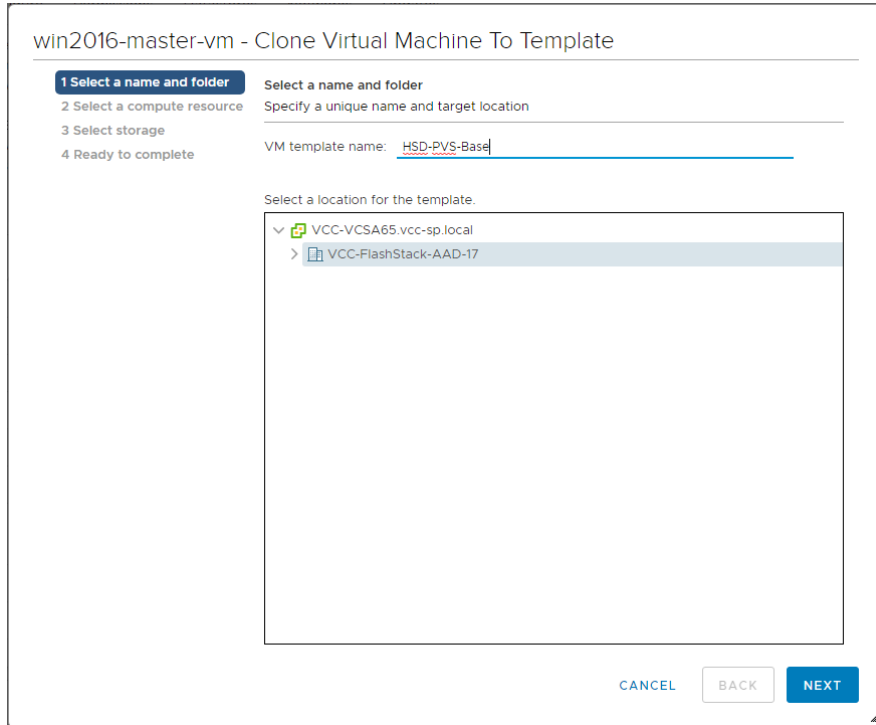

d. Select the cluster and datastore where the first phase of provisioning will occur.

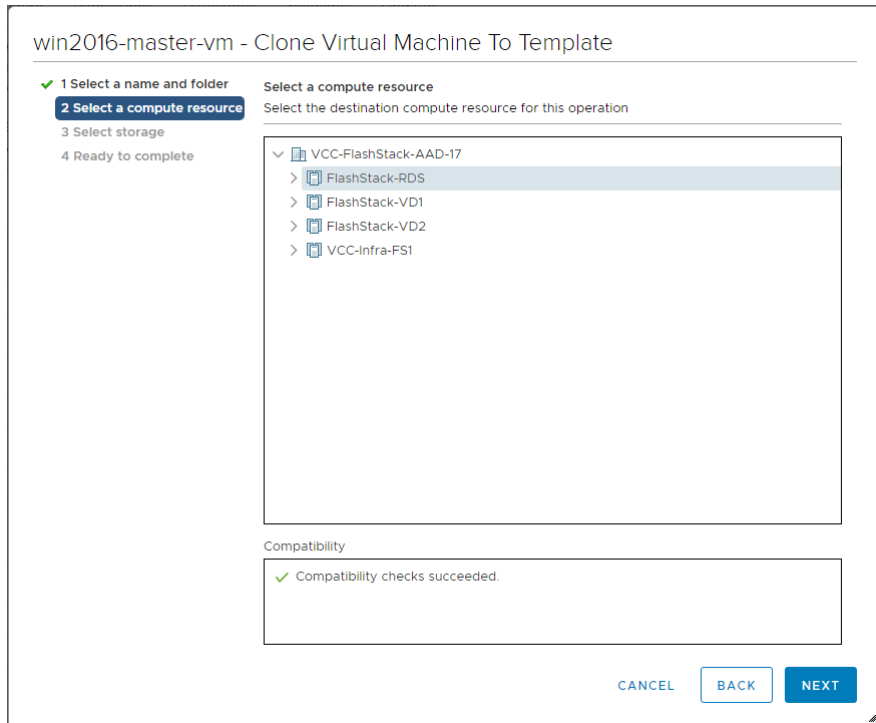

win2016-master-vm - Clone Virtual Machine To Template

✓ 1 Select a name and folder
✓ 2 Select a compute resource
3 Select storage
4 Ready to complete

Select storage
Select the storage for the configuration and disk files

Select virtual disk format: **Same format as source** Configure per disk

VM Storage Policy: **Keep existing VM storage policies**

Name	Capacity	Provisioned	Free
datastore1 (2)	12.5 GB	892 MB	11.63 GB
datastore1 (29)	12.5 GB	892 MB	11.63 GB
datastore1 (6)	12.5 GB	892 MB	11.63 GB
datastore1 (7)	12.5 GB	892 MB	11.63 GB
datastore1 (8)	12.5 GB	892 MB	11.63 GB
datastore1 (9)	12.5 GB	892 MB	11.63 GB
ESXTOP	1,023.75 GB	484.21 GB	539.54 GB
RDSH	10 TB	2.32 TB	7.71 TB

Compatibility
✓ Compatibility checks succeeded.

CANCEL BACK **NEXT**

e. Click Finish.

win2016-master-vm - Clone Virtual Machine To Template

✓ 1 Select a name and folder
✓ 2 Select a compute resource
✓ 3 Select storage
4 Ready to complete

Ready to complete
Click Finish to start creation.

Provisioning type	Clone virtual machine to template
Source virtual machine	win2016-master-vm
Template name	HSD-PVS-Base
Folder	VCC-FlashStack-AAD-17
Cluster	FlashStack-RDS
Datastore	RDSH
Disk storage	Same format as source

CANCEL BACK **FINISH**

f. Repeat the steps for the HVD template

2. Start the XenDesktop Setup Wizard from the Provisioning Services Console:

a. Right-click the Site.

b. Choose Streamed VM Setup Wizard... from the context menu.

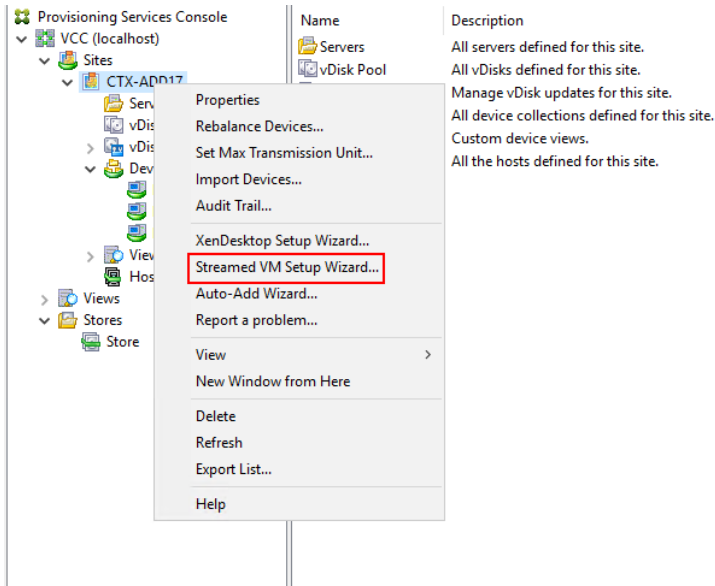

c. Click Next.

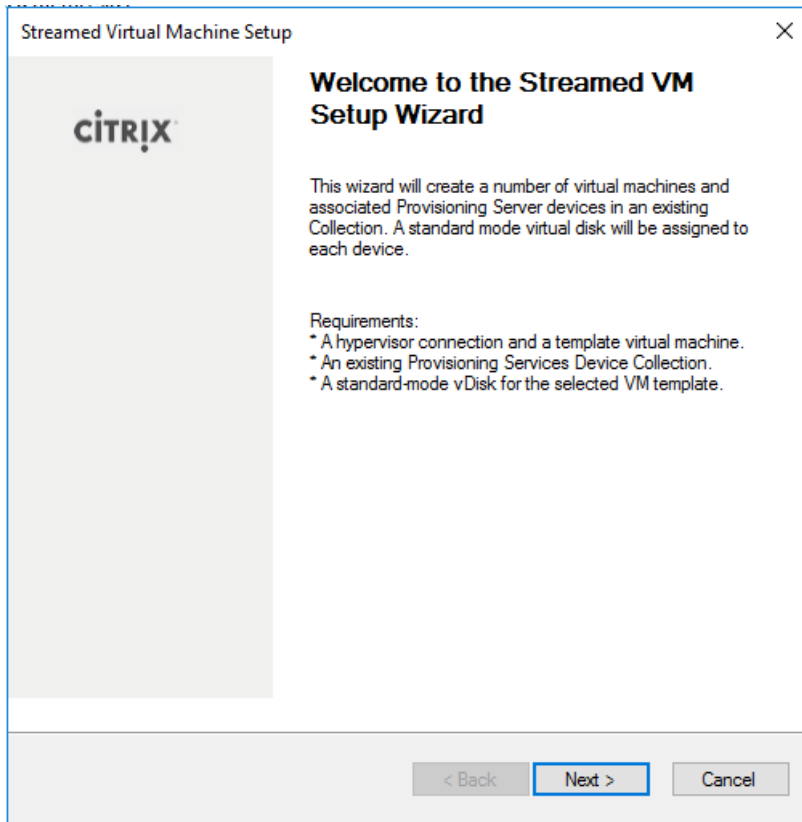

d. Enter the Hypervisor connection details that will be used for the wizard operations.

e. Click Next.

Streamed Virtual Machine Setup ×

Hypervisor connection
Select the type and location of a hypervisor and supply credentials. 

Citrix XenServer
 Microsoft SCVMM/Hyper-V
 VMWare vSphere/ESX

Hypervisor:

Username:

Password:

(Optional) If there are multiple datacenters in the hypervisor pool, enter the name of the desired datacenter here:

Next >

- f. Select the Hypervisor Cluster on which the virtual machines will be created.
- g. Click Next.

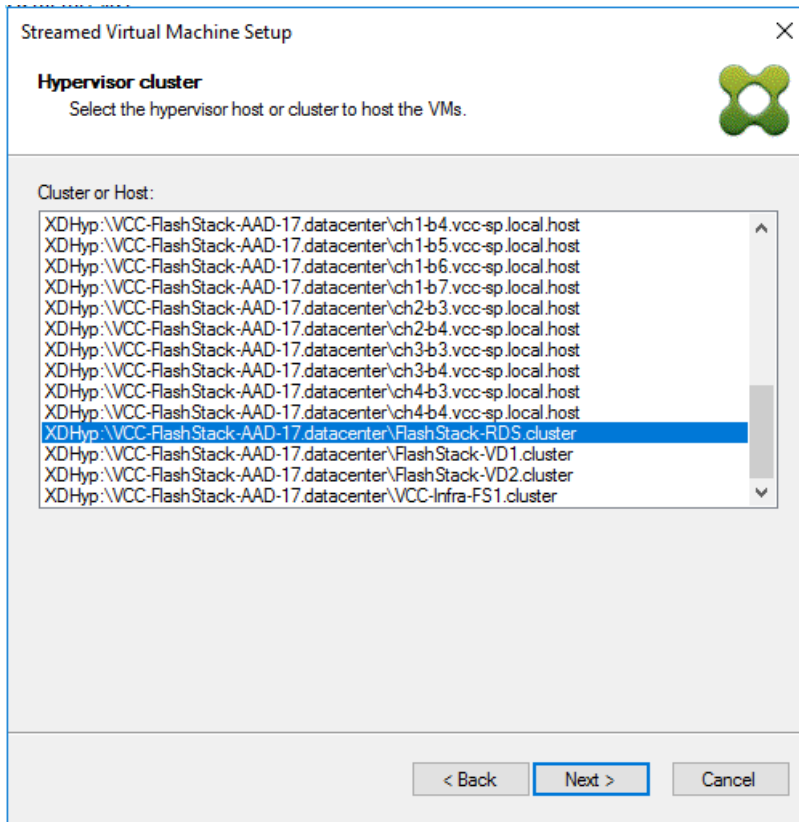

- h. Select the Template created earlier.
- i. Click Next.

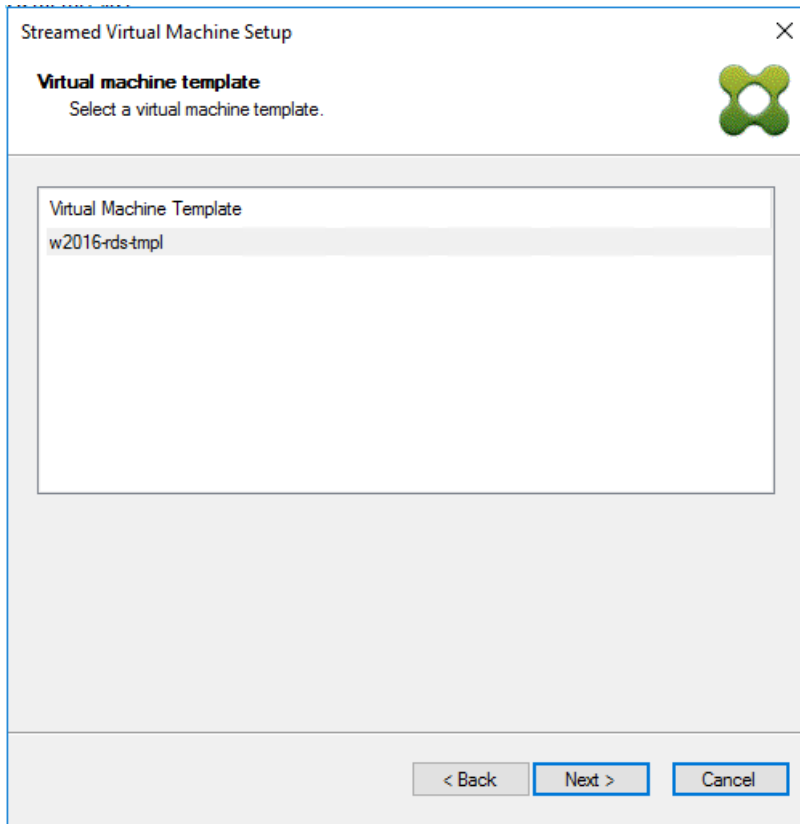

- j. Select the virtual disk (vDisk) that will be used to stream the provisioned virtual machines.
- k. Click Next.

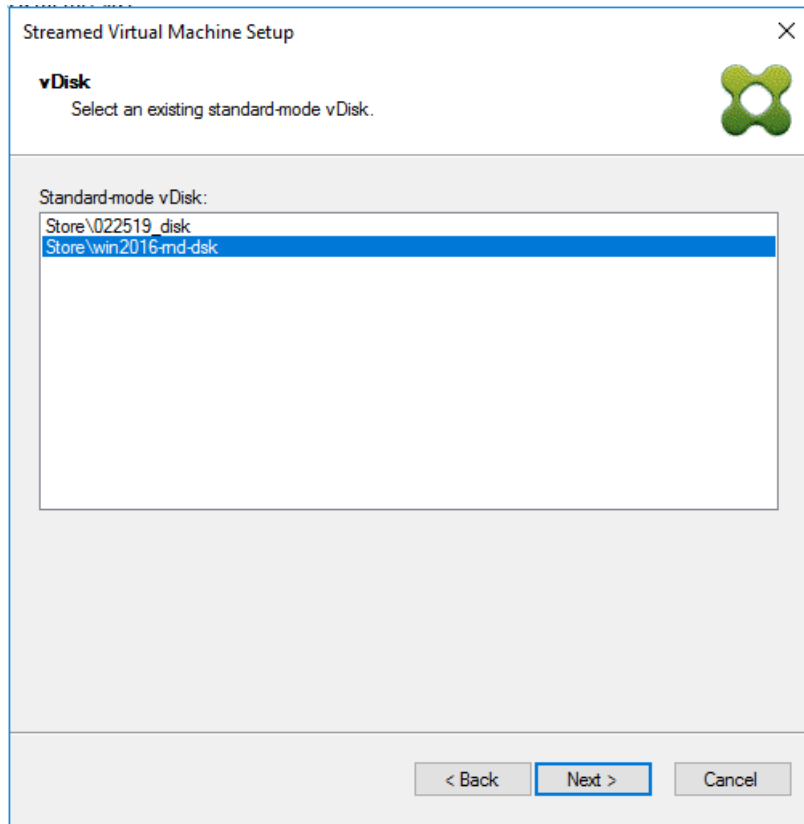

- l. Select Collection where the machines will be placed.
- m. Click Next.

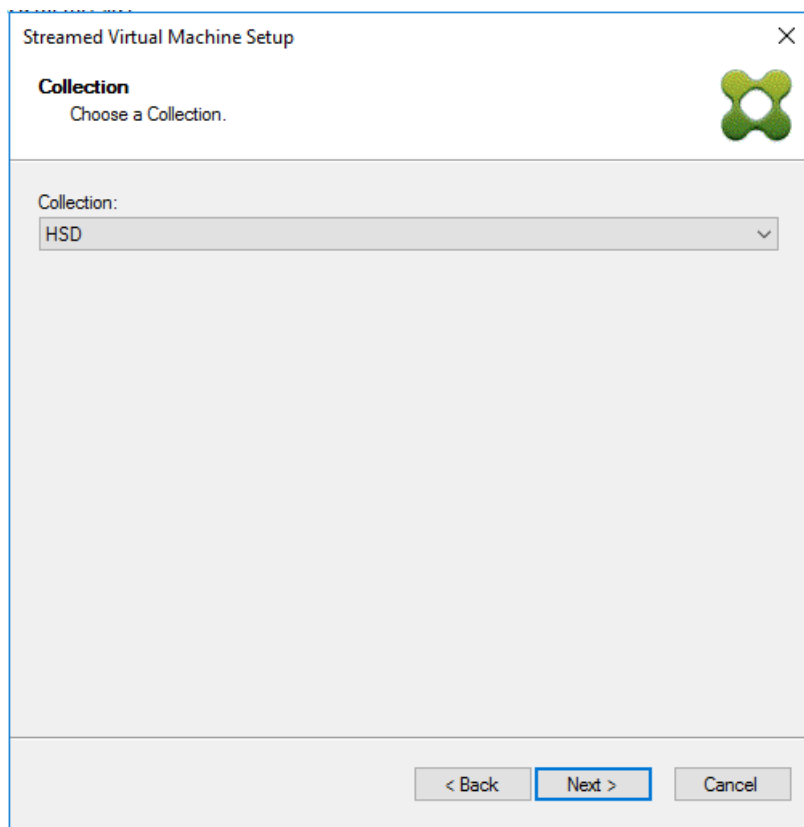

- n. On the Virtual machines dialog, specify:
 - The number of virtual machines to create. (Note that it is recommended to create 200 or less per provisioning run. Create a single virtual machine at first to verify the procedure.)
 - Number of vCPUs for the virtual machine (2 for HVD, 9 for HSD)
 - The amount of memory for the virtual machine (2GB for HVD, 24GB for HSD)
- o. Click Next.

Streamed Virtual Machine Setup ×

Virtual machines
Select your virtual machine preferences.



Number of virtual machines to create:		<input type="text" value="72"/>	
vCPUs:	9	<input type="text" value="9"/>	
Memory:	24576 MB	<input type="text" value="24576"/>	MB
Local write cache disk:	30 GB	30 GB	

- p. Select the Create new accounts radio button.
- q. Click Next.

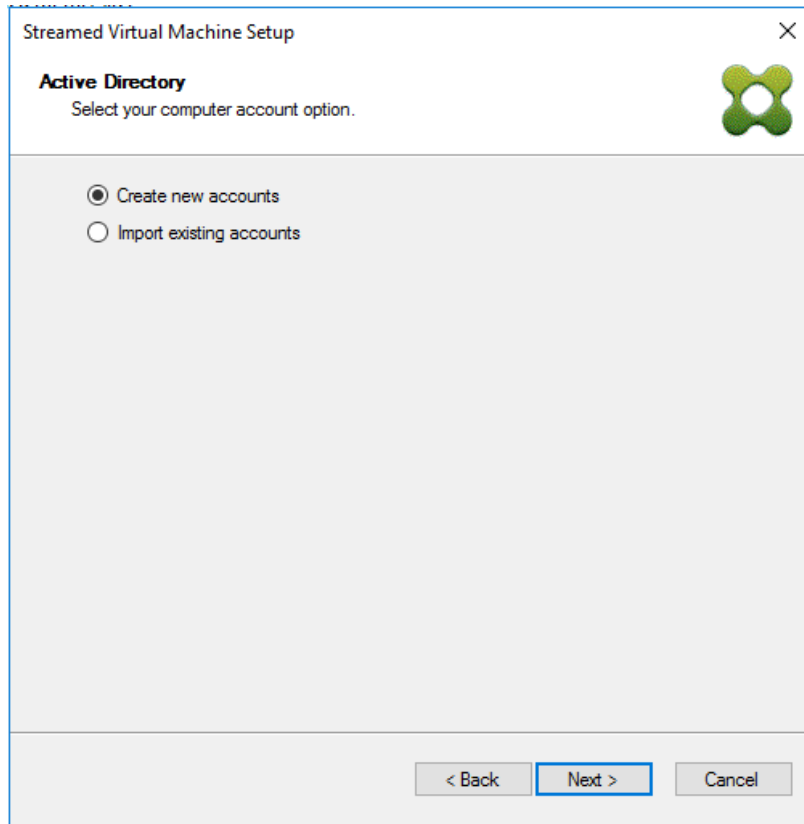

- r. Specify the Active Directory Accounts and Location. This is where the wizard should create computer accounts.
- s. Provide the Account naming scheme. An example name is shown in the text box below the naming scheme selection location.
- t. Click Next.

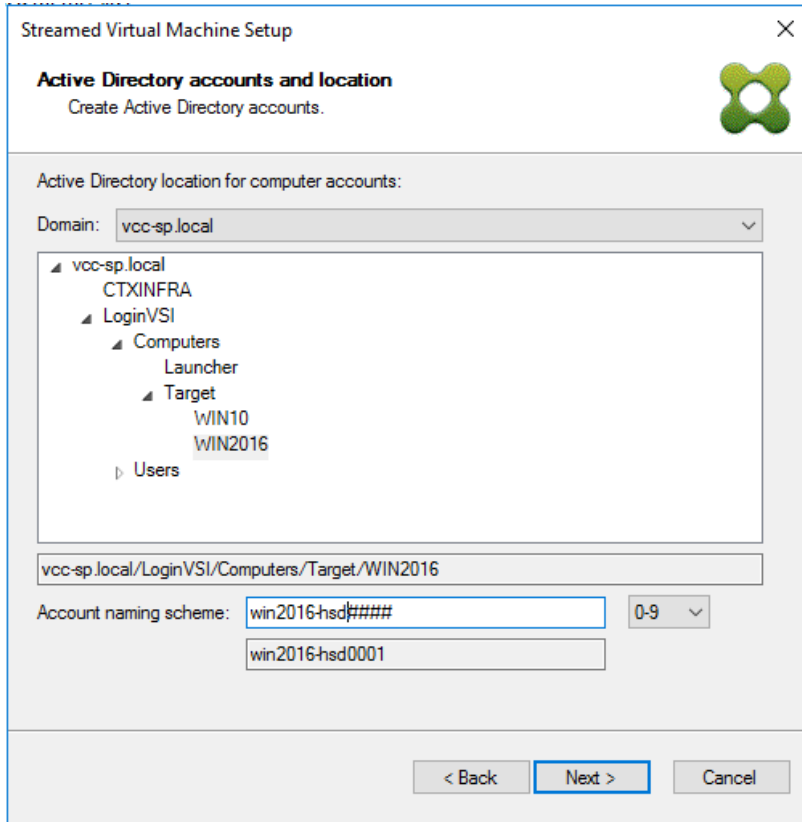

u. Click Finish to begin the virtual machine creation.

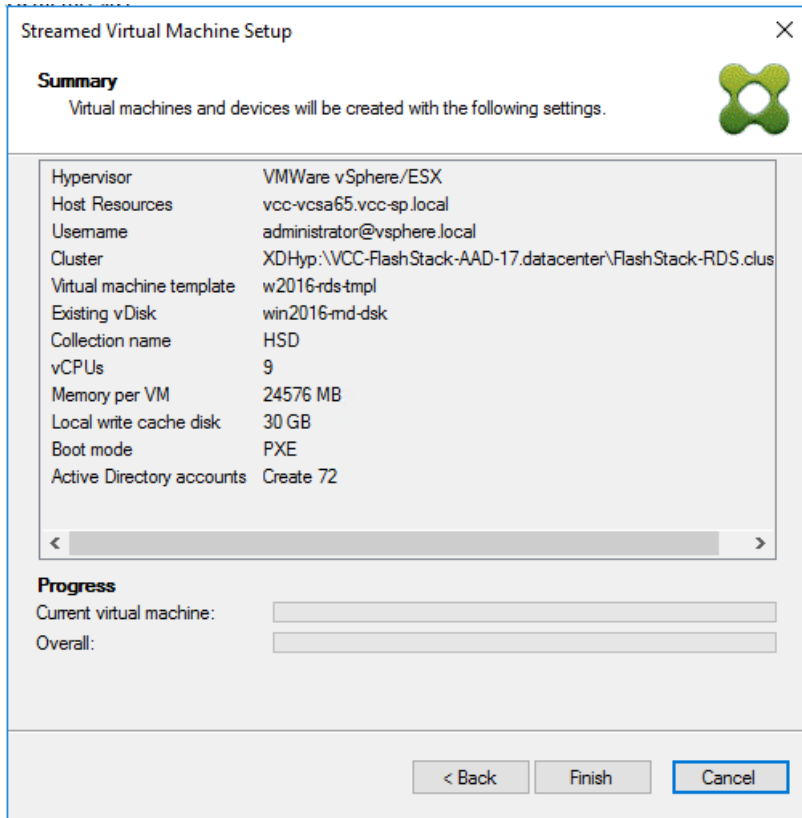

- v. When the wizard is done provisioning the virtual machines, click Done.

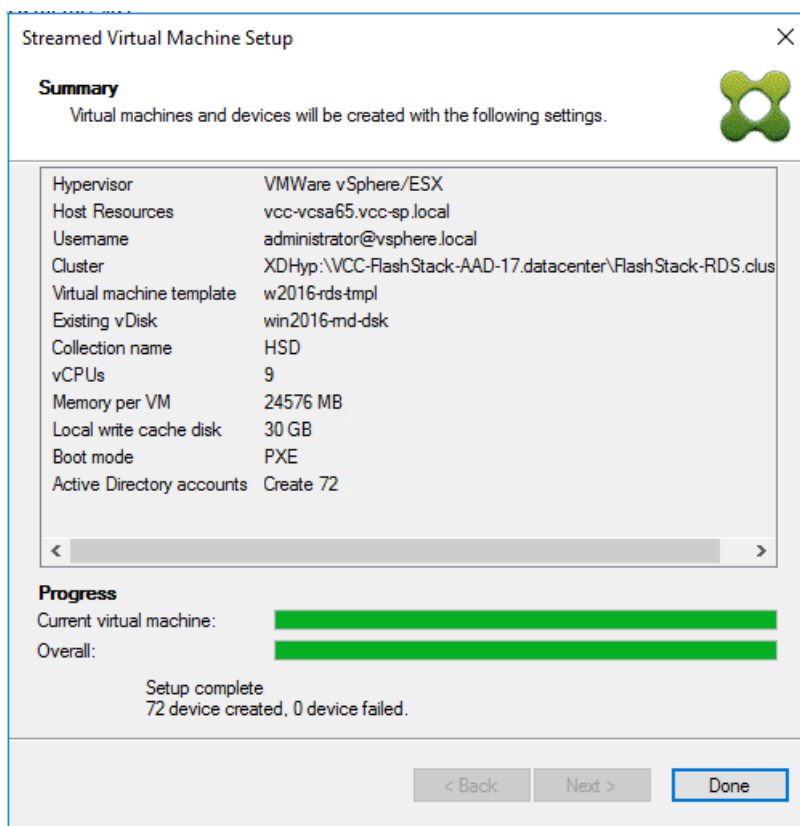

3. When the wizard is done provisioning the virtual machines, add virtual machines to the Machine Catalog on the XenDesktop Controller:
 - a. Connect to a XenDesktop server and launch Citrix Studio.
 - b. Select Machine Catalogs in the Studio navigation pane.
 - c. Select a machine catalog right-click and then select Add machines.

Machine Catalog	Machine type	No. of machines	Allocated machines
HSD Allocation Type: Random	Server OS (Virtual) Last data: Discard	0	0
RND Allocation Type: Random		0	0
STAT Allocation Type: Static		2050	2050

Context menu options for HSD:

- Add Machines
- Edit Machine Catalog
- View Machines
- Delete Machine Catalog
- Rename Machine Catalog
- Test Machine Catalog

d. Connect to a Provisioning Services server hosting virtual machine records.

Add machines

Studio

- Device collection
- Devices
- Summary

Device Collection

Connect to a Provisioning Services server and domain to show the available device collections in the list below.

Provisioning Services server address:

Device collection domain:

Select a Provisioning Services device collection:

No Provisioning Services information has been defined
Add the server address and domain details above...

e. Select Provisioning Services Device Collection contains the virtual machine records that will be added to the catalog.

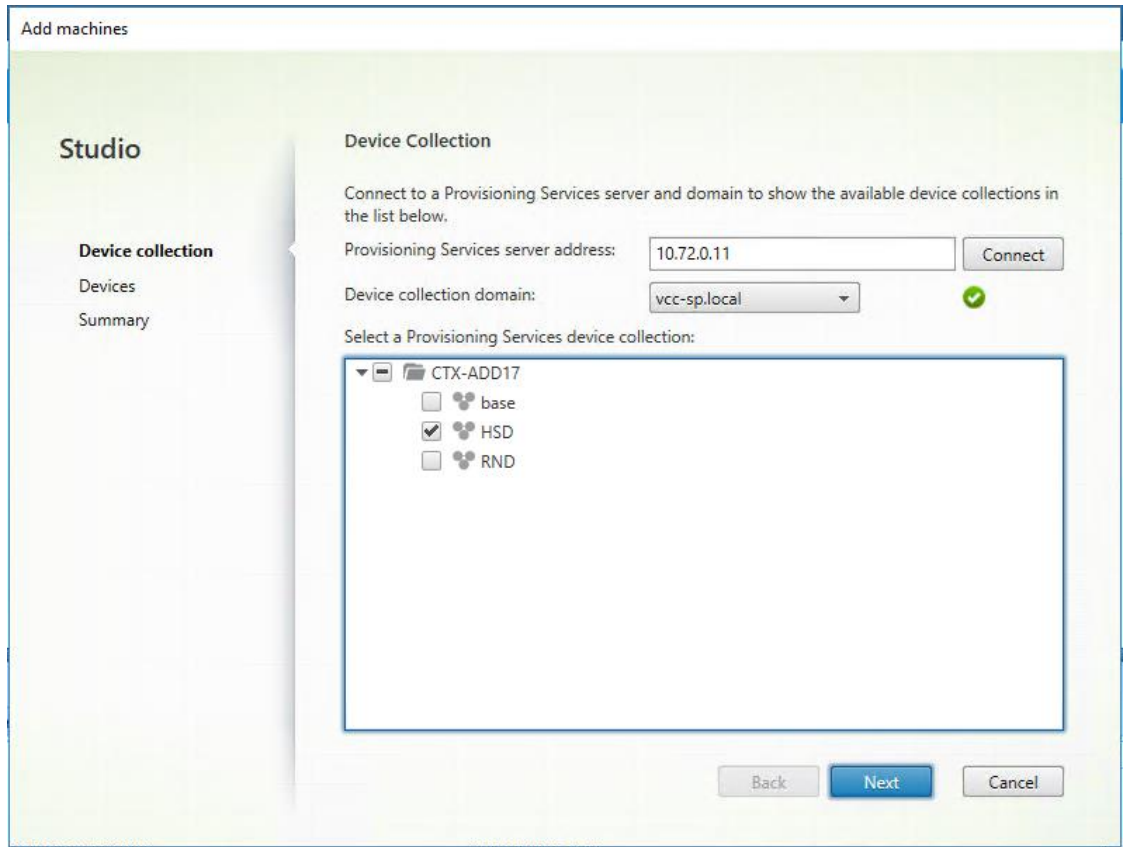

f. Inspect the devices that will be added and click Next.

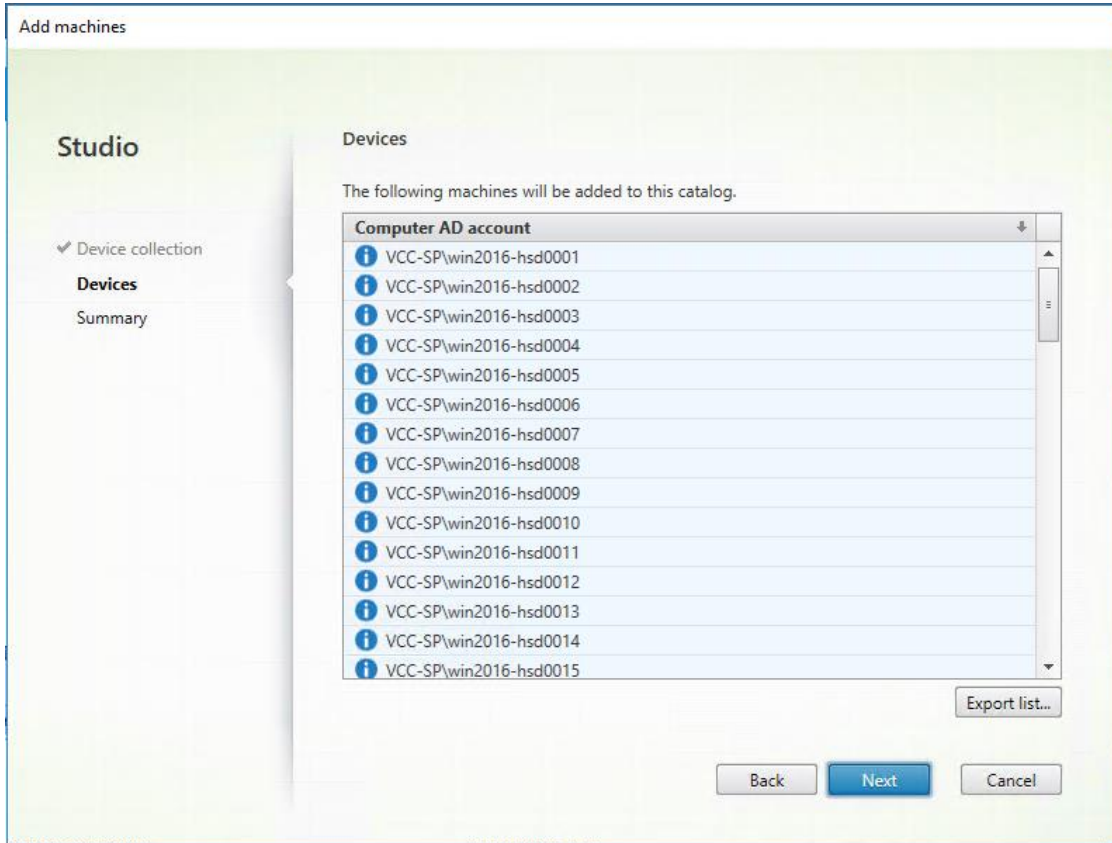

g. Click Finish on the Summary page.

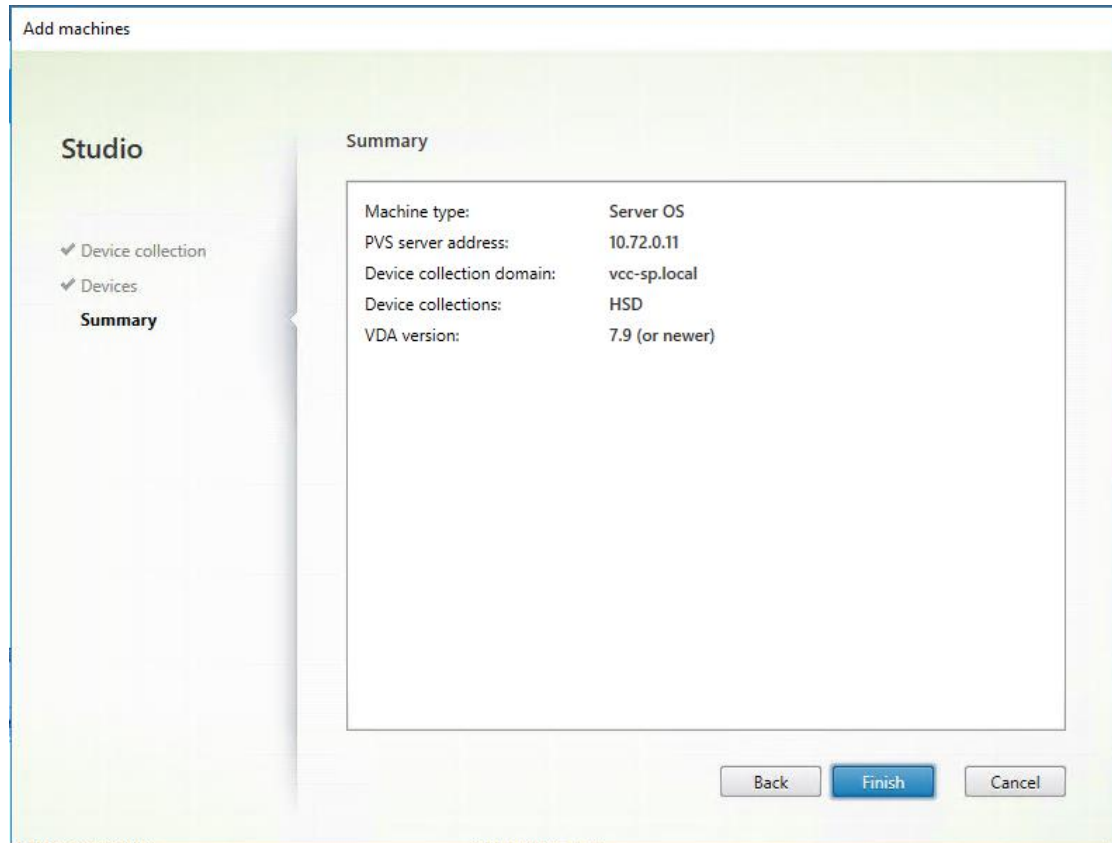

Citrix Machine Creation Services

To configure the Machine Catalog Setup, follow these steps:

1. Connect to a XenDesktop server and launch Citrix Studio.
2. Choose Create Machine Catalog from the Actions pane.
3. Click Next.

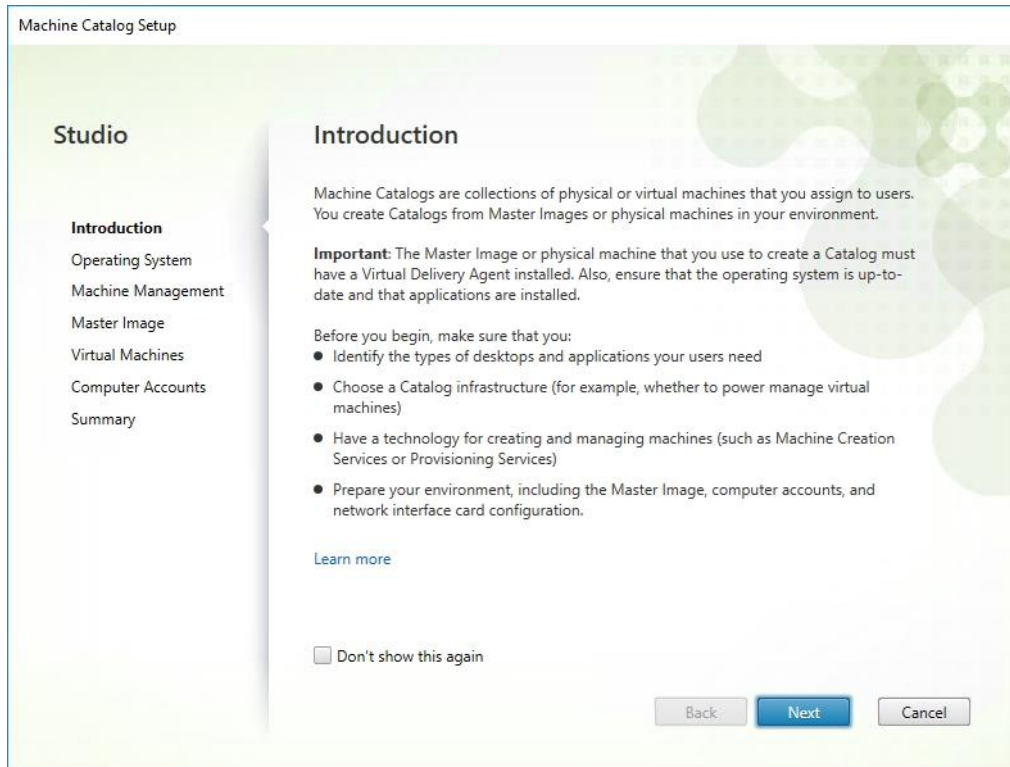

4. Select Desktop OS.

5. Click Next.

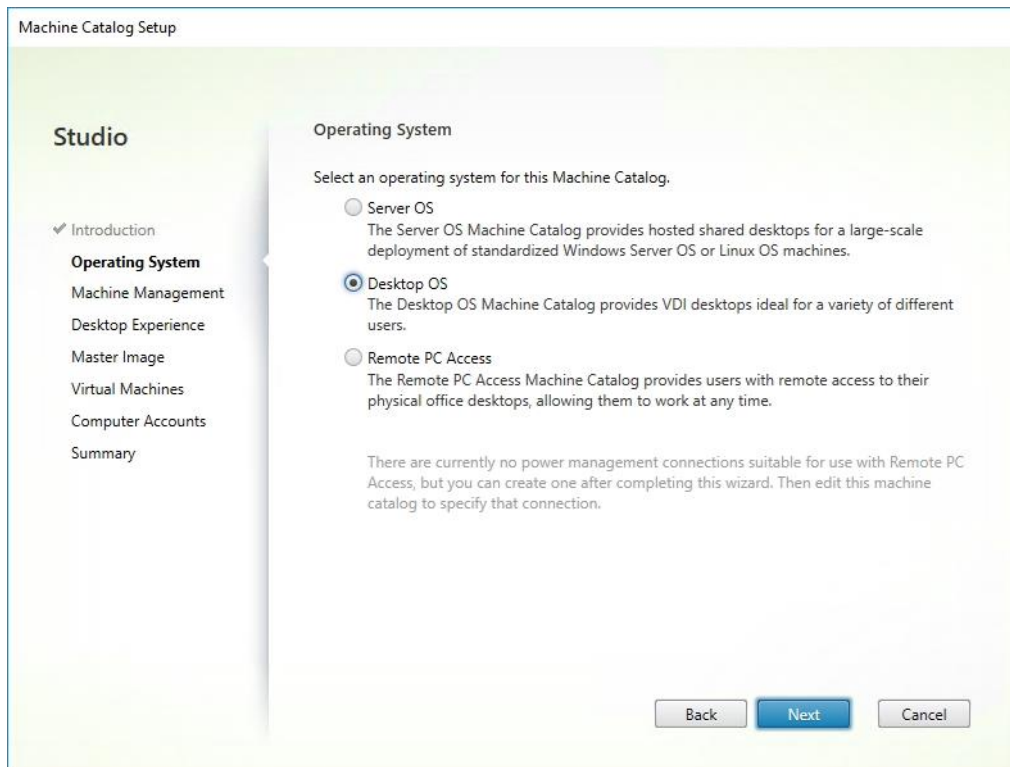

- 6. Select appropriate machine management.
- 7. Click Next.

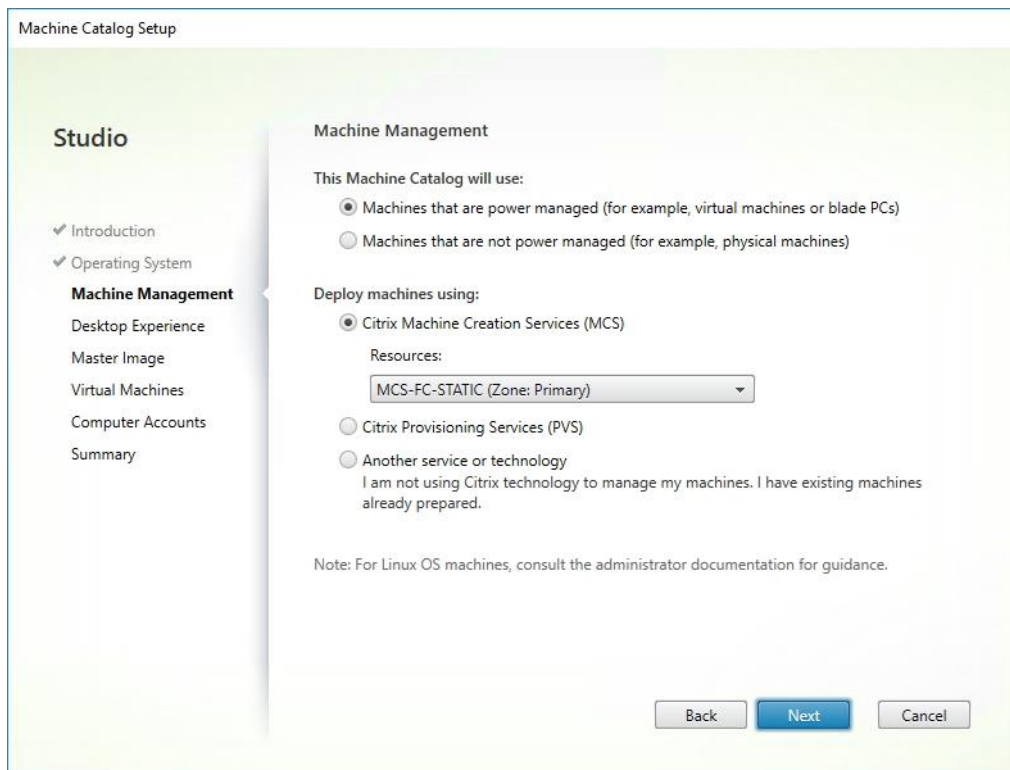

- 8. Select Static, Dedicated Virtual Machine for Desktop Experience.
- 9. Click Next.

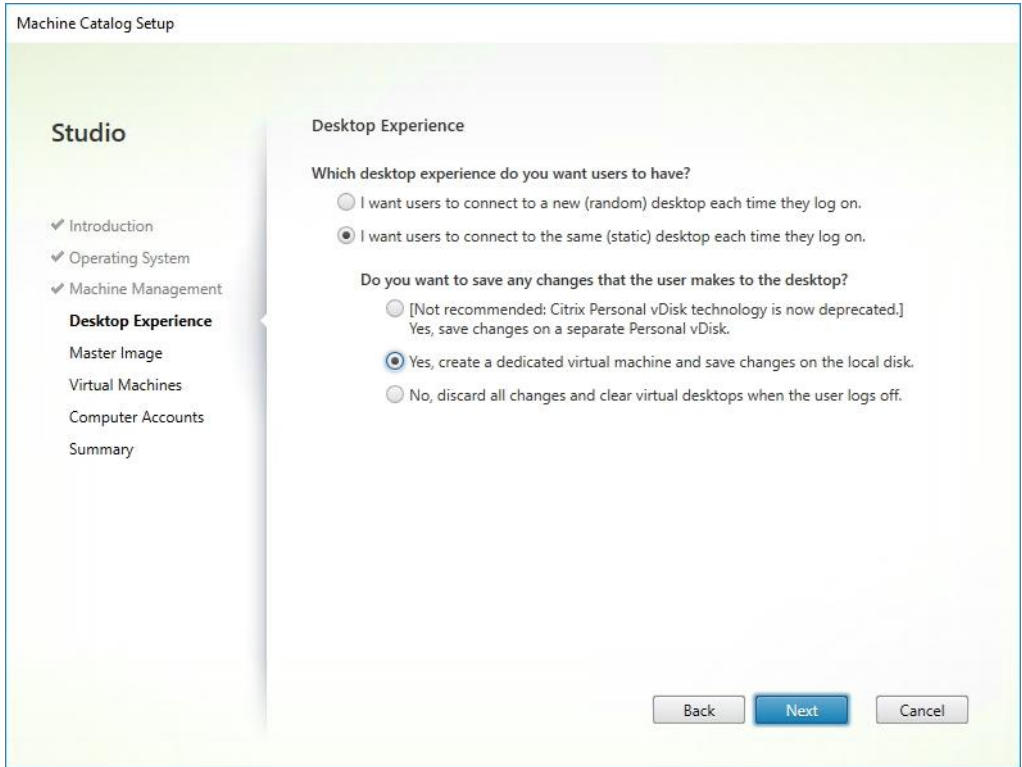

10. Select a Virtual Machine to be used for Catalog Master Image.

11. Click Next.

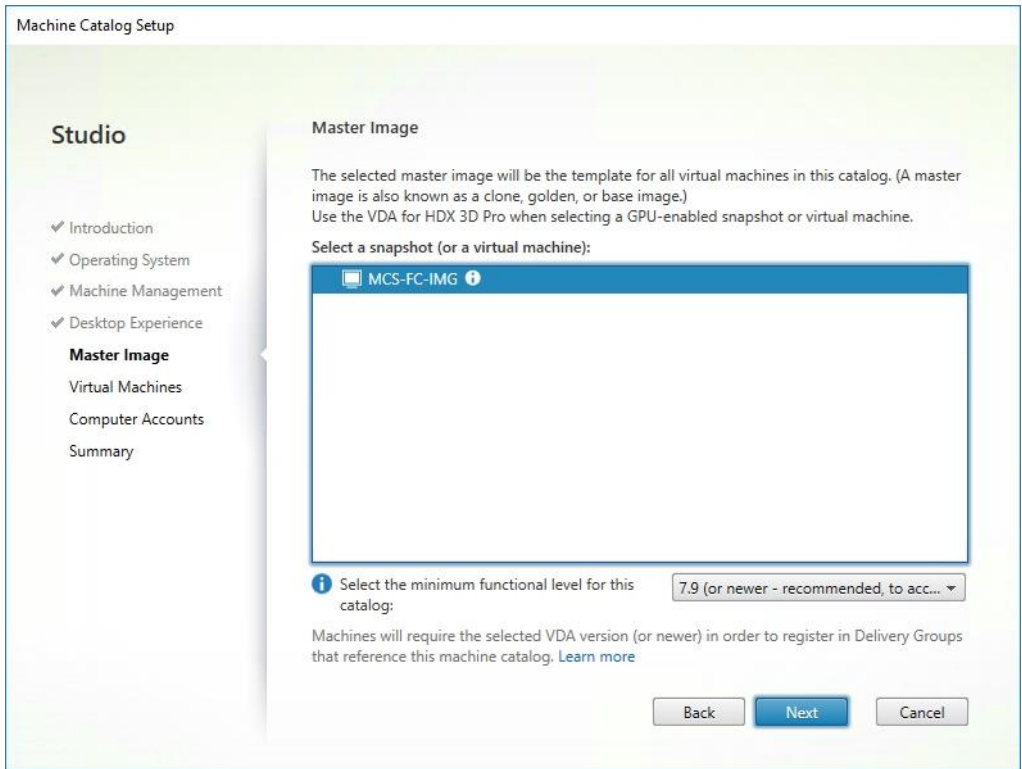

12. Specify the number of desktops to create and machine configuration.
13. Set amount of memory (MB) to be used by virtual desktops.
14. Select Full Copy for machine copy mode.
15. Click Next.

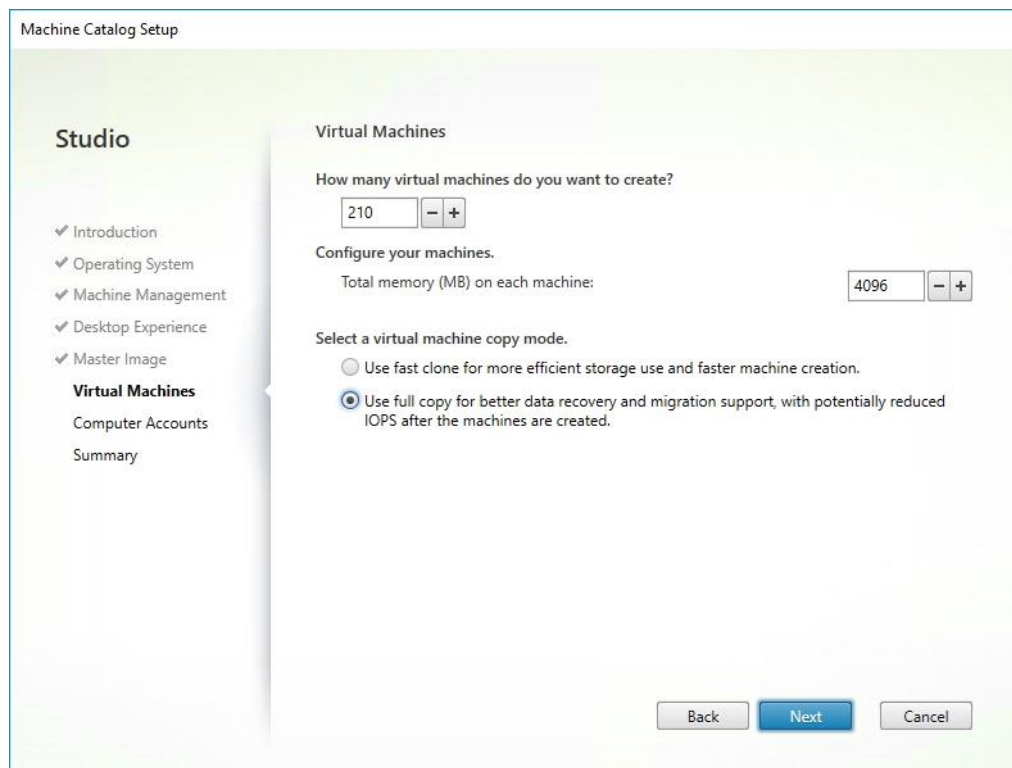

16. Specify the AD account naming scheme and OU where accounts will be created.
17. Click Next.

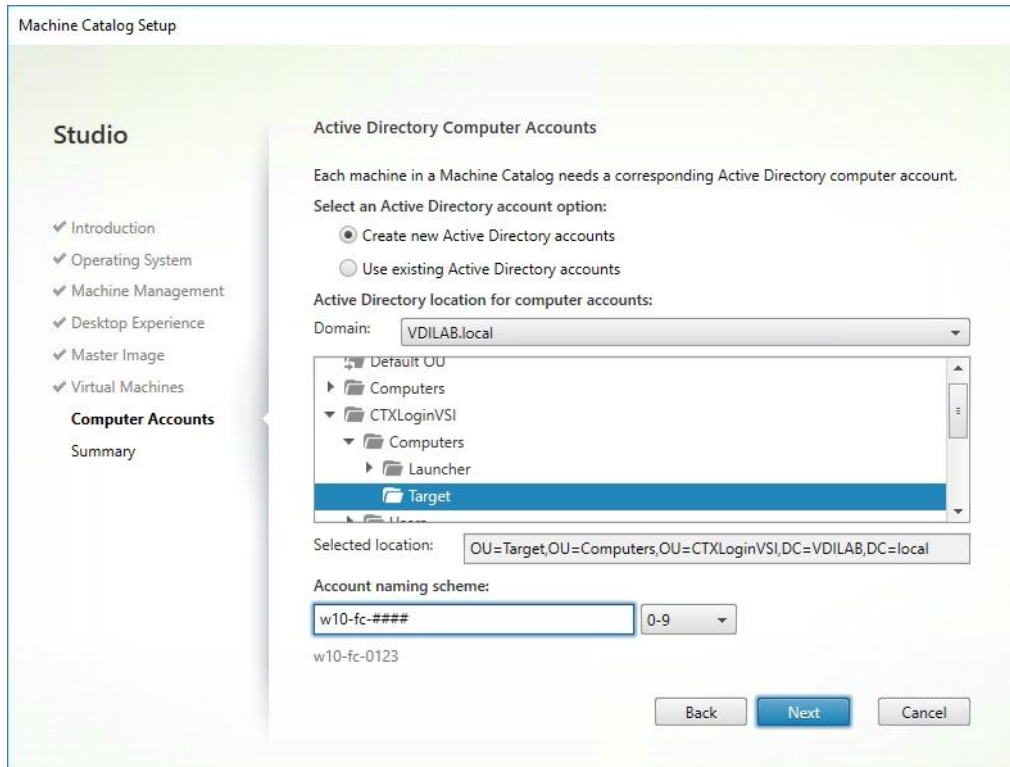

18. On Summary page specify Catalog name and click Finish to start the deployment.

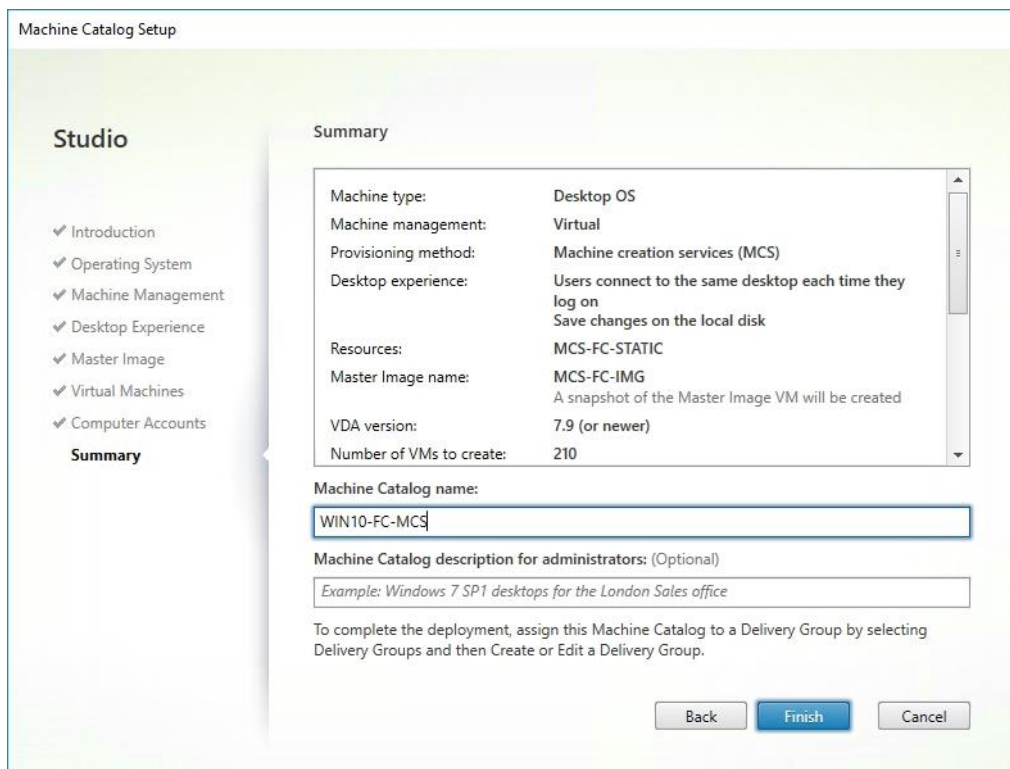

Create Delivery Groups

Delivery Groups are collections of machines that control access to desktops and applications. With Delivery Groups, you can specify which users and groups can access which desktops and applications.

To create delivery groups, follow these steps:

 **The instructions below outline the procedure to create a Delivery Group for VDI desktops. When you have completed these steps, repeat the procedure to a Delivery Group for RDS desktops.**

1. Connect to a XenDesktop server and launch Citrix Studio.
2. Choose Create Delivery Group from the drop-down list.

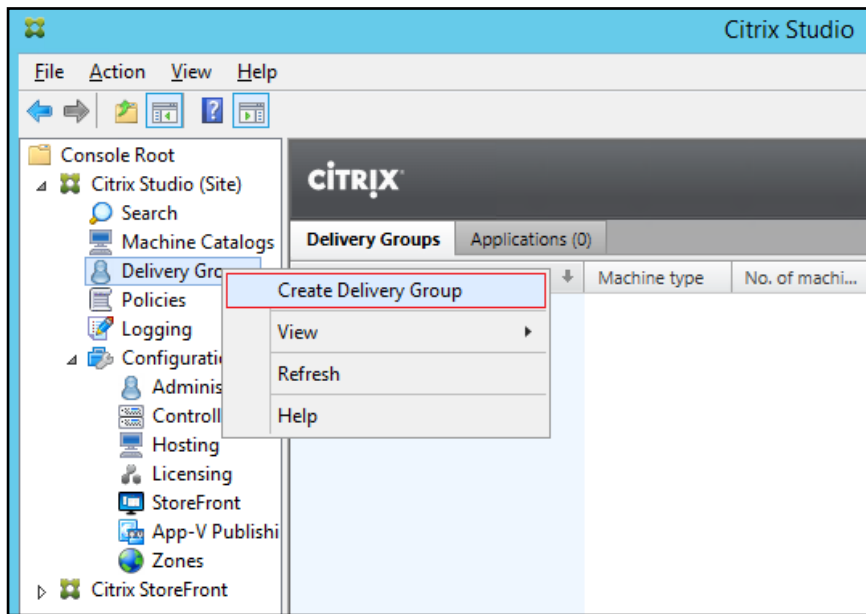

3. Click Next.

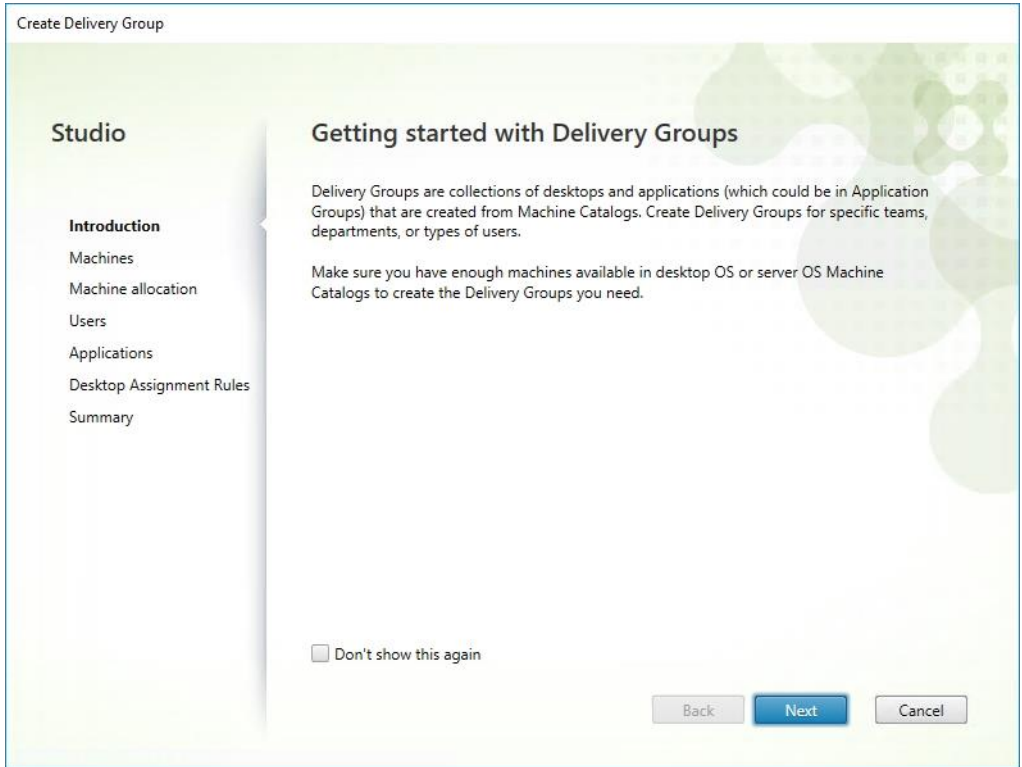

4. Specify the Machine Catalog and increment the number of machines to add.

5. Click Next.

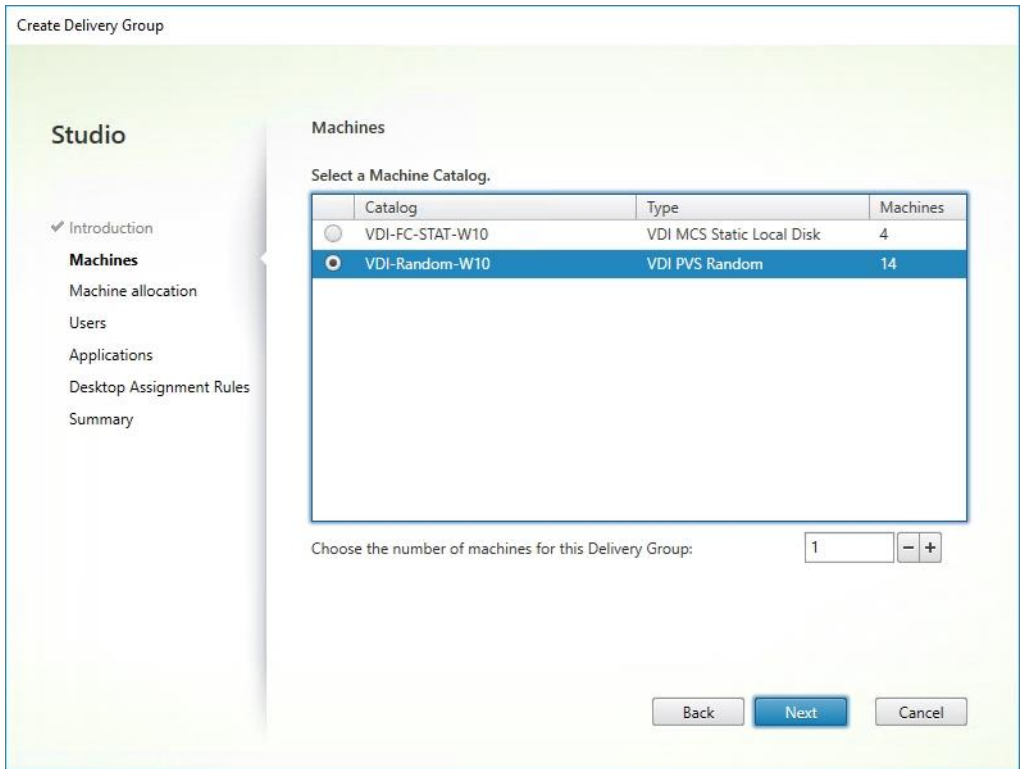

6. Specify what the machines in the catalog will deliver: Desktops, Desktops and Applications, or Applications.
7. Select Desktops.
8. Click Next.

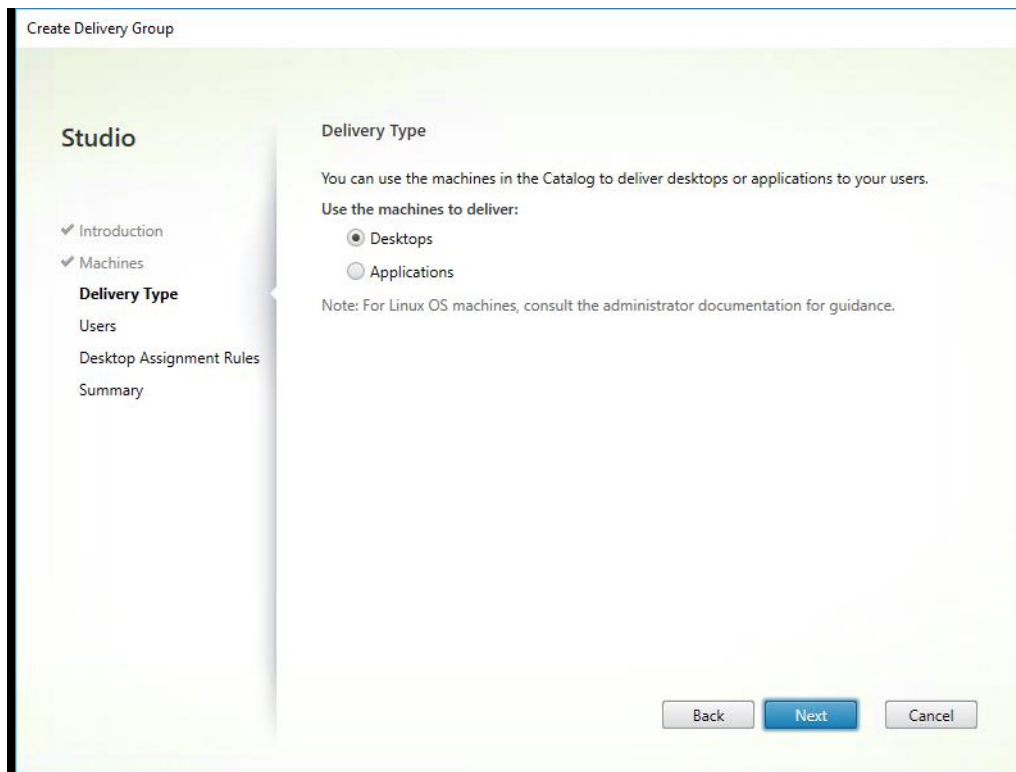

9. To make the Delivery Group accessible, you must add users, select Allow any authenticated users to use this Delivery Group.
10. User assignment can be updated any time after Delivery group creation by accessing Delivery group properties in Desktop Studio.
11. Click Next.

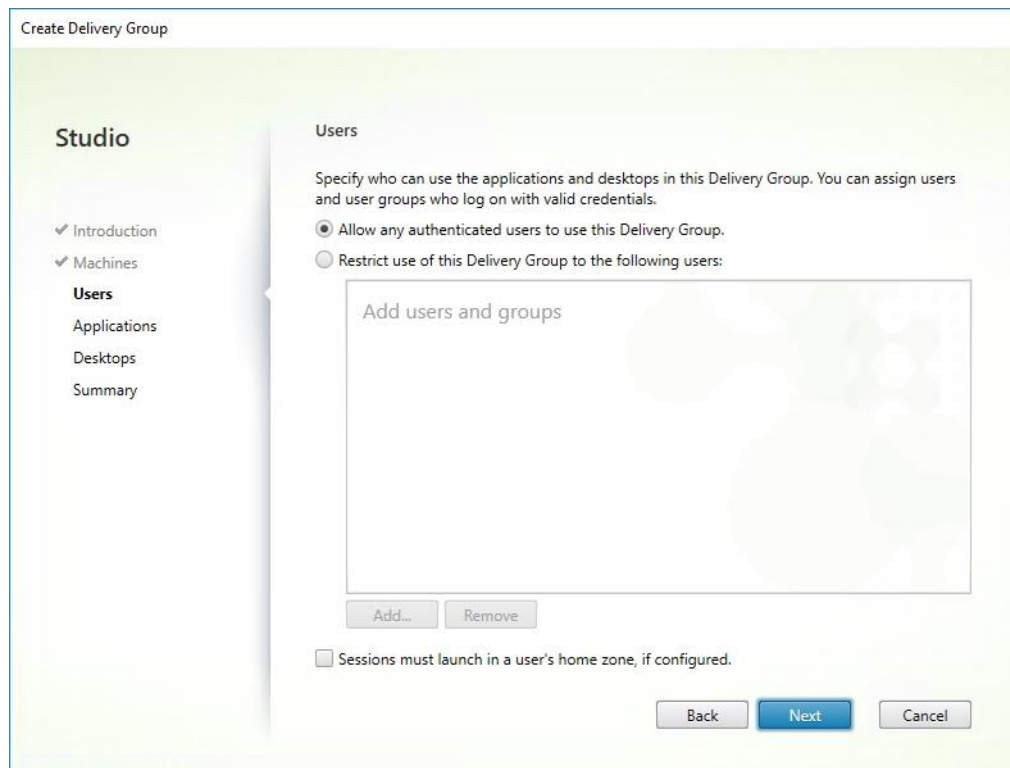

12. Click Next (no applications used in this design).

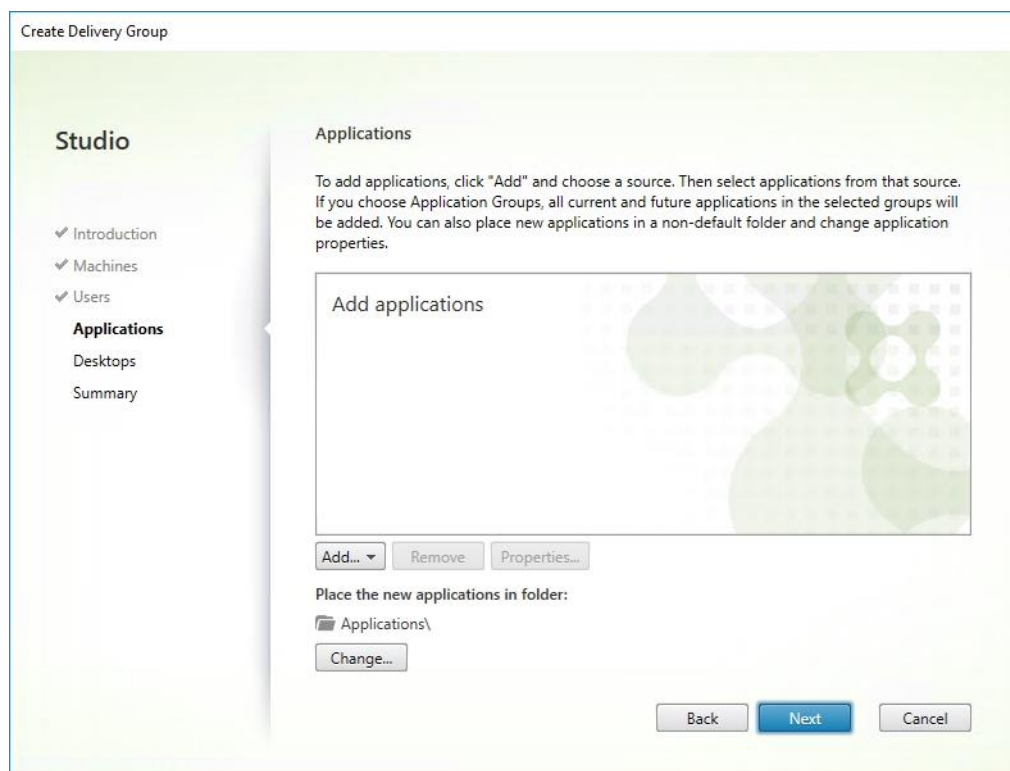

13. Enable Users to access the desktops.

14. Click Next.

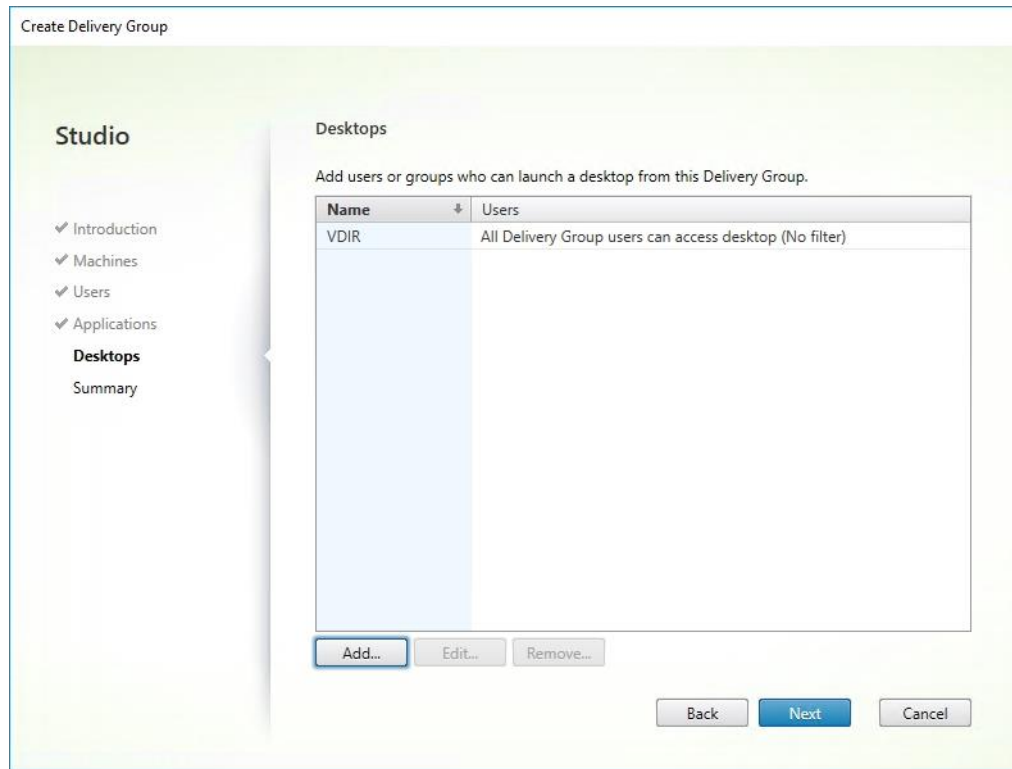

15. On the Summary dialog, review the configuration. Enter a Delivery Group name and a Description (Optional).

16. Click Finish.

Create Delivery Group

Studio

- Introduction
- Machines
- Users
- Applications
- Desktops
- Summary**

Summary

Machine Catalog:	VDI-Random-W10
Machine type:	Desktop OS
Allocation type:	Random
Machines added:	VDILAB\w10-rnd-2586 1 unassigned
Users:	Allow authenticated users
Desktops:	VDIR
Launch in user's home zone:	No

Delivery Group name:
W10-PVS-RND

Delivery Group description, used as label in Receiver (optional):

Back Finish Cancel

Citrix Studio lists the created Delivery Groups as well as the type, number of machines created, sessions, and applications for each group in the Delivery Groups tab.

17. On the drop-down list, select “Turn on Maintenance Mode.”

Citrix XenDesktop Policies and Profile Management

Policies and profiles allow the Citrix XenDesktop environment to be easily and efficiently customized.

Configure Citrix XenDesktop Policies

Citrix XenDesktop policies control user access and session environments, and are the most efficient method of controlling connection, security, and bandwidth settings. You can create policies for specific groups of users, devices, or connection types with each policy. Policies can contain multiple settings and are typically defined through Citrix Studio. (The Windows Group Policy Management Console can also be used if the network environment includes Microsoft Active Directory and permissions are set for managing Group Policy Objects). Figure 48 shows policies for Login VSI testing in this CVD.

Figure 48 XenDesktop Policy

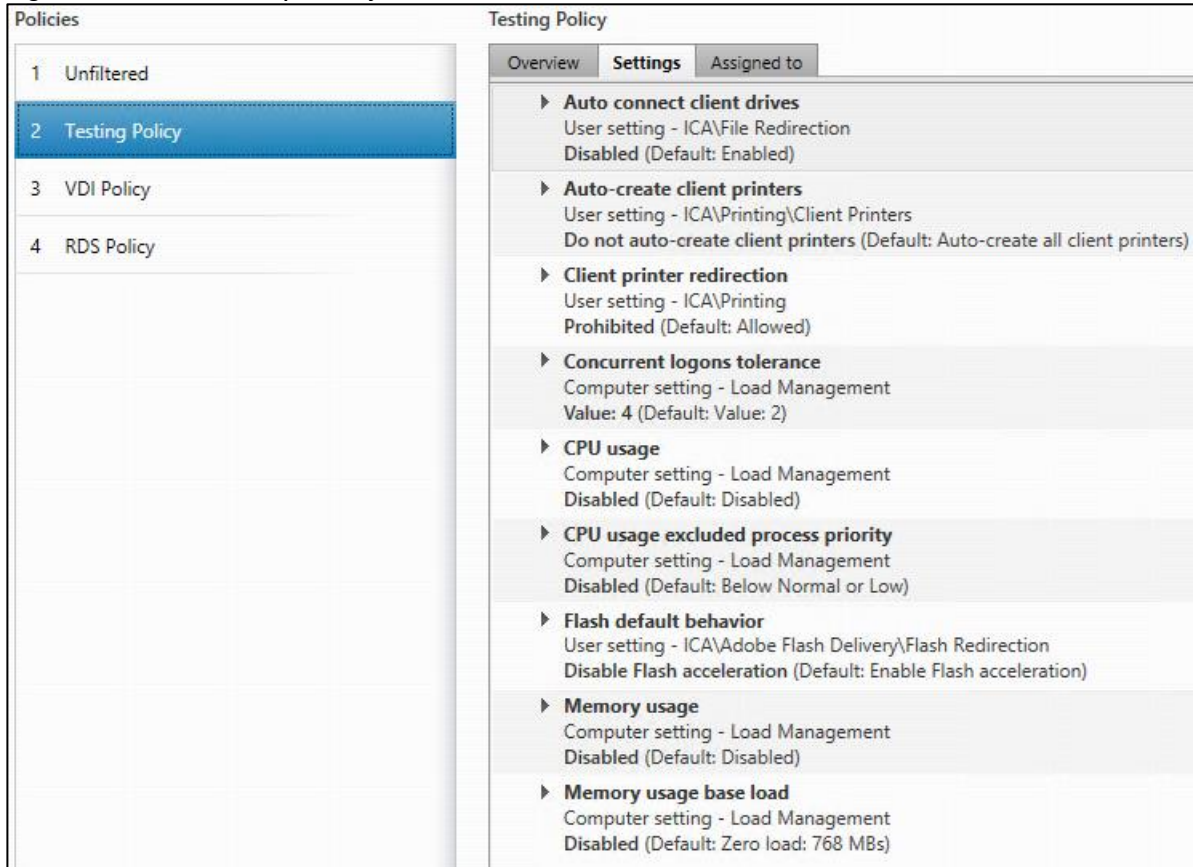
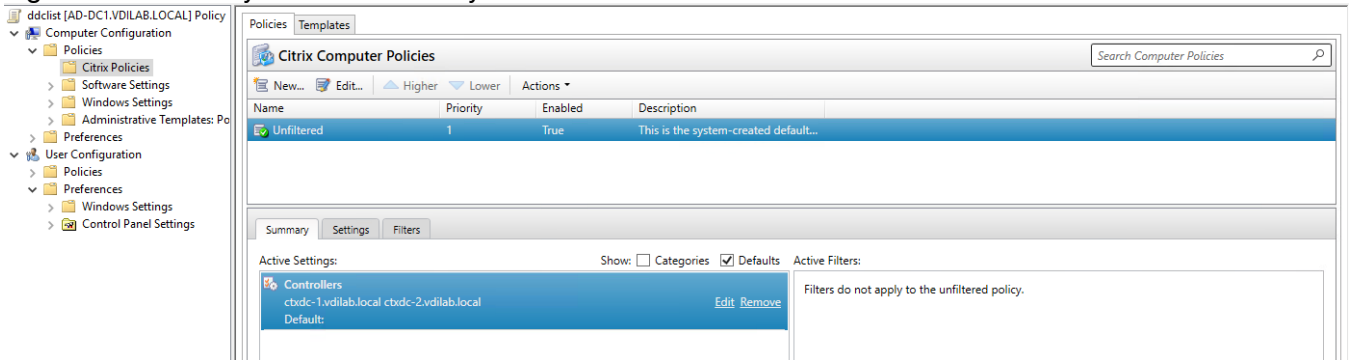

Figure 49 Delivery Controllers Policy



Configuring User Profile Management

Profile management provides an easy, reliable, and high-performance way to manage user personalization settings in virtualized or physical Windows environments. It requires minimal infrastructure and administration and provides users with fast logons and logoffs. A Windows user profile is a collection of folders, files, registry settings, and configuration settings that define the environment for a user who logs on with a particular user account. These settings may be customizable by the user, depending on the administrative configuration.

Examples of settings that can be customized are:

- Desktop settings such as wallpaper and screen saver

- Shortcuts and Start menu setting
- Internet Explorer Favorites and Home Page
- Microsoft Outlook signature
- Printers

Some user settings and data can be redirected by means of folder redirection. However, if folder redirection is not used these settings are stored within the user profile.

The first stage in planning a profile management deployment is to decide on a set of policy settings that together form a suitable configuration for your environment and users. The automatic configuration feature simplifies some of this decision-making for XenDesktop deployments. Screenshots of the User Profile Management interfaces that establish policies for this CVD’s RDS and VDI users (for testing purposes) are shown below. Basic profile management policy settings are documented here:

<https://docs.citrix.com/en-us/xenapp-and-xendesktop/7-15-ltsr.html>

Figure 50 VDI User Profile Manager Policy

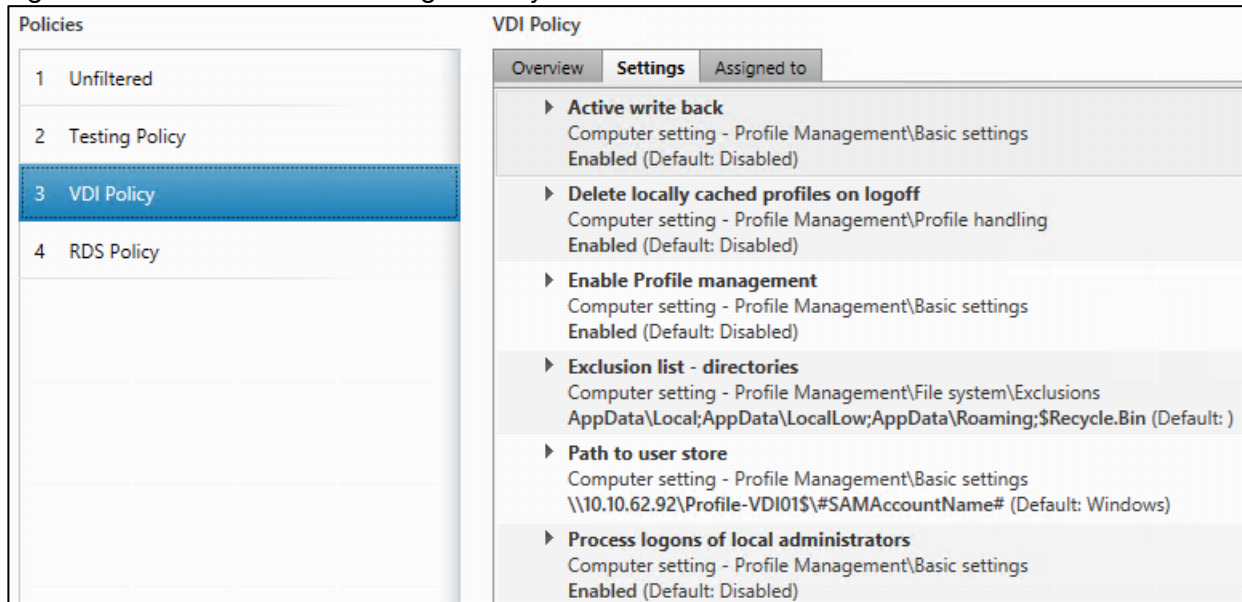
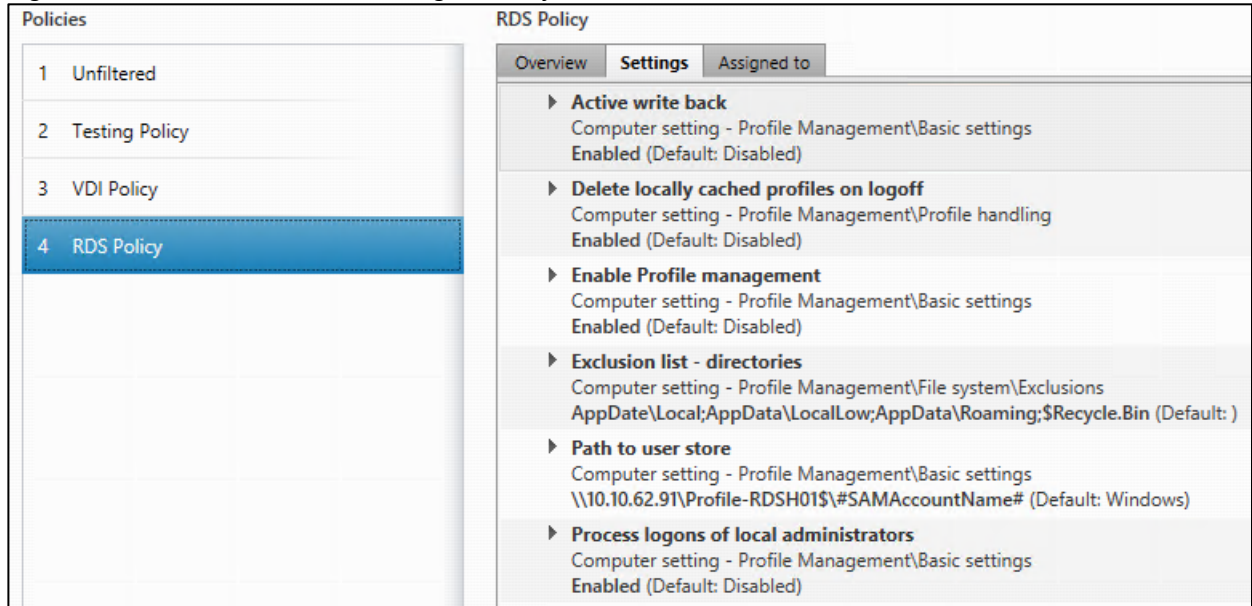

Figure 51 RDS User Profile Manager Policy



Install and Configure NVIDIA P6 Card

This section focuses on installing and configuring the NVIDIA P6 cards with the Cisco UCS B200 M5 servers to deploy vGPU enabled virtual desktops.

Physical Installation of P6 Card into Cisco UCS B200 M5 Server

The NVIDIA P6 graphics processing unit (GPU) card provides graphics and computing capabilities to the server. There are two supported versions of the NVIDIA P6 GPU card:

- UCSB-GPU-P6-F can be installed only in the front mezzanine slot of the server



No front mezzanine cards can be installed when the server has CPUs greater than 165 W.

- UCSB-GPU-P6-R can be installed only in the rear mezzanine slot (slot 2) of the server.

Figure 52 illustrates the installed NVIDIA P6 GPU in the front and rear mezzanine slots.

Figure 52 NVIDIA GPU Installed in the Front and Rear Mezzanine Slots

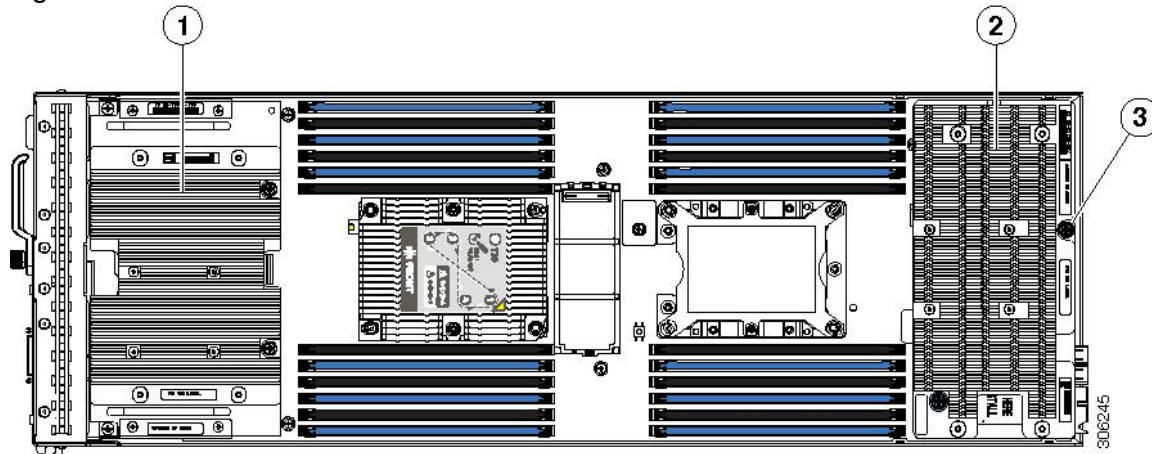

1	Front GPU	2	Rear GPU
3	Custom standoff screw	-	

Install an NVIDIA GPU Card in the Front of the Server

Figure 53 illustrates the front NVIDIA P6 GPU (UCSB-GPU-P6-F).

Figure 53 NVIDIA P6 GPU That Installs in the Front of the Server

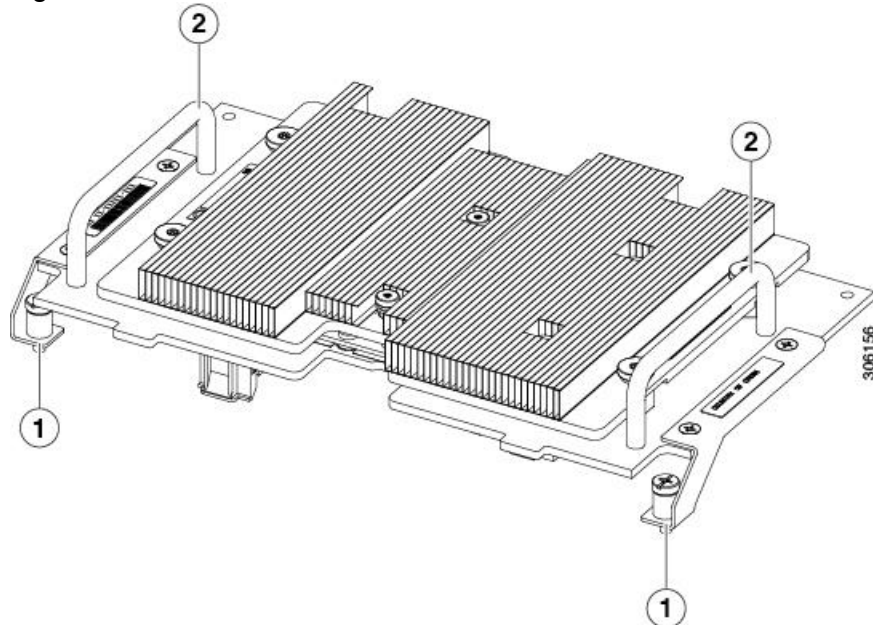

1	Leg with thumb screw that attaches to the server motherboard at the front	2	Handle to press down on when installing the GPU
---	---	---	---

Figure 54 Top-Down View of the NVIDIA P6 GPU for the Front of the Server

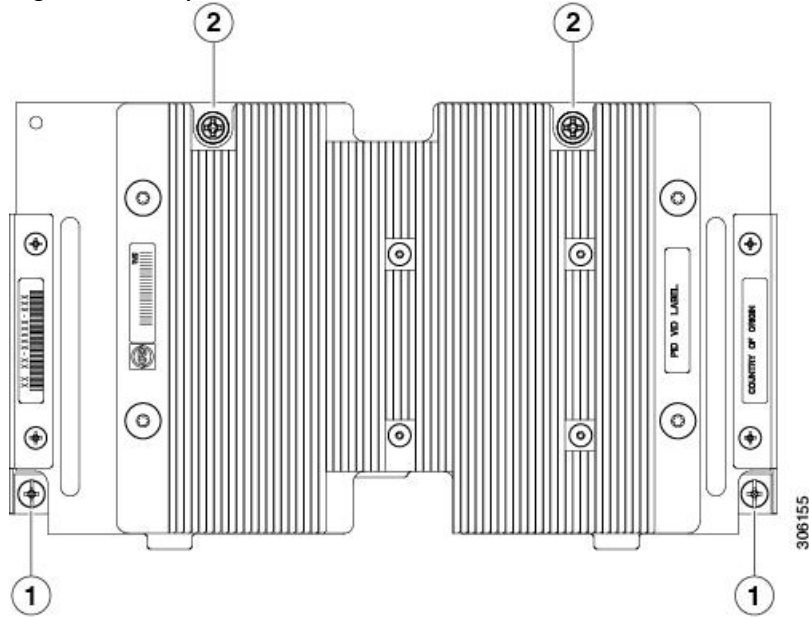

1	Leg with thumb screw that attaches to the server motherboard	2	Thumb screw that attaches to a standoff below
---	--	---	---

To install the NVIDIA GPU, follow these steps:



Before installing the NVIDIA P6 GPU (UCSB-GPU-P6-F) in the front mezzanine slot you need to upgrade the Cisco UCS domain that the GPU will be installed into to a version of Cisco UCS Manager that supports this card. Refer to the latest version of the Release Notes for Cisco UCS Software at the following URL for information about supported hardware: <http://www.cisco.com/c/en/us/support/servers-unified-computing/ucs-manager/products-release-notes-list.html>. Remove the front mezzanine storage module if it is present. You cannot use the storage module in the front mezzanine slot when the NVIDIA P6 GPU is installed in the front of the server.

1. Position the GPU in the correct orientation to the front of the server (callout 1) as shown in Figure 55.
2. Install the GPU into the server. Press down on the handles (callout 5) to firmly secure the GPU.
3. Tighten the thumb screws (callout 3) at the back of the GPU with the standoffs (callout 4) on the motherboard.
4. Tighten the thumb screws on the legs (callout 2) to the motherboard.
5. Install the drive blanking panels.

Figure 55 Installing the NVIDIA GPU in the Front of the Server

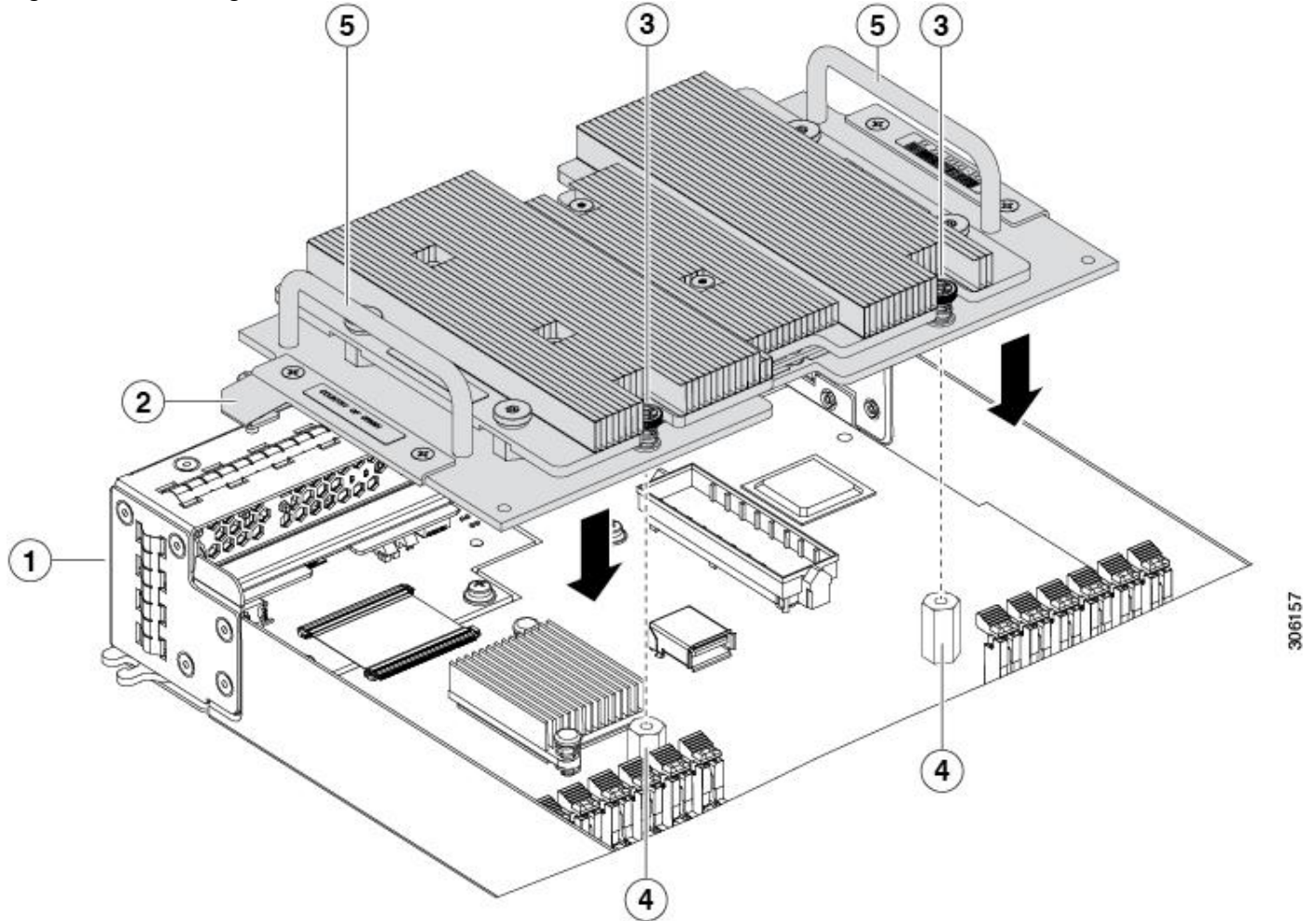

1	Front of the server	2	Leg with thumb screw that attaches to the motherboard
3	Thumbscrew to attach to standoff below	4	Standoff on the motherboard
5	Handle to press down on to firmly install the GPU	-	

Install an NVIDIA GPU Card in the Rear of the Server

If you are installing the UCSB-GPU-P6-R to a server in the field, the option kit comes with the GPU itself (GPU and heatsink), a T-shaped installation wrench, and a custom standoff to support and attach the GPU to the motherboard. Figure 56 shows the three components of the option kit.

Figure 56 NVIDIA P6 GPU (UCSB-GPU-P6-R) Option Kit

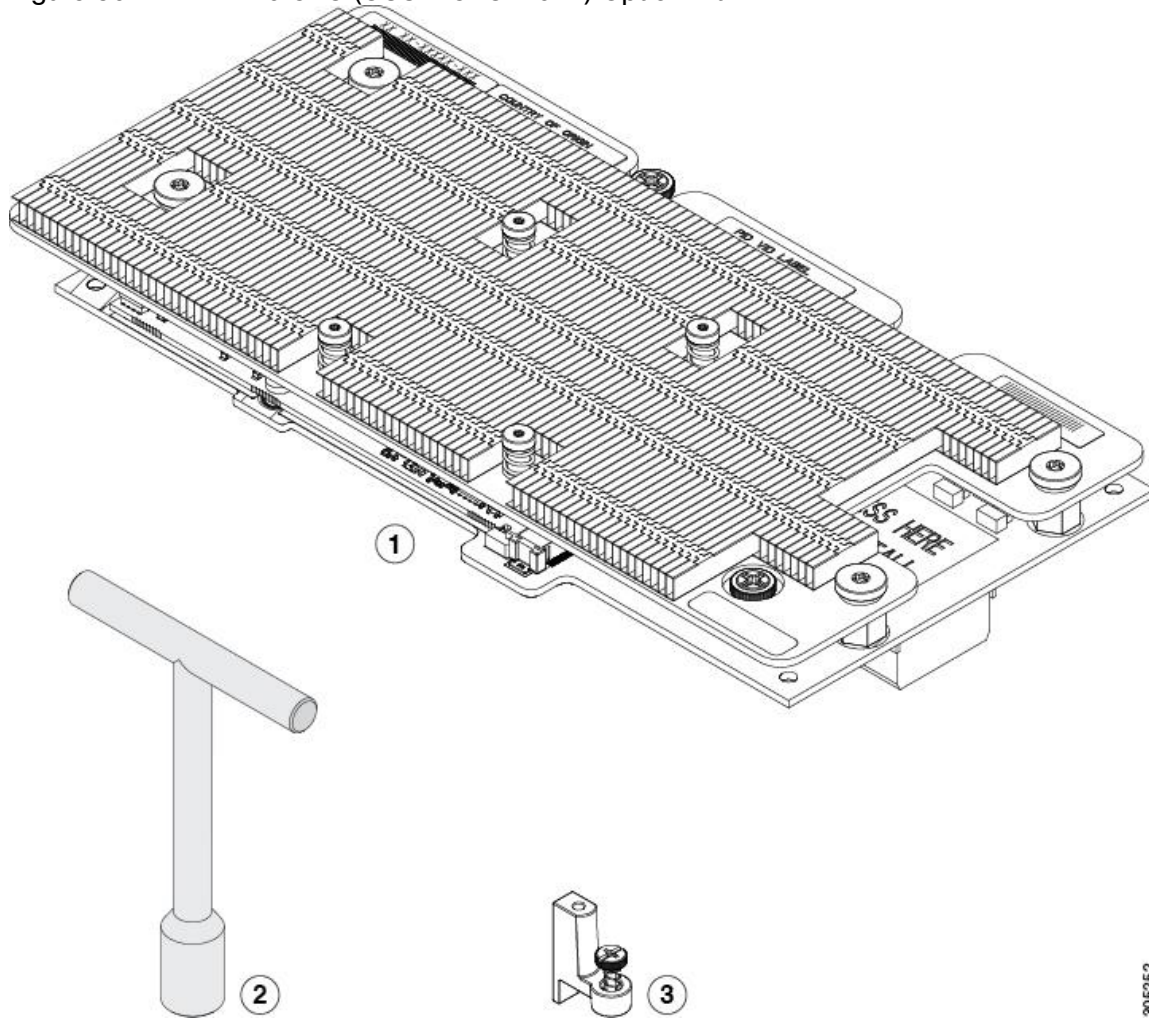

1	NVIDIA P6 GPU (CPU and heatsink)	2	T-shaped wrench
3	Custom standoff	-	



Before installing the NVIDIA P6 GPU (UCSB-GPU-P6-R) in the rear mezzanine slot, you need to Upgrade the Cisco UCS domain that the GPU will be installed into to a version of Cisco UCS Manager that supports this card. Refer to the latest version of the *Release Notes for Cisco UCS Software* at the following URL for information about supported hardware: <http://www.cisco.com/c/en/us/support/servers-unified-computing/ucs-manager/products-release-notes-list.html>. Remove any other card, such as a VIC 1480, VIC 1380, or VIC port expander card from the rear mezzanine slot. You cannot use any other card in the rear mezzanine slot when the NVIDIA P6 GPU is installed.

To install an NVIDIA GPU Card in the rear of the server, follow these steps:

1. Use the T-shaped wrench that comes with the GPU to remove the existing standoff at the back end of the motherboard.
2. Install the custom standoff in the same location at the back end of the motherboard.

3. Position the GPU over the connector on the motherboard and align all the captive screws to the standoff posts (callout 1).
4. Tighten the captive screws (callout 2).

Figure 57 Installing the NVIDIA P6 GPU in the Rear Mezzanine Slot

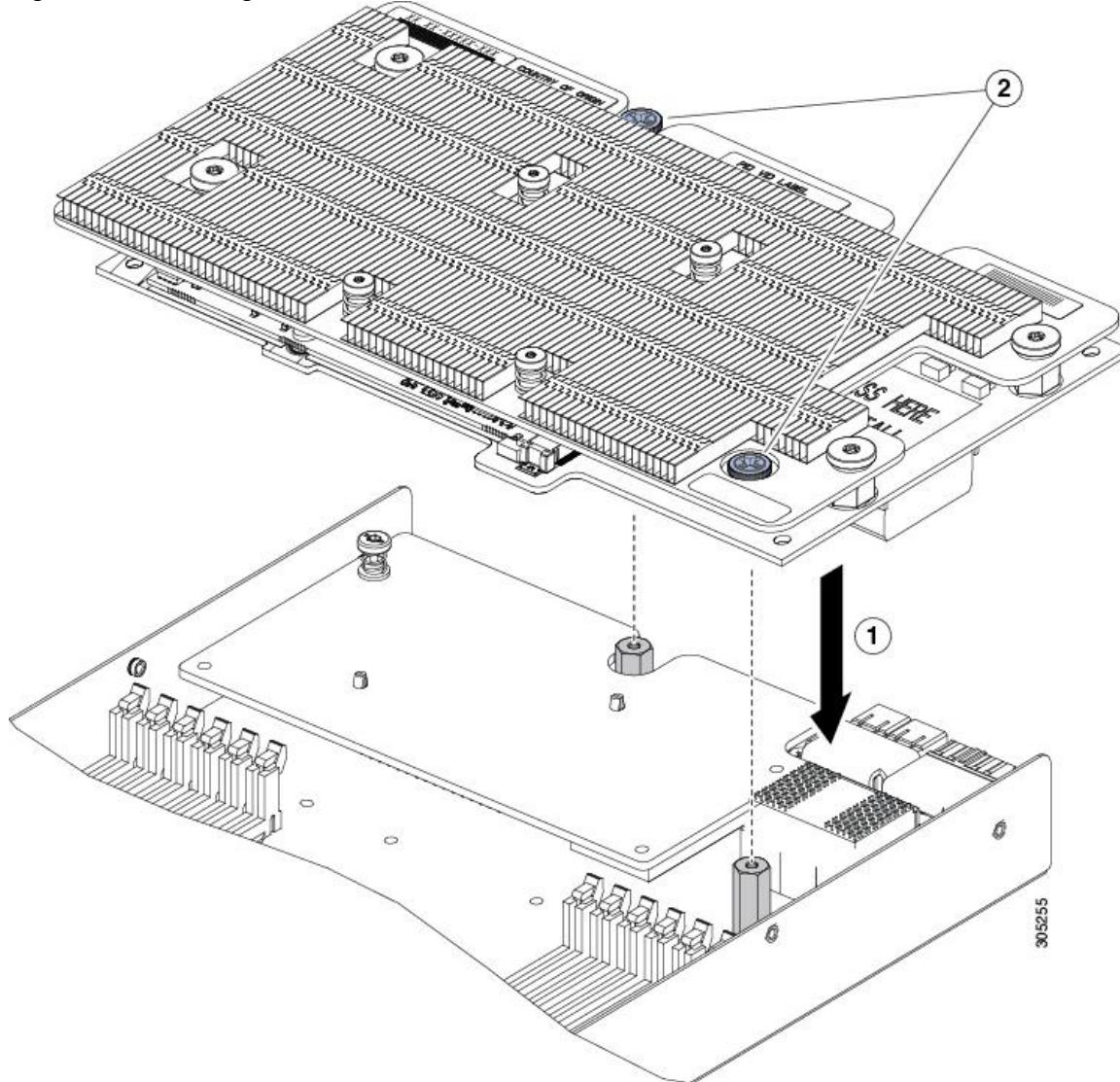

Install the NVIDIA VMware VIB Driver

To install the NVIDIA VMware VIB driver, follow these steps:

1. From Cisco UCS Manager, verify the GPU card has been properly installed.

Equipment / Chassis / Chassis 1 / Servers / Server 3				
General Inventory Virtual Machines Installed Firmware CIMC Sessions SEL Logs VIF Paths Health Diagnostics Faults Events FSM Statistics Temperatures Power				
Motherboard CIMC CPUs GPUs Memory Adapters HBAs NICs iSCSI vNICs Security Storage				
Advanced Filter Export Print				
Name	ID	Model	Serial	Mode
Graphics Card 2	2	UCSB-GPU-P6-R	FCH212373US	NA
Graphics Card 3	3	UCSB-GPU-P6-F	FCH21237472	NA

2. Download the NVIDIA GRID GPU driver pack for VMware vSphere ESXi 6.7.
3. Upload the NVIDIA driver (vSphere Installation Bundle [VIB] file) to the /tmp directory on the ESXi host using a tool such as WinSCP. (Shared storage is preferred if you are installing drivers on multiple servers or using the VMware Update Manager.)
4. Log in as root to the vSphere console through SSH using a tool such as Putty.



The ESXi host must be in maintenance mode for you to install the VIB module. To place the host in maintenance mode, use the command `esxcli system maintenanceMode set -enable true`.

5. Enter the following command to install the NVIDIA vGPU drivers:

```
esxcli software vib install --no-sig-check -v /<path>/<filename>.VIB
```

The command should return output similar to that shown here:

```
# esxcli software vib install --no-sig-check -v /tmp/NVIDIA-VMware_ESXi_6.7_Host_Driver_384.99-10EM.650.0.0.4598673.vib
Installation Result
  Message: Operation finished successfully.
  Reboot Required: false
  VIBs Installed: NVIDIA_bootbank_NVIDIA-VMware_ESXi_6.7_Host_Driver_384.99-10EM.650.0.0.4598673
  VIBs Removed:
  VIBs Skipped:
```



Although the display shows “Reboot Required: false,” a reboot is necessary for the VIB file to load and for xorg to start.

6. Exit the ESXi host from maintenance mode and reboot the host by using the vSphere Web Client or by entering the following commands:

```
#esxcli system maintenanceMode set -e false
#reboot
```

7. After the host reboots successfully, verify that the kernel module has loaded successfully using the following command:

```
#esxcli software vib list | grep -i nvidia
```

The command should return output similar to that shown here:

```
# esxcli software vib list | grep -i nvidia
NVIDIA-VMware_ESXi_6.7_Host_Driver 384.99-10EM.650.0.0.4598673          NVIDIA
VMwareAccepted 2017-11-27
```



See the VMware knowledge base article for information about removing any existing NVIDIA drivers before installing new drivers:
http://kb.vmware.com/selfservice/microsites/search.do?language=en_US&cmd=displayKC&externalId=2033434.

8. Confirm GRID GPU detection on the ESXi host. To determine the status of the GPU card’s CPU, the card’s memory, and the amount of disk space remaining on the card, enter the following command:

```
#nvidia-smi
```

The command should return output similar to that shown in Figure 58, depending on the card used in your environment.

Figure 58 VMware ESX SSH Console Report for GPU P6 Card Detection on Cisco UCS B200 M5 Blade Server

```
-sh: nvidia-smi: not found
[root@M5:~] nvidia-smi
Wed Sep  6 00:43:04 2017

+-----+
| NVIDIA-SMI 384.73                Driver Version: 384.73          |
+-----+-----+-----+-----+-----+-----+
| GPU Name               Persistence-M| Bus-Id        Disp.A | Volatile Uncorr. ECC |
| Fan  Temp  Perf    Pwr:Usage/Cap|     Memory-Usage | GPU-Util  Compute M. |
+-----+-----+-----+-----+-----+-----+
| 0   Tesla P6             On          | 00000000:18:00.0 Off  |    Off                |
| N/A   21C    P8           9W /  90W |  41MiB / 16383MiB |      0%      Default  |
+-----+-----+-----+-----+-----+-----+
| 1   Tesla P6             On          | 00000000:D8:00.0 Off  |    Off                |
| N/A   35C    P8          10W /  90W |  41MiB / 16383MiB |      0%      Default  |
+-----+-----+-----+-----+-----+-----+

Processes:
GPU      PID  Type  Process name                      GPU Memory
Usage
+-----+-----+-----+-----+-----+-----+
| No running processes found      |
+-----+-----+-----+-----+-----+
[root@M5:~] █
```



The NVIDIA system management interface (SMI) also allows GPU monitoring using the following command: `nvidia-smi -l` (this command adds a loop, automatically refreshing the display).

Configure a Virtual Machine with a vGPU

To create the virtual machine that you will use as the VDI base image, follow these steps:

1. Select the ESXi host and click the Configure tab. From the list of options at the left, choose Graphics > Edit Host Graphics Settings. Select Shared Direct “Vendor shared passthrough graphics.” Reboot the system to make the changes effective.

Figure 59 Edit Host Graphics Settings

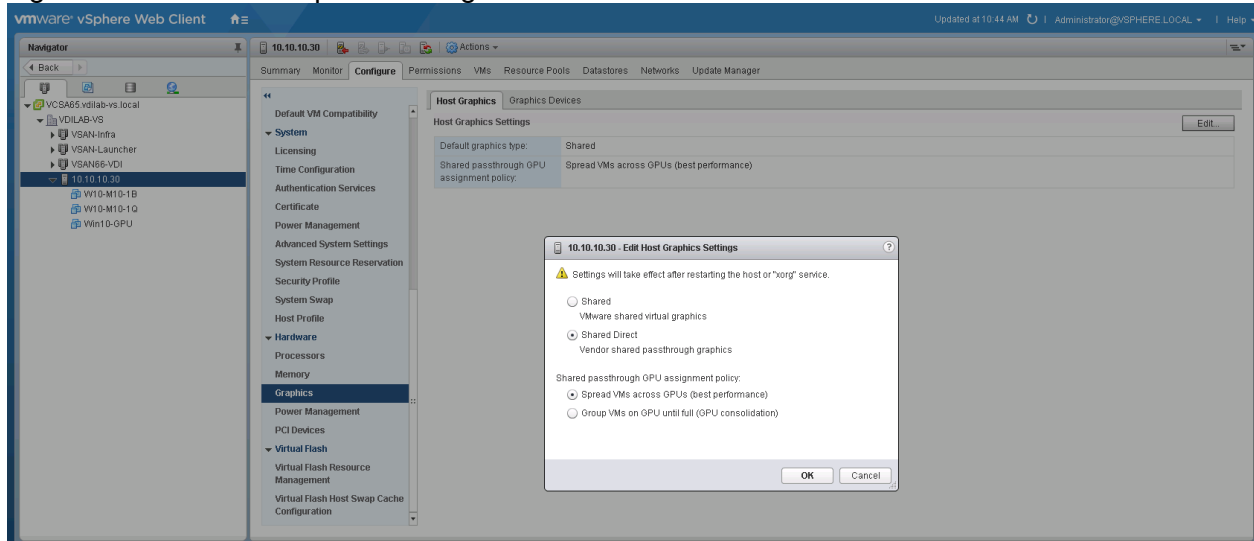

- Using the vSphere Web Client, create a new virtual machine. To do this, right-click a host or cluster and choose New Virtual Machine. Work through the New Virtual Machine wizard. Unless another configuration is specified, select the configuration settings appropriate for your environment.

Figure 60 Creating a New Virtual Machine in VMware vSphere Web Client

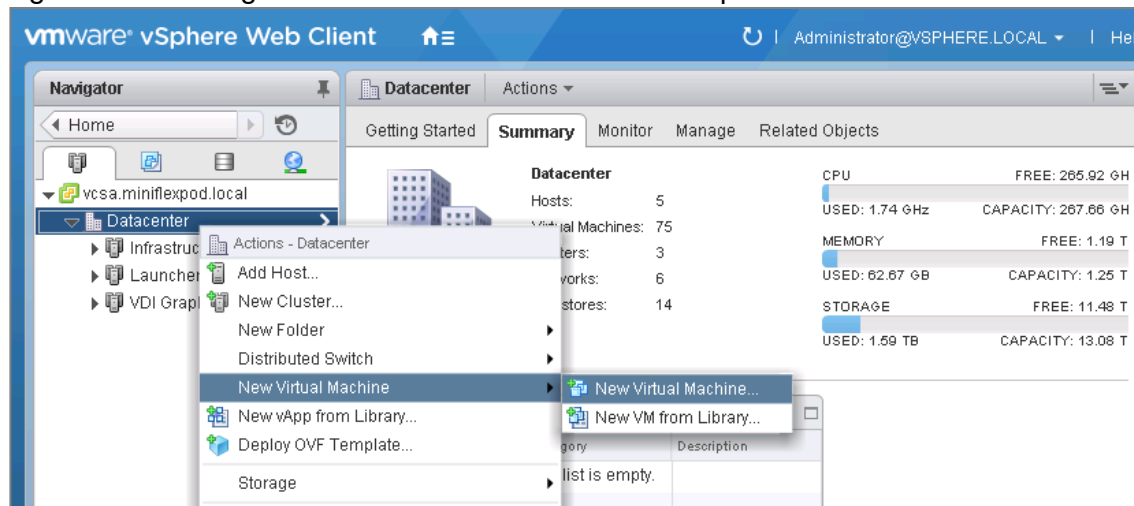

- Choose "ESXi 6.0 and later" from the "Compatible with" drop-down menu to use the latest features, including the mapping of shared PCI devices, which is required for the vGPU feature. This solution uses "ESXi 6.7 and later," which provides the latest features available in ESXi 6.7 and virtual machine hardware Version 13.

Figure 61 Selecting Virtual Machine Hardware Version 11 or Later

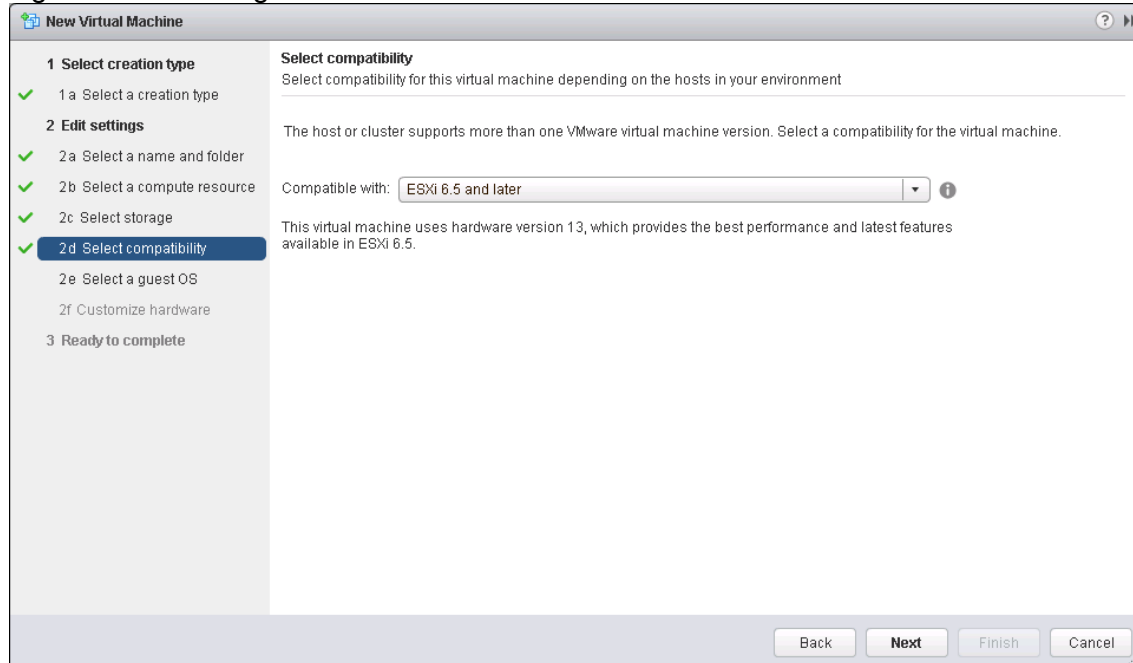

- To customize the hardware of the new virtual machine, add a new shared PCI device, select the appropriate GPU profile, and reserve all virtual machine memory.



If you are creating a new virtual machine and using the vSphere Web Client's virtual machine console functions, the mouse will not be usable in the virtual machine until after both the operating system and VMware Tools have been installed. If you cannot use the traditional vSphere Web Client to connect to the virtual machine, do not enable the NVIDIA GRID vGPU at this time.

Figure 62 Adding a Shared PCI Device to the Virtual Machine to Attach the GPU Profile



- A virtual machine with a vGPU assigned will not start if ECC is enabled. If this is the case, as a workaround disable ECC by entering the following commands:

```
# nvidia-smi -i 0 -e 0
# nvidia-smi -i 1 -e 0
```



Use `-i` to target a specific GPU. If two cards are installed in a server, run the command twice as shown in the example here, where `0` and `1` each specify a GPU card.

Figure 63 Disabling ECC

```
-sh: nvidia-smi: not found
[root@M5:~] nvidia-smi
Wed Sep  6 00:43:04 2017
-----+-----
| NVIDIA-SMI 384.73                Driver Version: 384.73          |
|-----+-----|
```

```

+-----+-----+-----+-----+-----+-----+-----+-----+
| GPU Name      Persistence-M | Bus-Id      Disp.A | Volatile Uncorr. ECC |
| Fan  Temp  Perf  Pwr:Usage/Cap|      Memory-Usage | GPU-Util  Compute M. |
+-----+-----+-----+-----+-----+-----+-----+-----+
| 0      Tesla P6             0n      | 0000:18:00.0  Off  |           0           |
| N/A    22C    P8             9W / 90W | 39MiB / 15359MiB |      0%      Default  |
+-----+-----+-----+-----+-----+-----+-----+-----+
| 1      Tesla P6             0n      | 0000:D8:00.0  Off  |           0           |
| N/A    37C    P8            10W / 90W | 39MiB / 15359MiB |      0%      Default  |
+-----+-----+-----+-----+-----+-----+-----+-----+

Processes:
+-----+-----+-----+-----+-----+-----+-----+-----+
| GPU      PID  Type  Process name      GPU Memory |
|-----+-----+-----+-----+-----+-----+-----+-----+
| No running processes found
+-----+-----+-----+-----+-----+-----+-----+-----+

[root@MS:~] esxtop -a -b -d 10 -n 600 > /vmfs/volumes/594d8376-1531284a-003b-0025b5000a2f/215U-003.csv
[root@MS:~] nvidia-smi -i 0 -e 0
-sh: nvidia-smi: not found
[root@MS:~] nvidia-smi -i 0 -e 0
Disabled ECC support for GPU 0000:18:00.0.
All done.
Reboot required.
[root@MS:~] nvidia-smi -i 1 -e 0
Disabled ECC support for GPU 0000:D8:00.0.
All done.
Reboot required.
[root@MS:~]

```

6. Install and configure Microsoft Windows on the virtual machine:
 - a. Configure the virtual machine with the appropriate amount of vCPU and RAM according to the GPU profile selected.
 - b. Install VMware Tools.
 - c. Join the virtual machine to the Microsoft Active Directory domain.
 - d. Choose "Allow remote connections to this computer" on the Windows System Properties menu.
 - e. Install or upgrade Citrix HDX 3D Pro Virtual Desktop Agent.



When you use the command-line interface (CLI) to install the VDA, include the `/enable_hdx_3d_pro` option with the `XenDesktop VdaSetup.exe` command.

- f. To upgrade HDX 3D Pro, uninstall both the separate HDX 3D for Professional Graphics component and the VDA before installing the VDA for HDX 3D Pro. Similarly, to switch from the standard VDA for a Windows desktop to the HDX 3D Pro VDA, uninstall the standard VDA and then install the VDA for HDX 3D Pro. Optimize the Windows OS. [Citrix Optimizer](#), the optimization tool, includes customizable templates to enable or disable Windows system services and features using VMware recommendations and best practices across multiple systems. Because most Windows system services are enabled by default, the optimization tool can be used to easily disable unnecessary services and features to improve performance.
- g. Restart the Windows OS when prompted to do so.

Install the GPU Drivers Inside Windows Virtual Machine



It is important to note that the drivers installed with the Windows VDI desktop must match the version that accompanies the driver for the ESXi host. So, if you downgrade or upgrade the ESXi host vib, you must do the same with the NVIDIA driver in your Windows master image.

In this study we used ESXi Host Driver version 352.83 and 354.80 for the Windows VDI image. These drivers come in the same download package from NVIDIA.

To install the GPU drivers, follow these steps:

1. Copy the Microsoft Windows drivers from the NVIDIA GRID vGPU driver pack downloaded earlier to the master virtual machine.
2. Copy the 32- or 64-bit NVIDIA Windows driver from the vGPU driver pack to the desktop virtual machine and run setup.exe.

Figure 64 NVIDIA Driver Pack

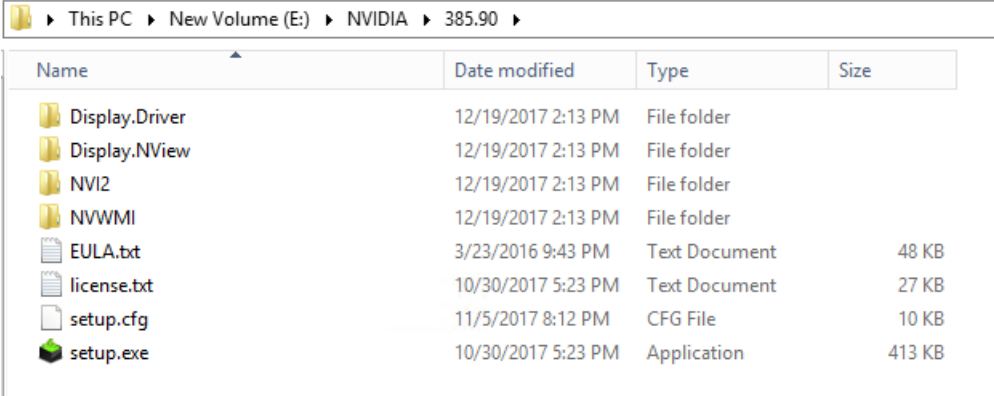

Name	Date modified	Type	Size
Display.Driver	12/19/2017 2:13 PM	File folder	
Display.NView	12/19/2017 2:13 PM	File folder	
NV12	12/19/2017 2:13 PM	File folder	
NVWMI	12/19/2017 2:13 PM	File folder	
EULA.txt	3/23/2016 9:43 PM	Text Document	48 KB
license.txt	10/30/2017 5:23 PM	Text Document	27 KB
setup.cfg	11/5/2017 8:12 PM	CFG File	10 KB
setup.exe	10/30/2017 5:23 PM	Application	413 KB



The vGPU host driver and guest driver versions need to match. **Do not** attempt to use a newer guest driver with an older vGPU host driver or an older guest driver with a newer vGPU host driver. In addition, the vGPU driver from NVIDIA is a different driver than the GPU pass-through driver.

3. Agree to the NVIDIA software license.

Figure 65 Agreeing to the NVIDIA Software License



- Install the graphics drivers using the Express or Custom option. After the installation has completed successfully, restart the virtual machine.



Make sure that remote desktop connections are enabled. After this step, console access may not be available for the virtual machine when you connect from a vSphere Client.

Figure 66 Selecting the Express or Custom Installation Option

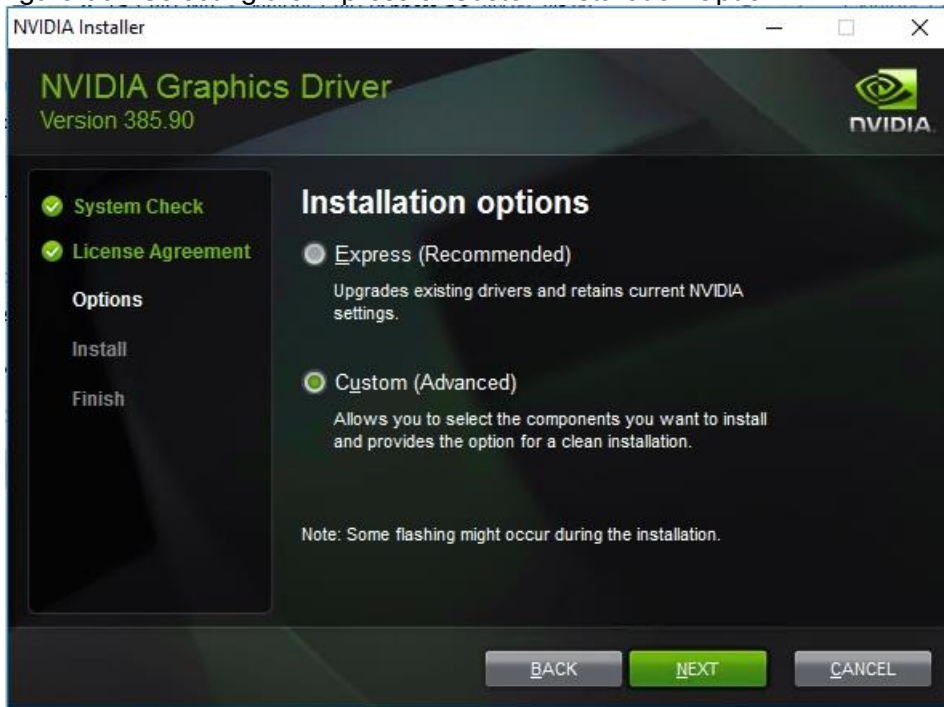

Figure 67 Components Installed During NVIDIA Graphics Driver Custom Installation Process



Figure 68 Restarting the Virtual Machine



Configure NVIDIA Grid License Server on Virtual Machine

When the License server is properly installed, you must point the master image to the license server so the virtual machines with vGPUs can obtain a license. To do so, follow these steps:

1. In the Windows Control Panel, double-click the NVidia Control Panel.

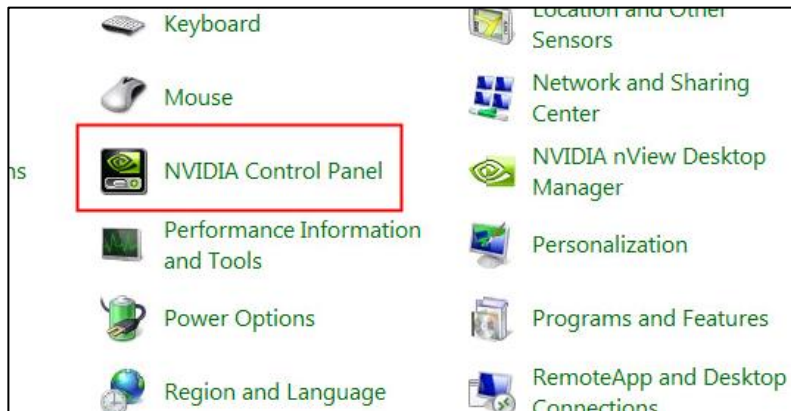

2. In the Control Panel, enter the IP or FQDN of the Grid License Server. You will receive a result similar to the one shown below.

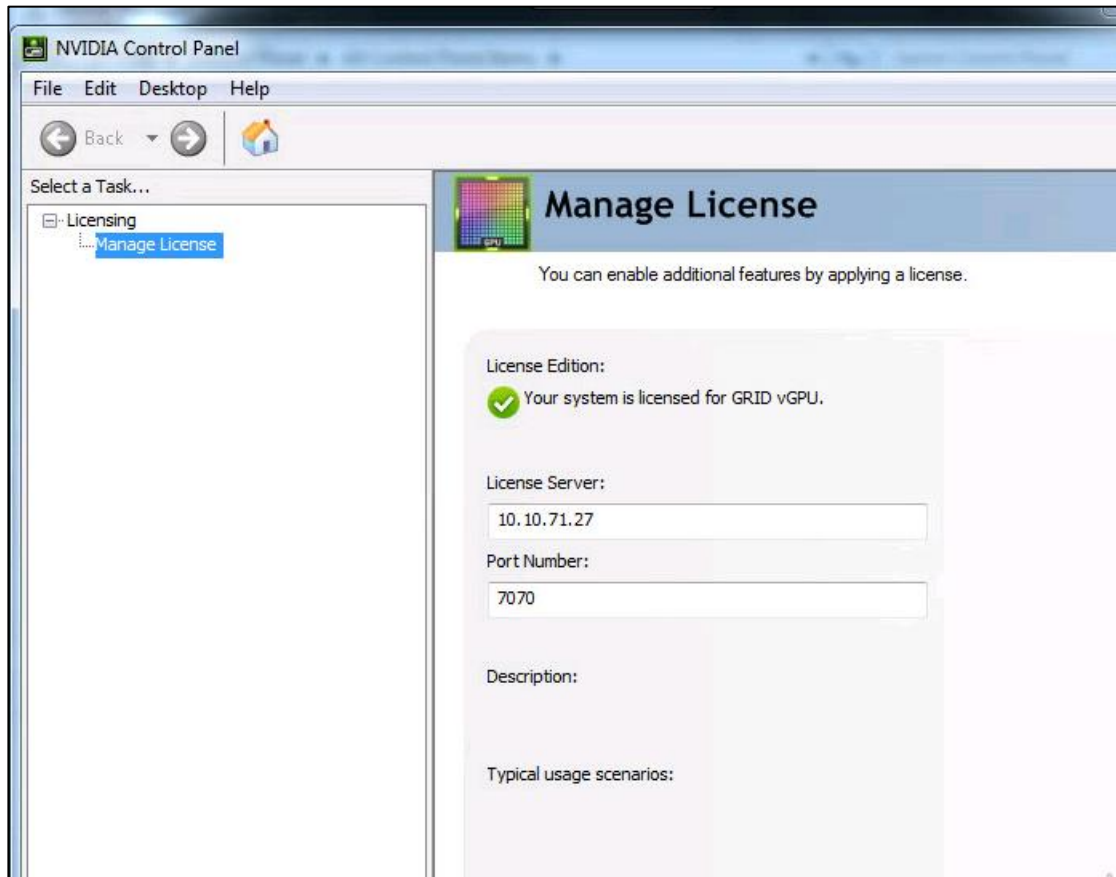

Cisco Intersight Cloud Based Management

[Cisco Intersight](#) is Cisco's new systems management platform that delivers intuitive computing through cloud-powered intelligence. This platform offers a more intelligent level of management that enables IT organizations to analyze, simplify, and automate their environments in ways that were not possible with prior generations of tools. This capability empowers organizations to achieve significant savings in Total Cost of Ownership (TCO) and to deliver applications faster, so they can support new business initiatives. The advantages of the model-based management of the Cisco UCS platform plus Cisco Intersight are extended to Cisco UCS servers and Cisco HyperFlex and Cisco HyperFlex Edge systems. Cisco HyperFlex Edge is optimized for remote sites, branch offices, and edge environments.

The Cisco UCS and Cisco HyperFlex platforms use model-based management to provision servers and the associated storage and fabric automatically, regardless of form factor. Cisco Intersight works in conjunction with Cisco UCS Manager and the Cisco® Integrated Management Controller (IMC). By simply associating a model-based configuration with a resource through service profiles, your IT staff can consistently align policy, server personality, and workloads. These policies can be created once and used by IT staff with minimal effort to deploy servers. The result is improved productivity and compliance and lower risk of failures due to inconsistent configuration.

Cisco Intersight will be integrated with data center, hybrid cloud platforms, and services to securely deploy and manage infrastructure resources across data center and edge environments. In addition, Cisco will provide future integrations to third-party operations tools to allow customers to use their existing solutions more effectively.

Figure 69 Cisco Intersight Includes a User-Customizable Dashboard; Example of Cisco Intersight Dashboard for FlashStack UCS Domain

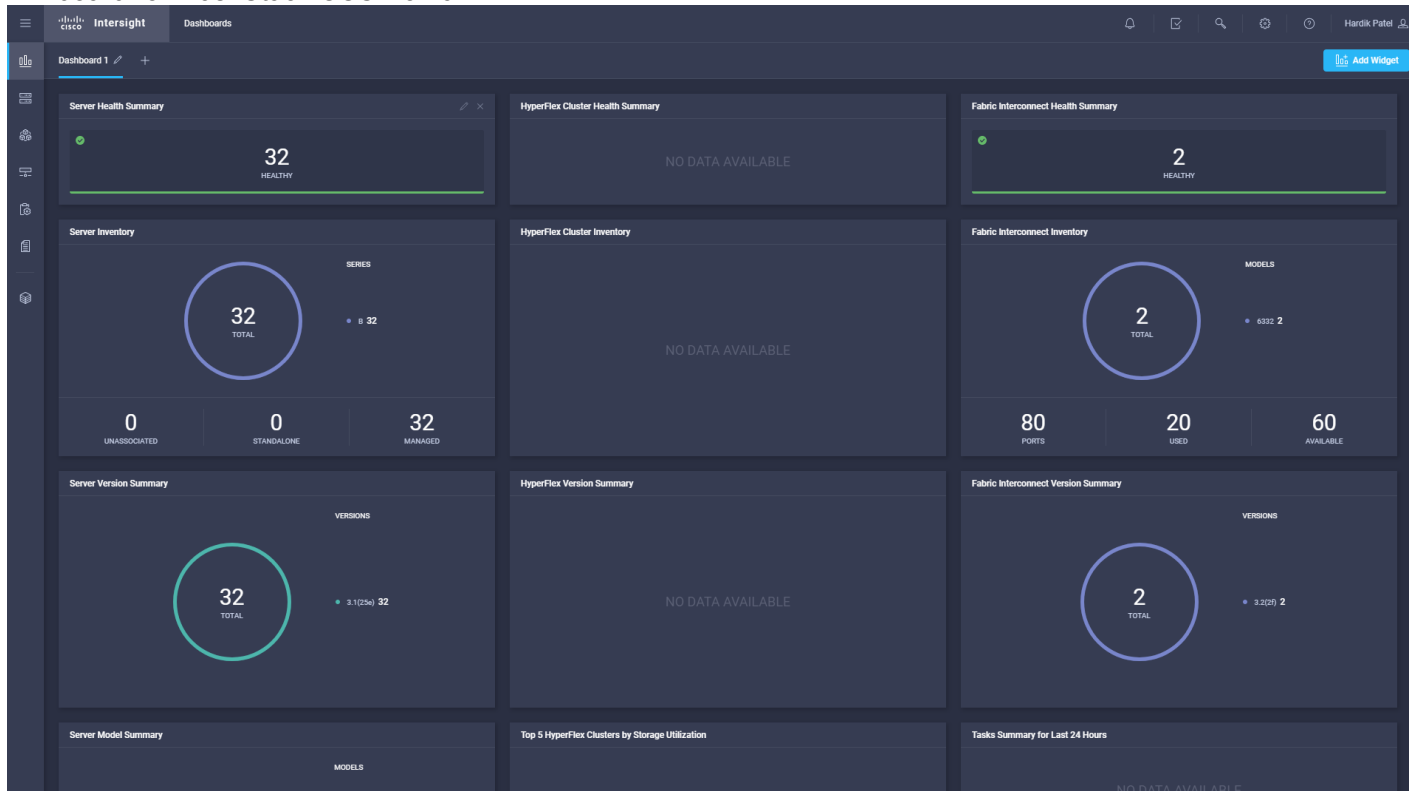

Test Setup, Configuration, and Load Recommendation

In this solution, we tested a single Cisco UCS B200 M5 blade to validate against the performance of one blade and thirty B200 M5 blades across four chassis to illustrate linear scalability for each workload use case studied.

Cisco UCS Test Configuration for Single Blade Scalability

This test case validates each workload on a single blade to determine the Recommended Maximum Workload per host server using XenApp/XenDesktop 7.15 with 270 HSD sessions, 205 HVD Non-Persistent sessions, and 205 HVD Persistent sessions.

Figure 70 Cisco UCS B200 M5 Blade Server for Single Server Scalability XenApp 7.15 HSD with PVS 7.15

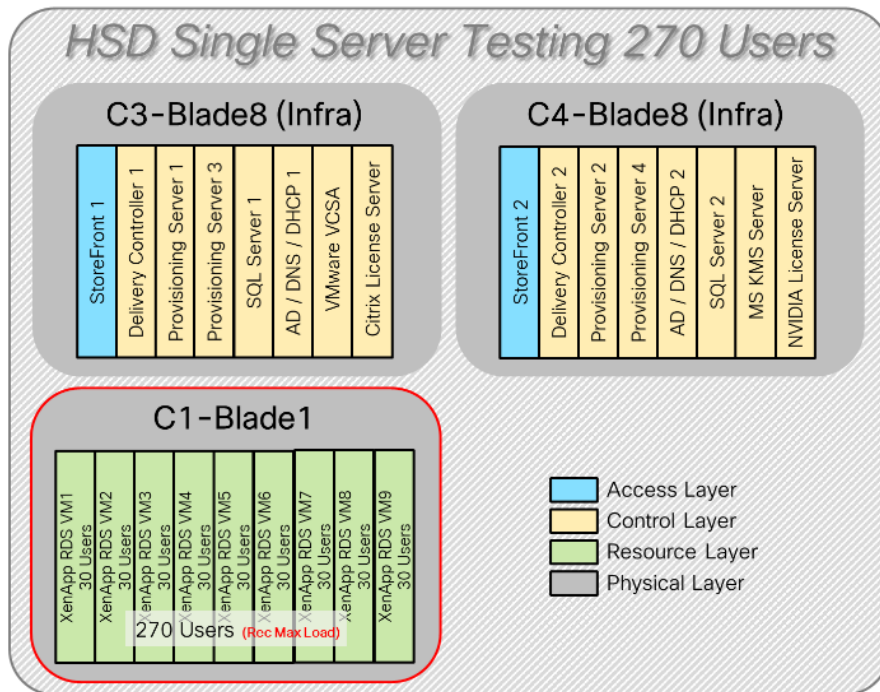

Figure 71 Cisco UCS B200 M5 Blade Server for Single Server Scalability XenDesktop 7.15 HVD (Non-Persistent) with PVS 7.15

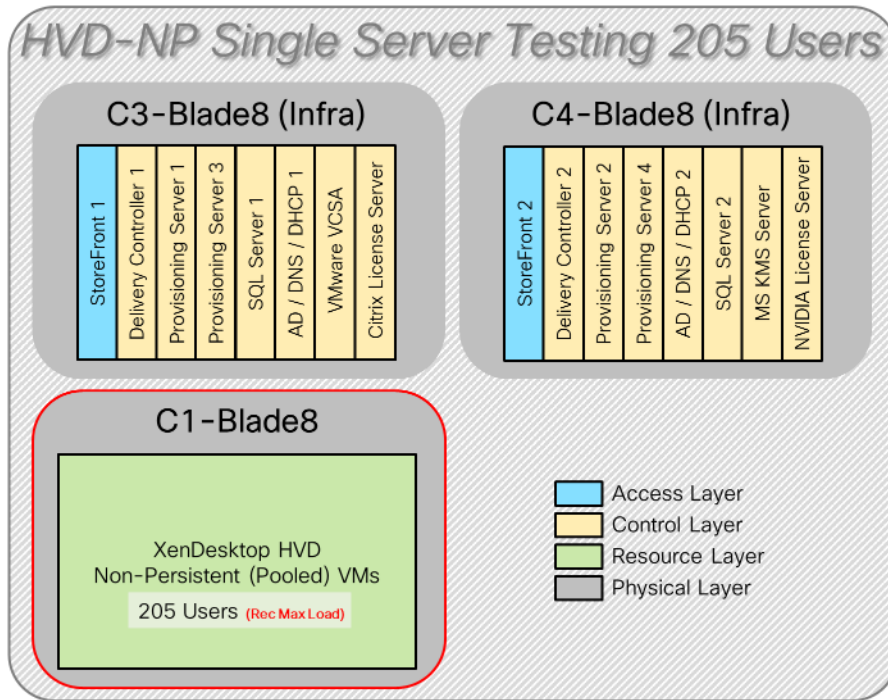
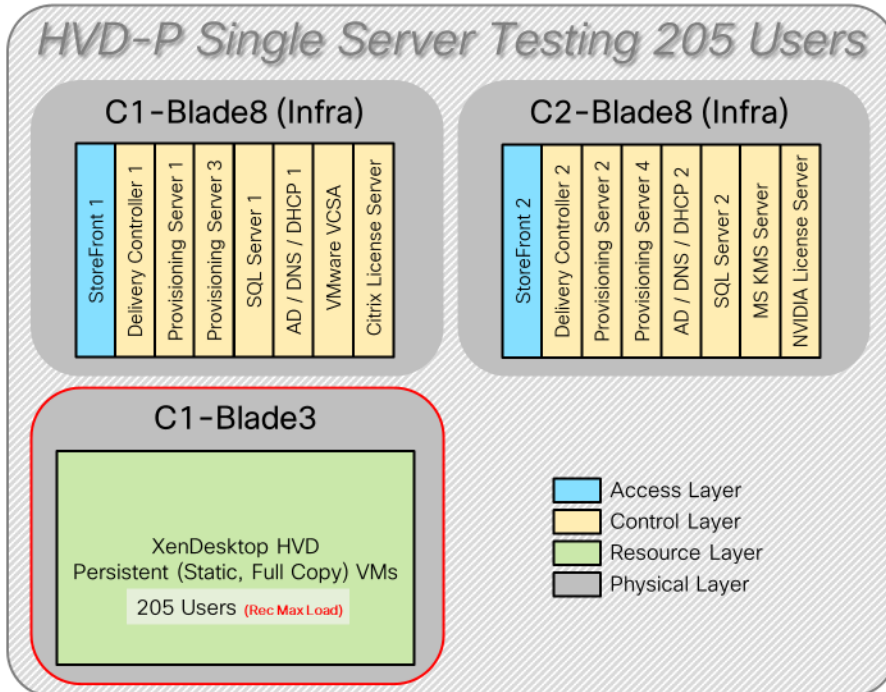

Figure 72 Cisco UCS B200 M5 Blade Server for Single Server Scalability XenDesktop 7.15 HVD (Persistent) MCS Full Clones



Hardware components:

- Cisco UCS 5108 Blade Server Chassis

- 2 Cisco UCS 6332 - 16 UP Fabric Interconnects
- 2 (Infrastructure Hosts) Cisco UCS B200 M5 Blade servers with Intel Xeon Silver 4114 2.20-GHz 10-core processors, 192GB 2400MHz RAM for all host blades
- 1 (RDS/VDI Host) Cisco UCS B200 M5 Blade Servers with Intel Xeon Gold 6140 2.30-GHz 18-core processors, 768GB 2666MHz RAM for all host blades
- Cisco VIC 1340 CNA (1 per blade)
- 2 Cisco Nexus 93180YC-FX Access Switches
- 2 Cisco MDS 9132T 32-Gbps 32-Port Fibre Channel Switches
- 1 • Pure Storage FlashArray//X70 R2 with dual redundant controllers, with Twenty 1.92TB DirectFlash NVMe drives

Software components:

- Cisco UCS firmware 4.0(2b)
- PureStorage Purity//FA 5.1.7
- VMware ESXi 6.7 Update 1 for host blades
- Citrix XenApp/XenDesktop 7.15 LTSR CU3 VDI Hosted Virtual Desktops and RDS Hosted Shared Desktops
- Citrix Provisioning Server 7.15 LTSR CU3
- Citrix User Profile Manager
- Microsoft SQL Server 2016 SP1
- Microsoft Windows 10 64 bit (1607), 2vCPU, 2 GB RAM, 32 GB vDisk (master)
- Microsoft Windows Server 2016 (1607), 9vCPU, 24GB RAM, 40 GB vDisk (master)
- Microsoft Office 2016
- Login VSI 4.1.32 Knowledge Worker Workload (Benchmark Mode)
- Cisco UCS Configuration for Cluster Testing

This test case validates three workload clusters using XenApp/XenDesktop 7.15 LTSR CU3 with 1900 HSD sessions, 2050 HVD Non-Persistent sessions, and 2050 HVD Persistent sessions. Server N+1 fault tolerance is factored into this test scenario for each workload and infrastructure cluster.

Figure 73 HSD Cluster Test Configuration with Eight Blades

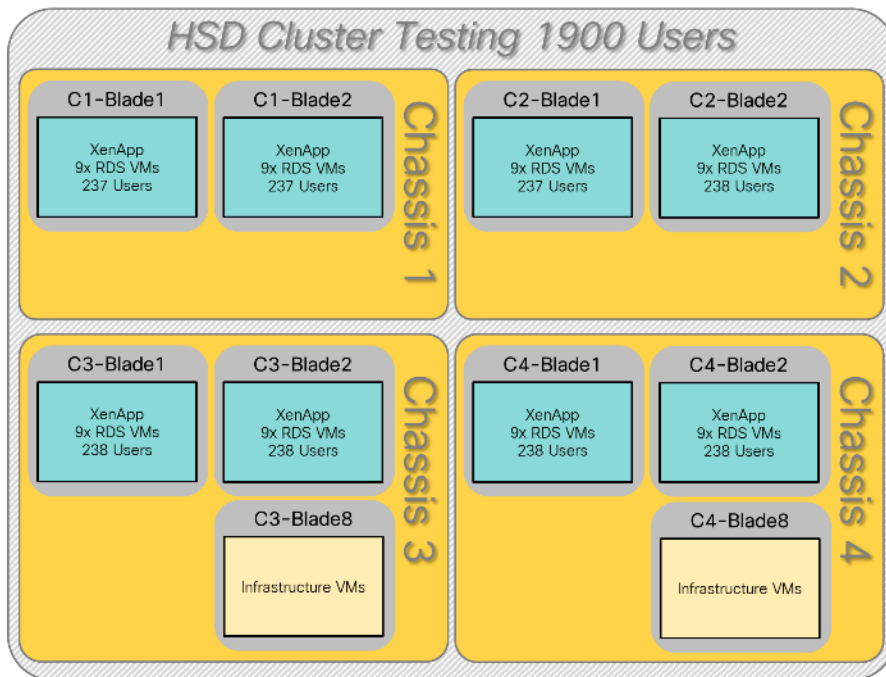

Figure 74 HVD Persistent Cluster Test Configuration with Eleven Blades

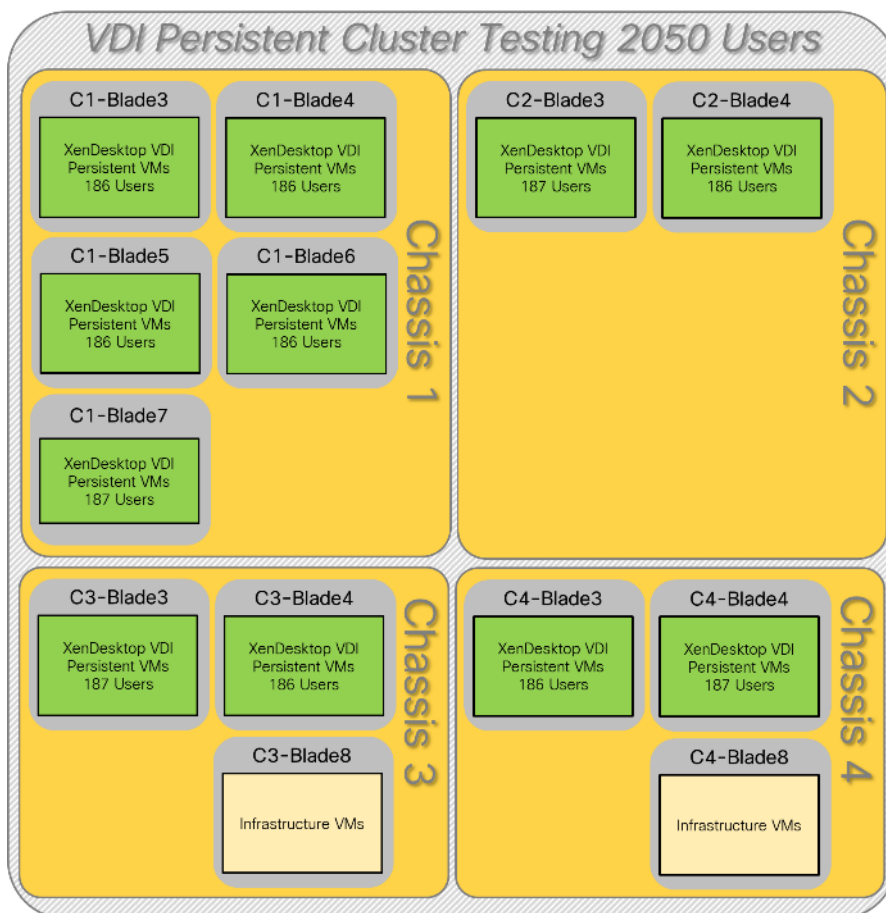
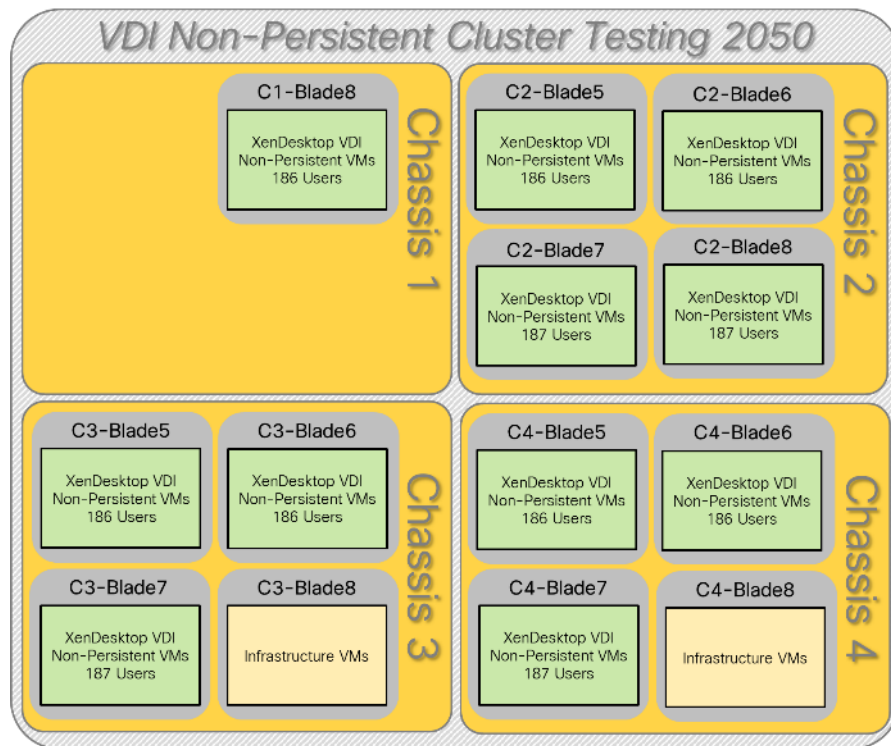

Figure 75 HVD Non-Persistent Cluster Test Configuration with Eleven Blades



Cisco UCS Configuration for Full Scale Testing

This test case validates twenty-eight blades mixed workloads using XenApp/XenDesktop 7.15 LTSR CU3 with 1,900 HSD sessions, 2,050 HVD Non-Persistent sessions, and 2,050 HVD Persistent sessions for a total sum of 6,000 users. Server N+1 fault tolerance is factored into this solution for each workload and infrastructure cluster.

Figure 76 Full Scale Test Configuration with Thirty Blades

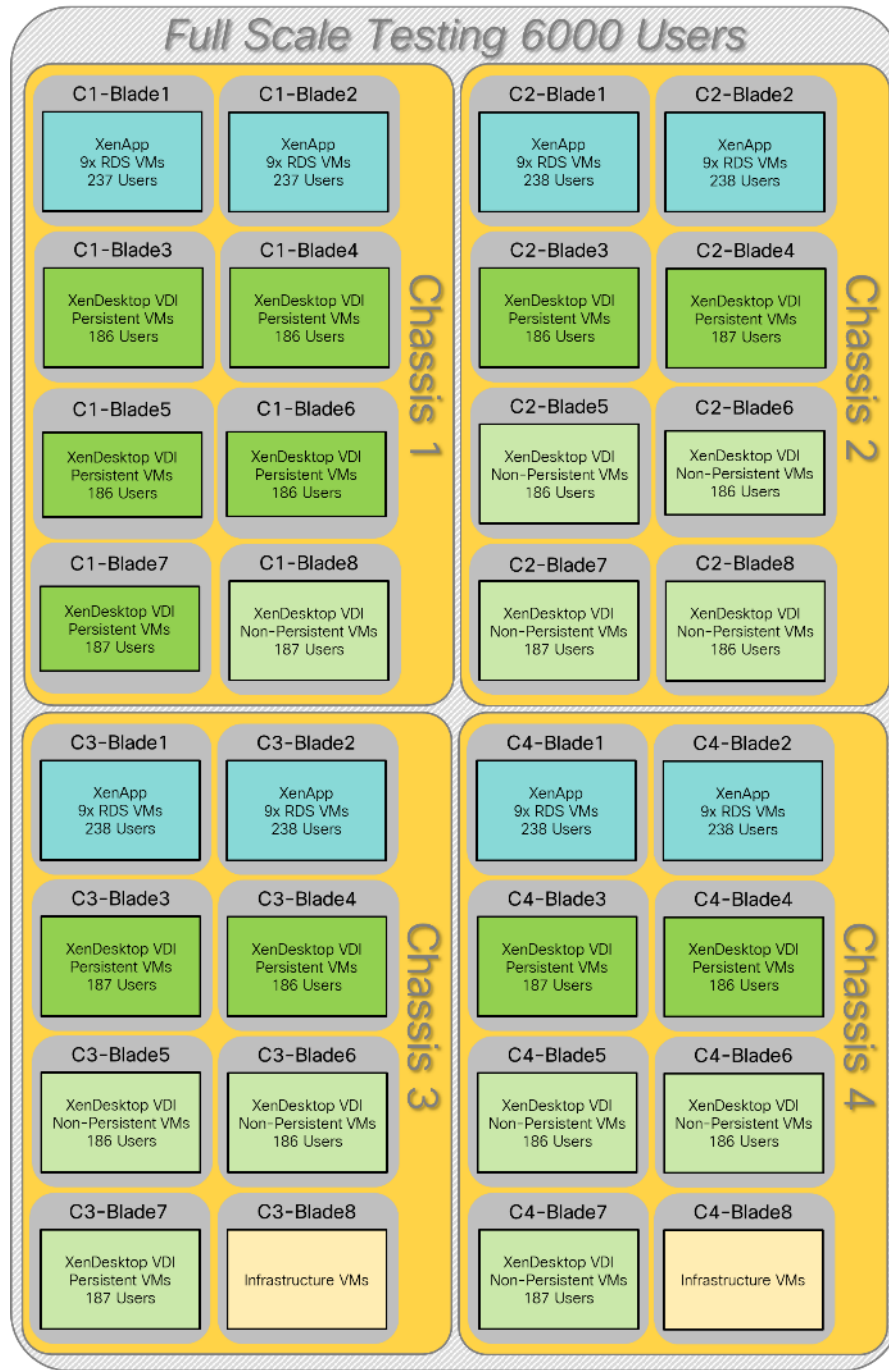

Hardware and Software Components

Hardware components:

- Cisco UCS 5108 Blade Server Chassis
- 2 Cisco UCS 6332 - 16 UP Fabric Interconnects

- 2 (Infrastructure Hosts) Cisco UCS B200 M5 Blade servers with Intel Xeon Silver 4114 2.20-GHz 10-core processors, 192GB 2400MHz RAM for all host blades
- 8 (RDS Host) Cisco UCS B200 M5 Blade Servers with Intel Xeon Gold 6140 2.30-GHz 18-core processors, 768GB 2666MHz RAM for all host blades
- 22 (VDI Host) Cisco UCS B200 M5 Blade Servers with Intel Xeon Gold 6140 2.30-GHz 18-core processors, 768GB 2666MHz RAM for all host blades
- Cisco VIC 1340 CNA (1 per blade)
- 2 Cisco Nexus 93180YC-FX Access Switches
- 2 Cisco MDS 9132T 32-Gbps 32-Port Fibre Channel Switches
- 1 Pure Storage FlashArray//X70 R2 with dual redundant controllers, with Twenty 1.92TB DirectFlash NVMe drives

Software components:

- Cisco UCS firmware 4.0(2b)
- PureStorage Purity//FA 5.1.7
- VMware ESXi 6.7 Update 1 for host blades
- Citrix XenApp/XenDesktop 7.15 LTSR CU3 VDI Hosted Virtual Desktops and RDS Hosted Shared Desktops
- Citrix Provisioning Server 7.15 LTSR CU3
- Citrix User Profile Manager 7.15
- Microsoft SQL Server 2016 SP1
- Microsoft Windows 10 64 bit (1607), 2vCPU, 2 GB RAM, 32 GB vDisk (master)
- Microsoft Windows Server 2016 (1607), 9vCPU, 24GB RAM, 40 GB vDisk (master)
- Microsoft Office 2016
- Login VSI 4.1.32 Knowledge Worker Workload (Benchmark Mode)

Test Methodology and Success Criteria

All validation testing was conducted on-site within the Cisco labs in San Jose, California.

The testing results focused on the entire process of the virtual desktop lifecycle by capturing metrics during the desktop boot-up, user logon and virtual desktop acquisition (also referred to as ramp-up,) user workload execution (also referred to as steady state), and user logoff for the RDSH Servers Session under test.

Test metrics were gathered from the virtual desktop, storage, and load generation software to assess the overall success of an individual test cycle. Each test cycle was not considered passing unless all of the planned test users completed the ramp-up and steady state phases (described below) and unless all metrics were within the permissible thresholds as noted as success criteria.

Three successfully completed test cycles were conducted for each hardware configuration and results were found to be relatively consistent from one test to the next.

You can obtain additional information and a free test license from <http://www.loginvsi.com>

Test Procedure

The following protocol was used for each test cycle in this study to ensure consistent results.

Pre-Test Setup for Single and Multi-Blade Testing

All virtual machines were shut down utilizing the XenDesktop Administrator and vCenter.

All Launchers for the test were shut down. They were then restarted in groups of 10 each minute until the required number of launchers was running with the Login VSI Agent at a “waiting for test to start” state.

All VMware ESXi VDI host blades to be tested were restarted prior to each test cycle.

Test Run Protocol

To simulate severe, real-world environments, Cisco requires the log-on and start-work sequence, known as Ramp Up, to complete in 48 minutes. For testing where the user session count exceeds 1000 users, we will now deem the test run successful with up to 0.5% session failure rate.

In addition, Cisco requires that the Login VSI Benchmark method is used for all single server and scale testing. This assures that our tests represent real-world scenarios. For each of the three consecutive runs on single server tests, the same process was followed. To do so, follow these steps:

1. Time 0:00:00 Start PerfMon/Esxstop/XenServer Logging on the following systems:
 - a. Infrastructure and VDI Host Blades used in the test run
 - b. SCVMM/vCenter used in the test run
 - c. All Infrastructure virtual machines used in test run (AD, SQL, brokers, image mgmt., etc.)
2. Time 0:00:10 Start Storage Partner Performance Logging on Storage System.
3. Time 0:05: Boot Virtual Desktops/RDS Virtual Machines using XenDesktop Studio or View Connection server.



The boot rate should be around 10-12 virtual machines per minute per server.

4. Time 0:06 First machines boot.
5. Time 0:30 Single Server or Scale target number of desktop virtual machines booted on 1 or more blades.



No more than 30 minutes for boot up of all virtual desktops is allowed.

6. Time 0:35 Single Server or Scale target number of desktop virtual machines desktops registered on XD Studio or available on View Connection Server.
7. Virtual machine settling time.



No more than 60 Minutes of rest time is allowed after the last desktop is registered on the XD Studio or available in View Connection Server dashboard. Typically, a 30-40 minute rest period is sufficient.

8. Time 1:35 Start Login VSI 4.1.x Office Worker Benchmark Mode Test, setting auto-logoff time at 900 seconds, with Single Server or Scale target number of desktop virtual machines utilizing sufficient number of Launchers (at 20-25 sessions/Launcher).
9. Time 2:23 Single Server or Scale target number of desktop virtual machines desktops launched (48 minute benchmark launch rate).
10. Time 2:25 All launched sessions must become active.



All sessions launched must become active for a valid test run within this window.

11. Time 2:40 Login VSI Test Ends (based on Auto Logoff 900 Second period designated above).
12. Time 2:55 All active sessions logged off.
13. Time 2:57 All logging terminated; Test complete.
14. Time 3:15 Copy all log files off to archive; Set virtual desktops to maintenance mode through broker; Shut-down all Windows machines.
15. Time 3:30 Reboot all hypervisor hosts.
16. Time 3:45 Ready for the new test sequence.

Success Criteria

Our “pass” criteria for this testing is as follows:

Cisco will run tests at a session count level that effectively utilizes the blade capacity measured by CPU utilization, memory utilization, storage utilization, and network utilization. We will use Login VSI to launch version 4.1.x Office Worker workloads. The number of launched sessions must equal active sessions within two minutes of the last session launched in a test as observed on the VSI Management console.

The Citrix Desktop Studio be monitored throughout the steady state to make sure of the following:

- All running sessions report In Use throughout the steady state
- No sessions move to unregistered, unavailable or available state at any time during steady state

Within 20 minutes of the end of the test, all sessions on all launchers must have logged out automatically and the Login VSI Agent must have shut down. Stuck sessions define a test failure condition.

Cisco requires three consecutive runs with results within +/-1% variability to pass the Cisco Validated Design performance criteria. For white papers written by partners, two consecutive runs within +/-1% variability are accepted. (All test data from partner run testing must be supplied along with the proposed white paper.)

We will publish Cisco Validated Designs with our recommended workload following the process above and will note that we did not reach a VSImax dynamic in our testing. FlashStack Data Center with Cisco UCS and Citrix XenApp/XenDesktop 7.15 LTSR on VMware ESXi 6.7 Update 1 Test Results

The purpose of this testing is to provide the data needed to validate Citrix XenApp Hosted Shared Desktop (RDS) and Citrix XenDesktop Hosted Virtual Desktop (VDI) randomly assigned, non-persistent with Citrix Provisioning Services 7.15 LTSR and Citrix XenDesktop Hosted Virtual Desktop (VDI) statically assigned, persistent full-clones models using ESXi and vCenter to virtualize Microsoft Windows 10 desktops and Microsoft Windows Server 2016 sessions on Cisco UCS B200 M5 Blade Servers using the Pure Storage FlashArray//X70 R2 storage system.

The information contained in this section provides data points that a customer may reference in designing their own implementations. These validation results are an example of what is possible under the specific environment conditions outlined here, and do not represent the full characterization of Citrix products with VMware vSphere.

Four test sequences, each containing three consecutive test runs generating the same result, were performed to establish single blade performance and multi-blade, linear scalability.

VSImax 4.1.x Description

The philosophy behind Login VSI is different from conventional benchmarks. In general, most system benchmarks are steady state benchmarks. These benchmarks execute one or multiple processes, and the measured execution time is the outcome of the test. Simply put: the faster the execution time or the bigger the throughput, the faster the system is according to the benchmark.

Login VSI is different in approach. Login VSI is not primarily designed to be a steady state benchmark (however, if needed, Login VSI can act like one). Login VSI was designed to perform benchmarks for SBC or VDI workloads through system saturation. Login VSI loads the system with simulated user workloads using well known desktop applications like Microsoft Office, Internet Explorer, and Adobe PDF reader. By gradually increasing the amount of simulated users, the system will eventually be saturated. Once the system is saturated, the response time of the applications will increase significantly. This latency in application response times show a clear indication whether the system is (close to being) overloaded. As a result, by nearly overloading a system it is possible to find out what its true maximum user capacity is.

After a test is performed, the response times can be analyzed to calculate the maximum active session/desktop capacity. Within Login VSI this is calculated as VSImax. When the system is coming closer to its saturation point, response times will rise. When reviewing the average response time, it will be clear the response times escalate at saturation point.

This VSImax is the "Virtual Session Index (VSI)". With Virtual Desktop Infrastructure (VDI) and Terminal Services (RDS) workloads this is valid and useful information. This index simplifies comparisons and makes it possible to understand the true impact of configuration changes on hypervisor host or guest level.

Server-Side Response Time Measurements

It is important to understand why specific Login VSI design choices have been made. An important design choice is to execute the workload directly on the target system within the session instead of using remote sessions. The scripts simulating the workloads are performed by an engine that executes workload scripts on every target system and are initiated at logon within the simulated user's desktop session context.

An alternative to the Login VSI method would be to generate user actions client side through the remoting protocol. These methods are always specific to a product and vendor dependent. More importantly, some protocols simply do not have a method to script user actions client side.

For Login VSI, the choice has been made to execute the scripts completely server side. This is the only practical and platform independent solution, for a benchmark like Login VSI.

Calculating VSImax v4.1.x

The simulated desktop workload is scripted in a 48 minute loop when a simulated Login VSI user is logged on, performing generic Office worker activities. After the loop is finished it will restart automatically. Within each loop, the response times of sixteen specific operations are measured in a regular interval: sixteen times in within each loop. The response times of these five operations are used to determine VSImax.

The five operations from which the response times are measured are:

- Notepad File Open (NFO)

Loading and initiating VSINotepad.exe and opening the openfile dialog. This operation is handled by the OS and by the VSINotepad.exe itself through execution. This operation seems almost instant from an end-user's point of view.

- Notepad Start Load (NSLD)

Loading and initiating VSINotepad.exe and opening a file. This operation is also handled by the OS and by the VSINotepad.exe itself through execution. This operation seems almost instant from an end-user's point of view.

- Zip High Compression (ZHC)

This action copy's a random file and compresses it (with 7zip) with high compression enabled. The compression will very briefly spike CPU and disk IO.

- Zip Low Compression (ZLC)

This action copy's a random file and compresses it (with 7zip) with low compression enabled. The compression will very briefly disk IO and creates some load on the CPU.

- CPU

Calculates a large array of random data and spikes the CPU for a short period of time.

These measured operations within Login VSI do hit considerably different subsystems such as CPU (user and kernel), Memory, Disk, the OS in general, the application itself, print, GDI, etc. These operations are specifically short by nature. When such operations become consistently long: the system is saturated because of excessive queuing on any kind of resource. As a result, the average response times will then escalate. This effect is clearly visible to end-users. If such operations consistently consume multiple seconds the user will regard the system as slow and unresponsive.

Figure 77 Sample of a VSI Max Response Time Graph, Representing a Normal Test



Figure 78 Sample of a VSI Test Response Time Graph with a Performance Issue

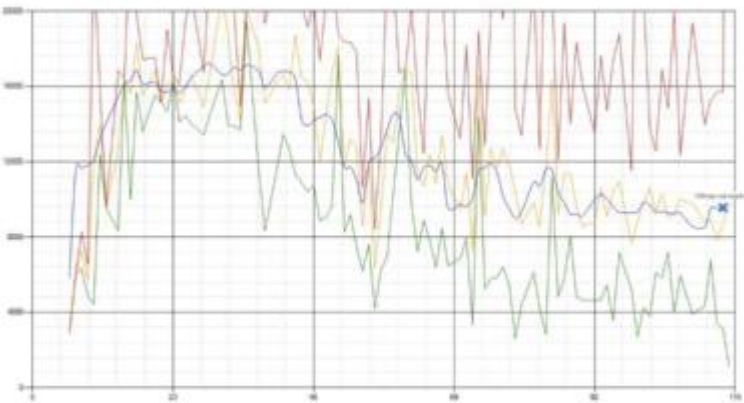

When the test is finished, VSI_{max} can be calculated. When the system is not saturated, and it could complete the full test without exceeding the average response time latency threshold, VSI_{max} is not reached and the amount of sessions ran successfully.

The response times are very different per measurement type, for instance Zip with compression can be around 2800 ms, while the Zip action without compression can only take 75ms. These response time of these actions are weighted before they are added to the total. This ensures that each activity has an equal impact on the total response time.

In comparison to previous VSI_{max} models, this weighting much better represents system performance. All actions have very similar weight in the VSI_{max} total. The following weighting of the response times is applied.

The following actions are part of the VSI_{max} v4.1.x calculation and are weighted as follows (US notation):

- Notepad File Open (NFO): 0.75
- Notepad Start Load (NSLD): 0.2
- Zip High Compression (ZHC): 0.125
- Zip Low Compression (ZLC): 0.2
- CPU: 0.75

This weighting is applied on the baseline and normal Login VSI response times.

With the introduction of Login VSI 4.1.x, we also created a new method to calculate the basephase of an environment. With the new workloads (Taskworker, Powerworker, and so on) enabling 'basephase' for a more reliable baseline has become obsolete. The calculation is explained below. In total the 15 lowest VSI response time samples are taken from the entire test, the lowest 2 samples are removed, and the 13 remaining samples are averaged. The result is the Baseline. To summarize:

- Take the lowest 15 samples of the complete test
- From those 15 samples remove the lowest 2
- Average the 13 results that are left is the baseline

The VSImax average response time in Login VSI 4.1.x is calculated on the number of active users that are logged on the system.

Always a 5 Login VSI response time samples are averaged + 40 percent of the amount of “active” sessions. For example, if the active sessions are 60, then latest 5 + 24 (=40 percent of 60) = 31 response time measurement is used for the average calculation.

To remove noise (accidental spikes) from the calculation, the top 5 percent and bottom 5 percent of the VSI response time samples are removed from the average calculation, with a minimum of 1 top and 1 bottom sample. As a result, with 60 active users, the last 31 VSI response time sample are taken. From those 31 samples, the top 2 samples are removed, and the lowest 2 results are removed (5 percent of 31 = 1.55, rounded to 2). At 60 users the average is then calculated over the 27 remaining results.

VSImax v4.1.x is reached when the VSIBase + a 1000 ms latency threshold is not reached by the average VSI response time result. Depending on the tested system, VSImax response time can grow 2 - 3x the baseline average. In end-user computing, a 3x increase in response time in comparison to the baseline is typically regarded as the maximum performance degradation to be considered acceptable.

In VSImax v4.1.x this latency threshold is fixed to 1000ms, this allows better and fairer comparisons between two different systems, especially when they have different baseline results. Ultimately, in VSImax v4.1.x, the performance of the system is not decided by the total average response time, but by the latency is has under load. For all systems, this is now 1000ms (weighted).

The threshold for the total response time is: average weighted baseline response time + 1000ms.

When the system has a weighted baseline response time average of 1500ms, the maximum average response time may not be greater than 2500ms (1500+1000). If the average baseline is 3000 the maximum average response time may not be greater than 4000ms (3000+1000).

When the threshold is not exceeded by the average VSI response time during the test, VSImax is not hit and the number of sessions ran successfully. This approach is fundamentally different in comparison to previous VSImax methods, as it was always required to saturate the system beyond VSImax threshold.

Lastly, VSImax v4.1.x is now always reported with the average baseline VSI response time result. For example: “The VSImax v4.1.x was 125 with a baseline of 1526ms”. This helps considerably in the comparison of systems and gives a more complete understanding of the system. The baseline performance helps to understand the best performance the system can give to an individual user. VSImax indicates what the total user capacity is for the system. These two are not automatically connected and related:

When a server with a very fast dual core CPU, running at 3.6 GHz, is compared to a 10 core CPU, running at 2,26 GHz, the dual core machine will give an individual user better performance than the 10 core machine. This is indicated by the baseline VSI response time. The lower this score is, the better performance an individual user can expect.

However, the server with the slower 10 core CPU will easily have a larger capacity than the faster dual core system. This is indicated by VSI_{max} v4.1.x, and the higher VSI_{max} is, the larger overall user capacity can be expected.

With Login VSI 4.1.x a new VSI_{max} method is introduced: VSI_{max} v4.1.x. This methodology gives much better insight into system performance and scales to extremely large systems.

Single-Server Recommended Maximum Workload

For both the Citrix XenDesktop 7.15 Hosted Virtual Desktop and Citrix XenApp 7.15 RDS Hosted Shared Desktop use cases, a recommended maximum workload was determined by the Login VSI Knowledge Worker Workload in VSI Benchmark Mode end user experience measurements and blade server operating parameters.

This recommended maximum workload approach allows you to determine the server N+1 fault tolerance load the blade can successfully support in the event of a server outage for maintenance or upgrade.

Our recommendation is that the Login VSI Average Response and VSI Index Average should not exceed the Baseline plus 2000 milliseconds to ensure that end user experience is outstanding. Additionally, during steady state, the processor utilization should average no more than 90-95 percent.

 **Memory should never be oversubscribed for Desktop Virtualization workloads.**

Figure 79 Phases of Test Runs

Test Phase	Description
Boot	Start all RDS and VDI virtual machines at the same time
Idle	The rest time after the last desktop is registered on the XD Studio. (typically, a 30-40 minute, <60 min)
Logon	The Login VSI phase of the test is where sessions are launched and start executing the workload over a 48 minutes duration
Steady state	The steady state phase is where all users are logged in and performing various workload tasks such as using Microsoft Office, Web browsing, PDF printing, playing videos, and compressing files (typically for the 15-minute duration)
Logoff	Sessions finish executing the Login VSI workload and logoff

Test Results

Single-Server Recommended Maximum Workload Testing

This section shows the key performance metrics that were captured on the Cisco UCS host blades during the single server testing to determine the Recommended Maximum Workload per host server. The single server testing comprised of three tests: 270 HSD sessions, 205 HVD Non-Persistent sessions, and 205 HVD Persistent sessions.

Single-Server Recommended Maximum Workload for HSD with 270 Users

Figure 80 Single Server Recommended Maximum Workload for HSD with 270 Users

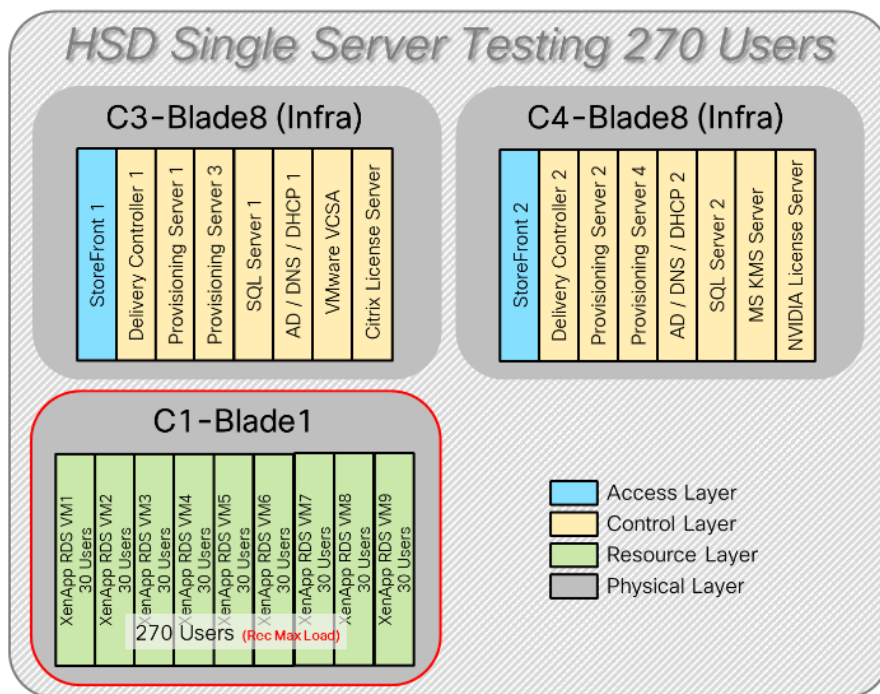

The recommended maximum workload for a Cisco UCS B200 M5 blade server with dual Intel Xeon Gold 6140 processors, 768GB 2666MHz RAM is 270 Server 2016 Hosted Shared Desktops. Each dedicated blade server ran 9 Server 2016 Virtual Machines. Each virtual server was configured with 9 vCPUs and 24GB RAM.

Figure 81 Single Server Recommended Maximum Workload | XenApp 7.15 HSD | VSI Score

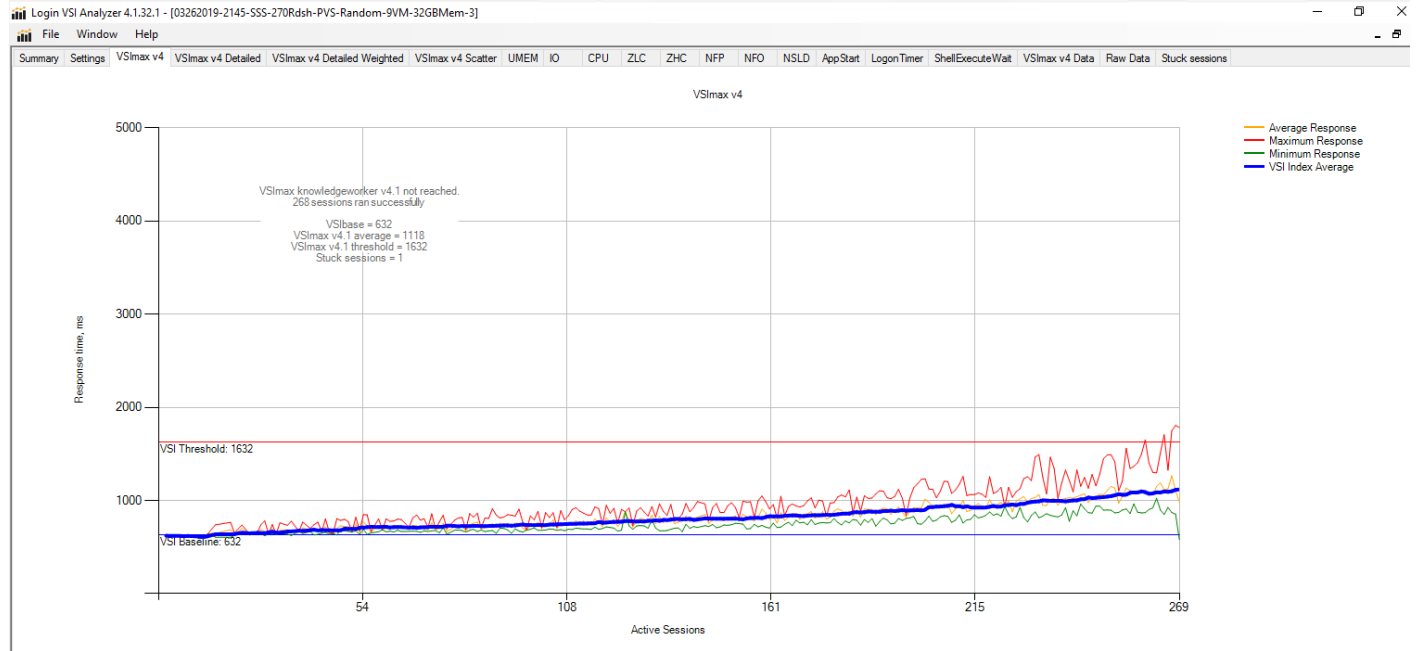
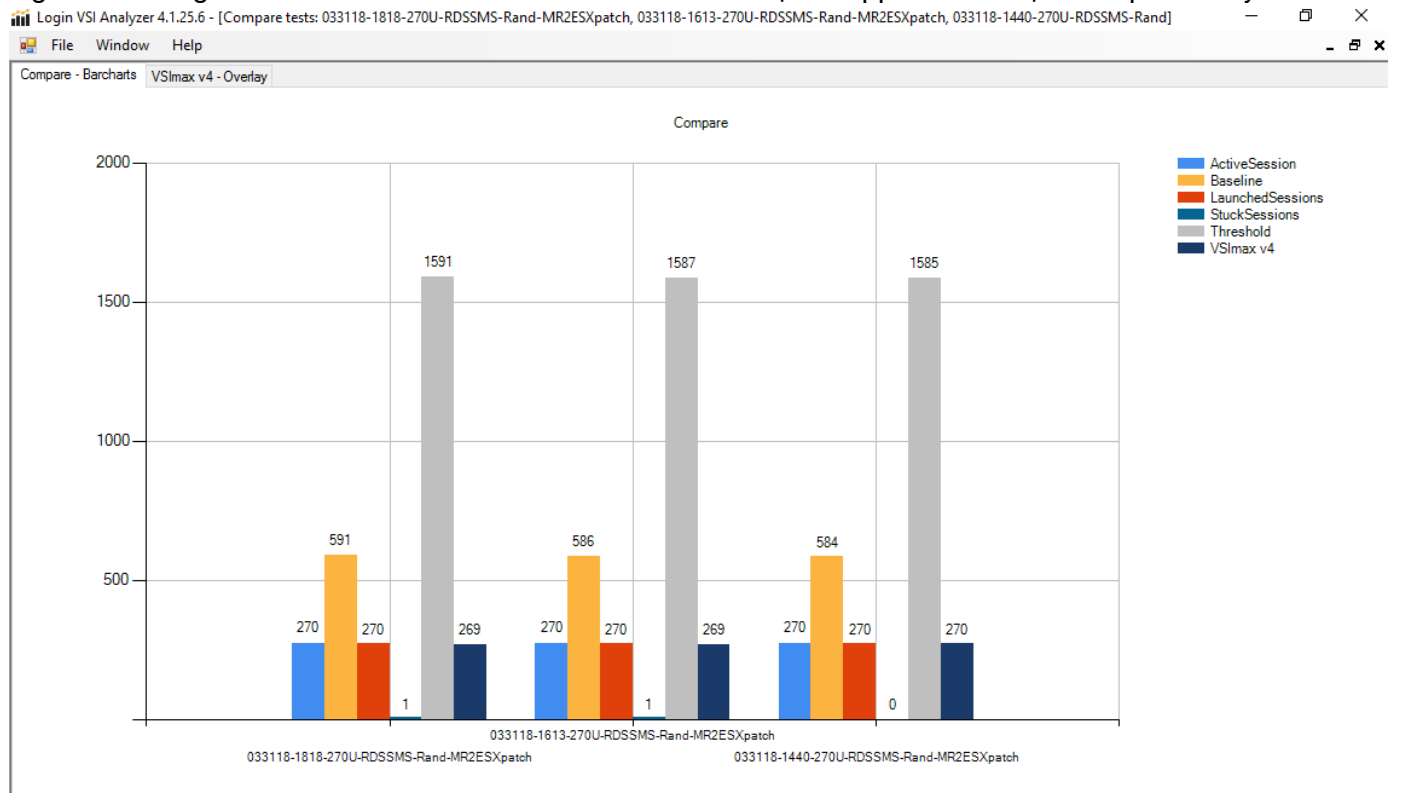

Figure 82 Single Server Recommended Maximum Workload | XenApp 7.15 HSD | VSI Repeatability



Performance data for the server running the workload is as follows:

Figure 83 Single Server Recommended Maximum Workload | XenApp 7.15 HSD | Host CPU Utilization

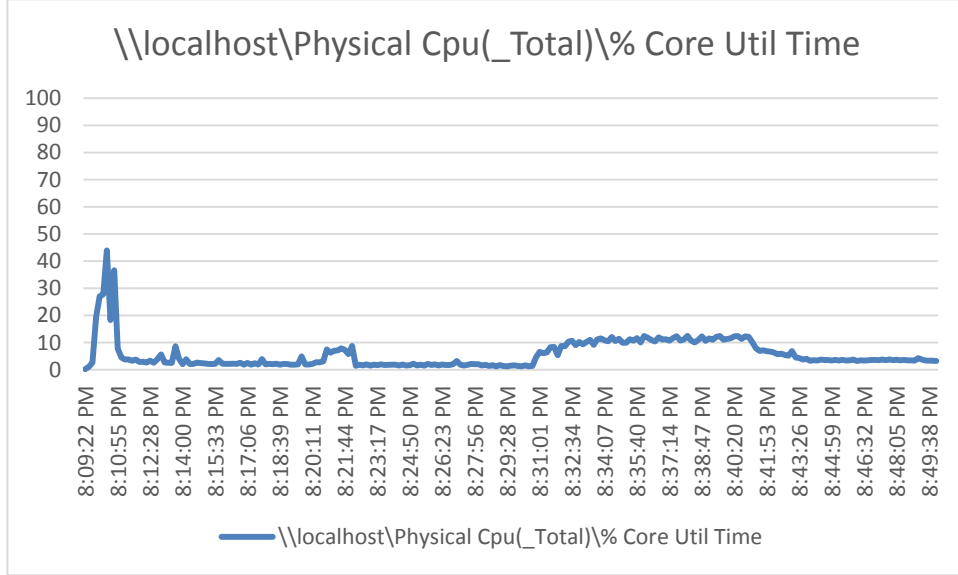

Figure 84 Single Server Recommended Maximum Workload | XenApp 7.15 HSD | Host Memory Utilization

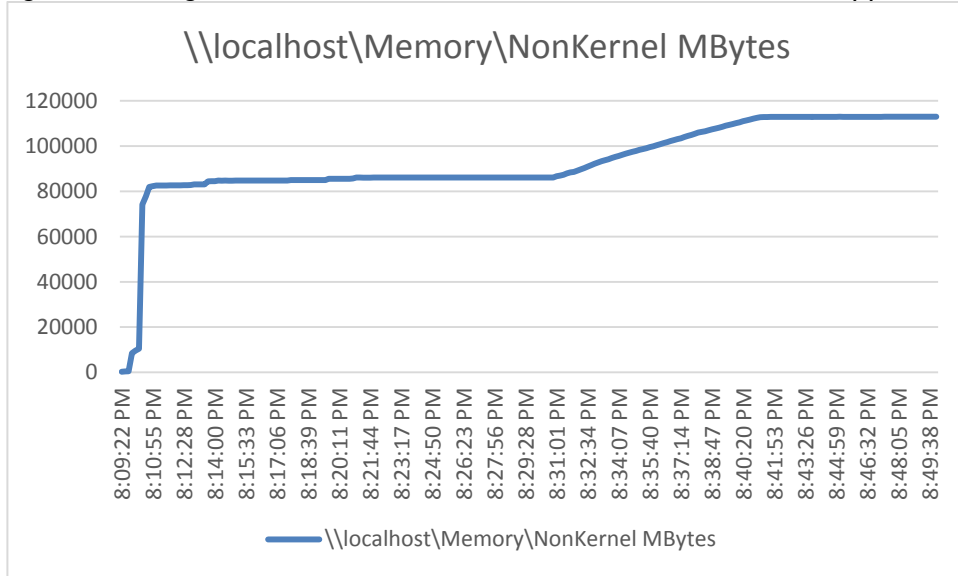
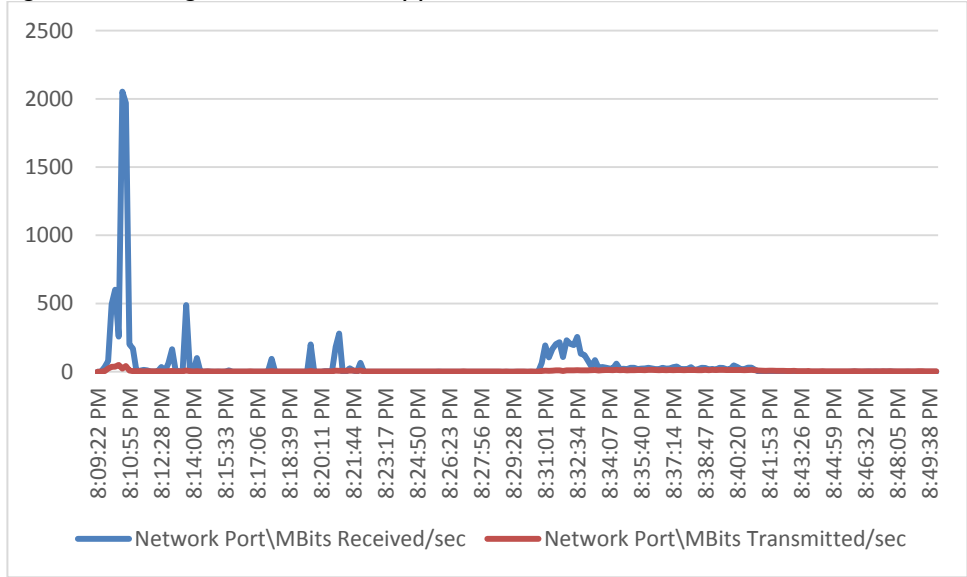
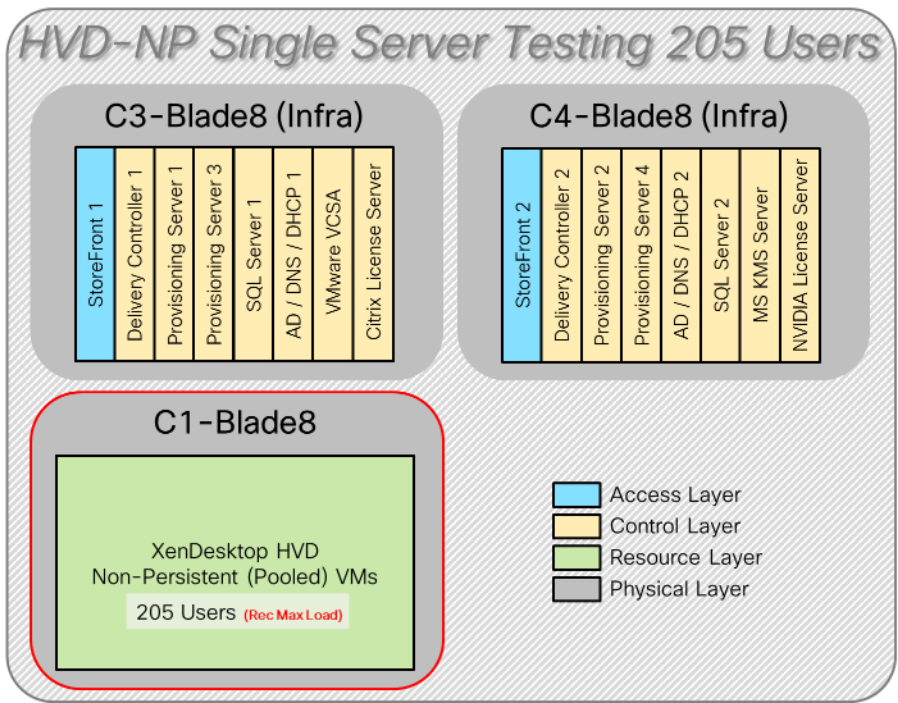

Figure 85 Single Server | XenApp 7.15 HSD | Host Network Utilization



Single-Server Recommended Maximum Workload for HVD Non-Persistent with 205 Users

Figure 86 Single Server Recommended Maximum Workload for HVD Non-Persistent with 205 Users



The recommended maximum workload for a Cisco UCS B200 M5 blade server with dual Intel Xeon Gold 6140 processors, 768GB 2666MHz RAM is 205 Windows 10 64-bit HVD non-persistent virtual machines with 2 vCPU and 2GB RAM.

Login VSI performance data is as follows.

Figure 87 Single Server | XenDesktop 7.15 HVD-NP | VSI Score

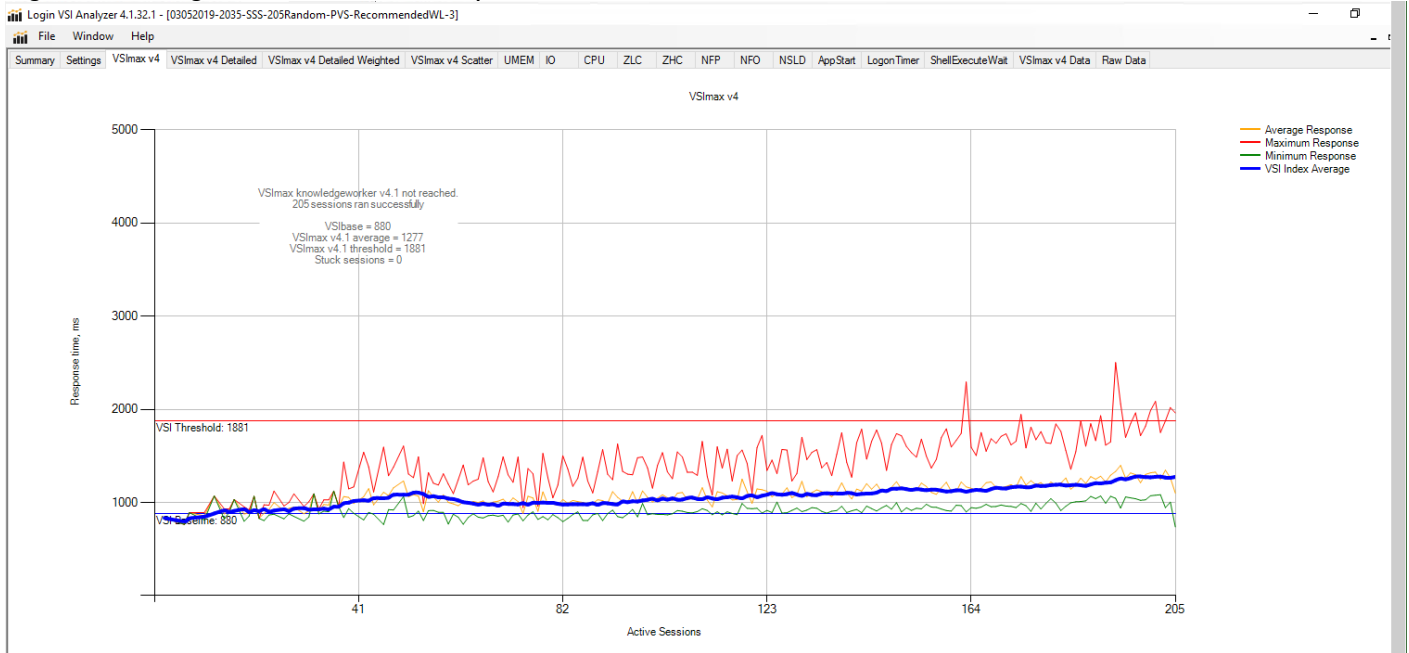
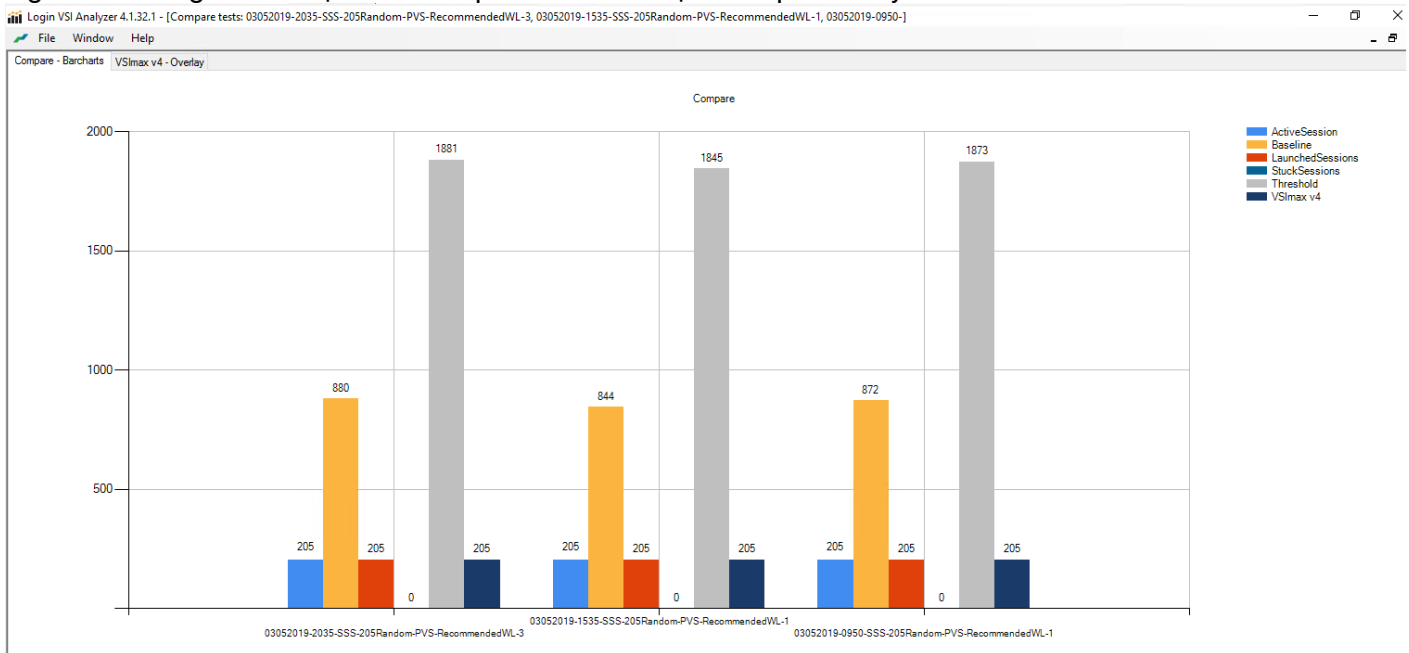

Figure 88 Single Server | XenDesktop 7.15 HVD-NP | VSI Repeatability



Performance data for the server running the workload is as follows:

Figure 89 Single Server | XenDesktop 7.15 HVD-NP | Host CPU Utilization

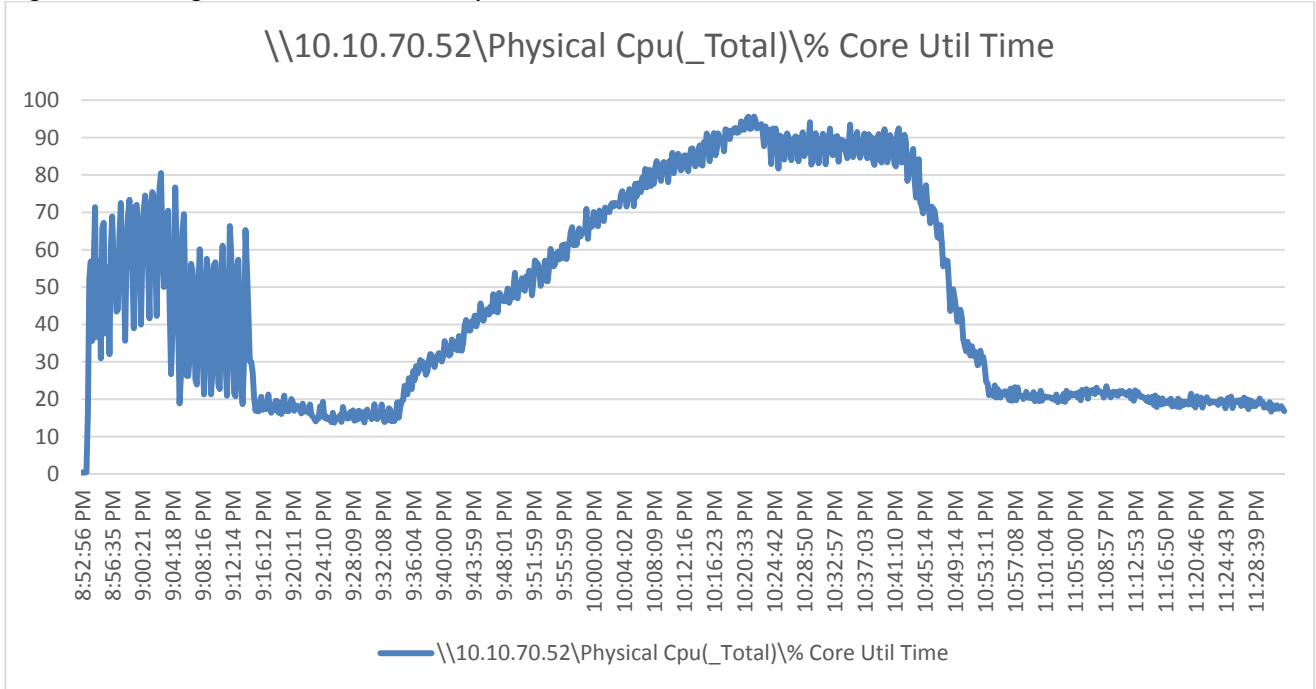

Figure 90 Single Server | XenDesktop 7.15 HVD-NP | Host Memory Utilization

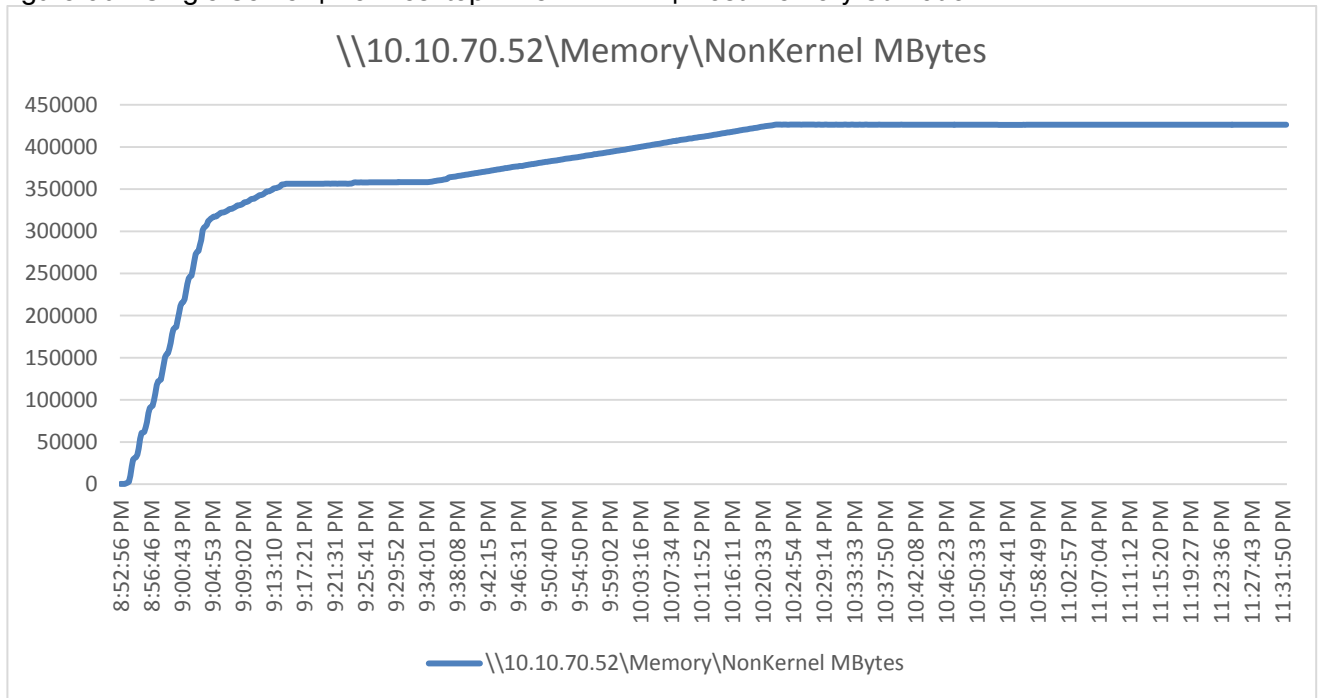
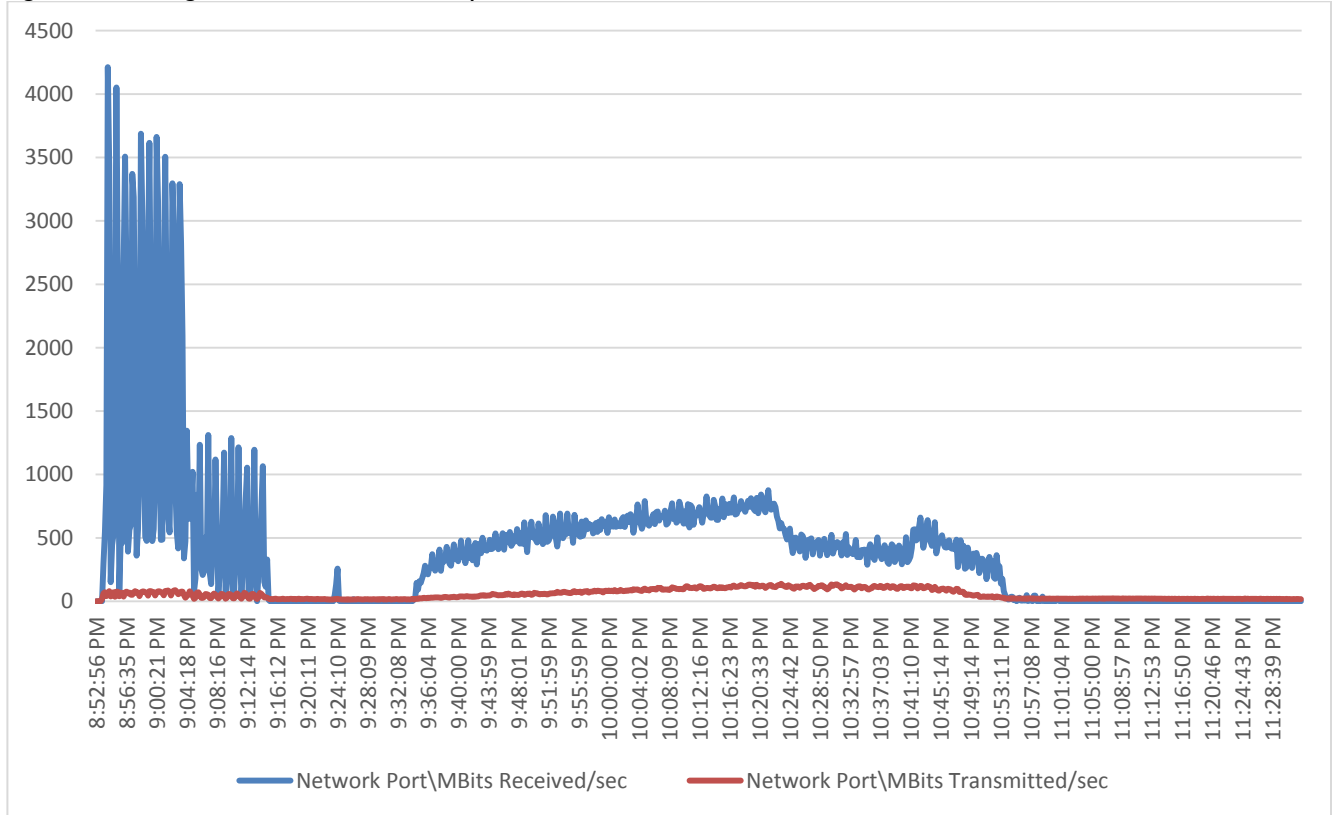
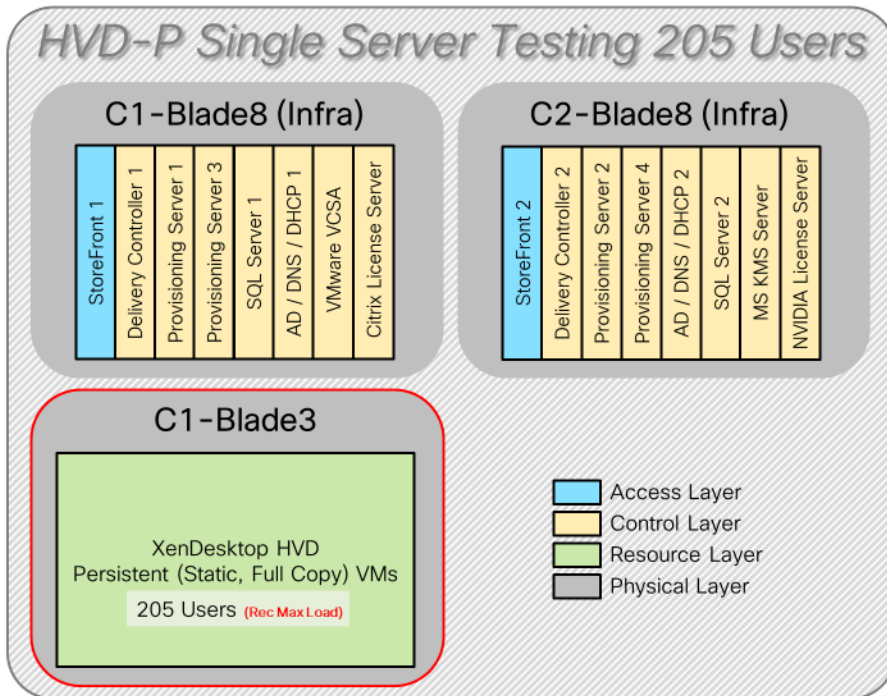

Figure 91 Single Server | XenDesktop 7.15 HVD-NP | Host Network Utilization



Single-Server Recommended Maximum Workload for HVD Persistent with 205 Users

Figure 92 Single Server Recommended Maximum Workload for HVD Persistent with 205 Users



The recommended maximum workload for a Cisco UCS B200 M5 blade server with dual Intel Xeon Gold 6140 processors, 768GB 2666MHz RAM is 205 Windows 10 64-bit HVD persistent virtual machines with 2 vCPU and 2GB RAM.

Login VSI performance data is as follows:

Figure 93 Single Server | XenDesktop 7.15 HVD-P | VSI Score

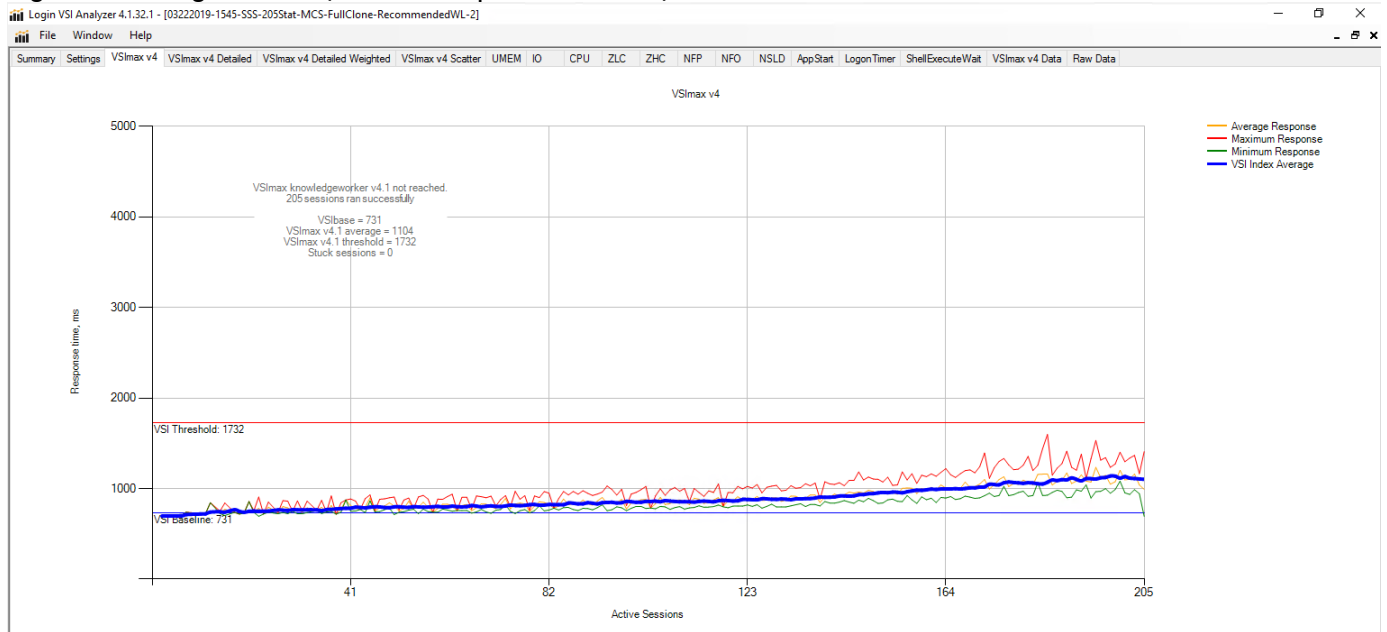
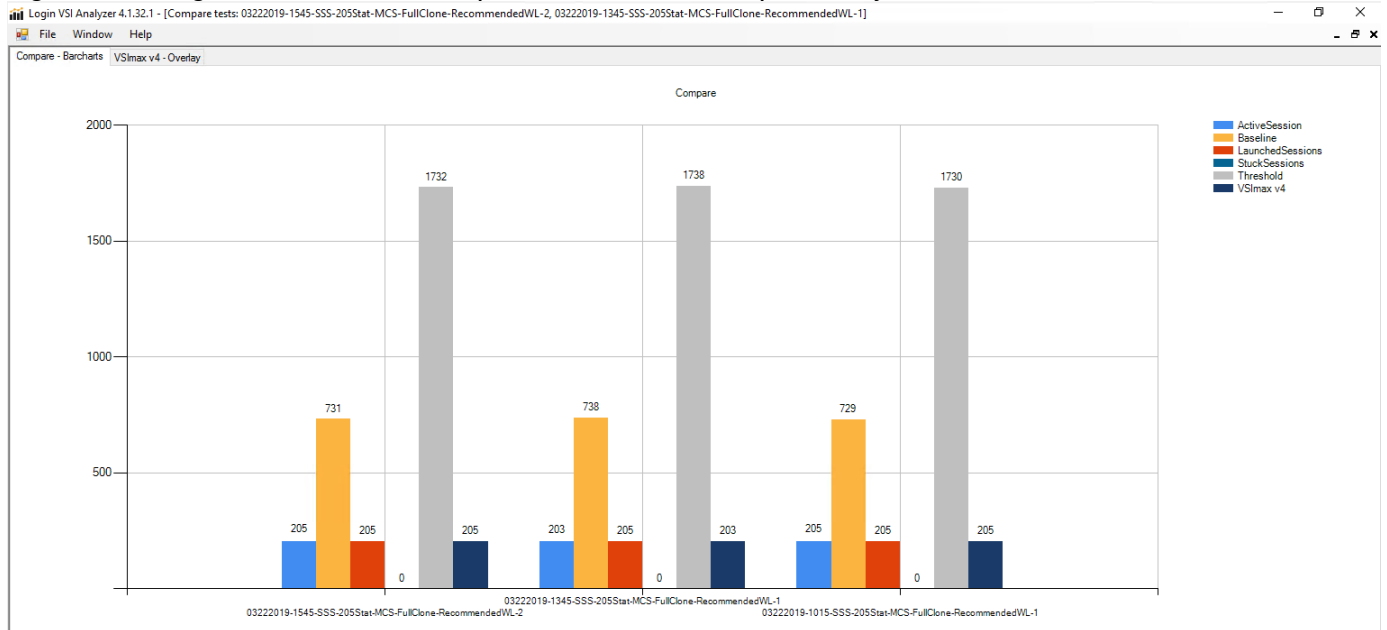

Figure 94 Single Server | XenDesktop 7.15 HVD-P | VSI Repeatability



Performance data for the server running the workload is as follows:

Figure 95 Single Server | XenDesktop 7.15 HVD-P | Host CPU Utilization

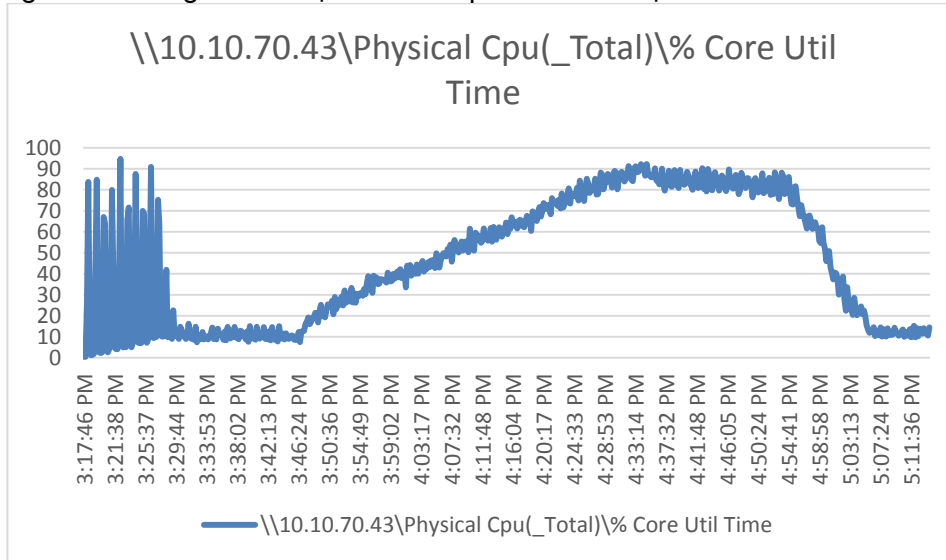

Figure 96 Single Server | XenDesktop 7.15 HVD-P | Host Memory Utilization

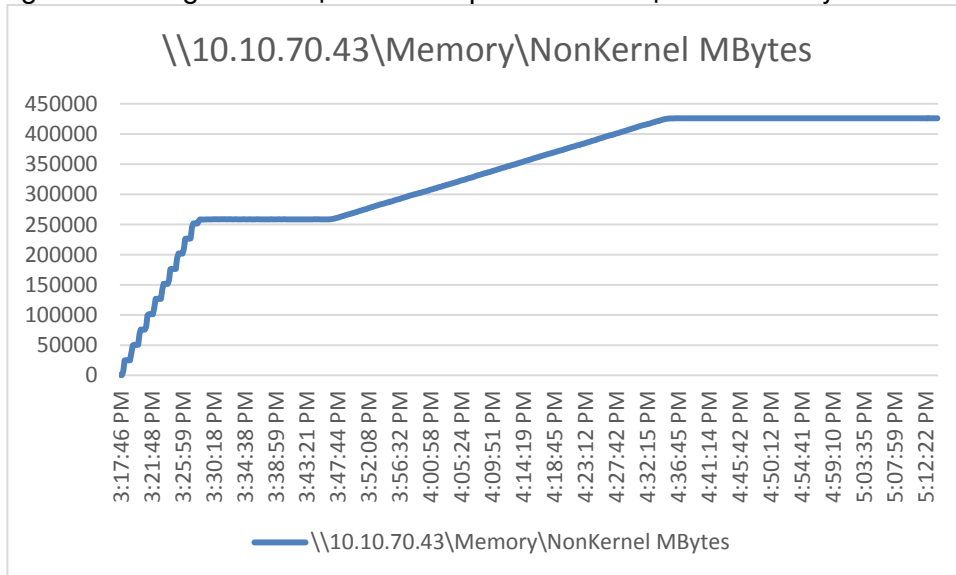
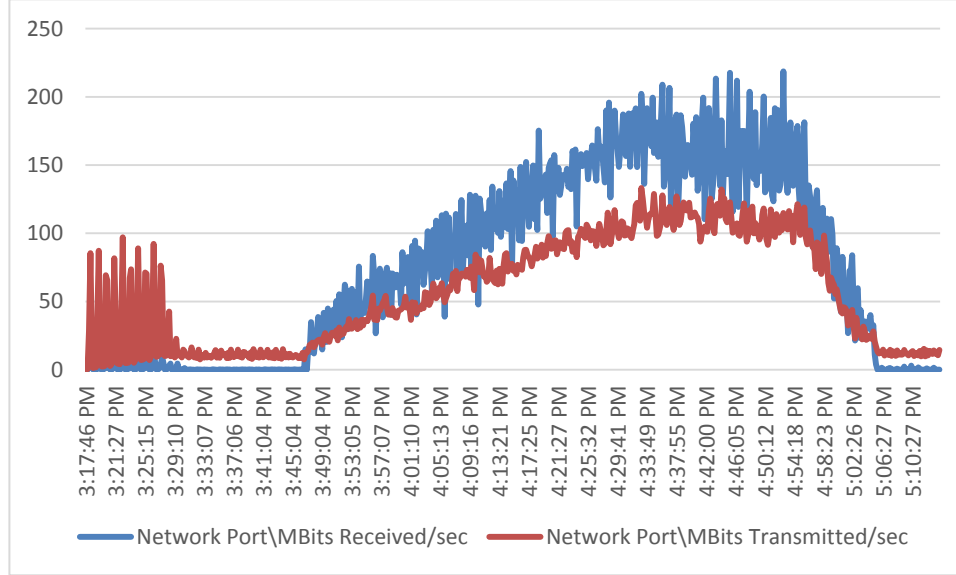

Figure 97 Single Server | XenDesktop 7.15 HVD-P | Host Network Utilization



Cluster Recommended Maximum Workload Testing

This section shows the key performance metrics that were captured on the Cisco UCS host blades during the cluster testing to determine the per host server workload in N+1 environment. The cluster testing comprised of three tests: 1900 HSD sessions, 2050 HVD Non-Persistent sessions, and 2050 HVD Persistent sessions.

Cluster Workload Testing with 1900 HSD Users

This section describes the key performance metrics that were captured on the Cisco UCS, Pure Storage array, and Infrastructure virtual machines during the non-persistent desktop testing. The cluster testing was comprised of 1900 HSD sessions using 8 workload blades.

Figure 98 HSD Cluster Testing with 1900 Users

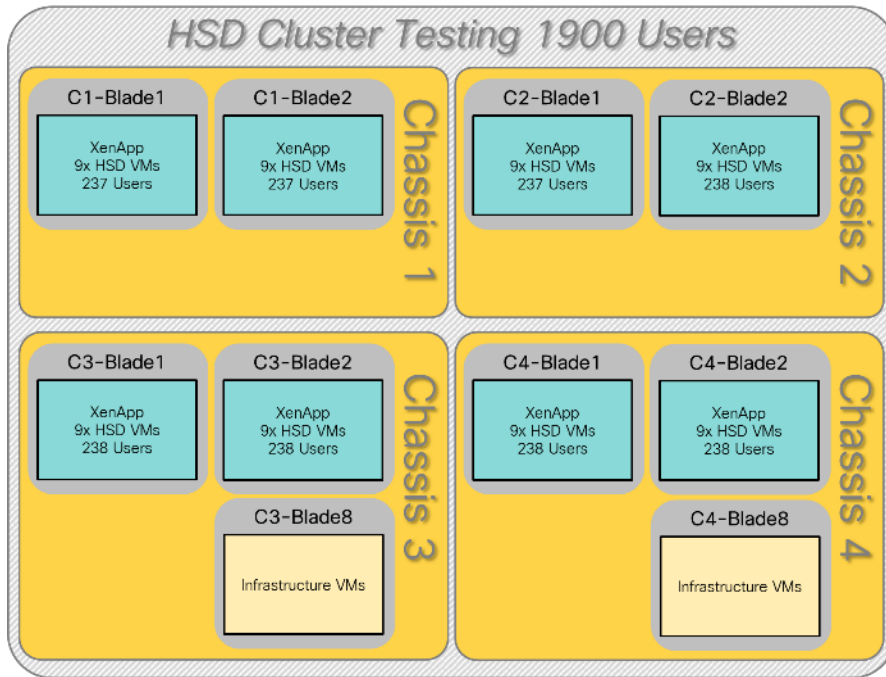

The workload for the test is 1900 HSD users. To achieve the target, sessions were launched against all workload clusters concurrently. As per the Cisco Test Protocol for VCC solutions, all sessions were launched within 48 minutes (using the official Knowledge Worker Workload in VSI Benchmark Mode) and all launched sessions became active within two minutes subsequent to the last logged in session.

The configured system efficiently and effectively delivered the following results:

Figure 99 Eight Node Cluster | 1900 HSD Users | VSI Score

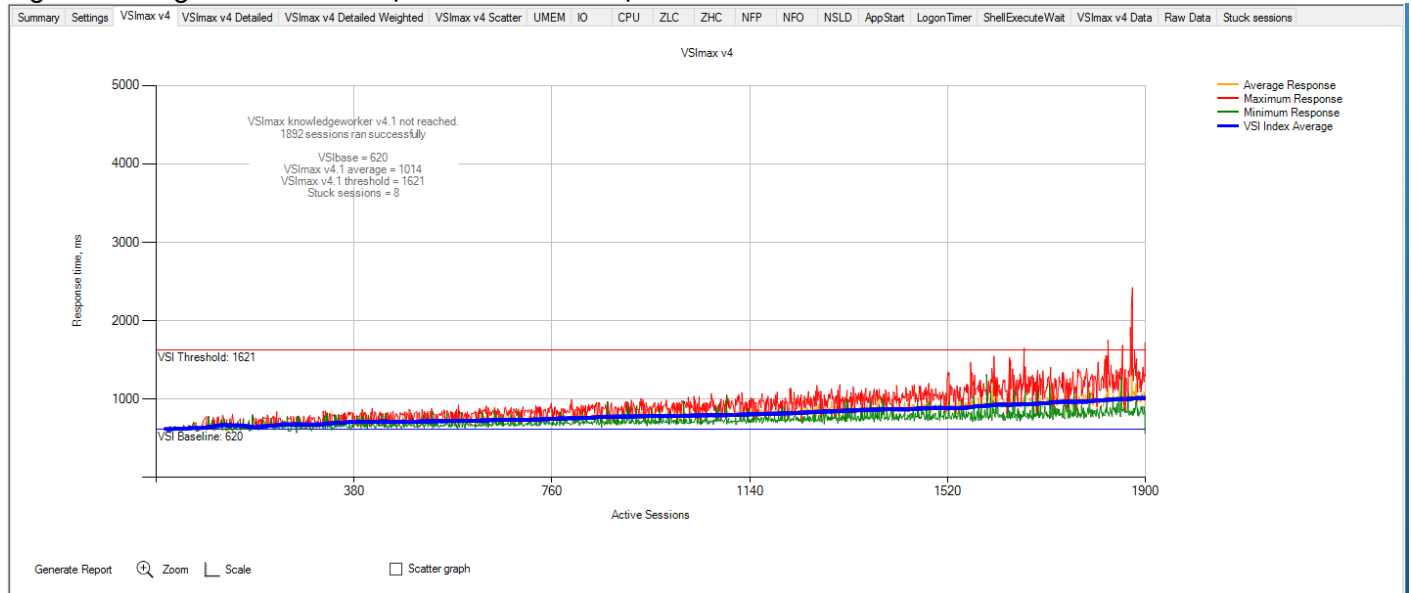

Figure 100 Eight Node Cluster | 1900 HSD Users | VSI Repeatability

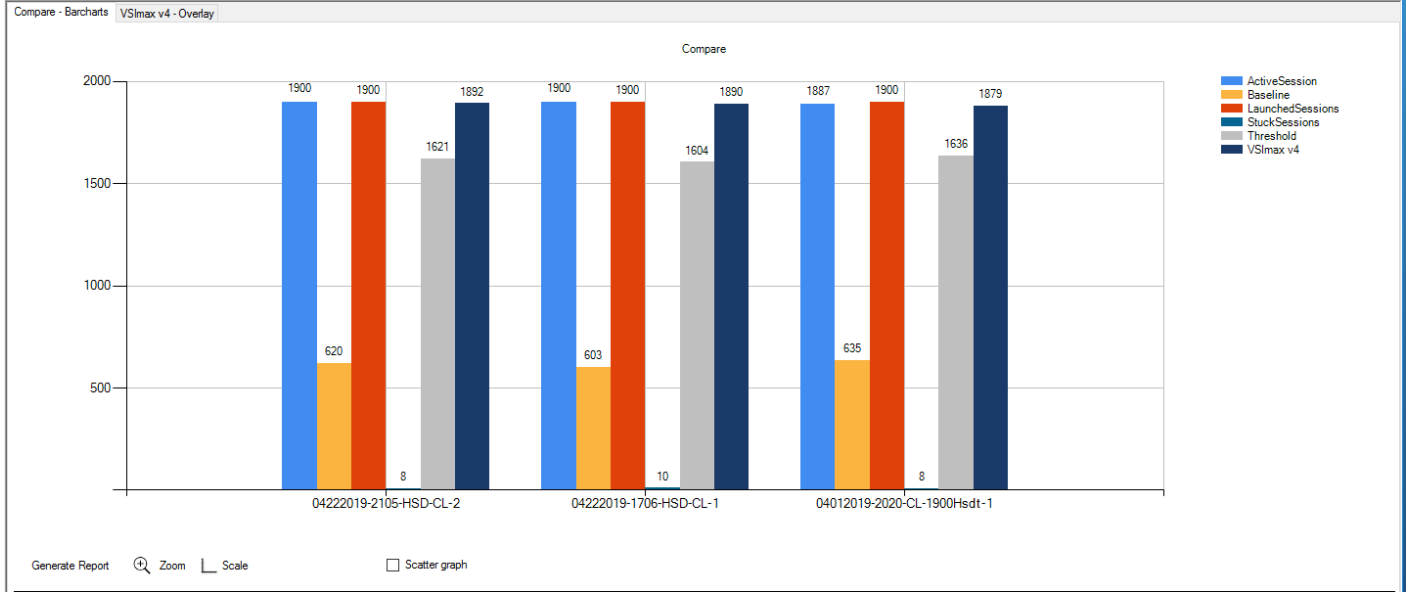

Figure 101 Cluster | 1900 HSD Users | 8 RDS Hosts | Host CPU Utilization

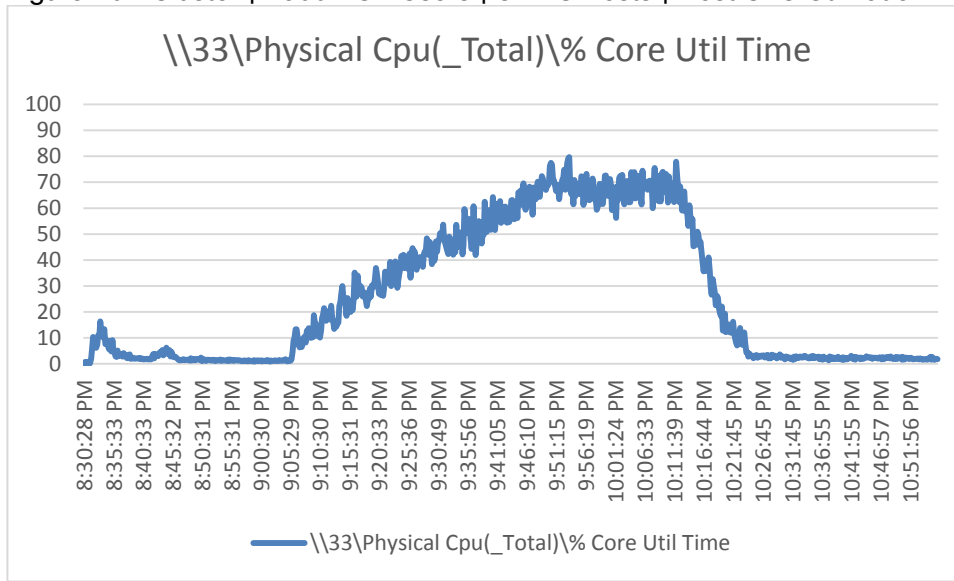

Figure 102 Cluster | 1900 HSD Users | 8 HSD Hosts | Host Memory Utilization

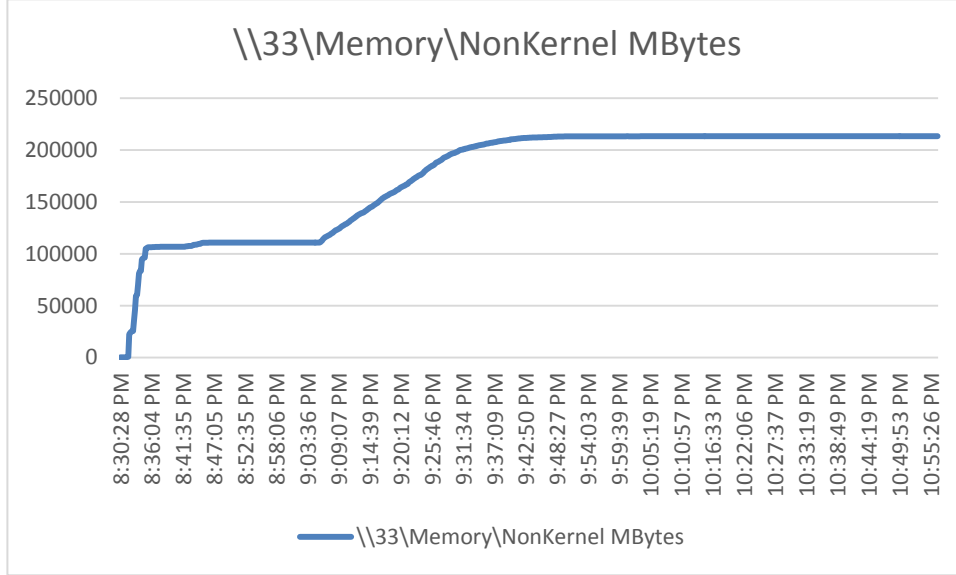

Figure 103 Cluster | 1900 HSD Users | RDS Hosts | Host System Uplink Network Utilization

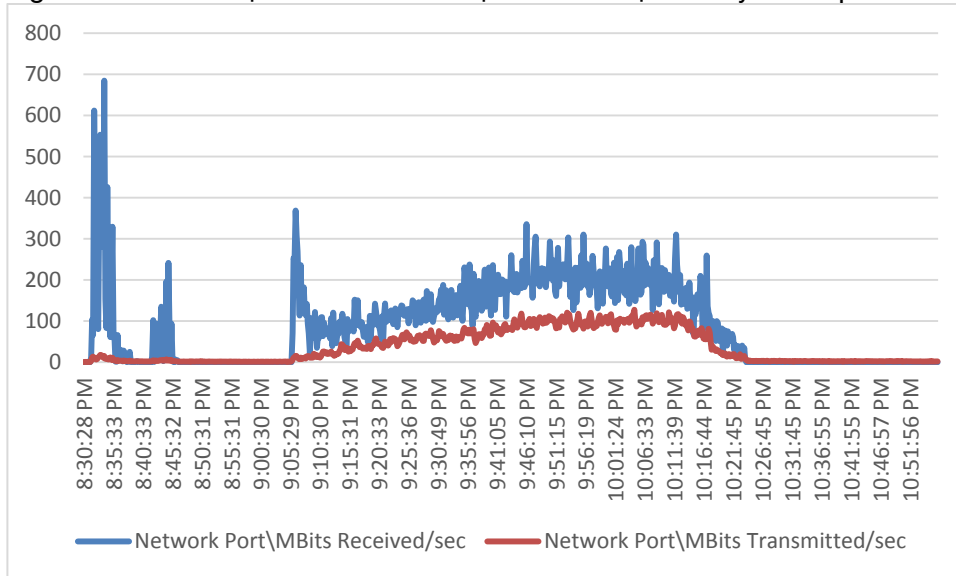
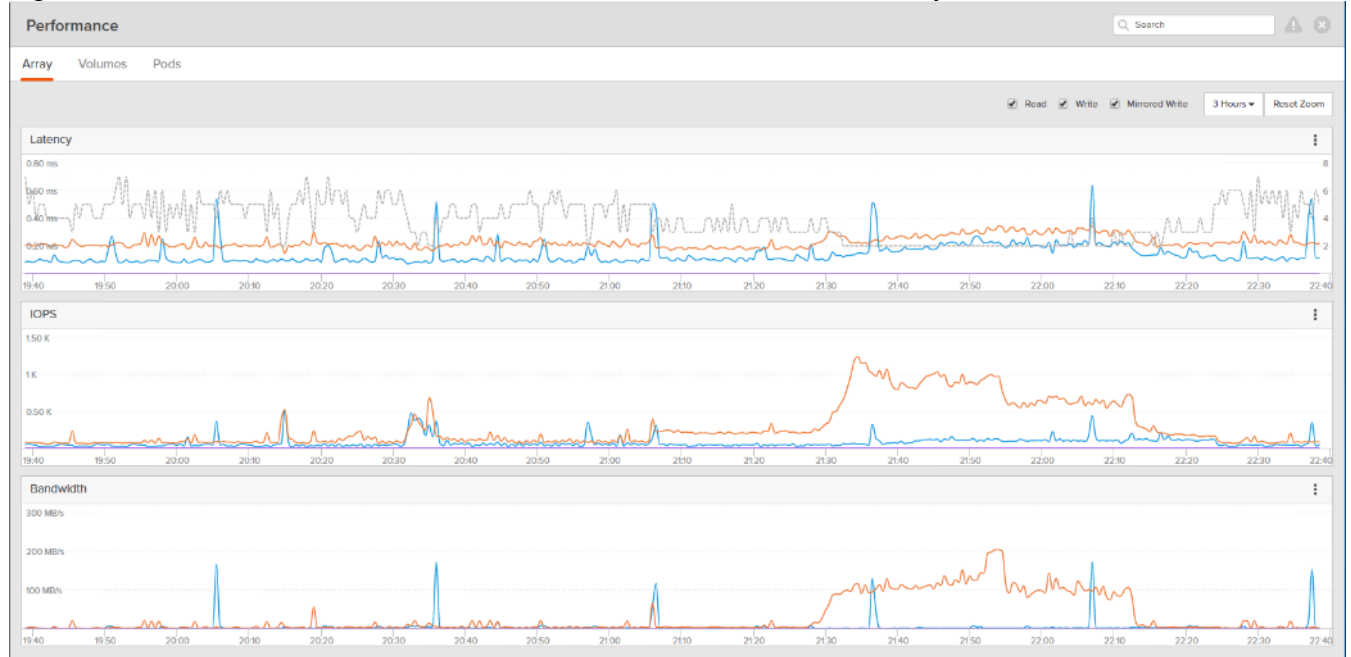

Figure 104 Cluster | 1900 RDS Users | HSD Users | RDS Hosts | FlashArray//X70 R2 Utilization



Cluster Workload Testing with 2050 Non-Persistent Desktop Users

This section describes the key performance metrics that were captured on the Cisco UCS, Pure Storage array, and Infrastructure virtual machines during the non-persistent desktop testing. The cluster testing with comprised of 2050 HVD non-persistent desktop sessions using 11 workload blades.

Figure 105 HVD Non-Persistent Cluster Testing with 2050 Users

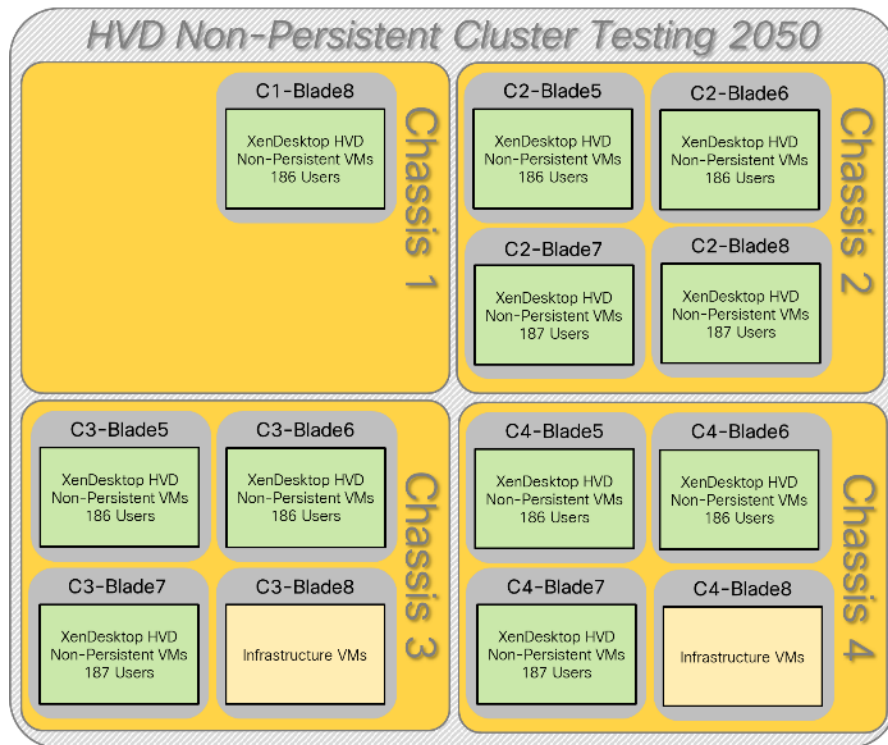

The workload for the test is 2050 HVD non-persistent desktop users. To achieve the target, sessions were launched against all workload clusters concurrently. As per the Cisco Test Protocol for VCC solutions, all sessions were launched within 48 minutes (using the official Knowledge Worker Workload in VSI Benchmark Mode) and all launched sessions became active within two minutes subsequent to the last logged in session.

The configured system efficiently and effectively delivered the following results.

Figure 106 Cluster | 2050 HVD-NP Users | VSI Score

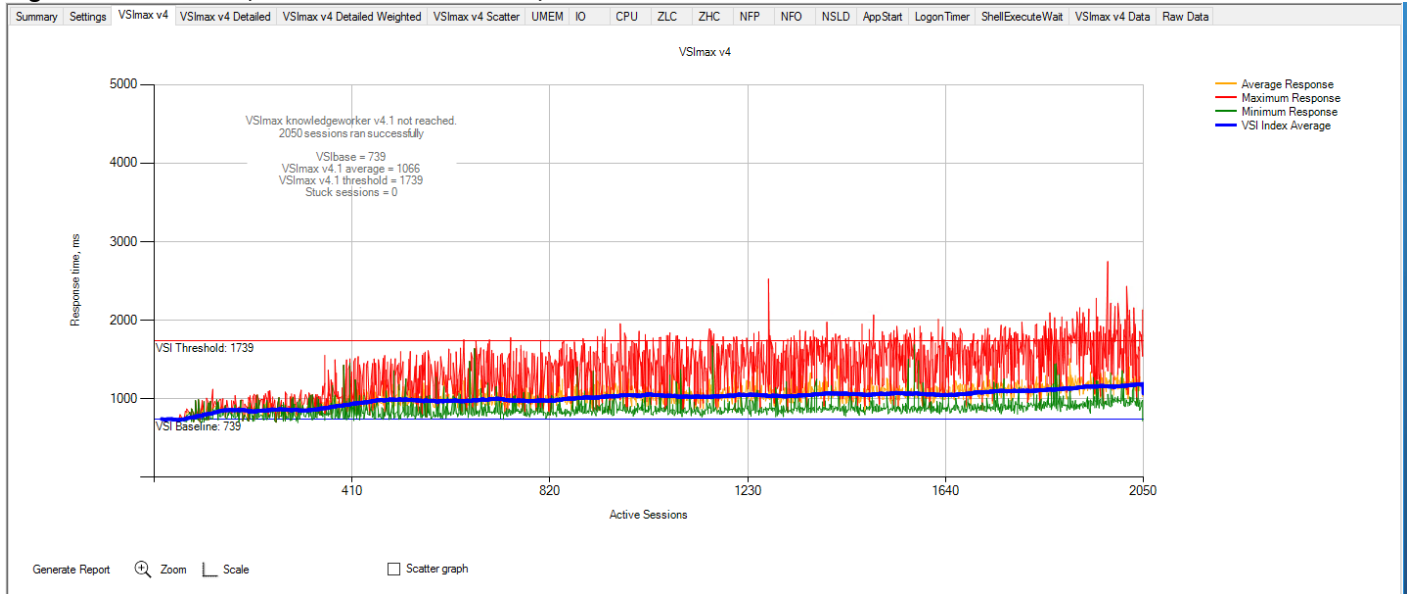

Figure 107 Cluster | 2050 HVD-NP Users | VSI Repeatability

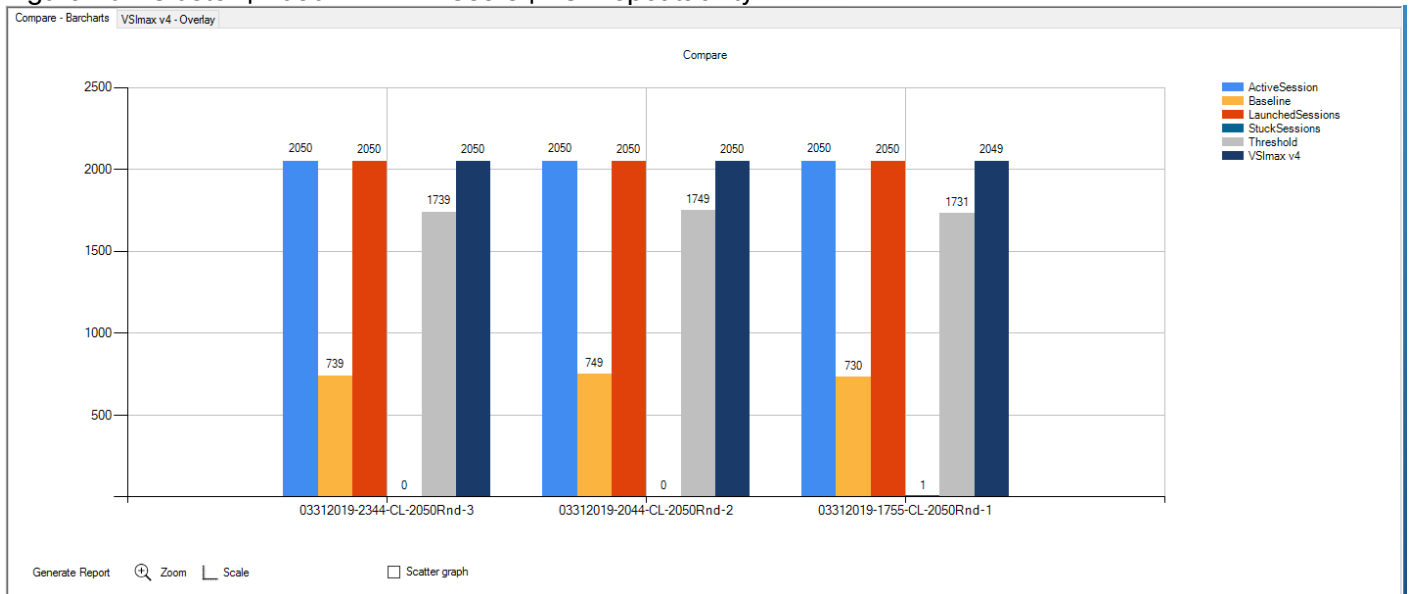

Figure 108 Cluster | 2050 HVD-NP Users | Non-Persistent Hosts | Host CPU Utilization

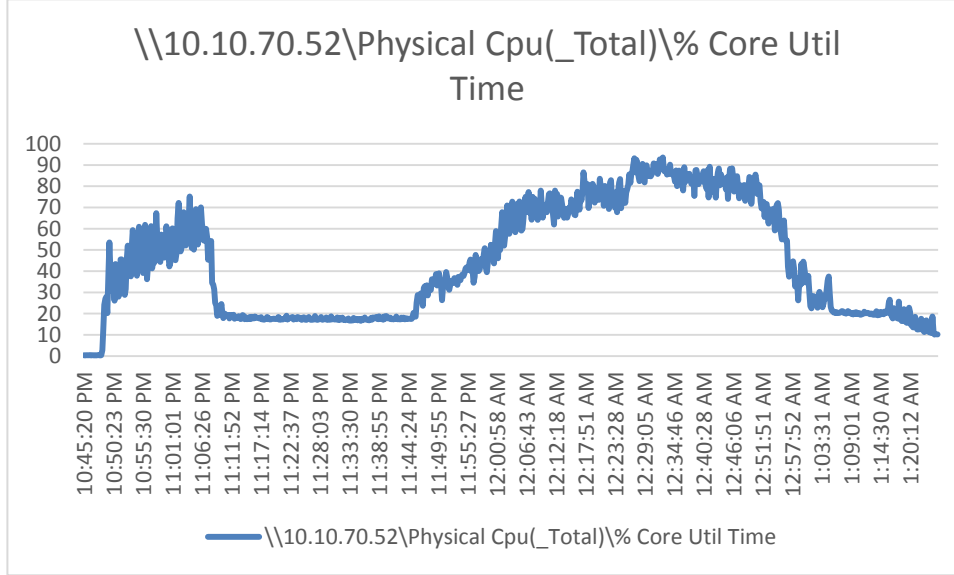

Figure 109 Cluster | 2050 HVD-NP Users | Non-Persistent Hosts | Host Memory Utilization

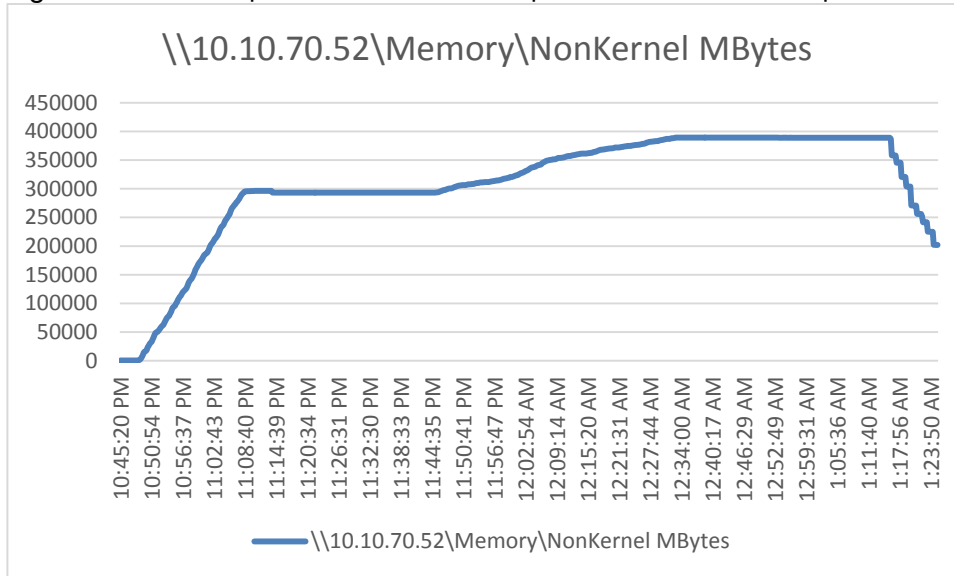

Figure 110 Cluster | 2050 HVD-NP Users | Non-Persistent Hosts | Host Network Utilization

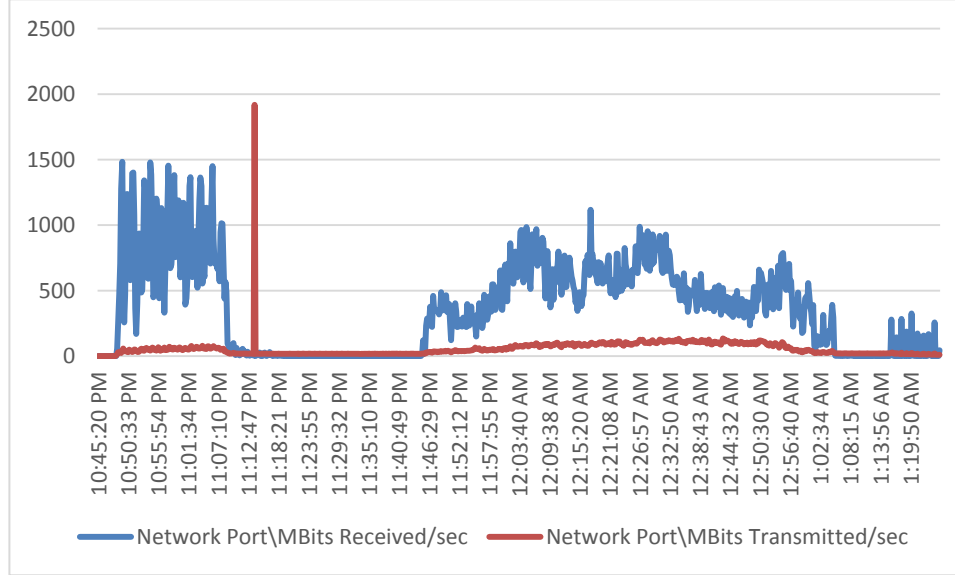
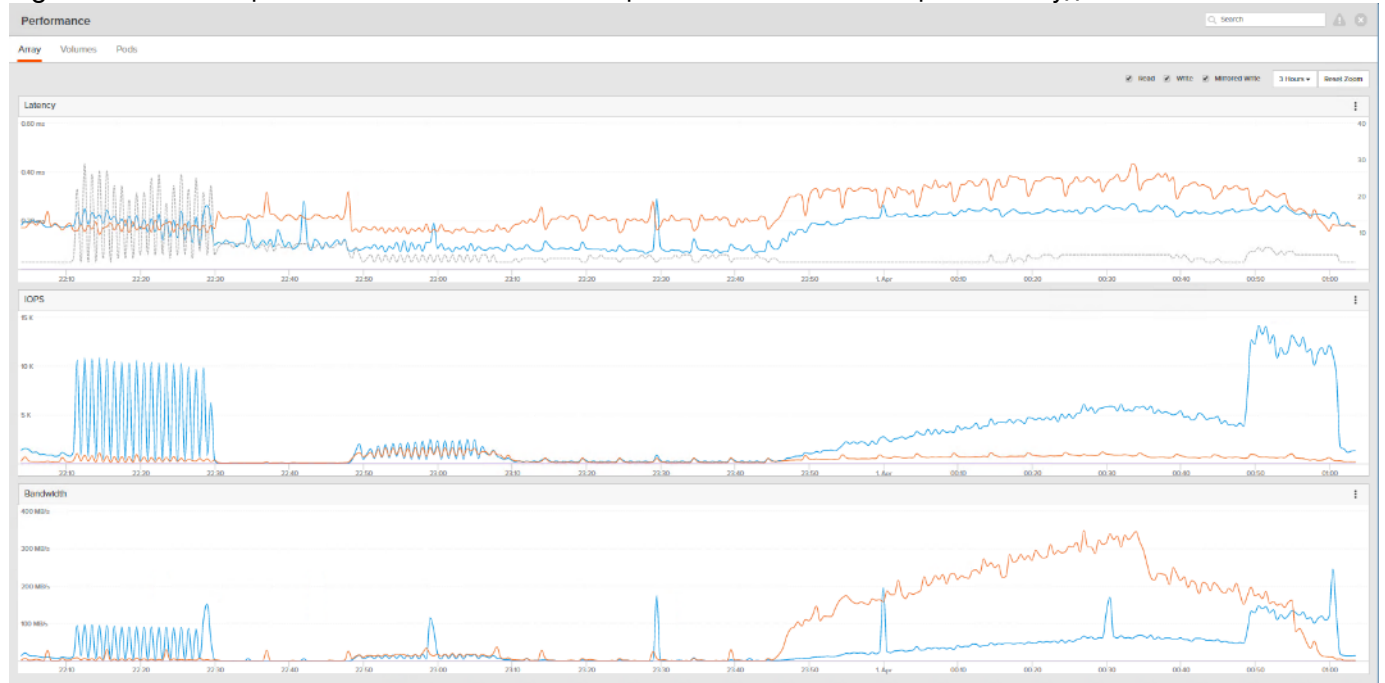

Figure 111 Cluster | 2050 VDI-NPHVD-NP Users | Non-Persistent Hosts | FlashArray//X70 R2 Utilization



Cluster Workload Testing with 2050 Persistent Desktop Users

This section describes the key performance metrics that were captured on the Cisco UCS, Pure Storage array, and Infrastructure virtual machines during the persistent desktop testing. The cluster testing with comprised of 2050 HVD Persistent desktop sessions using 11 workload blades.

Figure 112 HVD Persistent Cluster Testing with 2050 Users

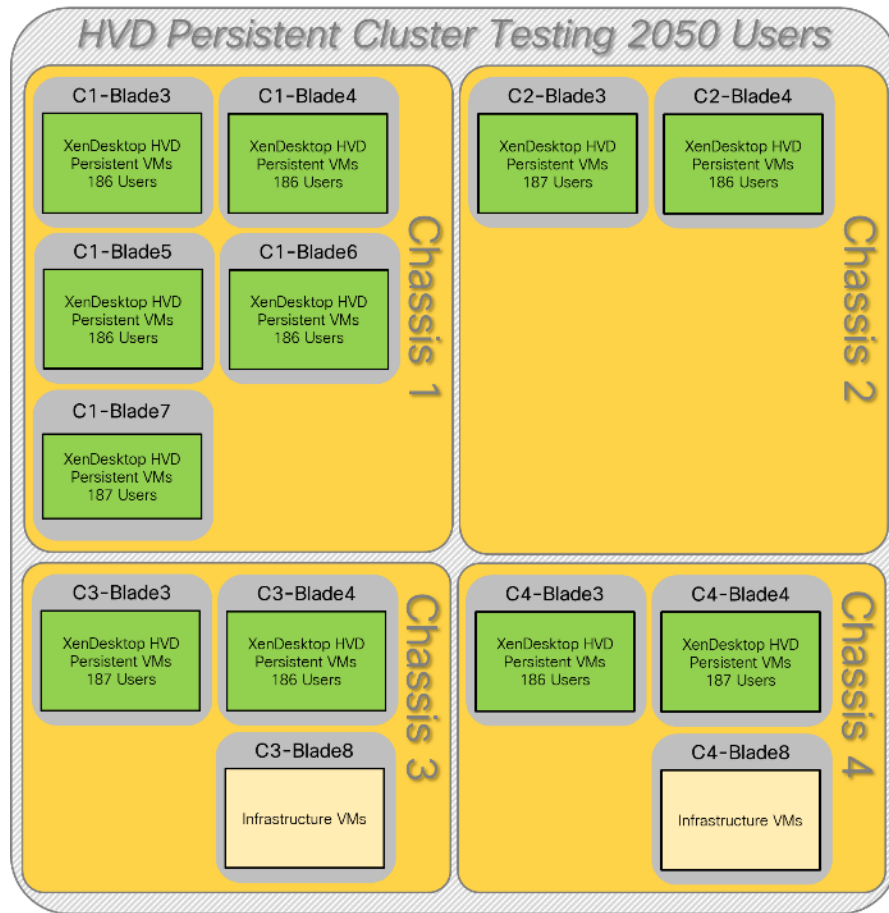

The workload for the test is 2050 HVD persistent desktop users. To achieve the target, sessions were launched against all workload clusters concurrently. As per the Cisco Test Protocol for VCC solutions, all sessions were launched within 48 minutes (using the official Knowledge Worker Workload in VSI Benchmark Mode) and all launched sessions became active within two minutes subsequent to the last logged in session.

The configured system efficiently and effectively delivered the following results:

Figure 113 Cluster | 2050 HVD-P Users | VSI Score

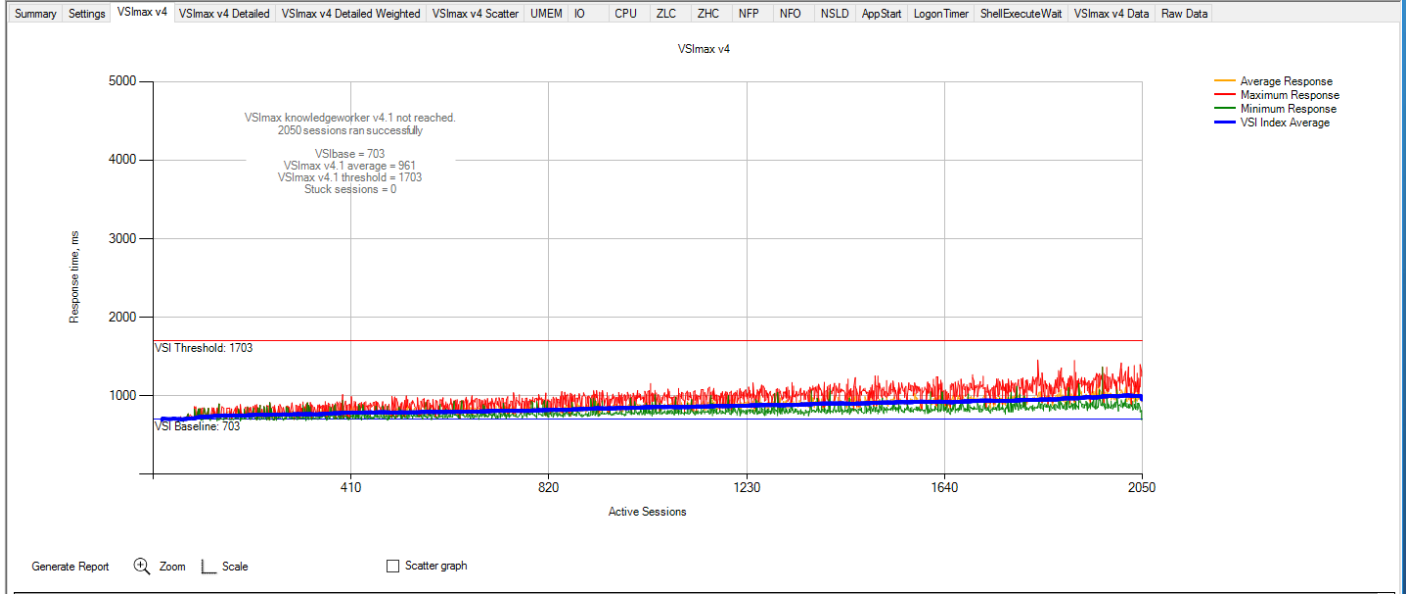

Figure 114 Cluster | 2050 HVD-P Users | VSI Repeatability

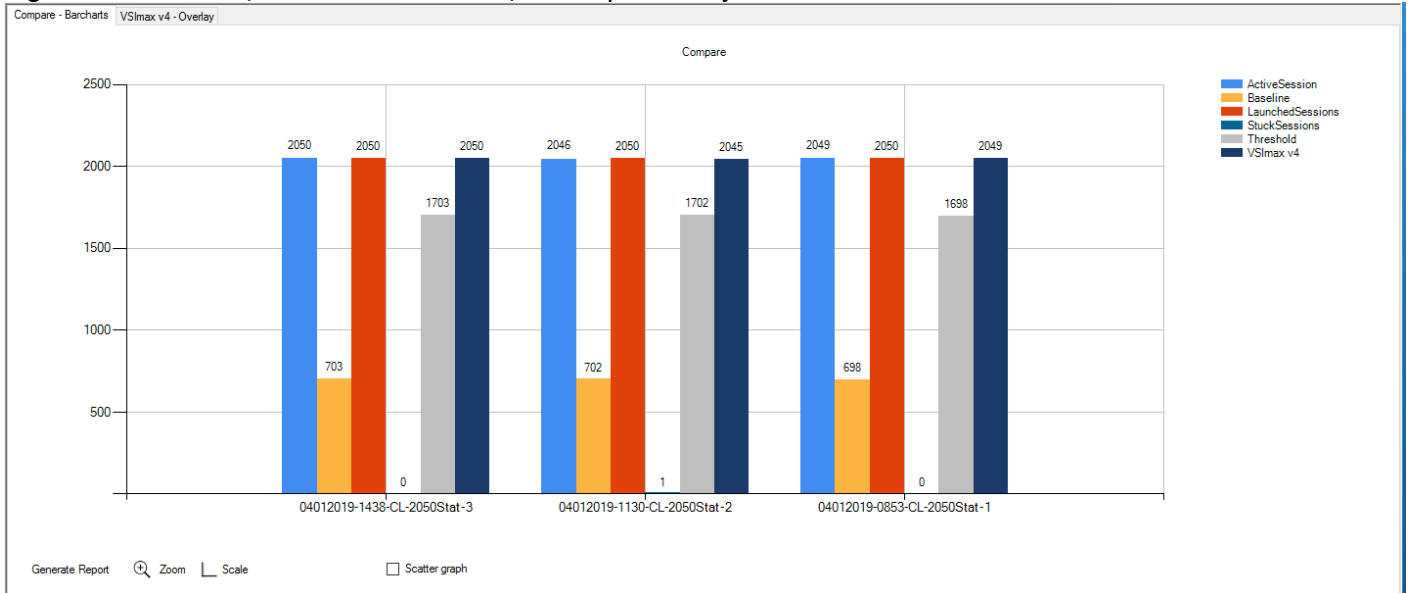

Figure 115 Cluster | 2050 HVD-P Users | Persistent Hosts | Host CPU Utilization

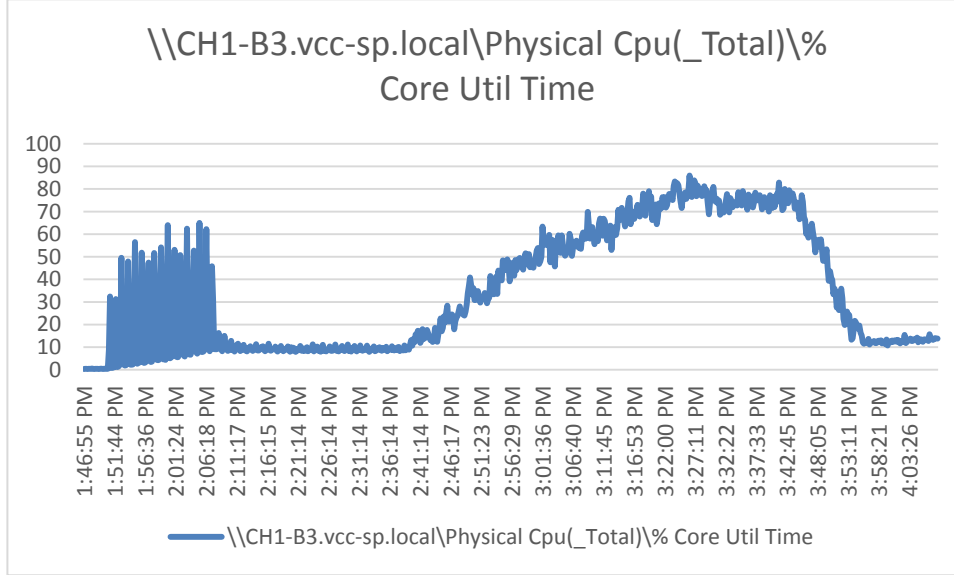

Figure 116 Cluster | 2050 HVD-P Users | Persistent Hosts | Host Memory Utilization

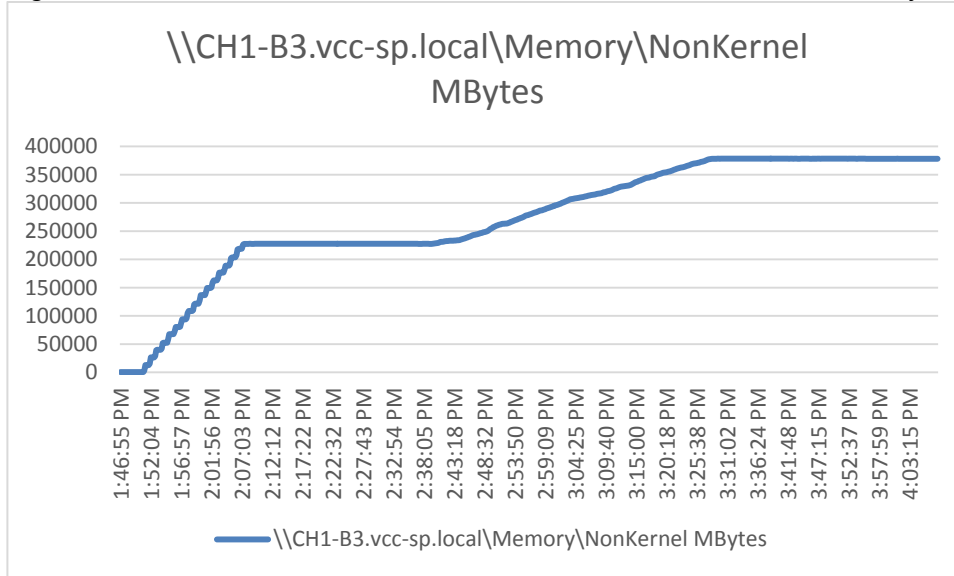

Figure 117 Cluster | 2050 HVD-P Users | Persistent Hosts | Host Network Utilization

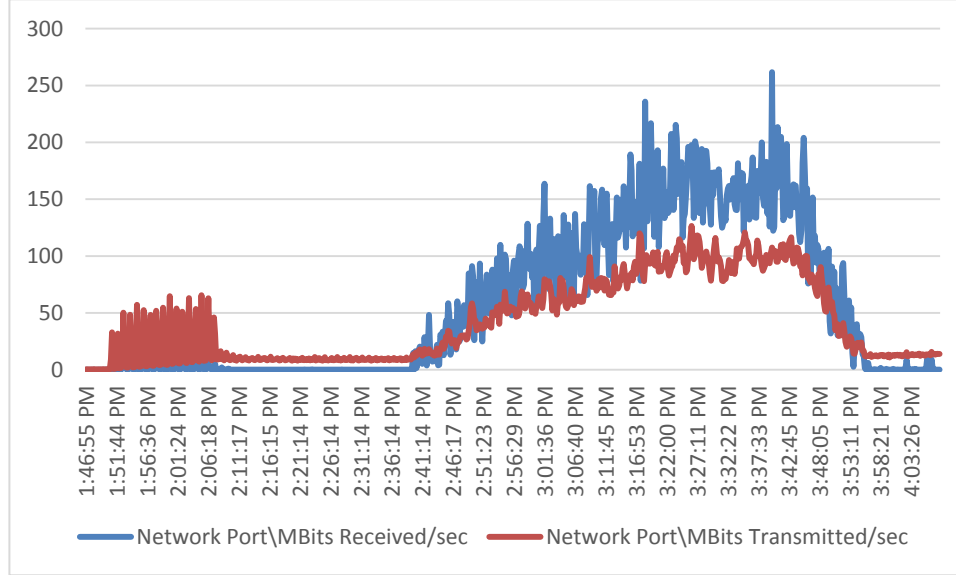

Figure 118 Cluster | 2050 VDI-PHVD-P Users | Persistent Hosts | FlashArray//X70 R2 Utilization



Full Scale Mixed Workload Testing with 6000 Users

This section describes the key performance metrics that were captured on the Cisco UCS, during the full-scale testing. The full-scale testing with 6000 users comprised of: 1900 Hosted Shared Desktop Sessions using 8 blades, 2050 HVD Non-Persistent sessions using 11 blades, and 2050 HVD Persistent sessions using 11 blades.

The combined mixed workload for the solution is 6000 users. To achieve the target, sessions were launched against all workload clusters concurrently. As per the Cisco Test Protocol for VCC solutions, all sessions were

launched within 48 minutes (using the official Knowledge Worker Workload in VSI Benchmark Mode) and all launched sessions became active within two minutes subsequent to the last logged in session.

Figure 119 Full Scale Testing 6000 Users

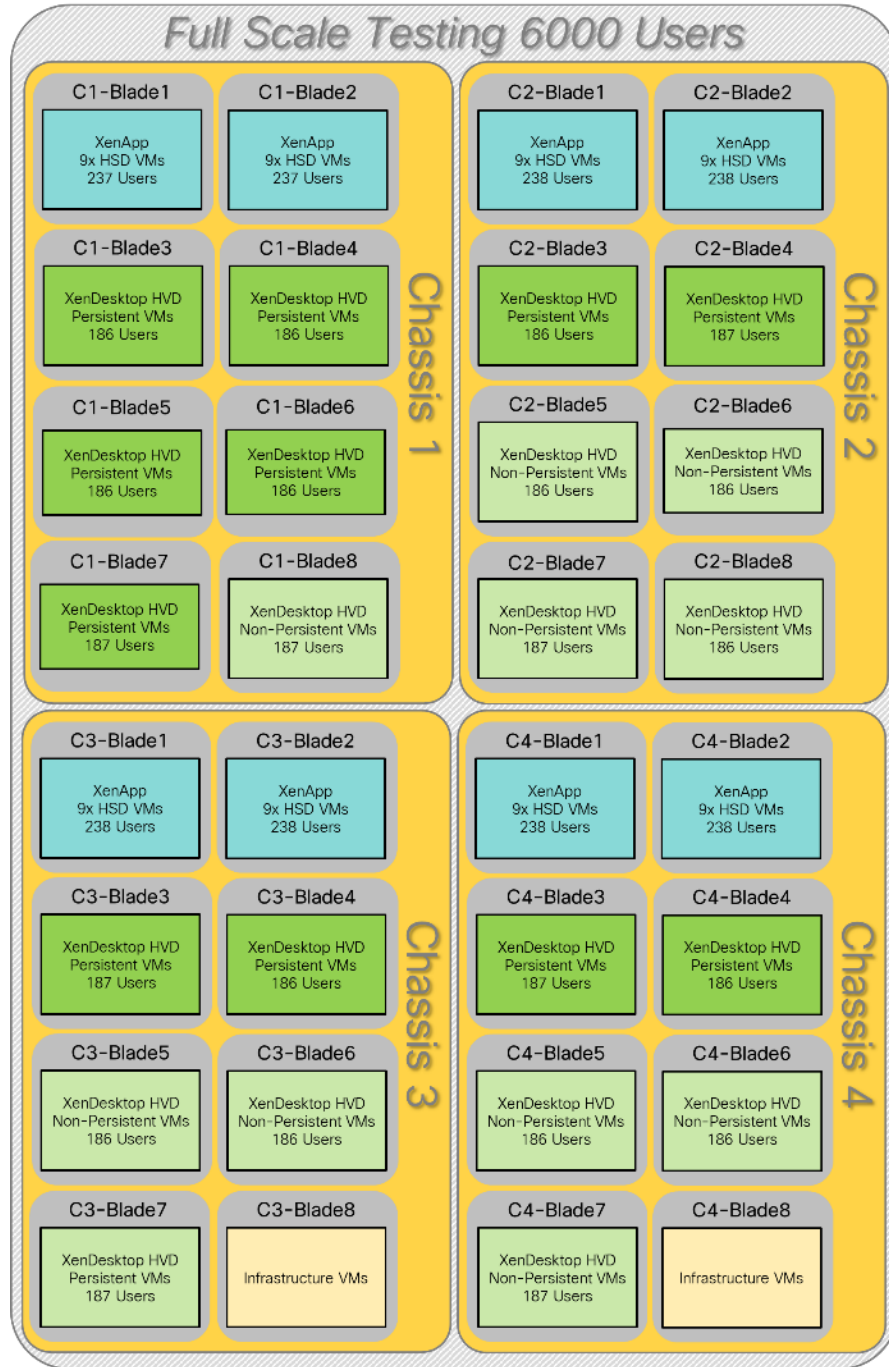

The configured system efficiently and effectively delivered the following results.

Figure 120 Full Scale | 6000 Mixed Users | VSI Score



Figure 121 Full Scale | 6000 Mixed Users | VSI Repeatability

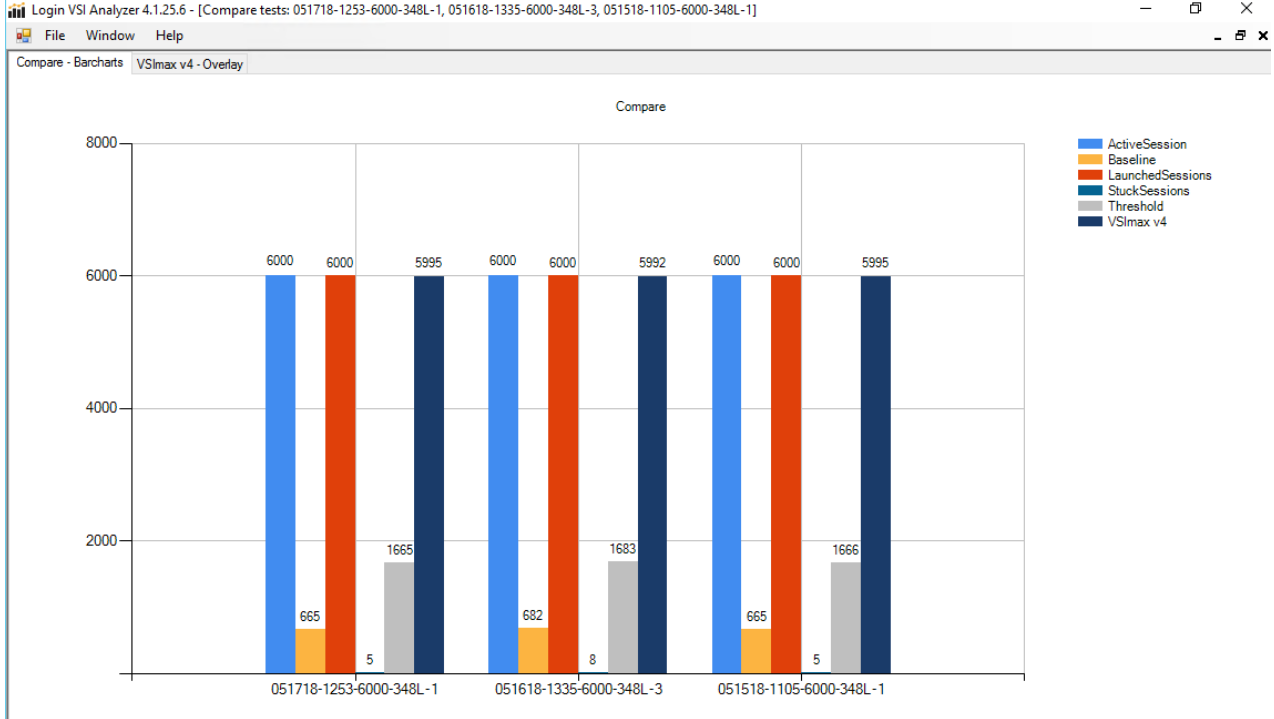

Figure 122 Full Scale | 6000 Mixed Users | HSD Hosts | Host CPU Utilization

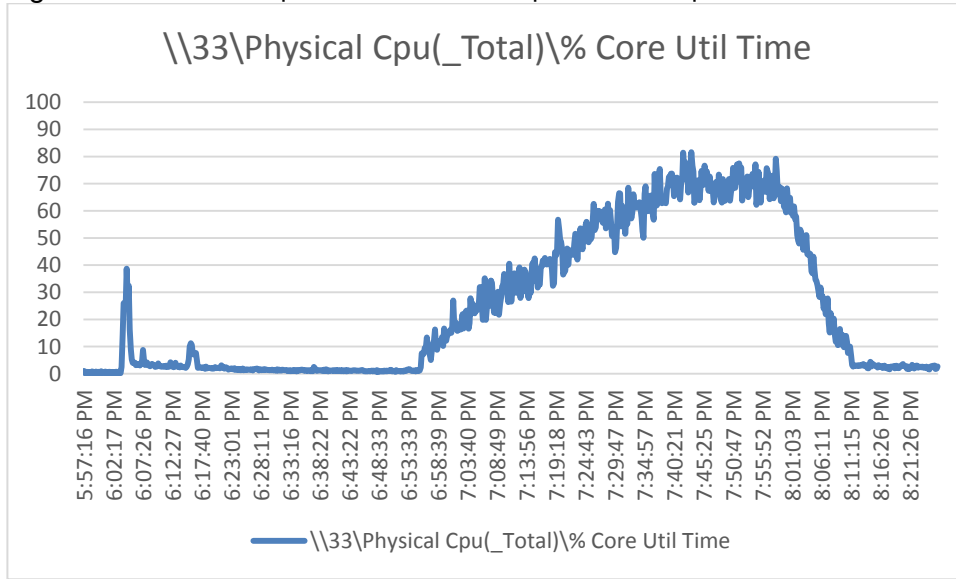

Figure 123 Full Scale | 6000 Mixed Users | HSD Hosts | Host Memory Utilization

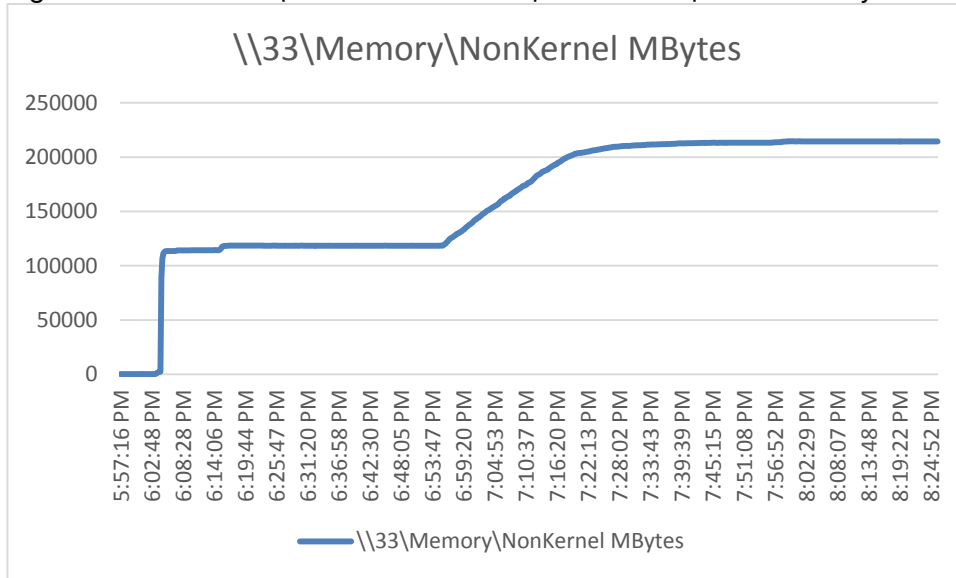

Figure 124 Full Scale | 6000 Mixed Users | HSD Hosts | Host Network Utilization

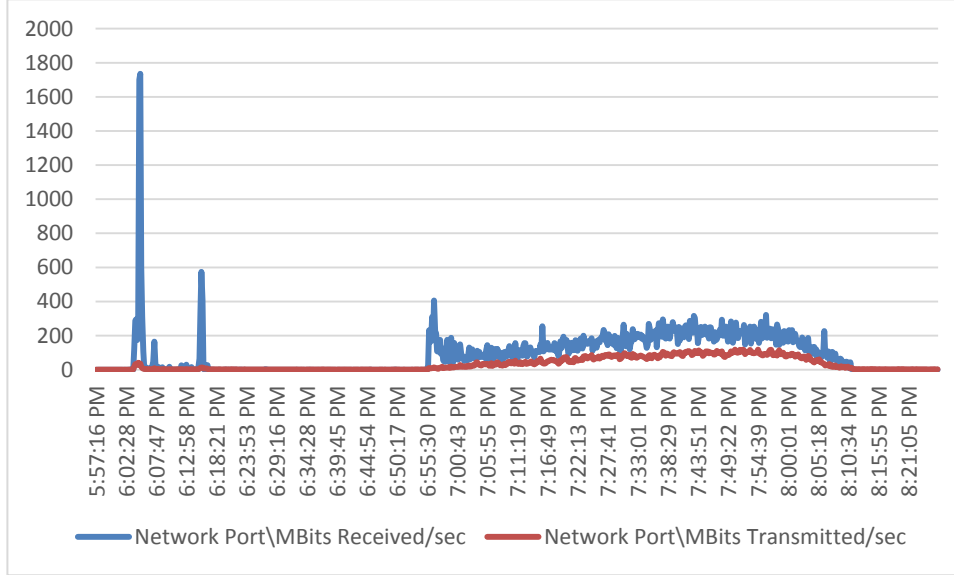

Figure 125 Full Scale | 6000 Mixed Users | HVD Non-Persistent Hosts | Host CPU Utilization

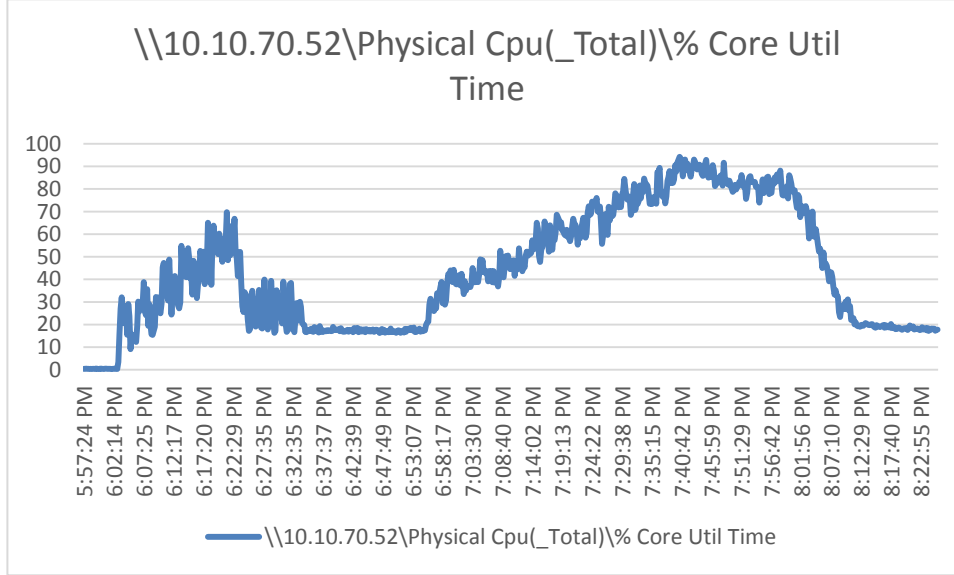

Figure 126 Full Scale | 6000 Mixed Users | HVD Non-Persistent Hosts | Host Memory Utilization

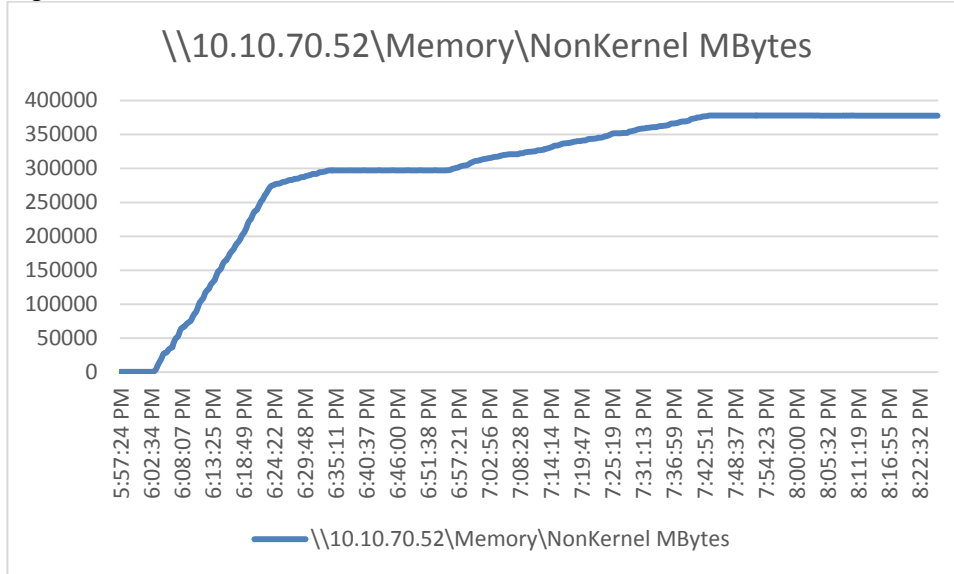

Figure 127 Full Scale | 6000 Mixed Users | HVD Non-Persistent Hosts | Host Network Utilization

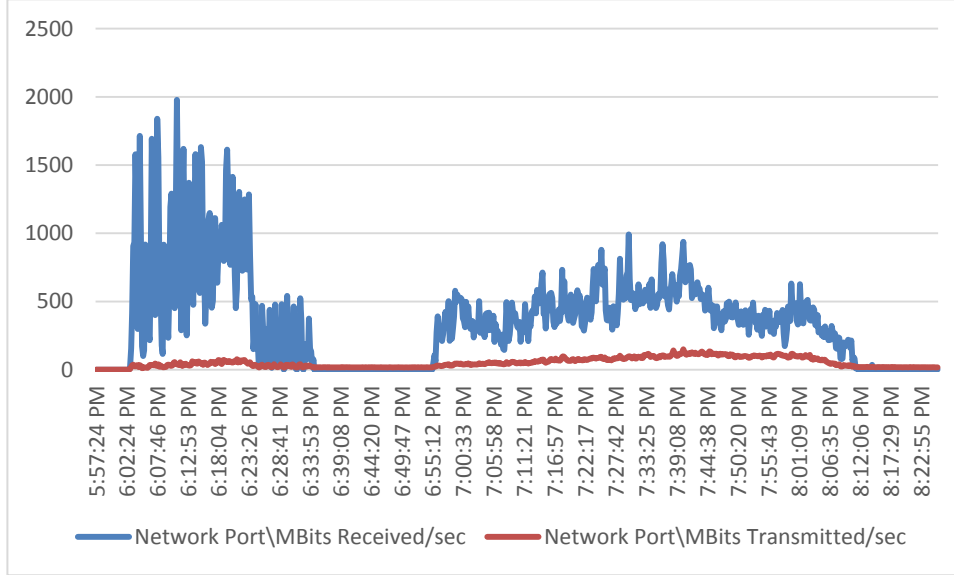

Figure 128 Full Scale | 6000 Mixed Users | HVD Persistent Hosts | Host CPU Utilization

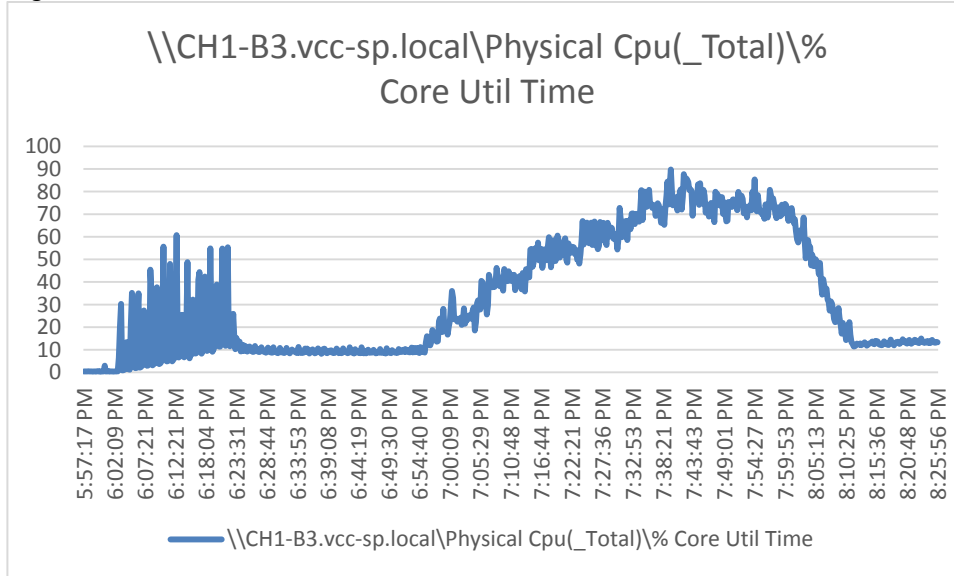

Figure 129 Full Scale | 6000 Mixed Users | HVD Persistent Hosts | Host Memory Utilization

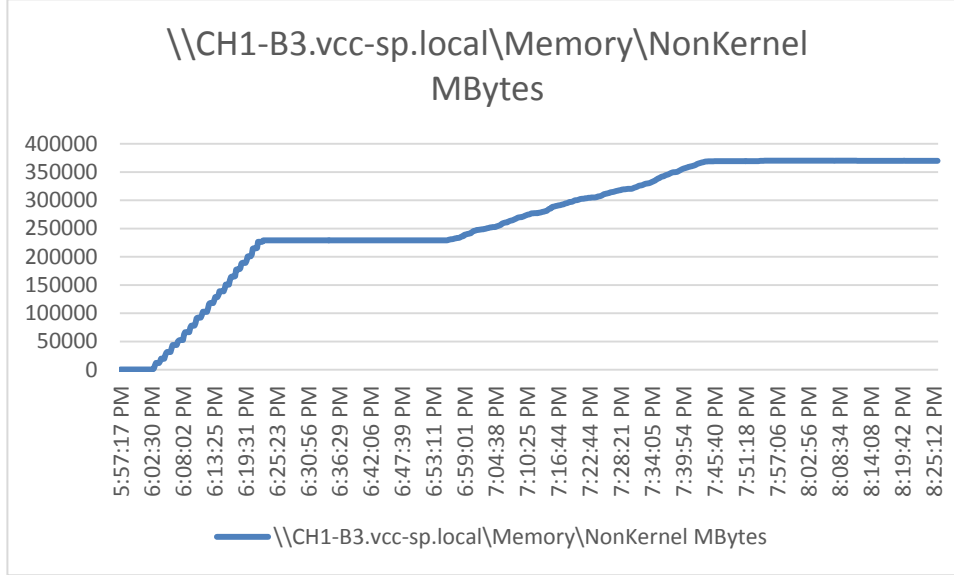
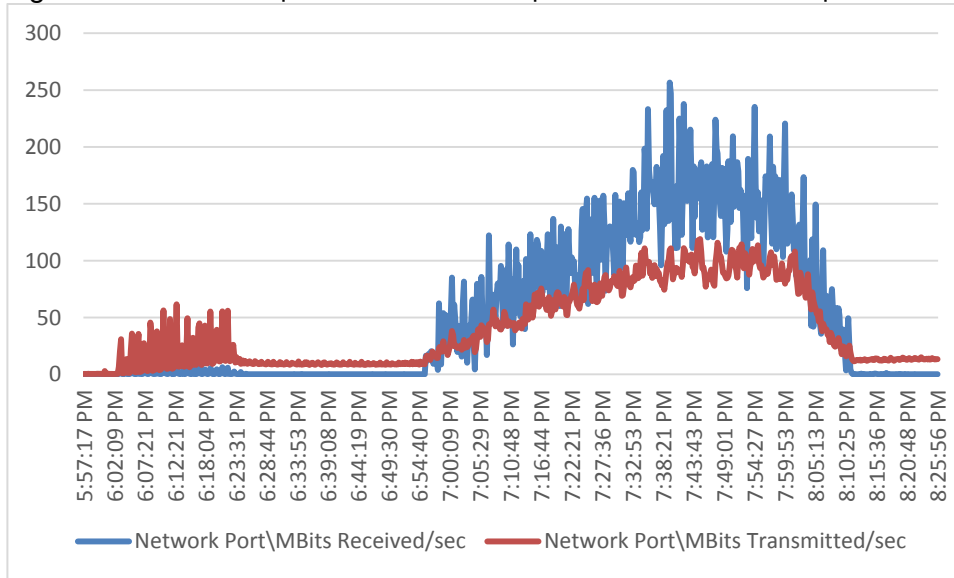

Figure 130 Full Scale | 6000 Mixed Users | HVD Persistent Hosts | Host Network Utilization



Pure Storage FlashArray//X70 R2 Storage System Graph for 6000 Users Mixed Workload Test

Figure 131 Full Scale 6000 Mixed User Running Knowledge Worker Workload - Pure Storage FlashArray//X70 R2 System Latency Chart

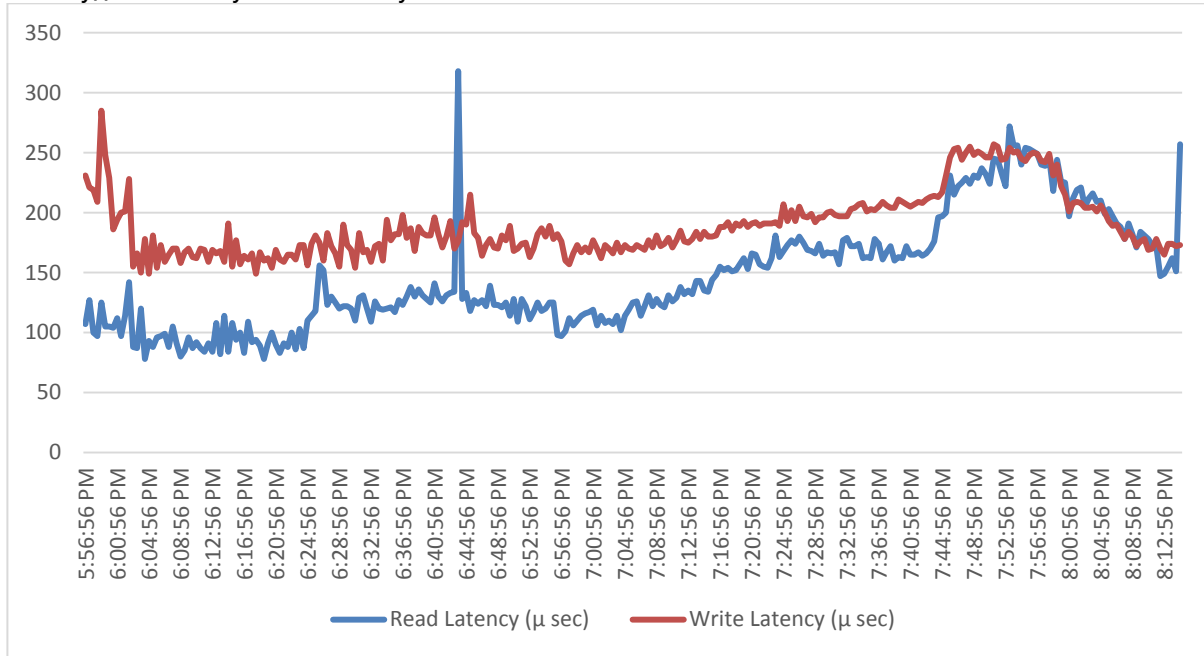

Figure 132 Full Scale 6000 Mixed User Running Knowledge Worker Workload - Pure Storage FlashArray//X70 R2 System IOPS Chart

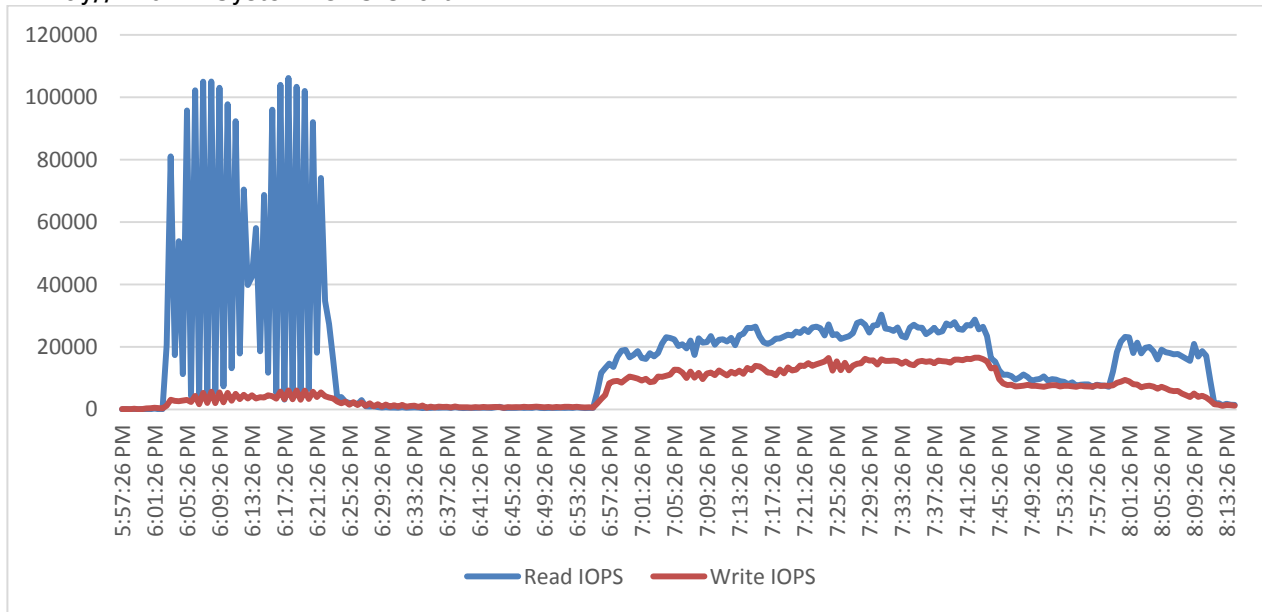

Figure 133 Full Scale 6000 Mixed User Running Knowledge Worker Workload - Pure Storage FlashArray//X70 R2 System Bandwidth Chart

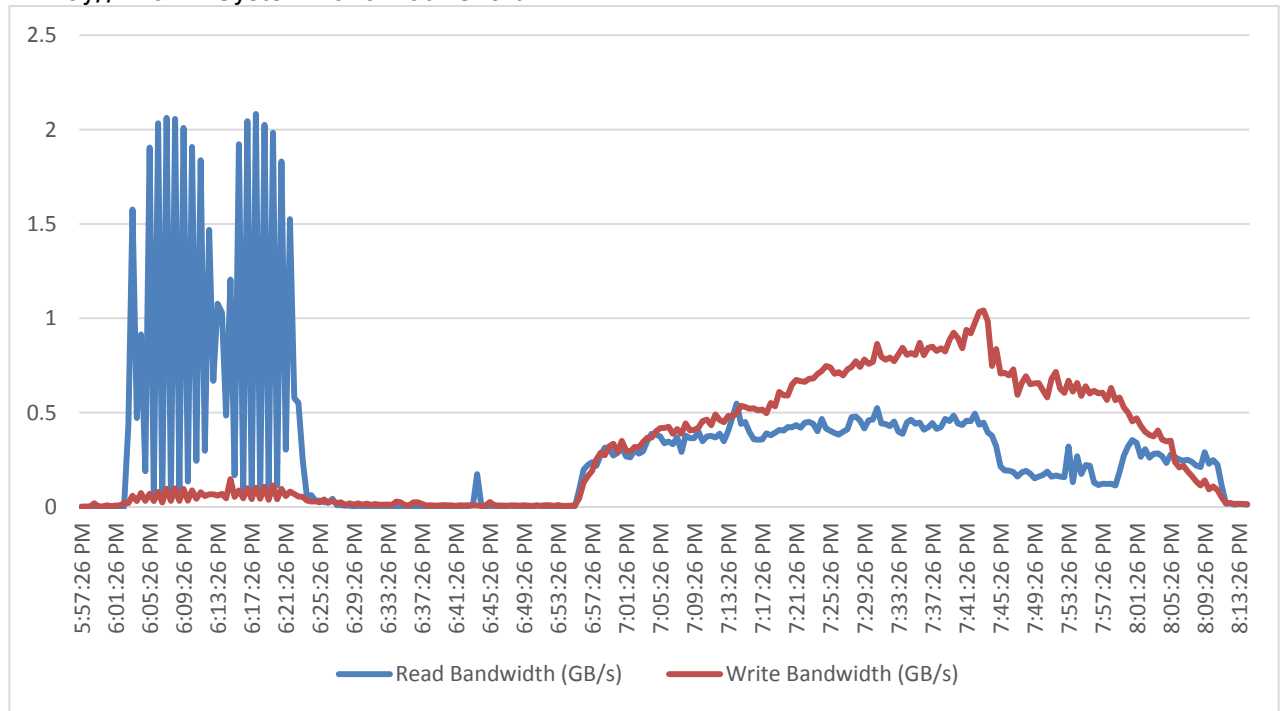
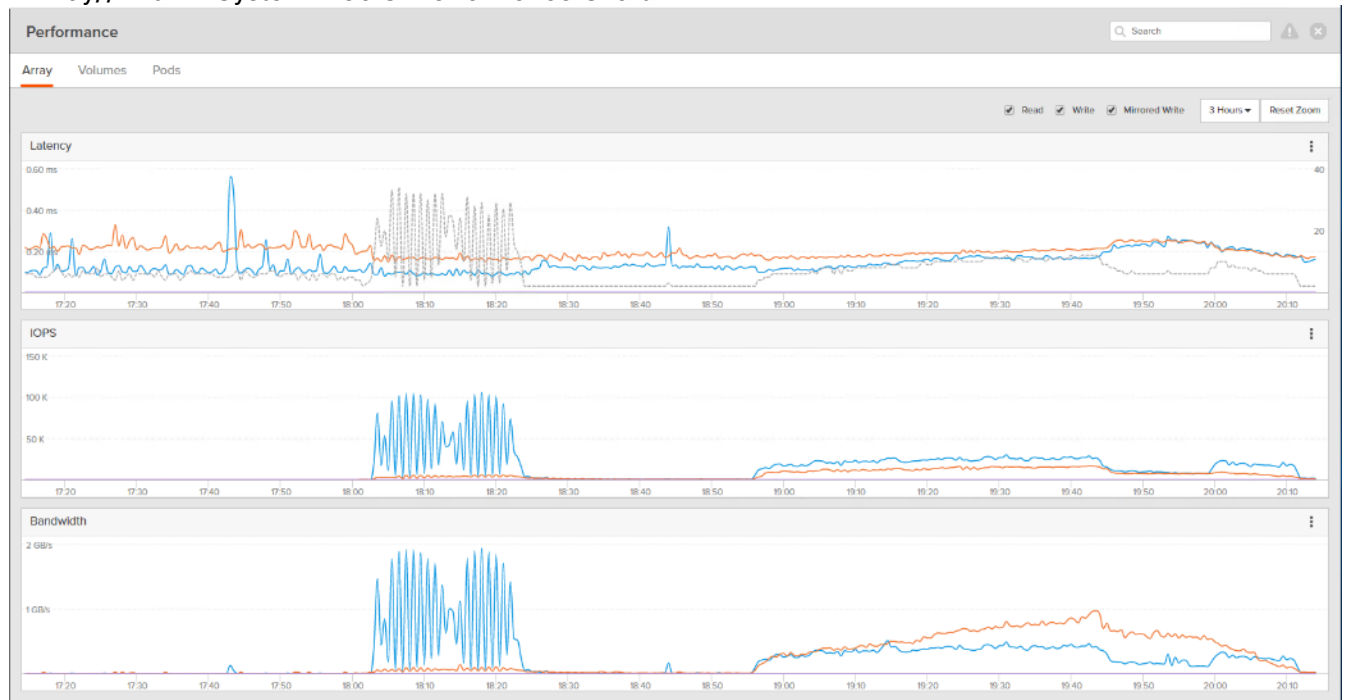

Figure 134 Full Scale 6000 Mixed User Running Knowledge Worker Workload - Pure Storage FlashArray//X70 R2 System Web UI Performance Chart



Summary

FlashStack delivers a platform for Enterprise End User Computing deployments and cloud data centers using Cisco UCS Blade and Rack Servers, Cisco Fabric Interconnects, Cisco Nexus 9000 switches, Cisco MDS 9100 Fibre Channel switches and Pure Storage FlashArray//X70 R2 Storage Array. FlashStack is designed and validated using compute, network and storage best practices and high availability to reduce deployment time, project risk and IT costs while maintaining scalability and flexibility for addressing a multitude of IT initiatives. This CVD validates the design, performance, management, scalability, and resilience that FlashStack provides to customers wishing to deploy enterprise-class Virtual Client Computing (VCC) for 6000 users at a time.

Get More Business Value with Services

Whether you are planning your next-generation environment, need specialized know-how for a major deployment, or want to get the most from your current storage, Cisco Advanced Services, Pure Storage FlashArray//X70 R2 storage and our certified partners can help. We collaborate with you to enhance your IT capabilities through a full portfolio of services that covers your IT lifecycle with:

- Strategy services to align IT with your business goals:
- Design services to architect your best storage environment
- Deploy and transition services to implement validated architectures and prepare your storage environment
- Operations services to deliver continuous operations while driving operational excellence and efficiency.

In addition, Cisco Advanced Services and Pure Storage Support provide in-depth knowledge transfer and education services that give you access to our global technical resources and intellectual property.

About the Authors

Vadim Lebedev, Technical Marketing Engineer, Desktop Virtualization and Graphics Solutions, Cisco Systems, Inc.

Vadim Lebedev is a member of the Cisco's Computing Systems Product Group team focusing on design, testing, and solutions validation, technical content creation, and performance testing/benchmarking. He has years of experience in server and desktop virtualization. Vadim is a subject matter expert on Cisco HyperFlex, Cisco Unified Computing System, Cisco Nexus Switching, and NVIDIA Graphics. He carries Citrix Certified Expert – Virtualization certification from Citrix Systems, Inc.

Acknowledgements

For their support and contribution to the design, validation, and creation of this Cisco Validated Design, we would like to acknowledge the following for their contribution and expertise that resulted in developing this document:

- Mike Brennan, Product Manager, Desktop Virtualization and Graphics Solutions, Cisco Systems, Inc.
- Kyle Grossmiller, Solutions Architect, Pure Storage, Inc.
- Craig Waters, Solutions Architect, Pure Storage, Inc.

References

This section provides links to additional information for each partner's solution component of this document.

Cisco UCS B-Series Servers

- <http://www.cisco.com/c/en/us/products/servers-unified-computing/ucs-b-series-blade-servers/index.html>
- <https://www.cisco.com/c/dam/en/us/products/collateral/servers-unified-computing/ucs-b-series-blade-servers/b200m5-specsheet.pdf>
- <https://www.cisco.com/c/en/us/products/servers-unified-computing/ucs-b-series-blade-servers/datasheet-listing.html>
- <https://www.cisco.com/c/en/us/support/servers-unified-computing/ucs-b200-m5-blade-server/model.html>
- https://www.cisco.com/c/en/us/td/docs/unified_computing/ucs/hw/blade-servers/B200M5.pdf

Cisco UCS Manager Configuration Guides

- <http://www.cisco.com/c/en/us/support/servers-unified-computing/ucs-manager/products-installation-and-configuration-guides-list.html>
- <https://www.cisco.com/c/en/us/support/servers-unified-computing/ucs-manager/products-release-notes-list.html>

Cisco UCS Virtual Interface Cards

- <http://www.cisco.com/c/en/us/products/collateral/interfaces-modules/ucs-virtual-interface-card-1340/datasheet-c78-732517.html>
- <http://www.cisco.com/c/en/us/products/interfaces-modules/ucs-virtual-interface-card-1340/index.html>

Cisco Nexus Switching References

- <http://www.cisco.com/c/en/us/products/collateral/switches/nexus-9000-series-switches/datasheet-c78-736967.html>
- <https://www.cisco.com/c/en/us/products/switches/nexus-93180yc-fx-switch/index.html>

Cisco MDS 9000 Service Switch References

- <http://www.cisco.com/c/en/us/products/storage-networking/mds-9000-series-multilayer-switches/index.html>
- <http://www.cisco.com/c/en/us/products/storage-networking/product-listing.html>
- <https://www.cisco.com/c/en/us/products/collateral/storage-networking/mds-9132T-32-Gbps-16g-multilayer-fabric-switch/datasheet-c78-731523.html>

VMware References

- <https://docs.vmware.com/en/VMware-vSphere/index.html>

Citrix References

- <https://docs.citrix.com/en-us/xenapp-and-xendesktop/7-15-ltsr.html>
- <https://docs.citrix.com/en-us/provisioning/7-15.html>
- <https://support.citrix.com/article/CTX216252?recommended>
- <https://support.citrix.com/article/CTX117374>
- <https://support.citrix.com/article/CTX202400>
- <https://support.citrix.com/article/CTX205488>

Login VSI Documentation

- https://www.loginvsi.com/documentation/Main_Page
- https://www.loginvsi.com/documentation/Start_your_first_test

Pure Storage Reference Documents

- <https://www.flashstack.com/>
- https://www.purestorage.com/content/dam/purestorage/pdf/datasheets/ps_ds_flasharray_03.pdf
- <https://www.purestorage.com>
- <https://www.purestorage.com/products/evergreen-subscriptions.html>
- <https://www.purestorage.com/solutions/infrastructure/vdi.html>
- <https://www.purestorage.com/solutions/infrastructure/vdi-calculator.html>

Appendix

Ethernet Network Configuration

The following section provides a detailed procedure for configuring the Cisco Nexus 9000 Switches used in this study.

Cisco Nexus 93180YC-FX-A Configuration

!Command: show running-config

!Time: Fri May 17 19:22:52 2019

```
version 7.0(3)I7(2)
switchname AAD17-NX9K-A
class-map type network-qos class-fcoe
match qos-group 1
class-map type network-qos class-all-flood
match qos-group 2
class-map type network-qos class-ip-multicast
match qos-group 2
policy-map type network-qos jumbo
  class type network-qos class-fcoe
    mtu 2158
  class type network-qos class-default
    mtu 9216
install feature-set fcoe-npv
vdc AAD17-NX9K-A id 1
  allow feature-set fcoe-npv
  limit-resource vlan minimum 16 maximum 4094
  limit-resource vrf minimum 2 maximum 4096
  limit-resource port-channel minimum 0 maximum 511
  limit-resource u4route-mem minimum 248 maximum 248
  limit-resource u6route-mem minimum 96 maximum 96
```

```
limit-resource m4route-mem minimum 58 maximum 58
limit-resource m6route-mem minimum 8 maximum 8
feature-set fcoe-npv

feature telnet
cfs eth distribute
feature interface-vlan
feature hsrp
feature lacp
feature dhcp
feature vpc
feature lldp

no password strength-check
username admin password 5 $5$d3vc8gvD$hmf.YoRRPcqZ2dDGV2laVKYZsPSPis8E9bpUzMciMZ
0 role network-admin
ip domain-lookup
system default switchport
class-map type qos match-all class-fcoe
policy-map type qos jumbo
  class class-default
    set qos-group 0
system qos
  service-policy type network-qos jumbo
copp profile lenient
snmp-server user admin network-admin auth md5 0xc9a73d344387b8db2dc0f3fc624240ac
priv 0xc9a73d344387b8db2dc0f3fc624240ac localizedkey
rmon event 1 description FATAL(1) owner PMON@FATAL
rmon event 2 description CRITICAL(2) owner PMON@CRITICAL
rmon event 3 description ERROR(3) owner PMON@ERROR
```

```
rmon event 4 description WARNING(4) owner PMON@WARNING
rmon event 5 description INFORMATION(5) owner PMON@INFO
ntp server 10.10.70.2 use-vrf default
ntp peer 10.10.70.3 use-vrf default
ntp server 72.163.32.44 use-vrf management
ntp logging
ntp master 8
```

```
vlan 1,70-76
vlan 70
    name InBand-Mgmt-SP
vlan 71
    name Infra-Mgmt-SP
vlan 72
    name VM-Network-SP
vlan 73
    name vMotion-SP
vlan 74
    name Storage_A-SP
vlan 75
    name Storage_B-SP
vlan 76
    name Launcher-SP
```

```
service dhcp
ip dhcp relay
ip dhcp relay information option
ipv6 dhcp relay
vrf context management
ip route 0.0.0.0/0 10.29.164.1
```

```
hardware access-list tcam region ing-racl 1536
hardware access-list tcam region ing-redirect 256
vpc domain 70
  role priority 1000
  peer-keepalive destination 10.29.164.234 source 10.29.164.233
```

```
interface Vlan1
  no shutdown
  ip address 10.29.164.241/24
```

```
interface Vlan70
  no shutdown
  ip address 10.10.70.2/24
  hsrp version 2
  hsrp 70
    preempt
    priority 110
  ip 10.10.70.1
```

```
interface Vlan71
  no shutdown
  ip address 10.10.71.2/24
  hsrp version 2
  hsrp 71
    preempt
    priority 110
  ip 10.10.71.1
```

```
interface Vlan72
```

```
no shutdown
ip address 10.72.0.2/19
hsrp version 2
hsrp 72
  preempt
  priority 110
  ip 10.72.0.1
ip dhcp relay address 10.10.71.11
ip dhcp relay address 10.10.71.12
```

```
interface Vlan73
  no shutdown
  ip address 10.10.73.2/24
  hsrp version 2
  hsrp 73
    preempt
    priority 110
    ip 10.10.73.1
```

```
interface Vlan74
  no shutdown
  ip address 10.10.74.2/24
  hsrp version 2
  hsrp 74
    preempt
    priority 110
    ip 10.10.74.1
```

```
interface Vlan75
  no shutdown
```

```
ip address 10.10.75.2/24
hsrp version 2
hsrp 75
  preempt
  priority 110
ip 10.10.75.1
```

```
interface Vlan76
  no shutdown
  ip address 10.10.76.2/23
  hsrp version 2
  hsrp 76
    preempt
    priority 110
  ip 10.10.76.1
  ip dhcp relay address 10.10.71.11
  ip dhcp relay address 10.10.71.12
```

```
interface port-channel10
```

```
interface port-channel11
  description FI-Uplink-D17
  switchport mode trunk
  switchport trunk allowed vlan 1,70-76
  spanning-tree port type edge trunk
  mtu 9216
  service-policy type qos input jumbo
  vpc 11
```

```
interface port-channel12
```

```
description FI-Uplink-D17
switchport mode trunk
switchport trunk allowed vlan 1,70-76
spanning-tree port type edge trunk
mtu 9216
service-policy type qos input jumbo
vpc 12
```

```
interface port-channel13
description FI-Uplink-D16
switchport mode trunk
switchport trunk allowed vlan 1,70-76
spanning-tree port type edge trunk
mtu 9216
service-policy type qos input jumbo
vpc 13
```

```
interface port-channel14
description FI-Uplink-D16
switchport mode trunk
switchport trunk allowed vlan 1,70-76
spanning-tree port type edge trunk
mtu 9216
service-policy type qos input jumbo
vpc 14
```

```
interface port-channel70
description vPC-PeerLink
switchport mode trunk
switchport trunk allowed vlan 1,70-76
```

```
spanning-tree port type network  
service-policy type qos input jumbo  
vpc peer-link
```

```
interface Ethernet1/1
```

```
interface Ethernet1/2
```

```
switchport mode trunk  
switchport trunk allowed vlan 1,70-76
```

```
interface Ethernet1/3
```

```
switchport mode trunk  
switchport trunk allowed vlan 1,70-76  
mtu 9216  
channel-group 13 mode active
```

```
interface Ethernet1/4
```

```
switchport mode trunk  
switchport trunk allowed vlan 1,70-76  
mtu 9216  
channel-group 13 mode active
```

```
interface Ethernet1/5
```

```
switchport mode trunk  
switchport trunk allowed vlan 1,70-76  
mtu 9216  
channel-group 14 mode active
```

```
interface Ethernet1/6
```

```
switchport mode trunk
```



```
switchport trunk allowed vlan 1,70-76
```

```
mtu 9216
```

```
channel-group 14 mode active
```

```
interface Ethernet1/7
```

```
interface Ethernet1/8
```

```
interface Ethernet1/9
```

```
interface Ethernet1/10
```

```
interface Ethernet1/11
```

```
interface Ethernet1/12
```

```
interface Ethernet1/13
```

```
interface Ethernet1/14
```

```
interface Ethernet1/15
```

```
interface Ethernet1/16
```

```
interface Ethernet1/17
```

```
interface Ethernet1/18
```

```
interface Ethernet1/19
```

interface Ethernet1/20

interface Ethernet1/21

interface Ethernet1/22

interface Ethernet1/23

interface Ethernet1/24

interface Ethernet1/25

interface Ethernet1/26

interface Ethernet1/27

interface Ethernet1/28

interface Ethernet1/29

interface Ethernet1/30

interface Ethernet1/31

interface Ethernet1/32

interface Ethernet1/33

interface Ethernet1/34

interface Ethernet1/35

interface Ethernet1/36

interface Ethernet1/37

interface Ethernet1/38

interface Ethernet1/39

interface Ethernet1/40

interface Ethernet1/41

interface Ethernet1/42

interface Ethernet1/43

interface Ethernet1/44

interface Ethernet1/45

interface Ethernet1/46

interface Ethernet1/47

interface Ethernet1/48

interface Ethernet1/49

```
interface Ethernet1/50
```

```
interface Ethernet1/51
```

```
  switchport mode trunk
```

```
  switchport trunk allowed vlan 1,70-76
```

```
  mtu 9216
```

```
  channel-group 11 mode active
```

```
interface Ethernet1/52
```

```
  switchport mode trunk
```

```
  switchport trunk allowed vlan 1,70-76
```

```
  mtu 9216
```

```
  channel-group 12 mode active
```

```
interface Ethernet1/53
```

```
  switchport mode trunk
```

```
  switchport trunk allowed vlan 1,70-76
```

```
  channel-group 70 mode active
```

```
interface Ethernet1/54
```

```
  switchport mode trunk
```

```
  switchport trunk allowed vlan 1,70-76
```

```
  channel-group 70 mode active
```

```
interface mgmt0
```

```
  vrf member management
```

```
  ip address 10.29.164.233/24
```

```
line console
```

```
line vty
```

```
boot nxos bootflash:/nxos.7.0.3.17.2.bin
```

no system default switchport shutdown

Cisco Nexus 93180YC-FX-B Configuration

!Command: show running-config

!Time: Fri May 17 19:25:15 2019

```
version 7.0(3)I7(2)
switchname AAD17-NX9K-B
class-map type network-qos class-fcoe
match qos-group 1
class-map type network-qos class-all-flood
match qos-group 2
class-map type network-qos class-ip-multicast
match qos-group 2
policy-map type network-qos jumbo
  class type network-qos class-fcoe
    mtu 2158
  class type network-qos class-default
    mtu 9216
install feature-set fcoe-npv
vdc AAD17-NX9K-B id 1
  allow feature-set fcoe-npv
  limit-resource vlan minimum 16 maximum 4094
  limit-resource vrf minimum 2 maximum 4096
  limit-resource port-channel minimum 0 maximum 511
  limit-resource u4route-mem minimum 248 maximum 248
  limit-resource u6route-mem minimum 96 maximum 96
  limit-resource m4route-mem minimum 58 maximum 58
  limit-resource m6route-mem minimum 8 maximum 8
feature-set fcoe-npv
```

```
feature telnet
cfs eth distribute
feature interface-vlan
feature hsrp
feature lacp
feature dhcp
feature vpc
feature lldp

no password strength-check
username admin password 5 $5$/48.OHa8$g6pOMLlwrzqx.JesMYoP5CNphujBksPPRjn4I3iFfOp
. role network-admin
ip domain-lookup
system default switchport
class-map type qos match-all class-fcoe
policy-map type qos jumbo
  class class-default
    set qos-group 0
system qos
  service-policy type network-qos jumbo
copp profile lenient
snmp-server user admin network-admin auth md5 0x6d450e3d5a3927ddee1dadd30e5f616f
priv 0x6d450e3d5a3927ddee1dadd30e5f616f localizedkey
rmon event 1 description FATAL(1) owner PMON@FATAL
rmon event 2 description CRITICAL(2) owner PMON@CRITICAL
rmon event 3 description ERROR(3) owner PMON@ERROR
rmon event 4 description WARNING(4) owner PMON@WARNING
rmon event 5 description INFORMATION(5) owner PMON@INFO
ntp peer 10.10.70.2 use-vrf default
ntp server 10.10.70.3 use-vrf default
```

```
ntp server 72.163.32.44 use-vrf management
```

```
ntp logging
```

```
ntp master 8
```

```
vlan 1,70-76
```

```
vlan 70
```

```
    name InBand-Mgmt-SP
```

```
vlan 71
```

```
    name Infra-Mgmt-SP
```

```
vlan 72
```

```
    name VM-Network-SP
```

```
vlan 73
```

```
    name vMotion-SP
```

```
vlan 74
```

```
    name Storage_A-SP
```

```
vlan 75
```

```
    name Storage_B-SP
```

```
vlan 76
```

```
    name Launcher-SP
```

```
service dhcp
```

```
ip dhcp relay
```

```
ip dhcp relay information option
```

```
ipv6 dhcp relay
```

```
vrf context management
```

```
    ip route 0.0.0.0/0 10.29.164.1
```

```
hardware access-list tcam region ing-racl 1536
```

```
hardware access-list tcam region ing-redirect 256
```

```
vpc domain 70
```

```
    role priority 2000
```

```
peer-keepalive destination 10.29.164.233 source 10.29.164.234
```

```
interface Vlan1  
no shutdown  
ip address 10.29.164.240/24
```

```
interface Vlan70  
no shutdown  
ip address 10.10.70.3/24  
hsrp version 2  
hsrp 70  
preempt  
priority 110  
ip 10.10.70.1
```

```
interface Vlan71  
no shutdown  
ip address 10.10.71.3/24  
hsrp version 2  
hsrp 71  
preempt  
priority 110  
ip 10.10.71.1
```

```
interface Vlan72  
no shutdown  
ip address 10.72.0.2/19  
hsrp version 2  
hsrp 72
```



```
preempt
```

```
priority 110
```

```
ip 10.72.0.1
```

```
ip dhcp relay address 10.10.71.11
```

```
ip dhcp relay address 10.10.71.12
```

```
interface Vlan73
```

```
no shutdown
```

```
ip address 10.10.73.3/24
```

```
hsrp version 2
```

```
hsrp 73
```

```
preempt
```

```
priority 110
```

```
ip 10.10.73.1
```

```
interface Vlan74
```

```
no shutdown
```

```
ip address 10.10.74.3/24
```

```
hsrp version 2
```

```
hsrp 74
```

```
preempt
```

```
priority 110
```

```
ip 10.10.74.1
```

```
interface Vlan75
```

```
no shutdown
```

```
ip address 10.10.75.3/24
```

```
hsrp version 2
```

```
hsrp 75
```

```
preempt
```

```
priority 110  
ip 10.10.75.1
```

```
interface Vlan76  
no shutdown  
ip address 10.10.76.3/23  
hsrp version 2  
hsrp 76  
preempt  
priority 110  
ip 10.10.76.1  
ip dhcp relay address 10.10.71.11  
ip dhcp relay address 10.10.71.12
```

```
interface port-channel10
```

```
interface port-channel11  
description FI-Uplink-D17  
switchport mode trunk  
switchport trunk allowed vlan 1,70-76  
spanning-tree port type edge trunk  
mtu 9216  
service-policy type qos input jumbo  
vpc 11
```

```
interface port-channel12  
description FI-Uplink-D17  
switchport mode trunk  
switchport trunk allowed vlan 1,70-76  
spanning-tree port type edge trunk
```

```
mtu 9216
service-policy type qos input jumbo
vpc 12
```

```
interface port-channel13
description FI-Uplink-D16
switchport mode trunk
switchport trunk allowed vlan 1,70-76
spanning-tree port type edge trunk
mtu 9216
service-policy type qos input jumbo
vpc 13
```

```
interface port-channel14
description FI-Uplink-D16
switchport mode trunk
switchport trunk allowed vlan 1,70-76
spanning-tree port type edge trunk
mtu 9216
service-policy type qos input jumbo
vpc 14
```

```
interface port-channel70
description vPC-PeerLink
switchport mode trunk
switchport trunk allowed vlan 1,70-76
spanning-tree port type network
service-policy type qos input jumbo
vpc peer-link
```

```
interface Ethernet1/1
  switchport access vlan 70
  speed 1000
```

```
interface Ethernet1/2
  switchport mode trunk
  switchport trunk allowed vlan 1,70-76
```

```
interface Ethernet1/3
  switchport mode trunk
  switchport trunk allowed vlan 1,70-76
  mtu 9216
  channel-group 13 mode active
```

```
interface Ethernet1/4
  switchport mode trunk
  switchport trunk allowed vlan 1,70-76
  mtu 9216
  channel-group 13 mode active
```

```
interface Ethernet1/5
  switchport mode trunk
  switchport trunk allowed vlan 1,70-76
  mtu 9216
  channel-group 14 mode active
```

```
interface Ethernet1/6
  switchport mode trunk
  switchport trunk allowed vlan 1,70-76
  mtu 9216
```

```
channel-group 14 mode active
```

```
interface Ethernet1/7
```

```
interface Ethernet1/8
```

```
interface Ethernet1/9
```

```
interface Ethernet1/10
```

```
interface Ethernet1/11
```

```
interface Ethernet1/12
```

```
interface Ethernet1/13
```

```
interface Ethernet1/14
```

```
interface Ethernet1/15
```

```
interface Ethernet1/16
```

```
interface Ethernet1/17
```

```
interface Ethernet1/18
```

```
interface Ethernet1/19
```

```
interface Ethernet1/20
```

interface Ethernet1/21

interface Ethernet1/22

interface Ethernet1/23

interface Ethernet1/24

interface Ethernet1/25

interface Ethernet1/26

interface Ethernet1/27

interface Ethernet1/28

interface Ethernet1/29

interface Ethernet1/30

interface Ethernet1/31

interface Ethernet1/32

interface Ethernet1/33

interface Ethernet1/34

interface Ethernet1/35

interface Ethernet1/36

interface Ethernet1/37

interface Ethernet1/38

interface Ethernet1/39

interface Ethernet1/40

interface Ethernet1/41

interface Ethernet1/42

interface Ethernet1/43

interface Ethernet1/44

interface Ethernet1/45

interface Ethernet1/46

interface Ethernet1/47

interface Ethernet1/48

interface Ethernet1/49

interface Ethernet1/50

```
interface Ethernet1/51
  switchport mode trunk
  switchport trunk allowed vlan 1,70-76
  mtu 9216
  channel-group 11 mode active
```

```
interface Ethernet1/52
  switchport mode trunk
  switchport trunk allowed vlan 1,70-76
  mtu 9216
  channel-group 12 mode active
```

```
interface Ethernet1/53
  switchport mode trunk
  switchport trunk allowed vlan 1,70-76
  channel-group 70 mode active
```

```
interface Ethernet1/54
  switchport mode trunk
  switchport trunk allowed vlan 1,70-76
  channel-group 70 mode active
```

```
interface mgmt0
  vrf member management
  ip address 10.29.164.234/24
  line console
  line vty
  boot nxos bootflash:/nxos.7.0.3.I7.2.bin
```

No System Default Switchport Shutdown Fibre Channel Network Configuration

The following section provides a detailed procedure for configuring the Cisco MDS 9100 Switches used in this study.

Cisco MDS 9132T 32-Gbps-A Configuration

```
!Command: show running-config
```

```
!Running configuration last done at: Wed Mar 20 04:02:24 2019
```

```
!Time: Fri May 17 20:50:47 2019
```

```
version 8.3(1)
```

```
power redundancy-mode redundant
```

```
feature npiv
```

```
feature fport-channel-trunk
```

```
role name default-role
```

```
description This is a system defined role and applies to all users.
```

```
rule 5 permit show feature environment
```

```
rule 4 permit show feature hardware
```

```
rule 3 permit show feature module
```

```
rule 2 permit show feature snmp
```

```
rule 1 permit show feature system
```

```
no password strength-check
```

```
username admin password 5 $5$kaIE4kXd$3rDLwb/BjpcAzi.KtGNzxmEWijVraamDzl/xL61as.4 role network-admin
```

```
ip domain-lookup
```

```
ip name-server 10.10.61.30
```

```
ip host ADD16-MDS-A 10.29.164.238
```

```
aaa group server radius radius
```

```
snmp-server user admin network-admin auth md5 0x3404c40cc872c0c3391c85d64ecdc64e priv 0xf61ac3a6f9d55d71960b617393b98ebe localizedkey
```

```
rmon event 1 log trap public description FATAL(1) owner PMON@FATAL
```

```
rmon event 2 log trap public description CRITICAL(2) owner PMON@CRITICAL
```

```
rmon event 3 log trap public description ERROR(3) owner PMON@ERROR
```

```
rmon event 4 log trap public description WARNING(4) owner PMON@WARNING
rmon event 5 log trap public description INFORMATION(5) owner PMON@INFO
ntp server 10.81.254.131
ntp server 10.81.254.202
vsan database
  vsan 100 name "FlashStack-VCC-CVD-Fabric-A"
  vsan 400 name "FlexPod-A"
device-alias database
  device-alias name C480M5-P0 pwwn 21:00:00:0e:1e:10:a2:c0
  device-alias name VDI-1-HBA1 pwwn 20:00:00:25:b5:3a:00:3f
  device-alias name VDI-2-HBA1 pwwn 20:00:00:25:b5:3a:00:0f
  device-alias name VDI-3-HBA1 pwwn 20:00:00:25:b5:3a:00:1f
  device-alias name VDI-4-HBA1 pwwn 20:00:00:25:b5:3a:00:4e
  device-alias name VDI-5-HBA1 pwwn 20:00:00:25:b5:3a:00:2e
  device-alias name VDI-6-HBA1 pwwn 20:00:00:25:b5:3a:00:3e
  device-alias name VDI-7-HBA1 pwwn 20:00:00:25:b5:3a:00:0e
  device-alias name VDI-9-HBA1 pwwn 20:00:00:25:b5:3a:00:4d
  device-alias name a300-01-0g pwwn 20:01:00:a0:98:af:bd:e8
  device-alias name a300-02-0g pwwn 20:03:00:a0:98:af:bd:e8
  device-alias name CS700-FC1-1 pwwn 56:c9:ce:90:0d:e8:24:02
  device-alias name CS700-FC2-1 pwwn 56:c9:ce:90:0d:e8:24:06
  device-alias name VDI-10-HBA1 pwwn 20:00:00:25:b5:3a:00:2d
  device-alias name VDI-11-HBA1 pwwn 20:00:00:25:b5:3a:00:3d
  device-alias name VDI-12-HBA1 pwwn 20:00:00:25:b5:3a:00:0d
  device-alias name VDI-13-HBA1 pwwn 20:00:00:25:b5:3a:00:1d
  device-alias name VDI-14-HBA1 pwwn 20:00:00:25:b5:3a:00:4c
  device-alias name VDI-15-HBA1 pwwn 20:00:00:25:b5:3a:00:2c
  device-alias name VDI-17-HBA1 pwwn 20:00:00:25:b5:3a:00:0c
  device-alias name VDI-18-HBA1 pwwn 20:00:00:25:b5:3a:00:1c
  device-alias name VDI-19-HBA1 pwwn 20:00:00:25:b5:3a:00:4b
```

device-alias name VDI-20-HBA1 pwwn 20:00:00:25:b5:3a:00:2b
device-alias name VDI-21-HBA1 pwwn 20:00:00:25:b5:3a:00:3b
device-alias name VDI-22-HBA1 pwwn 20:00:00:25:b5:3a:00:0b
device-alias name VDI-23-HBA1 pwwn 20:00:00:25:b5:3a:00:1b
device-alias name VDI-24-HBA1 pwwn 20:00:00:25:b5:3a:00:4a
device-alias name VDI-25-HBA1 pwwn 20:00:00:25:b5:3a:00:2a
device-alias name VDI-26-HBA1 pwwn 20:00:00:25:b5:3a:00:3a
device-alias name VDI-27-HBA1 pwwn 20:00:00:25:b5:3a:00:0a
device-alias name VDI-28-HBA1 pwwn 20:00:00:25:b5:3a:00:1a
device-alias name VDI-29-HBA1 pwwn 20:00:00:25:b5:3a:00:49
device-alias name VDI-30-HBA1 pwwn 20:00:00:25:b5:3a:00:39
device-alias name VDI-31-HBA1 pwwn 20:00:00:25:b5:3a:00:1e
device-alias name VDI-32-HBA1 pwwn 20:00:00:25:b5:3a:00:3c
device-alias name X70-CT0-FC0 pwwn 52:4a:93:75:dd:91:0a:00
device-alias name X70-CT0-FC2 pwwn 52:4a:93:75:dd:91:0a:02
device-alias name X70-CT0-FC8 pwwn 52:4a:93:75:dd:91:0a:06
device-alias name X70-CT1-FC0 pwwn 52:4a:93:75:dd:91:0a:10
device-alias name X70-CT1-FC2 pwwn 52:4a:93:75:dd:91:0a:12
device-alias name X70-CT1-FC8 pwwn 52:4a:93:75:dd:91:0a:16
device-alias name VCC-GPU1-HBA1 pwwn 20:00:00:25:b5:3a:00:29
device-alias name VCC-GPU2-HBA1 pwwn 20:00:00:25:b5:3a:00:19
device-alias name VCC-GPU3-HBA1 pwwn 20:00:00:25:b5:3a:00:09
device-alias name VCC-GPU4-HBA1 pwwn 20:00:00:25:b5:3a:00:48
device-alias name Infra01-8-HBA1 pwwn 20:00:00:25:b5:3a:00:4f
device-alias name Infra02-16-HBA1 pwwn 20:00:00:25:b5:3a:00:2f
device-alias name VCC-Infra01-HBA0 pwwn 20:00:00:25:b5:aa:17:1e
device-alias name VCC-Infra01-HBA2 pwwn 20:00:00:25:b5:aa:17:1f
device-alias name VCC-Infra02-HBA0 pwwn 20:00:00:25:b5:aa:17:3e
device-alias name VCC-Infra02-HBA2 pwwn 20:00:00:25:b5:aa:17:3f
device-alias name VCC-WLHost01-HBA0 pwwn 20:00:00:25:b5:aa:17:00

device-alias name VCC-WLHost01-HBA2 pwwn 20:00:00:25:b5:aa:17:01
device-alias name VCC-WLHost02-HBA0 pwwn 20:00:00:25:b5:aa:17:02
device-alias name VCC-WLHost02-HBA2 pwwn 20:00:00:25:b5:aa:17:03
device-alias name VCC-WLHost03-HBA0 pwwn 20:00:00:25:b5:aa:17:04
device-alias name VCC-WLHost03-HBA2 pwwn 20:00:00:25:b5:aa:17:05
device-alias name VCC-WLHost04-HBA0 pwwn 20:00:00:25:b5:aa:17:06
device-alias name VCC-WLHost04-HBA2 pwwn 20:00:00:25:b5:aa:17:07
device-alias name VCC-WLHost05-HBA0 pwwn 20:00:00:25:b5:aa:17:08
device-alias name VCC-WLHost05-HBA2 pwwn 20:00:00:25:b5:aa:17:09
device-alias name VCC-WLHost06-HBA0 pwwn 20:00:00:25:b5:aa:17:0a
device-alias name VCC-WLHost06-HBA2 pwwn 20:00:00:25:b5:aa:17:0b
device-alias name VCC-WLHost07-HBA0 pwwn 20:00:00:25:b5:aa:17:0c
device-alias name VCC-WLHost07-HBA2 pwwn 20:00:00:25:b5:aa:17:0d
device-alias name VCC-WLHost08-HBA0 pwwn 20:00:00:25:b5:aa:17:0e
device-alias name VCC-WLHost08-HBA2 pwwn 20:00:00:25:b5:aa:17:0f
device-alias name VCC-WLHost09-HBA0 pwwn 20:00:00:25:b5:aa:17:10
device-alias name VCC-WLHost09-HBA2 pwwn 20:00:00:25:b5:aa:17:11
device-alias name VCC-WLHost10-HBA0 pwwn 20:00:00:25:b5:aa:17:12
device-alias name VCC-WLHost10-HBA2 pwwn 20:00:00:25:b5:aa:17:13
device-alias name VCC-WLHost11-HBA0 pwwn 20:00:00:25:b5:aa:17:14
device-alias name VCC-WLHost11-HBA2 pwwn 20:00:00:25:b5:aa:17:15
device-alias name VCC-WLHost12-HBA0 pwwn 20:00:00:25:b5:aa:17:16
device-alias name VCC-WLHost12-HBA2 pwwn 20:00:00:25:b5:aa:17:17
device-alias name VCC-WLHost13-HBA0 pwwn 20:00:00:25:b5:aa:17:18
device-alias name VCC-WLHost13-HBA2 pwwn 20:00:00:25:b5:aa:17:19
device-alias name VCC-WLHost14-HBA0 pwwn 20:00:00:25:b5:aa:17:1a
device-alias name VCC-WLHost14-HBA2 pwwn 20:00:00:25:b5:aa:17:1b
device-alias name VCC-WLHost15-HBA0 pwwn 20:00:00:25:b5:aa:17:1c
device-alias name VCC-WLHost15-HBA2 pwwn 20:00:00:25:b5:aa:17:1d
device-alias name VCC-WLHost16-HBA0 pwwn 20:00:00:25:b5:aa:17:20

device-alias name VCC-WLHost16-HBA2 pwwn 20:00:00:25:b5:aa:17:21
device-alias name VCC-WLHost17-HBA0 pwwn 20:00:00:25:b5:aa:17:22
device-alias name VCC-WLHost17-HBA2 pwwn 20:00:00:25:b5:aa:17:23
device-alias name VCC-WLHost18-HBA0 pwwn 20:00:00:25:b5:aa:17:24
device-alias name VCC-WLHost18-HBA2 pwwn 20:00:00:25:b5:aa:17:25
device-alias name VCC-WLHost19-HBA0 pwwn 20:00:00:25:b5:aa:17:26
device-alias name VCC-WLHost19-HBA2 pwwn 20:00:00:25:b5:aa:17:27
device-alias name VCC-WLHost20-HBA0 pwwn 20:00:00:25:b5:aa:17:28
device-alias name VCC-WLHost20-HBA2 pwwn 20:00:00:25:b5:aa:17:29
device-alias name VCC-WLHost21-HBA0 pwwn 20:00:00:25:b5:aa:17:2a
device-alias name VCC-WLHost21-HBA2 pwwn 20:00:00:25:b5:aa:17:2b
device-alias name VCC-WLHost22-HBA0 pwwn 20:00:00:25:b5:aa:17:2c
device-alias name VCC-WLHost22-HBA2 pwwn 20:00:00:25:b5:aa:17:2d
device-alias name VCC-WLHost23-HBA0 pwwn 20:00:00:25:b5:aa:17:2e
device-alias name VCC-WLHost23-HBA2 pwwn 20:00:00:25:b5:aa:17:2f
device-alias name VCC-WLHost24-HBA0 pwwn 20:00:00:25:b5:aa:17:30
device-alias name VCC-WLHost24-HBA2 pwwn 20:00:00:25:b5:aa:17:31
device-alias name VCC-WLHost25-HBA0 pwwn 20:00:00:25:b5:aa:17:32
device-alias name VCC-WLHost25-HBA2 pwwn 20:00:00:25:b5:aa:17:33
device-alias name VCC-WLHost26-HBA0 pwwn 20:00:00:25:b5:aa:17:34
device-alias name VCC-WLHost26-HBA2 pwwn 20:00:00:25:b5:aa:17:35
device-alias name VCC-WLHost27-HBA0 pwwn 20:00:00:25:b5:aa:17:36
device-alias name VCC-WLHost27-HBA2 pwwn 20:00:00:25:b5:aa:17:37
device-alias name VCC-WLHost28-HBA0 pwwn 20:00:00:25:b5:aa:17:38
device-alias name VCC-WLHost28-HBA2 pwwn 20:00:00:25:b5:aa:17:39
device-alias name VCC-WLHost29-HBA0 pwwn 20:00:00:25:b5:aa:17:3a
device-alias name VCC-WLHost29-HBA2 pwwn 20:00:00:25:b5:aa:17:3b
device-alias name VCC-WLHost30-HBA0 pwwn 20:00:00:25:b5:aa:17:3c
device-alias name VCC-WLHost30-HBA2 pwwn 20:00:00:25:b5:aa:17:3d

device-alias commit

fcdomain fcid database

vsan 100 wwn 20:03:00:de:fb:92:8d:00 fcid 0x300000 dynamic

vsan 100 wwn 52:4a:93:75:dd:91:0a:02 fcid 0x300020 dynamic

! [X70-CT0-FC2]

vsan 100 wwn 52:4a:93:75:dd:91:0a:17 fcid 0x300040 dynamic

vsan 100 wwn 52:4a:93:75:dd:91:0a:06 fcid 0x300041 dynamic

! [X70-CT0-FC8]

vsan 100 wwn 52:4a:93:75:dd:91:0a:07 fcid 0x300042 dynamic

vsan 100 wwn 52:4a:93:75:dd:91:0a:16 fcid 0x300043 dynamic

! [X70-CT1-FC8]

vsan 100 wwn 20:00:00:25:b5:aa:17:3e fcid 0x300060 dynamic

! [VCC-Infra02-HBA0]

vsan 100 wwn 20:00:00:25:b5:aa:17:07 fcid 0x300061 dynamic

! [VCC-WLHost04-HBA2]

vsan 100 wwn 20:00:00:25:b5:aa:17:06 fcid 0x300062 dynamic

! [VCC-WLHost04-HBA0]

vsan 100 wwn 20:00:00:25:b5:aa:17:3a fcid 0x300063 dynamic

! [VCC-WLHost29-HBA0]

vsan 100 wwn 20:00:00:25:b5:aa:17:29 fcid 0x300064 dynamic

! [VCC-WLHost20-HBA2]

vsan 100 wwn 20:00:00:25:b5:aa:17:13 fcid 0x300065 dynamic

! [VCC-WLHost10-HBA2]

vsan 100 wwn 20:00:00:25:b5:aa:17:1c fcid 0x300066 dynamic

! [VCC-WLHost15-HBA0]

vsan 100 wwn 20:00:00:25:b5:aa:17:32 fcid 0x300067 dynamic

! [VCC-WLHost25-HBA0]

vsan 100 wwn 20:00:00:25:b5:aa:17:17 fcid 0x300068 dynamic

! [VCC-WLHost12-HBA2]

```
vsan 100 wwn 20:00:00:25:b5:aa:17:2e fcid 0x300069 dynamic
!      [VCC-WLHost23-HBA0]
vsan 100 wwn 20:00:00:25:b5:aa:17:1f fcid 0x30006a dynamic
!      [VCC-Infra01-HBA2]
vsan 100 wwn 20:00:00:25:b5:aa:17:1b fcid 0x30006b dynamic
!      [VCC-WLHost14-HBA2]
vsan 100 wwn 20:00:00:25:b5:aa:17:1a fcid 0x30006c dynamic
!      [VCC-WLHost14-HBA0]
vsan 100 wwn 20:00:00:25:b5:aa:17:0a fcid 0x30006d dynamic
!      [VCC-WLHost06-HBA0]
vsan 100 wwn 20:00:00:25:b5:aa:17:34 fcid 0x30006e dynamic
!      [VCC-WLHost26-HBA0]
vsan 100 wwn 20:00:00:25:b5:aa:17:19 fcid 0x30006f dynamic
!      [VCC-WLHost13-HBA2]
vsan 100 wwn 20:00:00:25:b5:aa:17:36 fcid 0x300070 dynamic
!      [VCC-WLHost27-HBA0]
vsan 100 wwn 20:00:00:25:b5:aa:17:01 fcid 0x300071 dynamic
!      [VCC-WLHost01-HBA2]
vsan 100 wwn 20:00:00:25:b5:aa:17:12 fcid 0x300072 dynamic
!      [VCC-WLHost10-HBA0]
vsan 100 wwn 20:00:00:25:b5:aa:17:16 fcid 0x300073 dynamic
!      [VCC-WLHost12-HBA0]
vsan 100 wwn 20:00:00:25:b5:aa:17:2b fcid 0x300074 dynamic
!      [VCC-WLHost21-HBA2]
vsan 100 wwn 20:00:00:25:b5:aa:17:25 fcid 0x300075 dynamic
!      [VCC-WLHost18-HBA2]
vsan 100 wwn 20:00:00:25:b5:aa:17:27 fcid 0x300076 dynamic
!      [VCC-WLHost19-HBA2]
vsan 100 wwn 20:00:00:25:b5:aa:17:3d fcid 0x300077 dynamic
!      [VCC-WLHost30-HBA2]
```

```
vsan 100 wwn 20:00:00:25:b5:aa:17:15 fcid 0x300078 dynamic
!      [VCC-WLHost11-HBA2]
vsan 100 wwn 20:00:00:25:b5:aa:17:38 fcid 0x300079 dynamic
!      [VCC-WLHost28-HBA0]
vsan 100 wwn 20:00:00:25:b5:aa:17:23 fcid 0x30007a dynamic
!      [VCC-WLHost17-HBA2]
vsan 100 wwn 20:00:00:25:b5:aa:17:00 fcid 0x30007b dynamic
!      [VCC-WLHost01-HBA0]
vsan 100 wwn 20:00:00:25:b5:aa:17:04 fcid 0x30007c dynamic
!      [VCC-WLHost03-HBA0]
vsan 100 wwn 20:00:00:25:b5:aa:17:03 fcid 0x30007d dynamic
!      [VCC-WLHost02-HBA2]
vsan 100 wwn 20:00:00:25:b5:aa:17:0f fcid 0x30007e dynamic
!      [VCC-WLHost08-HBA2]
vsan 100 wwn 20:00:00:25:b5:aa:17:1d fcid 0x30007f dynamic
!      [VCC-WLHost15-HBA2]
vsan 100 wwn 20:00:00:25:b5:aa:17:31 fcid 0x300080 dynamic
!      [VCC-WLHost24-HBA2]
vsan 100 wwn 20:00:00:25:b5:aa:17:30 fcid 0x300081 dynamic
!      [VCC-WLHost24-HBA0]
vsan 100 wwn 20:00:00:25:b5:aa:17:02 fcid 0x300082 dynamic
!      [VCC-WLHost02-HBA0]
vsan 100 wwn 20:00:00:25:b5:aa:17:08 fcid 0x300083 dynamic
!      [VCC-WLHost05-HBA0]
vsan 100 wwn 20:00:00:25:b5:aa:17:26 fcid 0x300084 dynamic
!      [VCC-WLHost19-HBA0]
vsan 100 wwn 20:00:00:25:b5:aa:17:22 fcid 0x300085 dynamic
!      [VCC-WLHost17-HBA0]
vsan 100 wwn 20:00:00:25:b5:aa:17:2c fcid 0x300086 dynamic
!      [VCC-WLHost22-HBA0]
```



```
vsan 100 wwn 20:00:00:25:b5:aa:17:33 fcid 0x300087 dynamic
!    [VCC-WLHost25-HBA2]
vsan 100 wwn 20:00:00:25:b5:aa:17:21 fcid 0x300088 dynamic
!    [VCC-WLHost16-HBA2]
vsan 100 wwn 20:00:00:25:b5:aa:17:2d fcid 0x300089 dynamic
!    [VCC-WLHost22-HBA2]
vsan 100 wwn 20:00:00:25:b5:aa:17:24 fcid 0x30008a dynamic
!    [VCC-WLHost18-HBA0]
vsan 100 wwn 20:00:00:25:b5:aa:17:3f fcid 0x30008b dynamic
!    [VCC-Infra02-HBA2]
vsan 100 wwn 20:00:00:25:b5:aa:17:39 fcid 0x30008c dynamic
!    [VCC-WLHost28-HBA2]
vsan 100 wwn 20:00:00:25:b5:aa:17:3c fcid 0x30008d dynamic
!    [VCC-WLHost30-HBA0]
vsan 100 wwn 20:00:00:25:b5:aa:17:14 fcid 0x30008e dynamic
!    [VCC-WLHost11-HBA0]
vsan 100 wwn 20:00:00:25:b5:aa:17:11 fcid 0x30008f dynamic
!    [VCC-WLHost09-HBA2]
vsan 100 wwn 20:00:00:25:b5:aa:17:10 fcid 0x300090 dynamic
!    [VCC-WLHost09-HBA0]
vsan 100 wwn 20:00:00:25:b5:aa:17:05 fcid 0x300091 dynamic
!    [VCC-WLHost03-HBA2]
vsan 100 wwn 20:00:00:25:b5:aa:17:0e fcid 0x300092 dynamic
!    [VCC-WLHost08-HBA0]
vsan 100 wwn 20:00:00:25:b5:aa:17:0d fcid 0x300093 dynamic
!    [VCC-WLHost07-HBA2]
vsan 100 wwn 20:00:00:25:b5:aa:17:0c fcid 0x300094 dynamic
!    [VCC-WLHost07-HBA0]
vsan 100 wwn 20:00:00:25:b5:aa:17:1e fcid 0x300095 dynamic
!    [VCC-Infra01-HBA0]
```

```

vsan 100 wwn 20:00:00:25:b5:aa:17:0b fcid 0x300096 dynamic
!      [VCC-WLHost06-HBA2]
vsan 100 wwn 20:00:00:25:b5:aa:17:28 fcid 0x300097 dynamic
!      [VCC-WLHost20-HBA0]
vsan 100 wwn 20:00:00:25:b5:aa:17:37 fcid 0x300098 dynamic
!      [VCC-WLHost27-HBA2]
vsan 100 wwn 20:00:00:25:b5:aa:17:3b fcid 0x300099 dynamic
!      [VCC-WLHost29-HBA2]
vsan 100 wwn 20:00:00:25:b5:aa:17:09 fcid 0x30009a dynamic
!      [VCC-WLHost05-HBA2]
vsan 100 wwn 20:00:00:25:b5:aa:17:2a fcid 0x30009b dynamic
!      [VCC-WLHost21-HBA0]
vsan 100 wwn 20:00:00:25:b5:aa:17:2f fcid 0x30009c dynamic
!      [VCC-WLHost23-HBA2]
vsan 100 wwn 20:00:00:25:b5:aa:17:20 fcid 0x30009d dynamic
!      [VCC-WLHost16-HBA0]
vsan 100 wwn 20:00:00:25:b5:aa:17:35 fcid 0x30009e dynamic
!      [VCC-WLHost26-HBA2]
vsan 100 wwn 20:00:00:25:b5:aa:17:18 fcid 0x30009f dynamic
!      [VCC-WLHost13-HBA0]
vsan 100 wwn 20:02:00:de:fb:92:8d:00 fcid 0x3000a0 dynamic
vsan 100 wwn 20:04:00:de:fb:92:8d:00 fcid 0x3000c0 dynamic
vsan 100 wwn 20:01:00:de:fb:92:8d:00 fcid 0x3000e0 dynamic
vsan 100 wwn 52:4a:93:75:dd:91:0a:00 fcid 0x300044 dynamic
!      [X70-CT0-FC0]

```

!Active Zone Database Section for vsan 100

```

zone name FlaskStack-VCC-CVD-WLHost01 vsan 100
  member pwwn 52:4a:93:75:dd:91:0a:00
!      [X70-CT0-FC0]
  member pwwn 52:4a:93:75:dd:91:0a:02

```

```
!      [X70-CT0-FC2]
member pwwn 52:4a:93:75:dd:91:0a:10
!      [X70-CT1-FC0]
member pwwn 52:4a:93:75:dd:91:0a:12
!      [X70-CT1-FC2]
member pwwn 52:4a:93:75:dd:91:0a:16
!      [X70-CT1-FC8]
member pwwn 20:00:00:25:b5:aa:17:00
!      [VCC-WLHost01-HBA0]
member pwwn 20:00:00:25:b5:aa:17:01
!      [VCC-WLHost01-HBA2]
```

zone name FlaskStack-VCC-CVD-WLHost02 vsan 100

```
member pwwn 52:4a:93:75:dd:91:0a:00
!      [X70-CT0-FC0]
member pwwn 52:4a:93:75:dd:91:0a:02
!      [X70-CT0-FC2]
member pwwn 52:4a:93:75:dd:91:0a:10
!      [X70-CT1-FC0]
member pwwn 52:4a:93:75:dd:91:0a:12
!      [X70-CT1-FC2]
member pwwn 52:4a:93:75:dd:91:0a:16
!      [X70-CT1-FC8]
member pwwn 20:00:00:25:b5:aa:17:02
!      [VCC-WLHost02-HBA0]
member pwwn 20:00:00:25:b5:aa:17:03
!      [VCC-WLHost02-HBA2]
```

zone name FlaskStack-VCC-CVD-WLHost03 vsan 100

```
member pwwn 52:4a:93:75:dd:91:0a:00
```

```
!      [X70-CT0-FC0]
member pwwn 52:4a:93:75:dd:91:0a:02
!      [X70-CT0-FC2]
member pwwn 52:4a:93:75:dd:91:0a:10
!      [X70-CT1-FC0]
member pwwn 52:4a:93:75:dd:91:0a:12
!      [X70-CT1-FC2]
member pwwn 52:4a:93:75:dd:91:0a:16
!      [X70-CT1-FC8]
member pwwn 20:00:00:25:b5:aa:17:04
!      [VCC-WLHost03-HBA0]
member pwwn 20:00:00:25:b5:aa:17:05
!      [VCC-WLHost03-HBA2]
```

zone name FlaskStack-VCC-CVD-WLHost04 vsan 100

```
member pwwn 52:4a:93:75:dd:91:0a:00
!      [X70-CT0-FC0]
member pwwn 52:4a:93:75:dd:91:0a:02
!      [X70-CT0-FC2]
member pwwn 52:4a:93:75:dd:91:0a:10
!      [X70-CT1-FC0]
member pwwn 52:4a:93:75:dd:91:0a:12
!      [X70-CT1-FC2]
member pwwn 52:4a:93:75:dd:91:0a:16
!      [X70-CT1-FC8]
member pwwn 20:00:00:25:b5:aa:17:06
!      [VCC-WLHost04-HBA0]
member pwwn 20:00:00:25:b5:aa:17:07
!      [VCC-WLHost04-HBA2]
```

zone name FlaskStack-VCC-CVD-WLHost05 vsan 100

```
member pwwn 52:4a:93:75:dd:91:0a:00
!      [X70-CT0-FC0]
member pwwn 52:4a:93:75:dd:91:0a:02
!      [X70-CT0-FC2]
member pwwn 52:4a:93:75:dd:91:0a:10
!      [X70-CT1-FC0]
member pwwn 52:4a:93:75:dd:91:0a:12
!      [X70-CT1-FC2]
member pwwn 52:4a:93:75:dd:91:0a:16
!      [X70-CT1-FC8]
member pwwn 20:00:00:25:b5:aa:17:08
!      [VCC-WLHost05-HBA0]
member pwwn 20:00:00:25:b5:aa:17:09
!      [VCC-WLHost05-HBA2]
```

zone name FlaskStack-VCC-CVD-WLHost06 vsan 100

```
member pwwn 52:4a:93:75:dd:91:0a:00
!      [X70-CT0-FC0]
member pwwn 52:4a:93:75:dd:91:0a:02
!      [X70-CT0-FC2]
member pwwn 52:4a:93:75:dd:91:0a:10
!      [X70-CT1-FC0]
member pwwn 52:4a:93:75:dd:91:0a:12
!      [X70-CT1-FC2]
member pwwn 52:4a:93:75:dd:91:0a:16
!      [X70-CT1-FC8]
member pwwn 20:00:00:25:b5:aa:17:0a
!      [VCC-WLHost06-HBA0]
member pwwn 20:00:00:25:b5:aa:17:0b
```

! [VCC-WLHost06-HBA2]

zone name FlaskStack-VCC-CVD-WLHost07 vsan 100

member pwwn 52:4a:93:75:dd:91:0a:00

! [X70-CT0-FC0]

member pwwn 52:4a:93:75:dd:91:0a:02

! [X70-CT0-FC2]

member pwwn 52:4a:93:75:dd:91:0a:10

! [X70-CT1-FC0]

member pwwn 52:4a:93:75:dd:91:0a:12

! [X70-CT1-FC2]

member pwwn 52:4a:93:75:dd:91:0a:16

! [X70-CT1-FC8]

member pwwn 20:00:00:25:b5:aa:17:0c

! [VCC-WLHost07-HBA0]

member pwwn 20:00:00:25:b5:aa:17:0d

! [VCC-WLHost07-HBA2]

zone name FlaskStack-VCC-CVD-WLHost08 vsan 100

member pwwn 52:4a:93:75:dd:91:0a:00

! [X70-CT0-FC0]

member pwwn 52:4a:93:75:dd:91:0a:02

! [X70-CT0-FC2]

member pwwn 52:4a:93:75:dd:91:0a:10

! [X70-CT1-FC0]

member pwwn 52:4a:93:75:dd:91:0a:12

! [X70-CT1-FC2]

member pwwn 52:4a:93:75:dd:91:0a:16

! [X70-CT1-FC8]

member pwwn 20:00:00:25:b5:aa:17:0e

```
!      [VCC-WLHost08-HBA0]
member pwwn 20:00:00:25:b5:aa:17:0f
!      [VCC-WLHost08-HBA2]
```

zone name FlaskStack-VCC-CVD-WLHost09 vsan 100

```
member pwwn 52:4a:93:75:dd:91:0a:00
!      [X70-CT0-FC0]
member pwwn 52:4a:93:75:dd:91:0a:02
!      [X70-CT0-FC2]
member pwwn 52:4a:93:75:dd:91:0a:10
!      [X70-CT1-FC0]
member pwwn 52:4a:93:75:dd:91:0a:12
!      [X70-CT1-FC2]
member pwwn 52:4a:93:75:dd:91:0a:16
!      [X70-CT1-FC8]
member pwwn 20:00:00:25:b5:aa:17:10
!      [VCC-WLHost09-HBA0]
member pwwn 20:00:00:25:b5:aa:17:11
!      [VCC-WLHost09-HBA2]
```

zone name FlaskStack-VCC-CVD-WLHost10 vsan 100

```
member pwwn 52:4a:93:75:dd:91:0a:00
!      [X70-CT0-FC0]
member pwwn 52:4a:93:75:dd:91:0a:02
!      [X70-CT0-FC2]
member pwwn 52:4a:93:75:dd:91:0a:10
!      [X70-CT1-FC0]
member pwwn 52:4a:93:75:dd:91:0a:12
!      [X70-CT1-FC2]
member pwwn 52:4a:93:75:dd:91:0a:16
```

```
!      [X70-CT1-FC8]
member pwwn 20:00:00:25:b5:aa:17:12
!      [VCC-WLHost10-HBA0]
member pwwn 20:00:00:25:b5:aa:17:13
!      [VCC-WLHost10-HBA2]
```

zone name FlaskStack-VCC-CVD-WLHost11 vsan 100

```
member pwwn 52:4a:93:75:dd:91:0a:00
!      [X70-CT0-FC0]
member pwwn 52:4a:93:75:dd:91:0a:02
!      [X70-CT0-FC2]
member pwwn 52:4a:93:75:dd:91:0a:10
!      [X70-CT1-FC0]
member pwwn 52:4a:93:75:dd:91:0a:12
!      [X70-CT1-FC2]
member pwwn 52:4a:93:75:dd:91:0a:16
!      [X70-CT1-FC8]
member pwwn 20:00:00:25:b5:aa:17:14
!      [VCC-WLHost11-HBA0]
member pwwn 20:00:00:25:b5:aa:17:15
!      [VCC-WLHost11-HBA2]
```

zone name FlaskStack-VCC-CVD-WLHost12 vsan 100

```
member pwwn 52:4a:93:75:dd:91:0a:00
!      [X70-CT0-FC0]
member pwwn 52:4a:93:75:dd:91:0a:02
!      [X70-CT0-FC2]
member pwwn 52:4a:93:75:dd:91:0a:10
!      [X70-CT1-FC0]
member pwwn 52:4a:93:75:dd:91:0a:12
```



```
!      [X70-CT1-FC2]
member pwwn 52:4a:93:75:dd:91:0a:16
!      [X70-CT1-FC8]
member pwwn 20:00:00:25:b5:aa:17:16
!      [VCC-WLHost12-HBA0]
member pwwn 20:00:00:25:b5:aa:17:17
!      [VCC-WLHost12-HBA2]
```

zone name FlaskStack-VCC-CVD-WLHost13 vsan 100

```
member pwwn 52:4a:93:75:dd:91:0a:00
!      [X70-CT0-FC0]
member pwwn 52:4a:93:75:dd:91:0a:02
!      [X70-CT0-FC2]
member pwwn 52:4a:93:75:dd:91:0a:10
!      [X70-CT1-FC0]
member pwwn 52:4a:93:75:dd:91:0a:12
!      [X70-CT1-FC2]
member pwwn 52:4a:93:75:dd:91:0a:16
!      [X70-CT1-FC8]
member pwwn 20:00:00:25:b5:aa:17:18
!      [VCC-WLHost13-HBA0]
member pwwn 20:00:00:25:b5:aa:17:19
!      [VCC-WLHost13-HBA2]
```

zone name FlaskStack-VCC-CVD-WLHost14 vsan 100

```
member pwwn 52:4a:93:75:dd:91:0a:00
!      [X70-CT0-FC0]
member pwwn 52:4a:93:75:dd:91:0a:02
!      [X70-CT0-FC2]
member pwwn 52:4a:93:75:dd:91:0a:10
```

```
!      [X70-CT1-FC0]
member pwwn 52:4a:93:75:dd:91:0a:12
!      [X70-CT1-FC2]
member pwwn 52:4a:93:75:dd:91:0a:16
!      [X70-CT1-FC8]
member pwwn 20:00:00:25:b5:aa:17:1a
!      [VCC-WLHost14-HBA0]
member pwwn 20:00:00:25:b5:aa:17:1b
!      [VCC-WLHost14-HBA2]
```

zone name FlaskStack-VCC-CVD-WLHost15 vsan 100

```
member pwwn 52:4a:93:75:dd:91:0a:00
!      [X70-CT0-FC0]
member pwwn 52:4a:93:75:dd:91:0a:02
!      [X70-CT0-FC2]
member pwwn 52:4a:93:75:dd:91:0a:10
!      [X70-CT1-FC0]
member pwwn 52:4a:93:75:dd:91:0a:12
!      [X70-CT1-FC2]
member pwwn 52:4a:93:75:dd:91:0a:16
!      [X70-CT1-FC8]
member pwwn 20:00:00:25:b5:aa:17:1c
!      [VCC-WLHost15-HBA0]
member pwwn 20:00:00:25:b5:aa:17:1d
!      [VCC-WLHost15-HBA2]
```

zone name FlaskStack-VCC-CVD-Infra01 vsan 100

```
member pwwn 52:4a:93:75:dd:91:0a:00
!      [X70-CT0-FC0]
member pwwn 52:4a:93:75:dd:91:0a:02
```

```
!      [X70-CT0-FC2]
member pwwn 52:4a:93:75:dd:91:0a:10
!      [X70-CT1-FC0]
member pwwn 52:4a:93:75:dd:91:0a:12
!      [X70-CT1-FC2]
member pwwn 52:4a:93:75:dd:91:0a:16
!      [X70-CT1-FC8]
member pwwn 20:00:00:25:b5:aa:17:1e
!      [VCC-Infra01-HBA0]
member pwwn 20:00:00:25:b5:aa:17:1f
!      [VCC-Infra01-HBA2]
```

zone name FlaskStack-VCC-CVD-WLHost16 vsan 100

```
member pwwn 52:4a:93:75:dd:91:0a:00
!      [X70-CT0-FC0]
member pwwn 52:4a:93:75:dd:91:0a:02
!      [X70-CT0-FC2]
member pwwn 52:4a:93:75:dd:91:0a:10
!      [X70-CT1-FC0]
member pwwn 52:4a:93:75:dd:91:0a:12
!      [X70-CT1-FC2]
member pwwn 52:4a:93:75:dd:91:0a:16
!      [X70-CT1-FC8]
member pwwn 20:00:00:25:b5:aa:17:20
!      [VCC-WLHost16-HBA0]
member pwwn 20:00:00:25:b5:aa:17:21
!      [VCC-WLHost16-HBA2]
```

zone name FlaskStack-VCC-CVD-WLHost17 vsan 100

```
member pwwn 52:4a:93:75:dd:91:0a:00
```

```
!      [X70-CT0-FC0]
member pwwn 52:4a:93:75:dd:91:0a:02
!      [X70-CT0-FC2]
member pwwn 52:4a:93:75:dd:91:0a:10
!      [X70-CT1-FC0]
member pwwn 52:4a:93:75:dd:91:0a:12
!      [X70-CT1-FC2]
member pwwn 52:4a:93:75:dd:91:0a:16
!      [X70-CT1-FC8]
member pwwn 20:00:00:25:b5:aa:17:22
!      [VCC-WLHost17-HBA0]
member pwwn 20:00:00:25:b5:aa:17:23
!      [VCC-WLHost17-HBA2]
```

zone name FlaskStack-VCC-CVD-WLHost18 vsan 100

```
member pwwn 52:4a:93:75:dd:91:0a:00
!      [X70-CT0-FC0]
member pwwn 52:4a:93:75:dd:91:0a:02
!      [X70-CT0-FC2]
member pwwn 52:4a:93:75:dd:91:0a:10
!      [X70-CT1-FC0]
member pwwn 52:4a:93:75:dd:91:0a:12
!      [X70-CT1-FC2]
member pwwn 52:4a:93:75:dd:91:0a:16
!      [X70-CT1-FC8]
member pwwn 20:00:00:25:b5:aa:17:24
!      [VCC-WLHost18-HBA0]
member pwwn 20:00:00:25:b5:aa:17:25
!      [VCC-WLHost18-HBA2]
```

zone name FlaskStack-VCC-CVD-WLHost19 vsan 100

member pwwn 52:4a:93:75:dd:91:0a:00

! [X70-CT0-FC0]

member pwwn 52:4a:93:75:dd:91:0a:02

! [X70-CT0-FC2]

member pwwn 52:4a:93:75:dd:91:0a:10

! [X70-CT1-FC0]

member pwwn 52:4a:93:75:dd:91:0a:12

! [X70-CT1-FC2]

member pwwn 52:4a:93:75:dd:91:0a:16

! [X70-CT1-FC8]

member pwwn 20:00:00:25:b5:aa:17:26

! [VCC-WLHost19-HBA0]

member pwwn 20:00:00:25:b5:aa:17:27

! [VCC-WLHost19-HBA2]

zone name FlaskStack-VCC-CVD-WLHost20 vsan 100

member pwwn 52:4a:93:75:dd:91:0a:00

! [X70-CT0-FC0]

member pwwn 52:4a:93:75:dd:91:0a:02

! [X70-CT0-FC2]

member pwwn 52:4a:93:75:dd:91:0a:10

! [X70-CT1-FC0]

member pwwn 52:4a:93:75:dd:91:0a:12

! [X70-CT1-FC2]

member pwwn 52:4a:93:75:dd:91:0a:16

! [X70-CT1-FC8]

member pwwn 20:00:00:25:b5:aa:17:28

! [VCC-WLHost20-HBA0]

member pwwn 20:00:00:25:b5:aa:17:29

! [VCC-WLHost20-HBA2]

zone name FlaskStack-VCC-CVD-WLHost21 vsan 100

member pwwn 52:4a:93:75:dd:91:0a:00

! [X70-CT0-FC0]

member pwwn 52:4a:93:75:dd:91:0a:02

! [X70-CT0-FC2]

member pwwn 52:4a:93:75:dd:91:0a:10

! [X70-CT1-FC0]

member pwwn 52:4a:93:75:dd:91:0a:12

! [X70-CT1-FC2]

member pwwn 52:4a:93:75:dd:91:0a:16

! [X70-CT1-FC8]

member pwwn 20:00:00:25:b5:aa:17:2a

! [VCC-WLHost21-HBA0]

member pwwn 20:00:00:25:b5:aa:17:2b

! [VCC-WLHost21-HBA2]

zone name FlaskStack-VCC-CVD-WLHost22 vsan 100

member pwwn 52:4a:93:75:dd:91:0a:00

! [X70-CT0-FC0]

member pwwn 52:4a:93:75:dd:91:0a:02

! [X70-CT0-FC2]

member pwwn 52:4a:93:75:dd:91:0a:10

! [X70-CT1-FC0]

member pwwn 52:4a:93:75:dd:91:0a:12

! [X70-CT1-FC2]

member pwwn 52:4a:93:75:dd:91:0a:16

! [X70-CT1-FC8]

member pwwn 20:00:00:25:b5:aa:17:2c

```
!      [VCC-WLHost22-HBA0]
member pwwn 20:00:00:25:b5:aa:17:2d
!      [VCC-WLHost22-HBA2]
```

zone name FlaskStack-VCC-CVD-WLHost23 vsan 100

```
member pwwn 52:4a:93:75:dd:91:0a:00
!      [X70-CT0-FC0]
member pwwn 52:4a:93:75:dd:91:0a:02
!      [X70-CT0-FC2]
member pwwn 52:4a:93:75:dd:91:0a:10
!      [X70-CT1-FC0]
member pwwn 52:4a:93:75:dd:91:0a:12
!      [X70-CT1-FC2]
member pwwn 52:4a:93:75:dd:91:0a:16
!      [X70-CT1-FC8]
member pwwn 20:00:00:25:b5:aa:17:2e
!      [VCC-WLHost23-HBA0]
member pwwn 20:00:00:25:b5:aa:17:2f
!      [VCC-WLHost23-HBA2]
```

zone name FlaskStack-VCC-CVD-WLHost24 vsan 100

```
member pwwn 52:4a:93:75:dd:91:0a:00
!      [X70-CT0-FC0]
member pwwn 52:4a:93:75:dd:91:0a:02
!      [X70-CT0-FC2]
member pwwn 52:4a:93:75:dd:91:0a:10
!      [X70-CT1-FC0]
member pwwn 52:4a:93:75:dd:91:0a:12
!      [X70-CT1-FC2]
member pwwn 52:4a:93:75:dd:91:0a:16
```

```
!      [X70-CT1-FC8]
member pwwn 20:00:00:25:b5:aa:17:30
!      [VCC-WLHost24-HBA0]
member pwwn 20:00:00:25:b5:aa:17:31
!      [VCC-WLHost24-HBA2]
```

zone name FlaskStack-VCC-CVD-WLHost25 vsan 100

```
member pwwn 52:4a:93:75:dd:91:0a:00
!      [X70-CT0-FC0]
member pwwn 52:4a:93:75:dd:91:0a:02
!      [X70-CT0-FC2]
member pwwn 52:4a:93:75:dd:91:0a:10
!      [X70-CT1-FC0]
member pwwn 52:4a:93:75:dd:91:0a:12
!      [X70-CT1-FC2]
member pwwn 52:4a:93:75:dd:91:0a:16
!      [X70-CT1-FC8]
member pwwn 20:00:00:25:b5:aa:17:32
!      [VCC-WLHost25-HBA0]
member pwwn 20:00:00:25:b5:aa:17:33
!      [VCC-WLHost25-HBA2]
```

zone name FlaskStack-VCC-CVD-WLHost26 vsan 100

```
member pwwn 52:4a:93:75:dd:91:0a:00
!      [X70-CT0-FC0]
member pwwn 52:4a:93:75:dd:91:0a:02
!      [X70-CT0-FC2]
member pwwn 52:4a:93:75:dd:91:0a:10
!      [X70-CT1-FC0]
member pwwn 52:4a:93:75:dd:91:0a:12
```



```
!      [X70-CT1-FC2]
member pwwn 52:4a:93:75:dd:91:0a:16
!      [X70-CT1-FC8]
member pwwn 20:00:00:25:b5:aa:17:34
!      [VCC-WLHost26-HBA0]
member pwwn 20:00:00:25:b5:aa:17:35
!      [VCC-WLHost26-HBA2]
```

zone name FlaskStack-VCC-CVD-WLHost27 vsan 100

```
member pwwn 52:4a:93:75:dd:91:0a:00
!      [X70-CT0-FC0]
member pwwn 52:4a:93:75:dd:91:0a:02
!      [X70-CT0-FC2]
member pwwn 52:4a:93:75:dd:91:0a:10
!      [X70-CT1-FC0]
member pwwn 52:4a:93:75:dd:91:0a:12
!      [X70-CT1-FC2]
member pwwn 52:4a:93:75:dd:91:0a:16
!      [X70-CT1-FC8]
member pwwn 20:00:00:25:b5:aa:17:36
!      [VCC-WLHost27-HBA0]
member pwwn 20:00:00:25:b5:aa:17:37
!      [VCC-WLHost27-HBA2]
```

zone name FlaskStack-VCC-CVD-WLHost28 vsan 100

```
member pwwn 52:4a:93:75:dd:91:0a:00
!      [X70-CT0-FC0]
member pwwn 52:4a:93:75:dd:91:0a:02
!      [X70-CT0-FC2]
member pwwn 52:4a:93:75:dd:91:0a:10
```

```
!      [X70-CT1-FC0]
member pwwn 52:4a:93:75:dd:91:0a:12
!      [X70-CT1-FC2]
member pwwn 52:4a:93:75:dd:91:0a:16
!      [X70-CT1-FC8]
member pwwn 20:00:00:25:b5:aa:17:38
!      [VCC-WLHost28-HBA0]
member pwwn 20:00:00:25:b5:aa:17:39
!      [VCC-WLHost28-HBA2]
```

zone name FlaskStack-VCC-CVD-WLHost29 vsan 100

```
member pwwn 52:4a:93:75:dd:91:0a:00
!      [X70-CT0-FC0]
member pwwn 52:4a:93:75:dd:91:0a:02
!      [X70-CT0-FC2]
member pwwn 52:4a:93:75:dd:91:0a:10
!      [X70-CT1-FC0]
member pwwn 52:4a:93:75:dd:91:0a:12
!      [X70-CT1-FC2]
member pwwn 52:4a:93:75:dd:91:0a:16
!      [X70-CT1-FC8]
member pwwn 20:00:00:25:b5:aa:17:3a
!      [VCC-WLHost29-HBA0]
member pwwn 20:00:00:25:b5:aa:17:3b
!      [VCC-WLHost29-HBA2]
```

zone name FlaskStack-VCC-CVD-WLHost30 vsan 100

```
member pwwn 52:4a:93:75:dd:91:0a:00
!      [X70-CT0-FC0]
member pwwn 52:4a:93:75:dd:91:0a:02
```

```
!      [X70-CT0-FC2]
member pwwn 52:4a:93:75:dd:91:0a:10
!      [X70-CT1-FC0]
member pwwn 52:4a:93:75:dd:91:0a:12
!      [X70-CT1-FC2]
member pwwn 52:4a:93:75:dd:91:0a:16
!      [X70-CT1-FC8]
member pwwn 20:00:00:25:b5:aa:17:3c
!      [VCC-WLHost30-HBA0]
member pwwn 20:00:00:25:b5:aa:17:3d
!      [VCC-WLHost30-HBA2]
```

zone name FlaskStack-VCC-CVD-Infra02 vsan 100

```
member pwwn 52:4a:93:75:dd:91:0a:00
!      [X70-CT0-FC0]
member pwwn 52:4a:93:75:dd:91:0a:02
!      [X70-CT0-FC2]
member pwwn 52:4a:93:75:dd:91:0a:10
!      [X70-CT1-FC0]
member pwwn 52:4a:93:75:dd:91:0a:12
!      [X70-CT1-FC2]
member pwwn 52:4a:93:75:dd:91:0a:16
!      [X70-CT1-FC8]
member pwwn 20:00:00:25:b5:aa:17:3e
!      [VCC-Infra02-HBA0]
member pwwn 20:00:00:25:b5:aa:17:3f
!      [VCC-Infra02-HBA2]
```

zoneset name FlashStack-VCC-CVD vsan 100

```
member FlaskStack-VCC-CVD-WLHost01
```

member FlaskStack-VCC-CVD-WLHost02
member FlaskStack-VCC-CVD-WLHost03
member FlaskStack-VCC-CVD-WLHost04
member FlaskStack-VCC-CVD-WLHost05
member FlaskStack-VCC-CVD-WLHost06
member FlaskStack-VCC-CVD-WLHost07
member FlaskStack-VCC-CVD-WLHost08
member FlaskStack-VCC-CVD-WLHost09
member FlaskStack-VCC-CVD-WLHost10
member FlaskStack-VCC-CVD-WLHost11
member FlaskStack-VCC-CVD-WLHost12
member FlaskStack-VCC-CVD-WLHost13
member FlaskStack-VCC-CVD-WLHost14
member FlaskStack-VCC-CVD-WLHost15
member FlaskStack-VCC-CVD-Infra01
member FlaskStack-VCC-CVD-WLHost16
member FlaskStack-VCC-CVD-WLHost17
member FlaskStack-VCC-CVD-WLHost18
member FlaskStack-VCC-CVD-WLHost19
member FlaskStack-VCC-CVD-WLHost20
member FlaskStack-VCC-CVD-WLHost21
member FlaskStack-VCC-CVD-WLHost22
member FlaskStack-VCC-CVD-WLHost23
member FlaskStack-VCC-CVD-WLHost24
member FlaskStack-VCC-CVD-WLHost25
member FlaskStack-VCC-CVD-WLHost26
member FlaskStack-VCC-CVD-WLHost27
member FlaskStack-VCC-CVD-WLHost28
member FlaskStack-VCC-CVD-WLHost29
member FlaskStack-VCC-CVD-WLHost30

```
member FlaskStack-VCC-CVD-Infra02

zoneset activate name FlashStack-VCC-CVD vsan 100
do clear zone database vsan 100
!Full Zone Database Section for vsan 100
zone name FlaskStack-VCC-CVD-WLHost01 vsan 100
  member pwwn 52:4a:93:75:dd:91:0a:00
  !      [X70-CT0-FC0]
  member pwwn 52:4a:93:75:dd:91:0a:02
  !      [X70-CT0-FC2]
  member pwwn 52:4a:93:75:dd:91:0a:10
  !      [X70-CT1-FC0]
  member pwwn 52:4a:93:75:dd:91:0a:12
  !      [X70-CT1-FC2]
  member pwwn 52:4a:93:75:dd:91:0a:16
  !      [X70-CT1-FC8]
  member pwwn 20:00:00:25:b5:aa:17:00
  !      [VCC-WLHost01-HBA0]
  member pwwn 20:00:00:25:b5:aa:17:01
  !      [VCC-WLHost01-HBA2]

zone name FlaskStack-VCC-CVD-WLHost02 vsan 100
  member pwwn 52:4a:93:75:dd:91:0a:00
  !      [X70-CT0-FC0]
  member pwwn 52:4a:93:75:dd:91:0a:02
  !      [X70-CT0-FC2]
  member pwwn 52:4a:93:75:dd:91:0a:10
  !      [X70-CT1-FC0]
  member pwwn 52:4a:93:75:dd:91:0a:12
  !      [X70-CT1-FC2]
```

member pwwn 52:4a:93:75:dd:91:0a:16

! [X70-CT1-FC8]

member pwwn 20:00:00:25:b5:aa:17:02

! [VCC-WLHost02-HBA0]

member pwwn 20:00:00:25:b5:aa:17:03

! [VCC-WLHost02-HBA2]

zone name FlaskStack-VCC-CVD-WLHost03 vsan 100

member pwwn 52:4a:93:75:dd:91:0a:00

! [X70-CT0-FC0]

member pwwn 52:4a:93:75:dd:91:0a:02

! [X70-CT0-FC2]

member pwwn 52:4a:93:75:dd:91:0a:10

! [X70-CT1-FC0]

member pwwn 52:4a:93:75:dd:91:0a:12

! [X70-CT1-FC2]

member pwwn 52:4a:93:75:dd:91:0a:16

! [X70-CT1-FC8]

member pwwn 20:00:00:25:b5:aa:17:04

! [VCC-WLHost03-HBA0]

member pwwn 20:00:00:25:b5:aa:17:05

! [VCC-WLHost03-HBA2]

zone name FlaskStack-VCC-CVD-WLHost04 vsan 100

member pwwn 52:4a:93:75:dd:91:0a:00

! [X70-CT0-FC0]

member pwwn 52:4a:93:75:dd:91:0a:02

! [X70-CT0-FC2]

member pwwn 52:4a:93:75:dd:91:0a:10

! [X70-CT1-FC0]

member pwwn 52:4a:93:75:dd:91:0a:12

! [X70-CT1-FC2]

member pwwn 52:4a:93:75:dd:91:0a:16

! [X70-CT1-FC8]

member pwwn 20:00:00:25:b5:aa:17:06

! [VCC-WLHost04-HBA0]

member pwwn 20:00:00:25:b5:aa:17:07

! [VCC-WLHost04-HBA2]

zone name FlaskStack-VCC-CVD-WLHost05 vsan 100

member pwwn 52:4a:93:75:dd:91:0a:00

! [X70-CT0-FC0]

member pwwn 52:4a:93:75:dd:91:0a:02

! [X70-CT0-FC2]

member pwwn 52:4a:93:75:dd:91:0a:10

! [X70-CT1-FC0]

member pwwn 52:4a:93:75:dd:91:0a:12

! [X70-CT1-FC2]

member pwwn 52:4a:93:75:dd:91:0a:16

! [X70-CT1-FC8]

member pwwn 20:00:00:25:b5:aa:17:08

! [VCC-WLHost05-HBA0]

member pwwn 20:00:00:25:b5:aa:17:09

! [VCC-WLHost05-HBA2]

zone name FlaskStack-VCC-CVD-WLHost06 vsan 100

member pwwn 52:4a:93:75:dd:91:0a:00

! [X70-CT0-FC0]

member pwwn 52:4a:93:75:dd:91:0a:02

! [X70-CT0-FC2]

member pwwn 52:4a:93:75:dd:91:0a:10

! [X70-CT1-FC0]

member pwwn 52:4a:93:75:dd:91:0a:12

! [X70-CT1-FC2]

member pwwn 52:4a:93:75:dd:91:0a:16

! [X70-CT1-FC8]

member pwwn 20:00:00:25:b5:aa:17:0a

! [VCC-WLHost06-HBA0]

member pwwn 20:00:00:25:b5:aa:17:0b

! [VCC-WLHost06-HBA2]

zone name FlaskStack-VCC-CVD-WLHost07 vsan 100

member pwwn 52:4a:93:75:dd:91:0a:00

! [X70-CT0-FC0]

member pwwn 52:4a:93:75:dd:91:0a:02

! [X70-CT0-FC2]

member pwwn 52:4a:93:75:dd:91:0a:10

! [X70-CT1-FC0]

member pwwn 52:4a:93:75:dd:91:0a:12

! [X70-CT1-FC2]

member pwwn 52:4a:93:75:dd:91:0a:16

! [X70-CT1-FC8]

member pwwn 20:00:00:25:b5:aa:17:0c

! [VCC-WLHost07-HBA0]

member pwwn 20:00:00:25:b5:aa:17:0d

! [VCC-WLHost07-HBA2]

zone name FlaskStack-VCC-CVD-WLHost08 vsan 100

member pwwn 52:4a:93:75:dd:91:0a:00

! [X70-CT0-FC0]

```
member pwwn 52:4a:93:75:dd:91:0a:02
!      [X70-CT0-FC2]
member pwwn 52:4a:93:75:dd:91:0a:10
!      [X70-CT1-FC0]
member pwwn 52:4a:93:75:dd:91:0a:12
!      [X70-CT1-FC2]
member pwwn 52:4a:93:75:dd:91:0a:16
!      [X70-CT1-FC8]
member pwwn 20:00:00:25:b5:aa:17:0e
!      [VCC-WLHost08-HBA0]
member pwwn 20:00:00:25:b5:aa:17:0f
!      [VCC-WLHost08-HBA2]
```

zone name FlaskStack-VCC-CVD-WLHost09 vsan 100

```
member pwwn 52:4a:93:75:dd:91:0a:00
!      [X70-CT0-FC0]
member pwwn 52:4a:93:75:dd:91:0a:02
!      [X70-CT0-FC2]
member pwwn 52:4a:93:75:dd:91:0a:10
!      [X70-CT1-FC0]
member pwwn 52:4a:93:75:dd:91:0a:12
!      [X70-CT1-FC2]
member pwwn 52:4a:93:75:dd:91:0a:16
!      [X70-CT1-FC8]
member pwwn 20:00:00:25:b5:aa:17:10
!      [VCC-WLHost09-HBA0]
member pwwn 20:00:00:25:b5:aa:17:11
!      [VCC-WLHost09-HBA2]
```

zone name FlaskStack-VCC-CVD-WLHost10 vsan 100

```
member pwwn 52:4a:93:75:dd:91:0a:00
!      [X70-CT0-FC0]
member pwwn 52:4a:93:75:dd:91:0a:02
!      [X70-CT0-FC2]
member pwwn 52:4a:93:75:dd:91:0a:10
!      [X70-CT1-FC0]
member pwwn 52:4a:93:75:dd:91:0a:12
!      [X70-CT1-FC2]
member pwwn 52:4a:93:75:dd:91:0a:16
!      [X70-CT1-FC8]
member pwwn 20:00:00:25:b5:aa:17:12
!      [VCC-WLHost10-HBA0]
member pwwn 20:00:00:25:b5:aa:17:13
!      [VCC-WLHost10-HBA2]
```

zone name FlaskStack-VCC-CVD-WLHost11 vsan 100

```
member pwwn 52:4a:93:75:dd:91:0a:00
!      [X70-CT0-FC0]
member pwwn 52:4a:93:75:dd:91:0a:02
!      [X70-CT0-FC2]
member pwwn 52:4a:93:75:dd:91:0a:10
!      [X70-CT1-FC0]
member pwwn 52:4a:93:75:dd:91:0a:12
!      [X70-CT1-FC2]
member pwwn 52:4a:93:75:dd:91:0a:16
!      [X70-CT1-FC8]
member pwwn 20:00:00:25:b5:aa:17:14
!      [VCC-WLHost11-HBA0]
member pwwn 20:00:00:25:b5:aa:17:15
!      [VCC-WLHost11-HBA2]
```

zone name FlaskStack-VCC-CVD-WLHost12 vsan 100

member pwwn 52:4a:93:75:dd:91:0a:00

! [X70-CT0-FC0]

member pwwn 52:4a:93:75:dd:91:0a:02

! [X70-CT0-FC2]

member pwwn 52:4a:93:75:dd:91:0a:10

! [X70-CT1-FC0]

member pwwn 52:4a:93:75:dd:91:0a:12

! [X70-CT1-FC2]

member pwwn 52:4a:93:75:dd:91:0a:16

! [X70-CT1-FC8]

member pwwn 20:00:00:25:b5:aa:17:16

! [VCC-WLHost12-HBA0]

member pwwn 20:00:00:25:b5:aa:17:17

! [VCC-WLHost12-HBA2]

zone name FlaskStack-VCC-CVD-WLHost13 vsan 100

member pwwn 52:4a:93:75:dd:91:0a:00

! [X70-CT0-FC0]

member pwwn 52:4a:93:75:dd:91:0a:02

! [X70-CT0-FC2]

member pwwn 52:4a:93:75:dd:91:0a:10

! [X70-CT1-FC0]

member pwwn 52:4a:93:75:dd:91:0a:12

! [X70-CT1-FC2]

member pwwn 52:4a:93:75:dd:91:0a:16

! [X70-CT1-FC8]

member pwwn 20:00:00:25:b5:aa:17:18

! [VCC-WLHost13-HBA0]

member pwwn 20:00:00:25:b5:aa:17:19

! [VCC-WLHost13-HBA2]

zone name FlaskStack-VCC-CVD-WLHost14 vsan 100

member pwwn 52:4a:93:75:dd:91:0a:00

! [X70-CT0-FC0]

member pwwn 52:4a:93:75:dd:91:0a:02

! [X70-CT0-FC2]

member pwwn 52:4a:93:75:dd:91:0a:10

! [X70-CT1-FC0]

member pwwn 52:4a:93:75:dd:91:0a:12

! [X70-CT1-FC2]

member pwwn 52:4a:93:75:dd:91:0a:16

! [X70-CT1-FC8]

member pwwn 20:00:00:25:b5:aa:17:1a

! [VCC-WLHost14-HBA0]

member pwwn 20:00:00:25:b5:aa:17:1b

! [VCC-WLHost14-HBA2]

zone name FlaskStack-VCC-CVD-WLHost15 vsan 100

member pwwn 52:4a:93:75:dd:91:0a:00

! [X70-CT0-FC0]

member pwwn 52:4a:93:75:dd:91:0a:02

! [X70-CT0-FC2]

member pwwn 52:4a:93:75:dd:91:0a:10

! [X70-CT1-FC0]

member pwwn 52:4a:93:75:dd:91:0a:12

! [X70-CT1-FC2]

member pwwn 52:4a:93:75:dd:91:0a:16

! [X70-CT1-FC8]

```
member pwwn 20:00:00:25:b5:aa:17:1c
!      [VCC-WLHost15-HBA0]
member pwwn 20:00:00:25:b5:aa:17:1d
!      [VCC-WLHost15-HBA2]
```

zone name FlaskStack-VCC-CVD-Infra01 vsan 100

```
member pwwn 52:4a:93:75:dd:91:0a:00
!      [X70-CT0-FC0]
member pwwn 52:4a:93:75:dd:91:0a:02
!      [X70-CT0-FC2]
member pwwn 52:4a:93:75:dd:91:0a:10
!      [X70-CT1-FC0]
member pwwn 52:4a:93:75:dd:91:0a:12
!      [X70-CT1-FC2]
member pwwn 52:4a:93:75:dd:91:0a:16
!      [X70-CT1-FC8]
member pwwn 20:00:00:25:b5:aa:17:1e
!      [VCC-Infra01-HBA0]
member pwwn 20:00:00:25:b5:aa:17:1f
!      [VCC-Infra01-HBA2]
```

zone name FlaskStack-VCC-CVD-WLHost16 vsan 100

```
member pwwn 52:4a:93:75:dd:91:0a:00
!      [X70-CT0-FC0]
member pwwn 52:4a:93:75:dd:91:0a:02
!      [X70-CT0-FC2]
member pwwn 52:4a:93:75:dd:91:0a:10
!      [X70-CT1-FC0]
member pwwn 52:4a:93:75:dd:91:0a:12
!      [X70-CT1-FC2]
```

```
member pwwn 52:4a:93:75:dd:91:0a:16
!      [X70-CT1-FC8]
member pwwn 20:00:00:25:b5:aa:17:20
!      [VCC-WLHost16-HBA0]
member pwwn 20:00:00:25:b5:aa:17:21
!      [VCC-WLHost16-HBA2]
```

zone name FlaskStack-VCC-CVD-WLHost17 vsan 100

```
member pwwn 52:4a:93:75:dd:91:0a:00
!      [X70-CT0-FC0]
member pwwn 52:4a:93:75:dd:91:0a:02
!      [X70-CT0-FC2]
member pwwn 52:4a:93:75:dd:91:0a:10
!      [X70-CT1-FC0]
member pwwn 52:4a:93:75:dd:91:0a:12
!      [X70-CT1-FC2]
member pwwn 52:4a:93:75:dd:91:0a:16
!      [X70-CT1-FC8]
member pwwn 20:00:00:25:b5:aa:17:22
!      [VCC-WLHost17-HBA0]
member pwwn 20:00:00:25:b5:aa:17:23
!      [VCC-WLHost17-HBA2]
```

zone name FlaskStack-VCC-CVD-WLHost18 vsan 100

```
member pwwn 52:4a:93:75:dd:91:0a:00
!      [X70-CT0-FC0]
member pwwn 52:4a:93:75:dd:91:0a:02
!      [X70-CT0-FC2]
member pwwn 52:4a:93:75:dd:91:0a:10
!      [X70-CT1-FC0]
```

member pwwn 52:4a:93:75:dd:91:0a:12

! [X70-CT1-FC2]

member pwwn 52:4a:93:75:dd:91:0a:16

! [X70-CT1-FC8]

member pwwn 20:00:00:25:b5:aa:17:24

! [VCC-WLHost18-HBA0]

member pwwn 20:00:00:25:b5:aa:17:25

! [VCC-WLHost18-HBA2]

zone name FlaskStack-VCC-CVD-WLHost19 vsan 100

member pwwn 52:4a:93:75:dd:91:0a:00

! [X70-CT0-FC0]

member pwwn 52:4a:93:75:dd:91:0a:02

! [X70-CT0-FC2]

member pwwn 52:4a:93:75:dd:91:0a:10

! [X70-CT1-FC0]

member pwwn 52:4a:93:75:dd:91:0a:12

! [X70-CT1-FC2]

member pwwn 52:4a:93:75:dd:91:0a:16

! [X70-CT1-FC8]

member pwwn 20:00:00:25:b5:aa:17:26

! [VCC-WLHost19-HBA0]

member pwwn 20:00:00:25:b5:aa:17:27

! [VCC-WLHost19-HBA2]

zone name FlaskStack-VCC-CVD-WLHost20 vsan 100

member pwwn 52:4a:93:75:dd:91:0a:00

! [X70-CT0-FC0]

member pwwn 52:4a:93:75:dd:91:0a:02

! [X70-CT0-FC2]

member pwwn 52:4a:93:75:dd:91:0a:10

! [X70-CT1-FC0]

member pwwn 52:4a:93:75:dd:91:0a:12

! [X70-CT1-FC2]

member pwwn 52:4a:93:75:dd:91:0a:16

! [X70-CT1-FC8]

member pwwn 20:00:00:25:b5:aa:17:28

! [VCC-WLHost20-HBA0]

member pwwn 20:00:00:25:b5:aa:17:29

! [VCC-WLHost20-HBA2]

zone name FlaskStack-VCC-CVD-WLHost21 vsan 100

member pwwn 52:4a:93:75:dd:91:0a:00

! [X70-CT0-FC0]

member pwwn 52:4a:93:75:dd:91:0a:02

! [X70-CT0-FC2]

member pwwn 52:4a:93:75:dd:91:0a:10

! [X70-CT1-FC0]

member pwwn 52:4a:93:75:dd:91:0a:12

! [X70-CT1-FC2]

member pwwn 52:4a:93:75:dd:91:0a:16

! [X70-CT1-FC8]

member pwwn 20:00:00:25:b5:aa:17:2a

! [VCC-WLHost21-HBA0]

member pwwn 20:00:00:25:b5:aa:17:2b

! [VCC-WLHost21-HBA2]

zone name FlaskStack-VCC-CVD-WLHost22 vsan 100

member pwwn 52:4a:93:75:dd:91:0a:00

! [X70-CT0-FC0]

```
member pwwn 52:4a:93:75:dd:91:0a:02
!      [X70-CT0-FC2]
member pwwn 52:4a:93:75:dd:91:0a:10
!      [X70-CT1-FC0]
member pwwn 52:4a:93:75:dd:91:0a:12
!      [X70-CT1-FC2]
member pwwn 52:4a:93:75:dd:91:0a:16
!      [X70-CT1-FC8]
member pwwn 20:00:00:25:b5:aa:17:2c
!      [VCC-WLHost22-HBA0]
member pwwn 20:00:00:25:b5:aa:17:2d
!      [VCC-WLHost22-HBA2]
```

zone name FlaskStack-VCC-CVD-WLHost23 vsan 100

```
member pwwn 52:4a:93:75:dd:91:0a:00
!      [X70-CT0-FC0]
member pwwn 52:4a:93:75:dd:91:0a:02
!      [X70-CT0-FC2]
member pwwn 52:4a:93:75:dd:91:0a:10
!      [X70-CT1-FC0]
member pwwn 52:4a:93:75:dd:91:0a:12
!      [X70-CT1-FC2]
member pwwn 52:4a:93:75:dd:91:0a:16
!      [X70-CT1-FC8]
member pwwn 20:00:00:25:b5:aa:17:2e
!      [VCC-WLHost23-HBA0]
member pwwn 20:00:00:25:b5:aa:17:2f
!      [VCC-WLHost23-HBA2]
```

zone name FlaskStack-VCC-CVD-WLHost24 vsan 100

```
member pwwn 52:4a:93:75:dd:91:0a:00
!      [X70-CT0-FC0]
member pwwn 52:4a:93:75:dd:91:0a:02
!      [X70-CT0-FC2]
member pwwn 52:4a:93:75:dd:91:0a:10
!      [X70-CT1-FC0]
member pwwn 52:4a:93:75:dd:91:0a:12
!      [X70-CT1-FC2]
member pwwn 52:4a:93:75:dd:91:0a:16
!      [X70-CT1-FC8]
member pwwn 20:00:00:25:b5:aa:17:30
!      [VCC-WLHost24-HBA0]
member pwwn 20:00:00:25:b5:aa:17:31
!      [VCC-WLHost24-HBA2]
```

zone name FlaskStack-VCC-CVD-WLHost25 vsan 100

```
member pwwn 52:4a:93:75:dd:91:0a:00
!      [X70-CT0-FC0]
member pwwn 52:4a:93:75:dd:91:0a:02
!      [X70-CT0-FC2]
member pwwn 52:4a:93:75:dd:91:0a:10
!      [X70-CT1-FC0]
member pwwn 52:4a:93:75:dd:91:0a:12
!      [X70-CT1-FC2]
member pwwn 52:4a:93:75:dd:91:0a:16
!      [X70-CT1-FC8]
member pwwn 20:00:00:25:b5:aa:17:32
!      [VCC-WLHost25-HBA0]
member pwwn 20:00:00:25:b5:aa:17:33
!      [VCC-WLHost25-HBA2]
```

zone name FlaskStack-VCC-CVD-WLHost26 vsan 100

member pwwn 52:4a:93:75:dd:91:0a:00

! [X70-CT0-FC0]

member pwwn 52:4a:93:75:dd:91:0a:02

! [X70-CT0-FC2]

member pwwn 52:4a:93:75:dd:91:0a:10

! [X70-CT1-FC0]

member pwwn 52:4a:93:75:dd:91:0a:12

! [X70-CT1-FC2]

member pwwn 52:4a:93:75:dd:91:0a:16

! [X70-CT1-FC8]

member pwwn 20:00:00:25:b5:aa:17:34

! [VCC-WLHost26-HBA0]

member pwwn 20:00:00:25:b5:aa:17:35

! [VCC-WLHost26-HBA2]

zone name FlaskStack-VCC-CVD-WLHost27 vsan 100

member pwwn 52:4a:93:75:dd:91:0a:00

! [X70-CT0-FC0]

member pwwn 52:4a:93:75:dd:91:0a:02

! [X70-CT0-FC2]

member pwwn 52:4a:93:75:dd:91:0a:10

! [X70-CT1-FC0]

member pwwn 52:4a:93:75:dd:91:0a:12

! [X70-CT1-FC2]

member pwwn 52:4a:93:75:dd:91:0a:16

! [X70-CT1-FC8]

member pwwn 20:00:00:25:b5:aa:17:36

! [VCC-WLHost27-HBA0]

member pwwn 20:00:00:25:b5:aa:17:37

! [VCC-WLHost27-HBA2]

zone name FlaskStack-VCC-CVD-WLHost28 vsan 100

member pwwn 52:4a:93:75:dd:91:0a:00

! [X70-CT0-FC0]

member pwwn 52:4a:93:75:dd:91:0a:02

! [X70-CT0-FC2]

member pwwn 52:4a:93:75:dd:91:0a:10

! [X70-CT1-FC0]

member pwwn 52:4a:93:75:dd:91:0a:12

! [X70-CT1-FC2]

member pwwn 52:4a:93:75:dd:91:0a:16

! [X70-CT1-FC8]

member pwwn 20:00:00:25:b5:aa:17:38

! [VCC-WLHost28-HBA0]

member pwwn 20:00:00:25:b5:aa:17:39

! [VCC-WLHost28-HBA2]

zone name FlaskStack-VCC-CVD-WLHost29 vsan 100

member pwwn 52:4a:93:75:dd:91:0a:00

! [X70-CT0-FC0]

member pwwn 52:4a:93:75:dd:91:0a:02

! [X70-CT0-FC2]

member pwwn 52:4a:93:75:dd:91:0a:10

! [X70-CT1-FC0]

member pwwn 52:4a:93:75:dd:91:0a:12

! [X70-CT1-FC2]

member pwwn 52:4a:93:75:dd:91:0a:16

! [X70-CT1-FC8]

```
member pwwn 20:00:00:25:b5:aa:17:3a
!      [VCC-WLHost29-HBA0]
member pwwn 20:00:00:25:b5:aa:17:3b
!      [VCC-WLHost29-HBA2]
```

zone name FlaskStack-VCC-CVD-WLHost30 vsan 100

```
member pwwn 52:4a:93:75:dd:91:0a:00
!      [X70-CT0-FC0]
member pwwn 52:4a:93:75:dd:91:0a:02
!      [X70-CT0-FC2]
member pwwn 52:4a:93:75:dd:91:0a:10
!      [X70-CT1-FC0]
member pwwn 52:4a:93:75:dd:91:0a:12
!      [X70-CT1-FC2]
member pwwn 52:4a:93:75:dd:91:0a:16
!      [X70-CT1-FC8]
member pwwn 20:00:00:25:b5:aa:17:3c
!      [VCC-WLHost30-HBA0]
member pwwn 20:00:00:25:b5:aa:17:3d
!      [VCC-WLHost30-HBA2]
```

zone name FlaskStack-VCC-CVD-Infra02 vsan 100

```
member pwwn 52:4a:93:75:dd:91:0a:00
!      [X70-CT0-FC0]
member pwwn 52:4a:93:75:dd:91:0a:02
!      [X70-CT0-FC2]
member pwwn 52:4a:93:75:dd:91:0a:10
!      [X70-CT1-FC0]
member pwwn 52:4a:93:75:dd:91:0a:12
!      [X70-CT1-FC2]
```

```
member pwwn 52:4a:93:75:dd:91:0a:16
!      [X70-CT1-FC8]
member pwwn 20:00:00:25:b5:aa:17:3e
!      [VCC-Infra02-HBA0]
member pwwn 20:00:00:25:b5:aa:17:3f
!      [VCC-Infra02-HBA2]
```

```
zoneset name FlashStack-VCC-CVD vsan 100
member FlaskStack-VCC-CVD-WLHost01
member FlaskStack-VCC-CVD-WLHost02
member FlaskStack-VCC-CVD-WLHost03
member FlaskStack-VCC-CVD-WLHost04
member FlaskStack-VCC-CVD-WLHost05
member FlaskStack-VCC-CVD-WLHost06
member FlaskStack-VCC-CVD-WLHost07
member FlaskStack-VCC-CVD-WLHost08
member FlaskStack-VCC-CVD-WLHost09
member FlaskStack-VCC-CVD-WLHost10
member FlaskStack-VCC-CVD-WLHost11
member FlaskStack-VCC-CVD-WLHost12
member FlaskStack-VCC-CVD-WLHost13
member FlaskStack-VCC-CVD-WLHost14
member FlaskStack-VCC-CVD-WLHost15
member FlaskStack-VCC-CVD-Infra01
member FlaskStack-VCC-CVD-WLHost16
member FlaskStack-VCC-CVD-WLHost17
member FlaskStack-VCC-CVD-WLHost18
member FlaskStack-VCC-CVD-WLHost19
member FlaskStack-VCC-CVD-WLHost20
member FlaskStack-VCC-CVD-WLHost21
```

member FlaskStack-VCC-CVD-WLHost22
member FlaskStack-VCC-CVD-WLHost23
member FlaskStack-VCC-CVD-WLHost24
member FlaskStack-VCC-CVD-WLHost25
member FlaskStack-VCC-CVD-WLHost26
member FlaskStack-VCC-CVD-WLHost27
member FlaskStack-VCC-CVD-WLHost28
member FlaskStack-VCC-CVD-WLHost29
member FlaskStack-VCC-CVD-WLHost30
member FlaskStack-VCC-CVD-Infra02

!Active Zone Database Section for vsan 400

zone name a300_VDI-1-HBA1 vsan 400

member pwwn 20:00:00:25:b5:3a:00:3f

! [VDI-1-HBA1]

member pwwn 20:01:00:a0:98:af:bd:e8

! [a300-01-0g]

member pwwn 20:03:00:a0:98:af:bd:e8

! [a300-02-0g]

zone name a300_VDI-2-HBA1 vsan 400

member pwwn 20:01:00:a0:98:af:bd:e8

! [a300-01-0g]

member pwwn 20:03:00:a0:98:af:bd:e8

! [a300-02-0g]

member pwwn 20:00:00:25:b5:3a:00:0f

! [VDI-2-HBA1]

zone name a300_VDI-3-HBA1 vsan 400

member pwwn 20:01:00:a0:98:af:bd:e8

```
!      [a300-01-0g]
member pwwn 20:03:00:a0:98:af:bd:e8
!      [a300-02-0g]
member pwwn 20:00:00:25:b5:3a:00:1f
!      [VDI-3-HBA1]
```

```
zone name a300_VDI-4-HBA1 vsan 400
member pwwn 20:01:00:a0:98:af:bd:e8
!      [a300-01-0g]
member pwwn 20:03:00:a0:98:af:bd:e8
!      [a300-02-0g]
member pwwn 20:00:00:25:b5:3a:00:4e
!      [VDI-4-HBA1]
```

```
zone name a300_VDI-5-HBA1 vsan 400
member pwwn 20:01:00:a0:98:af:bd:e8
!      [a300-01-0g]
member pwwn 20:03:00:a0:98:af:bd:e8
!      [a300-02-0g]
member pwwn 20:00:00:25:b5:3a:00:2e
!      [VDI-5-HBA1]
```

```
zone name a300_VDI-6-HBA1 vsan 400
member pwwn 20:01:00:a0:98:af:bd:e8
!      [a300-01-0g]
member pwwn 20:03:00:a0:98:af:bd:e8
!      [a300-02-0g]
member pwwn 20:00:00:25:b5:3a:00:3e
!      [VDI-6-HBA1]
```



```
zone name a300_VDI-7-HBA1 vsan 400
  member pwwn 20:01:00:a0:98:af:bd:e8
  !      [a300-01-0g]
  member pwwn 20:03:00:a0:98:af:bd:e8
  !      [a300-02-0g]
  member pwwn 20:00:00:25:b5:3a:00:0e
  !      [VDI-7-HBA1]
```

```
zone name a300_Infra01-8-HBA1 vsan 400
  member pwwn 20:01:00:a0:98:af:bd:e8
  !      [a300-01-0g]
  member pwwn 20:03:00:a0:98:af:bd:e8
  !      [a300-02-0g]
  member pwwn 20:00:00:25:b5:3a:00:4f
  !      [Infra01-8-HBA1]
```

```
zone name a300_VDI-9-HBA1 vsan 400
  member pwwn 20:01:00:a0:98:af:bd:e8
  !      [a300-01-0g]
  member pwwn 20:03:00:a0:98:af:bd:e8
  !      [a300-02-0g]
  member pwwn 20:00:00:25:b5:3a:00:4d
  !      [VDI-9-HBA1]
```

```
zone name a300_VDI-10-HBA1 vsan 400
  member pwwn 20:01:00:a0:98:af:bd:e8
  !      [a300-01-0g]
  member pwwn 20:03:00:a0:98:af:bd:e8
  !      [a300-02-0g]
  member pwwn 20:00:00:25:b5:3a:00:2d
```

! [VDI-10-HBA1]

zone name a300_VDI-11-HBA1 vsan 400

member pwwn 20:01:00:a0:98:af:bd:e8

! [a300-01-0g]

member pwwn 20:03:00:a0:98:af:bd:e8

! [a300-02-0g]

member pwwn 20:00:00:25:b5:3a:00:3d

! [VDI-11-HBA1]

zone name a300_VDI-12-HBA1 vsan 400

member pwwn 20:01:00:a0:98:af:bd:e8

! [a300-01-0g]

member pwwn 20:03:00:a0:98:af:bd:e8

! [a300-02-0g]

member pwwn 20:00:00:25:b5:3a:00:0d

! [VDI-12-HBA1]

zone name a300_VDI-13-HBA1 vsan 400

member pwwn 20:01:00:a0:98:af:bd:e8

! [a300-01-0g]

member pwwn 20:03:00:a0:98:af:bd:e8

! [a300-02-0g]

member pwwn 20:00:00:25:b5:3a:00:1d

! [VDI-13-HBA1]

zone name a300_VDI-14-HBA1 vsan 400

member pwwn 20:01:00:a0:98:af:bd:e8

! [a300-01-0g]

member pwwn 20:03:00:a0:98:af:bd:e8

```
!      [a300-02-0g]
member pwwn 20:00:00:25:b5:3a:00:4c
!      [VDI-14-HBA1]
```

```
zone name a300_VDI-15-HBA1 vsan 400
member pwwn 20:01:00:a0:98:af:bd:e8
!      [a300-01-0g]
member pwwn 20:03:00:a0:98:af:bd:e8
!      [a300-02-0g]
member pwwn 20:00:00:25:b5:3a:00:2c
!      [VDI-15-HBA1]
```

```
zone name a300_Infra02-16-HBA1 vsan 400
member pwwn 20:01:00:a0:98:af:bd:e8
!      [a300-01-0g]
member pwwn 20:03:00:a0:98:af:bd:e8
!      [a300-02-0g]
member pwwn 20:00:00:25:b5:3a:00:2f
!      [Infra02-16-HBA1]
```

```
zone name a300_VDI-17-HBA1 vsan 400
member pwwn 20:01:00:a0:98:af:bd:e8
!      [a300-01-0g]
member pwwn 20:03:00:a0:98:af:bd:e8
!      [a300-02-0g]
member pwwn 20:00:00:25:b5:3a:00:0c
!      [VDI-17-HBA1]
```

```
zone name a300_VDI-18-HBA1 vsan 400
member pwwn 20:01:00:a0:98:af:bd:e8
```

```
!      [a300-01-0g]
member pwwn 20:03:00:a0:98:af:bd:e8
!      [a300-02-0g]
member pwwn 20:00:00:25:b5:3a:00:1c
!      [VDI-18-HBA1]
```

```
zone name a300_VDI-19-HBA1 vsan 400
member pwwn 20:01:00:a0:98:af:bd:e8
!      [a300-01-0g]
member pwwn 20:03:00:a0:98:af:bd:e8
!      [a300-02-0g]
member pwwn 20:00:00:25:b5:3a:00:4b
!      [VDI-19-HBA1]
```

```
zone name a300_VDI-20-HBA1 vsan 400
member pwwn 20:01:00:a0:98:af:bd:e8
!      [a300-01-0g]
member pwwn 20:03:00:a0:98:af:bd:e8
!      [a300-02-0g]
member pwwn 20:00:00:25:b5:3a:00:2b
!      [VDI-20-HBA1]
```

```
zone name a300_VDI-21-HBA1 vsan 400
member pwwn 20:01:00:a0:98:af:bd:e8
!      [a300-01-0g]
member pwwn 20:03:00:a0:98:af:bd:e8
!      [a300-02-0g]
member pwwn 20:00:00:25:b5:3a:00:3b
!      [VDI-21-HBA1]
```

```
zone name a300_VDI-22-HBA1 vsan 400
  member pwwn 20:01:00:a0:98:af:bd:e8
  !      [a300-01-0g]
  member pwwn 20:03:00:a0:98:af:bd:e8
  !      [a300-02-0g]
  member pwwn 20:00:00:25:b5:3a:00:0b
  !      [VDI-22-HBA1]
```

```
zone name a300_VDI-23-HBA1 vsan 400
  member pwwn 20:01:00:a0:98:af:bd:e8
  !      [a300-01-0g]
  member pwwn 20:03:00:a0:98:af:bd:e8
  !      [a300-02-0g]
  member pwwn 20:00:00:25:b5:3a:00:1b
  !      [VDI-23-HBA1]
```

```
zone name a300_VDI-24-HBA1 vsan 400
  member pwwn 20:01:00:a0:98:af:bd:e8
  !      [a300-01-0g]
  member pwwn 20:03:00:a0:98:af:bd:e8
  !      [a300-02-0g]
  member pwwn 20:00:00:25:b5:3a:00:4a
  !      [VDI-24-HBA1]
```

```
zone name a300_VDI-25-HBA1 vsan 400
  member pwwn 20:01:00:a0:98:af:bd:e8
  !      [a300-01-0g]
  member pwwn 20:03:00:a0:98:af:bd:e8
  !      [a300-02-0g]
  member pwwn 20:00:00:25:b5:3a:00:2a
```

! [VDI-25-HBA1]

zone name a300_VDI-26-HBA1 vsan 400

member pwwn 20:01:00:a0:98:af:bd:e8

! [a300-01-0g]

member pwwn 20:03:00:a0:98:af:bd:e8

! [a300-02-0g]

member pwwn 20:00:00:25:b5:3a:00:3a

! [VDI-26-HBA1]

zone name a300_VDI-27-HBA1 vsan 400

member pwwn 20:01:00:a0:98:af:bd:e8

! [a300-01-0g]

member pwwn 20:03:00:a0:98:af:bd:e8

! [a300-02-0g]

member pwwn 20:00:00:25:b5:3a:00:0a

! [VDI-27-HBA1]

zone name a300_VDI-28-HBA1 vsan 400

member pwwn 20:01:00:a0:98:af:bd:e8

! [a300-01-0g]

member pwwn 20:03:00:a0:98:af:bd:e8

! [a300-02-0g]

member pwwn 20:00:00:25:b5:3a:00:1a

! [VDI-28-HBA1]

zone name a300_VDI-29-HBA1 vsan 400

member pwwn 20:01:00:a0:98:af:bd:e8

! [a300-01-0g]

member pwwn 20:03:00:a0:98:af:bd:e8

```
!      [a300-02-0g]
member pwwn 20:00:00:25:b5:3a:00:49
!      [VDI-29-HBA1]
```

```
zone name a300_VDI-30-HBA1 vsan 400
member pwwn 20:01:00:a0:98:af:bd:e8
!      [a300-01-0g]
member pwwn 20:03:00:a0:98:af:bd:e8
!      [a300-02-0g]
member pwwn 20:00:00:25:b5:3a:00:39
!      [VDI-30-HBA1]
```

```
zone name a300_VDI-31-HBA1 vsan 400
member pwwn 20:01:00:a0:98:af:bd:e8
!      [a300-01-0g]
member pwwn 20:03:00:a0:98:af:bd:e8
!      [a300-02-0g]
member pwwn 20:00:00:25:b5:3a:00:1e
!      [VDI-31-HBA1]
```

```
zone name a300_VDI-32-HBA1 vsan 400
member pwwn 20:01:00:a0:98:af:bd:e8
!      [a300-01-0g]
member pwwn 20:03:00:a0:98:af:bd:e8
!      [a300-02-0g]
member pwwn 20:00:00:25:b5:3a:00:3c
!      [VDI-32-HBA1]
```

```
zone name a300-GPU1-HBA1 vsan 400
member pwwn 20:00:00:25:b5:3a:00:29
```

```
!      [VCC-GPU1-HBA1]
member pwwn 20:01:00:a0:98:af:bd:e8
!      [a300-01-0g]
member pwwn 20:03:00:a0:98:af:bd:e8
!      [a300-02-0g]
```

```
zone name a300-GPU2-HBA1 vsan 400
member pwwn 20:00:00:25:b5:3a:00:19
!      [VCC-GPU2-HBA1]
member pwwn 20:01:00:a0:98:af:bd:e8
!      [a300-01-0g]
member pwwn 20:03:00:a0:98:af:bd:e8
!      [a300-02-0g]
```

```
zone name a300-GPU3-HBA1 vsan 400
member pwwn 20:00:00:25:b5:3a:00:09
!      [VCC-GPU3-HBA1]
member pwwn 20:01:00:a0:98:af:bd:e8
!      [a300-01-0g]
member pwwn 20:03:00:a0:98:af:bd:e8
!      [a300-02-0g]
```

```
zone name a300-GPU4-HBA1 vsan 400
member pwwn 20:00:00:25:b5:3a:00:48
!      [VCC-GPU4-HBA1]
member pwwn 20:01:00:a0:98:af:bd:e8
!      [a300-01-0g]
member pwwn 20:03:00:a0:98:af:bd:e8
!      [a300-02-0g]
```



```
zoneset name testpod vsan 400
  member a300_VDI-1-HBA1
  member a300_VDI-2-HBA1
  member a300_VDI-3-HBA1
  member a300_VDI-4-HBA1
  member a300_VDI-5-HBA1
  member a300_VDI-6-HBA1
  member a300_VDI-7-HBA1
  member a300_Infra01-8-HBA1
  member a300_VDI-9-HBA1
  member a300_VDI-10-HBA1
  member a300_VDI-11-HBA1
  member a300_VDI-12-HBA1
  member a300_VDI-13-HBA1
  member a300_VDI-14-HBA1
  member a300_VDI-15-HBA1
  member a300_Infra02-16-HBA1
  member a300_VDI-17-HBA1
  member a300_VDI-18-HBA1
  member a300_VDI-19-HBA1
  member a300_VDI-20-HBA1
  member a300_VDI-21-HBA1
  member a300_VDI-22-HBA1
  member a300_VDI-23-HBA1
  member a300_VDI-24-HBA1
  member a300_VDI-25-HBA1
  member a300_VDI-26-HBA1
  member a300_VDI-27-HBA1
  member a300_VDI-28-HBA1
  member a300_VDI-29-HBA1
```

```
member a300_VDI-30-HBA1
member a300_VDI-31-HBA1
member a300_VDI-32-HBA1
member a300-GPU1-HBA1
member a300-GPU2-HBA1
member a300-GPU3-HBA1
member a300-GPU4-HBA1

zoneset activate name testpod vsan 400
do clear zone database vsan 400
!Full Zone Database Section for vsan 400
zone name a300_VDI-1-HBA1 vsan 400
  member pwwn 20:00:00:25:b5:3a:00:3f
  !      [VDI-1-HBA1]
  member pwwn 20:01:00:a0:98:af:bd:e8
  !      [a300-01-0g]
  member pwwn 20:03:00:a0:98:af:bd:e8
  !      [a300-02-0g]

zone name a300_VDI-2-HBA1 vsan 400
  member pwwn 20:01:00:a0:98:af:bd:e8
  !      [a300-01-0g]
  member pwwn 20:03:00:a0:98:af:bd:e8
  !      [a300-02-0g]
  member pwwn 20:00:00:25:b5:3a:00:0f
  !      [VDI-2-HBA1]

zone name a300_VDI-3-HBA1 vsan 400
  member pwwn 20:01:00:a0:98:af:bd:e8
  !      [a300-01-0g]
```

```
member pwwn 20:03:00:a0:98:af:bd:e8
!      [a300-02-0g]
member pwwn 20:00:00:25:b5:3a:00:1f
!      [VDI-3-HBA1]
```

```
zone name a300_VDI-4-HBA1 vsan 400
  member pwwn 20:01:00:a0:98:af:bd:e8
  !      [a300-01-0g]
  member pwwn 20:03:00:a0:98:af:bd:e8
  !      [a300-02-0g]
  member pwwn 20:00:00:25:b5:3a:00:4e
  !      [VDI-4-HBA1]
```

```
zone name a300_VDI-5-HBA1 vsan 400
  member pwwn 20:01:00:a0:98:af:bd:e8
  !      [a300-01-0g]
  member pwwn 20:03:00:a0:98:af:bd:e8
  !      [a300-02-0g]
  member pwwn 20:00:00:25:b5:3a:00:2e
  !      [VDI-5-HBA1]
```

```
zone name a300_VDI-6-HBA1 vsan 400
  member pwwn 20:01:00:a0:98:af:bd:e8
  !      [a300-01-0g]
  member pwwn 20:03:00:a0:98:af:bd:e8
  !      [a300-02-0g]
  member pwwn 20:00:00:25:b5:3a:00:3e
  !      [VDI-6-HBA1]
```

```
zone name a300_VDI-7-HBA1 vsan 400
```

member pwwn 20:01:00:a0:98:af:bd:e8

! [a300-01-0g]

member pwwn 20:03:00:a0:98:af:bd:e8

! [a300-02-0g]

member pwwn 20:00:00:25:b5:3a:00:0e

! [VDI-7-HBA1]

zone name a300_Infra01-8-HBA1 vsan 400

member pwwn 20:01:00:a0:98:af:bd:e8

! [a300-01-0g]

member pwwn 20:03:00:a0:98:af:bd:e8

! [a300-02-0g]

member pwwn 20:00:00:25:b5:3a:00:4f

! [Infra01-8-HBA1]

zone name a300_VDI-9-HBA1 vsan 400

member pwwn 20:01:00:a0:98:af:bd:e8

! [a300-01-0g]

member pwwn 20:03:00:a0:98:af:bd:e8

! [a300-02-0g]

member pwwn 20:00:00:25:b5:3a:00:4d

! [VDI-9-HBA1]

zone name a300_VDI-10-HBA1 vsan 400

member pwwn 20:01:00:a0:98:af:bd:e8

! [a300-01-0g]

member pwwn 20:03:00:a0:98:af:bd:e8

! [a300-02-0g]

member pwwn 20:00:00:25:b5:3a:00:2d

! [VDI-10-HBA1]

```
zone name a300_VDI-11-HBA1 vsan 400
  member pwwn 20:01:00:a0:98:af:bd:e8
  !      [a300-01-0g]
  member pwwn 20:03:00:a0:98:af:bd:e8
  !      [a300-02-0g]
  member pwwn 20:00:00:25:b5:3a:00:3d
  !      [VDI-11-HBA1]
```

```
zone name a300_VDI-12-HBA1 vsan 400
  member pwwn 20:01:00:a0:98:af:bd:e8
  !      [a300-01-0g]
  member pwwn 20:03:00:a0:98:af:bd:e8
  !      [a300-02-0g]
  member pwwn 20:00:00:25:b5:3a:00:0d
  !      [VDI-12-HBA1]
```

```
zone name a300_VDI-13-HBA1 vsan 400
  member pwwn 20:01:00:a0:98:af:bd:e8
  !      [a300-01-0g]
  member pwwn 20:03:00:a0:98:af:bd:e8
  !      [a300-02-0g]
  member pwwn 20:00:00:25:b5:3a:00:1d
  !      [VDI-13-HBA1]
```

```
zone name a300_VDI-14-HBA1 vsan 400
  member pwwn 20:01:00:a0:98:af:bd:e8
  !      [a300-01-0g]
  member pwwn 20:03:00:a0:98:af:bd:e8
  !      [a300-02-0g]
```

member pwwn 20:00:00:25:b5:3a:00:4c
! [VDI-14-HBA1]

zone name a300_VDI-15-HBA1 vsan 400

member pwwn 20:01:00:a0:98:af:bd:e8
! [a300-01-0g]

member pwwn 20:03:00:a0:98:af:bd:e8
! [a300-02-0g]

member pwwn 20:00:00:25:b5:3a:00:2c
! [VDI-15-HBA1]

zone name a300_Infra02-16-HBA1 vsan 400

member pwwn 20:01:00:a0:98:af:bd:e8
! [a300-01-0g]

member pwwn 20:03:00:a0:98:af:bd:e8
! [a300-02-0g]

member pwwn 20:00:00:25:b5:3a:00:2f
! [Infra02-16-HBA1]

zone name a300_VDI-17-HBA1 vsan 400

member pwwn 20:01:00:a0:98:af:bd:e8
! [a300-01-0g]

member pwwn 20:03:00:a0:98:af:bd:e8
! [a300-02-0g]

member pwwn 20:00:00:25:b5:3a:00:0c
! [VDI-17-HBA1]

zone name a300_VDI-18-HBA1 vsan 400

member pwwn 20:01:00:a0:98:af:bd:e8
! [a300-01-0g]

member pwwn 20:03:00:a0:98:af:bd:e8

! [a300-02-0g]

member pwwn 20:00:00:25:b5:3a:00:1c

! [VDI-18-HBA1]

zone name a300_VDI-19-HBA1 vsan 400

member pwwn 20:01:00:a0:98:af:bd:e8

! [a300-01-0g]

member pwwn 20:03:00:a0:98:af:bd:e8

! [a300-02-0g]

member pwwn 20:00:00:25:b5:3a:00:4b

! [VDI-19-HBA1]

zone name a300_VDI-20-HBA1 vsan 400

member pwwn 20:01:00:a0:98:af:bd:e8

! [a300-01-0g]

member pwwn 20:03:00:a0:98:af:bd:e8

! [a300-02-0g]

member pwwn 20:00:00:25:b5:3a:00:2b

! [VDI-20-HBA1]

zone name a300_VDI-21-HBA1 vsan 400

member pwwn 20:01:00:a0:98:af:bd:e8

! [a300-01-0g]

member pwwn 20:03:00:a0:98:af:bd:e8

! [a300-02-0g]

member pwwn 20:00:00:25:b5:3a:00:3b

! [VDI-21-HBA1]

zone name a300_VDI-22-HBA1 vsan 400

```
member pwwn 20:01:00:a0:98:af:bd:e8
!      [a300-01-0g]
member pwwn 20:03:00:a0:98:af:bd:e8
!      [a300-02-0g]
member pwwn 20:00:00:25:b5:3a:00:0b
!      [VDI-22-HBA1]
```

```
zone name a300_VDI-23-HBA1 vsan 400
  member pwwn 20:01:00:a0:98:af:bd:e8
  !      [a300-01-0g]
  member pwwn 20:03:00:a0:98:af:bd:e8
  !      [a300-02-0g]
  member pwwn 20:00:00:25:b5:3a:00:1b
  !      [VDI-23-HBA1]
```

```
zone name a300_VDI-24-HBA1 vsan 400
  member pwwn 20:01:00:a0:98:af:bd:e8
  !      [a300-01-0g]
  member pwwn 20:03:00:a0:98:af:bd:e8
  !      [a300-02-0g]
  member pwwn 20:00:00:25:b5:3a:00:4a
  !      [VDI-24-HBA1]
```

```
zone name a300_VDI-25-HBA1 vsan 400
  member pwwn 20:01:00:a0:98:af:bd:e8
  !      [a300-01-0g]
  member pwwn 20:03:00:a0:98:af:bd:e8
  !      [a300-02-0g]
  member pwwn 20:00:00:25:b5:3a:00:2a
  !      [VDI-25-HBA1]
```



```
zone name a300_VDI-26-HBA1 vsan 400
  member pwwn 20:01:00:a0:98:af:bd:e8
  !      [a300-01-0g]
  member pwwn 20:03:00:a0:98:af:bd:e8
  !      [a300-02-0g]
  member pwwn 20:00:00:25:b5:3a:00:3a
  !      [VDI-26-HBA1]
```

```
zone name a300_VDI-27-HBA1 vsan 400
  member pwwn 20:01:00:a0:98:af:bd:e8
  !      [a300-01-0g]
  member pwwn 20:03:00:a0:98:af:bd:e8
  !      [a300-02-0g]
  member pwwn 20:00:00:25:b5:3a:00:0a
  !      [VDI-27-HBA1]
```

```
zone name a300_VDI-28-HBA1 vsan 400
  member pwwn 20:01:00:a0:98:af:bd:e8
  !      [a300-01-0g]
  member pwwn 20:03:00:a0:98:af:bd:e8
  !      [a300-02-0g]
  member pwwn 20:00:00:25:b5:3a:00:1a
  !      [VDI-28-HBA1]
```

```
zone name a300_VDI-29-HBA1 vsan 400
  member pwwn 20:01:00:a0:98:af:bd:e8
  !      [a300-01-0g]
  member pwwn 20:03:00:a0:98:af:bd:e8
  !      [a300-02-0g]
```

```
member pwwn 20:00:00:25:b5:3a:00:49  
!      [VDI-29-HBA1]
```

```
zone name a300_VDI-30-HBA1 vsan 400  
member pwwn 20:01:00:a0:98:af:bd:e8  
!      [a300-01-0g]  
member pwwn 20:03:00:a0:98:af:bd:e8  
!      [a300-02-0g]  
member pwwn 20:00:00:25:b5:3a:00:39  
!      [VDI-30-HBA1]
```

```
zone name a300_VDI-31-HBA1 vsan 400  
member pwwn 20:01:00:a0:98:af:bd:e8  
!      [a300-01-0g]  
member pwwn 20:03:00:a0:98:af:bd:e8  
!      [a300-02-0g]  
member pwwn 20:00:00:25:b5:3a:00:1e  
!      [VDI-31-HBA1]
```

```
zone name a300_VDI-32-HBA1 vsan 400  
member pwwn 20:01:00:a0:98:af:bd:e8  
!      [a300-01-0g]  
member pwwn 20:03:00:a0:98:af:bd:e8  
!      [a300-02-0g]  
member pwwn 20:00:00:25:b5:3a:00:3c  
!      [VDI-32-HBA1]
```

```
zone name a300-GPU1-HBA1 vsan 400  
member pwwn 20:00:00:25:b5:3a:00:29  
!      [VCC-GPU1-HBA1]
```

member pwwn 20:01:00:a0:98:af:bd:e8

! [a300-01-0g]

member pwwn 20:03:00:a0:98:af:bd:e8

! [a300-02-0g]

zone name a300-GPU2-HBA1 vsan 400

member pwwn 20:00:00:25:b5:3a:00:19

! [VCC-GPU2-HBA1]

member pwwn 20:01:00:a0:98:af:bd:e8

! [a300-01-0g]

member pwwn 20:03:00:a0:98:af:bd:e8

! [a300-02-0g]

zone name a300-GPU3-HBA1 vsan 400

member pwwn 20:00:00:25:b5:3a:00:09

! [VCC-GPU3-HBA1]

member pwwn 20:01:00:a0:98:af:bd:e8

! [a300-01-0g]

member pwwn 20:03:00:a0:98:af:bd:e8

! [a300-02-0g]

zone name a300-GPU4-HBA1 vsan 400

member pwwn 20:00:00:25:b5:3a:00:48

! [VCC-GPU4-HBA1]

member pwwn 20:01:00:a0:98:af:bd:e8

! [a300-01-0g]

member pwwn 20:03:00:a0:98:af:bd:e8

! [a300-02-0g]

zoneset name testpod vsan 400

member a300_VDI-1-HBA1
member a300_VDI-2-HBA1
member a300_VDI-3-HBA1
member a300_VDI-4-HBA1
member a300_VDI-5-HBA1
member a300_VDI-6-HBA1
member a300_VDI-7-HBA1
member a300_Infra01-8-HBA1
member a300_VDI-9-HBA1
member a300_VDI-10-HBA1
member a300_VDI-11-HBA1
member a300_VDI-12-HBA1
member a300_VDI-13-HBA1
member a300_VDI-14-HBA1
member a300_VDI-15-HBA1
member a300_Infra02-16-HBA1
member a300_VDI-17-HBA1
member a300_VDI-18-HBA1
member a300_VDI-19-HBA1
member a300_VDI-20-HBA1
member a300_VDI-21-HBA1
member a300_VDI-22-HBA1
member a300_VDI-23-HBA1
member a300_VDI-24-HBA1
member a300_VDI-25-HBA1
member a300_VDI-26-HBA1
member a300_VDI-27-HBA1
member a300_VDI-28-HBA1
member a300_VDI-29-HBA1
member a300_VDI-30-HBA1

```
member a300_VDI-31-HBA1  
member a300_VDI-32-HBA1  
member a300-GPU1-HBA1  
member a300-GPU2-HBA1  
member a300-GPU3-HBA1  
member a300-GPU4-HBA1
```

```
interface mgmt0  
  ip address 10.29.164.238 255.255.255.0
```

```
vsan database
```

```
vsan 400 interface fc1/1  
vsan 400 interface fc1/2  
vsan 400 interface fc1/3  
vsan 400 interface fc1/4  
vsan 400 interface fc1/5  
vsan 400 interface fc1/6  
vsan 400 interface fc1/7  
vsan 400 interface fc1/8  
vsan 100 interface fc1/9  
vsan 100 interface fc1/10  
vsan 100 interface fc1/11  
vsan 100 interface fc1/12  
vsan 100 interface fc1/13  
vsan 100 interface fc1/14  
vsan 100 interface fc1/15  
vsan 100 interface fc1/16
```

```
clock timezone PST 0 0
```

```
clock summer-time PDT 2 Sun Mar 02:00 1 Sun Nov 02:00 60
```

```
switchname ADD16-MDS-A
cli alias name autozone source sys/autozone.py
line console
line vty
boot kickstart bootflash:/m9100-s6ek9-kickstart-mz.8.3.1.bin
boot system bootflash:/m9100-s6ek9-mz.8.3.1.bin
interface fc1/1
interface fc1/2
interface fc1/3
interface fc1/4
interface fc1/5
interface fc1/6
interface fc1/7
interface fc1/8
interface fc1/9
interface fc1/10
interface fc1/11
interface fc1/12
interface fc1/13
interface fc1/14
interface fc1/15
interface fc1/16

interface fc1/1
  no port-license

interface fc1/2
  no port-license

interface fc1/3
```

no port-license

interface fc1/4

no port-license

interface fc1/5

no port-license

interface fc1/6

no port-license

interface fc1/7

no port-license

interface fc1/8

no port-license

interface fc1/9

switchport trunk allowed vsan 100

switchport trunk mode off

port-license acquire

no shutdown

interface fc1/10

switchport trunk allowed vsan 100

switchport trunk mode off

port-license acquire

no shutdown

interface fc1/11

```
switchport trunk allowed vsan 100  
switchport trunk mode off  
port-license acquire  
no shutdown
```

```
interface fc1/12  
switchport trunk allowed vsan 100  
switchport trunk mode off  
port-license acquire  
no shutdown
```

```
interface fc1/13  
switchport trunk allowed vsan 100  
switchport trunk mode off  
port-license acquire  
no shutdown
```

```
interface fc1/14  
switchport trunk allowed vsan 100  
switchport trunk mode off  
port-license acquire  
no shutdown
```

```
interface fc1/15  
switchport trunk allowed vsan 100  
switchport trunk mode off  
port-license acquire  
no shutdown
```

```
interface fc1/16
```



```
switchport trunk allowed vsan 100  
switchport trunk mode off  
port-license acquire  
no shutdown  
ip default-gateway 10.29.164.1
```

Cisco MDS 9132T 32-Gbps-B Configuration

```
login as: admin  
Pre-authentication banner message from server:  
| User Access Verification  
End of banner message from server  
Keyboard-interactive authentication prompts from server:  
| Password:  
End of keyboard-interactive prompts from server  
Access denied  
Keyboard-interactive authentication prompts from server:  
| Password:  
End of keyboard-interactive prompts from server  
Access denied  
Keyboard-interactive authentication prompts from server:  
| Password:  
login as: admin  
Pre-authentication banner message from server:  
| User Access Verification  
End of banner message from server  
Keyboard-interactive authentication prompts from server:  
| Password:  
End of keyboard-interactive prompts from server
```

Cisco Nexus Operating System (NX-OS) Software

TAC support: <http://www.cisco.com/tac>

Copyright (c) 2002–2018, Cisco Systems, Inc. All rights reserved.

The copyrights to certain works contained in this software are owned by other third parties and used and distributed under license. Certain components of this software are licensed under the GNU General Public License (GPL) version 2.0 or the GNU Lesser General Public License (LGPL) Version 2.1. A copy of each such license is available at

<http://www.opensource.org/licenses/gpl-2.0.php> and

<http://www.opensource.org/licenses/lgpl-2.1.php>

```
ADD16-MDS-B# show rum
```

```
^
```

```
% Invalid command at '^' marker.
```

```
ADD16-MDS-B# show running-config
```

```
!Command: show running-config
```

```
!Running configuration last done at: Thu Feb 28 23:15:58 2019
```

```
!Time: Fri May 17 20:58:34 2019
```

```
version 8.3(1)
```

```
power redundancy-mode redundant
```

```
feature npiv
```

```
feature fport-channel-trunk
```

```
role name default-role
```

```
description This is a system defined role and applies to all users.
```

```
rule 5 permit show feature environment
```

```
rule 4 permit show feature hardware
```

```
rule 3 permit show feature module
```

```
rule 2 permit show feature snmp
```

```
rule 1 permit show feature system
```

```
no password strength-check

username admin password 5 $5$1qs42bIH$hp2kMO3FA/4Zzg6EekVHWpA8IA7Mc/kBsFZVU8q1uU7 role
network-admin

ip domain-lookup

ip host ADD16-MDS-B 10.29.164.239

aaa group server radius radius

snmp-server user admin network-admin auth md5 0x6fa97f514b0cdf3638e31dfd0bd19c71 priv
0x6fa97f514b0cdf3638e31dfd0bd19c71 localizedkey

snmp-server host 10.155.160.97 traps version 2c public udp-port 1164

rmon event 1 log trap public description FATAL(1) owner PMON@FATAL
rmon event 2 log trap public description CRITICAL(2) owner PMON@CRITICAL
rmon event 3 log trap public description ERROR(3) owner PMON@ERROR
rmon event 4 log trap public description WARNING(4) owner PMON@WARNING
rmon event 5 log trap public description INFORMATION(5) owner PMON@INFO

ntp server 10.81.254.131

ntp server 10.81.254.202

vsan database

  vsan 101 name "FlashStack-VCC-CVD-Fabric-B"

  vsan 401 name "FlexPod-B"

device-alias database

device-alias name C480M5-P1 pwwn 21:00:00:0e:1e:10:a2:c1
device-alias name VDI-1-HBA2 pwwn 20:00:00:25:d5:06:00:3f
device-alias name VDI-2-HBA2 pwwn 20:00:00:25:d5:06:00:0f
device-alias name VDI-3-HBA2 pwwn 20:00:00:25:d5:06:00:1f
device-alias name VDI-4-HBA2 pwwn 20:00:00:25:d5:06:00:4e
device-alias name VDI-5-HBA2 pwwn 20:00:00:25:d5:06:00:2e
device-alias name VDI-6-HBA2 pwwn 20:00:00:25:d5:06:00:3e
device-alias name VDI-7-HBA2 pwwn 20:00:00:25:d5:06:00:0e
device-alias name VDI-9-HBA2 pwwn 20:00:00:25:d5:06:00:4d
device-alias name a300-01-0h pwwn 20:02:00:a0:98:af:bd:e8
device-alias name a300-02-0h pwwn 20:04:00:a0:98:af:bd:e8
```

device-alias name CS700-FC1-2 pwwn 56:c9:ce:90:0d:e8:24:01
device-alias name CS700-FC2-2 pwwn 56:c9:ce:90:0d:e8:24:05
device-alias name VDI-10-HBA2 pwwn 20:00:00:25:d5:06:00:2d
device-alias name VDI-11-HBA2 pwwn 20:00:00:25:d5:06:00:3d
device-alias name VDI-12-HBA2 pwwn 20:00:00:25:d5:06:00:0d
device-alias name VDI-13-HBA2 pwwn 20:00:00:25:d5:06:00:1d
device-alias name VDI-14-HBA2 pwwn 20:00:00:25:d5:06:00:4c
device-alias name VDI-15-HBA2 pwwn 20:00:00:25:d5:06:00:2c
device-alias name VDI-17-HBA2 pwwn 20:00:00:25:d5:06:00:0c
device-alias name VDI-18-HBA2 pwwn 20:00:00:25:d5:06:00:1c
device-alias name VDI-19-HBA2 pwwn 20:00:00:25:d5:06:00:4b
device-alias name VDI-20-HBA2 pwwn 20:00:00:25:d5:06:00:2b
device-alias name VDI-21-HBA2 pwwn 20:00:00:25:d5:06:00:3b
device-alias name VDI-22-HBA2 pwwn 20:00:00:25:d5:06:00:6b
device-alias name VDI-23-HBA2 pwwn 20:00:00:25:d5:06:00:1b
device-alias name VDI-24-HBA2 pwwn 20:00:00:25:d5:06:00:4a
device-alias name VDI-25-HBA2 pwwn 20:00:00:25:d5:06:00:2a
device-alias name VDI-26-HBA2 pwwn 20:00:00:25:d5:06:00:3a
device-alias name VDI-27-HBA2 pwwn 20:00:00:25:d5:06:00:0a
device-alias name VDI-28-HBA2 pwwn 20:00:00:25:d5:06:00:1a
device-alias name VDI-29-HBA2 pwwn 20:00:00:25:d5:06:00:49
device-alias name VDI-30-HBA2 pwwn 20:00:00:25:d5:06:00:39
device-alias name VDI-31-HBA2 pwwn 20:00:00:25:d5:06:00:1e
device-alias name VDI-32-HBA2 pwwn 20:00:00:25:d5:06:00:3c
device-alias name X70-CT0-FC1 pwwn 52:4a:93:75:dd:91:0a:01
device-alias name X70-CT0-FC3 pwwn 52:4a:93:75:dd:91:0a:03
device-alias name X70-CT0-FC9 pwwn 52:4a:93:75:dd:91:0a:07
device-alias name X70-CT1-FC1 pwwn 52:4a:93:75:dd:91:0a:11
device-alias name X70-CT1-FC3 pwwn 52:4a:93:75:dd:91:0a:13
device-alias name X70-CT1-FC9 pwwn 52:4a:93:75:dd:91:0a:17

device-alias name VCC-GPU1-HBA2 pwwn 20:00:00:25:d5:06:00:29
device-alias name VCC-GPU2-HBA2 pwwn 20:00:00:25:d5:06:00:19
device-alias name VCC-GPU3-HBA2 pwwn 20:00:00:25:d5:06:00:09
device-alias name VCC-GPU4-HBA2 pwwn 20:00:00:25:d5:06:00:48
device-alias name Infra01-8-HBA2 pwwn 20:00:00:25:d5:06:00:4f
device-alias name Infra02-16-HBA2 pwwn 20:00:00:25:d5:06:00:2f
device-alias name VCC-Infra01-HBA1 pwwn 20:00:00:25:b5:bb:17:1e
device-alias name VCC-Infra01-HBA3 pwwn 20:00:00:25:b5:bb:17:1f
device-alias name VCC-Infra02-HBA1 pwwn 20:00:00:25:b5:bb:17:3e
device-alias name VCC-Infra02-HBA3 pwwn 20:00:00:25:b5:bb:17:3f
device-alias name VCC-WLHost01-HBA1 pwwn 20:00:00:25:b5:bb:17:00
device-alias name VCC-WLHost01-HBA3 pwwn 20:00:00:25:b5:bb:17:01
device-alias name VCC-WLHost02-HBA1 pwwn 20:00:00:25:b5:bb:17:02
device-alias name VCC-WLHost02-HBA3 pwwn 20:00:00:25:b5:bb:17:03
device-alias name VCC-WLHost03-HBA1 pwwn 20:00:00:25:b5:bb:17:04
device-alias name VCC-WLHost03-HBA3 pwwn 20:00:00:25:b5:bb:17:05
device-alias name VCC-WLHost04-HBA1 pwwn 20:00:00:25:b5:bb:17:06
device-alias name VCC-WLHost04-HBA3 pwwn 20:00:00:25:b5:bb:17:07
device-alias name VCC-WLHost05-HBA1 pwwn 20:00:00:25:b5:bb:17:08
device-alias name VCC-WLHost05-HBA3 pwwn 20:00:00:25:b5:bb:17:09
device-alias name VCC-WLHost06-HBA1 pwwn 20:00:00:25:b5:bb:17:0a
device-alias name VCC-WLHost06-HBA3 pwwn 20:00:00:25:b5:bb:17:0b
device-alias name VCC-WLHost07-HBA1 pwwn 20:00:00:25:b5:bb:17:0c
device-alias name VCC-WLHost07-HBA3 pwwn 20:00:00:25:b5:bb:17:0d
device-alias name VCC-WLHost08-HBA1 pwwn 20:00:00:25:b5:bb:17:0e
device-alias name VCC-WLHost08-HBA3 pwwn 20:00:00:25:b5:bb:17:0f
device-alias name VCC-WLHost09-HBA1 pwwn 20:00:00:25:b5:bb:17:10
device-alias name VCC-WLHost09-HBA3 pwwn 20:00:00:25:b5:bb:17:11
device-alias name VCC-WLHost10-HBA1 pwwn 20:00:00:25:b5:bb:17:12
device-alias name VCC-WLHost10-HBA3 pwwn 20:00:00:25:b5:bb:17:13

device-alias name VCC-WLHost11-HBA1 pwwn 20:00:00:25:b5:bb:17:14
device-alias name VCC-WLHost11-HBA3 pwwn 20:00:00:25:b5:bb:17:15
device-alias name VCC-WLHost12-HBA1 pwwn 20:00:00:25:b5:bb:17:16
device-alias name VCC-WLHost12-HBA3 pwwn 20:00:00:25:b5:bb:17:17
device-alias name VCC-WLHost13-HBA1 pwwn 20:00:00:25:b5:bb:17:18
device-alias name VCC-WLHost13-HBA3 pwwn 20:00:00:25:b5:bb:17:19
device-alias name VCC-WLHost14-HBA1 pwwn 20:00:00:25:b5:bb:17:1a
device-alias name VCC-WLHost14-HBA3 pwwn 20:00:00:25:b5:bb:17:1b
device-alias name VCC-WLHost15-HBA1 pwwn 20:00:00:25:b5:bb:17:1c
device-alias name VCC-WLHost15-HBA3 pwwn 20:00:00:25:b5:bb:17:1d
device-alias name VCC-WLHost16-HBA1 pwwn 20:00:00:25:b5:bb:17:20
device-alias name VCC-WLHost16-HBA3 pwwn 20:00:00:25:b5:bb:17:21
device-alias name VCC-WLHost17-HBA1 pwwn 20:00:00:25:b5:bb:17:22
device-alias name VCC-WLHost17-HBA3 pwwn 20:00:00:25:b5:bb:17:23
device-alias name VCC-WLHost18-HBA1 pwwn 20:00:00:25:b5:bb:17:24
device-alias name VCC-WLHost18-HBA3 pwwn 20:00:00:25:b5:bb:17:25
device-alias name VCC-WLHost19-HBA1 pwwn 20:00:00:25:b5:bb:17:26
device-alias name VCC-WLHost19-HBA3 pwwn 20:00:00:25:b5:bb:17:27
device-alias name VCC-WLHost20-HBA1 pwwn 20:00:00:25:b5:bb:17:28
device-alias name VCC-WLHost20-HBA3 pwwn 20:00:00:25:b5:bb:17:29
device-alias name VCC-WLHost21-HBA1 pwwn 20:00:00:25:b5:bb:17:2a
device-alias name VCC-WLHost21-HBA3 pwwn 20:00:00:25:b5:bb:17:2b
device-alias name VCC-WLHost22-HBA1 pwwn 20:00:00:25:b5:bb:17:2c
device-alias name VCC-WLHost22-HBA3 pwwn 20:00:00:25:b5:bb:17:2d
device-alias name VCC-WLHost23-HBA1 pwwn 20:00:00:25:b5:bb:17:2e
device-alias name VCC-WLHost23-HBA3 pwwn 20:00:00:25:b5:bb:17:2f
device-alias name VCC-WLHost24-HBA1 pwwn 20:00:00:25:b5:bb:17:30
device-alias name VCC-WLHost24-HBA3 pwwn 20:00:00:25:b5:bb:17:31
device-alias name VCC-WLHost25-HBA1 pwwn 20:00:00:25:b5:bb:17:32
device-alias name VCC-WLHost25-HBA3 pwwn 20:00:00:25:b5:bb:17:33

```

device-alias name VCC-WLHost26-HBA1 pwwn 20:00:00:25:b5:bb:17:34
device-alias name VCC-WLHost26-HBA3 pwwn 20:00:00:25:b5:bb:17:35
device-alias name VCC-WLHost27-HBA1 pwwn 20:00:00:25:b5:bb:17:36
device-alias name VCC-WLHost27-HBA3 pwwn 20:00:00:25:b5:bb:17:37
device-alias name VCC-WLHost28-HBA1 pwwn 20:00:00:25:b5:bb:17:38
device-alias name VCC-WLHost28-HBA3 pwwn 20:00:00:25:b5:bb:17:39
device-alias name VCC-WLHost29-HBA1 pwwn 20:00:00:25:b5:bb:17:3a
device-alias name VCC-WLHost29-HBA3 pwwn 20:00:00:25:b5:bb:17:3b
device-alias name VCC-WLHost30-HBA1 pwwn 20:00:00:25:b5:bb:17:3c
device-alias name VCC-WLHost30-HBA3 pwwn 20:00:00:25:b5:bb:17:3d

```

```
device-alias commit
```

```
fcdomain fcid database
```

```

vsan 101 wwn 20:03:00:de:fb:90:a4:40 fcid 0xc40000 dynamic
vsan 101 wwn 52:4a:93:75:dd:91:0a:17 fcid 0xc40020 dynamic
!      [X70-CT1-FC9]
vsan 101 wwn 52:4a:93:75:dd:91:0a:07 fcid 0xc40040 dynamic
!      [X70-CT0-FC9]
vsan 101 wwn 52:4a:93:75:dd:91:0a:16 fcid 0xc40021 dynamic
vsan 101 wwn 52:4a:93:75:dd:91:0a:13 fcid 0xc40041 dynamic
!      [X70-CT1-FC3]
vsan 101 wwn 20:00:00:25:b5:bb:17:3e fcid 0xc40060 dynamic
!      [VCC-Infra02-HBA1]
vsan 101 wwn 20:00:00:25:b5:bb:17:07 fcid 0xc40061 dynamic
!      [VCC-WLHost04-HBA3]
vsan 101 wwn 20:00:00:25:b5:bb:17:3c fcid 0xc40062 dynamic
!      [VCC-WLHost30-HBA1]
vsan 101 wwn 20:00:00:25:b5:bb:17:11 fcid 0xc40063 dynamic
!      [VCC-WLHost09-HBA3]

```

```
vsan 101 wwn 20:00:00:25:b5:bb:17:01 fcid 0xc40064 dynamic
!      [VCC-WLHost01-HBA3]
vsan 101 wwn 20:00:00:25:b5:bb:17:00 fcid 0xc40065 dynamic
!      [VCC-WLHost01-HBA1]
vsan 101 wwn 20:00:00:25:b5:bb:17:13 fcid 0xc40066 dynamic
!      [VCC-WLHost10-HBA3]
vsan 101 wwn 20:00:00:25:b5:bb:17:04 fcid 0xc40067 dynamic
!      [VCC-WLHost03-HBA1]
vsan 101 wwn 20:00:00:25:b5:bb:17:17 fcid 0xc40068 dynamic
!      [VCC-WLHost12-HBA3]
vsan 101 wwn 20:00:00:25:b5:bb:17:16 fcid 0xc40069 dynamic
!      [VCC-WLHost12-HBA1]
vsan 101 wwn 20:00:00:25:b5:bb:17:30 fcid 0xc4006a dynamic
!      [VCC-WLHost24-HBA1]
vsan 101 wwn 20:00:00:25:b5:bb:17:21 fcid 0xc4006b dynamic
!      [VCC-WLHost16-HBA3]
vsan 101 wwn 20:00:00:25:b5:bb:17:1f fcid 0xc4006c dynamic
!      [VCC-Infra01-HBA3]
vsan 101 wwn 20:00:00:25:b5:bb:17:1a fcid 0xc4006d dynamic
!      [VCC-WLHost14-HBA1]
vsan 101 wwn 20:00:00:25:b5:bb:17:3f fcid 0xc4006e dynamic
!      [VCC-Infra02-HBA3]
vsan 101 wwn 20:00:00:25:b5:bb:17:0a fcid 0xc4006f dynamic
!      [VCC-WLHost06-HBA1]
vsan 101 wwn 20:00:00:25:b5:bb:17:38 fcid 0xc40070 dynamic
!      [VCC-WLHost28-HBA1]
vsan 101 wwn 20:00:00:25:b5:bb:17:19 fcid 0xc40071 dynamic
!      [VCC-WLHost13-HBA3]
vsan 101 wwn 20:00:00:25:b5:bb:17:22 fcid 0xc40072 dynamic
!      [VCC-WLHost17-HBA1]
```



```
vsan 101 wwn 20:00:00:25:b5:bb:17:2f fcid 0xc40073 dynamic
!      [VCC-WLHost23-HBA3]
vsan 101 wwn 20:00:00:25:b5:bb:17:1b fcid 0xc40074 dynamic
!      [VCC-WLHost14-HBA3]
vsan 101 wwn 20:00:00:25:b5:bb:17:3b fcid 0xc40075 dynamic
!      [VCC-WLHost29-HBA3]
vsan 101 wwn 20:00:00:25:b5:bb:17:2a fcid 0xc40076 dynamic
!      [VCC-WLHost21-HBA1]
vsan 101 wwn 20:00:00:25:b5:bb:17:29 fcid 0xc40077 dynamic
!      [VCC-WLHost20-HBA3]
vsan 101 wwn 20:00:00:25:b5:bb:17:1c fcid 0xc40078 dynamic
!      [VCC-WLHost15-HBA1]
vsan 101 wwn 20:00:00:25:b5:bb:17:0b fcid 0xc40079 dynamic
!      [VCC-WLHost06-HBA3]
vsan 101 wwn 20:00:00:25:b5:bb:17:0d fcid 0xc4007a dynamic
!      [VCC-WLHost07-HBA3]
vsan 101 wwn 20:00:00:25:b5:bb:17:37 fcid 0xc4007b dynamic
!      [VCC-WLHost27-HBA3]
vsan 101 wwn 20:00:00:25:b5:bb:17:31 fcid 0xc4007c dynamic
!      [VCC-WLHost24-HBA3]
vsan 101 wwn 20:00:00:25:b5:bb:17:08 fcid 0xc4007d dynamic
!      [VCC-WLHost05-HBA1]
vsan 101 wwn 20:00:00:25:b5:bb:17:10 fcid 0xc4007e dynamic
!      [VCC-WLHost09-HBA1]
vsan 101 wwn 20:00:00:25:b5:bb:17:34 fcid 0xc4007f dynamic
!      [VCC-WLHost26-HBA1]
vsan 101 wwn 20:00:00:25:b5:bb:17:25 fcid 0xc40080 dynamic
!      [VCC-WLHost18-HBA3]
vsan 101 wwn 20:00:00:25:b5:bb:17:3d fcid 0xc40081 dynamic
!      [VCC-WLHost30-HBA3]
```

```
vsan 101 wwn 20:00:00:25:b5:bb:17:15 fcid 0xc40082 dynamic
!      [VCC-WLHost11-HBA3]
vsan 101 wwn 20:00:00:25:b5:bb:17:23 fcid 0xc40083 dynamic
!      [VCC-WLHost17-HBA3]
vsan 101 wwn 20:00:00:25:b5:bb:17:3a fcid 0xc40084 dynamic
!      [VCC-WLHost29-HBA1]
vsan 101 wwn 20:00:00:25:b5:bb:17:28 fcid 0xc40085 dynamic
!      [VCC-WLHost20-HBA1]
vsan 101 wwn 20:00:00:25:b5:bb:17:32 fcid 0xc40086 dynamic
!      [VCC-WLHost25-HBA1]
vsan 101 wwn 20:00:00:25:b5:bb:17:0f fcid 0xc40087 dynamic
!      [VCC-WLHost08-HBA3]
vsan 101 wwn 20:00:00:25:b5:bb:17:0c fcid 0xc40088 dynamic
!      [VCC-WLHost07-HBA1]
vsan 101 wwn 20:00:00:25:b5:bb:17:2e fcid 0xc40089 dynamic
!      [VCC-WLHost23-HBA1]
vsan 101 wwn 20:00:00:25:b5:bb:17:03 fcid 0xc4008a dynamic
!      [VCC-WLHost02-HBA3]
vsan 101 wwn 20:00:00:25:b5:bb:17:02 fcid 0xc4008b dynamic
!      [VCC-WLHost02-HBA1]
vsan 101 wwn 20:00:00:25:b5:bb:17:2b fcid 0xc4008c dynamic
!      [VCC-WLHost21-HBA3]
vsan 101 wwn 20:00:00:25:b5:bb:17:35 fcid 0xc4008d dynamic
!      [VCC-WLHost26-HBA3]
vsan 101 wwn 20:00:00:25:b5:bb:17:2c fcid 0xc4008e dynamic
!      [VCC-WLHost22-HBA1]
vsan 101 wwn 20:00:00:25:b5:bb:17:27 fcid 0xc4008f dynamic
!      [VCC-WLHost19-HBA3]
vsan 101 wwn 20:00:00:25:b5:bb:17:18 fcid 0xc40090 dynamic
!      [VCC-WLHost13-HBA1]
```

```
vsan 101 wwn 20:00:00:25:b5:bb:17:14 fcid 0xc40091 dynamic
!      [VCC-WLHost11-HBA1]
vsan 101 wwn 20:00:00:25:b5:bb:17:0e fcid 0xc40092 dynamic
!      [VCC-WLHost08-HBA1]
vsan 101 wwn 20:00:00:25:b5:bb:17:1e fcid 0xc40093 dynamic
!      [VCC-Infra01-HBA1]
vsan 101 wwn 20:00:00:25:b5:bb:17:06 fcid 0xc40094 dynamic
!      [VCC-WLHost04-HBA1]
vsan 101 wwn 20:00:00:25:b5:bb:17:09 fcid 0xc40095 dynamic
!      [VCC-WLHost05-HBA3]
vsan 101 wwn 20:00:00:25:b5:bb:17:26 fcid 0xc40096 dynamic
!      [VCC-WLHost19-HBA1]
vsan 101 wwn 20:00:00:25:b5:bb:17:24 fcid 0xc40097 dynamic
!      [VCC-WLHost18-HBA1]
vsan 101 wwn 20:00:00:25:b5:bb:17:20 fcid 0xc40098 dynamic
!      [VCC-WLHost16-HBA1]
vsan 101 wwn 20:00:00:25:b5:bb:17:1d fcid 0xc40099 dynamic
!      [VCC-WLHost15-HBA3]
vsan 101 wwn 20:00:00:25:b5:bb:17:33 fcid 0xc4009a dynamic
!      [VCC-WLHost25-HBA3]
vsan 101 wwn 20:00:00:25:b5:bb:17:36 fcid 0xc4009b dynamic
!      [VCC-WLHost27-HBA1]
vsan 101 wwn 20:00:00:25:b5:bb:17:39 fcid 0xc4009c dynamic
!      [VCC-WLHost28-HBA3]
vsan 101 wwn 20:00:00:25:b5:bb:17:2d fcid 0xc4009d dynamic
!      [VCC-WLHost22-HBA3]
vsan 101 wwn 20:00:00:25:b5:bb:17:12 fcid 0xc4009e dynamic
!      [VCC-WLHost10-HBA1]
vsan 101 wwn 20:00:00:25:b5:bb:17:05 fcid 0xc4009f dynamic
!      [VCC-WLHost03-HBA3]
```

```

vsan 101 wwn 20:02:00:de:fb:90:a4:40 fcid 0xc400a0 dynamic
vsan 101 wwn 20:01:00:de:fb:90:a4:40 fcid 0xc400c0 dynamic
vsan 101 wwn 20:04:00:de:fb:90:a4:40 fcid 0xc400e0 dynamic
vsan 101 wwn 52:4a:93:75:dd:91:0a:00 fcid 0xc40022 dynamic
vsan 101 wwn 52:4a:93:75:dd:91:0a:12 fcid 0xc40042 dynamic
vsan 101 wwn 52:4a:93:75:dd:91:0a:11 fcid 0xc40023 dynamic
!      [X70-CT1-FC1]

```

!Active Zone Database Section for vsan 101

```
zone name FlaskStack-VCC-CVD-WLHost01 vsan 101
```

```

member pwwn 52:4a:93:75:dd:91:0a:01
!      [X70-CT0-FC1]
member pwwn 52:4a:93:75:dd:91:0a:03
!      [X70-CT0-FC3]
member pwwn 52:4a:93:75:dd:91:0a:07
!      [X70-CT0-FC9]
member pwwn 52:4a:93:75:dd:91:0a:11
!      [X70-CT1-FC1]
member pwwn 52:4a:93:75:dd:91:0a:13
!      [X70-CT1-FC3]
member pwwn 52:4a:93:75:dd:91:0a:17
!      [X70-CT1-FC9]
member pwwn 20:00:00:25:b5:bb:17:00
!      [VCC-WLHost01-HBA1]
member pwwn 20:00:00:25:b5:bb:17:01
!      [VCC-WLHost01-HBA3]

```

```
zone name FlaskStack-VCC-CVD-WLHost02 vsan 101
```

```

member pwwn 52:4a:93:75:dd:91:0a:01
!      [X70-CT0-FC1]
member pwwn 52:4a:93:75:dd:91:0a:03

```

```
!      [X70-CT0-FC3]
member pwwn 52:4a:93:75:dd:91:0a:07
!      [X70-CT0-FC9]
member pwwn 52:4a:93:75:dd:91:0a:11
!      [X70-CT1-FC1]
member pwwn 52:4a:93:75:dd:91:0a:13
!      [X70-CT1-FC3]
member pwwn 52:4a:93:75:dd:91:0a:17
!      [X70-CT1-FC9]
member pwwn 20:00:00:25:b5:bb:17:02
!      [VCC-WLHost02-HBA1]
member pwwn 20:00:00:25:b5:bb:17:03
!      [VCC-WLHost02-HBA3]
```

zone name FlaskStack-VCC-CVD-WLHost03 vsan 101

```
member pwwn 52:4a:93:75:dd:91:0a:01
!      [X70-CT0-FC1]
member pwwn 52:4a:93:75:dd:91:0a:03
!      [X70-CT0-FC3]
member pwwn 52:4a:93:75:dd:91:0a:07
!      [X70-CT0-FC9]
member pwwn 52:4a:93:75:dd:91:0a:11
!      [X70-CT1-FC1]
member pwwn 52:4a:93:75:dd:91:0a:13
!      [X70-CT1-FC3]
member pwwn 52:4a:93:75:dd:91:0a:17
!      [X70-CT1-FC9]
member pwwn 20:00:00:25:b5:bb:17:04
!      [VCC-WLHost03-HBA1]
member pwwn 20:00:00:25:b5:bb:17:05
```

! [VCC-WLHost03-HBA3]

zone name FlaskStack-VCC-CVD-WLHost04 vsan 101

member pwwn 52:4a:93:75:dd:91:0a:01

! [X70-CT0-FC1]

member pwwn 52:4a:93:75:dd:91:0a:03

! [X70-CT0-FC3]

member pwwn 52:4a:93:75:dd:91:0a:07

! [X70-CT0-FC9]

member pwwn 52:4a:93:75:dd:91:0a:11

! [X70-CT1-FC1]

member pwwn 52:4a:93:75:dd:91:0a:13

! [X70-CT1-FC3]

member pwwn 52:4a:93:75:dd:91:0a:17

! [X70-CT1-FC9]

member pwwn 20:00:00:25:b5:bb:17:06

! [VCC-WLHost04-HBA1]

member pwwn 20:00:00:25:b5:bb:17:07

! [VCC-WLHost04-HBA3]

zone name FlaskStack-VCC-CVD-WLHost05 vsan 101

member pwwn 52:4a:93:75:dd:91:0a:01

! [X70-CT0-FC1]

member pwwn 52:4a:93:75:dd:91:0a:03

! [X70-CT0-FC3]

member pwwn 52:4a:93:75:dd:91:0a:07

! [X70-CT0-FC9]

member pwwn 52:4a:93:75:dd:91:0a:11

! [X70-CT1-FC1]

member pwwn 52:4a:93:75:dd:91:0a:13

```
!      [X70-CT1-FC3]
member pwwn 52:4a:93:75:dd:91:0a:17
!      [X70-CT1-FC9]
member pwwn 20:00:00:25:b5:bb:17:08
!      [VCC-WLHost05-HBA1]
member pwwn 20:00:00:25:b5:bb:17:09
!      [VCC-WLHost05-HBA3]
```

zone name FlaskStack-VCC-CVD-WLHost06 vsan 101

```
member pwwn 52:4a:93:75:dd:91:0a:01
!      [X70-CT0-FC1]
member pwwn 52:4a:93:75:dd:91:0a:03
!      [X70-CT0-FC3]
member pwwn 52:4a:93:75:dd:91:0a:07
!      [X70-CT0-FC9]
member pwwn 52:4a:93:75:dd:91:0a:11
!      [X70-CT1-FC1]
member pwwn 52:4a:93:75:dd:91:0a:13
!      [X70-CT1-FC3]
member pwwn 52:4a:93:75:dd:91:0a:17
!      [X70-CT1-FC9]
member pwwn 20:00:00:25:b5:bb:17:0a
!      [VCC-WLHost06-HBA1]
member pwwn 20:00:00:25:b5:bb:17:0b
!      [VCC-WLHost06-HBA3]
```

zone name FlaskStack-VCC-CVD-WLHost07 vsan 101

```
member pwwn 52:4a:93:75:dd:91:0a:01
!      [X70-CT0-FC1]
member pwwn 52:4a:93:75:dd:91:0a:03
```

```
!      [X70-CT0-FC3]
member pwwn 52:4a:93:75:dd:91:0a:07
!      [X70-CT0-FC9]
member pwwn 52:4a:93:75:dd:91:0a:11
!      [X70-CT1-FC1]
member pwwn 52:4a:93:75:dd:91:0a:13
!      [X70-CT1-FC3]
member pwwn 52:4a:93:75:dd:91:0a:17
!      [X70-CT1-FC9]
member pwwn 20:00:00:25:b5:bb:17:0c
!      [VCC-WLHost07-HBA1]
member pwwn 20:00:00:25:b5:bb:17:0d
!      [VCC-WLHost07-HBA3]
```

zone name FlaskStack-VCC-CVD-WLHost08 vsan 101

```
member pwwn 52:4a:93:75:dd:91:0a:01
!      [X70-CT0-FC1]
member pwwn 52:4a:93:75:dd:91:0a:03
!      [X70-CT0-FC3]
member pwwn 52:4a:93:75:dd:91:0a:07
!      [X70-CT0-FC9]
member pwwn 52:4a:93:75:dd:91:0a:11
!      [X70-CT1-FC1]
member pwwn 52:4a:93:75:dd:91:0a:13
!      [X70-CT1-FC3]
member pwwn 52:4a:93:75:dd:91:0a:17
!      [X70-CT1-FC9]
member pwwn 20:00:00:25:b5:bb:17:0e
!      [VCC-WLHost08-HBA1]
member pwwn 20:00:00:25:b5:bb:17:0f
```

! [VCC-WLHost08-HBA3]

zone name FlaskStack-VCC-CVD-WLHost09 vsan 101

member pwwn 52:4a:93:75:dd:91:0a:01

! [X70-CT0-FC1]

member pwwn 52:4a:93:75:dd:91:0a:03

! [X70-CT0-FC3]

member pwwn 52:4a:93:75:dd:91:0a:07

! [X70-CT0-FC9]

member pwwn 52:4a:93:75:dd:91:0a:11

! [X70-CT1-FC1]

member pwwn 52:4a:93:75:dd:91:0a:13

! [X70-CT1-FC3]

member pwwn 52:4a:93:75:dd:91:0a:17

! [X70-CT1-FC9]

member pwwn 20:00:00:25:b5:bb:17:10

! [VCC-WLHost09-HBA1]

member pwwn 20:00:00:25:b5:bb:17:11

! [VCC-WLHost09-HBA3]

zone name FlaskStack-VCC-CVD-WLHost10 vsan 101

member pwwn 52:4a:93:75:dd:91:0a:01

! [X70-CT0-FC1]

member pwwn 52:4a:93:75:dd:91:0a:03

! [X70-CT0-FC3]

member pwwn 52:4a:93:75:dd:91:0a:07

! [X70-CT0-FC9]

member pwwn 52:4a:93:75:dd:91:0a:11

! [X70-CT1-FC1]

member pwwn 52:4a:93:75:dd:91:0a:13

```
!      [X70-CT1-FC3]
member pwwn 52:4a:93:75:dd:91:0a:17
!      [X70-CT1-FC9]
member pwwn 20:00:00:25:b5:bb:17:12
!      [VCC-WLHost10-HBA1]
member pwwn 20:00:00:25:b5:bb:17:13
!      [VCC-WLHost10-HBA3]
```

zone name FlaskStack-VCC-CVD-WLHost11 vsan 101

```
member pwwn 52:4a:93:75:dd:91:0a:01
!      [X70-CT0-FC1]
member pwwn 52:4a:93:75:dd:91:0a:03
!      [X70-CT0-FC3]
member pwwn 52:4a:93:75:dd:91:0a:07
!      [X70-CT0-FC9]
member pwwn 52:4a:93:75:dd:91:0a:11
!      [X70-CT1-FC1]
member pwwn 52:4a:93:75:dd:91:0a:13
!      [X70-CT1-FC3]
member pwwn 52:4a:93:75:dd:91:0a:17
!      [X70-CT1-FC9]
member pwwn 20:00:00:25:b5:bb:17:14
!      [VCC-WLHost11-HBA1]
member pwwn 20:00:00:25:b5:bb:17:15
!      [VCC-WLHost11-HBA3]
```

zone name FlaskStack-VCC-CVD-WLHost12 vsan 101

```
member pwwn 52:4a:93:75:dd:91:0a:01
!      [X70-CT0-FC1]
member pwwn 52:4a:93:75:dd:91:0a:03
```

```
!      [X70-CT0-FC3]
member pwwn 52:4a:93:75:dd:91:0a:07
!      [X70-CT0-FC9]
member pwwn 52:4a:93:75:dd:91:0a:11
!      [X70-CT1-FC1]
member pwwn 52:4a:93:75:dd:91:0a:13
!      [X70-CT1-FC3]
member pwwn 52:4a:93:75:dd:91:0a:17
!      [X70-CT1-FC9]
member pwwn 20:00:00:25:b5:bb:17:16
!      [VCC-WLHost12-HBA1]
member pwwn 20:00:00:25:b5:bb:17:17
!      [VCC-WLHost12-HBA3]
```

zone name FlaskStack-VCC-CVD-WLHost13 vsan 101

```
member pwwn 52:4a:93:75:dd:91:0a:01
!      [X70-CT0-FC1]
member pwwn 52:4a:93:75:dd:91:0a:03
!      [X70-CT0-FC3]
member pwwn 52:4a:93:75:dd:91:0a:07
!      [X70-CT0-FC9]
member pwwn 52:4a:93:75:dd:91:0a:11
!      [X70-CT1-FC1]
member pwwn 52:4a:93:75:dd:91:0a:13
!      [X70-CT1-FC3]
member pwwn 52:4a:93:75:dd:91:0a:17
!      [X70-CT1-FC9]
member pwwn 20:00:00:25:b5:bb:17:18
!      [VCC-WLHost13-HBA1]
member pwwn 20:00:00:25:b5:bb:17:19
```

! [VCC-WLHost13-HBA3]

zone name FlaskStack-VCC-CVD-WLHost14 vsan 101

member pwwn 52:4a:93:75:dd:91:0a:01

! [X70-CT0-FC1]

member pwwn 52:4a:93:75:dd:91:0a:03

! [X70-CT0-FC3]

member pwwn 52:4a:93:75:dd:91:0a:07

! [X70-CT0-FC9]

member pwwn 52:4a:93:75:dd:91:0a:11

! [X70-CT1-FC1]

member pwwn 52:4a:93:75:dd:91:0a:13

! [X70-CT1-FC3]

member pwwn 52:4a:93:75:dd:91:0a:17

! [X70-CT1-FC9]

member pwwn 20:00:00:25:b5:bb:17:1a

! [VCC-WLHost14-HBA1]

member pwwn 20:00:00:25:b5:bb:17:1b

! [VCC-WLHost14-HBA3]

zone name FlaskStack-VCC-CVD-WLHost15 vsan 101

member pwwn 52:4a:93:75:dd:91:0a:01

! [X70-CT0-FC1]

member pwwn 52:4a:93:75:dd:91:0a:03

! [X70-CT0-FC3]

member pwwn 52:4a:93:75:dd:91:0a:07

! [X70-CT0-FC9]

member pwwn 52:4a:93:75:dd:91:0a:11

! [X70-CT1-FC1]

member pwwn 52:4a:93:75:dd:91:0a:13

```
!      [X70-CT1-FC3]
member pwwn 52:4a:93:75:dd:91:0a:17
!      [X70-CT1-FC9]
member pwwn 20:00:00:25:b5:bb:17:1c
!      [VCC-WLHost15-HBA1]
member pwwn 20:00:00:25:b5:bb:17:1d
!      [VCC-WLHost15-HBA3]
```

zone name FlaskStack-VCC-CVD-Infra01 vsan 101

```
member pwwn 52:4a:93:75:dd:91:0a:01
!      [X70-CT0-FC1]
member pwwn 52:4a:93:75:dd:91:0a:03
!      [X70-CT0-FC3]
member pwwn 52:4a:93:75:dd:91:0a:07
!      [X70-CT0-FC9]
member pwwn 52:4a:93:75:dd:91:0a:11
!      [X70-CT1-FC1]
member pwwn 52:4a:93:75:dd:91:0a:13
!      [X70-CT1-FC3]
member pwwn 52:4a:93:75:dd:91:0a:17
!      [X70-CT1-FC9]
member pwwn 20:00:00:25:b5:bb:17:1e
!      [VCC-Infra01-HBA1]
member pwwn 20:00:00:25:b5:bb:17:1f
!      [VCC-Infra01-HBA3]
```

zone name FlaskStack-VCC-CVD-WLHost16 vsan 101

```
member pwwn 52:4a:93:75:dd:91:0a:01
!      [X70-CT0-FC1]
member pwwn 52:4a:93:75:dd:91:0a:03
```

```
!      [X70-CT0-FC3]
member pwwn 52:4a:93:75:dd:91:0a:07
!      [X70-CT0-FC9]
member pwwn 52:4a:93:75:dd:91:0a:11
!      [X70-CT1-FC1]
member pwwn 52:4a:93:75:dd:91:0a:13
!      [X70-CT1-FC3]
member pwwn 52:4a:93:75:dd:91:0a:17
!      [X70-CT1-FC9]
member pwwn 20:00:00:25:b5:bb:17:20
!      [VCC-WLHost16-HBA1]
member pwwn 20:00:00:25:b5:bb:17:21
!      [VCC-WLHost16-HBA3]
```

zone name FlaskStack-VCC-CVD-WLHost17 vsan 101

```
member pwwn 52:4a:93:75:dd:91:0a:01
!      [X70-CT0-FC1]
member pwwn 52:4a:93:75:dd:91:0a:03
!      [X70-CT0-FC3]
member pwwn 52:4a:93:75:dd:91:0a:07
!      [X70-CT0-FC9]
member pwwn 52:4a:93:75:dd:91:0a:11
!      [X70-CT1-FC1]
member pwwn 52:4a:93:75:dd:91:0a:13
!      [X70-CT1-FC3]
member pwwn 52:4a:93:75:dd:91:0a:17
!      [X70-CT1-FC9]
member pwwn 20:00:00:25:b5:bb:17:22
!      [VCC-WLHost17-HBA1]
member pwwn 20:00:00:25:b5:bb:17:23
```

! [VCC-WLHost17-HBA3]

zone name FlaskStack-VCC-CVD-WLHost18 vsan 101

member pwwn 52:4a:93:75:dd:91:0a:01

! [X70-CT0-FC1]

member pwwn 52:4a:93:75:dd:91:0a:03

! [X70-CT0-FC3]

member pwwn 52:4a:93:75:dd:91:0a:07

! [X70-CT0-FC9]

member pwwn 52:4a:93:75:dd:91:0a:11

! [X70-CT1-FC1]

member pwwn 52:4a:93:75:dd:91:0a:13

! [X70-CT1-FC3]

member pwwn 52:4a:93:75:dd:91:0a:17

! [X70-CT1-FC9]

member pwwn 20:00:00:25:b5:bb:17:24

! [VCC-WLHost18-HBA1]

member pwwn 20:00:00:25:b5:bb:17:25

! [VCC-WLHost18-HBA3]

zone name FlaskStack-VCC-CVD-WLHost19 vsan 101

member pwwn 52:4a:93:75:dd:91:0a:01

! [X70-CT0-FC1]

member pwwn 52:4a:93:75:dd:91:0a:03

! [X70-CT0-FC3]

member pwwn 52:4a:93:75:dd:91:0a:07

! [X70-CT0-FC9]

member pwwn 52:4a:93:75:dd:91:0a:11

! [X70-CT1-FC1]

member pwwn 52:4a:93:75:dd:91:0a:13

```
!      [X70-CT1-FC3]
member pwwn 52:4a:93:75:dd:91:0a:17
!      [X70-CT1-FC9]
member pwwn 20:00:00:25:b5:bb:17:26
!      [VCC-WLHost19-HBA1]
member pwwn 20:00:00:25:b5:bb:17:27
!      [VCC-WLHost19-HBA3]
```

zone name FlaskStack-VCC-CVD-WLHost20 vsan 101

```
member pwwn 52:4a:93:75:dd:91:0a:01
!      [X70-CT0-FC1]
member pwwn 52:4a:93:75:dd:91:0a:03
!      [X70-CT0-FC3]
member pwwn 52:4a:93:75:dd:91:0a:07
!      [X70-CT0-FC9]
member pwwn 52:4a:93:75:dd:91:0a:11
!      [X70-CT1-FC1]
member pwwn 52:4a:93:75:dd:91:0a:13
!      [X70-CT1-FC3]
member pwwn 52:4a:93:75:dd:91:0a:17
!      [X70-CT1-FC9]
member pwwn 20:00:00:25:b5:bb:17:28
!      [VCC-WLHost20-HBA1]
member pwwn 20:00:00:25:b5:bb:17:29
!      [VCC-WLHost20-HBA3]
```

zone name FlaskStack-VCC-CVD-WLHost21 vsan 101

```
member pwwn 52:4a:93:75:dd:91:0a:01
!      [X70-CT0-FC1]
member pwwn 52:4a:93:75:dd:91:0a:03
```



```
!      [X70-CT0-FC3]
member pwwn 52:4a:93:75:dd:91:0a:07
!      [X70-CT0-FC9]
member pwwn 52:4a:93:75:dd:91:0a:11
!      [X70-CT1-FC1]
member pwwn 52:4a:93:75:dd:91:0a:13
!      [X70-CT1-FC3]
member pwwn 52:4a:93:75:dd:91:0a:17
!      [X70-CT1-FC9]
member pwwn 20:00:00:25:b5:bb:17:2a
!      [VCC-WLHost21-HBA1]
member pwwn 20:00:00:25:b5:bb:17:2b
!      [VCC-WLHost21-HBA3]
```

zone name FlaskStack-VCC-CVD-WLHost22 vsan 101

```
member pwwn 52:4a:93:75:dd:91:0a:01
!      [X70-CT0-FC1]
member pwwn 52:4a:93:75:dd:91:0a:03
!      [X70-CT0-FC3]
member pwwn 52:4a:93:75:dd:91:0a:07
!      [X70-CT0-FC9]
member pwwn 52:4a:93:75:dd:91:0a:11
!      [X70-CT1-FC1]
member pwwn 52:4a:93:75:dd:91:0a:13
!      [X70-CT1-FC3]
member pwwn 52:4a:93:75:dd:91:0a:17
!      [X70-CT1-FC9]
member pwwn 20:00:00:25:b5:bb:17:2c
!      [VCC-WLHost22-HBA1]
member pwwn 20:00:00:25:b5:bb:17:2d
```

! [VCC-WLHost22-HBA3]

zone name FlaskStack-VCC-CVD-WLHost23 vsan 101

member pwwn 52:4a:93:75:dd:91:0a:01

! [X70-CT0-FC1]

member pwwn 52:4a:93:75:dd:91:0a:03

! [X70-CT0-FC3]

member pwwn 52:4a:93:75:dd:91:0a:07

! [X70-CT0-FC9]

member pwwn 52:4a:93:75:dd:91:0a:11

! [X70-CT1-FC1]

member pwwn 52:4a:93:75:dd:91:0a:13

! [X70-CT1-FC3]

member pwwn 52:4a:93:75:dd:91:0a:17

! [X70-CT1-FC9]

member pwwn 20:00:00:25:b5:bb:17:2e

! [VCC-WLHost23-HBA1]

member pwwn 20:00:00:25:b5:bb:17:2f

! [VCC-WLHost23-HBA3]

zone name FlaskStack-VCC-CVD-WLHost24 vsan 101

member pwwn 52:4a:93:75:dd:91:0a:01

! [X70-CT0-FC1]

member pwwn 52:4a:93:75:dd:91:0a:03

! [X70-CT0-FC3]

member pwwn 52:4a:93:75:dd:91:0a:07

! [X70-CT0-FC9]

member pwwn 52:4a:93:75:dd:91:0a:11

! [X70-CT1-FC1]

member pwwn 52:4a:93:75:dd:91:0a:13

```
!      [X70-CT1-FC3]
member pwwn 52:4a:93:75:dd:91:0a:17
!      [X70-CT1-FC9]
member pwwn 20:00:00:25:b5:bb:17:30
!      [VCC-WLHost24-HBA1]
member pwwn 20:00:00:25:b5:bb:17:31
!      [VCC-WLHost24-HBA3]
```

zone name FlaskStack-VCC-CVD-WLHost25 vsan 101

```
member pwwn 52:4a:93:75:dd:91:0a:01
!      [X70-CT0-FC1]
member pwwn 52:4a:93:75:dd:91:0a:03
!      [X70-CT0-FC3]
member pwwn 52:4a:93:75:dd:91:0a:07
!      [X70-CT0-FC9]
member pwwn 52:4a:93:75:dd:91:0a:11
!      [X70-CT1-FC1]
member pwwn 52:4a:93:75:dd:91:0a:13
!      [X70-CT1-FC3]
member pwwn 52:4a:93:75:dd:91:0a:17
!      [X70-CT1-FC9]
member pwwn 20:00:00:25:b5:bb:17:32
!      [VCC-WLHost25-HBA1]
member pwwn 20:00:00:25:b5:bb:17:33
!      [VCC-WLHost25-HBA3]
```

zone name FlaskStack-VCC-CVD-WLHost26 vsan 101

```
member pwwn 52:4a:93:75:dd:91:0a:01
!      [X70-CT0-FC1]
member pwwn 52:4a:93:75:dd:91:0a:03
```

```
!      [X70-CT0-FC3]
member pwwn 52:4a:93:75:dd:91:0a:07
!      [X70-CT0-FC9]
member pwwn 52:4a:93:75:dd:91:0a:11
!      [X70-CT1-FC1]
member pwwn 52:4a:93:75:dd:91:0a:13
!      [X70-CT1-FC3]
member pwwn 52:4a:93:75:dd:91:0a:17
!      [X70-CT1-FC9]
member pwwn 20:00:00:25:b5:bb:17:34
!      [VCC-WLHost26-HBA1]
member pwwn 20:00:00:25:b5:bb:17:35
!      [VCC-WLHost26-HBA3]
```

zone name FlaskStack-VCC-CVD-WLHost27 vsan 101

```
member pwwn 52:4a:93:75:dd:91:0a:01
!      [X70-CT0-FC1]
member pwwn 52:4a:93:75:dd:91:0a:03
!      [X70-CT0-FC3]
member pwwn 52:4a:93:75:dd:91:0a:07
!      [X70-CT0-FC9]
member pwwn 52:4a:93:75:dd:91:0a:11
!      [X70-CT1-FC1]
member pwwn 52:4a:93:75:dd:91:0a:13
!      [X70-CT1-FC3]
member pwwn 52:4a:93:75:dd:91:0a:17
!      [X70-CT1-FC9]
member pwwn 20:00:00:25:b5:bb:17:36
!      [VCC-WLHost27-HBA1]
member pwwn 20:00:00:25:b5:bb:17:37
```

! [VCC-WLHost27-HBA3]

zone name FlaskStack-VCC-CVD-WLHost28 vsan 101

member pwwn 52:4a:93:75:dd:91:0a:01

! [X70-CT0-FC1]

member pwwn 52:4a:93:75:dd:91:0a:03

! [X70-CT0-FC3]

member pwwn 52:4a:93:75:dd:91:0a:07

! [X70-CT0-FC9]

member pwwn 52:4a:93:75:dd:91:0a:11

! [X70-CT1-FC1]

member pwwn 52:4a:93:75:dd:91:0a:13

! [X70-CT1-FC3]

member pwwn 52:4a:93:75:dd:91:0a:17

! [X70-CT1-FC9]

member pwwn 20:00:00:25:b5:bb:17:38

! [VCC-WLHost28-HBA1]

member pwwn 20:00:00:25:b5:bb:17:39

! [VCC-WLHost28-HBA3]

zone name FlaskStack-VCC-CVD-WLHost29 vsan 101

member pwwn 52:4a:93:75:dd:91:0a:01

! [X70-CT0-FC1]

member pwwn 52:4a:93:75:dd:91:0a:03

! [X70-CT0-FC3]

member pwwn 52:4a:93:75:dd:91:0a:07

! [X70-CT0-FC9]

member pwwn 52:4a:93:75:dd:91:0a:11

! [X70-CT1-FC1]

member pwwn 52:4a:93:75:dd:91:0a:13

```
!      [X70-CT1-FC3]
member pwwn 52:4a:93:75:dd:91:0a:17
!      [X70-CT1-FC9]
member pwwn 20:00:00:25:b5:bb:17:3a
!      [VCC-WLHost29-HBA1]
member pwwn 20:00:00:25:b5:bb:17:3b
!      [VCC-WLHost29-HBA3]
```

zone name FlaskStack-VCC-CVD-WLHost30 vsan 101

```
member pwwn 52:4a:93:75:dd:91:0a:01
!      [X70-CT0-FC1]
member pwwn 52:4a:93:75:dd:91:0a:03
!      [X70-CT0-FC3]
member pwwn 52:4a:93:75:dd:91:0a:07
!      [X70-CT0-FC9]
member pwwn 52:4a:93:75:dd:91:0a:11
!      [X70-CT1-FC1]
member pwwn 52:4a:93:75:dd:91:0a:13
!      [X70-CT1-FC3]
member pwwn 52:4a:93:75:dd:91:0a:17
!      [X70-CT1-FC9]
member pwwn 20:00:00:25:b5:bb:17:3c
!      [VCC-WLHost30-HBA1]
member pwwn 20:00:00:25:b5:bb:17:3d
!      [VCC-WLHost30-HBA3]
```

zone name FlaskStack-VCC-CVD-Infra02 vsan 101

```
member pwwn 52:4a:93:75:dd:91:0a:01
!      [X70-CT0-FC1]
member pwwn 52:4a:93:75:dd:91:0a:03
```

```
!      [X70-CT0-FC3]
member pwwn 52:4a:93:75:dd:91:0a:07
!      [X70-CT0-FC9]
member pwwn 52:4a:93:75:dd:91:0a:11
!      [X70-CT1-FC1]
member pwwn 52:4a:93:75:dd:91:0a:13
!      [X70-CT1-FC3]
member pwwn 52:4a:93:75:dd:91:0a:17
!      [X70-CT1-FC9]
member pwwn 20:00:00:25:b5:bb:17:3e
!      [VCC-Infra02-HBA1]
member pwwn 20:00:00:25:b5:bb:17:3f
!      [VCC-Infra02-HBA3]
```

```
zoneset name FlashStack-VCC-CVD vsan 101
member FlaskStack-VCC-CVD-WLHost01
member FlaskStack-VCC-CVD-WLHost02
member FlaskStack-VCC-CVD-WLHost03
member FlaskStack-VCC-CVD-WLHost04
member FlaskStack-VCC-CVD-WLHost05
member FlaskStack-VCC-CVD-WLHost06
member FlaskStack-VCC-CVD-WLHost07
member FlaskStack-VCC-CVD-WLHost08
member FlaskStack-VCC-CVD-WLHost09
member FlaskStack-VCC-CVD-WLHost10
member FlaskStack-VCC-CVD-WLHost11
member FlaskStack-VCC-CVD-WLHost12
member FlaskStack-VCC-CVD-WLHost13
member FlaskStack-VCC-CVD-WLHost14
member FlaskStack-VCC-CVD-WLHost15
```

```
member FlaskStack-VCC-CVD-Infra01
member FlaskStack-VCC-CVD-WLHost16
member FlaskStack-VCC-CVD-WLHost17
member FlaskStack-VCC-CVD-WLHost18
member FlaskStack-VCC-CVD-WLHost19
member FlaskStack-VCC-CVD-WLHost20
member FlaskStack-VCC-CVD-WLHost21
member FlaskStack-VCC-CVD-WLHost22
member FlaskStack-VCC-CVD-WLHost23
member FlaskStack-VCC-CVD-WLHost24
member FlaskStack-VCC-CVD-WLHost25
member FlaskStack-VCC-CVD-WLHost26
member FlaskStack-VCC-CVD-WLHost27
member FlaskStack-VCC-CVD-WLHost28
member FlaskStack-VCC-CVD-WLHost29
member FlaskStack-VCC-CVD-WLHost30
member FlaskStack-VCC-CVD-Infra02
```

```
zoneset activate name FlashStack-VCC-CVD vsan 101
do clear zone database vsan 101
!Full Zone Database Section for vsan 101
zone name FlaskStack-VCC-CVD-WLHost01 vsan 101
  member pwwn 52:4a:93:75:dd:91:0a:01
  !      [X70-CT0-FC1]
  member pwwn 52:4a:93:75:dd:91:0a:03
  !      [X70-CT0-FC3]
  member pwwn 52:4a:93:75:dd:91:0a:07
  !      [X70-CT0-FC9]
  member pwwn 52:4a:93:75:dd:91:0a:11
  !      [X70-CT1-FC1]
```

member pwwn 52:4a:93:75:dd:91:0a:13

! [X70-CT1-FC3]

member pwwn 52:4a:93:75:dd:91:0a:17

! [X70-CT1-FC9]

member pwwn 20:00:00:25:b5:bb:17:00

! [VCC-WLHost01-HBA1]

member pwwn 20:00:00:25:b5:bb:17:01

! [VCC-WLHost01-HBA3]

zone name FlaskStack-VCC-CVD-WLHost02 vsan 101

member pwwn 52:4a:93:75:dd:91:0a:01

! [X70-CT0-FC1]

member pwwn 52:4a:93:75:dd:91:0a:03

! [X70-CT0-FC3]

member pwwn 52:4a:93:75:dd:91:0a:07

! [X70-CT0-FC9]

member pwwn 52:4a:93:75:dd:91:0a:11

! [X70-CT1-FC1]

member pwwn 52:4a:93:75:dd:91:0a:13

! [X70-CT1-FC3]

member pwwn 52:4a:93:75:dd:91:0a:17

! [X70-CT1-FC9]

member pwwn 20:00:00:25:b5:bb:17:02

! [VCC-WLHost02-HBA1]

member pwwn 20:00:00:25:b5:bb:17:03

! [VCC-WLHost02-HBA3]

zone name FlaskStack-VCC-CVD-WLHost03 vsan 101

member pwwn 52:4a:93:75:dd:91:0a:01

! [X70-CT0-FC1]

member pwwn 52:4a:93:75:dd:91:0a:03
! [X70-CT0-FC3]
member pwwn 52:4a:93:75:dd:91:0a:07
! [X70-CT0-FC9]
member pwwn 52:4a:93:75:dd:91:0a:11
! [X70-CT1-FC1]
member pwwn 52:4a:93:75:dd:91:0a:13
! [X70-CT1-FC3]
member pwwn 52:4a:93:75:dd:91:0a:17
! [X70-CT1-FC9]
member pwwn 20:00:00:25:b5:bb:17:04
! [VCC-WLHost03-HBA1]
member pwwn 20:00:00:25:b5:bb:17:05
! [VCC-WLHost03-HBA3]

zone name FlaskStack-VCC-CVD-WLHost04 vsan 101

member pwwn 52:4a:93:75:dd:91:0a:01
! [X70-CT0-FC1]
member pwwn 52:4a:93:75:dd:91:0a:03
! [X70-CT0-FC3]
member pwwn 52:4a:93:75:dd:91:0a:07
! [X70-CT0-FC9]
member pwwn 52:4a:93:75:dd:91:0a:11
! [X70-CT1-FC1]
member pwwn 52:4a:93:75:dd:91:0a:13
! [X70-CT1-FC3]
member pwwn 52:4a:93:75:dd:91:0a:17
! [X70-CT1-FC9]
member pwwn 20:00:00:25:b5:bb:17:06
! [VCC-WLHost04-HBA1]

member pwwn 20:00:00:25:b5:bb:17:07

! [VCC-WLHost04-HBA3]

zone name FlaskStack-VCC-CVD-WLHost05 vsan 101

member pwwn 52:4a:93:75:dd:91:0a:01

! [X70-CT0-FC1]

member pwwn 52:4a:93:75:dd:91:0a:03

! [X70-CT0-FC3]

member pwwn 52:4a:93:75:dd:91:0a:07

! [X70-CT0-FC9]

member pwwn 52:4a:93:75:dd:91:0a:11

! [X70-CT1-FC1]

member pwwn 52:4a:93:75:dd:91:0a:13

! [X70-CT1-FC3]

member pwwn 52:4a:93:75:dd:91:0a:17

! [X70-CT1-FC9]

member pwwn 20:00:00:25:b5:bb:17:08

! [VCC-WLHost05-HBA1]

member pwwn 20:00:00:25:b5:bb:17:09

! [VCC-WLHost05-HBA3]

zone name FlaskStack-VCC-CVD-WLHost06 vsan 101

member pwwn 52:4a:93:75:dd:91:0a:01

! [X70-CT0-FC1]

member pwwn 52:4a:93:75:dd:91:0a:03

! [X70-CT0-FC3]

member pwwn 52:4a:93:75:dd:91:0a:07

! [X70-CT0-FC9]

member pwwn 52:4a:93:75:dd:91:0a:11

! [X70-CT1-FC1]

member pwwn 52:4a:93:75:dd:91:0a:13

! [X70-CT1-FC3]

member pwwn 52:4a:93:75:dd:91:0a:17

! [X70-CT1-FC9]

member pwwn 20:00:00:25:b5:bb:17:0a

! [VCC-WLHost06-HBA1]

member pwwn 20:00:00:25:b5:bb:17:0b

! [VCC-WLHost06-HBA3]

zone name FlaskStack-VCC-CVD-WLHost07 vsan 101

member pwwn 52:4a:93:75:dd:91:0a:01

! [X70-CT0-FC1]

member pwwn 52:4a:93:75:dd:91:0a:03

! [X70-CT0-FC3]

member pwwn 52:4a:93:75:dd:91:0a:07

! [X70-CT0-FC9]

member pwwn 52:4a:93:75:dd:91:0a:11

! [X70-CT1-FC1]

member pwwn 52:4a:93:75:dd:91:0a:13

! [X70-CT1-FC3]

member pwwn 52:4a:93:75:dd:91:0a:17

! [X70-CT1-FC9]

member pwwn 20:00:00:25:b5:bb:17:0c

! [VCC-WLHost07-HBA1]

member pwwn 20:00:00:25:b5:bb:17:0d

! [VCC-WLHost07-HBA3]

zone name FlaskStack-VCC-CVD-WLHost08 vsan 101

member pwwn 52:4a:93:75:dd:91:0a:01

! [X70-CT0-FC1]

member pwwn 52:4a:93:75:dd:91:0a:03
! [X70-CT0-FC3]
member pwwn 52:4a:93:75:dd:91:0a:07
! [X70-CT0-FC9]
member pwwn 52:4a:93:75:dd:91:0a:11
! [X70-CT1-FC1]
member pwwn 52:4a:93:75:dd:91:0a:13
! [X70-CT1-FC3]
member pwwn 52:4a:93:75:dd:91:0a:17
! [X70-CT1-FC9]
member pwwn 20:00:00:25:b5:bb:17:0e
! [VCC-WLHost08-HBA1]
member pwwn 20:00:00:25:b5:bb:17:0f
! [VCC-WLHost08-HBA3]

zone name FlaskStack-VCC-CVD-WLHost09 vsan 101

member pwwn 52:4a:93:75:dd:91:0a:01
! [X70-CT0-FC1]
member pwwn 52:4a:93:75:dd:91:0a:03
! [X70-CT0-FC3]
member pwwn 52:4a:93:75:dd:91:0a:07
! [X70-CT0-FC9]
member pwwn 52:4a:93:75:dd:91:0a:11
! [X70-CT1-FC1]
member pwwn 52:4a:93:75:dd:91:0a:13
! [X70-CT1-FC3]
member pwwn 52:4a:93:75:dd:91:0a:17
! [X70-CT1-FC9]
member pwwn 20:00:00:25:b5:bb:17:10
! [VCC-WLHost09-HBA1]

member pwwn 20:00:00:25:b5:bb:17:11

! [VCC-WLHost09-HBA3]

zone name FlaskStack-VCC-CVD-WLHost10 vsan 101

member pwwn 52:4a:93:75:dd:91:0a:01

! [X70-CT0-FC1]

member pwwn 52:4a:93:75:dd:91:0a:03

! [X70-CT0-FC3]

member pwwn 52:4a:93:75:dd:91:0a:07

! [X70-CT0-FC9]

member pwwn 52:4a:93:75:dd:91:0a:11

! [X70-CT1-FC1]

member pwwn 52:4a:93:75:dd:91:0a:13

! [X70-CT1-FC3]

member pwwn 52:4a:93:75:dd:91:0a:17

! [X70-CT1-FC9]

member pwwn 20:00:00:25:b5:bb:17:12

! [VCC-WLHost10-HBA1]

member pwwn 20:00:00:25:b5:bb:17:13

! [VCC-WLHost10-HBA3]

zone name FlaskStack-VCC-CVD-WLHost11 vsan 101

member pwwn 52:4a:93:75:dd:91:0a:01

! [X70-CT0-FC1]

member pwwn 52:4a:93:75:dd:91:0a:03

! [X70-CT0-FC3]

member pwwn 52:4a:93:75:dd:91:0a:07

! [X70-CT0-FC9]

member pwwn 52:4a:93:75:dd:91:0a:11

! [X70-CT1-FC1]

member pwwn 52:4a:93:75:dd:91:0a:13

! [X70-CT1-FC3]

member pwwn 52:4a:93:75:dd:91:0a:17

! [X70-CT1-FC9]

member pwwn 20:00:00:25:b5:bb:17:14

! [VCC-WLHost11-HBA1]

member pwwn 20:00:00:25:b5:bb:17:15

! [VCC-WLHost11-HBA3]

zone name FlaskStack-VCC-CVD-WLHost12 vsan 101

member pwwn 52:4a:93:75:dd:91:0a:01

! [X70-CT0-FC1]

member pwwn 52:4a:93:75:dd:91:0a:03

! [X70-CT0-FC3]

member pwwn 52:4a:93:75:dd:91:0a:07

! [X70-CT0-FC9]

member pwwn 52:4a:93:75:dd:91:0a:11

! [X70-CT1-FC1]

member pwwn 52:4a:93:75:dd:91:0a:13

! [X70-CT1-FC3]

member pwwn 52:4a:93:75:dd:91:0a:17

! [X70-CT1-FC9]

member pwwn 20:00:00:25:b5:bb:17:16

! [VCC-WLHost12-HBA1]

member pwwn 20:00:00:25:b5:bb:17:17

! [VCC-WLHost12-HBA3]

zone name FlaskStack-VCC-CVD-WLHost13 vsan 101

member pwwn 52:4a:93:75:dd:91:0a:01

! [X70-CT0-FC1]

member pwwn 52:4a:93:75:dd:91:0a:03
! [X70-CT0-FC3]
member pwwn 52:4a:93:75:dd:91:0a:07
! [X70-CT0-FC9]
member pwwn 52:4a:93:75:dd:91:0a:11
! [X70-CT1-FC1]
member pwwn 52:4a:93:75:dd:91:0a:13
! [X70-CT1-FC3]
member pwwn 52:4a:93:75:dd:91:0a:17
! [X70-CT1-FC9]
member pwwn 20:00:00:25:b5:bb:17:18
! [VCC-WLHost13-HBA1]
member pwwn 20:00:00:25:b5:bb:17:19
! [VCC-WLHost13-HBA3]

zone name FlaskStack-VCC-CVD-WLHost14 vsan 101

member pwwn 52:4a:93:75:dd:91:0a:01
! [X70-CT0-FC1]
member pwwn 52:4a:93:75:dd:91:0a:03
! [X70-CT0-FC3]
member pwwn 52:4a:93:75:dd:91:0a:07
! [X70-CT0-FC9]
member pwwn 52:4a:93:75:dd:91:0a:11
! [X70-CT1-FC1]
member pwwn 52:4a:93:75:dd:91:0a:13
! [X70-CT1-FC3]
member pwwn 52:4a:93:75:dd:91:0a:17
! [X70-CT1-FC9]
member pwwn 20:00:00:25:b5:bb:17:1a
! [VCC-WLHost14-HBA1]

member pwwn 20:00:00:25:b5:bb:17:1b

! [VCC-WLHost14-HBA3]

zone name FlaskStack-VCC-CVD-WLHost15 vsan 101

member pwwn 52:4a:93:75:dd:91:0a:01

! [X70-CT0-FC1]

member pwwn 52:4a:93:75:dd:91:0a:03

! [X70-CT0-FC3]

member pwwn 52:4a:93:75:dd:91:0a:07

! [X70-CT0-FC9]

member pwwn 52:4a:93:75:dd:91:0a:11

! [X70-CT1-FC1]

member pwwn 52:4a:93:75:dd:91:0a:13

! [X70-CT1-FC3]

member pwwn 52:4a:93:75:dd:91:0a:17

! [X70-CT1-FC9]

member pwwn 20:00:00:25:b5:bb:17:1c

! [VCC-WLHost15-HBA1]

member pwwn 20:00:00:25:b5:bb:17:1d

! [VCC-WLHost15-HBA3]

zone name FlaskStack-VCC-CVD-Infra01 vsan 101

member pwwn 52:4a:93:75:dd:91:0a:01

! [X70-CT0-FC1]

member pwwn 52:4a:93:75:dd:91:0a:03

! [X70-CT0-FC3]

member pwwn 52:4a:93:75:dd:91:0a:07

! [X70-CT0-FC9]

member pwwn 52:4a:93:75:dd:91:0a:11

! [X70-CT1-FC1]

```
member pwwn 52:4a:93:75:dd:91:0a:13
!      [X70-CT1-FC3]
member pwwn 52:4a:93:75:dd:91:0a:17
!      [X70-CT1-FC9]
member pwwn 20:00:00:25:b5:bb:17:1e
!      [VCC-Infra01-HBA1]
member pwwn 20:00:00:25:b5:bb:17:1f
!      [VCC-Infra01-HBA3]
```

zone name FlaskStack-VCC-CVD-WLHost16 vsan 101

```
member pwwn 52:4a:93:75:dd:91:0a:01
!      [X70-CT0-FC1]
member pwwn 52:4a:93:75:dd:91:0a:03
!      [X70-CT0-FC3]
member pwwn 52:4a:93:75:dd:91:0a:07
!      [X70-CT0-FC9]
member pwwn 52:4a:93:75:dd:91:0a:11
!      [X70-CT1-FC1]
member pwwn 52:4a:93:75:dd:91:0a:13
!      [X70-CT1-FC3]
member pwwn 52:4a:93:75:dd:91:0a:17
!      [X70-CT1-FC9]
member pwwn 20:00:00:25:b5:bb:17:20
!      [VCC-WLHost16-HBA1]
member pwwn 20:00:00:25:b5:bb:17:21
!      [VCC-WLHost16-HBA3]
```

zone name FlaskStack-VCC-CVD-WLHost17 vsan 101

```
member pwwn 52:4a:93:75:dd:91:0a:01
!      [X70-CT0-FC1]
```

member pwwn 52:4a:93:75:dd:91:0a:03
! [X70-CT0-FC3]
member pwwn 52:4a:93:75:dd:91:0a:07
! [X70-CT0-FC9]
member pwwn 52:4a:93:75:dd:91:0a:11
! [X70-CT1-FC1]
member pwwn 52:4a:93:75:dd:91:0a:13
! [X70-CT1-FC3]
member pwwn 52:4a:93:75:dd:91:0a:17
! [X70-CT1-FC9]
member pwwn 20:00:00:25:b5:bb:17:22
! [VCC-WLHost17-HBA1]
member pwwn 20:00:00:25:b5:bb:17:23
! [VCC-WLHost17-HBA3]

zone name FlaskStack-VCC-CVD-WLHost18 vsan 101

member pwwn 52:4a:93:75:dd:91:0a:01
! [X70-CT0-FC1]
member pwwn 52:4a:93:75:dd:91:0a:03
! [X70-CT0-FC3]
member pwwn 52:4a:93:75:dd:91:0a:07
! [X70-CT0-FC9]
member pwwn 52:4a:93:75:dd:91:0a:11
! [X70-CT1-FC1]
member pwwn 52:4a:93:75:dd:91:0a:13
! [X70-CT1-FC3]
member pwwn 52:4a:93:75:dd:91:0a:17
! [X70-CT1-FC9]
member pwwn 20:00:00:25:b5:bb:17:24
! [VCC-WLHost18-HBA1]

member pwwn 20:00:00:25:b5:bb:17:25

! [VCC-WLHost18-HBA3]

zone name FlaskStack-VCC-CVD-WLHost19 vsan 101

member pwwn 52:4a:93:75:dd:91:0a:01

! [X70-CT0-FC1]

member pwwn 52:4a:93:75:dd:91:0a:03

! [X70-CT0-FC3]

member pwwn 52:4a:93:75:dd:91:0a:07

! [X70-CT0-FC9]

member pwwn 52:4a:93:75:dd:91:0a:11

! [X70-CT1-FC1]

member pwwn 52:4a:93:75:dd:91:0a:13

! [X70-CT1-FC3]

member pwwn 52:4a:93:75:dd:91:0a:17

! [X70-CT1-FC9]

member pwwn 20:00:00:25:b5:bb:17:26

! [VCC-WLHost19-HBA1]

member pwwn 20:00:00:25:b5:bb:17:27

! [VCC-WLHost19-HBA3]

zone name FlaskStack-VCC-CVD-WLHost20 vsan 101

member pwwn 52:4a:93:75:dd:91:0a:01

! [X70-CT0-FC1]

member pwwn 52:4a:93:75:dd:91:0a:03

! [X70-CT0-FC3]

member pwwn 52:4a:93:75:dd:91:0a:07

! [X70-CT0-FC9]

member pwwn 52:4a:93:75:dd:91:0a:11

! [X70-CT1-FC1]

member pwwn 52:4a:93:75:dd:91:0a:13

! [X70-CT1-FC3]

member pwwn 52:4a:93:75:dd:91:0a:17

! [X70-CT1-FC9]

member pwwn 20:00:00:25:b5:bb:17:28

! [VCC-WLHost20-HBA1]

member pwwn 20:00:00:25:b5:bb:17:29

! [VCC-WLHost20-HBA3]

zone name FlaskStack-VCC-CVD-WLHost21 vsan 101

member pwwn 52:4a:93:75:dd:91:0a:01

! [X70-CT0-FC1]

member pwwn 52:4a:93:75:dd:91:0a:03

! [X70-CT0-FC3]

member pwwn 52:4a:93:75:dd:91:0a:07

! [X70-CT0-FC9]

member pwwn 52:4a:93:75:dd:91:0a:11

! [X70-CT1-FC1]

member pwwn 52:4a:93:75:dd:91:0a:13

! [X70-CT1-FC3]

member pwwn 52:4a:93:75:dd:91:0a:17

! [X70-CT1-FC9]

member pwwn 20:00:00:25:b5:bb:17:2a

! [VCC-WLHost21-HBA1]

member pwwn 20:00:00:25:b5:bb:17:2b

! [VCC-WLHost21-HBA3]

zone name FlaskStack-VCC-CVD-WLHost22 vsan 101

member pwwn 52:4a:93:75:dd:91:0a:01

! [X70-CT0-FC1]

member pwwn 52:4a:93:75:dd:91:0a:03
! [X70-CT0-FC3]
member pwwn 52:4a:93:75:dd:91:0a:07
! [X70-CT0-FC9]
member pwwn 52:4a:93:75:dd:91:0a:11
! [X70-CT1-FC1]
member pwwn 52:4a:93:75:dd:91:0a:13
! [X70-CT1-FC3]
member pwwn 52:4a:93:75:dd:91:0a:17
! [X70-CT1-FC9]
member pwwn 20:00:00:25:b5:bb:17:2c
! [VCC-WLHost22-HBA1]
member pwwn 20:00:00:25:b5:bb:17:2d
! [VCC-WLHost22-HBA3]

zone name FlaskStack-VCC-CVD-WLHost23 vsan 101

member pwwn 52:4a:93:75:dd:91:0a:01
! [X70-CT0-FC1]
member pwwn 52:4a:93:75:dd:91:0a:03
! [X70-CT0-FC3]
member pwwn 52:4a:93:75:dd:91:0a:07
! [X70-CT0-FC9]
member pwwn 52:4a:93:75:dd:91:0a:11
! [X70-CT1-FC1]
member pwwn 52:4a:93:75:dd:91:0a:13
! [X70-CT1-FC3]
member pwwn 52:4a:93:75:dd:91:0a:17
! [X70-CT1-FC9]
member pwwn 20:00:00:25:b5:bb:17:2e
! [VCC-WLHost23-HBA1]

member pwwn 20:00:00:25:b5:bb:17:2f
! [VCC-WLHost23-HBA3]

zone name FlaskStack-VCC-CVD-WLHost24 vsan 101

member pwwn 52:4a:93:75:dd:91:0a:01
! [X70-CT0-FC1]

member pwwn 52:4a:93:75:dd:91:0a:03
! [X70-CT0-FC3]

member pwwn 52:4a:93:75:dd:91:0a:07
! [X70-CT0-FC9]

member pwwn 52:4a:93:75:dd:91:0a:11
! [X70-CT1-FC1]

member pwwn 52:4a:93:75:dd:91:0a:13
! [X70-CT1-FC3]

member pwwn 52:4a:93:75:dd:91:0a:17
! [X70-CT1-FC9]

member pwwn 20:00:00:25:b5:bb:17:30
! [VCC-WLHost24-HBA1]

member pwwn 20:00:00:25:b5:bb:17:31
! [VCC-WLHost24-HBA3]

zone name FlaskStack-VCC-CVD-WLHost25 vsan 101

member pwwn 52:4a:93:75:dd:91:0a:01
! [X70-CT0-FC1]

member pwwn 52:4a:93:75:dd:91:0a:03
! [X70-CT0-FC3]

member pwwn 52:4a:93:75:dd:91:0a:07
! [X70-CT0-FC9]

member pwwn 52:4a:93:75:dd:91:0a:11
! [X70-CT1-FC1]

member pwwn 52:4a:93:75:dd:91:0a:13

! [X70-CT1-FC3]

member pwwn 52:4a:93:75:dd:91:0a:17

! [X70-CT1-FC9]

member pwwn 20:00:00:25:b5:bb:17:32

! [VCC-WLHost25-HBA1]

member pwwn 20:00:00:25:b5:bb:17:33

! [VCC-WLHost25-HBA3]

zone name FlaskStack-VCC-CVD-WLHost26 vsan 101

member pwwn 52:4a:93:75:dd:91:0a:01

! [X70-CT0-FC1]

member pwwn 52:4a:93:75:dd:91:0a:03

! [X70-CT0-FC3]

member pwwn 52:4a:93:75:dd:91:0a:07

! [X70-CT0-FC9]

member pwwn 52:4a:93:75:dd:91:0a:11

! [X70-CT1-FC1]

member pwwn 52:4a:93:75:dd:91:0a:13

! [X70-CT1-FC3]

member pwwn 52:4a:93:75:dd:91:0a:17

! [X70-CT1-FC9]

member pwwn 20:00:00:25:b5:bb:17:34

! [VCC-WLHost26-HBA1]

member pwwn 20:00:00:25:b5:bb:17:35

! [VCC-WLHost26-HBA3]

zone name FlaskStack-VCC-CVD-WLHost27 vsan 101

member pwwn 52:4a:93:75:dd:91:0a:01

! [X70-CT0-FC1]

member pwwn 52:4a:93:75:dd:91:0a:03
! [X70-CT0-FC3]
member pwwn 52:4a:93:75:dd:91:0a:07
! [X70-CT0-FC9]
member pwwn 52:4a:93:75:dd:91:0a:11
! [X70-CT1-FC1]
member pwwn 52:4a:93:75:dd:91:0a:13
! [X70-CT1-FC3]
member pwwn 52:4a:93:75:dd:91:0a:17
! [X70-CT1-FC9]
member pwwn 20:00:00:25:b5:bb:17:36
! [VCC-WLHost27-HBA1]
member pwwn 20:00:00:25:b5:bb:17:37
! [VCC-WLHost27-HBA3]

zone name FlaskStack-VCC-CVD-WLHost28 vsan 101

member pwwn 52:4a:93:75:dd:91:0a:01
! [X70-CT0-FC1]
member pwwn 52:4a:93:75:dd:91:0a:03
! [X70-CT0-FC3]
member pwwn 52:4a:93:75:dd:91:0a:07
! [X70-CT0-FC9]
member pwwn 52:4a:93:75:dd:91:0a:11
! [X70-CT1-FC1]
member pwwn 52:4a:93:75:dd:91:0a:13
! [X70-CT1-FC3]
member pwwn 52:4a:93:75:dd:91:0a:17
! [X70-CT1-FC9]
member pwwn 20:00:00:25:b5:bb:17:38
! [VCC-WLHost28-HBA1]

member pwwn 20:00:00:25:b5:bb:17:39

! [VCC-WLHost28-HBA3]

zone name FlaskStack-VCC-CVD-WLHost29 vsan 101

member pwwn 52:4a:93:75:dd:91:0a:01

! [X70-CT0-FC1]

member pwwn 52:4a:93:75:dd:91:0a:03

! [X70-CT0-FC3]

member pwwn 52:4a:93:75:dd:91:0a:07

! [X70-CT0-FC9]

member pwwn 52:4a:93:75:dd:91:0a:11

! [X70-CT1-FC1]

member pwwn 52:4a:93:75:dd:91:0a:13

! [X70-CT1-FC3]

member pwwn 52:4a:93:75:dd:91:0a:17

! [X70-CT1-FC9]

member pwwn 20:00:00:25:b5:bb:17:3a

! [VCC-WLHost29-HBA1]

member pwwn 20:00:00:25:b5:bb:17:3b

! [VCC-WLHost29-HBA3]

zone name FlaskStack-VCC-CVD-WLHost30 vsan 101

member pwwn 52:4a:93:75:dd:91:0a:01

! [X70-CT0-FC1]

member pwwn 52:4a:93:75:dd:91:0a:03

! [X70-CT0-FC3]

member pwwn 52:4a:93:75:dd:91:0a:07

! [X70-CT0-FC9]

member pwwn 52:4a:93:75:dd:91:0a:11

! [X70-CT1-FC1]

```
member pwwn 52:4a:93:75:dd:91:0a:13
!      [X70-CT1-FC3]
member pwwn 52:4a:93:75:dd:91:0a:17
!      [X70-CT1-FC9]
member pwwn 20:00:00:25:b5:bb:17:3c
!      [VCC-WLHost30-HBA1]
member pwwn 20:00:00:25:b5:bb:17:3d
!      [VCC-WLHost30-HBA3]
```

zone name FlaskStack-VCC-CVD-Infra02 vsan 101

```
member pwwn 52:4a:93:75:dd:91:0a:01
!      [X70-CT0-FC1]
member pwwn 52:4a:93:75:dd:91:0a:03
!      [X70-CT0-FC3]
member pwwn 52:4a:93:75:dd:91:0a:07
!      [X70-CT0-FC9]
member pwwn 52:4a:93:75:dd:91:0a:11
!      [X70-CT1-FC1]
member pwwn 52:4a:93:75:dd:91:0a:13
!      [X70-CT1-FC3]
member pwwn 52:4a:93:75:dd:91:0a:17
!      [X70-CT1-FC9]
member pwwn 20:00:00:25:b5:bb:17:3e
!      [VCC-Infra02-HBA1]
member pwwn 20:00:00:25:b5:bb:17:3f
!      [VCC-Infra02-HBA3]
```

zoneset name FlashStack-VCC-CVD vsan 101

```
member FlaskStack-VCC-CVD-WLHost01
member FlaskStack-VCC-CVD-WLHost02
```

member FlaskStack-VCC-CVD-WLHost03
member FlaskStack-VCC-CVD-WLHost04
member FlaskStack-VCC-CVD-WLHost05
member FlaskStack-VCC-CVD-WLHost06
member FlaskStack-VCC-CVD-WLHost07
member FlaskStack-VCC-CVD-WLHost08
member FlaskStack-VCC-CVD-WLHost09
member FlaskStack-VCC-CVD-WLHost10
member FlaskStack-VCC-CVD-WLHost11
member FlaskStack-VCC-CVD-WLHost12
member FlaskStack-VCC-CVD-WLHost13
member FlaskStack-VCC-CVD-WLHost14
member FlaskStack-VCC-CVD-WLHost15
member FlaskStack-VCC-CVD-Infra01
member FlaskStack-VCC-CVD-WLHost16
member FlaskStack-VCC-CVD-WLHost17
member FlaskStack-VCC-CVD-WLHost18
member FlaskStack-VCC-CVD-WLHost19
member FlaskStack-VCC-CVD-WLHost20
member FlaskStack-VCC-CVD-WLHost21
member FlaskStack-VCC-CVD-WLHost22
member FlaskStack-VCC-CVD-WLHost23
member FlaskStack-VCC-CVD-WLHost24
member FlaskStack-VCC-CVD-WLHost25
member FlaskStack-VCC-CVD-WLHost26
member FlaskStack-VCC-CVD-WLHost27
member FlaskStack-VCC-CVD-WLHost28
member FlaskStack-VCC-CVD-WLHost29
member FlaskStack-VCC-CVD-WLHost30
member FlaskStack-VCC-CVD-Infra02

!Active Zone Database Section for vsan 401

zone name a300_VDI-1-HBA2 vsan 401

member pwwn 20:00:00:25:d5:06:00:3f

! [VDI-1-HBA2]

member pwwn 20:02:00:a0:98:af:bd:e8

! [a300-01-0h]

member pwwn 20:04:00:a0:98:af:bd:e8

! [a300-02-0h]

zone name a300_VDI-2-HBA2 vsan 401

member pwwn 20:00:00:25:d5:06:00:0f

! [VDI-2-HBA2]

member pwwn 20:02:00:a0:98:af:bd:e8

! [a300-01-0h]

member pwwn 20:04:00:a0:98:af:bd:e8

! [a300-02-0h]

zone name a300_VDI-3-HBA2 vsan 401

member pwwn 20:00:00:25:d5:06:00:1f

! [VDI-3-HBA2]

member pwwn 20:02:00:a0:98:af:bd:e8

! [a300-01-0h]

member pwwn 20:04:00:a0:98:af:bd:e8

! [a300-02-0h]

zone name a300_VDI-4-HBA2 vsan 401

member pwwn 20:00:00:25:d5:06:00:4e

! [VDI-4-HBA2]

member pwwn 20:02:00:a0:98:af:bd:e8

```
!      [a300-01-0h]
member pwwn 20:04:00:a0:98:af:bd:e8
!      [a300-02-0h]
```

```
zone name a300_VDI-5-HBA2 vsan 401
  member pwwn 20:00:00:25:d5:06:00:2e
!      [VDI-5-HBA2]
  member pwwn 20:02:00:a0:98:af:bd:e8
!      [a300-01-0h]
  member pwwn 20:04:00:a0:98:af:bd:e8
!      [a300-02-0h]
```

```
zone name a300_VDI-6-HBA2 vsan 401
  member pwwn 20:00:00:25:d5:06:00:3e
!      [VDI-6-HBA2]
  member pwwn 20:02:00:a0:98:af:bd:e8
!      [a300-01-0h]
  member pwwn 20:04:00:a0:98:af:bd:e8
!      [a300-02-0h]
```

```
zone name a300_VDI-7-HBA2 vsan 401
  member pwwn 20:00:00:25:d5:06:00:0e
!      [VDI-7-HBA2]
  member pwwn 20:02:00:a0:98:af:bd:e8
!      [a300-01-0h]
  member pwwn 20:04:00:a0:98:af:bd:e8
!      [a300-02-0h]
```

```
zone name a300_Infra01-8-HBA2 vsan 401
  member pwwn 20:00:00:25:d5:06:00:4f
```

```
!      [Infra01-8-HBA2]
member pwwn 20:02:00:a0:98:af:bd:e8
!      [a300-01-0h]
member pwwn 20:04:00:a0:98:af:bd:e8
!      [a300-02-0h]
```

```
zone name a300_VDI-9-HBA2 vsan 401
member pwwn 20:00:00:25:d5:06:00:4d
!      [VDI-9-HBA2]
member pwwn 20:02:00:a0:98:af:bd:e8
!      [a300-01-0h]
member pwwn 20:04:00:a0:98:af:bd:e8
!      [a300-02-0h]
```

```
zone name a300_VDI-10-HBA2 vsan 401
member pwwn 20:00:00:25:d5:06:00:2d
!      [VDI-10-HBA2]
member pwwn 20:02:00:a0:98:af:bd:e8
!      [a300-01-0h]
member pwwn 20:04:00:a0:98:af:bd:e8
!      [a300-02-0h]
```

```
zone name a300_VDI-11-HBA2 vsan 401
member pwwn 20:00:00:25:d5:06:00:3d
!      [VDI-11-HBA2]
member pwwn 20:02:00:a0:98:af:bd:e8
!      [a300-01-0h]
member pwwn 20:04:00:a0:98:af:bd:e8
!      [a300-02-0h]
```

```
zone name a300_VDI-12-HBA2 vsan 401
  member pwwn 20:00:00:25:d5:06:00:0d
!      [VDI-12-HBA2]
  member pwwn 20:02:00:a0:98:af:bd:e8
!      [a300-01-0h]
  member pwwn 20:04:00:a0:98:af:bd:e8
!      [a300-02-0h]
```

```
zone name a300_VDI-13-HBA2 vsan 401
  member pwwn 20:00:00:25:d5:06:00:1d
!      [VDI-13-HBA2]
  member pwwn 20:02:00:a0:98:af:bd:e8
!      [a300-01-0h]
  member pwwn 20:04:00:a0:98:af:bd:e8
!      [a300-02-0h]
```

```
zone name a300_VDI-14-HBA2 vsan 401
  member pwwn 20:00:00:25:d5:06:00:4c
!      [VDI-14-HBA2]
  member pwwn 20:02:00:a0:98:af:bd:e8
!      [a300-01-0h]
  member pwwn 20:04:00:a0:98:af:bd:e8
!      [a300-02-0h]
```

```
zone name a300_VDI-15-HBA2 vsan 401
  member pwwn 20:00:00:25:d5:06:00:2c
!      [VDI-15-HBA2]
  member pwwn 20:02:00:a0:98:af:bd:e8
!      [a300-01-0h]
  member pwwn 20:04:00:a0:98:af:bd:e8
```

! [a300-02-0h]

zone name a300_Infra02-16-HBA2 vsan 401

member pwwn 20:00:00:25:d5:06:00:2f

! [Infra02-16-HBA2]

member pwwn 20:02:00:a0:98:af:bd:e8

! [a300-01-0h]

member pwwn 20:04:00:a0:98:af:bd:e8

! [a300-02-0h]

zone name a300_VDI-17-HBA2 vsan 401

member pwwn 20:00:00:25:d5:06:00:0c

! [VDI-17-HBA2]

member pwwn 20:02:00:a0:98:af:bd:e8

! [a300-01-0h]

member pwwn 20:04:00:a0:98:af:bd:e8

! [a300-02-0h]

zone name a300_VDI-18-HBA2 vsan 401

member pwwn 20:00:00:25:d5:06:00:1c

! [VDI-18-HBA2]

member pwwn 20:02:00:a0:98:af:bd:e8

! [a300-01-0h]

member pwwn 20:04:00:a0:98:af:bd:e8

! [a300-02-0h]

zone name a300_VDI-19-HBA2 vsan 401

member pwwn 20:00:00:25:d5:06:00:4b

! [VDI-19-HBA2]

member pwwn 20:02:00:a0:98:af:bd:e8

```
!      [a300-01-0h]
member pwwn 20:04:00:a0:98:af:bd:e8
!      [a300-02-0h]
```

```
zone name a300_VDI-20-HBA2 vsan 401
  member pwwn 20:00:00:25:d5:06:00:2b
!      [VDI-20-HBA2]
  member pwwn 20:02:00:a0:98:af:bd:e8
!      [a300-01-0h]
  member pwwn 20:04:00:a0:98:af:bd:e8
!      [a300-02-0h]
```

```
zone name a300_VDI-21-HBA2 vsan 401
  member pwwn 20:00:00:25:d5:06:00:3b
!      [VDI-21-HBA2]
  member pwwn 20:02:00:a0:98:af:bd:e8
!      [a300-01-0h]
  member pwwn 20:04:00:a0:98:af:bd:e8
!      [a300-02-0h]
```

```
zone name a300_VDI-22-HBA2 vsan 401
  member pwwn 20:00:00:25:d5:06:00:6b
!      [VDI-22-HBA2]
  member pwwn 20:02:00:a0:98:af:bd:e8
!      [a300-01-0h]
  member pwwn 20:04:00:a0:98:af:bd:e8
!      [a300-02-0h]
```

```
zone name a300_VDI-23-HBA2 vsan 401
  member pwwn 20:00:00:25:d5:06:00:1b
```

```
!      [VDI-23-HBA2]
member pwwn 20:02:00:a0:98:af:bd:e8
!      [a300-01-0h]
member pwwn 20:04:00:a0:98:af:bd:e8
!      [a300-02-0h]
```

```
zone name a300_VDI-24-HBA2 vsan 401
member pwwn 20:00:00:25:d5:06:00:4a
!      [VDI-24-HBA2]
member pwwn 20:02:00:a0:98:af:bd:e8
!      [a300-01-0h]
member pwwn 20:04:00:a0:98:af:bd:e8
!      [a300-02-0h]
```

```
zone name a300_VDI-25-HBA2 vsan 401
member pwwn 20:00:00:25:d5:06:00:2a
!      [VDI-25-HBA2]
member pwwn 20:02:00:a0:98:af:bd:e8
!      [a300-01-0h]
member pwwn 20:04:00:a0:98:af:bd:e8
!      [a300-02-0h]
```

```
zone name a300_VDI-26-HBA2 vsan 401
member pwwn 20:00:00:25:d5:06:00:3a
!      [VDI-26-HBA2]
member pwwn 20:02:00:a0:98:af:bd:e8
!      [a300-01-0h]
member pwwn 20:04:00:a0:98:af:bd:e8
!      [a300-02-0h]
```

```
zone name a300_VDI-27-HBA2 vsan 401
  member pwwn 20:00:00:25:d5:06:00:0a
  !      [VDI-27-HBA2]
  member pwwn 20:02:00:a0:98:af:bd:e8
  !      [a300-01-0h]
  member pwwn 20:04:00:a0:98:af:bd:e8
  !      [a300-02-0h]
```

```
zone name a300_VDI-28-HBA2 vsan 401
  member pwwn 20:00:00:25:d5:06:00:1a
  !      [VDI-28-HBA2]
  member pwwn 20:02:00:a0:98:af:bd:e8
  !      [a300-01-0h]
  member pwwn 20:04:00:a0:98:af:bd:e8
  !      [a300-02-0h]
```

```
zone name a300_VDI-29-HBA2 vsan 401
  member pwwn 20:00:00:25:d5:06:00:49
  !      [VDI-29-HBA2]
  member pwwn 20:02:00:a0:98:af:bd:e8
  !      [a300-01-0h]
  member pwwn 20:04:00:a0:98:af:bd:e8
  !      [a300-02-0h]
```

```
zone name a300_VDI-30-HBA2 vsan 401
  member pwwn 20:00:00:25:d5:06:00:39
  !      [VDI-30-HBA2]
  member pwwn 20:02:00:a0:98:af:bd:e8
  !      [a300-01-0h]
  member pwwn 20:04:00:a0:98:af:bd:e8
```

```
!      [a300-02-0h]

zone name a300_VDI-31-HBA2 vsan 401
  member pwwn 20:02:00:a0:98:af:bd:e8
!      [a300-01-0h]
  member pwwn 20:04:00:a0:98:af:bd:e8
!      [a300-02-0h]
  member pwwn 20:00:00:25:d5:06:00:1e
!      [VDI-31-HBA2]
```

```
zone name a300_VDI-32-HBA2 vsan 401
  member pwwn 20:00:00:25:d5:06:00:3c
!      [VDI-32-HBA2]
  member pwwn 20:02:00:a0:98:af:bd:e8
!      [a300-01-0h]
  member pwwn 20:04:00:a0:98:af:bd:e8
!      [a300-02-0h]
```

```
zone name a300-GPU1-HBA2 vsan 401
  member pwwn 20:00:00:25:d5:06:00:29
!      [VCC-GPU1-HBA2]
  member pwwn 20:02:00:a0:98:af:bd:e8
!      [a300-01-0h]
  member pwwn 20:04:00:a0:98:af:bd:e8
!      [a300-02-0h]
```

```
zone name a300-GPU2-HBA2 vsan 401
  member pwwn 20:00:00:25:d5:06:00:19
!      [VCC-GPU2-HBA2]
  member pwwn 20:02:00:a0:98:af:bd:e8
```

```
!      [a300-01-0h]
member pwwn 20:04:00:a0:98:af:bd:e8
!      [a300-02-0h]

zone name a300-GPU3-HBA2 vsan 401
  member pwwn 20:00:00:25:d5:06:00:09
!      [VCC-GPU3-HBA2]
  member pwwn 20:02:00:a0:98:af:bd:e8
!      [a300-01-0h]
  member pwwn 20:04:00:a0:98:af:bd:e8
!      [a300-02-0h]

zone name a300-GPU4-HBA2 vsan 401
  member pwwn 20:00:00:25:d5:06:00:48
!      [VCC-GPU4-HBA2]
  member pwwn 20:02:00:a0:98:af:bd:e8
!      [a300-01-0h]
  member pwwn 20:04:00:a0:98:af:bd:e8
!      [a300-02-0h]

zoneset name testpod vsan 401
  member a300_VDI-1-HBA2
  member a300_VDI-2-HBA2
  member a300_VDI-3-HBA2
  member a300_VDI-4-HBA2
  member a300_VDI-5-HBA2
  member a300_VDI-6-HBA2
  member a300_VDI-7-HBA2
  member a300_Infra01-8-HBA2
  member a300_VDI-9-HBA2
```

member a300_VDI-10-HBA2
member a300_VDI-11-HBA2
member a300_VDI-12-HBA2
member a300_VDI-13-HBA2
member a300_VDI-14-HBA2
member a300_VDI-15-HBA2
member a300_Infra02-16-HBA2
member a300_VDI-17-HBA2
member a300_VDI-18-HBA2
member a300_VDI-19-HBA2
member a300_VDI-20-HBA2
member a300_VDI-21-HBA2
member a300_VDI-22-HBA2
member a300_VDI-23-HBA2
member a300_VDI-24-HBA2
member a300_VDI-25-HBA2
member a300_VDI-26-HBA2
member a300_VDI-27-HBA2
member a300_VDI-28-HBA2
member a300_VDI-29-HBA2
member a300_VDI-30-HBA2
member a300_VDI-31-HBA2
member a300_VDI-32-HBA2
member a300-GPU1-HBA2
member a300-GPU2-HBA2
member a300-GPU3-HBA2
member a300-GPU4-HBA2

zoneset activate name testpod vsan 401
do clear zone database vsan 401

```
!Full Zone Database Section for vsan 401
zone name a300_VDI-1-HBA2 vsan 401
  member pwwn 20:00:00:25:d5:06:00:3f
  !      [VDI-1-HBA2]
  member pwwn 20:02:00:a0:98:af:bd:e8
  !      [a300-01-0h]
  member pwwn 20:04:00:a0:98:af:bd:e8
  !      [a300-02-0h]
```

```
zone name a300_VDI-2-HBA2 vsan 401
  member pwwn 20:00:00:25:d5:06:00:0f
  !      [VDI-2-HBA2]
  member pwwn 20:02:00:a0:98:af:bd:e8
  !      [a300-01-0h]
  member pwwn 20:04:00:a0:98:af:bd:e8
  !      [a300-02-0h]
```

```
zone name a300_VDI-3-HBA2 vsan 401
  member pwwn 20:00:00:25:d5:06:00:1f
  !      [VDI-3-HBA2]
  member pwwn 20:02:00:a0:98:af:bd:e8
  !      [a300-01-0h]
  member pwwn 20:04:00:a0:98:af:bd:e8
  !      [a300-02-0h]
```

```
zone name a300_VDI-4-HBA2 vsan 401
  member pwwn 20:00:00:25:d5:06:00:4e
  !      [VDI-4-HBA2]
  member pwwn 20:02:00:a0:98:af:bd:e8
  !      [a300-01-0h]
```

member pwwn 20:04:00:a0:98:af:bd:e8
! [a300-02-0h]

zone name a300_VDI-5-HBA2 vsan 401
member pwwn 20:00:00:25:d5:06:00:2e
! [VDI-5-HBA2]
member pwwn 20:02:00:a0:98:af:bd:e8
! [a300-01-0h]
member pwwn 20:04:00:a0:98:af:bd:e8
! [a300-02-0h]

zone name a300_VDI-6-HBA2 vsan 401
member pwwn 20:00:00:25:d5:06:00:3e
! [VDI-6-HBA2]
member pwwn 20:02:00:a0:98:af:bd:e8
! [a300-01-0h]
member pwwn 20:04:00:a0:98:af:bd:e8
! [a300-02-0h]

zone name a300_VDI-7-HBA2 vsan 401
member pwwn 20:00:00:25:d5:06:00:0e
! [VDI-7-HBA2]
member pwwn 20:02:00:a0:98:af:bd:e8
! [a300-01-0h]
member pwwn 20:04:00:a0:98:af:bd:e8
! [a300-02-0h]

zone name a300_Infra01-8-HBA2 vsan 401
member pwwn 20:00:00:25:d5:06:00:4f
! [Infra01-8-HBA2]

member pwwn 20:02:00:a0:98:af:bd:e8

! [a300-01-0h]

member pwwn 20:04:00:a0:98:af:bd:e8

! [a300-02-0h]

zone name a300_VDI-9-HBA2 vsan 401

member pwwn 20:00:00:25:d5:06:00:4d

! [VDI-9-HBA2]

member pwwn 20:02:00:a0:98:af:bd:e8

! [a300-01-0h]

member pwwn 20:04:00:a0:98:af:bd:e8

! [a300-02-0h]

zone name a300_VDI-10-HBA2 vsan 401

member pwwn 20:00:00:25:d5:06:00:2d

! [VDI-10-HBA2]

member pwwn 20:02:00:a0:98:af:bd:e8

! [a300-01-0h]

member pwwn 20:04:00:a0:98:af:bd:e8

! [a300-02-0h]

zone name a300_VDI-11-HBA2 vsan 401

member pwwn 20:00:00:25:d5:06:00:3d

! [VDI-11-HBA2]

member pwwn 20:02:00:a0:98:af:bd:e8

! [a300-01-0h]

member pwwn 20:04:00:a0:98:af:bd:e8

! [a300-02-0h]

zone name a300_VDI-12-HBA2 vsan 401

member pwwn 20:00:00:25:d5:06:00:0d

! [VDI-12-HBA2]

member pwwn 20:02:00:a0:98:af:bd:e8

! [a300-01-0h]

member pwwn 20:04:00:a0:98:af:bd:e8

! [a300-02-0h]

zone name a300_VDI-13-HBA2 vsan 401

member pwwn 20:00:00:25:d5:06:00:1d

! [VDI-13-HBA2]

member pwwn 20:02:00:a0:98:af:bd:e8

! [a300-01-0h]

member pwwn 20:04:00:a0:98:af:bd:e8

! [a300-02-0h]

zone name a300_VDI-14-HBA2 vsan 401

member pwwn 20:00:00:25:d5:06:00:4c

! [VDI-14-HBA2]

member pwwn 20:02:00:a0:98:af:bd:e8

! [a300-01-0h]

member pwwn 20:04:00:a0:98:af:bd:e8

! [a300-02-0h]

zone name a300_VDI-15-HBA2 vsan 401

member pwwn 20:00:00:25:d5:06:00:2c

! [VDI-15-HBA2]

member pwwn 20:02:00:a0:98:af:bd:e8

! [a300-01-0h]

member pwwn 20:04:00:a0:98:af:bd:e8

! [a300-02-0h]

zone name a300_Infra02-16-HBA2 vsan 401

member pwwn 20:00:00:25:d5:06:00:2f

! [Infra02-16-HBA2]

member pwwn 20:02:00:a0:98:af:bd:e8

! [a300-01-0h]

member pwwn 20:04:00:a0:98:af:bd:e8

! [a300-02-0h]

zone name a300_VDI-17-HBA2 vsan 401

member pwwn 20:00:00:25:d5:06:00:0c

! [VDI-17-HBA2]

member pwwn 20:02:00:a0:98:af:bd:e8

! [a300-01-0h]

member pwwn 20:04:00:a0:98:af:bd:e8

! [a300-02-0h]

zone name a300_VDI-18-HBA2 vsan 401

member pwwn 20:00:00:25:d5:06:00:1c

! [VDI-18-HBA2]

member pwwn 20:02:00:a0:98:af:bd:e8

! [a300-01-0h]

member pwwn 20:04:00:a0:98:af:bd:e8

! [a300-02-0h]

zone name a300_VDI-19-HBA2 vsan 401

member pwwn 20:00:00:25:d5:06:00:4b

! [VDI-19-HBA2]

member pwwn 20:02:00:a0:98:af:bd:e8

! [a300-01-0h]

member pwwn 20:04:00:a0:98:af:bd:e8

! [a300-02-0h]

zone name a300_VDI-20-HBA2 vsan 401

member pwwn 20:00:00:25:d5:06:00:2b

! [VDI-20-HBA2]

member pwwn 20:02:00:a0:98:af:bd:e8

! [a300-01-0h]

member pwwn 20:04:00:a0:98:af:bd:e8

! [a300-02-0h]

zone name a300_VDI-21-HBA2 vsan 401

member pwwn 20:00:00:25:d5:06:00:3b

! [VDI-21-HBA2]

member pwwn 20:02:00:a0:98:af:bd:e8

! [a300-01-0h]

member pwwn 20:04:00:a0:98:af:bd:e8

! [a300-02-0h]

zone name a300_VDI-22-HBA2 vsan 401

member pwwn 20:00:00:25:d5:06:00:6b

! [VDI-22-HBA2]

member pwwn 20:02:00:a0:98:af:bd:e8

! [a300-01-0h]

member pwwn 20:04:00:a0:98:af:bd:e8

! [a300-02-0h]

zone name a300_VDI-23-HBA2 vsan 401

member pwwn 20:00:00:25:d5:06:00:1b

! [VDI-23-HBA2]

member pwwn 20:02:00:a0:98:af:bd:e8

! [a300-01-0h]

member pwwn 20:04:00:a0:98:af:bd:e8

! [a300-02-0h]

zone name a300_VDI-24-HBA2 vsan 401

member pwwn 20:00:00:25:d5:06:00:4a

! [VDI-24-HBA2]

member pwwn 20:02:00:a0:98:af:bd:e8

! [a300-01-0h]

member pwwn 20:04:00:a0:98:af:bd:e8

! [a300-02-0h]

zone name a300_VDI-25-HBA2 vsan 401

member pwwn 20:00:00:25:d5:06:00:2a

! [VDI-25-HBA2]

member pwwn 20:02:00:a0:98:af:bd:e8

! [a300-01-0h]

member pwwn 20:04:00:a0:98:af:bd:e8

! [a300-02-0h]

zone name a300_VDI-26-HBA2 vsan 401

member pwwn 20:00:00:25:d5:06:00:3a

! [VDI-26-HBA2]

member pwwn 20:02:00:a0:98:af:bd:e8

! [a300-01-0h]

member pwwn 20:04:00:a0:98:af:bd:e8

! [a300-02-0h]

zone name a300_VDI-27-HBA2 vsan 401

member pwwn 20:00:00:25:d5:06:00:0a

! [VDI-27-HBA2]

member pwwn 20:02:00:a0:98:af:bd:e8

! [a300-01-0h]

member pwwn 20:04:00:a0:98:af:bd:e8

! [a300-02-0h]

zone name a300_VDI-28-HBA2 vsan 401

member pwwn 20:00:00:25:d5:06:00:1a

! [VDI-28-HBA2]

member pwwn 20:02:00:a0:98:af:bd:e8

! [a300-01-0h]

member pwwn 20:04:00:a0:98:af:bd:e8

! [a300-02-0h]

zone name a300_VDI-29-HBA2 vsan 401

member pwwn 20:00:00:25:d5:06:00:49

! [VDI-29-HBA2]

member pwwn 20:02:00:a0:98:af:bd:e8

! [a300-01-0h]

member pwwn 20:04:00:a0:98:af:bd:e8

! [a300-02-0h]

zone name a300_VDI-30-HBA2 vsan 401

member pwwn 20:00:00:25:d5:06:00:39

! [VDI-30-HBA2]

member pwwn 20:02:00:a0:98:af:bd:e8

! [a300-01-0h]

member pwwn 20:04:00:a0:98:af:bd:e8

! [a300-02-0h]

```
zone name a300_VDI-31-HBA2 vsan 401
  member pwwn 20:02:00:a0:98:af:bd:e8
  !      [a300-01-0h]
  member pwwn 20:04:00:a0:98:af:bd:e8
  !      [a300-02-0h]
  member pwwn 20:00:00:25:d5:06:00:1e
  !      [VDI-31-HBA2]
```

```
zone name a300_VDI-32-HBA2 vsan 401
  member pwwn 20:00:00:25:d5:06:00:3c
  !      [VDI-32-HBA2]
  member pwwn 20:02:00:a0:98:af:bd:e8
  !      [a300-01-0h]
  member pwwn 20:04:00:a0:98:af:bd:e8
  !      [a300-02-0h]
```

```
zone name a300-GPU1-HBA2 vsan 401
  member pwwn 20:00:00:25:d5:06:00:29
  !      [VCC-GPU1-HBA2]
  member pwwn 20:02:00:a0:98:af:bd:e8
  !      [a300-01-0h]
  member pwwn 20:04:00:a0:98:af:bd:e8
  !      [a300-02-0h]
```

```
zone name a300-GPU2-HBA2 vsan 401
  member pwwn 20:00:00:25:d5:06:00:19
  !      [VCC-GPU2-HBA2]
  member pwwn 20:02:00:a0:98:af:bd:e8
  !      [a300-01-0h]
```



```
member pwwn 20:04:00:a0:98:af:bd:e8  
!      [a300-02-0h]
```

```
zone name a300-GPU3-HBA2 vsan 401  
member pwwn 20:00:00:25:d5:06:00:09  
!      [VCC-GPU3-HBA2]  
member pwwn 20:02:00:a0:98:af:bd:e8  
!      [a300-01-0h]  
member pwwn 20:04:00:a0:98:af:bd:e8  
!      [a300-02-0h]
```

```
zone name a300-GPU4-HBA2 vsan 401  
member pwwn 20:00:00:25:d5:06:00:48  
!      [VCC-GPU4-HBA2]  
member pwwn 20:02:00:a0:98:af:bd:e8  
!      [a300-01-0h]  
member pwwn 20:04:00:a0:98:af:bd:e8  
!      [a300-02-0h]
```

```
zoneset name testpod vsan 401  
member a300_VDI-1-HBA2  
member a300_VDI-2-HBA2  
member a300_VDI-3-HBA2  
member a300_VDI-4-HBA2  
member a300_VDI-5-HBA2  
member a300_VDI-6-HBA2  
member a300_VDI-7-HBA2  
member a300_Infra01-8-HBA2  
member a300_VDI-9-HBA2  
member a300_VDI-10-HBA2
```

member a300_VDI-11-HBA2
member a300_VDI-12-HBA2
member a300_VDI-13-HBA2
member a300_VDI-14-HBA2
member a300_VDI-15-HBA2
member a300_Infra02-16-HBA2
member a300_VDI-17-HBA2
member a300_VDI-18-HBA2
member a300_VDI-19-HBA2
member a300_VDI-20-HBA2
member a300_VDI-21-HBA2
member a300_VDI-22-HBA2
member a300_VDI-23-HBA2
member a300_VDI-24-HBA2
member a300_VDI-25-HBA2
member a300_VDI-26-HBA2
member a300_VDI-27-HBA2
member a300_VDI-28-HBA2
member a300_VDI-29-HBA2
member a300_VDI-30-HBA2
member a300_VDI-31-HBA2
member a300_VDI-32-HBA2
member a300-GPU1-HBA2
member a300-GPU2-HBA2
member a300-GPU3-HBA2
member a300-GPU4-HBA2

interface mgmt0

```
ip address 10.29.164.239 255.255.255.0
vsan database
vsan 401 interface fc1/1
vsan 401 interface fc1/2
vsan 401 interface fc1/3
vsan 401 interface fc1/4
vsan 401 interface fc1/5
vsan 401 interface fc1/6
vsan 401 interface fc1/7
vsan 401 interface fc1/8
vsan 101 interface fc1/9
vsan 101 interface fc1/10
vsan 101 interface fc1/11
vsan 101 interface fc1/12
vsan 101 interface fc1/13
vsan 101 interface fc1/14
vsan 101 interface fc1/15
vsan 101 interface fc1/16
clock timezone PST 0 0
clock summer-time PDT 2 Sun Mar 02:00 1 Sun Nov 02:00 60
switchname ADD16-MDS-B
cli alias name autozone source sys/autozone.py
line console
line vty
boot kickstart bootflash:/m9100-s6ek9-kickstart-mz.8.3.1.bin
boot system bootflash:/m9100-s6ek9-mz.8.3.1.bin
interface fc1/1
interface fc1/2
interface fc1/3
interface fc1/4
```

interface fc1/5

interface fc1/6

interface fc1/7

interface fc1/8

interface fc1/9

interface fc1/10

interface fc1/11

interface fc1/12

interface fc1/13

interface fc1/14

interface fc1/15

interface fc1/16

interface fc1/1

no port-license

interface fc1/2

no port-license

interface fc1/3

no port-license

interface fc1/4

no port-license

interface fc1/5

no port-license

interface fc1/6

no port-license

```
interface fc1/7  
  no port-license
```

```
interface fc1/8  
  no port-license
```

```
interface fc1/9  
  switchport trunk allowed vsan 101  
  switchport trunk mode off  
  port-license acquire  
  no shutdown
```

```
interface fc1/10  
  switchport trunk allowed vsan 101  
  switchport trunk mode off  
  port-license acquire  
  no shutdown
```

```
interface fc1/11  
  switchport trunk allowed vsan 101  
  switchport trunk mode off  
  port-license acquire  
  no shutdown
```

```
interface fc1/12  
  switchport trunk allowed vsan 101  
  switchport trunk mode off  
  port-license acquire  
  no shutdown
```

```
interface fc1/13
  switchport trunk allowed vsan 101
  switchport trunk mode off
  port-license acquire
  no shutdown
```

```
interface fc1/14
  switchport trunk allowed vsan 101
  switchport trunk mode off
  port-license acquire
  no shutdown
```

```
interface fc1/15
  switchport trunk allowed vsan 101
  switchport trunk mode off
  port-license acquire
  no shutdown
```

```
interface fc1/16
  switchport trunk allowed vsan 101
  switchport trunk mode off
  port-license acquire
  no shutdown
ip default-gateway 10.29.164.1
```

Full Scale 6000 Mixed-User Performance Chart with Boot and LoginVSI Knowledge Worker Workload Test

This section provides detailed performance charts for ESXi 6.7 U1 installed on Cisco UCS B200 M5 Blade Servers, as part of the workload test with Citrix XenDesktop 7.15 LTSR deployed pooled HSD and HVD (persistent/non-persistent) desktop virtual machines on Pure Storage //X70R2 system running LoginVSI v4.1.32

based knowledge worker workload, as part of the FlashStack Data Center reference architecture defined in this document.

The charts below are defined in the set of five host in the single performance chart.

HSD Server Performance Monitor Data for Eight HSD Server Cluster: 6000 Users Mixed Scale Testing

Figure 135 Full Scale | 6000 Mixed Users | 8 HSD Hosts | Host CPU Utilization

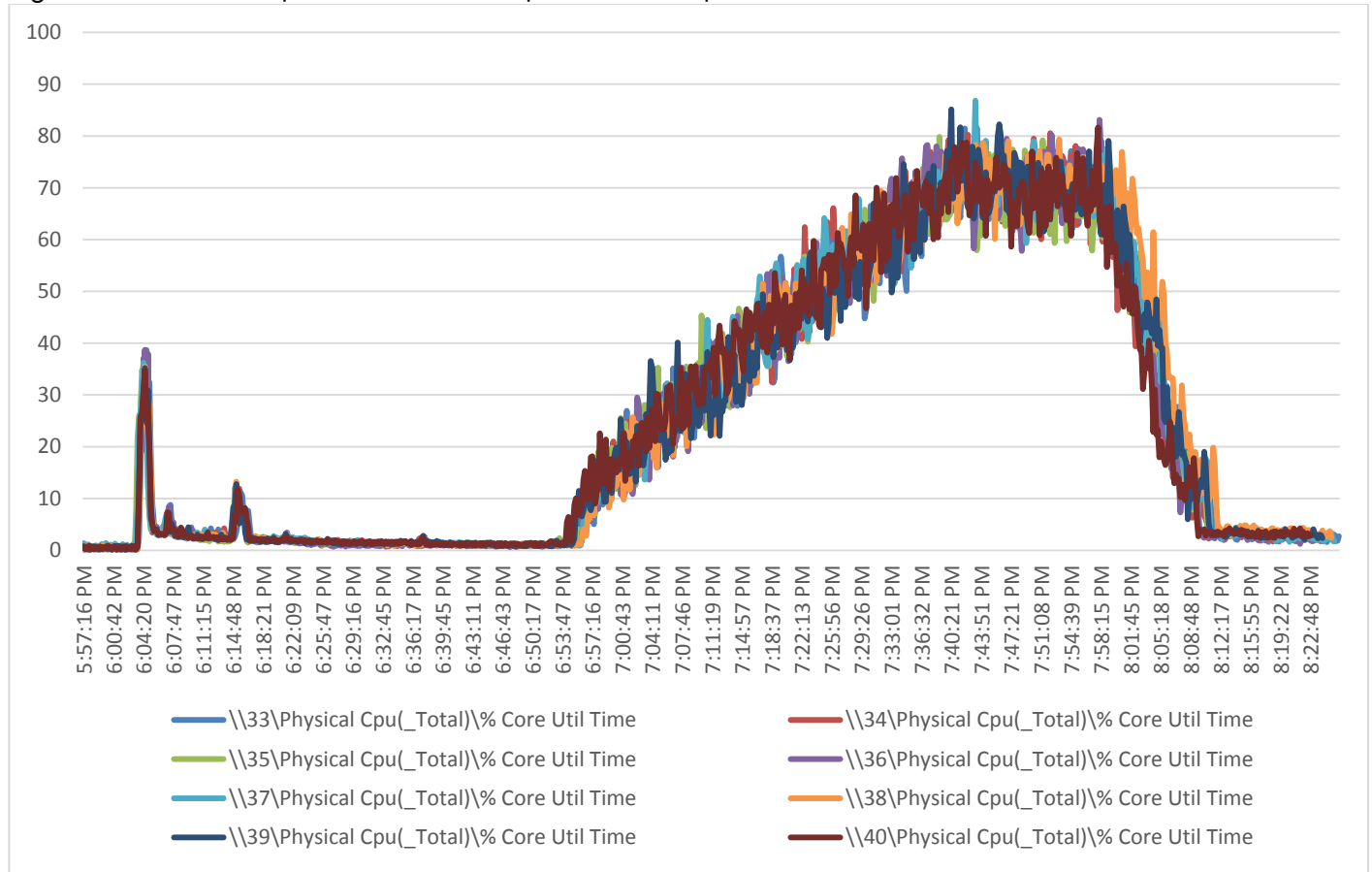

Figure 136 Full Scale | 6000 Mixed Users | 8 HSD Hosts | Host Memory Utilization

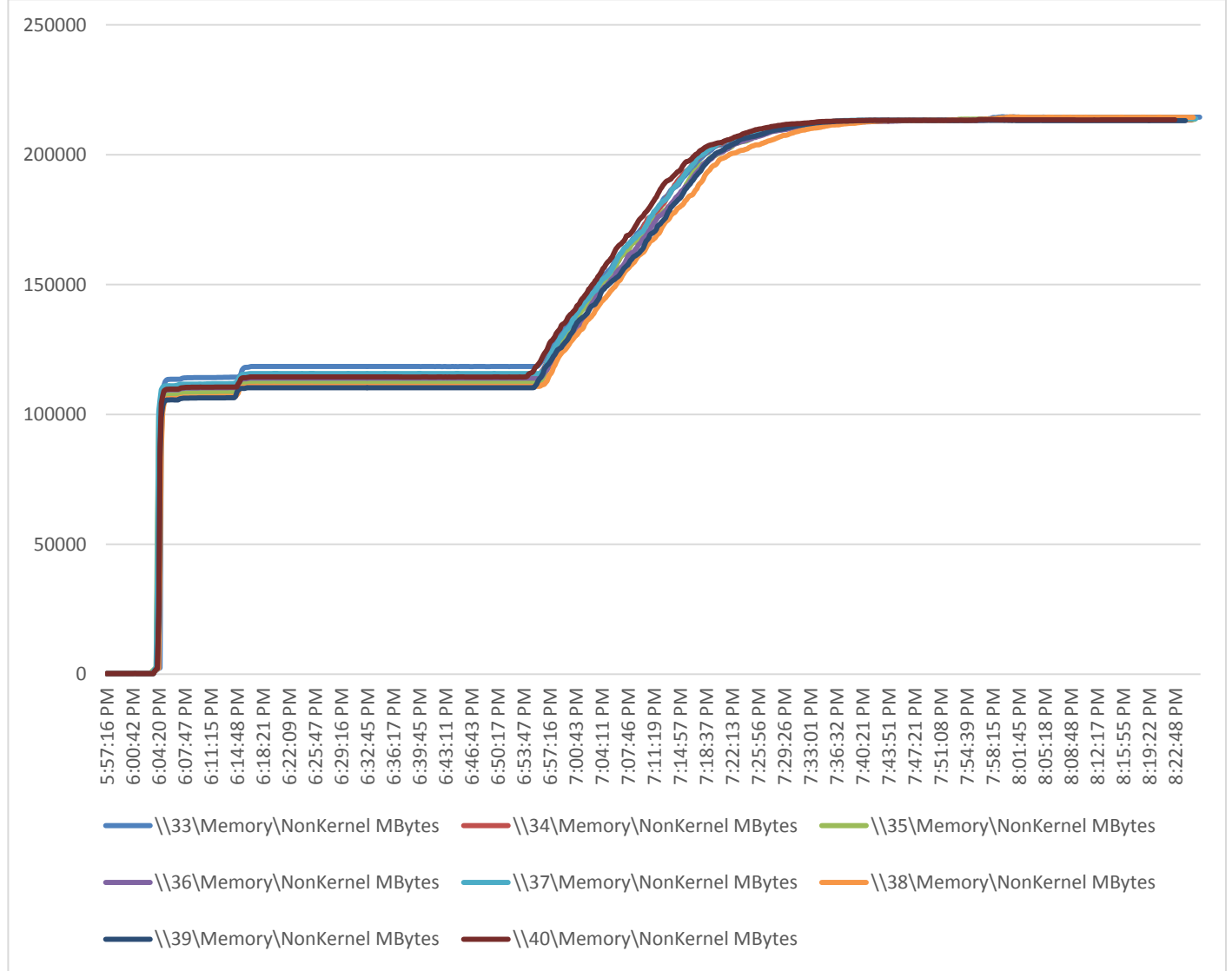

Figure 137 Full Scale | 6000 Mixed Users | 8 HSD Hosts | Host Fibre Channel Network Utilization | Reads

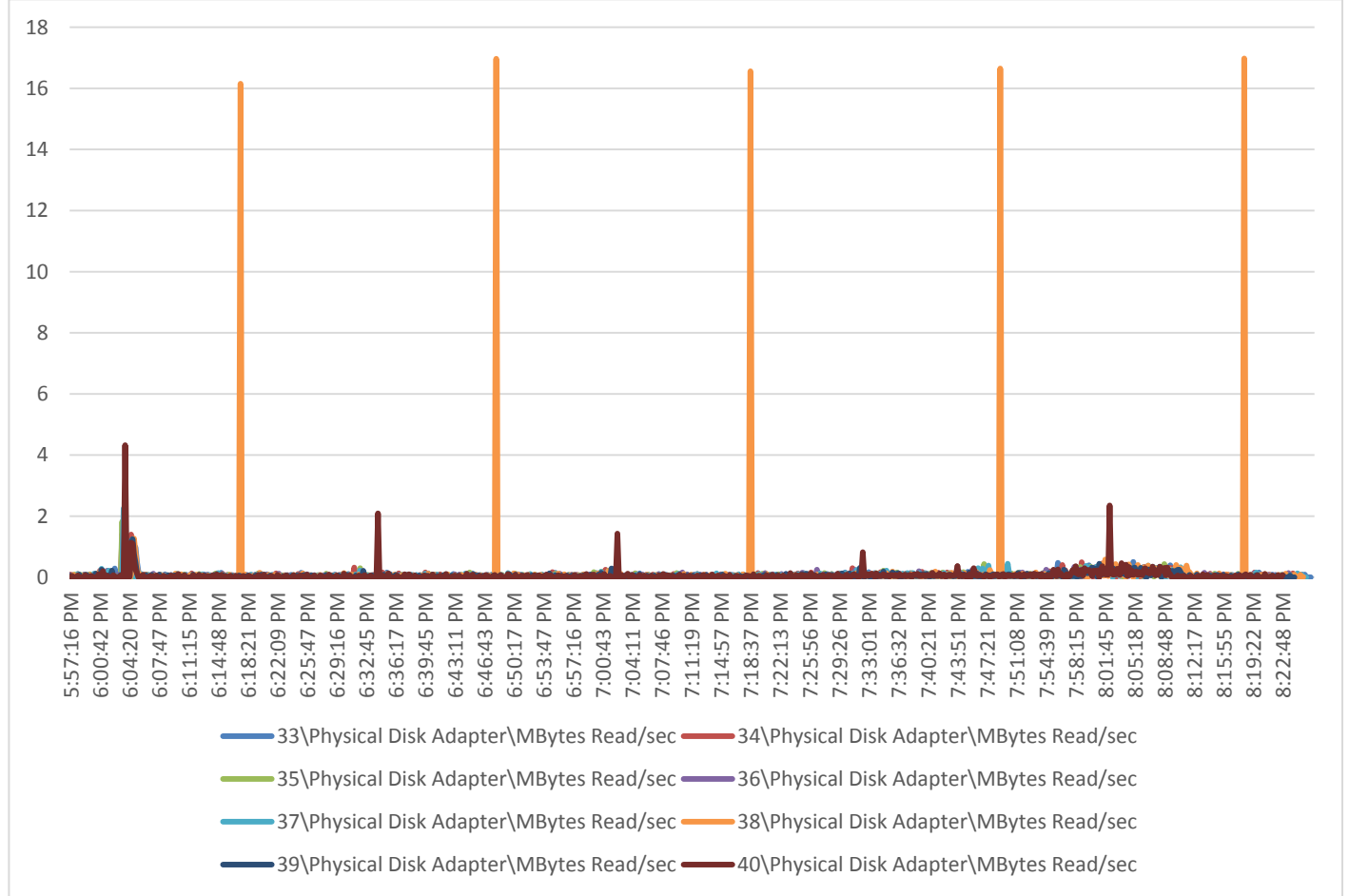

Figure 138 Full Scale | 6000 Mixed Users | 8 HSD Hosts | Host Fibre Channel Network Utilization | Writes

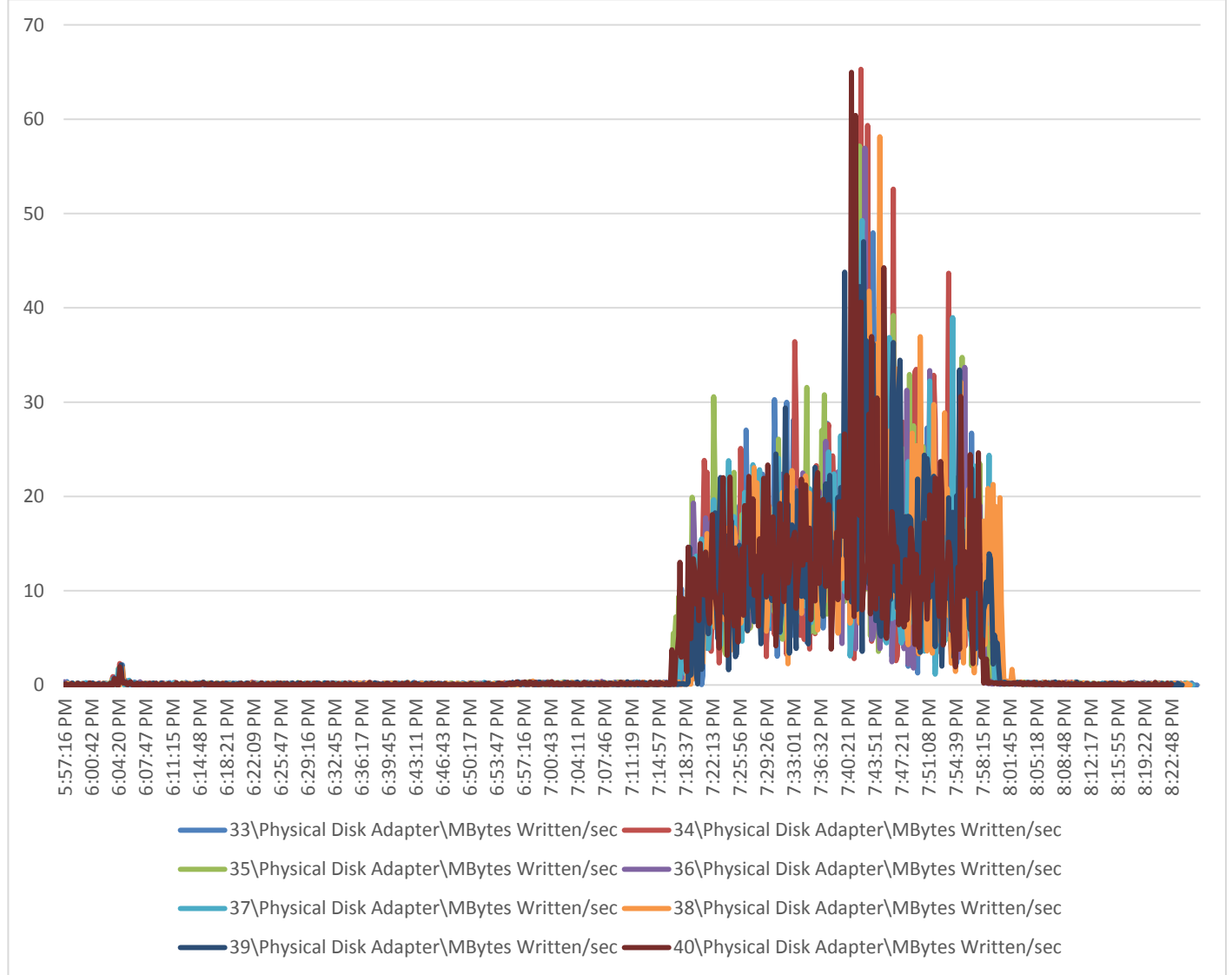

Figure 139 Full Scale | 6000 Mixed Users | 8 HSD Hosts | Host Network Utilization | Received

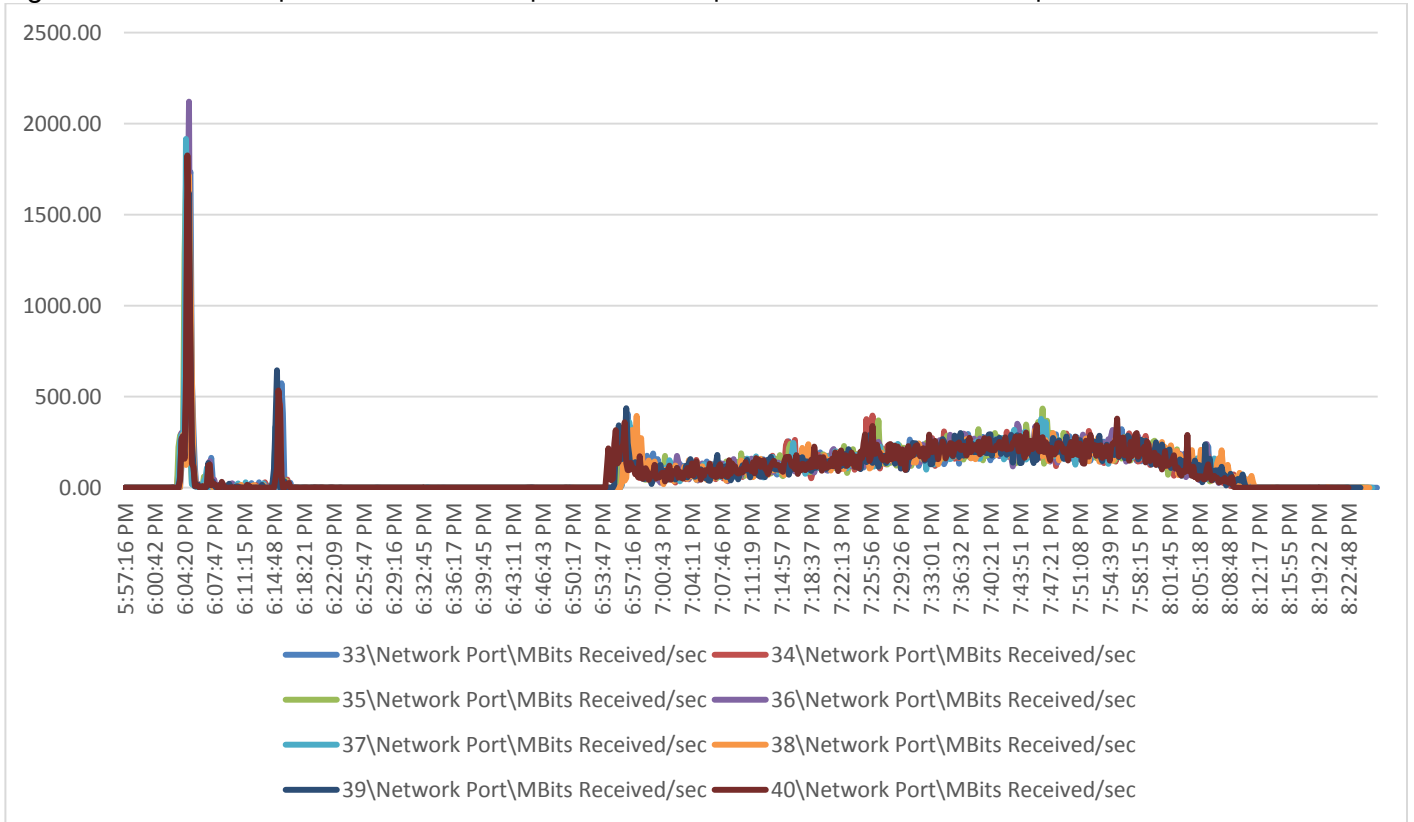
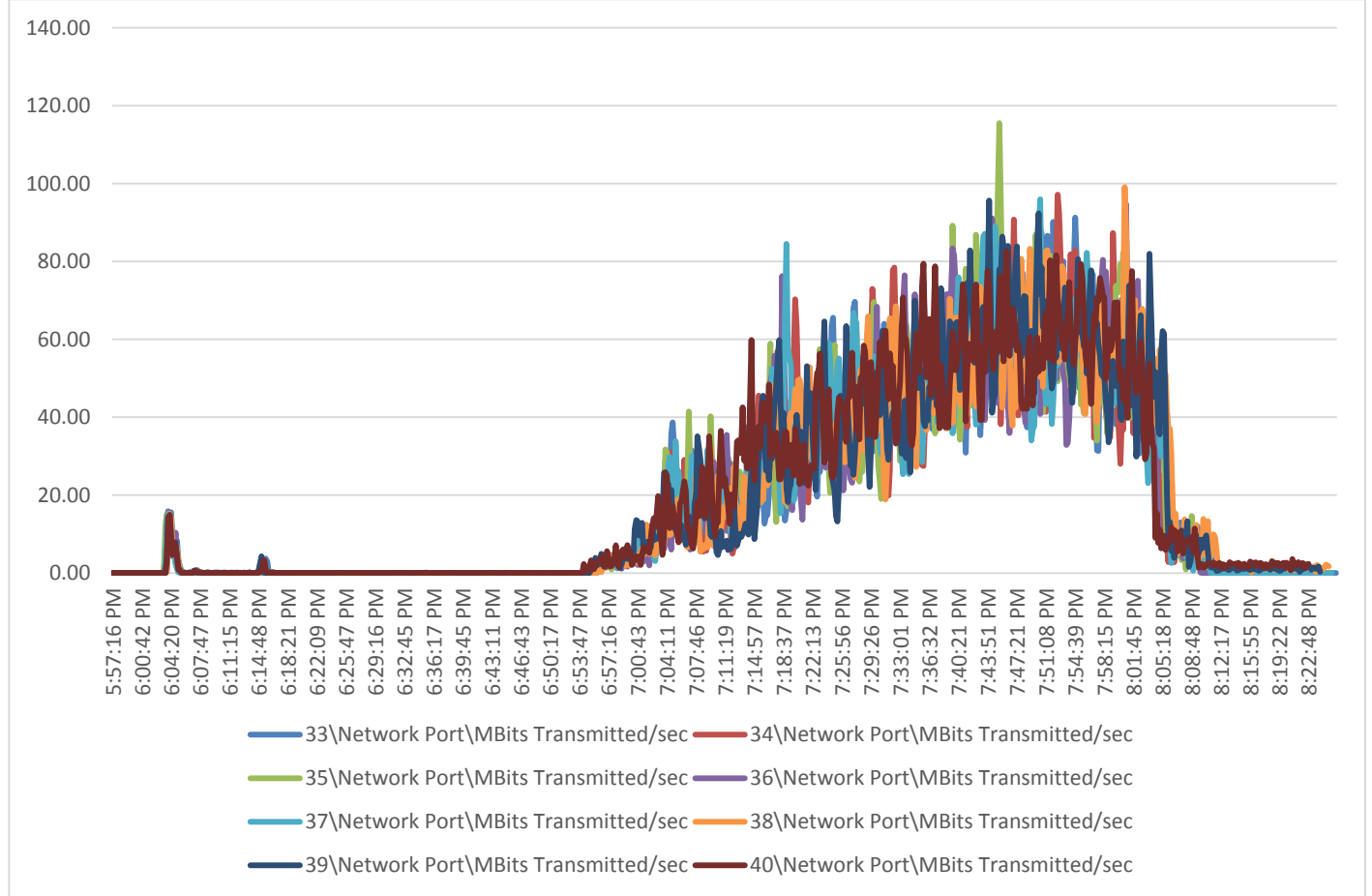

Figure 140 Full Scale | 6000 Mixed Users | 8 HSD Hosts | Host Network Utilization | Translation



Persistent HVD Server Performance Monitor Data for Eleven Sample HVD Server cluster: 6000 Users Mixed Scale Testing

Figure 141 Full Scale | 6000 Mixed Users | 11 HVD Hosts | Host CPU Utilization

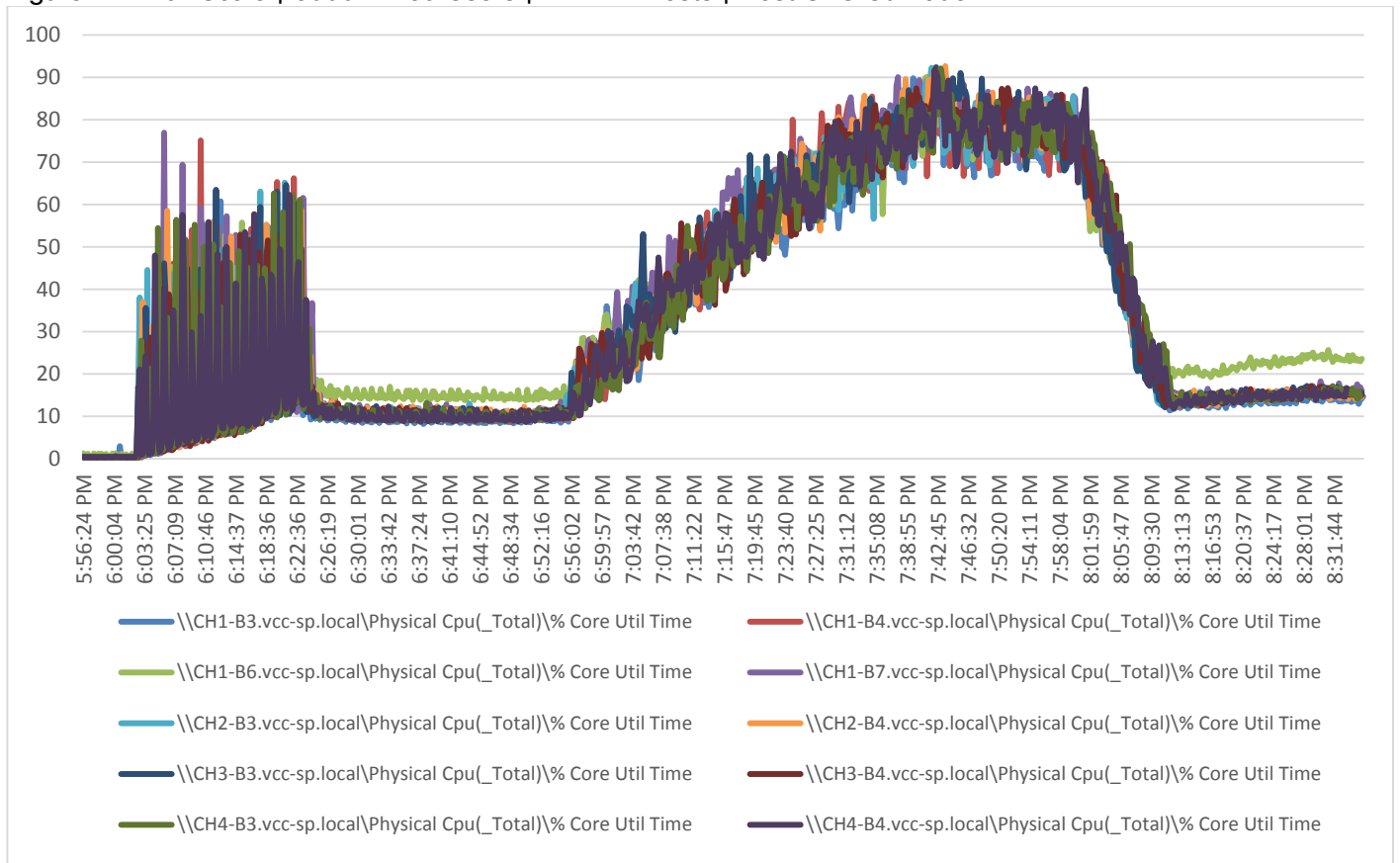

Figure 142 Full Scale | 6000 Mixed Users | 11 VDI Hosts | Host Memory Utilization

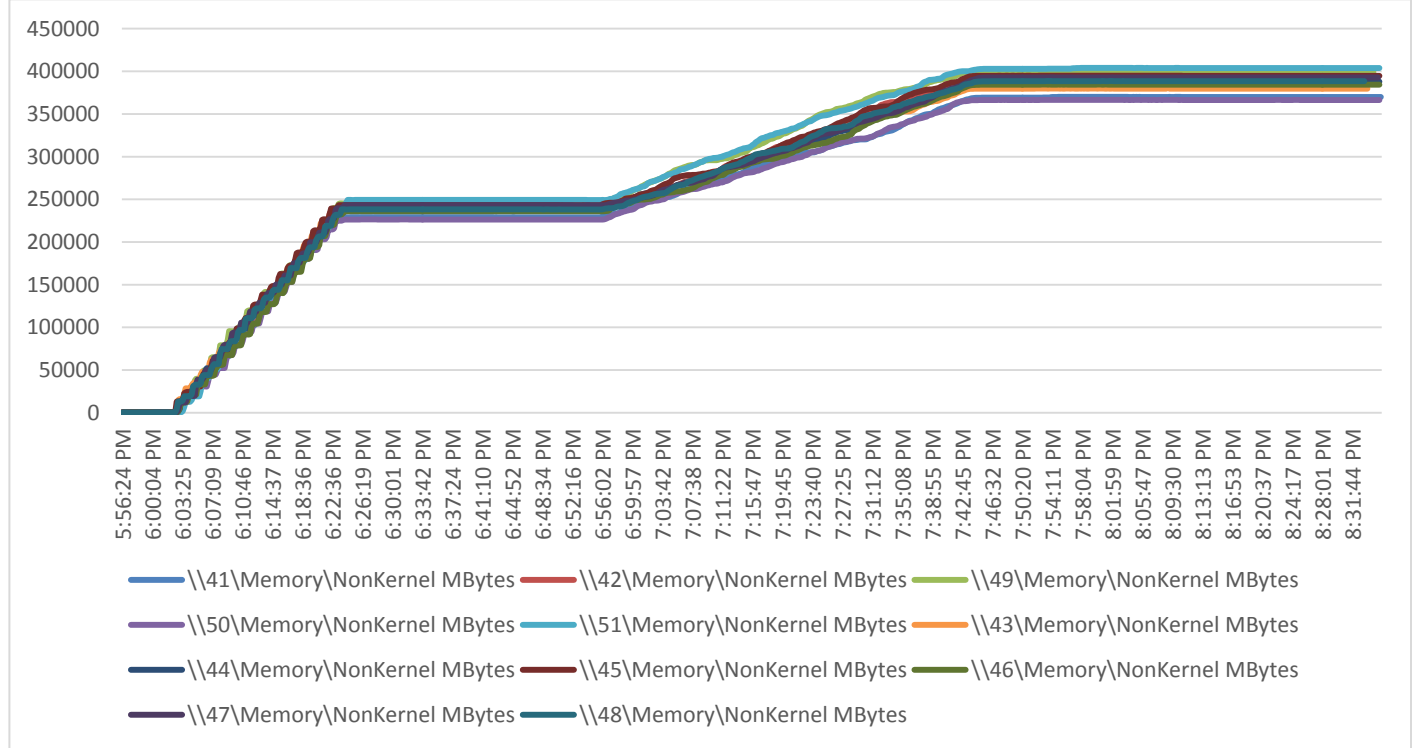

Figure 143 Full Scale | 6000 Mixed Users | 11 HVD Hosts | Host Fibre Channel Network Utilization | Reads

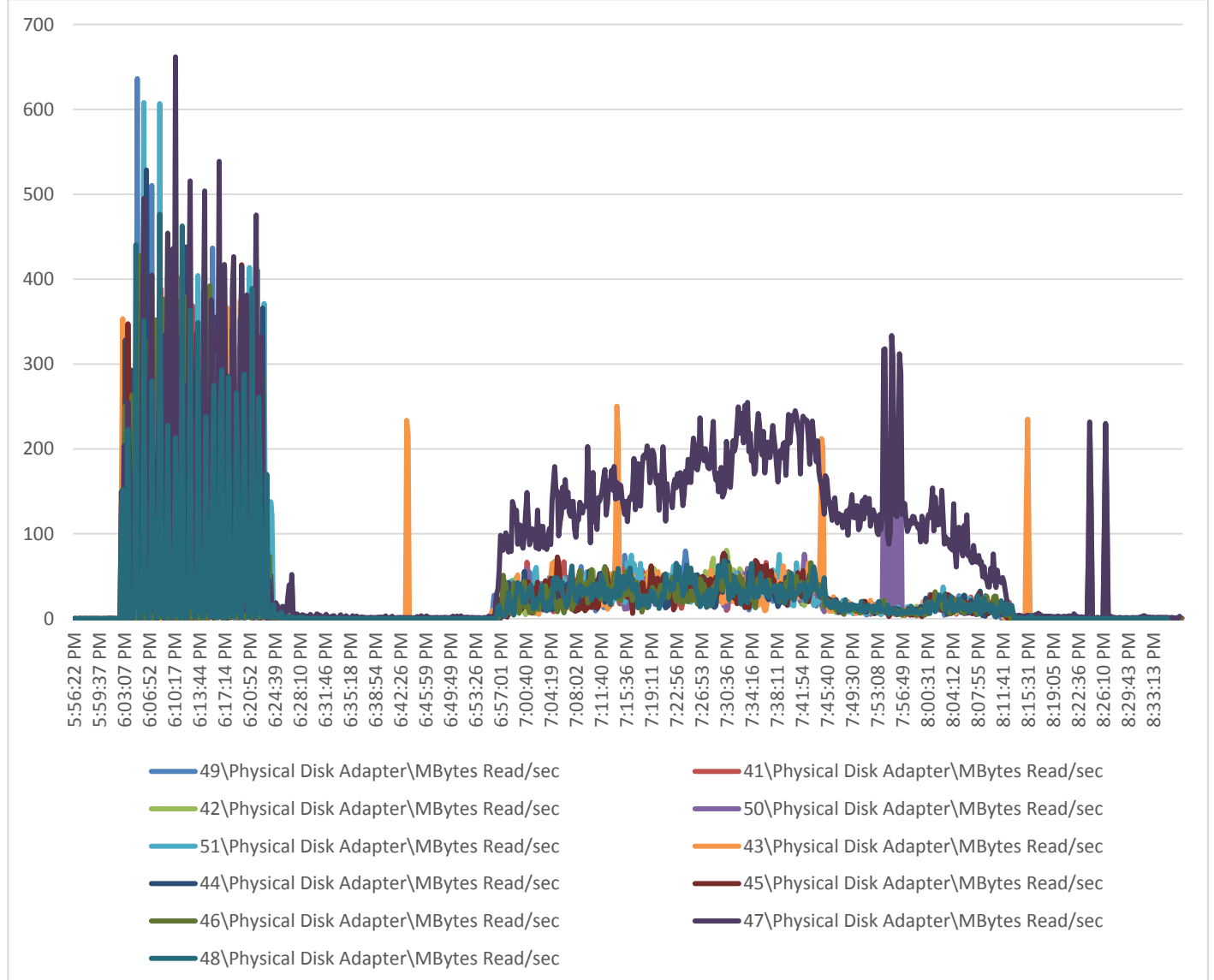

Figure 144 Full Scale | 6000 Mixed Users | 11 HVD Hosts | Host Fibre Channel Network Utilization | Writes

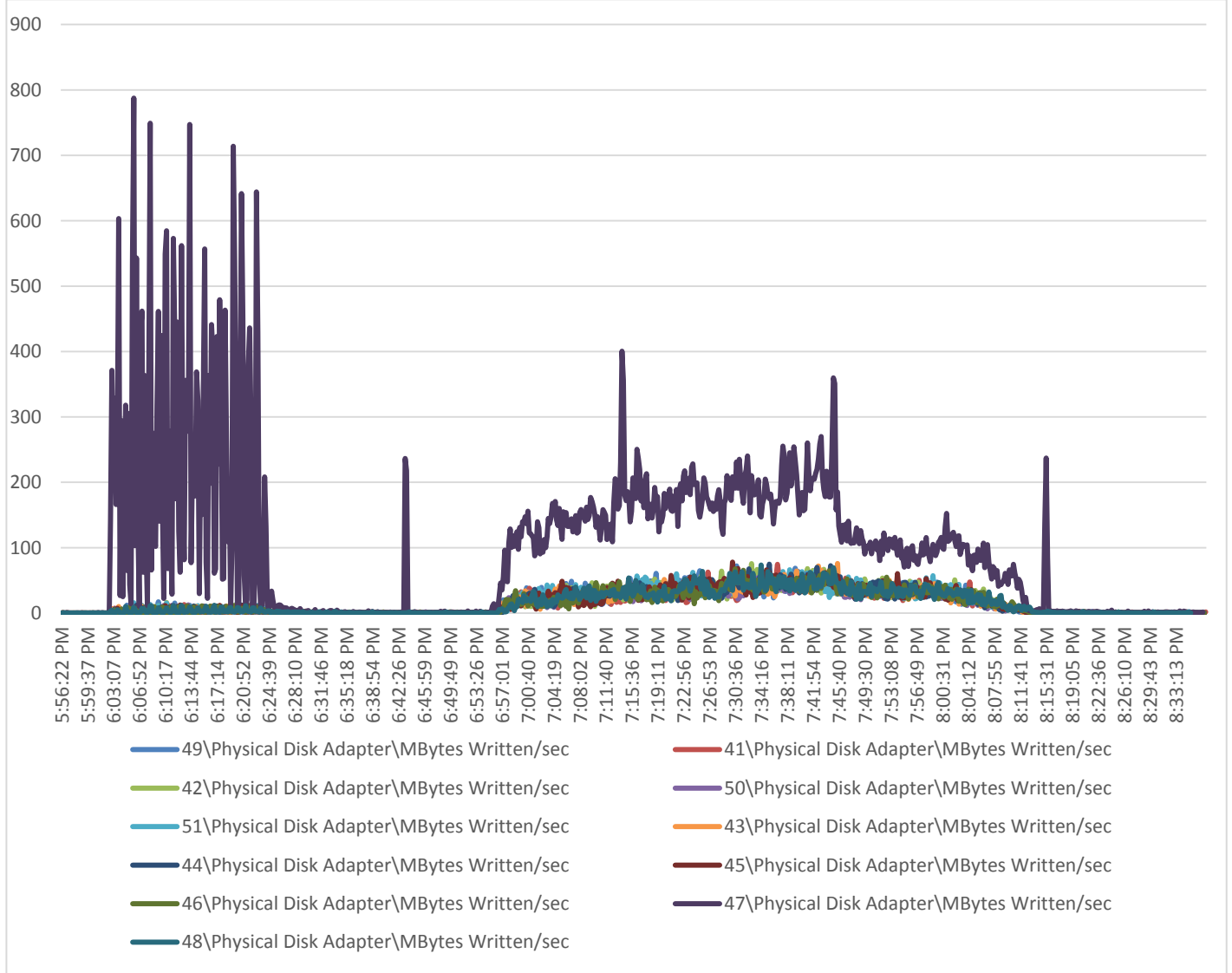

Figure 145 Full Scale | 6000 Mixed Users | 11 HVD Hosts | Host Network Utilization | Transmitted

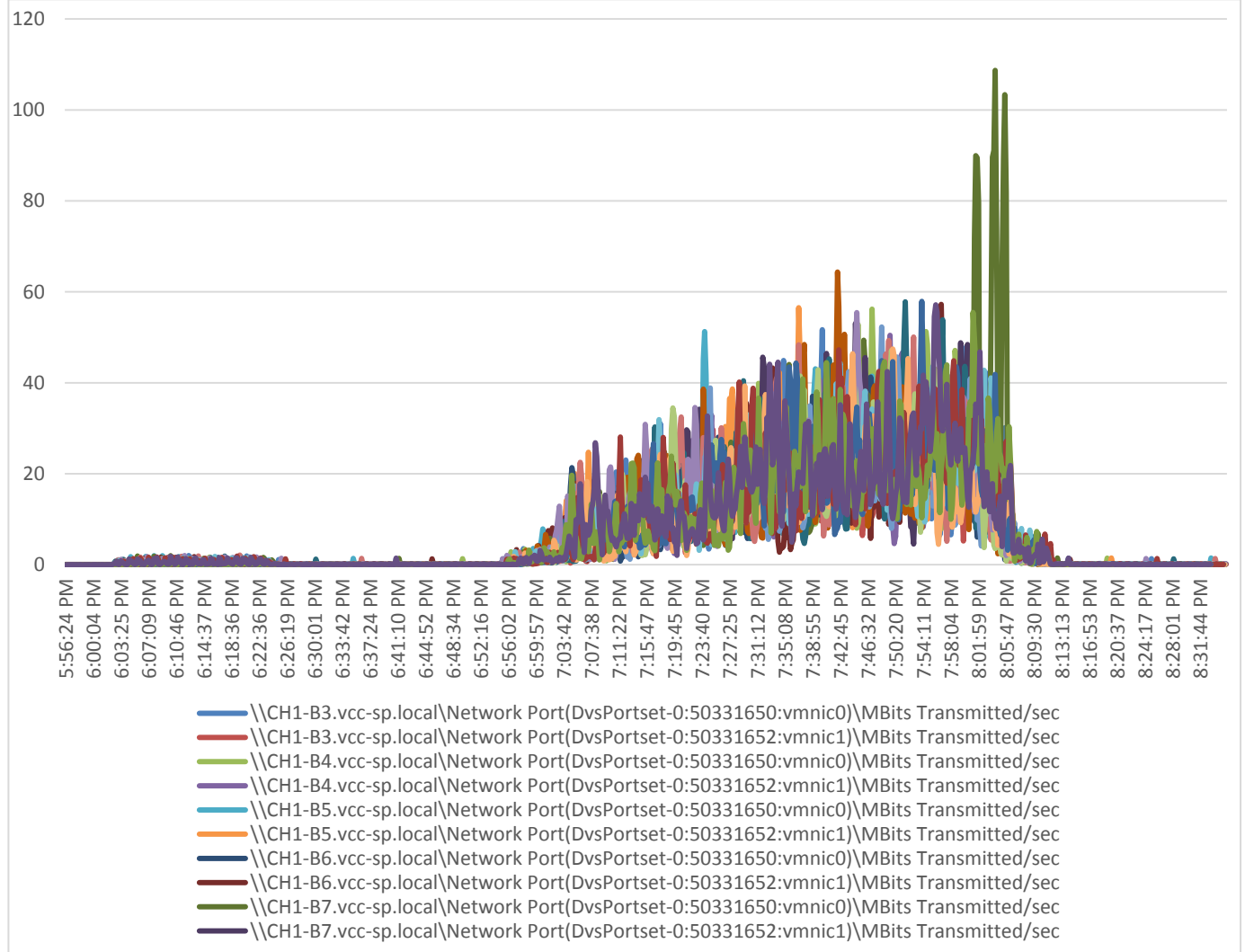
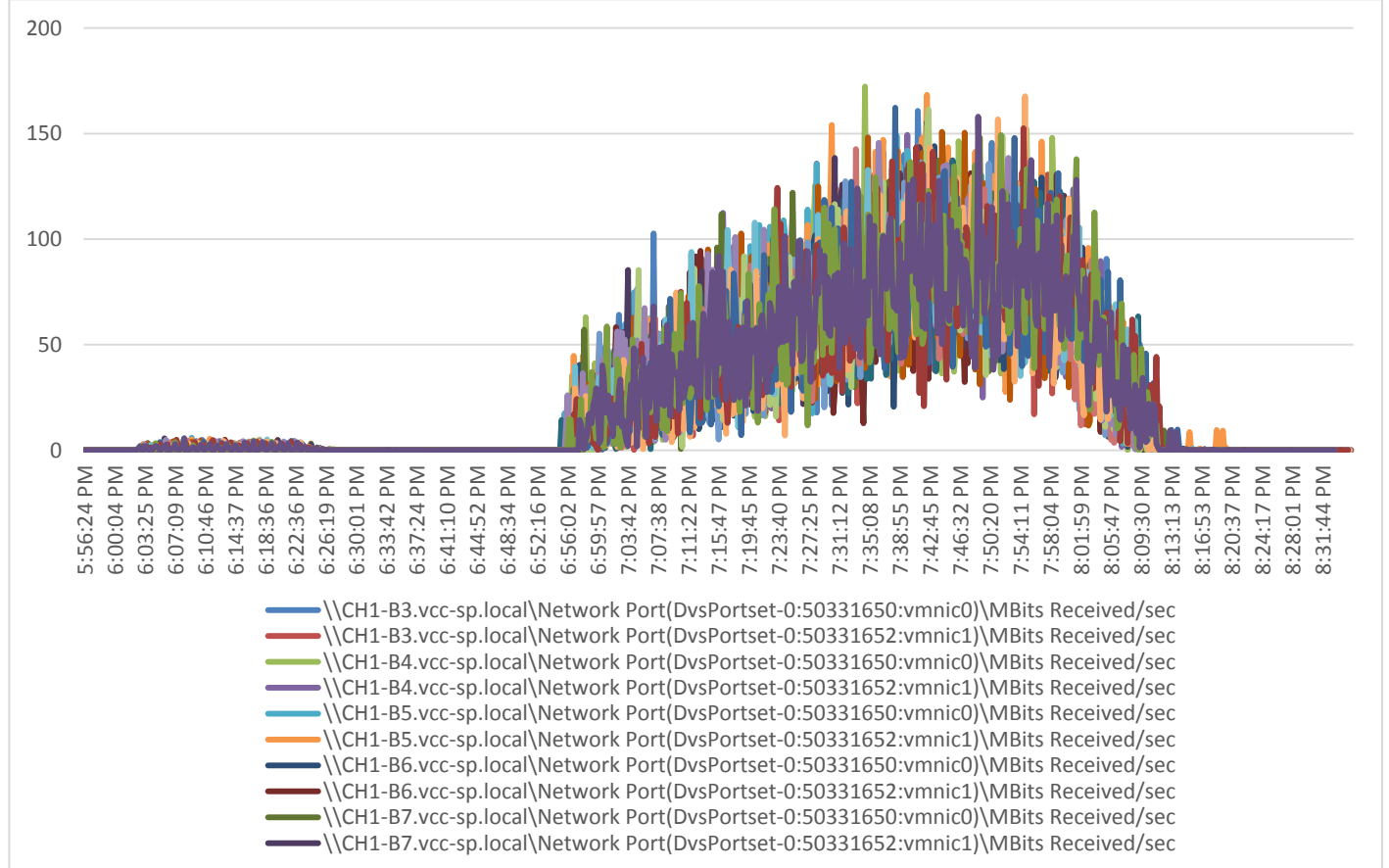

Figure 146 Full Scale | 6000 Mixed Users | 11 HVD Hosts | Host Network Utilization | Received



Non-persistent HVD Server Performance Monitor Data for Eleven HVD Server Cluster: 6000 Users Mixed Scale Testing

Figure 147 Full Scale | 6000 Mixed Users | 11 HVD Hosts | Host CPU Utilization

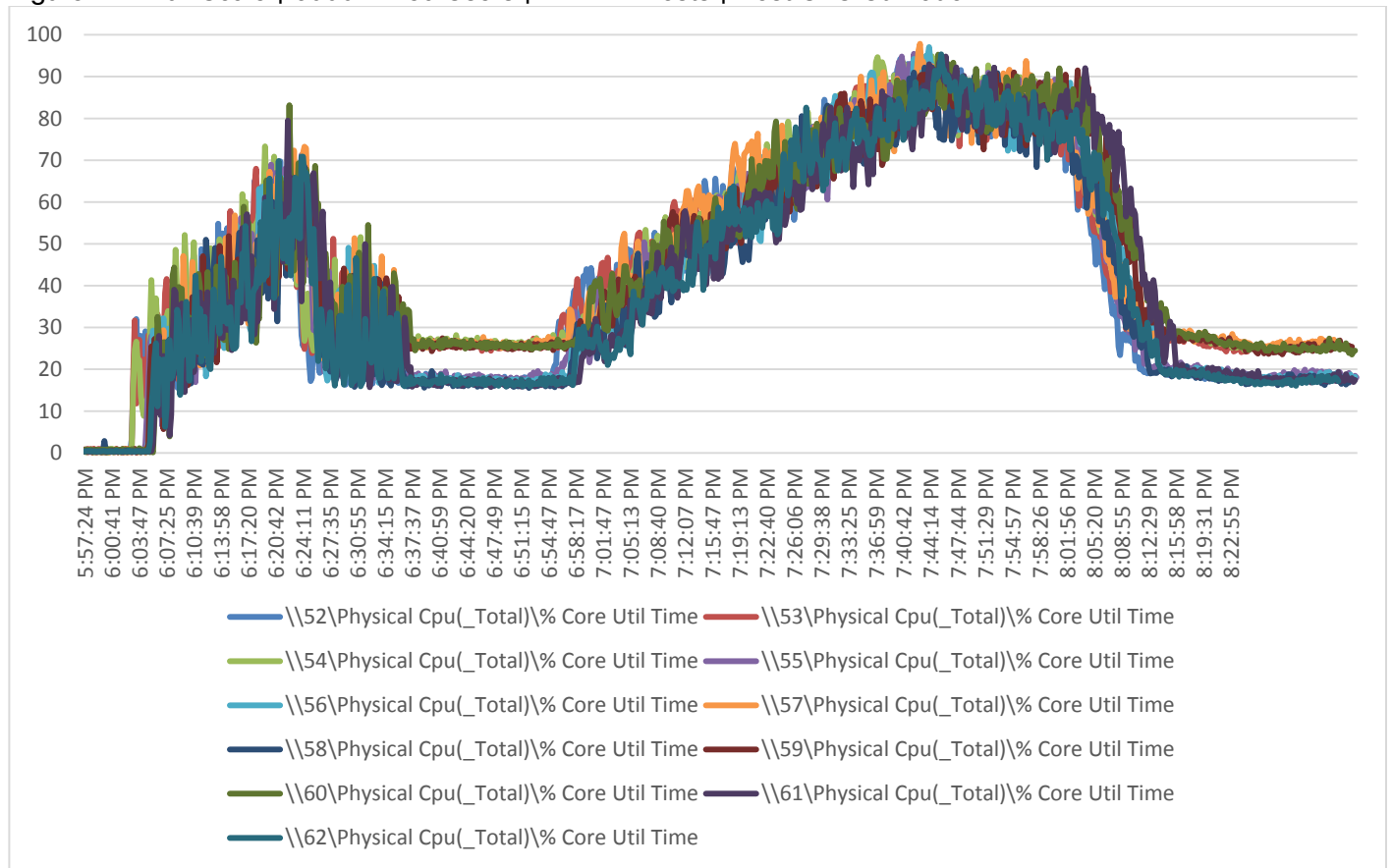

Figure 148 Full Scale | 6000 Mixed Users | 11 HVD Hosts | Host Memory Utilization

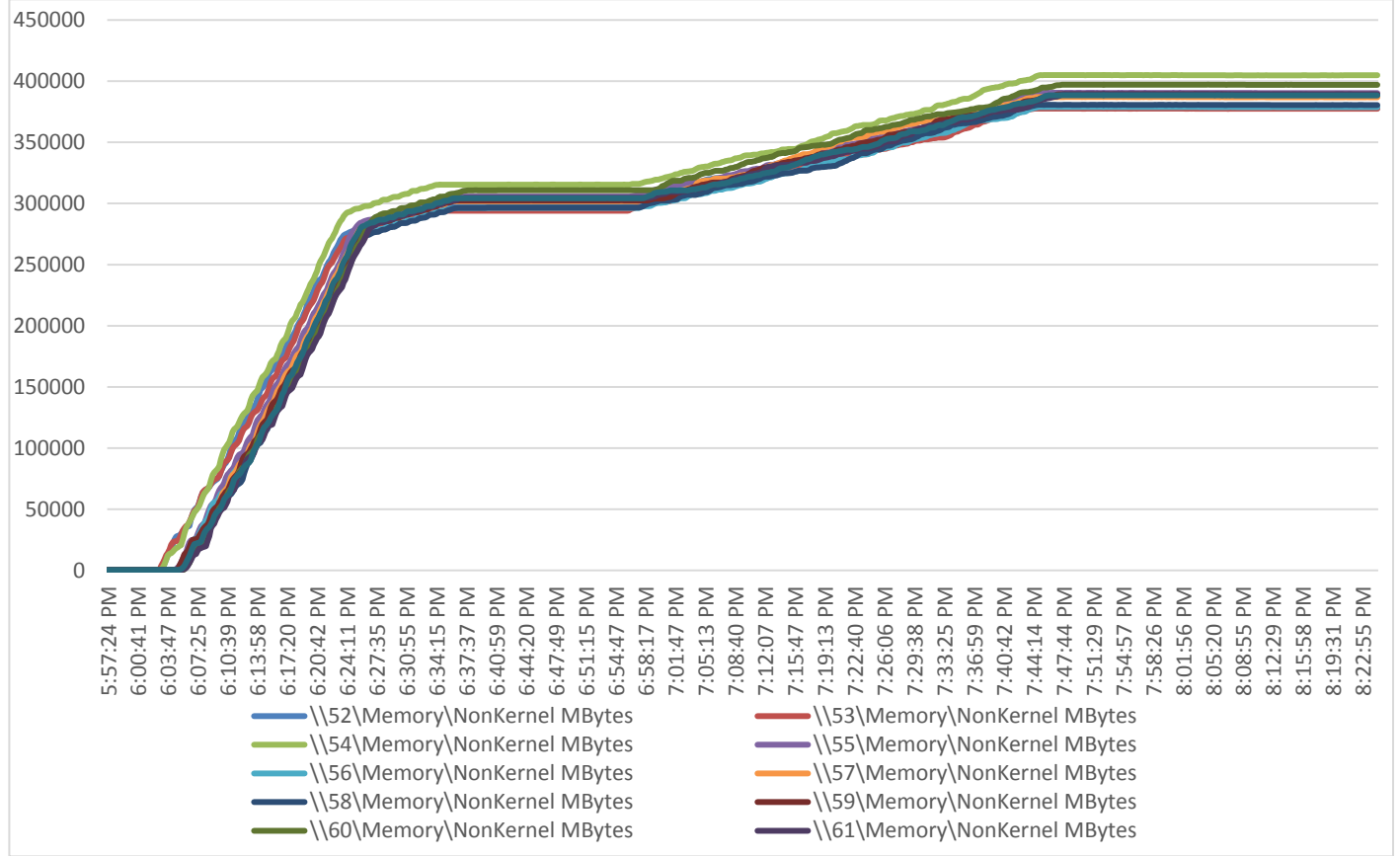

Figure 149 Full Scale | 6000 Mixed Users | 11 HVD Hosts | Host Fibre Channel Network Utilization | Reads

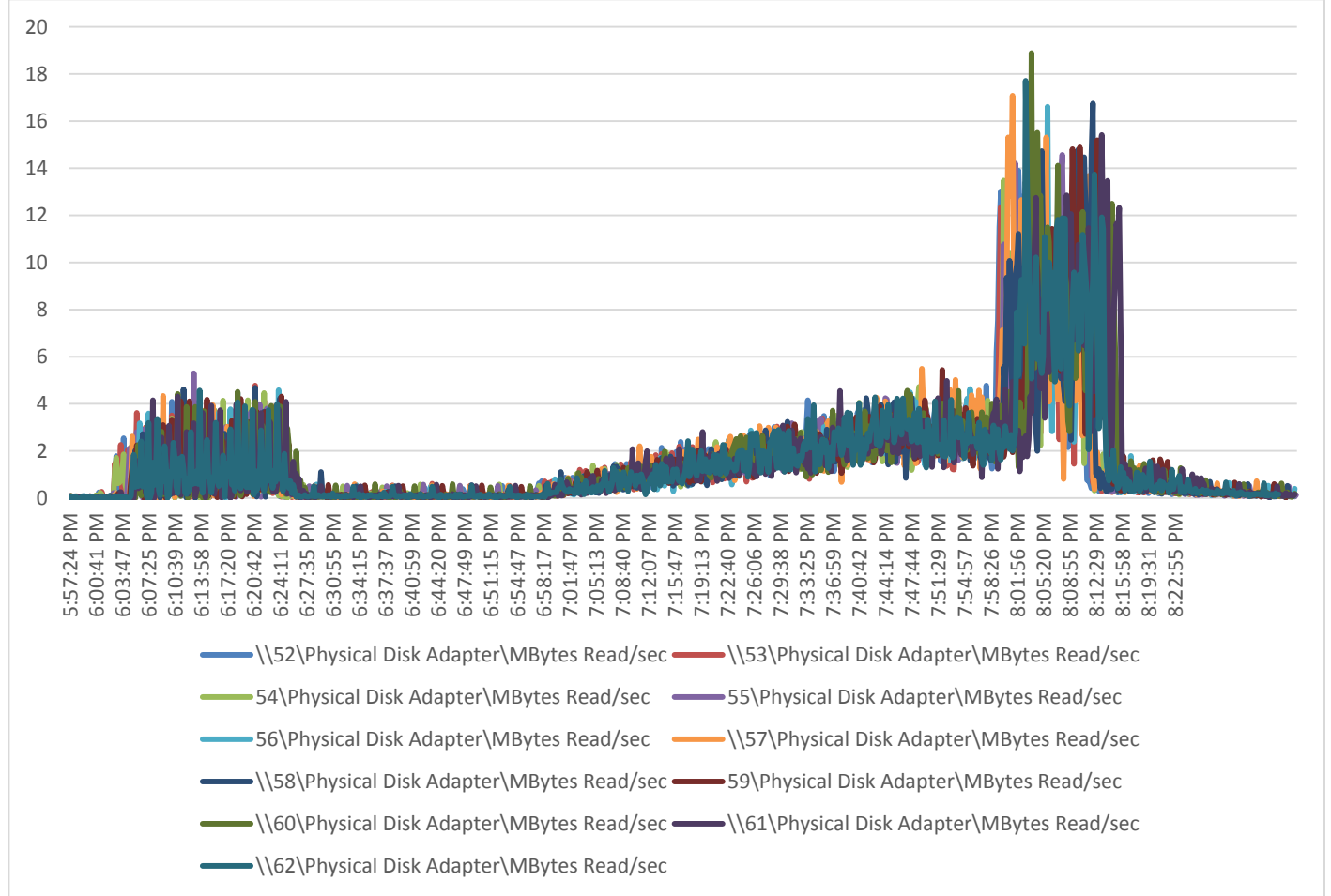

Figure 150 Full Scale | 6000 Mixed Users | 11 HVD Hosts | Host Fibre Channel Network Utilization | Writes

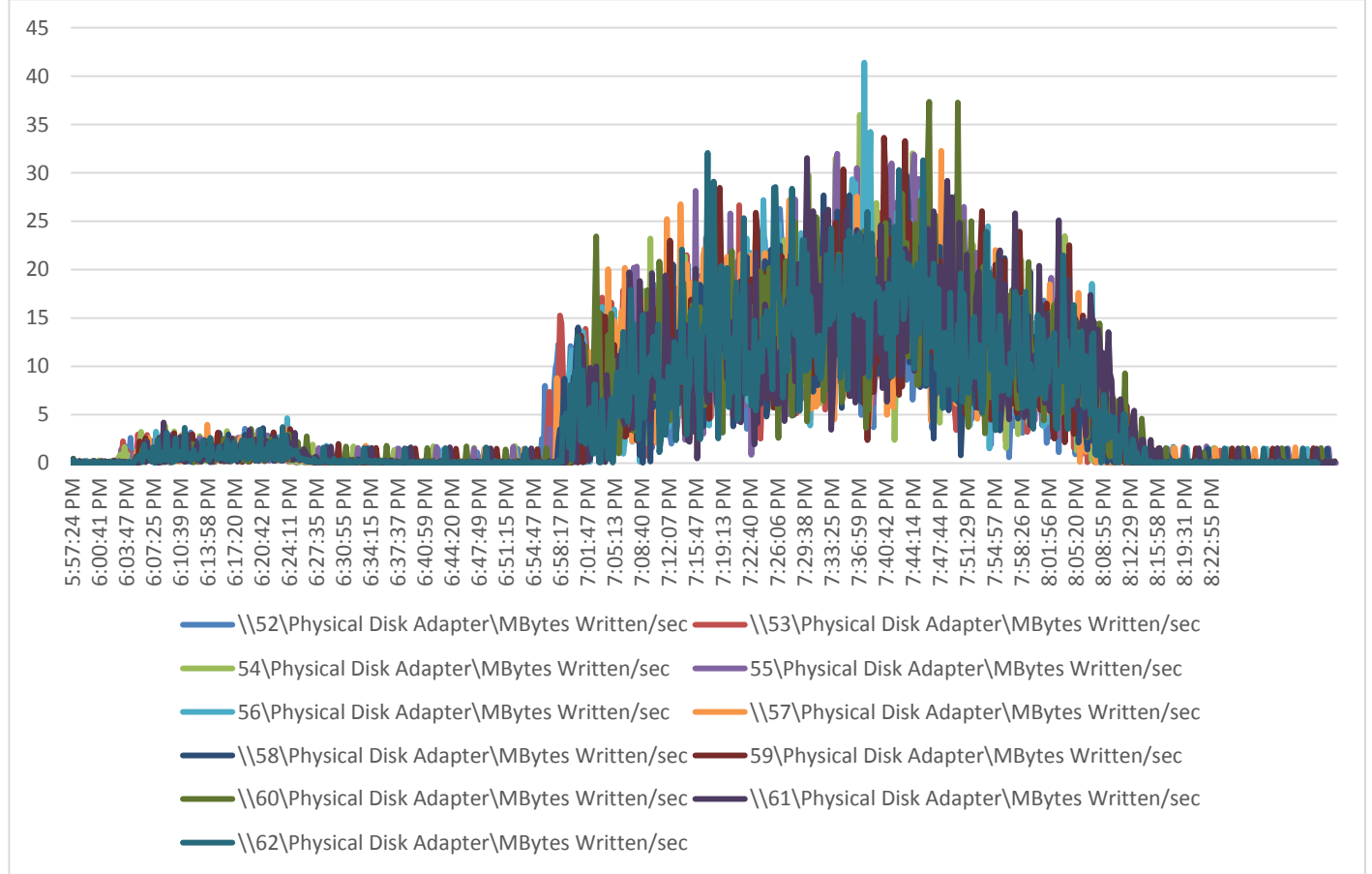

Figure 151 Full Scale | 6000 Mixed Users | 11 HVD Hosts | Host Network Utilization | Received

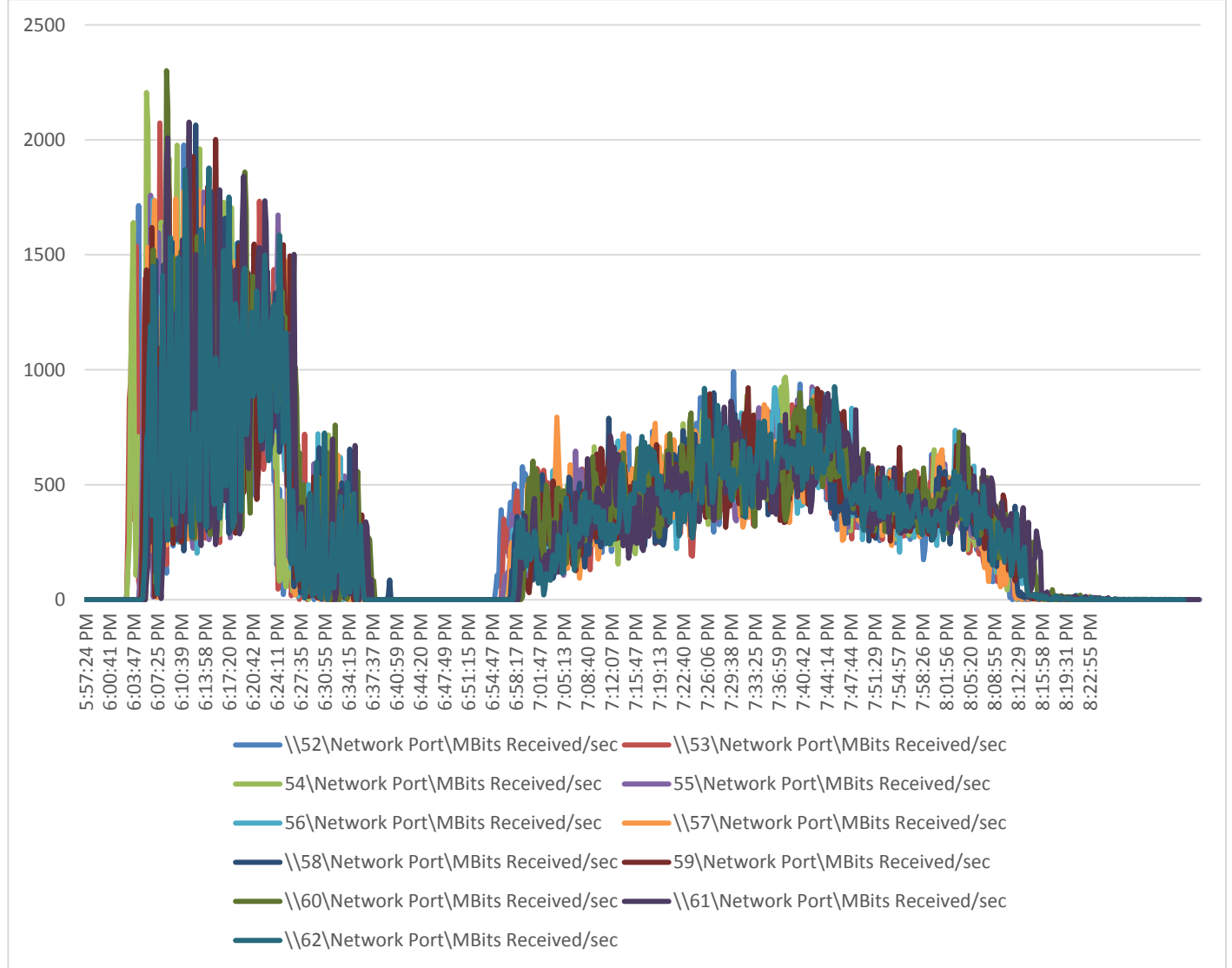

Figure 152 Full Scale | 6000 Mixed Users | 11 HVD Hosts | Host Network Utilization | Transmitted

