



PROFINET Configuration Guide, Cisco Catalyst IE3x00 and IE3100 Rugged, IE3400 Heavy Duty, and ESS3300 Series Switches

First Published: 2020-12-16

Last Modified: 2024-05-07

Americas Headquarters

Cisco Systems, Inc.
170 West Tasman Drive
San Jose, CA 95134-1706
USA
<http://www.cisco.com>
Tel: 408 526-4000
800 553-NETS (6387)
Fax: 408 527-0883

THE SPECIFICATIONS AND INFORMATION REGARDING THE PRODUCTS IN THIS MANUAL ARE SUBJECT TO CHANGE WITHOUT NOTICE. ALL STATEMENTS, INFORMATION, AND RECOMMENDATIONS IN THIS MANUAL ARE BELIEVED TO BE ACCURATE BUT ARE PRESENTED WITHOUT WARRANTY OF ANY KIND, EXPRESS OR IMPLIED. USERS MUST TAKE FULL RESPONSIBILITY FOR THEIR APPLICATION OF ANY PRODUCTS.

THE SOFTWARE LICENSE AND LIMITED WARRANTY FOR THE ACCOMPANYING PRODUCT ARE SET FORTH IN THE INFORMATION PACKET THAT SHIPPED WITH THE PRODUCT AND ARE INCORPORATED HEREIN BY THIS REFERENCE. IF YOU ARE UNABLE TO LOCATE THE SOFTWARE LICENSE OR LIMITED WARRANTY, CONTACT YOUR CISCO REPRESENTATIVE FOR A COPY.

The Cisco implementation of TCP header compression is an adaptation of a program developed by the University of California, Berkeley (UCB) as part of UCB's public domain version of the UNIX operating system. All rights reserved. Copyright © 1981, Regents of the University of California.

NOTWITHSTANDING ANY OTHER WARRANTY HEREIN, ALL DOCUMENT FILES AND SOFTWARE OF THESE SUPPLIERS ARE PROVIDED "AS IS" WITH ALL FAULTS. CISCO AND THE ABOVE-NAMED SUPPLIERS DISCLAIM ALL WARRANTIES, EXPRESSED OR IMPLIED, INCLUDING, WITHOUT LIMITATION, THOSE OF MERCHANTABILITY, FITNESS FOR A PARTICULAR PURPOSE AND NON-INFRINGEMENT OR ARISING FROM A COURSE OF DEALING, USAGE, OR TRADE PRACTICE.

IN NO EVENT SHALL CISCO OR ITS SUPPLIERS BE LIABLE FOR ANY INDIRECT, SPECIAL, CONSEQUENTIAL, OR INCIDENTAL DAMAGES, INCLUDING, WITHOUT LIMITATION, LOST PROFITS OR LOSS OR DAMAGE TO DATA ARISING OUT OF THE USE OR INABILITY TO USE THIS MANUAL, EVEN IF CISCO OR ITS SUPPLIERS HAVE BEEN ADVISED OF THE POSSIBILITY OF SUCH DAMAGES.

Any Internet Protocol (IP) addresses and phone numbers used in this document are not intended to be actual addresses and phone numbers. Any examples, command display output, network topology diagrams, and other figures included in the document are shown for illustrative purposes only. Any use of actual IP addresses or phone numbers in illustrative content is unintentional and coincidental.

All printed copies and duplicate soft copies of this document are considered uncontrolled. See the current online version for the latest version.

Cisco has more than 200 offices worldwide. Addresses and phone numbers are listed on the Cisco website at www.cisco.com/go/offices.

Cisco and the Cisco logo are trademarks or registered trademarks of Cisco and/or its affiliates in the U.S. and other countries. To view a list of Cisco trademarks, go to this URL: <https://www.cisco.com/c/en/us/about/legal/trademarks.html>. Third-party trademarks mentioned are the property of their respective owners. The use of the word partner does not imply a partnership relationship between Cisco and any other company. (1721R)

© 2020–2024 Cisco Systems, Inc. All rights reserved.



CONTENTS

[Full Cisco Trademarks with Software License](#) ?

CHAPTER 1

[Configuring PROFINET](#) 1

[Restrictions for Configuring PROFINET](#) 1

[Information About Configuring PROFINET](#) 1

[PROFINET Device Roles](#) 2

[PROFINET Device Data Exchange](#) 3

[General Station Description File](#) 4

[Configuring PROFINET](#) 5

[Default Configuration](#) 5

[Enabling PROFINET](#) 5

[Configuring the Switch with STEP7/TIA](#) 6

[Quality of Service for PROFINET](#) 12

[Monitoring and Maintaining PROFINET](#) 13

[Troubleshooting PROFINET](#) 14

CHAPTER 2

[Adding SFP Modules to Step 7/TIA](#) 17

[Supported Small Form-Factor Pluggables](#) 17

[Adding SFPs to the Hardware Configuration in SS7/TIA](#) 18

[Feature History](#) 21



CHAPTER 1

Configuring PROFINET

- [Restrictions for Configuring PROFINET, on page 1](#)
- [Information About Configuring PROFINET, on page 1](#)
- [Configuring PROFINET, on page 5](#)
- [Quality of Service for PROFINET, on page 12](#)
- [Monitoring and Maintaining PROFINET, on page 13](#)
- [Troubleshooting PROFINET, on page 14](#)

Restrictions for Configuring PROFINET

The following Cisco Industrial IoT switches meet the requirements of PROFINET Conformance Class B:

- Cisco Catalyst IE3100 Rugged Series Switches
- Cisco Catalyst IE3200 Rugged Series Switches
- Cisco Catalyst IE3300 Rugged Series Switches
- Cisco Embedded Services 3300 Series Switches
- Cisco Catalyst IE3400 Heavy-Duty Series Switches

The rest of this document refers to these switches as "the switch."

PROFINET Conformance Class B is included PROFINET Real Time (RT). The switches do not support Isochronous Real Time (IRT).

Information About Configuring PROFINET

PROFINET is the leading Industrial Ethernet Standard that uses TCP/IP and IT standards for automation control. PROFINET is particularly useful for industrial automation systems and process control networks in which motion control and precision control of instrumentation and test equipment are important. It emphasizes data exchange and defines communication paths to meet speed requirements. PROFINET communication is scalable on three levels:

- Normal non-real-time communication uses TCP/IP and enables bus cycle times of approximately 100 ms.
- Real-time communication enables cycle times of approximately 10 ms.

- Isochronous real-time communication enables cycle times of approximately 1 ms.

PROFINET input/output (I/O) is a modular communication framework for distributed automation applications. PROFINET I/O uses cyclic data transfer to exchange data, alarms, and diagnostic information with programmable controllers, I/O devices, and other automation controllers, for example, motion controllers.

PROFINET I/O recognizes three classes of devices:

- I/O devices
- I/O controllers
- I/O supervisors

PROFINET Device Roles

An I/O controller is a programmable logic controller (PLC) that controls I/O devices and exchanges data such as configuration, alarms, and I/O data through an automation program. The I/O controller and the I/O supervisor exchange diagnostic information. The I/O controller shares configuration and I/O information with an I/O device and receives alarms from the I/O device.

Figure 1: PROFINET Device Roles

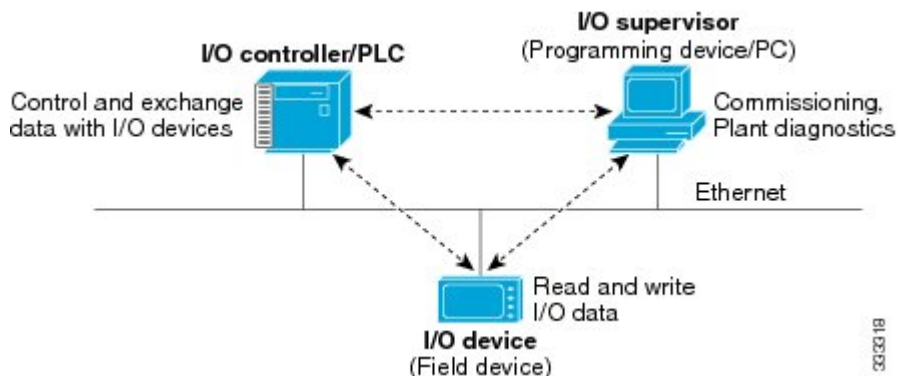

PROFINET is designed to be the sole or primary management system platform. Because the I/O controller detects the switch with the Discovery and Configuration Protocol (DCP), and sets the device name and IP address, you do not have to enter Cisco IOS commands for the basic configuration. For advanced configurations, for example, QoS, DHCP, and similar features, you must use Cisco IOS commands on the switch because these features cannot be configured by using PROFINET.

An I/O supervisor is an engineering station, such as a human machine interface (HMI) or PC, used for commissioning, monitoring, and diagnostic analysis. The I/O supervisor exchanges diagnostic, status, control, and parameter information with the I/O device.

An I/O device is a distributed I/O device such as a sensor, an actuator, or a motion controller.



Note If Profinet DCP cannot detect the switch, PLC, or IO mac addresses, temporarily disable the firewall or virus scan from the Windows PC that installed the Siemens STEP7 or TIA Portal Automation application.

In a PROFINET I/O system, all the I/O devices communicate over an Ethernet communication network to meet the automation industry requirement for bus cycle times of less than 100 ms. The network uses switches and full-duplex data exchange to avoid data collisions. The Cisco Catalyst IE3x00 Rugged Series switches play the role of I/O device in Figure [Figure 1: PROFINET Device Roles, on page 2](#).

PROFINET Device Data Exchange

After PROFINET uses DCP to discover devices, including the switch, the devices establish application relationships (ARs) and communication relationships (CRs). After a connection is established and information about device parameters is exchanged, I/O data is exchanged. The switch uses non-real-time CRs to exchange the data attributes listed below.

Table 1: PROFINET I/O Switch Attributes

PROFINET I/O Switch Configuration Attributes	Value or Action
Device name	Configures a name for the device.
TCP/IP	IP address, subnet mask, default gateway, and switch virtual interface (SVI).
Primary temperature alarm	Enables or disables monitoring for the specified alarm.
Secondary temperature alarm	Enables or disables monitoring for the specified alarm.
SD card alarm	Enables or disables monitoring for the specified alarm.
RPS failed alarm	Enables or disables monitoring for the redundant power supply alarm. Note Before enabling monitoring for the RPS failed alarm, the user must configure the command "power-supply dual" in CLI to trigger an alarm when one of the power supplies is missing or inoperable.
Relay major alarm	Enables or disables monitoring for the specified alarm.
Reset to factory	Reset to factory (Mode 2: Communication parameter) Uses the PROFINET I/O controller to reset the switch communication parameter. This action removes the Profinet device ID, IP address, and configured SNMP writable MIBs.
Relay major configuration	Specifies the type of port alarm, for example, link fault, that triggers the major relay. Any port configured with the specified alarm type can trigger the major relay.

Table 2: PROFINET I/O Port Attributes

PROFINET I/O Port Configuration Attributes	Value or Action
Speed	10, 100, 1000, or auto.
Duplex	half, full, or auto.
Port mode	access or trunk.
Link status	shut down or no shut down.
Configure rate limiting	Broadcast, unicast, or multicast threshold exceeds configured levels.
Port link fault alarm	Enables or disables monitoring for specified alarm.
Port not forwarding alarm	Enables or disables monitoring for specified alarm.
Port not operating alarm	Enables or disables monitoring for specified alarm.
Port FCS threshold alarm	Enables or disables monitoring for specified alarm.

General Station Description File

PROFINET devices are integrated by using a general station description (GSD) file that contains the data for engineering and data exchange between the I/O controller, the I/O supervisor, and the I/O devices, including the switch. Each PROFINET I/O field device must have an associated GSD file that describes the properties of the device and contains all this information required for configuration:

- Device identification information (device ID, vendor ID and name, product family, number of ports)
- Number and types of pluggable modules
- Error text for diagnostic information
- Communication parameters for I/O devices, including the minimum cycle time, the reduction ratio, and the watch dog time
- Configuration data for the I/O device modules, including speed, duplex, VLAN, port security information, alarms, and broadcast rate limiting thresholds
- Parameters configured for I/O device modules for the attributes listed above

The PROFINET GSD file is bundled with the Cisco IOS release. After the IE3x00 boots at least one time, the GSD files for the IE3x00 are located in a directory called ProfinetGSD. In this directory, there is a zip file containing all the GSDs for all IE3x00 SKUs. The file is called CISCO_Petra_product_id.zip, for example, CISCO_Petra_3400.zip. We recommend that you always use the latest released GSD file. The ProfinetGSD file is valid for the Cisco IOS XE version that is currently running.

The GSD file is in the switch and the I/O supervisor uses this file to manage the switch. For IOS XE-based platforms, the GSD file can be found in the Flash: or SDFlash: file system. If you want to load the GSD file for the Cisco IOS XE platform into the I/O supervisor, you need to copy it from the switch.



Note You must use the GSD file that is associated with the Cisco IOS release on the switch to manage your PROFINET network. Both the I/O supervisor and the Cisco IOS software alert you to a mismatch between the GSD file and the switch's Cisco IOS software version.

The status of GSD match or mismatch can be determined using the **show profinet status** command.

Configuring PROFINET

You can use either the SIMATIC STEP7 or TIA Portal Automation application on the I/O supervisor, or you can use the Cisco IOS software to configure PROFINET on the switch.

After you enable PROFINET, Link Layer Discovery Protocol (LLDP) is automatically enabled on the switch because PROFINET relies on LLDP to fully function. If you disable PROFINET, you can enable or disable LLDP as needed.

Default Configuration

PROFINET is enabled by default on all switch ports. The default configuration is enabled on VLAN 1, but you can change it to another VLAN ID. Out of the box, VLAN 1 is shut down. When bringing up an out-of-the-box switch for PROFINET, unshut VLAN 1 as follows:

```
Switch#configure term
Enter configuration commands, one per line. End with CNTL/Z.
Switch(config)#interface vlan 1
Switch(config-if)#no shut
Switch(config-if)#end
Switch#
```

If PROFINET has been disabled, follow the instructions in [Enabling PROFINET, on page 5](#).

Enabling PROFINET

To enable PROFINET, follow these steps:

Step 1 Enter global configuration mode:

```
Switch# configure terminal
```

Step 2 Enable PROFINET on the switch:

```
Switch(config)# profinet
```

After PROFINET is enabled, you can configure the device as described in [Configuring the Switch with STEP7/TIA, on page 6](#) (recommended) or by using the Cisco IOS commands provided in the subsequent steps.

Step 3 (Optional) Set the PROFINET device identifier (ID) by using the Cisco IOS software:

```
Switch(config)# profinet id line
```

The maximum length of the ID string can be 240 characters. The only special characters allowed are period (.) and hyphen (-), and they are allowed only in specific positions within the ID string. The ID can have multiple labels within the string.

Each label can be from 1 to 63 characters, and labels must be separated by a period (.). The final character in the string must not be zero (0).

For more details about configuring the PROFINET ID, see the PROFINET specification, document number TC2-06-0007a, filename PN-AL-protocol_2722_V22_Oct07, available at [PROFIBUS](#).

This step is optional and can be done through STEP7 or TIA PORTAL STEP 7 or the TIA Portal Automation application installed on the Supervisor (recommended).

Step 4 (Optional) Change the VLAN number. The default VLAN number is 1. The VLAN ID range is from 1 to 4096. One PROFINET VLAN is supported per switch.

```
Switch(config)# profinet vlan vlan_id
```

Note You must create a VLAN before assigning a new VLAN to PROFINET if you are using a nondefault VLAN.

Step 5 Return to privileged EXEC mode:

```
Switch(config)# end
```

Step 6 Verify your entries:

```
Switch# show running-config
```

Step 7 (Optional) Save your entries in the configuration file:

```
Switch# copy running-config startup-config
```

Configuring the Switch with STEP7/TIA

Complete the following steps to configure the switch with STEP7/TIA. TIA v15.1 is used in the following example. Ensure that you do not use the CLI to configure or modify the switch configuration when PROFINET and TIA are in use.

Step 1 Check the availability of the GSD file on the switch. You must use the same version that matches the GSD file bundled with the Cisco IOS release image.

See [General Station Description File, on page 4](#) for more information.

Step 2 Install the GSD file in STEP7/ TIA:

a) In STEP7/TIA, choose **Options > Manage general stations description files**, and browse to the location of the GSD file on the PC through source path.

The tool displays all the available GSD files.

b) Check the check box adjacent to the appropriate the desired GSD file and click **Install**.

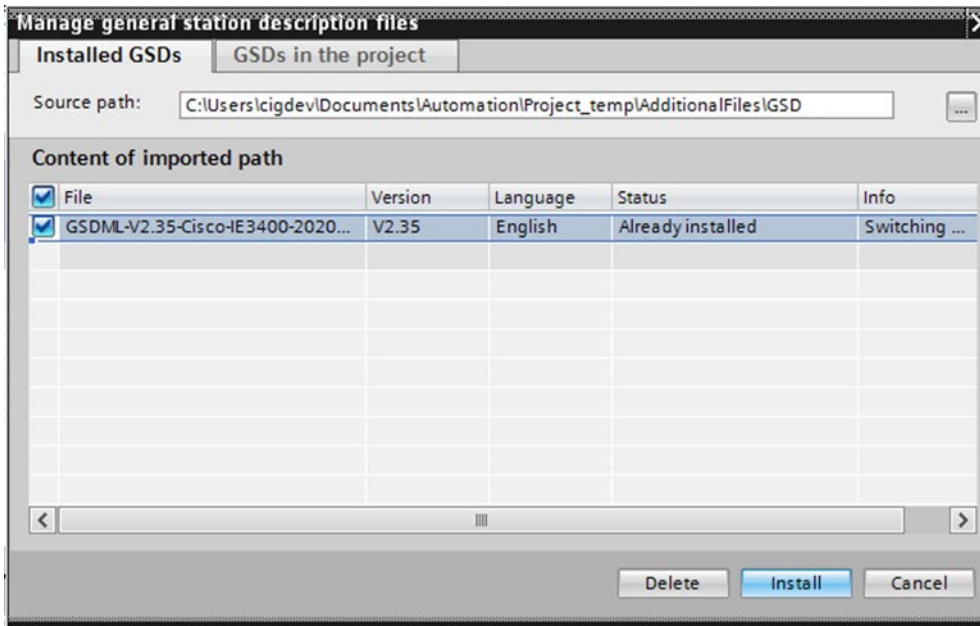

Step 3 After the installation is completed, give it a few seconds to update the **Hardware catalog**. Add the switch from the **Hardware catalog**:

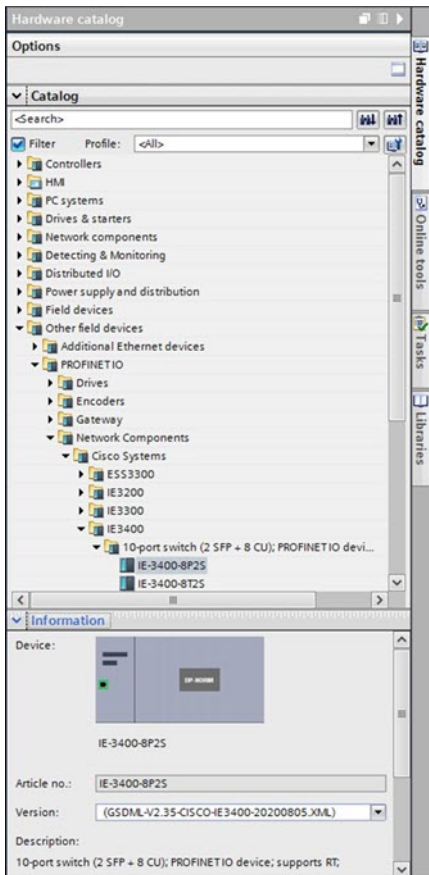

- a) In the Device view, configure **IP address** and **PROFINET device name** and save the configuration. These settings are for STEP7/TIA only; the switch is actually configured later during discovery steps.

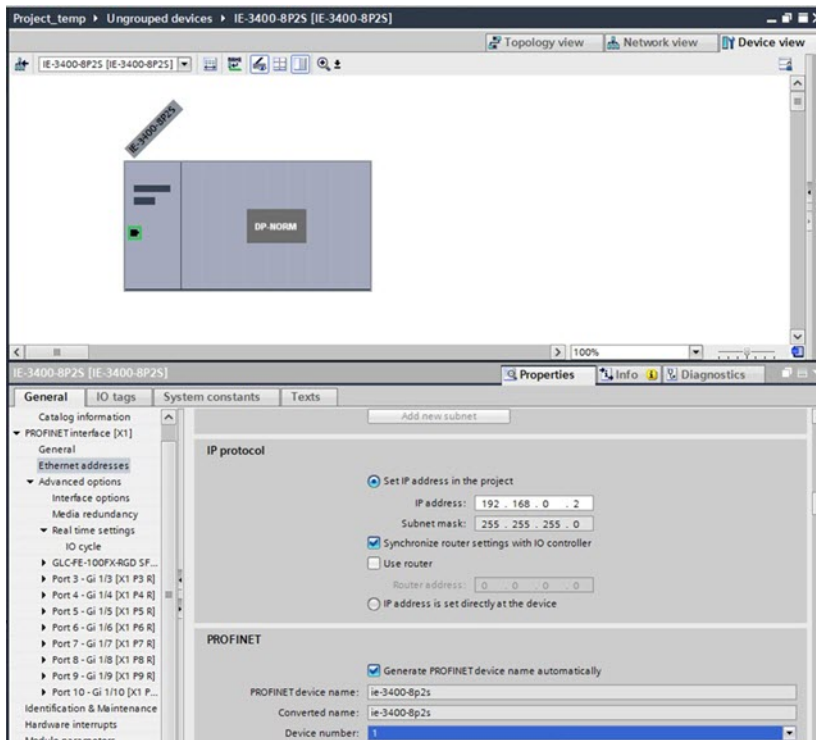

- b) Configure the required expansion module or pluggable modules in Device view.

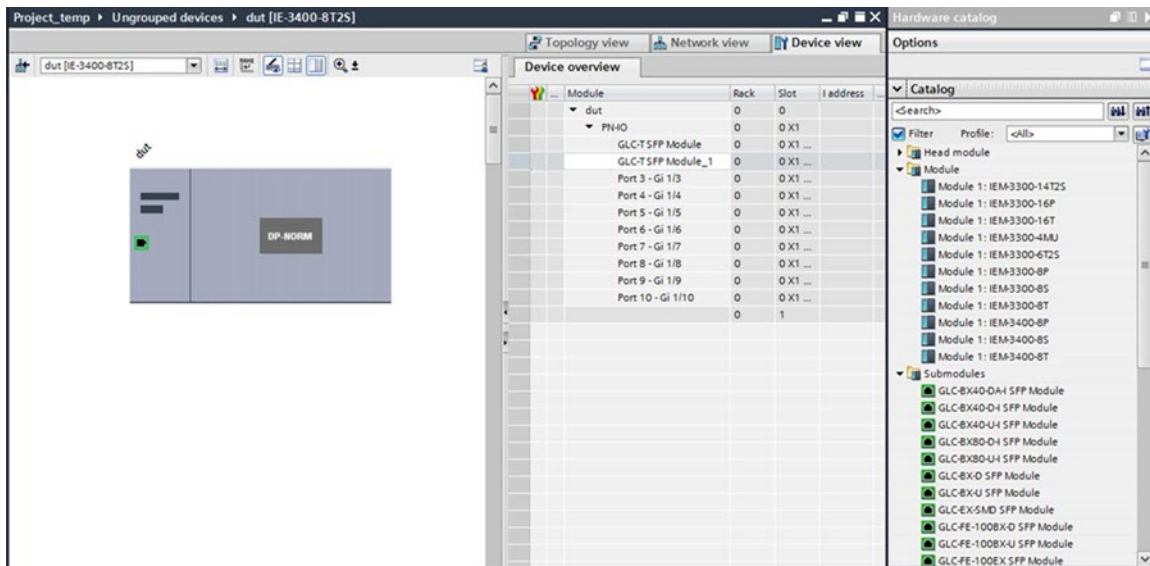

Step 4 After the device is added in the program, discover the device through the interface of the PC connected to the PROFINET topology.

Topology discovery uses LLDP for discovery. LLDP is enabled by default on the switch. You will see the new device listed as **Accessible device** followed by the MAC address under the network card of the PC.

In the **Devices** pane on the left, under **Online access**, find the PC network card and click **Update accessible device**. This initiates the discovery of all the devices in the network.

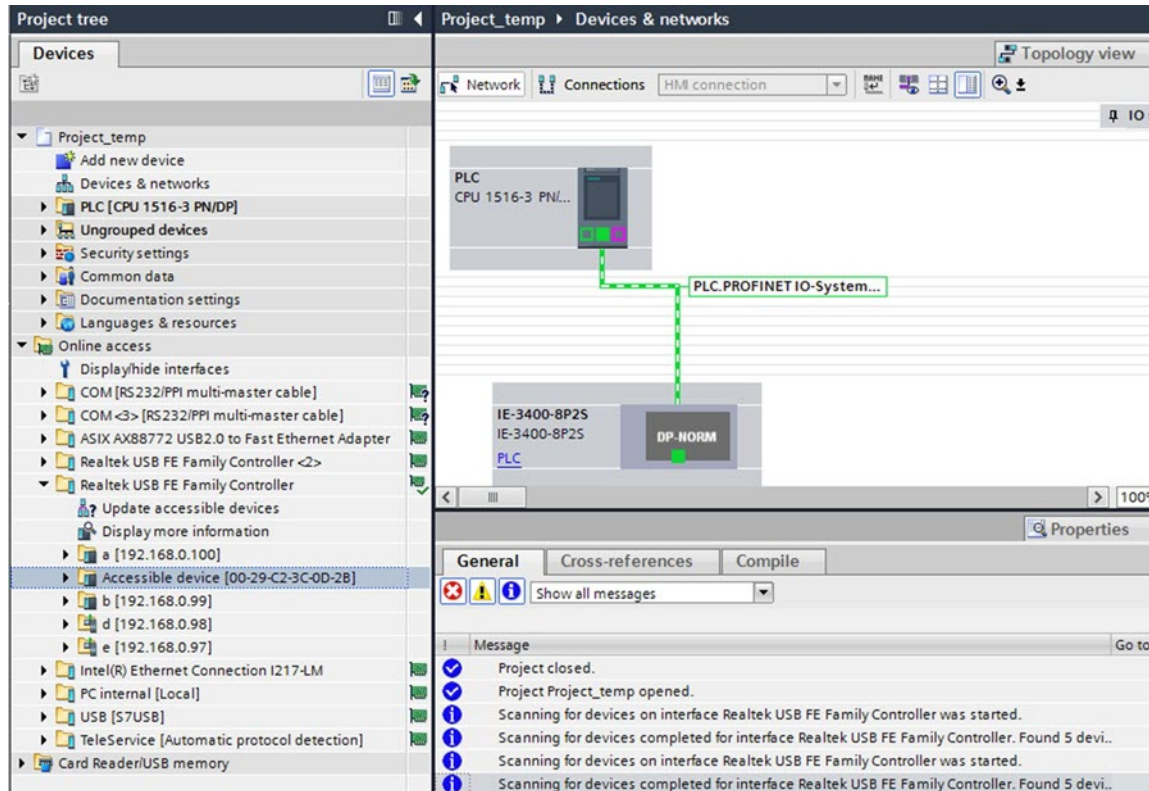

Step 5 In the **Devices** pane, expand the **Accessible device** folder, and click **Online & diagnostics** to further configure the device.

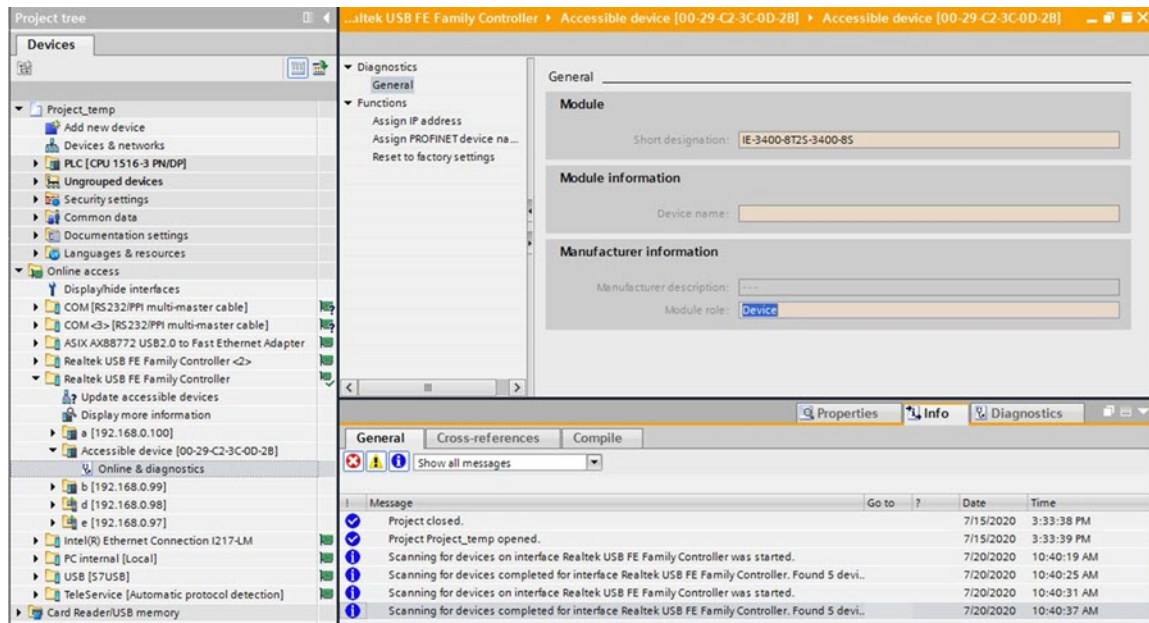

- a) In the **IP address** field, enter the IP address and click **Assign IP address** to push the IP address configuration to the switch.

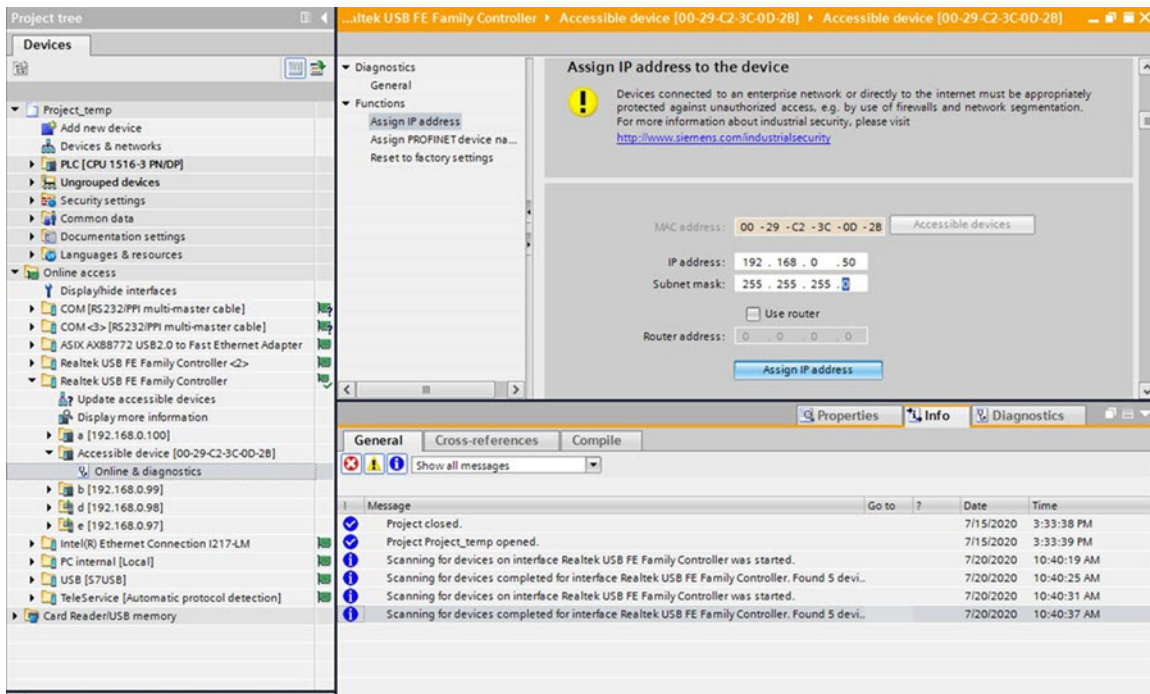

- b) In the **PROFINET device name** field, enter the device name and click **Assign name** to push the device name configuration to the switch.

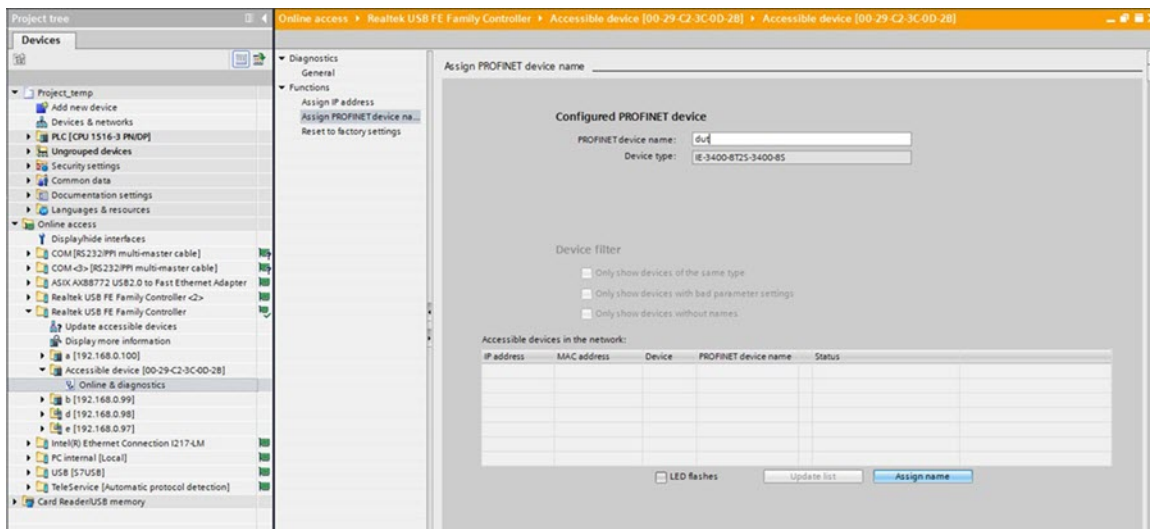

Step 6 Download the project from STEP7/TIA and go online.

- a) Compile, download, and load the project to the PLC (I/O Controller).

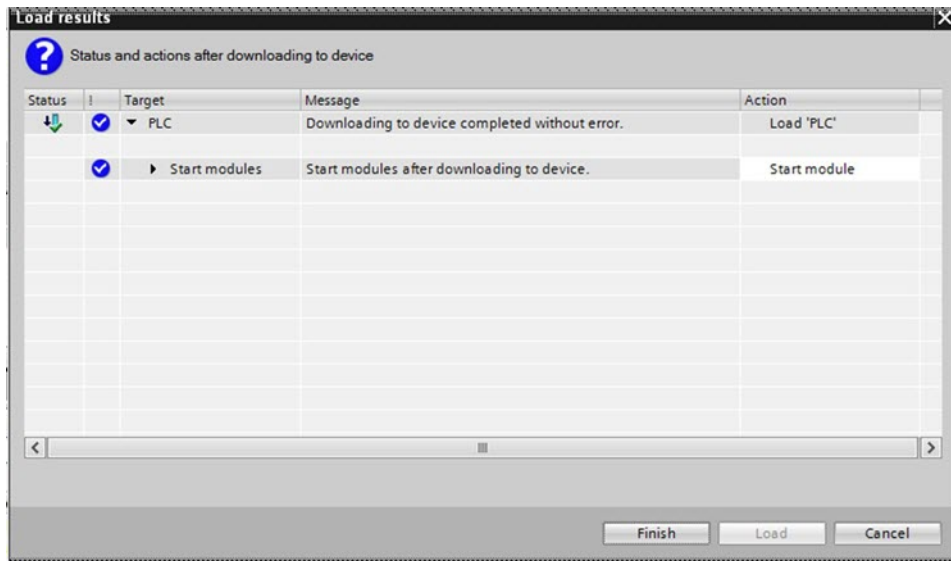
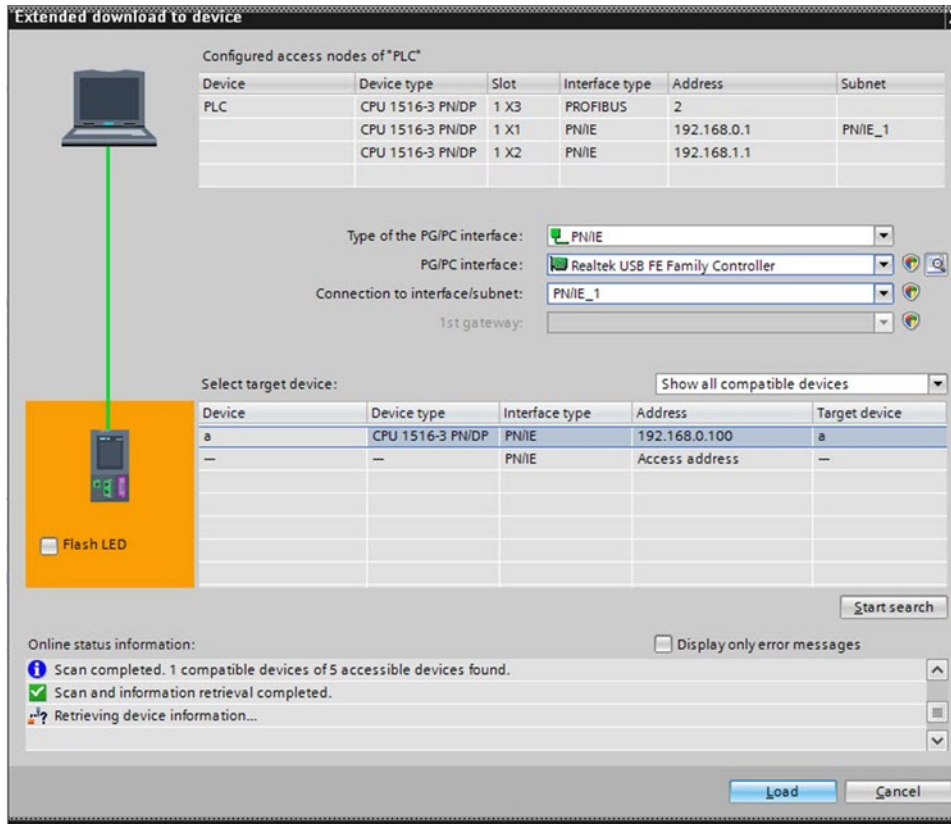

b) Go online.

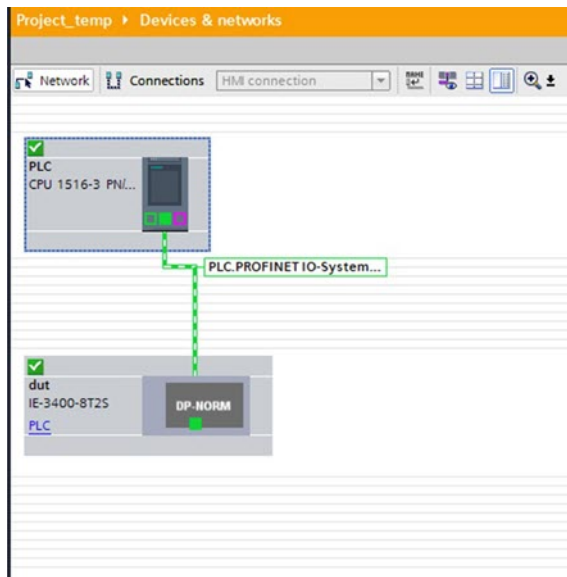

Quality of Service for PROFINET

The switch prioritizes PROFINET traffic using a quality of service (QoS) policy, which is configured when the switch goes into Connected mode. The default configuration for PROFINET QoS is shown here:

```

class-map match-all profinet-cos-2
match cos 2
class-map match-all profinet-cos-3
match cos 3
class-map match-all profinet-cos-1
match cos 1
class-map match-all profinet-cos-6
match cos 6
class-map match-all profinet-cos-7
match cos 7
class-map match-all profinet-cos-4
match cos 4
class-map match-all profinet-cos-5
match cos 5
!
policy-map profinet-qos
class profinet-cos-7
  priority percent 10
class profinet-cos-6
  bandwidth percent 1
class profinet-cos-5
  bandwidth percent 1
class profinet-cos-4
  bandwidth percent 1
class profinet-cos-3
  bandwidth percent 1
class profinet-cos-2
  bandwidth percent 1
class profinet-cos-1
  bandwidth percent 1

```



```

interface GigabitEthernet1/1
service-policy output profinet-qos
!
interface GigabitEthernet1/2
service-policy output profinet-qos

```

To change the QoS policy, for example, for a PROFINET QoS configuration that works regardless of the VLAN tagging on interfaces, it is best to match on PROFINET Ethertype.

COS is a value found in the VLAN tag of an Ethernet frame. To match on COS value, the PROFINET Ethernet frames must have a VLAN tag associated with them. If PROFINET Ethernet frames are being forwarded through the network without VLAN tags, as shown above, then this QoS policy may not work as expected.

```

mac access-list extended Profinet_macacl
permit any any 0x8892 0x0
!
!
class-map match-any COS_6_Class
match cos 6
class-map match-any class_match_profinet_in
match access-group name Profinet_macacl
!
policy-map Profinet_out_policy
class COS_6_Class
priority
policy-map Profinet_in_policy
class class_match_profinet_in
set cos 6
!
!

interface GigabitEthernet1/8
service-policy input Profinet_in_policy
!
interface GigabitEthernet1/9
service-policy output Profinet_out_policy
!

```



Note Use the Cisco IOS **show running-config** command to view the IE switch configuration.

Monitoring and Maintaining PROFINET

Table 3: Commands for Displaying the PROFINET Configuration

Command	Purpose
show profinet alarm	Displays all the alarms supported by PROFINET.
show profinet lldp	Displays whether LLDP is active or inactive on the ports.
show profinet sessions	Displays the currently connected PROFINET sessions.
show profinet status	Displays the status of the PROFINET subsystem.

Command	Purpose
Show profinet mrp ring 1	Displays the status of the MRP ring. Note PROFINET MRP is not supported for Cisco Catalyst IE3100 Rugged Series Switches in Cisco IOS XE Dublin 17.10.1b.
show lldp neighbor interface <i>interface_number</i> detail	Displays information about the adjacent interface.

The following example displays the PROFINET status and currently connected PROFINET sessions.

```
Switch#sh profinet status
Profinet                : Enabled
Connection Status      : Connected
Vlan                    : 1
Profinet ID             : dut
GSD version             : Match
Reduct Ratio           : 128
MRP                     : Enabled
MRP License Status     : Active
MRP Max Rings Allowed  : 3

Switch#sh profinet session
Session #1
-----
Connected: Yes
Number Of IO CR's: 2
Number Of DiffModules: 0

Session #2
-----
Connected: No
Number Of IO CR's: 0
Number Of DiffModules: 2

Session #3
-----
Connected: No
Number Of IO CR's: 0
Number Of DiffModules: 0

Session #4
-----
Connected: No
Number Of IO CR's: 0
Number Of DiffModules: 0
*****
Mode = Standard Mode
```

Troubleshooting PROFINET

The PLC has LEDs that display red for alarms. The I/O supervisor software monitors those alarms.

To troubleshoot PROFINET, use the **debug profinet** privileged EXEC command with the keywords listed in the following table.



Caution Be aware that the output of a **debug** command might cause a Telnet connection to fail due to long debug outputs. When you use this command, use the serial or console port rather than Telnet using Ethernet to access the Cisco IOS CLI. You should use these commands only under the guidance of a Cisco Technical Support engineer.

Table 4: Commands for Troubleshooting the PROFINET Configuration

Command	Purpose
debug profinet alarm	Displays the alarm status (on or off) and content of the PROFINET alarms.
debug profinet cyclic	Displays information about the time-cycle-based PROFINET Ethernet frames.
debug profinet error	Displays the PROFINET session errors.
debug profinet packet ethernet	Displays information about the PROFINET Ethernet packets.
debug profinet packet udp	Displays information about the PROFINET Upper Layer Data Protocol (UDP) packets.
debug profinet platform	Displays information about the interaction between the Cisco IOS software and PROFINET.
debug profinet topology	Displays the PROFINET topology packets received.
debug profinet trace	Displays a group of traced debug output logs.



CHAPTER 2

Adding SFP Modules to Step 7/TIA

- [Supported Small Form-Factor Pluggables, on page 17](#)
- [Adding SFPs to the Hardware Configuration in SS7/TIA, on page 18](#)
- [Feature History, on page 21](#)

Supported Small Form-Factor Pluggables

This chapter describes how to add Small Form-Factor Pluggable (SFP) modules to the SIMATIC STEP7 or TIA Portal Automation applications to enable these applications to recognize the SFP modules in the PROFINET environment.

The following SFPs are supported for Catalyst IE3100 IE3200, and IE3300 Rugged Series switches and Heavy-Duty Series switches. The SFP also are supported for the fiber port expansion module. They can be added to the STEP 7 or TIA Portal Automation application installed on the supervisor.

- GLC-T
- GLC-TE
- GLC-T-RGD
- GLC-FE-100FX-RGD
- GLC-FE-100LX-RGD
- GLC-SX-MM-RGD
- GLC-LX-SM-RGD
- GLC-FE-100FX
- GLC-FE-100LX
- GLC-SX-MMD
- GLC-LH-SMD
- GLC-SX-MM
- GLC-LH-SM

The following are the supported SFPs on IE3300 10-Gigabit Ethernet uplinks along with the 1-Gigabit Ethernet SFPs mentioned above. Note that the 10-Gigabit Ethernet SFPs are supported only on the IE3300 models supporting 10-Gigabit Ethernet interfaces.

- SFP-10G-SR
- SFP-10G-LR
- SFP-10G-ER
- SFP-10G-SR-X
- SFP-10G-LR-X
- SFP-10G-BXD-I
- SFP-10G-BXU-I
- SFP-H10GB-CU1M
- SFP-10G-BX40D-I
- SFP-10G-BX40U-I

Adding SFPs to the Hardware Configuration in SS7/TIA

Follow this procedure to add SFPs to the hardware configuration in STEP7 or TIA.

Before you begin

Install the latest GSD file for your IE switches in STEP7 or TIA (see [Configuring the Switch with STEP7/TIA, on page 6](#) for more information). The GSD file is not backward compatible. Combination ports do not have defaults and must be re-created in STEP7 or TIA with the new GSD file.

-
- Step 1** In STEP7 or TIA, open the project containing the Cisco IE switch, and double-click **Devices & networks** in the **Project tree**.
- Step 2** From the **Hardware catalog** in the hardware and network editor, select the Device Access Point (DAP) name for your switch.

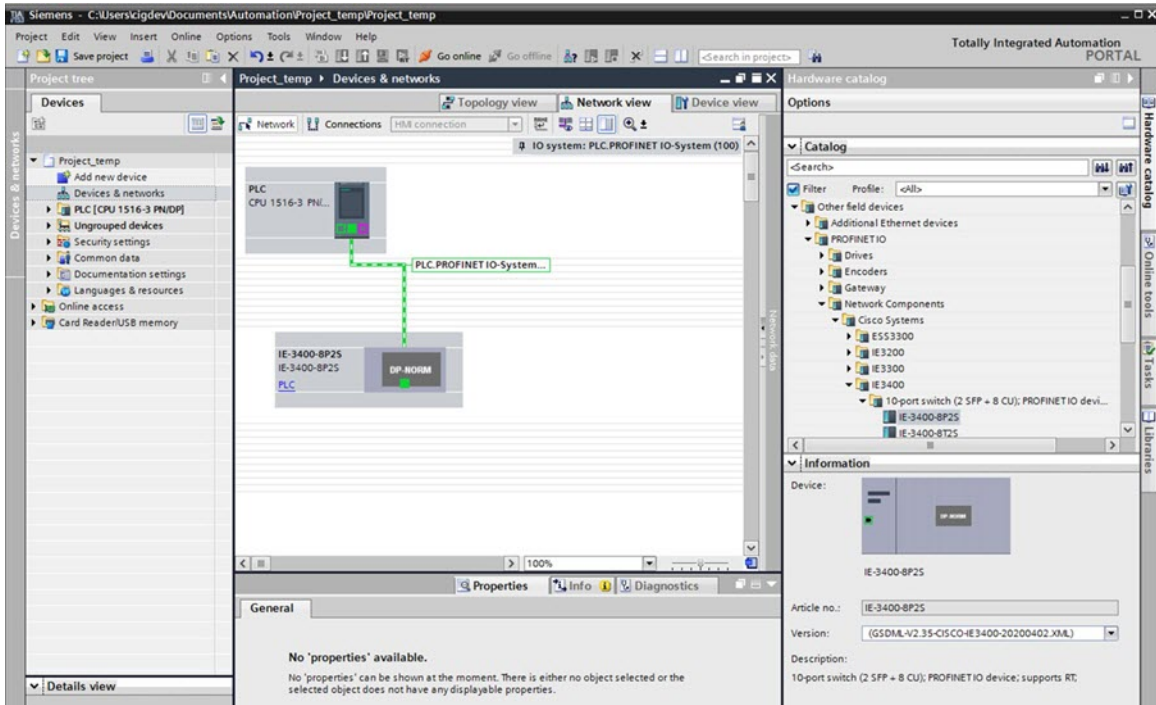

Step 3 Double-click the DAP name to go to **Device view** tab.

Step 4 Expand the PN-IO row in Device overview section if the port list is not displayed.

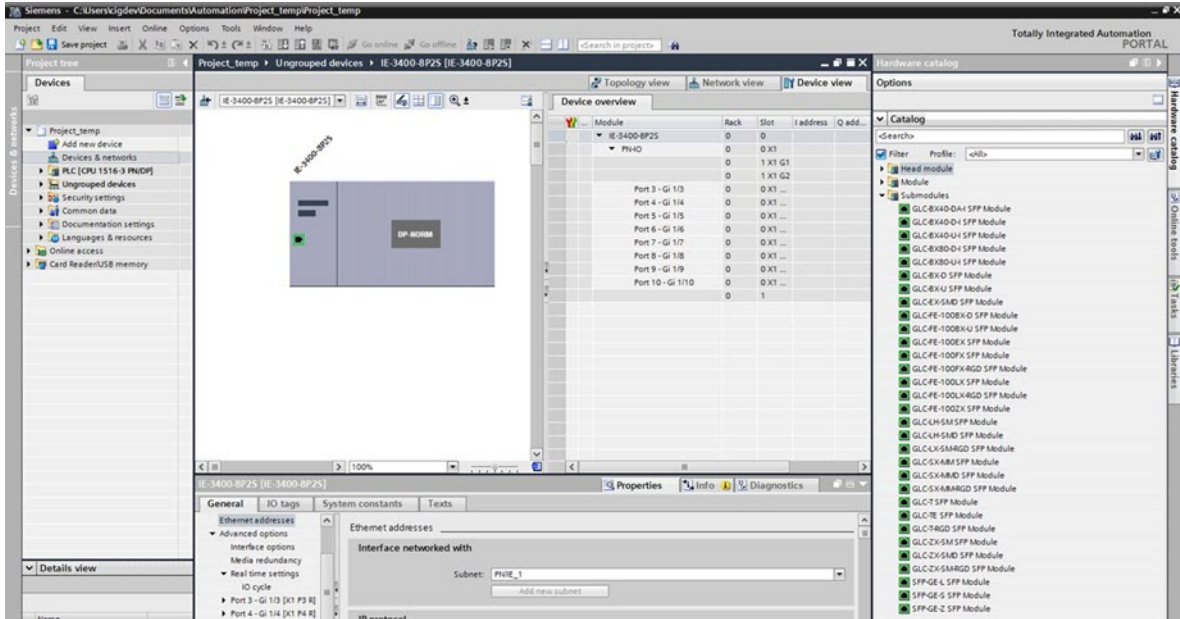

Step 5 Select the modules that you have installed in the switch from the **Hardware catalog** and drag them to the appropriate rows in the table area of **Device view**: Appropriate SFP module for port type (combo port or fiber-only port)

The following figure shows the **Device view** and **Hardware catalog** with SFP modules for IE 3400. There is an uplink module for Gi SFP. SFP GLC-FE-100FX-RGD is dragged to uplink port Gi1/1. The device in TIA is now ready to compile and download.

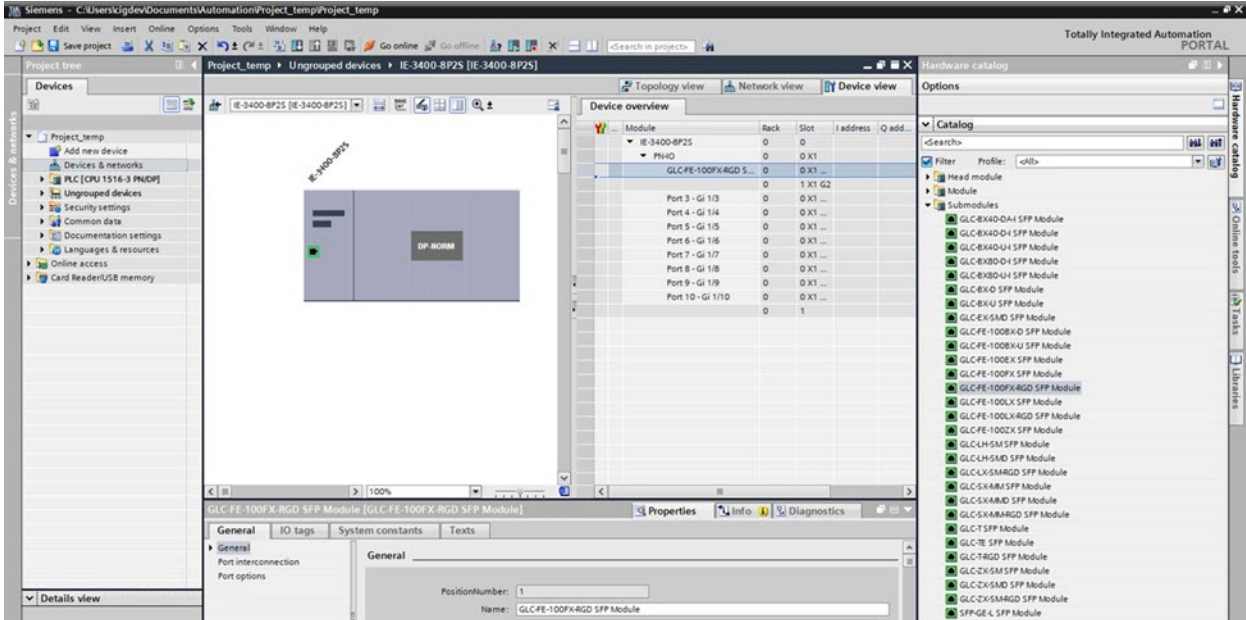

The following figure shows the **Device view** and **Hardware catalog** with SFP modules for IE3400 with the Fiber expansion module that has downlink SFP port Gi2/1-8, and where SFP GLC-FE-100FX-RGD is dragged to uplink port Gi2/8. The device in TIA is now ready to compile and download.

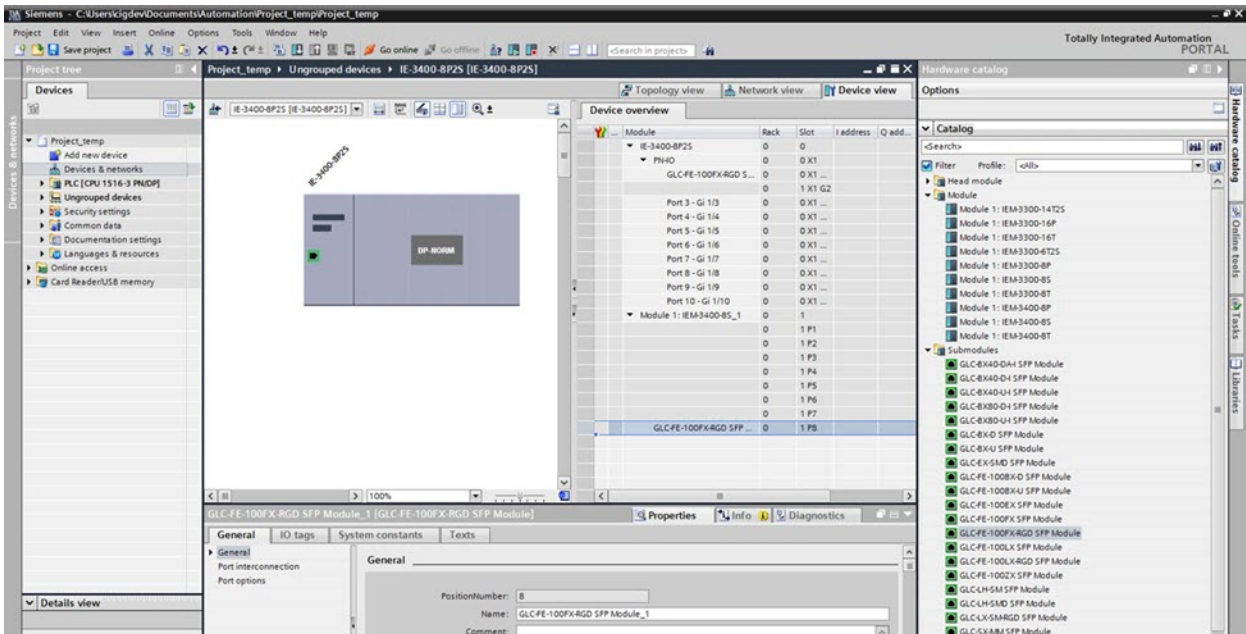

Feature History

Platform	Feature	First Supported Release
IE3x00	Support new SFPs for PROFINET	17.4.1
IE3x00	SFP support enabled for PROFINET	17.3.1

