



Product Overview

- [Switch Models, on page 1](#)
- [Front Panel Components, on page 2](#)
- [Rear Panel, on page 10](#)
- [Network Configurations, on page 11](#)

Switch Models

The following table describes all the available Cisco Catalyst 9200CX Series switches and the features supported.

Table 1: C9200CX Compact Switch Models and Descriptions

Switch Model	Description
C9200CX-8P-2X2G	8x1G PoE+ ports; 2x10G SFP+ and 2x1G fixed uplink ports; powered using 315W internal power supply unit; fanless.
C9200CX-12P-2X2G	12x1G PoE+ ports; 2x10G SFP+ and 2x1G fixed uplink ports; powered using 315W internal power supply unit; fanless.
C9200CX-8P-2XGH	8x1G PoE+ ports; 2x10G SFP+ and 2x1G Copper uplink ports; powered using 315W internal power supply unit; fanless; high-voltage DC (HVDC).
C9200CX-12P-2XGH	12x1G PoE+ ports; 2x10G SFP+ and 2x1G Copper fixed uplink ports; powered using 315W internal power supply unit; fanless; HVDC.
C9200CX-12T-2X2G	12x1G Ethernet ports, 2x10G SFP+ and 2x1G Copper uplink ports; powered by either an external auxiliary power adapter or the PoE Class 6 PD uplink port; fanless.
C9200CX-8UXG-2X	4x10G Multigigabit Ethernet UPoE * ¹ and 4x1G UPoE ports; 2x10G SFP+ fixed uplink ports; powered using 315W internal power supply unit; fanless.

Switch Model	Description
C9200CX-8UXG-2XH	4x10G Multigigabit Ethernet UPoE * and 4x1G UPoE ports; 2x10G SFP+ fixed uplink ports; powered using 315W internal power supply unit; fanless; HVDC.

¹ * Multigigabit Ethernet ports are 802.3bt Type 3 (60W) interfaces, supporting up to Class 6 on each port.

Front Panel Components

This section describes the front panel components of Cisco Catalyst 9200CX Series switches:

- 8 or 12 downlink ports of one of the following types:
 - 10/100/1000
 - 10/100/1000 PoE+
 - 10 M/100 M/1000 M Cisco UPoE
 - Multigigabit Ethernet 10M/100 M/1 GE/2.5 GE/5 GE/10 GE
- 1G/10G Uplink ports
- USB Type A storage port
- USB micro-Type B console port
- LEDs
- Blue Beacon
- SD card slot
- Internal power supply connector for compact switches

Front Panel of a C9200CX-8P-2X2G Switch

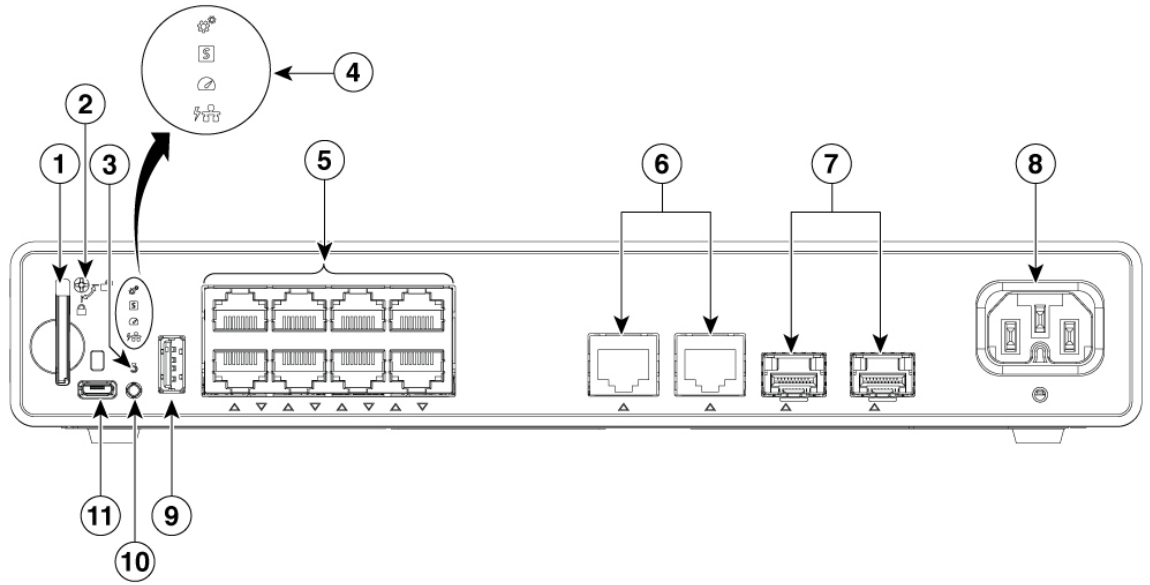

1	SD Card slot	7	2x10G SFP+ uplink ports
2	SD Card security lock	8	Internal power supply connector
3	Blue Beacon	9	USB Type A connector
4	Status LEDs	10	Mode button
5	8x1G PoE+ ports	11	USB micro-Type B (console) port
6	2x1G uplink ports	-	-

Front Panel of a C9200CX-12P-2X2G Switch

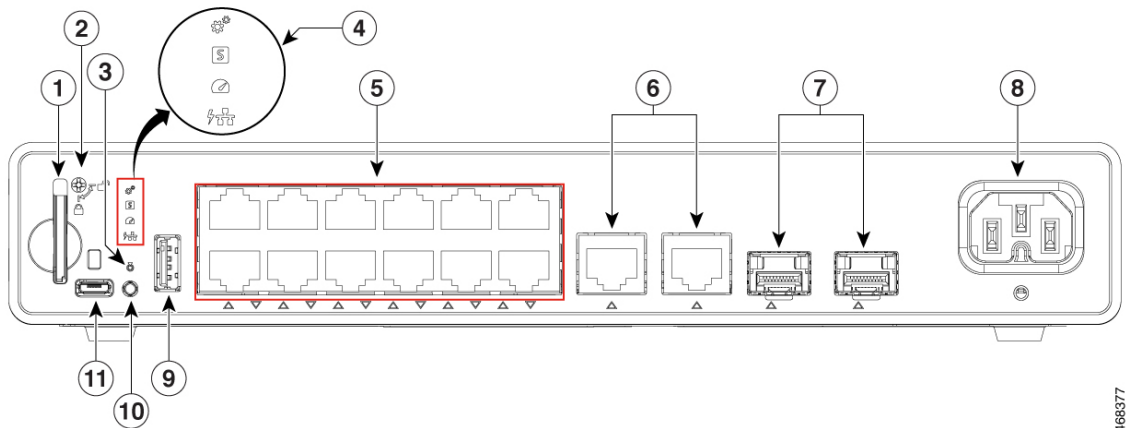

1	SD Card slot	7	2x10G SFP+ uplink ports
---	--------------	---	-------------------------

468377

2	SD Card security lock	8	Internal power supply connector
3	Blue Beacon	9	USB Type A connector
4	Status LEDs	10	Mode button
5	10/100/1000 PoE+ ports	11	USB micro-Type B (console) port
6	2x1G copper uplink ports	-	-

Front Panel of a C9200CX-8P-2XGH Switch

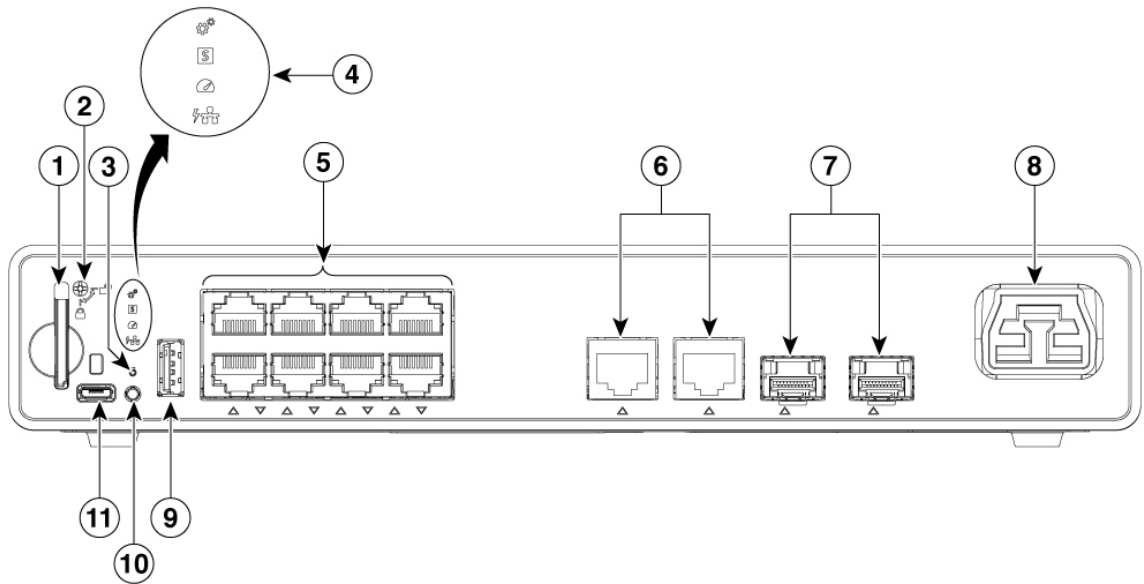

1	SD Card slot	7	2x10G SFP+ uplink ports
2	SD Card security lock	8	Saf-D-Grid Power Connector
3	Blue Beacon	9	USB Type A connector
4	Status LEDs	10	Mode button
5	8x1G POE+ ports	11	USB micro-Type B (console) port
6	2x1G copper uplink ports	-	

Front Panel of a C9200CX-12P-2XGH Switch

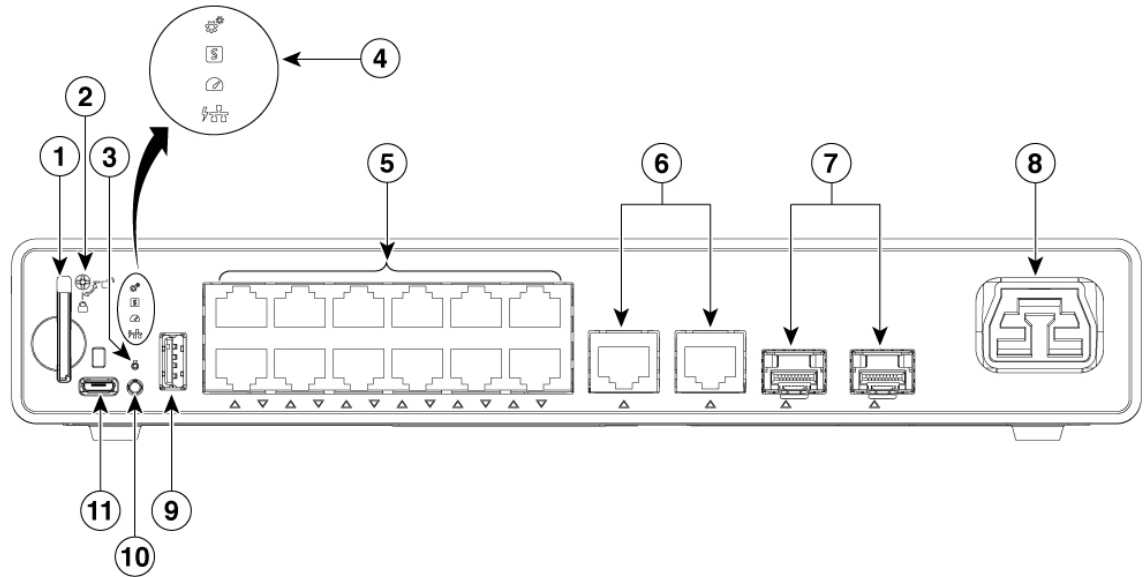

1	SD Card slot	7	2x10G SFP+ uplink ports
2	SD Card security lock	8	Saf-D-Grid Power Connector
3	Blue Beacon	9	USB Type A connector
4	Status LEDs	10	Mode button
5	12x1G POE+ ports	11	USB micro-Type B (console) port
6	2x1G copper uplink ports	-	

Front Panel of a C9200CX-12T-2X2G Switch

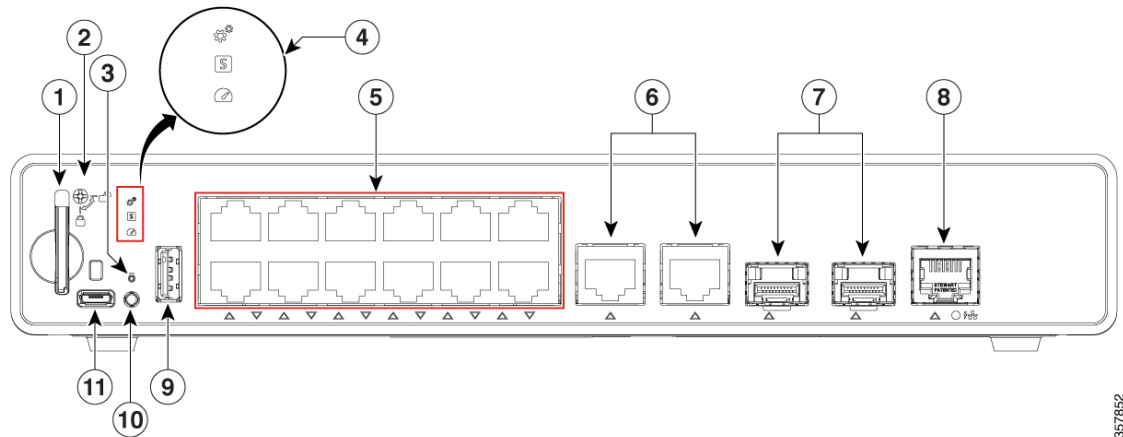

1	SD Card slot	7	2x10G SFP+ uplink ports
---	--------------	---	-------------------------

357852

2	SD Card security lock	8	1G copper uplink PD port
3	Blue Beacon	9	USB Type A connector
4	Status LEDs	10	Mode button
5	10/100/1000 Ethernet downlink ports	11	USB micro-Type B (console) port
6	2x1G copper uplink ports	-	-

Front Panel of a C9200CX-8UXG-2X Switch

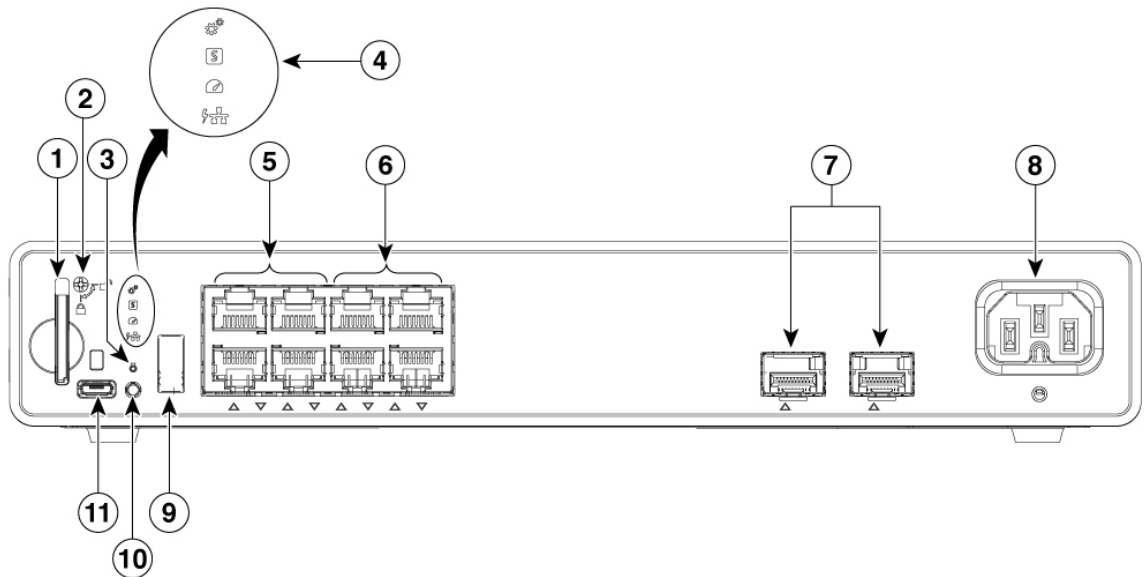

1	SD Card slot	7	2x10G SFP+ uplink ports
2	SD Card security lock	8	1G copper uplink PD port
3	Blue Beacon	9	USB Type A connector
4	Status LEDs	10	Mode button
5	4x10G Multigigabit Ethernet UPoE ports	11	USB micro-Type B (console) port
6	4x1G UPoE ports	-	

Front Panel of a C9200CX-8UXG-2XH Switch

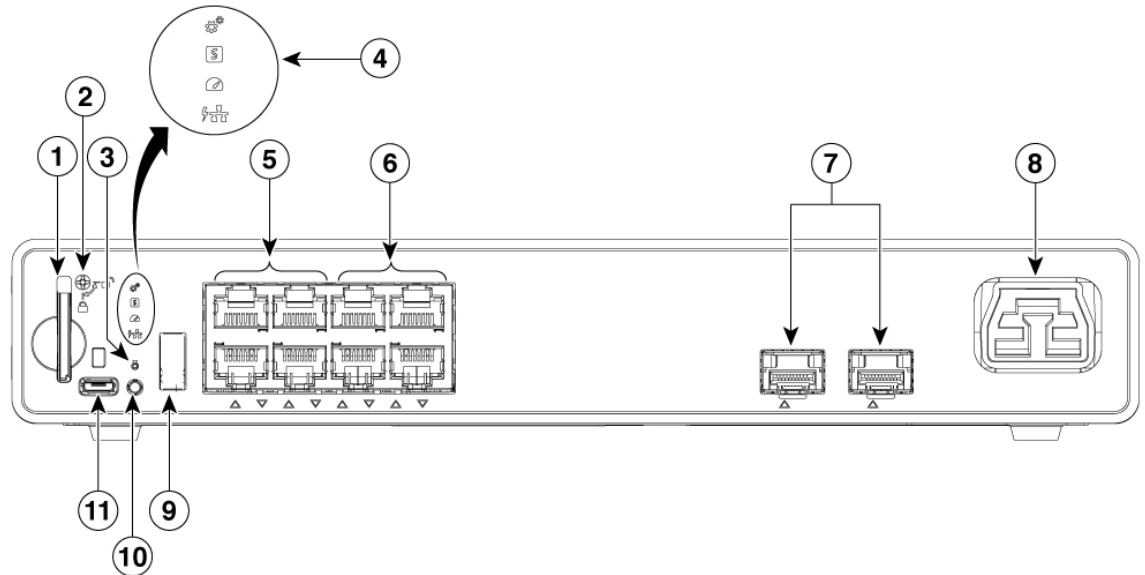

1	SD Card slot	7	2x10G SFP+ uplink ports
2	SD Card security lock	8	Saf-D-Grid Power Connector
3	Blue Beacon	9	USB Type A connector
4	Status LEDs	10	Mode button
5	4x10G Multigigabit Ethernet UPoE ports	11	USB micro-Type B (console) port
6	4x1G UPoE ports	-	

10/100/1000 Ports

The 10/100/1000 ports use RJ-45 connectors with Ethernet pinouts. The maximum cable length is 328 feet (100 meters). The 100BASE-TX and 1000BASE-T traffic requires twisted pair (UTP) cable of Category 5 or higher. The 10BASE-T traffic can use Category 3 cable or higher.

PoE, PoE+, and UPoE Ports

The PoE+ and Cisco Universal Power over Ethernet (Cisco UPoE) ports provide the following functionality:

- PoE/PoE+ ports: Support for IEEE 802.3af-compliant powered devices (up to 15.4W PoE per port) and support for IEEE 802.3at-compliant powered devices (up to 30W PoE+ per port).
- Cisco UPoE ports: Support for Type 1 (IEEE 802.3af), Type 2 (IEEE 802.3at), Type 3 (IEEE 802.3bt), and Cisco UPoE powered devices delivering up to 60 W PoE per port.
- Support for pre-standard Cisco powered devices.

- Configurable support for Cisco intelligent power management, including enhanced power negotiation, power reservation, and per-port power policing.

See the [Internal Power Supply, on page 11](#) section, for the power supply matrix that defines the available PoE, PoE+, and UPoE power per port. The PoE circuit has been evaluated to meet the limits for Limited Power Source (LPS) per Annex Q in IEC/UL 62368-1. It has also been evaluated as a class ES1, PS2.

Multigigabit Ethernet Ports

The Multigigabit (mGig) Ethernet ports can be configured to auto-negotiate multiple speeds on switch ports. The ports support 100 Mbps, 1 Gbps, 2.5 Gbps, and 5 Gbps speeds on Category 5e (Cat5e) cables, and up to 10 Gbps over Category 6 (Cat6) and Category 6A (Cat6A) cables up to a maximum of 100 m. 10Gbps over Cat6 cable is limited for distances up to 55 m. For 10GBASE-T, Cat6a can support up to 100 m when transmitting 10Gbps. Due to the extra bandwidth requirements from the cable, additional limitations exist for best performance. These limitations include, but are not limited to cable reach, cable bundling parameters (tightness, frequency, number of cables, speed with respect to each cable) and cable termination quality.

The 802.3 channel requirements for interoperability typically limit the cable reach to 100 m, but other factors can shorten this reach. In addition, for both Cisco UPoE and Cisco UPoE+ and data integrity, the 100 m total should not include more than 10 m total stranded or patch cable. Therefore, it is assumed that a 100 m link includes a maximum of two 5 m patch cables of the appropriate category, and 90 m of plenum or riser (i.e. solid copper core) cables. Ensure that you follow the TIA guidance on cable dressing.

It is recommended to test the complete link using an appropriate cable tester for 10 Gbps as well as 5 Gbps links. However, even if the link passes cable testing, it is still prone to occasional errors due to aggressors in the bundle, and physical disturbances of the cables. As an example of bundling limitations, for 5 Gbps with cat5e cable, only a total 45 m bundled length is supported; the remaining 55 m should be unbundled. For bundling, follow [Cisco Guidelines and Best Practices for the Installation and Maintenance of Data Networking Equipment](#), which recommends the use of Velcro ties every 1 to 2 m for bundled sections.

If you are upgrading the network gear but reusing the existing cable plant, note that at speeds above 2.5 Gbps traditional Cat5e channel specifications do not support full 100 m reach. To ensure 5 Gbps link speeds, we recommend using Cat6a cabling. For more information, see the Whitepaper from NBASE-T alliance, which has now merged with Ethernet Alliance, archived at <https://archive.nbaset.ethernetalliance.org/library/white-paper-2/>.



Note Multigigabit ports do not support half duplex mode. Use full duplex mode.

C9200CX-12T only PD Port

The PD port on C9200CX-12T switches is a 802.3bt class 6 port capable of powering the switch. It can accept PoE power of 51W to power the switch as an alternative to the auxiliary power input. The PD power is mutually exclusive from the auxiliary power input, and the auxiliary power input takes priority when used.

USB Type A Port

The USB Type A port provides access to external USB flash devices (also known as thumb drives or USB keys).

The port supports Cisco USB flash drives with capacities from 128 MB to 8 GB. USB devices with port densities of 128 MB, 256 MB, 1 GB, 4 GB, and 8 GB are supported. Cisco IOS software provides standard file system access to the flash device: read, write, erase, and copy, as well as the ability to format the flash device with a FAT file system.

It provides you with the ability to automatically upgrade the internal flash with the USB drive's configuration and image for emergency switch recovery using USB auto-upgrade. This feature checks the internal flash for a bootable image and configuration and if either image or the configuration is not available, then the USB drive is checked for boot images and configuration. If the boot image and configuration are available, these are copied to flash for the reboot.

USB Micro-B Port

The USB Micro-B port on the front panel that provides administrative access to the switch through a console terminal or a PC. It allows you to use a PC, Mac, or Linux machine with the appropriate drivers to connect to the USB micro Type-B port and gain access to the console port on the switch.

Alternatively, if you want to access the console using an RJ45 connection, you must use the Cisco USB micro-B to RJ45 adapter.

SD Card Slot

Cisco Catalyst 9200CX compact switches support an SD (Secure Digital) Card that extends the onboard flash storage memory on the switch.

The SD card can be used instead of the internal flash memory of the switch to update or restore configuration settings. Additionally, the SD card can be used to boot the switch. You can boot a switch from its internal flash memory or from an SD card; SD card takes precedence over internal flash memory. You can also copy IOS software and switch configuration settings from a PC or from the switch to the SD card, and then use the SD card to copy this software and settings to other switches.

You can access an SD card using the switch boot loader or the command prompt.

Figure 1: SD Card Slot

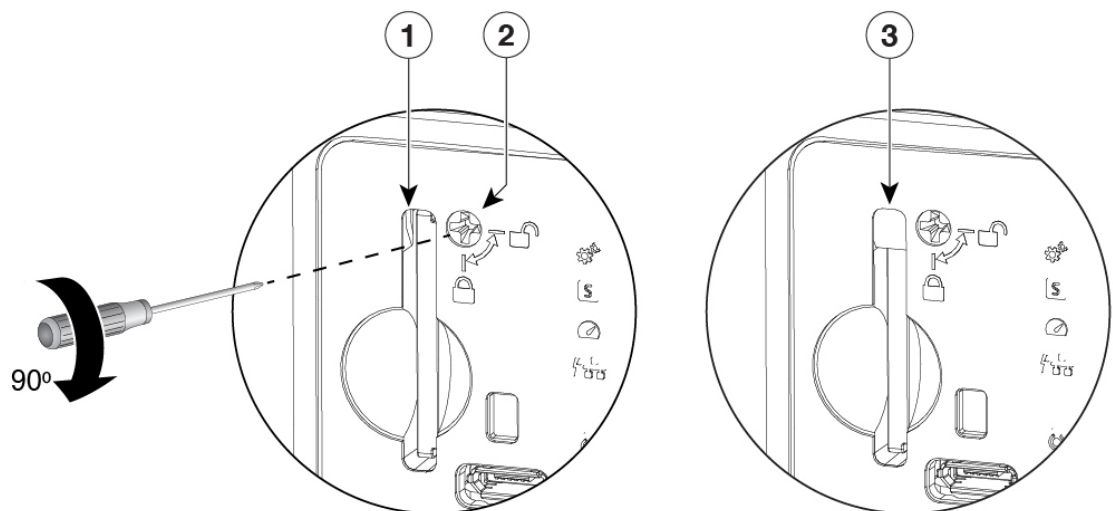

357863

1	SD Card slot in unlocked position	3	SD Card slot in locked position
2	<p>SD lock</p> <p>Note Carefully rotate the SD lock at 90° to lock or unlock the SD card slot. Do not apply excessive pressure while rotating the lock to the extreme end, to prevent it from damaging the lock.</p>		

Uplink Ports

The C9200CX compact switches provide fixed uplink ports that support 10G SFP+ and 1G SFP modules. For information about installing an optic module, see [Installing an SFP or SFP+ Module](#). The SFP+ uplink ports and copper uplink ports on the switch can function simultaneously.

Rear Panel

Figure 2: Rear Panel of a C9200CX-12T-2X2G Switch

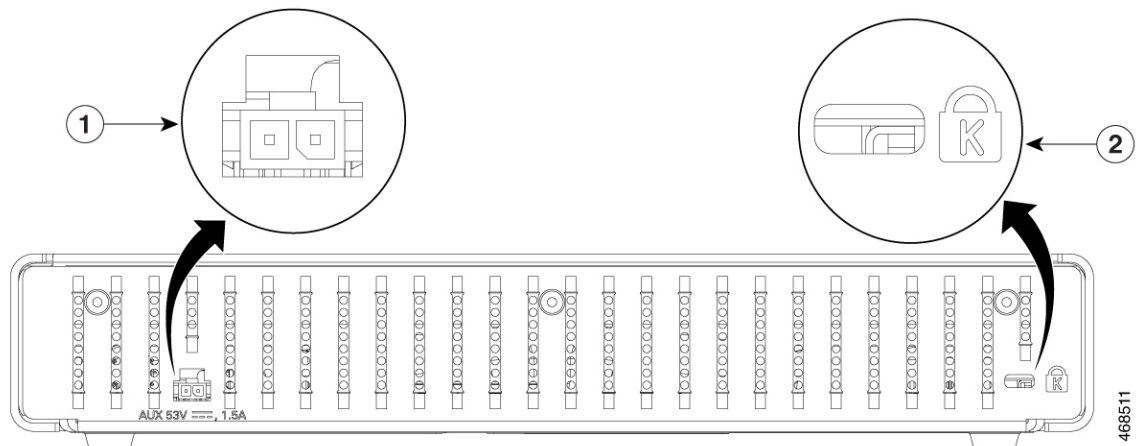

1	Auxiliary power connector	2	Security lock slot
			<p>Note The security slot on the C9200CX-8P-2X2G and C9200CX-12P-2X2G switches are available on the left side of switch at the rear.</p>

RFID Tag

The switch has a built-in, front-facing, passive RFID tag that uses UHF RFID technology and requires an RFID reader with compatible software. It provides auto-identification capabilities for asset management and tracking. The RFID tags are compatible with the Generation 2 GS1 EPC Global Standard and are ISO 18000-6C

compliant. They operate in the 860- to 960-MHz UHF band. For more information, see [Radio Frequency Identification \(RFID\) on Cisco Catalyst 9000 Family Switches White Paper](#).

Auxiliary Power Adapter

C9200CX-12T-2X2G switches can be powered either through the 1G copper uplink port connected to a PoE PSE port capable of providing IEEE 802.3bt Class 6 power or through an auxiliary AC-DC(PWR-ADPT) or DC-DC(C9K-ADPT-DC) power adapter. If the switch has both PD power and auxiliary power adapter connected, the auxiliary power takes precedence over PD power and the PD port gets disabled. If both are connected and the auxiliary power source is removed, the switch resets for the PD to perform detection and classification before providing power to the system.

You can order the power adapter with the switch, or you can order it later from your Cisco representative.

Internal Power Supply

All the compact switches except C9200CX-12T-2X2G are powered through internal power supplies. The internal power supply is an autoranging unit that supports input voltages between 100 and 240 VAC (max of 90V to 264V). The AC frequency of the power supply is 50Hz/60Hz.

The HVDC switches operate on 380 VDC. These switches can also operate in the input voltage between 100 to 277 VAC with the frequency of 50Hz/60 Hz.

You must plug the AC power cord into the AC power connector and into an AC power outlet.

Table 2: Available PoE with AC and HVDC Power Supply

Models	Default Power Supply	Available PoE
C9200CX-8P-2X2G	315W Internal	240W
C9200CX-12P-2X2G	315W Internal	240W
C9200CX-8P-2XGH	315W HVDC Internal	240W
C9200CX-12P-2XGH	315W HVDC Internal	240W
C9200CX-8UXG-2X	315W Internal	240W
C9200CX-8UXG-2XH	315W HVDC Internal	240W

Network Configurations

See the switch software configuration guide for network configuration concepts and examples of using the switch to create dedicated network segments and interconnecting the segments through Fast Ethernet and Gigabit Ethernet connections.

