



## **Cisco Catalyst SD-WAN Getting Started Guide**

**First Published:** 2019-04-25

**Last Modified:** 2024-09-30

### **Americas Headquarters**

Cisco Systems, Inc.  
170 West Tasman Drive  
San Jose, CA 95134-1706  
USA  
<http://www.cisco.com>  
Tel: 408 526-4000  
800 553-NETS (6387)  
Fax: 408 527-0883

THE SPECIFICATIONS AND INFORMATION REGARDING THE PRODUCTS IN THIS MANUAL ARE SUBJECT TO CHANGE WITHOUT NOTICE. ALL STATEMENTS, INFORMATION, AND RECOMMENDATIONS IN THIS MANUAL ARE BELIEVED TO BE ACCURATE BUT ARE PRESENTED WITHOUT WARRANTY OF ANY KIND, EXPRESS OR IMPLIED. USERS MUST TAKE FULL RESPONSIBILITY FOR THEIR APPLICATION OF ANY PRODUCTS.

THE SOFTWARE LICENSE AND LIMITED WARRANTY FOR THE ACCOMPANYING PRODUCT ARE SET FORTH IN THE INFORMATION PACKET THAT SHIPPED WITH THE PRODUCT AND ARE INCORPORATED HEREIN BY THIS REFERENCE. IF YOU ARE UNABLE TO LOCATE THE SOFTWARE LICENSE OR LIMITED WARRANTY, CONTACT YOUR CISCO REPRESENTATIVE FOR A COPY.

The Cisco implementation of TCP header compression is an adaptation of a program developed by the University of California, Berkeley (UCB) as part of UCB's public domain version of the UNIX operating system. All rights reserved. Copyright © 1981, Regents of the University of California.

NOTWITHSTANDING ANY OTHER WARRANTY HEREIN, ALL DOCUMENT FILES AND SOFTWARE OF THESE SUPPLIERS ARE PROVIDED "AS IS" WITH ALL FAULTS. CISCO AND THE ABOVE-NAMED SUPPLIERS DISCLAIM ALL WARRANTIES, EXPRESSED OR IMPLIED, INCLUDING, WITHOUT LIMITATION, THOSE OF MERCHANTABILITY, FITNESS FOR A PARTICULAR PURPOSE AND NON-INFRINGEMENT OR ARISING FROM A COURSE OF DEALING, USAGE, OR TRADE PRACTICE.

IN NO EVENT SHALL CISCO OR ITS SUPPLIERS BE LIABLE FOR ANY INDIRECT, SPECIAL, CONSEQUENTIAL, OR INCIDENTAL DAMAGES, INCLUDING, WITHOUT LIMITATION, LOST PROFITS OR LOSS OR DAMAGE TO DATA ARISING OUT OF THE USE OR INABILITY TO USE THIS MANUAL, EVEN IF CISCO OR ITS SUPPLIERS HAVE BEEN ADVISED OF THE POSSIBILITY OF SUCH DAMAGES.

Any Internet Protocol (IP) addresses and phone numbers used in this document are not intended to be actual addresses and phone numbers. Any examples, command display output, network topology diagrams, and other figures included in the document are shown for illustrative purposes only. Any use of actual IP addresses or phone numbers in illustrative content is unintentional and coincidental.

All printed copies and duplicate soft copies of this document are considered uncontrolled. See the current online version for the latest version.

Cisco has more than 200 offices worldwide. Addresses and phone numbers are listed on the Cisco website at [www.cisco.com/go/offices](http://www.cisco.com/go/offices).

Cisco and the Cisco logo are trademarks or registered trademarks of Cisco and/or its affiliates in the U.S. and other countries. To view a list of Cisco trademarks, go to this URL: <https://www.cisco.com/c/en/us/about/legal/trademarks.html>. Third-party trademarks mentioned are the property of their respective owners. The use of the word partner does not imply a partnership relationship between Cisco and any other company. (1721R)

© 2019–2024 Cisco Systems, Inc. All rights reserved.



## CONTENTS

---

<b>CHAPTER 1</b>	<b>Read Me First</b>	<b>1</b>
------------------	----------------------	----------

---

<b>CHAPTER 2</b>	<b>What's New in Cisco IOS XE (SD-WAN) and Cisco Catalyst SD-WAN Releases</b>	<b>3</b>
------------------	---	----------

---

<b>CHAPTER 3</b>	<b>The Cisco Catalyst SD-WAN Solution</b>	<b>5</b>
	The Cisco Catalyst SD-WAN Solution	5
	Cisco Catalyst SD-WAN Solution	5
	The Need for Cisco Catalyst SD-WAN Solution	5
	Challenges in Legacy Network Design	6
	Cisco Catalyst SD-WAN Solution	6
	The Virtual IP Fabric	8
	Cisco Catalyst SD-WAN Components	13
	Primary Cisco Catalyst SD-WAN Components	13
	Cisco Catalyst SD-WAN Manager	14
	Cisco Catalyst SD-WAN Controller	15
	Cisco Catalyst SD-WAN Validator	16
	Cisco vEdge Devices and Cisco IOS XE Catalyst SD-WAN Devices	17
	Cisco Catalyst SD-WAN Control Connections	19
	Information About Cisco Catalyst SD-WAN Control Connections	19
	Benefits of TLS 1.3 in Cisco Catalyst SD-WAN Control Connections	20
	Verify Cisco Catalyst SD-WAN Control Connections	20
	Cisco Catalyst SD-WAN Solution	23
	Cloud onRamp for SaaS	23
	Cisco Catalyst SD-WAN Analytics	24
	Cisco Catalyst SD-WAN Portal	24
	Cisco SD-AVC	25

Work with Cisco Catalyst SD-WAN	25
Build a Basic Overlay Network using Cisco vEdge Devices	25
Cisco Catalyst SD-WAN Terminology	29
Domain ID	30
OMP Routes	30
Site ID	31
System IP Address	31
TLOC	31
Additional Information	31
<hr/>	
<b>CHAPTER 4</b>	<b>Hardware and Software Installation 33</b>
Server Recommendations	34
Device Configuration Reset of Cisco IOS XE Catalyst SD-WAN devices after Adding or Removing Modules	34
On-Site Bootstrap Process for Cisco Catalyst SD-WAN Devices	35
On-Site Bootstrap Process for Cisco vEdge 5000 using SHA2 Enterprise Certificates	37
Generate a Bootstrap File For Cisco IOS XE Catalyst SD-WAN Devices Using the CLI	42
One Touch Provisioning: Onboard Cisco IOS XE Catalyst SD-WAN Devices Using Generic Bootstrap Configuration	43
Installing Cisco SD-AVC, Cisco vManage 20.1.1 and Earlier	47
Enabling SD-AVC on Cisco SD-WAN Manager	48
Enable SD-AVC on Cisco IOS XE Catalyst SD-WAN Devices	49
Install Cisco SD-AVC, Cisco vManage Release 20.3.1 and Later	50
Enable Cisco SD-AVC, Cisco vManage Release 20.3.1 and Later	50
Enable SD-AVC on Cisco IOS XE Catalyst SD-WAN Devices	51
Enable Cisco SD-AVC Cloud Connector, Cisco Catalyst SD-WAN Manager Release 20.14.1 and Later	52
Enable Cisco SD-AVC Cloud Connector, through Cisco Catalyst SD-WAN Manager Release 20.13.x	53
Software Installation and Upgrade for Cisco IOS XE Routers	59
Before You Begin	60
Download Cisco IOS XE Catalyst SD-WAN Software for Cisco IOS XE SD-WAN Release 16.12 and Earlier	61
Install the Cisco IOS XE Catalyst SD-WAN Software for Cisco IOS XE SD-WAN Release 16.12 and Earlier	62

Configure IOS XE Router Using CLI	64
Add IOS XE Devices to the Plug and Play Portal	67
Upgrading or Downgrading ROMMON	67
Perform Factory Reset	68
Recover the Default Password	69
Software Installation and Upgrade for vEdge Routers	70
Software Image Signing	70
Software Version Compatibility	70
Install the Software	70
Upgrade the Software	71
Best Practices for Software Upgrades	72
Obtain Software Images from Cisco Catalyst SD-WAN	73
Add New Software Images to the Repository	74
Upgrade the Software Image	75
Activate a New Software Image	75
View Log of Software Upgrade Activities	76
Upgrade a Software Image from the CLI	76
Redundant Software Images	77
Downgrade a Cisco vEdge Device to an Older Software Image	77
Upgrade Memory and vCPU Resources on a Virtual Machine Hosting Cisco Catalyst SD-WAN Manager	78
Expand the Secondary Disk Size, Cisco Catalyst SD-WAN Manager Release 20.12.x and Earlier	80
Software Maintenance Upgrade for Cisco IOS XE Catalyst SD-WAN Devices	80
Information About Software Maintenance Upgrade	81
Supported Devices for Software Maintenance Upgrade	82
Manage Software Maintenance Upgrade Images	82
Manage Software Maintenance Upgrade Images Using the CLI	83
Verify Status of Software Maintenance Upgrade Images	85
<b>CHAPTER 5</b>	<b>Install and Upgrade Cisco IOS XE Catalyst SD-WAN Release 17.2.1r and Later</b>
Platforms Supported in Controller Mode	90
Cisco IOS XE Image Compatibility	91
Upgrade Considerations	91
Restrictions	92

Self-Signed Trustpoint	92
Introducing Autonomous and Controller Mode	93
Software Installation for Cisco IOS XE Routers	93
Download the Software for Cisco IOS XE Release 17.2.1r or Later	93
Install Software on Cisco ASR, Cisco ISR and Cisco ENCS Platforms	94
Install Software on Cisco CSR 1000v Platform	94
Install a Cisco Catalyst 8000V Edge Software Platform	94
Plug and Play in Cisco IOS XE Catalyst SD-WAN Release 17.2.1r and Later Releases	95
Plug and Play Onboarding Workflow	95
Mode Discovery with Plug and Play Onboarding	96
Automatic IP Address Detection	97
Non-PnP Onboarding	99
Creating a Cisco Catalyst SD-WAN Bootstrap Configuration File	99
New Installation: Mode Change Device Day Zero Scenario	99
Switch Modes Using Cisco CLI	99
Mode Discovery and Mode Change with Bootstrap Files	101
Reset Controller Mode Configuration	103
Mode Switching: Additional Information	105
Configuration Persistence During Mode Switch	105
Verify Controller and Autonomous Modes	105
Show Command Output for Controller Mode	105
Show Command Output for Autonomous Mode	106
Change the Console Port Access After Installation, in Controller Mode	106
Upgrade to Cisco IOS XE Release 17.2.1r or Later	108
Supported Upgrades	108
Upgrade Using Cisco Catalyst SD-WAN	110
Upgrade Using CLI	110
Downgrade from Cisco IOS XE Catalyst SD-WAN Release 17.2.1r or Later Releases	112
Downgrade a Cisco IOS XE Catalyst SD-WAN Device to a Previously Installed Software Image	112
Downgrade a Cisco IOS XE Catalyst SD-WAN Device to an Older Software Image	112
Downgrade Scenarios for Cisco IOS XE Release 17.2.x	113
Restore Smart Licensing and Smart License Reservation	114
Restore Smart Licensing	114
Restore Smart License Reservation	114

Onboard Cisco Catalyst 8000V Edge Software Hosted by a Cloud Service, Using PAYG Licensing	114
Bootstrap Process for Cisco Catalyst SD-WAN Cloud-Hosted Devices	116
Troubleshooting	117
Troubleshooting Software Installation	117
Router Loads the Previous Software Version After Booting	117

---

**CHAPTER 6**

<b>Cisco Catalyst SD-WAN Overlay Network Bring-Up Process</b>	<b>119</b>
Network Overlay Bringup	119
Cisco SD-WAN Manager Persona and Storage Device	120
Bring-Up Sequence of Events	121
Steps to Bring Up the Overlay Network	123
Summary of the User Portion of the Bring-Up Sequence	126
Automatic Portions of the Bring-Up Sequence	129
User Input Required for the ZTP Automatic Authentication Process	129
Authentication between Cisco Catalyst SD-WAN Controller and Cisco Catalyst SD-WAN Validator	130
Authentication Between Cisco Catalyst SD-WAN Controllers	133
Authentication between Cisco Catalyst SD-WAN Validator and a Cisco vEdge Router	136
Authentication between the Cisco vEdge Router and Cisco SD-WAN Manager	139
Authentication between Cisco Catalyst SD-WAN Controller and the Cisco vEdge Router	141
Firewall Ports for Cisco Catalyst SD-WAN Deployments	145
Cisco Catalyst SD-WAN-Specific Port Terminology	145
Port Offset	145
Port Hopping	145
Effects of Port Hopping	146
Ports Used by Cisco vEdge Devices	147
Ports Used by Cisco Catalyst SD-WAN Devices Running Multiple vCPUs	148
Administrative Ports Used by Cisco SD-WAN Manager	149
Configure the Port Offset	150
Perform Port Hopping Manually	150
Download Software	151
Deploy Cisco SD-WAN Manager	152
Create Cisco Catalyst SD-WAN Manager VM Instance on ESXi	153
Launch vSphere Client and Create Cisco Catalyst SD-WAN Manager VM Instance	153

Create a New Virtual Disk	154
Add Additional vNICs	154
Connect Cisco Catalyst SD-WAN Manager VM Instance to Cisco Catalyst SD-WAN Manager Console	154
Create Cisco Catalyst SD-WAN Manager VM Instance on KVM	155
Create Cisco Catalyst SD-WAN Manager VM Instance on the KVM Hypervisor	155
Connect to a Cisco Catalyst SD-WAN Manager Instance	157
Configure Cisco Catalyst SD-WAN Manager	157
Configure Certificate Settings	160
Generate Cisco Catalyst SD-WAN Manager Certificate	161
Create a Cisco Catalyst SD-WAN Manager Cluster	161
Enable Timeout Value for a Cisco SD-WAN Manager Client Session	161
Deploy Cisco Catalyst SD-WAN Validator	161
Create Cisco Catalyst SD-WAN Validator VM Instance on ESXi	162
Launch vSphere Client and Create a Cisco Catalyst SD-WAN Validator VM Instance	162
Add a vNIC for the Tunnel Interface	163
Start the Cisco Catalyst SD-WAN Validator VM Instance and Connect to the Console	163
Create Cisco Catalyst SD-WAN Validator VM Instance on KVM	163
Configure Cisco Catalyst SD-WAN Validator	165
Create Configuration Templates for Cisco Catalyst SD-WAN Validator	168
Configuration Prerequisites	168
Feature Templates for Cisco Catalyst SD-WAN Validators	169
Create Feature Templates	169
Create Device Templates	170
Attach Device Templates To Cisco Catalyst SD-WAN Validator	171
Add Cisco Catalyst SD-WAN Validator to the Overlay Network	172
Start the Enterprise ZTP Server	173
Requirements for ZTP	173
Configure a Router to be a ZTP Server	175
vContainer Host	177
Deploy Cisco Catalyst SD-WAN Controller	177
Create Cisco Catalyst SD-WAN Controller VM Instance on ESXi	177
Launch vSphere Client and Create a Cisco Catalyst SD-WAN Controller VM Instance	178
Add a vNIC for the Management Interface	178



Start the Cisco Catalyst SD-WAN Controller VM Instance and Connect to the Console	179
Create Cisco Catalyst SD-WAN Controller VM Instance on KVM	179
Configure the Cisco Catalyst SD-WAN Controller	180
Create Configuration Templates for Cisco Catalyst SD-WAN Controller	185
Configuration Prerequisites	185
Feature Templates for Cisco Catalyst SD-WAN Controller	185
Create Feature Templates	186
Create Device Templates	187
Attach a Device Template To Cisco SD-WAN Controllers	188
Add Cisco Catalyst SD-WAN Controller to the Overlay Network	189
Deploy Cisco Catalyst 8000V Using Cloud Services Provider Portals	190
Notes and Limitations	190
Deploy Cisco CSR 1000v Using Cloud Service Provider Portals	190
Deploy Cisco Catalyst 8000V Edge Software on Alibaba Cloud	191
Features	191
Requirements for the Cisco Catalyst 8000V Instance	191
Configure the Cisco Catalyst 8000V Instance to Connect to Cisco Catalyst SD-WAN	191
Create a Bootstrap File for a Cisco Catalyst 8000V Instance Using Cisco Catalyst SD-WAN	192
Deploy the vEdge Cloud routers	192
Create vEdge Cloud router VM Instance on AWS	193
Create vEdge Cloud router VM Instance on Azure	198
Create vEdge Cloud VM Instance on ESXi	201
Create vEdge Cloud VM Instance on KVM	204
Configure Certificate Authorization Settings for WAN Edge Routers	206
Install Signed Certificates on vEdge Cloud Routers	207
Send Router Serial Numbers to the Controller Devices	214
How to Upload a Router Authorized Serial Number File	215
Configure the vEdge Routers	217
Enable Data Stream Collection from a WAN Edge Router	226
Prepare Routers for ZTP	227
<b>CHAPTER 7</b>	
<b>Quick Connect Workflow</b>	<b>233</b>
Quick Connect Workflow	233
Prerequisites for Using the Quick Connect Workflow	234

Restrictions for Quick Connect Workflow	234
Information About Quick Connect	234
Overview of the Quick Connect Workflow	234
Upload devices Using Auto Sync	235
Upload devices manually	236
Access the Quick Connect Workflow	237

---

**CHAPTER 8**
**Cluster Management 239**

Information About Cluster Management	239
Guidelines for a Cisco Catalyst SD-WAN Manager Cluster	240
View Available Cluster Services	241
Configure the Cluster IP Address of a Cisco Catalyst SD-WAN Manager Server	241
Add a Cisco Catalyst SD-WAN Manager Server to a Cluster	243
View Cisco Catalyst SD-WAN Manager Service Details	246
Edit Cisco Catalyst SD-WAN Manager Parameters	246
Update Configuration Database Login	247
Downgrade Cisco Catalyst SD-WAN Manager	248
Upgrade a Cisco SD-WAN Manager Cluster	249
Information About Cluster Upgrade	249
Prerequisites for Cluster Upgrade	250
Upgrade a Cluster Using CLI	251
Manually Restart Cisco Catalyst SD-WAN Manager Processes	252
Remove Cisco Catalyst SD-WAN Manager Nodes from a Cluster	254

---

**CHAPTER 9**
**Certificate Management 257**

Manage Certificates in Cisco Catalyst SD-WAN Manager	257
Check the WAN Edge Router Certificate Status	258
Validate a WAN Edge Router	259
Stage a WAN Edge Router	259
Invalidate a WAN Edge Router	259
Send the Controller Serial Numbers to Cisco Catalyst SD-WAN Validator	260
Install Signed Certificate	260
Export Root Certificate	261
View a Certificate Signing Request	261

View a Device Certificate Signing Request	261
View the Certificate	262
Generate a Certificate Signing Request	262
Generate a Controller Certificate Signing Request	262
Generate a Feature Certificate Signing Request	262
Generate a WAN Edge Device Certificate Signing Request	263
Reset the RSA Key Pair	263
Invalidate a Device	263
View Log of Certificate Activities	264
View a Signed Certificate	264
Certificate Revocation	264
Information About Certificate Revocation	264
Restrictions for Certificate Revocation	265
Configure Certificate Revocation	265
Configure Third-party CA Certificates to Cisco IOS XE Catalyst SD-WAN devices Using Cisco SD-WAN Manager	266
Information About Configure CA Certificates Using Cisco SD-WAN Manager	266
Supported Devices for Uploading CA Certificates	267
Prerequisites to Configuring CA Certificates	267
Restrictions for Uploading CA Certificates	267
Upload CA Certificates	267
Configure CA Certificates Using Cisco SD-WAN Manager	268
Revoke the CA Certificates	269
Renew the CA Certificates	269
Monitor CA Certificates and PKI Trustpoints	269
CRL-Based Quarantine	270
Information About CRL-Based Quarantine	270
Restrictions for CRL-Based Quarantine	271
Configure CRL-Based Quarantine	271
Manage Root Certificate Authority Certificates in Cisco Catalyst SD-WAN Manager	272
Add a Root Certificate Authority Certificate	272
View a Root Certificate Authority Certificate	273
Delete a Root Certificate	273
Enterprise Certificates	273

Configure Enterprise Certificates for Cisco SD-WAN Controllers	274
Information About Enterprise Certificates	275
Dependency on OU Fields in Enterprise Certificates	275
Devices that Support Enterprise Certificates	276
Configure Enterprise Certificates	276
Invalidate a Device Certificate	279
Authorize a Controller Certificate for an Enterprise Root Certificate	279
Generate a Bootstrap Configuration	280
Cisco PKI Controller Certificates	281
Use Case: Cisco-Hosted Cloud Overlays with Software Version 19.x and Above	282
Use Case: Migration of an Active Existing Overlay from Digicert to Cisco PKI Controller Certificates During Certificate Renewal	284
Use Case: Submitting CSRs and Downloading Certificates on On-Premises Controllers	286
Web Server Certificate for Cisco SD-WAN Manager	287

**CHAPTER 10****Reverse Proxy 291**

Reverse Proxy	291
Information About Reverse Proxy	291
Support for a Device with Both Private Network and Public Internet Connectivity	292
Restrictions for Reverse Proxy	294
Provision Certificates on the Reverse Proxy	295
Configure Reverse Proxy Using Cisco SD-WAN Manager	296
Configure Reverse Proxy Settings	296
Configure Reverse Proxy Settings on Cisco SD-WAN Controllers	296
Disable Reverse Proxy	297
Monitor Reverse Proxy Using CLI	298
Monitor Reverse Proxy Using CLI	301

**CHAPTER 11****Onboarding Modular Cisco ASR 1000 Series Platforms 307**

Cisco ASR 1006-X with an RP3 Module	307
Information About the Cisco ASR 1006-X with an RP3 Module	307
Hardware Configuration	308
ROM Monitor Software Version	309
Onboarding Workflow	309

RMA Replacement of the Cisco ASR 1006-X Chassis 309

RMA Replacement of the Cisco RP3 Module 313

---

**CHAPTER 12**

**API Cross-Site Request Forgery Prevention 317**

Cisco Catalyst SD-WAN REST API Token-Based Authentication 317

Token Use 318

API Docs 318

Third Party Application Users 318

---

**CHAPTER 13**

**Deploy Cisco SD-WAN Controller in Microsoft Azure 323**

Information About Deploying Cisco SD-WAN Controllers in Azure 323

Benefits of Deploying Cisco SD-WAN Controllers in Azure 324

Prerequisites for Deploying Cisco SD-WAN Controllers in Azure 324

Use Cases for Deploying Cisco SD-WAN Controllers in Azure 325

Deploy Cisco SD-WAN Controllers in Azure: Tasks 325

Task 1: Create a Controller Image in Azure 325

Task 2: Create a Virtual Network, Subnets, and Network Security Group in Azure 326

Task 3: Create a Virtual Machine for the Controller 327

Task 4: Configure the Network Security Group 330

Verify the Deployment of Cisco SD-WAN Controllers in Azure 330

Monitor the Deployment of Cisco SD-WAN Controllers in Azure 331

---

**CHAPTER 14**

**Deploy Cisco SD-WAN Controllers in the AWS Cloud 333**

Information About Deploying Cisco SD-WAN Controllers in AWS 333

Benefits of Deploying Cisco SD-WAN Controllers in AWS 334

Prerequisites for Deploying Cisco SD-WAN Controllers in AWS 335

Use Cases for Deploying Cisco SD-WAN Controllers in AWS 335

Deploy Cisco SD-WAN Controllers in AWS: Tasks 335

Task 1: Request AWS AMI Images 335

Task 2: Create a VPC, Subnet, and Security Group in AWS 336

Task 3: Create a Virtual Machine for the Controller 337

Task 4: Configure the Security Group 339

Verify the Deployment of Cisco SD-WAN Controllers in AWS 339

Monitor the Deployment of Cisco Catalyst SD-WAN Controller in AWS 340

---

<b>CHAPTER 15</b>	<b>Troubleshoot Cisco Catalyst SD-WAN Solution</b>	<b>341</b>
	Overview	341
	Support Articles	341
	Feedback Request	343
	Disclaimer and Caution	343

---

<b>CHAPTER 16</b>	<b>Appendix: Cisco Catalyst SD-WAN Manager How-Tos</b>	<b>345</b>
	RESTful API for Cisco Catalyst SD-WAN Manager	345
	Replace a vEdge Router	347
	Replace a Cisco IOS XE Catalyst SD-WAN Device	349
	Using Cisco Catalyst SD-WAN Manager on Different Servers	352
	Log In to the Cisco Catalyst SD-WAN Manager Web Application Server	353



# CHAPTER 1

## Read Me First

---



**Note** To achieve simplification and consistency, the Cisco SD-WAN solution has been rebranded as Cisco Catalyst SD-WAN. In addition, from Cisco IOS XE SD-WAN Release 17.12.1a and Cisco Catalyst SD-WAN Release 20.12.1, the following component changes are applicable: **Cisco vManage to Cisco Catalyst SD-WAN Manager**, **Cisco vAnalytics to Cisco Catalyst SD-WAN Analytics**, **Cisco vBond to Cisco Catalyst SD-WAN Validator**, **Cisco vSmart to Cisco Catalyst SD-WAN Controller**, and **Cisco Controllers to Cisco Catalyst SD-WAN Control Components**. See the latest Release Notes for a comprehensive list of all the component brand name changes. While we transition to the new names, some inconsistencies might be present in the documentation set because of a phased approach to the user interface updates of the software product.

---

### Related References

- [Cisco Catalyst SD-WAN Control Components Compatibility Matrix and Server Recommendations](#)
- [Cisco Catalyst SD-WAN Device Compatibility](#)

### User Documentation

- [User Documentation for Cisco IOS XE Catalyst SD-WAN Release 17](#)
- [User Documentation for Cisco SD-WAN Release 20](#)

### Communications, Services, and Additional Information

- Sign up for Cisco email newsletters and other communications at: [Cisco Profile Manager](#).
- For information on the latest technical, advanced, and remote services to increase the operational reliability of your network visit [Cisco Services](#).
- To browse and discover secure, validated enterprise-class apps, products, solutions, and services, visit [Cisco Devnet](#).
- To obtain general networking, training, and certification titles from Cisco Press Publishers, visit [Cisco Press](#).
- To find warranty information for a specific product or product family, visit [Cisco Warranty Finder](#).
- To view open and resolved bugs for a release, access the [Cisco Bug Search Tool](#).

- To submit a service request, visit [Cisco Support](#).

**Documentation Feedback**

To provide feedback about Cisco technical documentation use the feedback form available in the right pane of every online document.





## CHAPTER 2

# What's New in Cisco IOS XE (SD-WAN) and Cisco Catalyst SD-WAN Releases

---

Cisco is constantly enhancing the Cisco Catalyst SD-WAN solution with every release and we try and keep the content in line with the latest enhancements. The following links includes release-wise new and modified features that are documented in the Configuration, Command Reference, and Hardware Installation guides. For information on additional features and fixes that were committed to the Cisco Catalyst SD-WAN solution, see the *Resolved and Open Bugs* section in the Release Notes.

[What's New in Cisco IOS XE Catalyst SD-WAN Release 17.x](#)

[What's New in Cisco IOS XE Catalyst SD-WAN Release 16.x](#)

[What's New in Cisco SD-WAN \(vEdge\) Release 20.x](#)

[What's New in Cisco SD-WAN \(vEdge\) Release 19.x](#)





# CHAPTER 3

## The Cisco Catalyst SD-WAN Solution

- [The Cisco Catalyst SD-WAN Solution, on page 5](#)
- [Cisco Catalyst SD-WAN Solution, on page 5](#)
- [Cisco Catalyst SD-WAN Components, on page 13](#)
- [Work with Cisco Catalyst SD-WAN, on page 25](#)

## The Cisco Catalyst SD-WAN Solution

*Table 1: Feature History*

Feature Name	Release Information	Feature Description
Support for the TLS 1.3 Protocol for Cisco Catalyst SD-WAN Control Connections	Cisco IOS XE Catalyst SD-WAN Release 17.13.1a Cisco Catalyst SD-WAN Manager Release 20.13.1	This feature adds support for the Transport Layer Security (TLS) 1.3 protocol for Cisco Catalyst SD-WAN control connections.

## Cisco Catalyst SD-WAN Solution

### The Need for Cisco Catalyst SD-WAN Solution

Legacy networking technology has become increasingly expensive and complex, and it cannot scale to meet the needs of today's multisite enterprises. The Cisco Catalyst SD-WAN Solution, which is based on time-tested and proven elements of networking, offers an elegant, software-based solution that reduces the costs of running enterprise networks and provides straightforward tools to simplify the provisioning and management of large and complex networks that are distributed across multiple locations and geographies. Built in to the Cisco Catalyst SD-WAN Solution are inherent authentication and security processes that ensure the safety and privacy of the network and its data traffic.

Cisco Catalyst SD-WAN Solution represents an evolution of networking from an older, hardware-based model to a secure, software-based, virtual IP fabric. Cisco Catalyst SD-WAN fabric, also called an *overlay network*, forms a software overlay that runs over standard network transport services, including the public Internet, MPLS, and broadband. The overlay network also supports next-generation software services, thereby accelerating your shift to cloud networking.

## Challenges in Legacy Network Design

The traditional approach to network design cannot scale to meet today's needs for four fundamental reasons:

- **Cost:** Legacy networks run on expensive hardware such as routers and switches, which require time-consuming configuration and maintenance. In addition, these networks require expensive transport connections or carrier circuits to secure and segment the network.
- **Complexity:** Legacy networks operate on the old model of a distributed control plane, which means that every node in the network must be configured with routing and security rules. Remote site management, change control, and network maintenance represent major logistical challenges.
- **Lengthy installation times:** Legacy networks that run on dedicated carrier circuits depend on the carrier to install new circuits, which can take several months. This can dramatically delay the launch of new branch locations.
- **Control:** Legacy networks that run on carrier circuits sacrifice control to the ISP, from network design to configuration to monitoring. Requesting changes from the ISP also requires extra time and is prone to communication errors.

Cost and complexity become even more prohibitive for legacy networks in the face of today's requirements, including:

- Rigorous end-to-end security
- Disparate transport networks
- High-bandwidth cloud applications that are hosted in multiple data centers
- Ongoing increase in the number of mobile end users
- Any-to-any connectivity over fluid topologies
- Unique needs of particular businesses

## Cisco Catalyst SD-WAN Solution

The Cisco Catalyst SD-WAN solution is a Software-Defined WAN (SD-WAN). As with all SD-WANs, it is based on the same routing principles that allowed the Internet to scale during the 1990s and 2000s. What separates Cisco Catalyst SD-WAN from other SD-WANs is that it reimagines the WAN for a new generation of enterprise networks, separating the data plane from the control plane and virtualizing much of the routing that used to require dedicated hardware.

The virtualized network runs as an overlay on cost-effective hardware, whether physical routers or virtual devices. Centralized controllers, called Cisco SD-WAN Validators, oversee the control plane of the fabric, efficiently managing provisioning, maintenance, and security for the entire Cisco Catalyst SD-WAN overlay network. Another device, called the Cisco SD-WAN Validator, automatically authenticates all other Cisco vEdge devices when they join the Cisco Catalyst SD-WAN overlay network.

Figure 1: Components of the Cisco Catalyst SD-WAN Solution

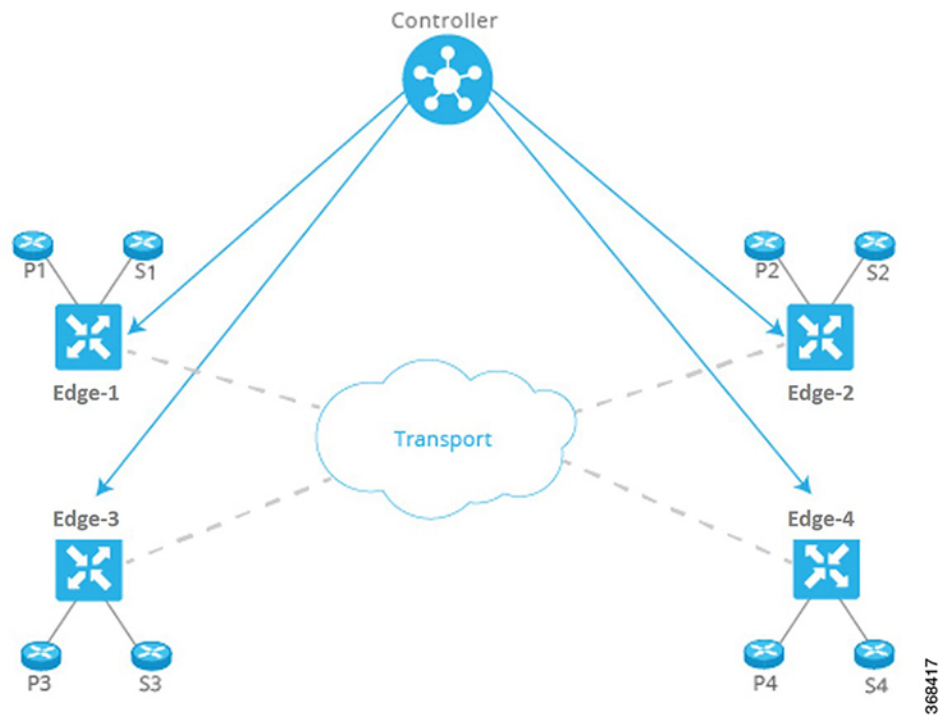

This division of labor allows each networking layer to focus on what it does best. The control plane manages the rules for the routing traffic through the overlay network, and the data plane passes the actual data packets among the network devices. The control plane and data plane form the warp and weft of a flexible, robust fabric that you weave according to your needs, on your schedule, over existing circuits.

Cisco SD-WAN Manager provides a simple, yet powerful, set of graphical dashboards for monitoring network performance on all devices in the overlay network, from a centralized monitoring station. In addition, Cisco SD-WAN Manager provides centralized software installation, upgrade, and provisioning, whether for a single device or as a bulk operation for many devices simultaneously.

Cisco Catalyst SD-WAN is ideally suited to the needs of cloud networking. Cisco Catalyst SD-WAN virtual IP fabric supports software services that streamline and optimize cloud networking, allowing you to take full advantage of the power of the overlay network for individual cloud applications.

**Note**

- Cisco SD-WAN Controllers are purpose-built, custom stacks. Although open-source Linux components are used, our custom operating system stacks bear no resemblance to the open-source Linux components used. The Linux components are not subject to the same hardening requirements as the custom operating system stacks that they are used in.
- The root access is disabled on Cisco SD-WAN Controllers and cannot be accessed from the user space.
- We meet compliance standards and requirements, such as, FedRAMP, FIPS, and CC. This compliance should be considered as proof of the security validation of our operating systems.
- We follow a secure development lifecycle outlined [here](#).
- We also follow a well-defined process run by the Cisco Product Security Incident Response Team (PSIRT) to address any new exploits or attacks, such as, CVE.
- If you are still concerned about the platform security of Cisco SD-WAN Controllers, we recommend that you conduct an independent penetration testing through third parties.

## The Virtual IP Fabric

The complexity in legacy enterprise networks stems from three main sources:

- There is no clear separation between entities that exchange data traffic and the transport network that binds these entities together. That is, there is no clear separation between hosts, devices, and servers on the service side of the network and the interconnects between routers on the transport side of the network.
- Policy and control decisions are embedded at every hop across the enterprise network.
- Security is a time-intensive, manual process, and security management must be implemented either at every node in the network or by using centralized security servers to manage group keys.

Cisco Catalyst SD-WAN uses time-tested and proven elements of networking in innovative ways to build the secure, virtual IP fabric. These networking elements include:

- Using routing and routing advertisements to establish and maintain the flow of traffic throughout the network.
- Layer 3 segmentation, sometimes called virtual routing and forwarding (VRF), to isolate different flows of traffic. This is useful to separate traffic from different customers or different business organizations within an enterprise.
- Peer-to-peer concepts to set up and maintain bidirectional connections between pairs of protocol entities
- Authentication and encryptions
- Policies for routing and data traffic

With five simple steps, Cisco Catalyst SD-WAN virtual IP fabric transforms a complex legacy network into an easy-to-manage, scalable network:

- Step 1: Separate transport from the service side of the network
- Step 2: Centralize routing intelligence and enable segmentation

- Step 3: Secure the network automatically
- Step 4: Influence reachability through centralized policy
- Step 5: Simplify orchestration and provisioning

### Step 1: Separate Transport from the Service Side of the Network

The job of the transport network is to carry packets from one transport router to another. The transport network needs to know only about the routes to follow to reach the next-hop or destination router. It need not know about the prefixes for nontransport routers, the routers that sit behind the transport routers in their local service networks.

Separating network transport from the service side of the network allows the network administrator to influence router-to-router communication independently of the communication between users or between hosts.

**Figure 2: Transport Network Separated from Service Network**

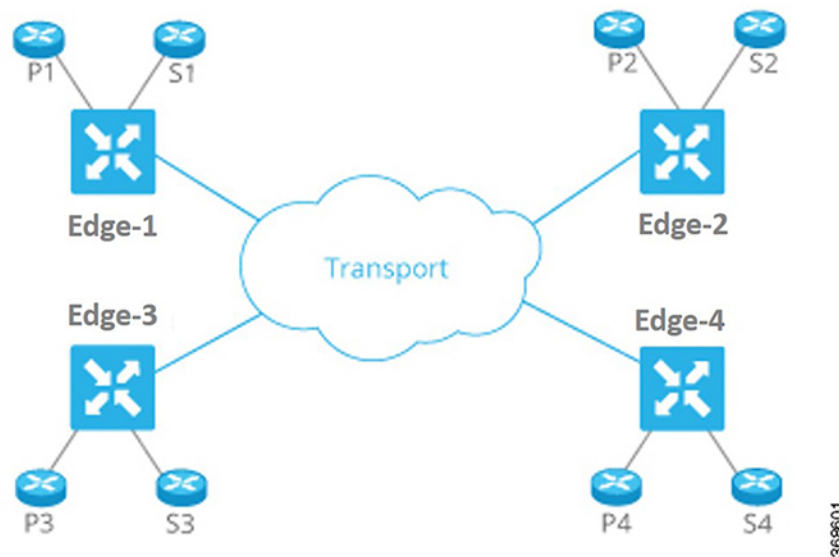

This approach has many benefits:

- The network administrator can choose transport circuits based on SLA and cost.
- The routing system can assign attributes to transport links for optimal routing, load balancing, and policy-based routing.

### Step 2: Centralize Routing Intelligence and Enable Segmentation

Every router at the edge of a network has two sides for routing: one to the transport network and one to the service side of the network. To have any-to-any communication among all routers, all routers need to learn all prefixes. Traditionally, routers learn these prefixes using full-mesh IGP/BGP or by enabling routing on an overlay tunnel (for example, BGP or IGP over MPLS or GRE). Various techniques allow the scaling issues associated with full-mesh routing adjacencies to be mitigated or eliminated, such as employing a route reflector for BGP.

**Figure 3: Centralizing Routing Intelligence with a Centralized Controller**

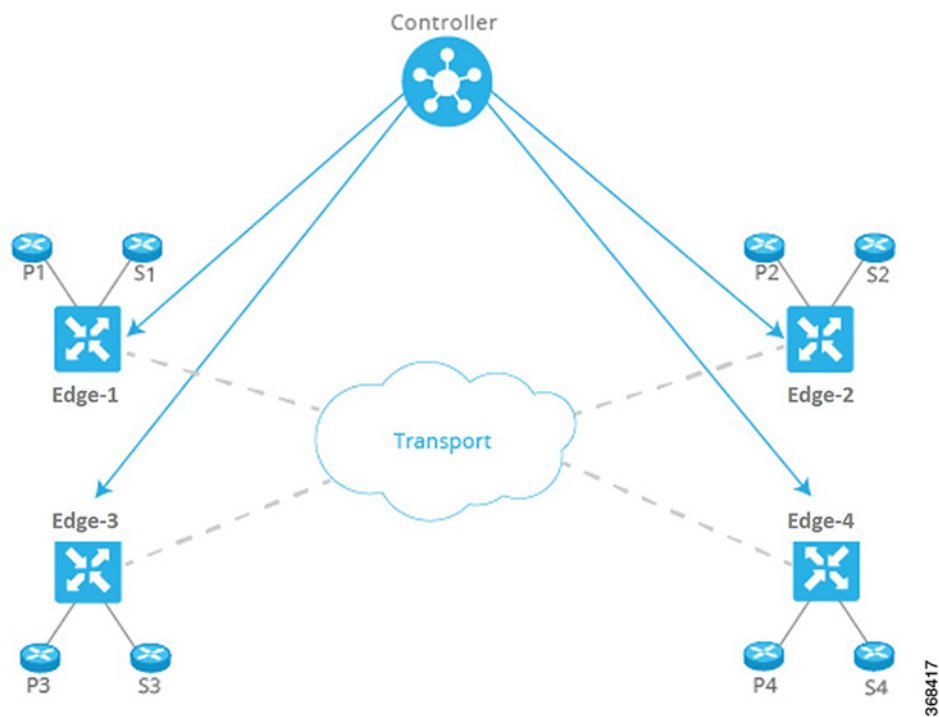

The Cisco Catalyst SD-WAN fabric builds on the route reflector model by centralizing routing intelligence. Essentially, all prefixes learned from the service side on a router are advertised to a centralized controller, which then reflects the information to other routers over the network's control plane. The controllers do not handle any of the data traffic; they are involved only in control plane communication.

This approach has many benefits:

- The centralized controller can use inexpensive or commodity servers for control plane processing.
- The routers can use off-the-shelf silicon, allowing cost benefits from economies of scale.
- Scale challenges associated with full-mesh routing on the transport side of the network are eliminated.
- The network administrator can create multiple segments without the need for complex signaling protocols. For example, in the figure here, all Px prefixes can be part of one VPN, while all Sx prefixes can be part of a different VPN.



---

**Note** The centralized controller only “influences” routing on the routers. The controller does not participate in every flow going through the network, nor does it participate in routing on the service side. This design allows the routers to have local intelligence—enough intelligence to make local site decisions quickly.

---



### Step 3: Secure the Network and Links Automatically

The Cisco Catalyst SD-WAN fabric identifies transport side links and automatically encrypts traffic between sites. The associated encryption keys are exchanged over a secure session with the centralized controller. Secure sessions with the controller are set up automatically using RSA and certificate infrastructure.

This approach has many benefits:

- The Cisco Catalyst SD-WAN fabric itself authenticates all devices participating in the network, which is an important step to secure the infrastructure.
- The fabric automatically exchanges encryption keys associated with the transport links, eliminating the hassle of configuring thousands of pair-wise keys.
- The fabric ensures that the network is not prone to attacks from the transport side.

### Step 4: Influence Reachability through Centralized Policy

Policy configured on a centralized controller strongly influences how prefixes are advertised among the routers. For example, if all traffic between routers P3 and P4 in the figure here has to make a U-turn at router vEdge-1, the network administrator can apply a simple route policy on the centralized controller. The controller then passes the policy to the affected edge routers. The network administrator does not need to provision the policy on each individual router.

**Figure 4: Policy Configured on a Centralized Controller**

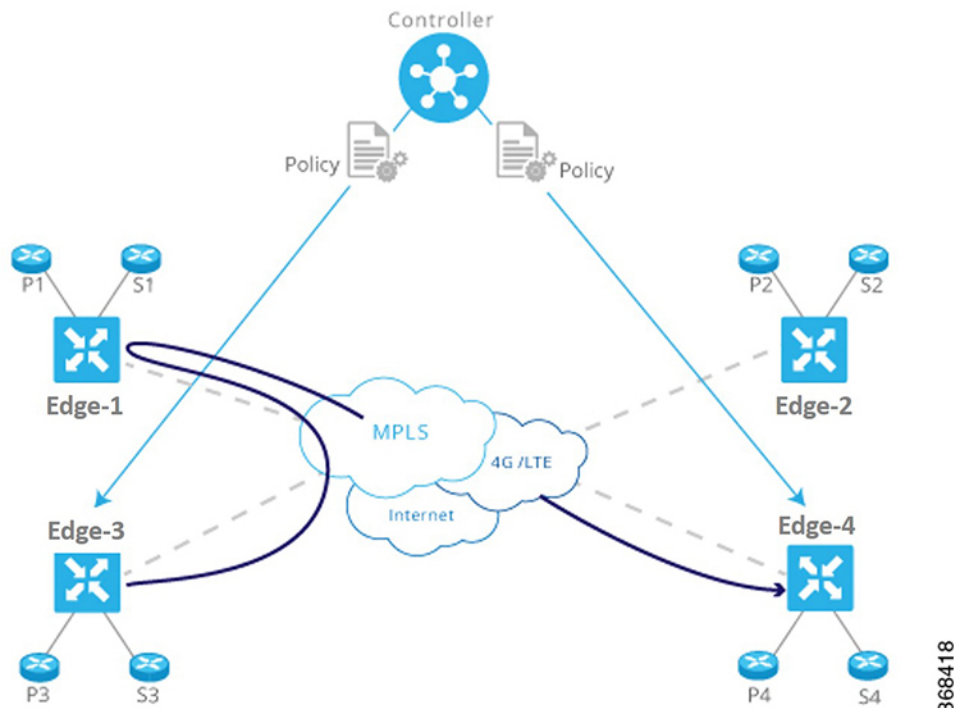

This approach has many benefits:

- The controller centrally influences access control, that is, which prefixes are allowed to talk to each other inside a VPN.

- The controller optimizes user experience by influencing transport link choice based on SLA or other attributes. The network administrator can color transport links (such as gold and bronze), and allow applications to map the colors to appropriate transport links.
- The network administrator can map business logic from a single centralized point.
- The network can react faster to planned and unexpected situations, such as routing all traffic from high-risk countries through an intermediate point.
- The network can centralize services such as firewalls, IDPs, and IDSs. Instead of distributing these services throughout the network at every branch and campus, the network administrator can centralize these functions, achieving efficiencies of scale and minimizing the number of touch points for provisioning.

**Step 5: Simplify Provisioning and Management**

Legacy network devices are provisioned and monitored manually through a CLI. Network administrators must type configurations line by line, and enter operational commands one at a time on individual devices in order to retrieve and read status information. This method is error prone and time consuming when provisioning and troubleshooting a network, and it can present serious difficulties when devices are in remote locations or when management ports are inaccessible.

*Figure 5: Simplified Provisioning and Management of a Network by Cisco Catalyst SD-WAN*

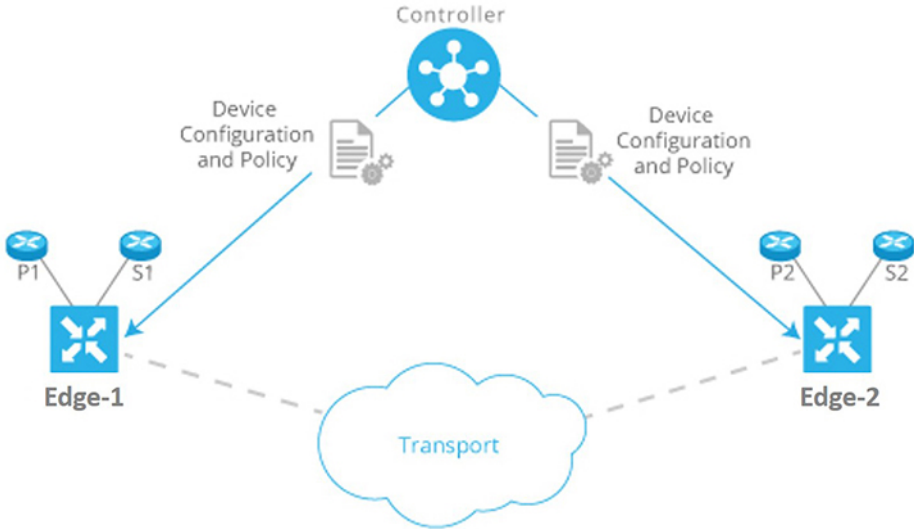

Cisco Catalyst SD-WAN centralizes and significantly simplifies provisioning and management through Cisco SD-WAN Manager. Cisco SD-WAN Manager provides an easy-to-use, graphical dashboard from which you can monitor, configure, and maintain all Cisco vEdge devices and links in the overlay network. For example, the GUI dashboard provides a templated view of various configurations to ease provisioning a service, so all common elements, such as AAA and company-specific servers, can be pushed to multiple devices with a single click, from a single point.

This approach has many benefits:

- The network administrator provisions and manages the network as a whole, efficiently and easily, as opposed to a piece-meal approach that deals with individual devices one at a time.

- The network administrator has improved network visibility (for example, viewing network-wide VPN statistics) from a single point.
- Troubleshooting tasks are simplified and presented visually, instead of requiring network administrators to read lengthy configurations and output from individual devices.

# Cisco Catalyst SD-WAN Components

## Primary Cisco Catalyst SD-WAN Components

The secure, virtual IP fabric of Cisco Catalyst SD-WAN is made up of four fundamental components:

- **Cisco SD-WAN Manager:** Cisco SD-WAN Manager is a centralized network management system that lets you configure and manage the entire overlay network from a simple graphical dashboard.
- **Cisco SD-WAN Controller:** The Cisco SD-WAN Controller is the centralized brain of the Cisco Catalyst SD-WAN solution, controlling the flow of data traffic throughout the network. The Cisco SD-WAN Controller works with the Cisco SD-WAN Validator to authenticate Cisco vEdge devices as they join the network and to orchestrate connectivity among the edge routers.
- **Cisco SD-WAN Validator:** The Cisco SD-WAN Validator automatically orchestrates connectivity between edge routers and Cisco SD-WAN Controllers. If any edge router or Cisco SD-WAN Controller is behind a NAT, the Cisco SD-WAN Validator also serves as an initial NAT-traversal orchestrator.
- **Cisco IOS XE Catalyst SD-WAN and Cisco vEdge Devices:** The edge routers sit at the perimeter of a site (such as remote offices, branches, campuses, data centers) and provide connectivity among the sites. They are either hardware devices or software (Cloud router), that runs as a virtual machine. The edge routers handle the transmission of data traffic.

Of these four components, the edge router can be a Cisco Catalyst SD-WAN hardware device or software that runs as a virtual machine, and the remaining three are software-only components. The Cloud router, Cisco SD-WAN Manager, and Cisco SD-WAN Controller software runs on servers, and the Cisco SD-WAN Validator software runs as a process (daemon) on a edge router.

The figure below illustrates the components of Cisco Catalyst SD-WAN. The sections below describe each component in detail.

Figure 6: Components of Cisco Catalyst SD-WAN

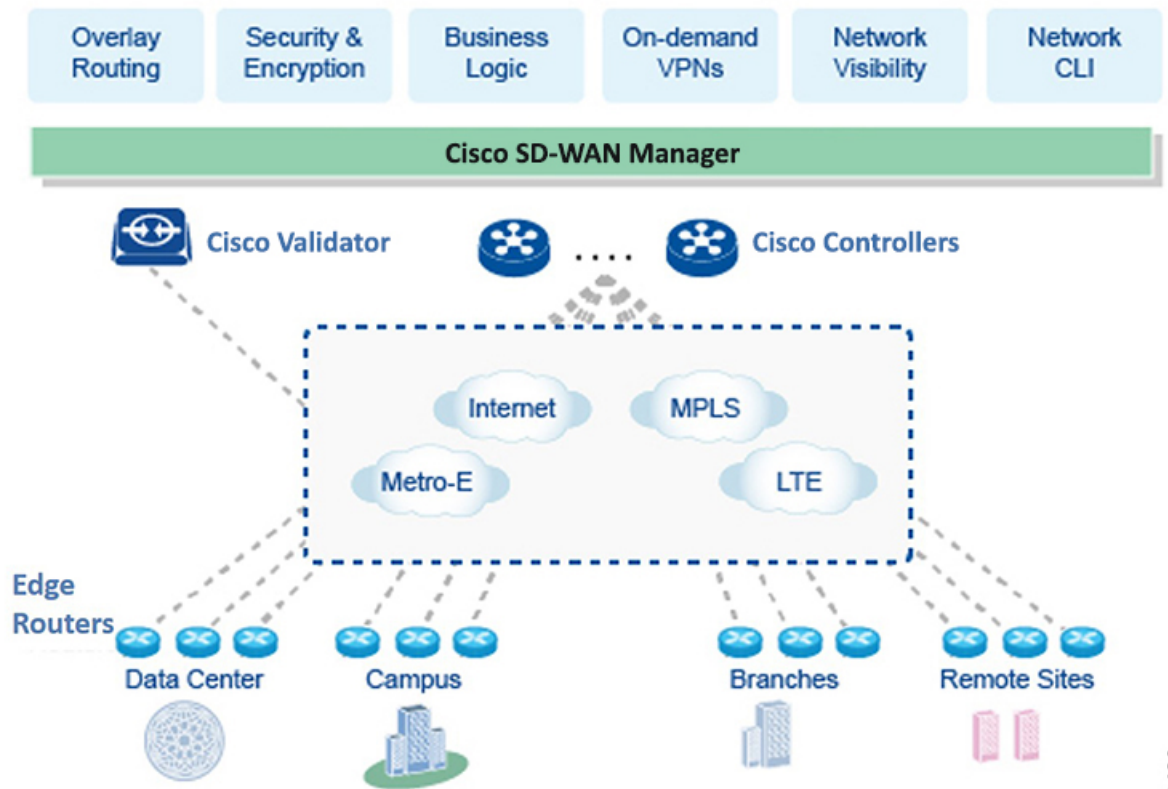

368420

## Cisco Catalyst SD-WAN Manager

Cisco SD-WAN Manager is a centralized network management system. Cisco SD-WAN Manager dashboard provides a visual window into the network, and it allows you to configure and manage Cisco edge network devices. Cisco SD-WAN Manager software runs on a server in the network. This server is typically situated in a centralized location, such as a data center. It is possible for Cisco SD-WAN Manager software to run on the same physical server as Cisco SD-WAN Controller software.

You can use Cisco SD-WAN Manager to store certificate credentials, and to create and store configurations for all Cisco edge network components. As these components come online in the network, they request their certificates and configurations from Cisco SD-WAN Manager. When Cisco SD-WAN Manager receives these requests, it pushes the certificates and configurations to the Cisco edge network devices.

For Cloud routers, Cisco SD-WAN Manager can also sign certificates and generate bootstrap configurations, and it can decommission the devices.

### Secure Communication with Devices and Controllers through a vmanage-admin Account

Cisco SD-WAN Manager communicates with edge devices and controllers using a secure channel—either a datagram transport layer security (DTLS) tunnel or transport layer security (TLS) tunnel. Within this secure channel, it communicates with the devices or controllers using the NETCONF protocol, within an SSH session. It uses an internal-use-only passwordless "vmange-admin" user account on the device or controller. The

vmanage-admin account is created during the initial device or controller setup. Cisco SD-WAN Manager uses this secure channel for monitoring, configuring, and managing each of the following:

- Edge devices
- Cisco SD-WAN Manager nodes in a cluster
- Cisco SD-WAN Validator
- Cisco SD-WAN Controllers

As noted, the vmanage-admin user accounts do not have any password associated with them, so Cisco SD-WAN Manager uses a passwordless procedure to log in to the account. To accomplish this, Cisco SD-WAN Manager generates an asymmetric encryption public-private key pair. During deployment of an edge device into the Cisco Catalyst SD-WAN fabric, or of a controller instance, Cisco SD-WAN Manager copies the public key that it has generated to the edge device or instance. It sends the public key using a proprietary protocol, within a secure channel—a DTLS or TLS tunnel.

The activity that Cisco SD-WAN Manager performs using the vmanage-admin account appears in syslog messages and in the output of certain **show** commands. The syslog messages are logged with the same level of detail as activities performed through any other user account. The level of syslog detail depends on the syslog configuration of the device.

Cisco SD-WAN Manager requires the vmanage-admin account on devices in the fabric in order to monitor, configure, and manage the devices. Removing, disabling, or altering this account on a device would prevent Cisco SD-WAN Manager from performing these activities, and is not supported.

## Cisco Catalyst SD-WAN Controller

The Cisco SD-WAN Controller oversees the control plane of the Cisco Catalyst SD-WAN overlay network, establishing, adjusting, and maintaining the connections that form the Cisco Catalyst SD-WAN fabric.

The major components of the Cisco SD-WAN Controller are:

- **Control plane connections:** Each Cisco SD-WAN Controller establishes and maintains a control plane connection with each edge router in the overlay network. (In a network with multiple Cisco SD-WAN Controllers, a single Cisco SD-WAN Controller may have connections only to a subset of the edge routers, for load-balancing purposes.) Each connection, which runs as a DTLS tunnel, is established after device authentication succeeds, and it carries the encrypted payload between the Cisco SD-WAN Controller and the edge router. This payload consists of route information necessary for the Cisco SD-WAN Controller to determine the network topology, and then to calculate the best routes to network destinations and distribute this route information to the Edge routers. The DTLS connection between a Cisco SD-WAN Controller and an edge router is a permanent connection. The Cisco SD-WAN Controller has no direct peering relationships with any devices that an edge router is connected to on the service side.
- **OMP (Overlay Management Protocol):** The OMP protocol is a routing protocol similar to BGP that manages the Cisco Catalyst SD-WAN overlay network. OMP runs inside DTLS control plane connections and carries the routes, next hops, keys, and policy information needed to establish and maintain the overlay network. OMP runs between the Cisco SD-WAN Controller and the edge routers and carries only control plane information. The Cisco SD-WAN Controller processes the routes and advertises reachability information learned from these routes to other edge routers in the overlay network.
- **Authentication:** The Cisco SD-WAN Controller has pre-installed credentials that allow it to authenticate every new edge router that comes online. These credentials ensure that only authenticated devices are allowed access to the network.

- **Key reflection and rekeying:** The Cisco SD-WAN Controller receives data plane keys from an edge router and reflects them to other relevant edge routers that need to send data plane traffic.
- **Policy engine:** The Cisco SD-WAN Controller provides rich inbound and outbound policy constructs to manipulate routing information, access control, segmentation, extranets, and other network needs.
- **Netconf and CLI:** Netconf is a standards-based protocol used by Cisco SD-WAN Manager to provision a Cisco SD-WAN Controller. In addition, each Cisco SD-WAN Controller provides local CLI access and AAA.

The Cisco SD-WAN Controller maintains a centralized route table that stores the route information, called OMP routes, that it learns from the edge routers and from any other Cisco SD-WAN Controllers in the Cisco Catalyst SD-WAN overlay network. Based on the configured policy, the Cisco SD-WAN Controller shares this route information with the Cisco edge network devices in the network so that they can communicate with each other.

The Cisco SD-WAN Controller is a software that runs as a virtual machine on a server configured with ESXi or VMware hypervisor software. The Cisco SD-WAN Controller software image is a signed image that is downloadable from the Cisco Catalyst SD-WAN website. A single Cisco Catalyst SD-WAN root-of-trust public certificate is embedded into all Cisco SD-WAN Controller software images.

During the initial startup of a Cisco SD-WAN Controller, you enter minimal configuration information, such as the IP addresses of the controller and the Cisco SD-WAN Validator. With this information and the root-of-trust public certificate, the Cisco SD-WAN Controller authenticates itself on the network, establishes a DTLS control connection with the Cisco SD-WAN Validator, and receives and activates its full configuration from Cisco SD-WAN Manager if one is present in the domain. (Otherwise, you can manually download a configuration file or create a configuration directly on the Cisco SD-WAN Controller through a console connection.) The Cisco SD-WAN Controller is now also ready to accept connections from the edge routers in its domain.

To provide redundancy and high availability, a typical overlay network includes multiple Cisco SD-WAN Controllers in each domain. A domain can have up to 20 Cisco SD-WAN Controllers. To ensure that the OMP network routes remain synchronized, all the Cisco SD-WAN Controllers must have the same configuration for policy and OMP. However, the configuration for device-specific information, such as interface locations and addresses, system IDs, and host names, can be different. In a network with redundant Cisco SD-WAN Controllers, the Cisco SD-WAN Validator tells the Cisco SD-WAN Controllers about each other and tells each Cisco SD-WAN Controller which edge routers in the domain it should accept control connections from. (Different edge routers in the same domain connect to different Cisco SD-WAN Controllers, to provide load balancing.) If one Cisco SD-WAN Controller becomes unavailable, the other controllers automatically and immediately sustain the functioning of the overlay network.

## Cisco Catalyst SD-WAN Validator

Cisco SD-WAN Validator automatically coordinates the initial bringup of Cisco SD-WAN Controllers and edge routers, and it facilitates connectivity between Cisco SD-WAN Controllers and edge routers. During the bringup processes, the Cisco SD-WAN Validator authenticates and validates the devices wishing to join the overlay network. This automatic orchestration process prevents tedious and error-prone manual bringup.

Cisco SD-WAN Validator is the only Cisco vEdge device that is located in a public address space. This design allows the Cisco SD-WAN Validator to communicate with Cisco SD-WAN Controllers and edge routers that are located behind NAT devices, and it allows the Cisco SD-WAN Validator to solve any NAT-traversal issues of these Cisco vEdge devices.

The major components of the Cisco SD-WAN Validator are:

- **Control plane connection:** Each Cisco SD-WAN Validator has a persistent control plane connection in the form of a DTLS tunnel with each Cisco Catalyst SD-WAN Controller in its domain. In addition, the Cisco SD-WAN Validator uses DTLS connections to communicate with edge routers when they come online, to authenticate the router, and to facilitate the router's ability to join the network. Basic authentication of an edge router is done using certificates and RSA cryptography.
- **NAT traversal:** The Cisco SD-WAN Validator facilitates the initial orchestration between edge routers and Cisco SD-WAN Controllers when one or both of them are behind NAT devices. Standard peer-to-peer techniques are used to facilitate this orchestration.
- **Load balancing:** In a domain with multiple Cisco SD-WAN Controllers, the Cisco SD-WAN Validator automatically performs load balancing of edge routers across the Cisco SD-WAN Controllers when routers come online.

Cisco SD-WAN Validator is a software module that authenticates the Cisco SD-WAN Controllers and the edge routers in the overlay network and coordinates connectivity between them. It must have a public IP address so that all Cisco vEdge devices in the network can connect to it. (It is the only Cisco vEdge device that must have a public address.)

Cisco SD-WAN Validator orchestrates the initial control connection between Cisco SD-WAN Controllers and edge routers. It creates DTLS tunnels to the Cisco SD-WAN Controllers and edge routers to authenticate each node that is requesting control plane connectivity. This authentication behavior assures that only valid customer nodes can participate in the Cisco Catalyst SD-WAN overlay network. The DTLS connections with Cisco SD-WAN Controllers are permanent so that the Cisco SD-WAN Validator controller can inform the Cisco SD-WAN Controllers as edge routers join the network. The DTLS connections with edge routers are temporary; once the Cisco SD-WAN Validator has matched a edge router with a Cisco Catalyst SD-WAN Controller, there is no need for the Cisco SD-WAN Validator and the edge router to communicate with each other. The Cisco SD-WAN Validator shares only the information that is required for control plane connectivity, and it instructs the proper edge routers and Cisco SD-WAN Controllers to initiate secure connectivity with each other. The Cisco SD-WAN Validator maintains no state.

To provide redundancy for the Cisco SD-WAN Validator, you can create multiple Cisco SD-WAN Validator entities in the network and point all edge routers to those Cisco SD-WAN Validators. Each Cisco SD-WAN Validator maintains a permanent DTLS connection with each Cisco Catalyst SD-WAN Controller in the network. If one Cisco SD-WAN Validator becomes unavailable, the others are automatically and immediately able to sustain the functioning of the overlay network. In a domain with multiple Cisco SD-WAN Controllers, the Cisco SD-WAN Validator pairs a edge router with one of the Cisco SD-WAN Controllers to provide load balancing.

## Cisco vEdge Devices and Cisco IOS XE Catalyst SD-WAN Devices

The edge router, whether a hardware or software device, is responsible for the data traffic sent across the network. When you place an edge router into an existing network, it appears as a standard router.

Figure 7: An Edge Router Placed into an Existing Network

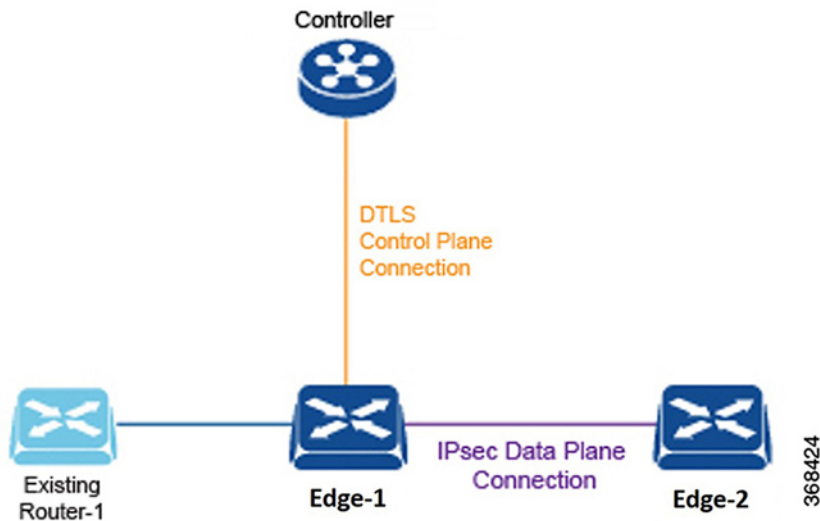

To illustrate this, the figure here shows an edge router and an existing router that are connected by a standard Ethernet interface. These two routers appear to each other to be Layer 3 end points, and if routing is needed between the two devices, OSPF or BGP can be enabled over the interface. Standard router functions, such as VLAN tagging, QoS, ACLs, and route policies, are also available on this interface.

The components of an edge router are:

- **DTLS control plane connection:** Each edge router has one permanent DTLS connection to each Cisco SD-WAN Controller it talks to. This permanent connection is established after device authentication succeeds, and it carries encrypted payload between the edge router and the Cisco SD-WAN Controller. This payload consists of route information necessary for the Cisco SD-WAN Controller to determine the network topology, and then to calculate the best routes to network destinations and distribute this route information to the edge routers.
- **OMP (Overlay Management Protocol):** As described for the Cisco SD-WAN Controller, OMP runs inside the DTLS connection and carries the routes, next hops, keys, and policy information needed to establish and maintain the overlay network. OMP runs between the edge router and the Cisco SD-WAN Controller and carries only control information.
- **Protocols:** The edge router supports standard protocols, including OSPF, BGP, VRRP, and BFD.
- **Routing Information Base (RIB):** Each edge router has multiple route tables that are populated automatically with direct interface routes, static routes, and dynamic routes learned via BGP and OSPF. Route policies can affect which routes are stored in the RIB.
- **Forwarding Information Base (FIB):** This is a distilled version of the RIB that the CPU on the edge router uses to forward packets.
- **Netconf and CLI:** Netconf is a standards-based protocol used by Cisco SD-WAN Manager to provision a edge router. In addition, each edge router provides local CLI access and AAA.
- **Key management:** Edge routers generate symmetric keys that are used for secure communication with other edge routers, using the standard IPsec protocol.



- **Data plane:** The edge router provides a rich set of data plane functions, including IP forwarding, IPsec, BFD, QoS, ACLs, mirroring, and policy-based forwarding.

The edge router has local intelligence to make site-local decisions regarding routing, high availability (HA), interfaces, ARP management, ACLs, and so forth. The OMP session with the Cisco SD-WAN Controller influences the RIB in the edge router, providing non-site-local routes and the reachability information necessary to build the overlay network.

The hardware edge router includes a Trusted Board ID chip, which is a secure cryptoprocessor that contains the private key and public key for the router, along with a signed certificate. All this information is used for device authentication. When you initially start up a edge router, you enter minimal configuration information, such as the IP addresses of the edge router and the Cisco SD-WAN Validator. With this information and the information on the Trusted Board ID chip, the edge router authenticates itself on the network, establishes a DTLS connection with the Cisco SD-WAN Controller in its domain, and receives and activates its full configuration from Cisco SD-WAN Manager if one is present in the domain. Otherwise, you can manually download a configuration file or create a configuration directly on the edge router through a console connection.

## Cisco Catalyst SD-WAN Control Connections

The following sections provide information about Cisco Catalyst SD-WAN control connections.

### Information About Cisco Catalyst SD-WAN Control Connections

Cisco Catalyst SD-WAN control connections refer to the communication channels that control and manage the operation of a Cisco Catalyst SD-WAN network. These connections are established between Cisco Catalyst SD-WAN control components (Cisco Catalyst SD-WAN Validator, Cisco Catalyst SD-WAN Controller, Cisco SD-WAN Manager) and Cisco IOS XE Catalyst SD-WAN devices.

#### Support for the TLS 1.3 Protocol

Starting from Cisco IOS XE Catalyst SD-WAN Release 17.13.1a and Cisco Catalyst SD-WAN Manager Release 20.13.1, the control connections in Cisco Catalyst SD-WAN support the Transport Layer Security protocol version 1.3. The TLS 1.3 version provides stronger security than TLS 1.2, thus improving network performance and efficiency.

If the Cisco Catalyst SD-WAN Control components are using Cisco Catalyst SD-WAN Control Components Release 20.13.1 or later, and devices are using Cisco IOS XE Catalyst SD-WAN Release 17.13.1a, they establish a TLS 1.3 connection between them. In the absence of a TLS 1.3 connection, these components negotiate and establish a connection using TLS 1.2.

#### Cipher Suites

For control connections, Cisco Catalyst SD-WAN automatically selects one of the following cipher suites:

- TLS-AES-256-GCM-SHA384
- TLS-AES-128-GCM-SHA256
- TLS-AES-128-CCM-8-SHA256
- TLS-AES-128-CCM-SHA256

## Benefits of TLS 1.3 in Cisco Catalyst SD-WAN Control Connections

- TLS 1.3 provides stronger security compared to TLS 1.2.
- TLS 1.3 reduces the number of round trips that are required for the initial connection setup (handshake). This reduces latency, and speeds up the establishment of a secure connection, improving overall performance.

## Verify Cisco Catalyst SD-WAN Control Connections

The following is a sample output from the **show sdwan control connections** command that displays the connection status, including the TLS version and selected cipher suite. This command displays the information about active control connections and control plane connections on Cisco IOS XE Catalyst SD-WAN devices.

In the following command output, the protocol version (TLS 1.3) and cipher suite are shown in bold.

```
Device# show sdwan control connections

LOCAL-COLOR- lte SYSTEM-IP- 12.16.255.19 PEER-PERSONALITY- vsmart

site-id 100
domain-id 1 protocol tls
protocol-version TLS1_3
cipher-name TLS_AES_256_GCM_SHA384 private-ip 10.0.5.19
private-port 23556
public-ip 10.0.5.19
public-port 23556
org-name vIPtela Inc Regression
state up [Local Err: NO_ERROR] [Remote Err: NO_ERROR] uptime 0:00:01:24
hello interval 1000
hello tolerance 12000
controller-grp-id 0 shared-region-id-set N/A peer-session-id 0xdba4a2f8
Tx Statistics- hello 86
connects 0
registers 0
register-replies 0
challenge 0
challenge-response 1
challenge-ack 0
teardown 0
teardown-all 0
vmanage-to-peer 0
register-to-vmanage 0 Rx Statistics-
hello 86
connects 0
registers 0
register-replies 0
challenge 1
challenge-response 0

challenge-ack 1
teardown 0
vmanage-to-peer 0
register-to-vmanage 0
```

This command displays information about control plane connection attempts initiated by the local device on Cisco IOS XE Catalyst SD-WAN devices.

```
Device# show sdwan control connection-history detail
```

```

LOCAL-COLOR- lte SYSTEM-IP- 0.0.0.0 PEER-PERSONALITY- vbond

site-id 0
domain-id 0 protocol dtls
protocol-version DTLS1_2
cipher-name ECDHE-RSA-AES256-GCM-SHA384
private-ip 10.0.12.26
private-port 12346
public-ip 10.0.12.26
public-port 12346
UUID/chassis-number eb8844be-f58f-4bd3-b8c2-4f8cbc78131c
state tear_down [Local Err: ERR_DISCONNECT_VBOND] [Remote Err: NO_ERROR] downtime
2023-10-13T20:06:44+0000
repeat count 0 previous downtime N/A
Tx Statistics- hello 17
connects 0
registers 2
register-replies 0
challenge 0
challenge-response 1
challenge-ack 0
teardown 1
teardown-all 0
vmanage-to-peer 0
register-to-vmanage 0 Rx Statistics-

hello 17
connects 0
registers 0
register-replies 2
challenge 1
challenge-response 0
challenge-ack 1
teardown 0
vmanage-to-peer 0
register-to-vmanage 0

```

This command displays information about control plane connection attempts initiated by a Cisco IOS XE Catalyst SD-WAN device toward Cisco Catalyst SD-WAN Validator and Cisco Catalyst SD-WAN Controller.

```
Device# show control connections detail"
```

```

-----
REMOTE-COLOR- lte SYSTEM-IP- 172.16.255.21 PEER-PERSONALITY- vedge
-----
site-id          100
domain-id       1
protocol        tls
protocol-version TLS1_2
cipher-name     ECDHE-RSA-AES256-GCM-SHA384
private-ip      10.0.111.1
private-port    46437
public-ip       10.0.111.1
public-port     46437
org-name        vIPtela Inc Regression
state           up [Local Err: NO_ERROR] [Remote Err: NO_ERROR]
uptime          0:00:10:02
hello interval  1000
hello tolerance 12000
peer-session-id 0x00656994de

Tx Statistics-
-----
hello          603

```

```

connects          0
registers         0
register-replies  0
challenge         1
challenge-response 0
challenge-ack     1
teardown         0
teardown-all     0
vmanage-to-peer  1
register-to-vmanage 0
create-cert-reply 0

```

## Rx Statistics-

```

-----
hello            603
connects         0
registers         0
register-replies  0
challenge         0
challenge-response 1
challenge-ack     0
teardown         0
vmanage-to-peer  0
register-to-vmanage 1
create-cert      0

```

```

-----
REMOTE-COLOR- default SYSTEM-IP- 172.16.255.19 PEER-PERSONALITY- vsmart
-----

```

```

site-id          100
domain-id        1
protocol         tls
protocol-version TLS1_3
cipher-name      TLS_AES_256_GCM_SHA384
private-ip       10.0.5.19
private-port     23456
public-ip        10.0.5.19
public-port      23456
org-name         vIPtela Inc Regression
state            up [Local Err: NO_ERROR] [Remote Err: NO_ERROR]
uptime           0:00:09:48
hello interval   1000
hello tolerance  12000
peer-session-id  0x00b6655c4d

```

## Tx Statistics-

```

-----
hello            589
connects         0
registers         0
register-replies  0
challenge         0
challenge-response 1
challenge-ack     0
teardown         0
teardown-all     0
vmanage-to-peer  1
register-to-vmanage 0
create-cert-reply 0

```

## Rx Statistics-

```

-----
hello            589

```

```

connects          0
registers         0
register-replies  0
challenge        1
challenge-response 0
challenge-ack    1
teardown         0
vmanage-to-peer  0
register-to-vmanage 1
create-cert      0

```

## Cisco Catalyst SD-WAN Solution

To streamline and optimize cloud networking, Cisco Catalyst SD-WAN offers next-generation software services that run on the secure, virtual IP fabric:

- **Cloud onRamp for SaaS:** Cloud onRamp for SaaS optimizes the performance of Software as a Service (SaaS) cloud applications. It provides clear visibility of the performance of individual applications and automatically chooses the best path for each one. Cloud onRamp calculates metrics about loss and latency using a formula customized for each application.
- **Cisco SD-WAN Analytics:** Cisco SD-WAN Analytics is a SaaS service hosted by Cisco Catalyst SD-WAN as part of the solution. It provides graphical representations of the performance of your entire overlay network over time and lets you drill down to the characteristics of a single carrier, tunnel, or application at a particular time.
- **Cisco Catalyst SD-WAN Portal:** Cisco Catalyst SD-WAN Portal is a cloud-infrastructure automation tool tailored for Cisco Catalyst SD-WAN, which provides a quick way to provision, monitor, and maintain Cisco SD-WAN Controllers on public cloud providers.

## Cloud onRamp for SaaS

Enterprises have been adopting business critical SaaS applications including Microsoft Office365, Salesforce, Dropbox, and others. Enterprises use three primary methods to offer connectivity to SaaS applications for their users:

- Direct Internet Access (DIA) from a branch office.
- Internet access through gateways in regional facilities.
- Cloud exchange or direct connection through gateways in a Carrier Neutral Facility (CNF).

Latency and packet loss have a direct impact on the performance of applications and on end-user experience, but in many cases network administrators have limited or no visibility into the network performance characteristics between the end-user and SaaS applications. When path impairment occurs and application performance suffers, shifting traffic from a primary to an alternate path usually requires the network administrator to perform a set of complex, manual, time-consuming, and error-prone steps.

Cisco Catalyst SD-WAN Cloud onRamp for SaaS provides visibility and continuous monitoring of network performance characteristics. It makes real-time decisions by choosing the best performing path between the end-user and SaaS application for an optimal user experience. It automatically reacts to changes in network performance by intelligently re-routing application traffic away from any degraded network paths.

Cloud onRamp for SaaS supports all access methods for cloud-based SaaS applications, including DIA, internet access through a regional facility, and access through a CNF.

Cloud onRamp for SaaS calculates an application performance value called the Viptela Quality of Experience (vQoE) for enterprise cloud applications. The vQoE value weighs loss and latency using a formula customized for each application. For example, email applications tolerate latency better than video applications do, and video applications tolerate loss better than email does. The vQoE value ranges from zero to ten, with zero being the worst quality and ten being the best.

You enable Cloud onRamp for SaaS in Cisco SD-WAN Manager with a few clicks of the mouse, and then you access the Cloud onRamp dashboard in Cisco SD-WAN Manager for continuous visibility into the performance of individual applications.

## Cisco Catalyst SD-WAN Analytics

Cisco SD-WAN Analytics offers visibility into the performance of applications and the network over time. Cisco SD-WAN Analytics is a SaaS service hosted by Cisco Catalyst SD-WAN as part of the solution. It provides graphical representations of your entire overlay network and lets you drill down to display the characteristics of a single carrier, tunnel, or application at a particular time.

The Cisco SD-WAN Analytics dashboard serves as an interactive overview of your network and an entrance point for more details. The dashboard by default displays information aggregated for the last 24 hours. When you drill down, you can select different time periods for different data sets to display. The dashboard displays data on application performance, WAN site usage, and carrier usage.

Cisco SD-WAN Analytics calculates application performance with the QoE value, which is customized for individual applications. This value ranges from zero to ten, with zero being the worst performance and ten being the best. Cisco SD-WAN Analytics calculates QoE based on latency, loss, and jitter, customizing the calculation for each application.

Cisco SD-WAN Analytics stores data over a long period of time, displays historical trend information, and offers insights that could be used for future planning.

It offers:

- Application visibility:
  - Best and worst performing applications: Display the best and worst performing applications and drill down to details at the site level.
  - Most bandwidth consuming applications: Display applications consuming the most bandwidth and drill down to sites and users.
- Network visibility:
  - Network availability and circuit availability: Display network availability and correlate network and circuit availability.
  - Tunnel performance: Display key performance indicators such as loss, latency and jitter over various Cisco Catalyst SD-WAN tunnels.
  - Carrier usage views: Display providers and their network characteristics.

## Cisco Catalyst SD-WAN Portal

Cisco Catalyst SD-WAN Portal is a cloud-infrastructure automation tool tailored for Cisco Catalyst SD-WAN, which provides a quick way to provision, monitor, and maintain Cisco SD-WAN Controllers on public cloud providers.

You can provision the following controllers using the Cisco Catalyst SD-WAN Portal:

- Cisco SD-WAN Manager
- Cisco Catalyst SD-WAN Validator
- Cisco Catalyst SD-WAN Controller



---

**Note** Beginning with Cisco vManage Release 20.9.1, a link to the Cisco Catalyst SD-WAN Portal is added from the Cisco Catalyst SD-WAN menu. From the Cisco Catalyst SD-WAN menu, click **SD-WAN Portal** to access the Cisco Catalyst SD-WAN Portal for provisioning, monitoring, and maintaining Cisco SD-WAN Controllers.

---

For more information on the Cisco Catalyst SD-WAN Portal, see the [Cisco Catalyst SD-WAN Portal Configuration Guide](#).

## Cisco SD-AVC

Beginning with the 18.4 release, Cisco Catalyst SD-WAN incorporates Cisco Software-Defined Application Visibility and Control (SD-AVC) to provide:

- Recognition of network application traffic for visibility, analytics, application-aware routing, and application-based policies, such as QoS and application-based firewall policy.
- Analytics at the network level.

Cisco SD-AVC operates on Cisco IOS XE Catalyst SD-WAN devices in the network, and the Cisco SD-AVC network service operates as a container within Cisco SD-WAN Manager.



---

**Note** All relevant Cisco SD-AVC functionality is accessed through the Cisco SD-WAN Manager interface. Cisco Catalyst SD-WAN does not support the use of a separate SD-AVC interface.

---

### Cisco SD-WAN Manager Cluster

Cisco SD-AVC must operate on only one Cisco SD-WAN Manager instance. In a Cisco SD-WAN Manager cluster, enable Cisco SD-AVC on only one instance of Cisco SD-WAN Manager.

# Work with Cisco Catalyst SD-WAN

## Build a Basic Overlay Network using Cisco vEdge Devices

Let's use a simple network design, one that has two vEdge routers and one Cisco SD-WAN Controller, to illustrate how to form a functioning overlay network from Cisco vEdge components. In this topology, the Cisco SD-WAN Validator software has been enabled on one of the vEdge routers. Once you understand a simple network, you can start designing and building more complex topologies.

## A Simple Network Topology

The following figure illustrates our simple topology. Here, we have two sites, Site-100 and Site-200. vEdge-1 is the edge device in Site-100, and vEdge-2 is the edge device at Site-200. At each local site, the vEdge router connects to an existing traditional router via a standard Ethernet interface. vEdge-2 is connected to the transport network through a NAT device that also has firewall functionality.

**Figure 8: A Simple Network Topology**

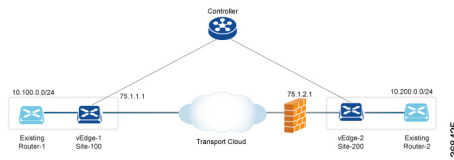

The goal of our design is to create a private network so that Router-1 and Router-2 can be next to each other from a Layer 3 perspective and so that hosts connected to each of these routers can communicate through the private network.

## Construct a Basic Network

The following steps allow you to create the simple overlay network depicted in the topology above.

- Step 1: Perform initial bringup and basic configuration.
- Step 2: Enable host or service-side interfaces and routing.
- Step 3: Enable overlay routing over OMP.
- Step 4: Check the automatic setup of the IPsec data plane.
- Step 5: Enforce policies.

Let's look at the steps in a bit more detail.

### Step 1: Perform Initial Bring up and Basic Configuration

From the perspective of a network administrator, the initial bringup of the Cisco vEdge network components is a straightforward and simple process, involving creating the configurations for each of the network components and ensuring that a few key authentication-related files are in place. From the perspective of user, bringup entails simply powering up the vEdge router and plugging in a cable to connect the router to the network. The remainder of the bringup occurs automatically via a zero-touch-provisioning process.

The network administrator performs the following tasks as part of the initial bringup:

1. Configure the Cisco SD-WAN Validator function on one of the vEdge routers in the network. In our example, this is vEdge-1.
2. Optionally, configure a top-level Cisco SD-WAN Validator to act as a ZTP server. In this situation, a DNS server must be present in the enterprise network.
3. Ensure that a DHCP server is present in the enterprise network.
4. Install the signed certificate on Cisco SD-WAN Manager, and download that certificate to Cisco SD-WAN Manager orchestrator.
5. Install the vEdge router authorized serial number file on Cisco SD-WAN Manager, and then download it to the Cisco SD-WAN Controllers.



6. From Cisco SD-WAN Manager CLI, create a configuration for each Cisco Catalyst SD-WAN Controller and vEdge router in the overlay network:
  - a. Configure a system IP address, which is similar to the router ID address on a traditional router, identifying the Cisco vEdge device with an address that is independent of any of the interfaces on the device. System IP addresses must be pre-allocated and must be unique across each vEdge router and Cisco Catalyst SD-WAN Controller. These addresses need not be routable through the network.
  - b. Configure site IDs for the various sites in the overlay network. In our example, vEdge-1 is at site-100 and vEdge-2 is at site-200. The Cisco Catalyst SD-WAN Controller can be collocated at a site, or it can be in its own site.
  - c. Configure domain IDs. This is an optional step to create clusters. For our example, configure the domain-ID as 1.
  - d. Configure the IP address or DNS name for the Cisco SD-WAN Validator server and the Cisco Catalyst SD-WAN Controller.
  - e. Configure WAN interfaces on vEdge-1 and vEdge-2. VPN 0 is the VPN reserved for WAN transport interfaces. IP addresses can be automatically obtained through DHCP. Alternatively, you can configure a default gateway and DNS explicitly.
  - f. By default, DTLS and IPsec are enabled on the WAN interfaces.
  - g. Save the configuration.

When the Cisco SD-WAN Controllers join the network, they are authenticated by the Cisco SD-WAN Validator, and when vEdge routers join the network, they are authenticated by both the Cisco SD-WAN Validator and the Cisco SD-WAN Controllers. These devices then connect to Cisco SD-WAN Manager, which downloads the configuration to them.

#### Example Configuration on vEdge-1:

```
system
  host-name vEdge-1
  system-ip 1.0.0.1
  domain-id 1
  site-id 100
  vbond 75.1.1.1 local
!
vpn 0
  interface ge 0/0
    ip address 75.1.1.1/24
    tunnel-interface
      color default
    no shutdown
  ip route 0.0.0.0/0 75.1.1.254
!
```

The remaining sections in this article describe how to configure other common functionality on vEdge routers and Cisco SD-WAN Controllers. Typically, you configure all functionality at one time, in the configuration that you create on Cisco SD-WAN Manager and that is downloaded to the device when it joins the overlay network. However, to highlight the different functionalities, this article describes the various portions of the configuration separately.

#### Step 2: Enable Host or Service-Side Interfaces and Routing

From Cisco SD-WAN Manager, you can also configure service-side interfaces and regular routing:

1. Configure interfaces on vEdge-1 towards the existing traditional router. Assign IP address and put the interface in a non-default VPN. In our example, this is VPN 1. Do the same on vEdge-2.
2. Configure OSPF or BGP on the vEdge routers towards the existing routers
3. Commit

To check for standard IP reachability, routes, and next hops at the local site, use the standard **ping**, **traceroute**, and various **show** commands on Cisco SD-WAN Manager or from the CLI of the device (if you have a direct connection to the device):

#### Example Configuration for the Host or Service-side VPN:

```
vpn 1
router
  ospf
    redistribute omp
    area 0
      interface ge 0/1
    exit
  exit
  !
!
interface ge 0/1
  ip address 10.1.2.12/24
  no shutdown
!
```

#### Step 3: Enable Overlay Routing over OMP

All site-local routes are populated on the vEdge routers. Distributed these routes to the other vEdge routers this is done through the Cisco Catalyst SD-WAN Controller, via OMP.

1. If you are using BGP or if there are OSPF external LSAs, allow OMP to redistribute the BGP routes.
2. Re-advertise OMP routes into BGP or OSPF.
3. Commit.

#### Example Configuration of Overlay Routing over OMP:

```
omp
  advertise ospf external
!
```

At this point, vEdge-1 is able to learn about the prefixes from site-200, and vEdge-2 is able to learn about prefixes from site-100. Because all the prefixes are part of VPN 1, the hosts in site-100 and site-200 have reachability with one another. From a Cisco Catalyst SD-WAN overlay network point of view, this reachability is possible because vEdge-1 advertises a vRoute consisting of the address 10.100.0.0/24 and the TLOC color of default, which we write as {75.1.1.1, default }, to the Cisco Catalyst SD-WAN Controller. In turn, the Cisco Catalyst SD-WAN Controller advertises this vRoute to vEdge-2. The same process happens with prefix 10.200.0.0/24 on vEdge-2.

#### Step 4: Check the Automatic Setup of the IPsec Data Plane

For every TLOC on a vEdge router, the vEdge router advertises a symmetric key for encryption. The Cisco Catalyst SD-WAN Controller reflects this key automatically and advertises the TLOC with the symmetric key. A two-way IPsec SA is set up as a result (that is, there is a different key in each direction), and data traffic

automatically starts to use this IPsec tunnel. Once a tunnel is up, BFD automatically starts on the tunnel. This is done to ensure fast data plane convergence in the event of a failure in the transport network.

The setup of the IPsec data plane happens automatically. No configuration is necessary. Multiple show commands are available to check the SAs and the state of the IPsec tunnel.

### Step 5: Enforce Policies

As an optional step, you can create control and data plane policies on the Cisco Catalyst SD-WAN Controller and push them to the vEdge routers. As an example, if the network administrator wants to enforce a policy to divert traffic destined to { vEdge-2, prefix 10.200.0.0/24 } to go to another site say vEdge-3, a control plane policy can be created on the Cisco Catalyst SD-WAN Controller and pushed to the respective vEdge routers. The results of the policy are pushed to the vEdge routers, not the configuration itself.

#### Example Configuration of Policies:

```

policy
  lists
    site-list site-100
      site-id 100
    !
    prefix-list my-prefixes
      ip-prefix 10.200.0.0/24
    !
  control-policy TE-thru-vedge3
    sequence 10
      match route
        prefix-list my-prefixes
      !
      action accept
      set
        tloc 1.0.0.3 color default
      !
      !
      default action accept
    !
  apply-policy
    site-list site-100
      control-policy TE-thru-vedge3 out
    !
  !

```

#### Advanced Options

Now that we have looked at basic routing, security, and policy, we can start adding various other elements to the network. You are encouraged to look at the *Software* category to add elements such as High Availability, Convergence, BFD, QoS, ACLs, segmentation, and advanced policy.

## Cisco Catalyst SD-WAN Terminology

The following figure summarizes the terminology used to describe a Cisco Catalyst SD-WAN overlay network.

Figure 9: Terminology used in a Cisco Catalyst SD-WAN overlay network

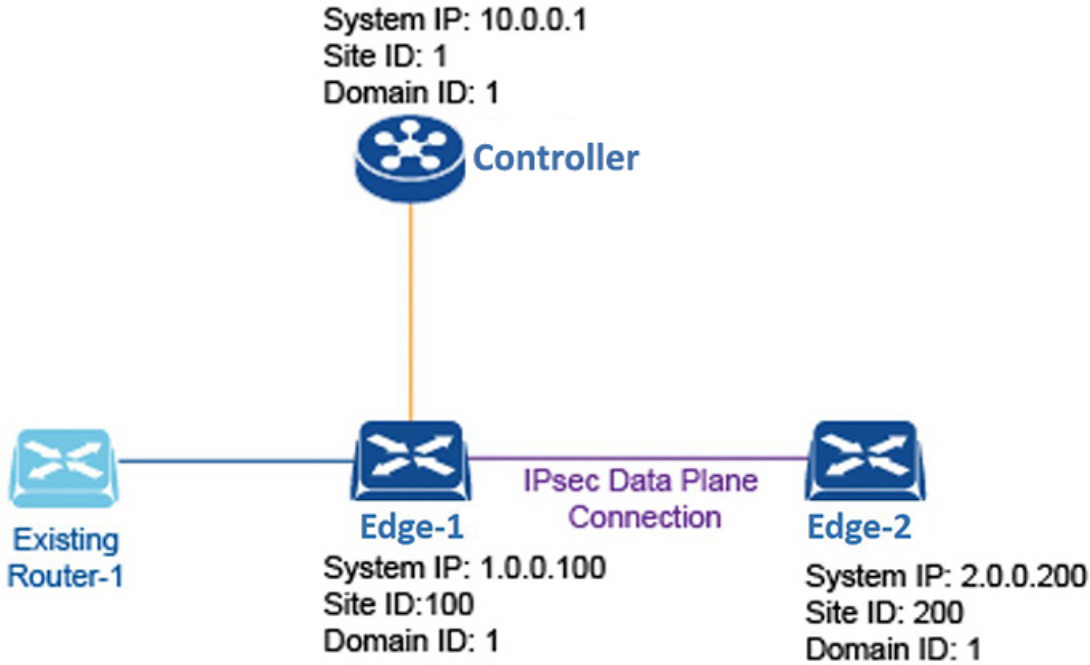

368423

### Domain ID

A domain is a logical grouping of edge routers and Cisco SD-WAN Controllers that demarcate the span of control for the Cisco SD-WAN Controllers. Each domain is identified by a unique integer, called the domain ID. Currently, you can configure only one domain in a Cisco Catalyst SD-WAN overlay network.

Within a domain, edge routers can connect only with the Cisco SD-WAN Controllers in their own domain. The Cisco SD-WAN Validator is aware of which Cisco SD-WAN Controllers are in which domain, so that when new edge routers come up, the Cisco SD-WAN Validator can point those routers to the Cisco SD-WAN Controllers in the proper domain. However, the Cisco SD-WAN Validator is never a member of a domain.

Within a domain, there is full synchronization of routing information among the Cisco SD-WAN Controllers and edge routers, and there is scope for route aggregation and summarization. An organization can divide up its network into domains to serve desired business purposes. For example, domains can correspond to a large geographic area or to data centers so that each data center and the branches for which it is responsible are contained within a single domain.

### OMP Routes

On Cisco SD-WAN Controllers and edge routers, OMP advertises to its peers the routes and services that it has learned from its local site, along with their corresponding transport location mappings, which are called Transport Locations (TLOCs). These routes are called OMP routes, to distinguish them from standard IP routes. It is through OMP routes that the Cisco SD-WAN Controllers learn the network topology and the available services.

Cisco Catalyst SD-WAN control plane architecture uses three types of OMP routes:

- OMP routes: Prefixes that establish reachability between end points that use the OMP-orchestrated transport network. OMP routes can represent services in a central data center, services at a branch office, or collections of hosts and other end points in any location of the overlay network. OMP routes require and resolve into TLOCs for functional forwarding. In comparison with BGP, an OMP route is the equivalent of a prefix carried in any of the BGP AFI/SAFI fields.
- TLOCs: Identifiers that tie an OMP route to a physical location. The TLOC is the only entity of the OMP routing domain that is visible to the underlying network, and it must be reachable via routing in the underlying network. A TLOC can be directly reachable via an entry in the routing table of the physical network, or it must be represented by a prefix residing on the outside of a NAT device and must be included in the routing table. In comparison with BGP, the TLOC acts as the next hop for OMP routes.
- Service routes: Identifiers that tie an OMP route to a service in the network, specifying the location of the service in the network. Services include firewalls, Intrusion Detection Systems (IDPs), and load balancers.



---

**Note** The maximum OMP routes supported are 140K on the C1131X\_8PW devices. When there are more than 140K OMP routes, the device crashes due to the out of memory issue.

---

## Site ID

A site is a particular physical location within the Cisco Catalyst SD-WAN overlay network, such as a branch office, a data center, or a campus. Each site is identified by a unique integer, called a site ID. Each Cisco vEdge device at a site is identified by the same site ID. So within a data center, all the Cisco SD-WAN Controllers and any edge routers are configured with the same site ID. A branch office or local site typically has a single edge router, but if a second one is present for redundancy, both routers are configured with the same site ID.

## System IP Address

Each edge router and Cisco Catalyst SD-WAN Controller is assigned a system IP address, which identifies the physical system independently of any interface addresses. This address is similar to the router ID on a regular router. The system IP address provides permanent network overlay addresses for edge routers and Cisco SD-WAN Controllers, and allows the physical interfaces to be renumbered as needed without affecting the reachability of the Cisco vEdge device. You write the system IP address as you would an IPv4 address, in decimal four-part dotted notation.

## TLOC

A TLOC, or transport location, identifies the physical interface where an edge router connects to the WAN transport network or to a NAT gateway. A TLOC is identified by a number of properties, the primary of which is an IP address–color pair, which can be written as the tuple {IP-address, color}. In this tuple, IP address is the system IP address and color is a fixed text string that identifies a VPN or traffic flow within a VPN. OMP advertised TLOCs using TLOC routes.

## Additional Information

For a description of the elements in a Cisco Catalyst SD-WAN overlay network, see *Components of the Cisco Catalyst SD-WAN Solution*. For an understanding of how you put together an overlay network using Cisco

Catalyst SD-WAN software and hardware, see *Constructing a Basic Network Using Cisco Catalyst SD-WAN Components*. For examples of how the components of the overlay network work, see the *Validated Examples*.



## CHAPTER 4

# Hardware and Software Installation

*Table 2: Feature History*

Feature Name	Release Information	Description
Generate a Bootstrap File For Cisco IOS XE Catalyst SD-WAN Devices Using the CLI	Cisco IOS XE Catalyst SD-WAN Release 17.3.1a	This feature enables you to generate a minimum bootstrap configuration file directly on a device, that enables a device to reconnect to the controller in case the full configuration is ever lost or removed.

- [Server Recommendations](#), on page 34
- [Device Configuration Reset of Cisco IOS XE Catalyst SD-WAN devices after Adding or Removing Modules](#), on page 34
- [On-Site Bootstrap Process for Cisco Catalyst SD-WAN Devices](#), on page 35
- [On-Site Bootstrap Process for Cisco vEdge 5000 using SHA2 Enterprise Certificates](#), on page 37
- [Generate a Bootstrap File For Cisco IOS XE Catalyst SD-WAN Devices Using the CLI](#), on page 42
- [One Touch Provisioning: Onboard Cisco IOS XE Catalyst SD-WAN Devices Using Generic Bootstrap Configuration](#), on page 43
- [Installing Cisco SD-AVC, Cisco vManage 20.1.1 and Earlier](#), on page 47
- [Install Cisco SD-AVC, Cisco vManage Release 20.3.1 and Later](#), on page 50
- [Software Installation and Upgrade for Cisco IOS XE Routers](#), on page 59
- [Recover the Default Password](#), on page 69
- [Software Installation and Upgrade for vEdge Routers](#), on page 70
- [Upgrade Memory and vCPU Resources on a Virtual Machine Hosting Cisco Catalyst SD-WAN Manager](#), on page 78
- [Expand the Secondary Disk Size, Cisco Catalyst SD-WAN Manager Release 20.12.x and Earlier](#), on page 80
- [Software Maintenance Upgrade for Cisco IOS XE Catalyst SD-WAN Devices](#), on page 80

# Server Recommendations

This topic links to the hardware recommendations for the Cisco SD-WAN Validator server, vEdge Cloud router server, Cisco SD-WAN Manager server, and Cisco SD-WAN Controller server: [Cisco Catalyst SD-WAN Controller Compatibility Matrix and Recommended Computing Resources](#).

## vEdge Cloud Router Server Recommendations

Refer to [vEdge Cloud Datasheet](#).

# Device Configuration Reset of Cisco IOS XE Catalyst SD-WAN devices after Adding or Removing Modules

## Prerequisites

You should have a basic knowledge of router modules hardware installation. For information on how to insert or remove modules from a platform, see the respective platform or module documentation.

## OIR Support



---

**Note** OIR is not supported on Cisco IOS XE Catalyst SD-WAN devices.

---

Online Insertion and Removal (OIR) enables you to replace parts in a Cisco device without affecting the system operation. When a module is inserted, power is available on the module, and it initializes itself to start working.

Hot swap functionality allows the system to determine when a change occurs in the unit's physical configuration, and reallocate the unit's resources to allow all interfaces to function adequately. This feature allows interfaces on the module to be reconfigured while other interfaces on the router remain unchanged.

The software performs the necessary tasks involved in handling the removal and insertion of the module. A hardware interrupt is sent to the software subsystem when a hardware change is detected, and the software reconfigures the system as follows:

- When a module is inserted, it is analyzed and initialized in such a way that the end user can configure it properly. The initialization routines used during OIR are the same as those called when the router is powered on. System resources, also handled by software, are allocated to the new interface.
- When a module is removed, the resources associated with the empty slot must either be freed or altered to indicate the change in its status.

## Reset Device Configuration

When a module is inserted or removed from your Cisco IOS XE Catalyst SD-WAN devices, you must perform a device configuration reset using the CLI to keep Cisco IOS XE Catalyst SD-WAN device synchronized with the physical change. For more information about resetting the controller mode configuration, see [Controller Mode Configuration Reset](#).



# On-Site Bootstrap Process for Cisco Catalyst SD-WAN Devices

The on-site bootstrap process involves generating a bootstrap configuration file that loads from a bootable USB drive or from internal boot flash to a device that supports Cisco Catalyst SD-WAN. When the device boots, it uses the information in the configuration file to come up on the network.

The on-site bootstrap process consists of this general workflow:

- Use Cisco SD-WAN Manager to generate a configuration file
- Copy the configuration file to a bootable USB drive and plug the drive into a device, or copy the configuration to the bootflash of a device
- Boot the device

If the configuration file is on both an inserted USB drive and on the bootflash, a device gives priority to the configuration file on the bootflash.

## Device Requirements

A device that you configure by using the on-site bootstrap process must meet these requirements:

- A supported Cisco Catalyst SD-WAN image must be installed on the device
- The device must be in its factory state with no added configuration

## Perform the On-Site Bootstrap Process

To perform the on-site bootstrap process for a device, follow these steps:

1. Upload the Chassis ID and the serial number of the device to Cisco SD-WAN Manager.  
For instructions, see *Upload the vEdge Serial Number File*.
2. From the Cisco SD-WAN Manager menu, choose **Administration > Settings** and make sure that the Organization Name and the Cisco Catalyst SD-WAN Validator IP address are configured properly.
3. If you are using your own enterprise root certificate authority (CA) for device certification in your network, take these actions in Cisco SD-WAN Manager:
  - a. From the Cisco SD-WAN Manager menu, choose **Administration > Settings**.
  - b. Click **WAN Edge Cloud Certificate Authorization**.  
(If you are using Cisco Catalyst SD-WAN Manager Release 20.12.x or earlier, click **Edit**.)
  - c. Click **Manual**.
  - d. Click **Save**.
4. From the Cisco SD-WAN Manager menu, choose **Configuration > Templates**.
5. Click **Feature Templates** and create a template for the device.



---

**Note** In Cisco vManage Release 20.7.x and earlier releases, **Feature Templates** is called **Feature**.

---

6. Perform the following steps:
  - a. From the Cisco SD-WAN Manager menu, choose **Configuration > Devices**.
  - b. For the desired device, click ... and choose **Generate Bootstrap Configuration**.
  - c. In the dialog box, choose **Cloud-init** and click **OK**.

The system generates a Multipurpose Internet Mail Extensions (MIME) file and displays its contents in a pop-up window. This file contains system properties for the device, the root CA if you are using an enterprise root CA, and configuration settings from the template that you created.

7. In the MIME file pop-up window, click **Download**.

The system downloads the file to your local system and saves it in your directory for downloads. The file name is `chassis.cfg`, where `chassis` is the device chassis ID that you uploaded in Step 1.



---

**Note** As an alternative to this step, you can copy the contents of the MIME file from the pop-up window to a text file, save the text file with the name `ciscosdwan.cfg` (case sensitive), and then skip to Step 8.

---



---

**Note** For hardware devices, use the bootstrap file name as `ciscosdwan.cfg`. This file is generated by Cisco SD-WAN Manager and includes UUID, but does not include OTP. For software devices (CSR and ISRv), and OTP-authenticated devices such as ASR1002-X, use the bootstrap file name as `ciscosdwan_cloud_init.cfg`. This file contains the OTP but not the UUID validation for `ciscosdwan_cloud_init.cfg`.

---

8. If you downloaded the MIME file, rename it to `ciscosdwan.cfg` (case sensitive).



---

**Note** This is the configuration file for the on-site bootstrap process.

---

9. Copy the `ciscosdwan.cfg` file to a bootable USB drive or to the bootflash of the device.



---

**Note** The file must be named exactly as shown or the device will not read it.

---

10. If you are using a USB drive, plug the USB drive into the device.
11. Boot the device.

The device reads the configuration file from the USB drive or the bootflash and uses the configuration information to come up on the network. The device give priority to a configuration file that is on its bootflash.

# On-Site Bootstrap Process for Cisco vEdge 5000 using SHA2 Enterprise Certificates

Table 3: Feature History

Feature Name	Release Information	Description
On-Site Bootstrap Process for Cisco vEdge 5000 using SHA2 Enterprise Certificates	Cisco SD-WAN Release 20.3.1 Cisco vManage Release 20.3.1	By default, a Cisco vEdge 5000 device uses an SHA1 certificate for authentication with controllers in the overlay network. With this feature, you can authenticate the device using an OTP and a Public Key, and install an SHA2 enterprise certificate on the device. By authenticating the device using an OTP and a Public Key and installing an SHA2 enterprise certificate, you can bypass SHA1 certificate authentication and secure the device against SHA1 vulnerabilities.

A Cisco vEdge 5000 device is equipped with a Trusted Platform Module (TPM 1.2) and uses SHA1 certificates for authentication while connecting to the overlay network. For information on the bootstrap process using SHA1 certificates, see *On-Site Bootstrap Process for Cisco Catalyst SD-WAN Devices*.

From Cisco Catalyst SD-WAN Release 20.3.1, while bootstrapping a Cisco vEdge 5000 device and connecting the device to the overlay network, you can authenticate the device using a One Time Password (OTP) and a Public Key, and install an SHA2 enterprise certificate on the device. By authenticating the device using an OTP and a Public Key and installing an SHA2 enterprise certificate, you can bypass SHA1 certificate authentication and secure the device against SHA1 vulnerabilities.

## How Cisco vEdge 5000 is Authenticated using OTP and Public Key

1. Enter the public key for the device on **Plug and Play Connect** and generate the `serial.viptela` file.
2. Upload the `serial.viptela` file to Cisco SD-WAN Manager.
3. Cisco SD-WAN Manager generates a random authentication token for the device. Cisco SD-WAN Manager encrypts the authentication token using the device public key and populates it as the OTP in the `<chassis>.config` file.
4. Download the `<chassis>.config` file to a bootable USB drive and insert the USB drive into the device after performing a factory reset.
5. The device reads the `<chassis>.config` file, reads the encrypted digest from the OTP field, decrypts the digest using the device private key and obtains the authentication token.
6. The device disables AVNET/TPM1.2 SHA1 certificate authentication.

7. The device authenticates itself with Cisco SD-WAN Manager using the authentication token and establishes a control connection.
8. Cisco SD-WAN Manager pushes the initial configuration into the device.
9. Cisco SD-WAN Manager pushes the SHA2 enterprise certificate for the device and installs the certificate on the device.
10. Device reauthenticates itself to controllers using the SHA2 enterprise certificate and connects to controllers.

### Points to Consider

- After a Cisco vEdge 5000 device is authenticated with Cisco SD-WAN Validator or Cisco SD-WAN Manager using OTP, do not reboot the device until the SHA2 enterprise certificate is installed and validated. If the device reboots before the Enterprise Certificate is validated, restart the bootstrap procedure.
- After a signed SHA2 enterprise certificate is installed on a Cisco vEdge 5000 device and the bootstrapping process is complete, if you perform a software reset, a configuration reset, or a factory reset, bootstrap the device again.
- Every time you generate the Cloud-Init(Encrypted OTP) bootstrap configuration, you must download the new configuration file to a bootable USB drive.

### Prerequisites

1. Ensure Enterprise Certificate authorization is configured.
  - a. From the Cisco SD-WAN Manager menu, choose **Administration > Settings**.
  - b. Click **Hardware WAN Edge Certificate Authorization**.  
(If you are using Cisco Catalyst SD-WAN Manager Release 20.12.x or earlier, click **Edit**.)
  - c. Ensure that **Enterprise Certificate (signed by Enterprise CA)** is selected and click **Save**.
2. Ensure that the public key entry for the device is available on the PNP server before generating the `serial.viptela` file. For more information, see *View or Add Public Key for a Cisco vEdge 5000 Device*.
3. If a Cisco vEdge 5000 device is connected to the overlay network using SHA1 certificates, you must invalidate and remove the device from the overlay network before configuring the use of OTP, Public Key, and SHA2 enterprise certificate for authentication.

### View or Add Public Key for a Cisco vEdge 5000 Device

1. On [Cisco Software Central](#), log in to **Plug and Play Connect** using the required Smart and Virtual Accounts required to access the Cisco vEdge 5000 device.
2. In the **Devices** list, click on the serial number of the Cisco vEdge 5000 device.  
The **Device Information** is displayed.
3. In the **Device Information** dialog box, check whether the device **Public Key** is available.
4. If the **Public Key** is not available, add the **Public Key**:

- a. In the **Devices** list, select the Cisco vEdge 5000 device using the check box.
- b. Click **Edit**.  
The **Edit Devices** page is displayed.
- c. In the **Selected Devices** area, click **view/edit** in the **Public Key** column.  
The **Public Key** dialog box is displayed.
- d. Enter the public key in the text box, or click **Browse** to upload a file containing the public key.
- e. Click **OK** to save the public key and close the dialog box.
- f. On the **Edit Devices** page, click **Submit** to attach the public key to the Cisco vEdge 5000 device.

### Bootstrap Procedure

The on-site bootstrap process involves generating a bootstrap configuration file that loads from a bootable USB drive. When the Cisco vEdge 5000 device boots, it uses the information in the configuration file to connect to the overlay network.

1. From the Cisco SD-WAN Manager menu, choose **Configuration > Devices > WAN Edge List**.
2. Click **Upload WAN Edge List**.
3. In the **Upload WAN Edge List** dialog box, select the the Cisco vEdge 5000 serial number file to upload. Select **Validate the uploaded vEdge list and send to controllers** and click **Upload**.  
The WAN Edge List is uploaded to controllers.  
The Cisco vEdge 5000 device is added to the **WAN Edge List**.
4. Attach the device to a device configuration template.
  - a. From the Cisco SD-WAN Manager menu, choose **Configuration > Templates**.
  - b. Click **Device** and select a template.
  - c. For the desired template, click **...** and choose **Attach Devices**. The **Attach Devices** dialog box opens.
  - d. In the **Available Devices** column, select a group, and search to select the Cisco vEdge 5000 device.
  - e. Click the arrow pointing right to move the device to the **Selected Devices** column.
  - f. Click **Attach**.  
Configuration template is scheduled for the device.
5. Generate the bootstrap configuration for the newly added device.
  - a. From the Cisco SD-WAN Manager menu, choose **Configuration > Devices**.
  - b. Click **WAN Edge List**, select the Cisco vEdge 5000 device.
  - c. For the selected device, click **...** and choose **Generate Bootstrap Configuration**.
  - d. In the **Generate Bootstrap Configuration** dialog box, select **Cloud-Init(Encrypted OTP)** and click **OK**.

- e. Click **Download** to download the bootstrap configuration and save the file with a filename in the `<ChassisNumber>.cfg` format.
- f. Copy the `<ChassisNumber>.cfg` file to a bootable USB drive.

**Note**

- The USB drive must be of the FAT-32 format for Cisco vEdge 5000 device to recognize and auto-mount the drive.
- Copy the `<ChassisNumber>.cfg` file to the home or parent directory of the USB drive.

6. Send the Cisco vEdge 5000 serial number file and OTP information to controllers.
  - a. From the Cisco SD-WAN Manager menu, choose **Configuration > Certificates > WAN Edge List**.
  - b. Click **Send to Controllers** to synchronize the WAN Edge list on all controllers.

The device serial number file and OTP information are sent to controllers.

- c. (Optional) Verify the WAN Edge List on controllers using the command **show orchestrator valid-vedges hardware-installed-serial-number prestaging**.

```
vbond# show orchestrator valid-vedges hardware-installed-serial-number prestaging

HARDWARE

  INSTALLED   SUBJECT
  SERIAL      SERIAL
  CHASSIS NUMBER  SERIAL NUMBER          VALIDITY  ORG
  NUMBER      NUMBER

-----
193A0122170001 deaedef5d39919454fdfcc8470eccd8d8  valid    vIPtela Inc Regression
prestaging N/A
```

7. Perform a factory reset of the Cisco vEdge 5000 device with a default image of Cisco SD-WAN Release 20.3.1 or later.
8. When the Cisco vEdge 5000 device is 'Up' (indicated by a status of 'System: Up' on the LCD display), insert the USB drive with `<ChassisNumber>.cfg` file.

The device reads the `<ChassisNumber>.cfg` file from the USB drive. Organization-name, Cisco SD-WAN Validator IP address, OTP token, and Enterprise root-ca are retrieved from the configuration file.

- a. (Optional) Issue the **show control local-properties** command on the device to verify the information retrieved from the configuration file.
- b. (Optional) If the device WAN interface is not assigned an IP address through DHCP, configure a static IP address and the routing information required to reach controllers.

The device connects to Cisco SD-WAN Validator and Cisco SD-WAN Manager after authentication using the OTP.

The device obtains the System IP address and the site ID from Cisco SD-WAN Manager configuration templates. If templates are not configured on Cisco SD-WAN Manager, configure the required system configuration on the device.

After the device connects to Cisco SD-WAN Manager, Cisco SD-WAN Manager retrieves the Enterprise Certificate Signing Request (CSR). From the Cisco SD-WAN Manager menu, choose **Configuration > Certificates > WAN Edge List**, the device certificate state is shown as **CSR**.

9. Download CSR.
  - a. From the Cisco SD-WAN Manager menu, choose **Configuration > Certificates**.
  - b. Select the Cisco vEdge 5000 device for which to sign a certificate.
  - c. For the selected device, click ... and select **View Enterprise CSR**.
  - d. To download the CSR, click **Download**.
10. Send the certificate to a third-party signing authority and have them sign it.
11. To install the certificate on the device, perform the following steps:
  - a. From the Cisco SD-WAN Manager menu, choose **Configuration > Certificates > Controllers**.



---

**Note** Starting from Cisco IOS XE Catalyst SD-WAN Release 17.13.1a, the **Controllers** tab is renamed as the **Control Components** tab to stay consistent with Cisco Catalyst SD-WAN rebranding.

---

- b. Click **Install Certificate** button located in the upper-right corner of the screen.
- c. In the **Install Certificate** screen, paste the certificate into the **Certificate Text** field, or click **Select a File** to upload the certificate in a file.
- d. Click **Install**.

The installed certificate serial number of the device is updated on the controllers.

From the Cisco SD-WAN Manager menu, choose **Configuration > Certificates > WAN Edge List**, the device certificate state is shown as installed.

12. (Optional) Check the WAN Edge list on the controller to confirm that the device serial number is installed.

```

vbond# show orchestrator valid-vedges hardware-installed-serial-number 12399910

```

CHASSIS NUMBER	SERIAL NUMBER	VALIDITY	ORG	HARDWARE INSTALLED SERIAL NUMBER	SUBJECT SERIAL NUMBER
193A0122170001	18DB5D4F	valid	vIPtela Inc Regression	12399910	N/A

13. Remove the USB drive from the device.

### Outcome

- The Cisco vEdge 5000 device is added to the overlay network and connected to the controllers using the SHA2 Enterprise Certificate.
- The device will use the installed SHA2 Enterprise Certificate after a reboot, a software upgrade, or a software downgrade to Cisco SD-WAN Release 20.3.1 or a later release. Use of SHA1 certificates is disabled.

## Generate a Bootstrap File For Cisco IOS XE Catalyst SD-WAN Devices Using the CLI

To establish connectivity with the Cisco Catalyst SD-WAN controller, a device requires a minimum configuration. In most situations, this minimum bootstrap configuration (MBC) can be provided initially by plug-and-play (PnP). But in some situations, such as in remote sites where it may be preferable not to use PnP, it is helpful to have a saved bootstrap configuration that can connect the device to the controller.

The **request platform software sdwan bootstrap-config save** command saves the device configuration to the bootflash. The command can be used to save the configuration at any time, but it is intended for saving a minimum bootstrap configuration (MBC) file that enables the device to reconnect to the controller in case the full configuration is ever lost or removed.

When setting up a device, add to the configuration the details that are required to connect to the controller, and then use this command to save the MBC. The file is saved to this location:

```
bootflash:/ciscosdwan.cfg
```

### Prerequisites

- The controller root certificate is installed on the Cisco IOS XE Catalyst SD-WAN device, to authenticate the device.
- The device is physically connected to the WAN through one of its interfaces.

### Procedure

1. On the Cisco IOS XE Catalyst SD-WAN device, establish connectivity to Cisco SD-WAN Manager, by configuring the following:
  - System IP address
  - Domain ID
  - Site ID
  - sp-organization-name
  - organization-name
  - Cisco SD-WAN Validator IP address and port number
  - Tunnel with encapsulation configured as either GRE or IPSEC

Example:



```

system
system-ip 10.0.0.10
domain-id 1
site-id 200
admin-tech-on-failure
sp-organization-name CiscoISR
organization-name CiscoISR
vbond 10.0.100.1 port 12346
!
interface Tunnell
no shutdown
ip unnumbered GigabitEthernet0/1/0
tunnel source GigabitEthernet0/1/0
tunnel mode sdwan
exit
sdwan
interface GigabitEthernet0/1/0
tunnel-interface
encapsulation ipsec
exit
exit
commit

```

2. Use **show sdwan control connections** to verify connectivity to the Cisco SD-WAN Manager, Cisco SD-WAN Controller, and Cisco SD-WAN Validator.
3. Use the **request platform software sdwan bootstrap-config save** command to save a bootstrap file to the device bootflash.

Example:

```

Device#request platform software sdwan bootstrap-config save
Saving bootstrap file 'bootflash:/ciscosdwan.cfg'...
Done

```

The configuration file is saved to this location:

```
bootflash:/ciscosdwan.cfg
```

## One Touch Provisioning: Onboard Cisco IOS XE Catalyst SD-WAN Devices Using Generic Bootstrap Configuration

*Table 4: Feature History*

Feature Name	Release Information	Description
One Touch Provisioning: Onboard Cisco IOS XE Catalyst SD-WAN Devices Using Generic Bootstrap Configuration	Cisco IOS XE Catalyst SD-WAN Release 17.4.1a Cisco vManage Release 20.4.1	You can generate a generic bootstrap configuration on Cisco SD-WAN Manager and use this configuration to onboard multiple Cisco IOS XE Catalyst SD-WAN devices. When you boot a device with the generic bootstrap configuration, the device is listed on Cisco SD-WAN Manager as an unclaimed WAN edge device. To complete the onboarding, claim the device on Cisco SD-WAN Manager and attach a device template that configures the system IP address and site ID.

## Overview of Generic Bootstrap Configuration

To onboard a Cisco IOS XE Catalyst SD-WAN device to the Cisco Catalyst SD-WAN overlay network, you generate a bootstrap configuration on Cisco SD-WAN Manager and boot the device with this configuration. After the device connects to Cisco SD-WAN Manager, you complete the onboarding using the Cisco SD-WAN Manager GUI. The bootstrap configuration contains device-specific configuration settings, requiring you to generate a bootstrap configuration for each device that you must onboard. From Cisco IOS XE Catalyst SD-WAN Release 17.4.1a, you can use a generic bootstrap configuration to onboard multiple Cisco IOS XE Catalyst SD-WAN devices.

The generic bootstrap configuration omits device-specific details, such as the device UUID, and provides settings that a Cisco IOS XE Catalyst SD-WAN device can use to connect to the Cisco SD-WAN Validator. When the device connects to the Cisco SD-WAN Validator, the device is listed as an unclaimed WAN edge device on Cisco SD-WAN Manager. To complete the onboarding, you must claim the device on Cisco SD-WAN Manager and attach a device template that configures the system IP and site ID. Cisco SD-WAN Manager authenticates the device using a certificate that is installed on the device as part of the generic bootstrap configuration.

The generic bootstrap configuration contains the following:

- Organization name
- WAN interface to be enabled on the Cisco IOS XE Catalyst SD-WAN device
- IP address of the Cisco SD-WAN Validator
- Cisco SD-WAN Manager-signed certificate for authenticating the device.

To use generic bootstrap configuration to onboard a device, you must have a Dynamic Host Configuration Protocol (DHCP) server in the branch network where you are installing the device. The generic bootstrap configuration does not assign an IP address to the WAN interface. Instead, the configuration enables a DHCP client on the WAN interface so that the interface can acquire an IP address from a DHCP server in the branch network.

## How the Generic Bootstrap Configuration Works

1. While generating the generic bootstrap configuration on Cisco SD-WAN Manager, you select the interface that will serve as the VPN 0 (WAN) interface on the Cisco IOS XE Catalyst SD-WAN device.
2. Copy the generic bootstrap configuration file onto the device bootflash and reset the device. On reset, the device is initialized with the generic bootstrap configuration.
3. The bootstrap configuration enables a DHCP client on the designated VPN 0 interface. The interface acquires an IP address and related details from a DHCP server in the network.
4. The device connects to the Cisco SD-WAN Validator through the VPN 0 interface is listed as an unclaimed WAN edge device on the Cisco SD-WAN Validator and Cisco SD-WAN Manager.
5. When you claim the device on Cisco SD-WAN Manager, Cisco SD-WAN Manager authenticates the device using the certificate installed on the device as part of the bootstrap configuration. After authentication, the device is listed among the valid WAN edge devices on Cisco SD-WAN Manager and the Cisco SD-WAN Validator.
6. Attach and push a template containing the system IP and site ID to the device.
7. The device establishes control connections to Cisco SD-WAN Controllers and is added to the overlay network.

## Onboard a Cisco IOS XE Catalyst SD-WAN Device using Generic Bootstrap Configuration

1. Enable One Touch Provisioning:
  - a. From the Cisco SD-WAN Manager menu, choose **Administration > Settings**.
  - b. Check if **One Touch Provisioning** is **Enabled**. If **Enabled**, go to Step 2.
  - c. If **One Touch Provisioning** is **Disabled**, click **Edit**.
  - d. For the **Enable Claim WAN Edges** setting, choose **Enabled** and click **Save**.
2. From the Cisco SD-WAN Manager menu, choose **Configuration > Devices > WAN Edge List**.
3. Click **Export Bootstrap Configuration**.
  - a. In the **Export Bootstrap Configuration** dialog box, enter the **VPN0 Interface name**.



---

**Note** The VPN 0 interface name may vary among Cisco IOS XE Catalyst SD-WAN device models. Specify the interface name based on the model you wish to onboard.

---

- b. Click **Generate Generic Configuration**.
4. Save the generic bootstrap configuration file.

The file is named in the format <filename>.cfg.
  5. Rename the generic bootstrap configuration file as `ciscosdwan.cfg`.
  6. Copy the `ciscosdwan.cfg` file to a bootable USB drive or to the bootflash of the device.
  7. If you are using a USB drive, plug the USB drive into the device.
  8. Reset the device software configuration by issuing the following commands on the CLI:

```
Device# request platform software sdwan config reset
Device# reload
```



---

**Note** Performing a config reset generates a new type 6 master key. Therefore, ensure that the current password protecting the bootstrap configuration file is in plaintext and does not contain any type 6 keys. If the bootstrap configuration password contains type 6 keys, it will cause the device reset to fail.

---

9. Reboot the device.
  - While rebooting, the device reads the configuration file from the USB drive or the bootflash and applies the configuration.

The configuration enables the VPN 0 interface and initializes a DHCP client on the interface. The interface acquires an IP address from a DHCP server in the network.

The device connects to the Cisco SD-WAN Validator and is listed as an unclaimed WAN edge device on the Cisco SD-WAN Validator and Cisco SD-WAN Manager.

- On the Cisco SD-WAN Validator, you can view the unclaimed WAN edge devices by using the command **show orchestrator unclaimed-vedges**.
- In Cisco SD-WAN Manager, you can view the unclaimed WAN edge devices by selecting **Configuration > Devices > Unclaimed WAN Edges**.

If the device is not listed as an unclaimed WAN edge device, check whether the device can connect to the Cisco SD-WAN Validator and correct any connectivity issues.

**10.** Claim the device on Cisco SD-WAN Manager:

From the Cisco SD-WAN Manager menu, choose **Configuration > Devices > Unclaimed WAN Edges**.

- Choose the device you wish to claim and click **Claim Device(s)**.
  - The device is removed from **Unclaimed WAN Edges** and listed on **WAN Edge List**.
  - On the Cisco SD-WAN Validator, the device is listed as a valid WAN edge device. You can view the valid WAN Edge devices by issuing the command **show orchestrator valid-vedges**.

**11.** Attach a configuration template to the device.

- Ensure that the template includes the system IP address and the site ID.
- Push the template to the device.

### Result

The device connects to Cisco SD-WAN Controllers and is added to the overlay network.

To verify that the device has established control connections and is part of the overlay network, from the Cisco SD-WAN Manager menu, choose **Monitor > Overview** and click the number in the **WAN Edges** area.



---

**Note** In Cisco vManage Release 20.6.x and earlier: To verify that the device has established control connections and is part of the overlay network, from the Cisco SD-WAN Manager menu, choose **Dashboard > Main Dashboard** and click **WAN Edge** devices in the **Summary Pane**.

---

### Remove a Cisco IOS XE Catalyst SD-WAN Device Onboarded Using Generic Bootstrap Configuration

**1.** Detach device from templates:

- From the Cisco SD-WAN Manager menu, choose **Configuration > Templates**.
- Click **Device Templates** and select the template attached to the device.



---

**Note** In Cisco vManage Release 20.7.x and earlier releases, **Device Templates** is called **Device**.

---

- For the selected template, click ... and choose **Detach Devices**.
- In the **Available Devices** column, select the device to be detached from the template.
- Click the arrow pointing right to move the device to the **Selected Devices** column.

- f. Click **Detach**.
2. Connect to the device using SSH. From the device SSH terminal, shut down the VPN 0 WAN interface by using the following commands:

```
Device(config)# interface vpn0-interface-name
Device(config-if)# shutdown
```
3. Invalidate the device:
  - a. From the Cisco SD-WAN Manager menu, choose **Configuration > Certificates**.
  - b. Click **WAN Edge List** and choose the device to invalidate.
  - c. In the **Validate** column, click **Invalid**.
  - d. Click **OK** to confirm the move to the invalid state.
  - e. Click **Send to Controllers** to send the chassis and serial number of the invalidated device to the controllers in the network. Cisco SD-WAN Manager displays the **Push WAN Edge List** screen showing the status of the push operation.
4. Delete the WAN edge device:
  - a. From the Cisco SD-WAN Manager menu, choose **Configuration > Devices**.
  - b. Click **WAN Edge List** and select the device you wish to remove.
  - c. For the selected device, click **...** and choose **Delete WAN Edge**.
  - d. Click **OK** to confirm deletion of the device.

## Installing Cisco SD-AVC, Cisco vManage 20.1.1 and Earlier



---

**Note** Beginning with Cisco vManage Release 20.3.1/Cisco IOS XE Catalyst SD-WAN Release 17.3.1a, the Cisco SD-AVC installation has changed. See [Install Cisco SD-AVC, Cisco vManage Release 20.3.1 and Later, on page 50](#).

---

### Overview

Beginning with the 18.4 release, Cisco Catalyst SD-WAN can optionally incorporate Cisco Software-Defined Application Visibility and Control (SD-AVC) on Cisco IOS XE Catalyst SD-WAN devices. The SD-AVC network service operates as a container within Cisco SD-WAN Manager.

### What are the benefits of this feature?

Cisco SD-AVC uses Cisco NBAR2 and other components that operate on devices in the network to provide:

- Recognition of network application traffic for visibility, analytics, application-aware routing, and application-based policies, such as QoS and application-based firewall policy.
- Analytics at the network level.

### Cisco SD-AVC Installation Requirements for Cisco SD-WAN Manager

The following table describes the SD-AVC installation requirements.

Cisco SD-WAN Manager Installation Scenario	Requirements
Cisco vManage 18.4 on a cloud-based server, provided fully configured by the Cisco cloud operations team	The SD-AVC package is pre-installed by the Cisco cloud operations team.
Cisco vManage 18.4 on a self-managed cloud or local server	Install the SD-AVC package as described below.
Upgrading from an earlier version of Cisco SD-WAN Manager to Cisco vManage 18.4	Install the SD-AVC package as described below.

## Enabling SD-AVC on Cisco SD-WAN Manager

### Prerequisites

- Download the latest container image for the SD-AVC network service. Save the file to an accessible location on the server hosting Cisco SD-WAN Manager. This container is required for the procedure. To download the container, open the Cisco Software Download page and enter "SD-WAN". Select "Software-Defined WAN (SD-WAN)" from the results, then "SD-WAN" in the results. In the software packages available for download, select SD-AVC.
- Ensure that routers in the network that are included in the SD-WAN topology have a DNS server configured.
- The virtual machine in which Cisco SD-WAN Manager operates must have the following resources available to dedicate to the SD-AVC network service:
  - vCPU: 4
  - RAM: 5 GB
  - Storage: 40 GB

### Procedure

1. Ensure that the downloaded SD-WAN image is compatible with your version of Cisco SD-WAN Manager.
  - a. Display the checksum for the compatible image, using the following API:  
`https://[vManage-IP-address]/dataservice/sdavic/checksum`  
**Example:** `https://10.0.0.1/dataservice/sdavic/checksum`
  - b. Verify that the checksum of the downloaded image matches this.
2. To upload the SD-AVC virtual service package to Cisco SD-WAN Manager:
  - a. From the Cisco SD-WAN Manager menu, choose **Maintenance > Software Repository**.
  - b. Click **Virtual Images** and select **Upload Virtual Image** to upload the SD-AVC package.

3. From the Cisco SD-WAN Manager menu, choose **Administration > Cluster Management** page.
4. For the desired host (the Cisco SD-WAN Manager portal on which you are enabling SD-AVC), click ... and choose **Edit**.
5. In the Edit Cisco SD-WAN Manager dialog box, enter the username and password, using Cisco SD-WAN Manager credentials.
6. Select the checkbox for **Enable SD-AVC**. Click **Update**.
7. Cisco SD-WAN Manager prompts you to confirm before rebooting the device to apply the changes to the device. Click **OK** to confirm.
8. After the reboot, Cisco SD-WAN Manager comes up automatically and displays progress on the SD-AVC activation. Wait for the activation to complete.
9. (Optional) After installation is complete, you can verify that Cisco SD-WAN Manager has the SD-AVC virtual service installed and operating correctly.
  - a. From the Cisco SD-WAN Manager menu, choose **Administration > Cluster Management**.
  - b. In Service Configuration, in Cisco SD-WAN Manager row of the table, verify that the SD-AVC shows a green checkmark.

For information about Cisco SD-WAN Manager commands, see *Cisco SD-WAN Manager Command Reference* documentation.

## Enable SD-AVC on Cisco IOS XE Catalyst SD-WAN Devices

To enable SD-AVC on the Cisco IOS XE Catalyst SD-WAN device, create a localized policy that enables **app visibility** and apply the policy to the template for the Cisco IOS XE Catalyst SD-WAN device.

### Prerequisites

- A template exists for the Cisco IOS XE Catalyst SD-WAN device (example: Cisco ASR 1001-X, Cisco ISR 4321).
- TCP port 10501 destination traffic must be permitted.

### Procedure

1. From the Cisco SD-WAN Manager menu, choose **Configuration > Policies**.
2. Click **Localized Policy**.
3. To add a policy and enable Application, follow the steps below:
  - a. Click **Add Policy**.
  - b. Click **Next** on the several screens (Create Groups of Interest, Configure Forwarding Classes/QOS, Configure Access Control Lists, Configure Route Policy) until the **Policy Overview** screen.
  - c. In the **Policy Overview** screen, enter a policy name and policy description.
  - d. Select **Application**.

- e. Save the policy.
4. To add the localized Policy to the device template, follow the steps below:
  - a. From the Cisco SD-WAN Manager menu, choose **Configuration > Templates**.
  - b. For the device on which you have to enable SD-AVC, click ... and select **Edit** from the menu.
  - c. Click **Additional Templates**.
  - d. Add the localized policy created in an earlier step of this procedure.
  - e. Click **Update** and proceed through the next screens to push the updated template to the device.
5. (Optional) After pushing the update to the device, you can check the status of SD-AVC on the device with one of the following commands.

```
show avc sd-service info summary
```

or

```
show avc sd-service info connectivity
```

## Install Cisco SD-AVC, Cisco vManage Release 20.3.1 and Later

Installing or upgrading to Cisco vManage Release 20.3.1 automatically includes installation of Cisco SD-AVC as a component.

For information about Cisco SD-AVC, see [Cisco SD-AVC, on page 25](#).

## Enable Cisco SD-AVC, Cisco vManage Release 20.3.1 and Later

### Prerequisites

Ensure that routers in the network that are included in the Cisco Catalyst SD-WAN topology have a DNS server configured.



---

**Note** Cisco SD-AVC must operate on only one Cisco SD-WAN Manager instance. In a Cisco SD-WAN Manager cluster, enable Cisco SD-AVC on only one instance of Cisco SD-WAN Manager.

---

To enable Cisco SD-AVC, perform the following steps.

1. From the Cisco SD-WAN Manager menu, choose **Administration > Cluster Management**.
2. For the desired host (the portal on which you are enabling SD-AVC), click ... and select **Edit**.
3. In the **Edit Manager** pop-up window, select the checkbox for **Enable SD-AVC**.





---

**Note** The **Edit Manager** pop-up window provides an option for disabling the application server. After disabling the application server, you cannot later enable other services using this method. If you need to disable the application server, do not do this at the same time that you enable other features.

---

4. Enter the username and password, using Cisco SD-WAN Manager credentials. Reboot the device to apply the changes.
5. After the reboot, Cisco SD-WAN Manager comes up automatically and displays progress on the SD-AVC activation. Wait for the activation to complete.
6. (optional) After installation is complete, you can verify that Cisco SD-WAN Manager has the SD-AVC virtual service installed and operating correctly.
  - a. From the Cisco SD-WAN Manager menu, choose **Administration > Cluster Management**.
  - b. Click **Service Configuration**, in the Cisco SD-WAN Manager row of the table, verify that SD-AVC shows a green checkmark.

## Enable SD-AVC on Cisco IOS XE Catalyst SD-WAN Devices

To enable SD-AVC on the Cisco IOS XE Catalyst SD-WAN device, create a localized policy that enables **app visibility** and apply the policy to the template for the Cisco IOS XE Catalyst SD-WAN device.

### Prerequisites

- A template exists for the Cisco IOS XE Catalyst SD-WAN device (example: Cisco ASR 1001-X, Cisco ISR 4321).
- TCP port 10501 destination traffic must be permitted.

### Procedure

1. From the Cisco SD-WAN Manager menu, choose **Configuration > Policies**.
2. Click **Localized Policy**.
3. To add a policy and enable Application, follow the steps below:
  - a. Click **Add Policy**.
  - b. Click **Next** on the several screens (Create Groups of Interest, Configure Forwarding Classes/QOS, Configure Access Control Lists, Configure Route Policy) until the **Policy Overview** screen.
  - c. In the **Policy Overview** screen, enter a policy name and policy description.
  - d. Select **Application**.
  - e. Save the policy.
4. To add the localized Policy to the device template, follow the steps below:
  - a. From the Cisco SD-WAN Manager menu, choose **Configuration > Templates**.

- b. For the device on which you have to enable SD-AVC, click ... and select **Edit** from the menu.
  - c. Click **Additional Templates**.
  - d. Add the localized policy created in an earlier step of this procedure.
  - e. Click **Update** and proceed through the next screens to push the updated template to the device.
5. (Optional) After pushing the update to the device, you can check the status of SD-AVC on the device with one of the following commands.

```
show avc sd-service info summary
```

or

```
show avc sd-service info connectivity
```

## Enable Cisco SD-AVC Cloud Connector, Cisco Catalyst SD-WAN Manager Release 20.14.1 and Later

*Table 5: Feature History*

Feature Name	Release Information	Description
New Procedure for Enabling Cisco SD-AVC Cloud Connector	Cisco IOS XE Catalyst SD-WAN Release 17.14.1a  Cisco Catalyst SD-WAN Control Components Release 20.14.1	This release introduces a new procedure for enabling Cisco SD-AVC Cloud Connector from the Cloud Services option in <b>Administration &gt; Settings</b> . From this release, enabling Cloud Connector does not require an OTP or opening a TAC case.

Before Cisco Catalyst SD-WAN Manager Release 20.14.1, client ID, client secret credentials, and sometimes a cloud gateway URL and OTP were required to enable Cloud Connector. From Cisco Catalyst SD-WAN Manager Release 20.14.1, you can configure Cisco SD-AVC Cloud Connector using the Cloud Services page. With this feature, you need not retrieve an OTP or create a TAC case separately to enable SD-AVC Cloud Connector.

### Prerequisites

Enable Cisco SD-AVC under **Administration > Cluster Management** to enable Cloud Connector.

### Enable Cisco SD-AVC Cloud Connector Using Cloud Services

1. From the Cisco SD-WAN Manager menu, choose **Administration > Settings**.
2. Click **Cloud Services**.
3. Enable **Cloud Services** in the **Cloud Services** tab.
4. Enter your Smart Account credentials in the fields.
5. (Optional) Enable **Analytics**.



**Note** Enable this option only if you have deployed Cisco Catalyst SD-WAN Analytics, and have confirmed that it is reachable by Cisco SD-WAN Manager.

6. Enable **SD-AVC Cloud Connector**.



**Note** If Cisco SD-WAN Manager is cloud-hosted by Cisco, this option does not appear and Cloud Connector is enabled automatically after you enable the Cloud Services option.

7. Click **Save**.

## Enable Cisco SD-AVC Cloud Connector, through Cisco Catalyst SD-WAN Manager Release 20.13.x

*Table 6: Feature History*

Feature Name	Release Information	Description
Cisco SD-AVC Cloud Connector	Cisco IOS XE Catalyst SD-WAN Release 17.3.1a Cisco vManage Release 20.3.1	When enabling Cloud onRamp for SaaS to manage Office 365 traffic, you can limit best path selection to apply only to some Office 365 traffic, according to the Office 365 traffic categories defined by Microsoft, or to include all Office 365 traffic.  The Cisco SD-AVC Cloud Connector provides support for this functionality.
Update to the SD-AVC Cloud Connector Enablement	Cisco vManage Release 20.10.1	Beginning with this release, enabling the Cloud Connector requires a cloud gateway URL and a one-time password (OTP) instead of a client ID and client secret.

### Before You Begin

- Before Cisco vManage Release 20.10.1, enabling Cloud Connector required client ID and client secret credentials. From Cisco vManage Release 20.10.1, it requires a cloud gateway URL and OTP. An advantage to using an OTP is that, in contrast to a client secret, it does not expire. See the following table for details about the credentials required for different releases, upgrade scenarios, and hosting options.
- Cisco SD-AVC Cloud Connector is a necessary component for Cloud onRamp for SaaS to manage Office 365 traffic according to the Office 365 traffic category.

Table 7: Requirements to Enable SD-AVC Cloud Connector

Releases	Cisco SD-WAN Manager Hosting	Requirements to Enable Cloud Connector
Cisco vManage Release 20.3.1 to Cisco vManage Release 20.9.x	All hosting options	<p><b>Required credentials:</b></p> <ul style="list-style-type: none"> <li>Client ID</li> <li>Client secret</li> </ul> <p>(As explained in the procedure, open the <a href="#">Cisco API Console</a> page to create Cloud Connector credentials if you do not already have credentials.)</p> <p><b>Note</b> When you receive a message in Cisco SD-WAN Manager indicating that SD-AVC credentials are expiring, return to the Cisco API Console and create new Cloud Connector credentials.</p> <p><b>Other requirements:</b></p> <p>Enable SD-AVC in cluster management, as described <a href="#">here</a>.</p>

Releases	Cisco SD-WAN Manager Hosting	Requirements to Enable Cloud Connector
Upgrade an existing instance to Cisco vManage Release 20.10.1 from an earlier release	Cisco-hosted	<p><b>Required credentials:</b></p> <ul style="list-style-type: none"> <li>• Cloud gateway URL: Use: <a href="https://dtmangmtus01sdwancisco.com/validate_sdavc/">https://dtmangmtus01sdwancisco.com/validate_sdavc/</a></li> <li>• OTP: Use the <a href="#">Cisco Catalyst SD-WAN Portal</a> to get the OTP. See the <a href="#">Cisco Catalyst SD-WAN Portal Configuration Guide</a> for details.</li> </ul> <p><b>Other requirements:</b> Enable SD-AVC in cluster management, as described <a href="#">here</a>.</p> <p><b>Notes:</b> In this scenario, the SD-AVC components operate differently than in earlier releases. Consequently, running the <b>request nms all status</b> command on the Cisco SD-WAN Manager instance shows that the “NMS SDAVC server” component is not enabled. This is expected behavior, and does not indicate any problem with SD-AVC. Note that the “NMS SDAVC gateway” component shows as enabled.</p>
	Self-managed, hosted in a public cloud, a private cloud, or on-premises	

Releases	Cisco SD-WAN Manager Hosting	Requirements to Enable Cloud Connector
		<p><b>Required credentials:</b></p> <ul style="list-style-type: none"> <li>If Cloud Connector was already enabled at the time of the upgrade, the client ID and client secret credentials continue to work until the client secret expires.</li> </ul> <p>When the client secret expires, an alarm appears in Cisco SD-WAN Manager to indicate the expiration. At this point, enabling Cloud Connector requires the cloud gateway URL and OTP. Use <a href="https://management.us01.sdwan.com/validate_sdavc/">https://management.us01.sdwan.com/validate_sdavc/</a> for the URL, and open a TAC case to get the OTP. See the procedure in this section for information about opening a TAC case.</p> <ul style="list-style-type: none"> <li>If Cloud Connector was not enabled at the time of the upgrade, enabling Cloud Connector requires the cloud gateway URL and OTP. Use <a href="https://management.us01.sdwan.com/validate_sdavc/">https://management.us01.sdwan.com/validate_sdavc/</a> for the URL, and open a TAC case to get the OTP. See the procedure in this section for information about opening a TAC case.</li> </ul> <p><b>Other requirements:</b></p> <p>Before enabling the Cloud Connector, enable SD-AVC in cluster management, as described <a href="#">here</a>.</p>

Releases	Cisco SD-WAN Manager Hosting	Requirements to Enable Cloud Connector
Fresh installation of Cisco vManage Release 20.10.1 and later	Cisco-hosted	<p><b>Required credentials:</b></p> <p>Cloud Connector is enabled by default, without requiring manual entry of credentials. You can use the <a href="#">Cisco Catalyst SD-WAN Portal</a> to view the OTP if needed. See the <a href="#">Cisco Catalyst SD-WAN Portal Configuration Guide</a> for details.</p> <p><b>Other requirements:</b></p> <p>Enable SD-AVC in cluster management, as described <a href="#">here</a>.</p> <p><b>Notes:</b></p> <p>In this scenario, the SD-AVC components operate differently than in earlier releases. Consequently, running the <b>request nms all status</b> command on the Cisco SD-WAN Manager instance shows that the “NMS SDAVC server” component is not enabled. This is expected behavior, and does not indicate any problem with SD-AVC. Note that the “NMS SDAVC gateway” component shows as enabled.</p>
	Self-managed, hosted in a public cloud, a private cloud, or on-premises	<p><b>Required credentials:</b></p> <ul style="list-style-type: none"> <li>• Cloud gateway URL: Use <a href="https://management.usdwan.cisco.com/validate_sdavc/">https://management.usdwan.cisco.com/validate_sdavc/</a></li> <li>• OTP: Open a TAC case to get the OTP. See the procedure in this section for information about opening a TAC case.</li> </ul> <p><b>Other requirements:</b></p> <p>Enable SD-AVC in cluster management, as described <a href="#">here</a>.</p>

### Enable Cisco SD-AVC Cloud Connector

1. From the Cisco SD-WAN Manager menu, choose **Administration** > **Settings**.

2. Click **SD-AVC** and enable **Cloud Connector**.

(If you are using Cisco vManage Release 20.10.x, Cisco vManage Release 20.11.x, or Cisco Catalyst SD-WAN Manager Release 20.12.x, click **Edit** and enable **Cloud Connector**.)

(In Cisco vManage Release 20.9.x and earlier releases, the option is called **SD-AVC Cloud Connector**. In these releases, click **Edit** and enable **Cloud Connector**.)



---

**Note** If Cisco SD-WAN Manager is cloud-hosted by Cisco, this option does not appear and Cloud Connector is enabled automatically.

---

3. (This step applies to Cisco vManage Release 20.10.1 and later, and is handled automatically if Cisco SD-WAN Manager is Cisco-hosted.)

See the **Before You Begin** section that precedes these steps for details about the requirements for enabling the SD-AVC Cloud Connector in different scenarios. As noted there, enable SD-AVC in cluster management before enabling the Cloud Connector.

If you need to enter the cloud gateway URL, use: [https://datamanagement-us-01.sdwan.cisco.com/validate\\_sdavc/](https://datamanagement-us-01.sdwan.cisco.com/validate_sdavc/)

If you need to use the [Cisco Catalyst SD-WAN Portal](#) to get the OTP, see the [Cisco Catalyst SD-WAN Portal Configuration Guide](#) for details.

If you need to open a TAC case to receive the OTP, open <https://mycase.cloudapps.cisco.com/case>. The workflow for receiving the OTP requires the following:

- Entitlement information.
- Smart Account.
- Virtual Account.
- The organization name configured in Cisco SD-WAN Manager.
- Cisco SD-WAN Manager geographic location: Americas, European Union (EU), or Asia-Pacific (APAC).
- Technology: Use Cisco Catalyst SD-WAN On-Prem for an on-prem installation or Cisco Catalyst SD-WAN - Cisco-Hosted for a Cisco-hosted installation.
- SubTechnology: Use SDWAN Cloud Infra.

4. (For Cisco vManage Release 20.9.x and earlier releases) Enter the following credentials:

- Client ID



---

**Note** Click (i) for **Client ID** and open the [Cisco API Console](#) page in a browser window to create Cloud Connector credentials if you do not already have credentials.

---

- Client Secret
- Organization Name: Use the descriptive name that you entered on the Cisco API Console page in the **Name of your application** field.



5. (Releases earlier than Cisco vManage Release 20.10.1) For **Affinity**, you can select a geographical location for storing the Cloud Connector data. For organizations located in Europe, it is recommended to change the location to Europe, in accordance with EU General Data Protection Regulation (GDPR) regulations.
6. For **Telemetry**, you can optionally disable the collection of telemetry data.



---

**Note** If Cisco SD-WAN Manager is cloud-hosted by Cisco, this option does not appear and telemetry is enabled automatically.

---

### Create Credentials on the Cisco API Console

The following steps show how to create credentials in the Cisco API Console. These steps are provided here for convenience, and are subject to change.

1. On the Cisco API Console page, sign in using your Cisco credentials.
2. Click **My Apps and keys**. A page opens for registering a new application.
3. To register SD-AVC, follow the steps below:
  - a. Name of your application: Use any descriptive name. Save this name for a later step.
  - b. In the **Application Type** area, click Service.
  - c. In the **Grant Type** area, check the **Client Credentials** check box.
  - d. Check the **Hello API** check box.
  - e. In the **Terms of Service** section, check the check box to agree with the terms.
  - f. Click **Register**. The Cisco API Console page displays the Client ID and Client Secret details. Keep this page open to complete the procedure.



---

**Note** These credentials expire after 90 days.

When you receive a message in Cisco SD-WAN Manager indicating that SD-AVC credentials are expiring, return to the Cisco API Console and create new Cloud Connector credentials.

---

## Software Installation and Upgrade for Cisco IOS XE Routers

You can install up to two Cisco Catalyst SD-WAN images on the same router.

### Supported Hardware Platforms and Interface Modules

For supported Hardware platforms and interface modules, see [Release Notes](#).



**Note** For Cisco IOS XE Catalyst SD-WAN devices from Cisco IOS XE Catalyst SD-WAN Release 17.8.1a, if a device boots using the .bin file after a PnP or auto-install process completes, the device comes up with its day-0 configuration. The device then reloads automatically and goes into install mode.

### Supported Crypto Modules

The following crypto modules are required for the ASR 1000 series routers:

- ASR1001HX-IPSECHW, for the ASR 1001-HX
- ASR1002HX-IPSECHW, for the ASR 1002-HX

## Before You Begin

Before you deploy an IOS XE router in the overlay network, review the following:

- The controller devices—Cisco SD-WAN Validators, Cisco SD-WAN Manager instances, and Cisco SD-WAN Controllers—are running Cisco Catalyst SD-WAN Software Release 18.3.
- If you deploy both IOS XE and vEdge routers in the overlay network, the vEdge routers are running Release 17.2.1 or higher of the Cisco Catalyst SD-WAN software. With these software versions, the vEdge and IOS XE software can interoperate, allowing BFD tunnels to be established between vEdge routers and IOS XE routers.
- If you deploy both IOS XE and vEdge routers in the same site, the vEdge routers are running Cisco Catalyst SD-WAN Software Release 18.3.
- The ISR 4000 series router has at least 4 gigabytes (GB) of DRAM installed. It is recommended that the router have 8 GB of DRAM.
- The ASR 1000 Cisco SD-WAN Validator series router has at least 8 GB of DRAM installed. The ASR 1002-HX router has at least 16 GB of DRAM installed.
- The router bootflash has a minimum of 1.5 GB space available for the XE SD-WAN image or, beginning with Cisco IOX SD-WAN Release 17.10, the router bootflash has a minimum of one half of its disk space available for the XE SD-WAN image.
- If using your enterprise root certificate to authenticate the router, the certificate is copied to the router's bootflash before installing the XE SD-WAN software.
- All unsupported modules are removed from the router before installing the XE SD-WAN software. For a list of supported modules, see Supported Interface Modules and Supported Crypto Modules.
- For information about deploying a Cisco ASR 1006-X with an RP3 module, see [Cisco ASR 1006-X with an RP3 Module](#).
- The updated device list is uploaded to Cisco SD-WAN Manager and sent to the Cisco SD-WAN Validator. To do so:
  1. Obtain the router's chassis and board ID serial number by issuing the **show crypto pki certificates CISCO\_IDEVID\_SUDI** command at the system prompt. If running Release 16.6.1 or earlier on an ASR series router, issue the **show sdwan certificate serial** command.

2. Add the router's serial number to Plug and Play (PnP) Connect portal. See Add the IOS XE Router to the PnP Portal section for more details..
3. From the Cisco SD-WAN Manager menu, choose **Configuration > Devices**. Click **Sync Smart Account** to download the updated device list to Cisco SD-WAN Manager and send it to the Cisco SD-WAN Validator.
  - Device configuration templates are created and attached to the router using Cisco SD-WAN Manager **Configuration > Templates**. This ensures that the router can obtain a configuration and establish full control connections when it comes up.
  - If the router exceeds the unidirectional encrypted bandwidth of 250 Mbps and if the HSECK9 license is not already installed, the license file is copied to the router's bootflash and license installed on the router license install file path.
  - The ASR 1000 series, ISR 1000 series, and ISR 4000 series router is running the required version of the ROM monitor software (ROMMON), as shown in the following table. To verify the ROMMON version running on the router, issue the **show rom-monitor** or **show platform** command at the system prompt.

Hardware Platform	Required ROM Monitor Software Version
ASR 1000 series	16.3 (2r)
ISR 1000 series	16.9 (1r)
ISR 4000 series	16.7 (3r)

- The ISRv router is running the minimum required version of the CIMC and NFVIS software, as shown in the following table:

Hardware Platform	CIMC	NFVIS
ISRv	3.2.4	3.8.1

## Download Cisco IOS XE Catalyst SD-WAN Software for Cisco IOS XE SD-WAN Release 16.12 and Earlier

### Download the Cisco IOS XE Catalyst SD-WAN Software

To download the Cisco IOS XE Catalyst SD-WAN software from the Cisco site:

1. Go to <https://www.cisco.com>.
2. Click **Support & Downloads** from the menu on the left side.
3. In the **Products and Downloads** page, in the **Downloads** search box, choose Software-Defined WAN (SD-WAN).
4. In the **Select a Product** page, from the right-most pane, choose **XE SD-WAN Routers**.

5. From the right-most pane, select your router model.
6. Click the desired software release version to download it. The software image name has the format *router-model-ucmk9.release-number*
7. Copy the software image to an HTTP or FTP file server in your local network.

## Install the Cisco IOS XE Catalyst SD-WAN Software for Cisco IOS XE SD-WAN Release 16.12 and Earlier

All new Cisco IOS XE Catalyst SD-WAN devices ships with the Cisco IOS XE Catalyst SD-WAN software already installed.

If you have an existing Cisco IOS XE Catalyst SD-WAN device, follow these steps to install the Cisco IOS XE Catalyst SD-WAN software. The router reboots with the Cisco IOS XE Catalyst SD-WAN image.

1. Download the Cisco IOS XE Catalyst SD-WAN software image from the Cisco site.
2. Upload the Cisco IOS XE Catalyst SD-WAN software image from the file server to the bootflash of the device. Sample syntax for FTP is given below:

```
Device# (config)# ip ftp source-interface interface
Device# copyftp:// username:password@server-IP/file-location bootflash:
TFTP:
Device(config)# ip tftp source-interface interface
Device(config)# ip tftp blocksize 8192
Device(config)#exit
Device#copy tftp: bootflash:
SCP (assumes SSH is enabled):
Device# configure terminal
Device# (config)# ip scp server enable
FileServer$ scp filenameusername@router-IP:/filename
```

3. Ensure that the device is connected to a management console.
4. Create a backup of the current configuration that can be saved in the bootflash of the device.

```
Device# copy run bootflash:original-xe-config
```

5. Remove all existing boot statements and save the configuration.

```
ISR4K# (config)# no boot system ...
ISR4K# wr mem
```

6. Verify that the BOOT variable is blank in the following output.

```
ISR4K# show bootvar
BOOT variable =
CONFIG_FILE variable does not exist
BOOTLDR variable does not exist
Configuration register is 0x2102
Standby not ready to show bootvar
```

7. Add a boot variable that points to the Cisco IOS XE Catalyst SD-WAN image.

```
Device(config)# boot system flash bootflash:
SDWAN-image
Device(config)# exit
ISR4K# write memory
```

8. Verify that the BOOT variable points to the Cisco IOS XE Catalyst SD-WAN image.

```
Device# show bootvar
BOOT variable = bootflash:isr4300-ucmk9.16.10.1a.SPA.bin,1;
CONFIG_FILE variable does not exist
BOOTLDR variable does not exist
Configuration register is 0x2102
Standby not ready to show bootvar
```

9. Remove all existing configurations from the router.

```
Device# write erase
```

10. Set the config-register to 0x2102.

```
Device# configure terminal
Deovce(config)# config-register 0x2102
Device(config)# end
```

11. Verify that the config-register is set to 0x2102 or that it will be set to 0x2102 at the next reboot.

```
Device# show bootvar
```

12. Reboot the router.

```
ISR4K# reload
Proceed with reload? [confirm] Yes
If prompted to save the configuration, enter No. The router reboots with the XE SD-WAN
image.
```

13. If prompted to enter the initial configuration dialog, enter **No**.

```
--- System Configuration Dialog ---
Would you like to enter the initial configuration dialog? [Yes/No]: No
```

14. If prompted to terminate auto-install, enter **Yes**.

```
Would you like to terminate auto-install? [Yes/No]: Yes
```

15. At the login prompt, log in with the default username and password as **admin**.

The default password can be used once and then must be changed. If the initial configuration session times out or if the session is interrupted or terminated before the password is changed and saved, subsequent login attempts fail. To restore login access to the device, you must reset the password to its default value through the local console in ROMMON mode. Then the initial provision process must be restarted. For information about restoring the password, see [Recover the Default Password, on page 69](#).

16. Stop PnP and allow the Cisco IOS XE Catalyst SD-WAN packages to install:

```
ISR4K# pnpa service discovery stop
```

17. Configure the upgrade on Cisco IOS XE Catalyst SD-WAN device using **request platform software sdwan software upgarde-confirm**.

```
Router# request platform software sdwan software upgrade-confirm
Router#
*Sep 21 00:26:29.242: %INSTALL-5-INSTALL_START_INFO: R0/0: install_engine: Started
install commit PACKAGE
*Sep 21 00:26:30.153: %INSTALL-5-INSTALL_COMPLETED_INFO: R0/0: install_engine: Completed
install commit PACKAGE
Router#
```

18. Ensure output of **show sdwan software** shows CONFIRMED state as user and no other value.

```
Router# sh sdwan software
VERSION          ACTIVE  DEFAULT  PREVIOUS  CONFIRMED  TIMESTAMP
```

```
-----
16.12.1b.0.4 true true true user 2019-09-21T00:24:22-00:00

Total Space:388M Used Space:86M Available Space:298M
```

19. Configure the Cisco IOS XE Catalyst SD-WAN device using **request platform software sdwan software reset**.

```
Router# request platform software sdwan software reset

*Sep 21 00:27:20.025: %INSTALL-5-INSTALL_START_INFO: R0/0: install_engine: Started
install activate bootflash:isr4300-ucmk9.16.12.1b.SPA.bin
*Sep 21 00:27:43.105: %SYS-7-NV_BLOCK_INIT: Initialized the geometry of nvram
Router#
*Sep 21 00:28:47.233: %INSTALL-5-INSTALL_COMPLETED_INFO: R0/0: install_engine: Completed
install activate PACKAGESep 21 00:28:54.240: %PMAN-5-EXITACTION: R0/0: pvp: Process
manager
```



**Note** Once you have installed this image, remember to use the command **config-transaction** to open CLI configuration mode. The **config terminal** command is not supported on Cisco Catalyst SD-WAN routers.



**Note** Downgrading to fresh install of old image versions is not supported. You can only downgrade to a previous existing version of old image. For example, if you have never installed Cisco IOS XE Catalyst SD-WAN 16.10.3 on your Cisco IOS XE Catalyst SD-WAN device, and if you try to downgrade from Cisco IOS XE Catalyst SD-WAN 16.11.1 release to Cisco IOS XE Catalyst SD-WAN 16.10.3 release then this operation is unsupported and results in unpredictable behavior. However, if you had a 16.10.3 image installed previously, then you could reactivate it by using the **request platform software sdwan activate** command.



**Note** Data is migrated from an existing Cisco Catalyst SD-WAN image to a new Cisco Catalyst SD-WAN image only during an upgrade. After an upgrade is completed, there is no migration of data between different versions of installed images for both Cisco IOS XE Catalyst SD-WAN and Cisco vEdge devices. For example, if you had installed 19.2.4 previously, and 20.3.2 is your current active image, then if you activate the 19.2.4 image, the additional configurations from 20.3.2 will not be migrated to 19.2.4.

## Configure IOS XE Router Using CLI

If your Cisco IOS XE Catalyst SD-WAN device is connected to a DHCP server, PnP runs automatically and Cisco SD-WAN Manager automatically configures the device after the control connections are up. To verify that the control connections are up and the device is validated, enter the following command at the system prompt:

```
Device# show sdwan control connections
```

If your IOS Ex router is connected to a DHCP server and you are not using PnP, or if your IOS XE router is not connected to a DHCP server on the WAN, configure the router manually using the CLI as shown in the following steps.

You also can configure the hostname by using the **system host-name** *hostname* command. Configuring the hostname is optional, but it is recommended because this name is included as part of the prompt in the CLI and it is used on various Cisco SD-WAN Manager screens to refer to the device. This command is not available on the device CLI but it is available when using the CLI device template.

1. Connect to the router using a management console.

2. Stop PnP to allow access to the CLI:

```
Device# pnpa service discovery stop
```

3. Enter configuration mode:

```
Device# config-transaction  
Device(config)#
```

4. Configure the system IP address.

```
Device(config-system)# system-ip ip-address
```

Cisco SD-WAN Manager uses the system IP address to identify the device so that the NMS can download the full configuration to the device.

5. Configure the numeric identifier of the site where the device is located:

```
Device(config-system)# site-id site-id
```

6. Configure the IP address of the Cisco SD-WAN Validator or a DNS name that points to the Cisco SD-WAN Validator. The Cisco SD-WAN Validator's IP address must be a public IP address, to allow the router to reach the Cisco SD-WAN Validator.

```
Device(config-system)# vbond (dns-name | ip-address)
```

7. Configure the organization name, which is the name that is included in the certificates on all devices in the overlay network. This name must be the same on all devices.

```
Device(config-system)# organization-name name
```

8. Configure the tunnel interface to use for overlay connectivity. Ensure that the tunnel interface ID does not conflict with any other interface IDs that may be auto-assigned by Cisco SD-WAN Manager. You can verify this in configuration preview.

```
Device(config)# interface Tunnel #  
Device(config-if)# ip unnumbered wan-physical-interface  
Device(config-if)# tunnel source wan-physical-interface  
Device(config-if)# tunnel mode sdwan
```



#### Note

- If you are using Cisco SD-WAN Manager **feature templates** for your configuration, a tunnel interface is automatically assigned based on the WAN interface used.
- If you switch to Cisco SD-WAN Manager **mode** from CLI mode, the tunnel interface you configured may change because Cisco SD-WAN Manager automatically assigns a tunnel interface number based on the WAN interface used. This change in tunnel number can cause the tunnel to go down before it comes up again when the configuration is pushed.

9. If the router is not connected to a DHCP server, configure the IP address of the WAN interface:

```
Device(config)# interface GigabitEthernet #  
Device(config)# ip address ip-address mask
```

```
Device(config)# no shut
Device(config)# exit
```

10. Configure tunnel parameters:

```
Device(config)# sdwan
Device(config-sdwan)# interface WAN-interface-name
Device(config-interface-interface-name)# tunnel-interface
Device(config-tunnel-interface)# color color/path-name
Device(config-tunnel-interface)# encapsulation ipsec
```

11. If an IP address is manually configured on the router, configure a default route:

```
Device(config)# ip route 0.0.0.0 0.0.0.0 next-hop-ip-address
```

12. If the Cisco SD-WAN Validator address was defined as a hostname, configure DNS:

```
Device(config)# ip domain lookup
Device(config)# ip name-server dns-server-ip-address
```

13. Save the changes and exit configuration mode:

```
Device(config)# commit and-quit
Device# exit
```

14. If you are using a certificate signed by your enterprise root CA, install the certificate:

```
Device# request platform software sdwan root-cert-chain install bootflash: certificate
```

15. Verify that the control connections are up and the router is validated.

```
Device# show sdwan control connections
```

PEER	PEER	PEER		SITE	DOMAIN	PEER	PEER PRIV	PEER	PEER PUB
TYPE	PORT	SYSTEM	IP	ID	ID	PRIVATE IP	PORT	PUBLIC IP	PORT
LOCAL	COLOR								
vsmart	dtls	192.168.1.2	10	1		172.1.1.3	12346	172.1.1.3	12346
	biz-internet								
vbond	dtls	-	0	0		172.1.1.4	12346	172.1.1.4	12346
	biz-internet								
vmanage	dtls	192.168.1.3	10	0		172.1.1.2	12346	172.1.1.2	12346
	biz-internet								

PROXY	STATE	UPTIME	CONTROLLER GROUP ID
up		1:19:51:40	0
up		1:19:51:45	0
up		1:19:51:38	0

You can now configure SD-WAN features on the router using Cisco SD-WAN Manager templates.



## Add IOS XE Devices to the Plug and Play Portal

Table 8: Feature History

Feature Name	Release Information	Description
On Premises ZTP Server for Cisco Catalyst SD-WAN	Cisco IOS XE Catalyst SD-WAN Release 17.3.1a Cisco vManage Release 20.3.1	This feature extends the on-premise Plug and Play implementation support to Cisco IOS XE Catalyst SD-WAN routers.

To add a device to the Plug and Play portal:

- If the device can reach the PNP portal, see [Cisco Plug and Play Support Guide for Cisco Catalyst SD-WAN Products](#).
- If the device does not have access to the PNP portal, see [Start the Enterprise ZTP Server and Prepare Routers for ZTP](#) sections in the [Cisco Catalyst SD-WAN Overlay Network Bring-Up Process](#) chapter.



**Note** When devices are due for Return Materials Authorization (RMA), the device details are with Cisco PNP. However, you cannot delete these devices from the RMA list in Cisco SD-WAN Manager. Instead Cisco SD-WAN Manager administrator can mark the devices returned as invalidated as per RMA.

For information about Cisco IOS XE Release 17.2 and later, see [Install and Upgrade Cisco IOS XE Release 17.2 and Later](#).

## Upgrading or Downgrading ROMMON

This section describes how to upgrade or downgrade the ROM monitor (ROMmon) version that is running on a device. Perform this procedure if you need to change a ROMmon version to a required version that is shown in the “Before You Begin” section.

To determine the ROMmon version that is running on a device, enter the following command:

```
Device# Show rom-monitor R0
```

To upgrade or downgrade ROMmon, follow these steps:

1. Take either of these actions:
  - a. Load the ROMmon file into the device bootflash using a method such as SCP, FTP, TFTP, or a USB drive.
  - b. If you do not have out-of-band management access to the router, transfer the ROMmon file by using Cisco SD-WAN Manager CLI, as shown in the following example:

```
vManage# request execute vpn 0 scp -P 830 C1100-rommon-16-1r-SPA.pkg
admin@router-ip-address:/bootflash/vmanage-admin/C1100-rommon-169-1r-SPA.pkg
```

2. Take either of these actions to verify that the ROMmon file that you loaded or transferred appears in the directory output:
  - a. If you loaded the ROMmon file into the device bootflash, enter the following command:

```
Device# dir bootflash
```

- b. If you transferred the ROMmon file by using the Cisco SD-WAN Manager CLI, enter the following command:

```
vManage# dir bootflash:vmanage-admin
```

3. Enter the following command to set config-register to 0x2102:

```
Device# config-register 0x2102
```

4. Upgrade (or downgrade) the ROMmon file on your device by using the upgrade command as shown in the following examples:

- Example upgrade command if you loaded the ROMmon file into the device bootflash:

```
Device# upgrade rom-monitor filename bootflash: C1100-rommon-169-1r-SPA.pkg R0
```

- Example upgrade command if you transferred the ROMmon file by using Cisco SD-WAN Manager CLI:

```
vManage# upgrade rom-monitor filename
bootflash:vmanage-admin/C1100-rommon-169-1r-SPA.pkg R0
```

5. After a series of messages pertaining to the upgrade display and the router prompt displays, enter the following command to reload the router:

```
Device# Reload
```

6. Enter the following command and verify that the output shows the new ROMmon version:

```
ISR4K# Show rom-monitor R0
```

## Perform Factory Reset

This section describes the Factory Reset feature and how it can be used to protect or restore a router to an earlier fully functional state. For information on factory reset procedures on different platforms, see:

- [Cisco ASR 1000 Series Aggregation Services Routers](#)
- [Cisco 4000 Series Integrated Services Routers](#)
- [Cisco Cloud Services Router 1000V Series](#)



---

**Note** To perform factory-reset on a Cisco IOS XE Catalyst SD-WAN ASR 1000 router, ensure that the router is booted in subpackages mode. Execute **show version** command and check the output for *system image file* to determine the booted image.

---

```
Device# show version
Cisco IOS XE Software, Version BLD_POLARIS_DEV_LATEST_20200303_002119_V17_X_X_XX
Cisco IOS Software [Amsterdam], ASR1000 Software (X86_64_LINUX_IOSD-UNIVERSALK9-M),
Copyright (c) 1986-2020 by Cisco Systems, Inc.
Compiled Tue 03-Mar-20 00:29 by mcpre
```

```
Cisco IOS-XE software, Copyright (c) 2005-2020 by cisco Systems, Inc.
All rights reserved. Certain components of Cisco IOS-XE software are
licensed under the GNU General Public License ("GPL") Version 2.0. The
```

```
software code licensed under GPL Version 2.0 is free software that comes
with ABSOLUTELY NO WARRANTY. You can redistribute and/or modify such
GPL code under the terms of GPL Version 2.0. For more details, see the
documentation or "License Notice" file accompanying the IOS-XE software,
or the applicable URL provided on the flyer accompanying the IOS-XE
software.
```

```
ROM: IOS-XE ROMMON
```

```
2KP-CEDGE uptime is 3 minutes
Uptime for this control processor is 5 minutes
System returned to ROM by Reload Command
System image file is "bootflash:packages.conf"
```

## Recover the Default Password

The default password for a Cisco IOS XE Catalyst SD-WAN device is admin. After using this password for the first time, the administrator must create a new password. If the initial configuration session times out or if the session is interrupted or terminated before a new password is created, subsequent login attempts fail. In this situation, you must recover the default password.

To recover the default password for a device, follow these steps:

1. Power the device down and then back up.
2. In the local console of the device, enter ROMMON mode.
3. Enter the following command to set the config-register value to 0x8000:  

```
rommon 1 > confreg 0x8000
```
4. Power the device down and then back up so that your update takes effect.
5. Log in to the device with the user name and the password as **admin**.
6. In the local console of the device, enter SD-WAN config mode.
7. Enter the following command to set the config-register value to 0x2102:  

```
Device# confreg 0x2102
```
8. In the local console of the device, enter privileged exec mode.
9. Take either of these actions:
  - For Cisco IOS XE SD-WAN 16.10 releases beginning with release 16.10.4 or for Cisco IOS XE SD-WAN 16.12 releases beginning with release 16.12.2:  

```
Device# request platform software sdwan config reset
```

```
Device# reload
```
  - For Cisco IOS XE SD-WAN 16.10 releases earlier than release 16.10.4 or for Cisco IOS XE SD-WAN 16.12 releases earlier than 16.12.2:  

```
Device# request platform software sdwan software reset
```
10. After the device comes back up, configure a new admin password.

# Software Installation and Upgrade for vEdge Routers

This article describes how to install software on all Cisco vEdge devices—Cisco SD-WAN Manager instances, Cisco Catalyst SD-WAN Control Components, Cisco SD-WAN Validators, and vEdge routers—and how to upgrade the software on devices already running the Cisco Catalyst SD-WAN software.

## Software Image Signing

Cisco Catalyst SD-WAN software images are digitally signed to ensure that the images are official Cisco Catalyst SD-WAN images and to guarantee that the code has not been altered or corrupted since the image was created and signed. All standard Cisco Catalyst SD-WAN software images are signed, while patch images are not. Standard software images are identified with three numeric fields (such as 16.1.0) and patch software images are identified with four numeric fields (such as 16.1.0.1).

Signed images include a revocation mechanism so that Cisco Catalyst SD-WAN can revoke an image if it is found to be dangerous, either due to a bug or a security flaw. These revocation mechanisms protect from attacks if you attempt to install a previously signed image that has a known vulnerability.

After you have installed a signed image onto a Cisco Catalyst SD-WAN device, you can no longer install an unsigned image onto the device.

Software image signing is available in Releases 16.1 and later.

## Software Version Compatibility

You can upgrade the software version on the controller devices—Cisco SD-WAN Manager instances, Cisco SD-WAN Controllers, and Cisco SD-WAN Validators—without upgrading the vEdge routers to the same version. However, the software version running on the controller devices must be compatible with the version running on the vEdge routers.

For a list of compatible versions on Controllers and vEdge routers, see [Release Notes](#).



---

**Note** All controller devices of the same type must run the same software version. That is, all Cisco SD-WAN Manager instances must run the same software version, all Cisco SD-WAN Controllers must run the same software version, and all Cisco SD-WAN Validators must run the same version.

---

## Install the Software

Before you begin, download the software from the Cisco Catalyst SD-WAN Support site.

You install software on Cisco Catalyst SD-WAN devices when you first bring up the overlay network and add those devices to the network:

- To install software on a Cisco SD-WAN Validator, see *Create Cisco SD-WAN Validator VM Instance on ESXi* or *Create Cisco Catalyst SD-WAN Validator VM Instance on KVM*. During the process of creating the VM, you install the vBond.ova file.

- To install software on a vEdge Cloud router, see *Create vEdge Cloud VM Instance on AWS*, *Create vEdge Cloud VM Instance on ESXi*, or *Create vEdge Cloud VM Instance on KVM*. During the process of creating the VM, you install the vEdge Cloud.ova file.
- To install software on a Cisco SD-WAN Manager, see *Create Cisco SD-WAN Manager VM Instance on ESXi* or *Create Cisco SD-WAN Manager Instance on KVM*. During the process of creating the VM, you install vManage.ova file.
- To install software on a Cisco Catalyst SD-WAN Controller, see *Create Cisco Catalyst SD-WAN Controller VM Instance on ESXi* or *Create Cisco Catalyst SD-WAN Controller VM Instance on KVM*. During the process of creating the VM, you install the vSmart.ova file.
- To install software on a hardware vEdge router, nothing is required. All vEdge hardware routers ship with the software already installed.

## Upgrade the Software

From Cisco SD-WAN Manager, you can upgrade the software image running on a Cisco vEdge device in the overlay network and reboot it with the new software. You can do this for a single device or for multiple devices simultaneously.

To upgrade the software, you obtain the software images from Cisco Catalyst SD-WAN, add the new software images to the repository located on either Cisco SD-WAN Manager or a remote server, and install the new software image on the device. The next reboot occurs immediately if you select the **Activate and Reboot** check box, or you can wait until the next regularly scheduled maintenance window. If an upgrade fails and the device does not come back up, Cisco SD-WAN Manager automatically reverts the device to the previously running software image.

Before you upgrade the software on Cisco vEdge devices, ensure that the devices are running the required software version.



**Note** Cisco Catalyst SD-WAN releases starting with Releases 18.4.5, 19.2.2, and 20.1.1 have a security lockout. When any of these software versions (or later) are installed and activated on a device, a 30-day timer is set for the removal of any old images that were previously installed on the device. After the timer expires, the old images are deleted. For example, if you install and activate Release 18.4.5, a 30-day timer starts on the previously installed Release 19.2.1 image, but not on Release 19.2.2. Similarly if you install and activate Release 19.2.2, a 30-day timer starts on the previously installed Release 18.4.4 image, but not on Release 18.4.5.

You can continue to activate an older image that is already installed, before the 30-day timer runs out. If the device restarts before the 30-day timer expires, the timer is reset.

See [Cisco Catalyst SD-WAN Command Reference](#) guide for more information.

- **request software secure-boot set-** Makes the system immediately delete old images\* without waiting the 30 days.
- **request software secure-boot status-** Displays the installed old images\*.
- **request software secure-boot list-** Prints a list of all old images\* that are installed.

\*old images= before releases 18.4.5, 19.2.2, and 20.1.1



---

**Note** Cisco SD-WAN Manager downgrade is not supported. Ensure that you take a snapshot of the VM prior to upgrading Cisco SD-WAN Manager. To rollback to an earlier Cisco SD-WAN Manager release, revert to the snapshot.

---

For additional information and caveats regarding software upgrades, see [Release Notes](#).

## Best Practices for Software Upgrades

- Upgrade the software from Cisco SD-WAN Manager rather than from the CLI.
- If you are upgrading the software image on a remote Cisco SD-WAN Manager, the overlay network must already be up and operational.
- If you are upgrading all devices in the overlay network, you must perform the upgrade in the following order:
  1. Upgrade Cisco SD-WAN Manager instances.
  2. Upgrade the Cisco SD-WAN Validators.
  3. Upgrade one-half of the Cisco SD-WAN Controllers.
  4. Have the upgraded Cisco SD-WAN Controllers run for at least one day (24 hours) to ensure that the Cisco vEdge devices and the overlay network are stable and running as expected.
  5. Upgrade the remainder of the Cisco SD-WAN Controllers.
  6. Upgrade 10 percent of the vEdge routers. For multirouter sites, it is recommended that you upgrade only one router per site.
  7. Have the upgraded vEdge routers run for at least one day (24 hours) to ensure that the Cisco Catalyst SD-WAN devices and the overlay network are stable and running as expected.
  8. Upgrade the remainder of vEdge routers.



---

**Note** From Cisco Catalyst SD-WAN Control Components Release 20.13.1, for a Cisco vEdge device, the control session rate for Datagram Transport Layer Security (DTLS) increases to 4000 pps only for the duration of upgrade and is reset to the original value after the upgrade is complete.

---

- If the new software images are located on an FTP server, ensure that the FTP server can handle concurrent file transfers.
- If the new software images are in the image repository on Cisco SD-WAN Manager, ensure that the WAN in which Cisco SD-WAN Manager is located has sufficient capacity for concurrent file transfers.
- You cannot include Cisco SD-WAN Manager in a group software upgrade operation. You must upgrade and reboot Cisco SD-WAN Manager server by itself.
- In a group software upgrade operation, you can upgrade up to 40 Cisco vEdge devices or Cisco IOS XE Catalyst SD-WAN devices and reboot or activate upto 100 Cisco vEdge devices or Cisco IOS XE Catalyst

SD-WAN devices simultaneously (when the new image is available locally). These maximum numbers assume that Cisco SD-WAN Manager is idle and only upgrade and reboot operations are being carried out. In case of other management tasks occurring on Cisco SD-WAN Manager at the same time, the number of available sessions reduces.

- When you are setting a software image to be the default software image, activate it first, before making it the default image.

## Obtain Software Images from Cisco Catalyst SD-WAN

To upgrade the software running on the devices in the overlay network, you must first obtain the new software packages from the Cisco Catalyst SD-WAN website. To do so, go to <http://www.cisco.com/go/support>, log in to Cisco Catalyst SD-WAN Support, and download the software packages for the new release. You can also download the software images to an FTP server in your network and, from Cisco SD-WAN Manager, point to the upgrade packages on the remote host.

For initial software installation, the software package names for Releases 16.1 and later have the following format, where *x.x.x* represents the Cisco Catalyst SD-WAN software release version. These packages contain the virtual machines and the Cisco Catalyst SD-WAN software.

- vEdge Cloud router
  - `viptela-x.x.x-edge-genericx86-64.ova` (for ESXi Hypervisor)
  - `viptela-edge-genericx86-64.qcow2` (for KVM Hypervisor)
- Cisco SD-WAN Validator
  - `viptela-edge-genericx86-64.ova` (for ESXi Hypervisor)
  - `viptela-edge-genericx86-64.qcow2` (for KVM Hypervisor)
- Cisco Catalyst SD-WAN Controller
  - `viptela-smart-genericx86-64.ova` (for ESXi Hypervisor)
  - `viptela-smart-genericx86-64.qcow2` (for KVM Hypervisor)
- Cisco SD-WAN Manager
  - `viptela-vmanage-genericx86-64.ova` (for ESXi Hypervisor)
  - `viptela-vmanage-genericx86-64.qcow2` (for KVM Hypervisor)

The software upgrade package names for Releases 16.1 and later have the following format, where *x.x.x* represents the release version. The strings `mips64` and `x86_64` represent the underlying chip architecture.

- vEdge router hardware—`viptela-x.x.x-mips64.tar.gz`
- Cisco SD-WAN Validator, vEdge Cloud router, and Cisco Catalyst SD-WAN Controller—`viptela-x.x.x-x86_64.tar.gz`
- Cisco SD-WAN Manager—`vmanage-x.x.x-x86_64.tar.gz`

For Releases 15.4 and earlier, the software upgrade packages are in files with the extension .tar.bz2, or in the case of the vEdge 100 router, .tar.gz. The package names have the following format, where *x.x.x* represents the release version. The strings *mips64* and *x86\_64* represent the underlying chip architecture.

- vEdge router—*viptela-x.x.x-mips64.tar.bz2*
- Cisco SD-WAN Validator and Cisco Catalyst SD-WAN Controller—*viptela-x.x.x-x86\_64.tar.bz2*
- Cisco SD-WAN Manager—*vmanage-x.x.x-x86\_64.tar.bz2*

## Add New Software Images to the Repository

Once you have downloaded the new software packages from the Cisco Catalyst SD-WAN website, upload them into Cisco SD-WAN Manager repository. If you downloaded the software images to an FTP server, from Cisco SD-WAN Manager, point to the upgrade packages on the remote host.

1. From the Cisco SD-WAN Manager menu, choose **Maintenance > Software Repository**.
- 2.
3. Click **Add New Software**, and select the location from which to download the software image. The location can be:
  - Cisco SD-WAN Manager—To select an image stored on the local Cisco SD-WAN Manager.
  - Remote Server (preferred) —To select an image stored on a remote file server.
  - Remote Server – Cisco SD-WAN Manager—To select an image stored on a remote Cisco SD-WAN Manager. This location is available in Releases 17.2 and later.
4. If you select Cisco SD-WAN Manager, the Upload Software to Cisco SD-WAN Manager dialog box opens.
  - a. Click **Browse** to select the software images or **Drag and Drop** the images for vEdge routers, Cisco SD-WAN Controllers, or Cisco SD-WAN Manager.
  - b. Click **Upload** to add the images to Cisco SD-WAN Manager repository.
5. If you select Remote Server, the Location of Software on Remote Server dialog box opens.
  - a. Enter the version number of the software image.
  - b. Enter the URL of the FTP or HTTP server on which the images reside.
  - c. Click **OK** to point to the software images on the remote host.
6. If you select Remote Server – Cisco SD-WAN Manager, the Upload Software to Cisco SD-WAN Manager dialog box opens.
  - a. Enter the hostname of the Cisco SD-WAN Manager server.
  - b. Click **Browse** to select the software images or **Drag and Drop** the software image for vEdge routers, Cisco SD-WAN Controllers, or Cisco SD-WAN Manager.
  - c. Click **Upload** to add the images to Cisco SD-WAN Manager repository.



The added software images are listed in Cisco SD-WAN Manager repository table and are available for installing on the devices. The table displays the name and type of image, when it was updated, and the URL.

For the desired software version, click ... and select **Delete** to delete the software version added to the list.

## Upgrade the Software Image

After the software images are present in Cisco SD-WAN Manager image repository, you can upload the software image on a device:

1. From the Cisco SD-WAN Manager menu, choose **Maintenance > Software Upgrade**.
2. Click the check box and select one or more devices on which to upgrade the software image. To search for a device, use the **Device Groups** drop-down and/or the Search box.
3. Click **Upgrade** and the Software Upgrade dialog box opens.
4. From the **Version** drop-down, select the version of the software image you want to install. Cisco SD-WAN Manager and Remote Server are activated.
5. Select whether the software image is available on Cisco SD-WAN Manager or on the Remote Server.
6. If you select Remote Server in Step 5, choose the appropriate VPN for Cisco Catalyst SD-WAN Controller/Cisco SD-WAN Manager and for vEdge, and continue with Step 8.
7. If you select Cisco SD-WAN Manager in Step 5, you can choose to automatically activate the new software image and reboot the device by selecting the **Activate and Reboot** check box. (Note that if you do not select the **Activate and Reboot** check box, the new software image is still installed but the device continues to use the existing software image. To activate the newly installed software image, see Activate a New Software Image below.)
8. Click **Upgrade**. A progress bar indicates the status of the software upgrade.

If the upgrade does not complete successfully within 60 minutes, it times out.

If the control connection to Cisco SD-WAN Manager does not come up within 15 minutes, Cisco SD-WAN Manager automatically reverts the device to the previously running software image.

## Activate a New Software Image

If you select **Activate and Reboot** check box when uploading the software image, then when you click **Upgrade**, the new software activates automatically and the device reboots.

If you uploaded the software image from a Remote Server, or if you did not select **Activate and Reboot** check box when uploading the software image from Cisco SD-WAN Manager, the new image is installed on the device but the device continues to use the existing software image. To activate the new software image:

1. From the Cisco SD-WAN Manager menu, choose **Maintenance > Software Upgrade**.
2. Click the check box to select one or more devices on which to activate the new software image. To search for a device, use the **Device Groups** drop-down and/or the Search box.
3. Click **Activate** to activate the new software. The activation process reboots the device and upgrades it to the newly installed software.

If the control connection between the device and Cisco SD-WAN Manager does not come up within 15 minutes, Cisco SD-WAN Manager automatically reverts the device to the previously running software image.

## View Log of Software Upgrade Activities

To view the status of software upgrades on each device and a log of related activities:

- 1.
- 2.

## Upgrade a Software Image from the CLI

If you need to upgrade a software image directly on a device, or if you are not using Cisco SD-WAN Manager in your network, to upgrade the software image, you can either repeat the installation process or you can install the software image from within the CLI.

To upgrade the software image from within the CLI:

1. Configure the time limit for confirming that a software upgrade is successful. The time can be from 1 through 60 minutes.

```
Device# system upgrade-confirmminutes
```

2. Install the software:

```
vEdge# request software install url
/viptela- release -mips64.tar.bz2 [reboot] [vpn vpn-id]
```

```
vSmart# request software install url/viptela- release
-x86_64.tar.bz2 [reboot] [vpn vpn-id]
```

Specify the image location in one of the following ways:

- The image file is on the local server:

```
/directory-path/
```

You can use the CLI's autocompletion feature to complete the path and filename.

- The image file is on an FTP server.  
ftp://hostname/
- The image file is on an HTTP server.  
http://hostname/
- The image file is on a TFTP server.  
tftp://hostname/

Optionally, specify the VPN identifier in which the server is located.

The **reboot** option activates the new software image and reboots the device after the installation completes.

3. If you did not include the **reboot** option in Step 2, activate the new software image and reboot the device:

```
Viptela# request software activate
```

4. Confirm, within the configured upgrade confirmation time limit, that the software upgrade was successful:

```
Viptela# request software upgrade-confirm
```

If you do not issue this command within this time limit, the device automatically reverts to the previous software image.

## Redundant Software Images

You can download and store multiple software images on a Cisco vEdge device.

To list the currently installed software version and to see which software image is currently running, use the following command:

```
Viptela# show software
VERSION  ACTIVE  DEFAULT  PREVIOUS  CONFIRMED  TIMESTAMP
-----
15.4.3   true   false   false     user       2016-02-04T03:45:13-00:00
15.4.2   false  true    true      user       2015-12-06T14:01:12-00:00
```

To upgrade the software to a specific version, use the following command:

```
Viptela# request software activate
```

## Downgrade a Cisco vEdge Device to an Older Software Image

To downgrade a Cisco vEdge Device to a previous software image using CLI:

1. If necessary, remove an existing software image to provide space for loading a new software image.

```
vEdge# request software remove previous-installed-build
```

2. Download the software image for the downgrade.
3. Install the downloaded image.

```
vEdge# request software install desired-build
```

We recommend copying the image to local storage before installing, but you can specify the image location in one of the following ways:

- The image file is on the local server:

```
/directory-path/
```

You can use the CLI's autocompletion feature to complete the path and filename.

- The image file is on an FTP server.

```
ftp://hostname/
```

- The image file is on an HTTP server.

```
http://hostname/
```

- The image file is on a TFTP server.

```
tftp://hostname/
```

4. Set the installed image as the default.

```
vEdge# request software set-default desired-build
```

5. Perform a reset. This resets the device, deleting any existing configuration. The device starts in day zero configuration.

```
vEdge# request software reset
```

## Upgrade Memory and vCPU Resources on a Virtual Machine Hosting Cisco Catalyst SD-WAN Manager

Perform the following steps to upgrade the memory and virtual central processing unit (vCPU) resources on a virtual machine (VM) hosting Cisco SD-WAN Manager.



**Note** Only memory or vCPU increase is allowed. After the memory or vCPU is upgraded, you cannot downgrade.

1. Check the current configuration on Cisco SD-WAN Manager using the command **show system status**.

```
vManage#show system status
```

```
Viptela (tm) vmanage Operating System Software
Copyright (c) 2013-2021 by Viptela, Inc.
Controller Compatibility:
Version: 20.7.0-185
Build: 185
```

```
System logging to host is disabled
System logging to disk is enabled
```

```
System state:           GREEN. All daemons up
System FIPS state:     Enabled
Testbed mode:         Enabled
Engineering Signed:   True
```

```
Last reboot:           Initiated by user.
CPU-reported reboot:   Not Applicable
Boot loader version:   Not applicable
System uptime:        1 days 02 hrs 44 min 52 sec
Current time:         Sat Oct 23 22:12:10 UTC 2021
```

```
Load average:         1 minute: 14.58, 5 minutes: 12.31, 15 minutes: 10.73
Processes:            5775 total
CPU allocation:       32 total
CPU states:           31.58% user, 4.36% system, 64.06% idle
Memory usage:         65741448K total, 38096172K used, 490324K free
                     4606444K buffers, 22548508K cache
```

```
Disk usage:           Filesystem      Size  Used Avail  Use % Mounted on
                     /dev/root        15230M 3496M 10898M 24% /
vManage storage usage: Filesystem      Size  Used Avail  Use% Mounted on
                     /dev/sdb          502942M 206906M 270435M 41% /opt/data
```

```
Personality:          vmanage
Model name:           vmanage
Services:             None
vManaged:            false
Commit pending:      false
Configuration template: None
```

Chassis serial number: None

2. Power the device down to upgrade the memory.
3. Upgrade the CPU and memory for the VM using the guidelines of the hosting platform. You can make the following upgrades:

Resources	Current	Upgrade
vCPU	16	32
Memory	32 G	64 G or 128 G
Memory	64 G	128 G

4. Power on the device and verify the memory and CPU.

```
vManage1# show system status
```

```
Viptela (tm) vmanage Operating System Software
Copyright (c) 2013-2021 by Viptela, Inc.
Controller Compatibility:
Version: 20.7.0-139
Build: 139
```

```
System logging to host is disabled
System logging to disk is enabled
```

```
System state: GREEN. All daemons up
System FIPS state: Enabled
Testbed mode: Enabled
Engineering Signed: True
```

```
Last reboot: Initiated by user - activate 20.7.0-139.
CPU-reported reboot: Not Applicable
Boot loader version: Not applicable
System uptime: 16 days 17 hrs 43 min 28 sec
Current time: Sat Oct 23 22:22:16 UTC 2021
```

```
Load average: 1 minute: 15.86, 5 minutes: 13.02, 15 minutes: 11.45
Processes: 6067 total
CPU allocation: 32 total
CPU states: 32.13% user, 4.34% system, 63.53% idle
Memory usage: 131703148K total, 88221488K used, 19285636K free
7022488K buffers, 17173536K cache
```

```
Disk usage: Filesystem Size Used Avail Use % Mounted on
/dev/root 15998M 10702M 4461M 71% /
vManage storage usage: Filesystem Size Used Avail Use% Mounted on
/dev/sdb 10402115M 702212M 9175615M 6% /opt/data
```

```
Personality: vmanage
Model name: vmanage
Services: None
vManaged: false
Commit pending: false
Configuration template: None
Chassis serial number: None
```

## Expand the Secondary Disk Size, Cisco Catalyst SD-WAN Manager Release 20.12.x and Earlier

Due to a known limitation, this procedure is not effective for Cisco Catalyst SD-WAN Manager Release 20.13.x or 20.14.x.

Perform these steps to increase the size of the secondary disk on the virtual machine hosting a Cisco SD-WAN Manager instance.

- 
- Step 1** Shut down the virtual machine hosting Cisco SD-WAN Manager.
- Step 2** Using the hypervisor (for example, ESXi, Azure, or AWS), provision additional space for the secondary disk of the virtual machine hosting Cisco SD-WAN Manager.
- Step 3** Restart the VM that is hosting Cisco SD-WAN Manager.
- Step 4** In Cisco SD-WAN Manager, enter the following to enable Cisco SD-WAN Manager to detect the additional disk space and extend the file system to use the space.

```
vm# request nms application-server resize-data-partition
```

- Step 5** Enter the following commands to confirm that the /opt/data disk has been resized.

```
vm# vshell
vm: ~$ df -hk | grep data
```

The output shows the new disk size.

---

## Software Maintenance Upgrade for Cisco IOS XE Catalyst SD-WAN Devices

*Table 9: Feature History*

Feature Name	Release Information	Description
Support for Software Maintenance Upgrade Package	Cisco IOS XE Catalyst SD-WAN Release 17.9.1a Cisco vManage Release 20.9.1	This feature enables support for a Software Maintenance Upgrade (SMU) package that can be installed on Cisco IOS XE Catalyst SD-WAN devices. The SMU package provides a patch fix or a security resolution to a released Cisco IOS XE image. Developers can build this package that provides a fix for a reported issue without waiting for the fix to become available in the next release.
SMU Support for Cisco ISR1100 and ISR1100X Series Routers	Cisco IOS XE Catalyst SD-WAN Release 17.11.1a Cisco vManage Release 20.11.1	Added support for Cisco ISR 1100 and ISR 1100X Series Integrated Services Routers.

## Information About Software Maintenance Upgrade

A software maintenance upgrade (SMU) is a point fix for a critical bug in released software that attempts to minimize disruption to the router, if possible. An SMU is not designed to replace a maintenance release.

Cisco provides SMU fixes as package files, a file for each release and each component of Cisco Catalyst SD-WAN. The package contains metadata that describes the content of the package and the fix for a reported issue.

### SMU Image Files

Each SMU image filename in the software repository includes a base image version and the defect ID related to the fix. In the image name:

- *base\_image\_version* is the Cisco IOS XE image version.
- *defect\_id* is the identifier of the defect for which the SMU package has the fix.

### SMU Types

An SMU type describes the effect of an installed SMU package on a Cisco IOS XE Catalyst SD-WAN device. The following are the SMU package types:

- Hot SMU (non-reload): Enables an SMU package to take effect after an SMU image activation without rebooting (reloading) the Cisco IOS XE Catalyst SD-WAN device.
- Cold SMU (reload): Enables an SMU package to take effect after rebooting (reloading) the Cisco IOS XE Catalyst SD-WAN device.

### Benefits of Software Maintenance Upgrades

- Allow you to address a network issue quickly while reducing the time and scope of the testing required. The Cisco IOS XE Catalyst SD-WAN device internally validates the SMU image compatibility and does not allow you to install non-compatible SMU packages.
- Allow you to install or activate only one SMU package on devices at a time to simplify the initial implementation process.
- Allow you to install an SMU package on multiple Cisco IOS XE Catalyst SD-WAN devices at the same time when installing using Cisco SD-WAN Manager. To install an SMU package on multiple devices using the CLI, ensure that you repeat the install process on multiple devices.

## Supported Devices for Software Maintenance Upgrade

Release	Supported Devices
Cisco IOS XE Catalyst SD-WAN Release 17.9.5a and later releases of Cisco IOS XE Catalyst SD-WAN Release 17.9.x	<ul style="list-style-type: none"> <li>• Cisco ISR 1000 Series Integrated Services Routers</li> <li>• Cisco IR1101 Integrated Services Router Rugged</li> </ul>
Cisco IOS XE Catalyst SD-WAN Release 17.12.3a and later releases of Cisco IOS XE Catalyst SD-WAN Release 17.12.x	<ul style="list-style-type: none"> <li>• Cisco ISR 4000 series Integrated Services Routers</li> <li>• Cisco ASR 1000 Series Aggregation Services Routers</li> </ul>
Cisco IOS XE Catalyst SD-WAN Release 17.15.1a and later	<ul style="list-style-type: none"> <li>• Cisco Catalyst 8500 Series Edge Platforms</li> <li>• Cisco Catalyst 8500L Series Edge Platforms</li> <li>• Cisco Catalyst 8000v Series Edge Platforms</li> </ul>
Cisco IOS XE Catalyst SD-WAN Release 17.10.1a and later	<ul style="list-style-type: none"> <li>• Cisco Catalyst 8300 Series Edge Platforms</li> <li>• Cisco Catalyst 8200L Series Edge Platforms</li> </ul>
Cisco IOS XE Catalyst SD-WAN Release 17.11.1a and later	Cisco ISR 1100 and ISR 1100X Series Integrated Services Routers

## Manage Software Maintenance Upgrade Images

Use Cisco SD-WAN Manager to add, upgrade and activate, or deactivate and remove an SMU image.



**Note** When you activate or deactivate an SMU image, the device may reboot, depending on the SMU image. A non-reload SMU type does not trigger a device reboot; a reload SMU type triggers a device reboot.

### Add, View, and Activate an SMU Image

1. Add an SMU image using the Cisco SD-WAN Manager software repository.

See the Cisco SD-WAN Manager [Add Software Images to Repository](#) procedure in the *Cisco Catalyst SD-WAN Monitor and Maintain Configuration Guide*.

2. View SMU images using the Cisco SD-WAN Manager software repository.

See the Cisco SD-WAN Manager [View Software Images](#) procedure in the *Cisco Catalyst SD-WAN Monitor and Maintain Configuration Guide*. Note the following points when viewing SMU images:

- The **Available SMU Versions** column displays the number of SMU images available for the current base image version (Cisco IOS XE image version).
- View the defects that are associated with an SMU image by clicking a desired entry in the **Available SMU Versions** column. In the **Available SMU Versions** dialog box, you can view the defect ID, the corresponding SMU version, and the SMU types, such as non-reload or reload.



- In the **Available SMU Versions** dialog box, delete an SMU version by clicking the delete icon next to an SMU version.

3. Upgrade an SMU image using the Cisco SD-WAN Manager software upgrade window.

See the Cisco SD-WAN Manager [Upgrade the Software Image on a Device](#) procedure in the *Cisco Catalyst SD-WAN Monitor and Maintain Configuration Guide*. Note the following points about the SMU image that you choose to upgrade:

- In the devices table, the **Available SMUs** column displays the number of SMU images that are available for the current base image version.
- View a list of all available SMU versions and the upgrade images for a device by clicking a desired entry under the **Available SMUs** column. In the **Available SMUs** dialog box, you can view the SMU versions, SMU types, and the state of an SMU version.

The SMU version is in the format *base\_image\_version.cdet\_id*.

- In the **Upgrade** dialog box, optionally check **Activate and Reboot** to activate an SMU image and perform a reboot of the Cisco IOS XE Catalyst SD-WAN device automatically.

After you check the **Activate and Reboot** check box, Cisco SD-WAN Manager installs and activates the SMU image on a device and triggers a reload based on the SMU type. For more information about activating a software image, see the Cisco SD-WAN Manager [Activate a Software Image](#) procedure in the *Cisco Catalyst SD-WAN Monitor and Maintain Configuration Guide*.

After a successful upgrade of an SMU image, the Cisco IOS XE Catalyst SD-WAN device sends a corresponding success message.

#### Deactivate or Remove an SMU Image

Deactivate an SMU image and remove the image from a device using the [Delete a Software Image](#) procedure in the *Cisco Catalyst SD-WAN Monitor and Maintain Configuration Guide*.

## Manage Software Maintenance Upgrade Images Using the CLI

Use the following CLIs to install, upgrade and activate, or deactivate and remove an SMU image.



---

**Note** When an SMU image is activated and deactivated, the device reboot may be triggered based on non-reload or reload SMU types. A non-reload SMU type does not trigger a device reboot, but a reload SMU type triggers a device reboot.

---

#### Install and Activate an SMU Image Using the CLI

1. Upload the SMU image from the file server to the bootflash of the device.

Use the `copy` command to upload an SMU image. For information about the copy command, see Step 2 of the [Install the Cisco IOS XE Software](#) topic.

2. If not already configured, configure the time limit for confirming that a SMU image activation is successful.

The time limit can be 1 through 60 minutes. We recommend that you configure the time limit to be at least 15 minutes.

```
Device# config-transaction
Device(config)# system
Device(config-system)# upgrade-confirm minutes
```

3. Install an SMU image from the bootflash of your device and perform a compatibility check for the device and SMU package version.

```
Device# request platform software sdwan smu install file-path
```

4. Activate the SMU image on a Cisco IOS XE Catalyst SD-WAN device.

```
Device# request platform software sdwan smu activate build-number.smu-defect-id
```

5. Confirm the upgrade of the SMU image within the configured confirmation time limit.

```
Device# request platform software sdwan smu upgrade-confirm
```



---

**Note** If you don't issue this command on the device within the time limit that is specified in the **upgrade-confirm** *minutes* command, the device automatically reverts to the state that it was in before the SMU image activation.

---

### Deactivate and Remove an SMU Image Using the CLI

1. If not already configured, configure the time limit for confirming that a SMU image deactivation is successful.

The time limit can be 1 through 60 minutes. We recommend that you configure the time limit to at least 15 minutes.

```
Device# config-transaction
Device(config)# system
Device(config-system)# upgrade-confirm minutes
```

2. Deactivate an SMU image on a Cisco IOS XE Catalyst SD-WAN device.

```
Device# request platform software sdwan smu deactivate
build-number.smu-defect-id
```

3. Confirm that the SMU image can be deactivated.

```
Device# request platform software sdwan smu upgrade-confirm
```



---

**Note** If you do not issue this command on the device within the time limit specified in the **upgrade-confirm** *minutes* command, the image deactivation fails and the device automatically reverts to the state that it was in before the SMU image deactivation.

---

4. Remove an SMU image from a Cisco IOS XE Catalyst SD-WAN device.

```
Device# request platform software sdwan smu remove build-number.smu-defect-id
```

The following examples show commands that you can use to manage the SMU image operations.

- Check the upgrade and confirm the configuration:

```
show sdwan running system
```

- Add and upgrade the confirm timer:

```
config-transaction
system
upgrade-confirm 15
commit
```

- Execution commands:

- `request platform software sdwan smu install`  
`bootflash:c8000v-universalk9.2022-08-17_23.44_mcpre.24042.CSCvq24042.SSA.smu.bin`
- `request platform software sdwan smu activate 17.09.01a.0.247.CSCvq24042`
- `request platform software sdwan smu upgrade-confirm`
- `request platform software sdwan smu deactivate 17.09.01a.0.247.CSCvq24042`
- `request platform software sdwan smu upgrade-confirm`
- `request platform software sdwan smu remove 17.09.01a.0.247.CSCvq24042`

## Verify Status of Software Maintenance Upgrade Images

You can monitor the status of the SMU image by using Cisco SD-WAN Manager or the CLI.

### Monitor SMU Status Using Cisco SD-WAN Manager

1. From the Cisco SD-WAN Manager menu, choose **Maintenance > Software Upgrade**.
2. For the desired Cisco IOS XE Catalyst SD-WAN device, click an SMU image link (hyperlink) under **Available SMUs**.

In the **Available SMUs** dialog box, you can view the state of an SMU image.

If no SMU images are available for the current base image version (Cisco IOS XE image version), the SMU image link is not available under **Available SMUs** and Cisco SD-WAN Manager displays 0.

### Verify SMU Status Using the CLI

Example 1:

The following is a sample output from the `show install summary` command after installing, activating, and confirming the upgrade (committed) of an SMU image.

```
Device# show install summary[ R0 ] Installed Package(s) Information:
State (St): I - Inactive, U - Activated & Uncommitted,
           C - Activated & Committed, D - Deactivated & Uncommitted
-----
Type  St  Filename/Version
-----
IMG   C   17.09.01a.0.247
SMU   I   bootflash:c8000v-universalk9.2022-08-17_23.44_mcpre.24042.CSCvq24042.SSA.smu.bin
-----
```

```
Auto abort timer: inactive
-----
```

The output shows that an SMU image is installed and activated from the bootflash file system. You can track the time that is left for rollback of an SMU image from the `Auto abort timer` value. This value displays the time that is left for the `Auto abort timer` to expire and the device to roll back.

Example 2:

The following example shows the output after using the **request platform software sdwan smu deactivate** command to deactivate an SMU image.

```
Device# request platform software sdwan smu deactivate 17.09.01a.0.247.CSCvq24042
smu_deactivate: START Mon Mar 5 21:54:06 PST 2021
smu_deactivate: Deactivating SMU
Executing pre scripts....

Executing pre scripts done.
--- Starting SMU Deactivate operation ---
Performing SMU_DEACTIVATE on all members
  [1] SMU_DEACTIVATE package(s) on switch 1
  [1] Finished SMU_DEACTIVATE on switch 1
Checking status of SMU_DEACTIVATE on [1]
SMU_DEACTIVATE: Passed on [1]
Finished SMU Deactivate operation
SUCCESS: smu_deactivate 17.09.01a.0.247.CSCvq24042
```

The output shows that an SMU image is deactivated from the device.

The following is a sample output from the **show install summary** command after deactivating an SMU image.

```
Device# show install summary
[ R0 ] Installed Package(s) Information:
State (St): I - Inactive, U - Activated & Uncommitted,
           C - Activated & Committed, D - Deactivated & Uncommitted
-----
Type  St  Filename/Version
-----
IMG   C   17.09.01a.0.247
SMU   D   bootflash: c8000v-universalk9.2022-08-17_23.44_mcpre.24042.CSCvq24042.SSA.smu.bin
-----
Auto abort timer: active , time before rollback - 00:04:57
-----
```

The following sample output shows the output of deactivating an SMU image after confirming that the SMU image can be deactivated using the **request platform software sdwan smu upgrade-confirm** command.

```
Device# request platform software sdwan smu deactivate 17.09.01a.0.247.CSCvq24042

install_deactivate: START Thu Aug 25 17:47:10 UTC 2022
install_deactivate: Deactivating SMU
Executing pre scripts....
Executing pre sripts done.

--- Starting SMU Deactivate operation ---
Performing SMU_DEACTIVATE on Active/Standby
  [1] SMU_DEACTIVATE package(s) on R0
  [1] Finished SMU_DEACTIVATE on R0
Checking status of SMU_DEACTIVATE on [R0]
SMU_DEACTIVATE: Passed on [R0]
```

```
Finished SMU Deactivate operation
```

```
CSCvq24042:SUCCESS  
SUCCESS: install_deactivate /bootflash/c8kv_hot.bin Thu Aug 25 17:47:33 UTC 2022
```

The following is a sample output from the **show install summary** command after removing an SMU image.

```
Device# show install summary[ R0 ] Installed Package(s) Information:  
State (St): I - Inactive, U - Activated & Uncommitted,  
           C - Activated & Committed, D - Deactivated & Uncommitted
```

```
-----  
Type  St  Filename/Version  
-----  
IMG   C   17.09.01a.0.247  
-----
```

```
Auto abort timer: inactive  
-----
```

### Example 3:

The following is a sample output from the **show install package** command to view the metadata of an SMU image such as, SMU type, SMU ID, SMU defect ID, and so on.

```
Device# show install package  
bootflash:c8000v-universalk9.2022-08-17_23.44_mcpred.24042.CSCvq24042.SSA.smu.bin  
Name: c8000v-universalk9.2022-08-17_23.44_mcpred.24042.CSCvq24042.SSA.smu.bin  
Version: 17.09.01a.0.247.1660805065  
Platform: C8000V  
Package Type: SMU  
Defect ID: CSCvq24042  
Package State: Inactive  
Supersedes List: {}  
SMU Fixes List: {}  
SMU ID: 24042  
SMU Type: non-reload  
SMU Compatible with Version: 17.09.01a.0.247  
SMUImpact:
```





## CHAPTER 5

# Install and Upgrade Cisco IOS XE Catalyst SD-WAN Release 17.2.1r and Later

*Table 10: Feature History*

Feature Name	Release Information	Description
Install and Upgrade	Cisco IOS XE Catalyst SD-WAN Release 17.2.1r	This feature supports the use of a single "universalk9" image to deploy Cisco IOS XE Catalyst SD-WAN and Cisco IOS XE functionality on all the supported devices. This universalk9 image supports two modes - Autonomous mode (for Cisco IOS XE features) and Controller mode (for Cisco Catalyst SD-WAN features) .
Cisco Catalyst 8000V Edge SoftwarePlatform	Cisco IOS XE Catalyst SD-WAN Release 17.4.1a	Support added for the Cisco Catalyst 8000V Edge Software platform. Upgrading Cisco CSR1000V or Cisco ISRV platforms to Cisco IOS XE Catalyst SD-WAN Release 17.4.1a includes upgrading to the platform type to the Cisco Catalyst 8000V.

Starting with Cisco IOS XE Catalyst SD-WAN Release 17.2.1r, use the universalk9 image to deploy both Cisco IOS XE Catalyst SD-WAN and Cisco IOS XE on Cisco IOS XE Catalyst SD-WAN devices.

Starting Cisco IOS XE Catalyst SD-WAN Release 17.2.1r, UCMK9 image is not available.

This release helps in seamless upgrades of both the Cisco Catalyst SD-WAN and non Cisco Catalyst SD-WAN features and deployments.

Access the Cisco IOS XE and Cisco IOS XE Catalyst SD-WAN functionality through Autonomous and Controller execution modes, respectively. The Autonomous mode is the default mode for the routers and includes the Cisco IOS XE functionality. To access Cisco IOS XE Catalyst SD-WAN functionality, switch to the Controller mode. You can use the existing Plug and Play Workflow to determine the mode of the device.

- [Platforms Supported in Controller Mode, on page 90](#)

- [Cisco IOS XE Image Compatibility](#), on page 91
- [Upgrade Considerations](#), on page 91
- [Restrictions](#), on page 92
- [Self-Signed Trustpoint](#), on page 92
- [Introducing Autonomous and Controller Mode](#), on page 93
- [Software Installation for Cisco IOS XE Routers](#), on page 93
- [Plug and Play in Cisco IOS XE Catalyst SD-WAN Release 17.2.1r and Later Releases](#), on page 95
- [Non-PnP Onboarding](#), on page 99
- [Mode Discovery and Mode Change with Bootstrap Files](#), on page 101
- [Reset Controller Mode Configuration](#), on page 103
- [Mode Switching: Additional Information](#), on page 105
- [Verify Controller and Autonomous Modes](#), on page 105
- [Change the Console Port Access After Installation, in Controller Mode](#), on page 106
- [Upgrade to Cisco IOS XE Release 17.2.1r or Later](#), on page 108
- [Downgrade from Cisco IOS XE Catalyst SD-WAN Release 17.2.1r or Later Releases](#), on page 112
- [Restore Smart Licensing and Smart License Reservation](#), on page 114
- [Onboard Cisco Catalyst 8000V Edge Software Hosted by a Cloud Service, Using PAYG Licensing](#), on page 114
- [Bootstrap Process for Cisco Catalyst SD-WAN Cloud-Hosted Devices](#), on page 116
- [Troubleshooting](#), on page 117

## Platforms Supported in Controller Mode

### Platforms Supported in Controller Mode

- Cisco ASR 1000 Series Aggregation Services Routers
- Modular Cisco ASR 1006-X with ASR1000-RP3 module (Cisco IOS XE Catalyst SD-WAN Release 17.5.1a or later, see [Cisco ASR 1006-X with an RP3 Module](#).)
- Cisco ISR 1000 Series Integrated Services Routers
- Cisco ISR 4000 Series Integrated Services Routers
- Cisco 1101 Industrial Integrated Services Router
- Cisco CSR 1000v Series Cloud Services Routers
- Cisco Integrated Services Virtual Router (ISRv)
- Cisco Catalyst 8200 Series Edge Platforms
- Cisco Catalyst 8300 Series Edge Platforms
- Cisco Catalyst 8500 Series Edge Platforms
- Cisco Catalyst 8000V Edge Software (Cisco IOS XE Catalyst SD-WAN Release 17.4.1a or later)

### Platforms Not Supported in Controller Mode

Modular platforms based on the following ASR 1000 Series Routers are not supported in controller mode:



- ASR1000-RP2

### Crypto Modules Supported in Controller Mode

The following crypto modules are required for the ASR 1000 series routers:

- ASR1001HX-IPSECHW, for the ASR 1001-HX
- ASR1002HX-IPSECHW, for the ASR 1002-HX

## Cisco IOS XE Image Compatibility

Deployment Image Version	Cisco Catalyst SD-WAN	Non Cisco Catalyst SD-WAN
Cisco IOS XE Releases 16.9.x, 16.10.x, 16.11.x, 16.12.x	ucmk9	universalk9
Cisco IOS XE Release 17.1.x	NA	universalk9
Cisco IOS XE Release 17.2.x and later	universalk9*	universalk9**

- \* For Cisco Catalyst SD-WAN use case, non-LI and non-payload encryption image types are not supported.
- \*\* For non Cisco Catalyst SD-WAN use case, non-LI and non-payload encryption image types are supported (universalk9\_noli, universalk9\_npe, universalk9\_npe\_noli).

## Upgrade Considerations

The following Cisco IOS XE Catalyst SD-WAN devices support multirate interfaces and support the 1GE SFP (optical and CU) and 10GE SFP+ (optical and CU) modules on their 10G interfaces ports:

- Cisco ASR 1001-HX Router
- Cisco Catalyst 8500-12X4QC
- Cisco Catalyst 8500-12X

These devices support auto-negotiation on 10G interfaces ports with 1GE SFP (optical and CU) modules. The following notes apply to auto-negotiation in both SD-WAN and non-SD-WAN modes:

- For releases before Cisco IOS XE 17.6.1a, auto-negotiation can be configured using the CLI.
- For releases before Cisco IOS XE 17.6.1a, if you use the CLI or Cisco Catalyst SD-WAN to reboot a device with a 10G interface that includes a 10GE SFP+ module, that interface will not come up. In this situation, use Cisco Catalyst SD-WAN or the CLI to configure **no negotiation auto** for the interface, then reboot the device.
- From Cisco IOS XE Release 17.6.3a, **auto neg** values for auto-negotiation are pushed to 10G interfaces on supported devices through feature templates. Ensure that you know which SFP module is on which 10G interface on a device so that you can properly configure the feature template.

- From Cisco IOS XE Release 17.6.3a, the **negotiation auto** command is not supported on a 10G interface that includes a 10GE SFP+ module.
- From Cisco IOS XE Release 17.6.3a, the **no negotiation auto** command with the default **OFF** option must be sent through a feature template to all 10G interfaces that include a 10GE SFP+ module. Otherwise, the template push fails.
- Before upgrading to Cisco IOS XE Release 17.6.3a, use a feature template, a CLI add-on feature templates, or the CLI to **apply no negotiation auto** to all 10G interfaces that include a 10GE SFP+ module.
- If you upgrade to Cisco IOS XE Release 17.6.3a from a release in which auto-negotiation was enabled on a 10G interface that includes a 10GE SFP+ module, that interface will not come up. In this situation, use the CLI to configure **no negotiation auto** for the interface after the upgrade completes.
- Before upgrading to Cisco Catalyst SD-WAN Manager Release 20.12.1 or Cisco IOS XE Catalyst SD-WAN Release 17.12.1a or later releases, contact Cisco TAC to check and drop any non-compatible indexes. Non-compatible old index can impact successful upgrade to newer version.

## Restrictions

### Restrictions for single "universalk9" image

- Dual-IOSd is supported only in autonomous mode.
- Images without payload encryption and NO-LI (universalk9\_npe, universalk9\_noli, universalk9\_npe\_noli) images are not supported in controller mode. Only universalk9 images are supported.
- After onboarding and determining the mode of operation, changing from Controller mode to Autonomous mode or vice-versa, results in the loss of configuration.
- Reset button functionality is not supported in controller mode on Cisco ISR 1000 series Integrated Service Routers. The reset button does not function to restore a golden image or configuration in controller mode.
- Auto-install (Python and TCL scripts) and ZTP—Autoinstall and ZTP are not supported in controller mode. If DHCP discovers an attempt to install using either of these processes, a mode change to Autonomous mode is triggered.
- WebUI—In controller mode, WebUI is not supported and an error message is displayed, if used.

## Self-Signed Trustpoint

A self-signed trustpoint is generated and loaded to a Cisco IOS XE Catalyst SD-WAN device when the device boots up. If this trustpoint is deleted for any reason, you can generate and load a new trustpoint by rebooting the device. The new key may be different than the deleted one.

## Introducing Autonomous and Controller Mode

The Cisco IOS XE Catalyst SD-WAN Release 17.2.1r release introduces two installation modes – Autonomous and Controller modes. The autonomous mode supports the functionality of Cisco IOS XE non Cisco Catalyst SD-WAN deployment and the controller mode supports the Cisco Catalyst SD-WAN solution.

The following are the main differences between Autonomous mode and Controller mode:

**Table 11:**

Feature	Autonomous Mode	Controller Mode
Configuration Method	<ul style="list-style-type: none"> <li>• Command Line Interface (CLI)</li> <li>• NETCONF</li> </ul>	YANG-based configuration <ul style="list-style-type: none"> <li>• Cisco SD-WAN Manager</li> <li>• NETCONF</li> </ul>
Onboarding Modes	<ul style="list-style-type: none"> <li>• Plug and Play</li> <li>• Config-Wizard</li> <li>• WebUI</li> <li>• Bootstrap (USB, bootflash, and so on)</li> <li>• Auto-Install (Python Script, TCL Script)</li> <li>• ZTP (Using DHCP Option 150 and Option 67)</li> </ul>	<ul style="list-style-type: none"> <li>• Plug and Play</li> <li>• Bootstrap (USB, bootflash, and so on)</li> </ul>
Licensing	Cisco Smart Licensing	Cisco High Performance Security (HSEC) software licensing. No device licensing.
Image Type	Universalk9	Universalk9
Dual-IOSd redundancy model	Supported	Not Supported
High Availability	Supported	Not Supported
Global configuration mode	configure terminal	config-transaction

## Software Installation for Cisco IOS XE Routers

### Download the Software for Cisco IOS XE Release 17.2.1r or Later

Download the *router-model-universalk9.release-number*. image for Cisco IOS XE Catalyst SD-WAN Release 17.2.1r or later software from the Cisco site <https://software.cisco.com>.

## Install Software on Cisco ASR, Cisco ISR and Cisco ENCS Platforms

Refer to the following documents for installation instructions:

- [Cisco ISR 1000 Series Integrated Services Router](#)
- [Cisco ISR 4000 Series Integrated Services Routers](#)
- [Cisco ASR 1000 Series Aggregation Services Routers](#)
- [Installing Cisco Enterprise NFVIS on Cisco ENCS 5100 and ENCS 5400](#)

## Install Software on Cisco CSR 1000v Platform

Based on the cloud in which you are deploying the [CSR 1000v](#) instance, see the following to perform the bootstrap and/or the day 0 configuration:

- [Deploying the OVA to the VM](#)
- [Manually creating the Cisco CSR 1000v VM using the .iso file \(Citrix XenServer\)](#)
- [Creating a CSR 1000v VM using the self installing .run package](#)
- [Manually creating the VM using the .iso file \(Microsoft Hyper-V\)](#)
- [Booting the CSR 1000v Instance](#)
- [Deploying a CSR 1000v VM Using Custom Data](#)
- [Deploying a CSR 1000v VM on Microsoft Azure](#)

## Install a Cisco Catalyst 8000V Edge Software Platform

*Table 12: Feature History*

Feature Name	Release Information	Description
Support for the Cisco Catalyst 8000V Edge Software Platform on OpenStack Train	Cisco IOS XE Catalyst SD-WAN Release 17.7.1a	This feature introduces support for managing a Cisco Catalyst 8000V Edge software platform hosted in the OpenStack cloud computing platform "Train" release.

Beginning with Cisco IOS XE Catalyst SD-WAN Release 17.4.1a, Cisco Catalyst SD-WAN supports the Cisco Catalyst 8000V virtual router platform, which replaces the Cisco CSR1000V and Cisco ISRv. Installing the Cisco Catalyst 8000V in an Cisco Catalyst SD-WAN environment requires Cisco vManage Release 20.4.1 or later.

Download the Cisco Catalyst 8000V software image that is appropriate for your method of deployment. For example, this can be an OVA file for ESXi, or a QCOW2 image for OpenStack or KVM. Do not choose an ISO image. Have the image ready to upload to the Cisco SD-WAN Manager software image repository. The file name begins with: c8000v-universalk9



---

**Note** To operate with Cisco Catalyst SD-WAN, the device must be in controller mode. When starting the device in controller mode, boot the device using the bootflash:packages.conf file.

---

For complete information about the platform, including installation in KVM, ESXi, and OpenStack environments, see the [Cisco Catalyst 8000V Edge Software Installation and Configuration Guide](#). For information about creating a bootstrap file for onboarding the Cisco Catalyst 8000V into Cisco Catalyst SD-WAN, see [Bootstrap Process for Cisco Catalyst SD-WAN Cloud-Hosted Devices](#).

### Clean Install

We recommend a clean install of the Cisco Catalyst 8000V. This ensures support for all features, provides the most up-to-date licensing, and ensures that devices and the controller stay synchronized. For cases where upgrade is necessary, see the procedure in [Upgrade to Cisco IOS XE Release 17.2.1r or Later](#).



---

**Note** After a clean install of the Cisco Catalyst 8000V, it is not possible to downgrade the device to a release earlier than Cisco IOS XE Catalyst SD-WAN Release 17.4.1a.

---

### Upgrading a Cisco CSR1000V to a Cisco Catalyst 8000V

Upgrading a Cisco CSR1000V or Cisco ISRv virtual router to Cisco IOS XE Catalyst SD-WAN Release 17.4.1a includes upgrading to the Cisco Catalyst 8000V. Note the following:

- The Cisco Catalyst 8000V preserves all of the functionality available on Cisco CSR1000V or Cisco ISRv platforms.
- Performing the upgrade in Cisco SD-WAN Manager preserves the configuration of the device(s) being upgraded.

### OpenStack

Installing a Cisco Catalyst 8000V on the OpenStack Train release requires using a Cisco IOS XE Catalyst SD-WAN Release 17.7.1a or later image for the Cisco Catalyst 8000V.

Cisco does not support installing a Cisco Catalyst 8000V on OpenStack using an earlier image, or installing on OpenStack using an earlier image and upgrading to Cisco IOS XE Catalyst SD-WAN Release 17.7.1a.

# Plug and Play in Cisco IOS XE Catalyst SD-WAN Release 17.2.1r and Later Releases

## Plug and Play Onboarding Workflow

1. Place an order for the device in Cisco Commerce with Smart Account and Virtual Account details of the customer.

2. The device information from Cisco Commerce like Device serial number, Smart Account, and Virtual Account are added to the Plug and Play portal.
3. Add a Cisco SD-WAN Validator controller profile into the Plug and Play (PnP) portal for the same Smart Account and Virtual Accounts.
4. Associate the new device to the Cisco SD-WAN Validator controller profile manually.
5. PnP sends all relevant information including Cisco SD-WAN Validator details, device serial number, organization name, and network ID to Zero Touch Provisioning (ZTP).
6. Download the device serial number file (provisioning file) from PnP and upload it to Cisco SD-WAN Manager. The devices are now available on Cisco SD-WAN Manager. You can also use the **Sync Smart Account** option on Cisco SD-WAN Manager to sync the device with your virtual account and populate the device in Cisco SD-WAN Manager.



---

**Note** If you created and scheduled a device template on Cisco vManage Release 20.3.x and upgraded Cisco SD-WAN Manager to Cisco vManage Release 20.4.1 or later before onboarding the target device, when you onboard the device using PnP or ZTP, the template push fails. To avoid this failure, reschedule the template after upgrading the Cisco SD-WAN Manager software and then onboard the device.

---



---

**Note** If the ZTP process for a device is interrupted because the device reloads or power cycles, the ZTP process does not restart and the device comes online with the Cisco SD-WAN Manager image that was in its original configuration. In this situation, upgrade the device to the desired Cisco SD-WAN Manager release manually.

---



---

**Note** For more information, refer to the [Plug and Play Support Guide](#).

---

## Mode Discovery with Plug and Play Onboarding

The PnP-based discovery process determines the mode in which the device operates, based on the controller discovery and initiates a mode change, if required. The mode change results in a reboot of the device. Once reboot is complete, the device performs appropriate discovery process.

When you upgrade to Cisco IOS XE Catalyst SD-WAN Release 17.2.1r or later, on a Cisco device that already runs a Cisco IOS XE or Cisco Catalyst SD-WAN image, the device starts in autonomous mode or controller mode depending on the configured controller.

Plug and Play (PnP) deployment include the following discovery process scenarios:

Table 13:

Boot up Mode	Deployment Mode	On-boarding agent	Cisco SD-WAN Validator	Discovery Process	Mode Change
Autonomous	Cisco Digital Network Architecture (DNA)	Plug and Play	No	Plug and Play Connect Discovery or on-premise plug and play server discovery	No Mode change
Autonomous	Cisco SD-WAN Manager	Plug and Play	Yes	Plug and Play Connect Discovery	Mode change to controller mode
Controller	Cisco DNA	Plug and Play	No	Plug and Play Connect Discovery or on-premise plug and play server discovery	Mode change to autonomous mode
Controller	Cisco SD-WAN Manager	Plug and Play	Yes	Plug and Play Connect Discovery	No mode change

## Automatic IP Address Detection

Table 14: Feature History

Feature Name	Release Information	Description
Day 0 WAN Interface Automatic IP Detection using ARP	Cisco IOS XE Catalyst SD-WAN Release 17.7.1a Cisco SD-WAN Release 20.7.1 Cisco vManage Release 20.7.1	This feature enables a device to automatically learn about the available IP addresses and default gateway information when a DHCP server is not available. The device assigns an IP address to its WAN interface, and then contacts the PnP server and begins the PnP onboarding process.

Typically, the WAN interface on a Cisco IOS XE Catalyst SD-WAN device or Cisco vEdge device is configured as a DHCP client, and this interface receives an IP address and gateway server information from the DHCP server during the plug-and-play (PnP) onboarding process.

If the DHCP server is not available, the device automatically learns about the available IP addresses and default gateway information by using Address Resolution Protocol (ARP) packets. If an IP address that the device learns allows a successful connection to the PnP server, the device continues with the PnP onboarding process.



---

**Note** This feature applies only to day zero deployments and is enabled by default.

---

### Prerequisites for Automatic IP Address Detection

- To trigger ARP, configure the IP address of the device as the BGP neighbor on the provider edge (PE) router.  
This PE router is the first point of contact for the device in the WAN transport network. The PE router then sends ARP packets with this IP address to the device. The device receives the ARP packets, and then the Automatic IP Address Detection feature defines the ARP destination IP address as the device's WAN interface IP address.
- For Cisco IOS XE Catalyst SD-WAN devices, the network mask of this IP address must be 30 bits.
- For automatic IP address detection and redirection through an on-premises ZTP server, the A record of the ZTP server on the DNS server must be set to ztp.cisco.com. In addition, the DNS server must have an ip name-server value of 8.8.8.8 or 8.8.4.4.

For automatic IP address detection, a device uses 8.8.8.8 or 8.8.4.4 as the DNS server to resolve devicehelper.cisco.com or ztp.cisco.com. The PnP process then attempts to reach devicehelper.cisco.com or ztp.cisco.com to continue onboarding.



---

**Note** An IP address that a device automatically detects is not preserved during reboots of the device that occur before the PnP onboarding completes. In such cases, an IP address is assigned automatically when the PE router ARP cache expires.

---

### Limitations and Restrictions for Automatic IP Address Detection

The following limitations and restrictions apply only to Cisco IOS XE Catalyst SD-WAN devices:

- This feature is supported only on Cisco 1000 Series Integrated Service Routers, Cisco 4000 Series Integrated Service Router, and Cisco Catalyst 8200 and 8300 Series Edge Platforms. On these devices, this feature is supported only for Gigabit Ethernet Interface 0/0/0.
- The feature is supported only on devices that are in controller (SD-WAN configuration) mode. See <https://www.cisco.com/c/en/us/td/docs/routers/sdwan/configuration/sdwan-xe-gs-book/install-upgrade-17-2-later.html>.
- This feature is supported only in a simple 30 bit network mask Layer 2 network in which one PE router and one customer edge router are in the same VLAN.
- This feature does not support VRRP, HSRP, or GLBP on the PE router.
- An ARP destination IP address is used as the WAN interface IP address on a device only after the device receives the same ARP request eight times within an interval of 150 seconds.



# Non-PnP Onboarding

## Creating a Cisco Catalyst SD-WAN Bootstrap Configuration File

See [On-Site Bootstrap Process for Cisco Catalyst SD-WAN Devices](#) and [Generate a Bootstrap File For Cisco IOS XE Catalyst SD-WAN Devices Using the CLI](#) for information about generating a bootstrap file.

## New Installation: Mode Change Device Day Zero Scenario

1. If the device is running a pre-17.2 universalk9 image on a new box, or for an existing box where you performed **write erase** and **reload** and loaded a Cisco IOS XE 17.2 or newer image, the device boots in day zero configuration and in autonomous mode.
2. The new device determines if a mode change is required based on the bootstrap file.
  - If `ciscosdwan.cfg` or `ciscosdwan_cloud_init.cfg` bootstrap file is plugged in the bootstrap location, mode change to controller mode is initiated. After the device boots up in controller mode, the configuration present in the configuration file is applied.
  - If a `ciscotr.cfg` bootstrap file or `config-wizard` is discovered, mode change is not initiated and the boot up continues in the Autonomous mode.



---

**Note**

- The bootstrap file (`ciscosdwan.cfg`) is generated by Cisco SD-WAN Manager, and has UUID, but no OTP.
  - For software devices (Cisco Catalyst 8000V Edge Software, Cisco Cloud Services Router 1000V Series, and Cisco ISRV), and for OTP-authenticated devices such as the Cisco ASR1002-X, use the bootstrap file `ciscosdwan_cloud_init.cfg`. This file has OTP but no UUID validation.
- 

## Switch Modes Using Cisco CLI

Use the **controller-mode** command in privileged EXEC mode to switch between controller and autonomous modes.

### Autonomous Mode

The **controller-mode disable** command switches the device to autonomous mode.

```
Device# controller-mode disable
```

### Controller Mode



---

**Note**

To switch the device to the controller-mode, boot the system using either the `bootflash:/*`.bin or `bootflash:/packages.conf` file.

---



**Note** If `bootflash:core` or `harddisk:core` contain core files (files containing information about process crashes), move the files to another location before changing the device to controller mode. If these files remain in the `bootflash:core` or `harddisk:core` directories, Cisco SD-WAN Manager displays an alarm after onboarding the device. You can move the files to any other directory on the device other than a core directory.

The **`controller-mode enable`** command switches the device to controller mode.

```
Device# controller-mode enable
```

### Notes

Note	Description
Bundle mode	<p>If device is booted with bundle mode (Super packages), after reboot, the image gets automatically expanded and activated to prepare the router for SDWAN operation. Devices with 4GB RAM may require an additional reboot to free up space in <code>/bootflash</code>. The following devices with 4GB RAM need reload:</p> <ul style="list-style-type: none"> <li>• Cisco ISR 4451</li> <li>• Cisco ISR 4431</li> <li>• Cisco ISR 4461</li> <li>• Cisco ISR 4351</li> <li>• Cisco ISR 4331</li> <li>• Cisco ISR 4321</li> </ul>
Viewing the contents of the <code>bootflash:/sdwaninstaller</code> directory	<p>You cannot view the contents of the <code>bootflash:/sdwaninstaller</code> directory of a Cisco IOS XE Catalyst SD-WAN device in either of the following conditions:</p> <ul style="list-style-type: none"> <li>• The device is in controller mode.</li> </ul> <p>or</p> <ul style="list-style-type: none"> <li>• The device is in autonomous mode and using Cisco IOS XE Catalyst SD-WAN Release 17.6.1a or later.</li> </ul>

# Mode Discovery and Mode Change with Bootstrap Files



**Note** If your Cisco IOS XE Catalyst SD-WAN device is already running an older Cisco Catalyst SD-WAN configuration version or file and when you upgrade your device from Cisco IOS XE Catalyst SD-WAN Release 16.x to Cisco IOS XE Catalyst SD-WAN Release 17.2.1r or later, the device boots up in the controller mode. To prevent the device from booting up in the controller mode, before performing the device upgrade, ensure that you remove the stale Cisco Catalyst SD-WAN configuration file from the bootflash.

Detailed steps to delete all Cisco Catalyst SD-WAN artifacts from bootflash:

```
delete /force bootflash:/ciscosdwan*.cfg
delete /force /recursive bootflash:/sdwaninstallerfs
delete /force /recursive bootflash:/sdwaninstaller
delete /force /recursive bootflash:/sdwaninternal
delete /force /recursive bootflash:/sdwan
delete /force /recursive bootflash:/vmanage-admin
delete /force /recursive bootflash:/cdb_backup
delete /force /recursive bootflash:/installer/active
delete /force /recursive bootflash:/installer
```

On a device that already runs a Cisco Catalyst SD-WAN image, after upgrading to a Cisco IOS XE Catalyst SD-WAN Release 17.2.1r or later image, the device boots up in controller mode.



**Note** Installing the Cisco Catalyst 8000V on OpenStack requires using the Cisco Catalyst 8000V image for Cisco IOS XE Catalyst SD-WAN Release 17.7.1a or later.

Use the **controller-mode enable** command to switch from autonomous to controller mode and the **controller-mode disable** command to switch from controller mode to autonomous mode.

To switch modes using CLI, ensure that the appropriate configuration files mentioned in the table below are present. After the device boots up, the configuration present in the configuration file is applied. The device reads the configuration file and uses the configuration information to come up on the network.

**Table 15: Configuration File Prerequisites for Mode Change**

Current Mode	Mode change to	Platforms	Configuration file and location
Controller	Autonomous	All supported platforms	ciscotr.cfg in any file system available to the device

Current Mode	Mode change to	Platforms	Configuration file and location
Autonomous	Controller	<ul style="list-style-type: none"> <li>• Cisco Cloud Services Router, CSR1000v</li> <li>• Cisco Integrated Services Virtual Router, ISRV</li> <li>• Cisco Catalyst 8000V</li> <li>• Cisco ASR1002-X</li> </ul>	ciscosdwan_cloud_init.cfg on bootflash, USB, CDROM0, or CDROM1
Autonomous	Controller	<ul style="list-style-type: none"> <li>• Cisco Aggregation Services Router, ASR 1000 Series</li> <li>• Cisco Integration Service Routers, ISR 4000 series and ISR 1000 series routers</li> </ul>	ciscosdwan.cfg on bootflash or USB



**Note** On a Cisco CSR1000v device (for Cisco IOS XE Release 17.2 or later) and a Cisco Catalyst 8000V (for Cisco IOS XE Release 17.4 or later) image deployment, if you want to boot up the device in controller mode, load the bootstrap file generated by Cisco SD-WAN Manager by bootstrap (ESXi, KVM, and OpenStack) or user-data (AWS) or custom-data (Azure and GCP).

The following fields must be present in the ciscosdwan\_cloud\_init.cfg bootstrap file:

- otp
- uuid
- vbond
- org



**Note** When the device mode is switched from autonomous to controller, the startup configuration and the information in NVRAM (certificates), are erased. This action is equivalent to running the **write erase** command.



**Note** When the device mode is switched from controller to autonomous, all Yang-based configuration is preserved and can be reused if you switch back to controller mode.



**Note** When the device is in Day N configuration and is reloaded, the presence of a bootstrap file does not impact the device operating mode.



---

**Note** You cannot view the contents of the bootflash:/sdwaninstaller directory and .sdwaninstallerfs file of a Cisco IOS XE Catalyst SD-WAN device in either of the following conditions:

- The device is in controller mode.
- or
- The device is in autonomous mode and using Cisco IOS XE Catalyst SD-WAN Release 17.6.1a or later.

Directory, more, copy and delete operations are not allowed when the file and directory are hidden in controller-mode.

---

## Reset Controller Mode Configuration

If you use **request platform software sdwan config reset** or **request platform software sdwan software reset** commands to bring the device back to controller-mode day-zero configuration, the device performs one of the following actions:

- Performs mode discovery. For more information on mode discovery, see [Mode Discovery with Plug and Play Onboarding, on page 96](#).
- Uses the appropriate configuration file to perform bootstrap. For more information on the Cisco Catalyst SD-WAN bootstrap configuration file, see [Creating a Cisco Catalyst SD-WAN Bootstrap Configuration File, on page 99](#).

To erase the Cisco Catalyst SD-WAN configuration of the current active image, use the following CLI:

```
Device# request platform software sdwan config reset
%WARNING: Bootstrap file doesn't exist and absence of it can cause loss of connectivity to
the controller.
For saving bootstrap config, use:
request platform software sdwan bootstrap-config save
Proceed to reset anyway? [confirm]
Backup of running config is saved under /bootflash/sdwan/backup.cfg
WARNING: Reload is required for config-reset to become effective.
```



---

**Note** The warning listed in the above configuration is visible only on Cisco IOS XE Catalyst SD-WAN Release 17.3.1a and later images.

---

For the changes to take effect, you must reload the router after running the CLI. Running this CLI ensures the configuration for the currently installed version is wiped along with crypto keys and the device enters the day zero workflow after the reload.

If the device is not set up to use PnP for onboarding, then it reads the configuration file in the bootflash and uses the configuration information to come up on the network. If the device is setup to use PnP onboarding, then after reload, the PnP discovery will start again.



---

**Note** In the case of public clouds, just like a fresh install, additional bootstrap configuration is provisioned that allows you to login to the instance.

---



---

**Note** In public cloud and NFVIS environments, ensure that a latest day-zero bootstrap configuration file (exported from Cisco SD-WAN Manager) is available in a supported location and following standard file naming conventions (example: `bootflash:/ciscosdwan_cloud_init.cfg` file), before the configuration reset operation is performed.

---



---

**Warning** Failure to follow save the bootstrap file in these environments cause loss of virtual machine connectivity.

---

### Configuration Reset

When you do a configuration reset, the device performs the following:

- Erases only the configuration of the current running image.
- Erases the certificates.
- Reboots the router with the same image. At this point, the device repeats Day-0 boot up.

### Software Reset

When you do a software reset, the device performs the following:

- Erases all SD-WAN metadata saved in the `bootflash:/sdwan` folder including certificates.
- Erases configuration of all the images (running as well as previously activated).
- Removes all image files except the one marked as default.
- Reboots the router with the default version image. At this point, the device repeats Day-0 boot up.

# Mode Switching: Additional Information

## Configuration Persistence During Mode Switch

Table 16:

Current Configuration Mode	Mode Switched to	Behavior
Autonomous	Controller	<p>Contents of NVRAM and the startup configuration are erased. Configuration is not be restored. Device is reverted to Day zero configuration. Previous running configuration is stored in bootflash.</p> <p><b>Note</b> When you switch from autonomous mode to controller mode, and switch back to autonomous mode, the Cisco IOS XE configuration is not restored because the startup configuration is empty. You have to manually restore configuration from the backup.</p>
Controller	Autonomous	<p>CDB contents are erased (for subsequent mode switches) and Cisco IOS configuration are not restored (as startup configuration is empty). You have to manually restore configuration from the backup.</p>

## Verify Controller and Autonomous Modes

### Show Command Output for Controller Mode

```

Device# show logging | include OPMODE_LOG
*Dec 8 16:01:17.339: %BOOT-5-OPMODE_LOG: R0/0: binos: System booted in CONTROLLER mode

Device# show version | inc operating

Router operating mode: Controller-Managed

Device# show platform software device-mode
Operating device-mode: Controller

Device-mode bootup status:
-----
Success

Device# show platform software chasfs r0 brief | inc device_managed_mode

/tmp/chassis/local/rp/chasfs/etc/device_managed_mode : [controller]
/tmp/fp/chasfs/etc/device_managed_mode : [controller]

Device# show version | inc Last reload
Last reload reason: Enabling controller-mode

```

## Show Command Output for Autonomous Mode

```

Device# show logging | include OPMODE_LOG
*Dec  8 17:01:17.339: %BOOT-5-OPMODE_LOG: R0/0: binos: System booted in AUTONOMOUS mode

Device# show version | inc operating

Router operating mode: Autonomous

Device# show platform software device-mode

Operating device-mode: Autonomous

Device-mode bootup status:
-----

Device# show platform software chasfs r0 brief | inc device_managed_mode

/tmp/chassis/local/rp/chasfs/etc/device_managed_mode : [autonomous]
/tmp/fp/chasfs/etc/device_managed_mode : [autonomous]

Device# show version | inc Last reload
Last reload reason: Enabling autonomous-mode

```



**Note** If the device is in controller mode, the **show sdwan running-config** command does not display the following information:

- All service commands under /native/service except tcp-small-servers, udp-small-servers, tcp-keepalives-in, and tcp-keepalives-out
- Configurations under line VTY except for transport, access-class, and ipv6 access-class
- IPv6 unicast routing configuration
- Commands in /native/enable

To verify these configuration use the **show running-config** command.

## Change the Console Port Access After Installation, in Controller Mode

### Before You Begin

Before beginning this procedure, ensure that you have access to the Cisco CSR1000V or Cisco Catalyst 8000V router through the currently configured console access method.

### Change the Console Port Access

This procedure changes the method for connecting to the console to access a Cisco CSR1000V or Cisco Catalyst 8000V software device.

The image used for deploying the Cisco CSR1000V or Cisco Catalyst 8000V software determines the default type of console access to use, which can be virtual or serial.



The procedure includes changing the mode from controller to autonomous, and then back to controller, which is required for operation with Cisco Catalyst SD-WAN. These mode changes cause the device to reload.

Perform the following steps to change the console port access.

1. In EXEC mode, enter **enable** to enter privileged EXEC mode.

```
Router> enable
```

2. Disable controller mode. Enter the following command and follow the prompts to complete the command.

```
Device# controller-mode disable
```



---

**Note** This reboots the device in autonomous mode.

---

3. After the device restarts, enter **enable** to enter privileged EXEC mode.

```
Router> enable
```

4. Enter global configuration mode.

```
Device# configure terminal
```

5. Use one of the following options to configure the type of access:

- virtual: This option specifies that the device is accessed through the hypervisor virtual VGA console.

```
Device(config)# platform console virtual
```

- serial: This option specifies that the device is accessed through the serial port on the virtual machine (VM).



---

**Note**

- Use this option only if your hypervisor supports serial port console access.
- If the device configuration is stored as a Cisco SD-WAN Manager device template and is attached to the device using Cisco SD-WAN Manager, enter the command

```
Device(config)# platform console serial
```

to the CLI add-on feature template. For more information on CLI Add-On Feature Templates see, [Cisco Catalyst SD-WAN Systems and Interfaces Configuration Guide](#). This helps in avoiding Cisco SD-WAN Manager removing the serial port when the device template is attached to the device.

---

```
Device(config)# platform console serial
```

- auto: (This option has been deprecated and is not recommended.) This option specifies that the device console is detected automatically. This is the default setting during the initial installation boot process. For additional information, see [Booting the Cisco CSR 1000v as the VM](#).

6. Exit configuration mode.

```
Device(config)# end
```

7. Save the configuration.

```
Device# write memory
```

- Copy the running configuration to the startup configuration.

```
Device# copy system:running-config nvram:startup-config
```

- Change the device back to controller mode. Enter the following command and follow the prompts to complete the command.

```
Device# controller-mode enable
```



---

**Note** This step reboots the device in controller mode.

---

## Upgrade to Cisco IOS XE Release 17.2.1r or Later

### Supported Upgrades

Table 17: Cisco CSR1000V and Cisco ISRv Routers

You Can Upgrade to...	From these Releases
Cisco IOS XE Catalyst SD-WAN Release 17.4.1a	Cisco IOS XE SD-WAN 17.3.1a or later Cisco IOS XE SD-WAN 17.2.2 or later Cisco IOS XE SD-WAN 16.12.4a or later  <b>Note</b> <ul style="list-style-type: none"> <li>To upgrade a Cisco CSR1000V or Cisco ISRv router to Cisco IOS XE Catalyst SD-WAN Release 17.4.1a from a release not listed here requires first upgrading to one of these releases.</li> <li>Upgrading a Cisco CSR1000V or Cisco ISRv router to Cisco IOS XE Catalyst SD-WAN Release 17.4.1a includes upgrading to the Cisco Catalyst 8000V.</li> </ul>
Cisco IOS XE 17.3.x	Cisco IOS XE Catalyst SD-WAN Release 17.2.1r Cisco IOS XE Release 17.2.1v Cisco IOS XE SD-WAN 16.12.x Cisco IOS XE SD-WAN 16.11.x Cisco IOS XE SD-WAN 16.10.x Cisco IOS XE SD-WAN 16.9.x

You Can Upgrade to...	From these Releases
Cisco IOS XE Catalyst SD-WAN Release 17.2.1r	Cisco IOS XE SD-WAN 16.12.x Cisco IOS XE SD-WAN 16.11.x Cisco IOS XE SD-WAN 16.10.x Cisco IOS XE SD-WAN 16.9.x

**Table 18: All Routers Supported by Cisco Catalyst SD-WAN Except Cisco CSR1000V, Cisco ISRv, and Cisco Catalyst 8000V**

You Can Upgrade to...	From these Releases
Cisco IOS XE Catalyst SD-WAN Release 17.4.1a	Cisco IOS XE SD-WAN 17.3.1a or later Cisco IOS XE SD-WAN 17.2.1 or later Cisco IOS XE SD-WAN 16.12.4a or later
Cisco IOS XE 17.3.x	
Cisco IOS XE Catalyst SD-WAN Release 17.2.1r	Cisco IOS XE SD-WAN 16.12.x Cisco IOS XE SD-WAN 16.11.x Cisco IOS XE SD-WAN 16.10.x Cisco IOS XE SD-WAN 16.9.x

Use the following procedures to upgrade your device to Cisco IOS XE Catalyst SD-WAN Release 17.2.1r or later images.



**Note** Do not delete the existing image to ensure that you have a rollback option.



**Note** If an upgrade fails, do not attempt to reactivate the new software image. Instead, remove the new software image, identify and correct any configuration settings that might have caused the failure, and try the upgrade procedure again. If the issue persists, contact Cisco for assistance.



---

**Note** When upgrading to Cisco IOS XE Catalyst SD-WAN Release 17.4.1a from Cisco IOS XE Releases 17.3.1a or earlier, we recommend that you do not make any changes to the device configuration using CLI, while a feature template is detached. Starting Cisco IOS XE Catalyst SD-WAN Release 17.4.1a, we use Cisco Catalyst SD-WAN assisted upgrades. In this upgrade procedure, Cisco Catalyst SD-WAN saves the device configuration before the upgrade. If the configuration on the device, that is modified using CLI is not same as on Cisco Catalyst SD-WAN, then the device has inconsistent configuration after the upgrade.

For example, if you configure the BGP AS number of a device to a different value using CLI, the device can have inconsistent configuration and the upgrade fails. If the upgrade is performed when the device is in CLI mode, then you must revert the BGP AS number to the original value and then upgrade the device. Therefore, we recommend that you upgrade the device using Cisco Catalyst SD-WAN.

---



---

**Note** Beginning with Cisco IOS XE Catalyst SD-WAN Release 17.5.1a, if you are upgrading the firmware for a device on which the primary tunnel interface is a cellular interface and the backup tunnel interface is a gigabit interface, use the gigabit interface as the primary interface for the firmware upgrade.

For information about configuring the priority of a tunnel interface, see the `vmanage-connection-preference` command in *Cisco Catalyst SD-WAN Command Reference*. An interface that is configured with a higher preference value has a higher priority.

---

## Upgrade Using Cisco Catalyst SD-WAN

We recommend using Cisco SD-WAN Manager to upgrade. This keeps devices and the controller synchronized.

1. Use the Cisco SD-WAN Manager [upgrade and activate](#) procedure described in the *Cisco Catalyst SD-WAN Monitor and Maintain* guide.

## Upgrade Using CLI

We recommend using Cisco SD-WAN Manager to upgrade. This keeps devices and the controller synchronized. If it is necessary to upgrade using the CLI, use the following steps.

### Back Up Configuration Files

Use these following steps to make configuration file copies before performing the manual upgrade process. Without these steps, the router will lose its configuration during the upgrade.



---

**Note** If the deployment is on a public cloud service, such as Amazon Web Services (AWS), failure to save the configuration before upgrading manually can cause an unrecoverable loss of connectivity with the device. In contrast to a hardware device, there may be no way to gain any type of console access to the virtual router.

---

1. Use the following command to make a backup copy of the Cisco IOS XE Catalyst SD-WAN configuration:
 

```
show running-config | redirect bootflash:/sdwan/ios.cli
```
2. Use the following command to make a backup copy of the Cisco Catalyst SD-WAN running configuration:

```
show sdwan running-config | redirect bootflash:/sdwan/sdwan.cli
```

### Upgrade Procedure

1. Download the Cisco IOS XE Release 17.2 image for your device from <https://software.cisco.com>
2. Upload the image to the device.
3. Install the new software. Example:

```
Device# request platform software sdwan software install
bootflash:/isr4300-universalk9.17.2.1.SPA.bin
```

4. Activate the software. The device reloads when the activation is complete. Example:

```
Device# request platform software sdwan software activate 17.2.01r.9.3
```

5. Verify that the software is activated.

```
Device# show sdwan software
```

```
VERSION          ACTIVE DEFAULT PREVIOUS CONFIRMED TIMESTAMP
-----
16.12.1d.0.48   false  true   true   auto   2020-03-04T10:43:45-00:00
17.2.01r.9.3    true   false  false  user   2020-03-04T11:15:20-00:00
```

```
Total Space:388M Used Space:100M Available Space:285M
```

6. (Optional) To ensure that the new version is preserved if software reset required, use the following command. Example:

```
Device# request platform software sdwan software set-default 17.2.01r.9.3
```

7. Verify the upgrade using **request platform software sdwan software upgrade-confirm**.

```
Device# request platform software sdwan software upgrade-confirm
```



**Note** From 17.6.1 release, you cannot perform another install, activate or deactivate operation for an image or a Software Maintenance Update (SMU), when the upgrade-confirm function is pending for an existing operation.



**Note** In controller mode, use the **config-transaction** command to enter global configuration mode. The **configuration terminal** command is not supported in Controller mode.

**Table 19: Configuration Persistence in Upgrade Scenarios**

Existing Installation (image)	Upgraded to (image)	Behavior
Cisco IOS XE SD-WAN Release 16.12 and earlier (ucmk9)	Cisco IOS XE Catalyst SD-WAN Release 17.2.1r (universalk9)	Device boots up in controller mode and configuration is preserved.
Cisco IOS XE Release 16.12 and earlier (universalk9)	Cisco IOS XE Catalyst SD-WAN Release 17.2.1r (universalk9)	Device boots up in autonomous mode and configuration is preserved (via startup configuration).

# Downgrade from Cisco IOS XE Catalyst SD-WAN Release 17.2.1r or Later Releases

## Downgrade a Cisco IOS XE Catalyst SD-WAN Device to a Previously Installed Software Image

To downgrade a Cisco IOS XE Catalyst SD-WAN device to an earlier software image that is currently installed on the device using the CLI, perform the following steps:

1. Display the currently installed images.

```
Device# show sdwan software
```

Example:

VERSION	ACTIVE	DEFAULT	PREVIOUS	CONFIRMED	TIMESTAMP
16.10.400.0.0	false	true	true	auto	2019-11-20T04:40:05-00:00
17.3.1.0.102822	true	false	false	auto	2020-07-31T11:01:22-00:00

2. Activate the image. This resets the device, deleting any existing configuration. The device starts in day zero configuration.

```
Device# request platform software software activate desired-build
```

Example:

```
Device# request platform software software activate 16.10.400.0.0
```

## Downgrade a Cisco IOS XE Catalyst SD-WAN Device to an Older Software Image

To download an earlier software image and downgrade a Cisco IOS XE Catalyst SD-WAN device to an earlier software image using the CLI, perform the following steps:

1. Display the currently installed images.

```
Device# show sdwan software
```

Example:

VERSION	ACTIVE	DEFAULT	PREVIOUS	CONFIRMED	TIMESTAMP
16.10.400.0.0	false	true	true	auto	2019-11-20T04:40:05-00:00
17.3.1.0.102822	true	false	false	auto	2020-07-31T11:01:22-00:00

2. If necessary, remove an existing software image to provide space for loading a new software image.

```
Device# request platform software sdwan software remove previous-installed-build
```

Example:

```
Device# request platform software sdwan software remove 16.10.400.0.0
```

3. Download the software image for the downgrade and copy it to the device bootflash.
4. Install the downloaded image.

```
Device# request platform software sdwan software install bootflash:/desired-build
```

Example:

```
Device# request platform software sdwan software install
bootflash:/isr1100be-universalk9.17.02.01a.SPA.bin
```

5. Display the currently installed images, which now include the new image.

```
Device# show sdwan software
```

```
VERSION          ACTIVE  DEFAULT  PREVIOUS  CONFIRMED  TIMESTAMP
-----
17.02.01a.0.211  false   true     true      auto       2020-03-30T09:34:04-00:00
```

6. Activate the new image. This resets the device, deleting any existing configuration. The device starts in day zero configuration.

```
Device# request platform software sdwan software activate desired-build clean
```

Example:

```
Device# request platform software sdwan software 17.02.01a.0.211 clean
```

## Downgrade Scenarios for Cisco IOS XE Release 17.2.x

*Table 20: Configuration Persistence in Downgrade Scenarios*

Existing Installation (image)	Downgrade to (image)	Behavior
Cisco IOS XE Catalyst SD-WAN Release 17.2.1r(universalk9) in controller mode	Cisco IOS XE SD-WAN Release 16.12 and earlier (ucmk9)	Device boots up with ucmk9 image and configuration is restored if the ucmk9 image was previously installed on the device.  Downgrading to a fresh install of old image versions brings the device to Day 0 configuration. To proceed, use the <b>clean</b> option at activation.
Cisco IOS XE Catalyst SD-WAN Release 17.2.1r (universalk9) in autonomous mode	Cisco IOS XE Release 17.1.1 and earlier (universalk9)	Device boots up with universalk9 image and configuration is restored.



### Note

- Downgrading directly from controller mode to Cisco IOS XE Amsterdam Release 17.1.x or earlier universalk9 or other non Cisco Catalyst SD-WAN images is not supported. To downgrade from controller mode to earlier IOS XE images, switch to autonomous mode and follow the downgrade process.
- Downgrading directly from autonomous mode to Cisco IOS XE SD-WAN 16.12 or earlier ucmk9 SD-WAN images is not supported. To downgrade from autonomous mode to earlier Cisco IOS XE Catalyst SD-WAN images, switch to controller mode and follow the downgrade process.

## Restore Smart Licensing and Smart License Reservation

The smart licensing authorization is lost when a device switches from autonomous to controller mode and back to autonomous mode again.

For more information about Smart Licensing, refer to [Smart Licensing Guide for Access and Edge Routers](#).

### Restore Smart Licensing

1. Reconfigure device to reach Cisco Smart Software Manager (CSSM).
2. Register the device using **license smart register idtoken *token* force** command in privileged EXEC mode.
3. Set the required crypto throughput using **platform hardware throughput crypto *crypto-value***.
4. Save the configuration using **write memory** in privileged EXEC mode.
5. Reload the device and verify that the new crypto throughput value is applied using the **show platform hardware throughput crypto** command.

### Restore Smart License Reservation

1. Enable the reservation mode using the **license smart reservation** command in global configuration mode.
2. Set the required crypto throughput using **platform hardware throughput crypto *crypto-value***.
3. Save the configuration using **write memory**.
4. Reload the device and verify that the new crypto throughput value is applied using the **show platform hardware throughput crypto** command.

## Onboard Cisco Catalyst 8000V Edge Software Hosted by a Cloud Service, Using PAYG Licensing

To onboard a Cisco Catalyst 8000V platform hosted by a cloud service, using pay as you go (PAYG) licensing, perform these steps.

You can also use Cisco Cloud onRamp for Multi-Cloud to onboard a Cisco Catalyst 8000V platform using PAYG licensing. For information to integrate public cloud infrastructure into the Cisco Catalyst SD-WAN fabric, see [Cloud OnRamp Configuration Guide, Cisco IOS XE Release 17.x](#).



---

**Note** This procedure is applicable to Cisco Catalyst 8000V hosted by Amazon Web Services (AWS).

---

1. From the Cisco SD-WAN Manager menu, choose **Configuration > Devices**, and click **Add PAYG WAN Edges**.



2. In the **Add PAYG WAN Edges** dialog box, enter the number of PAYG devices to onboard into Cisco Catalyst SD-WAN, select the **Validate** check box, and click **Add**.

The **Task View** page opens, showing the progress as Cisco SD-WAN Manager creates logical devices.



---

**Note** Validating causes Cisco SD-WAN Manager to publish the list of devices to the Cisco Catalyst SD-WAN Validator and Cisco Catalyst SD-WAN Controller controllers in the network.

---

3. After the **Task View** page shows the logical devices have been created successfully, choose **Configuration > Devices** to view the new logical devices on the **Devices** page.



---

**Note** The **Chassis Number** column shows the unique identifier for each logical device.

---

4. For the logical devices that you have created, click ... and choose **Generate Bootstrap Configuration**.
5. (Optional) Attach a device template to the logical devices that you have created.
6. In the **Generate Bootstrap Configuration** dialog box, click **Cloud-Init** and then click **OK**.

The **Generate Bootstrap Configuration** dialog box shows the content of the bootstrap configuration, which includes the UUID of the logical device, and includes the configuration details provided by the device template if you have attached one.



---

**Note** The UUID corresponds to the identifier in the **Chassis Number** column in the **Devices** table.

---

7. There are different methods for loading the bootstrap configuration onto a C8000V instance on a cloud service. The method you use depends on the cloud service. We recommend to click **Download** in the **Generate Bootstrap Configuration** dialog box to save a copy of the bootstrap configuration.
8. In the cloud services portal, create a PAYG instance of the Cisco Catalyst 8000V. When configuring the instance, use the bootstrap configuration that you created in Cisco SD-WAN Manager. The details of how to load the Cisco Catalyst SD-WAN bootstrap configuration onto the instance are specific to the cloud services provider.



---

**Note** On AWS, the workflow for bringing up an instance includes a user data step that enables loading the bootstrap configuration.

---

9. On the cloud service platform, start the Cisco Catalyst 8000V instance using the bootstrap configuration from an earlier step.

When the Cisco Catalyst 8000V instance boots up, it joins the Cisco Catalyst SD-WAN overlay automatically. In Cisco SD-WAN Manager, on the **Devices** page, this Cisco Catalyst 8000V instance shows a green medal icon in the **State** column and **In Sync** in the **Device Status** column.



---

**Note** On the **Devices** page, for logical devices that have not joined the Cisco Catalyst SD-WAN overlay, the **State** column shows a dotted-circle icon.

---

## Bootstrap Process for Cisco Catalyst SD-WAN Cloud-Hosted Devices

### Before You Begin

The device template provides the configuration details that enable the device to connect to Cisco SD-WAN Manager.

If you create a logical device and then generate a bootstrap configuration without first attaching a device template, the resulting file will include a minimal configuration. If you attach a device template to the logical device before generating the bootstrap configuration, the resulting file will include a more complete configuration, which can be helpful in enabling the device to connect to the Cisco Catalyst SD-WAN overlay. We recommend that you attach a device template to the logical device before creating the bootstrap configuration.

This procedure is useful when onboarding a software device, such as the Cisco Catalyst 8000V, to a private cloud, such as KVM, ESXi, or OpenStack.

### Bootstrap Process for Cisco SD-WAN Cloud-Hosted Devices

1. From the Cisco SD-WAN Manager menu, choose **Configuration > Devices**.
2. For the logical device (includes the UUID) that you are using for a new cloud-hosted instance, click ... and choose **Generate Bootstrap Configuration**.
3. In the **Generate Bootstrap Configuration** dialog box, choose **Cloud-Init** and click **OK**. The **Generate Bootstrap Configuration** dialog box displays the bootstrap configuration, including the OTP token for the license, Cisco SD-WAN Validator address, UUID, and organization information.



---

**Note** The UUID corresponds to the identifier in the **Chassis Number** column in the **Devices** table.

---



---

**Note** Ensure that the bootstrap configuration does not include more interfaces than the virtual device instance has in the cloud environment.

---

4. There are different methods for loading the bootstrap configuration onto a device instance on a cloud service. The method you use depends on the cloud service. We recommend that you click **Download** in the **Generate Bootstrap Configuration** dialog box to save a copy of the bootstrap configuration.

You can use the bootstrap configuration when setting up a device instance in the cloud service. The configuration enables the device instance to connect to Cisco Catalyst SD-WAN.

For information about onboarding a Cisco Catalyst 8000V in a private cloud, see the following:

- [Cisco Catalyst 8000V Edge Software Installation And Configuration Guide, Installing in KVM Environments](#)
- [Cisco Catalyst 8000V Edge Software Installation And Configuration Guide, Installing in VMware ESXi Environment](#)
- [Cisco Catalyst 8000V Edge Software Installation And Configuration Guide, Installing in OpenStack](#)

For example bootstrap configuration files for the Cisco Catalyst 8000V, see [Cisco Catalyst 8000V Cloud Initialization Files](#).

# Troubleshooting

## Troubleshooting Software Installation

### Router Loads the Previous Software Version After Booting

#### Router Loads the Previous Software Version After Booting

##### Problem

A router starts up using the previously installed software version.

##### Conditions

A router using Cisco IOS XE has two or more software versions installed.

##### Possible Causes

If the router begins booting up, and power cycles during the bootup, it may reboot using the previously installed software version.



---

**Note** Cisco IOS XE devices have a mechanism that preserves the previously installed software version. As a safeguard against getting stuck during bootup with a corrupted software image, a device can fall back to the previously installed software version. This fallback can also occur if the device experiences a power cycle during bootup. In this case (power cycle during bootup), you can reboot the device to load the latest software.

---

##### Solutions

1. Check the active and inactive system software versions for a device using one of the following procedures:
  - Cisco SD-WAN Manager procedure:
    - a. From the Cisco SD-WAN Manager menu, choose **Monitor** > **Devices**.
    - b. Click a device name in the **Hostname** column.

- c. In the left pane, click **Real Time**.
- d. In the **Device Options** field, enter **Software Versions**.

A table displays the installed software versions and indicates which version is active.

- CLI procedure:

- a. Execute the **show sdwan software** command in privileged EXEC mode to view the current active software version and the previous version.
- b. Execute the **show version** command on the device, in privileged EXEC mode.

If the device is using the latest installed software version, the command output shows `bootflash:packages.conf`.

If the device is using the previous software version, the command output shows `bootflash:prev_packages.conf`.

2. Reboot the device and check the loaded system software again.
3. If the device boots again with the previous software version (`bootflash:prev_packages.conf`), contact Cisco TAC for assistance.



## CHAPTER 6

# Cisco Catalyst SD-WAN Overlay Network Bring-Up Process

- [Network Overlay Bringup](#) , on page 119
- [Cisco SD-WAN Manager Persona and Storage Device](#), on page 120
- [Bring-Up Sequence of Events](#), on page 121
- [Download Software](#), on page 151
- [Deploy Cisco SD-WAN Manager](#), on page 152
- [Deploy Cisco Catalyst SD-WAN Validator](#), on page 161
- [vContainer Host](#), on page 177
- [Deploy Cisco Catalyst SD-WAN Controller](#), on page 177
- [Deploy Cisco Catalyst 8000V Using Cloud Services Provider Portals](#), on page 190
- [Deploy Cisco CSR 1000v Using Cloud Service Provider Portals](#), on page 190
- [Deploy Cisco Catalyst 8000V Edge Software on Alibaba Cloud](#), on page 191
- [Deploy the vEdge Cloud routers](#), on page 192

## Network Overlay Bringup

*Table 21: Feature History*

Feature Name	Release Information	Description
Disk Encryption in On-Premises ESXi for a Virtual Machine Hosting Cisco SD-WAN Control Components	Cisco Catalyst SD-WAN Control Components Release 20.14.1	With this feature, you can apply disk encryption on the virtual disk When hosting Cisco SD-WAN Control Components in an on-premises installation, using a VMWare ESXi hypervisor hosted on a Cisco UCS platform.

# Cisco SD-WAN Manager Persona and Storage Device

When you deploy Cisco SD-WAN Manager, you are prompted to choose a persona (from Cisco vManage Release 20.6.1) and a storage device for the Cisco SD-WAN Manager server the first time that the server boots up after Cisco SD-WAN Manager is installed.

## Cisco SD-WAN Manager Persona

From Cisco vManage Release 20.6.1, each Cisco SD-WAN Manager server has a *persona*. The persona defines which services run on the server and defines the role that the server has in a Cisco SD-WAN Manager cluster. For related information on Cisco SD-WAN Manager persona, see “Cisco SD-WAN Manager Cluster.”

The persona that is configured for a Cisco SD-WAN Manager server cannot be changed.

Cisco SD-WAN Manager supports the following personas:

- **Compute + Data:** Includes all services that are required for Cisco SD-WAN Manager, including services that are used for the application, statistics, configuration, messaging, and coordination. This persona should be used for a standalone node, and for the first node in a Cisco SD-WAN Manager cluster.
- **Compute:** Includes services that are used for the application, configuration, messaging, and coordination. This persona does not include services that are used for statistics. A node with this persona cannot operate as a standalone node and must be part of a Cisco SD-WAN Manager cluster.
- **Data:** Includes only services that are used for the application and statistics. A node with this persona cannot operate as a standalone node and must be part of a Cisco SD-WAN Manager cluster.

You are prompted to choose a persona for a Cisco SD-WAN Manager server the first time that the server boots up after Cisco SD-WAN Manager is installed. The prompt appears in the command line as follows:

```
1) COMPUTE_AND_DATA
2) DATA
3) COMPUTE
Select persona for vManage (1, 2 or 3):
```

When you see this prompt, type **1** to choose the Compute + Data persona, **2** to choose the Compute persona, or **3** to choose the Data persona. Then type **y** at the **Are you sure** prompt that displays to confirm your choice.

When you determine which persona to configure for a server, be aware that a Cisco SD-WAN Manager cluster supports any of the following deployments of nodes:

- Three Compute+Data nodes
- Three Compute+Data nodes and three Data nodes
- Three Compute nodes and three Data nodes (supported only in an upgrade from an existing deployment)

If you require a different combination of nodes, contact your Cisco representative.

## Cisco SD-WAN Manager Storage Device

Each Cisco SD-WAN Manager server has a storage device assigned to it. A storage device is a hard drive that is attached to the Cisco SD-WAN Manager server and that contains the /opt/data partition on which the database and other configuration information is saved.

You are prompted to choose a storage device for a Cisco SD-WAN Manager server the first time that the boots up after Cisco SD-WAN Manager is installed. You also are prompted whether you want to format the storage device.

The storage device assignment prompt appears in the command line as follows:

```
Available storage devices:
```

The prompt is followed by a list of available storage devices, each of which is preceded by a number. Type the number that corresponds to the storage device that you want to use for the server.

After you choose a storage device, you are prompted whether to format it. Type **y** to format the storage device, or type **n** to skip formatting. If you format a storage device, all data on the device is permanently deleted.

## Bring-Up Sequence of Events

The bring-up process for edge devices—which includes authenticating and validating all the devices and establishing a functional overlay network—occurs with only minimal user input. From a conceptual point of view, the bring-up process can be divided into two parts, one that requires user input and one that happens automatically:

1. In the first part, you design the network, create virtual machine (VM) instances for cloud routers, and install and boot hardware routers. Then, in Cisco SD-WAN Manager, you add the routers to the network and create configurations for each router. This process is described in the Summary of the User Portion of the Bring-Up Sequence.
2. The second part of the bring-up process occurs automatically, orchestrated by the Cisco Catalyst SD-WAN software. As routers join the overlay network, they validate and authenticate themselves automatically, and they establish secure communication channels between each other. For Cisco SD-WAN Validators and Cisco SD-WAN Controllers, a network administrator must download the necessary authentication-related files from Cisco SD-WAN Manager, and then these Cisco SD-WAN Controllers and Cisco SD-WAN Validators automatically receive their configurations from Cisco SD-WAN Manager. For vEdge Cloud routers, you must generate a certificate signing request (CSR), install the received certificate, and then upload the serial number that is included in the certificate to Cisco SD-WAN Manager. After Cisco hardware routers start, they are authenticated on the network and receive their configurations automatically from Cisco SD-WAN Manager through a process called zero-touch provisioning (ZTP). This process is described in the [Automatic Portions of the Bring-Up Sequence](#).

The end result of this two-part process is an operational overlay network.

This topic describes the sequence of events that occurs during the bring-up process, starting with the user portion and then explaining how automatic authentication and device validation occur.

### Sequence of Events of the Bring-Up Process

From a functional point of view, the task of bringing up the routers in the overlay network occurs in the following sequence:

Figure 10: Bring-Up Sequence of Events

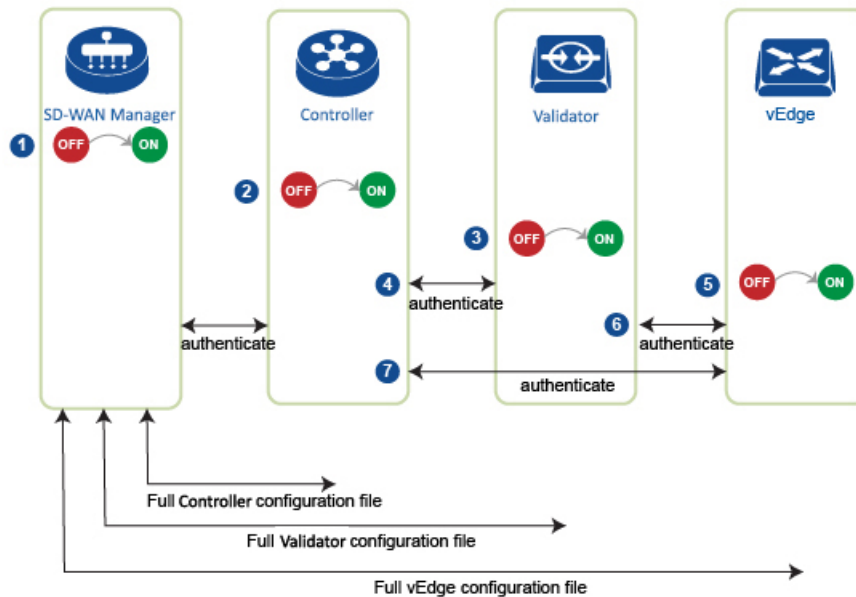

368439

1. The Cisco SD-WAN Manager software starts on a server in the data center.
2. The Cisco SD-WAN Validator starts on a server in the DMZ.
3. The Cisco SD-WAN Controller starts on a server in the data center.
4. Cisco SD-WAN Manager and the Cisco SD-WAN Validator authenticate each other, Cisco SD-WAN Manager and the Cisco SD-WAN Controller authenticate each other, and the Cisco SD-WAN Controller and the Cisco SD-WAN Validator securely authenticate each other.
5. Cisco SD-WAN Manager sends configurations to the Cisco SD-WAN Controller and the Cisco SD-WAN Validator.
6. The routers start in the network.
7. The routers authenticate themselves with the Cisco SD-WAN Validator.
8. The routers authenticate themselves with Cisco SD-WAN Manager.
9. The routers authenticate themselves with the Cisco SD-WAN Controller.
10. Cisco SD-WAN Manager sends configurations to the routers.

Before you start the bring-up process, note the following:

- To provide the highest level of security, only authenticated and authorized routers can access and participation in the Cisco Catalyst SD-WAN overlay network. To this end, the Cisco SD-WAN Controller performs automatic authentication on all the routers before they can send data traffic over the network.
- After the routers are authenticated, data traffic flows, regardless of whether the routers are in a private address space (behind a NAT gateway) or in a public address space.



To bring up the hardware and software components in a Cisco Catalyst SD-WAN overlay network, a transport network (also called a transport cloud), which connects all the routers and other network hardware components, must be available. Typically, these components are in data centers and branch offices. The only purpose of the transport network is to connect all the network devices in the domain. The Cisco Catalyst SD-WAN solution is agnostic with regards to the transport network, and, therefore, can be any type, including the internet, Multiprotocol Label Switching (MPLS), Layer 2 switching, Layer 3 routing, and Long-Term Evolution (LTE), or any mixture of transports.

For hardware routers, you can use the Cisco Catalyst SD-WAN zero-touch provisioning (ZTP) SaaS to bring up the routers. For more information on automatic process to bring-up hardware in the overlay network, see [Prepare Routers for ZTP](#).

## Steps to Bring Up the Overlay Network

### Bringing Up the Overlay Network

The following table lists the tasks for bringing up the overlay network using Cisco SD-WAN Manager.

**Table 22:**

Bring-Up Task	Step-by-Step Procedure
Step 1: Start the Cisco SD-WAN Manager.	<ol style="list-style-type: none"> <li>1. On the hypervisor, create a VM instance.</li> <li>2. Boot Cisco SD-WAN Manager server, start the VM, and enter login information.</li> <li>3. From the Cisco SD-WAN Manager menu, choose <b>Administration &gt; Settings</b>, configure certificate authorization settings. Select Automated to allow the certificate-generation process to occur automatically when a CSR is generated for a controller device.</li> <li>4. From the Cisco SD-WAN Manager menu, choose <b>Configuration &gt; Certificates</b>, generate the CSR.</li> <li>5. Check for a confirmation email from Symantec that your request has been received.</li> <li>6. Check for an email from Symantec that Viptela has approved your request and the certificate is signed.</li> <li>7. From the Cisco SD-WAN Manager menu, choose <b>Configuration &gt; Devices</b>, and check if the certificate has been installed.</li> </ol>

Bring-Up Task	Step-by-Step Procedure
<p>Step 2: Start the Cisco SD-WAN Validator.</p>	<ol style="list-style-type: none"> <li>1. On the hypervisor, create a VM instance.</li> <li>2. Boot the Cisco SD-WAN Validator server and start the VM.</li> <li>3. From the Cisco SD-WAN Manager menu, choose <b>Configuration &gt; Devices &gt; Controllers</b>, add Cisco SD-WAN Validator and generate the CSR. <ul style="list-style-type: none"> <li><b>Note</b> Starting from Cisco IOS XE Catalyst SD-WAN Release 17.13.1a, the <b>Controllers</b> tab is renamed as the <b>Control Components</b> tab to stay consistent with Cisco Catalyst SD-WAN rebranding.</li> </ul> </li> <li>4. Check for a confirmation email from Symantec that your request has been received.</li> <li>5. Check for an email from Symantec that Viptela has approved your request and the certificate is signed.</li> <li>6. From the Cisco SD-WAN Manager menu, choose <b>Configuration &gt; Devices</b>, and check if the certificate has been installed.</li> <li>7. From the Cisco SD-WAN Manager menu, choose <b>Configuration &gt; Templates</b>: <ol style="list-style-type: none"> <li>a. Create a configuration template for the Cisco SD-WAN Validator.</li> <li>b. Attach the template to Cisco SD-WAN Validator.</li> </ol> </li> <li>8. From the Cisco SD-WAN Manager menu, choose <b>Monitor &gt; Overview</b>, and verify that the Cisco SD-WAN Validator is operational. <p>Cisco vManage Release 20.6.x and earlier: From the Cisco SD-WAN Manager menu, choose <b>Dashboard &gt; Main Dashboard</b>, and verify that the Cisco SD-WAN Validator is operational.</p> </li> </ol>

Bring-Up Task	Step-by-Step Procedure
Step 3: Start the Cisco Catalyst SD-WAN Controller.	<ol style="list-style-type: none"> <li>1. On the hypervisor, create a VM instance.</li> <li>2. Boot the Cisco SD-WAN Controller server and start the VM.</li> <li>3. From the Cisco SD-WAN Manager menu, choose <b>Configuration &gt; Devices &gt; Controller</b>, add Cisco Catalyst SD-WAN Controller and generate the CSR. <b>Note</b> Starting from Cisco IOS XE Catalyst SD-WAN Release 17.13.1a, the <b>Controllers</b> tab is renamed as the <b>Control Components</b> tab to stay consistent with Cisco Catalyst SD-WAN rebranding.</li> <li>4. Check for a confirmation email from Symantec that your request has been received.</li> <li>5. Check for an email from Symantec that Viptela has approved your request and the certificate is signed.</li> <li>6. From the Cisco SD-WAN Manager menu, choose <b>Configuration &gt; Devices</b>, check that the certificate has been installed.</li> <li>7. From the Cisco SD-WAN Manager menu, choose <b>Configuration &gt; Templates</b>: <ol style="list-style-type: none"> <li>a. Create a configuration template for Cisco Catalyst SD-WAN Controller.</li> <li>b. Attach the template to Cisco Catalyst SD-WAN Controller.</li> </ol> </li> <li>8. From the Cisco SD-WAN Manager menu, choose <b>Monitor &gt; Overview</b>, and verify that Cisco Catalyst SD-WAN Controller is operational.  Cisco vManage Release 20.6.x and earlier: From the Cisco SD-WAN Manager menu, choose <b>Dashboard &gt; Main Dashboard</b>, and verify that Cisco Catalyst SD-WAN Controller is operational.</li> </ol>
Step 4: Configure the router.	<ol style="list-style-type: none"> <li>1. From the Cisco SD-WAN Manager menu, choose <b>Configuration &gt; Devices &gt; WAN Edge List</b>, upload the router authorized serial number file.</li> <li>2. From the Cisco SD-WAN Manager menu, choose <b>Configuration &gt; Certificates &gt; WAN Edge List</b>, check that the router's chassis and serial number are in the list.</li> <li>3. From the Cisco SD-WAN Manager menu, choose <b>Configuration &gt; Certificates &gt; WAN Edge List</b>, authorize each router by marking it Valid in the Validity column.</li> <li>4. From the Cisco SD-WAN Manager menu, choose <b>Configuration &gt; Certificates &gt; WAN Edge List</b>, send the WAN Edge list to the controller devices.</li> <li>5. From the Cisco SD-WAN Manager menu, choose <b>Configuration &gt; Templates</b>: <ol style="list-style-type: none"> <li>a. Create a configuration template for the router.</li> <li>b. Attach the template to the router.</li> </ol> </li> </ol>

Bring-Up Task	Step-by-Step Procedure
Step 5: Connect AC power and boot a hardware router.	<ol style="list-style-type: none"> <li>1. Connect AC power to the router.</li> <li>2. If needed, flip the On/Off switch on the rear of the router to the ON position.</li> <li>3. From the Cisco SD-WAN Manager menu, choose <b>Monitor &gt; Overview</b> or choose <b>Monitor &gt; Devices &gt; Device Dashboard</b>, verify that the router is operational.  Cisco vManage Release 20.6.x and earlier: From the Cisco SD-WAN Manager menu, choose <b>Dashboard &gt; Main Dashboard</b> or choose <b>Monitor &gt; Network &gt; Device Dashboard</b>, verify that the router is operational.</li> </ol>

## Summary of the User Portion of the Bring-Up Sequence





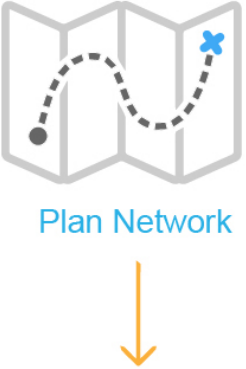

Generally, what you do to bring up the Cisco Catalyst SD-WAN overlay network is what you do to bring up any network. You plan out the network, create device configurations, and then deploy the network hardware and software components. These components include all the Cisco vEdge devices, all the traditional routers that participate in the overlay network, and all the network devices that provide shared services across the overlay network, such as firewalls, load balancers, and IDP systems.

The following table summarizes the steps for the user portion of the Cisco Catalyst SD-WAN overlay network bring-up sequence. The details of each step are provided in the articles that are listed in the **Procedure** column. While you can bring up the Cisco vEdge devices in any order, it is recommended that you deploy them in the order listed below, which is the functional order in which the devices verify and authenticate themselves.

If your network has firewall devices, see Firewall Ports for Cisco Catalyst SD-WAN Deployments.

**Table 23:**

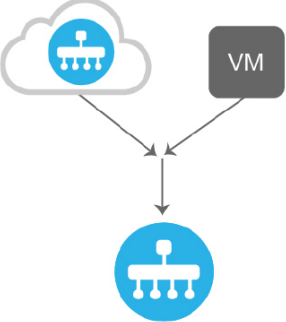
	Workflow	Procedure
1		Plan out your overlay network. See Components of the Cisco Catalyst SD-WAN Solution.

	Workflow	Procedure
2	 <p data-bbox="430 499 698 531">Create Configuration</p>  <p data-bbox="722 619 738 661">368183</p>	<p data-bbox="747 294 1510 388">On paper, create device configurations that implement the desired architecture and functionality. See the Software documentation for your software release.</p>
3	 <p data-bbox="430 924 698 955">Download Software</p>  <p data-bbox="722 1060 738 1102">368184</p>	<p data-bbox="747 703 1079 724">Download the software images.</p>
4	 <p data-bbox="438 1501 706 1533">Deploy SD-WAN Manager</p>  <p data-bbox="722 1596 738 1638">368185</p>	<p data-bbox="747 1144 1299 1165">Deploy Cisco SD-WAN Manager in the data center:</p> <ol data-bbox="747 1186 1518 1470" style="list-style-type: none"> <li data-bbox="747 1186 1518 1249">1. Create a Cisco SD-WAN Manager VM instance, either on an ESXi or a KVM hypervisor.</li> <li data-bbox="747 1270 1518 1333">2. Create either a minimal or a full configuration for each Cisco SD-WAN Manager server.</li> <li data-bbox="747 1354 1518 1417">3. Configure certificate settings and generate a certificate for Cisco SD-WAN Manager.</li> <li data-bbox="747 1438 1518 1459">4. Create a Cisco SD-WAN Manager cluster.</li> </ol>

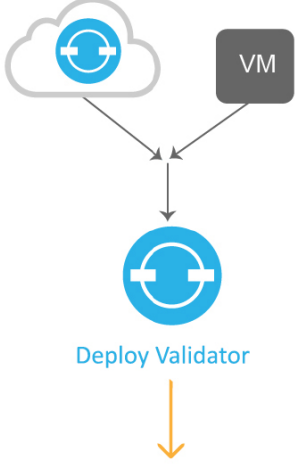
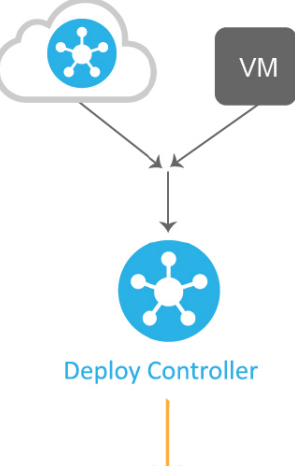
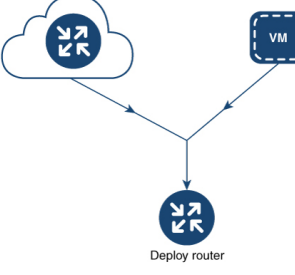
Workflow	Procedure
<p>5</p>  <p style="text-align: right; font-size: small;">368186</p>	<p>Deploy the Cisco SD-WAN Validator:</p> <ol style="list-style-type: none"> <li>1. Create a Cisco SD-WAN Validator VM instance, either on an ESXi or a KVM hypervisor.</li> <li>2. Create a minimal configuration for the Cisco SD-WAN Validator.</li> <li>3. Add the Cisco SD-WAN Validator to the overlay network. During this process, you generate a certificate for the Cisco SD-WAN Validator.</li> <li>4. Create a full configuration for the Cisco SD-WAN Validator.</li> </ol>
<p>6</p>  <p style="text-align: right; font-size: small;">368187</p>	<p>Deploy the Cisco SD-WAN Controller in the data center:</p> <ol style="list-style-type: none"> <li>1. Create a Cisco SD-WAN Controller VM instance, either on an ESXi or a KVM hypervisor.</li> <li>2. Create a minimal configuration for the Cisco SD-WAN Controller.</li> <li>3. Add the Cisco SD-WAN Controller to the overlay network. During this process, you generate a certificate for the Cisco SD-WAN Controller.</li> <li>4. Create a full configuration for the Cisco SD-WAN Controller.</li> </ol>
<p>7</p>  <p style="text-align: right; font-size: small;">368188</p>	<p>Deploy the Cisco vEdge routers in the overlay network:</p> <ol style="list-style-type: none"> <li>1. For software vEdge Cloud routers, create a VM instance, either on an AWS server, or on an ESXi or a KVM hypervisor.</li> <li>2. For software vEdge Cloud routers, send a certificate signing request to Symantec and then install the signed certificate on the router.</li> <li>3. From Cisco SD-WAN Manager, send the serial numbers of all Cisco vEdge routers to the Cisco SD-WAN Controller and Cisco SD-WAN Validator in the overlay network.</li> <li>4. Create a full configuration for the Cisco vEdge routers.</li> </ol>

## Automatic Portions of the Bring-Up Sequence

After the Cisco vEdge devices boot and start running with their initial configurations, the second part of the bring-up process begins automatically. This automatic process is led by the Cisco SD-WAN Validator, as illustrated in the figure below. Under the leadership of the Cisco SD-WAN Validator software, the Cisco vEdge devices set up encrypted communication channels between themselves. Over these channels, the devices automatically validate and authenticate each other, a process that establishes an operational overlay network. Once the overlay network is running, the Cisco vEdge devices automatically receive and activate their full configurations from the Cisco SD-WAN Manager server. (The exception is the Cisco SD-WAN Manager. You must manually configure each Cisco SD-WAN Manager server itself).

**Figure 11: Cisco SD-WAN Validator Automated Bring-Up Sequence**

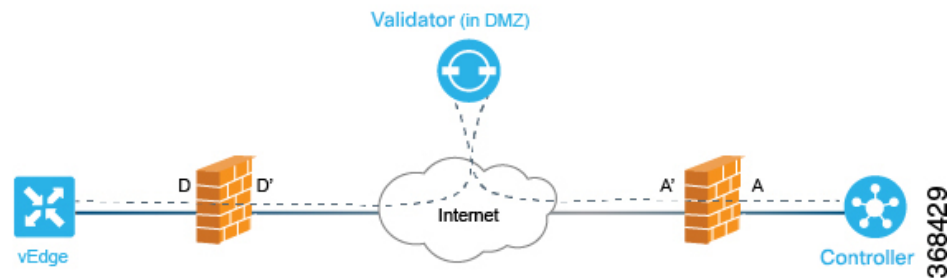

The following sections explain what happens under the covers, during the automatic portion of the bring-up process. This explanation is provided to help you understand the detailed workings of the Cisco Catalyst SD-WAN software so that you can better appreciate the means by which the Cisco Catalyst SD-WAN solution creates a highly secure overlay framework to support your networking requirements.

## User Input Required for the ZTP Automatic Authentication Process

The automatic validation and authentication of Cisco vEdge devices that occurs during the bringup process can happen only if Cisco SD-WAN Controllers and Cisco SD-WAN Validators know the serial and chassis numbers of the devices that are permitted in the network. Let's first define these two terms:

- **Serial number**—Each Cisco vEdge device has a serial number, which is a 40-byte number that is included in the device's certificate. For Cisco SD-WAN Validator and Cisco SD-WAN Controller, the certificate can be provided by Symantec or by an enterprise root CA. For the vEdge routers, the certificate is provided in the hardware's trusted board ID chip.
- **Chassis number**—In addition to a serial number, each vEdge router is identified by a chassis number. Because the vEdge router is the only Cisco SD-WAN Controller manufactured hardware, it is the only Cisco vEdge device that has a chassis number. There is a one-to-one mapping between a vEdge router's serial number and its chassis number.

The Cisco SD-WAN Controllers and Cisco SD-WAN Validators learn the serial and chassis numbers during the initial configuration of these devices:

- **Cisco SD-WAN Controller authorized serial numbers**—The Cisco SD-WAN Manager learns the serial numbers for all Cisco SD-WAN Controllers that are allowed to be in the network while it is creating a CSR and installing the signed certificate. You download these serial numbers to Cisco SD-WAN Validator, and Cisco SD-WAN Validator pushes them to the Cisco Catalyst SD-WAN Controller during the automatic authentication process.

- vEdge authorized serial number file—This file contains the serial and chassis numbers of all the vEdge routers that are allowed to be in the network. You upload this file to Cisco SD-WAN Validators and Cisco SD-WAN Controllers.

In addition to the device serial and chassis numbers, the automatic validation and authentication procedure depends on having each device configured with the same organization name. You configure this name on Cisco SD-WAN Manager, and it is included in the configuration file on all devices. The organization name must be identical on all the devices that belong to a single organization (the name is case-sensitive). The organization name is also included in the certificate for each device, which is created either by Cisco Catalyst SD-WAN or by an enterprise root CA.

## Authentication between Cisco Catalyst SD-WAN Controller and Cisco Catalyst SD-WAN Validator

From a functional point of view, the first two devices on the Cisco Catalyst SD-WAN overlay network that validate and authenticate each other are Cisco SD-WAN Controller and Cisco SD-WAN Validator. This process is initiated by Cisco SD-WAN Controller.

**Figure 12: Authentication of Cisco SD-WAN Controller and Cisco SD-WAN Validator**

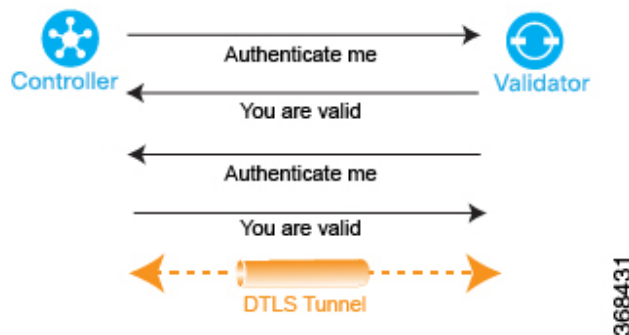

When Cisco SD-WAN Controller comes up, it initiates a connection to Cisco SD-WAN Validator, which is how Cisco SD-WAN Validator learns about Cisco SD-WAN Controller. These two devices then automatically begin a two-way authentication process—Cisco SD-WAN Controller authenticates itself with , and Cisco SD-WAN Validator authenticates itself with Cisco SD-WAN Validator. The two-way handshaking between the two devices during the authentication process occurs in parallel. However, for clarity, the figure here, which is a high-level representation of the authentication steps, illustrates the handshaking sequentially. If the authentication handshaking succeeds, a permanent DTLS communication channel is established between the Cisco SD-WAN Controller and Cisco SD-WAN Validator devices. If any one of the authentication steps fails, the device noting the failure tears down the connection between the two devices, and the authentication attempt terminates.

The Cisco SD-WAN Controller knows how to reach Cisco SD-WAN Validator, because one of the parameters that you provision when you configure it is the IP address or DNS name of Cisco SD-WAN Validator. Cisco SD-WAN Validator is primed to respond to requests from Cisco SD-WAN Validator because:

- It knows that its role is to be the authentication system, because you included this information in the Cisco SD-WAN Validator configuration.
- You downloaded the Cisco SD-WAN Controller authorized serial numbers from Cisco SD-WAN Manager to Cisco SD-WAN Validator.



If Cisco SD-WAN Validator has not yet started when Cisco SD-WAN Controller initiates the authentication process, Cisco SD-WAN Controller periodically attempts to initiate a connection until it is successful.

Below is a more detailed step-by-step description of how the automatic authentication occurs between Cisco SD-WAN Controller and Cisco SD-WAN Validator.

To initiate a session between Cisco SD-WAN Controller and Cisco SD-WAN Validator, Cisco SD-WAN Controller initiates an encrypted DTLS connection to Cisco SD-WAN Validator. The encryption is provided by RSA. Each device automatically generates an RSA private key–public key pair when it boots.

Over this encrypted channel, Cisco SD-WAN Controller and Cisco SD-WAN Validator authenticate each other. Each device authenticates the other in parallel. For our discussion, let's start with Cisco SD-WAN Controller authentication of Cisco SD-WAN Validator:

1. Cisco SD-WAN Validator sends its trusted root CA signed certificate to the Cisco SD-WAN Controller.
2. Cisco SD-WAN Validator sends the vEdge authorized serial number file to the Cisco SD-WAN Controller.
3. Cisco SD-WAN Controller uses its chain of trust to extract the organization name from the certificate and compares it to the organization name that is configured on Cisco SD-WAN Controller. If the two organization names match, Cisco SD-WAN Controller knows that the organization of Cisco SD-WAN Validator is proper. If they do not match, Cisco Catalyst SD-WAN Controller tears down the DTLS connection.
4. Cisco Catalyst SD-WAN Controller uses the root CA chain to verify that the certificate has indeed been signed by the root CA (either Symantec or the enterprise CA). If the signature is correct, Cisco Catalyst SD-WAN Controller knows that the certificate itself is valid. If the signature is incorrect, Cisco Catalyst SD-WAN Controller tears down the DTLS connection.

**Figure 13: Cisco SD-WAN Controller authenticates Cisco SD-WAN Validator**

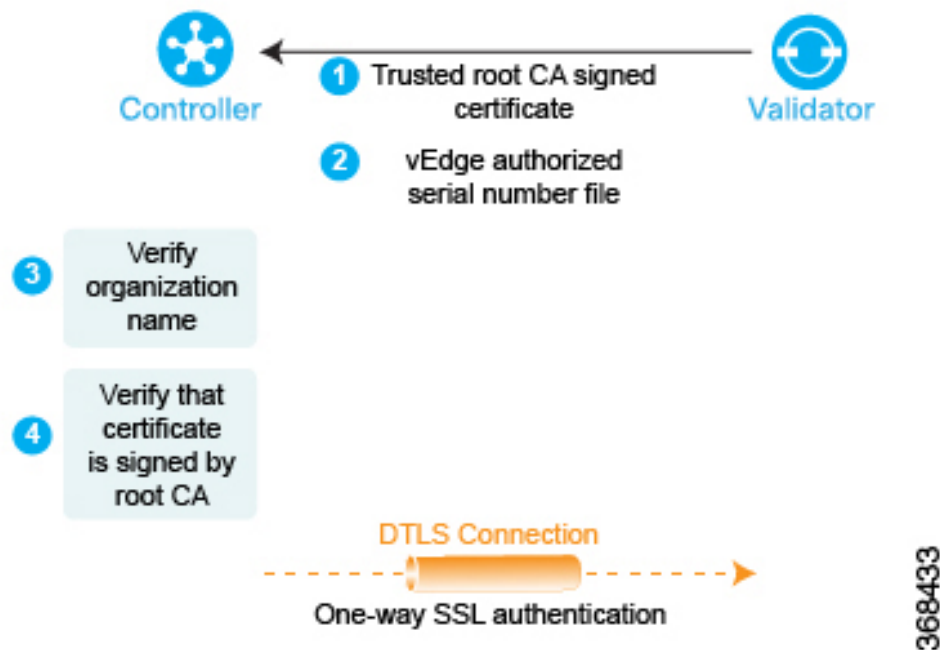

After performing these two checks, Cisco SD-WAN Controller authentication of Cisco SD-WAN Validator is complete.

In the other direction, Cisco SD-WAN Validator authenticates Cisco SD-WAN Controller:

1. Cisco SD-WAN Controller sends its trusted root CA signed certificate to Cisco SD-WAN Validator.
2. Cisco SD-WAN Validator uses its chain of trust to extract Cisco SD-WAN Controller serial number from the certificate. The number must match one of the numbers in the Cisco SD-WAN Controller authorized serial number file. If there is no match, Cisco SD-WAN Validator tears down the DTLS connection.
3. Cisco SD-WAN Validator uses its chain of trust to extract the organization name from the certificate and compares it to the organization name that is configured on Cisco SD-WAN Validator. If the two organization names match, the Cisco SD-WAN Validator knows that the organization of Cisco SD-WAN Controller is proper. If they do not match, Cisco SD-WAN Validator tears down the DTLS connection.
4. The Cisco SD-WAN Validator uses the root CA chain to verify that the certificate has indeed been signed by the root CA (either Symantec or the enterprise CA). If the signature is correct, Cisco SD-WAN Validator knows that the certificate itself is valid. If the signature is incorrect, Cisco SD-WAN Validator tears down the DTLS connection.

**Figure 14: Cisco SD-WAN Validator authenticates Cisco SD-WAN Controller**

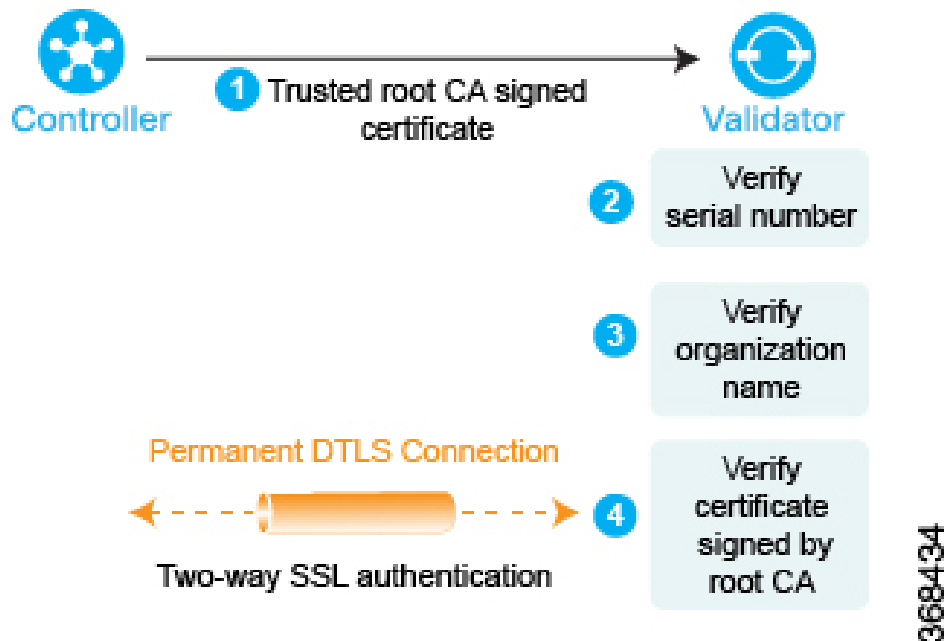

After performing these three checks, the Cisco SD-WAN Validator authentication of Cisco SD-WAN Controller is complete.

After the bidirectional authentication completes between the two devices, the DTLS connection between Cisco SD-WAN Validator and Cisco SD-WAN Controller transitions from being a temporary connection to being a permanent connection, and the two devices establish an OMP session over the connection.

In a domain that has multiple Cisco SD-WAN Controllers for redundancy, this process repeats between each pair of Cisco SD-WAN Controller and Cisco SD-WAN Validator devices. In coordination with Cisco SD-WAN Validator, Cisco SD-WAN Controllers learn about each other and they synchronize their route information. It is recommended that you connect the different Cisco SD-WAN Controller to the WAN network through different NAT devices for higher availability.

A Cisco SD-WAN Validator has only as many permanent DTLS connections as the number of Cisco SD-WAN Controllers in the network topology. These DTLS connections are part of the network's control plane; no data traffic flows over them. After all Cisco SD-WAN Controllers have registered themselves with Cisco SD-WAN Validator, Cisco SD-WAN Validator and Cisco SD-WAN Controllers are ready to validate and authenticate the vEdge routers in the Cisco Catalyst SD-WAN network.

## Authentication Between Cisco Catalyst SD-WAN Controllers

In a domain with multiple Cisco SD-WAN Controllers, the controllers must authenticate each other so that they can establish a full mesh of permanent DTLS connection between themselves for synchronizing OMP routes. Cisco SD-WAN Controller learns the IP address of the other Cisco SD-WAN Controller from Cisco SD-WAN Validator.

Cisco SD-WAN Controller learns about the possibility of other Cisco SD-WAN Controllers being present on the network during the authentication handshaking with the Cisco SD-WAN Validator, when it receives a copy of the Cisco SD-WAN Controller authorized serial number file. If this file has more than one serial number, it indicates that the network may, at some point, have multiple Cisco SD-WAN Controllers.

As one Cisco SD-WAN Controller authenticates with Cisco SD-WAN Validator, Cisco SD-WAN Validator sends Cisco SD-WAN Controller the IP address of other Cisco SD-WAN Controllers it has authenticated with. If Cisco SD-WAN Validator later learns of another Cisco SD-WAN Controller, it sends that controller's address to the other already authenticated Cisco SD-WAN Controllers.

Then, Cisco SD-WAN Controllers perform the steps below to authenticate each other. Again, each device authenticates the other in parallel, but for clarity, we describe the process sequentially.

1. Cisco SD-WAN Controller1 (vSmart1) initiates an encrypted DTLS connection to Cisco SD-WAN Controller2 (vSmart2) and sends its trusted root CA signed certificate to Cisco SD-WAN Controller2.
2. Cisco SD-WAN Controller2 uses its chain of trust to extract the Cisco SD-WAN Controller1's serial number. The number must match one of the numbers in the Cisco SD-WAN Controller authorized serial number file. If there is no match, Cisco SD-WAN Controller2 tears down the DTLS connection.
3. Cisco SD-WAN Controller2 uses its chain of trust to extract the organization name from the certificate and compares it to the locally configured organization name. If the two organization names match, Cisco SD-WAN Controller2 knows that the organization of Cisco SD-WAN Controller1 is proper. If they do not match, Cisco SD-WAN Controller2 tears down the DTLS connection.
4. Cisco SD-WAN Controller2 uses the root CA chain to verify that the certificate has indeed been signed by the root CA (either Symantec or the enterprise CA). If the signature is correct, Cisco SD-WAN Controller2 knows that the certificate itself is valid. If the signature is incorrect, Cisco SD-WAN Controller2 tears down the DTLS connection.

After performing these three checks, Cisco SD-WAN Controller2 authentication of Cisco SD-WAN Controller1 is complete.

Now, Cisco SD-WAN Controller1 authenticates Cisco SD-WAN Controller2, performing the same steps as above.

1. First, Cisco SD-WAN Controller2 sends its trusted root CA signed certificate to Cisco SD-WAN Controller1.
2. Cisco SD-WAN Controller1 uses its chain of trust to extract the Cisco SD-WAN Controller2's serial number. The number must match one of the numbers in the Cisco SD-WAN Controller authorized serial number file. If there is no match, Cisco SD-WAN Controller1 tears down the DTLS connection.

3. Cisco SD-WAN Controller1 uses its chain of trust to extract the organization name from the certificate and compares it to the locally configured organization name. If the two organization names match, Cisco SD-WAN Controller2 knows that the organization of Cisco SD-WAN Controller2 is proper. If they do not match, Cisco SD-WAN Controller1 tears down the DTLS connection.
4. Cisco SD-WAN Controller1 uses the root CA chain to verify that the certificate has indeed been signed by the root CA (either Symantec or the enterprise CA). If the signature is correct, Cisco SD-WAN Controller2 knows that the certificate itself is valid. If the signature is incorrect, Cisco SD-WAN Controller1 tears down the DTLS connection.

Figure 15: Authentication of Cisco SD-WAN Controller

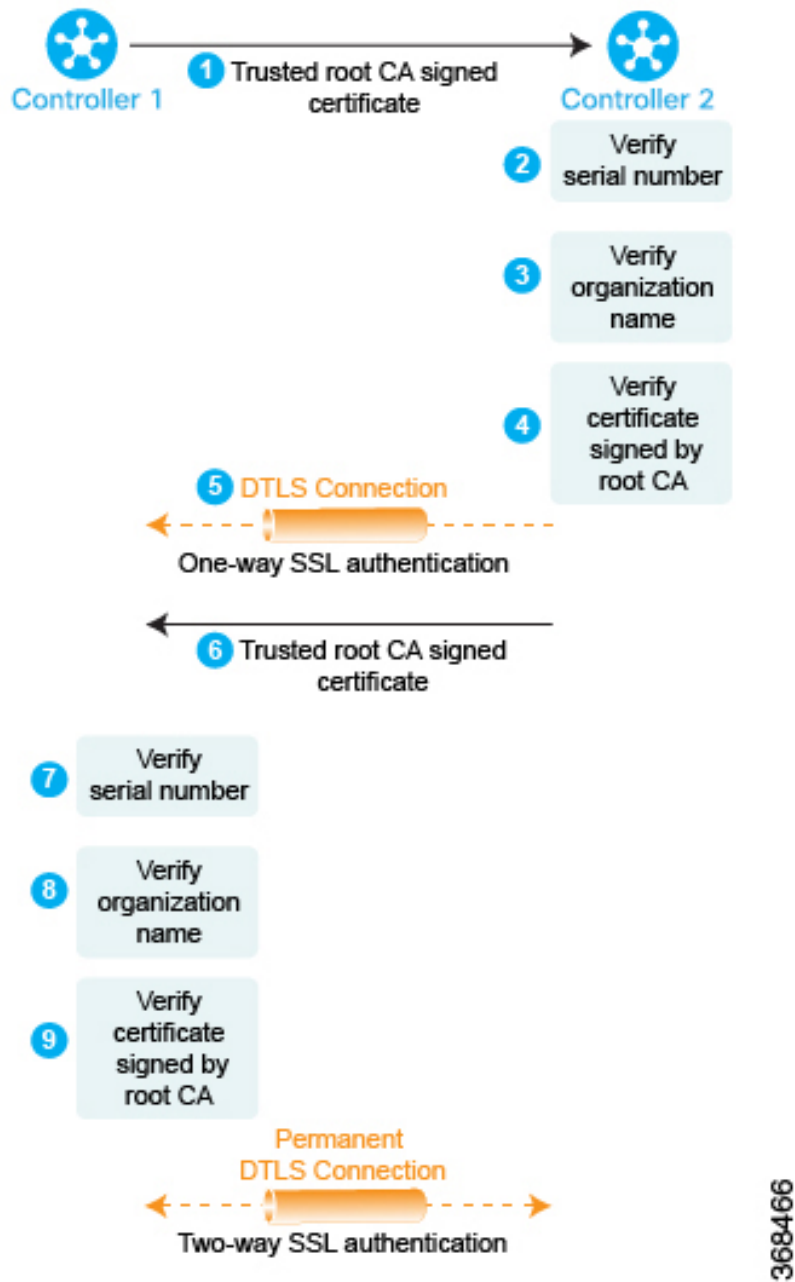

After performing these three checks, Cisco SD-WAN Controller1 authentication of Cisco SD-WAN Controller2 is complete, and the temporary DTLS connection between the two devices becomes permanent.

After all the Cisco SD-WAN Controllers have registered themselves with , Cisco SD-WAN Validator and Cisco SD-WAN Controllers are ready to validate and authenticate the vEdge routers in the Cisco Catalyst SD-WAN network.

## Authentication between Cisco Catalyst SD-WAN Validator and a Cisco vEdge Router

When you deploy a Cisco vEdge router in the network, it first needs to do two things:

- Establish a secure connection with Cisco SD-WAN Manager so that it can receive its full configuration.
- Establish a secure connection with Cisco Catalyst SD-WAN Controller can begin participating in the Cisco Catalyst SD-WAN overlay network.

When a Cisco vEdge device comes up, how does it automatically discover Cisco SD-WAN Manager and Cisco Catalyst SD-WAN Controller and establish connections with them? It does so with help from Cisco SD-WAN Validator. The initial configuration on the Cisco vEdge router contains the Cisco SD-WAN Validator system's IP address (or DNS name). Using this information, the Cisco vEdge router establishes a DTLS connection with Cisco SD-WAN Validator, and the two devices authenticate each other to confirm that they are valid Cisco vEdge devices. Again, this authentication is a two-way process that happens automatically. When the authentication completes successfully, Cisco SD-WAN Validator sends the Cisco vEdge router the IP addresses of Cisco SD-WAN Manager and Cisco Catalyst SD-WAN Controller. Then, the Cisco vEdge router tears down its connection with Cisco SD-WAN Validator and begins establishing secure DTLS connections with the other two devices.

**Figure 16: Automatic Authentication of Cisco vEdge Router and Cisco SD-WAN Validator**

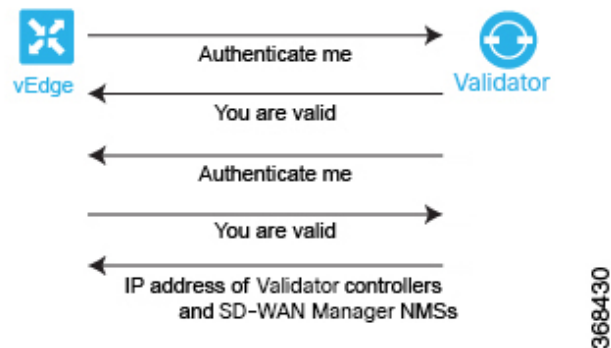

After you boot Cisco vEdge routers and manually perform the initial configuration, they automatically start looking for their Cisco SD-WAN Validator. Cisco SD-WAN Validator and Cisco SD-WAN Controllers are able to recognize and authenticate the Cisco vEdge routers in part because you have installed the Cisco vEdge authorized device list file on both these devices.

After you boot a Cisco vEdge router, you manually perform the initial configuration, at a minimum setting the IP address or DNS name of Cisco SD-WAN Validator. The Cisco vEdge router uses this address information to reach Cisco SD-WAN Validator. Cisco SD-WAN Validator is primed to respond to requests from a Cisco vEdge router because:

- It knows that its role is to be the authentication system, because you included this information in the initial Cisco SD-WAN Validator configuration.
- As part of the initial configuration, you installed the Cisco vEdge authorized serial number file on Cisco SD-WAN Validator.

If Cisco SD-WAN Validator has not yet started when a Cisco vEdge router initiates the authentication process, the Cisco vEdge router periodically attempts to initiate a connection until the attempt succeeds.

Below is a more detailed step-by-step description of how the automatic authentication occurs between Cisco SD-WAN Validator and a Cisco vEdge router.

First, the Cisco vEdge router initiates an encrypted DTLS connection to the public IP address of Cisco SD-WAN Validator. The encryption is provided by RSA. Each device automatically generates an RSA private key–public key pair when it boots. Cisco SD-WAN Validator receives the Cisco vEdge router's original interface address and uses the outer IP address in the received packet to determine whether the Cisco vEdge router is behind a NAT. If it is, Cisco SD-WAN Validator creates a mapping of the Cisco vEdge router's public IP address and port to its private IP address.

Over this encrypted DTLS channel, the Cisco vEdge router and Cisco SD-WAN Validator proceed to authenticate each other. As with other device authentication, the Cisco vEdge router and Cisco SD-WAN Validator authenticate each other in parallel. We start our discussion by describing how the Cisco vEdge router authenticates Cisco SD-WAN Validator:

1. Cisco SD-WAN Validator sends its trusted root CA signed certificate to the Cisco vEdge router.
2. The Cisco vEdge router uses its chain of trust to extract the organization name from the certificate and compares it to the organization name that is configured on the router itself. If the two organization names match, the Cisco vEdge routers knows that the organization of Cisco SD-WAN Validator is proper. If they do not match, the Cisco vEdge router tears down the DTLS connection.
3. The Cisco vEdge router uses the root CA chain to verify that the certificate has indeed been signed by the root CA (either Symantec or the enterprise CA). If the signature is correct, the Cisco vEdge router knows that the certificate itself is valid. If the signature is incorrect, the Cisco vEdge router tears down the DTLS connection.

**Figure 17: Cisco vEdge router authenticates Cisco SD-WAN Validator**

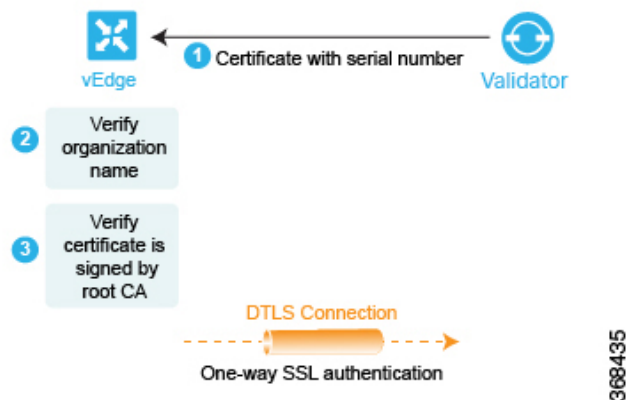

After performing these two checks, the Cisco vEdge router knows that Cisco SD-WAN Validator is valid, and its authentication of Cisco SD-WAN Validator is complete.

In the opposite direction, Cisco SD-WAN Validator authenticates the Cisco vEdge router:

1. Cisco SD-WAN Validator sends a challenge to the Cisco vEdge router. The challenge is a 256-bit random value.
2. The Cisco vEdge router sends a response to the challenge that includes the following:
  - Cisco vEdge serial number
  - Cisco vEdge chassis number

- Cisco vEdge board ID certificate
  - 256-bit random value signed by the Cisco vEdge router's private key
3. Cisco SD-WAN Validator compares the serial and chassis numbers to the list in its Cisco vEdge authorized device list file. The numbers must match one of the number pairs in the file. If there is no match, Cisco SD-WAN Validator tears down the DTLS connection.
  4. Cisco SD-WAN Validator checks that the signing of the 256-bit random value is proper. It does this using the Cisco vEdge router's public key, which it extracts from the router's board ID certificate. If the signing is not correct, Cisco SD-WAN Validator tears down the DTLS connection.
  5. Cisco SD-WAN Validator uses the root CA chain from the Cisco vEdge routers board ID certificate to validate that the board ID certificate is itself valid. If the certificate is not valid, Cisco SD-WAN Validator tears down the DTLS connection.

**Figure 18: Cisco SD-WAN Validator authenticates Cisco vEdge router**

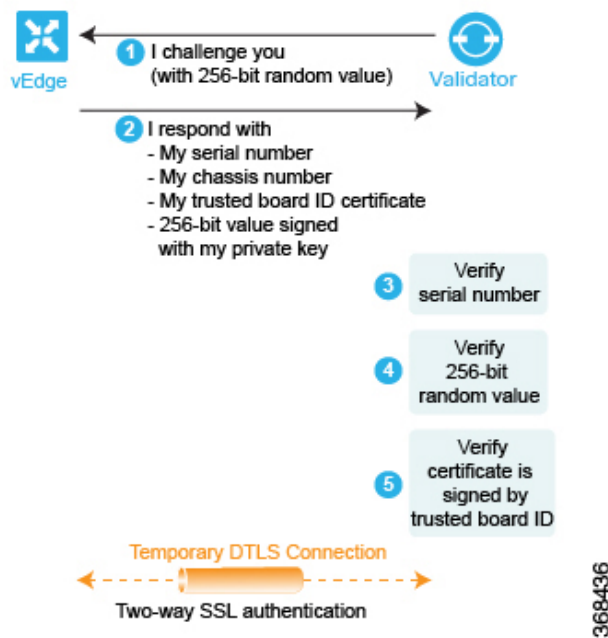

After performing these three checks, Cisco SD-WAN Validator knows that Cisco vEdge router is valid, and its authentication of the router is complete.

When the two-way authentication succeeds, Cisco SD-WAN Validator performs the final step of its orchestration, sending messages to the Cisco vEdge router and Cisco Catalyst SD-WAN Controller in parallel. To the Cisco vEdge router, Cisco SD-WAN Validator sends the following:

- The IP addresses of Cisco SD-WAN Controllers in the network so that the Cisco vEdge router can initiate connections to them. The address can be public IP addresses, or for the controllers that are behind a NAT gateway, the addresses are a list of the public and private IP addresses and port numbers. If the Cisco vEdge router is behind a NAT gateway, Cisco SD-WAN Validator requests that the Cisco vEdge router initiate a session with Cisco Catalyst SD-WAN Controller.
- Serial numbers of Cisco SD-WAN Controllers that are authorized to be in the network.



To Cisco Catalyst SD-WAN Controller, Cisco SD-WAN Validator sends the following:

- A message announcing the new Cisco vEdge router in the domain.
- If the Cisco vEdge router is behind a NAT gateway, Cisco SD-WAN Validator sends a request to Cisco Catalyst SD-WAN Controller to initiate a session with the Cisco vEdge router.

Then, the Cisco vEdge router tears down the DTLS connection with the Cisco SD-WAN Validator.

## Authentication between the Cisco vEdge Router and Cisco SD-WAN Manager

After the Cisco vEdge router and Cisco SD-WAN Validator have authenticated each other, the Cisco vEdge router receives its full configuration over a DTLS connection with Cisco SD-WAN Manager:

1. The Cisco vEdge router establishes a DTLS connection with Cisco SD-WAN Manager.
2. Cisco SD-WAN Manager server sends the configuration file to the Cisco vEdge router.
3. When the Cisco vEdge router receives the configuration file and activates its full configuration.
4. The Cisco vEdge router starts advertising prefixes to Cisco SD-WAN Controller.

If you are not using Cisco SD-WAN Manager, you can log in to the Cisco vEdge router and either manually load its configuration file or manually configure the router.

Below is a more detailed step-by-step description of how the automatic authentication occurs between a Cisco vEdge router and Cisco SD-WAN Manager.

First, the Cisco vEdge router initiates an encrypted DTLS connection to the IP address of Cisco SD-WAN Manager. The encryption is provided by RSA. Each device automatically generates an RSA private key–public key pair when it boots. Cisco SD-WAN Manager receives the Cisco vEdge router's original interface address and uses the outer IP address in the received packet to determine whether the Cisco vEdge router is behind a NAT. If it is, Cisco SD-WAN Manager creates a mapping of the Cisco vEdge router's public IP address and port to its private IP address.

Over this encrypted DTLS channel, the Cisco vEdge router and Cisco SD-WAN Manager proceed to authenticate each other. As with other device authentication, the Cisco vEdge router and Cisco SD-WAN Manager authenticate each other in parallel. We start our discussion by describing how the Cisco vEdge router authenticates Cisco SD-WAN Manager:

1. Cisco SD-WAN Manager sends its trusted root CA signed certificate to the Cisco vEdge router.
2. The Cisco vEdge router uses its chain of trust to extract the organization name from the certificate and compares it to the organization name that is configured on the router itself. If the two organization names match, the Cisco vEdge routers knows that the organization of Cisco SD-WAN Manager is proper. If they do not match, the Cisco vEdge router tears down the DTLS connection.
3. The Cisco vEdge router uses the root CA chain to verify that the certificate has indeed been signed by the root CA (either Symantec or the enterprise CA). If the signature is correct, the Cisco vEdge router knows that the certificate itself is valid. If the signature is incorrect, the Cisco vEdge router tears down the DTLS connection.

Figure 19: Cisco vEdge Router Authenticates Cisco SD-WAN Manager

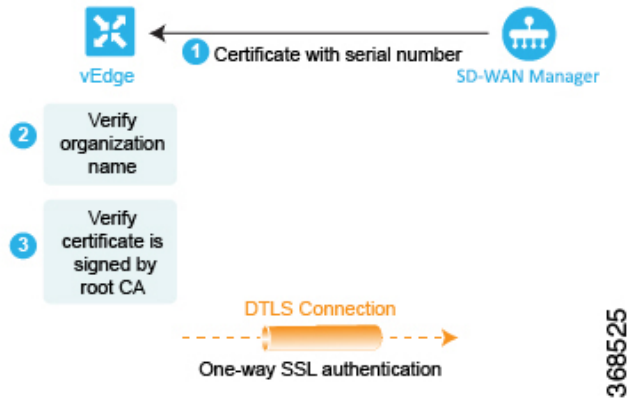

After performing these two checks, the Cisco vEdge router knows that Cisco SD-WAN Manager is valid, and its authentication of Cisco SD-WAN Manager is complete.

In the opposite direction, Cisco SD-WAN Manager authenticates the Cisco vEdge router:

1. Cisco SD-WAN Manager sends a challenge to the Cisco vEdge router. The challenge is a 256-bit random value.
2. The Cisco vEdge router sends a response to the challenge that includes the following:
  - Cisco vEdge serial number
  - Cisco vEdge chassis number
  - Cisco vEdge board ID certificate (for a hardware Cisco vEdge router) or the signed certification (for a Cisco vEdge Cloud router)
  - 256-bit random value signed by the Cisco vEdge router's private key
3. Cisco SD-WAN Manager compares the serial and chassis numbers to the list in its Cisco vEdge authorized device list file. The numbers must match one of the number pairs in the file. If there is no match, Cisco SD-WAN Manager the Cisco SD-WAN Manager NMS tears down the DTLS connection.
4. Cisco SD-WAN Manager checks that the signing of the 256-bit random value is proper. It does this using the Cisco vEdge router's public key, which it extracts from the router's board ID certificate. If the signing is not correct, Cisco SD-WAN Manager tears down the DTLS connection.
5. Cisco SD-WAN Manager uses the root CA chain from the Cisco vEdge routers board ID certificate to validate that the board ID certificate is itself valid. If the certificate is not valid, Cisco SD-WAN Manager tears down the DTLS connection.

Figure 20: Cisco SD-WAN Manager Authenticates Cisco vEdge Router

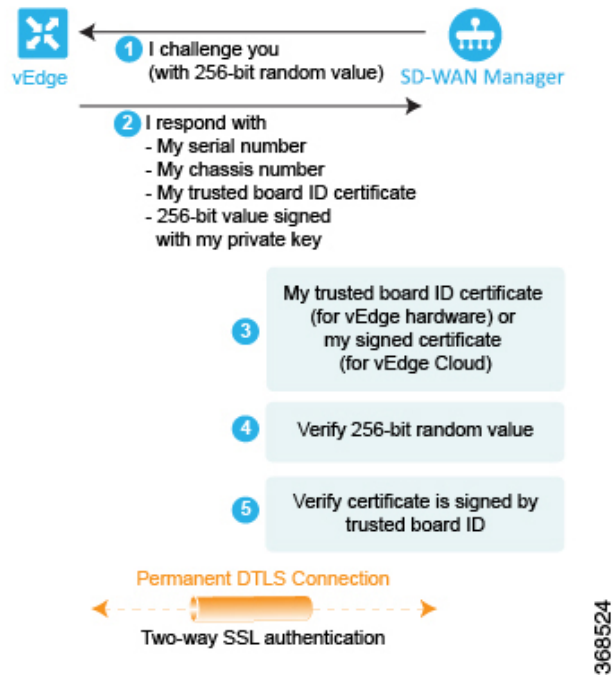

After performing these three checks, Cisco SD-WAN Manager knows that Cisco vEdge router is valid, and its authentication of the router is complete.

When the two-way authentication succeeds, Cisco SD-WAN Manager server sends the configuration file to the Cisco vEdge router. When the Cisco vEdge router receives the configuration file, it activates its full configuration and starts advertising prefixes to Cisco SD-WAN Controller.

## Authentication between Cisco Catalyst SD-WAN Controller and the Cisco vEdge Router

The last step in the automatic authentication process is for Cisco SD-WAN Controller and the Cisco vEdge router to authenticate each other. In this step, Cisco SD-WAN Controller performs authentication to ensure that the Cisco vEdge router belongs in its network, and the Cisco vEdge router also authenticates Cisco SD-WAN Controller. When the authentication completes, the DTLS connection between the two devices becomes permanent, and Cisco SD-WAN Controller establishes an OMP peering session running over the DTLS connection. Then, the Cisco vEdge router starts sending data traffic over the Cisco Catalyst SD-WAN overlay network.

Figure 21: Authentication of Cisco SD-WAN Controller and Cisco vEdge Router

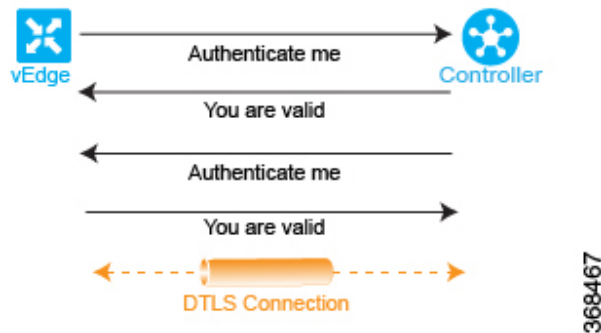

In this section below, is a more detailed step-by-step description of how the automatic authentication occurs between Cisco SD-WAN Controller and a Cisco vEdge router.

To initiate a session between Cisco SD-WAN Controller and a Cisco vEdge router, one of the two devices initiates an encrypted DTLS connection to the other. The encryption is provided by RSA. Each device automatically generates an RSA private key–public key pair when it boots.

The authentication between Cisco SD-WAN Controller and a Cisco vEdge router is a two-way process that occurs in parallel. Let's start our discussion with how Cisco SD-WAN Controller authenticates a Cisco vEdge router:

1. Cisco SD-WAN Controller sends a challenge to the Cisco vEdge router. The challenge is a 256-bit random value.
2. The Cisco vEdge router sends a response to the challenge that includes the following:
  - Cisco vEdge serial number
  - Cisco vEdge chassis number
  - Cisco vEdge board ID certificate
  - 256-bit random value signed by the Cisco vEdge router's private key
3. Cisco SD-WAN Controller compares the serial and chassis numbers to the list in its Cisco vEdge authorized device list file. The numbers must match one of the number pairs in the file. If there is no match, Cisco SD-WAN Controller tears down the DTLS connection.
4. Cisco SD-WAN Controller checks that the signing of the 256-bit random value is proper. It does this using the Cisco vEdge router's public key, which it extracts from the router's board ID certificate. If the signing is not correct, Cisco SD-WAN Controller tears down the DTLS connection.
5. Cisco SD-WAN Controller uses the root CA chain from the Cisco vEdge routers board ID certificate to validate that the board ID certificate is itself valid. If the certificate is not valid, Cisco SD-WAN Controller tears down the DTLS connection.
6. Cisco SD-WAN Controller compares the response with the original challenge. If the response matches the challenge that Cisco SD-WAN Validator issued, authentication between the two devices occurs. Otherwise, Cisco SD-WAN Controller tears down the DTLS connection.

Figure 22: Cisco SD-WAN Controller authenticates a Cisco vEdge router

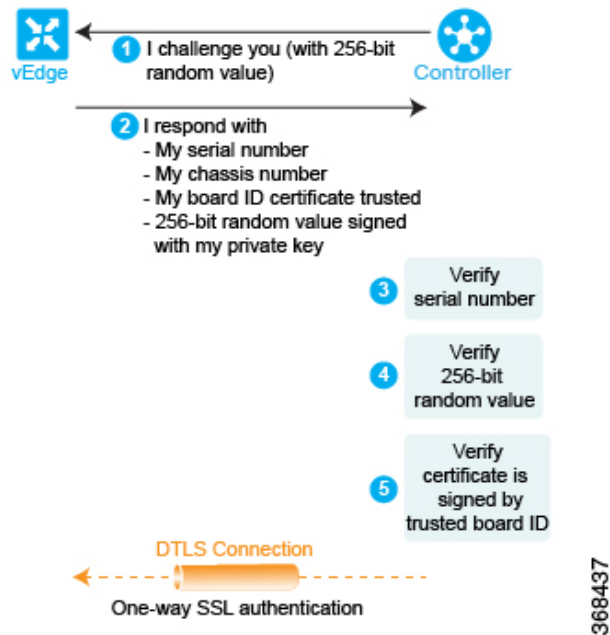

After performing these three checks, Cisco SD-WAN Controller knows that Cisco vEdge router is valid, and its authentication of the router is complete.

In the other direction, the Cisco vEdge router authenticates Cisco SD-WAN Controller:

1. Cisco SD-WAN Controller sends its trusted root CA signed certificate to the Cisco vEdge router.
2. The Cisco vEdge router uses its chain of trust to extract Cisco SD-WAN Controller's serial number from the certificate. The number must match one of the numbers in the Cisco SD-WAN Controller authorized serial number file. If there is no match, the Cisco vEdge router tears down the DTLS connection.
3. The Edge router uses its chain of trust to extract the organization name from the certificate and compares it to the organization name that is configured on the Cisco vEdge router. If the two organization names match, the Cisco vEdge router knows that the organization of Cisco SD-WAN Controller is proper. If they do not match, the Cisco vEdge router tears down the DTLS connection.
4. The Cisco vEdge router uses the root CA chain to verify that the certificate has indeed been signed by the root CA (either Symantec or the enterprise CA). If the signature is correct, the Cisco vEdge router knows that the certificate itself is valid. If the signature is incorrect, the Cisco vEdge router tears down the DTLS connection.

Figure 23: Cisco vEdge Router authenticates Cisco SD-WAN Controller

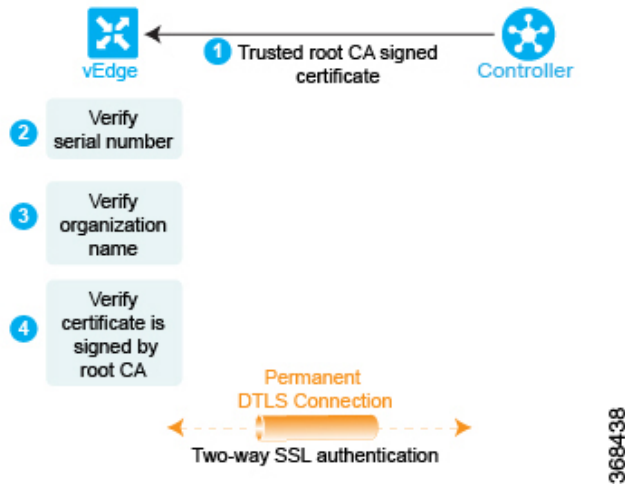

After performing these three checks, the Cisco vEdge authentication of Cisco SD-WAN Controller is complete. The DTLS connection that is used for authentication now becomes a permanent (nontransient) connection, and the two devices establish an OMP session over it that is used to exchange control plane traffic.

This authentication procedure repeats for each Cisco SD-WAN Controller and each Cisco vEdge router that you introduce into the overlay network.

Each Cisco vEdge router in the network must connect to at least one Cisco SD-WAN Controller. That is, a DTLS connection must be successfully established between each Cisco vEdge router and one Cisco SD-WAN Controller. The Cisco SD-WAN network has the notion of a domain. Within a domain, it is recommended that you have multiple Cisco SD-WAN Controllers for redundancy. Then each Cisco vEdge router can connect to more than one Cisco SD-WAN Controller.

Over the OMP session, a Cisco vEdge router relays various control plane–related information to Cisco SD-WAN Controller so that Cisco SD-WAN Controller can learn the network topology:

- The Cisco vEdge router advertises the service-side prefixes and routes that it has learned from its local static and dynamic (BGP and OSPF) routing protocols.
- Each Cisco vEdge router has a transport address, called a TLOC, or transport location, which is the address of the interface that connects to the WAN transport network (such as the Internet) or to the NAT gateway that connects to the WAN transport. Once the DTLS connection comes up between the Cisco vEdge router and Cisco SD-WAN Controller, OMP registers the TLOCs with Cisco SD-WAN Controller.
- The Cisco vEdge router advertises the IP addresses of any services that are located on its service-side network, such as firewalls and intrusion detection devices.

Cisco SD-WAN Controller installs these OMP routes in its routing database and advertises them to the other Cisco vEdge routers in the Cisco Catalyst SD-WAN overlay network. Cisco SD-WAN Controller also updates the Cisco vEdge router with the OMP route information that it learns from other Cisco vEdge routers in the network. Cisco SD-WAN Controller can apply inbound policy on received routes and prefixes before installing them into its routing table, and it can apply outbound policy before advertising routes from its routing table.

# Firewall Ports for Cisco Catalyst SD-WAN Deployments

This article describes which ports Cisco Catalyst SD-WAN devices use. If your network has firewall devices, you must open these ports on the firewalls so that devices in the Cisco Catalyst SD-WAN overlay network can exchange traffic.

## Cisco Catalyst SD-WAN-Specific Port Terminology

By default, all Cisco vEdge devices use base port 12346 for establishing the connections that handle control and traffic in the overlay network. Each device uses this port when establishing connections with other Cisco vEdge devices.

## Port Offset

When multiple Cisco vEdge devices are installed behind a single NAT device, you can configure different port numbers for each device so that the NAT can properly identify each individual device. You do this by configuring a port offset from the base port 12346. For example, if you configure a device with a port offset of 1, that device uses port 12347. The port offset can be a value from 0 through 19. The default port offset is 0.

For NAT devices that can differentiate among the devices behind the NAT, you do not need to configure the port offset.

## Port Hopping

In the context of a Cisco Catalyst SD-WAN overlay network, port hopping is the process by which devices try different ports when attempting to establish connections with each other, in the event that a connection attempt on the first port fails. After such a failure, the port value is incremented and the connection attempt is retried. The software rotates through a total of five base ports, waiting longer and longer between each connection attempt.

If you have not configured a port offset, the default base port is 12346, and port hopping is done sequentially among ports 12346, 12366, 12386, 12406, and 12426, and then returning to port 12346.

If you have configured a port offset, that initial port value is used and the next port is incremented by 20. For example, for a port configured with an offset of 2, port hopping is done sequentially among ports 12348, 12368, 12388, 12408, and 12428, and then returning to port 12348.

Incrementing the ports by 20 ensures that there is never any overlap among the possible base port numbers.

Cisco vEdge devices use port hopping when attempting to establish connections to Cisco SD-WAN Manager, Cisco SD-WAN Validator, and Cisco SD-WAN Controllers. You can also manually request a Cisco vEdge device to port-hop.

Cisco SD-WAN Controllers and Cisco SD-WAN Manager instances are normally installed behind a properly behaving NAT device, so port hopping is generally not needed and generally does not occur on these devices.

Cisco SD-WAN Validators always connect to other Cisco vEdge devices using port 12346. They never use port hopping.

To describe how port hopping works, we use an example of a Cisco vEdge device with the default base port of 12346. When a router has attempted to connect to another Cisco vEdge device but the connection does not succeed within a certain time, the router hops to the next base port and tries establishing the connection on that port.



**Note** As port-hop is the default configuration, the devices request the Cisco SD-WAN Validator for a new control connection. When the new control connection is established, the edge devices start transmitting TLOC updates to the peer. TLOC update messages could be lost during unstable control connections and IPSec security association between the devices and the peer may not be in sync, which results in a BFD session failure.

To avoid this issue, we recommend that you configure no port-hop or static entries on data center devices. You can either have all edges connected to a single Cisco SD-WAN Validator or balance the edges between two Cisco SD-WAN Validators by changing the order of the IP in the below command.

For static entries, you can configure the IP addresses on a data center device in the following command:

```
system
  vbond <vBond FQDN>
  vpn 0
  host <vBond FQDN> ip <vBond ip1> <vBond ip2>
```



**Note** If you choose to configure no port-hopping, then use the following command:

```
system
  no port-hop
```

External triggers like change of System IP, change of Color on TLOC while adding TLOC can trigger port-hop, even though no port-hop is configured.

**Figure 24: Example of Cisco vEdge Device Port Hopping**

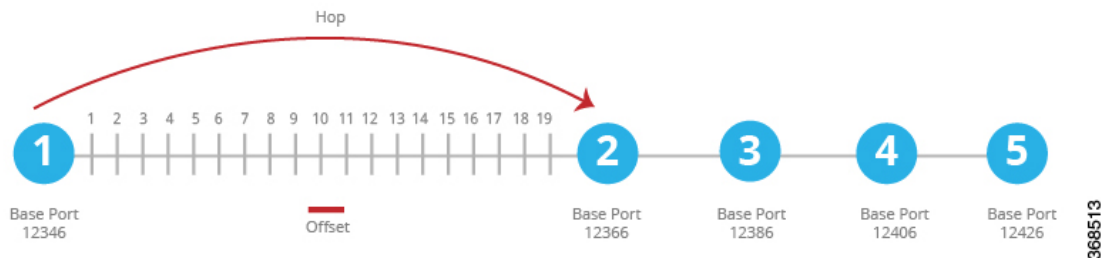

If the first connection attempt on the initial base port does not succeed after about 1 minute, the router hops to port 12366. After about 2 minutes, it hops to port 12386; after about 5 minutes, it hops to port 12406; and after about 6 minutes, it hops to port 12426. Then the cycle returns to initial port, 12346.

With a full-cone NAT device, the source ports for all connections initiated by a given Cisco vEdge device remain consistent across all sessions initiated by the Cisco vEdge device. For example, if the router initiates a session with public source port 12346, this is the port used for all communication.

## Effects of Port Hopping

Cisco vEdge devices use port hopping to make every attempt to keep the control plane of the overlay network up and operational. If a controller device—Cisco SD-WAN Validator, Cisco SD-WAN Manager, or Cisco SD-WAN Controller—goes down for any reason and the Cisco vEdge devices remain up, when the controller device comes back up, the connection between it and the Cisco vEdge device might shut down and restart,



and in some cases the BFD sessions on the Cisco vEdge device might shut down and restart. This behavior occurs because of port hopping: When one device loses its control connection to another device, it port hops to another port in an attempt to re-establish the connection.

Two examples illustrate when this might occur:

- When Cisco SD-WAN Validator crashes, Cisco SD-WAN Manager might take down all connections to the Cisco vEdge devices. The sequence of events that occurs is as follows: When Cisco SD-WAN Validator crashes, Cisco SD-WAN Manager might lose or close all its control connections. Cisco SD-WAN Manager then port hops, to try to establish connections to the Cisco SD-WAN Controllers on a different port. This port hopping on Cisco SD-WAN Manager shuts down and then restarts all its control connections, including those to the Cisco vEdge devices.
- All control sessions on all Cisco SD-WAN Controllers go down, and BFD sessions on the Cisco vEdge devices remain up. When any one of the Cisco SD-WAN Controllers comes back up, the BFD sessions on the routers go down and then come back up because the Cisco vEdge devices have already port hopped to a different port in an attempt to reconnect to Cisco SD-WAN Controllers.



---

**Note** Changing the Cisco SD-WAN Controller **graceful-restart timers** result in an OMP peer flap, independent of whether or not **port-hop** is enabled. We recommend that you change Cisco SD-WAN Controller **graceful-restart timers** with redundant Cisco SD-WAN Controller peering (where only a single Cisco SD-WAN Controller configuration is changed at a time) or during a maintenance period when a data plane disruption can be tolerated.

---

## Ports Used by Cisco vEdge Devices

When a Cisco vEdge device joins the overlay network, it establishes DTLS control plane connections with the controller devices—Cisco SD-WAN Validator, Cisco SD-WAN Manager, and Cisco Catalyst SD-WAN Controller. The router uses these control connections to learn the location of Cisco Catalyst SD-WAN Controller from Cisco SD-WAN Validator, to receive its configuration from Cisco SD-WAN Manager, and to receive its policy and any policy updates from Cisco Catalyst SD-WAN Controller. When initially establishing these DTLS connections, the Cisco vEdge device uses the base port 12346. If it is unable to establish a connection using this base port, it port-hops through ports 12366, 12386, 12406, and 12426, returning, if necessary, to 12346, until it successfully establishes the DTLS connections with the three controller devices. This same port number is used to establish the IPsec connections and BFD sessions to the other Cisco vEdge devices in the overlay network. Note that if the vEdge configuration includes a port offset, the base port number and the four sequential port numbers are incremented by the configured offset.

To see which port DTLS and BFD are using for the control and data connections, look at the Private Port column in the output of the **show control local-properties** command. The command output also shows the public port number that the interface is using. If the WAN port of the Cisco vEdge device is not connected to a NAT device, the private and public port numbers are the same. If a NAT device is present, the port number listed in the Public Port column is the one being used by the NAT device, and it is the port that BFD is using. This public port number is the one remote Cisco vEdge devices use to send traffic to the local site.

If a NAT device is present, the port number listed in the Public Port column is used by the NAT device, and BFD. This public port number is used by remote Cisco vEdge devices to send traffic to the local site.

In a network with firewall devices, you must open the Cisco Catalyst SD-WAN base ports on the firewall devices to allow traffic to flow across the overlay network. You open all the base ports that the Cisco vEdge

devices in the network might use, which are the default base ports and the four base ports that the router can port-hop among.



---

**Note** Port hopping is generally not needed on Cisco SD-WAN Controllers and on Cisco SD-WAN Manager.

---

For additional details regarding DTLS, TLS, and IPsec ports for Cisco Catalyst SD-WAN device connections, see [Firewall Port Considerations](#)

For Cisco vEdge devices configured to use DTLS tunnels, which use UDP, at a minimum you must open the five base ports that are used by a Cisco vEdge device with a default port offset of 0. Specifically, you open:

- Port 12346
- Port 12366
- Port 12386
- Port 12406
- Port 12426

If you have configured a port offset value on any of the Cisco vEdge devices, you also need to open the ports configured with the port offset value:

- Port (12346 + port offset value)
- Port (12366 + port offset value)
- Port (12386 + port offset value)
- Port (12406 + port offset value)
- Port (12426 + port offset value)

## Ports Used by Cisco Catalyst SD-WAN Devices Running Multiple vCPUs

The Cisco SD-WAN Controllers can run on a virtual machine (VM) with up to eight virtual CPUs (vCPUs). Cisco SD-WAN Manager can be configured to a minimum of 16 vCPUs, and eight vCPUs are used for control connection ports. The vCPUs are designated as Core0 through Core7.

Each core is allocated separate base ports for control connections. The base ports differ, depending on whether the connection is over a DTLS tunnel (which uses UDP) or a TLS tunnel (which uses TCP).



---

**Note** Cisco SD-WAN Validators do not support multiple cores. Cisco SD-WAN Validators always use DTLS tunnels to establish control connections with other Cisco vEdge devices, so they always use UDP. The UDP port is 12346.

---

The following table lists the port used by each vCPU core for Cisco SD-WAN Manager. Each port is incremented by the configured port offset, if offset is configured.

Core Number	Ports for DTLS (UDP)	Ports for TLS (TCP)
Core0	12346	23456
Core1	12446	23556
Core2	12546	23656
Core3	12646	23756
Core4	12746	23856
Core5	12846	23956
Core6	12946	24056
Core7	13046	24156

## Administrative Ports Used by Cisco SD-WAN Manager

Cisco SD-WAN Manager uses the following administrative ports for protocol-specific communication:

Purpose	Traffic Direction	Protocol	Port Number
Netconf	Bidirectional Between Cisco SD-WAN Manager and Cisco SD-WAN Controllers or Cisco SD-WAN Validators. This port is used in Cisco SD-WAN Manager to establish initial discovery.	TCP	830
HTTPS	Incoming	TCP	443
SNMP query	Incoming	UDP	161
SSH	Incoming Cisco SD-WAN Manager uses SCP to install signed certificates onto the controllers if DTLS/TLS connections are not yet formed between them. SSH uses TCP destination port 22.	TCP	22
RADIUS	Outgoing	UDP	1812
SNMP trap	Outgoing	UDP	162
Syslog	Outgoing	UDP	514
TACACS	Outgoing	TCP	49

Cisco SD-WAN Manager clusters use the following ports for communication among the NMSs that comprise the cluster:

Cisco SD-WAN Manager Service	Traffic Direction	Protocol	Port Numbers
Application server	Bidirectional	TCP	80, 443, 7600, 8080, 8443, 57600
Configuration database	Bidirectional	TCP	5000, 7474, 7687
Coordination server	Bidirectional	TCP	2181, 2888, 3888
Message bus	Bidirectional	TCP	4222, 6222, 8222
Statistics database	Bidirectional	TCP	9200, 9300
Tracking of device configurations (NCS and Netconf)	Bidirectional	TCP	830
Cloud Agent	Bidirectional	TCP	8553
SD-AVC	Bidirectional	TCP	10502, 10503
Cloud Agent V2	Bidirectional	TCP	50051

## Configure the Port Offset

When two or more Cisco vEdge devices are behind the same full-cone NAT device, one device can use the default port offset, and you should configure a port offset on the remaining devices:

```
Device (config) # system port-offset number
```

The port offset can be a value from 0 through 19. The default port offset is 0.

In the following example, vEdge-1 uses the default port offset of 0, and on vEdge-2 the port offset is set to 1.

**Figure 25: Example of Port Offset Configuration**

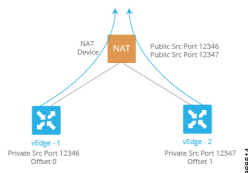

In this example:

- vEdge-1 attempts to connect first using base port 12346. If that attempt is not successful, the router attempts port 12366, 12386, 12406 and 12426.
- vEdge-2 has a port offset of 1, so the first port it attempts to connect on is 12347 (12346 plus offset of 1). If it fails to connect using port 12347, the router hops by increments of 20 and attempts to connect on ports 12367, 12387, 12407, and 12427.

## Perform Port Hopping Manually

You can manually request a Cisco vEdge device to port-hop:

```
vEdge# request port-hop
```

One reason to use this command is if the router's control connections are up, but BFD is not starting. The **request port-hop** command restarts the control connections on the next port number, and BFD should then also start.

## Download Software

You can download Cisco Catalyst SD-WAN software from the [Cisco Software Download](#) site. The direct link for downloading Cisco Catalyst SD-WAN software is [here](#).

Download the following components, and any other software that you need for your Cisco Catalyst SD-WAN installation. The Cisco SD-WAN Controllers operate as virtual machines on a server.



**Note** Starting from Cisco vManage Release 20.9.1, vEdge Cloud router is not supported.

Component	Comments
Cisco SD-WAN Validator	Appears as vEdge Cloud router on the download page because the Cisco SD-WAN Validator is deployed as a Cisco vEdge device.
Cisco SD-WAN Manager	Appears as Cisco SD-WAN Controller Software on the download page
Cisco Catalyst SD-WAN Controller	Appears as Cisco SD-WAN Controller Software on the download page

### File Names for Cisco Catalyst SD-WAN Control Components Release 20.14.1 and Later

Starting from Cisco Catalyst SD-WAN Manager Release 20.14.1, the software images are renamed from viptela-edge to viptela-bond and an unified software image is used for Cisco SD-WAN Controller (vSmart) and Cisco SD-WAN Validator (vBond). The initial default hostname for both controllers is vsmart. We recommended you to update the hostname.

Software Images	Before Cisco Catalyst SD-WAN Manager Release 20.14.1	Cisco Catalyst SD-WAN Manager Release 20.14.1 and Later
.qcow2 (name change)	viptela-edge-genericx86-64.qcow2 viptela-image-generic86-64.qcow2	viptela-bond-genericx86-64.qcow2
.vhd (name change)	viptela-edge-genericx86-64_vhd.tar.gz viptela-image-generic86-64_vhd.tar.gz	viptela-bond-genericx86-64_vhd.tar.gz
.ova (name change)	viptela-edge-genericx86-64.ova viptela-image-generic86-64.ova	viptela-bond-genericx86-64.ova
.tar.gz (no change)	viptela-20.14.1-x86_64.tar.gz	viptela-20.14.1-x86_64.tar.gz

# Deploy Cisco SD-WAN Manager

The Cisco SD-WAN Manager is a centralized network management system that provides a GUI interface to easily monitor, configure, and maintain all Cisco vEdge devices and links in the overlay network. The Cisco SD-WAN Manager runs as a virtual machine (VM) on a network server.

An SD-WAN overlay network can be managed by one Cisco SD-WAN Manager, or it can be managed by a cluster, which consists of a minimum of three Cisco SD-WAN Manager instances. It is recommended that you build a network, especially a larger network, with a Cisco SD-WAN Manager cluster. The Cisco SD-WAN Manager manages all the Cisco vEdge devices in the overlay network, providing dashboard and detailed views of device operation, and controlling device configurations and certificates.



---

**Note** Default route with non-zero prefix is not supported on vEdge routers.

---

To deploy Cisco SD-WAN Manager instances:

1. Create a Cisco SD-WAN Manager VM instance, either on an ESXi or a KVM hypervisor.
2. Create either a minimal or a full configuration for each of the Cisco SD-WAN Manager instance. You can configure Cisco SD-WAN Manager by using the ESXi console, or you can use SSH to open a CLI session and then manually configure Cisco SD-WAN Manager.
3. Configure certificate settings and generate a certificate for the Cisco SD-WAN Manager.
4. Create a Cisco SD-WAN Manager cluster.

## Cisco SD-WAN Manager Web Server Ciphers

In Releases 16.3.0 and later, Cisco SD-WAN Manager web servers support the following ciphers:

- TLS\_DHE\_DSS\_WITH\_AES\_128\_GCM\_<wbr/>SHA256
- TLS\_DHE\_DSS\_WITH\_AES\_256\_GCM\_<wbr/>SHA384
- TLS\_DHE\_RSA\_WITH\_AES\_128\_GCM\_<wbr/>SHA256
- TLS\_DHE\_RSA\_WITH\_AES\_256\_GCM\_<wbr/>SHA384
- TLS\_ECDHE\_ECDSA\_WITH\_AES\_128\_<wbr/>GCM\_SHA256
- TLS\_ECDHE\_ECDSA\_WITH\_AES\_256\_<wbr/>GCM\_SHA384
- TLS\_ECDHE\_RSA\_WITH\_AES\_128\_<wbr/>GCM\_SHA256
- TLS\_ECDHE\_RSA\_WITH\_AES\_256\_<wbr/>GCM\_SHA384

In Release 16.2, Cisco SD-WAN Manager web servers support the following ciphers:

- TLS\_ECDHE\_ECDSA\_WITH\_AES\_128\_<wbr/>CBC\_SHA
- TLS\_ECDHE\_RSA\_WITH\_AES\_128\_<wbr/>CBC\_SHA
- TLS\_RSA\_WITH\_AES\_128\_CBC\_SHA

# Create Cisco Catalyst SD-WAN Manager VM Instance on ESXi

## Before You Begin

To run Cisco SD-WAN Manager, you must create a virtual machine (VM) instance for it on a server that is running hypervisor software. This topic describes how to create a virtual machine on a server running the VMware vSphere ESXi Hypervisor. You can also create the virtual machine on a server running the Kernel-based Virtual Machine (KVM) hypervisor.

For server requirements, see Server Hardware Recommendations.

From Cisco Catalyst SD-WAN Control Components Release 20.14.1, you can enable disk encryption on the hypervisor.

## Create Cisco Catalyst SD-WAN Manager VM Instance

1. Start the vSphere Client and create a Cisco SD-WAN Manager VM instance.
2. Create a new virtual disk that has a volume of at least 100 GB for the Cisco SD-WAN Manager database.
3. Add another vNICs.
4. Start the Cisco SD-WAN Manager VM instance and connect to the Cisco SD-WAN Manager console.
5. To create a Cisco SD-WAN Manager cluster, repeat Steps 1 through 4 to create a VM for each Cisco SD-WAN Manager instance.

If you are using the VMware vCenter Server to create the Cisco SD-WAN Manager VM instance, follow the same procedure.

## Launch vSphere Client and Create Cisco Catalyst SD-WAN Manager VM Instance

1. Launch the VMware vSphere Client application, and enter the IP address or name of the ESXi server, your username, and your password. Click **Login** to log in to the ESXi server.  
The system displays the ESXi screen.
2. Click **File > Deploy OVF Template** to deploy the virtual machine.
3. In the Deploy OVF Template screen, enter the location to install and download the OVF package. This package is the vmanage.ova file that you downloaded from the Support page. Click **Next**.
4. Click **Next** to verify OVF template details.
5. Enter a name for the deployed template and click **Next**.
6. Click **Next** to accept the default format for the virtual disks.
7. From the **Destination Networks** drop-down list, select the destination network for the deployed OVF template, and click **Next**.
8. In the Ready to Complete screen, click **Finish** to complete deployment of the Cisco SD-WAN Manager VM instance.

The system has successfully created the VM instance with the parameters you just defined and displays the vSphere Client screen with the **Getting Started** tab selected. By default, this includes one vNIC. This vNIC is used for the tunnel interface.

## Create a New Virtual Disk

You must create a new virtual disk with a volume of at least 100 GB for the Cisco SD-WAN Manager database:

1. In the left navigation bar of the vSphere Client screen, select the Cisco SD-WAN Manager VM instance that you just created, and click **Edit** virtual machine settings.
2. In the Cisco SD-WAN Manager Virtual Machine Properties screen, click **Add** to add a new virtual disk, and then click **OK**.
3. In the Add Hardware screen, select **Hard Disk** for the device type you want to add to your VM, and click **Next**.
4. In the Select a Disk screen, select **Create a new virtual** disk, and click **Next**.
5. In the Create a Disk screen, specify the disk capacity for the Cisco SD-WAN Manager database to be 100 GB, and click **Next**.
6. In the Advanced Options screen, choose IDE (starting Cisco vManage Release 20.3.1, choose SCSI) for the virtual storage device, and click **Next**. If you are using IDE for release older than Cisco vManage Release 20.3.1, the virtual store device must be IDE.
7. In the Ready to Complete screen, click **Finish** to complete creating a new virtual disk with a capacity of 500 GB.

The system displays the vSphere Client screen with **Getting Started** selected.

## Add Additional vNICs

To add another vNICs for the management interface and for the Message Bus:

1. In the left navigation bar of the vSphere Client, select the Cisco SD-WAN Manager VM instance that you just created, and click **Edit** virtual machine settings.
2. In the Cisco SD-WAN Manager – Virtual Machine Properties screen, click **Add** to add a new vNIC for the management interface. Then click **OK**.
3. Click Ethernet Adapter for the type of device you wish to add. Then click **Next**.
4. In the **Adapter Type** drop-down, select VMXNET3 for the vNIC to add. Then click **Next**.
5. In the Ready to Complete screen, click **Finish**.
6. The Cisco SD-WAN Manager – Virtual Machine Properties screen opens showing that the new vNIC is being added. Click **OK** to return to the vSphere Client screen.
7. If the Cisco SD-WAN Manager instance is part of a cluster, repeat Steps 2 through 6 to create a third vNIC. This vNIC is used for the Message Bus.

## Connect Cisco Catalyst SD-WAN Manager VM Instance to Cisco Catalyst SD-WAN Manager Console

1. In the left navigation bar of the vSphere Client, select the Cisco SD-WAN Manager VM instance that you just created, and click **Power on the virtual machine**. The Cisco SD-WAN Manager virtual machine is powered on.



2. Select the **Console** tab, to connect to the Cisco SD-WAN Manager console. The Cisco SD-WAN Manager console is displayed. Log in to Cisco SD-WAN Manager.
3. Select the storage device to use.
4. Select **hdc**, which is the new partition you added for the Cisco SD-WAN Manager database.
5. Confirm that you want to format the new partition, **hdc**. The system then reboots and displays the Cisco SD-WAN Manager instance.
6. To connect to the Cisco SD-WAN Manager instance using a web browser, configure an IP address on the Cisco SD-WAN Manager instance:
  - a. Log in to Cisco SD-WAN Manager.
  - b. In the management VPN, VPN 512, configure an IP address on interface eth0. Specify an IP address that is reachable on your network. If necessary, add a default route:

```
# config
(config)# vpn 512
(config)# ip route prefix/length next-hop-ip-address
(config-vpn-512)# interface eth0
(config-interface-eth0)# ip address ip-address
(config-interface-eth0)# no shutdown
(config-interface-eth0)# commit and-quit
#
```

7. To connect to the Cisco SD-WAN Manager instance, type the following string in the URL:

```
https:// ip-address :8443/
```

8. Log in.



---

**Note** Starting from Cisco Catalyst SD-WAN Manager Release 20.12.1, you can commit the configuration before rebooting a control manage device through Cisco SD-WAN Manager.

---

## Create Cisco Catalyst SD-WAN Manager VM Instance on KVM

To run Cisco SD-WAN Manager, you must create a virtual machine (VM) instance for it on a server that is running hypervisor software. This topic describes the process for creating a VM on a server running VMware Kernel-based Virtual Machine (KVM) Hypervisor. You can also create the VM on a server running VMware vSphere ESXi Hypervisor.

For server requirements, see Server Hardware Requirements.

### Create Cisco Catalyst SD-WAN Manager VM Instance on the KVM Hypervisor

To create a Cisco SD-WAN Manager VM instance on the KVM hypervisor:

1. Launch the Virtual Machine Manager client application. The system displays the Virtual Machine Manager screen.
2. Click **New** to deploy the virtual machine. The Create a new virtual machine screen opens.
3. Enter the name of the virtual machine.

- a. Select **Import existing disk image** radio button.
  - b. Click **Forward**. The virtual disk is imported and associated to the VM instance you are creating.
4. Provide the existing storage path box, click **Browse** to find the Cisco SD-WAN Manager software image.
    - a. In the **OS Type** field, select **Linux**.
    - b. In the **Version** field, select the Linux version that you are running.
    - c. Click **Forward**.
  5. Specify Memory and CPU based on your network topology and number of sites, and click **Forward**.
  6. Select Customize configuration before install, and click **Finish**.
  7. Select **Disk 1** in the left navigation bar.
    - a. Click **Advanced Options**.
    - b. In the Disk Bus field, choose IDE (starting Cisco vManage Release 20.3.1, choose SCSI).
    - c. In the **Storage Format** field, choose **qcow2**.
    - d. Click **Apply** to create the VM instance with the parameters you defined. By default, this VM instance includes one vNIC, which is used for the tunnel interface.



---

**Note** Cisco Catalyst SD-WAN supports only VMXNET3 vNICs.

---

8. In the Cisco SD-WAN Manager Virtual Machine window, click **Add Hardware** to add a new virtual disk for the Cisco SD-WAN Manager database.
9. In the Add New Virtual Hardware screen, specify the following for the new virtual disk:
  - a. In Create a disk image on the computer's hard drive, specify the disk capacity for the Cisco SD-WAN Manager database to be 100GB.
  - b. In the **Device Type** field, specify IDE disk (starting Cisco vManage Release 20.3.1, specify SCSI disk) for the virtual storage.
  - c. In the **Storage Format** field, specify **qcow2**.
  - d. Click **Finish** to complete the creation of a new virtual disk with a capacity of 100 GB.
10. In the Cisco SD-WAN Manager Virtual Machine screen, click **Add Hardware** to add another vNIC for the management interface.
11. In the Add New Virtual Hardware screen, click **Network**.
  - a. In the **Host Device** field, select an appropriate host device.
  - b. Click **Finish**.

The newly created vNIC is listed in the left pane. This vNIC is used for the management interface.

12. If the Cisco SD-WAN Manager instance is a part of a cluster, repeat Steps 10 and 11 to create a third vNIC. This vNIC is used for the Message Bus.
13. In the Cisco SD-WAN Manager Virtual Machine screen click **Begin Installation** in the top upper-left corner of the screen.
14. The system creates the virtual machine instance and displays the Cisco SD-WAN Manager console.
15. At the login prompt, log in with the default username, which is **admin**, and the default password, which is **admin**. The system prompts you to select the storage device to use.
16. Select **hdc**, which is the new partition you added for the Cisco SD-WAN Manager database.
17. Confirm that you want to format the new partition, **hdc**. The system reboots and displays the Cisco SD-WAN Manager instance.
18. To create a Cisco SD-WAN Manager cluster, repeat Steps 1 through 17 to create a VM for each Cisco SD-WAN Manager instance.

## Connect to a Cisco Catalyst SD-WAN Manager Instance

To connect to a Cisco SD-WAN Manager instance using a web browser, configure an IP address on the Cisco SD-WAN Manager instance:

1. Log in with the default username and password:

```
Login: admin password: admin #
```

2. In the management VPN, VPN 512, configure an IP address on interface eth0. Specify an IP address that is reachable on your network. If necessary, add a default route:

```
# config
(config)# vpn 512
(config)# ip route prefix/length next-hop-ip-address
(config-vpn-512)# interface eth0
(config-interface-eth0)# ip address ip-address
(config-interface-eth0)# no shutdown
(config-interface-eth0)# command and-quit
#
```

3. To connect to the Cisco SD-WAN Manager instance, type the following string in the URL:

```
https:// ip-address :8443/
```

4. Log in with the username **admin** and the password **admin**.

## Configure Cisco Catalyst SD-WAN Manager

You can configure Cisco SD-WAN Manager using device templates. However, Cisco recommends that you use the CLI mode to configure Cisco SD-WAN Manager instead of using the device templates.

Once you have set up and started the virtual machines (VMs) for Cisco SD-WAN Manager, they come up with a factory-default configuration. You then configure each Cisco SD-WAN Manager instance directly from the Cisco SD-WAN Manager server itself using CLI mode or ESXi console so that each Cisco SD-WAN Manager can be authenticated and verified and can join the overlay network. At a minimum, you must configure the IP address of your network's Cisco SD-WAN Validator, the device's system IP address, and a tunnel

interface in VPN 0 to use for exchanging control traffic among the network controller devices (the Cisco SD-WAN Validator, Cisco SD-WAN Manager, and Cisco SD-WAN Controller devices).

For the overlay network to be operational and for Cisco SD-WAN Manager instances to participate in the overlay network, you must do the following:

- Configure a tunnel interface on at least one interface in VPN 0. This interface must connect to a WAN transport network that is accessible by all Cisco vEdge devices. VPN 0 carries all control plane traffic among the Cisco vEdge devices in the overlay network.
- Ensure that the Overlay Management Protocol (OMP) is enabled. OMP is the protocol responsible for establishing and maintaining the Cisco Catalyst SD-WAN control plane. OMP is enabled by default, and you cannot disable it. If you edit the configuration from the CLI, do not remove the **omp** configuration command.



---

**Note** For a Cisco SD-WAN Manager cluster, you must configure each Cisco SD-WAN Manager instance in the cluster individually, from the Cisco SD-WAN Manager server itself using CLI mode or ESXi console.

---

### Configure Cisco Catalyst SD-WAN Manager

To configure Cisco SD-WAN Manager, create a device configuration template:

1. Configure the address of Cisco SD-WAN Validator:
  - a. From the Cisco SD-WAN Manager menu, select **Administration > Settings**.
  - b. Click **Validator**. (If you are using Cisco Catalyst SD-WAN Manager Release 20.12.1 or earlier, click **Edit**.)
  - c. In the **Validator DNS/IP Address: Port** field, enter the DNS name that points to Cisco SD-WAN Validator or the IP address of Cisco SD-WAN Validator and the port number to use to connect to it.
  - d. Click **Save**.
2. Configure Cisco SD-WAN Manager Using CLI

Use CLI mode to configure Cisco SD-WAN Manager. You can access the CLI by using the ESXi console using a separate SSH client or by establishing an SSH session through the Cisco SD-WAN Manager Graphical User Interface (GUI).

To establish an SSH session to a device:

- a. From the Cisco SD-WAN Manager menu, choose **Tools > SSH Terminal**.
- b. From the left pane, click to select a device.
- c. Log in as the user **admin**, using the default password, **admin**. The CLI prompt is displayed.
- d. Enter configuration mode:

```
Device# config
Device(config)#
```

You can now issue CLI commands to configure Cisco SD-WAN Manager.

The following features are mandatory for Cisco SD-WAN Manager operation. Configure these features from the CLI mode.

- Authentication, Authorization, and Accounting (AAA)
- Security
- System-wide parameters
- Transport VPN (VPN 0)
- Management VPN (for out-of-band management traffic)

### Sample CLI Configuration

This section provides sample CLI configurations to configure Cisco SD-WAN Manager using CLI.

Note that this configuration includes a number of settings from the factory-default configuration and shows a number of default configuration values.

```
vManage# show running-config
system
 host-name          vManage
 gps-location latitude 40.7127837
 gps-location longitude -74.00594130000002
 system-ip          172.16.255.22
 site-id            200
 organization-name "Cisco"
 clock timezone America/Los_Angeles
 vbond 10.1.14.14
 aaa
  auth-order local radius tacacs
  usergroup basic
   task system read write
   task interface read write
  !
  usergroup netadmin
  !
  usergroup operator
   task system read
   task interface read
   task policy read
   task routing read
   task security read
  !
  user admin
   password encrypted-password
  !
 logging
  disk
  enable
  !
 !
 snmp
  no shutdown
  view v2
   oid 1.3.6.1
  !
  community private
   view v2
```

```

    authorization read-only
    !
    trap target vpn 0 10.0.1.1 16662
    group-name      Cisco
    community-name  private
    !
    trap group test
    all
    level critical major minor
    exit
    exit
    !
    vpn 0
    interface eth1
    ip address 10.0.12.22/24
    tunnel-interface
    color public-internet
    allow-service dhcp
    allow-service dns
    allow-service icmp
    no allow-service sshd
    allow-service netconf
    no allow-service ntp
    no allow-service stun
    allow-service https
    !
    no shutdown
    !
    ip route 0.0.0.0/0 10.0.12.13
    !
    vpn 512
    interface eth0
    ip 172.16.14.145/23
    no shutdown
    !
    ip route 0.0.0.0/0 172.16.14.1
    !

```

## Configure Certificate Settings

New controller devices in the overlay network—Cisco SD-WAN Manager instances, Cisco SD-WAN Validators, and Cisco SD-WAN Controllers—are authenticated using signed certificates. From Cisco SD-WAN Manager, you can automatically generate the certificate signing requests (CSRs), retrieve the generated certificates, and install them on all controller devices when they are added to the network.



---

**Note** All controller devices must have a certificate installed on them to be able to join the overlay network.

---

To automate the certificate generation and installation process, configure the name of your organization and certificate authorization settings before adding the controller devices to the network.

For more information on configuring certificate settings, see [Certificates](#).

## Generate Cisco Catalyst SD-WAN Manager Certificate

For Cisco SD-WAN Manager to be able to join the overlay network, you must generate a certificate signing request (CSR) for Cisco SD-WAN Manager instance. Cisco SD-WAN Manager automatically retrieves the generated certificate and installs it.

For more information on generating Cisco SD-WAN Manager certificate, see [Certificates](#).

## Create a Cisco Catalyst SD-WAN Manager Cluster

A Cisco SD-WAN Manager cluster is a collection of three or more Cisco SD-WAN Manager instances in a Cisco Catalyst SD-WAN overlay network domain. The cluster collectively provides network management services to all Cisco vEdge devices in the network. Some of the services, such as determining which Cisco SD-WAN Manager instance connects to and handles requests for a router, are distributed automatically, while for others (the statistics and configuration databases, and the messaging server), you configure which Cisco SD-WAN Manager instance handles the service.

For more information on creating Cisco SD-WAN Manager cluster, refer to [Cluster Management](#).

## Enable Timeout Value for a Cisco SD-WAN Manager Client Session

By default, a user's session to a Cisco SD-WAN Manager client remains established indefinitely and never times out.

To set how long a Cisco SD-WAN Manager client session is inactive before a user is logged out:

1. From the Cisco SD-WAN Manager menu, select **Administration > Settings**.
2. Click **User Sessions**. In the **Client Session Timeout** option, enable the **Session Timeout**. (If you are using Cisco Catalyst SD-WAN Manager Release 20.12.1 or earlier, click **Edit**.)
3. Enter the timeout value, in minutes. This value can be from 10 to 180 minutes.
4. Click **Save**.

The client session timeout value applies to all Cisco SD-WAN Manager servers in a Cisco SD-WAN Manager cluster.

## Deploy Cisco Catalyst SD-WAN Validator

Cisco SD-WAN Validator is a software module that authenticates the Cisco SD-WAN Controllers and the vEdge routers in the overlay network and coordinates connectivity between them. It must have a public IP address so that all Cisco vEdge devices in the network can connect to it (it is the only Cisco vEdge device that must have a public address). While the Cisco SD-WAN Validator can be located anywhere in the network, it is strongly recommended that you place it in a DMZ. Assigning a public IP address to the orchestrator allows Cisco SD-WAN Controllers and vEdge routers that are situated in private address spaces, secured behind different NAT gateways, to establish communication connections with each other. Cisco SD-WAN Validator runs as a VM on a network server.

A Cisco Catalyst SD-WAN overlay network can have one or more Cisco SD-WAN Validators.

To deploy Cisco SD-WAN Validators:

1. Create a Cisco SD-WAN Validator VM instance, either on an ESXi or a KVM hypervisor.
2. Create a minimal configuration for Cisco SD-WAN Validator, to allow it to be accessible on the network. You do this by using SSH to open a CLI session to Cisco SD-WAN Validator and manually configuring the device.
3. Add Cisco SD-WAN Validator to the overlay network so that Cisco SD-WAN Manager is aware of it.
4. If you are hosting Cisco Catalyst SD-WAN zero-touch-provisioning (ZTP) Cisco SD-WAN Validator server in your enterprise, configure one Cisco SD-WAN Validator to perform this role.
5. Create a full configuration for Cisco SD-WAN Validator. You create the initial configuration by using SSH to open a CLI session to Cisco SD-WAN Validator. Then you create the full configuration by creating configuration templates on Cisco SD-WAN Manager and then attaching the templates to Cisco SD-WAN Validator. When you attach the configuration templates to Cisco SD-WAN Validator, the configuration parameters in the templates overwrite the initial configuration.

## Create Cisco Catalyst SD-WAN Validator VM Instance on ESXi

### Before You Begin

To start Cisco SD-WAN Validator, you must create a virtual machine (VM) instance for it on a server that is running hypervisor software. This article describes how to create a VM on a server running the VMware vSphere ESXi Hypervisor. You can also create the VM on a server running the Kernel-based Virtual Machine (KVM) Hypervisor software.

For server information, see [Server Hardware Recommendations](#).

From Cisco Catalyst SD-WAN Control Components Release 20.14.1, you can enable disk encryption on the hypervisor.

### Create Cisco Catalyst SD-WAN Validator VM Instance

1. Launch the vSphere client and create a Cisco SD-WAN Validator VM instance.
2. Add a vNIC for the tunnel interface.
3. Start the Cisco SD-WAN Validator VM instance and connect to the console.

The details of each step are provided below.

If you are using the VMware vCenter Server to create the Cisco SD-WAN Validator VM instance, follow the same procedure. Note, however, that the vCenter Server pages look different than the vSphere Client pages shown in the procedure.

## Launch vSphere Client and Create a Cisco Catalyst SD-WAN Validator VM Instance

1. Launch the VMware vSphere Client application, and enter the IP address or name of the ESXi server, your username, and your password. Click **Login** to log in to the ESXi server.
2. Click **File > Deploy OVF Template** to deploy the virtual machine.
3. In the Deploy OVF Template page, enter the location to install and download the OVF package. This package is the `vedge.ova` file that you downloaded from Cisco. Then click **Next**.



4. Click **Next** to verify OVF template details.
5. Enter a name for the deployed template and click **Next**. The figure below specifies a name for the Cisco SD-WAN Validator instance.
6. Click **Next** to accept the default format for the virtual disks.
7. Click **Next** to accept your destination network name as the destination network for the deployed OVF template. For this instance, CorpNet is the destination network.
8. In the Ready to Complete page, click **Finish**. The figure below shows the name for the Cisco SD-WAN Validator instance.

The system has successfully created the VM instance with the parameters you just defined and displays the vSphere Client page with **Getting Started** selected. By default, this includes one vNIC. This vNIC is used for the management interface.

## Add a vNIC for the Tunnel Interface

1. In the left navigation bar of the vSphere Client, select the Cisco SD-WAN Validator VM instance you just created, and click **Edit virtual machine settings**.
2. In the vEdge Cloud – Virtual Machine Properties page, click **Add** to add a new vNIC for the management interface. Then click **OK**.
3. Click Ethernet Adapter for the type of device you wish to add. Then click **Next**.
4. In the **Adapter Type** drop-down, select VMXNET3 for the vNIC to add. Then click **Next**.
5. In the Ready to Complete page, click **Finish**.
6. The vEdge Cloud – Virtual Machine Properties page opens showing that the new vNIC is being added. Click **OK** to return to the vSphere Client page.

## Start the Cisco Catalyst SD-WAN Validator VM Instance and Connect to the Console

1. In the left navigation bar of the vSphere Client, select the Cisco SD-WAN Validator virtual machine instance you created, and click **Power** on the virtual machine. The Cisco SD-WAN Validator virtual machine is powered on.
2. Select **Console** to connect to the Cisco SD-WAN Validator console.
3. At the login prompt, log in with the default username, which is **admin**, and the default password, which is **admin**.

### What's Next

See *Configure Cisco Catalyst SD-WAN Validator*.

## Create Cisco Catalyst SD-WAN Validator VM Instance on KVM

To start Cisco SD-WAN Validator, you must create a virtual machine (VM) instance for it on a server that is running hypervisor software. This article describes how to create a VM on a server running the Kernel-based

Virtual Machine (KVM) Hypervisor. You can also create the VM on a server running the vSphere ESXi Hypervisor software.

For server information, see *Server Hardware Recommendations*.

To create a Cisco SD-WAN Validator VM instance on the KVM hypervisor:

1. Launch the Virtual Machine Manager (virt-manager) client application. The system displays the Virtual Machine Manager page.
2. Click **New** to deploy the virtual machine. The system opens the Create a new virtual machine page.
3. Enter the name of the virtual machine. The figure below specifies a name for the Cisco SD-WAN Validator instance.
  - a. Choose **Import existing disk image** option to install the operating system.
  - b. Click **Forward**.
4. For **Provide the existing storage path**, click **Browse** to find the Cisco SD-WAN Validator software image.
  - a. For **OS Type**, choose **Linux**.
  - b. For **Version**, choose the Linux version that you are running.
  - c. Click **Forward**.
5. Specify Memory and CPU based on your network topology and the number of sites, and click **Forward**.
6. Check **Customize configuration before install**. Then click **Finish**.
7. Choose **Disk 1** in the left navigation bar. Then:
  - a. Click **Advanced Options**.
  - b. For **Disk Bus**, choose **IDE**.
  - c. For **Storage Format**, choose **qcow2**.
  - d. Click **Apply** to create the VM instance with the parameters you had defined. By default, this includes one vNIC. This vNIC is used for the management interface.



---

**Note** The software supports only VMXNET3 vNICs.

---

8. In the vEdge Cloud Virtual Machine page, click **Add Hardware** to add a second vNIC for the tunnel interface.
9. In the Add New Virtual Hardware page, click **Network**.
  - a. In the **Host Device**, choose an appropriate **Host device**.
  - b. Click **Finish**.

The newly created vNIC is listed in the left pane. This vNIC is used for the tunnel interface.

10. In the Cisco SD-WAN Validator Virtual Machine page, click **Begin Installation** in the top upper-left corner of the page.
11. The system creates the virtual machine instance and displays the Cisco SD-WAN Validator console.
12. In the login page, log in with the default username, which is **admin**, and the default password, which is **admin**.

### What's Next

See *Configure Cisco Catalyst SD-WAN Validator*.

## Configure Cisco Catalyst SD-WAN Validator

Once you have set up and started the virtual machine (VM) for Cisco SD-WAN Validator in your overlay network, Cisco SD-WAN Validator comes up with a factory-default configuration. You then need to manually configure few basic features and functions so that the devices can be authenticated and verified and can join the overlay network. Among these features, you configure the device as Cisco SD-WAN Validator providing the system IP address, and you configure a WAN interface that connects to the Internet. This interface must have a public IP address so that all Cisco vEdge devices in the overlay network can connect to Cisco SD-WAN Validator.

You create the initial configuration by using SSH to open a CLI session to Cisco SD-WAN Validator.

After you have created the initial configuration, you create the full configuration by creating configuration templates on Cisco SD-WAN Manager and then attach the templates to Cisco SD-WAN Validator. When you attach the configuration templates to Cisco SD-WAN Validator, the configuration parameters in the templates overwrite the initial configuration.

### Create Initial Configuration for Cisco Catalyst SD-WAN Validator

To create the initial configuration on Cisco SD-WAN Validator using a CLI session:

1. Open a CLI session to Cisco vEdge device via SSH.
2. Log in as the user **admin**, using the default password, **admin**. The CLI prompt is displayed.
3. Enter configuration mode:

For Cisco Catalyst SD-WAN Control Components Release 20.14.x and later releases:

```
vSmart# config  
vSmart(config)#
```

For releases before Cisco Catalyst SD-WAN Control Components Release 20.14.x:

```
vBond# config  
vBond(config)#
```

4. Configure the hostname:

For Cisco Catalyst SD-WAN Control Components Release 20.14.x and later releases:

```
vSmart(config)# system host-name vBond
```

For releases before Cisco Catalyst SD-WAN Control Components Release 20.14.x:

```
vBond(config)# system host-name hostname
```

Configuring the hostname is optional, but is recommended because this name is included as part of the prompt in the CLI and it is used on various Cisco SD-WAN Manager screens to refer to the device.

5. Configure the system IP address:

```
vBond(config-system)#system-ip ip-address
```

Cisco SD-WAN Manager uses the system IP address to identify the device so that the NMS can download the full configuration to the device.

6. Configure the IP address of Cisco SD-WAN Validator. Cisco SD-WAN Validator's IP address must be a public IP address, to allow all Cisco vEdge devices in the overlay network to reach Cisco SD-WAN Validator:

```
vBond(config-system)#vbond ip-address local
```

In Releases 16.3 and later, the address can be an IPv4 or an IPv6 address. In earlier releases, it must be an IPv4 address. A Cisco SD-WAN Manager is effectively a vEdge router that performs only the orchestrator functions. The **local** option designates the device to be Cisco SD-WAN Validator, not a vEdge router. Cisco SD-WAN Validator must run on a standalone virtual machine (VM) or hardware router; it cannot coexist in the same device as a software or hardware vEdge router.

7. Configure a time limit for confirming that a software upgrade is successful:

```
vBond(config-system)#upgrade-confirm minutes
```

The time can be from 1 through 60 minutes. If you configure this time limit, when you upgrade the software on the device, Cisco SD-WAN Manager (when it comes up) or you must confirm that a software upgrade is successful within the configured number of minutes. If the device does not received the confirmation within the configured time, it reverts to the previous software image.

8. Change the password for the user "admin":

```
vBond(config-system)#user admin password password
```

The default password is "admin".

9. Configure an interface in VPN 0, to connect to the Internet or other WAN transport network. In Releases 16.3 and later, the IP address can be an IPv4 or an IPv6 address. In earlier releases, it must be an IPv4 address. Ensure that the prefix you configure for the interface contains the IP address that you configure in the **vbond local** command.

```
vBond(config)#vpn 0 interface interface-name
vBond(config-interface)#ip address ipv4-prefix/length
vBond(config-interface)#ipv6 address ipv6-prefix/length
vBond(config-interface)#no shutdown
```



---

**Note** The IP address must be a public address so that all devices in the overlay network can reach Cisco SD-WAN Validator.

---

10. Commit the configuration:

```
vBond(config)#commit and-quit
vBond#
```

11. Verify that the configuration is correct and complete:

```
vBond#show running-config
```

After the overlay network is up and operational, create a Cisco SD-WAN Validator configuration template on the Cisco SD-WAN Manager that contains the initial configuration parameters. Use the following Cisco SD-WAN Manager feature templates:

- System feature template to configure the hostname, system IP address, and Cisco SD-WAN Validator functionality.
- AAA feature template to configure a password for the "admin" user.
- VPN Interface Ethernet feature template to configure the interface in VPN 0.

In addition, it is recommended that you configure the following general system parameters:

- From the Cisco SD-WAN Manager menu, choose **Administration > Settings** and configure Organization name.
- From the Cisco SD-WAN Manager menu, choose **Configuration > Templates**. From System configuration template drop-down, select **create template** and configure Timezone, NTP servers, and device physical location.
- Click **Additional Templates** and from banner feature template drop-down, select **Create Template**. Configure Login banner.
- From System feature configuration template drop-down, select **Create Template** and configure disk and server parameters.
- From AAA feature configuration template drop-down, select **Create Template** and configure AAA, RADIUS and TACACS servers.
- Click **Additional Templates** and from SNMP feature template drop-down, select **Create Template** and configure SNMP.



---

**Note** The IP address must be a public address so that all devices in the overlay network can reach Cisco SD-WAN Validator.

---

### Sample Initial CLI Configuration

Below is an example of a simple configuration on Cisco SD-WAN Validator. Note that this configuration includes a number of settings from the factory-default configuration and shows a number of default configuration values.

```
vBond#show running-config
system
 host-name          vBond
 gps-location latitude 40.7127837
 gps-location longitude -74.00594130000002
 system-ip          172.16.240.161
 organization-name  "Cisco"
 clock timezone America/Los_Angeles
 vbond 11.1.1.14 local
 aaa
  auth-order local radius tacacs
  usergroup basic
   task system read write
   task interface read write
!
```

```

usergroup netadmin
!
usergroup operator
task system read
task interface read
task policy read
task routing read
task security read
!
user admin
password encrypted-password
!
!
logging
disk
enable
!
!
vpn 0
interface ge0/0
ip address 11.1.1.14/24
no shutdown
!
ip route 0.0.0.0/0 11.1.1.1
!
vpn 512
interface eth0
ip dhcp-client
no shutdown
!
!

```

### What's Next

See *Add Cisco SD-WAN Validator to the Overlay Network*.

## Create Configuration Templates for Cisco Catalyst SD-WAN Validator

This article describes how to configure Cisco SD-WAN Validators that are being managed by Cisco SD-WAN Manager. These devices must be configured from Cisco SD-WAN Manager. If you configure them directly from the CLI on the router, Cisco SD-WAN Manager overwrites the configuration with the one stored on the NMS system.

### Configuration Prerequisites

#### Security Prerequisites

Before you can configure Cisco SD-WAN Validators in the Cisco SD-WAN overlay network, you must have generated a certificate for Cisco SD-WAN Validator, and the certificate must already be installed on the device. See *Generate a Certificate*.

#### Variables Spreadsheet

The feature templates that you create will most likely contain variables. To have Cisco SD-WAN Manager populate the variables with actual values when you attach a device template to a device, either enter the values manually or click **Import File** in the upper right corner to load an Excel file in CSV format that contains the variables values.

In the spreadsheet, the header row contains the variable name and each row after that corresponds to a device, defining the values of the variables. The first three columns in the spreadsheet must be (in the order listed below):

- csv-deviceId—Serial number of the device (used to uniquely identify the device).
- csv-deviceIP—System IP address of the device (used to populate the **system ip address** command).
- csv-host-name—Hostname of the device (used to populate the **system hostname** command).

You can create a single spreadsheet for all devices in the overlay network—routers, Cisco SD-WAN Controllers, and Cisco SD-WAN Validators. You do not need to specify values for all variables for all devices.

## Feature Templates for Cisco Catalyst SD-WAN Validators

The following features are mandatory for Cisco SD-WAN Validator operation, and so creating a feature template for each of them is required:

Feature	Template Name
Authentication, Authorization, and Accounting (AAA)	AAA
Security	Security
System-wide parameters	System
Transport VPN (VPN 0)	VPN, with the VPN ID set to 0
Management VPN (for out-of-band management traffic)	VPN, with the VPN ID set to 512

## Create Feature Templates

Feature templates are the building blocks of a Cisco SD-WAN Validator's complete configuration. For each feature that you can enable on Cisco SD-WAN Validator, Cisco SD-WAN Manager provides a template form that you fill out with the desired parameters for that feature.

You must create feature templates for the mandatory Cisco SD-WAN Validator features.

You can create multiple templates for the same feature.

To create Cisco SD-WAN Validator feature templates:

1. From the Cisco SD-WAN Manager menu, choose **Configuration > Templates**.
2. Click **Feature Templates**.



**Note** In Cisco vManage Release 20.7.x and earlier releases, **Feature Templates** is called **Feature**.

3. Select **Add Template**.
4. In the left pane, from **Select Devices**, select **Cloud router**.
5. In the right pane, select the template. The template form is displayed. The top of the form contains fields for naming the template, and the bottom contains fields for defining required parameters applicable to

that template. Optional parameters are generally grayed out. A plus sign (+) is displayed to the right when you can add multiple entries for the same parameter.

6. Enter a template name and description. These fields are mandatory. You cannot use any special characters in template names.
7. For each required parameter, choose the desired value, and if applicable, select the scope of the parameter. Select the scope from the drop-down menu available to the left of each parameter's value box.
8. Click the plus sign (+) below the required parameters to set the values for additional parameters, if applicable.
9. Click **Create**.
10. Create feature templates for each of the required features listed in the previous section.
  - a. In the System template, in the top portion, configure all desired parameters except for Controller Groups, Maximum Controllers, and Maximum OMP Sessions. These parameters are specific to routers and have no meaning for Cisco SD-WAN Validator. In the **Advanced Options** portion, in Cisco SD-WAN Validator Only and Local Cisco SD-WAN Validator, click **On**. These two parameters instantiates Cisco SD-WAN Validator.
  - b. Create two VPN templates, one for VPN 0 (the VPN that connects to the Internet or other public transport network) and one for VPN 512 (the VPN that handles out-of-band management traffic).
  - c. Create AAA and Security templates.
11. Create feature templates for each feature that you want to enable on Cisco SD-WAN Validators:
  - a. Create Archive and Banner templates
  - b. Create one Interface Ethernet template for each additional Ethernet interface you want to configure on the Cisco SD-WAN Validator. Do not create any tunnel interfaces, or tunnels of any kind, for Cisco SD-WAN Validators.

## Create Device Templates

Device templates contain all or large portions of a device's complete operational configuration. You create device templates by consolidating together individual feature templates. You can also create them by entering a CLI text-style configuration directly on Cisco SD-WAN Manager. You can use both styles of device templates when configuring the Cisco SD-WAN Validator.

To create Cisco SD-WAN Validator device templates from feature templates:

1. From the Cisco SD-WAN Manager menu, choose **Configuration > Templates**.
2. Click **Device Templates**.



---

**Note** In Cisco vManage Release 20.7.x and earlier releases, **Device Templates** is called **Device**.

---

3. From the **Create Template** drop-down, select **From Feature Templates**.
4. From the **Device Model** drop-down, select a **Cloud router**.



5. Enter a name and description for the Cisco SD-WAN Validator device template. These fields are mandatory. You cannot use any special characters in template names.
6. From the **Load Running config from reachable device** drop-down, select the desired group of templates.
7. In each section, select the desired template. All required templates are marked with an asterisk (\*). Initially, the drop-down for each template lists the default feature template.
  - a. For each required and optional template, select the feature template from the drop-down. These templates are the ones that you previously created (see Create Feature Templates above). Do not select a BFD or an OMP template for Cisco SD-WAN Validators.
  - b. For additional templates, click the plus (+) sign next to the template name, and select the feature template from the drop-down.
8. Click **Create**. The new device template is listed in the Templates table. The Feature Templates column shows the number of feature templates that are included in the device template, and the Type column shows "Feature" to indicate that the device template was created from a collection of feature templates.

To create device templates by entering a CLI text-style configuration directly on Cisco SD-WAN Manager:

1. From the Cisco SD-WAN Manager menu, choose **Configuration > Templates**.
2. Click **Device Templates**.



---

**Note** In Cisco vManage Release 20.7.x and earlier releases, **Device Templates** is called **Device**.

---

3. From the **Create Template** drop-down, select **CLI Template**.
4. Enter a template name and description.
5. Enter the configuration in the **Config Preview** window, either by typing it, cutting and pasting it, or uploading a file.
6. To convert an actual configuration value to a variable, select the value and click **Create Variable**. Enter the variable name, and click **Create Variable**. You can also type the variable name directly, in the format `{{variable-name}}`; for example, `{{hostname}}`.
7. Click **Add**. The new device template is listed in the Templates table. The Feature Templates column shows the number of feature templates that are included in the device template, and the Type column shows "CLI" to indicate that the device template was created from CLI text.

## Attach Device Templates To Cisco Catalyst SD-WAN Validator

To configure Cisco SD-WAN Validator, you attach one device template to the orchestrator. You can attach the same template to multiple Cisco SD-WAN Validators simultaneously.

To attach a device template to the Cisco SD-WAN Validator:

1. From the Cisco SD-WAN Manager menu, choose **Configuration > Templates**.
2. Click **Device Templates**.



---

**Note** In Cisco vManage Release 20.7.x and earlier releases, **Device Templates** is called **Device**.

---

3. Select the desired device template.
4. For the selected device template, click **...**, and select **Attach Devices**.
5. In the **Attach Devices** column, select the desired Cisco SD-WAN Validator from the **Available Devices** list, and click the right-pointing arrow to move them to the **Selected Devices** column. You can select one or more orchestrators. Click **Select All** to choose all listed orchestrator.
6. Click **Attach**.

## Add Cisco Catalyst SD-WAN Validator to the Overlay Network

After you create a minimal configuration for Cisco SD-WAN Validator, you must add it to overlay network by making Cisco SD-WAN Manager aware of Cisco SD-WAN Validator. When you add Cisco SD-WAN Validator, a signed certificate is generated and is used to validate and authenticate the orchestrator.

### Add Cisco Catalyst SD-WAN Validator and Generate Certificate

To add Cisco SD-WAN Validator to the network, automatically generate the CSR, and install the signed certificate:

1. From the Cisco SD-WAN Manager menu, choose **Configuration > Devices**.
2. Click **Control Components** and click **Add Validator**.
3. In the **Add Validator** window:
  - a. Enter the VPN 0 IP address.
  - b. Enter the username and password to access Cisco SD-WAN Validator.
  - c. Choose the **Generate CSR** check box to allow the certificate-generation process to occur automatically.
  - d. Click **Add**.

Cisco SD-WAN Manager generates the CSR, retrieves the generated certificate, and automatically installs it on Cisco SD-WAN Validator. The new controller device is listed in the Controller table with the controller type, hostname of the controller, IP address, site ID, and other details.

### Verify Certificate Installation

To verify that the certificate is installed on Cisco SD-WAN Validator:

1. From the Cisco SD-WAN Manager menu, choose **Configuration > Devices**.
2. Choose the new device listed, and check in the Certificate Status column to ensure that the certificate has been installed.

## Start the Enterprise ZTP Server

The ZTP server must be configured before the ZTP workflow starts.

If you are hosting the Cisco Catalyst SD-WAN zero-touch-provisioning (ZTP) server in your enterprise, you must configure one Cisco SD-WAN Validator to perform this role. This Cisco SD-WAN Validator provides the Cisco vEdge devices in the overlay network with the IP address of your enterprise Cisco SD-WAN Validator and with the enterprise root CA chain. You can think of this Cisco SD-WAN Validator server as a top-level Cisco SD-WAN Validator, analogous to a top-level domain server in the Internet.

If you are using the Cisco Catalyst SD-WAN ZTP hosted service, there is no need to set up a top-level Cisco SD-WAN Validator.

This section provides step-by-step instructions on how to start the Cisco SD-WAN Validator and perform initial configuration.

### Requirements for ZTP

To start the Cisco SD-WAN Validator software, you need the following hardware and software components:

- A Cisco vEdge device on which the Cisco SD-WAN Validator software has been installed or the Cisco SD-WAN Validator VM instance on the hypervisor.
- Appropriate power cables. See the packing list for your hardware platform.
- An enterprise DNS server that has been configured with a record that redirects the URL `ztp.cisco.com` to your enterprise ZTP server. The recommended URL for this enterprise server is `ztp.local-domain`.
- Certificate generated as a result of a Certificate Signing Request (CSR).
- Enterprise root CA chain.
- For releases through Cisco SD-WAN Release 20.1.1 on Cisco vEdge devices, a CSV file that contains the Cisco vEdge device chassis information required by the Cisco SD-WAN Validator that is acting as the ZTP server. Each row in the CSV file must contain the following information for each Cisco vEdge device.



---

**Note** The `ztp-server` should be `csr-cert` signed from either `cisco-pki` or `symantec` (Digicert).

---



---

**Note** Some operating systems, including Microsoft Windows, may add carriage return special characters (such as `^M`) at the end of each line in this file. Use a text editor to remove these characters before you upload the file.

---

- vEdge router chassis number
- vEdge router serial number
- Validity (either valid or invalid)
- Cisco SD-WAN Validator IP address

- Cisco SD-WAN Validator port number (entering a value is optional)
  - Organization name as specified in the device certificate
  - Path to the enterprise root certification (entering a value is optional)
- For releases beginning with Cisco SD-WAN Release 20.3.1 on Cisco vEdge devices, a JSON file that contains the router chassis information that the Cisco SD-WAN Validator that acts as the ZTP server requires. This file is extracted from the PNP portal downloaded zip bundled device file. The JSON file contains the following information for each router:
    - Organization name as specified in the device certificate
    - Certificate information
    - Router chassis number
    - Router serial number
    - Validity (either valid or invalid)
    - Cisco SD-WAN Validator IP address
    - Cisco SD-WAN Validator port number (optional)



**Note** Before upgrading edge devices, ensure that your on-premises ZTP server is using the same release number (or higher) as the Cisco SD-WAN Controller release that you are using for Cisco SD-WAN Manager, Cisco SD-WAN Controller, and Cisco SD-WAN Validator. For example, before upgrading from Cisco vManage Release 20.6.x to Cisco vManage Release 20.9.x, ensure that the ZTP server is using release 20.9 or later.

From Cisco SD-WAN Release 20.4.1, if **Multi-Tenancy** is enabled in controller profile on the PNP portal, the JSON file also contains the SP Organization Name.

For Cisco SD-WAN Release 20.3.1, download the Chassis ZIP file from the PNP portal and extract the JSON file from it. Use the following command to upload the JSON file to the ZTP server:

```
vBond# request device-upload chassis-file JSON-file-name
```

Here is an example of a JSON file:

```
{
    "version": "1.1",
    "organization": "vIPtela Inc Regression",
    "overlay": "vIPtela Inc Regression",
    "root_cert_bundle": "-----BEGIN CERTIFICATE-----
<certificate>
----END CERTIFICATE-----\n-----BEGIN CERTIFICATE-----
<certificate>
----END CERTIFICATE-----",
    "controller_details": {
        "primary_ipv4": "10.0.12.26",
        "primary_port": "12346"
    },
    "chassis_list": [{
        "chassis": "JAE214906FZ",
        "SKU": "ASR1002-HX",
```

```

        "HWPID": "ASR1002-HX",
        "serial_list": [{
            "sudi_subject_serial": "JAE214906FX",
            "sudi_cert_serial": "021C0203",
            "HWPID": "ASR1002-HX"}]
        }
    ],
    "timestamp": "2019-10-21 23:40:02.248"
}

```

From Cisco SD-WAN Release 20.3.2, you need not extract the JSON file from the Chassis ZIP file that you download from the PNP portal. Use the **request device-upload chassis-file** command to upload the serialFile.Viptela file downloaded from the PNP portal to the ZTP server. The ZTP server extracts the JSON file from serialFile.Viptela and loads the chassis entries into the database.

```

vBond# request device-upload chassis-file /home/admin/serialFile.viptela
Uploading chassis numbers via VPN 0
Copying ... /home/admin/serialFile.viptela via VPN 0
file: /tmp/tmp.DkaQ18u3aM/viptela_serial_file
PnP
Verifying public key received from PnP against production root cert
is_public_key_ok against production root ca: O = Cisco, CN = MMI Signer STG - DEV error
20 at 0 depth lookup:unable to get local issuer certificate
Verifying public key received from PnP against engineering root cert
is_public_key_ok against engineering root ca: OK
Signature verified for viptela_serial_file
final file: /tmp/tmp.DkaQ18u3aM/viptela_serial_file
Removing unsigned file (cisco_cert.cer).
Signature verification Succeeded.
Success: Serial file is /tmp/tmp.DkaQ18u3aM/viptela_serial_file
INFO: Input File specified was '/usr/share/viptela/chassis_numbers.tmp'
INFO: Root Cert File is /home/admin/vIPtela Inc Regression.crt
INFO: # of complete chassis entries written: 19
Json to CSV conversion succeeded!
Successfully loaded the chassis numbers file to the database.

```

Optionally, you can configure the Cisco vEdge device information manually using the **request device** command.

## Configure a Router to be a ZTP Server

To start the top-level Cisco SD-WAN Validator software and perform initial configuration:

1. Boot the Cisco vEdge device.
2. Use a console cable to connect a PC to the Cisco vEdge device.
3. Log in to the Cisco vEdge device using the default username, which is **admin**, and the default password, which is **admin**. The CLI prompt is displayed.
4. Configure the Cisco vEdge device to be a top-level Cisco SD-WAN Validator:

```

vBond# config
vBond(config)# system vbond ip-address local ztp-server

```

The IP address must be a public address so that the Cisco SD-WAN Validator is reachable by all Cisco SD-WAN Controllers and Cisco vEdge devices through the transport network. The **local** option indicates that this Cisco vEdge device is acting as the Cisco SD-WAN Validator. It is this option that starts the Cisco SD-WAN Validator software process on the Cisco vEdge device. The **ztp-server** option establishes this Cisco SD-WAN Validator as the ZTP server.

5. Configure an IP address for the interface that connects to the transport network:

```
vBond(config)# vpn 0 interface ge slot/port
vBond(config-ge)# ip address prefix/length
vBond(config-ge)# no shutdown
```

- Commit the configuration:

```
vBond(config)# commit
```

- Exit configuration mode:

```
vBond(config)# exit
```

- Verify that the configuration is correct and complete:

```
vBond# show running-config
system
  host-name          vm3
  system-ip          172.16.255.2
  admin-tech-on-failure
  route-consistency-check
  organization-name  "Cisco Inc"
  vbond 10.1.15.13 local ztp-server
```

- Generate CSR manually:

```
vbond_ztp# request csr upload home/admin/vbond_ztp.csr
```

- Sign CSR manually and generate certificate via PNP Connect Cisco PKI or Symantec via Cloud Ops.

- Install Certificate:

```
vbond_ztp# request certificate install/home/admin/vbond_ztp.cer
```

- Ensure Cisco IOS XE Catalyst SD-WAN has Cisco root-ca-cert or Symantec root-ca-cert in root-ca chain.

- Check clock on vBond\_ZTP and Cisco IOS XE Catalyst SD-WAN.

- Upload the JSON file that contains the router chassis information to the ZTP server:

```
vBond# request device-upload chassis-file path
```

*path* is the path to a local file or a file on a remote device that is reachable via FTP, TFTP, HTTP, or SCP.

- Verify that the list of Cisco vEdge device chassis numbers are present on the Cisco SD-WAN Validator using one of the following commands:

```
vBond# show ztp entries
vBond# show orchestrator valid-devices
```

Here is an example of the configuration of a top-level Cisco SD-WAN Validator:

```
vBond# show running-config vpn 0
interface ge0/0
  ip address 75.1.15.27/24
  !
  no shutdown
!

vBond# show running-config system
system
  vbond 75.1.15.27 local ztp-server
!
```

### What's Next

See *Deploy the Cisco Catalyst SD-WAN Controller*.

## vContainer Host

The support for vContainer Host is deferred. For more information on vContainer host, refer to [deferral notice](#).

## Deploy Cisco Catalyst SD-WAN Controller

Cisco SD-WAN Controller is the brains of the centralized control plane for the Cisco Catalyst SD-WAN overlay network, maintaining a centralized routing table and centralized routing policy. Once the network is operational, Cisco SD-WAN Controller effects its control by maintaining a direct DTLS control plane connection to each vEdge router. Cisco SD-WAN Controller runs as a virtual machine (VM) on a network server.

A Cisco Catalyst SD-WAN overlay network can have one or more Cisco SD-WAN Controllers. Cisco SD-WAN Controllers provide a means to control the flow of data traffic throughout the overlay network. It is recommended that an overlay network have at least two Cisco SD-WAN Controllers to provide redundancy. A single Cisco SD-WAN Controller can support up to 2,000 control sessions (that is, up to 2,000 TLOCs). Cisco SD-WAN Manager or Cisco SD-WAN Manager cluster can support up to 20 Cisco SD-WAN Controllers in the overlay network.

To deploy a Cisco SD-WAN Controller:

1. Create a Cisco SD-WAN Controller VM instance, either on an ESXi or a KVM hypervisor.
2. Create a minimal configuration for the Cisco SD-WAN Controller, to allow it to be accessible on the network. You do this by using SSH to open a CLI session to Cisco SD-WAN Controller and manually configuring the device.
3. Add Cisco SD-WAN Controller to the overlay network so that Cisco SD-WAN Manager is aware of it.
4. Create a full configuration for Cisco SD-WAN Controller. You do this by creating a Cisco SD-WAN Manager template for the Cisco SD-WAN Controller and attaching that template to the controller. When you attach the Cisco SD-WAN Manager template, the initial minimal configuration is overwritten.

## Create Cisco Catalyst SD-WAN Controller VM Instance on ESXi

### Before You Begin

To start the Cisco SD-WAN Controller, you must create a virtual machine (VM) instance for it on a server that is running hypervisor software. This article describes how to create a VM on a server running the VMware vSphere ESXi Hypervisor software. You can also create the VM on a server running the Kernel-based Virtual Machine (KVM) Hypervisor software.

For server requirements, see [Server Hardware Recommendations](#).

From Cisco Catalyst SD-WAN Control Components Release 20.14.1, you can enable disk encryption on the hypervisor.

### Create Cisco Catalyst SD-WAN Controller VM Instance

1. Launch the vSphere Client and create a Cisco SD-WAN Controller VM instance.
2. Add a vNIC for the management interface.
3. Start the Cisco SD-WAN Controller VM instance and connect to the console.

The details of each step are provided below.

If you are using the VMware vCenter Server to create the Cisco SD-WAN Controller VM instance, follow the same procedure. Note, however, that the vCenter Server pages look different than the vSphere Client pages shown in the procedure.

## Launch vSphere Client and Create a Cisco Catalyst SD-WAN Controller VM Instance

1. Launch the VMware vSphere Client application, and enter the IP address or name of the ESXi server, your username, and your password. Click **Login** to log in to the ESXi server.  
The system displays the ESXi screen.
2. Click **File > Deploy OVF Template** to deploy the virtual machine.
3. In the Deploy OVF Template screen, enter the location to install and download the OVF package. This package is the vsmart.ova file that you downloaded from Cisco. Then click **Next**.
4. Click **Next** to verify OVF template details.
5. Enter a name for the deployed template and click **Next**. The figure below specifies a name for the Cisco SD-WAN Controller instance.
6. Click **Next** to accept the default format for the virtual disks.
7. Click **Next** to accept your destination network as the destination network for the deployed OVF template. In the figure below, CorpNet is the destination network.
8. In the Ready to Complete page, click **Finish**. The figure below shows the name for the Cisco SD-WAN Controller instance.

The system has successfully created the VM instance with the parameters you just defined and displays the vSphere Client page with **Getting Started** selected. By default, this includes one vNIC. This vNIC is used for the tunnel interface.

## Add a vNIC for the Management Interface

1. In the left navigation bar of the vSphere Client, select the Cisco SD-WAN Manager VM instance you just created, and click **Edit virtual machine settings**.
2. In the Cisco SD-WAN Manager – Virtual Machine Properties page, click **Add** to add a new vNIC for the management interface. Then click **OK**.
3. Click **Ethernet Adapter** for the type of device you wish to add. Then click **Next**.
4. In the **Adapter Type** drop-down, select VMXNET3 for the vNIC to add. Then click **Next**.
5. In the Ready to Complete page, click **Finish**.



6. The Cisco SD-WAN Manager – Virtual Machine Properties page opens showing that the new vNIC is being added. Click **OK** to return to the vSphere Client page.

## Start the Cisco Catalyst SD-WAN Controller VM Instance and Connect to the Console

1. In the left navigation bar of the vSphere Client, select the virtual machine instance you just created, and click **Power on the virtual machine**. The Cisco SD-WAN Controller virtual machine is powered on.
2. Select **Console** to connect to the Cisco SD-WAN Controller console.
3. At the login prompt, log in with the default username, which is **admin**, and the default password, which is **admin**.

### What's Next

See *Configure Cisco Catalyst SD-WAN Controller*.

## Create Cisco Catalyst SD-WAN Controller VM Instance on KVM

To start the Cisco SD-WAN Controller, you must create a virtual machine (VM) instance for it on a server that is running hypervisor software. This article describes how to create a VM on a server running the Kernel-based Virtual Machine (KVM) Hypervisor software. You can also create the VM on a server running the VMware vSphere ESXi Hypervisor software.

For server requirements, see *Server Hardware Recommendations*.

To create a Cisco SD-WAN Controller VM instance on the KVM hypervisor:

1. Launch the Virtual Machine Manager (virt-manager) client application. The system displays the Virtual Machine Manager page.
2. Click **New** to deploy the virtual machine. The system opens the Create a new virtual machine page.
3. Enter the name of the virtual machine. The figure below specifies a name for the Cisco SD-WAN Controller instance.
  - a. Select **Import existing disk image**.
  - b. Click **Forward**.
4. In **Provide the existing storage path** field, click **Browse** to find the Cisco SD-WAN Controller software image.
  - a. For **OS Type**, select **Linux**.
  - b. For **Version**, select the Linux version you are running.
  - c. Click **Forward**.
5. Specify Memory and CPU based on your network topology and the number of sites, and click **Forward**.
6. Select Customize configuration before install. Then click **Finish**.
7. Select **Disk 1** in the left navigation bar. Then:
  - a. Click **Advanced Options**.

- b. In the **Disk Bus** field, select **IDE**.
- c. In the **Storage Format** field, select **qcow2**.
- d. Click **Apply** to create the VM instance with the parameters you just defined. By default, this includes one vNIC. This vNIC is used for the tunnel interface.



---

**Note** The software supports only VMXNET3 vNICs.

---

8. In the Cisco SD-WAN Controller Virtual Machine page, click **Add Hardware** to add a second vNIC for the management interface.
9. In the Add New Virtual Hardware page, click **Network**.
  - a. In the **Host Device** field, select an appropriate host device.
  - b. Click **Finish**.  
The newly created vNIC is listed in the left pane. This vNIC is used for the management interface.
10. In the Cisco SD-WAN Controller Virtual Machine page, click **Begin Installation** in the top upper-left corner of the screen.
11. The system creates the virtual machine instance and displays the Cisco SD-WAN Controller console.
12. At the login prompt, log in with the default username, which is **admin**, and the default password, which is **admin**.

### What's Next

See *Configure Cisco Catalyst SD-WAN Controller*.

## Configure the Cisco Catalyst SD-WAN Controller

Once you have set up and started the virtual machines (VMs) for the Cisco SD-WAN Controllers in your overlay network, they come up with a factory-default configuration. You then need to manually configure a few basic features and functions so that the devices can be authenticated and verified and can join the overlay network. These features include the IP address of your network's Cisco SD-WAN Validator, the device's system IP address, and a tunnel interface in VPN 0 to use for exchanging control traffic among the network controller devices (the Cisco SD-WAN Validator, Cisco SD-WAN Manager, and Cisco SD-WAN Controller devices).

For the overlay network to be operational and for the Cisco SD-WAN Controllers to participate in the overlay network, do the following:

- Configure a tunnel interface on at least one interface in VPN 0. This interface must connect to a WAN transport network that is accessible by all Cisco vEdge devices. VPN 0 carries all control plane traffic among the Cisco vEdge devices in the overlay network.
- Ensure that the Overlay Management Protocol (OMP) is enabled. OMP is the protocol responsible for establishing and maintaining the Cisco Catalyst SD-WAN control plane. It is enabled by default, and

you cannot disable it. When you edit the configuration from the CLI, do not remove the **omp** configuration command.

You create these initial configuration by using SSH to open a CLI session to the the Cisco SD-WAN Controller.

After you have created the initial configuration, you create the full configuration by creating configuration templates on the Cisco SD-WAN Manager NMS and then attaching them to the Cisco SD-WAN Controllers. When you attach the configuration template to the Cisco SD-WAN Controllers, the configuration parameters in the templates overwrite the initial configuration.

In this initial configuration, you should assign a system IP address to the Cisco SD-WAN Controller. This address, which is similar to the router ID on non-Cisco SD-WAN routers, is a persistent address that identifies the controller independently of any interface addresses. The system IP is a component of the device's TLOC address. Setting the system IP address for a device allows you to renumber interfaces as needed without affecting the reachability of the Cisco vEdge device. Control traffic over secure DTLS or TLS connections between Cisco SD-WAN Controllers and vEdge routers and between Cisco SD-WAN Controllers and Cisco SD-WAN Validator is sent over the system interface identified by the system IP address. In the transport VPN (VPN 0), the system IP address is used as the device's loopback address. You cannot use this same address for another interface in VPN 0.



**Note** For the overlay network to function properly and predictably, the policies configured on all Cisco SD-WAN Controllers must be identical.

### Create Initial Configuration for the Cisco Catalyst SD-WAN Controller

To create the initial configuration on a Cisco SD-WAN Controller from a CLI session:

1. Open a CLI session to the Cisco vEdge device via SSH.
2. Log in as the user **admin**, using the default password, **admin**. The CLI prompt is displayed.
3. Enter configuration mode:

```
vSmart# config
vSmart(config)#
```

4. Configure the hostname:

```
Cisco(config)# system host-name hostname
```

Configuring the hostname is optional, but is recommended because this name is included as part of the prompt in the CLI and it is used on various Cisco SD-WAN Manager pages to refer to the device.

5. Configure the system IP address. In Releases 16.3 and later, the IP address can be an IPv4 or an IPv6 address. In earlier releases, it must be an IPv4 address. Releases 19.1 and later do not allow the configuration of IPv6 unique local addresses. In these releases, configure IPv6 addresses from the FC00::/7 prefix range.



**Note** Starting from Cisco Catalyst SD-WAN Control Components Release 20.9.x release, you can configure unique local IPv6 addresses. Prior to this release, you can configure IPv6 addresses from the FC00::/7 prefix range.

```
vSmart(config-system)#system-ip ip-address
```

The Cisco SD-WAN Manager uses the system IP address to identify the device so that the NMS can download the full configuration to the device.

- Configure the numeric identifier of the site where the device is located:

```
vSmart(config-system) # site-id site-id
```

- Configure the numeric identifier of the domain in which the device is located:

```
vSmart(config-system) # domain-id domain-id
```

- Configure the IP address of the Cisco Catalyst SD-WAN Validator or a DNS name that points to the Cisco Catalyst SD-WAN Validator. The Cisco Catalyst SD-WAN Validator's IP address must be a public IP address, to allow all Cisco vEdge devices in the overlay network to reach it.

```
vSmart(config-system) # vbond (dns-name | ip-address)
```

- Configure a time limit for confirming that a software upgrade is successful:

```
vSmart(config-system) # upgrade-confirm minutes
```

The time can be from 1 through 60 minutes. If you configure this time limit, when you upgrade the software on the device, Cisco SD-WAN Manager (when it comes up) or you must confirm that a software upgrade is successful within the configured number of minutes. If the device does not receive the confirmation within the configured time, it reverts to the previous software image.

- Change the password for the user "admin":

```
vSmart(config-system) # user admin password password
```

The default password is "admin".

- Configure an interface in VPN 0 to be used as a tunnel interface. VPN 0 is the WAN transport VPN, and the tunnel interface carries the control traffic among the devices in the overlay network. The interface name has the format **eth number**. You must enable the interface and configure its IP address, either as a static address or as a dynamically assigned address received from a DHCP server. In Releases 16.3 and later, the address can be an IPv4 or an IPv6 address, or you can configure both to enable dual-stack operation. In earlier releases, it must be an IPv4 address.

```
vSmart(config) # vpn 0
vSmart(config-vpn-0) # interface interface-name
vSmart(config-interface) # (ip dhcp-client | ip address prefix/length)
vSmart(config-interface) # (ipv6 address ipv6-prefix/length | ipv6 dhcp-client [dhcp-distance number | dhcp-rapid-commit])
vSmart(config-interface) # no shutdown
vSmart(config-interface) # tunnel-interface
vSmart(config-tunnel-interface) # allow-service netconf
```



---

**Note** You must configure a tunnel interface on at least one interface in VPN 0 in order for the overlay network to come up and for Cisco SD-WAN Controller to be able to participate in the overlay network. This interface must connect to a WAN transport network that is accessible by all Cisco vEdge devices. VPN 0 carries all control plane traffic among the Cisco vEdge devices in the overlay network.

---

- Configure a color for the tunnel to identify the type of WAN transport. You can use the default color (**default**), but you can also configure a more appropriate color, such as **mpls** or **metro-ethernet**, depending on the actual WAN transport.

```
vSmart(config-tunnel-interface) # color color
```

13. Configure a default route to the WAN transport network:

```
vSmart(config-vpn-0)# ip route 0.0.0.0/0 next-hop
```

14. Commit the configuration:

```
vSmart(config)# commit and-quit
vSmart#
```

15. Verify that the configuration is correct and complete:

```
vSmart# show running-config
```

After the overlay network is up and operational, create a Cisco SD-WAN Controller configuration template on the Cisco SD-WAN Manager that contains the initial configuration parameters. Use the following Cisco SD-WAN Manager feature templates:

- System feature template to configure the hostname, system IP address, and Cisco SD-WAN Validator functionality.
- AAA feature template to configure a password for the "admin" user.
- VPN Interface Ethernet feature template to configure the interface, default route, and DNS server in VPN 0.

In addition, it is recommended that you configure the following general system parameters:

- From the Cisco SD-WAN Manager menu, select **Administration > Settings** and configure Organization name.
- From the Cisco SD-WAN Manager menu, select **Configuration > Templates** and configure the following:
  - For NTP and System feature configuration template, configure Timezone, NTP servers, and device physical location.
  - For Banner feature template, configure Login banner.
  - For Logging feature configuration template, configure Logging parameters.
  - For AAA feature configuration template, configure AAA, and RADIUS and TACACS+ servers.
  - For SNMP feature configuration template, configure SNMP.

### Sample Initial CLI Configuration

Below is an example of a simple configuration on a Cisco SD-WAN Controller. Note that this configuration includes a number of settings from the factory-default configuration and shows a number of default configuration values.

```
vSmart# show running-config
system
 host-name          vSmart
 gps-location latitude 40.7127837
 gps-location longitude -74.00594130000002
 system-ip          172.16.240.172
 site-id            200
 organization-name  "Cisco"
 clock timezone America/Los_Angeles
 upgrade-confirm    15
 vbond 184.122.2.2
 aaa
```

```

auth-order local radius tacacs
usergroup basic
  task system read write
  task interface read write
!
usergroup netadmin
!
usergroup operator
  task system read
  task interface read
  task policy read
  task routing read
  task security read
!
user admin
  password encrypted-password
!
!
logging
disk
  enable
!
server 192.168.48.11
  vpn      512
  priority warm
exit
!
!
omp
no shutdown
graceful-restart
!
snmp
no shutdown
view v2
  oid 1.3.6.1
!
community private
  view      v2
  authorization read-only
!
trap target vpn 0 10.0.1.1 16662
  group-name      Cisco
  community-name private
!
trap group test
  all
  level critical major minor
exit
exit
!
vpn 0
interface eth1
ip address 10.0.12.22/24
tunnel-interface
  color public-internet
  allow-service dhcp
  allow-service dns
  allow-service icmp
  no allow-service sshd
  allow-service netconf
  no allow-service ntp
  no allow-service stun
!

```

```

no shutdown
!
vpn 512
interface eth0
 ip dhcp-client
 no shutdown
!
!
```

### What's Next

See *Add the Cisco SD-WAN Controller to the Overlay Network*.

## Create Configuration Templates for Cisco Catalyst SD-WAN Controller

For Cisco SD-WAN Controllers that are being managed by a Cisco SD-WAN Manager, you must configure them from Cisco SD-WAN Manager. If you configure them directly from the CLI on Cisco Catalyst SD-WAN Controller, Cisco SD-WAN Manager overwrites the configuration with the one stored on Cisco SD-WAN Manager.

### Configuration Prerequisites

#### Security Prerequisites

Before you can configure Cisco SD-WAN Controllers in the Cisco overlay network, you must have generated a certificate for Cisco SD-WAN Controller, and the certificate must already be installed on the device. See *Generate a Certificate*.

#### Variables Spreadsheet

The feature templates that you create will most likely contain variables. To have Cisco SD-WAN Manager populate the variables with actual values when you attach a device template to a device, either enter the values manually or click **Import File** in the upper right corner to load an Excel file in CSV format that contains the variables values.

In the spreadsheet, the header row contains the variable name and each row after that corresponds to a device, defining the values of the variables. The first three columns in the spreadsheet must be (in order):

- `csv-deviceId`—Serial number of the device (used to uniquely identify the device).
- `csv-deviceIP`—System IP address of the device (used to populate the **system ip address** command).
- `csv-host-name`—Hostname of the device (used to populate the **system hostname** command).

You can create a single spreadsheet for all devices in the overlay network—routers, Cisco SD-WAN Controllers, and Cisco SD-WAN Validators. You do not need to specify values for all variables for all devices.

### Feature Templates for Cisco Catalyst SD-WAN Controller

The following features are mandatory for Cisco SD-WAN Controller operation, so you must create a feature template for each of them:

Feature	Template Name
Authentication, Authorization, and Accounting (AAA)	AAA

Feature	Template Name
Overlay Management Protocol (OMP)	OMP
Security	Security
System-wide parameters	System
Transport VPN (VPN 0)	VPN with the VPN ID set to 0
Management VPN (for out-of-band management traffic)	VPN with the VPN ID set to 512

## Create Feature Templates

Feature templates are the building blocks of Cisco SD-WAN Controller's complete configuration. For each feature that you can enable on Cisco Catalyst SD-WAN Controller, Cisco SD-WAN Manager provides a template form that you fill out with the desired parameters for that feature.

You must create feature templates for the mandatory Cisco SD-WAN Controller features.

You can create multiple templates for the same feature.

To create Cisco SD-WAN Controller feature templates:

1. From the Cisco SD-WAN Manager menu, select **Configuration > Templates**.
2. Click **Feature Templates**.



---

**Note** In Cisco vManage Release 20.7.x and earlier releases, **Feature Templates** is called **Feature**.

---

3. Select **Add Template**.
4. In the left pane, from **Select Devices**, select **Controller**. You can create a single feature template for features that are available on both Cisco SD-WAN Controllers and other devices. You must, however, create separate feature templates for software features that are available only on Cisco SD-WAN Controllers.
5. In the right pane, select the template. The template form is displayed. The top of the form contains fields for naming the template, and the bottom contains fields for defining parameters applicable to that template. Optional parameters are generally grayed out. A plus sign (+) is displayed to the right when you can add multiple entries for the same parameter.
6. Enter a template name and description. These fields are mandatory. You cannot use any special characters in template names.
7. For each required parameter, choose the desired value, and if applicable, select the scope of the parameter. Select the scope from the drop-down menu to the left of each parameter field.
8. Click the plus sign (+) below the required parameters to set values for additional parameters, if applicable.
9. Click **Create**.
10. Create feature templates for each of the required features listed in the previous section. For the transport VPN, use the template called VPN-vSmart and in the VPN Template section, set the VPN to 0, with a



scope of Global. For the management VPN, use the template called VPN- and in the VPN Template section, set the VPN to 512, with a scope of Global.

11. Create any additional feature templates for each optional feature that you want to enable on Cisco SD-WAN Controllers.

## Create Device Templates

Device templates contain a device's complete operational configuration. You create device templates by consolidating together individual feature templates. You can also create them by entering a CLI text-style configuration directly on Cisco SD-WAN Manager.

You can attach only one device template to configure a Cisco SD-WAN Controller, so it must contain, at a minimum, all the required portions of the Cisco SD-WAN Controller configuration. If it does not, the Cisco SD-WAN Manager returns an error message. If you attach a second device template to the Cisco SD-WAN Controller, it overwrites the first one.

To create device templates from feature templates:

1. From the Cisco SD-WAN Manager menu, select **Configuration > Templates**.
2. Click **Device Templates**.



---

**Note** In Cisco vManage Release 20.7.x and earlier releases, **Device Templates** is called **Device**.

---

3. From the **Create Template** drop-down select **From Feature Templates**.
4. From the **Device Model** drop-down list, select **Controller**.
5. Enter a name and description for the Cisco SD-WAN Controller device template. These fields are mandatory. You cannot use any special characters in template names.
6. Complete the **Required Templates** section. All required templates are marked with an asterisk.
  - a. For each required template, select the feature template from the drop-down list. These templates are the ones that you previously created (see Create Feature Templates above). After you select a template, the circle next to the template name turns green and displays a green check mark.
  - b. For templates that have Sub-Templates, click the plus (+) sign or the Sub-Templates title to display a list of sub-templates. As you select a sub-template, the name of the sub-template along with a drop-down is displayed. If the sub-template is mandatory, its name is marked with an asterisk.
  - c. Select the desired sub-template.
7. Complete the **Optional Templates** section, if required. To do so:
  - a. Click **Optional Templates** to add optional feature templates to the device template.
  - b. Select the template to add.
  - c. Click the template name and select a specific feature template.
8. Click **Create**. The new device template is listed in the Templates table. The Feature Templates column shows the number of feature templates that are included in the device template, and the Type column shows "Feature" to indicate that the device template was created from a collection of feature templates.

To create device templates by entering a CLI text-style configuration directly on Cisco SD-WAN Manager:

1. From the Cisco SD-WAN Manager menu, select **Configuration > Templates**.
2. Click **Device Templates**.



---

**Note** In Cisco vManage Release 20.7.x and earlier releases, **Device Templates** is called **Device**.

---

3. From the **Create Template** drop-down list, select **CLI Template**.
4. In the **Add Device CLI Template** window, enter a template name and description, and select **Controller**.
5. Enter the configuration in the **CLI Configuration** box, either by typing it, cutting and pasting it, or uploading a file.
6. To convert an actual configuration value to a variable, select the value and click **Create Variable**. Enter the variable name, and click **Create Variable**. You can also type the variable name directly, in the format `{{variable-name}}`; for example, `{{hostname}}`.
7. Click **Add**. The right pane on the screen lists the new device template. The Feature Templates column shows the number of feature templates that are included in the device template, and the Type column shows "CLI" to indicate that the device template was created from CLI text.

## Attach a Device Template To Cisco SD-WAN Controllers

To configure a Cisco SD-WAN Controller, you attach one device template to the controller. You can attach the same template to multiple Cisco SD-WAN Controller simultaneously.

To attach a device template to Cisco SD-WAN Controllers:

1. From the Cisco SD-WAN Manager menu, select **Configuration > Templates**.
2. Click **Device Templates**.



---

**Note** In Cisco vManage Release 20.7.x and earlier releases, **Device Templates** is called **Device**.

---

3. For the desired device template, click **...**, and select **Attach Devices**.
4. In the **Attach Devices** window, select the desired Cisco SD-WAN Controller from the **Available Devices** column, and click the right-pointing arrow to move them to the **Selected Devices** column. You can select one or more controllers. Click **Select All** to choose all listed controllers.
5. Click **Attach**.
6. Click **Next**.
7. To preview the configuration that is about to be sent to Cisco SD-WAN Controller, in the left pane, click the device. The configuration is displayed in the right pane, in the **Device Configuration Preview** window.
8. To send the configuration in the device template to Cisco SD-WAN Controllers, click **Configure Devices**.

## Add Cisco Catalyst SD-WAN Controller to the Overlay Network

After you create a minimal configuration for Cisco SD-WAN Controller, you must add it to an overlay network by making Cisco SD-WAN Manager aware of the controller. When you add Cisco SD-WAN Controller, a signed certificate is generated and is used to validate and authenticate the controller.

Cisco SD-WAN Manager can support up to 20 Cisco SD-WAN Controllers in the network.

### Add a Cisco Catalyst SD-WAN Controller and Generate Certificate

To add a Cisco SD-WAN Controller to the network, automatically generate the CSR, and install the signed certificate:

1. From the Cisco SD-WAN Manager menu, choose **Configuration > Devices**.
2. Click **Controllers**, and from the **Add Controller** drop-down menu.



---

**Note** Starting from Cisco IOS XE Catalyst SD-WAN Release 17.13.1a, the **Controllers** tab is renamed as the **Control Components** tab to stay consistent with Cisco Catalyst SD-WAN rebranding.

---

3. In the **Add Controller** window:
  - a. Enter the system IP address of Cisco SD-WAN Controller.
  - b. Enter the username and password to access Cisco SD-WAN Controller.
  - c. Choose the protocol to use for control-plane connections. The default is DTLS.
  - d. If you select TLS, enter the port number to use for TLS connections. The default is 23456.
  - e. Check the **Generate CSR** check box to allow the certificate-generation process to occur automatically.
  - f. Click **Add**.

Cisco SD-WAN Manager automatically generates the CSR, retrieves the generated certificate, and installs it on Cisco SD-WAN Controller. The new controller is listed in the Controller table with the controller type, hostname of the controller, IP address, site ID, and other details.

### Verify Certificate Installation

To verify that the certificate is installed on a Cisco SD-WAN Controller:

1. From the Cisco SD-WAN Manager menu, choose **Configuration > Devices**.
2. Choose the new controller listed and check in the Certificate Status column to ensure that the certificate has been installed.



---

**Note** If Cisco SD-WAN Controller and Cisco SD-WAN Validator have the same system IP addresses, they do not appear in Cisco SD-WAN Manager as devices or controllers. The certificate status of Cisco SD-WAN Controller and Cisco SD-WAN Validator is also not displayed. However, the control connections still successfully comes up.

---

**What's Next**

See *Deploy the vEdge Routers*.

# Deploy Cisco Catalyst 8000V Using Cloud Services Provider Portals

*Table 24: Feature History*

Feature Name	Release Information	Description
Support for Deploying Cisco Catalyst 8000V Instances for Supported Cloud Services Provider Platforms	Cisco IOS XE Catalyst SD-WAN Release 17.4.1a	Starting from this release, Cisco Catalyst 8000V instances can be deployed on Cloud Services Provider portals such as Google Cloud Platform, Microsoft Azure and Amazon Web Services.
Support for Deploying Cisco Catalyst 8000V Instances on Alibaba Cloud	Cisco IOS XE Catalyst SD-WAN Release 17.5.1a	Starting from this release, Cisco Catalyst 8000V instances can be deployed on Alibaba Cloud.

For information on supported instances of Cisco Catalyst 8000V and how to deploy them on the supported cloud service provider portals, see the following links:

- [Deploying Cisco Catalyst 8000V Edge Software on Amazon Web Services](#)
- [Deploying Cisco Catalyst 8000V Edge Software on Microsoft Azure](#)
- [Deploying Cisco Catalyst 8000V Edge Software on Google Cloud Platform](#)
- [Cisco Catalyst 8000V Edge Software Deployment Guide for Alibaba Cloud](#)

## Notes and Limitations

- Creating new Cisco Catalyst 8000V instances by snapshot: Creating a new Cisco Catalyst 8000V instance by snapshot (cloning) results in a new instance with the same serial number as the original. This creates a conflict in Cisco Catalyst SD-WAN. You can use the snapshot (cloning) function to create a new instance only if the new instance is replacing an existing one, so that the serial number will be used with only one Cisco Catalyst 8000V instance.

# Deploy Cisco CSR 1000v Using Cloud Service Provider Portals

For information on supported instances of Cisco CSR 1000v routers and how to deploy them on the supported cloud service provider portals, see the following links:

- [Cisco CSR 1000v Series Cloud Services Router Deployment Guide for Amazon Web Services](#)
- [Cisco CSR 1000v Deployment Guide for Microsoft Azure](#)

# Deploy Cisco Catalyst 8000V Edge Software on Alibaba Cloud

This section provides information helpful when using the Alibaba Cloud instance with Cisco Catalyst SD-WAN. For detailed information about the Cisco Catalyst 8000V Edge Software deployment process, see [Cisco Catalyst 8000V Edge Software Deployment Guide for Alibaba Cloud](#).

## Features

The following Cisco Catalyst 8000V features are not supported in an Alibaba Cloud deployment when operating as part of Cisco Catalyst SD-WAN:

**Table 25: Unsupported Features**

Feature	Additional Information
<b>Deployment and Licensing</b>	
Cisco Catalyst SD-WAN Cloud onRamp integration	Connect the Cisco Catalyst 8000V to Cisco Catalyst SD-WAN by creating a bootstrap file, as described in <a href="#">Create a Bootstrap File for a Cisco Catalyst 8000V Instance Using Cisco Catalyst SD-WAN, on page 192</a> . Deployment by Cloud onRamp is not supported.
Pay as you go (PAYG) licensing	None

## Requirements for the Cisco Catalyst 8000V Instance

The Cisco Catalyst 8000V instance deployed in Alibaba Cloud must meet the following requirements to work with Cisco Catalyst SD-WAN:

- Alibaba Cloud Elastic Compute Service (ECS) instance type: G5ne
- vCPU: 2
- RAM: 8 GB

The following image options are supported by Cisco Catalyst SD-WAN:

- ecs.g5ne.large: 2 vCPU and 8 GB RAM
- ecs.g5ne.xlarge: 4 vCPU and 16 GB RAM
- ecs.g5ne.2xlarge: 8 vCPU and 32 GB RAM

## Configure the Cisco Catalyst 8000V Instance to Connect to Cisco Catalyst SD-WAN

When you create a Cisco Catalyst SD-WAN instance on Alibaba Cloud, create a Day 0 bootstrap file using Cisco SD-WAN Manager and use this bootstrap file on the Cisco Catalyst 8000V instance to onboard the

instance to Cisco Catalyst SD-WAN. When the instance starts up using the bootstrap file, it connects to the Cisco SD-WAN Validator and Cisco SD-WAN Manager controller.

## Create a Bootstrap File for a Cisco Catalyst 8000V Instance Using Cisco Catalyst SD-WAN

1. For instructions on creating a bootstrap file for a cloud-hosted device, using Cisco SD-WAN Manager, see Bootstrap Process for Cisco Catalyst SD-WAN Cloud-Hosted Devices.
2. In the Alibaba Cloud portal, create an instance of the Cisco Catalyst 8000V. When configuring the instance, use the bootstrap configuration that you created in Cisco SD-WAN Manager.

## Deploy the vEdge Cloud routers

vEdge routers, as their name implies, are edge routers that are located at the perimeters of the sites in your overlay network, such as remote office, branches, campuses, and data centers. They route the data traffic to and from their site, across the overlay network.

vEdge routers are either physical hardware routers or software vEdge Cloud router, which run as virtual machines on a hypervisor or an AWS server.

An overlay network can consist of a few or a large number of vEdge routers. A single Cisco SD-WAN Manager, which provides management and configuration services to the vEdge routers, can support up to about 2,000 routers, and a Cisco SD-WAN Manager cluster can support up to about 6,000 routers.

To deploy vEdge Cloud routers:

1. For software vEdge Cloud routers, create a VM instance, either on an AWS server, or on an ESXi or a KVM hypervisor.
2. For software vEdge Cloud router, install a signed certificate on the router. In Releases 17.1 and later, Cisco SD-WAN Manager can act as a Certificate Authority (CA) and can automatically generate and installed signed certificates on vEdge Cloud router. In earlier releases, send a certificate signing request to Symantec and then install that certificate on the router so that the router can be authenticated on and can participate in the overlay network.
3. From Cisco SD-WAN Manager, send the serial numbers of all vEdge Cloud routers to Cisco SD-WAN Controllers and Cisco SD-WAN Validators in the overlay network.
4. Create a full configuration for the vEdge Cloud router. You do this by creating a Cisco SD-WAN Manager template for Cisco SD-WAN Validator and attaching that template to the orchestrator. When you attach the Cisco SD-WAN Manager template, the initial minimal configuration is overwritten.
5. Prepare hardware vEdge Cloud router for automatic provisioning, which is done using the Cisco Catalyst SD-WAN zero-touch provisioning (ZTP) tool. The ZTP process allows hardware routers to join the overlay network automatically.

Starting with Release 18.2.0, vEdge Cloud routers that are hosted in countries affected by United States government embargoes cannot connect to overlay network controllers (Cisco SD-WAN Validators, Cisco SD-WAN Managers, and Cisco SD-WAN Controllers) that are hosted in the Cisco cloud. Any vEdge Cloud router from an embargoed country that attempts to connect to one of these controllers will be disabled. (The vEdge Cloud routers can, however, connect to controllers that are hosted in other clouds). As a result, when

a vEdge Cloud router initially attempts to connect to a controller in the Cisco cloud, the router might not come up and might remain in a pending state if the Cisco SD-WAN Validator and the Cisco SD-WAN Manager are unable to communicate with each other or if the Cisco cloud server is down.

## Create vEdge Cloud router VM Instance on AWS



**Note** Starting from Cisco vManage Release 20.9.1, vEdge Cloud router is not supported.

To start a software vEdge Cloud router, you must create a virtual machine (VM) instance for it. This article describes how to create a VM instance on Amazon AWS. You can also create the VM on a server running the vSphere ESXi Hypervisor software or the Kernel-based Virtual Machine (KVM) Hypervisor software.

To start the vEdge Cloud router virtual machine (VM) instance on Amazon AWS, first create a Virtual Private Cloud (VPC). The VPC is a self-contained environment in which you build the infrastructure you need in order to build your network.

Plan your network addressing carefully before creating the VPC. The VPC can use addresses only in the range you specify, and once you create a VPC, you cannot modify it. If your network addressing requirements change, you must delete the VPC and create a new one.

Starting Cisco SD-WAN 18.4 Release, Cisco Cloud Services 1000v (CSR 1000v) Router Cisco Catalyst SD-WAN version is supported on AWS.

To start a vEdge Cloud router on Amazon AWS:

1. Create a VPC.
2. Set up the vEdge Cloud router VM instance.
3. Define additional interfaces.

### Create a VPC

Plan your network address blocks carefully before creating the VPC. Once you create a VPC, you cannot modify it. To make any changes to the network addressing, you must delete the VPC and create a new one.

1. Log in to AWS. In the Networking section of the AWS home page, click **VPC**.
2. On the page that opens, click **Start VPC**.
3. On the Select a VPC Configuration page, select **VPC with Public and Private Subnets**.
4. On the VPC with Public and Private Subnets screen:
  - a. In IP CIDR Block, enter the desired IP addressing block. The VPC can use addresses only in this range.
  - b. Specify a public subnet and a private subnet from within the IP CIDR block.
  - c. In Elastic IP Allocation ID, enter the address of your Internet gateway. This gateway translates internal traffic for delivery to the public Internet.
  - d. Add endpoints for S3 only if you need extended storage space, such as for a large database.
  - e. To use the AWS automatic registration of IP addresses to DNS, enable DNS hostnames.

- f. Select the desired Hardware tenancy, either shared or dedicated. You can share your AWS hardware with other AWS clients, or you can have dedicated hardware. With dedicated hardware, the device assigned to you can host only your data. However, the cost is higher.
- g. Click **Create VPC**.

Wait a few minutes until the VPC Dashboard displays the VPC Successfully Created message.

The infrastructure is now complete and ready for you to deploy applications, appliances, and the vEdge Cloud router. Click the links on the left to see the subnets, route tables, internet gateways, and NAT address translation points in the VPC.

### Set Up the vEdge Cloud router VM Instance

1. Click **Services > EC2** to open the EC2 Dashboard, and then click **Launch Instance**.
1. Choose an Amazon Machine Image (AMI). The Cisco Catalyst SD-WAN AMI has a name in the format *release-number-vEdge*; for example, 16.1.0-vEdge. The Cisco Catalyst SD-WAN AMI is private. Contact your Cisco Catalyst SD-WAN sales representative, who can share it with you.
2. Choose the Cisco Catalyst SD-WAN AMI, then click **Select**.
3. The Choose an Instance Type screen appears. Determine which instance type best meets your needs, according to the following table. The minimum requirement is 2 vCPUs.

**Table 26: Table 1: EC2 Instance Types that Support the vEdge Cloud router**

	vCPU	Memory (GB)	Instance Storage (GB)
<b>General Purpose — Current Generation</b>			
m4.large	2	8	EBS only
m4.xlarge	4	16	EBS only
m4.2xlarge	8	32	EBS only
m4.4xlarge	16	64	EBS only
m4.10xlarge	40	160	EBS only
<b>Compute Optimized — Current Generation</b>			
c4.large	2	3.75	EBS only
c4.xlarge	4	7.5	EBS only
c4.2xlarge	8	15	EBS only
c4.4xlarge	16	30	EBS only
c4.8xlarge	36	60	EBS only
c3.large	2	3.75	2 x 16 SSD



	vCPU	Memory (GB)	Instance Storage (GB)
c3.xlarge	4	7.5	2 x 40 SSD
c3.2xlarge	8	15	2 x 80 SSD
c3.4xlarge	16	30	2 x 160 SSD
c3.8xlarge	32	60	2 x 320 SSD

4. Select the preferred instance type, then click **Next**: Configure Instance Details.

### Configure Instance Details

On the Configure Instance Details screen:

1. In Network, select the VPC you just created.
2. In Subnet, select the subnet for your first interface.
3. In Network Interfaces, click **Add Device** and select a subnet for each additional interface.



#### Note

Starting from Cisco SD-WAN Release 20.5.1, a Cisco vEdge Cloud router VM with the default username and password (admin/admin) cannot be deployed on AWS. Therefore, when you deploy a Cisco vEdge Cloud router VM using a third-party cloud provider, ensure that you use the following cloud configuration to continue using the default credentials.

In the **User Data** field, enter the following cloud configuration:

```
#cloud-config

hostname: vedge
write_files:
- content: "vedge\n"
  owner: root:root
  path: /etc/default/personality
  permissions: '0644'
- content: "1\n"
  owner: root:root
  path: /etc/default/inited
  permissions: '0600'
- path: /etc/confd/init/zcloud.xml
  content: |
    <config xmlns="http://tail-f.com/ns/config/1.0">
      <system xmlns="http://viptela.com/system">
        <aaa>
          <user>
            <name>admin</name>
            <password>$6$9ac6aF765f1cc0c0$jFM/rCPsQ56J1U/1s9f7zhksy/FZhw37zDJkMgh/IU/FsrItcBulw3AVI5kChf9wtrqF8CsGk.4PrjC22/</password>
          </user>
          <group>netadmin</group>
        </aaa>
      </system>
    </config>
```

This cloud configuration configures the VM with admin/admin credentials, and forces a password change on your first login.

5. Click **Next: Add Storage**.
6. The Add Storage page opens. You do not need to change any settings on this screen. Click **Next: Tag Instance**.
7. The Tag Instance page opens. Enter your desired Key and Value, and then click **Next: Configure Security Group**.
8. The Configure Security Group page opens. Add rules to configure your firewall settings. These rules apply to outside traffic coming into your vEdge Cloud router.
  - a. Below **Type**, select **SSH**.
  - b. Below **Source**, select **My IP**.
9. Click **Add Rule**, then fill out the fields as follows:
  - a. Below **Type**, select **Custom UDP Rule**.
  - b. Below **Port Range**, enter **12346**.
  - c. Below **Source**, select **Anywhere**. 12346 is the default port for IPSec.
  - d. If **port hopping** is enabled, you may need to add more rules.
10. Click **Review and Launch**. The Review Instance Launch screen opens. Click **Launch**.
11. Select **Proceed without a key pair**, click the acknowledgement check box, then click **Launch Instances**.
12. Wait a few minutes, the instance initializes. The vEdge Cloud router is now running. The first interface, eth0, is always the management interface. The second interface, ge0/0, appears in VPN 0, but you can configure it to be in a different VPN.

### Define Additional Interfaces

The vEdge Cloud router supports a total of nine interfaces. The first is always the management interface, and the remaining eight are transport and service interfaces. To configure additional interfaces:

1. In the left pane, click **Network Interfaces**.
2. Click **Create Network Interface**. Select the **Subnet and Security group**, and then click **Yes, Create**. Note that two interfaces in the same routing domain cannot be in the same subnet.
3. Select the check box to the left of the new interface, and click **Attach**.
4. Select the vEdge Cloud router, and click **Attach**.
5. Reboot the vEdge Cloud router, because the vEdge Cloud router detects interfaces only during the boot process.

The new interface is now up. The interface in VPN 0 connects to a WAN transport, such as the internet. The interface in VPN 1 faces a service-side network and can be used for appliances and applications. The interface in VPN 512 is dedicated to out-of-band management.

6. To allow the interface to carry jumbo frames (packets with an MTU of 2000 bytes), configure the MTU from the CLI. For example:

```
Router# show interface
```

VPN	INTERFACE	AF		TCP		IF		ENCAP TX	PORT	TYPE	MTU	HWADDR
		TYPE	IP ADDRESS	MSS	ADJUST	ADMIN	OPER					
		SPEED	DUPLEX			UPTIME	PACKETS	PACKETS				
0	ge0/0	ipv4	10.66.15.15/24	Up	Up	null	service	1500				
	00:0c:29:db:f0:62	1000	full	1420	0:14:05:07	545682	545226					
0	ge0/1	ipv4	10.1.17.15/24	Up	Up	null	service	1500				
	00:0c:29:db:f0:6c	1000	full	1420	0:14:21:19	0	10					
0	ge0/2	ipv4	-	Down	Up	null	service	1500				
	00:0c:29:db:f0:76	1000	full	1420	0:14:21:47	0	0					
0	ge0/3	ipv4	10.0.20.15/24	Up	Up	null	service	1500				
	00:0c:29:db:f0:80	1000	full	1420	0:14:21:19	0	10					
0	ge0/6	ipv4	172.17.1.15/24	Up	Up	null	service	1500				
	00:0c:29:db:f0:9e	1000	full	1420	0:14:21:19	0	10					
0	ge0/7	ipv4	10.0.100.15/24	Up	Up	null	service	1500				
	00:0c:29:db:f0:a8	1000	full	1420	0:14:21:19	770	705					
0	system	ipv4	172.16.255.15/32	Up	Up	null	loopback	1500				
	00:00:00:00:00:00	0	full	1420	0:14:21:30	0	0					
0	loopback3	ipv4	10.1.15.15/24	Up	Up	null	transport	2000				
	00:00:00:00:00:00	10	full	1920	0:14:21:22	0	0					
1	ge0/4	ipv4	10.20.24.15/24	Up	Up	null	service	2000				
	00:0c:29:db:f0:8a	1000	full	1920	0:14:21:15	52014	52055					
1	ge0/5	ipv4	172.16.1.15/24	Up	Up	null	service	1500				
	00:0c:29:db:f0:94	1000	full	1420	0:14:21:15	0	8					
512	eth0	ipv4	10.0.1.15/24	Up	Up	null	service	1500				
	00:50:56:00:01:05	0	full	0	0:14:21:16	28826	29599					

```
Router# config
```

```
Entering configuration mode terminal
```

```
Router(config)# vpn 0 interface ge0/3 mtu 2000
```

```
Router(config-interface-ge0/3)# commit
```

```
Commit complete.
```

```
vEdge(config-interface-ge0/3)# end
```

```
vEdge# show interface
```

VPN	INTERFACE	AF		TCP		IF		ENCAP TX	PORT	TYPE	MTU	HWADDR
		TYPE	IP ADDRESS	MSS	ADJUST	ADMIN	OPER					
		SPEED	DUPLEX			UPTIME	PACKETS	PACKETS				
0	ge0/0	ipv4	10.66.15.15/24	Up	Up	null	service	1500				
	00:0c:29:db:f0:62	1000	full	1420	0:14:05:30	546018	545562					
0	ge0/1	ipv4	10.1.17.15/24	Up	Up	null	service	1500				
	00:0c:29:db:f0:6c	1000	full	1420	0:14:21:42	0	10					
0	ge0/2	ipv4	-	Down	Up	null	service	1500				
	00:0c:29:db:f0:76	1000	full	1420	0:14:22:10	0	0					
0	ge0/3	ipv4	10.0.20.15/24	Up	Up	null	service	2000				
	00:0c:29:db:f0:80	1000	full	1920	0:14:21:42	0	10					
0	ge0/6	ipv4	172.17.1.15/24	Up	Up	null	service	1500				
	00:0c:29:db:f0:9e	1000	full	1420	0:14:21:42	0	10					
0	ge0/7	ipv4	10.0.100.15/24	Up	Up	null	service	1500				
	00:0c:29:db:f0:a8	1000	full	1420	0:14:21:42	773	708					
0	system	ipv4	172.16.255.15/32	Up	Up	null	loopback	1500				
	00:00:00:00:00:00	0	full	1420	0:14:21:54	0	0					
0	loopback3	ipv4	10.1.15.15/24	Up	Up	null	transport	2000				
	00:00:00:00:00:00	10	full	1920	0:14:21:46	0	0					

```

1    ge0/4    ipv4  10.20.24.15/24  Up    Up    null  service  2000
00:0c:29:db:f0:8a 1000  full  1920    0:14:21:38 52038 52079
1    ge0/5    ipv4  172.16.1.15/24  Up    Up    null  service  1500
00:0c:29:db:f0:94 1000  full  1420    0:14:21:38 0      8
512 eth0      ipv4  10.0.1.15/24   Up    Up    null  service  1500
00:50:56:00:01:05 0      full  0        0:14:21:39 28926 29663

```

The following instances support jumbo frames:

- Accelerated computing—CG1, G2, P2
- Compute optimized—C3, C4, CC2
- General purpose—M3, M4, T2
- Memory optimized—CR1, R3, R4, X1
- Storage optimized—D2, H11, HS1, I2

### What's Next

See *Install Signed Certificates on vEdge Cloud Routers*.

## Create vEdge Cloud router VM Instance on Azure

To start a software vEdge Cloud router, you must create a virtual machine (VM) instance for it. This article describes how to create a VM instance on Microsoft Azure. You can also create the VM on Amazon AWS or on a server running the vSphere ESXi Hypervisor software or the Kernel-based Virtual Machine (KVM) Hypervisor software.

Note: Cisco Catalyst SD-WAN offers only a Bring Your Own License (BYOL) for the vEdge Cloud router, so you are not actually purchasing the Cisco Catalyst SD-WAN product. You are charged hourly for the VNET instance.

For server requirements, see *Server Hardware Recommendations*.

### Launch Azure Marketplace and Create a vEdge Cloud router VM Instance

1. Launch the Azure Marketplace application:
  - a. In the left pane, click **New** to create a new vEdge Cloud router VM instance.
  - b. In the **Search** box, search for **Cisco**.
2. In the right pane, select Cisco vEdge Cloud router (3 NICs) (Staged).
3. In the Cisco vEdge Cloud router (3 NICs) (Staged) screen, click **Basics** in the left pane to configure basic settings for the vEdge Cloud router VM:
  - a. In the **VM Name** field, enter a name for the vEdge Cloud router VM instance.
  - b. In the **Username** field, enter the name of a user who can access the VM instance.
  - c. In the **Authentication type** field, select either **Password** or **SSH public key**.
  - d. If you selected password, enter, and then confirm, your password. You use the username and password to open SSH session to the VM instance.



Figure 26: Example Topology of VNET with VM Subnets

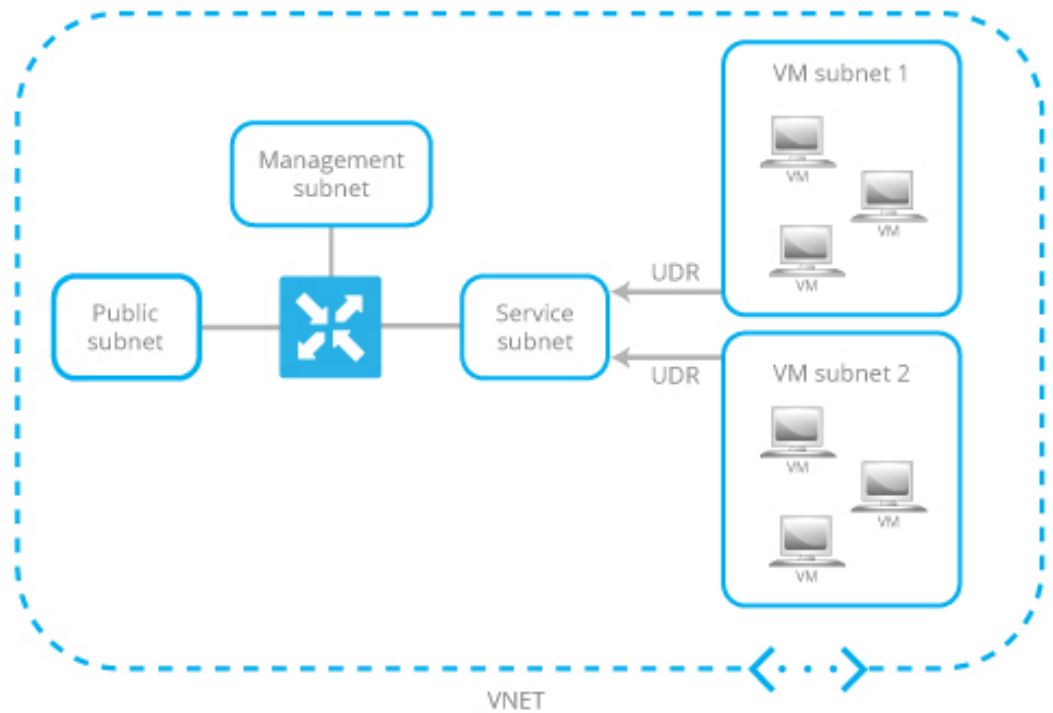

368532

- g. If you created a new VNET, define the address space within that VNET. Then click **OK** in the Subnets pane.

Cisco Catalyst SD-WAN prepopulates subnet names and assigns IP addresses per subnet from the VNET address space you defined. If you plan to connect your VNET instances through the service subnet associated to the vEdge Cloud router, you do not need to make updates to the route table.

6. In the Summary pane, click **OK**. The Summary pane validates and displays the configuration you defined for the vEdge Cloud router VM instance.
7. Click **Buy to purchase**. Then click **Purchase** in the **Purchase** pane.



**Note** Cisco Catalyst SD-WAN offers only a Bring Your Own License (BYOL) for the vEdge Cloud router, so you are not actually purchasing the Viptela product. You are charged hourly for the VNET instance.

The system creates the vEdge Cloud router VM instance and notifies you that the deployment has succeeded.

8. Click the **vEdge VM** instance you just created.  
The system displays the public IP address and DNS name of the vEdge Cloud router VM instance.
9. SSH into the public IP address of the vEdge Cloud router VM instance.
10. At the login prompt, log in with the username and password you created in Step 3. To view the vEdge Cloud router default configuration, enter the following command:

```
vEdge# show running-config
```

When you create a vEdge Cloud router VM, the security group configuration shown below is applied to the NIC associated with the public subnet. This security group does not restrict traffic from specific sources, but it does restrict specific services. Custom services for TCP and UDP that need to be enabled for Cisco Catalyst SD-WAN control protocols are also automatically configured. You can change the security group configuration to suit your requirements.

### vEdge Cloud Router Interface and Subnet Mapping

To create a vEdge Cloud router VM instance on Azure Marketplace, a minimum of three NICs are required—one each for management, service, and transport. The table below shows the mapping of the vEdge Cloud router interface with the subnet associated to these NICs.

vEdge Cloud Router Interface	Subnet	Description
eth0	Management subnet	In-band management
ge0/1	Service subnet	Connects the vEdge Cloud router as a gateway device
ge0/0	Transport subnet	Transport/WAN link

### What's Next

See *Install Signed Certificates on vEdge Cloud Routers*.

## Create vEdge Cloud VM Instance on ESXi

To start a software vEdge Cloud router, you must create a virtual machine (VM) instance for it. This article describes how to create a VM instance on a server running the vSphere ESXi Hypervisor software. You can also create the VM on Amazon AWS or on a server running the Kernel-based Virtual Machine (KVM) Hypervisor software.

For server requirements, see *Server Hardware Recommendations*.

To create a vEdge Cloud VM instance on the ESXi hypervisor:

1. Launch the vSphere Client and create a vEdge Cloud VM instance.
2. Add a vNIC for the tunnel interface.
3. Start the vEdge Cloud VM instance and connect to the console.

The details of each step are provided below.

If you are using the VMware vCenter Server to create the vEdge Cloud VM instance, follow the same procedure. Note, however, that the vCenter Server screens look different than the vSphere Client screens shown in the procedure.

### Launch vSphere Client and Create a vEdge Cloud VM Instance

1. Launch the VMware vSphere Client application, and enter the IP address or name of the ESXi server, your username, and your password. Click Login to log in to the ESXi server.

The system displays the ESXi screen.

2. Click **File > Deploy OVF Template** to deploy the virtual machine.
3. In the Deploy OVF Template screen, enter the location to install and download the OVF package. This package is the vedge.ova file that you downloaded from Cisco. Then click **Next**.
4. Click **Next** to verify OVF template details.
5. Enter a name for the deployed template and click **Next**. The figure below specifies a name for the vEdge instance.
6. Click **Next** to accept the default format for the virtual disks.
7. Click **Next** to accept your destination network name as the destination network for the deployed OVF template. In the figure below, CorpNet is the destination network.
8. In the Ready to Complete screen, click **Finish**.

The system has successfully created the VM instance with the parameters you just defined and displays the vSphere Client screen with the **Getting Started** tab selected. By default, this includes four vNICs which can be used for the management, tunnel, or service interface.

### Add a New vNIC

1. In the left navigation bar of the vSphere Client, select the vEdge Cloud VM instance you just created, and click **Edit virtual machine settings**.
2. In the vEdge Cloud – Virtual Machine Properties screen, click **Add** to add a new vNIC. Then click **OK**.
3. Click Ethernet Adapter for the type of device you wish to add. Then click **Next**.
4. In the **Adapter Type** drop-down, select VMXNET3 for the vNIC to add. Then click **Next**.
5. In the Ready to Complete screen, click **Finish**.
6. The vEdge Cloud – Virtual Machine Properties screen opens showing that the new vNIC is being added. Click **OK** to return to the vSphere Client screen.

### Modify the MTU for a vSwitch

To allow the interface to carry jumbo frames (packets with an MTU of 2000 bytes), configure the MTU for each virtual switch (vSwitch):

1. Launch the ESXi Hypervisor and select the **Configuration** tab.
2. In the **Hardware** field, click **Networking**. The network adapters you added are displayed in the right pane.
  - a. Click **Properties** for the vSwitch whose MTU you wish to modify.
3. In the vSwitch Properties screen, click **Edit**.
4. In the **Advanced Properties MTU** drop-down, change the vSwitch MTU to the desired value. The range is 2000 to 9000. Then click **OK**.



### Start the vEdge Cloud VM Instance and Connect to the Console

1. In the left navigation bar of the vSphere Client, select the vEdge Cloud VM instance you just created, and click **Power** on the virtual machine. The vEdge Cloud virtual machine is powered on.
2. Select the **Console** tab to connect to the vEdge Cloud console.
3. At the login prompt, log in with the default username, which is **admin**, and the default password, which is **admin**. To view the vEdge Cloud router default configuration, enter the following command:

```
vEdge# show running-config
```

### Mapping vNICs to Interfaces

When you create a vEdge Cloud router VM instance on ESXi in the procedure in the previous section, you create two vNICs: vNIC 1, which is used for the management interface, and vNIC 2, which is used as a tunnel interface. From the perspective of the VM itself, these two vNICs map to the eth0 and eth1 interfaces, respectively. From the perspective of the Cisco Catalyst SD-WAN software for the vEdge Cloud router, these two vNICs map to the mgmt0 interface in VPN 512 and the ge0/0 interface in VPN 0, respectively. You cannot change these mappings.

You can configure up to five additional vNICs, numbered 3 through 7, on the VM host. You can map these vNICs to interfaces eth2 through eth7 as desired, and to Cisco Catalyst SD-WAN interfaces ge0/1 through ge0/7, as desired.

The table below summarizes the mapping between vNICs, VM host interfaces, and vEdge Cloud interfaces.

**Table 27:**

vNIC	Interface on VM Host	Interface in vEdge Cloud Configuration
vNIC 1	eth0	mgmt0 in VPN 512
vNIC 2	eth1	ge0/0
vNIC 3 through 7	eth2 through eth7	ge0/1 through ge0/7



**Note** The traffic destined to VRRP IP is not forwarded by ESXi, since VRRP MAC address is not learned by the Virtual Software Switch of ESXi associated with the vEdge Ethernet interface. This is due to the limitation of the VMWare ESXi, which does not allow multiple unicast MAC address configuration on vNIC. As a workaround, place the vNIC in promiscuous mode and perform MAC filtering in the software. To let Cisco vEdge software place interface in promiscuous mode, Virtual Software Switch port-group or switch configuration must be changed to allow the same. Be aware that ESXi VSS forwards all packets to all virtual machines that are connected to the port-group or switch. This can have an adverse performance impact on the ESXi Host other virtual machines. This might also have an adverse effect on the vEdge packet processing performance. Design your network carefully to avoid performance impact.

### What's Next

See *Install Signed Certificates on vEdge Cloud Routers*.

## Create vEdge Cloud VM Instance on KVM

To start a software vEdge Cloud router, you must create a virtual machine (VM) instance for it. This article describes how to create a VM instance on a server running the Kernel-based Virtual Machine (KVM) Hypervisor software. You can also create the VM on Amazon AWS or on a server running the vSphere ESXi Hypervisor software.

For server requirements, see *Server Hardware Recommendations*.

### Create vEdge Cloud VM Instance on the KVM Hypervisor

To create a vEdge Cloud VM instance on the KVM hypervisor:

1. Launch the Virtual Machine Manager (virt-manager) client application. The system displays the Virtual Machine Manager screen.
2. Click **New** to deploy the virtual machine. The system opens the Create a new virtual machine screen.
3. Enter the name of the virtual machine. The figure below specifies a name for the vEdge Cloud instance.
  - a. Select **Import existing disk image**.
  - b. Click **Forward**.
4. In **Provide the existing storage path** field, click **Browse to find the vEdge Cloud software image**.
  - a. In the **OS Type** field, select **Linux**.
  - b. In the **Version** field, select the Linux version you are running.
  - c. Click **Forward**.
5. Specify Memory and CPU based on your network topology and the number of sites. Click **Forward**.
6. Select **Customize configuration before install**. Then click **Finish**.
7. Select **Disk 1** in the left navigation bar. Then:
  - a. Click **Advanced Options**.
  - b. In the **Disk Bus** field, select **IDE**.
  - c. In the **Storage Format** field, select **qcow2**.
  - d. Click **Apply** to create the VM instance with the parameters you just defined. By default, this includes one vNIC. This vNIC is used for the management interface.



---

**Note** Cisco Catalyst SD-WAN software supports VMXNET3 and Virtio vNICs. It is recommended, however, that you use the Virtio vNICs.

---

8. In the vEdge Cloud Virtual Machine screen, click **Add Hardware** to add a second vNIC for the tunnel interface.
9. In the Add New Virtual Hardware screen, click **Network**.
  - a. In the **Host Device** field, select an appropriate host device.

- b. Click **Finish**.

The newly created vNIC is listed in the left pane. This vNIC is used for the tunnel interface.

10. Create an ISO file to include a cloud-init configuration for the vEdge Cloud router.



---

**Note** Starting from Cisco SD-WAN Release 20.7.1, the cloud-init configuration file should only contain the minimum configuration required for setting up control connections to Cisco SD-WAN Manager. Other configuration such as the VPN0 and clear-text passwords should be pushed through the Add-On CLI template on Cisco SD-WAN Manager.

---

11. In the Virtual Machine Manager screen, click Add Hardware to attach the ISO file you created.
12. In the Add New Virtual Hardware screen:
  - a. Click **Select** managed or other existing storage.
  - b. Click **Browse** and select the ISO file you created.
  - c. In the **Device type** field, select IDE CDROM.
  - d. Click **Finish**.
13. To allow the interface to carry jumbo frames (packets with an MTU of 2000 bytes), configure the MTU for each virtual network (vnet) and virtual bridge NIC-containing VNET (virbr-nic) interface to a value in the range of 2000 to 9000:
  - a. From the VM shell, issue the following command to determine the MTU on the vnet and virbr-nic interfaces:

```
user@vm:~$ ifconfig -a
virbr1-nic Link encap:Ethernet HWaddr 52:54:00:14:4e:6f
           BROADCAST MULTICAST MTU:1500 Metric
           RX packets:0 errors:0 dropped:0 overruns:0 frame:0
           TX packets:0 errors:0 dropped:0 overruns:0 carrier:0
           collisions:0 txqueuelen:500
           RX bytes:0 (0.0 B) TX bytes:0 (0.0B)
...
vnet0     Link encap:Ethernet HWaddr fe:50:56:00:10:1e
           inet6 addr: fe80::fc50:56ff:fe00:11e/64 Scope:Link
           UP BROADCAST RUNNING MULTICAST MTU:1500 Metric:1
           RX packets:167850 errors:0 dropped:0 overruns:0 frame:0
           TX packets:663186 errors:0 dropped:0 overruns:0 carrier:0
           collisions:0 txqueuelen:500
           RX bytes:19257426 (19.2 MB) TX bytes:42008544 (42.0 MB)
...
```

- b. Change the MTU of each vnet:

```
user@vm:~$ sudo ifconfig vnet number mtu 2000
```

- c. Change the MTU of each virbr-nic:

```
user@vm:~$ sudo ifconfig virbr-nic number mtu 2000
```

- d. Verify the MTU value:

```
user@vm:~$ ifconfig -a
```

14. In the vEdge Cloud Virtual Machine page, click **Begin Installation** in the top upper-left corner of the screen.
15. The system creates the virtual machine instance and displays the vEdge Cloud console.
16. At the login prompt, log in with the default username, which is **admin**, and the default password, which is **admin**. To view the vEdge Cloud router default configuration, enter the following command:

```
vEdge# show running-config
```

Note that the Cisco Catalyst SD-WAN software supports VMXNET3 and Virtio vNICs. It is recommended, however, that you use the Virtio vNICs.

### Mapping vNICs to Interfaces

When you create a vEdge Cloud router VM instance on KVM in the procedure in the previous section, you create two vNICs: vNIC 1, which is used for the management interface, and vNIC 2, which is used as a tunnel interface. From the perspective of the VM itself, these two vNICs map to the eth0 and eth1 interfaces, respectively. From the perspective of the Cisco Catalyst SD-WAN software for the vEdge Cloud router, these two vNICs map to the mgmt0 interface in VPN 512 and the ge0/0 interface in VPN 0, respectively. You cannot change these mappings.

You can configure up to five additional vNICs, numbered 3 through 7, on the VM host. You can map these vNICs to interfaces eth2 through eth7 as desired, and to Cisco Catalyst SD-WAN interfaces ge0/1 through ge0/7, as desired.

The table below summarizes the mapping between vNICs, VM host interfaces, and vEdge Cloud interfaces.

**Table 28:**

vNIC	Interface on VM Host	Interface in vEdge Cloud Configuration
vNIC 1	eth0	mgmt0 in VPN 512
vNIC 2	eth1	ge0/0
vNIC 3 through 7	eth2 through eth7	ge0/1 through ge0/7

### What's Next

See *Install Signed Certificates on Edge Cloud Routers*.

## Configure Certificate Authorization Settings for WAN Edge Routers

Certificates are used to authenticate routers in the overlay network. Once authentication is complete, the routers can establish secure sessions with other devices in the overlay network.

By default, the WAN Edge Cloud Certificate Authorization is automated. This is the recommended setting.

If you use third-party certificate authorization, configure certificate authorization to be manual:

1. From the Cisco SD-WAN Manager menu, select **Administration > Settings**.

2. Click **Hardware WAN Edge Certificate Authorization**. (If you are using Cisco Catalyst SD-WAN Manager Release 20.12.1 or earlier, click **Edit**.)
3. In the **Security**, select Enterprise Certificate (signed by Enterprise CA).
4. Click **Save**.

## Install Signed Certificates on vEdge Cloud Routers

When a vEdge Cloud router virtual machine (VM) instance starts, it has a factory-default configuration, which allows the router to boot. However, the router is unable to join the overlay network. For the router to be able to join the overlay network, you must install a signed certificate on the router. The signed certificates are generated based on the router's serial number, and they are used to authorize the router to participate in the overlay network.

Starting from Releases 17.1, the Cisco SD-WAN Manager can act as a Certificate Authority (CA), and in this role it can automatically generate and install signed certificates on vEdge Cloud routers. You can also use another CA and then install the signed certificate manually. For Releases 16.3 and earlier, you manually install signed Symantec certificates on vEdge Cloud routers.

To install signed certificates:

1. Retrieve the vEdge authorized serial number file. This file contains the serial numbers of all the vEdge routers that are allowed to join the overlay network.
2. Upload the vEdge authorized serial number file to Cisco SD-WAN Manager.
3. Install a signed certificate on each vEdge Cloud router.

### Retrieve vEdge Authorized Serial Number File

1. Go to <http://viptela.com/support/> and log in.
2. Click **Downloads**.
3. Click **My Serial Number Files**. The screen displays the serial number files. Starting from Releases 17.1, the filename extension is .viptela. For Releases 16.3 and earlier, the filename extension is .txt.
4. Click the most recent serial number file to download it.

### Upload vEdge Authorized Serial Number File

1. From the Cisco SD-WAN Manager menu, select **Configuration > Devices**.
2. Click **vEdge List**, and select **Upload vEdge List**.
3. In the Upload vEdge window:
  - a. Click **Choose File**, and select the vEdge authorized serial number file you downloaded from Cisco.
  - b. To automatically validate the vEdge routers and send their serial numbers to the controllers, click and select the checkbox **Validate the Uploaded vEdge List** and **Send to Controllers**. If you do not select this option, you must individually validate each router in the **Configuration > Certificates > vEdge List** page.

#### 4. Click **Upload**.

During the process of uploading the vEdge authorized serial number file, the Cisco SD-WAN Manager generates a token for each vEdge Cloud router listed in the file. This token is used as a one-time password for the router. The Cisco SD-WAN Manager sends the token to the Cisco SD-WAN Validator and the Cisco SD-WAN Controller.

After the vEdge authorized serial number file has been uploaded, a list of vEdge routers in the network is displayed in the vEdge Routers Table in the **Configuration > Devices** page, with details about each router, including the router's chassis number and its token.

#### **Install Signed Certificates in Releases 17.1 and Later**

Starting from Releases 17.1, to install a signed certificates on a vEdge Cloud router, you first generate and download a bootstrap configuration file for the router. This file contains all the information necessary to allow the Cisco SD-WAN Manager to generate a signed certificate for the vEdge Cloud router. You then copy the contents of this file into the configuration for the router's VM instance. For this method to work, the router and the Cisco SD-WAN Manager must both be running Release 17.1 or later. Finally, you download the signed certificate to the router. You can configure the Cisco SD-WAN Manager to do this automatically or manually.

The bootstrap configuration file contains the following information:

- UUID, which is used as the router's chassis number.
- Token, which is a randomly generated one-time password that the router uses to authenticate itself with the Cisco SD-WAN Validator and the Cisco SD-WAN Manager.
- IP address or DNS name of the Cisco SD-WAN Validator.
- Organization name.

Starting from Cisco Catalyst SD-WAN Manager Release 20.12.1 you cannot include a comma in the **Organization Name** field of the bootstrap configuration file.

- If you have already created a device configuration template and attached it to the vEdge Cloud router, the bootstrap configuration file contains this configuration. For information about creating and attaching a configuration template, see [Create Configuration Templates for a vEdge Router](#) .

You can generate a bootstrap configuration file that contains information for an individual router or for multiple routers.

Starting from Releases 17.1, you can also have Symantec generate signed certificates that you install manually on each router, as described later in this article, but this method is not recommended.

#### **Configure the Cisco Catalyst SD-WAN Validator and Organization Name**

Before you can generate a bootstrap configuration file, you must configure the Cisco SD-WAN Validator DNS name or address and your organization name:

1. From the Cisco SD-WAN Manager menu, select **Administration > Settings**.
2. Click **Validator**. ( click **Edit**.)
3. In the **DNS/IP Address: Port field**, enter the DNS name or IP address of the Cisco SD-WAN Validator.
4. Click **Save**.

5. Verify the organization name. This name must be identical to that configured on the Cisco SD-WAN Validator. (If you are using Cisco Catalyst SD-WAN Manager Release 20.12.1 or earlier, to verify **Organization Name**, click **View**.)

Starting from Cisco Catalyst SD-WAN Manager Release 20.12.1, the system Organization Name cannot contain a comma. Comma is not allowed during the device configuration.

6. Click **Save**.

### Configure Automatic or Manual vEdge Cloud Authorization

Signed certificates must be installed on each vEdge cloud router so that the router is authorized to participate in the overlay network. You can use the Cisco SD-WAN Manager as the CA to generate and install the signed certificate, or you can use an enterprise CA to install the signed certificate.

It is recommended that you use the Cisco SD-WAN Manager as a CA. In this role, Cisco SD-WAN Manager automatically generates and installs a signed certificate on the vEdge Cloud router. Having Cisco SD-WAN Manager act as a CA is the default setting. You can view this setting in the WAN vEdge Cloud Certificate Authorization, on the Cisco SD-WAN Manager **Administration** > **Settings** page.

To use an enterprise CA for generating signed certificates for vEdge Cloud routers:

1. From the Cisco SD-WAN Manager menu, select **Administration** > **Settings**.
2. Click **WAN Edge Cloud Certificate Authorization** and select **Manual**.
3. Click **Save**.

### Generate a Bootstrap Configuration File



---

**Note** In Cisco SD-WAN Release 20.5.1, the cloud-init bootstrap configuration that you generate for the Cisco vEdge Cloud router cannot be used for deploying Cisco vEdge Cloud router 20.5.1. However, you can use the bootstrap configuration for deploying Cisco vEdge Cloud router 20.4.1 and the earlier versions.

---

To generate a bootstrap configuration file for a vEdge Cloud router:

1. From the Cisco SD-WAN Manager menu, select **Configuration** > **Devices**.
2. To generate a bootstrap configuration file for one or multiple vEdge Cloud routers:
  - a. Click **WAN Edge List**, select **Export Bootstrap Configuration**.
  - b. In the Generate Bootstrap Configuration field, select the file format:
    - For a vEdge Cloud router on a KVM hypervisor or on an AWS server, select **Cloud-Init** to generate a token, Cisco SD-WAN Validator IP address, vEdge Cloud router UUID, and organization name.

Starting from Cisco Catalyst SD-WAN Manager Release 20.12.1, the system Organization Name cannot contain a comma. Comma is not allowed during the device configuration.
    - For a vEdge Cloud router on a VMware hypervisor, select Encoded String to generate an encoded string.
  - c. From the **Available Devices** column, select one or more routers.

- d. Click the arrow pointing to right to move the selected routers to **Selected Devices** column.
  - e. Click **Generate Generic Configuration**. The bootstrap configuration is downloaded in a .zip file, which contains one .cfg file for each router.
3. To generate a bootstrap configuration file individually for each vEdge Cloud router:
    - a. Click **WAN Edge List**, select the desired vEdge Cloud router.
    - b. For the desired vEdge Cloud router, click ..., and select **Generate Bootstrap Configuration**.
    - c. In the **Generate Bootstrap Configuration** window, select the file format:
      - For a vEdge Cloud router on a KVM hypervisor or on an AWS server, select Cloud-Init to generate a token, Cisco SD-WAN Validator IP address, vEdge Cloud router UUID, and organization name.
      - For a vEdge Cloud router on a VMware hypervisor, select Encoded String to generate an encoded string.

**Note**

Beginning with Cisco vManage Release 20.7.1, there is an option available when generating a bootstrap configuration file for a Cisco vEdge device, enabling you generate two different forms of the bootstrap configuration file.

- If you are generating a bootstrap configuration file for a Cisco vEdge device that is using Cisco Catalyst SD-WAN Release 20.4.x or earlier, then check the **The version of this device is 20.4.x or earlier** check box.
- If you are generating a bootstrap configuration for a Cisco vEdge device that is using Cisco SD-WAN Release 20.5.1 or later, then do not use the check box.

- d. Click **Download** to download the bootstrap configuration. The bootstrap configuration is downloaded in a .cfg file.

Then use the contents of the bootstrap configuration file to configure the vEdge Cloud router instance in AWS, ESXi, or KVM. For example, to configure a router instance in AWS, paste the text of the Cloud-Init configuration into the User data field:

By default, the **ge0/0** interface is the router's tunnel interface, and it is configured as a DHCP client. To use a different interface or to use a static IP address, and if you did not attach a device configuration template to the router, change the vEdge Cloud router's configuration from the CLI. See *Configuring Network Interfaces*.

### Install the Certificate on the vEdge Cloud Router

If you are using automated vEdge Cloud certificate authorization, which is the default, after you configure the vEdge Cloud router instance, Cisco SD-WAN Manager automatically installs a certificate on the router and the router's token changes to its serial number. You can view the router's serial number in the **Configuration > Devices** page. After the router's control connections to the Cisco SD-WAN Manager come up, any templates attached to the router are automatically pushed to the router.

If you are using manual vEdge Cloud certificate authorization, after you configure the vEdge Cloud router instance, follow this procedure to install a certificate on the router:



1. Install the enterprise root certificate chain on the router:

```
vEdge# request root-cert-chain install filename [vpn vpn-id]
```

Then, Cisco SD-WAN Manager generates a CSR.

2. Download the CSR:
  - a. From the Cisco SD-WAN Manager menu, select **Configuration > Certificates**.
  - b. For the selected vEdge Cloud router for which to sign a certificate, click ... and select **View CSR**.
  - c. To download the CSR, click **Download**.
3. Send the certificate to a third-party signing authority, to have them sign it.
4. Import the certificate into the device:
  - a. From the Cisco SD-WAN Manager menu, select **Configuration > Certificates**.
  - b. Click **Controllers**, and select **Install Certificate**.
  - c. In the **Install Certificate** page, paste the certificate into the Certificate Text field, or click **Select a File** to upload the certificate in a file.
  - d. Click **Install**.
5. Issue the following REST API call, specifying the IP address of your Cisco SD-WAN Manager:

```
https://vmanage-ip-address/dataservice/system/device/sync/rootcertchain
```

### Create the vEdge Cloud Router Bootstrap Configuration from the CLI

It is recommended that you generate the vEdge Cloud router's bootstrap configuration using Cisco SD-WAN Manager. If, for some reason, you do not want to do this, you can create the bootstrap configuration using the CLI. With this process, you must still, however, use Cisco SD-WAN Manager. You collect some of this information for the bootstrap configuration from Cisco SD-WAN Manager, and after you have created the bootstrap configuration, you use Cisco SD-WAN Manager to install the signed certificate on the router.

Installing signed certificates by creating a bootstrap configuration from the CLI is a three-step process:

1. Edit the router's configuration file to add the DNS name or IP address of the Cisco SD-WAN Validator and your organization name.
2. Send the router's chassis and token numbers to Cisco SD-WAN Manager.
3. Have Cisco SD-WAN Manager authenticate the vEdge Cloud router and install the signed certificate on the router.

To edit the vEdge Cloud router's configuration file from the CLI:

1. Open a CLI session to the vEdge Cloud router via SSH. To do this in Cisco SD-WAN Manager, select **Tools > SSH Terminal** page, and select the desired router.
2. Log in as the user **admin**, using the default password, **admin**. The CLI prompt is displayed.
3. Enter configuration mode:

```
vEdge# config
vEdge(config)#
```

- Configure the IP address of the Cisco SD-WAN Validator or a DNS name that points to the Cisco SD-WAN Validator. The Cisco SD-WAN Validator's IP address must be a public IP address:

```
vEdge(config)# system vbond (dns-name | ip-address)
```

- Configure the organization name:

```
vEdge(config-system)# organization-name name
```

- Commit the configuration:

```
vEdge(config)# commit and-quit
vEdge#
```

To send the vEdge Cloud router's chassis and token numbers to Cisco SD-WAN Manager:

- Locate the vEdge Cloud router's token and chassis number:
  - From the Cisco SD-WAN Manager menu, select **Configuration > Devices**.
  - Click **WAN Edge List**, locate the vEdge Cloud router.
  - Make a note of the values in the vEdge Cloud router's Serial No./Token and Chassis Number columns.
- Send the router's bootstrap configuration information to Cisco SD-WAN Manager:

```
vEdge# request vedge-cloud activate chassis-number chassis-number token token-number
```

Issue the **show control local-properties** command on the router to verify the Cisco SD-WAN Validator IP address, the organization name the chassis number, and the token. You can also verify whether the certificate is valid.

Finally, have Cisco SD-WAN Manager authenticate the vEdge Cloud router and install the signed certificate on the router.

If you are using automated vEdge Cloud certificate authorization, which is the default, the Cisco SD-WAN Manager uses the chassis and token numbers to authenticate the router. Then, Cisco SD-WAN Manager automatically installs a certificate on the router and the router's token changes to a serial number. You can display the router's serial number in the **Configuration > Devices** page. After the router's control connections to Cisco SD-WAN Manager come up, any templates attached to the router are automatically pushed to the router.

If you are using manual vEdge Cloud certificate authorization, after you configure the vEdge Cloud router instance, follow this procedure to install a certificate on the router:

- Install the enterprise root certificate chain on the router:

```
vEdge# request root-cert-chain install filename [vpn vpn-id]
```

After you install the root chain certificate on the router, and after Cisco SD-WAN Manager receives the chassis and token numbers, Cisco SD-WAN Manager generates a CSR.

- Download the CSR:
  - From the Cisco SD-WAN Manager menu, select **Configuration > Certificates**.
  - For the selected vEdge Cloud router for which to sign a certificate, click **...** and select **View CSR**.
  - To download the CSR, click **Download**.
- Send the certificate to a third-party signing authority, to have them sign it.

4. Import the certificate into the device:
  - a. From the Cisco SD-WAN Manager menu, select **Configuration > Certificates**.
  - b. Click **Controllers** and select **Install Certificate**.
  - c. In the **Install Certificate** page, paste the certificate into the Certificate Text field, or click **Select a File** to upload the certificate in a file.
  - d. Click **Install**.
5. Issue the following REST API call, specifying the IP address of your Cisco SD-WAN Manager:
 

**`https://vmanage-ip-address/dataservice/system/device/sync/rootcertchain`**

### Install Signed Certificates in Releases 16.3 and Earlier

For vEdge Cloud router virtual machine (VM) instances running Releases 16.3 and earlier, when the vEdge Cloud router VM starts, it has a factory-default configuration, but is unable to join the overlay network because no signed certificate is installed. You must install a signed Symantec certificate on the vEdge Cloud router so that it can participate in the overlay network.

To generate a certificate signing request (CSR) and install the signed certificate on the vEdge Cloud router:

1. Log in to the vEdge Cloud router as the user **admin**, using the default password, **admin**. If the vEdge Cloud router is provided through AWS, use your AWS key pair to log in. The CLI prompt is displayed.
2. Generate a CSR for the vEdge Cloud router:

```
vEdge# request csr upload path
```

*path* is the full path and filename where you want to upload the CSR. The path can be in a directory on the local device or on a remote device reachable through FTP, HTTP, SCP, or TFTP. If you are using SCP, you are prompted for the directory name and filename; no file path name is provided. When prompted, enter and then confirm your organization name. For example:

```
vEdge# request csr upload home/admin/vm9.csr
Uploading CSR via VPN 0
Enter organization name      : Cisco
Re-enter organization name   : Cisco
Generating CSR for this vEdge device
.....[DONE]
Copying ... /home/admin/vm9.csr via VPN 0
CSR upload successful
```

3. Log in to the Symantec Certificate Enrollment portal:

```
https://certmanager.websecurity.symantec.com/mcep/enroll/index?jur_hash=422d7cb508a24e32ea7de4f78d37f8
```

4. In the **Select Certificate Type** drop-down, select **Standard Intranet SSL** and click **Go**. The Certificate Enrollment page is displayed. Cisco Catalyst SD-WAN uses the information you provide on this form to confirm the identity of the certificate requestor and to approve your certificate request. To complete the Certificate Enrollment form:
  - a. In the Your Contact Information section, specify the First Name, Last Name, and Email Address of the requestor.
  - b. In the Server Platform and Certificate Signing section, select Apache from the Select Server Platform drop-down. In the Enter Certificate Signing Request (CSR) box, upload the generated CSR file, or

copy and paste the contents of the CSR file. (For details about how to do this, log in to support.viptela.com. Click Certificate, and read the Symantec certificate instructions.)

- c. In the Certificate Options section, enter the validity period for the certificate.
  - d. In the Challenge Phrase section, enter and then re-enter a challenge phrase. You use the challenge phrase to renew, and, if necessary, to revoke a certificate on the Symantec Customer Portal. It is recommended that you specify a different challenge phrase for each CSR.
  - e. Accept the Subscriber Agreement. The system generates a confirmation message and sends an email to the requestor confirming the certificate request. It also sends an email to the Cisco to approve the CSR.
5. After Cisco approves the CSR, Symantec sends the signed certificate to the requestor. The signed certificate is also available through the Symantec Enrollment portal.
  6. Install the certificate on the vEdge Cloud router:

```
vEdge# request certificate install filename [vpn vpn-id]
```

The file can be in your home directory on the local device, or it can be on a remote device reachable through FTP, HTTP, SCP, or TFTP. If you are using SCP, you are prompted for the directory name and filename; no file path name is provided.

7. Verify that the certificate is installed and valid:

```
vEdge# show certificate validity
```

After you have installed the certificate on the vEdge Cloud router, the Cisco SD-WAN Validator is able to validate and authenticate the router, and the router is able to join the overlay network.

### What's Next

See *Send vEdge Serial Numbers to the Controller Devices*.

## Send Router Serial Numbers to the Controller Devices

Table 29: Feature History

Feature Name	Release Information	Description
Device Onboarding Enhancement	Cisco IOS XE Catalyst SD-WAN Release 17.3.1a Cisco vManage Release 20.3.1	This feature provides an enhancement to onboard your device to Cisco SD-WAN Manager by directly uploading a .csv file.

Only authorized routers can join the overlay network. The controller devices Cisco SD-WAN Manager, Cisco SD-WAN Controllers and Cisco SD-WAN Validators learn which routers are authorized to join the overlay network from the router-authorized serial number file. This is a file that you receive from Cisco. The router authorized serial number file lists the serial numbers and corresponding chassis numbers for all authorized routers. Upload the file to one of the Cisco SD-WAN Manager in your network, and it then distributes the file to the controllers.

When you upload the router serial number file, you can place the routers in one of these states:

- Invalid: When you power on the routers, they are not authorized to join the overlay network.

- **Staging:** When you power on the routers, they are validated and authorized to join the overlay network, and can establish connections only to the control plane. Over the control plane, the routers receive their configuration from Cisco SD-WAN Manager. However, the routers are unable to establish data plane connections, so they cannot communicate with other routers in the network. The Staging state is useful when you are preparing routers at one location and then sending them to different sites for installation. Once the routers reach their final destination, you change their state from Staging to Valid, to allow the routers to establish data plane connections and to fully join the overlay network.
- **Valid:** When you power on the routers, they are validated and authorized to join the overlay network, and they are able to establish both control plane and data plane connections in the network. Over the control plane, the routers receive their configuration from Cisco SD-WAN Manager. Over the data plane, they are able to communicate with other routers. The Valid state is useful when the routers are being installed at their final destination.



---

**Note** To successfully send a router serial number file to Cisco Catalyst SD-WAN Manager in Cisco vManage Release 20.10.1 and earlier, ensure that the file is installed in `/home/admin` or `/home/vmanage-admin`. Using credentials other than **admin** or **vmanage-admin** to send a router serial number file will result in an error.

---

## How to Upload a Router Authorized Serial Number File

The following sections describe how to upload the router authorized serial number file to Cisco SD-WAN Manager and distribute the file to all the overlay network controllers.

### Enable PnP Connect Sync (Optional)

To sync the uploaded device to your Smart Account or Virtual Account and for your device to reflect on the PnP (Plug and Play) Connect portal, when an unsigned .csv file is uploaded through Cisco SD-WAN Manager, enable the PnP Connect Sync.

Ensure you have an active connection to the PnP (Plug and Play) Connect portal and an active Smart Account or Virtual Account. You have to also use a CCO ID that is associated as the Smart Account or Virtual Account admin of the account, on PnP Connect portal.



---

**Note** PnP Connect Sync is only applicable to .csv file upload. It does not affect the .viptela file (which is downloaded from the PnP Connect portal) upload process.

---



---

**Note** You will be allowed to enable PnP Connect Sync only once you enter the Smart Account credentials.

---

To enable the PnP Connect Sync:

1. From the Cisco SD-WAN Manager menu, select **Administration > Settings**.
2. Click **Smart Account Credentials**. (If you are using Cisco Catalyst SD-WAN Manager Release 20.12.1 and earlier, click **Edit**.)
3. Enter **Username** and **Password** and click **Save**.

4. Click **PnP Connect Sync**. (If you are using Cisco Catalyst SD-WAN Manager Release 20.12.1 and earlier, click **Edit**.)
5. Click **Enabled** and click **Save**.

### Place Routers in Valid State

Perform the following task to place the routers in the Valid state so that they can establish control and data plane connections and can receive their configurations from the Cisco SD-WAN Manager:

1. From the Cisco SD-WAN Manager menu, select **Configuration > Devices**.
2. Click **WAN Edge List** and click **Upload WAN Edge List**.
3. You can upload WAN Edge devices in the following two ways:
  - Upload a signed file (.viptela file). You can download this .viptela file from the Plug and Play Connect portal.
  - Starting from Cisco vManage Release 20.3.1, you can upload an unsigned file (.csv file). This enhancement is only applicable when you add hardware platforms on-demand onto Cisco SD-WAN Manager. To upload the .csv file this:
    - a. Click **Sample CSV**. An excel file will be downloaded.
    - b. Open the downloaded .csv file. Enter the following parameters:
      - Chassis number
      - Product ID (mandatory for Cisco vEdge devices, blank value for all other devices)
      - Serial number
      - SUDI serial

Either the Serial number or SUDI number is mandatory for Cisco IOS XE Catalyst SD-WAN devices, along with chassis number. Cisco ASR1002-X is an exception and does not need Serial or SUDI numbers, it can be onboarded with only the chassis number on the .csv file.
    - c. To view your device details in Cisco SD-WAN Manager, go to **Tools > SSH Terminal**. Choose your device and use one of the following command-
      - show certificate serial** (for vEdge devices)
      - show sdwan certificate serial** (for Cisco IOS XE Catalyst SD-WAN devices)
    - d. Enter the specific device details in the downloaded .csv file.
4. To upload the .viptela or .csv file on Cisco SD-WAN Manager click **Choose file** and upload the file that contains the product ID, serial number and chassis number of your device.



---

**Note** If you have enabled PnP Sync Connect, the .csv file can contain up to 25 devices. If you have more than 25 devices, you can split them and upload multiple files.

---

5. Check the check box next to **Validate the uploaded vEdge List and send to controllers**.

6. Click **Upload**.
7. You should now see your device listed in the table of devices.

If you have enabled the PnP Sync Connect previously, your device will also reflect on the PnP Portal.

A list of routers in the network is displayed, showing detailed information about each router. To verify that the routers are in the Valid state, select **Configuration > Certificates**.

### Place Routers in Invalid State

To upload the authorized serial number file to the Cisco SD-WAN Manager, but place the routers in Invalid state so that they cannot establish control plane or data plane connections and cannot receive their configurations from Cisco SD-WAN Manager:

1. From the Cisco SD-WAN Manager menu, select **Configuration > Devices**.
2. Click **WAN Edge List** and click **Upload WAN Edge List**.
3. In the **Upload WAN Edge List** dialog box, choose the file to upload.
4. To upload the router serial number file to Cisco SD-WAN Manager, click **Upload**.

A list of routers in the network is displayed, showing detailed information about each router. To verify that the routers are in the Invalid state, from the Cisco SD-WAN Manager menu, select **Configuration > Certificates**.

### Place Routers in Staging State

To move the routers from the Invalid state to the Staging state and then send the serial number file to the controllers, follow the steps below. In the Staging state, the routers can establish control plane connections, over which they receive their configurations from Cisco SD-WAN Manager. However, the routers cannot establish data plane connections.

1. From the Cisco SD-WAN Manager menu, select **Configuration > Certificates**.
2. Click **WAN Edge List**.
3. In the **Validate** column, click **Staging** for each router.
4. Click **Send to Controller**.
5. When you are ready to have the router join the data plane in the overlay network, in the **Validate** column, click **Valid** for each router, and then click **Send to Controller**. Placing the routers in the Valid state allows them to establish data plane connections and to communicate with other routers in the overlay network.

## Configure the vEdge Routers

Once you have set up and started the virtual machines (VMs) for the vEdge Cloud routers and set up and started the hardware vEdge routers in your overlay network, they come up with a factory-default configuration.



---

**Note** **Log In to a Device for the First Time:** When you first deploy a Cisco Catalyst SD-WAN overlay network, log in to the Cisco SD-WAN Validator, Cisco SD-WAN Manager, and Cisco SD-WAN Controller to manually create the device's initial configuration. Routers are shipped with a factory default configuration. If you choose to modify this configuration manually, log in through the router's console port.

---

For the overlay network to be operational and for the vEdge routers to be able to participate in the overlay network, you must do the following:

- Configure a tunnel interface on at least one interface in VPN 0. This interface must be connected to a WAN transport network that is accessible to all Cisco vEdge devices. VPN 0 carries all control plane traffic between the Cisco vEdge devices in the overlay network.
- Ensure that the Overlay Management Protocol (OMP) is enabled. OMP is the protocol responsible for establishing and maintaining the Cisco Catalyst SD-WAN control plane. It is enabled by default, and you cannot disable it. If you edit the configuration from the CLI, do not remove the **omp** configuration command.
- Ensure that BFD is enabled. BFD is the protocol that the transport tunnels on vEdge routers use for transmitting data traffic through the overlay network. BFD is enabled by default, and cannot be disabled. If you edit the configuration from the CLI, do not remove the **bfd color** command.
- Configure the IP address of DNS name of your network's Cisco SD-WAN Validator.
- Configure the IP address of the router.



---

**Note** The DNS cache timeout should be proportional to the number of Cisco SD-WAN Validator IP addresses that DNS has to resolve, otherwise the control connection for Cisco SD-WAN Manager may not occur during a link failure. This is because, when there are more than six IP addresses (this is the recommended number since the default DNS cache timeout is currently two minutes) to be checked, the DNS cache timer expires even as the highest preferred interface tries all Cisco SD-WAN Validator IP addresses, before failing over to a different color. For instance, it takes about 20 seconds to attempt to connect to one IP address. So, if there are eight IP addresses to be resolved, the DNS cache timeout should be  $20 \times 8 = 160$  seconds or three minutes.

---

You should also assign a system IP address to each vEdge router. This address, which is similar to the router ID on non-Cisco vEdge devices, is a persistent address that identifies the router independently of any interface addresses. The system IP is a component of the device's TLOC address. Setting the system IP address for a device allows you to renumber interfaces as needed without affecting the reachability of the Cisco vEdge device. Control traffic over secure DTLS or TLS connections between Cisco SD-WAN Controllers and vEdge routers and between Cisco SD-WAN Controllers and Cisco SD-WAN Validators is sent over the system interface identified by the system IP address. In the transport VPN (VPN 0), the system IP address is used as the loopback address of the device. You cannot use the same address for another interface in VPN 0.

You can also configure other features and functions required for your network topology.

You configure vEdge routers by creating configuration templates on the Cisco SD-WAN Manager. For each configuration templates, you create one or more feature templates, which you then consolidate into a vEdge router device template. You then attach the device template to a vEdge router. When the vEdge router joins



the overlay network, the Cisco SD-WAN Manager automatically pushes the configuration template to the router.

It is strongly recommended that you create the full configuration for vEdge routers by creating configuration templates on the Cisco SD-WAN Manager. When the Cisco SD-WAN Manager discovers a router in the overlay network, it pushes the appropriate configuration template to the device. The configuration parameters in the configuration template overwrite the initial configuration.

### Create Configuration Templates for the vEdge Routers

To create vEdge configuration templates, first create feature templates:

1. From the Cisco SD-WAN Manager menu, choose **Configuration > Templates**.
2. Click **Feature Templates**.



---

**Note** In Cisco vManage Release 20.7.x and earlier releases, **Feature Templates** is called **Feature**.

---

3. Click **Add Template**.
4. In the left pane, select vEdge Cloud or a router model.
5. In the right pane, select the **System feature template**. Configure the following parameters:
  - a. Template Name
  - b. Description
  - c. Site ID
  - d. System IP
  - e. Timezone
  - f. Hostname
  - g. Console baud rate (vEdge hardware routers only)
  - h. GPS location
6. Click **Save** to save the System template.
7. In the right pane, select **VPN-Interface-Ethernet feature template**. Configure the following parameters:
  - a. Template Name
  - b. Description
  - c. Shutdown No
  - d. Interface name
  - e. IPv4 address (static or DHCP)
  - f. IPv6 address (static or DHCPv6), if desired (in Releases 16.3 and later)
  - g. Tunnel interface (for VPN 0), color, encapsulation, and services to allow.

8. Click **Save** to save the VPN-Interface Ethernet template.
9. In the right pane, select other templates to configure any desired features. Save each template when you complete the configuration. For information about configuration cellular parameters for vEdge 100m and vEdge 100wm routers, see the next section in this article.

For information about configuration templates and parameters, see the Cisco SD-WAN Manager configuration help articles for your software release.

Next, create a device template that incorporates all the feature templates for the vEdge router:

1. From the Cisco SD-WAN Manager menu, choose **Configuration > Templates**.
2. Click **Device Templates**.



---

**Note** In Cisco vManage Release 20.7.x and earlier releases, **Device Templates** is called **Device**.

---

3. From the **Create Template** drop-down list, select **From Feature Template**.
4. From the **Device Model** drop-down, select the type of device for which you are creating the device template. Cisco SD-WAN Manager displays the feature templates for the device type you selected. Required templates are indicated with an asterisk (\*).
5. Enter a name and description for the device template. These fields are mandatory. The template name cannot contain special characters.
6. In the **Transport & Management VPN** section, under VPN 0, from the drop-down list of available templates, select the desired feature template. The list of available templates shows the ones that you have previously created.
7. To include additional feature templates in the device template, in the remaining sections, select the feature templates in turn, and from the drop-down list of available templates, select the desired template. The list of available templates are the ones that you have previously created. Ensure that you select templates for all mandatory feature templates and for any desired optional feature templates.
8. Click **Create** to create the device template.

To attach a device template to a device:

1. From the Cisco SD-WAN Manager menu, choose **Configuration > Templates**.
2. Click **Device Templates**, and select a template.



---

**Note** In Cisco vManage Release 20.7.x and earlier releases, **Device Templates** is called **Device**.

---

3. For the selected template, click **...** and select **Attach Device**.
4. In the **Attach Device** window, either search for a device or select a device from the **Available Device(s)** column.
5. Click the arrow pointing right to move the device to the **Selected Device(s)** column on the right.
6. Click **Attach**.

When Cisco SD-WAN Manager discovers that the vEdge router has joined the overlay network, it pushes the configuration template to the router.

### Configuring Cellular Routers

For vEdge 100m and vEdge 100wm routers, you configure cellular interface parameters on the VPN-Interface-Cellular feature template. In this template, the default Profile ID is 0, which enables automatic profile selection. The automatic profile uses the Mobile Country Code/Mobile Network Code (MCC/MNC) values on the router's SIM card. Profile 0 enables the cellular router to automatically join the overlay network during the Cisco Catalyst SD-WAN ZTP automatic provisioning process .

If your MCC/MNC is not supported, the automatic profile selection process fails, and the ZTP process is unable to autodetect the router. In this case, you must configure a cellular profile as follows:

1. In the right pane, select the Cellular Profile feature template.
2. Set the Profile ID to a value from 1 through 15, and configure the desired cellular parameters.
3. Save the Cellular Profile feature template.
4. In the right pane, select the VPN-Interface-Cellular template.
5. Select the Profile ID you configured in Step 2, and for Shutdown, click Yes.
6. Save the VPN-Interface-Cellular feature template.
7. Include the Cellular Profile and VPN-Interface Cellular templates in a device template.
8. Attach the device template to the vEdge router to activate the MCC/MCN.
9. In the right pane, select the VPN-Interface-Cellular template.
10. For Shutdown click No, to enable the cellular interface.
11. Save the VPN-Interface-Cellular feature template.
12. Repush the device template to the vEdge router. This is the device template that you pushed in Step 8.

### Configure the vEdge Routers from the CLI

Normally, you create vEdge router configurations using Cisco SD-WAN Manager configuration templates. However, in some situations, such as network test and proof-of-concept (POC) environments, you might want to configure vEdge routers manually, either to speed up the configuration process or because your test environment does not include Cisco SD-WAN Manager. In such situations, you can configure vEdge routers from the router's CLI.



---

**Note** If you configure a vEdge router manually from the CLI and then the router later becomes managed by a Cisco SD-WAN Manager, when the Cisco SD-WAN Manager discovers the router, it pushes the router's configuration from the Cisco SD-WAN Manager server to the router, overwriting the existing configuration.

---

For vEdge Cloud routers, use SSH to open a CLI session to the router. For hardware vEdge routers, connect to the router via the management console.

### Configure Minimum Parameters from the CLI

To create the initial configuration on a Cisco vEdge device from a CLI session:

1. Open a CLI session to the Cisco vEdge device via SSH or the console port.
2. Log in as the user **admin**, using the default password, **admin**. The CLI prompt is displayed.
3. Enter configuration mode:

```
vEdge# config
vEdge (config) #
```

4. Configure the hostname:

```
vEdge (config) # system host-name hostname
```

Configuring the hostname is optional, but is recommended because this name is included as part of the prompt in the CLI and it is used on various Cisco SD-WAN Manager pages to refer to the device.

5. Configure the system IP address. Starting from Releases 16.3 and later, the IP address can be an IPv4 or an IPv6 address. In earlier releases, it must be an IPv4 address.

```
vEdge (config-system) #system-ip ip-address
```

Cisco SD-WAN Manager uses the system IP address to identify the device so that the NMS can download the full configuration to the device.

6. Configure the numeric identifier of the site where the device is located:

```
vEdge (config-system) # site-id site-id
```

7. Configure the organization name:

```
vEdge (config-system) # organization-name organization-name
```

8. Configure the IP address of the Cisco SD-WAN Validator or a DNS name that points to the Cisco SD-WAN Validator. The IP address of the Cisco SD-WAN Validator must be a public IP address, to allow all Cisco vEdge devices in the overlay network to reach the Cisco SD-WAN Validator:

```
vEdge (config-system) # vbond (dns-name | ip-address)
```

9. Configure a time limit for confirming that a software upgrade is successful:

```
vEdge (config-system) # upgrade-confirm minutes
```

The time can be from 1 through 60 minutes. If you configure this time limit, when you upgrade the software on the device, the Cisco SD-WAN Manager (when it comes up) or you must confirm that a software upgrade is successful within the configured number of minutes. If the device does not received the confirmation within the configured time, it reverts to the previous software image.

10. Change the password for the user "admin":

```
vEdge (config-system) # user admin password password
```

The default password is "admin".

11. Configure an interface in VPN 0 to be used as a tunnel interface. VPN 0 is the WAN transport VPN, and the tunnel interface carries the control traffic among the devices in the overlay network. For vEdge Cloud routers, the interface name has the format **eth number**. For hardware vEdge routers, the interface name has the format **ge slot / port**. You must enable the interface and configure its IP address, either as a static address or as a dynamically assigned address received from a DHCP server. Starting from Releases 16.3 and later, the IP address can be an IPv4 or an IPv6 address, or you can configure both to enable dual-stack operation. In earlier releases, it must be an IPv4 address.

```
vEdge(config)# vpn 0
vEdge(config-vpn-0)# interface interface-name
vEdge(config-interface)# (ip dhcp-client | ip address prefix/length)
vSmart(config-interface)# (ipv6 address ipv6-prefix/length | ipv6 dhcp-client
[dhcp-distance number | dhcp-rapid-commit])
vEdge(config-interface)# no shutdown
vEdge(config-interface)# tunnel-interface
```



**Note** You must configure a tunnel interface on at least one interface in VPN 0 in order for the overlay network to come up and for the Cisco SD-WAN Manager to be able to participate in the overlay network. This interface must connect to a WAN transport network that is accessible by all Cisco vEdge devices. VPN 0 carries all control plane traffic among the Cisco vEdge devices in the overlay network.

- Configure a color for the tunnel to identify the type of WAN transport. You can use the default color (**default**), but you can also configure a more appropriate color, such as **mpls** or **metro-ethernet**, depending on the actual WAN transport.

```
vEdge(config-tunnel-interface)# color color
```

- Configure a default route to the WAN transport network:

```
vEdge(config-vpn-0)# ip route 0.0.0.0/0 next-hop
```

- Commit the configuration:

```
vEdge(config)# commit and-quit
vEdge#
```

- Verify that the configuration is correct and complete:

```
vEdge# show running-config
```

After the overlay network is up and operational, create a vEdge configuration template on the Cisco SD-WAN Manager that contains the initial configuration parameters. Use the following Cisco SD-WAN Manager feature templates:

- System feature template to configure the hostname, system IP address, and Cisco SD-WAN Validator functionality.
- AAA feature template to configure a password for the "admin" user.
- VPN-Interface-Ethernet feature template to configure the interface in VPN 0.

In addition, it is recommended that you configure the following general system parameters:

- From the Cisco SD-WAN Manager menu, select **Administration > Settings** and configure Organization name.
- From the Cisco SD-WAN Manager menu, select **Configuration > Templates**. For the NTP and System feature configuration templates, configure Timezone, NTP servers, and device physical location.
  - For the Banner feature configuration template, configure Login banner.
  - For the Logging feature configuration template, configure Logging parameters.
  - For the AAA feature configuration template, configure AAA, and RADIUS and TACACS+ servers.
  - For the SNMP feature configuration template, configure SNMP.

### Sample Initial CLI Configuration

Below is an example of a simple configuration on a vEdge router. Note that this configuration includes a number of settings from the factory-default configuration and shows a number of default configuration values.

```
vEdge# show running-config
system
 host-name          vEdge
 gps-location latitude 40.7127837
 gps-location longitude -74.00594130000002
 system-ip          172.16.251.20
 site-id            200
 max-controllers    1
 organization-name  "Cisco"
 clock timezone America/Los_Angeles
 upgrade-confirm    15
 vbond 184.122.2.2
aaa
 auth-order local radius tacacs
 usergroup basic
   task system read write
   task interface read write
 !
 usergroup netadmin
 !
 usergroup operator
   task system read
   task interface read
   task policy read
   task routing read
   task security read
 !
 user admin
   password encrypted-password
 !
 !
 logging
 disk
   enable
 !
 !
 ntp
 keys
   authentication 1 md5 $4$L3rwZmsIic8zj4BgLEFXKw==
   authentication 2 md5 $4$LyLwZmsIif8BvrJgLEFXKw==
   authentication 60124 md5 $4$LXbzZmcKj5Bd+/BgLEFXKw==
   trusted 1 2 60124
 !
 server 180.20.1.2
   key 1
   source-interface ge0/3
   vpn 1
   version 4
 exit
 !
 radius
 server 180.20.1.2
   vpn 1
   source-interface ge0/3
   secret-key $4$L3rwZmsIic8zj4BgLEFXKw==
 exit
 !
 tacacs
 server 180.20.1.2
```

```
        vpn                1024
        source-interface   ge0/3
        secret-key         $4$L3rwZmsIic8zj4BgLEFXKw==
    exit
    !
    !
omp
    no shutdown
    graceful-restart
    advertise bgp
    advertise connected
    advertise static
    !
security
    ipsec
        authentication-type ah-sha1-hmac sha1-hman
    !
    !
snmp
    no shutdown
    view v2
        oid 1.3.6.1
    !
    community private
        view v2
        authorization read-only
    !
    trap target vpn 0 10.0.1.1 16662
        group-name Cisco
        community-name private
    !
    trap group test
        all
        level critical major minor
    exit
    exit
    !
vpn 0
    interface ge0/0
        ip address 184.111.20.2/24
        tunnel-interface
            encapsulation ipsec
            color mpls restrict
            no allow-service bgp
            allow-service dhcp
            allow-service dns
            allow-service icmp
            no allow-service sshd
            no allow-service netconf
            no allow-service ntp
            no allow-service ospf
            no allow-service stune
        !
        no shutdown
        bandwidth-upstream 60
        bandwidth-downstream 60
    !
    interface ge0/1
        no shutdown
    !
    interface ge0/2
        no shutdown
    !
```

```

ip route 0.0.0.0/0 184.111.20.1

!
vpn 1
router
  bgp 111000
  neighbor 172.16.1.20
  no shutdown
  remote-as 111000
  password $4$LzLwZj1ApK4zj4BgLEFXKw==
  !
!
ospf
timers spf 200 1000 10000
area 0
interface ge0/1
authentication type message-direct
authentication message-digest message-digest-key 1 md5 $4$LzLwZj1ApK4zj4BgLEFXKw==
exit
exit
!
!
!

```

## Enable Data Stream Collection from a WAN Edge Router

By default, collecting streams of data from a network device is not enabled.

To collect data streams from a WAN Edge router in the overlay network, perform the following steps.

Collecting data streams also requires that VPN 512 be configured in your Cisco Catalyst SD-WAN network.

1. From the Cisco SD-WAN Manager menu, select **Administration > Settings**.
2. Click **Data Stream**. (If you are using Cisco Catalyst SD-WAN Manager Release 20.12.1 or earlier, click **Edit**.)
3. Enable **Data Stream**.
4. From Cisco vManage Release 20.4.1, choose one of the following **IP Address Type** options:
  - **Transport**: Click this option send the data stream to the transport IP address of the Cisco SD-WAN Manager node to which the device is connected.
  - **Management**: Click this option send the data stream to the management IP address of the Cisco SD-WAN Manager node to which the device is connected.
  - **System**: Click this option to send the data stream to the internally configured system IP address of the Cisco SD-WAN Manager node to which the device is connected.

In a Cisco SD-WAN Manager cluster deployment, we recommend that you choose **System** so that the data stream is collected from edge devices that are managed by all Cisco SD-WAN Manager instances in the cluster.

5. From Cisco vManage Release 20.4.1, perform one of these actions:
  - If you choose **Transport** as the IP address type, in the **Hostname** field, enter the public transports IP address that is used to connect to the router.  
You can determine this IP address by using an SSH client to access the router and entering the **show interface** CLI command.



- If you choose **Management** as the IP address type, in the **Hostname** field, enter the IP address or name of the host to collect the data.

We recommend that this host is one that is used for out-of-band management and that it is located in the management VPN.

This **Hostname** option is dimmed when **IP Address Type** is **System**.

6. In the **VPN** field, enter the number of the VPN in which the host is located.

We recommend that this VPN be the management VPN, which is typically VPN 512.

This **VPN** option is dimmed when **IP Address Type** is **System**.

7. Click **Save**.

## Prepare Routers for ZTP

Cisco Catalyst SD-WAN provides an automatic provisioning software as a service (SaaS) called zero-touch provisioning (ZTP), which allows hardware vEdge routers to join the overlay network automatically. The ZTP process begins when you power on a hardware vEdge router for the first time.

For the ZTP process to work:

- The edge or gateway router at the site where the hardware vEdge router is located must be able to reach public DNS servers. We recommend that the router be configured to reach the Google public DNS servers.
- For Cisco vEdge devices, the edge or gateway router at the site must be able to reach `ztp.viptela.com`.
- For Cisco IOS XE Catalyst SD-WAN devices, the edge or gateway router at the site must be able to reach `ztp.local-domain`.
- A network cable must be plugged into the interface that the hardware router uses for ZTP. These interfaces are:
  - For Cisco vEdge 1000 routers: `ge0/0`
  - For Cisco vEdge 2000 routers: `ge2/0`
  - For Cisco vEdge 100 series routers: `ge0/4`
  - For Cisco IOS XE Catalyst SD-WAN devices, there is no specific interface that is used for connection to the ZTP server. The router attempts to obtain a DHCP IP address on one interface at a time. It uses the first interface on which it obtains the DHCP IP address to resolve the domain name `ztp.local-domain` to the IP address of the ZTP server.

The ZTP process occurs in the following sequence:

Figure 27: Sequence Flow of the ZTP Process

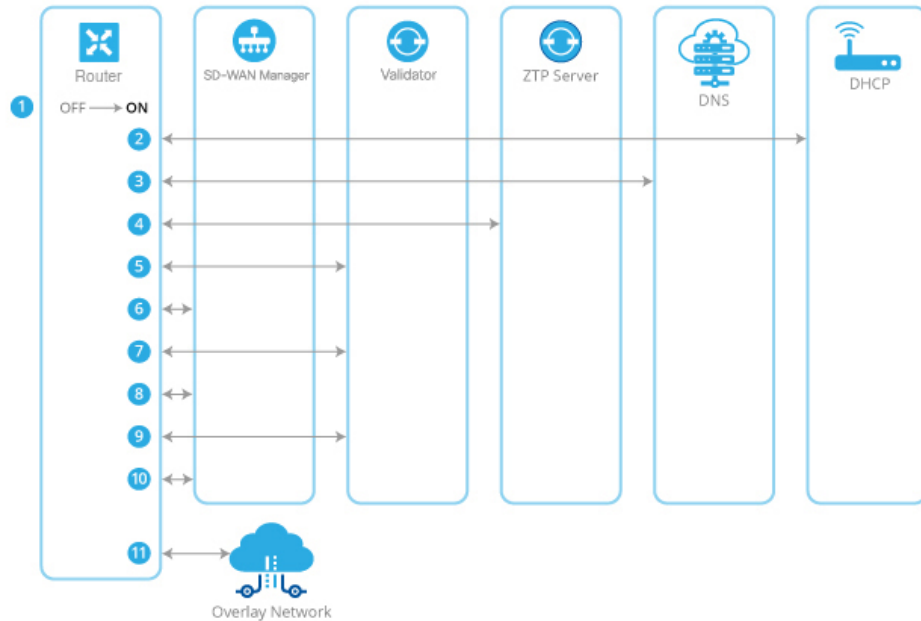

520628

1. The hardware router powers up.
2. The router attempts to contact a DHCP server, sending a DHCP discovery message.
  - a. If a DHCP server is present in the network, the router receives a DHCP offer message that contains the IP address of its ZTP interface. Then, the ZTP process continues with Step 3.
  - b. For Cisco vEdge devices, and for Cisco IOS XE Catalyst SD-WAN devices from Cisco IOS XE Catalyst SD-WAN Release 17.7.1a, if no DHCP server is present, the router does not receive a DHCP offer. In this situation, the router initiates an automatic IP address detection process (also referred to as auto-IP). This process examines the ARP packets on the subnetwork and, from these packets, it infers the IP address of the ZTP interface. Then, the ZTP process continues with Step 3.  
For Cisco IOS XE Catalyst SD-WAN devices before Cisco IOS XE Catalyst SD-WAN Release 17.7.1a, if no DHCP server is present, the ZTP process does not continue.
3. The router contacts a DNS server to resolve the hostname `ztp.viptela.com` (for Cisco vEdge devices) or `ztp.local-domain` (Cisco IOS XE Catalyst SD-WAN devices) and receives the IP address of the Cisco Catalyst SD-WAN ZTP server
4. The router connects to the ZTP server. The ZTP server verifies the vEdge router and sends the IP address of the Cisco SD-WAN Validator. This Cisco SD-WAN Validator has the same Organization name as the vEdge router.
5. The router establishes a transient connection to the Cisco SD-WAN Validator and sends its chassis ID and serial number. (At this point in the ZTP process, the router does not have a system IP address, so the connection is established with a null system IP address.) The Cisco SD-WAN Validator uses the chassis ID and serial number to verify the router. The Cisco SD-WAN Validator then sends the IP address of Cisco SD-WAN Manager to the router.

6. The router establishes a connection to and is verified by Cisco SD-WAN Manager. Cisco SD-WAN Manager sends the router its system IP address.
7. The router re-establishes a connection to the Cisco SD-WAN Validator using its system IP address.
8. The router re-establishes a connection to Cisco SD-WAN Manager using its system IP address.  
For Cisco vEdge devices, if necessary, Cisco SD-WAN Manager pushes the proper software image to the vEdge router. As part of the software image installation, the router reboots.
9. After the reboot, the router reestablishes a connection to the Cisco SD-WAN Validator, which again verifies the router.
10. The router establishes a connection to Cisco SD-WAN Manager, which pushes the full configuration to the router. (If the router has rebooted, it re-establishes a connection to Cisco SD-WAN Manager.)
11. The router joins the organization's overlay network.



---

**Note** For the ZTP process to succeed, Cisco SD-WAN Manager must contain a device configuration template for the vEdge router. If the Cisco SD-WAN Manager instance has no template, the ZTP process fails. Ignore the device-model and ztp-status display in the configuration preview and intent configuration. This information is visible after you push the configuration on device side.

---

### Using ZTP on Non-Wireless Routers

The default configuration that is shipped on non-wireless hardware vEdge routers includes the following commands that allow the ZTP process to occur automatically:

- **system vbond ztp.viptela.com**—Configures the initial Cisco SD-WAN Validator to be the Cisco Catalyst SD-WAN ZTP SaaS server.
- **vpn 0 interface ip dhcp-client**—Enables DHCP on one of the interfaces in VPN 0, which is the transport interface. Note that the actual interface in the default configuration varies by router model. This interface must be connected to the Internet, MPLS, metro Ethernet, or other WAN network.

Warning: For ZTP to work, do not modify or delete either of these configuration commands before you connect the vEdge router to a WAN.

### Using ZTP on Wireless Routers

The vEdge 100m and vEdge 100wm are wireless routers. On these routers, ZTP is supported using both the cellular and the Ethernet interfaces.



---

**Note** In Release 16.3, you cannot use the LTE USB dongle on a vEdge 1000 router for ZTP.

---

The vEdge 100m router supports software Releases 16.1 and later. If the vEdge 100m router is running Release 16.2.10 or later, we recommend, when performing ZTP, that Cisco SD-WAN Manager also be running Release 16.2.10 or later.

The vEdge 100wm router supports software Releases 16.3 and later.

The default configuration that is shipped on wireless hardware vEdge routers includes the following commands that allow the ZTP process to occur automatically on the cellular interface:

- **system vbond ztp.viptela.com**: Configure the initial Cisco SD-WAN Validator to be the Cisco Catalyst SD-WAN ZTP SaaS server.
- **vpn 0 interface cellular0 ip dhcp-client** : Enable DHCP on one of the cellular interface called **cellular0** in VPN 0, which is the transport interface. This interface must be connected to the cellular network.
- **vpn 0 interface cellular0 technology** : Associate a radio access technology (RAT) with the cellular interface. In the default configuration, the RAT is set to **lte**. For ZTP to work, you must change this value to **auto**.
- **vpn 0 interface cellular0 profile 0**: Enable automatic profile selection. For firmware-dependent mobile carriers, the automatic profile uses the firmware default values. For other carriers, the automatic profile uses the Mobile Country Code/Mobile Network Code (MCC/MNC) values on the SIM card. One exception is the vEdge 100m-NT: The automatic profile tries OCN MVNO APN before the firmware default, which is NTT Docomo. If the router finds a matching entry, it autocreates profile 16, which is used for the ZTP connection. To check which profile is being used for the active ZTP connection, look at the Active profile entry in the **show cellular sessions** command output.

The **profile 0** configuration command recognizes the MCCs and MCNs listed in the [vEdge SKU Information table](#). If your MCC/MNC is supported, you do not need to configure them in the Cellular Profile feature template or with the **profile** command. If your MCC/MNC is not supported, you must configure them manually, using the Cellular-Profile configuration template or the **profile** CLI command.

If you need to use Cisco SD-WAN Manager configuration templates to create the portions of the default configuration that allow ZTP to occur automatically, use the VPN-Interface-Cellular feature template. In the template the Profile ID field is set to 0 and the tunnel interface is enabled. Starting from Releases 16.3.1 and later, the Technology field has been added, and the default value is "lte". To match the vEdge router's ZTP cellular0 configuration, change the value to "auto".

Click **Advanced**, to view the default cellular MTU configuration is 1428 bytes:

The following guidelines help to troubleshoot issues that can occur when using ZTP from a wireless router:

- For ZTP to work correctly, ensure that you are using the correct SIM with the correct modem model (SKU).
- If the default profile APN is not configured correctly, the ZTP process does not work correctly. If ZTP does not work, issue the **show cellular status** command to display the error. If an error occurs, configure the appropriate APN and retry the ZTP process.
- For SKUs that do not have default profile APN configurations, such as Generic (MC7304) and North America (MC7354) SKUs, if the automatic profile selection does not detect the APN on the SIM card, configure the profile, including an APN. If the router has a second circuit that has access to Cisco SD-WAN Manager, add the profile information, including the APN, to the feature configuration template and then push the device template to the cellular router. Otherwise, configure the profile on the cellular router from the CLI, including an APN.
- To check whether the router is unable to detect the SIM card, issue the **show cellular status** command. Check for the SIM Read error. To correct this problem, insert the SIM card correctly in the router.
- In Release 16.3.0, after you run ZTP on a cellular router, the cellular interface is in a **no shutdown** state. Because of this, Cisco SD-WAN Manager is unable to push a device configuration template to the router.

To correct this problem, from the CLI on the router, configure the cellular interface state to be in **shutdown** state.





# CHAPTER 7

## Quick Connect Workflow

- [Quick Connect Workflow](#), on page 233
- [Prerequisites for Using the Quick Connect Workflow](#), on page 234
- [Restrictions for Quick Connect Workflow](#), on page 234
- [Information About Quick Connect](#), on page 234
- [Access the Quick Connect Workflow](#), on page 237

## Quick Connect Workflow

*Table 30: Feature History*

Feature Name	Release Information	Description
Quick Connect Workflow for Onboarding Cisco IOS XE Catalyst SD-WAN Devices	Cisco IOS XE Catalyst SD-WAN Release 17.6.1a Cisco vManage Release 20.6.1	<p>This feature provides an alternative, guided method in Cisco SD-WAN Manager to onboard supported WAN edge devices into the Cisco Catalyst SD-WAN overlay network. As part of the Quick Connect workflow, basic day-0 configuration profiles are created, which apply to all Cisco Catalyst SD-WAN Device (IOS XE) devices, irrespective of the device model and device family. This workflow adds edge devices to the WAN transport and establishes data plane and control plane connections.</p> <p>This feature is supported on Cisco IOS XE Catalyst SD-WAN devices only.</p>

Feature Name	Release Information	Description
Specify a Region and Subregion When Deploying a Device	Cisco IOS XE Catalyst SD-WAN Release 17.13.1a Cisco Catalyst SD-WAN Control Components Release 20.13.1	You can specify both a region and a subregion when deploying a device.

## Prerequisites for Using the Quick Connect Workflow

- The organization name should be configured.
- Certificate authorization for the Cisco SD-WAN Validator and the Cisco SD-WAN Controller should be configured.
- The controllers (Cisco SD-WAN Manager, Cisco SD-WAN Validator, and Cisco SD-WAN Controller) should be installed and configured.



---

**Note** If you haven't configured these, the Quick Connect workflow directs you to the **Administration > Settings** window in Cisco SD-WAN Manager to complete the prerequisite configuration.

---

## Restrictions for Quick Connect Workflow

- The Quick Connect workflow is limited to configuring WAN settings (VPN 0). To be able to complete the Cisco Catalyst SD-WAN overlay bring up process, you also need to configure service-side VPN templates.

For detailed information about configuring network interfaces, see [Configure Network Interfaces](#).

- The Quick Connect workflow is supported for Cisco Catalyst SD-WAN Device (IOS XE) devices only.
- The Quick Connect workflow supports creating day-0 configurations for a maximum of 25 devices at a time. If you have more than 25 devices, run the workflow more than once, as applicable.
- You can have only one in-progress workflow at any given point.

## Information About Quick Connect

### Overview of the Quick Connect Workflow

The Quick Connect workflow in Cisco SD-WAN Manager creates a basic day-0 configuration profile, which is applicable to all Cisco IOS XE SD-WAN devices, irrespective of the device family and model. This workflow establishes control plane and data plane access in your WAN.



The behavior of the Quick Connect workflow depends on how you upload devices to Cisco SD-WAN Manager. You can upload your devices in one of the following ways, either as part of the Quick Connect workflow or independently.

- Using the auto sync option, where your Smart Account is synced with Cisco SD-WAN Manager. This option requires Cisco SD-WAN Manager to be able to connect with the Cisco Plug n Play (PnP) portal
- Using the manual upload method, where you download the authorized serial number file of devices from the Cisco PnP portal and upload it to Cisco SD-WAN Manager

### Subregions

From Cisco Catalyst SD-WAN Manager Release 20.13.1, you can specify both a region and subregion when deploying a device.

## Upload devices Using Auto Sync

The auto sync method of uploading your devices to Cisco SD-WAN Manager can be used for both, deployments that include cloud controllers and deployments that include on-premises controllers, provided that Cisco SD-WAN Manager is able to connect with the Plug n Play (PnP) portal.

### How the Auto Sync Option Works with Cisco PnP

After the Cisco team has configured and deployed the Cisco SD-WAN Controllers, an email, which includes the Cisco SD-WAN Manager information associated with the order is sent. To add devices to the overlay network in such a case, follow these steps:

1. Log in to Cisco SD-WAN Manager using the default credentials (admin/admin).
2. To transfer device information from Cisco PnP portal to Cisco SD-WAN Manager, sync your Smart Account or Virtual account in Cisco SD-WAN Manager. You need Cisco credentials of the Virtual Account administrator role for this step. For more information about uploading the WAN Edge router serial numbers, see [Upload WAN Edge Router Serial Numbers from Cisco Smart Account](#).



---

**Note** Every time you add new devices to the PnP portal, you need to resync Cisco SD-WAN Manager with the Smart Account or the Virtual Account for the new devices to appear in Cisco SD-WAN Manager.

---

After the device information is transferred to Cisco SD-WAN Manager, you can configure Cisco SD-WAN Manager overlay.



---

**Note** For more information about the Cisco PnP portal and its role in onboarding devices for Cisco SD-WAN Manager, see the following reference documentation:

- [Cisco Plug and Play Support Guide for Cisco SD-WAN Products](#)
  - [Plug n Play Onboarding Workflow](#)
-

### How the Auto Sync Option Works with ZTP

If your supported WAN edge devices are registered with Cisco Zero Touch Provisioning (ZTP), the device onboarding is automated and concludes with the devices being authenticated by the Cisco SD-WAN Validator.

With ZTP, after a device is unboxed, connect its WAN port to the network, ensuring that the IP settings from DHCP are configured. This includes configuring the IP address, mask, gateway, and DNS. The device then looks for the ZTP server, which is aware of the Cisco PnP portal inventory. The ZTP server then authenticates the device and redirects it to the Cisco SD-WAN Validator for further authentication.



---

**Note** For more information about configuring the vEdge routers to join the overlay network automatically, see [Prepare Routers for ZTP](#).

---

### How Devices Onboarded Using the Auto Sync Option Appear

If you upload devices to Cisco SD-WAN Manager using one of the auto sync options (through Cisco ZTP or Cisco PnP), at the end of the Quick Connect workflow, your devices appear in the Cisco SD-WAN Manager dashboard, accessible from **Monitor > Overview**.

Cisco vManage Release 20.6.x and earlier: If you upload devices to Cisco SD-WAN Manager using one of the auto sync options (through Cisco ZTP or Cisco PnP), at the end of the Quick Connect workflow, your devices appear in the Cisco SD-WAN Manager dashboard, accessible from **Dashboard > Main Dashboard**.

## Upload devices manually

You can choose to upload your devices to Cisco SD-WAN Manager manually, if:

- You don't want to use the auto sync option, which requires you to sync your Smart Account with Cisco SD-WAN Manager
- Your Cisco SD-WAN Manager instance is unable to connect with the Cisco PnP portal

### How Manual Upload of Devices Works

Follow this procedure to manually upload your devices to Cisco SD-WAN Manager.

1. Download the authorized serial number file or the provisioning file from the Cisco PnP portal. This file is available in the PnP portal under **Controllers > Provisioning File**



---

**Note** Starting from Cisco IOS XE Catalyst SD-WAN Release 17.13.1a, the **Controllers** tab is renamed as the **Control Components** tab to stay consistent with Cisco Catalyst SD-WAN rebranding.

---

2. Transfer the device information to Cisco SD-WAN Manager by manually uploading the authorized serial number file to Cisco SD-WAN Manager. For more information about manually uploading the WAN Edge router serial numbers, see [Upload WAN Edge Router Authorized Serial Number File](#).

### Quick Connect Behavior with Manual Upload of Devices

If you upload your devices to Cisco SD-WAN Manager using the manual method, they do not appear in the Cisco SD-WAN Manager dashboard until you deploy them using the CLI bootstrap configuration that the Quick Connect workflow generates.

The bootstrap method helps you onboard a factory-shipped WAN Edge device with the configuration needed to securely deploy it to join the Cisco Catalyst SD-WAN network.



---

**Note** For the complete procedure to deploy Cisco Catalyst SD-WAN Device (IOS XE)s using the CLI bootstrap configuration, see [On-Site Bootstrap Process for Cisco SD-WAN Devices](#).

---

## Access the Quick Connect Workflow

1. From the Cisco SD-WAN Manager menu, choose **Workflows**.
2. **Start a new Quick Connect workflow:** Under the **Library** area, choose **Quick Connect**.

OR

**Resume an in-progress Quick Connect workflow:** Under the **In-progress** area, click **Quick Connect**.



---

**Note** If you upload devices to Cisco SD-WAN Manager the manual upload method, you need to complete the additional step of deploying them using the CLI bootstrap configuration that the Quick Connect workflow generates. For more information about generating a bootstrap configuration file that loads to a device, see [On-Site Bootstrap Process for Cisco SD-WAN Devices](#).

---





## CHAPTER 8

# Cluster Management

Table 31: Feature History

Feature Name	Release Information	Description
Cisco SD-WAN Manager Persona-based Cluster Configuration	Cisco IOS XE Catalyst SD-WAN Release 17.6.1a Cisco SD-WAN Release 20.6.1 Cisco vManage Release 20.6.1	Simplifies adding Cisco SD-WAN Manager servers to a cluster by identifying servers based on personas. A persona defines what services run on a server.

- [Information About Cluster Management, on page 239](#)
- [Guidelines for a Cisco Catalyst SD-WAN Manager Cluster, on page 240](#)
- [View Available Cluster Services, on page 241](#)
- [Configure the Cluster IP Address of a Cisco Catalyst SD-WAN Manager Server, on page 241](#)
- [Add a Cisco Catalyst SD-WAN Manager Server to a Cluster, on page 243](#)
- [View Cisco Catalyst SD-WAN Manager Service Details, on page 246](#)
- [Edit Cisco Catalyst SD-WAN Manager Parameters, on page 246](#)
- [Update Configuration Database Login, on page 247](#)
- [Downgrade Cisco Catalyst SD-WAN Manager, on page 248](#)
- [Upgrade a Cisco SD-WAN Manager Cluster, on page 249](#)
- [Manually Restart Cisco Catalyst SD-WAN Manager Processes, on page 252](#)
- [Remove Cisco Catalyst SD-WAN Manager Nodes from a Cluster, on page 254](#)

## Information About Cluster Management

A Cisco SD-WAN Manager cluster consists of at least three Cisco SD-WAN Manager servers. These servers manage the Cisco Catalyst SD-WAN edge devices in a network. Cisco SD-WAN Manager servers in a cluster perform specific functions based on the services that are running on them. In this way, a cluster distributes the workload among Cisco SD-WAN Manager servers while sharing information between these servers. For scaling recommendations, see *Server Recommendations* for your release in [Cisco Catalyst SD-WAN Controller Compatibility Matrix and Server Recommendations](#).

Use the **Administration > Cluster Management** window to create a Cisco SD-WAN Manager cluster and perform related tasks.

From Cisco vManage Release 20.6.1, each Cisco SD-WAN Manager server has a *persona*. The persona is determined when the Cisco SD-WAN Manager server first boots up after Cisco SD-WAN Manager is installed and defines which services run on the server. The persona of a server lasts for the lifetime of the server and cannot be changed. A server must have a persona before it can be added to a cluster. For more information on personas, see [Cisco Catalyst SD-WAN Manager Persona and Storage Device](#).

The role that a server has in a cluster depends on its persona. A Cisco SD-WAN Manager server can have any of the following personas:

- Compute+Data: Includes all services that are required for Cisco SD-WAN Manager, including services that are used for the application, statistics, configuration, messaging, and coordination
- Compute: Includes services that are used for the application, configuration, messaging, and coordination
- Data: Includes services that are used for the application and statistics

### Encryption

From Cisco IOS XE Catalyst SD-WAN Release 17.14.1a, cluster traffic for all services is encrypted.

### Reserved IP Addresses

From Cisco IOS XE Catalyst SD-WAN Release 17.14.1a, a WAN edge device or Cisco SD-WAN Control Components in a Cisco SD-WAN Manager cluster reserve IP addresses with the 172.30.0.0/16 prefix. These reserved IP addresses cannot be used as a system IP address by a WAN edge device or Cisco SD-WAN Control Components. If the reserved IP address is already in use by a WAN edge device or Cisco SD-WAN Control Components, open a TAC case to replace the IP addresses.

## Guidelines for a Cisco Catalyst SD-WAN Manager Cluster

The following guidelines apply to a Cisco SD-WAN Manager cluster:

- We recommend that all members of a Cisco SD-WAN Manager cluster be located in the same data center.
- We recommend that the IP addresses of all members of the Cisco SD-WAN Manager cluster be in the same subnet.
- We recommend that Cisco SD-WAN Manager cluster interface should not be the same as transport interface. Beginning with Cisco vManage Release 20.9.1, this is enforced. If you attempt to configure this, Cisco SD-WAN Manager displays an error message.
- The cluster interface should not be accessible externally.
- Access to Cisco SD-WAN Manager cluster IP addresses is restricted to Cisco SD-WAN Manager instances in the same cluster.
- The members of a Cisco SD-WAN Manager cluster rely on timestamps to synchronize data and to track device uptime. For this time-dependent data to remain accurate, if you need to change the clock time of a Cisco SD-WAN Manager server in a cluster, make the same change on every Cisco SD-WAN Manager server in the cluster.
- In a three node cluster deployment, only one node can have a systematic failure. When one node fails, the Cisco SD-WAN Manager Graphical User Interface (GUI) of two remaining nodes are reachable and

can communicate with remaining nodes through SSH. If two nodes fail, the GUI of an active node on which a user is already logged in allows read-only operations, but new logins to the GUI are not permitted.

- When the guest node has factory default credentials configured on it and a host node tries to add it to the cluster, the cluster management fails. You must modify the password on new node same as that of the other nodes in the cluster.
- When logged in using a single sign-on (SSO) user with netadmin privilege, user cannot perform any of the cluster or disaster recovery operations using the SSO user. For any cluster operations like add, delete node, or enable SD-AVC, Cisco SD-WAN Manager expects any local username and password part of the net-admin group. In case of multitenancy, only admin user can update the SD-AVC. Other users even with netadmin privileges cannot update SD-AVC.

## View Available Cluster Services

To view the services that are available in and reachable on all the members in a Cisco SD-WAN Manager cluster, choose **Administration > Cluster Management > Service Reachability**.

## Configure the Cluster IP Address of a Cisco Catalyst SD-WAN Manager Server

When you start Cisco SD-WAN Manager for the first time, the default IP address of the Cisco SD-WAN Manager server is shown as localhost. Before you can add a new Cisco SD-WAN Manager server to a cluster, you must change the localhost address of the primary Cisco SD-WAN Manager server to an out-of-band IP address. (From Cisco vManage Release 20.6.1, the primary Cisco SD-WAN Manager server has the Compute+Data persona.) Servers in the cluster use this out-of-band IP address to communicate with each other.

If you need to change the out-of-band IP address in the future, contact your Cisco support representative.

Cluster interconnection between Cisco SD-WAN Manager servers requires that each of the servers be assigned a static IP address. We recommend that you do not use DHCP to assign IP addresses to Cisco SD-WAN Manager servers that are to be a part of a cluster. Configure the IP address on a nontunnel interface in VPN 0.

Before you configure the cluster IP address of a Cisco SD-WAN Manager server, ensure that out-of-band IP addresses have been configured on VPN0 for its server interfaces. This configuration typically is done when the server is provisioned. The port type for an out-of-band IP address must be **service** for the IP address to be available for assigning to a Cisco SD-WAN Manager server.



---

**Note** From Cisco vManage Release 20.11.1, some alarms display the hostname as **localhost** during the cluster setup for the first time as the system-ip/hostname is not configured in Cisco SD-WAN Manager. When the system-ip/hostname is configured, the alarms display the correct hostname.

---

### Configure the IP Address for Releases Before Cisco vManage Release 20.6.1

Configure the IP address of a Cisco SD-WAN Manager server before you add the server to the cluster. To do so for releases before Cisco vManage Release 20.6.1, follow these steps:

1. From the Cisco SD-WAN Manager menu, choose **Administration > Cluster Management** and click **Service Configuration**.
2. Click **Add vManage**.  
The **Edit vManage** dialog box opens.
3. From the **vManage IP Address** drop-down list, choose an IP address to assign to the Cisco SD-WAN Manager server.
4. Enter the user name and password for logging in to the Cisco SD-WAN Manager server.
5. Click **Update**.

The Cisco SD-WAN Manager server reboots and displays the **Cluster Management** window.

### Configure the IP Address for Cisco vManage Release 20.6.1 and Later Releases

Configure the IP address of a Cisco SD-WAN Manager server before you add the server to the cluster. To do so from Cisco vManage Release 20.6.1, perform the following steps.

Perform this procedure on the primary Cisco SD-WAN Manager server (which has the Compute+Data persona).

1. From the Cisco SD-WAN Manager menu, choose **Administration > Cluster Management**.

The **Cluster Management** window is displayed. The table on this window lists the Cisco SD-WAN Manager servers that are in the cluster.

2. Click ... adjacent to the Cisco SD-WAN Manager server to configure and click **Edit**.

The **Edit vManage** dialog box is displayed.

3. In the **Edit vManage** dialog box, perform the following actions.



---

**Note** You cannot change the persona of a server. So the Node Persona options are disabled.

---

- a. From the **vManage IP Address** drop-down list, choose an out-of-band static IP address to assign to the server.
- b. In the **Username** field, enter the user name for logging in to the server.
- c. In the **Password** field, enter the password for logging in to the server.
- d. (Optional) Click **Enable SD-AVC** if you want Cisco Software-Defined Application Visibility and Control (SD-AVC) to run on the server.

Cisco SD-AVC is a component of Cisco Application Visibility and Control (AVC). It can be enabled on only one Cisco SD-WAN Manager server. The server on which it is enabled must have the Compute+Data or the Compute persona. Cisco SD-AVC cannot be enabled on a server that has the Data persona.





**Note** If Cisco SD-WAN Manager is set up as a cluster and the cluster crashes as a result of a reboot or upgrade, the connection to the edge device is reset and the custom app ceases to function.

To resolve this and to resume operation, redefine the custom application name with a new, unique name. For more information to define custom applications, see the [Define Custom Applications Using Cisco Catalyst SD-WAN Manager](#) chapter of the *Cisco Catalyst SD-WAN Policies Configuration Guide*.

e. Click **Update**.

The server reboots and displays the **Cluster Management** window.

## Add a Cisco Catalyst SD-WAN Manager Server to a Cluster

**Table 32: Feature History**

Feature Name	Release Information	Description
Cisco SD-WAN Manager Persona-based Cluster Configuration	Cisco IOS XE Catalyst SD-WAN Release 17.6.1a Cisco SD-WAN Release 20.6.1 Cisco vManage Release 20.6.1	Simplifies adding Cisco SD-WAN Manager servers to a cluster by identifying servers based on personas. A persona defines what services run on a server.

The following sections provide information about adding a Cisco SD-WAN Manager server to a cluster in various Cisco SD-WAN Manager releases.

### Add a Cisco SD-WAN Manager Server to a Cluster for Releases Before Cisco vManage Release 20.6.1

To add a new Cisco SD-WAN Manager server to a cluster for releases before Cisco vManage Release 20.6.1, perform the following steps on the primary Cisco SD-WAN Manager server.

Before you begin, ensure that the default IP address of the Cisco SD-WAN Manager server has been changed to an out-of-band IP address as described in [Configure the Cluster IP Address of a Cisco Catalyst SD-WAN Manager Server, on page 241](#).

1. From the Cisco SD-WAN Manager menu, choose **Administration > Cluster Management** and click **Service Configuration**.
2. Click **Add Manager**.  
The **Edit Manager** window opens.
3. In the **Manager IP Address** field, select an IP address to assign to the Cisco SD-WAN Manager server.
4. Enter the username and password for logging in to the Cisco SD-WAN Manager server.
5. Enter the IP address of the Cisco SD-WAN Manager server that you are adding to the cluster.
6. Specify the username and password for the new Cisco SD-WAN Manager server.

7. Select the services to be run on the Cisco SD-WAN Manager server. You can select from the services listed below. Note that the **Application Server** field is not editable. The Cisco SD-WAN Manager Application Server is the local Cisco SD-WAN Manager HTTP web server.
  - Statistics Database: Stores statistics from all the Cisco Catalyst SD-WAN devices in the network.
  - Configuration Database: Stores all the device and feature templates and configurations for all the Cisco Catalyst SD-WAN devices in the network.
  - Messaging Server: Distributes messages and shares state among all the Cisco SD-WAN Manager cluster members.
8. Click **Add**.

The Cisco SD-WAN Manager server that you just added reboots before joining the cluster.



---

**Note**

- In a cluster, we recommend that you run at least three instances of each service.
  - When you add the first two compute or compute+data nodes to the cluster, the host node's application-server is unavailable. The following message is displayed on the host node's GUI, before the application-server shuts down in the host node: `\Node added to the cluster. The operation may take up to 30 minutes and may cause application-server to restart in between. Once the application server is back online, the post cluster operation progress can be viewed under tasks pop-up\.`
  - Starting Cisco IOS XE Catalyst SD-WAN Release 17.12.1a, ensure that you disable the **HTTP/HTTPS Proxy** option in the Cisco SD-WAN Manager settings, before adding a node to the cluster.
- 

### Add a Cisco SD-WAN Manager Server to a Cluster for Cisco vManage Release 20.6.1 and Later Releases

From Cisco vManage Release 20.6.1, a cluster supports any of the following deployments of nodes:

- Three Compute+Data nodes
- Three Compute+Data nodes and three Data nodes



---

**Note** DATA nodes should be added only after 3 node cluster with CONFIG+DATA is added.

---

- Three Compute nodes and three Data nodes (supported only in an upgrade from an existing deployment)

If you require a different combination of nodes, contact your Cisco representative.

To add a Cisco SD-WAN Manager server to a cluster from Cisco vManage Release 20.6.1, perform the following steps.

Perform this procedure on a Compute+Data node or a Compute node. Performing this procedure on a Data node is not supported because a Data node does not run all the services that are required for the addition.

Do not add a server that was a member of the cluster and then removed from the cluster. If you need to add that server to the cluster, bring up a new VM on that server to be used as the node to add.

Before you begin, ensure that the default IP address of the Cisco SD-WAN Manager server has been changed to an out-of-band IP address, as described in [Configure the Cluster IP Address of a Cisco Catalyst SD-WAN Manager Server, on page 241](#). This operation must happen only once on the Cisco SD-WAN Manager server and then the same is used to add other servers to form a cluster.

1. From the Cisco SD-WAN Manager menu, choose **Administration > Cluster Management**.

The **Cluster Management page** window appears. The table on this window shows the Cisco SD-WAN Manager servers that are in the cluster.

2. Click **Add Manager**.

The **Add Manager** dialog box opens.



---

**Note** If the **Edit Manager** dialog box opens, configure an out-of-band IP address for the server, as described in [Configure the Cluster IP Address of a Cisco Catalyst SD-WAN Manager Server, on page 241](#), and then repeat this procedure for adding a server.

---

3. In the **Add Manager** dialog box, perform the following actions:

- a. Click the **Node Persona** option (**Compute+Data**, **Compute**, or **Data**) that corresponds to the persona that has been configured for the server.

You can determine the persona of a server by logging in to the server and looking at the persona display on the **Administration > Cluster Management** window. If you choose an incorrect persona, a message displays the persona that you should choose.

- b. From the **Manager IP Address** drop-down list, choose the IP address of the server to be added to the cluster.
- c. In the **Username** field, enter the user name for logging in to the server.
- d. In the **Password** field, enter the password for logging in to the server.
- e. (Optional) Click **Enable SD-AVC** if you want Cisco Software-Defined Application Visibility and Control (SD-AVC) to run on the server.

Cisco SD-AVC is a component of Cisco Application Visibility and Control (AVC). It can be enabled on one Cisco SD-WAN Manager server. The server on which it is enabled must have the Compute+Data or the Compute persona. Cisco SD-AVC cannot be enabled on a server that has the Data persona.

If you enabled Cisco SD-AVC for this server when you changed its IP address, the **Enable SD-AVC** check box is checked by default.

- f. Click **Add**.
- g. To confirm, click **OK**.

The dialog box indicates that the services will restart, and that the existing metadata and other information that is not required when the server joins the cluster will be deleted from the server.

When you click **OK**, the system starts the server add operation. The **Cluster Management** window displays the tasks that the system performs as it adds the server.

As part of this operation, the system checks the compatibility of the server that you are adding. This check ensures that the server has sufficient disk space, and that the persona that you specified matches the persona of the node.

After the server is added, the system performs a cluster sync operation, which rebalances the services in the cluster. Then the Cisco SD-WAN Manager servers in the cluster restart.

## View Cisco Catalyst SD-WAN Manager Service Details

The following sections describe how to view detailed information about services that are running on a Cisco SD-WAN Manager server and how to view devices that are connected to Cisco SD-WAN Manager.

### View Detailed Information about Services

To view detailed information about the services running on a Cisco SD-WAN Manager server:

1. From the Cisco SD-WAN Manager menu, choose **Administration > Cluster Management** and click **Service Configuration**.
2. Click the hostname of the Cisco SD-WAN Manager server.  
The **vManage Details** window opens, displaying the process IDs of all the Cisco SD-WAN Manager services that are enabled on Cisco SD-WAN Manager.
3. Click **Cluster Management** in the breadcrumb in the title bar to return to the **Cluster Management** window.

### View Devices Connected to Cisco SD-WAN Manager

To view the list of devices connected to Cisco SD-WAN Manager:

1. From the Cisco SD-WAN Manager menu, choose **Administration > Cluster Management** and click **Service Configuration**.
2. Click the hostname of the Cisco SD-WAN Manager server.
3. Click **Managed Devices**.

Alternatively:

1. From the Cisco SD-WAN Manager menu, choose **Administration > Cluster Management** and click **Service Configuration**.
2. Click ... adjacent to the Cisco SD-WAN Manager server and choose **Device Connected**.
3. If a device is connected to Cisco SD-WAN Manager from a cluster, ensure that you do not configure the data stream hostname to the Cisco SD-WAN Manager system IP address. However, you can configure the management IP address on VPN 512 or the internet public IP address on VPN 0. For information about data stream troubleshooting tools, see [Data Stream Troubleshooting Tools FAQ](#).

## Edit Cisco Catalyst SD-WAN Manager Parameters

You can edit various parameters for a Cisco SD-WAN Manager server that has been added to a cluster. To do so, follow these steps:

1. From the Cisco SD-WAN Manager menu, choose **Administration > Cluster Management** and click **Service Configuration**.
2. Click ... adjacent to the Cisco SD-WAN Manager server to edit, and click **Edit**.  
The **Edit vManage** window opens.
3. Select an IP address to edit.
4. Enter the username and password, and edit parameters for the selected Cisco SD-WAN Manager server.
  - For releases before Cisco vManage Release 20.6.1, you can edit the cluster services.
  - From Cisco vManage Release 20.6.1, you can change the IP address to another IP address that appears in the **vManage IP Address** drop-down list, change the Cisco SD-AVC setting, or change the username and password if the server credentials have changed.
5. Click **Update**.

## Update Configuration Database Login

The default username of the configuration database is **neo4j** and the default password is **password**. To update the default login credentials of the configuration database, access Cisco SD-WAN Manager using a terminal and run the following commands. Do not use the SSH terminal option in Cisco SD-WAN Manager to run these commands. Doing so causes you to lose access to Cisco SD-WAN Manager.

1. Use **request nms application-server stop** to stop application servers on all the Cisco SD-WAN Manager servers whether configuration-db is enabled or not.  
.
2. Use one of the following commands to reset the user name and password for the configuration database on all the Cisco SD-WAN Manager servers:
  - For Cisco SD-WAN Release 20.1.1 and earlier:  
**request nms configuration-db update-admin-user username *username* password *password* newusername *newadminuser* newpassword *newpassword***
  - For releases from Cisco SD-WAN Release 20.1.2:  
**request nms configuration-db update-admin-user**  
When prompted, enter your current username and password, and your new username and password.  
When you run one of these commands, Cisco SD-WAN Manager restarts the application server



### Note

- If you do not know the default credentials of the configuration database, contact your Cisco support representative to retrieve the credentials.
- You cannot use a previous username.
- Passwords can include only a mix of characters A to Z ( upper or lowercase), digits 0 to 9, and special characters @, #, and \*.

**Example**

- For Cisco SD-WAN Release 20.1.1 and earlier:

```
request nms configuration-db update-admin-user username neo4j
password ***** newusername myusername newpassword mypassword
```

- For releases from Cisco SD-WAN Release 20.1.2:

```
request nms configuration-db update-admin-user
```

```
Enter current user name: neo4j
```

```
Enter current user password: password
```

```
Enter new user name: myusername
```

```
Enter new user password: mypassword
```



---

**Note** After a configuration database admin user update, if you are unable to view a specific Cisco SD-WAN Manager instance, use the **request nms application-server restart** command to restart the application server on that Cisco SD-WAN Manager instance again.

---



---

**Note** Starting from Cisco SD-WAN Release 20.6.1, when using the **request nms configuration-db update-admin-user** command to update the admin user credentials, provide the same inputs (old username, password and the new username, password) across all the nodes in the Cisco SD-WAN Manager cluster. You must execute the **request nms configuration-db update-admin-user** command one node at a time. We recommend that you do not push the CLI to all the nodes at the same time because the NMS services will restart for the new configuration to take effect.

---

## Downgrade Cisco Catalyst SD-WAN Manager

You cannot downgrade Cisco SD-WAN Manager (install a version of Cisco SD-WAN Manager that is lower than the current version), either through Cisco SD-WAN Manager or by using CLI commands.



---

**Note** This restriction applies for single Cisco SD-WAN Manager instances and for Cisco SD-WAN Manager clusters. This restriction is not related to software upgrades or downgrades on network devices.

---

To downgrade your Cisco SD-WAN Manager version, contact your Cisco support representative.

# Upgrade a Cisco SD-WAN Manager Cluster

Table 33: Feature History

Feature Name	Release Information	Description
Cisco SD-WAN Manager Cluster Upgrade	Cisco IOS XE Catalyst SD-WAN Release 17.3.1a Cisco SD-WAN Release 20.3.1 Cisco vManage Release 20.3.1	This feature outlines the upgrade procedure for Cisco SD-WAN Manager servers in a cluster.
Check for Database Schema Violation	Cisco Catalyst SD-WAN Manager Release 20.13.1	Updated the <b>request nms application-server status</b> command to indicate whether there is a schema violation in the configuration database. You can check for violations before upgrading a cluster.
Cisco SD-WAN Manager Cluster Upgrade Compatibility Check	Cisco IOS XE Catalyst SD-WAN Release 17.14.1a Cisco Catalyst SD-WAN Manager Release 20.14.1	This feature helps to upgrade a Cisco SD-WAN Manager cluster, performing a pre-upgrade software compatibility check and a post-upgrade check to ensure a successful upgrade. The feature helps to ensure a successful upgrade and helps to troubleshoot any problems in case of an unsuccessful upgrade.

## Information About Cluster Upgrade

This section describes how to upgrade Cisco SD-WAN Manager in a cluster.

You can upgrade directly from Cisco vManage 20.3.1 or later releases to Cisco vManage Release 20.6.1. To upgrade from earlier releases, first upgrade to Cisco vManage 20.4.2 or Cisco vManage Release 20.5.1.

If you are upgrading a Cisco SD-WAN Manager cluster deployment from Cisco vManage Release 20.3.1 or later to Cisco vManage Release 20.5.1 or later, you must do it through the CLI.

If you are upgrading to Cisco vManage Release 20.6.1 or later releases from a six-node Cisco SD-WAN Manager cluster deployment in which not all services are running on all nodes, contact your Cisco support representative before performing the upgrade.

### Checking Software Compatibility Before Upgrade

(Minimum supported release: Cisco Catalyst SD-WAN Manager Release 20.14.1)

In a cluster deployment, Cisco SD-WAN Manager services such as the configuration database, coordination service, and messaging services operate in a cluster mode.

We recommend using Cisco SD-WAN Manager to perform cluster upgrade, rather than CLI methods. Cisco SD-WAN Manager performs an important pre-upgrade check before proceeding with an upgrade. The pre-upgrade check includes items such as certificate expiration dates, the configuration database, CPU, disk, memory, and the status of services such as the coordination service and messaging service. If the cluster is not ready for upgrade, Cisco SD-WAN Manager notifies you.

After an upgrade, Cisco SD-WAN Manager performs a post-upgrade check, which includes checking the functionality of services to ensure a successful upgrade. If an upgrade fails, you can use Cisco SD-WAN Manager to troubleshoot and run the upgrade again.

While a cluster upgrade is in progress, at a given time, some nodes in the cluster continue to run an older software release while others have been upgraded to the newer release. Consequently, during the upgrade, there may be incompatibilities between services of the older and newer releases, preventing them from functioning properly.

For information about how to upgrade Cisco SD-WAN Manager clusters using Cisco SD-WAN Manager, see the [Software Upgrade](#) section in the *Cisco Catalyst SD-WAN Monitor and Maintain Configuration Guide*.

### Encryption

Minimum supported release: Cisco Catalyst SD-WAN Manager Release 20.14.1

For a multitenant cluster upgrade from Cisco Catalyst SD-WAN Manager Release 20.13.1 to Cisco Catalyst SD-WAN Manager Release 20.14.1 using Cisco SD-WAN Manager, the upgrade coordinator sometimes fails due to the encryption keys. The upgrade coordinator service uses the encryption keys to encrypt the service credentials.

To re-encrypt the service credentials, reboot the Cisco SD-WAN Manager and trigger the software activation.

## Prerequisites for Cluster Upgrade

Before you upgrade Cisco SD-WAN Manager nodes to Cisco vManage Release 20.6.1 or later releases, verify the following:

- Ensure that the internal user account `vmanage-admin` is not locked for any server that you are upgrading.

You can check the status of this admin account by pushing a template to the devices that are connected to the server. The push fails if the account is locked. In such a scenario, you can unlock the account by using the **`request aaa unlock-user vmanage-admin`** command.

- Ensure that PKI keys have been exchanged between the servers that you are upgrading.

To do so, ensure that the control connections are in the UP state on the servers and restart the application server.

- Ensure that the out-of-band IP address of each server is reachable.
- Ensure that the Cisco SD-WAN Manager is accessible on all servers in the cluster.
- Ensure that DCA is running on all nodes in the cluster.

To do so, use the **`request ms data-collection-agent status`** command and ensure that the status value shows **running** for each node.

To start DCA, if needed, use the **`request nms data-collection-agent start`** command.

- (Minimum supported release: Cisco Catalyst SD-WAN Manager Release 20.13.1) Use the **`request nms application-server status`** command to verify that there is no schema violation in the configuration



database. If the command output indicates a violation, contact Cisco Customer Support to resolve the issue.

If these prerequisites are not met or if another error occurs during the upgrade the activation of the image fails and a file named `upgrade-context.json` is created in the `/opt/data/extra-packages/image-version` folder on each node in the cluster. You can provide this file to your Cisco representative for assistance with resolving the issue.

## Upgrade a Cluster Using CLI

1. Take snapshots of all the Cisco SD-WAN Manager servers. Take a backup of the configuration database and save it in a location outside of the Cisco SD-WAN Manager server using the following command:

```
request nms configuration-db backup path path_and_filename
```

2. Ensure that Cisco vManage Release 18.3 or later is installed.
3. For upgrades from Cisco vManage Release 20.3.1 or later, copy the current image to each Cisco SD-WAN Manager server in the cluster and install the image on each Cisco SD-WAN Manager server by using the following command. Do not activate the image at this time.

```
request software install path
```



---

**Note** The copy to Cisco SD-WAN Manager can be done using SCP using CLI using the VPN 512 interface.

---

4. For upgrades from Cisco vManage Release 20.3.1 or later, activate the current image on each Cisco SD-WAN Manager server using the following command. All servers reboot simultaneously.

```
request software activate version
```

5. You must upgrade the configuration database when upgrading from one of the following:
  - Cisco vManage Release 18.4.x or 19.2.x to Cisco vManage 20.3.x or 20.4.x
  - Cisco vManage Release 20.3.x or 20.4.x to Cisco vManage Release 20.5.x or 20.6.x
  - Any Cisco SD-WAN Manager release to Cisco vManage Release 20.10.1 or later



---

**Note**

- Starting from Cisco vManage Release 20.1.1, before upgrading the configuration database, ensure that you verify the database size. We recommend that the database size is less than or equal to 5 GB. To verify the database size, use the following diagnostic command:

```
request nms configuration-db diagnostics
```

- When you upgrade the configuration database, ensure that you have activated the current image on each Cisco SD-WAN Manager server in the cluster as described in the previous step. In addition, ensure that all services except the application server and configuration-db services are running on these servers by entering the **request nms all status** command on each server.
- 

To upgrade the configuration database, do the following:

- a. To determine which node to upgrade, enter the **request nms configuration-db status** command on each node. In the output look for the following:

```
Enabled: true
Status: not running
```



---

**Note** After activating a new image on a Cisco SD-WAN Manager host server, the server reboots. After the reboot, for approximately 30 minutes, the output of the **request nms configuration-db status** command shows **Enabled: false** even on a node that has the configuration database enabled, while NMS services are being migrated to a containerized form.

---

- b. On the node to upgrade, as determined in the previous step, enter the following:

```
request nms configuration-db upgrade
```



---

**Note**

- Enter this command on one node only.
- Do not enter this command if you are upgrading from Cisco vManage Release 20.5.x to Cisco vManage Release 20.6.1 or later.

---

6. Enter your login credentials, if prompted. Login credentials are prompted in releases earlier than Cisco vManage Release 20.3.1 if all the Cisco SD-WAN Manager servers establish control connection with each other. After a successful upgrade, all the configuration database services are UP across the cluster, and the application server is started.

You can check the database upgrade logs at the following location:

```
vmanage-server:/var/log/nms/neo4j-upgrade.log.
```

## Manually Restart Cisco Catalyst SD-WAN Manager Processes

If the cluster is malfunctioning and requires restart, you can manually restart the Cisco SD-WAN Manager processes. Do one of the following:

- (Cisco vManage Release 20.6.1 and later) Use the **request nms all restart** command to restart all processes.
- (Releases earlier than Cisco vManage Release 20.6.1) Restart the processes one at a time in an orderly manner using the procedure that follows. The manual restart order may vary for your cluster, depending on what services you are running on the Cisco SD-WAN Manager instances in the cluster. The following order is based on a basic cluster with three Cisco SD-WAN Manager devices.

1. On each Cisco SD-WAN Manager device, stop all the NMS services:

```
request nms all stop
```

2. Verify that all the services have stopped. It is normal for the **request nms all stop** command to display a message about failing to stop a service if it takes too long. So use the following command to verify that everything is stopped before proceeding further:

```
request nms all status
```

3. Start the Statistics database on each device that is configured to run it. Wait for the service to start each time before proceeding to the next Cisco SD-WAN Manager device.

```
request nms statistics-db start
```

4. Verify that the service is started before proceeding to start it on the next Cisco SD-WAN Manager. After the service starts, perform step 3 to start the Statistics database on the next Cisco SD-WAN Manager device. After all the Cisco SD-WAN Manager devices have the Statistics database running, proceed to the next step.

```
request nms statistics-db status
```

5. Start the Configuration database on each device that is configured to run it. Wait for the service to start each time before proceeding to the next Cisco SD-WAN Manager device.

```
request nms configuration-db start
```

6. For releases earlier than Cisco vManage Release 20.3.1, verify that the service has started before proceeding to start it on the next Cisco SD-WAN Manager device. Go to vshell and tail a log file to look for a message that the database is online. After confirming, go to step 5 to start the Configuration database on the next Cisco SD-WAN Manager device. After all the Cisco SD-WAN Manager devices have the Configuration database running, proceed to the next step.

```
tail -f -n 100 /var/log/nms/vmanage-neo4j-out.log
```

7. Start the Coordination server on each device. Wait for the service to start each time before proceeding to the next Cisco SD-WAN Manager device.

```
request nms coordination-server start
```

8. Verify that the service is started before proceeding to start it on the next Cisco SD-WAN Manager device. After verifying, go to step 7 to start the Coordination server on the next Cisco SD-WAN Manager device. After the Coordination server runs on all the Cisco SD-WAN Manager devices, proceed to the next step.

```
request nms coordination-server status
```

9. Start the Messaging server on each device. Wait for the service to start each time before proceeding to the next Cisco SD-WAN Manager device.

```
request nms messaging-server start
```

10. Verify that the service has started before proceeding to start the service on the next Cisco SD-WAN Manager device. After verifying, go to step 9 to start the Messaging server on the next Cisco SD-WAN Manager device. After the Messaging server runs on all the Cisco SD-WAN Manager devices, proceed to the next step.

```
request nms messaging-server status
```

11. Start the Application server on each device. Wait for the service to start each time before proceeding to the next Cisco SD-WAN Manager device.

```
request nms application-server start
```

12. For Cisco vManage Release 20.3.1 and later releases, start the server-proxy service on each Cisco SD-WAN Manager device:

```
request nms server-proxy start
```

To verify that the service is fully started, open the GUI of that Cisco SD-WAN Manager device. After the GUI is fully loaded and you are able to log in, start the server-proxy service on the next Cisco SD-WAN Manager device.

13. Restart the NMS cloud services on each device. Wait for the services to start each time before proceeding to the next Cisco SD-WAN Manager device.

You can verify that the cloud services are running by entering the following commands:

```
request nms cloud-agent status
request nms cloud-agent-v2 status
```

Verify that the service has started before proceeding to start it on the next Cisco SD-WAN Manager device. After verifying, start the cloud services on the next Cisco SD-WAN Manager device. After the cloud services run on all the Cisco SD-WAN Manager devices, continue to the next step.

14. To verify that there are no errors and everything has loaded cleanly, tail the log files.

If you experience issues when upgrading to Cisco vManage Release 20.6.1 or later, contact your Cisco support representative for assistance.



---

**Note** Consider bringing up the services manually as described in this section whenever you have to reboot a Cisco SD-WAN Manager device, or after an upgrade.

---

Starting from Cisco IOS XE Catalyst SD-WAN Release 17.10.1a, a **device-data-collector** service container is added. The following is a sample output for the command, **request nms device-data-collector**.

```
Device# request nms device-data-collector
Possible completions:
diagnostics  Run diagnostics on NMS component
jcmd         Run jcmd on NMS component
restart      Restart NMS component
start       Start NMS component
status      Status of NMS component
stop        Stop NMS component
```

## Remove Cisco Catalyst SD-WAN Manager Nodes from a Cluster

You can remove a Cisco SD-WAN Manager node from a cluster, if necessary.

In releases earlier than Cisco vManage Release 20.6.1, you can only remove  $n - 2$  Cisco SD-WAN Manager nodes from a cluster of  $n$  nodes. You must retain at least two Cisco SD-WAN Manager nodes in a cluster.

From Cisco vManage Release 20.6.1, you must retain at least two Cisco SD-WAN Manager nodes that include the compute capability and at least one node that includes the data capability. That is, the cluster must retain any of the following:

- At least two Cisco SD-WAN Manager nodes that include the Compute+Data persona
- At least one Cisco SD-WAN Manager nodes that includes the Compute+Data persona and one Cisco SD-WAN Manager node that includes the Compute persona
- At least two Cisco SD-WAN Manager nodes that include the Compute persona and one Cisco SD-WAN Manager node that includes the Data persona

From Cisco vManage Release 20.6.1, if a Cisco SD-WAN Manager node is reachable when you remove it from a cluster, Cisco SD-WAN Manager automatically performs a factory reset operation on the removed

node to ensure that the node does not join the cluster again. If a Cisco SD-WAN Manager node is unreachable when you remove it from a cluster, a factory reset operation is not performed on the node. In this situation, the node is added back to the cluster automatically when the node becomes reachable. To prevent the node from being added back to the cluster, enter the command **request software reset** from the CLI of the node after the node is removed from the cluster.

To remove a Cisco SD-WAN Manager node from a cluster, follow these steps:

1. From the Cisco SD-WAN Manager, choose **Administration > Cluster Management** and click **Service Configuration**.
2. Click ... adjacent to the Cisco SD-WAN Manager instance that you want to remove and click **Remove**.  
The **Remove Manager** dialog box opens.
3. Enter the username and password to confirm the removal of the device from the network.
4. Click **Remove**.

The Cisco SD-WAN Manager instance is removed from the cluster, the certificates for that Cisco SD-WAN Manager are deleted, and Cisco SD-WAN Manager undergoes a factory reset.





## CHAPTER 9

# Certificate Management

- [Manage Certificates in Cisco Catalyst SD-WAN Manager, on page 257](#)
- [Configure Third-party CA Certificates to Cisco IOS XE Catalyst SD-WAN devices Using Cisco SD-WAN Manager, on page 266](#)
- [Information About Configure CA Certificates Using Cisco SD-WAN Manager, on page 266](#)
- [Supported Devices for Uploading CA Certificates, on page 267](#)
- [Prerequisites to Configuring CA Certificates, on page 267](#)
- [Restrictions for Uploading CA Certificates, on page 267](#)
- [Upload CA Certificates, on page 267](#)
- [Configure CA Certificates Using Cisco SD-WAN Manager, on page 268](#)
- [Monitor CA Certificates and PKI Trustpoints, on page 269](#)
- [CRL-Based Quarantine, on page 270](#)
- [Manage Root Certificate Authority Certificates in Cisco Catalyst SD-WAN Manager, on page 272](#)
- [Enterprise Certificates, on page 273](#)
- [Cisco PKI Controller Certificates, on page 281](#)
- [Web Server Certificate for Cisco SD-WAN Manager, on page 287](#)

## Manage Certificates in Cisco Catalyst SD-WAN Manager

Perform certificate operations in Cisco SD-WAN Manager on the **Configuration > Certificates** page.

- **Top bar**—On the left are the menu icon, for expanding and collapsing the Cisco SD-WAN Manager menu, and the Cisco SD-WAN Manager product name. On the right are a number of icons and the user profile drop-down.
- **Title bar**—Includes the title of the screen, Certificates.
- **WAN Edge List tab**—Install the router authorized serial number file on the controllers in the overlay network and manage the serial numbers in the file. When you first open the Certificates screen, the WAN Edge List tab is selected.
  - **Send to Controllers**—Send the WAN edge router chassis and serial numbers to the controllers in the network.
  - **Table of WAN edge routers in the overlay network**—To re-arrange the columns, drag the column title to the desired position.

- **Controllers tab**—Install certificates and download the device serial numbers to the Cisco SD-WAN Validator.



**Note** Starting from Cisco IOS XE Catalyst SD-WAN Release 17.13.1a, the **Controllers** tab is renamed as the **Control Components** tab to stay consistent with Cisco Catalyst SD-WAN rebranding.

- **Send to Cisco SD-WAN Validator**—Send the controller serial numbers to the Cisco SD-WAN Validator.
- **Install Certificate**—Install the signed certificates on the controller devices. This button is available only if you select Manual in **Administration > Settings > Certificate Signing by Symantec**.
- **Export Root Certificate**—Display a copy of the root certificate for the controller devices that you can download to a file.
- **Table of controller devices in the overlay network**—To re-arrange the columns, drag the column title to the desired position.
- **Certificate status bar**—Located at the bottom of the screen, this bar is available only if you select Server Automated in **Administration > Settings > Certificate Authorization**. It displays the states of the certificate installation process:
  - Device Added
  - Generate CSR
  - Waiting for Certificate
  - Send to Controllers

A green check mark indicates that the step has been completed. A grey check mark indicates that the step has not yet been performed.

- **Search box**—Includes the Search Options drop-down, for a Contains or Match string.
- **Refresh icon**—Click to refresh data in the device table with the most current data.
- **Export icon**—Click to download all data to a file, in CSV format.
- **Show Table Fields icon**—Click the icon to display or hide columns from the device table. By default, all columns are displayed.

## Check the WAN Edge Router Certificate Status

In the **WAN Edge List** tab, check the **Validate** column. The status can be one of the following:

- **Valid (shown in green)**—The router's certificate is valid.
- **Staging (shown in yellow)**—The router is in the staging state.
- **Invalid (shown in red)**—The router's certificate is not valid.



## Validate a WAN Edge Router

When you add Cisco vEdge devices and WAN routers to the network using the **Configuration > Devices** screen, you can automatically validate the routers and send their chassis and serial numbers to the controller devices by clicking the checkbox **Validate the uploaded WAN Edge List and send to controllers**. If you do not select this option, you must individually validate each router and send their chassis and serial numbers to the controller devices. To do so:

1. In the **WAN Edge List** tab, select the router to validate.
2. In the **Validate** column, click **Valid**.
3. Click **OK** to confirm the move to the valid state.
4. Repeat the steps above for each router you wish to validate.
5. Click the **Send to Controllers** button in the upper left corner of the screen to send the chassis and serial numbers of the validated routers to the controller devices in the network. Cisco SD-WAN Manager NMS displays the Push WAN Edge List screen showing the status of the push operation.

## Stage a WAN Edge Router

When you initially bring up and configure a WAN Edge router, you can place it in staging state using the Cisco SD-WAN Manager instance. When the router is in this state, you can configure the router, and you can test that the router is able to establish operational connections with the Cisco SD-WAN Controller and the Cisco SD-WAN Manager instance.

After you physically place the router at its production site, you change the router's state from staging to valid. It is only at this point that the router joins the actual production network. To stage a router:

1. In the WAN Edge List tab, select the router to stage.
2. In the **Validate** column, click **Staging**.
3. Click **OK** to confirm the move to the staging state.
4. Click **Send to Controllers** in the upper left corner of the screen to sync the WAN edge authorized serial number file with the controllers. Cisco SD-WAN Manager NMS displays the **Push WAN Edge List** screen showing the status of the push operation.
5. To unstage, validate the WAN Edge Router.

## Invalidate a WAN Edge Router

1. In the **WAN Edge List** tab, select the router to invalidate.
2. In the **Validate** column, click **Invalid**.
3. Click **OK** to confirm the move to the invalid state.
4. Repeat the steps above for each router you wish to invalidate.
5. Click the **Send to Controllers** button in the upper left corner of the screen to send the chassis and serial numbers of the validated routers to the controller devices in the network. Cisco SD-WAN Manager instance displays the **Push WAN Edge List** screen showing the status of the push operation.

## Send the Controller Serial Numbers to Cisco Catalyst SD-WAN Validator

To determine which controllers in the overlay network are valid, the Cisco SD-WAN Validator keeps a list of the controller serial numbers. The Cisco SD-WAN Manager instance learns these serial numbers during the certificate-generation process.

To send the controller serial numbers to the Cisco SD-WAN Validator:

1. In the **Controllers** tab, check the certificate status bar at the bottom of the screen. If the **Send to Controllers** check mark is green, all serial numbers have already been sent to the Cisco SD-WAN Validator. If it is grey, you can send one or more serial numbers to the Cisco SD-WAN Validator.



---

**Note** Starting from Cisco IOS XE Catalyst SD-WAN Release 17.13.1a, the **Controllers** tab is renamed as the **Control Components** tab to stay consistent with Cisco Catalyst SD-WAN rebranding.

---

2. Click the **Send to Validator** button in the **Controllers** tab. The controller's serial number and the UUIDs of the validated routers are sent to the Cisco SD-WAN Validator. If all serial numbers have been sent, when you click **Send to Validator**, an error message is displayed. To resend a controller's serial number, you must first select the device and then select **Invalid in the Validity** column.



---

**Note** In Cisco IOS XE Catalyst SD-WAN Release 17.14.x and earlier, when you click the **Send to Validator** button in the **Controllers** tab, only the controller's serial number is sent once to the Cisco SD-WAN Validator.

Starting from Cisco IOS XE Catalyst SD-WAN Release 17.13.1a, the **Controllers** tab is renamed as the **Control Components** tab to stay consistent with Cisco Catalyst SD-WAN rebranding.

---

After the serial numbers have been sent, click the **Tasks** icon in the Cisco SD-WAN Manager toolbar to display a log of the file download and other recent activities.

## Install Signed Certificate

If in **Administration > Settings > Certificate Signing by Symantec**, you selected the **Manual** option for the certificate-generation process, use the **Install Certificate** button to manually install certificates on the controller devices.

After Symantec or your enterprise root CA has signed the certificates, they return the files containing the individual signed certificates. Place them on a server in your local network. Then install them on each controller:

1. In the **Controllers** tab, click **Install Certificate**.



---

**Note** Starting from Cisco IOS XE Catalyst SD-WAN Release 17.13.1a, the **Controllers** tab is renamed as the **Control Components** tab to stay consistent with Cisco Catalyst SD-WAN rebranding.

---

2. In the **Install Certificate** window, select a file, or copy and paste the certificate text.
3. Click **Install** to install the certificate on the device. The certificate contains information that identifies the controller, so you do not need to select the device on which to install the certificate.

4. Repeat Steps the steps above to install additional certificates.

## Export Root Certificate

1. In the **Controllers** tab, click the **Export Root Certificate** button.



---

**Note** Starting from Cisco IOS XE Catalyst SD-WAN Release 17.13.1a, the **Controllers** tab is renamed as the **Control Components** tab to stay consistent with Cisco Catalyst SD-WAN rebranding.

---

2. In the **Export Root Certificate** window, click **Download** to export the root certificate to a file.
3. Click **Close**.

## View a Certificate Signing Request

1. In the WAN Edge List or **Controllers** tab, select a device.



---

**Note** Starting from Cisco IOS XE Catalyst SD-WAN Release 17.13.1a, the **Controllers** tab is renamed as the **Control Components** tab to stay consistent with Cisco Catalyst SD-WAN rebranding.

---

2. Click the **More Actions** icon to the right of the row, and click **View CSR** to view the certificate signing request (CSR).

## View a Device Certificate Signing Request

1. In the **WAN Edge List** or **Controllers** tab, select a Cisco IOS XE Catalyst SD-WAN device.



---

**Note** Starting from Cisco IOS XE Catalyst SD-WAN Release 17.13.1a, The **Controllers** tab is renamed as **Control Components** tab to stay consistent with Cisco Catalyst SD-WAN rebranding.

---

2. Click the **More Actions** icon to the right of the row, and click **View Device CSR** to view the certificate signing request (CSR).

For a Cisco IOS XE Catalyst SD-WAN device where trustpoint has been configured, clicking the **More Actions** icon allows you to view three options:

- View Device CSR
- Generate Feature CSR
- View Feature CSR



---

**Note** Cisco SD-WAN Manager will generate alarms only if device certificate is installed through Cisco SD-WAN Manager. If you install certificate manually, Cisco SD-WAN Manager will not generate alarms for certificate expiration.

---

## View the Certificate

1. In the **Controllers** tab, select a device.



---

**Note** Starting from Cisco IOS XE Catalyst SD-WAN Release 17.13.1a, The **Controllers** tab is renamed as **Control Components** tab to stay consistent with Cisco Catalyst SD-WAN rebranding.

---

2. Click the **More Actions** icon to the right of the row and click **View Certificate**.

## Generate a Certificate Signing Request

The following procedures describe the process of generating CSRs.

### Generate a Controller Certificate Signing Request

1. From the Cisco SD-WAN Manager menu, choose **Configuration > Certificates**.
2. Click **Controllers**.



---

**Note** Starting from Cisco IOS XE Catalyst SD-WAN Release 17.13.1a, The **Controllers** tab is renamed as **Control Components** tab to stay consistent with Cisco Catalyst SD-WAN rebranding.

---

3. For the desired controller, click ... and choose **Generate CSR**.  
The **Generate CSR** window is displayed.
4. In the **Generate CSR** window, click **Download** to download the file to your local PC (that is, to the PC you are using to connect to the Cisco SD-WAN Manager NMS).
5. Repeat the preceding steps to generate a CSR for another controller.

### Generate a Feature Certificate Signing Request

1. From the Cisco SD-WAN Manager menu, choose **Configuration > Certificates**.
2. Click **WAN Edge List**.
3. For the desired device, click ... and choose **Generate Feature CSR**.  
The **Generate Feature CSR** window is displayed.

4. In the **Generate Feature CSR** window, click **OK** to continue with the generation of feature CSR. This step authenticates the device trustpoint that has been set and extracts the CSR from the device.
5. Repeat the steps above for each device for which you are generating a CSR.

## Generate a WAN Edge Device Certificate Signing Request

1. From the Cisco SD-WAN Manager menu, choose **Configuration > Certificates**.
2. Click **WAN Edge List**.
3. For the desired device, click ... and choose **Renew Device CSR**.  
The **Renew Device CSR** window is displayed.
4. In the **Renew Device CSR** window, click **OK** to continue with the generation of a new CSR.



---

**Note** Cisco vManage Release 20.9.1 and later releases: Clicking **Renew Device CSR** resets the RSA private and public keys, and generates a CSR that uses a new key pair. Cisco SD-WAN Manager also resets RSA private and public keys before generating a new CSR in Cisco vManage Release 20.6.4 and later Cisco vManage 20.6.x releases.

Cisco SD-WAN Manager releases other than the above-mentioned releases: Clicking **Renew Device CSR** generates a CSR using the existing key pair.

---

## Reset the RSA Key Pair

1. In the **Controllers** tab, select a device.



---

**Note** Starting from Cisco IOS XE Catalyst SD-WAN Release 17.13.1a, The **Controllers** tab is renamed as **Control Components** tab to stay consistent with Cisco Catalyst SD-WAN rebranding.

---

2. Click the **More Actions** icon to the right of the row and click **Reset RSA**.
3. Click **OK** to confirm resetting of the device's RSA key and to generate a new CSR with new public or private keys.

## Invalidate a Device

1. In the **Controllers** tab, select a device.



---

**Note** Starting from Cisco IOS XE Catalyst SD-WAN Release 17.13.1a, The **Controllers** tab is renamed as **Control Components** tab to stay consistent with Cisco Catalyst SD-WAN rebranding.

---

2. Click the **More Actions** icon to the right of the row and click **Invalidate**.

3. Click **OK** to confirm invalidation of the device.

## View Log of Certificate Activities

To view the status of certificate-related activities:

1. Click the **Tasks** icon located in the Cisco SD-WAN Manager toolbar. Cisco SD-WAN Manager NMS displays a list of all running tasks along with the total number of successes and failures.
2. Click a row to see details of a task. Cisco SD-WAN Manager NMS opens a status window displaying the status of the task and details of the device on which the task was performed.

## View a Signed Certificate

Signed certificates are used to authenticate Cisco SD-WAN devices in the overlay network. To view the contents of a signed certificate using Cisco SD-WAN Manager:

1. From the Cisco SD-WAN Manager menu, choose **Configuration > Certificates**.
2. Click **Controllers**.



---

**Note** Starting from Cisco IOS XE Catalyst SD-WAN Release 17.13.1a, The **Controllers** tab is renamed as **Control Components** tab to stay consistent with Cisco Catalyst SD-WAN rebranding.

---

3. For the desired device, click **...** and choose **View Certificate** to view the installed certificate.

## Certificate Revocation

*Table 34: Feature History*

Feature Name	Release Information	Feature Description
Certificate Revocation	Cisco IOS XE Catalyst SD-WAN Release 17.7.1a Cisco SD-WAN Release 20.7.1 Cisco vManage Release 20.7.1	This feature revokes enterprise certificates from devices based on a certificate revocation list that Cisco SD-WAN Manager obtains from a root certificate authority.

### Information About Certificate Revocation

If you are using enterprise certificates with Cisco Catalyst SD-WAN, you can enable Cisco SD-WAN Manager to revoke designated certificates from devices, as needed. For example, you might need to revoke certificates if there has been a security issue at your site.



---

**Note** The certificate revocation feature is disabled by default.

---

Cisco SD-WAN Manager revokes the certificates that are included in a certificate revocation list (CRL) that Cisco SD-WAN Manager obtains from a root certificate authority (CA).

When you enable the Certificate Revocation feature and provide the URL of the CRL to Cisco SD-WAN Manager, Cisco SD-WAN Manager polls the root CA at a configured interval, retrieves the CRL, and pushes the CRL to Cisco IOS XE Catalyst SD-WAN devices, Cisco vEdge devices, Cisco SD-WAN Validators, and Cisco SD-WAN Controllers in the overlay network. Certificates that are included in the CRL are revoked from devices.

When certificates are revoked, they are marked as not valid. Device control connections remain up until the next control connection flap occurs, at which time device control connections are brought down. To bring a device control connection back up, reinstall a certificate on the device and onboard the device.

When Cisco SD-WAN Manager revokes certificates from devices, the devices are not removed from the overlay network, but they are prevented from communicating with other devices in the overlay network. A peer device rejects a connection attempt from a device whose certificate is in the CRL.

## Restrictions for Certificate Revocation

- By default, the Certificate Revocation feature is disabled. When you enable the Certificate Revocation feature for the first time, control connections to all the devices in the network flap. We recommend that you enable the feature for the first time during a maintenance window to avoid service disruption.

When you disable the Certificate Revocation feature, control connections to all the devices in the network flap. We recommend that you disable the feature during a maintenance window to avoid service disruption.

- You can use the Certificate Revocation feature only if you are using an enterprise CA to sign certificates for hardware WAN edge certificate authorization, controller certificate authorization, or WAN edge cloud certificate authorization.
- Cisco SD-WAN Manager can connect to a server to retrieve a CRL only through the VPN 0 interface.



---

**Note** Starting from Cisco vManage Release 20.11.1, connections through the VPN 512 are supported.

---

## Configure Certificate Revocation

### Before You Begin

Make a note of the URL of the root CA CRL.

### Procedure

1. From the Cisco SD-WAN Manager menu, choose **Administration > Settings**.
2. In the **Administration Settings** window, click **Edit** next to **Certificate Revocation List**.  
The certificate revocation options appear.
3. Click **Enabled**.
4. In the **CRL Server URL** field, enter the URL of the CRL that you created on your secure server.
5. In the **Retrieval Interval** field, enter the interval, in hours, at which Cisco SD-WAN Manager retrieves the CRL from your secure server and revokes the certificates that the CRL designates.

Enter a value from 1 to 24. The default retrieval interval is 1 hour.

6. Click **Save**.

Cisco SD-WAN Manager immediately retrieves the CRL and revokes the certificates that the CRL designates. From then on, Cisco SD-WAN Manager retrieves the CRL according to the retrieval interval period that you specified.

## Configure Third-party CA Certificates to Cisco IOS XE Catalyst SD-WAN devices Using Cisco SD-WAN Manager

Table 35: Feature History

Feature Name	Release Information	Description
Configure Third-party CA Certificates to Cisco IOS XE Catalyst SD-WAN devices using Cisco SD-WAN Manager	Cisco IOS XE Catalyst SD-WAN Release 17.13.1a Cisco Catalyst SD-WAN Manager Release 20.13.1	Using Cisco SD-WAN Manager, conveniently upload and push generic third-party CA certificates to Cisco IOS XE Catalyst SD-WAN devices with a Trustpoint name. The provisioning is executed via configuration groups parcel, with the status readily viewable in monitoring.

## Information About Configure CA Certificates Using Cisco SD-WAN Manager

The Cisco SD-WAN Manager currently permits the upload of third party certificates to devices during their integration with the Cisco Catalyst SD-WAN fabric, yet this function is only available during the control connection establishment and initial device setup.

Starting from Cisco IOS XE Catalyst SD-WAN Release 17.13.1a, the feature enables certificate upload using the UI. The Cisco SD-WAN Manager supports CA certificate uploads even after device setup.

The CA certificates authenticate the server identities and prevent unauthorized access. The Cisco IOS XE Catalyst SD-WAN devices use CA certificates to establish and manage secure connections with different servers in a network. When you upload a CA certificate to Cisco SD-WAN Manager, the Cisco IOS XE Catalyst SD-WAN device uses this certificate information from the configuration group parcels in verifying and authenticating the connections it establishes with servers across a network, thus improving the overall security and integrity of your network traffic.



---

**Note** The CA certificates isn't suited for SSL-based access with router trusted roots.

---



# Supported Devices for Uploading CA Certificates

Cisco IOS XE Catalyst SD-WAN devices

## Prerequisites to Configuring CA Certificates

- Your Cisco SD-WAN Manager must run Cisco Catalyst SD-WAN Manager Release 20.13.1 and later releases to upload CA certificates.
- Your Cisco IOS XE Catalyst SD-WAN device must run Cisco IOS XE Catalyst SD-WAN Release 17.13.1a and later releases to upload CA certificates.

## Restrictions for Uploading CA Certificates

- Supports only PEM encoded certificate files.
- Maximum certificate file size: 10 MB.
- If you are using Cisco Catalyst SD-WAN Multitenancy, you need to be a tenant to upload and manage CA certificates. For more information see, [Tenant Role](#).



---

**Note** When you login into Cisco SD-WAN Manager as a provider, you can't upload and manage CA certificates.

---

## Upload CA Certificates

1. From the Cisco SD-WAN Manager menu, choose **Configuration > Certificates**.
2. Click the **CA Cert** tab.
3. Click **Add CA Certificate**.
4. In the **Add CA Certificate** pane, enter **Certificate Name**.
5. **Choose a file** or drag and drop to upload a CA certificate.
6. Click the **Paste** tab and paste the certificate details.
7. Click **Save**.

On the **Certificate Authority** page, find the CA certificate listed in the **Device Group** table.



---

**Note** Spot the **Expiration Date** in the **Device Group** table for your CA certificate and perform more **Actions** by clicking the **...** icon.

---

**Delete CA Certificates**

1. From the Cisco SD-WAN Manager menu, choose **Configuration > Certificates**.
2. Click the **CA Cert** tab.
3. In the **Device Group** table, select the CA certificate to delete.
4. Click **Delete**.



---

**Note** Alternate method to delete a CA certificate: click the ... icon in the **Actions** column and click **Delete**.

---

## Configure CA Certificates Using Cisco SD-WAN Manager

1. From the Cisco SD-WAN Manager menu, choose **Configuration > Configuration Groups**.  
For more information on creating a configuration group, see [Configuration Group Workflows](#).
2. Add a feature to the configuration group.  
For more information on adding a feature, see [Feature Management](#).
3. Under **System Profile**, click **Add Feature**.
4. In the **Add Feature** pane, choose **CA Certificate**.
5. Configure the **CA Certificates** section.

*Table 36: CA Certificates*

Field	Description
<b>Type</b>	Choose <b>CA Certificate</b> from the drop-down list.
<b>Name</b>	Enter a name for the certificate.
<b>Description</b>	(Optional) Provide a description for the certificate.
<b>Add CA Certificate</b>	Click <b>Add CA Certificate</b> to add additional CA certificates.
<b>TrustPoint Name</b>	Enter a TrustPoint Name.
<b>Certificate Name</b>	Choose a CA certificate to add from the drop-down list.

6. Click **Save**.
7. Deploy the devices associated to the configuration group. For more information, see [Deploy Devices](#).



**Note** When you modify a certificate from the **Device Group** table, the changes won't be mirrored on the device. This is due to the certificate's association with a TrustPoint. To update the certificate, it's necessary to remove the existing TrustPoint that contains the certificate information. Subsequently, create a new TrustPoint and add the certificate to it. Finally, deploy the changes to the device for the certificates to take effect.

Deleting certificates from the **Certificates** tab doesn't automatically delete the associated TrustPoint. To delete the TrustPoint, you must manually delete and then save the changes to the TrustPoint.

## Revoke the CA Certificates

Use the following instructions to revoke a CA certificate:

1. From the Cisco SD-WAN Manager menu, choose **Configuration > Configuration Groups**.
2. Click ... adjacent to the configuration group name and choose **Edit**.
3. Click the desired system profile.
4. Click ... adjacent to the CA certificate feature and choose **Delete Feature**.
5. Deploy the changes to the device.

## Renew the CA Certificates

Use the following instructions to renew a CA certificate:

1. Upload the CA certificate that you'd like to renew to the Cisco SD-WAN Manager.
2. From the Cisco SD-WAN Manager menu, choose **Configuration > Configuration Groups**.
3. Click ... adjacent to the configuration group name and choose **Edit**.
4. Click the desired system profile.
5. Click ... adjacent to the CA certificate feature and choose **Delete Feature**.
6. Using **Configuration Groups**, add a feature to the configuration group and follow the instructions from step 3 to step 7 in the **Configure CA Certificate** topic.

## Monitor CA Certificates and PKI Trustpoints

### Track CA Certificate

Track a CA certificate using the **Issuer Name**, **Certificate Serial No.**, and **Expiration Date** listed in the Cisco SD-WAN Manager.

1. In the Cisco SD-WAN Manager menu, choose **Configuration > Certificates**.
2. Click the **CA Cert** tab.
3. The CA certificate added to Cisco SD-WAN Manager appears in the **Device Group** table.

### Monitor CA Certificate Installation

Once the CA certificate installation is complete, the Cisco IOS XE Catalyst SD-WAN device sends the event logs to Cisco Catalyst SD-WAN Manager.

From the Cisco SD-WAN Manager menu, choose **Monitor > Logs > Events**.

The CA certificate installation is listed as an event and appears in the **Events** table.

### Monitor PKI Trustpoints

Monitor PKI Trustpoints using the real time command **PKI Trustpoint**. For more information, see View PKI Trustpoint information.

## CRL-Based Quarantine

Table 37: Feature History

Feature Name	Release Information	Feature Description
CRL-Based Quarantine	Cisco vManage Release 20.11.1	With this feature you can quarantine SD-WAN edge devices based on a certificate revocation list that Cisco SD-WAN Manager obtains from a certificate authority.

## Information About CRL-Based Quarantine

When you use enterprise certificates with Cisco Catalyst SD-WAN, you can use Cisco SD-WAN Manager to quarantine SD-WAN edge devices that are compromised, and their certificates have been revoked.



**Note** The certificate revocation list (CRL)-based quarantine feature is disabled by default.

- Cisco SD-WAN Manager revokes the certificates that are included in a certificate revocation list (CRL). Cisco SD-WAN Manager obtains this list from a certificate authority (CA).
- At defined intervals, Cisco SD-WAN Manager polls the CRL server for the latest CRL. On receiving the list, Cisco SD-WAN Manager analyzes it to determine which SD-WAN edge device is to be quarantined.
- Cisco SD-WAN Manager checks if the serial numbers of certificates for each valid SD-WAN edge device in the network match the serial numbers of certificates within the CRL. On finding a match, the certificates on the SD-WAN edge devices are not removed to enable the SD-WAN edge devices to retain a control connection to Cisco SD-WAN Manager.

The quarantine process for SD-WAN edge devices is as follows:

- For each SD-WAN edge device that is quarantined:

- Cisco SD-WAN Manager moves the SD-WAN edge device to the staging mode. The staging mode shuts down data traffic while maintaining a control connection to Cisco SD-WAN Manager.
- Cisco SD-WAN Manager generates notifications for the SD-WAN edge device being quarantined.

For each Cisco SD-WAN Controller that is quarantined, Cisco SD-WAN Manager generates notifications for the controller.



---

**Note** The CRL server connects to Cisco SD-WAN Manager through VPN 0 or VPN 512.

---

## Restrictions for CRL-Based Quarantine

- You can use the CRL-based quarantine feature only if you have an enterprise CA (certificate authority) to sign certificates for hardware WAN edge certificate authorization, controller certificate authorization, or WAN edge cloud certificate authorization.
- Disable the CRL to switch from certificate revocation to quarantine or quarantine to certificate revocation. You cannot enable the certificate revocation and CRL-based quarantine option at the same time.

## Configure CRL-Based Quarantine

### Before You Begin

- From the Cisco SD-WAN Manager menu, choose **Administration > Settings**. Click any one of the following options and choose enterprise mode to enable the CRL (certificate revocation list).
  - In the **Controller Certificate Authorization** field, choose **Enterprise Root Certificate** or
  - In the **Hardware WAN Edge Certificate Authorization** field, choose **Enterprise Certificate (signed by Enterprise CA)** or
  - In the **WAN Edge Cloud Certificate Authorization** field, choose **Manual (Enterprise CA - recommended)**.
- Make a note of the URL of the CA CRL.



---

**Note** By default, the CRL-based quarantine feature is disabled.

---

To configure CRL-based quarantine:

1. From the Cisco SD-WAN Manager menu, choose **Administration > Settings**.
2. In the **Administration Settings** page, click **Edit** next to **Certificate Revocation List**.  
The Certificate Revocation and CRL-Based Quarantine options appear.
3. Click **CRL-Based Quarantine**.

4. In the **CRL Server URL** field, enter the URL of the CRL that you created on your secure server.
5. In the **Retrieval Interval** field, enter the interval in hours. Cisco SD-WAN Manager uses the certificate revocation list (CRL) to quarantine SD-WAN edge devices.  
Enter a value from 1 to 24. The default retrieval interval is 24 hours.
6. Click **VPN 0** or **VPN 512**. Cisco SD-WAN Manager connects to a server to retrieve the CRL through the VPN 0 or VPN 512 interface.
7. Click **Save**.  
Cisco SD-WAN Manager at intervals, polls the CRL server for the latest CRL. This list is analyzed to determine which SD-WAN edge devices are to be quarantined.



**Note** If the CRL is disabled in earlier releases, the CRL remains disabled after upgrading to the Cisco vManage Release 20.11.1. If the CRL was enabled in a release prior to Cisco vManage Release 20.11.1, then after upgrading to Cisco vManage Release 20.11.1, the certificate revocation option is enabled with VPN0 as the default.

## Manage Root Certificate Authority Certificates in Cisco Catalyst SD-WAN Manager

Feature Name	Release Information	Description
Support for Managing Root CA Certificates in Cisco SD-WAN Manager	Cisco IOS XE Catalyst SD-WAN Release 17.4.1a Cisco SD-WAN Release 20.4.1 Cisco vManage Release 20.4.1	This feature enables you to add and manage root certificate authority (CA) certificates.

### Add a Root Certificate Authority Certificate

1. In Cisco SD-WAN Manager, choose **Administration > Root CA Management**.
2. Click **Modify Root CA**.
3. In the **Root Certificate** field, paste in certificate text, or click **Select a File** to load a certificate from a file.
4. Click **Add**. The new certificate appears in the certificate table. The **Recent Status** column indicates that the certificate has not yet been installed.
5. Click **Next** and review the details of any certificates that have not been installed.
6. Click **Save** to install the certificate(s). The new certificate appears in the certificate table.

## View a Root Certificate Authority Certificate

1. In Cisco SD-WAN Manager, choose **Administration > Root CA Management**.
2. (optional) In the search field, enter text to filter the certificate view. You can filter by certificate text or attribute values, such as serial number.
3. In the table of certificates, click **More Actions (...)** and choose **View**. A pop-up window appears, displaying the certificate and its details.

## Delete a Root Certificate

Use this procedure to delete a root Certificate Authority (CA) certificate.

1. In Cisco SD-WAN Manager, choose **Administration > Root CA Management**.
2. Click **Modify Root CA**.
3. Select one or more root certificates in the table and click the **trash** icon in the **Action** column. The table shows the certificate as marked for deletion.
4. Click **Next** and review the details of any certificates that are marked for deletion.
5. Click **Save** to delete the certificate(s).

## Enterprise Certificates

In Cisco IOS XE SD-WAN Release 16.11.1 and Cisco SD-WAN Release 19.1, enterprise certificates were introduced. Enterprise certificates replace the controller certificates authorization used previously.



---

**Note** When using enterprise certificates for Cisco SD-WAN Controllers, ensure that you use root certificates with an RSA key that is at least 2048 bit.

---



---

**Note** For purposes of certificate management, the term *controller* is used to collectively refer to Cisco SD-WAN Manager, the Cisco Catalyst SD-WAN Controller, and the Cisco Catalyst SD-WAN Validator.

---



---

**Note** For more information about enterprise certificates, see the [Cisco Catalyst SD-WAN Controller Certificates and Authorized Serial Number File Prescriptive Deployment Guide](#).

---

Use the Certificates page to manage certificates and authenticate WAN edge and controller devices in the overlay network.

Two components of the Cisco Catalyst SD-WAN solution provide device authentication:

- Signed certificates are used to authenticate devices in the overlay network. Once authenticated, devices can establish secure sessions between each other. It is from Cisco SD-WAN Manager that you generate these certificates and install them on the controller devices—Cisco SD-WAN Manager, Cisco SD-WAN Validators, and Cisco SD-WAN Controllers.
- The WAN edge authorized serial number file contains the serial numbers of all valid vEdge and WAN routers in your network. You receive this file from Cisco Catalyst SD-WAN, mark each router as valid or invalid, and then from Cisco SD-WAN Manager, send the file to the controller devices in the network.

Install the certificates and the WAN edge authorized serial number file on the controller devices to allow the Cisco Catalyst SD-WAN overlay network components to validate and authenticate each other and thus to allow the overlay network to become operational.

## Configure Enterprise Certificates for Cisco SD-WAN Controllers

Feature Name	Release Information	Description
Support for Secondary Organizational Unit	Cisco IOS XE Catalyst SD-WAN Release 17.2.1r Cisco SD-WAN Release 20.1.1	This optional feature allows you to configure a secondary organizational unit when configuring the certificates. If specified, this setting is applied to all controllers and edge devices.
Support for Subject Alternative Name (SAN)	Cisco IOS XE Catalyst SD-WAN Release 17.4.1a Cisco SD-WAN Release 20.4.1 Cisco vManage Release 20.4.1	This feature enables you to configure subject alternative name (SAN) DNS Names or uniform resource identifiers (URIs). It enables multiple host names and URIs to use the same SSL certificate.
Support for Specifying Any Organization for WAN Edge Cloud Device Enterprise Certificates	Cisco Catalyst SD-WAN Control Components Release 20.11.1	When configuring controller certificate authorization for enterprise certificates on WAN edge cloud devices, you can specify any organization in the <b>Organization</b> field. You are not limited to names such as <b>Viptela LLC</b> , <b>vIptela Inc</b> , or <b>Cisco Systems</b> . This enables you to use your organization's certificate authority name or a third-party certificate authority name.
Support for Certificates Without the Organizational Unit Field	Cisco IOS XE Catalyst SD-WAN Release 17.12.1a Cisco Catalyst SD-WAN Control Components Release 20.12.1	Enterprise certificates that you install on devices do not require the Organizational Unit (OU) field to be defined. Earlier, this field was used as part of the authentication of a device.



## Information About Enterprise Certificates

Enterprise certificates allow organizations to use their own private certificate signing authority rather than having to rely on public certificate signing authorities. You can also apply custom certificate properties using the **Set CSR Properties** field.



---

**Note** In the 16.11/19.1 release, enterprise certificates were introduced. Enterprise certificates replace the controller certificates authorization that were used previously. An independent organization handles the signing of enterprise certificates.

---

Use the **Configuration > Certificates** page to manage certificates and authenticate WAN edge and controller devices in the overlay network.

Two components of the Cisco Catalyst SD-WAN solution provide device authentication:

- Signed certificates are used to authenticate devices in the overlay network. Once authenticated, devices can establish secure sessions between each other. It is from Cisco SD-WAN Manager that you generate these certificates and install them on the controller devices—Cisco SD-WAN Manager instances, Cisco SD-WAN Validators, and Cisco SD-WAN Controller.
- WAN edge authorized serial number file contains the serial numbers of all valid vEdge and WAN routers in your network. You receive this file from Cisco Plug and Play (PnP), mark each router as valid or invalid, and then from Cisco SD-WAN Manager, send the file to the controller devices in the network.

You must install the certificates and the WAN edge authorized serial number file on the controller devices to allow the Cisco Catalyst SD-WAN overlay network components to validate and authenticate each other and thus to allow the overlay network to become operational.



---

**Note** For purposes of certificate management, the term controller refers collectively to Cisco SD-WAN Manager, Cisco SD-WAN Controller, and Cisco SD-WAN Validator.

---

Once you reset a WAN edge device, you have to install the enterprise root certificate manually on the device. If you perform an upgrade, your certificate is retained.



---

**Note** Cisco SD-WAN Manager supports only Base 64 encoded certificates. Other formats, such as DER, encoded are not supported.

For example, the PEM extension is used for different types of X.509v3 files that contain ASCII (Base64) armored data prefixed with a **--BEGIN ...** line.

---

## Dependency on OU Fields in Enterprise Certificates

From Cisco Catalyst SD-WAN Control Components Release 20.12.1, when onboarding a device, Cisco Catalyst SD-WAN does not require that the associated enterprise certificate have any OU fields defined. However, if at least one OU field is defined, then Cisco Catalyst SD-WAN requires that one of the OU fields match the organization name of the fabric.

From Cisco Catalyst SD-WAN Control Components Release 20.12.2, when onboarding a device, if the associated enterprise certificate has one or more OU fields defined, the OU fields need not match the organization name of the fabric.

## Devices that Support Enterprise Certificates

Device	Enterprise Certificate Support
Cisco SD-WAN Manager	Yes
Cisco SD-WAN Validator	Yes
Cisco SD-WAN Controller	Yes
Edge routers	All hardware WAN edge routers vEdge/IOS-XE-SD-WAN except ASR1002-X, ISRv, CSR1000v

## Configure Enterprise Certificates

- From the Cisco SD-WAN Manager menu, choose **Administration > Settings > Hardware WAN Edge Certificate Authorization**.
- Click **Enterprise Certificate** (signed by Enterprise CA).  
**On Box Certificate (TPM/SUDI Certificate)** is the default option.
- If you want to specify custom certificate properties, click **Set CSR Properties** and configure the following properties.

Property	Description
<b>Domain Name</b>	Network domain name.
<b>Organizational Unit</b>	<p>This is a noneditable field. The organization unit must be the same as the organization name used in Cisco SD-WAN Manager.</p> <p><b>Note</b> For devices using Cisco IOS XE Catalyst SD-WAN Release 17.9.3a or later releases of Cisco IOS XE Release 17.9.x, or Cisco IOS XE Catalyst SD-WAN Release 17.12.1a or later, the certificates that you install on the devices do not require the Organizational Unit field to be defined. However, if a signed certificate includes the Organizational Unit field, the field must match the organization name configured on the device. This addresses the policy of the Certification Authority Browser Forum (CA/Browser Forum), as of September 2022, to stop including an organizational unit in signed certificates. Despite the change in policy of the CA/Browser Forum, some certificate authorities might still include an organizational unit in the signed certificate.</p>

Property	Description
<b>Secondary Organization Unit</b>	<p>This optional field is available from Cisco IOS XE Release 17.2 or Cisco SD-WAN Release 20.1.x. If this optional field is specified, it will be applied to all controllers and edge devices.</p> <p><b>Note</b> If a signed certificate includes the Organizational Unit field or the Secondary Organizational Unit field, one of these fields must match the organization name configured on the device. This addresses the policy of the Certification Authority Browser Forum (CA/Browser Forum), as of September 2022, to stop including an organizational unit in signed certificates. Despite the change in policy of the CA/Browser Forum, some certificate authorities might still include an organizational unit in the signed certificate.</p>
<b>Organization</b>	Organization name.
<b>City</b>	City name.
<b>State</b>	State name.
<b>Email</b>	Email address.
<b>2-Letter Country Code</b>	Country code.
<b>Subject Alternative Name (SAN) DNS Names</b>	<p>Optionally, you can configure multiple host names to use the same SSL certificate.</p> <p>Example: cisco.com and cisco2.com</p>
<b>Subject Alternative Name (SAN) URIs</b>	<p>Optionally, you can configure multiple uniform resource identifiers (URIs) to use the same SSL certificate.</p> <p>Example: cisco.com and support.cisco.com</p>

4. Chose **Select a file** to upload a root certificate authority file.  
The uploaded root certificate authority displays in the text box.
5. Click **Save**.
6. From the Cisco SD-WAN Manager menu, choose **Configuration > Devices**.
7. Select the **Upload WAN Edge List** tab.
8. Browse to the location of the Cisco IOS XE Catalyst SD-WAN devices and Cisco vEdge devices list and click **Upload**.
9. On the **Configuration > Certificates** page, click ... and choose an action:
  - **View Enterprise CSR** (certificate signing request): Copy the CSR and sign it using the enterprise root certificate, and upload the signed certificate on Cisco SD-WAN Manager using the Install Certificate operation. Cisco SD-WAN Manager automatically discovers on which hardware edge the certificate needs to be installed on.
  - **View Enterprise Certificate**: After the certificate is installed, you can see the installed certificate and download it.

- **Renew Enterprise CSR:** If you need to install a new certificate on the hardware device, you can use the Renew Enterprise CSR option. The Renew Enterprise CSR option generates the CSR. You can then view the certificate (View Enterprise CSR option) and install the certificate (Install Certificate option). This step flaps the control connections as a new serial number. You can see the new serial number and expiry data on the Configuration > Certificates page.



**Note** The certificates that you install on devices in the Cisco Catalyst SD-WAN overlay do not require the Organizational Unit field to be defined. However, if a signed certificate includes the Organizational Unit field, the field must match the organization name configured on the device.

- **Revoke Enterprise Certificate:** This option removes the enterprise certificate from the device and moves it back to prestaging. The device has only Cisco SD-WAN Validator and Cisco SD-WAN Manager controls up.

For a Cisco IOS XE Catalyst SD-WAN device, click ... and choose an action:

- **View Feature CSR:**
  - Copy the CSR available from the Cisco IOS XE Catalyst SD-WAN device.
  - Sign the certificate using the enterprise root certificate from a certifying authority.
  - Upload the signed certificate on Cisco SD-WAN Manager using the **Install Feature Certificate** operation.  
Cisco SD-WAN Manager automatically discovers on which hardware edge the certificate needs to be installed. After you install feature certificate, the option **View Feature Certificate** is available.
- **View Feature Certificate:** After you install the feature certificate, you can view the feature certificate and download it.
- **Revoke Feature Certificate:** This option removes the feature certificate or trustpoint information from the Cisco IOS XE Catalyst SD-WAN device. After revoking a certificate, all actions against devices are not available. To view all actions for a device, ensure that you configure logging information of the device to a Transport Layer Security (TLS) profile with authentication type as server, and then configure back to mutual. Alternatively, to view the actions, reset Cisco IOS XE Catalyst SD-WAN device to factory default configuration.

To reset a device to factory default:

- From the Cisco SD-WAN Manager menu, choose **Configuration > Templates**.
- Create a device template with the factory-default template.

The factory-default template is, `Factory_Default_feature-name_Template`. See [Create a Device Template from Feature Templates](#) for information about creating a device template with feature template.

10. Click **Install Certificate** or **Install Feature Certificate** to upload the signed certificate.

The certificate must be a signed certificate. Initially, the state is CSR Generated.

The state changes to Certificate Installed when successfully installed.

11. From the Cisco SD-WAN Manager menu, choose **Configuration > Certificates**. You can see enterprise certificate columns, including the device type, chassis-id, enterprise serial number, and enterprise certificate date.

## Invalidate a Device Certificate

Before deleting a WAN edge device, invalidate the device.

1. From the Cisco SD-WAN Manager menu, choose **Configuration > Certificates**.
2. In the row showing the device, click **Invalid** to invalidate the device.

## Authorize a Controller Certificate for an Enterprise Root Certificate

1. From the Cisco SD-WAN Manager menu, choose **Administration > Settings**.
2. In the **Controller Certificate Authorization** area, click **Edit**.
3. Click **Enterprise Root Certificate**. If a warning appears, click **Proceed** to continue.
4. Optionally, click **Set CSR Properties** to configure certificate signing request (CSR) details manually.



---

**Note** In a multi-tenant scenario, if you configure CSR properties manually and if you are using Cisco Catalyst SD-WAN Control Components Release 20.11.1 or later, then ensure that devices in the network are using Cisco IOS XE Catalyst SD-WAN Release 17.11.1a or later. In a single-tenant scenario, this is not required.

In a multi-tenant scenario, if you configure CSR properties manually, then when you are ready to generate a CSR for a tenant device, enter the tenant's organization name in the **Secondary Organizational Unit** field described below. In a multi-tenant scenario, if you are generating a CSR for a service provider device, this is not required.

---

The following properties appear:

- **Domain Name:** Network domain name
- **Organizational Unit**



---

**Note** **Organizational Unit** is a noneditable field. This field is auto-filled with the organization name that you have configured for Cisco SD-WAN Manager in **Administration > Settings > Organization Name**.

---

- **Secondary Organizational Unit:** This optional field is only available in Cisco IOS XE Release 17.2 or Cisco SD-WAN Release 20.1.x and onwards. Note that if this optional field is specified, it will be applied to all controllers and edge devices.
- **Organization:** Beginning with Cisco vManage Release 20.11.1, when configuring controller certificate authorization for enterprise certificates on WAN edge cloud devices, you can specify any organization

in this field. You are not limited to names such as **Viptela LLC**, **vIPtela Inc**, or **Cisco Systems**. This enables you to use your organization's certificate authority name or a third-party certificate authority name. The maximum length is 64 characters, and can include spaces and special characters. Cisco SD-WAN Manager validates the name when you enter it.

- **City**
  - **State**
  - **Email**
  - **2-Letter Country Code**
  - **Subject Alternative Name (SAN) DNS Names:** (optional) You can configure multiple host names to use the same SSL certificate. Example: cisco.com and cisco2.com
  - **Subject Alternative Name (SAN) URIs:** (optional) You can configure multiple uniform resource identifiers (URIs) to use the same SSL certificate. Example: cisco.com and support.cisco.com
5. Paste an SSL certificate into the **Certificate** field or click **Select a file** and navigate to an SSL certificate file.
  6. (Optional) In the **Subject Alternative Name (SAN) DNS Names** field, you can enter multiple host names to use the same SSL certificate.  
Example: cisco.com and cisco2.com
  7. (Optional) In the **Subject Alternative Name (SAN) URIs** field, you can enter multiple URIs to use the same SSL certificate.  
Example: cisco.com and support.cisco.com

This is helpful for an organization that uses a single certificate for a host name, without using different subdomains for different parts of the organization.

## Generate a Bootstrap Configuration

The on-site bootstrap process involves generating a bootstrap configuration file that loads from a bootable USB drive or from internal boot flash to a device that supports SD-WAN. When the device boots, it uses the information in the configuration file to come up on the network.



---

**Note** If you need to generate a bootstrap configuration, use the **Configuration > Devices** page, click **...**, and choose **Generate Bootstrap Configuration**.

---



**Note** Beginning with Cisco vManage Release 20.7.1, there is an option available when generating a bootstrap configuration file for a Cisco vEdge device, enabling you generate two different forms of the bootstrap configuration file.

- If you are generating a bootstrap configuration file for a Cisco vEdge device that is using Cisco Catalyst SD-WAN Release 20.4.x or earlier, then check the **The version of this device is 20.4.x or earlier** check box.
- If you are generating a bootstrap configuration for a Cisco vEdge device that is using Cisco SD-WAN Release 20.5.1 or later, then do not use the check box.

## Cisco PKI Controller Certificates

From software release 19.x and onwards, there is an option to use Cisco as the certificate authority (CA) instead of Symantec/Digicert for Cisco Catalyst SD-WAN controller certificates.

This section describes deployment types, scenarios to administer, install, and troubleshoot controller certificates using Cisco public key infrastructure (PKI). Cisco PKI provides certificate management to support security protocols such IP Security (IPSec), secure shell (SSH), and secure socket layer (SSL).

The major difference between Symantec/Digicert and Cisco PKI certificates is that Cisco PKI certificates are linked to a Smart Account (SA) and Virtual Account (VA) in Plug and Play (PnP) and do not require manual approval using a portal like Digicert. Each VA has a limit of 100 certificates, meaning that each overlay has a limit of 100 certificates, and after the certificate signing request (CSR) is generated, the approval and installation happens automatically if the Cisco SD-WAN Manager settings are set correctly.

Devices are added and certificates are installed automatically from the Cisco PKI servers. No intervention is required to approve the certificate.

### Supported Devices for Cisco PKI Certificates

The following are the supported devices for using Cisco PKI certificates.

Device	Support
Cisco SD-WAN Manager	Yes
Cisco Catalyst SD-WAN Validator	Yes
Cisco Catalyst SD-WAN Controller	Yes
Cisco vEdge devices	Yes
Cisco IOS XE Catalyst SD-WAN devices	Yes

### Use Cases for Cisco PKI Controller Certificates

- [Use Case: Cisco-Hosted Cloud Overlays with Software Version 19.x and Above, on page 282](#)

- [Use Case: Migration of an Active Existing Overlay from Digicert to Cisco PKI Controller Certificates During Certificate Renewal, on page 284](#)
- [Use Case: Submitting CSRs and Downloading Certificates on On-Premises Controllers, on page 286](#)

## Use Case: Cisco-Hosted Cloud Overlays with Software Version 19.x and Above

### Prerequisites

Cisco SD-WAN Manager and the controllers should all be running the same software version.

On the **Configuration > Devices > Controllers** page, ensure that the OOB IP address and credentials are updated for all the controllers.



---

**Note** Starting from Cisco IOS XE Catalyst SD-WAN Release 17.13.1a, The **Controllers** tab is renamed as **Control Components** tab to stay consistent with Cisco Catalyst SD-WAN rebranding.

---

You can verify the software version for the new or expired overlays without having control connections using SSH.

1. SSH to each of the controllers and the version should show during the SSH process.
2. You do not need to actually have the credentials work, therefore you can run this on a controller where the credentials do not work.  
  
Repeat this process for all the controllers in the overlay to make sure.
3. Customer Smart Account credentials need to be ready using either of the following methods:
  - a. Email and request the customer contact from PnP trigger notifications to individually email you and provide the Smart Account credentials.

**or**

- b. Email and request the customer contact to log on to Cisco SD-WAN Manager and add them. Also ensure that you ask the customer for their IPs to be added to the allowed list..

Ensure that if asking the customer to provide their customer contact to log on, this step is done after asking the customer for their IPs to be added to the allowed list, so that they can reach the Cisco SD-WAN Manager GUI, be able to log in, and input their Smart Account credentials.

To find your Smart Account credentials, from the Cisco SD-WAN Manager menu, choose **Administration > Settings > Smart Account Credentials** .

Enter the user name and password and click **Save**.

### Runbook to Request and Install Cisco PKI Certificates

1. Verify that you have satisfied the prerequisites and that you have added the Smart Account credentials.
2. From the Cisco SD-WAN Manager menu, choose **Administration > Settings > Controller Certificate Authorization** and click **Edit**.
3. Click **Cisco (Recommended)**.





---

**Note** Cisco SD-WAN Manager displays an error if the Smart Account credentials are not added. Check the prerequisites.

---

4. Set the validity period to 1 year for POCs, 2 years for production overlays in the drop-down.
5. Set Certificate Retrieve Interval to 1 minute and press Save.



---

**Note** Currently there is no customer email field to notify customers about approval because the certificates are auto-approved as soon as the CSR request is done.

---

6. From this step onwards, the process is the same as for the Symantec/Digicert controllers in the Cisco SD-WAN Manager GUI.

From the Cisco SD-WAN Manager menu, choose **Configuration** > **Certificates** and click **Controllers**. Click ... and choose **Generate CSR**.



---

**Note** Starting from Cisco IOS XE Catalyst SD-WAN Release 17.13.1a, The **Controllers** tab is renamed as **Control Components** tab to stay consistent with Cisco Catalyst SD-WAN rebranding.

---

The operation status shows the CSR sent for signing, the certificate signed and installed automatically without needing human intervention.

7. The certificates are installed automatically. If successful, the **Configuration** > **Certificates** > **Controllers** page shows the following:



---

**Note** Starting from Cisco IOS XE Catalyst SD-WAN Release 17.13.1a, The **Controllers** tab is renamed as **Control Components** tab to stay consistent with Cisco Catalyst SD-WAN rebranding.

---

- Expiration date for the certificates for each controller
- Operation Status column:
  - Cisco SD-WAN Validator: "Installed"
  - Cisco SD-WAN Manager and Cisco Catalyst SD-WAN Controller: "Cisco SD-WAN Validator Updated"
- Certificate Serial column: Certificate serial number

8. Ensure that the control connections have come up to the controllers on the Cisco SD-WAN Manager dashboard.

# Use Case: Migration of an Active Existing Overlay from Digicert to Cisco PKI Controller Certificates During Certificate Renewal

## Prerequisites

Cisco SD-WAN Manager, controllers, and vEdges should all have their control connections up.

Ensure OOB IP address and credentials are updated in **Configuration > Devices > Controllers**.



---

**Note** Starting from Cisco IOS XE Catalyst SD-WAN Release 17.13.1a, The **Controllers** tab is renamed as **Control Components** tab to stay consistent with Cisco Catalyst SD-WAN rebranding.

---

For each controller, click ... and verify the updates.

## Migrate an Active Existing Overlay from Digicert to Cisco PKI Controller Certificates

1. In Cisco SD-WAN Manager, verify that the control connections to controllers and Cisco vEdge devices are up.

If the control connections are not up, migrating from Digicert to Cisco PKI cannot proceed.

If the control connections are only partially up, that is some Cisco vEdge devices are control down, then those Cisco vEdge devices will not be able to automatically reconnect to the controllers if their control comes up after the certificates have been moved to Cisco PKI.

If it is a case of expired certificates and control connections are down, then certificates need to be renewed on Digicert first and control connections need to be brought up before migrating them to the Cisco PKI controller certificates.

2. Verify that the software version of the controllers is 19.x or later.

### How to Verify the Software Version for the Active Existing Overlays (with Valid Control Connections to Controllers) Using Cisco SD-WAN Manager

- a. From the Cisco SD-WAN Manager menu, choose **Maintenance > Software Upgrade**.
- b. Click **Manager** and check the **Current Version** column. Verify that it is 19.x or later.

If the control connections are up and Cisco SD-WAN Manager and controller versions are not 19.x or later, then upgrade them first (Cisco vEdge devices need not be upgraded) before migration to Cisco PKI can be done.



---

**Note** It is mandatory that controllers upgraded to 19.x should immediately have their certificates renewed with Cisco PKI as part of the upgrade; they cannot be allowed to run with the existing Symantec certificates even if those certificates are going to remain valid.

---

- c. After verifying the prerequisites, check that the Cisco PKI root-CA has been propagated to all the controllers and the Cisco vEdge devices. This requires SSH access to the controllers.
  1. SSH into the Cisco SD-WAN Manager and controllers and run the following command: **show certificate root-ca-cert | include Cisco**.

If the output is blank or does not show the result, escalate to the cloud infrastructure team.

- d. Customer Smart Account credentials need to be ready by either of the following methods:
1. Email and request the customer contact from a PnP trigger notification to individually email you and provide the Smart Account credentials.

or

2. Email and request your customer contact to log on to the Cisco SD-WAN Manager themselves and add them. Also ensure that you ask for the customer IPs to be added to the allowed list.

Ensure that if asking the customer to provide, this step is done after asking the customer for their IPs to be added to the allowed list, so that they can reach the Cisco SD-WAN Manager GUI, be able to log on, and input the Smart Account Credentials.

To view the Smart Account credentials, from the Cisco SD-WAN Manager menu, choose **Administration > Settings** and see the **Smart Account Credentials** section.

3. Enter the username and password and click **Save**.

Once all the prerequisites have been satisfied, follow the **Runbook to Request and Install Cisco PKI Certificates** procedure to request CSRs and get the Cisco certificates installed. Verify that all the control connections to the controllers and the Cisco vEdge devices have come back up. If not, then escalate to the cloud infrastructure team.

### Runbook to Request and Install Cisco PKI Certificates

1. Verify that you have satisfied the prerequisites and that you have added the Smart Account credentials.
2. From the Cisco SD-WAN Manager menu, choose **Administration > Settings**, and in the **Controller Certificate Authorization** section, click **Edit**.
3. Click **Cisco (Recommended)**.



---

**Note** Cisco SD-WAN Manager displays an error if the Smart Account credentials are not added. Check the prerequisites.

---

4. Set the validity period to 1 year for POCs, 2 years for production overlays in the drop-down.
5. Set Certificate Retrieve Interval to 1 minute and press Save.



---

**Note** Currently there is no customer email field to notify customers about approval because the certificates are auto-approved as soon as the CSR request is done.

---

6. From this step onwards, the process is the same as for the Symantec/Digicert controllers in the Cisco SD-WAN Manager GUI.

From the Cisco SD-WAN Manager menu, choose **Configuration > Certificates** and click **Controllers**. Click **...** and choose **Generate CSR**.



---

**Note** Starting from Cisco IOS XE Catalyst SD-WAN Release 17.13.1a, The **Controllers** tab is renamed as **Control Components** tab to stay consistent with Cisco Catalyst SD-WAN rebranding.

---

The operation status shows the CSR sent for signing, the certificate signed and installed automatically without requiring intervention.

7. The certificates are installed automatically. If successful, the **Configuration > Certificates > Controllers** page shows the following:



---

**Note** Starting from Cisco IOS XE Catalyst SD-WAN Release 17.13.1a, The **Controllers** tab is renamed as **Control Components** tab to stay consistent with Cisco Catalyst SD-WAN rebranding.

---

- Expiration date for the certificates for each controller
  - Operation Status column:
    - Cisco SD-WAN Validator: "Installed"
    - Cisco SD-WAN Manager and Cisco SD-WAN Controller: "Cisco SD-WAN Validator Updated"
  - Certificate Serial column: Certificate serial number
8. Ensure that the control connections have come up to the controllers on the Cisco SD-WAN Manager dashboard.
  9. Set the Certificate Retrieve Interval to 1 minute.
  10. Click **Sync Root Certificate** to migrate the Cisco vEdge devices or Cisco IOS XE Catalyst SD-WAN devices in Cisco SD-WAN Manager to Cisco pki. This support available from 19.2.1 version or later.
  11. Click **Save**.

## Use Case: Submitting CSRs and Downloading Certificates on On-Premises Controllers

The following steps require access to PnP and to the SA/VA in question. Customers have access to their own SA/VA.

### Prerequisites

The prerequisites are the same in the above cases, except that you use the manual method for installing the certificates.

### Runbook

1. From the Cisco SD-WAN Manager menu, choose **Administration > Settings**. In the **Controller Certificate Authorization** section, verify that it is set to Manual.
2. Generate the CSRs for the controllers.

From the Cisco SD-WAN Manager menu, choose **Configuration** > **Certificates** and click **Controllers**.



---

**Note** Starting from Cisco IOS XE Catalyst SD-WAN Release 17.13.1a, The **Controllers** tab is renamed as **Control Components** tab to stay consistent with Cisco Catalyst SD-WAN rebranding.

---

Click ... and choose **Generate CSR**.

Download each CSR to a file with a filename `.csr` and keep it ready to submit to the PnP portal for getting the signed certificates.

3. Log on to the PnP portal to the required SA/VA and select the Certificates tab.
4. Click **Generate Certificate** and follow the steps to give a name for the certificate file, paste the CSR, and download the signed certificate.

The finished certificate is ready for download. Repeat this process for each CSR and download all the required certificates.

5. To install the downloaded certificates, from the Cisco SD-WAN Manager menu, choose **Configuration** > **Certificates** and click **Controllers**.



---

**Note** Starting from Cisco IOS XE Catalyst SD-WAN Release 17.13.1a, The **Controllers** tab is renamed as **Control Components** tab to stay consistent with Cisco Catalyst SD-WAN rebranding.

---

Click **Install Certificate**.

After installation, verify that the control connections are up.

### Debugging and Log Information

1. Check the Cisco Catalyst SD-WAN Validator profile under the VA in PnP to verify that the correct organization name exists.
2. Check the output at `/var/log/nms/vmanage-server.log` on Cisco SD-WAN Manager for logs of the entire certificate process.
3. Verify that Cisco SD-WAN Manager has internet connectivity to reach the Cisco PKI servers.

## Web Server Certificate for Cisco SD-WAN Manager

To establish a secure connection between your web browser and the Cisco SD-WAN Manager server using authentication certificates, you must generate a CSR to create a certificate, have it signed by a root CA, and then install it. You must install a separate certificate on each Cisco SD-WAN Manager server in a cluster by performing the following steps for each server:

1. From the Cisco SD-WAN Manager menu, choose **Administration** > **Settings**.
2. In the **Web Server Certificate** area, click **CSR**.

3. In the **Common Name** field, enter the domain name or IP address of the Cisco SD-WAN Manager server. For example, the fully-qualified domain name of Cisco SD-WAN Manager could be `vmanage.org.local`.
4. In the **Organizational Unit** field, enter the unit name within your organization — for example, Network Engineering.
5. In the **Organization** field, enter the exact name of your organization as specified by your root CA — for example, Viptela Inc.
6. In the **City** field, enter the name of the city where your organization is located — for example, San Jose.
7. In the **State** field, enter the state in which your city is located — for example, California.
8. In the **2-Letter Country Code** field, enter the two-letter code for the country in which your state is located. For example, the two-letter country code for the United States of America is US.
9. Click **Validity** and choose the validity period for the certificate.
10. Optionally, in the **Subject Alternative Name (SAN) DNS Names** field, enter the names of DNS servers to which the certificate trust should be extended. If you enter more than one DNS server name, separate each name with a space or a comma.



---

**Note** Cisco Catalyst SD-WAN supports SAN DNS names, from Cisco IOS XE SD-WAN release 16.11 and Cisco SD-WAN release 19.1.

---

11. Optionally, in the **Subject Alternative Name (SAN) URIs** field, enter the URIs of resources to which the certificate trust should be extended. If you enter more than one URI, separate each URI with a space or a comma.

Enter each URI in *scheme:value* format, where *scheme* is the protocol for accessing the resource and *value* is the resource. For example, `https://example.example.com` or `scp://example.example.com`.



---

**Note** Cisco Catalyst SD-WAN supports SAN URIs beginning with Cisco IOS XE SD-WAN release 16.11 and Cisco SD-WAN release 19.1.

---

12. Click **Generate** to generate the CSR.
13. Send the CSR to your CA server to have it signed.
14. When you receive the signed certificate, click **Certificate** near the **Web Server Certificate** bar to install the new certificate. The **View** box displays the current certificate on the Cisco SD-WAN Manager server.
15. Copy and paste the new certificate in the box. Alternatively, click **Import** and **Select a File** to download the new certificate file.
16. Restart the application server and log in to Cisco SD-WAN Manager.

### View Web Server Certificate Expiration Date

When you establish a secure connection between your web browser and the Cisco SD-WAN Manager server using authentication certificates, configure the time period for which the certification is valid (in Step 8 in the previous section). At the end of this time period, the certificate expires. The **Web Server Certificate** bar shows the expiration date and time.

Starting 60 days before the certificate expires, the Cisco SD-WAN Manager dashboard displays a notification indicating that the certificate will expire soon. This notification is then displayed again 30, 15, and 7 days before the expiration date, and then daily.







# CHAPTER 10

## Reverse Proxy

- [Reverse Proxy](#), on page 291
- [Information About Reverse Proxy](#), on page 291
- [Restrictions for Reverse Proxy](#), on page 294
- [Provision Certificates on the Reverse Proxy](#), on page 295
- [Configure Reverse Proxy Using Cisco SD-WAN Manager](#), on page 296
- [Monitor Reverse Proxy Using CLI](#), on page 298
- [Monitor Reverse Proxy Using CLI](#), on page 301

## Reverse Proxy

*Table 38: Feature History*

Feature Name	Release Information	Description
Support for Reverse Proxy with Cisco Catalyst SD-WAN and Cisco Catalyst SD-WAN Multitenancy	Cisco IOS XE Release 17.6.1a Cisco SD-WAN Release 20.6.1 Cisco vManage Release 20.6.1	With this feature, you can deploy a reverse proxy in your overlay network between Cisco IOS XE Catalyst SD-WAN devices and Cisco SD-WAN Manager and Cisco SD-WAN Controllers. Also, this feature enables you to deploy a reverse proxy in both single-tenant and multitenant deployments that include Cisco vEdge devices or Cisco IOS XE Catalyst SD-WAN devices. In a multitenant deployment, the service provider manages reverse proxy and the associated configuration.

## Information About Reverse Proxy

In a standard overlay network, Cisco Catalyst SD-WAN edge devices initiate direct connections to the Cisco SD-WAN Control Components (Cisco SD-WAN Manager and Cisco SD-WAN Controllers) and exchange control plane information over these connections. The WAN edge devices are typically located in branch sites and connect to the Cisco SD-WAN Controllers over the internet. As a result, Cisco SD-WAN Manager and Cisco SD-WAN Controllers are also connected directly to the internet.

For security, or other reasons, you may not want the Cisco SD-WAN Controllers to have direct internet connections. In such a scenario, you can deploy a reverse proxy between the Cisco SD-WAN Controllers and the WAN edge devices. The reverse proxy acts as an intermediary to pass control traffic between the Cisco SD-WAN Controllers and the WAN edge devices. Instead of communicating directly with Cisco SD-WAN Manager and the Cisco SD-WAN Controllers, the WAN edge devices communicate with the reverse proxy, and the reverse proxy relays the traffic to and from Cisco SD-WAN Manager and Cisco SD-WAN Controllers.

The following figure illustrates a reverse proxy deployed between a WAN edge device and Cisco SD-WAN Manager and the Cisco SD-WAN Controllers.

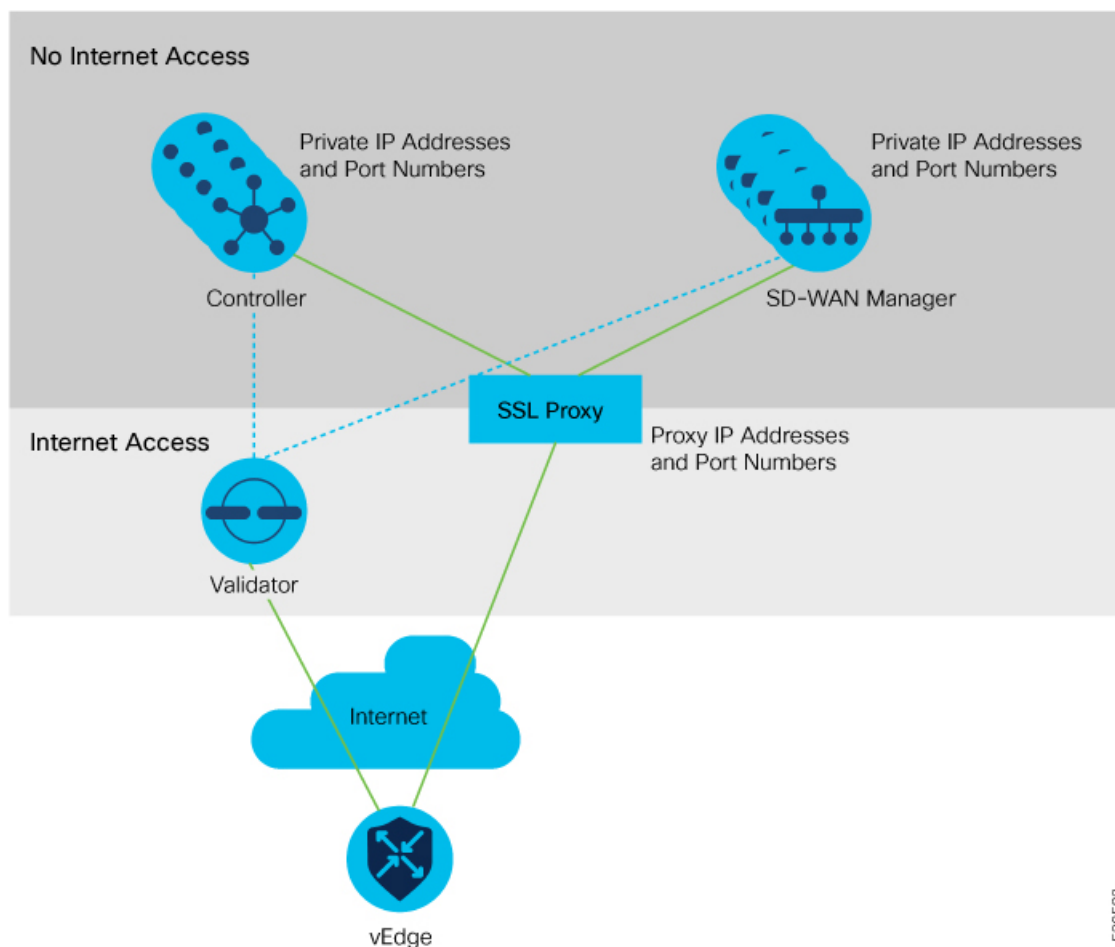

You can deploy a reverse proxy in both single-tenant and multi-tenant Cisco Catalyst SD-WAN deployments. The TLOC communicates with the reverse proxy on its public IP address and port, regardless of public or private TLOC.

## Support for a Device with Both Private Network and Public Internet Connectivity

You can use a reverse proxy in a Cisco Catalyst SD-WAN network that includes a device with these multiple TLOCs:

- A TLOC that connects to an internal private network without internet access, and

- A TLOC that connects to the public internet

This scenario has a specific requirement for configuring the TLOC color of each Cisco SD-WAN Controller. This table describes this special case. For comparison, the table includes examples of devices with only one TLOC, and devices that have separate TLOCs for a private network and the public internet.

**Table 39: TLOC Color Requirements**

Device	TLOC	TLOC Connectivity	Configure this TLOC Color as a...	The Device Connects to this Cisco SD-WAN Validator	Connectivity to: <b>Cisco SD-WAN Controller, and Cisco SD-WAN Manager</b>	Specific TLOC Color Requirements
A	1	Internal private network	Private color Example: private1	Cisco SD-WAN Validator reachable through the private network	Direct connectivity through the private network	None
B	1	Public internet	Public color Example: custom1	Cisco SD-WAN Validator reachable through the public internet	Connectivity through a reverse proxy	None

Device	TLOC	TLOC Connectivity	Configure this TLOC Color as a...	The Device Connects to this Cisco SD-WAN Validator	Connectivity to: Cisco SD-WAN Controller, and Cisco SD-WAN Manager	Specific TLOC Color Requirements
C	1	Internal private network	Private color Example: privatel	Cisco SD-WAN Validator reachable through the private network	Direct connectivity through the private network	<p>A network that includes a device with multiple TLOCs as shown here has this specific requirement:</p> <p>Configure the TLOCs for each Cisco SD-WAN Controller with the private color that you are using for the private network. Do not leave the TLOC color as default.</p> <p>Leaving the TLOC color for the Cisco SD-WAN Controllers as the default color causes this problem: Devices with a TLOC connecting to the internal private network, such as Device C, cannot connect to the Cisco SD-WAN Controllers.</p>
	2	Public internet	Public color Example: custom1	Cisco SD-WAN Validator reachable through the public internet	Connectivity through a reverse proxy	

## Restrictions for Reverse Proxy

- Multitenant scenario

In a multitenant Cisco Catalyst SD-WAN overlay network, you can deploy a reverse proxy device with only a three-node Cisco SD-WAN Manager cluster.

- TLS-based control plane

Deployment of the reverse proxy is only supported with a TLS-based control plane for Cisco SD-WAN Manager and Cisco SD-WAN Controllers.

- Cisco vEdge 5000 router restriction

You cannot deploy a reverse proxy with a Cisco vEdge 5000 router.

- IPv6

You cannot deploy a reverse proxy with IPv6 control connections.

- Devices with a TLOC for a private WAN

The following restriction applies to edge devices in a scenario in which (a) one or more devices have a TLOC connecting them to a private WAN, and (b) one or more Cisco SD-WAN Validators do not have reachability to a reverse proxy:

In this scenario, Zero-Touch Provisioning (ZTP) onboarding does not support onboarding a Cisco IOS XE Catalyst SD-WAN device with a TLOC using the default TLOC color. Bootstrap the device with a minimal configuration that configures a non-default TLOC color.

## Provision Certificates on the Reverse Proxy

Before exchanging traffic, the reverse proxy and the WAN edge devices must authenticate each other.

On the reverse proxy you must provision a certificate that is signed by the CA that has signed the certificate of the Cisco SD-WAN Controllers. This certificate is used by the reverse proxy to verify the WAN edge devices.

To generate a Certificate Signing Request (CSR) for the reverse proxy and have it signed by Cisco, do as follows:

1. Run the following command on the reverse proxy:

```
proxy$ openssl req -new -days 365 -newkey rsa:2048 -nodes -keyout Proxy.key -out Proxy.csr
```

When prompted, enter values as suggested in the following table:

Property	Description
Country Name (2 letter code)	Any country code. Example: US
State or Province Name	Any state or province. Example: CA
Locality Name	Any locality. Example: San Jose
Organization Name	Use either "vIptela Inc" or "Viptela LLC".  Starting from Cisco IOS XE Catalyst SD-WAN Release 17.10.1a, you can use "Cisco Systems" string as the Organization Name for enterprise certificates.  Starting from Cisco Catalyst SD-WAN Manager Release 20.12.1 you cannot include a comma in the <b>Organization Name</b> field of the bootstrap configuration file.  Example: Viptela LLC

Property	Description
Organizational Unit Name	Use the “organization” name configured on the overlay. Example: cisco-sdwan-12345
Common Name	Host name ending with “.viptela.com”. Example: proxy.viptela.com
Email Address	Use any valid email address. Example: someone@example.com

- Get the CSR signed by Cisco.
  - If you use Symantec/Digicert as the CA for the Cisco SD-WAN Controllers, open a case with Cisco TAC to sign the CSR.
  - If you use Cisco Public Key Infrastructure (PKI) as the CA for the Cisco SD-WAN Controllers, submit the CSR on the Cisco Network Plug and Play (PnP) application and retrieve the signed certificate.

## Configure Reverse Proxy Using Cisco SD-WAN Manager

### Configure Reverse Proxy Settings

- From the Cisco SD-WAN Manager menu, choose **Administration > Settings**.
- For the **Reverse Proxy** setting, click **Edit**.
- For **Enable Reverse Proxy**, click **Enabled**.
- Click **Save**.

### Configure Reverse Proxy Settings on Cisco SD-WAN Controllers

- From the Cisco SD-WAN Manager menu, choose **Configure > Devices**.
- Click **Controllers**.



---

**Note** Starting from Cisco IOS XE Catalyst SD-WAN Release 17.13.1a, the **Controllers** tab is renamed as the **Control Components** tab to stay consistent with Cisco Catalyst SD-WAN rebranding.

---

- For the desired Cisco SD-WAN Manager instance or Cisco SD-WAN Controller, click **...** and click **Add Reverse Proxy**.  
The **Add Reverse Proxy** dialog box appears.
- To map a private IP address and port number to a proxy IP address and port number, do as follows:

- a. Click **Add Reverse Proxy**.
- b. Enter the following details:

Private IP	The private IP address is the IP address of the transport interface in VPN 0.
Private Port	This is the port used to establish the connections that handle control and traffic in the overlay network. The default port number is 12346.
Proxy IP	Proxy IP address to which private IP address must be mapped.
Proxy Port	Proxy port to which the private port must be mapped.

- c. If the Cisco SD-WAN Manager instance or Cisco SD-WAN Controller has multiple cores, repeat **Step 4 a** and **Step 4 b** for each core.
5. To delete a private IP address-port number to proxy IP address-port number mapping, find the mapping and click the trash icon.
6. To save the reverse proxy settings, click **Add**.  
To discard the settings, click **Cancel**.
7. In the Security feature template attached to the Cisco SD-WAN Manager instance or Cisco SD-WAN Controller, choose TLS as the transport protocol.

After you configure reverse proxy settings on a Cisco SD-WAN Manager instance or a Cisco SD-WAN Controller, WAN edge devices in the overlay network are provisioned with a certificate for authentication with the reverse proxy.

1. When a reverse proxy is deployed, Cisco SD-WAN Validator shares the details of the reverse proxy with the WAN edge devices.
2. On learning about the reverse proxy, a WAN edge device initiates the installation of a signed certificate from Cisco SD-WAN Manager.
3. After the certificate is installed, the WAN edge device uses the certificate for authentication with the reverse proxy and connects to the reverse proxy.

## Disable Reverse Proxy



**Note** Before you disable reverse proxy, delete any private IP address-port number to proxy IP address-port number mappings that you have configured for Cisco SD-WAN Manager instances and Cisco SD-WAN Controller. See *Configure Reverse Proxy Settings on Cisco Catalyst SD-WAN Controllers* for information about deleting the mappings.

1. From the Cisco SD-WAN Manager menu, choose **Administration > Settings**.
2. For the **Reverse Proxy** setting, click **Edit**.
3. For **Enable Reverse Proxy**, click **Disabled**.
4. Click **Save**.

# Monitor Reverse Proxy Using CLI

## Monitor Private and Proxy IP Address and Port Numbers of WAN Edge Devices on Cisco SD-WAN Controllers

The following is a sample output from the execution of the **show control connections** command on a Cisco SD-WAN Controller. In the command output, for a WAN edge device, the entries in the PEER PRIVATE IP and PEER PRIV PORT columns are the configured TLOC IP address and port number of the WAN edge interface. The entries in the PEER PUBLIC IP and PEER PUB PORT columns are the corresponding IP address and port number of the reverse proxy interface. The same command can also be executed on a Cisco SD-WAN Manager instance to obtain a similar output.

```
vsmart1# show control connections
```

INDEX	TYPE	PROT	SYSTEM IP	SITE	DOMAIN	PEER PRIVATE IP	PEER PRIV PORT	PEER PUBLIC IP	PEER PUB PORT
	ORGANIZATION		REMOTE COLOR	ID	UP				
0	vbond	dtls	172.16.1.2	0	0	10.1.1.2	12346	10.1.1.2	
12346	EXAMPLE-ORG		default		up	53:08:18:50			
0	vmanage	tls	172.16.1.6	1	0	10.2.100.6	45689	10.2.100.6	
45689	EXAMPLE-ORG		default		up	53:08:18:32			
1	vedge	tls	1.1.100.1	100	1	10.3.1.2	57853	10.2.100.1	53624
	EXAMPLE-ORG		biz-internet		up	53:08:18:44			
1	vedge	tls	1.1.101.1	101	1	10.4.1.2	55411	10.2.100.1	53622
	EXAMPLE-ORG		biz-internet		up	53:08:18:48			
1	vbond	dtls	172.16.1.2	0	0	10.1.1.2	12346	10.1.1.2	
12346	EXAMPLE-ORG		default		up	53:08:18:51			

```
vsmart1#
```

## View Mapping of SD-WAN Controller Private IP Address and Port Number to Proxy IP Address and Port Number on Cisco SD-WAN Validator

The following is a sample output from the execution of the **show orchestrator reverse-proxy-mapping** command on a Cisco SD-WAN Validator. In the command output, the entries in the PROXY IP and PROXY PORT columns are the proxy IP address and port number. The entries in the PRIVATE IP and PRIVATE PORT columns are the private IP address and port number of the transport interface in VPN 0.

```
vbond# show orchestrator reverse-proxy-mapping
```

UUID	PRIVATE IP	PRIVATE PORT	PROXY IP	PROXY PORT
14c35ae4-69e3-41c5-a62f-725c839d25df	10.2.100.4	23456	10.2.1.10	23458
14c35ae4-69e3-41c5-a62f-725c839d25df	10.2.100.4	23556	10.2.1.10	23558
6c63e80a-8175-47de-a455-53a127ee70bd	10.2.100.6	23456	10.2.1.10	23457
6c63e80a-8175-47de-a455-53a127ee70bd	10.2.100.6	23556	10.2.1.10	23557



```

6c63e80a-8175-47de-a455-53a127ee70bd 10.2.100.6 23656 10.2.1.10 23657
6c63e80a-8175-47de-a455-53a127ee70bd 10.2.100.6 23756 10.2.1.10 23757
6c63e80a-8175-47de-a455-53a127ee70bd 10.2.100.6 23856 10.2.1.10 23857
6c63e80a-8175-47de-a455-53a127ee70bd 10.2.100.6 23956 10.2.1.10 23957
6c63e80a-8175-47de-a455-53a127ee70bd 10.2.100.6 24056 10.2.1.10 24057
6c63e80a-8175-47de-a455-53a127ee70bd 10.2.100.6 24156 10.2.1.10 24157

```

```
vbond#
```

### Example: View Mapping of SD-WAN Controller Private IP Address and Port Number to Proxy IP Address and Port Number on a WAN Edge Device

The following is a sample output from the execution of the **show sdwan control connections** command on a Cisco IOS XE Catalyst SD-WAN device. In the command output, check the entry in the PROXY column for a Cisco SD-WAN Manager instance or a Cisco SD-WAN Controller. If the entry is Yes, the entries in the PEER PUBLIC IP and PEER PUBLIC PORT are the proxy IP address and port number.

```
Device# show sdwan control connections
```

PEER	PEER	PEER	CONTROLLER			PEER		PEER	
			SITE	DOMAIN	PEER	PRIV	PEER	PUB	
GROUP	TYPE	PROT	SYSTEM IP	ID	ID	PRIVATE IP	PORT	PUBLIC IP	PORT
	ORGANIZATION		LOCAL	COLOR	PROXY	STATE	UPTIME	ID	
vsmart	tls	172.16.1.4	1		1	10.2.100.4	23558	10.2.1.10	23558
EXAMPLE-ORG		biz-internet	Yes	up	52:08:44:25	0			
vbond	dtls	0.0.0.0	0		0	10.1.1.2	12346	10.1.1.2	12346
EXAMPLE-ORG		biz-internet	-	up	52:08:50:47	0			
vmanage	tls	172.16.1.6	1		0	10.2.100.6	23957	10.2.1.10	23957
EXAMPLE-ORG		biz-internet	Yes	up	66:03:04:50	0			

```
Device#
```

On a Cisco vEdge device, you can obtain a similar output by executing the command **show control connections**.

### View Signed Certificate Installed on a WAN Edge Device for Authentication with Reverse Proxy

The following is a sample output from the execution of the **show sdwan certificate reverse-proxy** command on a Cisco IOS XE Catalyst SD-WAN device.

```
Device# show sdwan certificate reverse-proxy
```

```
Reverse proxy certificate
```

-----

Certificate:

Data:

Version: 1 (0x0)

Serial Number: 1 (0x1)

Signature Algorithm: sha256WithRSAEncryption

Issuer: C = US, CN = 6c63e80a-8175-47de-a455-53a127ee70bd, O = Viptela

Validity

Not Before: Jun 2 19:31:08 2021 GMT

Not After : May 27 19:31:08 2051 GMT

Subject: C = US, ST = California, CN = C8K-9AE4A5A8-4EB0-E6C1-1761-6E54E4985F78, O = ViptelaClient

Subject Public Key Info:

Public Key Algorithm: rsaEncryption

RSA Public-Key: (2048 bit)

Modulus:

00:e2:45:49:53:3a:56:d4:b8:70:59:90:01:fb:b1:  
 44:e3:73:17:97:a3:e9:b7:55:44:d4:2d:dd:13:4a:  
 a8:ef:78:14:9d:bd:b5:69:de:c9:31:29:bd:8e:57:  
 09:f2:02:f8:3d:1d:1e:cb:a3:2e:94:c7:2e:61:ea:  
 e9:94:3b:28:8d:f7:06:12:56:f3:24:56:8c:4a:e7:  
 01:b1:2b:1b:cd:85:4f:8d:34:78:78:a1:26:17:2b:  
 a5:1b:2a:b6:dd:50:51:f8:2b:13:93:cd:a6:fd:f8:  
 71:95:c4:db:fc:a7:83:05:23:68:61:15:05:cc:aa:  
 60:af:09:ef:3e:ce:70:4d:dd:50:84:3c:9a:57:ce:  
 cb:15:84:3e:cd:b2:b6:30:ab:86:68:17:94:fa:9c:  
 1a:ab:28:96:68:8c:ef:c8:f7:00:8a:7a:01:ca:58:  
 84:b0:87:af:9a:f6:13:0f:aa:42:db:8b:cc:6e:ba:  
 c8:c1:48:d2:f4:d8:08:b1:b5:15:ca:36:80:98:47:  
 32:3a:df:54:35:fe:75:32:23:9f:b5:ed:65:41:99:  
 50:b9:0f:7a:a2:10:59:12:d8:3e:45:78:cb:dc:2a:  
 95:f2:72:02:1a:a6:75:06:87:52:4d:01:17:f2:62:

```

8c:40:ad:29:e4:75:17:04:65:a9:b9:6a:dd:30:95:
34:9b
Exponent: 65537 (0x10001)
Signature Algorithm: sha256WithRSAEncryption
99:40:af:23:bb:cf:7d:59:e9:a5:83:78:37:02:76:83:79:02:
b3:5c:56:e8:c3:aa:fc:78:ef:07:23:f8:14:19:9c:a4:5d:88:
07:4d:6e:b8:0d:b5:af:fa:5c:f9:55:d0:60:94:d9:24:99:5e:
33:06:83:03:c3:73:c1:38:48:45:ba:6a:35:e6:e1:51:0e:92:
c3:a2:4a:a2:e1:2b:da:cd:0c:c3:17:ef:35:52:e1:6a:23:20:
af:99:95:a2:cb:99:a7:94:03:f3:78:99:bc:76:a3:0f:de:04:
7d:35:e1:dc:4d:47:79:f4:c8:4c:19:df:80:4c:4f:15:ab:f1:
61:a2:78:7a:2b:6e:98:f6:7b:8f:d6:55:44:16:79:e3:cd:51:
0e:27:fc:e6:4c:ff:bb:8f:2d:b0:ee:ed:98:63:e9:c9:cf:5f:
d7:b1:dd:7b:19:32:22:94:77:d5:bc:51:85:65:f3:e0:93:c7:
3c:79:fc:34:c7:9f:40:dc:b1:fc:6c:e5:3d:af:2d:77:b7:c3:
88:b3:89:7c:a6:1f:56:35:3b:35:66:0c:c8:05:b5:28:0b:98:
19:c7:b0:8e:dc:b7:3f:9d:c1:bb:69:f0:7d:20:95:b5:d1:f0:
06:35:b7:c4:64:ba:c4:95:31:4a:97:03:0f:04:54:6d:cb:50:
2f:31:02:59

```

Device#

On a Cisco vEdge device, you can obtain a similar output by executing the command **show certificate reverse-proxy**.

## Monitor Reverse Proxy Using CLI

### Monitor Private and Proxy IP Address and Port Numbers of WAN Edge Devices on Cisco SD-WAN Controllers

The following is a sample output from the execution of the **show control connections** command on a Cisco SD-WAN Controller. In the command output, for a WAN edge device, the entries in the PEER PRIVATE IP and PEER PRIV PORT columns are the configured TLOC IP address and port number of the WAN edge interface. The entries in the PEER PUBLIC IP and PEER PUB PORT columns are the corresponding IP address and port number of the reverse proxy interface. The same command can also be executed on a Cisco SD-WAN Manager instance to obtain a similar output.

```

vsmart1# show control connections

```

	PEER	PEER	PEER	SITE	DOMAIN	PEER	PEER	PEER	PEER
	IP	IP	IP			IP	IP	IP	IP

INDEX	TYPE	PROT	SYSTEM IP	ID	ID	PRIVATE IP	PORT	PUBLIC IP	PORT
	ORGANIZATION		REMOTE COLOR	STATE	UPTIME				
0	vbond	dtls	172.16.1.2	0	0	10.1.1.2	12346	10.1.1.2	
12346	EXAMPLE-ORG		default	up	53:08:18:50				
0	vmanage	tls	172.16.1.6	1	0	10.2.100.6	45689	10.2.100.6	
45689	EXAMPLE-ORG		default	up	53:08:18:32				
1	vedge	tls	1.1.100.1	100	1	10.3.1.2	57853	10.2.100.1	53624
	EXAMPLE-ORG		biz-internet	up	53:08:18:44				
1	vedge	tls	1.1.101.1	101	1	10.4.1.2	55411	10.2.100.1	53622
	EXAMPLE-ORG		biz-internet	up	53:08:18:48				
1	vbond	dtls	172.16.1.2	0	0	10.1.1.2	12346	10.1.1.2	
12346	EXAMPLE-ORG		default	up	53:08:18:51				

```
vsmart1#
```

### View Mapping of SD-WAN Controller Private IP Address and Port Number to Proxy IP Address and Port Number on Cisco SD-WAN Validator

The following is a sample output from the execution of the **show orchestrator reverse-proxy-mapping** command on a Cisco SD-WAN Validator. In the command output, the entries in the PROXY IP and PROXY PORT columns are the proxy IP address and port number. The entries in the PRIVATE IP and PRIVATE PORT columns are the private IP address and port number of the transport interface in VPN 0.

```
vbond# show orchestrator reverse-proxy-mapping
```

UUID	PRIVATE		PROXY	
	PRIVATE IP	PORT	PROXY IP	PORT
-----				
14c35ae4-69e3-41c5-a62f-725c839d25df	10.2.100.4	23456	10.2.1.10	23458
14c35ae4-69e3-41c5-a62f-725c839d25df	10.2.100.4	23556	10.2.1.10	23558
6c63e80a-8175-47de-a455-53a127ee70bd	10.2.100.6	23456	10.2.1.10	23457
6c63e80a-8175-47de-a455-53a127ee70bd	10.2.100.6	23556	10.2.1.10	23557
6c63e80a-8175-47de-a455-53a127ee70bd	10.2.100.6	23656	10.2.1.10	23657
6c63e80a-8175-47de-a455-53a127ee70bd	10.2.100.6	23756	10.2.1.10	23757
6c63e80a-8175-47de-a455-53a127ee70bd	10.2.100.6	23856	10.2.1.10	23857
6c63e80a-8175-47de-a455-53a127ee70bd	10.2.100.6	23956	10.2.1.10	23957
6c63e80a-8175-47de-a455-53a127ee70bd	10.2.100.6	24056	10.2.1.10	24057
6c63e80a-8175-47de-a455-53a127ee70bd	10.2.100.6	24156	10.2.1.10	24157

```
vbond#
```

### Example: View Mapping of SD-WAN Controller Private IP Address and Port Number to Proxy IP Address and Port Number on a WAN Edge Device

The following is a sample output from the execution of the `show sdwan control connections` command on a Cisco IOS XE Catalyst SD-WAN device. In the command output, check the entry in the PROXY column for a Cisco SD-WAN Manager instance or a Cisco SD-WAN Controller. If the entry is Yes, the entries in the PEER PUBLIC IP and PEER PUBLIC PORT are the proxy IP address and port number.

Device# `show sdwan control connections`

		CONTROLLER				PEER		PEER	
PEER	PEER	PEER	SITE	DOMAIN	PEER	PRIV	PEER	PUB	
ORGANIZATION	PROT	SYSTEM IP	GROUP	ID	ID	PRIVATE IP	PORT	PUBLIC IP	PORT
		LOCAL	COLOR	PROXY	STATE	UPTIME			
vsmart EXAMPLE-ORG	tls	172.16.1.4	biz-internet	1 Yes	up	1 10.2.100.4	23558	10.2.1.10	23558
vbond EXAMPLE-ORG	dtls	0.0.0.0	biz-internet	0 -	up	0 10.1.1.2	12346	10.1.1.2	12346
vmanage EXAMPLE-ORG	tls	172.16.1.6	biz-internet	1 Yes	up	0 10.2.100.6	23957	10.2.1.10	23957

Device#

On a Cisco vEdge device, you can obtain a similar output by executing the command `show control connections`.

### View Signed Certificate Installed on a WAN Edge Device for Authentication with Reverse Proxy

The following is a sample output from the execution of the `show sdwan certificate reverse-proxy` command on a Cisco IOS XE Catalyst SD-WAN device.

Device# `show sdwan certificate reverse-proxy`

Reverse proxy certificate

-----

Certificate:

Data:

Version: 1 (0x0)

Serial Number: 1 (0x1)

Signature Algorithm: sha256WithRSAEncryption

Issuer: C = US, CN = 6c63e80a-8175-47de-a455-53a127ee70bd, O = Viptela

```
Validity
    Not Before: Jun  2 19:31:08 2021 GMT
    Not After  : May 27 19:31:08 2051 GMT

    Subject: C = US, ST = California, CN = C8K-9AE4A5A8-4EB0-E6C1-1761-6E54E4985F78, O
= ViptelaClient
    Subject Public Key Info:

        Public Key Algorithm: rsaEncryption

            RSA Public-Key: (2048 bit)

            Modulus:

                00:e2:45:49:53:3a:56:d4:b8:70:59:90:01:fb:b1:
                44:e3:73:17:97:a3:e9:b7:55:44:d4:2d:dd:13:4a:
                a8:ef:78:14:9d:bd:b5:69:de:c9:31:29:bd:8e:57:
                09:f2:02:f8:3d:1d:1e:cb:a3:2e:94:c7:2e:61:ea:
                e9:94:3b:28:8d:f7:06:12:56:f3:24:56:8c:4a:e7:
                01:b1:2b:1b:cd:85:4f:8d:34:78:78:a1:26:17:2b:
                a5:1b:2a:b6:dd:50:51:f8:2b:13:93:cd:a6:fd:f8:
                71:95:c4:db:fc:a7:83:05:23:68:61:15:05:cc:aa:
                60:af:09:ef:3e:ce:70:4d:dd:50:84:3c:9a:57:ce:
                cb:15:84:3e:cd:b2:b6:30:ab:86:68:17:94:fa:9c:
                1a:ab:28:96:68:8c:ef:c8:f7:00:8a:7a:01:ca:58:
                84:b0:87:af:9a:f6:13:0f:aa:42:db:8b:cc:6e:ba:
                c8:c1:48:d2:f4:d8:08:b1:b5:15:ca:36:80:98:47:
                32:3a:df:54:35:fe:75:32:23:9f:b5:ed:65:41:99:
                50:b9:0f:7a:a2:10:59:12:d8:3e:45:78:cb:dc:2a:
                95:f2:72:02:1a:a6:75:06:87:52:4d:01:17:f2:62:
                8c:40:ad:29:e4:75:17:04:65:a9:b9:6a:dd:30:95:
                34:9b

            Exponent: 65537 (0x10001)

    Signature Algorithm: sha256WithRSAEncryption

        99:40:af:23:bb:cf:7d:59:e9:a5:83:78:37:02:76:83:79:02:
        b3:5c:56:e8:c3:aa:fc:78:ef:07:23:f8:14:19:9c:a4:5d:88:
        07:4d:6e:b8:0d:b5:af:fa:5c:f9:55:d0:60:94:d9:24:99:5e:
        33:06:83:03:c3:73:c1:38:48:45:ba:6a:35:e6:e1:51:0e:92:
        c3:a2:4a:a2:e1:2b:da:cd:0c:c3:17:ef:35:52:e1:6a:23:20:
```

```
af:99:95:a2:cb:99:a7:94:03:f3:78:99:bc:76:a3:0f:de:04:
7d:35:e1:dc:4d:47:79:f4:c8:4c:19:df:80:4c:4f:15:ab:f1:
61:a2:78:7a:2b:6e:98:f6:7b:8f:d6:55:44:16:79:e3:cd:51:
0e:27:fc:e6:4c:ff:bb:8f:2d:b0:ee:ed:98:63:e9:c9:cf:5f:
d7:b1:dd:7b:19:32:22:94:77:d5:bc:51:85:65:f3:e0:93:c7:
3c:79:fc:34:c7:9f:40:dc:b1:fc:6c:e5:3d:af:2d:77:b7:c3:
88:b3:89:7c:a6:1f:56:35:3b:35:66:0c:c8:05:b5:28:0b:98:
19:c7:b0:8e:dc:b7:3f:9d:c1:bb:69:f0:7d:20:95:b5:d1:f0:
06:35:b7:c4:64:ba:c4:95:31:4a:97:03:0f:04:54:6d:cb:50:
2f:31:02:59
```

Device#

On a Cisco vEdge device, you can obtain a similar output by executing the command **show certificate reverse-proxy**.







# CHAPTER 11

## Onboarding Modular Cisco ASR 1000 Series Platforms

- [Cisco ASR 1006-X with an RP3 Module, on page 307](#)
- [Information About the Cisco ASR 1006-X with an RP3 Module, on page 307](#)
- [RMA Replacement of the Cisco ASR 1006-X Chassis, on page 309](#)
- [RMA Replacement of the Cisco RP3 Module, on page 313](#)

### Cisco ASR 1006-X with an RP3 Module

*Table 40: Feature History*

Feature Name	Release Information	Description
Cisco Catalyst SD-WAN Support for the Cisco ASR 1006-X Platform with an RP3 Module	Cisco IOS XE Catalyst SD-WAN Release 17.5.1a Cisco vManage Release 20.5.1	Starting from this release, Cisco Catalyst SD-WAN supports the Cisco ASR 1006-X platform with a Cisco ASR 1000 Series Route Processor 3 module installed.

### Information About the Cisco ASR 1006-X with an RP3 Module

Minimum supported releases: Cisco IOS XE Catalyst SD-WAN Release 17.5.1a, Cisco vManage Release 20.5.1

Last supported releases: Cisco IOS XE Catalyst SD-WAN Release 17.12.x, Cisco Catalyst SD-WAN Control Components Release 20.12.x

Cisco Catalyst SD-WAN supports the Cisco ASR 1006-X platform with a Cisco ASR 1000 Series Route Processor 3 (Cisco ASR1000-RP3) module.



**Note** Cisco Catalyst SD-WAN supports this configuration only when the Cisco ASR 1006-X and RP3 module are ordered as a unit for operation with Cisco Catalyst SD-WAN.

# Hardware Configuration

The Cisco ASR 1006-X operates with Cisco Catalyst SD-WAN in the following configuration.

**Table 41: Hardware Configuration**

ASR 1006-X Slot	Contents
R0	Cisco ASR 1000 Series Route Processor 3 (Cisco ASR1000-RP3) module
F0	Cisco ASR 1000 Series 200-Gbps Embedded Services Processor (ASR1000-ESP200-X)
CC0	Cisco ASR1000-MIP100 carrier card + 1 or 2 EPA cards in the subslots of the carrier <b>Note</b> See below for supported EPA cards. When using only one EPA card in the carrier, you can place the EPA card in either subslot.
CC1	Cisco ASR1000-MIP100 carrier card + 1 or 2 EPA cards in the subslots of the carrier <b>Note</b> See below for supported EPA cards. When using only one EPA card in the carrier, you can place the EPA card in either subslot.
R1	This slot must be empty.
F1	This slot must be empty.

**Figure 28: Cisco ASR 1006-X Slots and Modules**

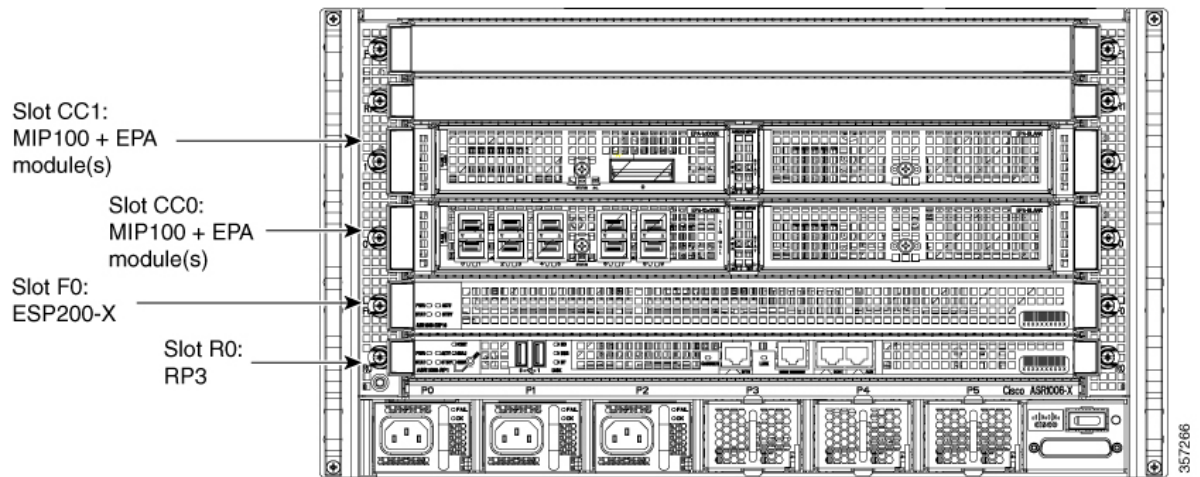

For information about installing the ASR1000-MIP100 carrier card and EPA cards, see the [Cisco ASR 1000 Series Modular Interface Processor Hardware Installation Guide](#).

### Supported Cards and Modules

The following Ethernet port adapter (EPA) cards are supported. Each ASR1000-MIP100 carrier card supports two EPA cards, and you can install a total of up to four EPA cards.

- 10-port 10 Gigabit Ethernet (10x10G):  
EPA-10X10GE
- 2-port 40 Gigabit Ethernet (2x40G):  
EPA-2X40GE
- 1-port 100 Gigabit Ethernet (1x100G):  
EPA-QSFP-1X100GE

### Notes and Limitations

- **Hardware redundancy**

Use only one ASR1000-RP3 and one ASR1000-ESP200-X, as described in the Hardware Configuration table above. Dual RP module or dual ESP hardware redundancy is not supported for the Cisco ASR 1006-X in this Cisco Catalyst SD-WAN use-case.

- **ISSU and OIR**

The modules and cards do not support in-service software upgrade (ISSU) or online insertion and removal (OIR).

## ROM Monitor Software Version

- For the Cisco ASR 1006-X platform, there are no specific ROM monitor (ROMmon) version requirements.
- The RP3 module requires ROM monitor (ROMmon) software version 16.9(5r) or later.

## Onboarding Workflow

1. Verify that the Cisco ASR 1006-X meets the requirements described in [Hardware Configuration](#) and [ROM Monitor Software Version](#).
2. Follow the Plug and Play onboard procedures described in the [Cisco Plug and Play Support Guide for Cisco SD-WAN Products](#).
3. Follow the Cisco Catalyst SD-WAN onboarding procedure described in [Plug and Play Onboarding Workflow](#).

## RMA Replacement of the Cisco ASR 1006-X Chassis

Use this procedure if it is necessary to replace the Cisco ASR 1006-X chassis as part of a return material authorization (RMA) process. This procedure replaces the Cisco ASR 1006-X chassis, but keeps the current cards (RP3 module, ESP200 module, MIP100 carrier cards, EPA cards).

**Before You Begin**

- The Cisco ASR 1006-X (which is now faulty) with an RP3 module has been fully onboarded in Cisco SD-WAN Manager.
- Make note of the following serial numbers:
  - Replacement Cisco ASR 1006-X chassis serial number
  - Certificate serial number for the RP3 module
  - SUDI serial number for the RP3 module

**Replace the Cisco ASR 1006-X Chassis**

To replace the Cisco ASR 1006-X chassis, perform the following steps.



---

**Note** In tables listing devices, Cisco SD-WAN Manager does not distinguish between the Cisco ASR 1006-X chassis and the RP3 module installed in the chassis. A single row in the table shows the combined information for both.

---

1. (Perform this step only if you have applied a feature template to the current device (which is now faulty), and if you want to save the existing configuration to use it on the replacement device.)

Save the device settings file for the RP3 module.

- a. From the Cisco SD-WAN Manager menu, choose **Configuration > Templates**.
- b. Click **Device Templates**.



---

**Note** In Cisco vManage Release 20.7.x and earlier releases, **Device Templates** is called **Device**.

---

- c. Click ... for the template that is attached to the Cisco ASR 1006-X containing the RP3 module, and choose **Export CSV** to download the device settings CSV file.
2. In the Cisco Plug and Play (PnP) Connect web portal, remove the current Cisco ASR 1006-X chassis.



---

**Note** The PnP Connect web portal is linked to Cisco commerce workspace (CCW), facilitating automatic registration of the serial numbers and PIDs of purchased devices in the PnP Connect web portal. For more information see the [Cisco Plug and Play Support Guide for Cisco SD-WAN Products](#), and the RMA topic in the [Cisco Network Plug and Play Connect Capability Overview](#).

---



---

**Note** The functionality of the PnP Connect web portal is subject to change, and is outside the scope of this document. For additional details, see the PnP Connect web portal documentation.

---

In the PnP Connect web portal, use **Devices > Delete Selected Device**, or the equivalent, to remove the current Cisco ASR 1006-X chassis.

3. In the Cisco Plug and Play (PnP) Connect web portal, add the replacement Cisco ASR 1006-X chassis.
  - a. In the PnP Connect web portal, choose **Devices > Add Device**, or the equivalent, and select the option to enter new device details.
  - b. Enter the serial number for the replacement Cisco ASR 1006-X chassis.



---

**Note** You can use the **show pnp version** command on the Cisco ASR 1006-X router to display the serial number.

---

- c. Add the SUDI serial number and certificate serial number of the RP3 module.



---

**Note** If the RP3 module is mounted in a working chassis, you can use the **show sdwan certificate serial** command to display these serial numbers.

---

- d. Save the update.
4. Remove the entry for the current Cisco ASR 1006-X chassis in Cisco SD-WAN Manager.
  - a. In Cisco SD-WAN Manager, detach the current device template from the current Cisco ASR 1006-X chassis.
  - b. From the Cisco SD-WAN Manager menu, choose **Configuration > Certificates**.
  - c. In the row with the current Cisco ASR 1006-X, in the **Validate** column, click **Invalid**, and **OK**.  
The task view indicates when the process is complete.
  - d. Click **Send to Controllers**.
  - e. From the Cisco SD-WAN Manager menu, choose **Configuration > Devices**.
  - f. In the row with the current Cisco ASR 1006-X, click **More Options (...)** and choose **Delete WAN Edge**.
5. From the Cisco SD-WAN Manager menu, choose **Configuration > Devices** and click **Sync Smart Account**.  
Cisco SD-WAN Manager loads the details of the replacement Cisco ASR 1006-X chassis from your Smart Account.
6. If you saved a CSV file in an earlier step, edit the file to update it with the device ID of the replacement chassis.
  - a. From the Cisco SD-WAN Manager menu, choose **Configuration > Devices > WAN Edge List**.
  - b. Copy device ID of the new chassis from the **Chassis Number** column in the device list.
  - c. Open the CSV file in a text editor or spreadsheet application, and edit the csv-deviceId value in the first column, updating it to use the device ID of the new chassis.

7. Attach a device template to the replacement Cisco ASR 1006-X. Use the same device template that was used for previous chassis. If you saved a CSV file in an earlier step, use it in the substeps that follow.
  - a. From the Cisco SD-WAN Manager menu, choose **Configuration > Templates**.
  - b. Click **Device Templates**.



---

**Note** In Cisco vManage Release 20.7.x and earlier releases, **Device Templates** is called **Device**.

---

- c. In the row of the template that was previously attached to the current chassis, click **More Actions (...)** and choose **Attach Devices**.
  - d. In the **Available Devices** pane, select the replacement chassis and move it to the **Selected Devices** pane.
  - e. Click **Attach**. The **Configuration Templates** page opens.
  - f. If you saved a CSV file in an earlier step, click the **up arrow** button to upload a CSV file.
  - g. If you saved a CSV file in an earlier step, in the **Upload CSV File** pop-up window, select the CSV file edited in a previous step, and click **Upload**. The values stored in the CSV file are copied to the device template.
  - h. Click **Next**.
  - i. Click **Configure Devices** to push the device template to the replacement Cisco ASR 1006-X chassis. The task status shows this task as Scheduled because the replacement device is not yet reachable.
8. Save the device configuration file.
  - a. From the Cisco SD-WAN Manager menu, choose **Configuration > Devices > WAN Edge List**.
  - b. In the row of the Cisco ASR 1006-X, click **More Options (...)** and choose **Generate Bootstrap Configuration**.
  - c. In the pop-up window, click the **Cloud-Init** radio button.
  - d. Click **Download** to download the configuration file.
  - e. Rename the downloaded file to: ciscosdwan.cfg
9. Copy the bootstrap file (ciscosdwan.cfg) created in an earlier step, to a USB flash drive, and plug this into the current RP3 module.
10. If the current Cisco ASR 1006-X chassis is still operating, power it down.
11. Remove the modules and cards (RP3 module, ESP200 module, MIP100 carrier cards, EPA cards) from the current Cisco ASR 1006-X chassis.
12. Connect the USB flash drive, which has the configuration file saved in an earlier step, to the RP3 module.
13. Install the modules and cards in the new Cisco ASR 1006-X chassis.

For information about RP3 module installation, see the [Cisco ASR 1000 Route Processor 3 Installation and Configuration Guide](#).

For information about MIP100 and EPA installation, see the [Cisco ASR 1000 MIP and EPA Hardware Installation Guide](#).

14. Power up the replacement Cisco ASR 1006-X router.
15. After the router is powered up, execute the **controller-mode reset** command on the router to reset the RP3 module.

When the RP3 module starts, the following occurs:

- The RP3 module loads the configuration from the `ciscosdwan.cfg` file on the USB flash drive.
- The RP3 module boots up in controller mode.



---

**Note** From Cisco IOS XE Catalyst SD-WAN Release 17.13.1a, controller mode is not supported.

---

- When the connection to the controller is established, the controller pushes the device template, which was in Scheduled state, to the RP3 module.

## RMA Replacement of the Cisco RP3 Module

Use this procedure if it is necessary to replace the RP3 module used with the Cisco ASR 1006-X as part of a return material authorization (RMA) process.

### Prerequisites

- The Cisco ASR 1006-X with an RP3 module (which is now faulty) has been onboarded in Cisco SD-WAN Manager.
- Make note of the following serial numbers:
  - Cisco ASR 1006-X chassis serial number
  - Certificate serial number for the replacement RP3 module
  - SUDI serial number for the replacement RP3 module

### Replace the Cisco RP3 Module

To replace the Cisco RP3 module, perform the following steps.



---

**Note** In tables listing devices, Cisco SD-WAN Manager does not distinguish between the Cisco ASR 1006-X chassis and the RP3 module installed in the chassis. A single row in the table shows the combined information for both.

---

1. (Perform this step only if you have applied a feature template to the current device (which is now faulty), and if you want to save the existing configuration to use it on the replacement device.)

Save the device settings file for the RP3 module.

- a. From the Cisco SD-WAN Manager menu, choose **Configuration > Templates**.
- b. Click **Device Templates**.



---

**Note** In Cisco vManage Release 20.7.x and earlier releases, **Device Templates** is called **Device**.

---

- c. Click **More Options (...)** for the template that is attached to the Cisco ASR 1006-X containing the RP3 module, and choose **Export CSV** to download the device settings CSV file.
2. Save the device configuration file for the RP3 module.
    - a. From the Cisco SD-WAN Manager menu, choose **Configuration > Devices > WAN Edge List**.
    - b. In the row for the Cisco ASR 1006-X containing the RP3 module, click **More Options (...)** and choose **Generate Bootstrap Configuration**.
    - c. In the pop-up window, click the **Cloud-Init** radio button.
    - d. Click **Download** to download the configuration file.
    - e. Rename the downloaded file to: ciscosdwan.cfg
  3. In the Cisco Plug and Play (PnP) Connect web portal, update the SUDI serial number and certificate serial number within the Cisco ASR 1006-X entry, to use the serial numbers of the replacement RP3 module.



---

**Note** The PnP Connect web portal is linked to Cisco commerce workspace (CCW), facilitating automatic registration of the serial numbers and PIDs of purchased devices in the PnP Connect web portal. For more information see the [Cisco Plug and Play Support Guide for Cisco Catalyst SD-WAN Products](#), and the RMA topic in the [Cisco Network Plug and Play Connect Capability Overview](#).

---



---

**Note** The functionality of the PnP Connect web portal is subject to change, and is outside the scope of this document. For additional details, see the PnP Connect web portal documentation.

---

- a. In the PnP Connect web portal, choose **Devices > Edit Device** and select the Cisco ASR 1006-X entry for the device that contains the RP3 module that is being replaced.
  - b. In the Cisco ASR 1006-X entry, delete the SUDI serial number and certificate serial number of any existing RP3 module entries (there may be more than one).
  - c. Add the SUDI serial number and certificate serial number for the replacement RP3 module.
  - d. Save the update.
4. In Cisco SD-WAN Manager, remove the current RP3 module and add the replacement RP3 module.
    - a. From the Cisco SD-WAN Manager menu, choose **Configuration > Certificates**.



- b. In the row with the Cisco ASR 1006-X device containing the RP3 module, in the **Validate** column, click **Invalid**, and **OK**.

The task view indicates when the process is complete.

- c. Click **Send to Controllers**.
- d. From the Cisco SD-WAN Manager menu, choose **Configuration > Devices**.
- e. In the row with the Cisco ASR 1006-X device containing the RP3 module, click **More Options (...)** and choose **Delete WAN Edge**.
- f. From the Cisco SD-WAN Manager menu, choose **Configuration > Devices** and click **Sync Smart Account**.

Cisco SD-WAN Manager loads the details of the replacement RP3 module. At this point, before you have physically replaced the RP3 module, the device table shows the following in the row of the Cisco ASR 1006-X device:

- Device Model: ASR1006-X
- Chassis Number: No change to the chassis number
- Serial No./Token: Updated to show the serial number of the replacement RP3 module, as loaded from the Smart Account

5. Attach a device template to the replacement Cisco ASR 1006-X. Use the same device template that was used for previous chassis. If you saved a CSV file in an earlier step, use it in the substeps that follow.
  - a. From the Cisco SD-WAN Manager menu, choose **Configuration > Templates**.
  - b. Click **Device Templates**.



---

**Note** In Cisco vManage Release 20.7.x and earlier releases, **Device Templates** is called **Device**.

---

- c. In the row of the template that was previously attached to the current chassis, click **More Actions (...)** and choose **Attach Devices**.
  - d. In the **Available Devices** pane, select the replacement chassis and move it to the **Selected Devices** pane.
  - e. Click **Attach**. The **Configuration Templates** page opens.
  - f. If you saved a CSV file in an earlier step, click the **up arrow** button to upload a CSV file.
  - g. If you saved a CSV file in an earlier step, in the **Upload CSV File** pop-up window, select the CSV file and click **Upload**. The values stored in the CSV file are copied to the device template.
  - h. Click **Next**.
  - i. Click **Configure Devices** to push the device template to the replacement Cisco ASR 1006-X chassis. The task status shows this task as **Scheduled** because the replacement device is not yet reachable.
6. Copy the bootstrap file (ciscosdwan.cfg) created in an earlier step, to a USB flash drive, and plug this into the replacement RP3 module.

7. Remove the previous RP3 module from the Cisco ASR 1006-X chassis, and install the replacement RP3 module.

For information about RP3 module installation, see the [Cisco ASR 1000 Route Processor 3 Installation and Configuration Guide](#).

When the RP3 module starts, the following occurs:

- The RP3 module loads the configuration from the ciscosdwan.cfg file on the USB flash drive.
- The RP3 module boots up in controller mode.



---

**Note** From Cisco IOS XE Catalyst SD-WAN Release 17.13.1a, controller mode is not supported.

---

- When the connection to the controller is established, the controller pushes the device template, which was in Scheduled state, to the RP3 module.



## CHAPTER 12

# API Cross-Site Request Forgery Prevention

Table 42: Feature History

Feature Name	Release Information	Description
API Cross-Site Request Forgery Prevention	Cisco IOS XE Catalyst SD-WAN Release 16.12.1b  Cisco Catalyst SD-WAN Release 19.2.1	This feature adds protection against Cross-Site Request Forgery (CSRF) that occurs when using Cisco Catalyst SD-WAN REST APIs. This protection is provided by including a CSRF token with API requests. You can put requests on an allowed list so that they do not require protection if needed.

- [Cisco Catalyst SD-WAN REST API Token-Based Authentication, on page 317](#)
- [Token Use, on page 318](#)
- [API Docs, on page 318](#)
- [Third Party Application Users, on page 318](#)

## Cisco Catalyst SD-WAN REST API Token-Based Authentication

Cisco Catalyst SD-WAN release 19.2 offers token-based authentication when you use the Cisco Catalyst SD-WAN REST API. This protection is provided by requiring that a token be included with API requests. Each API session uses a unique token that is valid throughout the session. If an API request does not include this token, Cisco SD-WAN Manager rejects the request, unless the endpoint is included on an allowed list. (For assistance with adding endpoints to an allowed list, open a case with the Cisco TAC or escalation support team.)



**Note** However, some of the GET API's and all the POST API's of Cisco SD-WAN Manager, which are not on an allowed list require Cross-Site Request Forgery (CSRF) token authentication.

## Token Use

The following sections describe how the token is used with the API when you use API docs or third party applications.

## API Docs

Cisco SD-WAN Manager automatically generates a token and appends the token to every request that you send from the Cisco SD-WAN Manager API Docs page. This process requires no action from you, and you will not notice any difference from previous releases in how the API Docs page operates.

If there are API requests that you want to exclude from this token-based authentication, you can request that these API endpoints be included in an allowed list by opening a case with the Cisco TAC or escalation support team.

## Third Party Application Users

If you use scripts or third party applications such as Postman, LiveAction, SolarWinds, or SevOne for Cisco SD-WAN Manager API requests, each request must include the token, unless the API is included in an allowed list. If an API request does not include a token and is not included in the allowed list, Cisco SD-WAN Manager rejects the request and returns the response code 403 (forbidden) with the message, “SessionTokenFilter: Token provided via HTTP Header does not match the token generated by the server.”

To request that certain API endpoints be included in an allowed list, open a case with the Cisco TAC or escalation support team.

To include the token in a third party API request:

### Method 1

In the first method, the session you create is stored in the cookies.txt file and the same session can be used for all subsequent requests, using the jsessionid that the file contains. This is the recommended method.

1. To log in to Cisco SD-WAN Manager, use the following example command and modify the URL according to your IP address:

```
sampleuser$ TOKEN=$(curl "https://209.165.200.254/dataservice/client/token" -X GET -b cookies.txt -s -insecure)
```

To verify the login, see the cookies.txt file.

2. After logging in to Cisco SD-WAN Manager, obtain a token by making a request, where *vManage\_IP* is the IP address of your Cisco SD-WAN Manager server. You can obtain a token in string format or in JSON format.

To obtain a token in string format, use the following URL:

```
https://vManage_IP/dataservice/client/token
```

To obtain a token in JSON format (beginning with Cisco IOS XE SD-WAN Release 16.12 and Cisco SD-WAN Release 19.2), use the following URL:

```
https://vManage_IP/dataservice/client/token?json=true
```

The token that these calls return is valid for the rest of your current session. The following example shows requests for obtaining a token:

Command for obtaining a token in string format:

```
sampleuser$ TOKEN=$(curl "https://vManage_IP/dataservice/client/token" -X GET -b cookies.txt -s -insecure)
```

Output in string format:

```
FC5B19BB3521EE20CFBDCD3CEDCC48F50CB1095C9654407936029E9C0EF99FEAE50440B60E49F7CD4A0BAB5307C2855F2E0C
```

Command for obtaining a token in JSON format:

```
TOKEN=$(curl "https://vManage_IP/dataservice/client/token?json=true" -X GET -b cookies.txt -s -insecure)
```

Output in JSON format:

```
sampleuser$ echo $TOKEN
```

```
{"token":"56CF324A8F67993B6FCCF57302068B0756DA8703BE712EEA18D4D9055B11312843F9D30B48A3902320FFAA8659AD01202A63"}
```



---

**Note** JSON format is not supported for curl commands.

---

3. In the header of each subsequent API request in the current session, include the X-XSRF-TOKEN key, with a value that consists of the token that you generated.

The following examples show a GET request and a POST request that include a generated token in the header:

Command:

```
sampleuser$ curl "https://vManage_IP/dataservice/server/info" -b cookies.txt -silent -insecure -H "X-XSRF-TOKEN: $TOKEN"
```

Output:

```
{"Architecture":"amd64","Available processors":2}
```

Command

```
sampleuser$ curl "https://vManage_IP/dataservice/settings/configuration/emailNotificationSettings" -X POST -b cookies.txt -silent -insecure -H "X-XSRF-TOKEN: $TOKEN" -d '{"enabled":true,"from_address":"test@mydomain.com","protocol":"smtp","smtp_server":"a.com","smtp_port":25,"reply_to_address":"test@test.com","notification_use_smtp_authentication":false}'
```

Output:

```
{"data":[{"enabled":true,"notification_use_email_setting_authentication":false,"notification_use_smtp_authentication":false}]}
```

4. To prevent memory leaks, you must logout after each API call, including the token, starting from Cisco SD-WAN Release 19.2.1.

The following example shows how you can logout:

Command:

```
sampleuser$ curl "https://vManage_IP/logout" -b cookies.txt -insecure -H
"X-XSRF-TOKEN:$TOKEN"
```

Output:

```
Replaced cookie JSESSIONID="DcOke5mqix_15qCpWA1blIJVAMnVg3lDMU4ABRgVinvalid" for domain
209.165.200.254, path /, expire 0
< set-cookie: JSESSIONID=DcOke5mqix_15qCpWA1blIJVAMnVg3lDMU4ABRgVinvalid
```



---

**Note** To verify that you have logged out of the session, check the jsessionid and ensure that it ends with 'invalid'.

---

## Method 2

In the second method, the session you create is not stored and you must create a new session for each request.

1. After logging in to Cisco SD-WAN Manager, obtain a token by making a request, where *vManage\_IP* is the IP address of your Cisco SD-WAN Manager server. You can obtain a token in string format or in JSON format.

To obtain a token in string format, use the following URL:

```
https://vManage_IP/dataservice/client/token
```

To obtain a token in JSON format (beginning with Cisco IOS XE SD-WAN Release 16.12 and Cisco SD-WAN Release 19.2), use the following URL:

```
https://vManage_IP/dataservice/client/token?json=true
```

The token that these calls return is valid for the rest of your current session. The following example shows requests for obtaining a token:

Command for obtaining a token in string format:

```
sampleuser$ curl --user admin:admin https://vManage_IP/dataservice/client/token --insecure
```

Output in string format:

```
FC5B19BB3521EE20CFBDCD3CEDCC48F50CB1095C9654407936029E9C0EF99FEAE50440B60E49F7CD4A0BAB5307C2855F2E0C
```

Command for obtaining a token in JSON format:

```
sampleuser$ curl --user admin:admin https://vManage_IP/dataservice/client/token?json=true
--insecure
{"token":"F1E047E444DB2CA4237B0246DFE133345584B788C6E8776F04749A371B73F3C0C683043F1CDBB5E01EBBDA7D6C35F58EA37A"}
```

Output in JSON format:

```
FC5B19BB3521EE20CFBDCD3CEDCC48F50CB1095C9654407936029E9C0EF99FEAE50440B60E49F7CD4A0BAB5307C2855F2E0C
```

2. In the header of each subsequent API request in the current session, include the X-XSRF-TOKEN key, with a value that consists of the token that you generated.

The following examples show a GET request and a POST request that include a generated token in the header:

Command:

```
sampleuser$ curl "https://vManage_IP/dataservice/server/info" -H "Cookie:
JSESSIONID=pSvrX3AEWokiDO1TkFiOjgSehp-ITNdFn7Xj9PsL.c331d01e-91d7-41cc-ab90-b629c2ae6d97"
--insecure -H "X-XSRF-TOKEN=
FC5B19BB3521EE20CFBDCD3CEDCC48F50CB1095C9654407936029E9C0EF99FEAE50440B60E49F7CD4A0BAB5307C2855F2E0C"
```

Output:

```
{"Architecture":"amd64","Available processors":2}
```

Command

```
sampleuser$
"https://vManage_IP/dataservice/settings/configuration/emailNotificationSettings" -H
"Cookie:
JSESSIONID=pSwrx3AEWokiD01TkFiOjgSehp-ITNdFn7Xj9PsL.c331d01e-91d7-41cc-ab90-b629c2ae6d97"
--insecure -H "X-XSRF-TOKEN=
FC5B19BB3521EE20CFBDCD3CEDCC48F50CB1095C9654407936029E9C0EF99FEAE50440B60E49F7CD4A0BAB5307C2855F2E0C"
-X POST --insecure -d
'{"enabled":true,"from_address":"test@mydomain.com","protocol":"smtp","smtp_server":"a.com",
"smtp_port":25,"reply_to_address":"test@test.com","notification_use_smtp_authentication":false}='
```

Output:

```
{"data":[{"enabled":true,"protocol":"smtp","smtp_server":"a.com","from_address":"test@mydomain.com",
"smtp_port":25,"notification_use_smtp_authentication":false,"reply_to_address":"test@test.com"}]}
```

3. To prevent memory leaks, you must logout after each API call, including the token, starting from Cisco SD-WAN Release 19.2.1.

The following example shows how you can logout:

Command:

```
sampleuser$ curl "https://vManage_IP/logout" -b cookies.txt --insecure -H
"X-XSRF-TOKEN:$TOKEN"
```

Output:

```
Replaced cookie JSESSIONID="DcOke5mqix_15qCpWA1blIJVAMnVg3lDMU4ABRgVinvalid" for domain
209.165.200.254, path /, expire 0
< set-cookie: JSESSIONID=DcOke5mqix_15qCpWA1blIJVAMnVg3lDMU4ABRgVinvalid
```



---

**Note** To verify that you have logged out of the session, check the jsessionid and ensure that it ends with 'invalid'.

---







## CHAPTER 13

# Deploy Cisco SD-WAN Controller in Microsoft Azure

*Table 43: Feature History*

Feature Name	Release Information	Description
Deploy Cisco SD-WAN Controllers in Azure	Cisco vManage Release 20.6.1	This feature enables you to deploy the Cisco SD-WAN Controllers (Cisco SD-WAN Manager, Cisco SD-WAN Controller, and Cisco Catalyst SD-WAN Validator) in a Microsoft Azure environment.

- [Information About Deploying Cisco SD-WAN Controllers in Azure, on page 323](#)
- [Prerequisites for Deploying Cisco SD-WAN Controllers in Azure, on page 324](#)
- [Use Cases for Deploying Cisco SD-WAN Controllers in Azure, on page 325](#)
- [Deploy Cisco SD-WAN Controllers in Azure: Tasks, on page 325](#)
- [Verify the Deployment of Cisco SD-WAN Controllers in Azure, on page 330](#)
- [Monitor the Deployment of Cisco SD-WAN Controllers in Azure, on page 331](#)

## Information About Deploying Cisco SD-WAN Controllers in Azure

Minimum supported controller images: Cisco vManage Release 20.6.1, Cisco Catalyst SD-WAN Control Components Release 20.6.1, and Cisco SD-WAN Validator Release 20.6.1

You can deploy the following Cisco SD-WAN Controllers in an Azure environment: Cisco SD-WAN Manager, Cisco SD-WAN Controller, and Cisco SD-WAN Validator.

The following illustration shows the architecture of the Azure region, virtual network, security group, and so on, and it shows where the Cisco SD-WAN Controllers function within the architecture.

Figure 29: Cisco SD-WAN Controllers in Azure

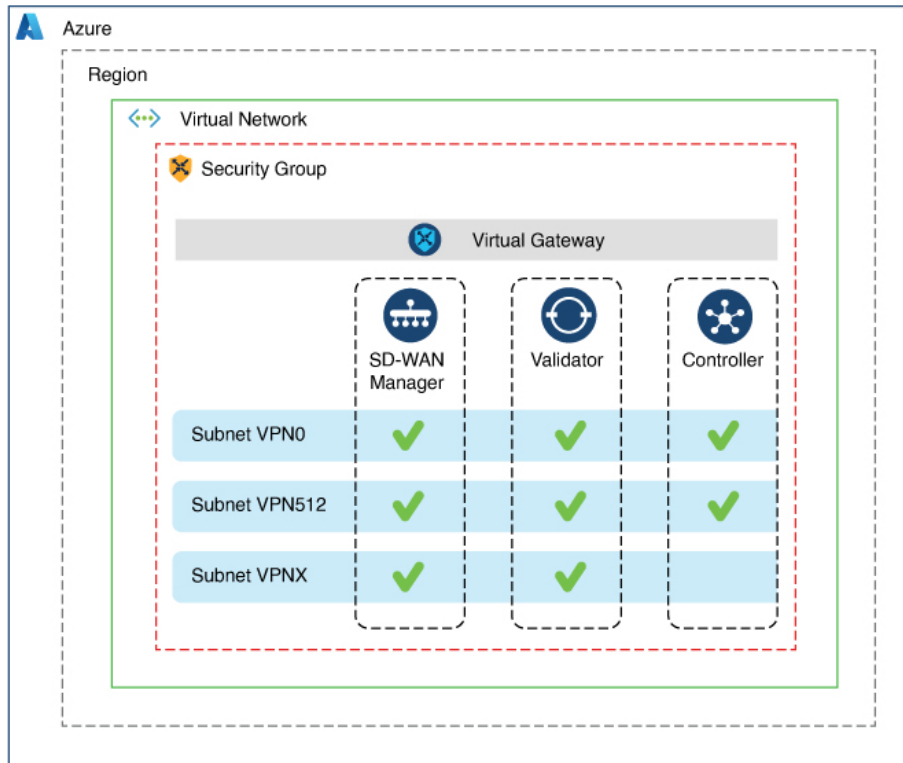

357661

## Benefits of Deploying Cisco SD-WAN Controllers in Azure

- **Set-up cost:** Requires low initial set-up cost, as compared with on-premises hosting, as there is no requirement to purchase additional data center infrastructure
- **Deployment:** Ease of cloud-based deployment
- **Management:** Ability to manage devices worldwide
- **Stability:** Because of its reliability, Azure hosting provides a stable environment for Cisco SD-WAN Controllers.
- **Security:** Azure provides a secure hosting environment.
- **Scaling:** Azure provides an easy path to increasing the scale of your Cisco Catalyst SD-WAN network.

## Prerequisites for Deploying Cisco SD-WAN Controllers in Azure

You must have a valid (and active) Microsoft Azure subscription.

# Use Cases for Deploying Cisco SD-WAN Controllers in Azure

For a Cisco Catalyst SD-WAN deployment that is already using Azure, such as for Cisco Catalyst 8000V Edge Software, hosting the Cisco SD-WAN Controllers in Azure is a logical, efficient choice, keeping all services in alignment.

## Deploy Cisco SD-WAN Controllers in Azure: Tasks



---

**Note** The procedures described here apply to the three types of Cisco SD-WAN Controllers— Cisco SD-WAN Manager, Cisco SD-WAN Controller, and Cisco SD-WAN Validator. Where applicable, we indicate where the instructions are different for specific controllers.

---



---

**Note** In DHCP configurations, IPv6 Unique Local Addresses (ULA) are assigned to the interface in some instances. Cisco SD-WAN Validator is designed to drop the packets with source or destination as the ULA addresses. In an Azure setup, to allow packets with these addresses on the device, configure the **enable-ipv6-unique-local-address** command to enable or disable these addresses.

---

## Task 1: Create a Controller Image in Azure

### Before You Begin

On the Cisco [Software Download](#) page, download the images for the Cisco SD-WAN Control Components: Cisco SD-WAN Manager, Cisco SD-WAN Controller, and Cisco SD-WAN Validator. Decompress the downloaded files, which are in .tar format. The image file for each controller is in virtual hard disk (VHD) format.

Create a Controller Image in Azure



---

**Note** For definitive information about tasks in Azure, see the Azure documentation.

---

Perform the following steps in the Azure portal:

1. If you do not already have a storage account in Azure, create one now.
  - Provide a name, location, and so on, for the storage account.
  - For network connectivity, use the default options for connectivity method, routing preference, data protection, and secure transfer.
  - Optionally, you can enter a tag to categorize the storage account.

2. Create a new private container in the storage account. Choose a storage account in the region where you intend to deploy the controller.



---

**Note** Each controller requires a separate container.

---

3. Upload the VHD file of the controller into the container.  
During the upload procedure, choose Page Blob for the blob type.



---

**Note** For information about choosing the blob type, see Azure documentation.

---

4. Create a new image, selecting the VHD file uploaded in the previous step.

When creating an image, ensure that you complete the following actions:

- Choose a valid subscription.
- Choose an existing resource group or create a new one.
- Enter a name and region for the image.
- For OS, choose Linux.
- For VM generation, choose Gen 1.
- For account type, choose Premium SSD.
- For host caching, choose read/write
- For encryption, choose the default settings.
- Optionally, you can enter a tag to categorize the image.

## Task 2: Create a Virtual Network, Subnets, and Network Security Group in Azure



---

**Note** For definitive information about tasks in Azure, see the Azure documentation.

---

Perform the following steps in the Azure portal:

1. Begin the workflow for creating a virtual network.

When creating a virtual network, ensure that you complete the following actions:

- Choose a valid subscription.
- Choose an existing resource group or create a new one.



---

**Note** A resource group is a logical construct in Azure that includes all of the resources that you have deployed across regions. We recommend defining one resource group for each Cisco Catalyst SD-WAN overlay.

---

- Enter a name and region for the virtual network.
- Enter an address space for the virtual network.  
Example: 10.0.0.0/16
- Add a minimum of two subnets to the virtual network, and an additional subnet if you are using a Cisco SD-WAN Manager cluster. For each subnet, provide a name and an address space for the subnet. A later step associates these subnets with VM network interfaces.  
Example:  
10.0.1.0/24  
10.0.2.0/24  
10.0.3.0/24
- Optionally, you can enter a tag to categorize the virtual network.

2. Begin the workflow for creating a network security group (NSG).

When creating a network security group, ensure that you complete the following actions:

- Choose a valid subscription.
- Choose the resource group created in the previous step, as part of the workflow for creating a virtual network.
- Enter a name and region for the NSG.
- Optionally, you can enter a tag to categorize the NSG.

3. Associate the newly created NSG with the subnets created in an earlier step.

## Task 3: Create a Virtual Machine for the Controller



---

**Note** For definitive information about tasks in Azure, see the Azure documentation.

---

Perform the following steps in the Azure portal:

1. Begin the workflow for creating a virtual machine (VM).

When creating a VM, ensure that you complete the following actions:

- Deploy the VM in the virtual network created in Task 2.
- Select the resource group that you created in a previous task, during the workflow for creating a virtual network.

- Enter a name and region for the VM.
- For the image, select the uploaded controller image.



---

**Note** For information about how to locate custom images, see the Azure documentation.

---

- For the VM size, select an option with the number of CPUs and memory that you want to use for the controller.

For information about Cisco SD-WAN Controller-device compatibility and server requirements, see [Cisco SD-WAN Controller Compatibility Matrix and Server Recommendations](#).

- Choose an authentication type (for example, SSH public key, or password) and provide the credentials, as required.
- For disk resources, do one of the following:
  - If you are deploying a Cisco Catalyst SD-WAN Controller or a Cisco Catalyst SD-WAN Validator, no additional disk resources are required beyond the default.
  - If you are deploying a Cisco SD-WAN Manager controller, choose one disk.
    - Choose the Premium SSD option and default encryption.
    - Choose a disk size of 1 TiB (called P30 in Azure) or larger.
 

For server recommendations relevant to controllers in Azure, see [Cisco SD-WAN Controller Compatibility Matrix and Server Recommendations](#).
    - Configure the disk host caching as read/write.
- For networking details, choose the virtual network, the subnets, and the NSG that you created in earlier steps.
- For the public IP address, choose the following options:
  - SKU: Basic
  - Assignment: static



---

**Note** Cisco Catalyst SD-WAN requires a static IP address for controllers.

---

- Optionally, you can enable advanced boot diagnostics (a management option) to create an additional storage account in the resource group for storing diagnostics logs.
- (Controller releases 20.6.1 and later) Optionally, you can use the custom data feature (an advanced option) to enter commands for the VM to execute when rebooting.
- Optionally, you can add a tag to categorize the controller.

## 2. After creating the VM, create additional network interfaces (NICs) for the VM.

Create the network interfaces in the resource group that you created in an earlier task.

- If you are deploying a Cisco SD-WAN Controller or Cisco SD-WAN Validator, create one additional network interface.
- If you are deploying a Cisco SD-WAN Manager controller, create two additional network interfaces.
- If you are deploying a Cisco SD-WAN Manager controller in a cluster, see [Cluster Management](#) and [Deploy Cisco Catalyst SD-WAN Manager](#) for additional information about Cisco SD-WAN Manager out-of-band interfaces.

When creating a network interface, ensure that you complete the following actions:

- Specify the virtual network, subnets, and NSG created in earlier tasks.
- Associate NIC 1 with subnet 1.

If you are deploying a Cisco SD-WAN Manager controller, associate NIC 2 with subnet 2.

If you are using a Cisco SD-WAN Manager cluster, associate NIC 3 with subnet 3.



---

**Note** Associating a NIC with a subnet enables the VM to connect to the subnet.

---

- For each NIC, enter the tag used for the controller that you are deploying.

3. Create a static public IP for all of the controllers to use, and associate this public IP with NIC 1.



---

**Note** Use the IP configurations option in Azure to create the public IP.

---

When creating a public IP, ensure that you complete the following actions:

- For assignment, choose static.
- Use the associate option to specify NIC 1.

4. Stop the VM, and confirm when it has stopped.
5. Attach the newly created NICs to the VM.
  - If you are deploying a Cisco SD-WAN Controller or Cisco SD-WAN Validator, attach the NIC to the VM.
  - If you are deploying Cisco SD-WAN Manager, attach both of the newly created NICs to the VM.
6. Restart the VM.

Confirm in the Azure portal that the VM has restarted.

## Task 4: Configure the Network Security Group

### Before You Begin

The NSG is related functionally to firewall policy. When configuring the NSG, it is helpful to be aware of firewall port configuration in Cisco Catalyst SD-WAN. For more information on firewall ports, see [Firewall Ports for Cisco SD-WAN Deployments](#).

### Configure the Network Security Group



---

**Note** For definitive information about tasks in Azure, see the Azure documentation.

---

1. Using the Azure portal, add inbound security rules to the NSG created in an earlier task, to allow inbound traffic from the IP ranges needed for the following:
  - Establishing control connections between each of the Cisco SD-WAN Controller. If the controllers lack connectivity to each other, the control plane and data plane cannot operate.
  - Accessing the controllers using HTTPS or SSH protocols.

For the NSG, use the option to add inbound security rules. Using the rules, allow all of the controller VM IP addresses, to enable the required connectivity between the Cisco SD-WAN Controller.

When creating a new inbound security rule, ensure that you complete the following actions:

- Specify IP ranges, protocol, and so on.
  - For the action of the rule, choose the option to allow the traffic.
2. To verify connectivity, log in to the VM using the NIC 0 public IP of Cisco SD-WAN Manager.

## Verify the Deployment of Cisco SD-WAN Controllers in Azure

### • Infrastructure:

To verify the deployment of Cisco SD-WAN Controllers within virtual machines in Azure, use the Azure portal to check that the VMs hosting each controller are active.

### • Services:

To verify that Cisco Catalyst SD-WAN services are operating after deployment of the controllers, use the following steps:

1. Check for a successful ping to the VM that hosts Cisco SD-WAN Manager.
2. Log in to Cisco SD-WAN Manager.
3. Use SSH to connect to Cisco SD-WAN Manager, and use the **request nms all status** command. The output shows the status of all of the Cisco SD-WAN Manager services. Confirm that the application server is active.



The following excerpt of the **request nms all status** command output shows that the application server is active:

```
vmanage# request nms all status
NMS service proxy
    Enabled: true
    Status: running PID:2881 for 9479s
NMS service proxy rate limit
    Enabled: true
    Status: running PID:4359 for 9521s
NMS application server
    Enabled: true
    Status: running PID:6131 for 9419s
...
```

4. After installing the controllers, follow the steps in [Cisco SD-WAN Overlay Network Bring-Up Process](#) to establish the control connections for the controllers and to verify that each controller is operational.

## Monitor the Deployment of Cisco SD-WAN Controllers in Azure

To monitor infrastructure status, such as CPU usage and disk usage, use the monitoring tools in the Azure portal.

For information about monitoring the status of Cisco Catalyst SD-WAN services, see the [Cisco SD-WAN Monitor and Maintain guide](#).





# CHAPTER 14

## Deploy Cisco SD-WAN Controllers in the AWS Cloud

Table 44: Feature History

Feature Name	Release Information	Description
Deploy Cisco SD-WAN Controllers in AWS	Cisco vManage Release 20.6.1	This feature enables you to deploy the Cisco SD-WAN Controllers (Cisco SD-WAN Manager, Cisco Catalyst SD-WAN Controller, and Cisco SD-WAN Validator) in an Amazon AWS environment.

- [Information About Deploying Cisco SD-WAN Controllers in AWS](#), on page 333
- [Prerequisites for Deploying Cisco SD-WAN Controllers in AWS](#), on page 335
- [Use Cases for Deploying Cisco SD-WAN Controllers in AWS](#), on page 335
- [Deploy Cisco SD-WAN Controllers in AWS: Tasks](#), on page 335
- [Verify the Deployment of Cisco SD-WAN Controllers in AWS](#), on page 339
- [Monitor the Deployment of Cisco Catalyst SD-WAN Controller in AWS](#), on page 340

## Information About Deploying Cisco SD-WAN Controllers in AWS

Minimum supported controller images: Cisco vManage Release 20.6.1, Cisco vSmart controller Release 20.6.1, and Cisco vBond orchestrator Release 20.6.1.

You can deploy the following Cisco SD-WAN Controllers in an Amazon Web Services (AWS) environment using Amazon Machine Images (AMI): Cisco SD-WAN Manager, Cisco SD-WAN Controller, and Cisco SD-WAN Validator.

The AMI images that Cisco provides to you are for your use only. Do not share them with others. You can do the following:

- You can deploy the number of controllers as per your order quantity. For example, if you have ordered 50 Cisco SD-WAN Manager controller PIDs, then you can deploy only 50 Cisco SD-WAN Manager controllers within your AWS account.
- You can copy the AMI between regions and your own separate AWS accounts, if you do not exceed the quantity of PIDs ordered.
- After the initial deployment of the controllers, you are responsible for any upgrades or downgrades.

The following illustration shows the architecture of the AWS region, virtual private cloud (VPC), security group, and so on, and it shows where the Cisco SD-WAN Controllers function within the architecture.

**Figure 30: Cisco SD-WAN Controllers in AWS**

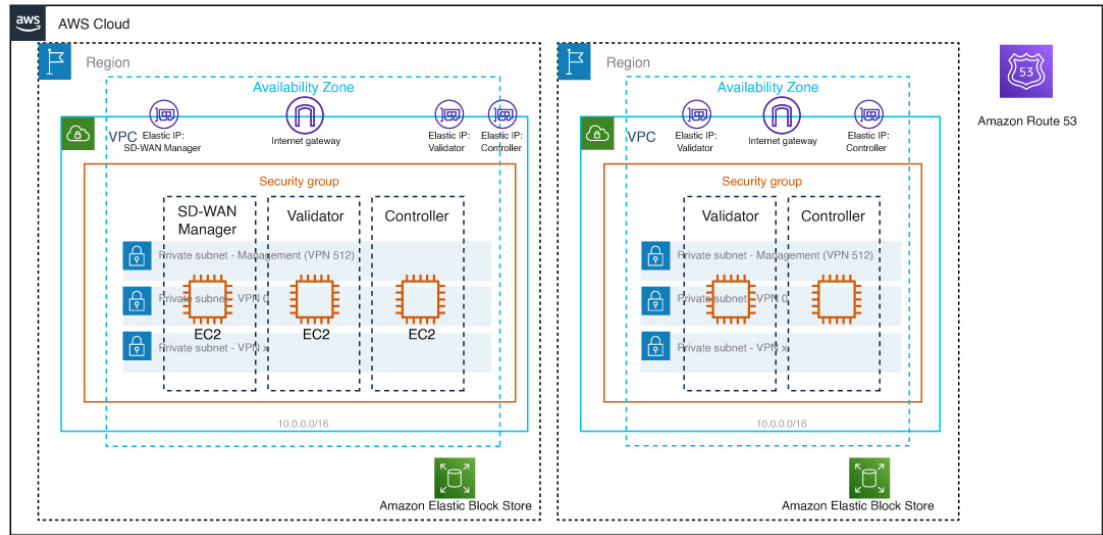

### Considerations Before Installing Cisco SD-WAN Controllers in AWS

- Cisco Catalyst SD-WAN controller AMIs are not available on the Cisco software download site or AWS marketplace. They are provided only when you request them with a valid business case to set up Cisco SD-WAN Controllers in your AWS cloud account.
- For information about ordering Cisco SD-WAN Controllers to use with AWS, contact your Cisco account team or Cisco partner.
- Cisco does not provide support for any issues that arise with the cloud infrastructure during the provisioning or installation of the controllers.
- Troubleshooting:
  - Functionality issues: Please open a Cisco TAC case for functionality issues.
  - Infrastructure issues: You are responsible for infrastructure management, monitoring, and troubleshooting. After the controllers are provisioned and running in your cloud account, Cisco does not provide support for cloud infrastructure-related issues.
- Software upgrade: Controller software upgrade doesn't require AMI images. You can download the controller images from the Cisco software download site and upgrade the controller software as described in the [Manage Software Upgrade and Repository](#) chapter of the *Cisco Catalyst SD-WAN Monitor and Maintain Configuration Guide*.

## Benefits of Deploying Cisco SD-WAN Controllers in AWS

- Set-up cost: Low initial set-up cost, as compared with on-premises hosting, as there is no requirement to purchase additional data center infrastructure.

- **Deployment:** Ease of cloud-based deployment.
- **Management:** Ability to manage devices worldwide.
- **Stability:** Because of its reliability, AWS hosting provides a stable environment for Cisco SD-WAN Controllers.
- **Security:** AWS provides a secure hosting environment.
- **Scaling:** AWS provides an easy path to increase the scale of your Cisco Catalyst SD-WAN network.

## Prerequisites for Deploying Cisco SD-WAN Controllers in AWS

- You must have valid (and active) AWS and Cisco accounts.
- Contact your Cisco account team for PID information for ordering the appropriate controller PID for your cloud deployment.

## Use Cases for Deploying Cisco SD-WAN Controllers in AWS

- **Use case 1:** For complete control of provisioning, management and monitoring of controllers and scalability using your own public cloud account.
- **Use case 2:** For specific architectural or security posture requirements.

## Deploy Cisco SD-WAN Controllers in AWS: Tasks



---

**Note** The procedures described here apply to the three types of Cisco SD-WAN Controllers—Cisco SD-WAN Manager, Cisco SD-WAN Controller, and Cisco SD-WAN Validator. We indicate the difference in the instructions for specific controllers wherever applicable.

---

### Task 1: Request AWS AMI Images

You can deploy Cisco SD-WAN Controllers in an AWS account using AMI images.

1. You must place an order for \$0 customer managed Cisco Catalyst SD-WAN Controller SKU. For more information, refer section 2.3 SKU Table in the [Cisco Catalyst SD-WAN Controller Ordering Guide](#).
2. After you purchase the SKU, the Cisco CloudOps team validates the order information, and reach out to the customer asking for additional details such as:
  - a. AWS account number.
  - b. Software version requirement for the AMI.

3. Cisco CloudOps team verifies the information and shares the requested AMIs to your AMI inventory in the US-WEST-2 region.



---

**Note** The AMI images that the CloudOps team provides are for your use only. Do not share them with others. If the images are shared with others, Cisco reserves the right to remove the images and take any necessary action to prevent the images from being shared.

---

## Task 2: Create a VPC, Subnet, and Security Group in AWS



---

**Note** For definitive information about tasks in AWS, see the AWS documentation.

---

Perform the following steps in the AWS portal:

1. Create a virtual private cloud (VPC), and while creating the VPC ensure that you complete the following actions:

- Enter a name and a region for the VPC.
- Enter an address space for the VPC. Example: 10.0.0.0/16
- Add a minimum of two subnets to the VPC, and an additional subnet if you plan to create a Cisco SD-WAN Manager cluster. For each subnet, provide a name and an address space for the subnet. A later step associates these subnets with virtual machine network interfaces.

Example:

- Add subnet 0 with the address 10.0.1.0/24, which will be VPN 512 used as the primary interface for the controllers.
  - Add subnet 1 with the address 10.0.2.0/24, which will be used as the controllers' transport or tunnel interface for VPN 0.
  - Add subnet 2 with the address 10.0.3.0/24, which will be for used for Cisco SD-WAN Manager clustering (only if you are needed in case of deploying a Cisco SD-WAN Manager cluster).
- (Optional) Enter a tag to categorize the VPC.
2. Create the necessary resources required for the VPC, to form the environment for running the controller instances:
    - The security group must contain the following:
      - Source public IP address of the user NOC center to access the controllers for management purpose.
      - Address 0.0.0.0/0 for all TCP/UDP ports for TLS/DTLS for all edges to join the controllers.
      - Enable public IPs each controller to reach other controllers.
    - Enter a name and a region for the security group.

- (Optional) Enter a tag to categorize the security group.
3. Associate the newly created security group with the subnets created in Step 1.
  4. Create an internet gateway and associate it with the VPC.
  5. Create a routing table and associate it with the VPC. Add a default route entry pointing to the internet gateway.

## Task 3: Create a Virtual Machine for the Controller



---

**Note** For definitive information about tasks in AWS, see the AWS documentation.

---

Perform the following steps in the AWS portal:

1. Begin the workflow for creating a virtual machine. When creating a virtual machine, ensure that you complete the following actions:
  - Deploy the virtual machine in the virtual private cloud (VPC) created in Task 2.
  - Enter a name and region for the virtual machine.
  - For the image, select the appropriate shared controller AMI for Cisco SD-WAN Manager or Cisco SD-WAN Validator or Cisco SD-WAN Controller.



---

**Note** For information about how to locate custom images, see the AWS documentation.

---

- For the virtual machine size, select an option with the number of CPUs and memory that you want to use for the controller. For Cisco SD-WAN Controller-device compatibility and Cisco SD-WAN Controller server requirements, see [Cisco SD-WAN Controller Compatibility Matrix and Server Recommendations](#).
  - Choose an authentication type (for example, SSH public key, or password) and provide the credentials, as required.
  - For disk resources, perform one of the following:
    - If you are deploying a Cisco SD-WAN Controller or a Cisco SD-WAN Validator, no additional disk resources are required beyond the default.
    - If you are deploying a Cisco SD-WAN Manager controller, choose one disk.
      - Choose the Premium SSD option and default encryption.
      - Choose a disk size of 1 TB (General Purpose SSD gp2) or larger.
- For server recommendations relevant to controllers in AWS, see [Cisco SD-WAN Controller Compatibility Matrix and Server Recommendations](#).
- Configure the disk host caching as read/write.

- For networking details, choose the VPC, the subnets, and the security group that you created in earlier steps. Each virtual machine must have two network interfaces, one for the VPN 512 management subnet and one for the VPN 0 tunnel subnet.
  - Assign an Elastic IP address to the VPN 0 and VPN 512 network interfaces of each controller.
  - (Optional) Enable advanced boot diagnostics (a management option) to create an additional storage account in the resource group for storing diagnostics logs.
  - For Cisco SD-WAN Controller Release 20.6.1 and later, you can optionally use the custom data feature to enter commands for the virtual machine to execute when rebooting.
  - (Optional) Add a tag to categorize the controller.
2. After creating the virtual machine, create additional network interfaces (NICs) for the virtual machine. Create the network interfaces in the resource group that you created in an earlier task.
    - If you are deploying a Cisco SD-WAN Controller or Cisco SD-WAN Validator, create one additional network interface.
    - If you are deploying a Cisco SD-WAN Manager controller, create two additional network interfaces.
    - If you are deploying a Cisco SD-WAN Manager controller in a cluster, see [Cluster Management](#) and [Deploy Cisco SD-WAN Manager](#) for additional information about Cisco SD-WAN Manager out-of-band interfaces.
  3. When creating a network interface, ensure that you complete the following actions:
    - Specify the VPC, subnets, and the security group created in Task 2.
    - Associate NICs with subnets.  
Example: Associate NIC 1 with subnet 1.
      - If you are deploying a Cisco SD-WAN Manager controller, associate NIC 2 with subnet 2.
      - If you are using a Cisco SD-WAN Manager cluster, associate NIC 3 with subnet 3.



---

**Note** Associating a NIC with a subnet enables the virtual machine to connect to the subnet.

---

- For each NIC, enter the tag used for the controller that you are deploying.

4. Create a static public IP for all the controllers to use, and associate this public IP with NIC 1.



---

**Note** Use the IP configuration option in AWS to create the public IP.

---

5. When creating a public IP, ensure that you complete the following actions:
  - For assignment, choose static.
  - Use the associate option to specify NIC 1.



6. Stop the virtual machine, and confirm when it has stopped.
7. Attach the newly created NICs to the virtual machine.
  - If you are deploying a Cisco SD-WAN Controller or Cisco SD-WAN Validator, attach the NIC to the virtual machine.
  - If you are deploying Cisco SD-WAN Manager, attach both of the newly created NICs to the virtual machine.
8. Restart the virtual machine. Confirm in the AWS portal that the virtual machine has restarted.

## Task 4: Configure the Security Group

### Before You Begin

The security group is functionally related to a firewall policy. When configuring the security group, it is helpful to be aware of firewall port configuration in Cisco Catalyst SD-WAN. See [Firewall Ports for Cisco SD-WAN Deployments](#).



---

**Note** For definitive information about tasks in AWS, see the AWS documentation.

---

### Configure the Security Group

1. Using the AWS portal, add inbound security rules to the security group created in an earlier task, to allow inbound traffic from the IP range required for the following:
  - Establishing control connections between each of the Cisco SD-WAN Controllers. If the controllers lack connectivity to each other, the control plane and the data plane cannot operate.
  - Accessing the controllers using HTTPS or SSH protocols.
2. For the security group, use the option to add inbound security rules. Using the rules, allow all the controller virtual machine IP addresses, to enable the required connectivity between the Cisco SD-WAN Controllers.

When creating a new inbound security rule, ensure that you complete the following actions:

  - Specify IP ranges, protocol, and so on.
  - For the action of the rule, choose the option to allow the traffic.
3. To verify the connectivity, log in to the virtual machine using the NIC 0 public IP of Cisco SD-WAN Manager.

## Verify the Deployment of Cisco SD-WAN Controllers in AWS

- Infrastructure: To verify the deployment of Cisco SD-WAN Controllers within virtual machines in AWS, use the AWS portal to check if the virtual machines hosting each controller are active.

- Services: To verify that Cisco Catalyst SD-WAN services are operating after deployment of the controllers, use the following steps:
  1. Check for a successful ping to the virtual machine that hosts Cisco SD-WAN Manager.
  2. Log in to the controller instance using AWS console with user as admin. You may be prompted to configure a new password. Once configured, verify login via SSH to the public IP of the controller.
  3. Use SSH to connect to Cisco SD-WAN Manager, and use the **request nms all status** command. The output shows the status of all the Cisco SD-WAN Manager services. Confirm that the application server is active.

The following excerpt of the **request nms all status** command output shows that the application server is active:

```
vmanage# request nms all status
NMS service proxy
    Enabled: true
    Status: running PID:2881 for 9479s
NMS service proxy rate limit
    Enabled: true
    Status: running PID:4359 for 9521s
NMS application server
    Enabled: true
    Status: running PID:6131 for 9419s
...
```

4. After installing the controllers, follow the steps in [Cisco SD-WAN Overlay Network Bring-Up Process](#) to establish the control connections for the controllers and to verify that each controller is operational.

## Monitor the Deployment of Cisco Catalyst SD-WAN Controller in AWS

To monitor the infrastructure status, such as CPU usage and disk usage, use the monitoring tools in the AWS portal.

For information about monitoring the status of Cisco Catalyst SD-WAN services, see the [Cisco Catalyst SD-WAN Monitor and Maintain guide](#).



# CHAPTER 15

## Troubleshoot Cisco Catalyst SD-WAN Solution

- [Overview](#), on page 341
- [Support Articles](#), on page 341
- [Feedback Request](#), on page 343
- [Disclaimer and Caution](#), on page 343

### Overview

This chapter provides links to documents authored by Cisco subject matter experts (SMEs). They aim to help you resolve technical issues without requiring a support ticket. If these documents are unable to resolve your issue, we recommend visiting the applicable [Cisco Community](#). There is a wealth of information and advice available from fellow Cisco customers who may have experienced this issue already and provided a solution. If you are not able to find a resolution on the Community, it may be best that you raise a support ticket at [Cisco Support](#). In cases where a support ticket has to be raised, these documents provide guidance about the data that should be collected and added to the support ticket. Specify the support document you referred, and TAC can create an improvement request with the document owner.

### Support Articles

The documents in this section were created using specific software and hardware listed in the Components Used section of each article. However, this does not mean that they are limited to what is listed in Components Used, and generally remain relevant for later versions of software and hardware. Note that there could be some changes in the software or hardware that can cause commands to stop working, the syntax to change, or GUIs and CLIs to look different from one release to another.

The following are the support articles associated with this technology:

Document	Description
<a href="#">Activate Debugs in vManage</a>	This video provides the steps to activate debugs in Cisco Catalyst SD-WAN Manager
<a href="#">Cisco Catalyst SD-WAN Control Traffic Overhead User Guide</a>	This document describes how to calculate control traffic overhead on an SD-WAN overlay deployment.
<a href="#">Collect an Admin-Tech in SDWAN Environment and Upload to TAC Case</a>	This document describes how to initiate an <code>admin-tech</code> in a Cisco Catalyst SD-WAN environment.

Document	Description
<a href="#">Configure Basic Parameters to Form Control Connections on cEdge</a>	This document describes the basic configuration and correct commit order to onboard a cEdge to a Software-Defined Wide Area Network (SD-WAN) overlay.
<a href="#">Configure HSECK9 License on cEdge SD-WAN XE</a>	This document describes how to install and troubleshoot HSECK9 licenses on SD-WAN XE cEdges.
<a href="#">Configure SD-AVC on Cisco Catalyst SD-WAN</a>	This document describes how to configure Software Defined-Application Visibility and Control (SD-AVC) on a Software-Defined Wide Area Network (SD-WAN).
<a href="#">Deploy a CSR1000v/C8000v on Google Cloud Platform</a>	This document describes the procedure to deploy and configure a Cisco Cloud Services Router 1000v (CSR1000v) and Catalyst 8000v (C800v) Edge Router on Google Cloud Platform (GCP).
<a href="#">How To Generate Self-Signed Web Certificate For Cisco Catalyst SD-WAN Manager</a>	This document describes how to generate and install a self-signed web certificate when the existing one is expired on an on-prem Cisco SD-WAN Manager. Cisco does not sign web certificates for such deployments, customers have to sign it by own Certificate Authority (CA) or some third-party CA.
<a href="#">HSEC License FAQs for Cisco Catalyst SD-WAN</a>	This document describes a few queries about the HSEC license for the autonomous and SD-WAN modes.
<a href="#">Manual Certificate Renewal on SD-WAN Controller</a>	This video provides the steps to get controllers certificates renewal.
<a href="#">Modifying "Statistics Configuration &gt; Collection Interval" in a vManage Cluster</a>	This document describes the process of modifying the <b>Statistics Configuration &gt; Collection Interval</b> in a vManage cluster.
<a href="#">Quick Start Guide - Data Collection for Various Cisco Catalyst SD-WAN Issues</a>	This document describes several SD-WAN issues along relevant data that must be collected in advance before you open a TAC case to improve the speed of troubleshooting and/or problem resolution. This document is broken up into two main technical sections: Cisco SD-WAN Manager and Edge routers. Relevant outputs and command syntax are provided dependent upon the device in question.
<a href="#">Replace a cEdge RMA Router</a>	This document describes how to replace a failed cEdge unit with another one. This consists of a copy of the configuration from the failed router to the replacement router, the removal of this cEdge, and the addition of the new router into the network. This process is similar to vEdge replacement however, the copy option is missed in Cisco SD-WAN Manager for cEdges.

Document	Description
<a href="#">Transfer Files between a cEdge and Cisco Catalyst SD-WAN Manager</a>	This document describes how to transfer files between a remote cEdge and a local Cisco SD-WAN Manager through CLI.
<a href="#">Transfer Files between a vEdge and Cisco Catalyst SD-WAN Manager</a>	This document describes how to transfer files between a remote vEdge and a local Cisco SD-WAN Manager through CLI.
<a href="#">Troubleshoot IOS XE SD-WAN Upgrade Failure: Insufficient Space</a>	This document describes the process to diagnose and resolve the issue when a Cisco IOS XE Catalyst SD-WAN upgrade fails due to insufficient storage capacity.
<a href="#">Understand the Web Certificate For Cisco Catalyst SD-WAN Manager</a>	This document describes the difference between the Web Certificate and the Controller Certificates on the Cisco Catalyst SD-WAN solution. This document also explains in detail the Web Certificate and clarifies the use between these two types of certificates.
<a href="#">Upgrade Cisco Catalyst SD-WAN cEdge Router with the Use of CLI or Cisco Catalyst SD-WAN Manager</a>	This document describes the process to upgrade or downgrade an SD-WAN cEdge (Cisco Edge) router in Controller mode from the Command Line (CLI) and from Cisco SD-WAN Manager.
<a href="#">Verify APIs Used by vManage to Gather Statistics</a>	This document describes how to get a specific API call used by Cisco Catalyst SD-WAN Manager to gather statistics from the overlay.

## Feedback Request

Your input helps. A key aspect to improving these support documents is customer feedback. Note that these documents are owned and maintained by multiple teams within Cisco. If you find an issue specific to the document (unclear, confusing, information missing, etc):

- Provide feedback using the **Feedback** button located at the right panel of the corresponding article. The document owner will be notified, and will either update the article, or flag it for removal.
- Include information regarding the section, area, or issue you had with the document and what could be improved. Provide as much detail as possible.

## Disclaimer and Caution

The information in this document was created from the devices in a specific lab environment. All of the devices used in this document started with a cleared (default) configuration. If your network is live, ensure that you understand the potential impact of any command.





## CHAPTER 16

# Appendix: Cisco Catalyst SD-WAN Manager How-Tos

---

- [RESTful API for Cisco Catalyst SD-WAN Manager, on page 345](#)
- [Replace a vEdge Router, on page 347](#)
- [Replace a Cisco IOS XE Catalyst SD-WAN Device, on page 349](#)
- [Using Cisco Catalyst SD-WAN Manager on Different Servers, on page 352](#)
- [Log In to the Cisco Catalyst SD-WAN Manager Web Application Server, on page 353](#)

## RESTful API for Cisco Catalyst SD-WAN Manager

The Cisco SD-WAN Manager supports RESTful (Representational State Transfer) API, which provides calls for retrieving real-time and static information about the Cisco Catalyst SD-WAN overlay network and the devices in the network and for uploading device configuration templates and other configuration-related information. Using the RESTful API, you can design a custom portal for interacting with Cisco SD-WAN Manager.

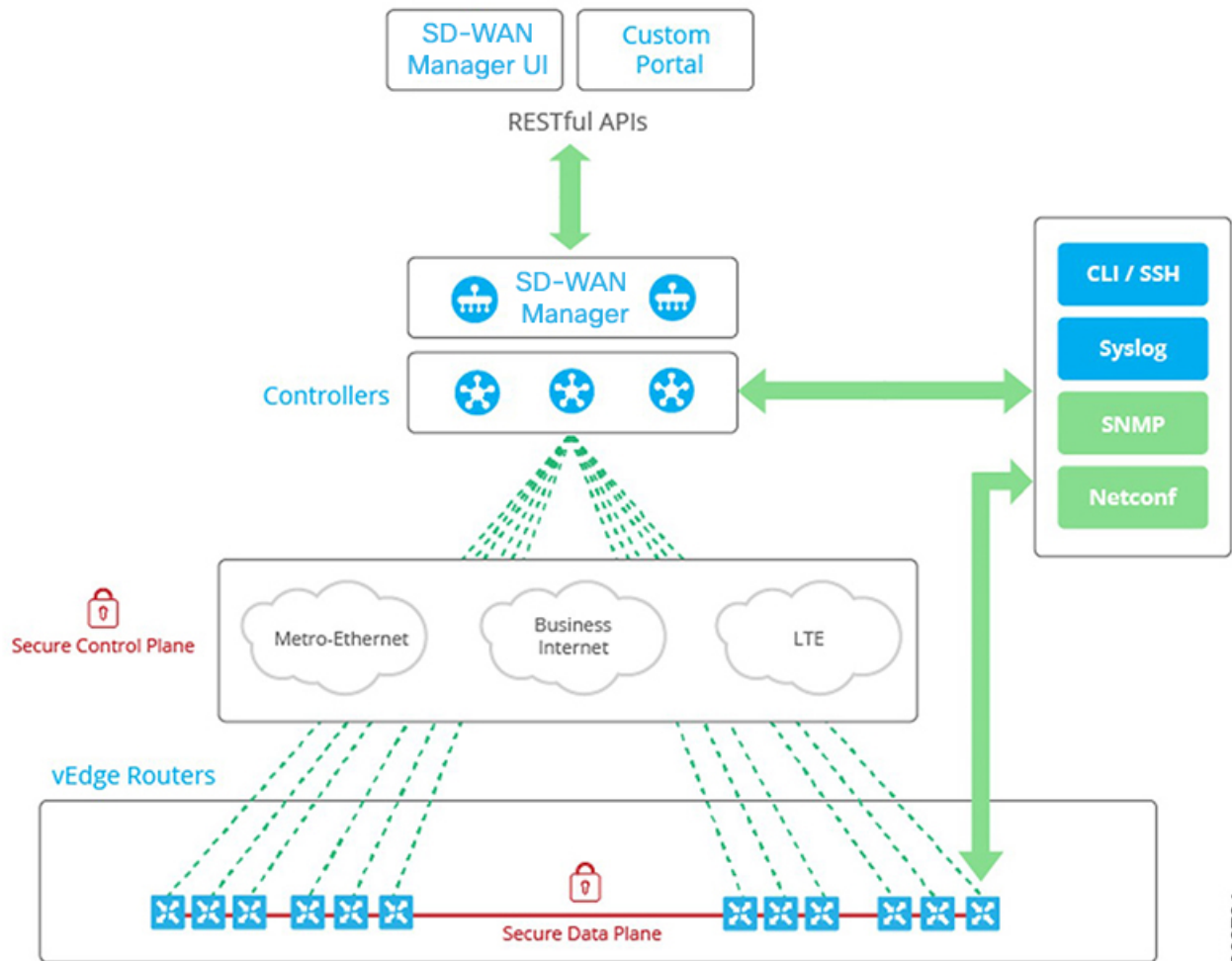

368734

The Cisco SD-WAN Manager API documentation is provided as part of the Cisco SD-WAN Manager software, at the URL <https://vmanage-ip-address/apidocs>. (More accurately, the full URL includes the Cisco SD-WAN Manager port number, <https://vmanage-ip-address:8443/apidocs>.) *vmanage-ip-address* is the IP address of the Cisco SD-WAN Manager server.

API calls are provided for the following categories of operations:

- Certificate Management
- Configuration
- Device and Device Inventory
- Monitoring
- Real-Time Monitoring
- Troubleshooting Tools

NAT configuration using REST APIs is not supported.





**Note** Starting from Cisco SD-WAN Release 20.6.1, Cisco SD-WAN Manager supports below API limits:

- API Rate-limit: 100/second
- Bulk API Rate-limit: 48/minute

Real-time monitoring of APIs is CPU intensive and should be used for troubleshooting purposes only. They should not be used continuously for active monitoring of the devices.

For each group of API calls, click **Show/Hide** to list the individual calls and the URL for each call. Each call shows its response class, required parameters, and response messages (status codes).

Click **Try It Out**, to display the request URL for each API call and the format of the response body. The request URL consists of the Cisco SD-WAN Manager's URL, followed by /dataservice. For example, <https://10.0.1.32:8443/dataservice/device/interface/statistics/ge0/0?deviceId=172.16.255.11>

Below are a few examples of the URLs to use for API calls:

**Table 45:**

Requested Information	API Call
List all network devices	dataservice/device
Health status of hardware device components, such as CPU, memory, fan, and power	dataservice/device/hardware/environment?deviceId= <i>system-ip-address</i>
Status of a device's transport interfaces	dataservice/device/interface?deviceId= <i>system-ip-address</i> &port-type=transport
Interface statistics, errors, and packet drops	dataservice/device/interface?deviceId= <i>system-ip-address</i>
DTLS/TLS control connection status	dataservice/device/control/connections?deviceId= <i>system-ip-address</i>
OMP peering	dataservice/device/omp/peers?deviceId= <i>system-ip-address</i>
BGP peering on the service side	dataservice/device/bgp/neighbors?deviceId= <i>system-ip-address</i>

## Replace a vEdge Router

This section describes how to replace a vEdge router at a particular location. You might do this when a vEdge router has failed completely or when a component in a router, such as one of the power supplies, has failed, and you want to replace the entire router.

At a high level, to replace one vEdge router with another, you simply copy the configuration from the router you are removing to the new router and then put the new router into the network.

Before you can replace the vEdge router in Cisco SD-WAN Manager, Cisco SD-WAN Manager must have learned the chassis number and serial number of the replacement vEdge router.

- If the replacement vEdge router is a router that you have previously received, such as a router that part of your spares inventory, Cisco SD-WAN Manager will have already learned the router's chassis and serial number when you previously uploaded the serial number file to Cisco SD-WAN Manager.
- If you initiated an RMA process and have received a new router as a replacement, you need to upload the updated version of the authorized vEdge serial number file to Cisco SD-WAN Manager.

To replace a failed router using Cisco SD-WAN Manager, perform the following steps:

1. Copy the configuration from the failed router to the replacement router.
2. Invalidate the failed router. Invalidating a router deactivates its certificate and thus removes it from the overlay network.
3. Validate the replacement router, to activate its certificate.

The new router is a complete replacement for the failed router, its configuration is identical to that of the failed router. (Remember, though, that each router has a unique chassis number and a unique serial number in its certificate.) After you copy the configuration from the failed router to the replacement, both routers have the same configurations, including the same IP address. Two routers with the same IP address cannot be present in the network at the same time, one router must be in valid state on Cisco SD-WAN Manager and the other must be in invalid state—or both routers must be in invalid state.

### Before You Begin

Ensure that you have uploaded the authorized serial number file to Cisco SD-WAN Manager.

### Copy the Configuration from the Failed to the Replacement Router

From Cisco SD-WAN Manager, you copy the configuration from the failed vEdge router to the replacement router.

The vEdge router that you are copying the configuration from can be a device that is active in the overlay network (that is, it is in a valid state) or it can be one that is inactive (that is, it is in invalid state). For example, if you are replacing a router in which one of the two power supplies has failed, the router might still be active in the network, but if you are replacing one that has failed completely, you might have already marked it as invalid to remove it from the network.

The vEdge router that you are copying the configuration to must be in invalid state.

To view the state of a vEdge router or to change the validity state, see [Validate or Invalidate a vEdge Router](#).

To copy the configuration from the failed router to the replacement router:

1. From the Cisco SD-WAN Manager menu, choose **Configuration > Devices**.
2. For the failed router, click ... and choose **Copy Configuration**.
3. In the **Copy Configuration** window, choose the replacement router.
4. Click **Update**.

### Remove the Failed Router

1. From the Cisco SD-WAN Manager menu, choose **Configuration > Certificates**.
2. For the failed router, in the **Validate** column, click **Invalid**.
3. Click **OK** to confirm invalidation of the device.
4. Click **Send to Controllers**.

### Add the Replacement Router

1. From the Cisco SD-WAN Manager menu, choose **Configuration > Certificates**.
2. For the replacement router, in the **Validate** column, click **Valid**.
3. Click **OK** to confirm validation of the device.
4. Click **Send to Controllers**.

If you attempt to validate a router that has the same IP address as another router in the network, an error message is displayed, and the validation process is terminated.

### Release Information

Introduced in Cisco SD-WAN Manager in Release 15.4.

## Replace a Cisco IOS XE Catalyst SD-WAN Device

You might replace a Cisco IOS XE Catalyst SD-WAN device if the device has failed completely or when a component of the device, such as one of the power supplies, has failed.

In general terms, to replace one Cisco IOS XE Catalyst SD-WAN device with another, copy the configuration from the device that you are removing to the new device and then add the new device into the network.

### A. Copy the configuration from the device that you are replacing

1. From the Cisco SD-WAN Manager menu, choose **Configuration > Devices**.
2. In the list of devices, locate the device to be replaced. In the row of the device, click **...** and choose **Running Configuration**.



---

**Note** If Cisco SD-WAN Manager cannot reach the device, skip to step 4 for instructions on logging in to the device directly to copy the configuration information.

---

3. Copy the text of the configuration and paste it into a text editor.

The configuration information is useful especially if you choose the manual deployment method for onboarding the new replacement device.

4. If the device is not reachable by Cisco SD-WAN Manager, log in to the device directly and use the following commands on the device to display the configuration information. Copy the configuration information from the output.

- Display the running configuration and save the output to a text file.
 

```
show running-config | redirect bootflash:sdwan/ios.cli
```
- Display the SD-WAN running configuration and save the output to a text file.
 

```
show sdwan running-config | redirect bootflash:sdwan/sdwan.cli
```

## B. Remove the device from the overlay network

1. From the Cisco SD-WAN Manager menu, choose **Configuration > Certificates**.
2. In the list of devices, locate the device to be replaced. In the row of the device, in the **Validate** column, click **Invalid**, then **OK**.



---

**Note** This step causes any control connections to the device to be lost.

---

3. Click **Send to Controllers**.
4. From the Cisco SD-WAN Manager menu, choose **Configuration > Devices**.
5. In the list of devices, locate the device to be replaced. In the row of the device, click **...** and choose **Delete WAN Edge**.

## C. Add the replacement device to the Cisco SD-WAN Manager inventory

1. Obtain the chassis number and serial number of the replacement device.



---

**Note** You can use the **show sdwan certificate serial** command on the device to display this information.

---

2. Add the new device to the inventory using one of the methods described in the [Cisco Catalyst SD-WAN Getting Started Guide](#).



---

**Note** The methods for adding a new device to the inventory are relevant to onboarding devices in general. They are not unique to replacing a device.

---

## D. Apply a device template to the new device, using the same device template that was applied to the device that is being replaced

1. From the Cisco SD-WAN Manager menu, choose **Configuration > Templates**.
2. In the row for the template that was used for the device being replaced, click **...** and choose **Export CSV**. The CSV file shows the parameters for each device to which the template is attached.
3. Review the exported CSV file.
  - If the new device is identical to the device being replaced, you do not need to update any of the parameters in the CSV file.

- If the new device is not identical to the device being replaced, then optionally, you can update parameter values in the CSV file to match the new device, as required. For example, if the replacement device uses a different interface numbering, as compared with the device being replaced, you can update the parameter that specifies interface numbering.

4. To attach the template to the replacement device, do the following:
  - a. From the Cisco SD-WAN Manager menu, choose **Configuration > Templates**.
  - b. Click **Device Templates**.



---

**Note** In Cisco vManage Release 20.7.x and earlier releases, **Device Templates** is called **Device**.

---

- c. In the row for the template that was used for the device being replaced, click **...** and choose **Attach Devices**.
- d. In the **Attach Devices** window, move the replacement device to the **Selected Devices** pane and click **Attach**.
- e. Optionally, you can update parameters in the template before applying it to the device, using one of the following methods:
  - In the row of the replacement device, click **...** and choose **Edit Device Template**. Edit any parameters, as needed.
  - Upload the CSV file that you downloaded and edited to update the parameters for the replacement device. To upload the CSV file, click **Upload** (up arrow button) and navigate to the CSV file.

### E. Onboard the new device

Use one of the following methods to onboard the new device.



---

**Note** The methods for onboarding a new device to the inventory are relevant to onboarding devices in general. They are not unique to replacing a device.

---

- Plug and Play (PnP)

For information, see the [Plug and Play Onboarding Workflow](#) section of the [Cisco Catalyst SD-WAN Getting Started Guide](#), and see the [Cisco Catalyst SD-WAN: WAN Edge Onboarding](#) guide.

- Bootstrap

For information, see the [Non-PnP Onboarding](#) section of the [Cisco Catalyst SD-WAN Getting Started Guide](#), and see the bootstrap deployment section of the [Cisco Catalyst SD-WAN: WAN Edge Onboarding](#) guide.

- Manual deployment



---

**Note** To configure the new device, you can use the configuration files that you saved earlier in part A.

---



---

**Note** The manual deployment method requires installing a root certificate authority (CA) for the new device.

---

For information, see the [Cisco Catalyst SD-WAN: WAN Edge Onboarding](#) guide.

For information about installing a root CA, see the [Enterprise Certificates](#) section of the [Cisco Catalyst SD-WAN Getting Started Guide](#).

## Using Cisco Catalyst SD-WAN Manager on Different Servers

- . You can perform the following operations in parallel from one or more Cisco SD-WAN Manager servers:
  - From the Cisco SD-WAN Manager menu, select **Maintenance** > **Software Upgrade** to do the following:
    - Upgrade the software image on a device.
    - Activate a software image on a device.
    - Delete a software image from a device.
    - Set a software image to be the default image on a device.
  - From the Cisco SD-WAN Manager menu, select **Maintenance** > **Device Reboot** to reboot a device.
  - From the Cisco SD-WAN Manager menu, select **Configuration** > **Templates** to manage templates:
    - Attach devices to a device template.
    - Detach devices from a device template.
    - Change the variable values for a device template that has devices attached to it.

For template operations, the following rules apply:

- When a device template is already attached to a device, you can modify one of its feature templates. When you click **Update** > **Configure Devices**, all other template operations—including attach devices, detach devices, and edit device values—are locked on all Cisco SD-WAN Manager servers until the update operation completes. This means that a user on another Cisco SD-WAN Manager server cannot perform any template operations until the update completes.
- You can perform the attach and detach device template operations on different devices, from one or more Cisco SD-WAN Manager servers, at the same time. However, if any one of these operations is in progress on one Cisco SD-WAN Manager server, you cannot edit any feature templates on any of the servers until the attach or detach operation completes.

# Log In to the Cisco Catalyst SD-WAN Manager Web Application Server

The Cisco SD-WAN Manager runs as a web application server through which you log in to a running Cisco SD-WAN Manager.

In an overlay network with a single Cisco SD-WAN Manager, to log in to the server, use HTTPS, and specify the IP address of the server. Enter a URL in the format `https://ip-address:8443`, where 8443 is the port number used by Cisco SD-WAN Manager. On the login page, enter a valid username and password, and then click **Log In**. You have five chances to enter the correct password. After the fifth incorrect attempt, you are locked out of the device, and you must wait for 15 minutes before attempting to log in again.

In an overlay network that has a cluster of Cisco SD-WAN Managers, the cluster allows you to log in to one of the Cisco SD-WAN Managers that is operating in the role of a web application server. Use HTTPS, specifying the IP address of one of the Cisco SD-WAN Managers, in the format `https://ip-address:8443`. The cluster software load-balances login sessions among the individual Cisco SD-WAN Managers that are acting as web application servers. You cannot control which of the individual Cisco SD-WAN Managers you log in to.

With a Cisco SD-WAN Manager cluster, if you enter invalid login credentials, it might take some time for you to see an invalid login error message, and the amount of time increases as the size of the cluster increases. This delay happens because each Cisco SD-WAN Manager attempts sequentially to validate the credentials. If none of the Cisco SD-WAN Manager servers validate you, only then do you see an invalid login error message.

To determine which Cisco SD-WAN Manager you are logged in to, look in the Cisco SD-WAN Manager toolbar, which is located at the top of the screen. To view more information about this particular Cisco SD-WAN Manager server, enter the name of the server in the Search filter of the **Monitor > Devices**.

Cisco vManage Release 20.6.x and earlier: To determine which Cisco SD-WAN Manager you are logged in to, look in the Cisco SD-WAN Manager toolbar, which is located at the top of the screen. To view more information about this particular Cisco SD-WAN Manager server, enter the name of the server in the Search filter of the **Monitor > Network**.

