



# Line Cards and Physical Layer Interface Modules Overview

---

This chapter describes the modular services cards (MSCs), forwarding processor (FP) cards, label switch processor (LSP) cards, and associated physical layer interface modules (PLIMs) of the Cisco CRS 8-slot Line Card Chassis Enhanced router.

- [Line Cards and Physical Layer Interface Modules Overview, on page 1](#)

## Line Cards and Physical Layer Interface Modules Overview

This chapter describes the modular services cards (MSCs), forwarding processor (FP) cards, label switch processor (LSP) cards, and associated physical layer interface modules (PLIMs) of the Cisco CRS 8-slot Line Card Chassis Enhanced router. It includes the following topics:



---

**Note** For a complete list of line cards, route processors, SPAs and SIPs, and interface modules supported in the Cisco CRS 8-slot Line Card Chassis Enhanced router, see the [Cisco Carrier Routing System Data Sheets](http://www.cisco.com/en/US/products/ps5763/products_data_sheets_list.html) at: [http://www.cisco.com/en/US/products/ps5763/products\\_data\\_sheets\\_list.html](http://www.cisco.com/en/US/products/ps5763/products_data_sheets_list.html)

---

## Overview of Line Cards and Physical Layer Interface Modules

The MSC, FP, and LSP card, also called line cards, are the Layer 3 forwarding engine in the Cisco CRS 8-slot Line Card Chassis Enhanced router. Each line card is paired with a corresponding physical layer interface module (PLIM) that contains the packet interfaces for the line card. A line card can be paired with different types of PLIMs to provide a variety of packet interfaces, such as OC-192 POS and OC-48 POS.

- The MSC card is available in the following versions: CRS-MSC (end-of-sale), CRS-MSC-B, CRS-MSC-140G, and CRS-MSC-X / CRS-MSC-X-L (400G mode).
- The FP card is available in the following versions: CRS-FP140, CRS-FP-X/CRS-FP-X-L 400G mode).
- The LSP card is available in the following versions: CRS-LSP, CRS-LSP-X.



---

**Note** See [CRS Hardware Compatibility, page 1-14](#) for information about CRS fabric, MSC, and PLIM component compatibility.

---



**Note** The following MSC functional description is also generally applicable to the FP and LSP cards, unless noted otherwise.

Each line card and associated PLIM implement Layer 1 through Layer 3 functionality that consists of physical layer framers and optics, MAC framing and access control, and packet lookup and forwarding capability. The line cards deliver line-rate performance at line rate.

Line cards support several forwarding protocols, including IPV4, IPV6, and MPLS. Note that the route processor (RP) performs routing protocol functions and routing table distributions, while the line card actually forwards the data packets.

Line cards (MSCs, FPs, LSPs) and PLIMs are installed on opposite sides of the Cisco CRS 8-Slot Line Card Chassis Enhanced router, and mate through the Cisco CRS 8-Slot Line Card Chassis Enhanced router midplane. Each line card and PLIM pair is installed in corresponding chassis slots in the chassis (on opposite sides of the chassis).

The following figure shows how data enters the optical interfaces on the ingress PLIM and is passed to the ingress MSC. From there, data packets are converted to cells, and forwarded to the switch fabric, where the data cells are switched to the egress MSC and are reassembled into data packets and forwarded out the egress PLIM.

**Figure 1: MSCs, PLIMs, and Switch Fabric Diagram**

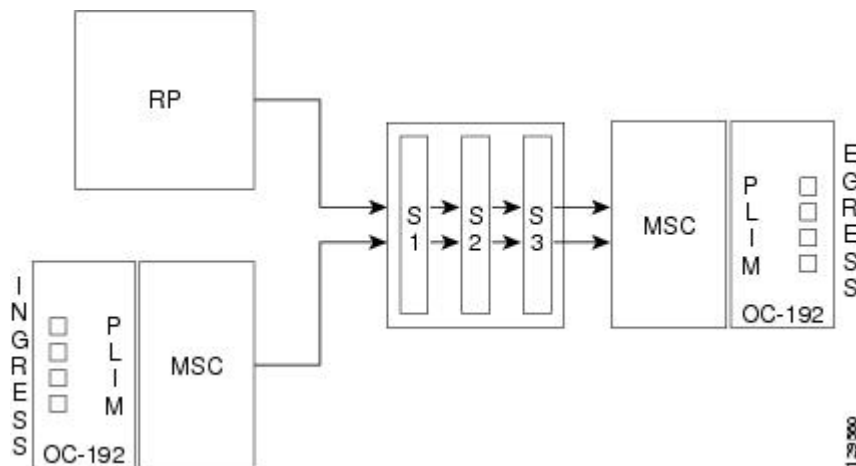

The PLIM provides the interface to user IP data. PLIMs perform Layer 1 and Layer 2 functions, such as framing, clock recovery, serialization and deserialization, channelization, and optical interfacing. Different PLIMs provide a range of optical interfaces, such as very-short-reach (VSR), intermediate-reach (IR), or long-reach (LR).

The line card receives the data from the PLIM and then, based upon the IP packet header, it will perform QoS functionality or other actions, such as the mapping of VLANs. And for ingress data, it will disassemble the packet into 36-byte fabric cells.

The following figure is a simple block diagram of the major components of an MSC/PLIM pair. These components are described in the following sections:

This diagram also applies to the FP and LSP line cards.

Figure 2: MSC and PLIM Simple Block Diagram

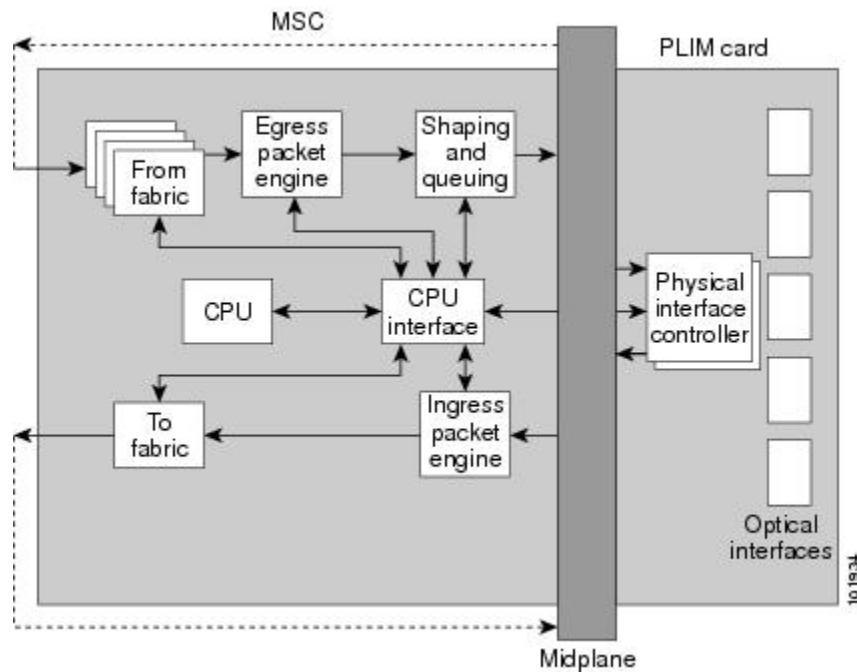

## PLIM Physical Interface Module On Ingress

As shown in [#con\\_1114973/fig\\_1134197](#), received data enters a PLIM from the physical optical interface. The data is routed to the physical interface controller, which provides the interface between the physical ports, and the Layer 3 function of the MSC. For receive (ingress) data, the physical interface controller performs the following functions:

- Multiplexes the physical ports and transfers them to the ingress packet engine through the Cisco CRS 8-Slot Line Card Chassis Enhanced router midplane.
- Buffers incoming data, if necessary, to accommodate back-pressure from the packet engine.
- A GE PLIM provides Gigabit Ethernet specific functions, such as:
  - VLAN accounting and filtering database
  - Mapping of VLAN subports

## MSC Ingress Packet Engine

The ingress packet engine performs packet processing on the received data. It makes the forwarding decision and places the data into a rate-shaping queue in the “to fabric” section of the board. To perform Layer 3 forwarding, the packet engine performs the following functions:

- Classifies packets by protocol type and parses the appropriate headers on which to do the forwarding lookup
- Determines the appropriate output interface to which to route the data
- Performs access control list filtering
- Maintains per-interface and per-protocol byte-and-packet statistics
- Maintains Netflow accounting
- Implements a flexible dual-bucket policing mechanism

## MSC To Fabric Section Queuing

The “to fabric” section of the board takes packets from the ingress packet engine, segments them into fabric cells, and distributes (sprays) the cells into the eight planes of the switch fabric. Because each MSC has multiple connections per plane, the “to fabric” section distributes the cells over the links within a fabric plane. The chassis midplane provides the path between the “to fabric” section and the switch fabric (as shown in [#con\\_1114973/fig\\_1143840](#) and [#con\\_1114973/fig\\_1134197](#)).

## MSC From Fabric Section

The “from fabric” section of the board receives cells from the switch fabric and reassembles the cells into IP packets. The section then places the IP packets in one of its 8K egress queues, which helps the section adjust for the speed variations between the switch fabric and the egress packet engine.

## MSC Egress Packet Engine

The transmit (egress) packet engine performs a lookup on the IP address or MPLS label of the egress packet. The egress packet engine performs transmit side features such as output committed access rate (CAR), access lists, diffServ policing, MAC layer encapsulation, and so on.

## Shaping and Queuing Function

The transmit packet engine sends the egress packet to the shaping and queuing function (shape and regulate queues function), which contains the output queues. Here the queues are mapped to ports and classes of service (CoS) within a port. Random early-detection algorithms perform active queue management to maintain low average queue occupancies and delays.

## PLIM Physical Interface Section On Egress

On the transmit (egress) path, the physical interface controller provides the interface between the MSC and the physical ports on the PLIM. For the egress path, the controller performs the following functions:

- Support for the physical ports.
- Queuing for the ports
- Back-pressure signalling for the queues
- Dynamically shared buffer memory for each queue
- A loopback function where transmitted data can be looped back to the receive side

## MSC CPU and CPU Interface

As shown in [#con\\_1114973/fig\\_1134197](#), the MSC contains a central processing unit (CPU) that performs the following functions:

- MSC configuration
- Management
- Protocol control

The CPU subsystem includes:

- A CPU chip
- A Layer 3 cache
- NVRAM
- A flash boot PROM

- A memory controller
- Memory, a dual in-line memory module (DIMM) socket, providing the following:
  - Up to 2 GB of 133 MHz DDR SDRAM on the CRS-MSC
  - Up to 2 GB of 166 MHz DDR SDRAM on the CRS-MSC-B
  - Up to 8GB of 533 MHz DDR2 SDRAM on the CRS-MSC-140G
  - Up to 15GB of 667 MHz DDR3 DIMM on the CRS-MSC-X

The CPU interface module, provides the interface between the CPU subsystem and the other ASICs on the MSC and PLIM.

The MSC also contains a service processor (SP) module that provides:

- MSC and PLIM power-up sequencing
- Reset sequencing
- JTAG configuration
- Power monitoring

The SP, CPU subsystem, and CPU interface work together to perform housekeeping, communication, and control plane functions for the MSC. The SP controls card power up, environmental monitoring, and Ethernet communication with the Cisco CRS 8-Slot Line Card Chassis Enhanced router RP cards. The CPU subsystem performs a number of control plane functions, including receipt of FIB downloads, local PLU and TLU management, statistics gathering and performance monitoring, and MSC ASIC management and fault-handling. The CPU interface drives high-speed communication ports to all ASICs on the MSC and PLIM. The CPU talks to the CPU interface through a high-speed bus attached to its memory controller.

## Line Card Physical Descriptions

[Figure 3: Modular Services Card, Original Version \(CRS-MSC\)](#) shows a Cisco CRS Carrier Routing System Modular Services Card (MSC). An MSC fits into any available MSC slot and connects directly to the midplane. Forwarding processor (FP) cards and label switch processor (LSP) cards are similar.

- The MSC card is available in the following versions: CRS-MSC (end-of-sale), CRS-MSC-B, CRS-MSC-140G, and CRS-MSC-X/ CRS-MSC-X-L (400G mode).
- The FP card is available in the following versions: CRS-FP140, CRS-FP-X/CRS-FP-X -L (400G mode).
- The LSP card is available in the following versions: CRS-LSP, CRS-LSP-X.



---

**Note** You must have CRS-8-FC140/S fabric cards installed in your system to use the CRS-MSC-140G, CRS-FP140, CRS-LSP, and 14-port and 20-port 10-GE XFP PLIMs.

---



---

**Note** The CRS-FP40 only supports the Cisco CRS 4-port 10-GE PLIM, Cisco CRS 42-port 1-GE PLIM, Cisco CRS 20-port 1-GE Flexible Interface Module, and 2x10GE WAN/LAN Flexible Interface Module.

---



---

**Note** See [CRS Hardware Compatibility, page 1-14](#) for information about CRS fabric, MSC, and PLIM component compatibility.

---

The power consumption of the line cards is:

- CRS-MSC (end-of-sale) = 375 W
- CRS-MSC-B = 300 W
- CRS-MSC-140G = 446 W
- CRS-MSC-X/CRS-MSC-X-L (400G) = 650 W
- CRS-FP40 = 270 W
- CRS-FP140 = 446 W
- CRS-FP-X/CRS-FP-X-L (400G) = 650 W
- CSR-LSP = 446 W
- CRS-LSP-X = 650 W

**Figure 3: Modular Services Card, Original Version (CRS-MSC)**

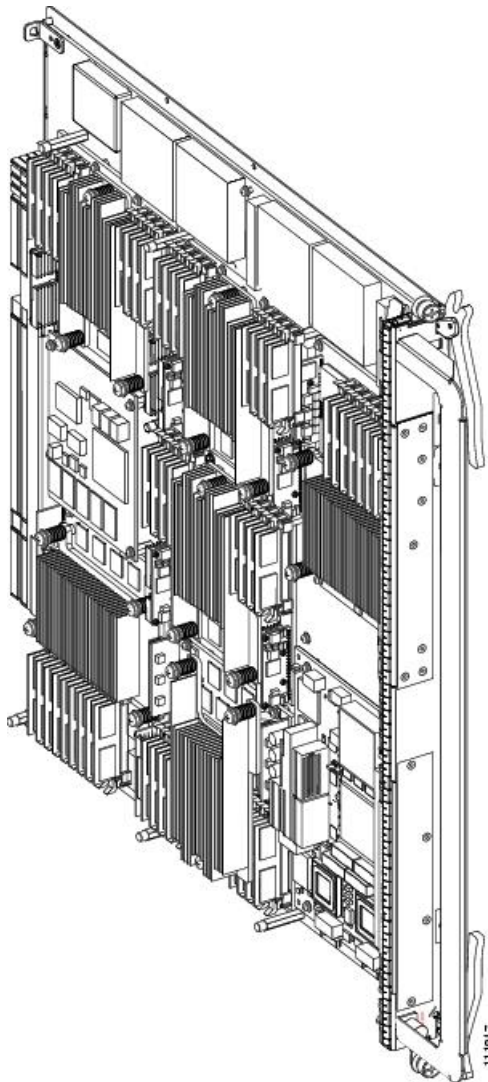

The following figure shows the front panel of the CRS-MSC (end-of-sale).

**Figure 4: CRS-MSC Front Panel**



1	Status LED	2	Alphanumeric LED
---	------------	---	------------------

The following figure shows the front panel of the CRS-MSC-B.

**Figure 5: CRS-MSC-B Front Panel**



1	Status LED	2	Alphanumeric LEDs
---	------------	---	-------------------

The following figure shows the front panel of the CRS-FP40.

**Figure 6: CRS-FP40 Front Panel**



1	Status LED	2	Alphanumeric LEDs
---	------------	---	-------------------

The following figure shows the front panel of the CRS-MSC-140G. The CRS-MSC-X card front panel is similar.

**Figure 7: CRS-MSC-140G Front Panel**

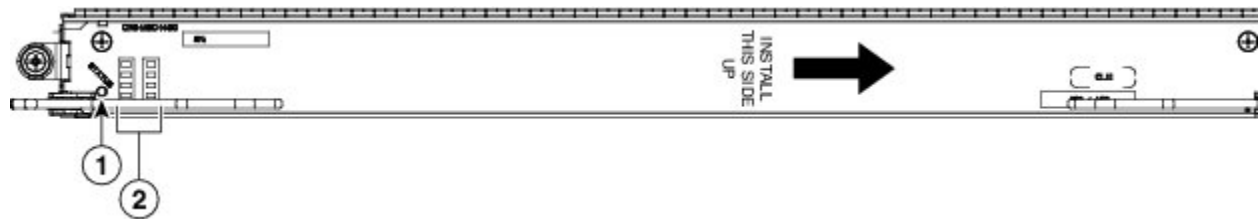

1	Status LED	2	Alphanumeric LEDs
---	------------	---	-------------------

The following figure shows the front panel of the CRS-FP140. The CRS-FP-X card front panel is similar.

Figure 8: CRS-FP140 Front Panel

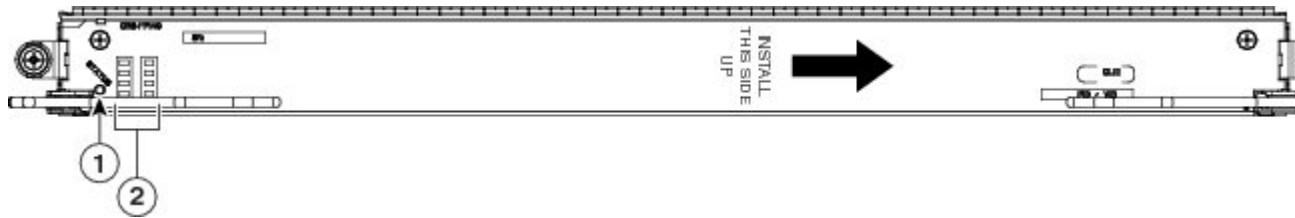

1 Status LED	2 Two alphanumeric LEDs
--------------	-------------------------

The following figure shows the CRS-LSP front panel.

Figure 9: CRS-LSP Front Panel

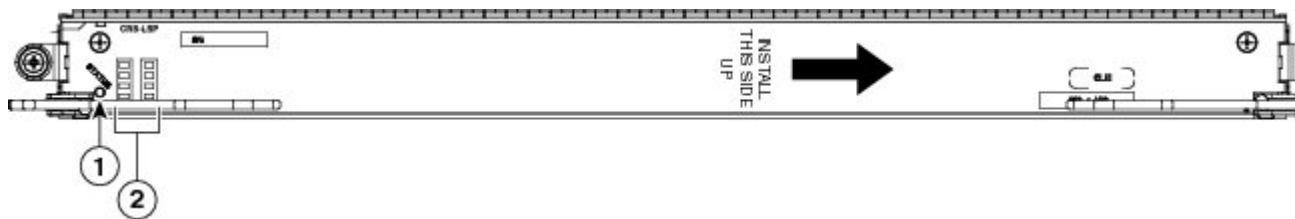

1 Status LED	2 Alphanumeric LED
--------------	--------------------

## Physical Layer Interface Modules

A physical layer interface module (PLIM) provides the packet interfaces for the routing system. Optic modules on the PLIM contain ports to which fiber-optic cables are connected. User data is received and transmitted through the PLIM ports, and converted between the optical signals (used in the network) and the electrical signals (used by Cisco CRS components).

Each PLIM is paired with an MSC, FP, or LSP line card through the chassis midplane. The line card provides Layer 3 services for the user data, and the PLIM provides Layer 1 and Layer 2 services. A line card can be paired with different types of PLIMs to provide a variety of packet interfaces and port densities (for example, OC-192, 10-Gigabit Ethernet, and 100-Gigabit Ethernet).

Line cards are installed on opposite sides of the Cisco CRS 8-Slot Line Card Chassis Enhanced router, and mate through the chassis midplane. Each line card pair is installed in corresponding chassis slots in the chassis (on opposite sides of the chassis). The chassis midplane enables you to remove and replace a line card without disconnecting the user cables on the PLIM. Physical layer interface modules (PLIMs) contain the packet interfaces for the routing system.

The use of separate PLIMs also provides the ability to choose a number of different packet interfaces and port densities.

The following sections describe some of the PLIMs currently available for the Cisco CRS-1:



**Note** For a full list of supported PLIMs, see the Cisco CRS Carrier Routing System Ethernet Physical Layer Interface Module Installation Note.





**Danger** Class 1 Laser Product Statement 113



**Danger** Because invisible radiation may be emitted from the aperture of the port when no fiber cable is connected, avoid exposure to radiation and do not stare into open apertures. Statement 125

## OC-768 Packet-Over-SONET (POS) PLIMs

The 1-port OC-768 PLIM provides an interface of 40 gigabits per second (Gbps), which is the OC-768 line rate. The PLIM performs Layer 1 and Layer 2 processing for an OC-768 data stream by removing and adding the proper header information as data packets enter and exit the PLIM.

The OC-768 PLIM is a class 1 laser product that operates in POS mode only; DPT mode is not supported. The PLIM contains:

- Optics module: Provides receive (RX) and transmit (TX) optic interfaces that comply with ITU Recommendation G.693. The module provides short-reach (SR) optics with SC fiber-optic interfaces.
- Framer: Provides processing and termination for SONET/SDH section, line, and path layers, including alarm processing and automatic protection switching (APS) support.
- Physical interface controller: Provides data packet buffering and Layer 2 processing, including processing for VLANs and back-pressure signals from the MSC.
- Additional components: Include power and clocking components, voltage and temperature sensors, and an identification EEPROM that stores initial configuration and PLIM hardware information.

The Cisco IOS XR software also provides diagnostic functions for the PLIM.

The following figure shows the front panel of the OC-768 PLIM.

**Figure 10: 1-Port OC-768 PLIM Front Panel**

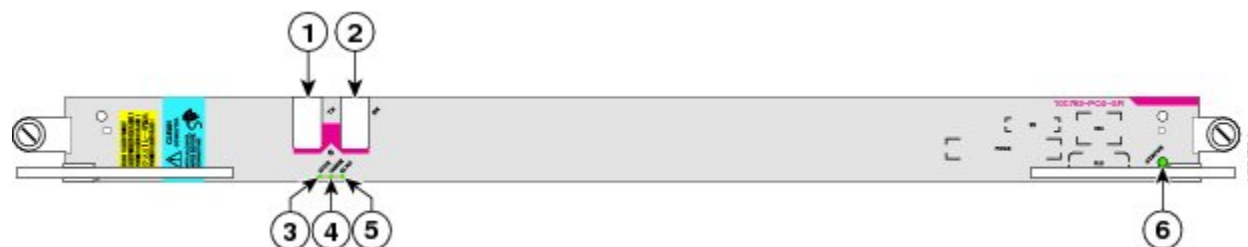

1	TX Alphanumeric LED	4	CARRIER
2	RX Alphanumeric LED	5	RX PKT
3	ACTIVE	6	Status LED

The 1-port OC-768 PLIM has the following components:

- Single port (0) with SC fiber-optic interfaces for TX and RX.
- Three port LEDs that provide information about the status of the port:
  - ACTIVE: Indicates that the port is logically active; the laser is on.

- CARRIER: Indicates that the receive port (RX) is receiving a carrier signal. The LED goes out (turns dark) if a loss-of-signal (LOS) or loss-of-frame (LOF) condition is detected.
- RX PKT: Blinks every time a packet is received.
- STATUS LED: Green indicates that the PLIM is properly seated and operating correctly. Yellow or amber indicates a problem with the PLIM. If the LED is off (dark), check that the board is properly seated and that system power is on.
- Power consumption: 65 W

## OC-192 Packet-Over-SONET/Dynamic Packet Transport PLIMs

The OC-192 PLIM contains four ports that can be software configured to operate in packet-over-SONET (POS) or Dynamic Packet Transport (DPT) modes. The OC-192 PLIM provides Layer 1 and Layer 2 interface capabilities for four OC-192 data streams by removing and adding the proper Layer 1 and Layer 2 header information as data packets enter and exit the PLIM. The OC-192 PLIM feeds the MSC with one 40-Gbps data packet stream. The OC-192 PLIM has features described in [Table 1: Features of the OC-192 PLIM](#).



**Note** DPT mode is not available at this time.

**Table 1: Features of the OC-192 PLIM**

Feature	Description
Optics modules	Provide the receive (RX) and transmit (TX) optic interfaces in accordance with GR-1377 for long-reach (LR), intermediate-reach (IR), short-reach (SR), and very-short-reach (VSR).
Framers	Provide processing and termination for SONET Section, Line, and Path layers. This includes alarm processing and automatic protection switching (APS) support. The framer supports both packet and cell processing for a multiservice operating mode.
Physical interface controller	Provides data packet buffering and Layer 2 processing and multiplexing and demultiplexing the four OC-192 data streams. This includes processing for VLANs and back-pressure signals from the MSC.
DPT or transparent mode components	Provide the MAC layer function for the Spatial Reuse Protocol used in the DPT mode. When the PLIM is in POS mode, these components operate in the transparent mode.
Additional components	Provide power, clocking, voltage and temperature sensing, and an identification EEPROM that stores initial configuration information and details about the PLIM type and hardware revision.

The Cisco IOS XR software also provides loopback and diagnostic functions for the OC-192 PLIM.

The four different types of optics modules define the four major variants of the OC-192 PLIM:

- Long-reach (LR), Product ID: OC192-POS/DPT-LR=
- Intermediate-reach (IR), Product ID: OC192-POS/DPT-IR=
- Short-reach (SR), Product ID: OC192-POS/DPT-SR=

- Very-short-reach (VSR), Product ID: OC192-POS/DPT-VS=

The following figure shows the front panel of the three versions of the OC-192 PLIM.

Figure 11: 4-Port OC-192 POS/DPT VSR, SR, and IR Front Panels

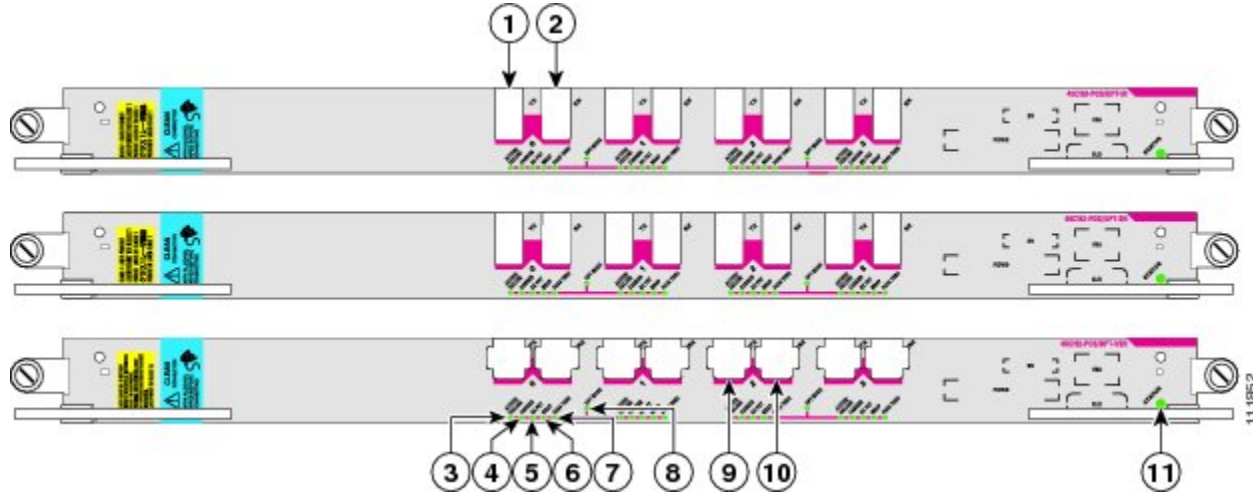

1	Port 0 with TX jacks	7	PASS THRU
2	Port 0 with RX jack	8	DPT MODE
3	ACTIVE/FAILURE LED	9	Port 2 with TX jacks
4	CARRIER	10	Port 2 with RX jack
5	RX PKT	11	STATUS LED
6	WRAP		

Each 4-port OC-192 PLIM has the following components:

- Four ports (0, 1, 2, and 3) with TX and RX jacks for each port.
- STATUS LED: Indicates that the board is properly seated and operating OK.
- Five green LEDs for each port:
  - ACTIVE/FAILURE: Indicates that the port is logically active; the laser is on.
  - CARRIER: Indicates that the receive port (RX) is receiving a carrier signal.
  - RX PKT: Blinks every time a packet is received.
  - WRAP: Indicates that the port is in DPT wrapped mode.
  - PASS THRU: Indicates that the port is operating in the POS mode (DPT pass through).
- Two DPT MODE LEDs: One of these DPT MODE LEDs is for ports 0 and 1, and the other DPT MODE LED is for ports 2 and 3. The DPT mode is always configured on pairs of ports.
- Each 4-port OC-192 PLIM power consumption—138 W

## OC-48 Packet Over SONET/Dynamic Packet Transport PLIMs

The OC-48 PLIM comes in three different variants which can be software configured to operate in packet-over-SONET (POS) or Dynamic Packet Transport (DPT) mode. The 16xOC-48 PLIM contains 16

OC-192 interfaces and provides Layer 1 and Layer 2 interface capabilities, for 16 separate OC-48 data streams, by removing and adding the proper Layer 1 and Layer 2 header information as data packets enter and exit the PLIM. The 16xOC-48 PLIM feeds the MSC with one 40 Gbps data packet stream.

The following table describes the features of the 16xOC-48 PLIM.

**Table 2: Features of the 16xOC-48 PLIM**

Feature	Description
Optics modules	Provide the receive (RX) and transmit (TX) optic interfaces for each of the 16 ports. The 16xOC-48 PLIM uses small form-factor pluggable (SFP) optics modules that can be removed and replaced in the field while the PLIM is powered up. The SFPs provide the 16xOC-48 PLIM with the ability to support short-reach (SR), intermediate-reach (IR), and long-reach (LR) optics on any port.
Framers	Provide processing and termination for SONET Section, Line, and Path layers. This includes alarm processing and APS support and management. The framer supports both packet and cell processing for a multiservice operating mode.
DPT or transparent mode components	Provide the MAC layer function for the Spatial Reuse Protocol used in the DPT mode. When the 16xOC-48 PLIM operates in the POS mode, these components operate in the transparent mode.
Physical interface controller	Provides data packet buffering and Layer 2 processing and multiplexing and demultiplexing of the 16 OC-48 data streams. This includes processing for VLANs and back-pressure signals from the MSC.
Additional components	Provide power, clocking, voltage and temperature sensing, and an identification EEPROM that stores initial configuration information and details about the PLIM type and hardware revision.

The Cisco IOS XR software also provides loopback and diagnostic functions for the 16xOC-48 PLIM.

Figure 12: 16xOC-48 POS PLIM

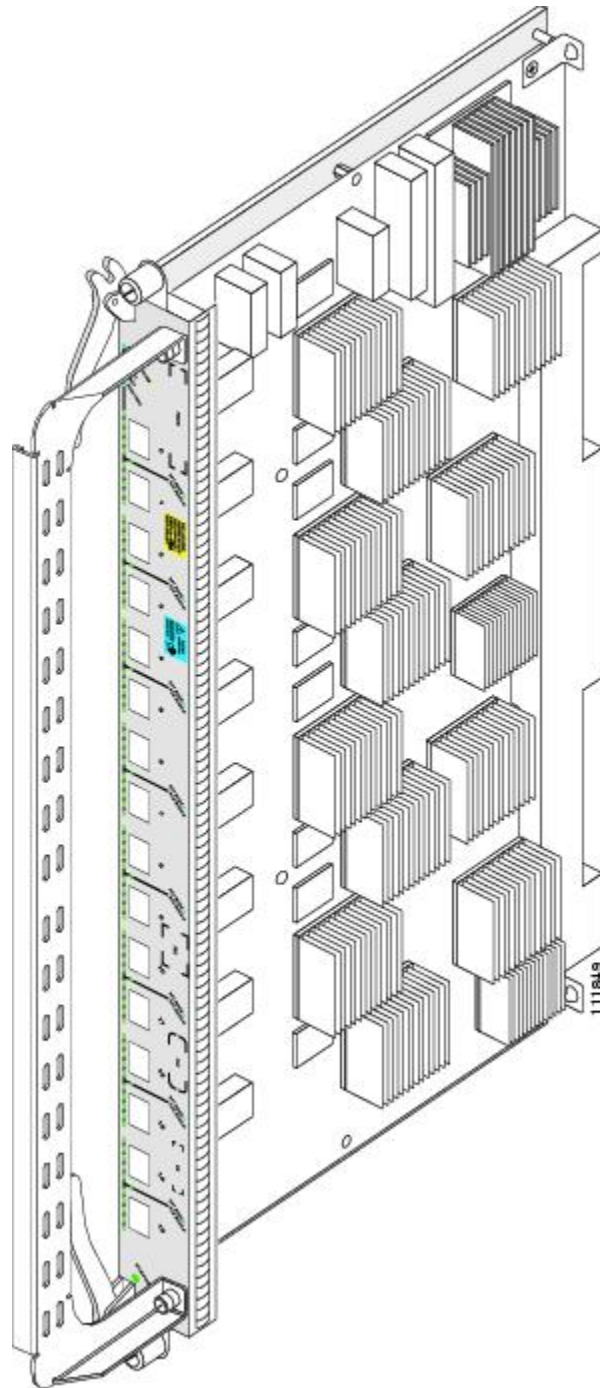

Figure 13: OC-48 POS PLIM Front Panel View



1	DPT MODE LED	6	WRAP LED
2	POS MODE LED	7	PASS THRU LED
3	ACTIVE/FAILURE LEDS	8	One of sixteen slots for SFPs numbered from 0 through 15 left to right
4	CARRIER LED	9	Five LEDs per port
5	RX PKT LED	10	Status LED

Each OC-48 PLIM has the following components:

- A STATUS LED: Indicates that the card is properly seated and operating OK.
- 16 ports with SFP optic modules for each port.
- Eight DPT MODE or POS MODE LEDs: One of these DPT MODE or POS MODE LEDs is for each pair of ports, 0 and 1, 2 and 3, 4 and 5, 6 and 7, 8 and 9, 10 and 11, 12 and 13, and 14 and 15. The DPT mode is always configured on pairs of ports. The LED is lit when a pair of ports are configured in the DPT mode. At this time, the 16xOC-48 PLIM operates only in the POS mode.
- Five green LEDs for each port:
  - ACTIVE/FAILURE: Indicates that the port is logically active; the laser is on.
  - CARRIER: Indicates that the receive port (RX) is receiving a carrier signal.
  - RX PKT: Blinks every time a packet is received.
  - WRAP: Indicates that the port is in DPT wrapped mode.
  - PASS THRU: Indicates that the port is operating in the POS mode (DPT pass through).
- Each 16xOC-48 PLIM power consumption—136 W

## 10-Gigabit Ethernet XENPAK PLIM

The 8-port 10-Gigabit Ethernet (GE) XENPAK PLIM provides from one to eight 10-GE interfaces. The PLIM supports from one to eight pluggable XENPAK optic modules that provide the 10-GE interfaces for the card. The PLIM performs Layer 1 and Layer 2 processing for up to eight 10-GE data streams by removing and adding the proper header information as data packets enter and exit the PLIM.

Although the PLIM can terminate up to 80 Gbps of traffic, the MSC forwards traffic at 40 Gbps. Therefore, the PLIM provides 40 Gbps of throughput, which it passes to the MSC as two 20-Gbps data packet streams:

- Ports 0 to 3 (the upper set of ports) provide 20 Gbps of throughput.
- Ports 4 to 7 (the lower set of ports) provide another 20 Gbps of throughput.

## Oversubscription of 10-GE Ports

If more than two optic modules are installed in either set of ports, oversubscription occurs on all ports in that set. For example, if modules are installed in ports 0 and 1, each interface has 10 Gbps of throughput. Adding another module in port 2 causes oversubscription on all of the interfaces (0, 1, and 2).



**Note** If your configuration cannot support oversubscription, do not install more than 4 optic modules in each PLIM, and do not install more than 2 optic modules in each set of ports: upper (0 to 3) or lower (4 to 7).

## 10-GE XENPAK PLIM Components

The 8-port 10-GE PLIM consists of:

- **Optic modules:** Provide receive (RX) and transmit (TX) optical interfaces that comply with IEEE 802.3ae. The PLIM supports from one to eight pluggable XENPAK optic modules, each providing full-duplex long-reach (LR) optics with SC fiber-optic interfaces. Note that the PLIM automatically shuts down any optic module that is not a valid type.
- **Physical interface controller:** Provides data packet buffering, Layer 2 processing, and multiplexing and demultiplexing of the 10-GE data streams, including processing for VLANs and back-pressure signals from the MSC.
- **Additional components:** Include power and clocking components, voltage and temperature sensors, and an identification EEPROM that stores initial configuration and PLIM hardware information.

[Figure 14: 10-GE XENPAK PLIM Front Panel](#) shows the front panel of the 10-GE PLIM.

**Figure 14: 10-GE XENPAK PLIM Front Panel**

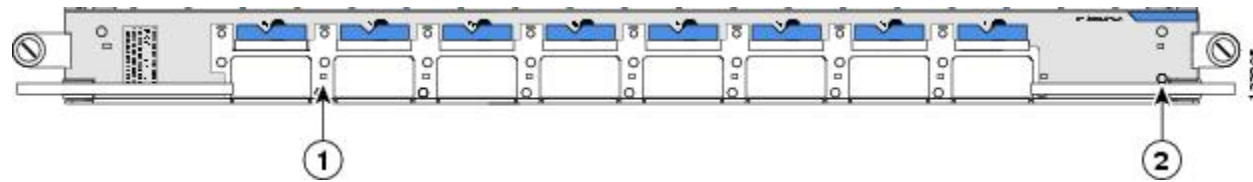

1	Port LED (one per port)	2	STATUS LED
---	-------------------------	---	------------

The 8-port 10-GE XENPAK PLIM has the following components:

- Eight slots that accept XENPAK optic modules, which provide LR optics with SC fiber-optic interfaces.
- A STATUS LED: Green indicates that the PLIM is properly seated and operating correctly. Yellow or amber indicates a problem with the PLIM. If the LED is off (dark), check that the board is properly seated and that system power is on.
- An LED for each port: Indicates that the port is logically active; the laser is on.

The 8-port 10-GE XENPAK PLIM power consumption—110 W (with 8 optic modules)

## 8-Port 10-GE PLIM with XFP Optics Modules

The 8-port 10-GE XFP PLIM supports from one to eight pluggable XFP optics modules. The 8-port 10-GE XFP PLIM has:

- Eight ports that accept XFP optics modules
- Status LED for the PLIM

- LED for each port



**Note** For information about the XFP optical transceiver modules supported on the 8-port 10-GE XFP PLIM, see [Cisco CRS Carrier Routing System Ethernet Physical Layer Interface Module Installation Note](#).

The 8-port 10-GE XFP PLIM supports the following types of XFP optical transceiver modules:

- Single-mode low power multirate XFP module—XFP10GLR-192SR-L, V01
- Single-mode low power multirate XFP module—XFP10GER-192IR-L, V01

Cisco qualifies the optics that are approved for use with its PLIMs.

For the modules listed, use a single-mode optical fiber that has a modal-field diameter of  $8.7 \pm 0.5$  microns (nominal diameter is approximately 10/125 micron) to connect your router to a network.

The following figure shows the front panel of the 8-Port 10-GE XFP PLIM.

**Figure 15: 8-Port 10-Gigabit Ethernet XFP PLIM front panel**

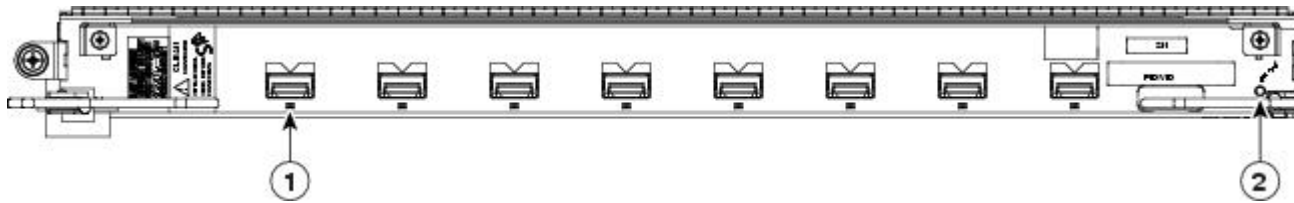

1	Port LED (one per port)	2	Status LED
---	-------------------------	---	------------

The following table describes the PLIM LEDs for the 8-Port 10-GE XFP PLIM.

**Table 3: 8-Port 10-GE XFP PLIM LED Descriptions**

LED	State	Description
Status	Green	PLIM is properly seated and operating correctly.
	Yellow	PLIM has a problem.
	Off	PLIM is not properly seated or system power is off.
Port	On	Port is logically active and the laser is on.
	Off	Port is not active.

The 8-port 10-GE XFP PLIM power consumption—88 W (with eight optics modules)

The following table provides cabling specifications for the XFP modules that can be installed on the 8-port 10-GE XFP PLIM.



Table 4: XFP Module Port Cabling Specifications for the 8-Port 10-GE XFP PLIM

Part Number	Description	Wavelength	Fiber Type	Typical Maximum Distance
XFP10GLR-192SR-L, V01	Low Power multirate XFP supporting 10GBASE-LR and OC-192 SR	1310 nm	SMF	6.213 miles (10 km)
XFP10GER-192IR-L, V01	Low Power multirate XFP supporting 10GBASE-ER and OC-192 IR	1550 nm	SMF	24.85 miles (40 km)

## 4-Port 10-GE PLIM with XFP Optics Modules

The 4-port 10-GE XFP PLIM supports from one to four pluggable XFP optics modules. The 4-port 10-GE XFP PLIM has:

- Four ports that accept XFP optics modules
- Status LED for the PLIM
- LED for each port



**Note** For information about the XFP optical transceiver modules supported on the 8-port 10-GE XFP PLIM, see [Cisco CRS Carrier Routing System Ethernet Physical Layer Interface Module Installation Note](#).

The 4-port 10-GE XFP PLIM supports the following types of XFP optical transceiver modules:

- Single-mode low power multirate XFP module—XFP10GLR-192SR-L, V01
- Single-mode low power multirate XFP module—XFP10GER-192IR-L, V01

Cisco qualifies the optics that are approved for use with its PLIMs.

For the modules listed, use a single-mode optical fiber that has a modal-field diameter of  $8.7 \pm 0.5$  microns (nominal diameter is approximately 10/125 micron) to connect your router to a network.

The following figure shows the front panel of the 4-Port 10-GE XFP PLIM.

**Figure 16: 4-Port 10-Gigabit Ethernet XFP PLIM Front Panel**

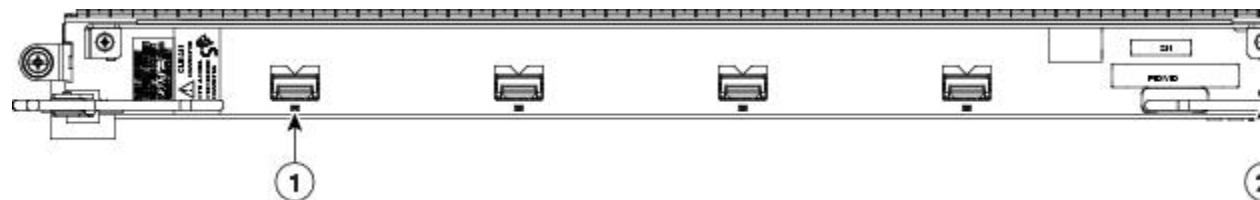

1	Port LED (one per port)	2	Status LED
---	-------------------------	---	------------

The following table describes the PLIM LEDs for the 4-Port 10-GE XFP PLIM.

**Table 5: 4-Port 10-GE XFP PLIM LED Descriptions**

LED	State	Description
Status	Green	PLIM is properly seated and operating correctly.
	Yellow	PLIM has a problem.
	Off	PLIM is not properly seated or system power is off.
Port	On	Port is logically active and the laser is on.
	Off	Port is not active.

The 4-port 10-GE XFP PLIM power consumption—74 W (with four optics modules).

The following table provides cabling specifications for the XFP modules that can be installed on the 4-port 10-GE XFP PLIMs.

**Table 6: XFP Module Port Cabling Specifications for the 4-Port 10-GE XFP PLIM**

Part Number	Description	Wavelength	Fiber Type	Typical Maximum Distance
XFP10GLR-192SR-L, V01	Low Power multirate XFP supporting 10GBASE-LR and OC-192 SR	1310 nm	SMF	6.213 miles (10 km)
XFP10GER-192IR-L, V01	Low Power multirate XFP supporting 10GBASE-ER and OC-192 IR	1550 nm	SMF	24.85 miles (40 km)

## 1-Port 100-GE PLIM with CFP Optics Module

The 1-port 100-GE CFP PLIM supports one pluggable CFP optics module.

The 1-port 100-GE PLIM has:

- One port that accepts a CFP optics module
- Status LED for the PLIM
- Four LED indicators for the single port
- The 1-Port 100-GE CFP PLIM power consumption—150 W

The 1-port 100-GE PLIM supports the following types of CFP optical transceiver modules:

- 100-GE pluggable optical transceiver module—CFP-100GE-LR4, V01

Cisco qualifies the optics that are approved for use with its PLIMs.

The following figure shows the front panel of the 1-Port 100-GE CFP PLIM.

Figure 17: 1-Port 100-Gigabit Ethernet CFP PLIM front panel

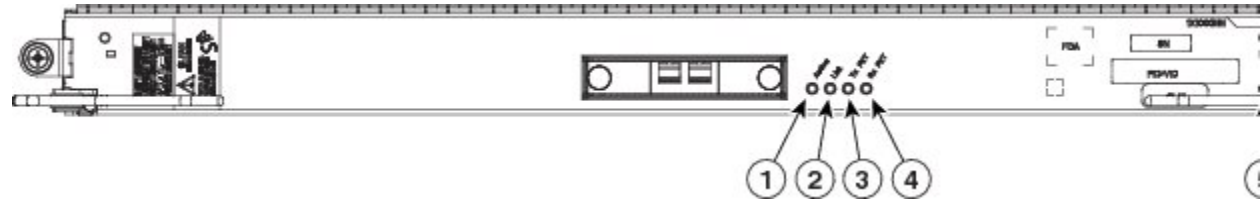

1	Active LED	2	Link LED	3	Tx PKT LED	4	Rx PKT LED	5	Status LED
---	------------	---	----------	---	------------	---	------------	---	------------

The following table describes the PLIM LEDs for the 1-Port 100-GE CFP PLIM.

Table 7: 1-Port 100-GE XFP PLIM LED Descriptions

LED	State	Description
PLIM Status	Green	PLIM is properly seated and operating correctly.
	Yellow	PLIM is powered on, but initializing.
	Off	PLIM is not properly seated, system power is off, or power up did not complete successfully.
Active	Green	Port is enabled by software and there is a valid link.
	Yellow	Port is enabled by software, but there is a problem with the link.
	Off	Port is not enabled by software.
Link	Green	Active link is achieved.
	Yellow	TBD
	Off	Active link is not achieved.
Tx PKT	Green (flashing)	Packets are being transmitted on the port.
	Yellow	TBD
	Off	No packets are being transmitted on the port.
Rx PKT	Green (flashing)	Packets are being received on the port.
	Yellow	TBD
	Off	No packets are being received on the port.

The CFP uses duplex single mode SC fiber cabling. [Table 8: CFP Module Port Cabling Specifications](#) provides cabling specifications for the CFP modules that can be installed on the 1-Port 100-GE CFP PLIM.



**Caution** A CFP optics module must be installed in the CFP transceiver module slot of each 100GE PLIM installed in the Cisco CRS chassis. The CFP transceiver module preserves the integrity of the card and is required for EMI and Safety compliance and proper cooling in the chassis.

**Table 8: CFP Module Port Cabling Specifications**

Part Number	Description	Wavelength	Fiber Type	Typical Maximum Distance
CFP-100GE-LR4, V01	100-GE pluggable optical transceiver modules	1295.56 nm 1300.055 nm 1304.585 nm 1309.14 nm	SMF	6.213 miles (10 km)

## 20-Port 10-GE PLIM with XFP Optics Modules

The 20-port 10-GE XFP PLIM supports from one to twenty pluggable XFP optics modules.

The 20-port 10-GE PLIM has:

- Twenty ports that accept XFP optics modules
- Status LED for the PLIM
- Port status LED for each port



**Note** For information about the XFP optical transceiver modules supported on the 20-port 10-GE XFP PLIM, see [Cisco CRS Carrier Routing System Ethernet Physical Layer Interface Module Installation Note](#).



**Note** The 20-port XFP PLIM has a fixed power budget for the pluggable XFP optics. See [XFP Optics Power Management](#) for detailed information.

The 20-port 10-GE PLIM supports the following types of XFP optical transceiver modules:

- Single-mode low power multirate XFP module—XFP10GLR-192SR-L, V01
- Single-mode low power multirate XFP module—XFP10GER-192IR-L, V01

Cisco qualifies the optics that are approved for use with its PLIMs.

For the modules listed, use a single-mode optical fiber that has a modal-field diameter of  $8.7 \pm 0.5$  microns (nominal diameter is approximately 10/125 micron) to connect your router to a network.

The following figure shows the front panel of the 20-Port 10-GE XFP PLIMs.

Figure 18: 20-Port 10-Gigabit Ethernet XFP PLIM Front Panel

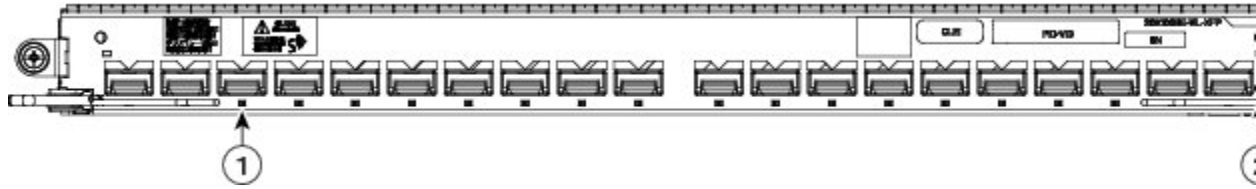

1	Port LED (one per port)	2	Status LED
---	-------------------------	---	------------

The following table describes the PLIM LEDs for the 20-Port 10-GE XFP PLIM.

Table 9: 20-Port 10-GE XFP PLIM LED Descriptions

LED	State	Description
PLIM Status	Green	PLIM is properly seated and operating correctly.
	Yellow	PLIM is powered on, but initializing.
	Off	PLIM is not properly seated, system power is off, or power up did not complete successfully.
Port Status	On	Port is enabled by software and there is a valid link.
	Yellow	Port is enabled by software, but there is a problem with the link.
	Off	Port is not enabled by software.

The 20-port 10-GE XFP PLIM power consumption—150 W (120 W with no optics installed, 30 W optics budget)

**Caution**

The 20-port 10-GE XFP PLIM can have all 20 ports filled with SR (1.5W) 10km XFPs. If you use optics other than SR, you must be careful not to exceed the power budget, which may result in some ports remaining unpowered. Cisco IOS XR software enables the ports in a sequence that allows the configuration to remain within the optics power budget. For more details on how the software controls PLIM power consumption, see the [Cisco IOS XR Interface and Hardware Component Command Reference for the Cisco CRS Router](#).

## 14-Port 10-GE PLIM with XFP Optics Modules

The 14-port 10-GE XFP PLIM supports from one to fourteen pluggable XFP optics modules.

The 14-port 10-GE PLIM has:

- Fourteen ports that accept XFP optics modules
- Status LED for the PLIM
- LED for each port



**Note** For information about the XFP optical transceiver modules supported on the 14-port 10-GE XFP PLIM, see the [Cisco CRS Carrier Routing System Ethernet Physical Layer Interface Module Installation Note](#).



**Note** The 14-port XFP PLIM has a fixed power budget for the pluggable XFP optics. See [XFP Optics Power Management](#) for detailed information.

The 14-port 10-GE PLIM supports the following types of XFP optical transceiver modules:

- Single-mode low power multirate XFP module—XFP10GLR-192SR-L, V01
- Single-mode low power multirate XFP module—XFP10GER-192IR-L, V01

Cisco qualifies the optics that are approved for use with its PLIMs.

For the modules listed, use a single-mode optical fiber that has a modal-field diameter of  $8.7 \pm 0.5$  microns (nominal diameter is approximately 10/125 micron) to connect your router to a network.

The following figure [Figure 19: 14-Port 10-Gigabit Ethernet XFP PLIM Front Panel](#) shows the front panel of the 14-Port 10-GE XFP PLIMs.

**Figure 19: 14-Port 10-Gigabit Ethernet XFP PLIM Front Panel**

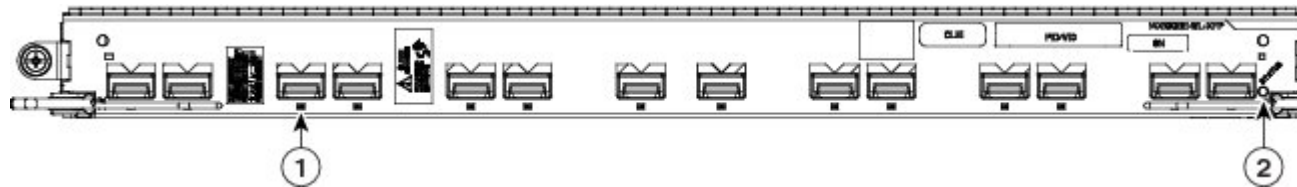

1	Port LED	2	Status LED
---	----------	---	------------

The following table describes the PLIM LEDs for the 14-Port 10-GE XFP PLIM.

**Table 10: 14-Port 10-GE XFP PLIM LED Descriptions**

LED	State	Description
PLIM Status	Green	PLIM is properly seated and operating correctly.
	Yellow	PLIM is powered on, but initializing.
	Off	PLIM is not properly seated, system power is off, or power up did not complete successfully.
Port Status	On	Port is enabled by software and there is a valid link.
	Yellow	Port is enabled by software, but there is a problem with the link.
	Off	Port is not enabled by software.

The 14-port 10-GE XFP PLIM power consumption—150 W (115 W with no optics installed, 35 W optics budget)

**Caution**

The 14-port 10-GE XFP PLIM can have all 14 ports filled with a combination of SR (1.5W) 10km XFPs and LR (2.5W) 40km XFPs. If you use optics other than SR or LR, you must be careful not to exceed the power budget, which may result in some ports remaining unpowered. Cisco IOS XR software enables the ports in a sequence that allows the configuration to remain within the optics power budget. For more details on how the software controls PLIM power consumption, see [Cisco IOS XR Interface and Hardware Component Command Reference for the Cisco CRS Router](#).

**Note**

The 14-port XFP PLIM has a fixed power budget for the pluggable XFP optics. See [XFP Optics Power Management](#) for detailed information.

## XFP Optics Power Management

The 20- and 14-port XFP PLIMs have a fixed power budget for the pluggable XFP optics. The XFP pluggable optics for the 20- and 14-port XFP PLIMs have different power consumptions based on their reach and type. The number of XFPs which will power up in a PLIM depends on their aggregate power consumption within the allocated power budget.

During XFP insertion, the power is allotted to the optics based on the insertion order of the XFPs. On boot up and reload, priority is re-assigned to the lower numbered ports.

The recommended insertion sequence is to alternate between inserting XFPs in lowest numbered ports for each interface device driver ASIC to avoid oversubscription. The insertion order for a 20 Port PLIM would be “0,10,1,11,2,12,...9,19.” For a 14 Port PLIM, insertion order would be “0,7,1,8,...6,13.”

If the PLIM power budget is exceeded, a console log message is displayed informing the user the power budget has been exceeded and to remove the XFP:

```
plim_[x]ge: %L2-PLIM-6-NO_POWER_XFP : Port <port number>, Not enough power available
to power XFP, powering off
```

Any unpowered XFPs should be removed to ensure that the same XFPs that were powered before a reload are the same XFPs that are powered after a reload. Removing the unpowered XFPs prevents the powered down XFPs being given priority after the reload.

A show command is provided to indicate how much of the XFP power budget is currently used and how much power an XFP is consuming:

```
show controllers tenGigE 0/3/0/0 internal
```

## PLIM Impedance Carrier

A PLIM impedance carrier must be installed in each empty PLIM slot in the Cisco CRS-1 chassis (see [Figure 20: PLIM Impedance Carrier](#)). The CRS 8-slot chassis is shipped with impedance carriers installed in the empty slots. The impedance carrier preserves the integrity of the chassis and is required for EMI compliance and proper cooling in the chassis.

Figure 20: PLIM Impedance Carrier

