



LAN Switching Configuration Guide, Cisco IOS XE Release 3S (Cisco ASR 920 Series)

First Published: 2014-07-29

Last Modified: 2019-05-02

Americas Headquarters

Cisco Systems, Inc.
170 West Tasman Drive
San Jose, CA 95134-1706
USA
<http://www.cisco.com>
Tel: 408 526-4000
800 553-NETS (6387)
Fax: 408 527-0883



CONTENTS

CHAPTER 1

Configuring Resilient Ethernet Protocol 1

Restrictions for Resilient Ethernet Protocol	1
Information About REP	2
REP Segments	2
Link Integrity	3
Fast Convergence	4
VLAN Load Balancing	4
Spanning Tree Protocol Interaction	5
REP Ports	5
REP Integrated with VPLS	6
Default REP Configuration	6
REP Segments and REP Administrative VLANs	6
REP Configuration Guidelines	6
REP Support on a Trunk EFP	7
REP Configurable Timers	8
SSO Support for REP Fast Hello	8
REP Edge No-Neighbor Support	8
How to Configure REP	9
Configuring the REP Administrative VLAN	9
Configuring Trunk EFP on an Interface	10
Configuring REP Support on a Trunk EFP	12
Setting the Preemption for VLAN Load Balancing	15
Restrictions	15
Configuring SNMP Traps for REP	16
Monitoring the REP Configuration	17
Configuring REP Configurable Timers	18

Configuring REP as an Edge No-Neighbor Port	21
Configuration Examples for REP	23
Configuring the REP Administrative VLAN	23
Configuring REP Support on a Trunk EFP	23
Setting the Preemption for VLAN Load Balancing	24
Configuring SNMP Traps for REP	24
Monitoring the REP Configuration	24
Configuring REP Configurable Timers	25
Configuring REP Edge No-Neighbor Support	25
Additional References	25
Feature Information for Resilient Ethernet Protocol	26

CHAPTER 2**REP Access Gateway 27**

Prerequisites for REP Access Gateway	27
Restrictions for REP Access Gateway	27
Information About REP Access Gateway	28
REP Access Gateway Enhancements	28
How to Configure REP Access Gateway	29
Enabling EFD Notifications	29
Configuration Examples	30
Example: Configuring REP AG EFD	30
Verifying REP Access Gateway	31
Example: Verifying REP AG EFD Notifications	31
Additional References	32

CHAPTER 3**UniDirectional Link Detection (UDLD) Protocol 35**

Restrictions for the UDLD Protocol	35
Information About the UDLD Protocol	35
UDLD Overview	35
UDLD Normal Mode	36
UDLD Aggressive Mode	36
UDLD Functions	37
Detecting Unidirectional Links	37
How to Configure UDLD Protocol	38

Enabling UDLD Protocol	38
Enabling UDLD Protocol at Interface Level	38
Enabling UDLD Protocol at Interface Level	39
Enabling UDLD Probe Message Interval	40
Recovering the UDLD Protocol	41
Resetting Ports	41
Configuration Examples	42
Example: Configuring UDLD Protocol	42
Verifying UDLD Protocol	42
Example: Verifying UDLD Protocol	42

CHAPTER 4

Configuring Auto Media Sense	47
Restrictions for Configuring Auto Media Sense	47
Information About Auto Media Sense	47
How to Configure Auto Media Sense	48
Configuring Media-Type	48
Verifying Media-Type	49
Example for Verifying Media-Type Configuration	50
Troubleshooting Media-Type Configuration	51

CHAPTER 5

Configuring Flex Links	53
Restrictions for Configuring Flex Links	53
Information About Flex Links	53
Active-Alone forwarding Method	54
Configuring Active Alone Forwarding Method	54
Verifying Active Alone Forwarding Method Configuration	56
Active-Backup-Both forwarding Method	56
Configuring Active Backup Both Forwarding Method	57
Verifying Active-Backup-Both Forwarding Method Configuration	58
Unsupported Functions	59
Additional References	60

CHAPTER 6

ITU-T G.8032 Ethernet Ring Protection Switching	61
Prerequisites for Configuring ITU-T G.8032 Ethernet Ring Protection Switching	61

About ITU-T G.8032 Ethernet Ring Protection Switching	61
Ring Protection Links	61
ITU-T G.8032 Ethernet Ring Protection Switching Functionality	61
R-APS Control Messages	62
CFM Protocols and Link Failures	62
G.8032 Ring-Supported Commands and Functionality	63
G.8032 ERP Timers	64
Protection Switching Functionality in a Single Link Failure and Recovery	64
Ethernet Flow Points	67
Service Instances and Associated EFPs	68
Restrictions for Configuring ITU-T G.8032 Ethernet Ring Protection Switching	69
How to Configure ITU-T G.8032 Ethernet Ring Protection Switching	70
Configuring the Ethernet Ring Profile	70
Configuring Ethernet CFM MEPs	71
Enabling Ethernet Fault Detection for a Service	71
Configuring the Ethernet Protection Ring	73
Configuring Topology Change Notification Propagation	76
Configuring a Service Instance	77
Verifying the Ethernet Ring Protection (ERP) Switching Configuration	78
Configuration Examples for ITU-T G.8032 Ethernet Ring Protection Switching	80
Example: Configuring Ethernet Ring Protection Switching	80
Example: Enabling Ethernet Fault Detection for a Service	80
Example: Verifying the Ethernet Ring Protection Configuration	82

CHAPTER 7
Multiple Spanning Tree Protocol 83

Restrictions for configuring MSTP	83
How to Configure MST Protocol	83
Enabling Multiple Spanning Tree Protocol	83
Configuring Multiple Spanning Tree Protocol	84
Configuring Untagged EFP over MST Interface	85



CHAPTER 1

Configuring Resilient Ethernet Protocol

The Resilient Ethernet Protocol (REP) is a Cisco proprietary protocol that provides an alternative to the Spanning Tree Protocol (STP). REP provides a way to control network loops, handle link failures, and improve convergence time. It controls a group of ports connected in a segment, ensures that the segment does not create any bridging loops, and responds to link failures within the segment. REP provides a basis for constructing complex networks and supports VLAN load balancing.



Note The convergence value is improved from Cisco IOS XE 3.17 release.

- [Restrictions for Resilient Ethernet Protocol, on page 1](#)
- [Information About REP, on page 2](#)
- [How to Configure REP, on page 9](#)
- [Configuration Examples for REP, on page 23](#)
- [Additional References, on page 25](#)
- [Feature Information for Resilient Ethernet Protocol, on page 26](#)

Restrictions for Resilient Ethernet Protocol

- With respect to control frames, REP ALT port will block only tagged (part of Trunk EFP) control frames and not untagged (part of Untagged EFP) control frames.
- You must configure each segment port; an incorrect configuration can cause forwarding loops in networks.
- REP can manage only a single failed port within the segment; multiple port failures within the REP segment causes high loss of network connectivity.
- You should configure REP only in networks with redundancy. Configuring REP in a network without redundancy causes loss of network connectivity.
- Use LSL timers greater than 280mseconds to avoid REP flaps with IGMP snooping.
- Use LSL timers of 520mseconds to avoid REP flaps.
- The rate at which the layer 3 packets are punted to Host Q must be lesser than 1000 packets/second to avoid REP flap. The credit limit for Host Q is 1000 packets/second.
- There is no drop in REP LSL packet in STP Queue.

- REP is supported only on Trunk EFPs configured on the interfaces.
- REP enabled port do not support EFP configuration.
- The recommended minimum REP LSL timer value is 200 ms.
- The REP ports are removed from the topology list during the following situations:It is designed to avoid the traffic loop based on the above behavior to adopt dynamic REP configuration changes.
 - New port is added after the removal of the old port.
 - Both REP ports are removed.
 - The port is an Edge or Edge no neighbor port.

Information About REP

REP Segments

A REP segment is a chain of ports connected to each other and configured with a segment ID. Each segment consists of standard (nonedge) segment ports and two user-configured edge ports. A router can have no more than two ports that belong to the same segment, and each segment port can have only one external neighbor. A segment can go through a shared medium, but on any link, only two ports can belong to the same segment. REP is supported only on Trunk Ethernet Flow Point (EFP) interfaces.

The figure below shows an example of a segment consisting of six ports spread across four switches. Ports E1 and E2 are configured as edge ports. When all ports are operational (as in the segment on the left), a single port is blocked, shown by the diagonal line. When there is a failure in the network, the blocked port returns to the forwarding state to minimize network disruption.

Figure 1: REP Open Segments

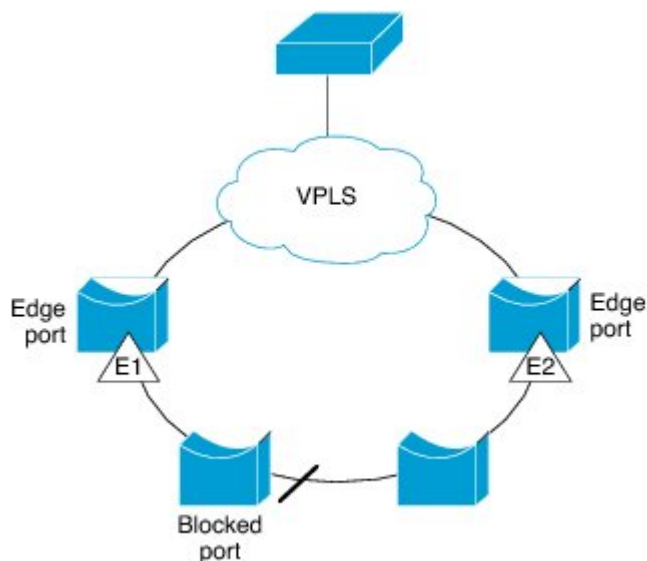

2844-409

The segment shown in the figure above is an open segment; there is no connectivity between the two edge ports. The REP segment cannot cause a bridging loop, and you can safely connect the segment edges to any network. All hosts connected to routers inside the segment have two possible connections to the rest of the network through the edge ports, but only one connection is accessible at any time. If a failure occurs on any segment or on any port on a REP segment, REP unblocks all ports to ensure that connectivity is available through the other gateway.

The segment shown in the figure below is a ring segment, and it has both edge ports located on the same router. With this configuration, you can create a redundant connection between any two routers in the segment.

Figure 2: REP Ring Segment

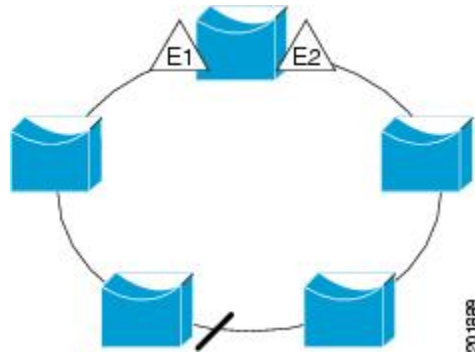

REP segments have the following characteristics:

- If all ports in a segment are operational, one port (referred to as the *alternate* port) is in the blocked state for each VLAN. If VLAN load balancing is configured, two ports in the segment control the blocked state of VLANs.
- If one or more ports in a segment is not operational, and cause a link failure, all ports forward traffic on all VLANs to ensure connectivity.
- In case of a link failure, alternate ports are unblocked as quickly as possible. When the failed link is up, a logically blocked port per VLAN is selected with minimal disruption to the network.

You can construct almost any type of network based on REP segments. REP also supports VLAN load balancing, which is controlled by the primary edge port but can occur at any port in the segment.

Link Integrity

REP does not use an end-to-end polling mechanism between edge ports to verify link integrity. It implements local link failure detection. When enabled on an interface, the REP Link Status Layer (LSL) detects its REP-aware neighbor and establishes connectivity within the segment. All VLANs are blocked on an interface until the REP LSL detects the neighbor. After the neighbor is identified, REP determines which neighbor port should become the alternate port and which ports should forward traffic.

Each port in a segment has a unique port ID. The port ID format is similar to that used by the spanning tree algorithm: a port number (unique on the bridge), associated to a MAC address (unique in the network). When a segment port is up, LSL sends packets that include the segment ID and the port ID. The port is declared as operational after it performs a three-way handshake with a neighbor in the same segment. A segment port does not become operational under the following conditions:

- No neighbor has the same segment ID.

- More than one neighbor has the same segment ID.
- The neighbor does not acknowledge the local port as a peer.

Each port creates an adjacency with its immediate neighbor. Once the neighbor adjacencies are created, the ports negotiate to determine one blocked port for the segment, which is the alternate port. All other ports become unblocked. By default, REP packets are sent to a PortFast Bridge Protocol Data Unit (BPDU) class MAC address. The packets can also be sent to the Cisco multicast address, which at present is used only to send blocked port advertisement (BPA) messages when there is a failure in the segment. The packets are dropped by devices not running REP.

Fast Convergence

Because REP runs on a physical-link basis and not on a per-VLAN basis, only one hello message is required for all VLANs, thus reducing the load on the protocol. We recommend that you create VLANs consistently on all switches in a given segment and configure VLANs on REP trunk ports. To avoid the delay introduced by relaying messages in software, REP also allows some packets to be flooded to a regular multicast address. These messages operate at the hardware flood layer (HFL) and are flooded to the whole network, not just the REP segment. Switches that do not belong to the segment treat the messages as data traffic. You can control flooding of these messages by configuring a dedicated administrative VLAN for the whole domain.

The estimated convergence recovery time is less than 200 milliseconds (ms) for the local segment.

VLAN Load Balancing

One edge port in a REP segment acts as the primary edge port and the other as the secondary edge port. It is the primary edge port that always participates in VLAN load balancing in the segment. REP VLAN load balancing is achieved by blocking some VLANs at a configured alternate port and all other VLANs at the primary edge port. When you configure VLAN load balancing, you can specify the alternate port using any one of the following ways:

- By entering the port ID of the interface. To identify the port ID of a port in the segment, enter the **show interface rep detail** command for the port.
- By entering the neighbor offset number of a port in the segment, which identifies the downstream neighbor port of an edge port. The neighbor offset number range is -256 to +256; a value of 0 is invalid. The primary edge port has an offset number of 1; positive numbers above 1 identify downstream neighbors of the primary edge port. Negative numbers indicate the secondary edge port (offset number -1) and its downstream neighbors.



Note You configure offset numbers on the primary edge port by identifying a port's downstream position from the primary (or secondary) edge port. You cannot enter an offset value of 1 because 1 is the offset number of the primary edge port.

- By entering the **preferred** keyword to select the port that you previously configured as the preferred alternate port in the **rep segment preferred** command.

When the REP segment is complete, all VLANs are blocked. VLAN load balancing can be triggered in one of the following two ways:

- You can manually trigger VLAN load balancing at any time by entering the **rep preempt segment *segment-id*** command on the router that has the primary edge port.
- You can configure a preempt delay time by entering the **rep preempt delay *seconds*** command. After a link failure and recovery, VLAN load balancing begins after the configured preemption time period elapses. The delay timer restarts if another port fails before the time has elapsed.



Note A VLAN load balancing does not start working until triggered by either a manual intervention or a link failure and recovery.

When VLAN load balancing is triggered, the primary edge port sends out a message to alert all interfaces in the segment about the preemption. When the message is received by the secondary edge port, a message is generated in the network to notify the alternate port to block the set of VLANs specified in the message and to notify the primary edge port to block the remaining VLANs.

You can also configure a particular port in the segment to block all VLANs. VLAN load balancing is initiated only by the primary edge port and is not possible if the segment is not terminated by an edge port on each end. The primary edge port determines the local VLAN load balancing configuration.

To reconfigure VLAN load balancing, you must reconfigure the primary edge port. When you change the VLAN-load balancing configuration, the primary edge port again waits for the **rep preempt segment** command or for the configured preempt delay period after a port failure and recovery before executing the new VLAN load balancing configuration. If you change an edge port to a regular segment port, the existing VLAN load balancing status does not change. Configuring a new edge port might cause a new topology configuration.

Spanning Tree Protocol Interaction

REP does not interact with STP or with Flex Links but can coexist with both of them. A port that belongs to a segment is removed from spanning tree control, and STP BPDUs are not accepted or sent from segment ports. Therefore, STP cannot run on a segment.

To migrate from an STP ring configuration to a REP segment configuration, begin by configuring a single port in the ring as part of the segment and continue by configuring contiguous ports to minimize the number of segments. Each segment always contains a blocked port, so multiple segments mean multiple blocked ports and a potential loss of connectivity. You can configure the edge ports when the segment has been configured in both directions up to the location of the edge ports.

REP Ports

Ports in REP segments take one of following three roles or states: Failed, Open, or Alternate.

- A port configured as a regular segment port starts as a failed port.
- After neighbor adjacencies are determined, the port transitions to the alternate port state, blocking all VLANs on the interface. Blocked port negotiations occur, and when the segment settles, one blocked port remains in the alternate role, and all other ports become open ports.

- When a failure occurs in a link, all ports move to the failed state. When the alternate port receives the failure notification, the port changes to the open state forwarding all VLANs.

A regular segment port converted to an edge port, or an edge port converted to a regular segment port, does not always result in a topology change. If you convert an edge port into a regular segment port, VLAN load balancing is not implemented unless it has been configured. For VLAN load balancing, you must configure two edge ports in the segment.

A segment port that is reconfigured as a spanning tree port restarts according to the spanning tree configuration. By default, this port is a designated blocking port. If the PortFast BPDU Guard Enhancement feature is configured or if STP is disabled, the port goes into the forwarding state.

REP Integrated with VPLS

Normally, in a Virtual Private LAN Service (VPLS) network core, all nodes are connected in a full-mesh topology and each node has connectivity to all other nodes. In the full-mesh topology, there is no need for a node to retransmit data to another node. In Figure 3, the common ring provides a path where the packet can be forwarded to another network provider edge (N-PE) router, breaking split horizon model.

REP emulates a common link connection the REP ring supports the VPLS full-mesh model, but maintains the split horizon properties so the super-loop does not exist. The emulated common link uses the Clustering over the WAN (CWAN) line card, which is also used for the VPLS uplink. This emulated common link forwards data from the ring to either the VPLS uplink or to the other side of the ring; blocks data coming from the VPLS core network; and handles access to pseudowire for Hierarchical-VPLS (H-VPLS) topologies.

Default REP Configuration

REP is disabled on all interfaces. When enabled, the interface is a regular segment port unless it is configured as an edge port.

When REP is enabled, the sending of segment topology change notices (STCNs) is disabled, all VLANs are blocked, and the administrative VLAN is VLAN 1.

When VLAN load balancing is enabled, the default is manual preemption with the delay timer disabled. If VLAN load balancing is not configured, the default after manual preemption is to block all VLANs at the primary edge port.

REP Segments and REP Administrative VLANs

A segment is a collection of ports connected in a chain and configured with a segment ID. To configure REP segments, you should configure the REP administrative VLAN (or use the default VLAN 1) and then add ports to the segment in interface configuration mode. You should configure two edge ports in the segment, with one as the primary edge port and the other, by default, as the secondary edge port. A segment has only one primary edge port. If you configure two ports in a segment as primary edge ports, for example, ports on different switches, REP selects one of them to serve as the primary edge port. You can also optionally configure where to send segment STCNs and VLAN load balancing. For more information about configuring REP Administrative VLANs, see the *Configuring the REP Administrative VLAN* section.

REP Configuration Guidelines

Follow these guidelines when configuring REP:

- We recommend that you begin by configuring one port and then configure contiguous ports to minimize the number of segments and the number of blocked ports.
- If more than two ports in a segment fail when no external neighbors are configured, one port goes into a forwarding state for the data path to help maintain connectivity during configuration. In the **show rep interface** command output, the Port Role for this port shows as “Fail Logical Open”; the Port Role for the other failed port shows as “Fail No Ext Neighbor”. When the external neighbors for the failed ports are configured, the ports go through the alternate port state transitions and eventually go to an open state or remain as the alternate port, based on the alternate port selection mechanism.
- REP ports must be Layer 2 IEEE 802.1Q or Trunk EFP ports.
- We recommend that you configure all trunk ports in the segment with the same set of allowed VLANs.
- Be careful when configuring REP through a Telnet connection. Because REP blocks all VLANs until another REP interface sends a message to unblock it. You might lose connectivity to the router if you enable REP in a Telnet session that accesses the router through the same interface.
- You cannot run REP and STP on the same segment or interface.
- If you connect an STP network to a REP segment, be sure that the connection is at the segment edge. An STP connection that is not at the edge could cause a bridging loop because STP does not run on REP segments. All STP BPDUs are dropped at REP interfaces.
- If REP is enabled on two ports on a router, both ports must be either regular segment ports or edge ports. REP ports follow these rules:
 - If only one port on a router is configured in a segment, the port should be an edge port.
 - If two ports on a router belong to the same segment, both ports must be edge ports or must be regular segment ports.
 - If two ports on a router belong to the same segment and one is configured as an edge port and the other as a regular segment port (a misconfiguration), the edge port is treated as a regular segment port.
- REP interfaces come up in a blocked state and remain in a blocked state until they are safe to be unblocked. You need to be aware of this status to avoid sudden connection losses.
- REP ports cannot be configured as one of the following port types:
 - Switched Port Analyzer (SPAN) destination port
 - Tunnel port
 - Access port
- There can be a maximum of 22 REP segments per router.

REP Support on a Trunk EFP

Resilient Ethernet Protocol (REP) can be configured on Trunk EFP ports at the interface level on Cisco ASR 920 Series Router. Trunk EFP ports can have several bridged VLAN services running on them. Trunk EFP supports only 1000 VLANs. VLANs can be set to blocking and forwarding state on a Trunk EFP port. A user must enable REP on a port. By default, REP is disabled on all ports.

REP Configurable Timers

In a ring network topology, the Fast Last Link Status (LSL) process detects a neighboring port and maintains a connection with it. The timer on a port can be configured within 200-10000 ms to receive LSL frames. If no LSL frames are received from 200 to 10000 ms from the neighboring port, the link between routers is considered as down. The tear-down operation and action is taken to bring up the link and restore traffic.

In the ring network topology, REP might fail to converge the traffic within 50 ms. For example, if the topology is made of copper cable, REP might fail to converge the traffic due to hardware limitations of the copper interface. In such a scenario, a remote end can take up to 700 ms to detect shutdown failure of a local port. The REP LSL is enhanced to achieve higher timer granularity and faster failure detection on the remote side.

The figure below shows the delay in failure detection due to hardware limitation of a Copper interface.

Figure 3: Delay in Failure Detection

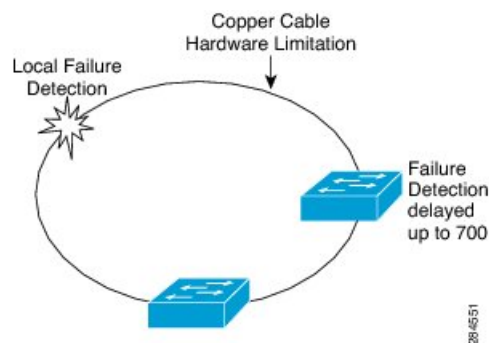

SSO Support for REP Fast Hello

When a router crashes, it takes between 3 to 5 seconds for the router to get into active mode and start sending REP Fast Hello packets. If the value of the age out timer configured by the **lsl age out timer** command is less than 3 seconds, the remote end detects a port failure and reconverges. After reconverging, the router sends out a BPDU with a special type, length, and, value (TLV) to the connected port. The router learns the port's local and remote sequence number so that the subsequent REP three-way link integrity check does not fail. The Stateful Switchover (SSO) support for REP ensures that a Fast Hello packet can be sent from the router before the LSL interval expires.

REP Edge No-Neighbor Support

In a ring network topology, aggregation nodes do not support REP. A REP segment can be created with no-neighbor ports to achieve convergence of switches. The figure below shows P1 and P2 as Edge No-Neighbor ports in a ring topology. In this configuration P1 and P2 can block traffic. If there is a failure on any of the links, all the switches with REP configuration converge. Since P1 and P2 are not edges, they do not support the following tasks:

- Perform VLAN load balancing.
- Detect topology changes to other segments and the Spanning Tree Protocol (STP).
- Choose the port that can preempt.
- Display the complete segment topology.

The Edge No-Neighbor support enables defining a new type of edge that has an internal neighbor. In the figure below, P1 and P2 are configured as Edge No-Neighbor ports rather than intermediate segment ports. These ports inherit properties of edge ports and overcome the limitations listed above. Thus, the Edge No-Neighbor port (P1 or P2) can send the Multiple Spanning Tree (MST) protocol, a Topology Change Notification (TCN), and a REP TCN for another segment towards the aggregation switch.

Figure 4: Ring Topology with Edge No-Neighbor Ports

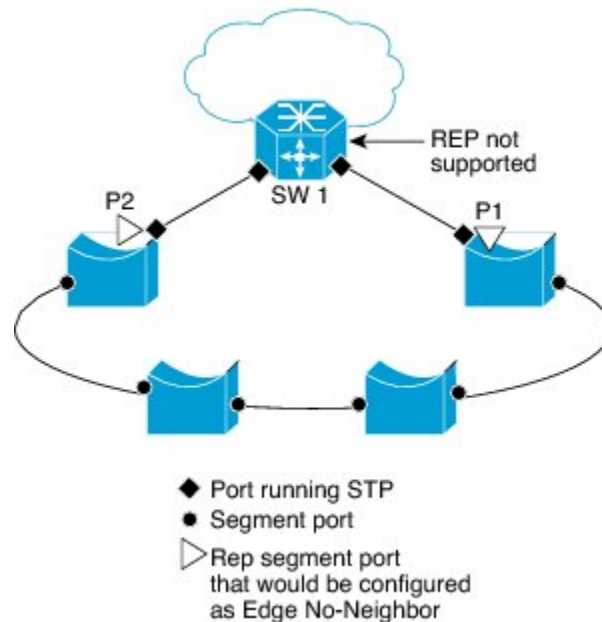

How to Configure REP

Configuring the REP Administrative VLAN

To avoid the delay introduced by relaying messages that are related to link-failures or VLAN-blocking notifications during VLAN load balancing, REP floods packets at the hardware flood layer (HFL) to a regular multicast address. These messages are flooded to the whole network and not just the REP segment. You can control flooding of these messages by configuring an administrative VLAN for the whole domain.

Follow these guidelines when configuring the REP administrative VLAN:

- There can be only one administrative VLAN on a router and on a segment. However, this is not enforced by the software.
- If you do not configure an administrative VLAN, the default is VLAN 1.
- If you want to configure REP on an interface, ensure that the REP administrative VLAN is part of the Trunk EFP encapsulation list.

SUMMARY STEPS

1. `enable`

2. **configure terminal**
3. **rep admin vlan** *vlan-id*
4. **end**
5. **show interface** [*interface-id*] **rep** [**detail**]
6. **copy running-config startup-config**

DETAILED STEPS

	Command or Action	Purpose
Step 1	enable Example: <pre>Router> enable</pre>	Enables privileged EXEC mode. <ul style="list-style-type: none"> • Enter your password if prompted.
Step 2	configure terminal Example: <pre>Router# configure terminal</pre>	Enters global configuration mode.
Step 3	rep admin vlan <i>vlan-id</i> Example: <pre>Router(config)# rep admin vlan 2</pre>	Configures a REP administrative VLAN. <ul style="list-style-type: none"> • Specify the administrative VLAN. The range is from 2 to 4094. The default is VLAN 1.
Step 4	end Example: <pre>Router(config)# end</pre>	Returns to privileged EXEC mode.
Step 5	show interface [<i>interface-id</i>] rep [detail] Example: <pre>Router# show interface gigabitethernet0/1 rep detail</pre>	Displays the REP configuration and status for a specified interface. <ul style="list-style-type: none"> • Enter the physical interface or port channel ID.
Step 6	copy running-config startup-config Example: <pre>Router# copy running-config startup-config</pre>	(Optional) Save your entries in the router startup configuration file.

Configuring Trunk EFP on an Interface

Before you begin

For the REP operation, you must configure Trunk EFP on an interface. This task is required and must be done before configuring REP support on a Trunk EFP.

SUMMARY STEPS

1. **enable**
2. **configure terminal**
3. **interface** *type number*
4. **service instance trunk** *service-instance-id* **ethernet**
5. **encapsulation dot1q vlan** *range*
6. **rewrite ingress tag pop 1 symmetric**
7. **bridge-domain from-encapsulation**
8. **end**

DETAILED STEPS

	Command or Action	Purpose
Step 1	enable Example: Router> enable	Enables privileged EXEC mode. <ul style="list-style-type: none">• Enter your password if prompted.
Step 2	configure terminal Example: Router# configure terminal	Enters global configuration mode.
Step 3	interface <i>type number</i> Example: Router(config)# interface GigabitEthernet 0/0/1	Specifies the interface, and enters interface configuration mode. <ul style="list-style-type: none">• Enter the interface ID.
Step 4	service instance trunk <i>service-instance-id</i> ethernet Example: Router(config-if)# service instance trunk 1 ethernet	Configures a service instance on an interface and enters service instance configuration mode.
Step 5	encapsulation dot1q vlan <i>range</i> Example: Router(config-if-srv)# encapsulation dot1q vlan 10	Defines the match criteria to be used to map dot1q frames ingress on an interface to the appropriate service instance. <ul style="list-style-type: none">• The range of VLAN-IDs is from 1 to 20.
Step 6	rewrite ingress tag pop 1 symmetric Example: Router(config-if-srv)# rewrite ingress tag pop 1 symmetric	Specifies the encapsulation adjustment to be performed on the frames ingress to the service instance.
Step 7	bridge-domain from-encapsulation Example: Router(config-if-srv)# bridge-domain from-encapsulation	Derives bridge domains from encapsulation.

	Command or Action	Purpose
Step 8	end Example: Router (config-if-srv)end	Returns to privileged EXEC mode.

Configuring REP Support on a Trunk EFP

Before you begin

For the REP operation, you must enable REP on each segment interface and identify the segment ID. This task is required and must be done before other REP configurations. You must also configure a primary and secondary edge port on each segment. All other steps are optional.

SUMMARY STEPS

1. **enable**
2. **configure terminal**
3. **interface** *interface type number*
4. **rep segment** *segment-id* [**edge** [**primary**]] [**preferred**]
5. **rep stcn** {**interface type number** | **segment id-list** | **stp**}
6. **rep block port** {**id port-id** | **neighbor-offset** | **preferred**} **vlan** {*vlan-list* | **all**}
7. **rep preempt delay** *seconds*
8. **end**
9. **show interface** *type number* **rep** [**detail**]
10. **copy running-config startup-config**

DETAILED STEPS

	Command or Action	Purpose
Step 1	enable Example: Router> enable	Enables privileged EXEC mode. <ul style="list-style-type: none"> • Enter your password if prompted.
Step 2	configure terminal Example: Router# configure terminal	Enters global configuration mode.
Step 3	interface <i>interface type number</i> Example: Router(config)# interface GigabitEthernet 0/0/1	Specifies the interface and enters interface configuration mode. <ul style="list-style-type: none"> • Enter the interface type and number.
Step 4	rep segment <i>segment-id</i> [edge [primary]] [preferred] Example: Router(config-if)# rep segment 3 edge preferred	Enables REP on the interface and identifies a segment number. <ul style="list-style-type: none"> • The segment ID range is from 1 to 1024.

	Command or Action	Purpose
		<p>Note You must configure two edge ports, including one primary edge port for each segment.</p> <ul style="list-style-type: none"> • (Optional) edge—Configures the port as an edge port. Each segment has only two edge ports. Entering the edge without the primary keyword configures the port as the secondary edge port. • (Optional) primary—Configures the port as the primary edge port, the port on which you can configure VLAN load balancing. <p>Note Although each segment can have only one primary edge port, if you configure edge ports on two different switches and enter the primary keyword on both switches, the configuration is valid. However, REP selects only one of these ports as the segment primary edge port. You can identify the primary edge port for a segment by entering the show rep topology privileged EXEC command.</p> <ul style="list-style-type: none"> • (Optional) preferred—Indicates that the port is the preferred alternate port or the preferred port for VLAN load balancing. <p>Note Configuring a port as preferred does not guarantee that it becomes the alternate port; it merely gives the port a slight edge over equal contenders. The alternate port is usually a previously failed port.</p>
<p>Step 5</p>	<p>rep stcn {interface <i>type number</i> segment <i>id-list</i> stp}</p> <p>Example:</p> <pre>Router(config-if)# rep stcn segment 2-5</pre>	<p>(Optional) Configures the edge port to send STCNs.</p> <ul style="list-style-type: none"> • Use the interface <i>type number</i> keyword-argument pair to designate a physical interface or port channel to receive STCNs. • Use the segment <i>id-list</i> keyword-argument pair to identify one or more segments to receive STCNs. The range is from 1 to 1024. • Enter the stp to send STCNs to STP networks.
<p>Step 6</p>	<p>rep block port {id <i>port-id</i> <i>neighbor-offset</i> preferred} vlan {<i>vlan-list</i> all}</p> <p>Example:</p> <pre>Router(config-if)# rep block port 0009001818D68700 vlan all</pre>	<p>(Optional) Configures VLAN load balancing on the primary edge port, identifies the REP alternate port in one of three ways, and configures the VLANs to be blocked on the alternate port.</p> <ul style="list-style-type: none"> • Enter the id <i>port-id</i> keyword-pair to identify the alternate port by port ID. The port ID is automatically

	Command or Action	Purpose
		<p>generated for each port in the segment. You can view interface port IDs by entering the show interface type number rep [detail] command.</p> <ul style="list-style-type: none"> • Enter a <i>neighbor-offset</i> number to identify the alternate port as a downstream neighbor from an edge port. The range is from -256 to 256, with negative numbers indicating the downstream neighbor from the secondary edge port. A value of 0 is invalid. Enter -1 to identify the secondary edge port as the alternate port. <p>Note Because you enter this command at the primary edge port (offset number 1), you cannot enter an offset value of 1 to identify an alternate port.</p> <ul style="list-style-type: none"> • Enter the preferred keyword to select the regular segment port previously identified as the preferred alternate port for VLAN load balancing. • Enter the vlan vlan-list keyword-argument pair to block one VLAN or a range of VLANs. • Enter the vlan all keyword to block all VLANs. • Execute this command multiple times to accommodate the desired set of VLANs. It works as append VLAN to the existing list instead of replacing an existing one. <p>Note Enter this command only on the REP primary edge port.</p>
Step 7	<p>rep preempt delay <i>seconds</i></p> <p>Example:</p> <pre>Router(config-if)# rep preempt delay 60</pre>	<p>(Optional) Configures a preempt time delay.</p> <ul style="list-style-type: none"> • Use this command if you want VLAN load balancing to automatically trigger after a link failure and recovery. • The time delay range is between 15 to 300 seconds. The default is manual preemption with no time delay. <p>Note Use this command only on the REP primary edge port.</p>
Step 8	<p>end</p> <p>Example:</p> <pre>Router(config-if-srv)# end</pre>	Returns to privileged EXEC mode.
Step 9	<p>show interface type number rep [detail]</p> <p>Example:</p>	(Optional) Verifies the REP interface configuration.

	Command or Action	Purpose
	Router# show interface GigabitEthernet0/0/1 rep detail	<ul style="list-style-type: none"> Enter the interface type and number and the optional detail keyword, if desired.
Step 10	copy running-config startup-config Example: Router# copy running-config startup-config	(Optional) Saves your entries in the router startup configuration file.

Setting the Preemption for VLAN Load Balancing

To set the preemption for VLAN load balancing, complete these steps on the router that has the segment with the primary edge port.

Restrictions

If you do not enter the **rep preempt delay** *seconds* command on the primary edge port to configure a preemption time delay, the default is to manually trigger VLAN load balancing on the segment. Use the **show rep topology** command to see which port in the segment is the primary edge port.

Before you begin

Be sure that all other segment configurations have been completed before setting the preemption for VLAN load balancing. When you enter the **rep preempt segment** *segment-id* command, a confirmation message appears before the command is executed because preemption for VLAN load balancing can disrupt the network.

SUMMARY STEPS

1. **enable**
2. **configure terminal**
3. **rep preempt segment** *segment-id*
4. **end**
5. **show rep topology**

DETAILED STEPS

	Command or Action	Purpose
Step 1	enable Example: Router> enable	Enables privileged EXEC mode. <ul style="list-style-type: none"> Enter your password if prompted.
Step 2	configure terminal Example: Router# configure terminal	Enters global configuration mode.
Step 3	rep preempt segment <i>segment-id</i>	Manually triggers VLAN load balancing on the segment.

	Command or Action	Purpose
	Example: <pre>Router(config)# rep preempt segment 1</pre>	<ul style="list-style-type: none"> Enter the segment ID. Note You will be asked to confirm the action before the command is executed.
Step 4	end Example: <pre>Router(config)# end</pre>	Returns to privileged EXEC mode.
Step 5	show rep topology Example: <pre>Router# show rep topology</pre>	Displays the REP topology information.

Configuring SNMP Traps for REP

You can configure the router to send REP-specific traps to notify the Simple Network Management Protocol (SNMP) server of link operational status changes and any port role changes.

SUMMARY STEPS

1. **enable**
2. **configure terminal**
3. **snmp mib rep trap-rate *value***
4. **end**
5. **show running-config**
6. **copy running-config startup-config**

DETAILED STEPS

	Command or Action	Purpose
Step 1	enable Example: <pre>Router> enable</pre>	Enables privileged EXEC mode. <ul style="list-style-type: none"> Enter your password if prompted.
Step 2	configure terminal Example: <pre>Router# configure terminal</pre>	Enters global configuration mode.
Step 3	snmp mib rep trap-rate <i>value</i> Example: <pre>Router(config)# snmp mib rep trap-rate 500</pre>	Enables the router to send REP traps, and sets the number of traps sent per second. <ul style="list-style-type: none"> Enter the number of traps sent per second. The range is from 0 to 1000. The default is 0 (no limit imposed; a trap is sent at every occurrence).

	Command or Action	Purpose
		Note To remove the traps, enter the no snmp mib rep trap-rate command.
Step 4	end Example: Router(config)# end	Returns to privileged EXEC mode.
Step 5	show running-config Example: Router# show running-config	(Optional) Displays the running configuration, which can be used to verify the REP trap configuration.
Step 6	copy running-config startup-config Example: Router# copy running-config startup-config	(Optional) Saves your entries in the router startup configuration file.

Monitoring the REP Configuration

SUMMARY STEPS

1. **enable**
2. **show interface** [*interface-id*] **rep** [**detail**]
3. **show rep topology** [**segment** *segment-id*] [**archive**] [**detail**]

DETAILED STEPS

	Command or Action	Purpose
Step 1	enable Example: Router> enable	Enables privileged EXEC mode. <ul style="list-style-type: none"> • Enter your password if prompted.
Step 2	show interface [<i>interface-id</i>] rep [detail] Example: Router# show interface gigabitethernet0/1 rep detail	(Optional) Displays the REP configuration and status for a specified interface. <ul style="list-style-type: none"> • Enter the physical interface or port channel ID, and the optional detail keyword, if desired.
Step 3	show rep topology [segment <i>segment-id</i>] [archive] [detail] Example: Router# show rep topology	(Optional) Displays REP topology information for a segment or for all segments, including the primary and secondary edge ports in the segment. <ul style="list-style-type: none"> • Enter the optional keywords and arguments, as desired.

Configuring REP Configurable Timers

Before you begin

For the REP operation, you must enable REP on each segment interface.

SUMMARY STEPS

1. **enable**
2. **configure terminal**
3. **interface** *type number*
4. **rep segment** *segment-id* [**edge** [**no-neighbor**] [**primary**]] [**preferred**]
5. **rep stcn** {**interface** *type number* | **segment** *id-list* | **stp**}
6. **rep block port** {**id** *port-id* | *neighbor-offset* | **preferred**} **vlan** {*vlan-list* | **all**}
7. **rep lsl-retries** *number-of-tries*
8. **rep lsl-age-timer** *timer-value*
9. **rep preempt delay** *seconds*
10. **end**
11. **show interface** *type number* **rep** [**detail**]
12. **copy running-config startup-config**

DETAILED STEPS

	Command or Action	Purpose
Step 1	enable Example: Router> enable	Enables privileged EXEC mode. <ul style="list-style-type: none">• Enter your password if prompted.
Step 2	configure terminal Example: Router# configure terminal	Enters global configuration mode.
Step 3	interface <i>type number</i> Example: Router(config)# interface GigabitEthernet 0/0/1	Specifies the interface and enters interface configuration mode. <ul style="list-style-type: none">• Enter the interface type and number.
Step 4	rep segment <i>segment-id</i> [edge [no-neighbor] [primary]] [preferred] Example: Router(config-if)# rep segment 1 edge preferred	Enables REP on the interface and identifies a segment number. <ul style="list-style-type: none">• The segment ID range is from 1 to 1024. Note You must configure two edge ports, including one primary edge port for each segment. <ul style="list-style-type: none">• (Optional) edge—Configures the port as an edge port. Each segment has only two edge ports. Entering the edge keyword without the primary keyword configures the port as the secondary edge port.

	Command or Action	Purpose
		<ul style="list-style-type: none"> • (Optional) no-neighbor—Configures the segment edge as one with no external REP neighbor on a port. • (Optional) primary—Configures the port as the primary edge port, the port on which you can configure VLAN load balancing. <p>Note Although each segment can have only one primary edge port, if you configure edge ports on two different switches and enter the primary keyword on both switches, the configuration is valid. However, REP selects only one of these ports as the segment primary edge port. You can identify the primary edge port for a segment by entering the show rep topology privileged EXEC command.</p> <ul style="list-style-type: none"> • (Optional) preferred—Indicates that the port is the preferred alternate port or the preferred port for VLAN load balancing. <p>Note Configuring a port as preferred does not guarantee that it becomes the alternate port; it merely gives the port a slight edge over equal contenders. The alternate port is usually a previously failed port.</p>
Step 5	<p>rep stcn {interface <i>type number</i> segment <i>id-list</i> stp}</p> <p>Example:</p> <pre>Router(config-if)# rep stcn segment 2-5</pre>	<p>(Optional) Configures the edge port to send STCNs.</p> <ul style="list-style-type: none"> • Use the interface <i>type number</i> keyword and arguments pair to designate a physical interface or port channel to receive STCNs. • Use the segment <i>id-list</i> keyword and arguments pair to identify one or more segments to receive STCNs. The range is from 1 to 1024. • Enter the stp keyword to send STCNs to STP networks.
Step 6	<p>rep block port {id <i>port-id</i> <i>neighbor-offset</i> preferred} vlan {<i>vlan-list</i> all}</p> <p>Example:</p> <pre>Router(config-if)# rep block port 0009001818D68700 vlan all</pre>	<p>(Optional) Configures VLAN load balancing on the primary edge port, identifies the REP alternate port in one of three ways, and configures VLANs to be blocked on the alternate port.</p> <ul style="list-style-type: none"> • Enter the id <i>port-id</i> keyword and arguments pair to identify the alternate port by port ID. The port ID is automatically generated for each port in the segment. You can view interface port IDs by entering the show interface <i>type number</i> rep [detail] command.

	Command or Action	Purpose
		<ul style="list-style-type: none"> Enter a <i>neighbor-offset</i> number to identify the alternate port as a downstream neighbor from an edge port. The range is from -256 to 256, with negative numbers indicating the downstream neighbor from the secondary edge port. A value of 0 is invalid. Enter -1 to identify the secondary edge port as the alternate port. <p>Note Because you enter this command at the primary edge port (offset number 1), you cannot enter an offset value of 1 to identify an alternate port.</p> <ul style="list-style-type: none"> Enter the preferred keyword to select the regular segment port previously identified as the preferred alternate port for VLAN load balancing. Enter the vlan vlan-list keyword and arguments pair to block one VLAN or a range of VLANs. Enter the vlan all keyword to block all VLANs. Execute this command multiple times to accommodate the desired set of VLANs. It works as append VLAN to the existing list instead of replacing an existing one. <p>Note Enter this command only on the REP primary edge port.</p>
Step 7	rep lsl-retries <i>number-of-tries</i> Example: <pre>Router(config-if)# rep lsl-retries 3</pre>	Configures the number of retries permitted by LSL.
Step 8	rep lsl-age-timer <i>timer-value</i> Example: <pre>Router(config-if)# rep lsl-age-timer 200</pre>	Configures the failure detection time. <ul style="list-style-type: none"> The valid range is from 120 to 10000. We recommend that you configure the minimum range as 200 for better performance. While a lower value can help improve performance, any changes to this command must be carefully evaluated. Lowering the value indiscriminately may destabilize the system.
Step 9	rep preempt delay <i>seconds</i> Example: <pre>Router(config-if)# rep preempt delay 60</pre>	<ul style="list-style-type: none"> (Optional) Configures a preempt time delay. Use this command if you want VLAN load balancing to automatically trigger after a link failure and recovery. The time delay range is from 15 to 300 seconds. The default is manual preemption with no time delay.

	Command or Action	Purpose
		Note Use this command only on the REP primary edge port.
Step 10	end Example: Router(config-if-srv)# end	Returns to privileged EXEC mode.
Step 11	show interface type number rep [detail] Example: Router# show interface GigabitEthernet0/0/1 rep detail	(Optional) Displays the REP interface configuration. • Enter the interface type and number and the optional detail keyword, if desired.
Step 12	copy running-config startup-config Example: Router# copy running-config startup-config	(Optional) Saves your entries in the router startup configuration file.

Configuring REP as an Edge No-Neighbor Port

Before you begin

For the REP operation, you must enable REP on each segment interface.

SUMMARY STEPS

1. **enable**
2. **configure terminal**
3. **interface type number**
4. **rep segment segment-id [edge [no-neighbor] [primary]] [preferred]**

DETAILED STEPS

	Command or Action	Purpose
Step 1	enable Example: Router> enable	Enables privileged EXEC mode. • Enter your password if prompted.
Step 2	configure terminal Example: Router# configure terminal	Enters global configuration mode.
Step 3	interface type number Example: Router(config)# interface GigabitEthernet 0/0/1	Specifies the interface and enters interface configuration mode. • Enter the interface type and number.

	Command or Action	Purpose
Step 4	<p>rep segment <i>segment-id</i> [edge [no-neighbor] [primary]] [preferred]</p> <p>Example:</p> <pre>Router(config-if)# rep segment 1 edge no-neighbor preferred</pre>	<p>Enables REP on the interface and identifies a segment number.</p> <ul style="list-style-type: none"> The segment ID range is from 1 to 1024. <p>Note You must configure two edge ports, including one primary edge port for each segment.</p> <ul style="list-style-type: none"> (Optional) edge-Configures the port as an edge port. Each segment has only two edge ports. Entering edge without the primary keyword configures the port as the secondary edge port. (Optional) no-neighbor-Indicates the segment edge as one with no external REP neighbor on a port. (Optional) primary-Configures the port as the primary edge port, the port on which you can configure VLAN load balancing. <p>Note Although each segment can have only one primary edge port, if you configure edge ports on two different switches and enter the primary keyword on both switches, the configuration is valid. However, REP selects only one of these ports as the segment primary edge port. You can identify the primary edge port for a segment by entering the show rep topology privileged EXEC command.</p> <ul style="list-style-type: none"> (Optional) preferred-Indicates that the port is the preferred alternate port or the preferred port for VLAN load balancing. <p>Note Configuring a port as preferred does not guarantee that it becomes the alternate port; it merely gives the port a slight edge over equal contenders. The alternate port is usually a previously failed port.</p>

Example

Configuration Examples for REP

Configuring the REP Administrative VLAN

This example shows how to configure the administrative VLAN as VLAN 100.

```
Router# configure terminal
Router(config)# rep admin vlan 100
Router(config-if)# end
```

Configuring REP Support on a Trunk EFP

This example shows how to configure REP support on a Trunk EFP. An interface is configured as the primary edge port for segment 1 to send STCNs to segments 2 through 5; the alternate port is configured as the port with port ID 0009001818D68700 to block all VLANs after a preemption delay of 60 seconds after a segment port failure and recovery.

```
Router# configure terminal
Router(config)# interface gigabitethernet0/0/1
Router(config-if)# rep segment 1 edge primary
Router(config-if)# rep stcn segment 2-5
Router(config-if)# rep block port id 0009001818D68700 vlan all
Router(config-if)# rep preempt delay 60
Router(config-if)# service instance trunk 1 ethernet
Router(config-if-srv)# encapsulation dot1q
Router(config-if-srv)# rewrite ingress tag pop 1 symmetric
Router(config-if-srv)# bridge-domain from-encapsulation
Router(config-if-srv)# end
```

This example shows how to configure the VLAN blocking configuration as shown in the figure below. The alternate port is the neighbor with neighbor offset number 4. After manual preemption, VLANs 100 to 200 are blocked at this port and all other VLANs are blocked at the primary edge port E1 (Gigabit Ethernet port 0/0/1).

Figure 5: Example of VLAN Blocking

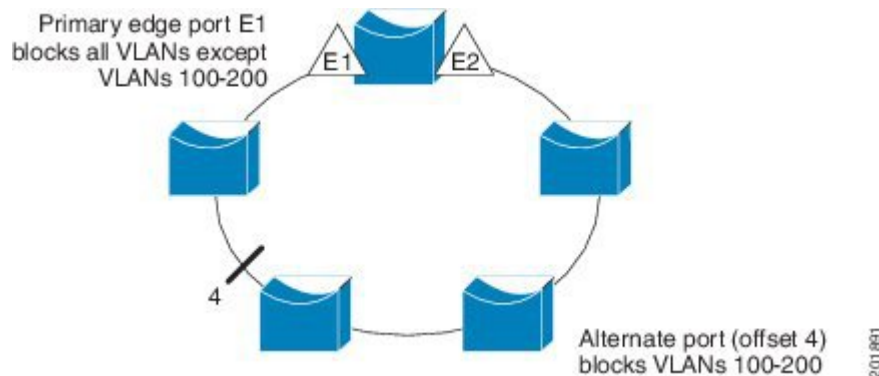

```
Router# configure terminal
Router(config)# interface gigabitethernet0/0/1
Router(config-if)# rep segment 1 edge primary
Router(config-if)# rep block port 4 vlan 100-200
Router(config-if)# end
```

Setting the Preemption for VLAN Load Balancing

```
Router>end
Router# configure terminal
Router(config)rep preempt segment 1
Router(config)# end
```

Configuring SNMP Traps for REP

This example shows how to configure the router to send REP traps at a rate of 10 traps per second:

```
Router> enable
Router# configure terminal
Router(config)# snmp mib rep trap-rate 10
Router(config)# end
```

Monitoring the REP Configuration

The following is sample output of the **show interface rep detail** command. Use the **show interface rep detail** command on one of the REP interfaces to monitor and verify the REP configuration.

```
Router# show interface GigabitEthernet 0/0/1 rep detail

GigabitEthernet0/1 REP enabled
Segment-id: 2 (Edge)
PortID: 00010019E7144680
Preferred flag: No
Operational Link Status: TWO_WAY
Current Key: 0002001121A2D5800E4D
Port Role: Open
Blocked Vlan: <empty>
Admin-vlan: 100
Preempt Delay Timer: disabled
Load-balancing block port: none
```

```

Load-balancing block vlan: none
STCN Propagate to: none
LSL PDU rx: 3322, tx: 1722
HFL PDU rx: 32, tx: 5
BPA TLV rx: 16849, tx: 508
BPA (STCN, LSL) TLV rx: 0, tx: 0
BPA (STCN, HFL) TLV rx: 0, tx: 0
EPA-ELECTION TLV rx: 118, tx: 118
EPA-COMMAND TLV rx: 0, tx: 0
EPA-INFO TLV rx: 4214, tx: 4190

```

Configuring REP Configurable Timers

```

Router# configure terminal
Router(config)# interface GigabitEthernet 0/0/4
Router(config-if)# rep segment 4 edge preferred
Router(config-if)# rep stcn segment 2-5
Router(config-if)# rep block port 0009001818D68700 vlan all
Router(config-if)# rep lsl-retries 3
Router(config-if)# rep lsl-age-timer 200
Router(config-if)# rep preempt delay 300
Router(config-if)# exit
Router# show interface GigabitEthernet 0/0/1 rep detail
Router# copy running-config startup-config

```

Configuring REP Edge No-Neighbor Support

```

Router> enable
Router# configure terminal
Router(config)# interface GigabitEthernet0/2
Router(config-if)# rep segment t1 edge no-neighbor primary

```

Additional References

Related Documents

Related Topic	Document Title
Cisco IOS commands	Cisco IOS Master Commands List, All Releases
LAN Switching commands: complete command syntax, command modes, command history, defaults, usage guidelines, and examples.	Cisco IOS LAN Switching Command Reference
Introduction to spanning tree protocols	Spanning Tree Protocol (STP)/802.1D
Spanning Tree PortFast BPDU Guard Enhancement feature	Spanning Tree PortFast BPDU Guard Enhancement

Technical Assistance

Description	Link
The Cisco Support and Documentation website provides online resources to download documentation, software, and tools. Use these resources to install and configure the software and to troubleshoot and resolve technical issues with Cisco products and technologies. Access to most tools on the Cisco Support and Documentation website requires a Cisco.com user ID and password.	http://www.cisco.com/cisco/web/support/index.html

Feature Information for Resilient Ethernet Protocol

The following table provides release information about the feature or features described in this module. This table lists only the software release that introduced support for a given feature in a given software release train. Unless noted otherwise, subsequent releases of that software release train also support that feature.

Use Cisco Feature Navigator to find information about platform support and Cisco software image support. To access Cisco Feature Navigator, go to www.cisco.com/go/cfn. An account on Cisco.com is not required.

Table 1: Feature Information for Resilient Ethernet Protocol

Feature Name	Releases	Feature Information
Resilient Ethernet Protocol	Cisco IOS XE Release 3.13.0S	This feature was introduced on the Cisco ASR 920 Series Aggregation Services Router (ASR-920-12CZ-A, ASR-920-12CZ-D, ASR-920-4SZ-A, ASR-920-4SZ-D).



CHAPTER 2

REP Access Gateway

Resilient Ethernet Protocol (REP) is a ring protection protocol designed to provide fast failure detection and recovery. A REP Edge No-Neighbor (RENN) port is a port at the edge of a REP segment, connected to a peer device that does not support REP. This feature allows CFM to notify REP when an error is detected, such that CFM can be used to monitor the status of the Edge link, and REP can take actions.

This feature allows communication for REP to enable Ethernet Fault Detection (EFD) notifications between the Cisco ASR 900 Series Routers and Cisco ASR 9000 Series Aggregation Services Routers configured with REP Access Gateway (REP-AG).

- [Prerequisites for REP Access Gateway, on page 27](#)
- [Restrictions for REP Access Gateway, on page 27](#)
- [Information About REP Access Gateway, on page 28](#)
- [How to Configure REP Access Gateway, on page 29](#)
- [Configuration Examples, on page 30](#)
- [Verifying REP Access Gateway, on page 31](#)
- [Additional References, on page 32](#)

Prerequisites for REP Access Gateway

- The interface connected to non-REP device port should be configured as a REP edgeNN port.
- CCM notification is processed only on a REP edgeNN port.
- Port MEP is only supported in REP AG. Port MEPs are configured to protect a single hop and used to monitor link state through CFM. See [Configuring Ethernet Connectivity Fault Management in a Service Provider Network](#).
- EFD is supported on down MEPs. A down MEP sends and receives CFM frames through the wire connected to the port on which the MEP is configured. See [Configuring Ethernet Connectivity Fault Management in a Service Provider Network](#).

Restrictions for REP Access Gateway

- REP AG is supported for only for Port MEPs.

- When a link down is observed between the REP and Non-REP device, the convergence time is greater with a Copper connection.
- EFD is supported on Port MEPs and EFP MEPs.
- CCM interval for MAs on which EFD is supported is limited.
- EFD is *not* supported on Trunk EFPs.
- EFD notifications are only supported for a single client per MA. EFD notifications are *not* supported for both G-8032 and REP simultaneously.
- Only a single MEP can be configured on a the interface or EFP for EFD.
- REP Edge No-Neighbour (ENN) configured ports receiving Link Status Layer (LSL) frames from the peer node will automatically be converted to REP ports.
You will see the log message **%REP-6-AUTOCONFIG: Interface GigabitEthernet<>** automatically configured to the REP device.
- REP is supported on port-channel interface, without **efd notify rep** (CCM).
- The convergence time is between 100miliseconds to 200miliseconds.

Information About REP Access Gateway

In a network when a link failure occurs, a Non-REP device network (access gateway) directly connected to REP network sends failure notification, so that REP network can reroute the traffic to alternate route. But, access devices supporting REP Edge No-Neighbor (REP ENN) only support one interface configured as a REP Edge No-Neighbor port resulting in an unsupported architecture with the REP Access Gateway (REP AG) device.

Fast failure detection can be established by enabling communication between Connectivity Fault Manager (CFM) and REP. CFM on the edge ports can notify REP if any failures are detected on the monitored links, allowing the appropriate re-convergence actions to be taken.

The mechanism for the communication is for REP to register as an Ethernet Fault Detection (EFD) client, so that any CFM defects above a configurable threshold triggers a notification to REP.



Note To trigger EFD notifications on the router, CFM must be configured.

REP Access Gateway Enhancements

In a network where a REP and non-REP devices are connected and when a link failure occurs, a Non-REP device network (access gateway) directly connected to REP network sends failure notification, so that REP network can reroute the traffic to an alternate route. But, access devices supporting REP Edge No-Neighbor (REP ENN) only support one interface configured as a REP Edge No-Neighbor port, resulting in an unsupported architecture with the REP Access Gateway (REP AG) device.

Fast failure detection in a REP-AG configured device can be achieved by enabling communication between Connectivity Fault Manager (CFM) and REP. CFM on the edge ports can notify REP if any failure is detected on the monitored links, allowing the appropriate re-convergence actions to be taken.

The mechanism for the communication is for REP to register as an Ethernet Fault Detection (EFD) client, so that any CFM defects above a configurable threshold triggers a notification to REP.

How to Configure REP Access Gateway

Enabling EFD Notifications

Before you begin

CFM IEEE must be enabled before enabling EFD notifications. For information, see [Configuring Ethernet Connectivity Fault Management in a Service Provider Network](#).

For information on CFM configuration, see [Carrier Ethernet Configuration Guide, Cisco IOS XE Release \(Cisco ASR 900 Series\)](#).

SUMMARY STEPS

1. **enable**
2. **configure terminal**
3. **ethernet cfm domain** *domain-name* **level** *level-id*
4. **service** {*short-ma-name* | **number** *MA-number* | **vlan-id** *primary-vlan-id* | **vpn-id** *vpn-id*} {**vlan** *vlan-id* | **port** | **evc** *evc-name*} **direction** {**up** | **down**}
5. **continuity-check** [**interval** *time* | **loss-threshold** *threshold* | **static rmp**]
6. **continuity-check** [**interval** *cc-interval*]
7. **efd notify** {**g8032** | **rep**}
8. **end**

DETAILED STEPS

	Command or Action	Purpose
Step 1	enable Example: Device> enable	Enables privileged EXEC mode. <ul style="list-style-type: none"> • Enter your password if prompted.
Step 2	configure terminal Example: Device# configure terminal	Enters global configuration mode.

	Command or Action	Purpose
Step 3	ethernet cfm domain <i>domain-name</i> level <i>level-id</i> Example: <pre>Router(config)# ethernet cfm domain Customer level 7</pre>	Defines a CFM maintenance domain at a specified maintenance level and places the CLI in Ethernet CFM configuration mode.
Step 4	service { <i>short-ma-name</i> number <i>MA-number</i> vlan-id <i>primary-vlan-id</i> vpn-id <i>vpn-id</i> } { vlan <i>vlan-id</i> port evc <i>evc-name</i> } direction { up down } Example: <pre>Device(config-ecfm)# service s1 port</pre>	Configures a maintenance association within a maintenance domain and enters Ethernet connectivity fault management (CFM) service configuration mode.
Step 5	continuity-check [interval <i>time</i> loss-threshold <i>threshold</i> static <i>rmep</i>] Example: <pre>Router(config-ecfm-srv)# continuity-check</pre>	Enables the transmission of CCMs.
Step 6	continuity-check [interval <i>cc-interval</i>] Example: <pre>Device(config-ecfm-srv)# continuity-check interval 10s</pre>	Configures the per-service parameters and sets the interval at which CCMs are transmitted.
Step 7	efd notify { g8032 rep } Example: <pre>Router(config)# efd notify rep</pre>	<ul style="list-style-type: none"> • g8032—Enables G.8032 notifications on the MA. • rep—Enables REP notifications on the MA. <p>Note Either g8032 or rep notifications can be configured for an MA at an instance. For example, if REP notifications are enabled while G.8032 notifications are enabled for an MA, the G.8032 notifications are disabled.</p>
Step 8	end Example: <pre>Device(config-erp-profile)# end</pre>	Returns to user EXEC mode.

Configuration Examples

Example: Configuring REP AG EFD

The example shows EFD notify enabled on the router.

```
ethernet cfm ieee
ethernet cfm global
```

```

ethernet cfm traceroute cache
ethernet cfm traceroute cache hold-time 60
ethernet cfm domain d1 level 6
  service s1 port
    continuity-check
    continuity-check interval 100ms
    efd notify rep
end
..
1

interface GigabitEthernet0/1/2
ethernet cfm mep domain d1 mpid 3 service s1
  service instance trunk 1 ethernet
  encapsulation dot1q 209-212
  rewrite ingress tag pop 1 symmetric
  bridge-domain from-encapsulation
end
..
!

interface GigabitEthernet0/1/3
ethernet cfm mep domain d1 mpid 4 service s1
  service instance trunk 1 ethernet
  encapsulation dot1q 209-212
  rewrite ingress tag pop 1 symmetric
  bridge-domain from-encapsulation
end
..
!
```

Verifying REP Access Gateway

Example: Verifying REP AG EFD Notifications

Use the **show interface** command to view the status EFD.

- This example shows EFD status on the interface .

```
Router# show interface gigabitethernet 0/1/7 rep detail
```

```

Interface Gi0/1/7
---
GigabitEthernet1/7  REP enabled

Segment-id: 1 (Primary Edge No-Neighbor)
PortID: 000DE8BA70DD3000
Preferred flag: No
Operational Link Status: NO_NEIGHBOR
Current Key: 001878DA6ED817002FF3
Port Role: Open
Blocked VLAN: empty
Admin-vlan: 2
Preempt Delay Timer: disabled
LSL Ageout Timer: 5000 ms
LSL Ageout Retries: 5
Configured Load-balancing Block Port: none
Configured Load-balancing Block VLAN: none
```

```

STCN Propagate to: STP
EFD State : Enabled
EFD Status : Clear
LSL PDU rx: 0, tx: 0
HFL PDU rx: 32, tx: 1
BPA TLV rx: 0, tx: 0
BPA (STCN, LSL) TLV rx: 0, tx: 0
BPA (STCN, HFL) TLV rx: 0, tx: 0
EPA-ELECTION TLV rx: 0, tx: 18
EPA-COMMAND TLV rx: 0, tx: 0
EPA-INFO TLV rx: 0, tx: 0

```

- This example shows REP topology.

```

Router# show rep topolgy

REP Segment 911
BridgeName      PortName      Edge Role
-----
node3           Te0/0/12     Pri* Alt
node3           Gi0/0/11           Open
node4           Gi0/0/11           Open
node4           Gi0/0/0           Open
node2           Gi0/0/0           Open
node2           Gi0/0/7     Sec* Open

```

- This example shows the CFM EFD MEP information.



Note Configure service internal in configuration mode before executing the **show ethernet cfm efd mep** command.

```

Router# show ethernet cfm efd mep

Domain dl, Service sl: notify REP, EFD not triggered
ID Interface  SrvcInst Defect      Threshold      Triggered?
-----
4 Te0/0/12   N/A       None        DefMACstatus  No

```

This example shows the CFM EFD MEP information when a fault is detected.

```

Router# show ethernet cfm efd meps | sec ring1
Domain dom1_ring1, Service ser1_ring1: notify REP, EFD not triggered
ID  Interface  SrvcInst  Defect      Threshold      Triggered?
----  -
3   Te0/0/12   NA        None        DefMACstatus  No

```

Additional References

Related Documents

Related Topic	Document Title
Cisco IOS master command list	Cisco IOS Master Command List , All Releases

Related Topic	Document Title
Carrier Ethernet Configuration Guide, Cisco IOS XE Release (Cisco ASR 900 Series)	Carrier Ethernet Configuration Guide, Cisco IOS XE Release (Cisco ASR 900 Series)

Standards

Standard	Title
No new or modified standards are supported, and support for existing standards has not been modified.	--

MIBs

MIB	MIBs Link
No new or modified MIBs are supported, and support for existing MIBs has not been modified.	To locate and download MIBs for selected platforms, Cisco IOS releases, and feature sets, use Cisco MIB Locator found at the following URL: http://www.cisco.com/go/mibs

RFCs

RFC	Title
No new or modified RFCs are supported, and support for existing RFCs has not been modified.	--

Technical Assistance

Description	Link
The Cisco Support and Documentation website provides online resources to download documentation, software, and tools. Use these resources to install and configure the software and to troubleshoot and resolve technical issues with Cisco products and technologies. Access to most tools on the Cisco Support and Documentation website requires a Cisco.com user ID and password.	http://www.cisco.com/cisco/web/support/index.html



CHAPTER 3

UniDirectional Link Detection (UDLD) Protocol

The UniDirectional Link Detection protocol is a Layer 2 protocol that detects and disables one-way connections before they create undesired situation such as Spanning Tree loops.

- [Restrictions for the UDLD Protocol, on page 35](#)
- [Information About the UDLD Protocol, on page 35](#)
- [How to Configure UDLD Protocol, on page 38](#)
- [Configuration Examples, on page 42](#)
- [Verifying UDLD Protocol, on page 42](#)

Restrictions for the UDLD Protocol

- Only Gigabit Ethernet, 10 Gigabit Ethernet, and Fast Ethernet interfaces are supported.
- Supports only the basic UDLD functions.

Information About the UDLD Protocol

UDLD Overview

The Cisco-proprietary UDLD protocol allows the devices connected through fiber optic or copper (for example, Category 5 cabling) Ethernet cables that are connected to the LAN ports to monitor the physical configuration of the cables and detect whether a unidirectional link exists. When a unidirectional link is detected, the UDLD shuts down the affected LAN port and alerts the corresponding user, because unidirectional links cause a variety of problems, including spanning tree topology loops.

UDLD is a Layer 2 protocol that works with the Layer 1 protocols to determine the physical status of a link. In Layer 1, auto negotiation takes care of physical signaling and fault detection. UDLD performs tasks that auto negotiation cannot perform, such as detecting the identities of neighbors and shutting down misconnected LAN ports. When you enable both auto negotiation and UDLD, the Layer 1 and Layer 2 detections work together to prevent physical and logical unidirectional connections and the malfunctioning of other protocols.

A unidirectional link occurs whenever the traffic transmitted by a local device over a link is received by a neighbor, but traffic transmitted from the neighbor is not received by the local device. If one of the fiber strands in a pair is disconnected, the link does not stay up as long as the auto negotiation is active. In such a scenario, the logical link is undetermined, and the UDLD does not take any action. If both the fibers are working normally in Layer 1, the UDLD in Layer 2 determines whether those fibers are connected correctly

and whether the traffic is flowing bidirectionally between the correct neighbors. This check cannot be performed by auto negotiation because auto negotiation operates in Layer 1.

The router periodically transmits the UDLD packets to the neighbor devices on LAN ports where UDLD is enabled. If the packets are echoed back within a specific timeframe and they are lacking a specific acknowledgment (echo), the link is flagged as unidirectional and the LAN port is shut down. Devices on both ends of the link must support UDLD for the protocol to successfully identify and disable the unidirectional links.

UDLD detects and disables unidirectional links on Ethernet fiber and copper interfaces due to miswiring or malfunctioning of the interfaces.



Note UDLD is disabled by default on all ports to avoid sending unnecessary traffic.

To configure fibre-optic interfaces, enable the **udld** command at the global level. For copper interfaces, enable the **udld port** command at the interface level.

The figure displays the UDLD mechanism.

Figure 6: Unidirectional Link

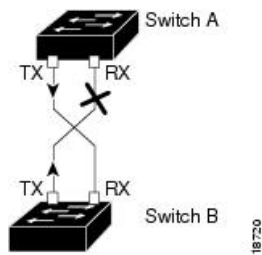

UDLD supports two modes of operation: normal (the default) and aggressive. In normal mode, UDLD can detect unidirectional links due to misconnected interfaces on fiber-optic connections. In aggressive mode, UDLD can also detect unidirectional links due to one-way traffic on fiber-optic and twisted-pair links and to misconnected interfaces on fiber-optic links.

UDLD Normal Mode

In normal mode, UDLD detects the unidirectional link when fiber strands in a fiber-optic interface are misconnected and the Layer 1 mechanisms do not detect this misconnection. If the interfaces are connected correctly, but the traffic is one way, UDLD does not detect the unidirectional link because the Layer 1 mechanism, which is supposed to detect this condition, does not do so. In case, the logical link is considered undetermined, and UDLD does not disable the interface. If one of the fiber strands in a pair is disconnected and autonegotiation is active, the link does not stay up because the Layer 1 mechanisms did not detect a physical problem with the link. In this case, UDLD does not take any action, and the logical link is considered undetermined.

UDLD Aggressive Mode

The UDLD aggressive mode is configured only on the point-to-point link between the network devices that support the UDLD aggressive mode. With UDLD aggressive mode enabled, a port on a bidirectional link that has a UDLD neighbor relationship established stops receiving the UDLD packets. The UDLD tries to re-establish the connection with the neighbor; the port is disabled after eight failed retries.

To prevent spanning tree loops, nonaggressive UDLD with the default interval of 15 seconds is fast enough to shut down a unidirectional link before a blocking port transitions to the forwarding state (with default spanning tree parameters).

The UDLD can error disable the ports on the link to prevent the traffic from being discarded under the following scenarios, when either of the modes is enabled. That is normal or aggressive mode:

- One side of a link has a port (either Tx and Rx) stuck.
- One side of a link remains up while the other side of the link has gone down.

UDLD Functions

UDLD performs the following functions

- Sends a probe packet on every active interface on which UDLD is configured to keep each device informed about its neighbors.
- Learns about the neighbors and keeps the updated neighbor information in a cache table
- Sends several echo messages whenever it detects a new neighbor sending UDLD packets or whenever a neighbor requests a resynchronization of the caches
- Shuts down the affected port and notifies the user when one-way connection is detected. Devices on both ends of the link must support UDLD in order for the protocol to successfully identify and disable unidirectional links
- Reestablishes the connection with the neighbor when a port on a bidirectional link stops receiving UDLD packets if aggressive mode is enabled. After eight failed retries, the port goes into disabled state

Detecting Unidirectional Links

UDLD operates by using two mechanisms:

Neighbor database maintenance

UDLD learns about other UDLD-capable neighbors by periodically sending a hello packet (also called an advertisement or probe) on every active interface to keep each device informed about its neighbors. When the switch receives a hello message, it caches the information until the age time (hold time or time-to-live) expires. If the switch receives a new hello message before an older cache entry ages, the switch replaces the older entry with the new one. Whenever an interface is disabled and UDLD is running, whenever UDLD is disabled on an interface, or whenever the switch is reset, UDLD clears all existing cache entries for the interfaces affected by the configuration change. UDLD sends at least one message to inform the neighbors to flush the part of their caches affected by the status change. The message is intended to keep the caches synchronized.

Event-driven detection and echoing

UDLD relies on echoing as its detection mechanism. Whenever a UDLD device learns about a new neighbor or receives a resynchronization request from an out-of-sync neighbor, it restarts the detection window on its side of the connection and sends echo messages in reply. Because this behavior is the same on all UDLD neighbors, the sender of the echoes expects to receive an echo in reply. If the detection window ends and no valid reply message is received, the link might shut down, depending on the UDLD mode. When UDLD is in normal mode, the link might be considered undetermined and might not be shut down. When UDLD is in

aggressive mode, the link is considered unidirectional, and the interface is shut down. If UDLD in normal mode is in the advertisement or in the detection phase and all the neighbor cache entries are aged out, UDLD restarts the link-up sequence to resynchronize with any potentially out-of-sync neighbors. If you enable aggressive mode when all the neighbors of a port have aged out either in the advertisement or in the detection phase, UDLD restarts the link-up sequence to resynchronize with any potentially out-of-sync neighbor. UDLD shuts down the port if, after the fast train of messages, the link state is still undetermined.

How to Configure UDLD Protocol

Enabling UDLD Protocol

SUMMARY STEPS

1. `enable`
2. `configure terminal`
3. `udld {enable | aggressive}`
4. `end`

DETAILED STEPS

	Command or Action	Purpose
Step 1	enable Example: Device> enable	Enables privileged EXEC mode. <ul style="list-style-type: none"> • Enter your password if prompted.
Step 2	configure terminal Example: Device# configure terminal	Enters global configuration mode.
Step 3	udld {enable aggressive} Example: Router(config)# udld enable	Enables UDLD protocol on the router.
Step 4	end Example: Device(config-erp-profile)# end	Returns to user EXEC mode.

Enabling UDLD Protocol at Interface Level

SUMMARY STEPS

1. `interface interface-id`

2. udld port [aggressive]

DETAILED STEPS

	Command or Action	Purpose
Step 1	interface <i>interface-id</i> Example: Router(config)# interface gigabitethernet0/0/1	Enter interface configuration mode. Valid interfaces are physical ports.
Step 2	udld port [aggressive] Example: Router(config)# udld port aggressive	Enables UDLD on a specific port. Enter the aggressive keyword to enable the aggressive mode. On a fiber-optic LAN port, this command overrides the udld enable global configuration command setting. Use the no form of this command to disable the UDLD on a non fiber-optic LAN port.

Enabling UDLD Protocol at Interface Level

SUMMARY STEPS

1. enable
2. configure terminal
3. interface *interface-id*
4. udld port [aggressive]
5. end

DETAILED STEPS

	Command or Action	Purpose
Step 1	enable Example: Device> enable	Enables privileged EXEC mode. <ul style="list-style-type: none"> • Enter your password if prompted.
Step 2	configure terminal Example: Device# configure terminal	Enters global configuration mode.
Step 3	interface <i>interface-id</i> Example: Router(config)# interface gigabitethernet0/0/1	Enter interface configuration mode. Valid interfaces are physical ports.
Step 4	udld port [aggressive] Example:	Enables UDLD on a specific port. Enter the aggressive keyword to enable the aggressive mode. On a fiber-optic

	Command or Action	Purpose
	Router(config)# udld port aggressive	LAN port, this command overrides the udld enable global configuration command setting. Use the no form of this command to disable the UDLD on a non fiber-optic LAN port.
Step 5	end Example: Device(config-erp-profile)# end	Returns to user EXEC mode.

Enabling UDLD Probe Message Interval

SUMMARY STEPS

1. enable
2. configure terminal
3. udld message time *interval*
4. end

DETAILED STEPS

	Command or Action	Purpose
Step 1	enable Example: Device> enable	Enables privileged EXEC mode. • Enter your password if prompted.
Step 2	configure terminal Example: Device# configure terminal	Enters global configuration mode.
Step 3	udld message time <i>interval</i> Example: Router(config)# udld message time 90	Set the time in seconds between UDLD probe messages. The valid range is from 7 to 90 seconds. The default is 15 seconds
Step 4	end Example: Device(config-erp-profile)# end	Returns to user EXEC mode.

Recovering the UDLD Protocol

UDLD recovery when enabled, attempts to bring an UDLD error-disabled port out of reset. The default recovery timer is 300 seconds.

SUMMARY STEPS

1. **enable**
2. **configure terminal**
3. **udld recovery *interval***
4. **end**

DETAILED STEPS

	Command or Action	Purpose
Step 1	enable Example: Device> enable	Enables privileged EXEC mode. <ul style="list-style-type: none"> • Enter your password if prompted.
Step 2	configure terminal Example: Device# configure terminal	Enters global configuration mode.
Step 3	udld recovery <i>interval</i> Example: Router(config)# udld recovery	Enables UDLD recovery on the router. <ul style="list-style-type: none"> • <i>interval</i>—Sets the recovery time interval. The valid range is from 30 to 86400 seconds. The default value is 300 seconds.
Step 4	end Example: Device(config-erp-profile)# end	Returns to user EXEC mode.

Resetting Ports

SUMMARY STEPS

1. **enable**
2. **udld reset**
3. **end**

DETAILED STEPS

	Command or Action	Purpose
Step 1	enable	Enables privileged EXEC mode.

	Command or Action	Purpose
	Example: Device> enable	<ul style="list-style-type: none"> Enter your password if prompted.
Step 2	udld reset Example: Router# udld reset	Resets ports that are shut down by UDLD.
Step 3	end Example: Device(config-erp-profile)# end	Returns to user EXEC mode.

Configuration Examples

Example: Configuring UDLD Protocol

This example shows UDLD on the router.

```
show running-config | i udld
udld enable
udld message time 7
udld recovery
udld recovery interval 30
```

Verifying UDLD Protocol

Example: Verifying UDLD Protocol

Use the **show udld** command to view the status of the UDLD protocol on the ports.

- This example shows UDLD protocol on all ports the router.

```
Router# show udld
  Interface Te0/0/0
  ---
  Port enable administrative configuration setting: Follows device default
  Port enable operational state: Enabled
  Current bidirectional state: Bidirectional
  Current operational state: Advertisement - Single neighbor detected
  Message interval: 15
  Time out interval: 5

  Entry 1
  ---
  Expiration time: 40
  Cache Device index: 1
  Current neighbor state: Bidirectional
  Device ID: FOX1736P0JP
```



```
Port ID: Te0/1/0
Neighbor echo 1 device: FOX1709P3D0
Neighbor echo 1 port: Te0/0/0

Message interval: 15
Time out interval: 5
CDP Device name: RSP1B

Interface Gi0/2/0
---
Port enable administrative configuration setting: Follows device default
Port enable operational state: Enabled
Current bidirectional state: Bidirectional
Current operational state: Advertisement - Single neighbor detected
Message interval: 15
Time out interval: 5

Entry 1
---
Expiration time: 33
Cache Device index: 1
Current neighbor state: Bidirectional
Device ID: FOC1528V27K
Port ID: Gi0/2
Neighbor echo 1 device: FOX1709P3D0
Neighbor echo 1 port: Gi0/2/0

Message interval: 15
Time out interval: 5
CDP Device name: RSP1A

Interface Gi0/2/1
---
Port enable administrative configuration setting: Follows device default
Port enable operational state: Enabled
Current bidirectional state: Bidirectional
Current operational state: Advertisement - Single neighbor detected
Message interval: 15
Time out interval: 5

Entry 1
---
Expiration time: 33
Cache Device index: 1
Current neighbor state: Bidirectional
Device ID: FOC1639V1Z4
Port ID: Gi0/4
Neighbor echo 1 device: FOX1709P3D0
Neighbor echo 1 port: Gi0/2/1

Message interval: 15
Time out interval: 5
CDP Device name: RSP1A

Interface Gi0/2/2
---
Port enable administrative configuration setting: Follows device default
Port enable operational state: Enabled
Current bidirectional state: Unknown
Current operational state: Advertisement
Message interval: 15
Time out interval: 5
No neighbor cache information stored
```

```

Interface Gi0/2/3
---
Port enable administrative configuration setting: Follows device default
Port enable operational state: Enabled
Current bidirectional state: Unknown
Current operational state: Link down
Message interval: 15
Time out interval: 5
No neighbor cache information stored

Interface Gi0/2/4
---
Port enable administrative configuration setting: Follows device default
Port enable operational state: Disabled
Current bidirectional state: Unknown

Interface Gi0/2/5
---
Port enable administrative configuration setting: Disabled
Port enable operational state: Disabled
Current bidirectional state: Unknown

Interface Gi0/2/6
---
Port enable administrative configuration setting: Disabled
Port enable operational state: Disabled
Current bidirectional state: Unknown
.
.
.

```

- This example shows UDLD protocol on the Ten Gigabit Ethernet interface.

```

Router# show udld tengigabitethernet 0/0/0

Interface Te0/0/0
---
Port enable administrative configuration setting: Follows device default
Port enable operational state: Enabled
Current bidirectional state: Bidirectional
Current operational state: Advertisement - Single neighbor detected
Message interval: 15
Time out interval: 5

Entry 1
---
Expiration time: 43
Cache Device index: 1
Current neighbor state: Bidirectional
Device ID: FOX1736P0JP
Port ID: Te0/1/0
Neighbor echo 1 device: FOX1709P3D0
Neighbor echo 1 port: Te0/0/0

Message interval: 15
Time out interval: 5
CDP Device name: RSP1B

Router# show running-config | i udld
udld enable
udld message time 15
udld recovery
udld recovery interval 30

```

- This example shows the UDLD protocol neighbors.

```
Router# show udld neighbors
```

Port	Device Name	Device ID	Port ID	Neighbor State
Te0/0/0	FOX1736P0JP	1	Te0/1/0	Bidirectional
Gi0/2/0	FOC1528V27K	1	Gi0/2	Bidirectional
Gi0/2/1	FOC1639V1Z4	1	Gi0/4	Bidirectional



CHAPTER 4

Configuring Auto Media Sense

Cisco ASR 920 Series (ASR-920-12CZ-A and ASR-920-12CZ-D) supports eight dual media ports. The dual media ports can operate either in RJ45 mode or in SFP (fiber) mode. The AMS detects the presence of a link activity on any of the media dual ports, and enables the link for communication. By default, if there is no link connection, the link state goes down. When media is connected, the AMS detects the connection, establishes the link, and brings the link state to UP. When for the same port, both RJ45 and fiber links are connected, the port goes UP in the fiber mode.

- [Restrictions for Configuring Auto Media Sense, on page 47](#)
- [Information About Auto Media Sense, on page 47](#)
- [How to Configure Auto Media Sense, on page 48](#)

Restrictions for Configuring Auto Media Sense

- When the media-type is changed from RJ45 to SFP or vice versa with 100% line rate, the port goes DOWN. The workaround is to stop the traffic, and to perform shut/no shut operation on the port.
- By default, the auto negotiation is always enabled when the media-type is selected as auto-select.
- For ports 4 to 11, the same port cannot be used as RJ45 or SFP at the same time.

Information About Auto Media Sense

Dual-media is the support given at the PHY level. The Cisco ASR 920 Series (ASR-920-12CZ-A and ASR-920-12CZ-D) supports eight dual media ports. All the media type modes are driven through IOS Interface configuration command:

- Media-type 'auto' is for auto-media sense
- Media-type 'rj45' is for rj45 mode
- Media-type 'sfp' is for SFP mode.

Port numbers from 4 - 11 can operate either in RJ45 or in Fiber mode.

Table 2: Cisco ASR 920 Series Front Panel Port mapping

1G SFP Only	1G AMS Ports	10G SFP+
-------------	--------------	----------

1	3	5	7	9	11	5x	7x	9x	11x	13
0	2	4	6	8	10	4x	6x	8x	10x	12

How to Configure Auto Media Sense

Configuring Media-Type

SUMMARY STEPS

1. `enable`
2. `configure terminal`
3. `interface interface-id`
4. `media-type {auto-select | rj45 | sfp}`
5. `end`

DETAILED STEPS

	Command or Action	Purpose
Step 1	<code>enable</code> Example: Router> <code>enable</code>	Enables privileged EXEC mode. <ul style="list-style-type: none">• Enter your password if prompted.
Step 2	<code>configure terminal</code> Example: Router# <code>configure terminal</code>	Enters global configuration mode.
Step 3	<code>interface interface-id</code> Example: Router(config)# <code>interface gigabitEthernet 0/0/5</code>	Specify the dual-media port to be configured, and enter interface configuration mode.
Step 4	<code>media-type {auto-select rj45 sfp}</code> Example: Router (config-if)# <code>media-type sfp</code>	Select the interface and type of a dual-media uplink port. The keywords mean the following: <ul style="list-style-type: none">• auto-select—The switch dynamically selects the type. When both RJ-45 and SFP modules are up, port goes UP in SFP mode. The port switches over to RJ-45 mode, when the link in SFP module goes down. When the SFP module link is up, the mode is switched back from RJ-45 to SFP. In auto-select mode, the switch configures both types with autonegotiation of speed and duplex (the default). This is the default media-type configured on the AMS port.• rj45—The switch disables the SFP module interface. If you connect an SFP module to this port, it cannot attain a link even if the RJ-45 side is down or is not

	Command or Action	Purpose
		<p>connected. In this mode, the dual-purpose port behaves like a 10/100/1000BASE-TX interface. You can configure the speed and duplex settings consistent with this interface type.</p> <ul style="list-style-type: none"> • sfp—The switch disables the RJ-45 interface. If you connect a cable to the RJ-45 port, it cannot attain a link even if the SFP module side is down or if the SFP module is not present. Based on the type of installed SFP module, you can configure the speed and duplex settings consistent with this interface type.
Step 5	<p>end</p> <p>Example:</p> <pre>Router(config-if)# end</pre>	Return to privileged EXEC mode.

Configuration Example

```
Router> enable
Router# configure terminal
Router(config)# interface gigabitEthernet 0/0/5
Router (config-if)# media-type sfp
Router(config-if)# end
```

Verifying Media-Type

SUMMARY STEPS

1. **enable**
2. **show running-config interface *interface-id***
3. **show interface *interface-id***

DETAILED STEPS

	Command or Action	Purpose
Step 1	<p>enable</p> <p>Example:</p> <pre>Router> enable</pre>	<p>Enables privileged EXEC mode.</p> <ul style="list-style-type: none"> • Enter your password if prompted.
Step 2	<p>show running-config interface <i>interface-id</i></p> <p>Example:</p> <pre>Router> show running-config interface gigabitEthernet 0/0/6</pre>	This displays the media-type configured on the port.

	Command or Action	Purpose
Step 3	show interface <i>interface-id</i> Example: Router> show interface gigabitEthernet 0/0/6	This displays the media-type in which the port is operating.

Example for Verifying Media-Type Configuration

This example shows how to verify the media-type configuration

Part I

```
Router> enable
Router>show running-config interface gigabitEthernet 0/0/5
Building configuration...

Current configuration : 95 bytes
!
interface GigabitEthernet0/0/5
 no ip address
 media-type auto-select
 negotiation auto
Router> end
```

Part II

```
Router> enable
Router> show interfaces gigabitEthernet 0/0/5
GigabitEthernet0/0/5 is up, line protocol is up
 Hardware is 12xGE-2x10GE-FIXED, address is badb.adba.de85 (bia badb.adba.de85)
 MTU 1500 bytes, BW 1000000 Kbit/sec, DLY 10 usec,
   reliability 255/255, txload 1/255, rxload 1/255
 Encapsulation ARPA, loopback not set
 Keepalive set (10 sec)
 Full Duplex, 1000Mbps, link type is auto, media type is SX
 output flow-control is off, input flow-control is on
 ARP type: ARPA, ARP Timeout 04:00:00
 Last input never, output never, output hang never
 Last clearing of "show interface" counters never
 Input queue: 0/375/0/0 (size/max/drops/flushes); Total output drops: 0
 Queueing strategy: fifo.

Router> end
```



Note The media type is:

- SX—when GLC-SX-SMD is connected.
- ZX—when GLC-ZX-SMD is connected.
- RJ45—when copper mode is connected.

Troubleshooting Media-Type Configuration

The `show platform software agent iomd 0/0 phy <port_num> 1 14` command is used to determine the media-type at the PHY level for a specific port.

```
Router> enable
Router# show platform software agent iomd 0/0 phy 5 1 14

Port Number: 5
Device/Page: 0x1
Register   : 0x14
Value      : 0xa084
```



Note The value of the register determines the media-type configuration:

- 0xa084—then port is operating in SFP mode.
 - 0xa045—then the port is operating in RJ45 mode.
-



CHAPTER 5

Configuring Flex Links

This chapter describes how to configure Flex Links, a pair of Layer 2 interfaces, where one interface is configured to act as a backup to the other.

- [Restrictions for Configuring Flex Links, on page 53](#)
- [Information About Flex Links, on page 53](#)
- [Additional References, on page 60](#)

Restrictions for Configuring Flex Links

- You can configure only one Flex Link backup link for any active link, and it must be a different interface from the active interface.
- An interface can belong to only one Flex Link pair. An interface can be a backup link for only one active link. An active link cannot belong to another Flex Link pair.
- Neither of the links can be a port that belongs to an EtherChannel nor port channel
- A backup link does not have to be the same type (Fast Ethernet, Gigabit Ethernet) as the active link.
- STP is disabled on Flex Link ports. If STP is configured on the switch, Flex Links do not participate in STP in all VLANs in which STP is configured. With STP not running, be sure that there are no loops in the configured topology.
- Flex link is only supported on trunk EFP.
- In bi-directional traffic, FlexLink Convergence will be high in one-direction due to mac address black holing.

Information About Flex Links

The feature provides an alternative solution to the Spanning Tree Protocol (STP), allowing you to turn off STP and still provide basic link redundancy. Flex Links are typically configured in service provider or enterprise networks, where, you do not want to run STP on the router. If the router is running STP, it is not necessary to configure Flex Links, because STP already provides link-level redundancy or backup. Flex Links are supported only on Trunk EFP and are not supported on other EVCs.

Following are the two flex link modes supported:

- Active-Alone Forwarding Method
- Active-Backup-Both Forwarding Method

Active-Alone forwarding Method

From the schematic representation, ports 1 and 2 on switch A are connected to uplink switches B and C. Because they are configured as Flex Link in active-backup both forwarding mode, both the interfaces will be forwarding traffic. If port 1 is the active link, all mutually inclusive VLANs (common VLANs configured in both active / backup interface) would be forwarded on active interface and mutually exclusive VLANs would be forwarded from the respective active / backup interfaces. If port 1 goes down, then port 2 will start forwarding only the traffic for the common VLANs along with its specific exclusive vlans. All traffic belonging to the exclusive VLANs as part of active interface configuration would be dropped until port 1 comes back to operational state.

Figure 7: Active-Alone Forwarding Method

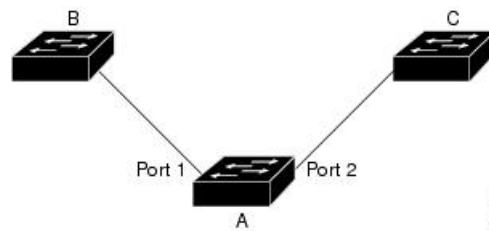

Configuring Active Alone Forwarding Method

SUMMARY STEPS

1. **enable**
2. **configure terminal**
3. **interface *interface-id***
4. **no shutdown**
5. **ethernet backup interface *interface-id***
6. **end**

DETAILED STEPS

	Command or Action	Purpose
Step 1	enable Example: Router> enable	Enables privileged EXEC mode. <ul style="list-style-type: none"> • Enter your password if prompted.
Step 2	configure terminal Example: Router# configure terminal	Enters global configuration mode.

	Command or Action	Purpose
Step 3	interface <i>interface-id</i> Example: Router(config)# interface gigabitEthernet 0/0/5	Specify the interface, and enter interface configuration mode. The interface can be a physical Layer 2 interface or a port channel (logical interface). The port-channel range is 1 to 48.
Step 4	no shutdown Example: Router(config-if)# no shutdown	Enable the port, if necessary. By default, UNIs are disabled, and NNIs are enabled.
Step 5	ethernet backup interface <i>interface-id</i> Example: Router(config)# ethernet backup interface gigabitEthernet 0/0/5	Configure a physical Layer 2 interface (or port channel) as part of a Flex Link pair with the interface. When one link is forwarding traffic, the other interface is in standby mode.
Step 6	end Example: Router(config-if)# end	Return to privileged EXEC mode.

Configuration Example

On Active interface (Port 5)

```
Router> enable
Router# configure terminal
Router# service instance trunk 1000 ethernet
Router# encapsulation dot1q 1-1000
Router# rewrite ingress tag pop 1 symmetric
Router# bridge-domain from-encapsulation
```

Backup interface (Port 6)

```
Router> enable
Router# configure terminal
Router# service instance trunk 1000 ethernet
Router# encapsulation dot1q 1-1000
Router# rewrite ingress tag pop 1 symmetric
Router# bridge-domain from-encapsulation
```

Flexlink Configuration

```
Router> enable
Router# configure terminal
Router(config)# interface gigabitEthernet 0/0/5
Router(config-if)# no shutdown
Router(config-if)# ethernet backup interface gigabitEthernet 0/0/6
Router(config-if)# end
```

Verifying Active Alone Forwarding Method Configuration

SUMMARY STEPS

1. enable
2. configure terminal
3. show ethernet backup detail

DETAILED STEPS

	Command or Action	Purpose
Step 1	enable Example: Router> enable	Enables privileged EXEC mode. <ul style="list-style-type: none"> • Enter your password if prompted.
Step 2	configure terminal Example: Router# configure terminal	Enters global configuration mode.
Step 3	show ethernet backup detail Example: Router# show ethernet backup detail	This displays the flex link configuration.

Configuration Output

```
Switch Backup Interface Pairs:
Active Interface      Backup Interface      State
-----
GigabitEthernet0/0/5  Te0/0/12              Active Up/Backup Standby
  Preemption Mode    : off
  Multicast Fast Convergence : Off
  Bandwidth : 1000000 Kbit (Gi0/0/3), 1000000 Kbit (Te0/0/12)
  Mac Address Move Update Vlan : auto
  Forwarding : Active-Only
```

Active-Backup-Both forwarding Method

From the schematic representation, ports 1 and 2 on switch A are connected to uplink switches B and C. Because they are configured as Flex Link in active-backup both forwarding mode, both the interfaces will be forwarding traffic. If port 1 is the active link, all mutually inclusive vlans (common vlans configured in both active / backup interface) would be forwarded on active interface and mutually exclusive vlans would be forwarded from the respective active / backup interfaces. If port 1 goes down, then port 2 will start forwarding only the traffic for the common vlans along with its specific exclusive vlans. All traffic belonging to the exclusive vlans as part of active interface configuration would be dropped until port 1 comes back to operational state.

Figure 8: Active-Backup-Both Forwarding Method

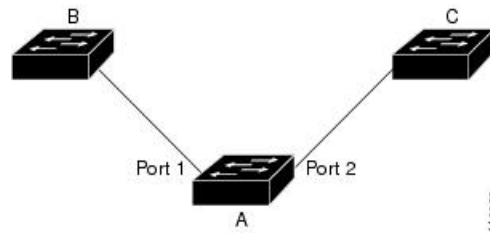

Configuring Active Backup Both Forwarding Method

SUMMARY STEPS

1. **enable**
2. **configure terminal**
3. **interface** *interface-id*
4. **no shutdown**
5. **ethernet backup interface** *interface-id* **prefer forwarding**
6. **end**

DETAILED STEPS

	Command or Action	Purpose
Step 1	enable Example: Router> enable	Enables privileged EXEC mode. <ul style="list-style-type: none">• Enter your password if prompted.
Step 2	configure terminal Example: Router# configure terminal	Enters global configuration mode.
Step 3	interface <i>interface-id</i> Example: Router(config)# interface gigabitEthernet 0/0/8	Specify the interface, and enter interface configuration mode. The interface can be a physical Layer 2 interface or a port channel (logical interface). The port-channel range is 1 to 48.
Step 4	no shutdown Example: Router(config-if)# no shutdown	Enable the port, if necessary. By default, UNIs are disabled, and NNIs are enabled.
Step 5	ethernet backup interface <i>interface-id</i> prefer forwarding Example: Router(config)# ethernet backup interface gigabitEthernet 0/0/8 prefer forwarding	Configure a physical Layer 2 interface (or port channel) as part of a Flex Link pair with the interface. When one link is forwarding traffic, the other interface is in standby mode.
Step 6	end Example:	Return to privileged EXEC mode.

	Command or Action	Purpose
	Router(config-if)# end	

Configuration Example

On Active interface (Port 7)

```
Router> enable
Router# configure terminal
Router# service instance trunk 1000 ethernet
Router# encapsulation dot1q 1-512
Router# rewrite ingress tag pop 1 symmetric
Router# bridge-domain from-encapsulation
```

Backup interface (Port 8)

```
Router> enable
Router# configure terminal
Router# service instance trunk 1000 ethernet
Router# encapsulation dot1q 512-1000
Router# rewrite ingress tag pop 1 symmetric
Router# bridge-domain from-encapsulation
```

Flexlink Configuration

```
Router> enable
Router# configure terminal
Router(config)# interface gigabitEthernet 0/0/8
Router(config-if)# no shutdown
Router(config-if)# ethernet backup interface gigabitEthernet 0/0/8 prefer forwarding

Router(config-if)# end
```

Verifying Active-Backup-Both Forwarding Method Configuration

SUMMARY STEPS

1. enable
2. configure terminal
3. show ethernet backup detail

DETAILED STEPS

	Command or Action	Purpose
Step 1	enable Example: Router> enable	Enables privileged EXEC mode. • Enter your password if prompted.

	Command or Action	Purpose
Step 2	configure terminal Example: Router# configure terminal	Enters global configuration mode.
Step 3	show ethernet backup detail Example: Router# show ethernet backup detail	This displays the flex link configuration.

Configuration Output

```

Switch Backup Interface Pairs:
Active Interface      Backup Interface      State
-----
GigabitEthernet0/0/3  Te0/0/12              Active Up/Backup Standby
  Preemption Mode    : off
  Multicast Fast Convergence : Off
  Bandwidth : 1000000 Kbit (Gi0/0/3), 1000000 Kbit (Te0/0/12)
  Mac Address Move Update Vlan : auto
  Forwarding : Active-Backup-Both

```

Unsupported Functions

Following functions are not supported:

- MMU Notification
- IGMP Fast convergence
- Preemption Support
- Flex links support on a Port channel interface.
- Flex links support on EVC
- Flex links with VLB
- Flex links on IP configured Physical interface.
- Flexlink cannot be configured on a REP / G8032 configured interface and vice-versa.
- STP can be enabled globally but will not be applied on flex link configured interfaces alone.

Additional References

Related Documents

Related Topic	Document Title
Cisco IOS commands	https://www.cisco.com/c/en/us/td/docs/ios-xml/ios/mcl/allreleasemcl/all-book.html

Standards and RFCs

Standard/RFC	Title
No specific Standards and RFCs are supported by the features in this document.	—

MIBs

MB	MIBs Link
—	To locate and download MIBs for selected platforms, Cisco IOS releases, and feature sets, use Cisco MIB Locator found at the following URL: http://www.cisco.com/go/mibs

Technical Assistance

Description	Link
<p>The Cisco Support website provides extensive online resources, including documentation and tools for troubleshooting and resolving technical issues with Cisco products and technologies.</p> <p>To receive security and technical information about your products, you can subscribe to various services, such as the Product Alert Tool (accessed from Field Notices), the Cisco Technical Services Newsletter, and Really Simple Syndication (RSS) Feeds.</p> <p>Access to most tools on the Cisco Support website requires a Cisco.com user ID and password.</p>	http://www.cisco.com/cisco/web/support/index.html



CHAPTER 6

ITU-T G.8032 Ethernet Ring Protection Switching

The ITU-T G.8032 Ethernet Ring Protection Switching feature implements protection switching mechanisms for Ethernet layer ring topologies. This feature uses the G.8032 Ethernet Ring Protection (ERP) protocol, defined in ITU-T G.8032, to provide protection for Ethernet traffic in a ring topology, while ensuring that no loops are within the ring at the Ethernet layer. The loops are prevented by blocking traffic on either a predetermined link or a failed link.

- [Prerequisites for Configuring ITU-T G.8032 Ethernet Ring Protection Switching, on page 61](#)
- [About ITU-T G.8032 Ethernet Ring Protection Switching, on page 61](#)
- [Restrictions for Configuring ITU-T G.8032 Ethernet Ring Protection Switching, on page 69](#)
- [How to Configure ITU-T G.8032 Ethernet Ring Protection Switching, on page 70](#)
- [Configuration Examples for ITU-T G.8032 Ethernet Ring Protection Switching, on page 80](#)

Prerequisites for Configuring ITU-T G.8032 Ethernet Ring Protection Switching

- The Ethernet Flow Points (EFPs) and Trunk Ethernet Flow Points (TEFPs) must be configured.

About ITU-T G.8032 Ethernet Ring Protection Switching

Ring Protection Links

An Ethernet ring consists of multiple Ethernet ring nodes. Each Ethernet ring node is connected to adjacent Ethernet ring nodes using two independent ring links. A ring link prohibits formation of loops that affect the network. The Ethernet ring uses a specific link to protect the entire Ethernet ring. This specific link is called the Ring Protection Link (RPL). A ring link is bound by two adjacent Ethernet ring nodes and a port for a ring link (also known as a ring port). There must be at least two Ethernet ring nodes in an Ethernet ring.

ITU-T G.8032 Ethernet Ring Protection Switching Functionality

The Ethernet ring protection functionality includes the following:

- Loop avoidance

- The use of learning, forwarding, and Filtering Database (FDB) mechanisms

Loop avoidance in an Ethernet ring is achieved by ensuring that, at any time, traffic flows on all but the Ring Protection Link (RPL).

The following is a list of RPL types (or RPL nodes) and their functions:

- RPL owner—Responsible for blocking traffic over the RPL so that no loops are formed in the Ethernet traffic. There can be only one RPL owner in a ring.
- RPL neighbor node—An Ethernet ring node adjacent to the RPL. It is responsible for blocking its end of the RPL under normal conditions. This node type is optional and prevents RPL usage when protected.
- RPL next-neighbor node—Next-neighbor node is an Ethernet ring node adjacent to an RPL owner node or RPL neighbor node. It is mainly used for FDB flush optimization on the ring. This node is also optional.

The following figure illustrates the G.8032 Ethernet ring topology.

Figure 9: G.8032 Ethernet Ring Topology

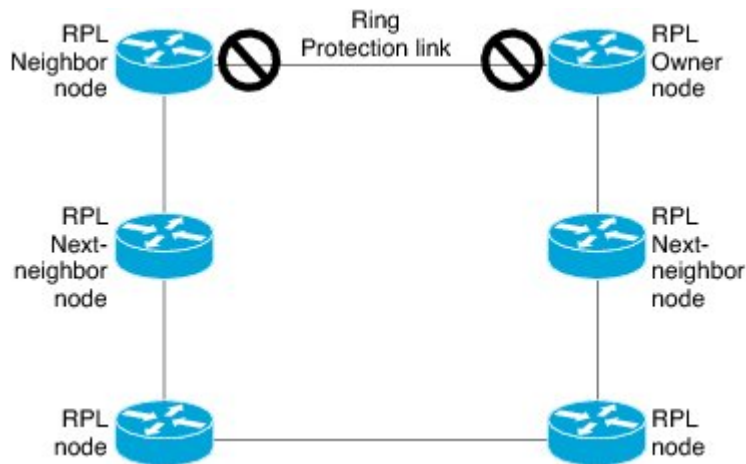

R-APS Control Messages

Nodes on the ring use control messages called Ring Automatic Protection Switching (R-APS) messages to coordinate the activities of switching the ring protection link (RPL) on and off. Any failure along the ring triggers a R-APS Signal Failure (R-APS SF) message in both directions of the nodes adjacent to the failed link, after the nodes have blocked the port facing the failed link. On obtaining this message, the RPL owner unblocks the RPL port.



Note A single link failure in the ring ensures a loop-free topology.

CFM Protocols and Link Failures

Connectivity Fault Management (CFM) and line status messages are used to detect ring link and node failure. During the recovery phase, when the failed link is restored, the nodes adjacent to the restored link send Ring Automatic Protection Switching (R-APS) No Request (R-APS NR) messages. On obtaining this message, the

ring protection link (RPL) owner blocks the RPL port and sends R-APS NR and R-APS RPL (R-APS NR, RB) messages. These messages cause all other nodes, other than the RPL owner in the ring, to unblock all blocked ports. The Ethernet Ring Protection (ERP) protocol works for both unidirectional failure and multiple link failure scenarios in a ring topology.



Note The G.8032 Ethernet Ring Protection (ERP) protocol uses CFM Continuity Check Messages (CCMs) at an interval of 3.3 milliseconds (ms). At this interval (which is supported only on selected platforms), SONET-like switching time performance and loop-free traffic can be achieved.

G.8032 Ring-Supported Commands and Functionality

A G.8032 ring supports these basic operator administrative commands:

- Force switch (FS)—Allows the operator to forcefully block a particular ring port. Note the following points about Force Switch commands:
 - Effective even if there is an existing SF condition
 - Multiple FS commands for ring are supported
 - May be used to allow immediate maintenance operations
- Manual switch (MS)—Allows the operator to manually block a particular ring port. Note the following points about MS commands:
 - Ineffective in an existing FS or signal failure (SF) condition
 - Overridden by new FS or SF conditions
 - When multiple MS commands are executed more than once on the same device, all MS commands are cancelled.

When multiple MS commands are executed on different devices in the ring, for the same instance, then the command executed on the second device is rejected.
- Clear—Cancels an existing FS or MS command on the ring port. The Clear command is used at the ring protection link (RPL) owner to clear a nonrevertive mode condition.

A G.8032 ring can support multiple instances. An instance is a logical ring running over a physical ring. Such instances are used for various reasons, such as load-balancing VLANs over a ring. For example, odd-numbered VLANs may go in one direction of the ring, and even-numbered VLANs may go in the other direction. Specific VLANs can be configured under only one instance. They cannot overlap multiple instances. Otherwise, data traffic or Ring Automatic Protection Switching (R-APS) messages may cross logical rings, which is not desirable.



Note G.8032 Ethernet Ring Protection Switching Version 1 and Version 2 are supported.

G.8032 ERP Timers

The G.8032 Ethernet Ring Protection (ERP) protocol specifies the use of different timers to avoid race conditions and unnecessary switching operations:

- Delay timers—Used by the Ring Protection Link (RPL) owner to verify that the network has stabilized before blocking the RPL. Note the following points about delay timers.
 - After a signal failure (SF) condition, a Wait-to-Restore (WTR) timer is used to verify that the SF is not intermittent.
 - The WTR timer can be configured by the operator. The default time interval is 5 minutes; the time interval ranges from 1 to 12 minutes.
 - After a force switch (FS) or a manual switch (MS) command is issued, a Wait-to-Block (WTB) timer is used to verify that no background condition exists.



Note The WTB timer interval may be shorter than the WTR timer interval.

- Guard timer—Used by all nodes when changing state; the guard timer blocks latent outdated messages from causing unnecessary state changes. The guard timer can be configured. The default time interval is 500 ms; the time interval ranges from 10 to 2000 ms.
- The recommended Guard Timer is 500 ms.
- Hold-off timers—Used by the underlying Ethernet layer to filter out intermittent link faults. The hold-off timer can be configured. The default time interval is 0 seconds; the time interval ranges from 0 to 10 seconds. Faults are reported to the ring protection mechanism only if this timer expires.

Protection Switching Functionality in a Single Link Failure and Recovery

The following figure illustrates protection switching functionality in a single-link failure.

Figure 10: G.8032 Ethernet Ring Protection Switching in a Single-Link Failure

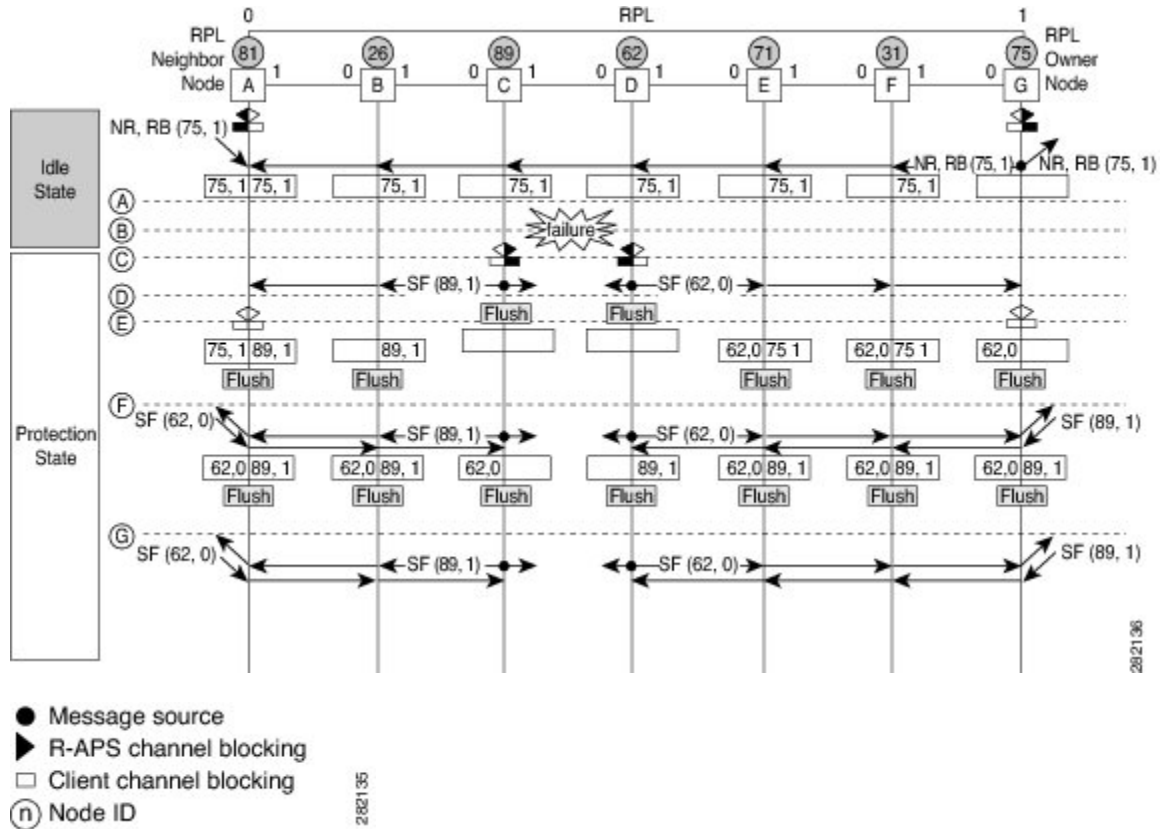

The figure represents an Ethernet ring topology consisting of seven Ethernet ring nodes. The ring protection link (RPL) is the ring link between Ethernet ring nodes A and G. In this topology, both ends of the RPL are blocked. Ethernet ring node G is the RPL owner node, and Ethernet ring node A is the RPL neighbor node.

The following sequence describes the steps followed in the single-link failure:

1. A link operates in the normal condition.
2. A failure occurs.
3. Ethernet ring nodes C and D detect a local signal failure (SF) condition and after the hold-off time interval, block the failed ring port and perform the FDB flush.
4. Ethernet ring nodes C and D start sending Ring Automatic Protection Switching (R-APS) SF messages periodically along with the (node ID and bidirectional path-protected ring (BPR) identifier pair) on both ring ports while the SF condition persists.
5. All Ethernet ring nodes receiving an R-APS SF message perform the FDB flush. When the RPL owner node G and RPL neighbor node A receive an R-APS SF message, the Ethernet ring node unblocks its end of the RPL and performs the FDB flush.
6. All Ethernet ring nodes receiving a second R-APS SF message perform the FDB flush again; the additional FDB flush is because of the node ID and BPR-based configuration.
7. R-APS SF messages are detected on the Ethernet Ring indicating a stable SF condition. Further R-APS SF messages trigger no further action.

The following figure illustrates the steps taken in a revertive operation in a single-link failure.

Figure 11: Single-Link Failure Recovery (Revertive Operation)

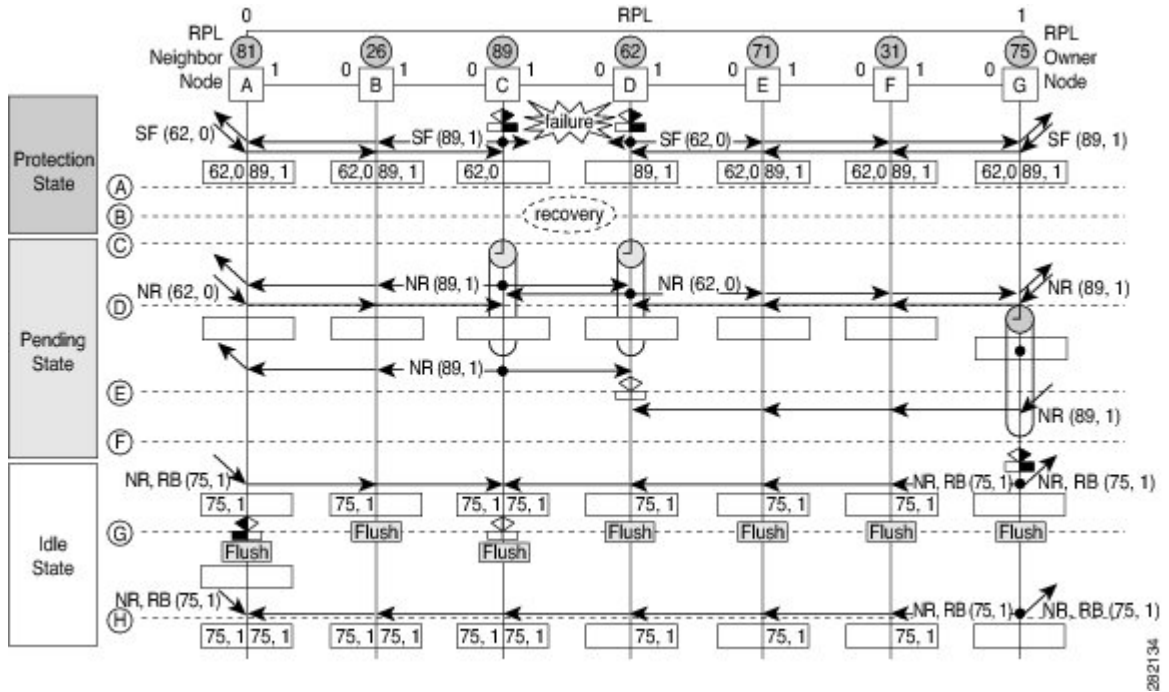

The following sequence describes the steps followed in the single-link failure revertive (recovery) operation:

1. A link operates in the stable SF condition.
2. Recovery of link failure occurs.
3. Ethernet ring nodes C and D detect clearing of the SF condition, start the guard timer, and initiate periodic transmission of the R-APS No Request (NR) messages on both ring ports. (The guard timer prevents the reception of R-APS messages.)
4. When the Ethernet ring nodes receive an R-APS NR message, the node ID and BPR identifier pair of a receiving ring port is deleted and the RPL owner node starts the Wait-to-Restore (WTR) timer.
5. When the guard timer expires on Ethernet ring nodes C and D, the nodes may accept the new R-APS messages, if any. Ethernet ring node D receives an R-APS NR message with a higher node ID from Ethernet ring node C, and unblocks its nonfailed ring port.
6. When the WTR timer expires, the RPL owner node blocks its end of the RPL, sends R-APS (NR or route blocked [RB]) message with the (node ID and BPR identifier pair), and performs the FDB flush.
7. When Ethernet ring node C receives an R-APS (NR or RB) message, the node removes the block on its blocked ring ports, and stops sending R-APS NR messages. On the other hand, when the RPL neighbor node A receives an R-APS NR or RB message, the node blocks its end of the RPL. In addition, Ethernet ring nodes A to F perform the FDB flush when receiving an RAPS NR or RB message because of the node ID and BPR-based configuration.

Ethernet Flow Points

An Ethernet flow point (EFP) is a forwarding decision point in the provider edge (PE) router, which gives network designers flexibility to make many Layer 2 flow decisions within the interface. Many EFPs can be configured on a single physical port. (The number varies from one device to another.) EFPs are the logical demarcation points of an Ethernet virtual connection (EVC) on an interface. An EVC that uses two or more user network interfaces (UNIs) requires an EFP on the associated ingress and egress interfaces of every device that the EVC passes through.

EFPs can be configured on any Layer 2 traffic port; however, they are usually configured on UNI ports. The following parameters (matching criteria) can be configured on the EFP:

- Frames of a specific VLAN, a VLAN range, or a list of VLANs (100-150 or 100,103,110)
- Frames with no tags (untagged)
- Frames with identical double-tags (VLAN tags) as specified
- Frames with identical Class of Service (CoS) values

A frame passes each configured match criterion until the correct matching point is found. If a frame does not fit any of the matching criteria, it is dropped. Default criteria can be configured to avoid dropping frames.

You can configure a new type of TEFP called TEFP with encapsulation from bridge domain (BD). All the BDs configured on the switch are part of the VLAN list of the encapsulated TEFP. The TEFP is encapsulated using the **encapsulation dot1q from-bd** command. The feature brings about the following interaction between the Ethernet-EFP and Layer2-bridge domain components:

- If BDs exist in the system and a TEFP with encapsulation from bridge domain is created, then all the BDs get added to the VLAN list of TEFP with encapsulation from bridge domain.
- If TEFP with encapsulation from bridge domain exists in the system and a new BD is created, then the BD is added to the VLAN list of all the TEFP with encapsulation from bridge domain in the system.
- If TEFP with encapsulation from bridge domain exists in the system and a BD gets deleted, and if the deleted BD is not part of an existing TEFP or EFP then it gets deleted from all the TEFP with encapsulation from bridge domain in the system.

The following types of commands can be used in an EFP:

- Rewrite commands—In each EFP, VLAN tag management can be specified with the following actions:
 - Pop—1) pops out a tag; 2) pops out two tags
 - Push— pushes in a tag
 - Translate—1 to 1) changes a tag value; 1 to 2) pops one tag and pushes two tags; 2 to 1) pops two tags and pushes one tag; 2 to 2) changes the value for two tags
- Forwarding commands—Each EFP specifies the forwarding command for the frames that enter the EFP. Only one forwarding command can be configured per EFP. The forwarding options are as follows:
 - Layer 2 point-to-point forwarding to a pseudowire tunnel
 - Multipoint bridge forwarding to a bridge domain entity
 - Local switch-to-switch forwarding between two different interfaces

- Feature commands—In each EFP, the QoS features or parameters can be changed and the ACL can be updated.

Service Instances and Associated EFPs

Configuring a service instance on a Layer 2 port creates a pseudoport or EFP on which you configure EVC features. Each service instance has a unique number per interface, but you can use the same number on different interfaces because service instances on different ports are not related.

An EFP classifies frames from the same physical port to one of the multiple service instances associated with that port, based on user-defined criteria. Each EFP can be associated with different forwarding actions and behavior.

When an EFP is created, the initial state is UP. The state changes to DOWN under the following circumstances:

- The EFP is explicitly shut down by a user.
- The main interface to which the EFP is associated is down or removed.
- If the EFP belongs to a bridge domain, the bridge domain is down.
- The EFP is forced down as an error-prevention measure of certain features.

Use the **service instance ethernet** interface configuration command to create an EFP on a Layer 2 interface and to enter service instance configuration mode. Service instance configuration mode is used to configure all management and control data plane attributes and parameters that apply to the service instance on a per-interface basis. The service instance number is the EFP identifier.

After the device enters service instance configuration mode, you can configure these options:

- **default**--Sets a command to its defaults
- **description**--Adds a service instance-specific description
- **encapsulation**--Configures Ethernet frame match criteria
- **exit**--Exits from service instance configuration mode
- **no**--Negates a command or sets its defaults
- **shutdown**--Takes the service instance out of service

Restrictions for Configuring ITU-T G.8032 Ethernet Ring Protection Switching

Table 3: Feature History

Feature Name	Release Information	Feature Description
G.8032 Support for IEEE 802.1Q EFPs	Cisco IOS XE Bengaluru 17.6.1	This feature supports G.8032 Ethernet ring protection for IEEE 802.1Q Ethernet Flow Points (EFPs). Prior to this release, G.8032 Ethernet ring protection for IEEE 802.1Q was supported only for Trunk Ethernet Flow Points (TEFPs).

Given below are the restrictions for configuring the ITU-T G.8032 Ethernet Ring Protection switching:



Note Effective Cisco IOS XE Bengaluru 17.6.1, G.8032 is supported on both EFPs and TEFPs with IEEE 802.1Q on the RSP3 Module.

- G.8032 is supported only on EFP bridge domains on the physical interface and port-channel interface.
- G.8032 is supported only on EFP with dot1q, dot1ad, QinQ, or dot1ad-dot1Q encapsulation type.
- G.8032 is not supported on cross-connect interface.
- G.8032 supports a maximum of eight ERP rings with a maximum of two ERP instances per ring.
- Link flap occurs while configuring the inclusion or exclusion VLAN list.
- Admin shutdown is highly recommended before making any changes in Connectivity Fault Management (CFM) configuration.
- The **efd notify** command must be used under CFM configuration to notify G.8032 of failures, if any.
- G.8032 support is claimed only over the normal interfaces and not on the port-channels.
- G.8032 Ethernet Ring Protection Switching Version 1 and Version 2 are supported.
- BFD IPv4 and IPv6 Single Hop is supported. BFD Echo Mode is not supported.

The following restrictions are applicable for configuring the ITU-T G.8032 Ethernet Ring Protection protocol over EFPs on RSP3:

- Adding a VLAN range on the EFP that participates in the G.8032 ring is not supported.
- Like TEFPs, G.8032 is supported only on IEEE 802.1Q EFPs with the **rewrite action as pop1 symmetric** command.

- The ports participating in the G.8032 protocol should not have a TEFP, if G.8032 is configured with IEEE 802.1Q EFP.
- Both the ring ports must be shut down while migrating TEFPs to EFPs. This results in a service interruption.
- While migrating the TEFPs to EFPs, ensure to remove all data VLANs present in both inclusion and exclusion VLAN lists from the ring ports. Reconfigure all of these VLANs on the ring ports.
- While configuring G.8032 over an EFP, the encapsulation VLAN and bridge domain values should be the same within a service instance. Using different values for the encapsulation VLAN and bridge domain is not allowed in a service instance.

How to Configure ITU-T G.8032 Ethernet Ring Protection Switching

Configuring the Ethernet Ring Profile

To configure the Ethernet ring profile, complete the following steps.

SUMMARY STEPS

1. **enable**
2. **configure terminal**
3. **ethernet ring g8032 profile** *profile-name*
4. **timer** {**guard** *seconds* | **hold-off** *seconds* | **wtr** *minutes*}
5. **non-revertive**
6. **end**

DETAILED STEPS

	Command or Action	Purpose
Step 1	enable Example: Device> enable	Enables privileged EXEC mode. <ul style="list-style-type: none"> • Enter your password if prompted.
Step 2	configure terminal Example: Device# configure terminal	Enters global configuration mode.
Step 3	ethernet ring g8032 profile <i>profile-name</i> Example:	Creates the Ethernet ring profile and enters Ethernet ring profile configuration mode.

	Command or Action	Purpose
	Device(config)# ethernet ring g8032 profile profile1	
Step 4	timer {guard seconds hold-off seconds wtr minutes} Example: Device(config-erp-profile)# timer hold-off 5	Specifies the time interval for the guard, hold-off, and Wait-to-Restore (WTR) timers.
Step 5	non-revertive Example: Device(config-erp-profile)# non-revertive	Specifies a nonrevertive Ethernet ring instance. <ul style="list-style-type: none"> • By default, Ethernet ring instances are revertive.
Step 6	end Example: Device(config-erp-profile)# end	Returns to user EXEC mode.

Configuring Ethernet CFM MEPs

Configuring Ethernet Connectivity Fault Management (CFM) maintenance endpoints (MEPs) is optional although recommended for fast failure detection and CFM monitoring. When CFM monitoring is configured, note the following points:

- Static remote MEP (RMEP) checking should be enabled.
- The MEPs should be configured to enable Ethernet fault detection.

For information about configuring Ethernet Connectivity Fault Management (CFM) maintenance endpoints (MEPs), see the “Configuring Ethernet Connectivity Fault Management in a Service Provider Network” module of the *Carrier Ethernet Configuration Guide*.

Enabling Ethernet Fault Detection for a Service

To enable Ethernet Fault Detection (EFD) for a service to achieve fast convergence, complete the following steps



Note Link protection is not supported on the RSP3 Module.

SUMMARY STEPS

1. enable
2. configure terminal
3. ethernet cfm global
4. ethernet cfm domain domain-name level level-id [direction outward]

5. `service {ma-name | ma-num | vlan-id vlan-id | vpn-id vpn-id} [port | vlan vlan-id [direction down]]`
6. `continuity-check [interval time | loss-threshold threshold | static rmep]`
7. `efd notify g8032`
8. `end`

DETAILED STEPS

	Command or Action	Purpose
Step 1	enable Example: Device> enable	Enables privileged EXEC mode. <ul style="list-style-type: none"> • Enter your password if prompted.
Step 2	configure terminal Example: Device# configure terminal	Enters global configuration mode.
Step 3	ethernet cfm global Example: Device(config)# ethernet cfm global	Enables Ethernet CFM globally.
Step 4	ethernet cfm domain domain-name level level-id [direction outward] Example: Device(config)# ethernet cfm domain G8032 level 4	Configures the CFM domain for ODU 1 and enters Ethernet CFM configuration mode.
Step 5	service {ma-name ma-num vlan-id vlan-id vpn-id vpn-id} [port vlan vlan-id [direction down]] Example: Device(config-ecfm)# service 8032_service evc 8032-etc vlan 1001 direction down	Defines a maintenance association for ODU 1 and enters Ethernet CFM service instance configuration mode.
Step 6	continuity-check [interval time loss-threshold threshold static rmep] Example: Device(config-ecfm-srv)# continuity-check interval 3.3ms	Enables the transmission of continuity check messages (CCMs).
Step 7	efd notify g8032 Example: Device(config-ecfm-srv)# efd notify g8032	Enables CFM to notify registered protocols when a defect is detected or cleared, which matches the current fault alarm priority.

	Command or Action	Purpose
Step 8	end Example: Device(config-ecfm-srv)# end	Returns to user EXEC mode.

Configuring the Ethernet Protection Ring

To configure the Ethernet Protection Ring (EPR), complete the following steps.

SUMMARY STEPS

1. **enable**
2. **configure terminal**
3. **ethernet ring g8032** *ring-name*
4. **port0 interface** *type number*
5. **monitor service instance** *instance-id*
6. **exit**
7. **port1** {*interfacetype number* | **none**}
8. **monitor service instance** *instance-id*
9. **exit**
10. **exclusion-list vlan-ids** *vlan-id*
11. **open-ring**
12. **instance** *instance-id*
13. **description** *descriptive-name*
14. **profile** *profile-name*
15. **rpl** {**port0** | **port1**} {**owner** | **neighbor** | **next-neighbor** }
16. **inclusion-list vlan-ids** *vlan-id*
17. **aps-channel**
18. **level** *level-value*
19. **port0 service instance** *instance-id*
20. **port1 service instance** {*instance-id* | **none** }
21. **end**

DETAILED STEPS

	Command or Action	Purpose
Step 1	enable Example: Device> enable	Enables privileged EXEC mode. <ul style="list-style-type: none"> • Enter your password if prompted.
Step 2	configure terminal Example:	Enters global configuration mode.

	Command or Action	Purpose
	Device# configure terminal	
Step 3	ethernet ring g8032 <i>ring-name</i> Example: Device(config)# ethernet ring g8032 ring1	Specifies the Ethernet ring and enters Ethernet ring port configuration mode.
Step 4	port0 interface <i>type number</i> Example: Device(config-erp-ring)# port0 interface gigabitethernet 0/1/0	Connects port0 of the local node of the interface to the Ethernet ring and enters Ethernet ring protection mode.
Step 5	monitor service instance <i>instance-id</i> Example: Device(config-erp-ring-port)# monitor service instance 1	Assigns the Ethernet service instance to monitor the ring port (port0) and detect ring failures.
Step 6	exit Example: Device(config-erp-ring-port)# exit	Exits Ethernet ring port configuration mode.
Step 7	port1 { <i>interfacetype number</i> none} Example: Device(config-erp-ring)# port1 interface gigabitethernet 0/1/1	Connects port1 of the local node of the interface to the Ethernet ring and enters Ethernet ring protection mode.
Step 8	monitor service instance <i>instance-id</i> Example: Device(config-erp-ring-port)# monitor service instance 2	Assigns the Ethernet service instance to monitor the ring port (port1) and detect ring failures. <ul style="list-style-type: none"> • The interface (to which port1 is attached) must be a subinterface of the main interface.
Step 9	exit Example: Device(config-erp-ring-port)# exit	Exits Ethernet ring port configuration mode.
Step 10	exclusion-list vlan-ids <i>vlan-id</i> Example: Device(config-erp-ring)# exclusion-list vlan-ids 2	Specifies VLANs that are unprotected by the Ethernet ring protection mechanism.

	Command or Action	Purpose
Step 11	<p>open-ring</p> <p>Example:</p> <pre>Device(config-erp-ring)# open-ring</pre>	Specifies the Ethernet ring as an open ring. By default, each node on the Ethernet ring is closed. You must configure the open-ring command on each node for ITU-T G.8032 Ethernet open ring.
Step 12	<p>instance <i>instance-id</i></p> <p>Example:</p> <pre>Device(config-erp-ring)# instance 1</pre>	Configures the Ethernet ring instance and enters Ethernet ring instance configuration mode.
Step 13	<p>description <i>descriptive-name</i></p> <p>Example:</p> <pre>Device(config-erp-inst)# description cisco_customer_instance</pre>	Specifies a descriptive name for the Ethernet ring instance.
Step 14	<p>profile <i>profile-name</i></p> <p>Example:</p> <pre>Device(config-erp-inst)# profile profile1</pre>	Specifies the profile associated with the Ethernet ring instance.
Step 15	<p>rpl {port0 port1} {owner neighbor next-neighbor }</p> <p>Example:</p> <pre>Device(config-erp-inst)# rpl port0 neighbor</pre>	Specifies the Ethernet ring port on the local node as the RPL owner, neighbor, or next neighbor.
Step 16	<p>inclusion-list <i>vlan-ids</i> <i>vlan-id</i></p> <p>Example:</p> <pre>Device(config-erp-inst)# inclusion-list vlan-ids 11</pre>	<p>Specifies VLANs that are protected by the Ethernet ring protection mechanism.</p> <p>Note VLANs should be within or equal to VLAN configured in the interface.</p>
Step 17	<p>aps-channel</p> <p>Example:</p> <pre>Device(config-erp-inst)# aps-channel</pre>	Enters Ethernet ring instance aps-channel configuration mode.
Step 18	<p>level <i>level-value</i></p> <p>Example:</p> <pre>Device(config-erp-inst-aps)# level 5</pre>	<p>Specifies the Automatic Protection Switching (APS) message level for the node on the Ethernet ring.</p> <ul style="list-style-type: none"> All nodes in the Ethernet ring must be configured with the same level.
Step 19	<p>port0 service instance <i>instance-id</i></p> <p>Example:</p>	Associates APS channel information with port0.

	Command or Action	Purpose
	Device(config-erp-inst-aps)# port0 service instance 100	
Step 20	port1 service instance {instance-id none } Example: Device(config-erp-inst-aps)# port1 service instance 100	Associates APS channel information with port1.
Step 21	end Example: Device(config-erp-inst-aps)# end	Returns to user EXEC mode.

Configuring Topology Change Notification Propagation

To configure topology change notification (TCN) propagation, complete the following steps.

SUMMARY STEPS

1. **enable**
2. **configure terminal**
3. **ethernet tcn-propagation G8032 to {REP | G8032}**
4. **end**

DETAILED STEPS

	Command or Action	Purpose
Step 1	enable Example: Device> enable	Enables privileged EXEC mode. <ul style="list-style-type: none"> • Enter your password if prompted.
Step 2	configure terminal Example: Device# configure terminal	Enters global configuration mode.
Step 3	ethernet tcn-propagation G8032 to {REP G8032} Example: Device(config)# ethernet tcn-propagation G8032 to G8032	Allows topology change notification (TCN) propagation from a source protocol to a destination protocol. <ul style="list-style-type: none"> • Source and destination protocols vary by platform and release.
Step 4	end Example:	Returns to user EXEC mode.

	Command or Action	Purpose
	Device(config)# end	

Configuring a Service Instance

To configure a service instance, complete the following steps.

SUMMARY STEPS

1. **enable**
2. **configure terminal**
3. **interface** *type number*
4. **service instance** *instance-id* **ethernet** [*evc-id*]
5. **encapsulation dot1q** *vlan-id* [**native**]
6. **bridge-domain** *bridge-id* [**split-horizon** [**group** *group-id*]]
7. **end**

DETAILED STEPS

	Command or Action	Purpose
Step 1	enable Example: Device> enable	Enables privileged EXEC mode. <ul style="list-style-type: none">• Enter your password if prompted.
Step 2	configure terminal Example: Device# configure terminal	Enters global configuration mode.
Step 3	interface <i>type number</i> Example: Device(config)# interface gigabitethernet 0/1/0	Specifies the interface type and number.
Step 4	service instance <i>instance-id</i> ethernet [<i>evc-id</i>] Example: Device(config-if)# service instance 101 ethernet	Creates a service instance (an instance of an EVC) on an interface and enters service instance configuration mode.
Step 5	encapsulation dot1q <i>vlan-id</i> [native] Example: Device(config-if-srv)# encapsulation dot1q 13	Defines the matching criteria to be used in order to map ingress dot1q frames on an interface to the appropriate service instance.
Step 6	bridge-domain <i>bridge-id</i> [split-horizon [group <i>group-id</i>]]	Binds the service instance to a bridge domain instance.

	Command or Action	Purpose
	Example: Device(config-if-srv)# bridge-domain 12	
Step 7	end Example: Device(config-if-srv)# end	Exits service instance configuration mode.

Verifying the Ethernet Ring Protection (ERP) Switching Configuration

To verify the ERP switching configuration, use one or more of the following commands in any order.



Note Follow these rules while adding or deleting VLANs from the inclusion list:

- While adding VLAN into the inclusion list, it has to be first added on the interface and then in the G.8032 inclusion list.
- While removing VLAN from the inclusion list, it has to be removed from the G.8032 inclusion list and then from the interface.

Addition or Deletion of VLANs in exclusion list is not supported.

SUMMARY STEPS

1. **enable**
2. **show ethernet ring g8032 status** [*ring-name*] [**instance** [*instance-id*]]
3. **show ethernet ring g8032 brief** [*ring-name*] [**instance** [*instance-id*]]
4. **show ethernet ring g8032 summary**
5. **show ethernet ring g8032 statistics** [*ring-name*] [**instance** [*instance-id*]]
6. **show ethernet ring g8032 profile** [*profile-name*]
7. **show ethernet ring g8032 port status interface** [*type number*]
8. **show ethernet ring g8032 configuration** [*ring-name*] **instance** [*instance-id*]
9. **show ethernet ring g8032 trace** {ctrl [*ring-name* **instance** *instance-id*] | sm}
10. **end**

DETAILED STEPS

	Command or Action	Purpose
Step 1	enable Example: Device> enable	Enables privileged EXEC mode. <ul style="list-style-type: none"> • Enter your password if prompted.

	Command or Action	Purpose
Step 2	<p>show ethernet ring g8032 status [<i>ring-name</i>] [instance [<i>instance-id</i>]]</p> <p>Example:</p> <pre>Device# show ethernet ring g8032 status RingA instance 1</pre>	Displays a status summary for the ERP instance.
Step 3	<p>show ethernet ring g8032 brief [<i>ring-name</i>] [instance [<i>instance-id</i>]]</p> <p>Example:</p> <pre>Device# show ethernet ring g8032 brief</pre>	Displays a brief description of the functional state of the ERP instance.
Step 4	<p>show ethernet ring g8032 summary</p> <p>Example:</p> <pre>Device# show ethernet ring g8032 summary</pre>	Displays a summary of the number of ERP instances in each state of the ERP switching process.
Step 5	<p>show ethernet ring g8032 statistics [<i>ring-name</i>] [instance [<i>instance-id</i>]]</p> <p>Example:</p> <pre>Device# show ethernet ring g8032 statistics RingA instance 1</pre>	Displays the number of events and Ring Automatic Protection Switching (R-APS) messages received for an ERP instance.
Step 6	<p>show ethernet ring g8032 profile [<i>profile-name</i>]</p> <p>Example:</p> <pre>Device# show ethernet ring g8032 profile gold</pre>	Displays the settings for one or more ERP profiles.
Step 7	<p>show ethernet ring g8032 port status interface [<i>type number</i>]</p> <p>Example:</p> <pre>Device# show ethernet ring g8032 port status interface gigabitethernet 0/0/1</pre>	Displays Ethernet ring port status information for the interface.
Step 8	<p>show ethernet ring g8032 configuration [<i>ring-name</i>] instance [<i>instance-id</i>]</p> <p>Example:</p> <pre>Device# show ethernet ring g8032 configuration RingA instance 1</pre>	Displays the details of the ERP instance configuration manager.
Step 9	<p>show ethernet ring g8032 trace {ctrl [<i>ring-name</i>] instance [<i>instance-id</i>] sm}</p> <p>Example:</p>	Displays information about ERP traces.

	Command or Action	Purpose
	Device# show ethernet ring g8032 trace sm	
Step 10	end Example: Device# end	Returns to privileged EXEC mode.

Configuration Examples for ITU-T G.8032 Ethernet Ring Protection Switching

Example: Configuring Ethernet Ring Protection Switching

The following is an example of an Ethernet Ring Protection (ERP) switching configuration:

```

ethernet ring g8032 profile profile_ABC
 timer wtr 1
 timer guard 100
 timer hold-off 1

ethernet ring g8032 major_ring_ABC
 exclusion-list vlan-ids 1000
 port0 interface GigabitEthernet 0/0/1
 monitor service instance 103
 port1 interface GigabitEthernet 0/1/0
 monitor service instance 102
 instance 1
 profile profile_ABC
 rpl port0 owner
 inclusion-list vlan-ids 100
 aps-channel
 port0 service instance 100
 port1 service instance 100
 !
interface GigabitEthernet0/1/0
 mtu 9216
 no ip address
 negotiation auto
 service instance trunk 1 ethernet
 encapsulation dot1q 60-61
 rewrite ingress tag pop 1 symmetric
 bridge-domain from-encapsulation

!
!

```

Example: Enabling Ethernet Fault Detection for a Service

```

ethernet cfm domain G8032 level 4
 service 8032_service evc 8032-evc vlan 1001 direction down

```

```
continuity-check
continuity-check interval 3.3ms
offload sampling 1000
efd notify g8032
ethernet ring g8032 profile TEST
timer wtr 1
timer guard 100
ethernet ring g8032 open
open-ring
port0 interface GigabitEthernet0/1/3
  monitor service instance 1001
port1 none
instance 1
  profile TEST
  inclusion-list vlan-ids 2-500,1001
  aps-channel
  port0 service instance 1001
  port1 none
  !
!
instance 2
  profile TEST
  rpl port0 owner
  inclusion-list vlan-ids 1002,1005-2005
  aps-channel
  port0 service instance 1002
  port1 none
  !

interface GigabitEthernet0/1/3
no ip address
load-interval 30
shutdown
negotiation auto
storm-control broadcast level 10.00
storm-control multicast level 10.00
storm-control unicast level 90.00
service instance 1 ethernet
  encapsulation untagged
  l2protocol peer lldp
  bridge-domain 1
!
service instance trunk 10 ethernet
  encapsulation dot1q 2-500,1005-2005
  rewrite ingress tag pop 1 symmetric
  bridge-domain from-encapsulation
!
service instance 1001 ethernet 8032-evc
  encapsulation dot1q 1001
  rewrite ingress tag pop 1 symmetric
  bridge-domain 1001
  cfm mep domain G8032 mpid 20
!
service instance 1002 ethernet 8032-evc-1
  encapsulation dot1q 1002
  rewrite ingress tag pop 1 symmetric
  bridge-domain 1002
!
End
```

Example: Verifying the Ethernet Ring Protection Configuration

The following is sample output from the **show ethernet ring g8032 configuration** command. Use this command to verify if the configuration entered is valid and to check for any missing configuration parameters.

```
Device# show ethernet ring g8032 configuration

ethernet ring ring0
Port0: GigabitEthernet0/0/0 (Monitor: GigabitEthernet0/0/0)
Port1: GigabitEthernet0/0/4 (Monitor: GigabitEthernet0/0/4)
Exclusion-list VLAN IDs: 4001-4050
Open-ring: no
Instance 1
Description:
Profile:      opp
RPL:
Inclusion-list VLAN IDs: 2,10-500
APS channel
Level: 7
Port0: Service Instance 1
Port1: Service Instance 1
State: configuration resolved
```



CHAPTER 7

Multiple Spanning Tree Protocol

The Multiple Spanning Tree Protocol (MSTP) is an STP variant that allows multiple and independent spanning trees to be created over the same physical network. The parameters for each spanning tree can be configured separately, so as to cause a different network devices to be selected as the root bridge or different paths to be selected to form the loop-free topology. Consequently, a given physical interface can be blocked for some of the spanning trees and unblocked for others.

Having set up multiple spanning trees, the set of VLANs in use can be partitioned among them; for example, VLANs 1 - 100 can be assigned to spanning tree 1, VLANs 101 - 200 can be assigned to spanning tree 2, VLANs 201 - 300 can be assigned to spanning tree 3, and so on. Since each spanning tree has a different active topology with different active links, this has the effect of dividing the data traffic among the available redundant links based on the VLAN - a form of load balancing.

- [Restrictions for configuring MSTP, on page 83](#)
- [How to Configure MST Protocol, on page 83](#)

Restrictions for configuring MSTP

- RSTP is not supported. To support RSTP, all vlans are mapped to MSTI 0 when no instance is created for MSTP.
- PVSTP is *not* supported.
- Supports only 16 instances.
- Untagged EVCs do not participate in MST loop detection.

How to Configure MST Protocol

This section describes the procedure for configuring MSTP:

Enabling Multiple Spanning Tree Protocol

By default, MSTP is disabled on all interfaces. MSTP need not be enabled explicitly on each interfaces. By turning the global configuration on, it is enabled on all interfaces.

Configuring Multiple Spanning Tree Protocol

Describes steps to configure MST

SUMMARY STEPS

1. **configure**
2. **spanning-tree mode mst**
3. **spanning-tree mst configuration**
4. **instance** *vlan-id* **vlan** *vlan-range*
5. **name** *region*
6. **revision** *revision -number*
7. **end**

DETAILED STEPS

	Command or Action	Purpose
Step 1	configure Example: Device> configure	Enters global configuration mode.
Step 2	spanning-tree mode mst Example: Device> spanning-tree mode mst	Enables MSTP configuration mode.
Step 3	spanning-tree mst configuration Example: Device(config)#spanning-tree mst configuration	Enters the MSTP configuration submenu.
Step 4	instance <i>vlan-id</i> vlan <i>vlan-range</i> Example: Device(config-mstp-inst)# instance 1 vlan 450-480	Maps the VLANs to an MST instance
Step 5	name <i>region</i> Example: Device(config-mstp)# name m1	Sets the name of the MSTP region.
Step 6	revision <i>revision -number</i> Example: Device(config-mstp)# revision 1	Sets the revision level of the MSTP region.
Step 7	end Example: Device(config-mstp-if)# end	Returns to privileged EXEC mode.

Configuring Untagged EFP over MST Interface

Describes steps to configure untagged EFP over MST:

SUMMARY STEPS

1. **enable**
2. **configure terminal**
3. **interface** *interface number*
4. **no ip address**
5. **service instance** *number* **ethernet** [*name*]
6. **bridge-domain** *bridge-id*
7. **encapsulation untagged dot1q** {*any*|*vlan-id* [*,vlan-id* [-*vlan-d*]]}
8. **l2protocol peer stp**
9. **end**

DETAILED STEPS

	Command or Action	Purpose
Step 1	enable Example: Router> enable	Enables privileged EXEC mode.
Step 2	configure terminal Example: Router# configure terminal	Enters global configuration mode.
Step 3	interface <i>interface number</i> Example: Router(config)# interface gigabitEthernet 0/0/5	Specifies the Gigabit Ethernet interface to configure, where: slot/subslot/port-Specifies the location of the interface.
Step 4	no ip address Example: Router (config-if)# no ip address	Disables the IP address on the interface.
Step 5	service instance <i>number</i> ethernet [<i>name</i>] Example: Router (config-if)# service instance 200 ethernet	Configure an EFP (service instance) and enter service instance configuration mode.
Step 6	bridge-domain <i>bridge-id</i> Example: Router (config-if-srv)# bridge-domain from-encapsulation	Creates a list of bridge domains for an EFP trunk port using the bridge-domain IDs derived from the encapsulation VLAN numbers.
Step 7	encapsulation untagged dot1q { <i>any</i> <i>vlan-id</i> [<i>,vlan-id</i> [- <i>vlan-d</i>]]} Example:	Configures the encapsulation. Defines the matching criteria that maps the ingress dot1q or untagged frames on an interface for the appropriate service instance.

	Command or Action	Purpose
	Router (config-if-srv)# encapsulation dot1q 20	
Step 8	l2protocol peer stp Example: Router (config-if-srv)# l2protocol peer stp	Configures STP to peer with a neighbor on a port that has an EFP service instance.
Step 9	end Example: Device(config-mstp-if)# end	Returns to privileged EXEC mode.

Configuration Example

This example shows how to configure STP to peer with a neighbor on a service instance.

```

interface GigabitEthernet0/0/0
no ip address
negotiation auto
service instance trunk 10 ethernet
  encapsulation dot1q 10-20
  bridge-domain from-encapsulation
!
service instance 1024 ethernet
  encapsulation untagged
  l2protocol peer stp
  bridge-domain 1024
!
end

```