



Hardware Installation Guide for Cisco NCS 1014

First Published: 2023-12-07

Last Modified: 2024-09-04

Americas Headquarters

Cisco Systems, Inc.
170 West Tasman Drive
San Jose, CA 95134-1706
USA
<http://www.cisco.com>
Tel: 408 526-4000
800 553-NETS (6387)
Fax: 408 527-0883

THE SPECIFICATIONS AND INFORMATION REGARDING THE PRODUCTS IN THIS MANUAL ARE SUBJECT TO CHANGE WITHOUT NOTICE. ALL STATEMENTS, INFORMATION, AND RECOMMENDATIONS IN THIS MANUAL ARE BELIEVED TO BE ACCURATE BUT ARE PRESENTED WITHOUT WARRANTY OF ANY KIND, EXPRESS OR IMPLIED. USERS MUST TAKE FULL RESPONSIBILITY FOR THEIR APPLICATION OF ANY PRODUCTS.

THE SOFTWARE LICENSE AND LIMITED WARRANTY FOR THE ACCOMPANYING PRODUCT ARE SET FORTH IN THE INFORMATION PACKET THAT SHIPPED WITH THE PRODUCT AND ARE INCORPORATED HEREIN BY THIS REFERENCE. IF YOU ARE UNABLE TO LOCATE THE SOFTWARE LICENSE OR LIMITED WARRANTY, CONTACT YOUR CISCO REPRESENTATIVE FOR A COPY.

The Cisco implementation of TCP header compression is an adaptation of a program developed by the University of California, Berkeley (UCB) as part of UCB's public domain version of the UNIX operating system. All rights reserved. Copyright © 1981, Regents of the University of California.

NOTWITHSTANDING ANY OTHER WARRANTY HEREIN, ALL DOCUMENT FILES AND SOFTWARE OF THESE SUPPLIERS ARE PROVIDED "AS IS" WITH ALL FAULTS. CISCO AND THE ABOVE-NAMED SUPPLIERS DISCLAIM ALL WARRANTIES, EXPRESSED OR IMPLIED, INCLUDING, WITHOUT LIMITATION, THOSE OF MERCHANTABILITY, FITNESS FOR A PARTICULAR PURPOSE AND NON-INFRINGEMENT OR ARISING FROM A COURSE OF DEALING, USAGE, OR TRADE PRACTICE.

IN NO EVENT SHALL CISCO OR ITS SUPPLIERS BE LIABLE FOR ANY INDIRECT, SPECIAL, CONSEQUENTIAL, OR INCIDENTAL DAMAGES, INCLUDING, WITHOUT LIMITATION, LOST PROFITS OR LOSS OR DAMAGE TO DATA ARISING OUT OF THE USE OR INABILITY TO USE THIS MANUAL, EVEN IF CISCO OR ITS SUPPLIERS HAVE BEEN ADVISED OF THE POSSIBILITY OF SUCH DAMAGES.

Any Internet Protocol (IP) addresses and phone numbers used in this document are not intended to be actual addresses and phone numbers. Any examples, command display output, network topology diagrams, and other figures included in the document are shown for illustrative purposes only. Any use of actual IP addresses or phone numbers in illustrative content is unintentional and coincidental.

All printed copies and duplicate soft copies of this document are considered uncontrolled. See the current online version for the latest version.

Cisco has more than 200 offices worldwide. Addresses and phone numbers are listed on the Cisco website at www.cisco.com/go/offices.

Cisco and the Cisco logo are trademarks or registered trademarks of Cisco and/or its affiliates in the U.S. and other countries. To view a list of Cisco trademarks, go to this URL: <https://www.cisco.com/c/en/us/about/legal/trademarks.html>. Third-party trademarks mentioned are the property of their respective owners. The use of the word partner does not imply a partnership relationship between Cisco and any other company. (1721R)

© 2022 Cisco Systems, Inc. All rights reserved.



CHAPTER 1

Cisco NCS 1014 Overview

This chapter provides an overview for the Cisco NCS 1014 chassis, its modules and line cards.

- [Cisco NCS 1014 Chassis Overview](#) , on page 1
- [Cisco NCS 1014 Line Cards](#), on page 4
- [Cisco NCS 1014 Modules](#), on page 11
- [Supported Pluggables](#), on page 24

Cisco NCS 1014 Chassis Overview

The Cisco NCS 1014 chassis is an advanced multihaul optical platform supporting transponders and line system cards. It is a 2RU chassis that delivers a universal transponder solution which provides excellent performance for metro, long-haul and submarine applications.

Cisco NCS 1014 chassis has slots for the following modules:

- Removable controller
- Removable backup solid state drive (SSD)
- Two replaceable power supply units (PSU)
- Three replaceable fan modules
- Four line cards

The Cisco NCS 1014 chassis supports the following line cards.

Table 1: Supported Line Cards

Line Card	Description	Release
2.4T Line Card	2.4T DWDM Transponder Card	Cisco IOS XR Release 7.11.1
NCS 1000 16-Port Colorless Mux/Demux Optical Line Card	16-port Colorless Mux/Demux Optical Line Card, C-band	Cisco IOS XR Release 7.11.1
NCS 1000 16-Port Colorless Mux/Demux Optical Line Card	16-port Colorless Mux/Demux Optical Line Card, L-band	Cisco IOS XR Release 7.11.1
1.2T Line Card	1.2T DWDM Transponder Card	Cisco IOS XR Release 7.11.1

Line Card	Description	Release
2.4TX Line Card	2.4TX DWDM Transponder Card	Cisco IOS XR Release 24.1.1
QXP-K9 Line Card	3.2T DWDM Transponder Card	Cisco IOS XR Release 24.1.1

The Cisco NCS 1014 chassis has two slots for field-replaceable AC and DC PSUs that support up to 2.5 kW per system and 580 W per line card slot.

For more information about the Cisco NCS 1014 chassis, see [Cisco NCS 1014 datasheet](#).

Note

- "2.4T" refers to the NCS1K14-2.4T-K9 line card.
- "CCMD-16-C" refers to the NCS1K14-CCMD-16-C C-band optical line card.
- "CCMD-16-L" refers to the NCS1K14-CCMD-16-L optical line card.
- "1.2T" refers to the NCS1K4-1.2T-K9 line card.
- "2.4TX" refers to the NCS1K14-2.4T-X-K9 line card.
- "QXP-K9" refers to the NCS1K4-QXP-K9 line card.

The controller is on the front side. The SSD, PSUs, and the fan modules are on the rear side of the chassis. You can insert the line cards into the four slots as shown in the following figure.

Figure 1: NCS 1014 Front View

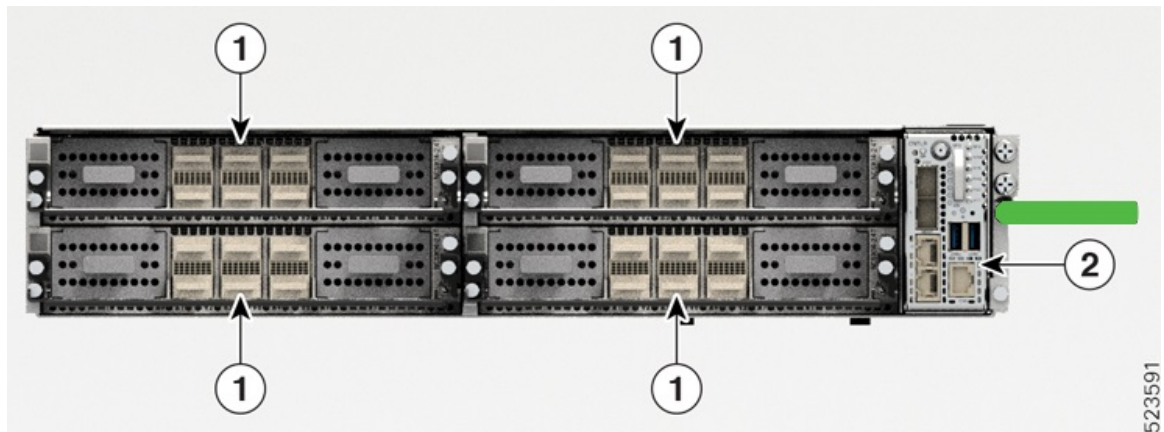

Callout	Modules
1	Line Cards
2	Controller

The following figure shows the PSUs, fan modules, and SSD installed in the chassis.

Figure 2: NCS 1014 Rear View

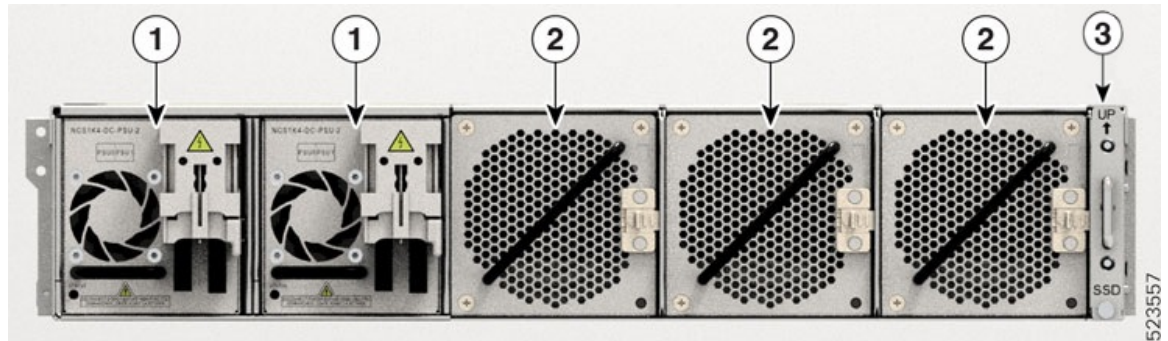

Callout	Modules
1	Power Supply Units (Slots 0 and 1)
2	Fan Modules (Slots 0, 1, and 2)
3	SSD

You must install AC or DC PSUs as the power supply modules. The chassis does not allow mixed PSU configuration.

Airflow in the Cisco NCS 1014 Chassis

The Cisco NCS 1014 chassis has a front-to-back airflow scheme. The air inlet is at the front side of the chassis and the exhaust is on the rear side. The fan modules cool down the line cards. Ensure that no object obstructs or impedes the airflow as it can lead to reduced airflow in the system, causing components to operate at a higher temperature.

Figure 3: Airflow Through the Cisco NCS 1014 Chassis

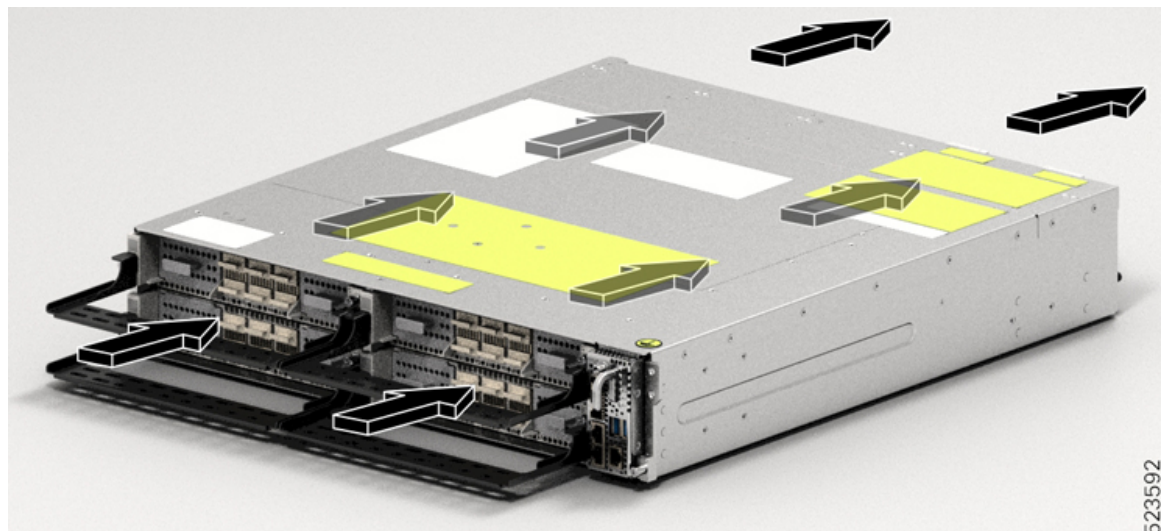

Class 1M Laser Product Label

The Class 1M Laser Product label is shown in the following figure.

Figure 4: Class 1M Laser Product Label



Complies with 21 CFR 1040.10 and 1040.11 except for conformance with IEC 60825-1 Ed. 3., as described in Laser Notice No. 56, dated May 8, 2019.

Conforme à la norme 21 CFR 1040.10 et 1040.11, sauf conformité avec la norme IEC 60825-1 Ed. 3., comme décrit dans l'avis relatif au laser no. 56, daté du 8 Mai 2019.

Cooling System

The Cisco NCS 1014 cooling system actively regulates the chassis temperature using the three field-replaceable fan trays and the built-in fans within the PSU units. This system implements cooling in two different airflow paths:

- **Line Cards Cooling**

The three fan modules enable cooling for the line cards. The software monitors the chassis temperature and adjusts the fan speed according to the ambient temperature range.

- **Controller Card Cooling**

The internal fans within the two PSUs cool the controller card. If any critical alarms arise due to controller temperature, the software overrides the PSU fan speed.



Note For normal operating conditions, the software does not control the PSU fans.

During the power cycle, each fan runs at maximum rotations per minute. After the chassis boots up, the fans return to their normal speed according to the ambient temperature.

Cisco NCS 1014 Line Cards

The Cisco NCS 1014 chassis supports the following line cards:

2.4T Line Card

The 2.4T line card is a coherent optics Transponder and Muxponder for the Cisco NCS 1014 chassis. It is a single-slot card that supports C-band traffic at trunk ports. This line card delivers 400GE, 100GE, and OTU4 client traffic over two trunk ports operating at speeds ranging from 400G to 1.2T each.



Note In Release 7.11.1, the 2.4T line card supports only 400, 600, 800, and 1000G trunk payloads.

In the 2.4T card, the client and trunk ports support the pluggable form factor and data rates as shown in the following table.

Table 2: NCS1K14-2.4T-K9 Interfaces and Data Rates

Interfaces	Form Factor	Ports	Data Rates
Client	QSFP-DD56	1, 2, 3, 4, 5, 6	100, 200, 400G
	QSFP-DD112	2, 5, 6	100, 200, 400, 800G
Trunk	Coherent Interface Module 8 (CIM8)	0, 7	1.2T in each port



Note In Release 7.11.1, the ports 2, 5, and 6 support only up to 400GE data rates.

For more information about the 2.4T card, see [datasheet](#).

The 2.4T card has two trunk ports and six client ports as shown in the following figure.

Figure 5: 2.4T Line Card Front View

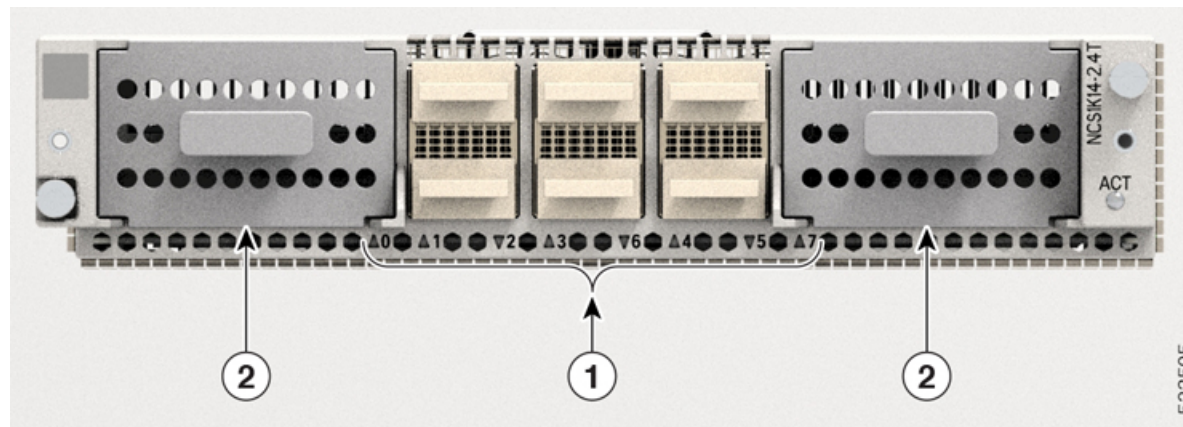

Table 3: 2.4T Line Card Interfaces

Callout	Interface
1	Client port

Callout	Interface
2	Trunk port

The following figure shows the mapping between the client and trunk ports.

Figure 6: 2.4T Card Client and Trunk Mapping

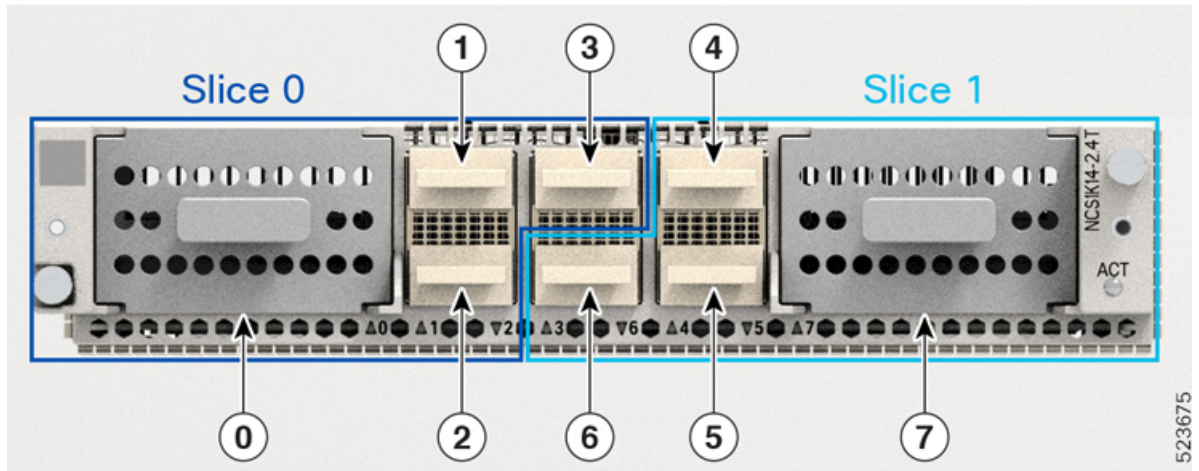

Table 4: Client-to-Trunk Port Mapping

Trunk Port	Client Ports
0	1, 2, 3
7	4, 5, 6

NCS 1000 16-Port Colorless Mux/Demux Optical Line Card

The NCS 1000 16-port Colorless Mux/Demux Optical Line Card is a multiplexing and demultiplexing unit with fixed gain EDFAs on both Add and Drop sections. The optical line card provides colorless functionality on the add/drop ports. It multiplexes any wavelength with the flexible options of baud rate and modulation format to the line side ROADMs or amplifier units for transmission. It transmits and receives signals from optical line terminal (OLT) units.

In the Cisco NCS 1014 chassis, you can install the optical line card in one or more cardslots.

The optical line card has:

- Two line ports to transmit and receive using the same LC connectors.
- 16 ports for add/drop with LC connector-based interfaces

There are two variants of the optical line card:

- **NCS1K14-CCMD-16-C**

The NCS1K14-CCMD-16-C line card is a C-band, 16-port Colorless Direct attach optical line card with EDFA. It can host up to 16 channels. It supports any signal distribution between 191250 and 196200 GHz, for example, the 64 channels grid with 75-GHz spacing.

The following table summarizes the central frequency of the first and the last channel of this specific grid.

Table 5: C-Band Channel Wavelength Plan

Channel	Central Frequency (THz)	Wavelength (nm)
1	196.100	1528.77
64	191.375	1566.52

• NCS1K14-CCMD-16-L

The NCS1K14-CCMD-16-L line card is an L-band, 16-port Colorless Direct attach optical line card with EDFA. It can host up to 16 channels. It supports any signal distribution between 186025 and 191000 GHz, for example, the 64 channels grid with 75-GHz spacing.

The following table summarizes the central frequency of the first and the last channel of this specific grid.

Table 6: L-Band Channel Wavelength Plan

Channel	Central Frequency (THz)	Wavelength (nm)
1	190.850	1570.83
64	186.125	1610.7

Figure 7: NCS1K14-CCMD-16 Line Card Front View

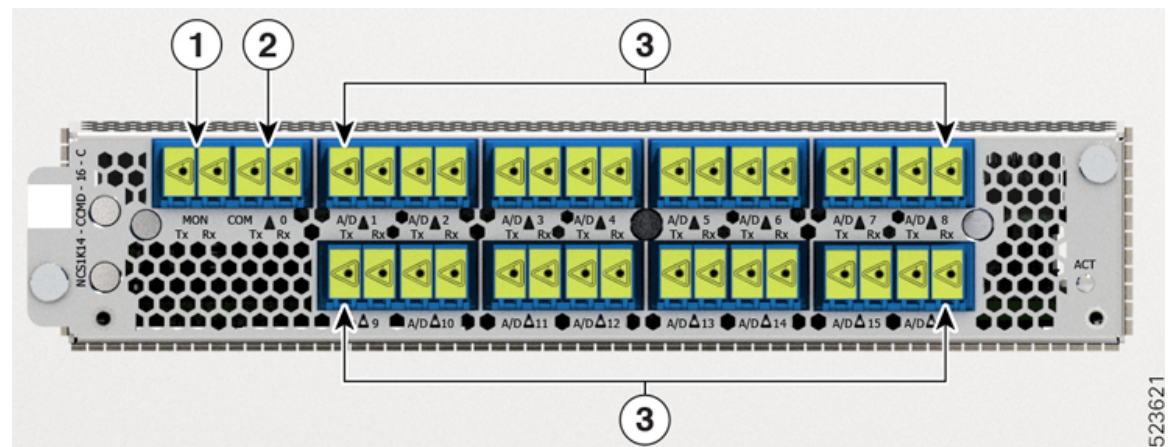

The following table shows the port names and their connector types for both CCDM-16-C and CCMD-16-L cards.

Table 7: Line Card Interface and Connector Assignment

Callout	Connector Label	Connector Type	Port Name
1	MON	LC	MON TX
			MON RX
2	COM	LC	COM TX
			COM RX
3	A/D 1...16	LC	A/D TX [1...16]
			A/D RX [1...16]

1.2T Line Card

The 1.2T DWDM line card can provide up to 12 OTU4 or three 400G client ports.

The 1.2T DWDM line card is a transponder that has 12 client ports to deliver 100GE and OTU4 client traffic. This line card has two trunks that operate at any rate between 100G and 600G in 50G increments. It uses Advanced Encryption Standard with a 256-bit key length (AES256)-based Layer-1 encryption to encrypt client-side data for 100GE and OTU4. The NCS1K4-1.2T-K9 line card is a single-slot unit that supports C-band traffic.

Figure 8: 1.2T DWDM Line Card Front View

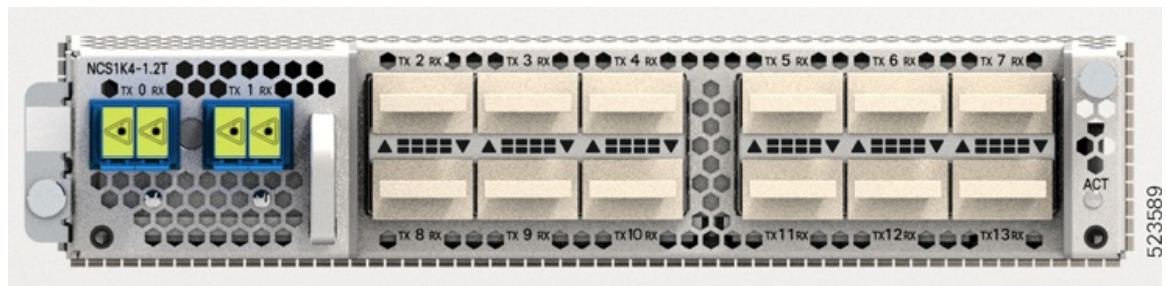

2.4TX Line Card

Table 8: Feature History

Feature Name	Release Information	Feature Description
NCS1K14-2.4T-X-K9 Line Card	Cisco IOS XR Release 24.1.1	<p>The new NCS1K14-2.4T-X-K9 line card is a single-slot Transponder and Muxponder card that delivers up to 1.2T C-band traffic at each trunk port. It has six QDD client ports that support 400GE and 4x100GE traffic on each port. This card provides two trunk ports that support 1.2T traffic on each port. The mxponder-slice and mxponder keywords in the hw-module command enable this card to operate in the following modes.</p> <ul style="list-style-type: none"> • Muxponder Slice Mode—The card virtually splits into two slices in this mode. It is possible to configure both trunks to carry different data rates. The supported trunk rates are 400G, 500G, 600G, 800G, 1000G, and 1200G. • Muxponder Mode—The card acts as one unit in this mode, configuring both trunks to the same data rate. The supported trunk rates are 600G and 1000G. Additionally, the capacity of a specific shared client port is consumed by two trunk ports.

The 2.4TX line card is a coherent optics Transponder and Muxponder for the Cisco NCS 1014 chassis. It is a single-slot card that supports C-band traffic at trunk ports. This card delivers 400GE and 100GE client traffic over two trunk ports operating at speeds ranging from 400G to 1.2T each. This card operates in two card modes, namely, the muxponder mode and the muxponder slice mode. In muxponder mode, the client traffic splits between the two trunk ports for 600G and 1000G payloads on port 2 and 3 respectively. In this mode, both trunk ports always carry the same data rate. In muxponder slice mode, both trunk ports act independently, carrying different data rates in each trunk.



Note In Release 24.1.1, the 2.4TX line card supports only 400, 500, 600, 800, 1000, and 1200G trunk payloads.

For more information about the 2.4TX card, see [datasheet](#).

In the 2.4TX card, the client and trunk ports support the pluggable form factor and data rates as shown in the following table.

Table 9: NCS1K14-2.4T-X-K9 Interfaces and Data Rates

Interfaces	Form Factor	Ports	Data Rates
Client	QSFP-DD56	1, 2, 3, 4, 5, 6	400G
	QSFP-DD112	2, 5	400, 800G
Trunk	Coherent Interface Module 8 (CIM8)	0, 7	up to 1.2T in each port



Note In Release 24.1.1, the ports 2 and 5 support only up to 400G data rates.

The 2.4TX card has two trunk ports and six client ports as shown in the following figure.

Figure 9: 2.4TX Line Card Front View

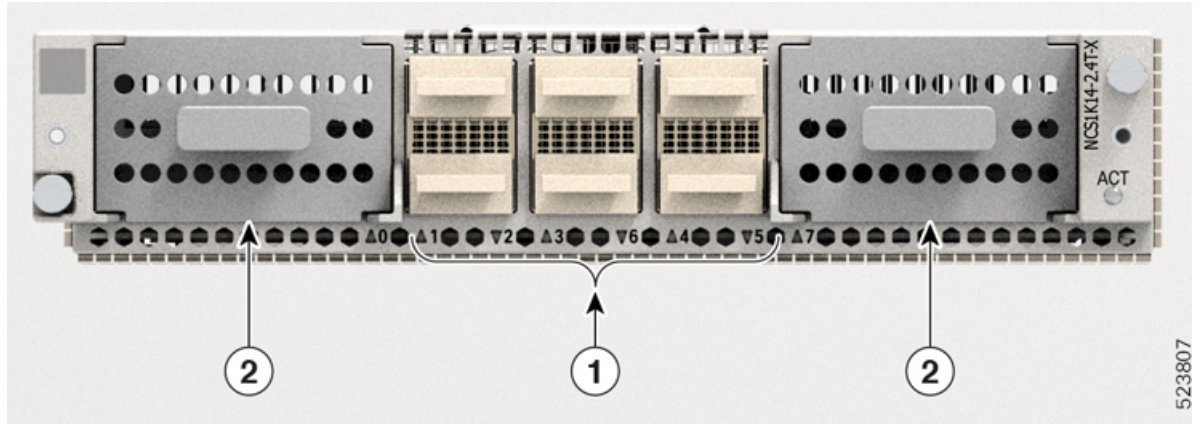

Table 10: 2.4TX Line Card Interfaces

Callout	Interface
1	Client port
2	Trunk port

The following figure shows the mapping between the client and trunk ports.

Figure 10: 2.4TX Card Client and Trunk Mapping

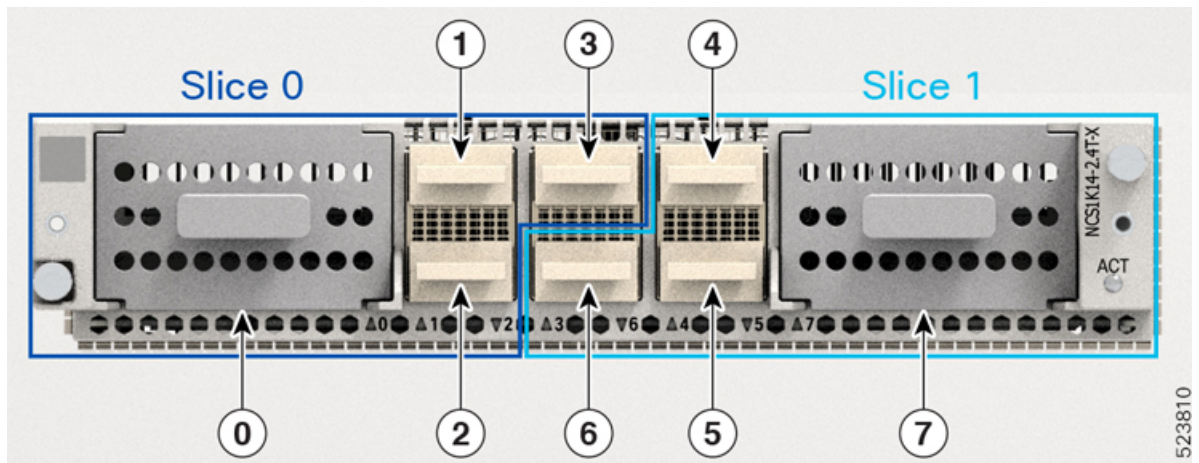

Table 11: Client-to-Trunk Port Mapping

Trunk Port	Client Ports
0	1, 2, 3
7	4, 5, 6



Note This client-to-trunk port mapping is only applicable for the mxponder-slice mode.

QXP-K9 Line Card

The QXP-K9 line card is a high-density QSFP-DD transponder that has eight client ports (QSFP-DD) and eight trunk ports (QSFP-DD ZR+). It is a single-slot card that supports 3.2T traffic through its eight QSFP-DD trunk ports. Each trunk port operates at speed up to 400G in a 50G increment. Each client port supports 400GE, 4x100GE, and 100GE without FEC client rates.

Table 12: QXP-K9 Interfaces

Interfaces	Form Factor	Ports
Client	QSFP-DD	1, 3, 5, 7, 9, 11, 13, 15
Trunk	QSFP-DD	0, 2, 4, 6, 8, 10, 12, 14

The QXP-K9 card has eight trunk ports and eight client ports as shown in the following figure.

Figure 11: QXP-K9 Line Card Front View

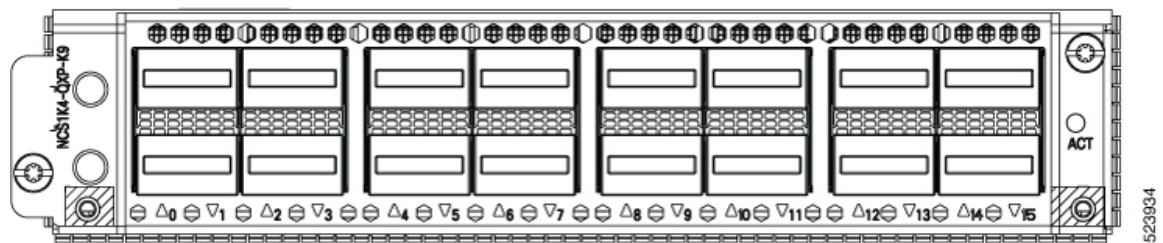

For more details of the QXP-K9 card, see the [data sheet](#).

Cisco NCS 1014 Modules

The Cisco NCS 1014 chassis supports the following modules:

Removable SSD

Table 13: Feature History

Feature Name	Release Information	Description
Removable NCS1K14-SSD Solid-State Disk (SSD)	Cisco IOS XR Release 7.10.1	The removable NCS1K14-SSD is the redundant SSD in the NCS 1014 chassis. At 2.5” in size, this SSD has 480 GB storage space to store running software and its configuration. This SSD acts as a backup storage to quickly recover the Cisco NCS 1014 chassis after an RP corruption or replacement.

The **NCS1K14-SSD** is the redundant chassis-based SSD in NCS 1014. It is field-replaceable and is accessible from the rear of the Cisco NCS 1014 chassis. This chassis SSD acts as the backup software storage in case the SSD inside the CPU fails. It has 480 GB storage space to store the running software and configuration. This backup storage enables Cisco NCS 1014 to quickly recover to functional state if either route processor (RP) corruption or replacement occurs.

The chassis SSD is 2.5 inch (63.5 mm) and is removable.

Figure 12: Removable Chassis SSD

Fan Modules

The Cisco NCS 1014 chassis has three field-replaceable fan modules (FAN0, FAN1, and FAN2) that cool down the line cards. Each fan module (**NCS1K14-FAN**) has two counterrotating fans—Inlet fan and Outlet fan. Each fan has its own power rail with inrush controller to increase reliability. These counterrotating fans ensure the following benefits:

- Higher back-pressure with respect to a single fan in each module.
- In case a single fan fails, the system can run with 5/6th of the total fans.
- In case a single fan fails, the other fan in the same module prevents the inversion of airflow.



Note The Cisco NCS 1004 fan modules and the Cisco NCS 1014 fan modules look identical. However, the Cisco NCS 1014 chassis does not support the Cisco NCS 1004 fan modules physically.

Each fan module has a cross handle to support lifting, status LED, and side lock lever to secure the module into the chassis.

Figure 13: Perspective View of Fan Module

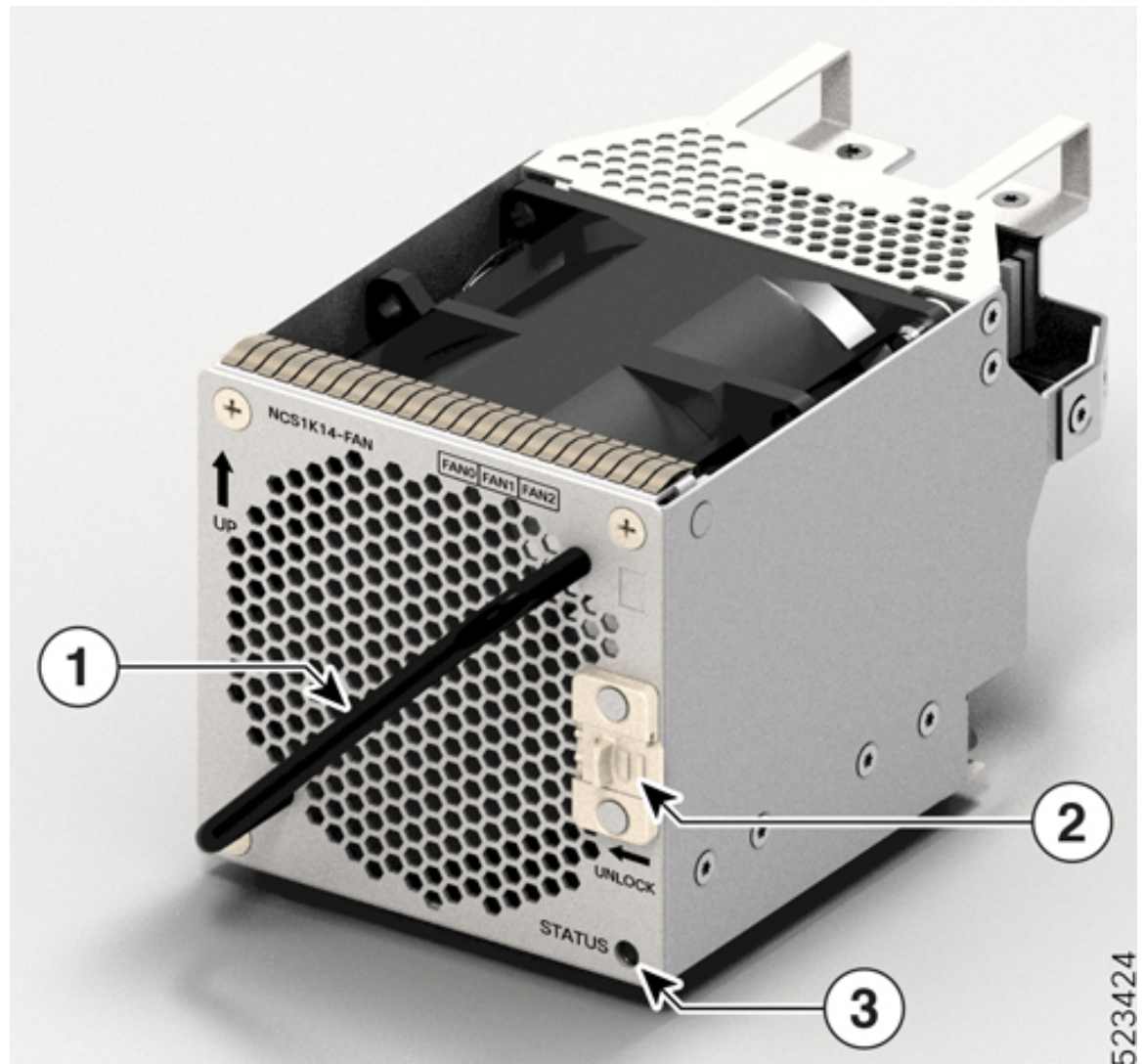

Table 14: Fan Module Components

Callout	Component
1	Cross handle
2	Side lever lock
3	Status LED

Controller Cards

The Cisco NCS 1014 chassis supports the following controller cards:

- NCS1K14-CNTRLR-B-K9

The NCS1K14-CNTRLR-B-K9 controller card supports a default of 9600-baud rate on the RS-232 console port. The controller card has two USB 2.0, two 10/100/1000 Ethernet, one RS-232 console and two 1GE SFP ports. The SFP port of the controller card supports 1GE payload for PTP. It also has an OIR button and six status LEDs. The controller card provides encryption, remote console connection, PTP and SyncE timing, and GPS.

Figure 14: NCS1K14-CNTRL-B-K9 Controller Card

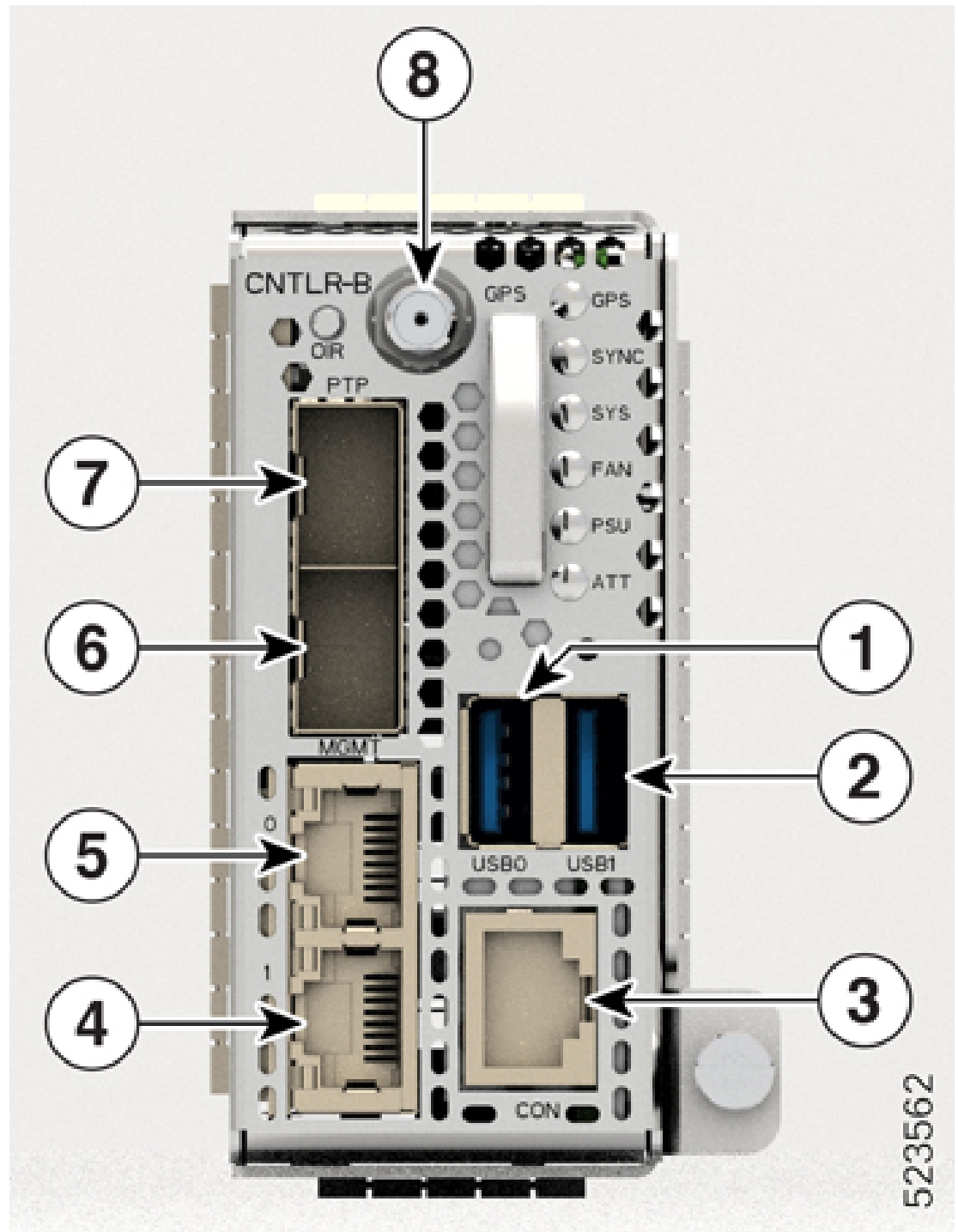

- **NCS1K14-CNTRL-K9**

The NCS1K14-CNTRL-K9 controller card supports a default of 115200-baud rate on the RS-232 console port. The controller card has two USB 2.0, two 10/100/1000 Ethernet, one RS-232 console and two 1GE

SFP ports. The SFP port of the controller card supports 1GE payload for PTP. It also has an OIR button and six status LEDs. The controller card provides encryption, remote console connection, PTP and SyncE timing, and GPS.

Figure 15: NCS1K14-CNTRLR-K9 Controller Card

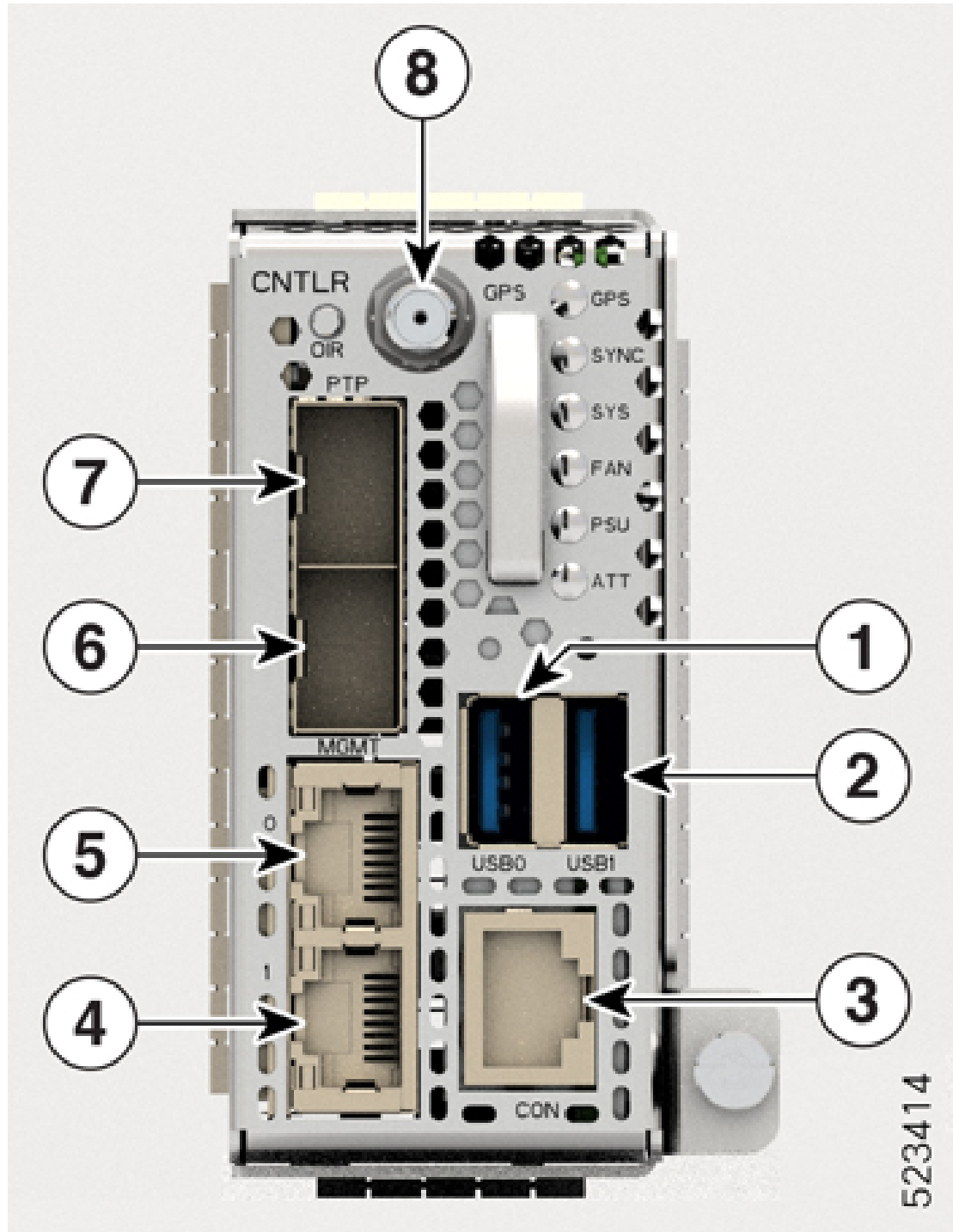

Table 15: Controller Card Interfaces

Callout	Interface	Description
1, 2	USB 0 and 1	External USB port. USB 2.0 type A, 1.8 A max at 12 V provides support to external passive optical modules (2x) The USB ports have following functions: <ul style="list-style-type: none"> • Essential—boot the image through pen drive (Only USB 2.0 sticks and pen drives are supported). • Optional—copy files to and from local devices (Only USB 2.0 sticks and pen drives are supported).
3	CON	Console interface (1x) Note Set the DTR (Data Terminal Ready) value to 1 to enable the CON interface.
4, 5	MGMT 0 and 1	10/100/1000 RJ-45 Ethernet management ports (2x)
7, 6	PTP 0 and 1	SFP for 1GE optical PTP ports (1588-nm PTP and SyncE) (2x)
8	GPS	Coaxial connector for GPS antenna RF input (with 5 V antenna power, if necessary) (1x)

Power Supply

The Cisco NCS 1014 chassis has two slots for 2.5-kW AC and DC redundant PSUs. Both the PSUs must always remain installed in the chassis, except during replacement. When the chassis has only one PSU installed, the system raises the *Power Module Redundancy Lost* alarm. The Cisco NCS 1014 chassis also supports 2-kW AC and DC PSUs.

2.5-KW PSUs (NCS1K4-AC-PSU-2 and NCS1K4-DC-PSU-2)

2.5-kW PSU power derating and option table, including ambient temperature details are here. The power details are for output power.

- AC high voltage range output power—2500 W up to 40°C for 1 PSU; 2500 W up to 55°C for 2 PSUs (for a short duration, as specified by Telcordia GR-63-Core).
- AC low voltage range output power—1500 W up to 40°C for 1 PSU; 1500 W up to 55°C for 2 PSUs (for a short duration, as specified by Telcordia GR-63-Core).
- DC power supply—2500 W output power up to 40°C for 1 PSU; 2500 W up to 55°C for 2 PSUs (for a short duration, as specified by Telcordia GR-63-Core).

For DC-DC (2500 W at 12 Vout)

- Input Voltage Rating = -48...-60 Vdc
- Maximum Input current at -48 Vdc = 60 A
- Input Voltage range = -40...-72 Vdc (operating)

- Input turn ON Voltage = $-41 \dots -42$ Vdc maximum
- Recommended protective device rating = 90 A maximum per feed

For the AC-DC (2500 W (HL) / 1500 W (LL) at 12 Vout)

- Input Low Line (LL) Nominal voltage = 100–120 V~
- Input High Line (HL) Nominal voltage = 200–230 V~
- Maximum Input current at 100 V~ = 16 A
- Maximum Input current at 200 V~ = 14 A
- Input frequency rating = 50/60 Hz
- Input LL voltage range = 90–140 V~
- Input HL voltage range = 180–264 V~
- Input frequency range = 47–63 Hz (nominal 50/60Hz)
- Minimum Input turn ON voltage = 85 V~ / 175 V~ (LL/ HL)
- Maximum Input turn ON voltage = 90 V~ / 180 V~ (LL/ HL)
- Recommended protective device (HL) = 16 A
- Recommended protective device (LL) = 20 A

2-KW PSUs (NCS1K4-AC-PSU and NCS1K4-DC-PSU)

2-kW PSU power derating and option table, including ambient temperature details are here. The power details are for output power.

- AC high voltage range output power—2000 W up to 40°C for 1 PSU; 2000 W up to 55°C for 2 PSUs (for a short duration, as specified by Telcordia GR-63-Core).
- AC low voltage range output power—1300 W up to 40°C for 1 PSU; 1300 W up to 55°C for 2 PSUs (for a short duration, as specified by Telcordia GR-63-Core).
- DC power supply—2000 W output power up to 40°C for 1 PSU; 2000 W up to 55°C for 2 PSUs (for a short duration, as specified by Telcordia GR-63-Core).



Caution The NCS 1014 chassis must have both the PSUs at all times. In case one of the PSUs is not energized (due to a fault or missing mains), ensure that the system works at an ambient temperature of not more than 40°C.

For DC-DC (2000 W at 12 Vout)

- Input Voltage Rating = -48 Vdc / -60 Vdc
- Maximum Input current at 48 Vdc = 44 A
- Input Voltage range = 40.5–72 Vdc (operating)
- Input turn ON Voltage = -42 Vdc maximum

- Recommended protective device rating = 60 A maximum per feed

For the AC-DC (2000 W (HL) / 1300 W (LL) at 12 Vout)

- Input Low Line (LL) Nominal voltage = 100–127 V~
- Input High Line (HL) Nominal voltage = 200–240 V~
- Maximum Input current at 100 V~ = 15 A
- Maximum Input current at 200 V~ = 12 A
- Input frequency rating = 50/60 Hz
- Input LL voltage range = 90–140 V~
- Input HL voltage range = 180–264 V~
- Input frequency range = 47–63 Hz (nominal 50/60 Hz)
- Input turn ON voltage = 80 V~ / 175 V~ (LL/ HL)
- Recommended protective device (HL) = 16 A
- Recommended protective device (LL) = 20 A

For the trip time response, the breaker trip curve may be "D" or faster.

Power Supply Units (PSUs)

The redundant, field-replaceable PSUs power the Cisco NCS 1014 chassis. The chassis has slots for two PSUs at the rear side. Each PSU supports up to 2.5 kW per system.

The PSUs have internal fans to regulate the temperature inside the PSUs. The fans in the PSU receive power from the main PSU or the standby PSU. The PSUs are available in reverse airflow (RAF) direction meaning the airflow direction is from the output connector to the input connector.

To ensure the necessary fan redundancy, the two PSUs implement a protection mechanism. When the mechanism detects a single PSU failure or if a PSU fails to power up, it triggers all the operational fans to run at maximum speed. This mechanism activates without intervention from the software.

The Cisco NCS 1014 chassis supports the following PSUs:

- **NCS1K4-AC-PSU-2**

NCS1K4-AC-PSU-2 is a 2.5-kW AC to DC, power-factor-corrected (PFC) power supply that converts standard AC power into a main output of 12 VDC.

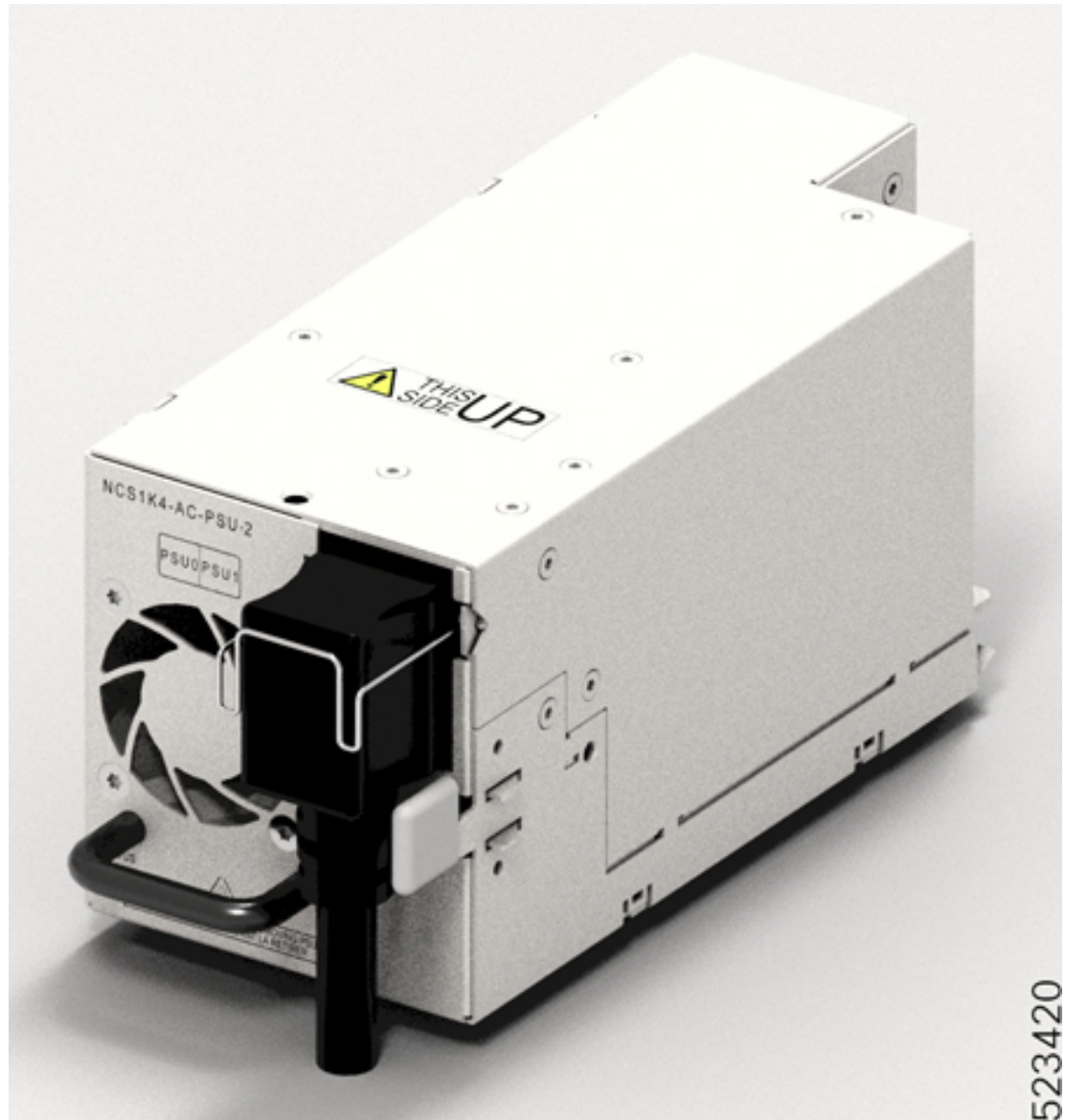
Figure 16: NCS1K4-AC-PSU-2

- **NCS1K4-DC-PSU-2**

NCS1K4-DC-PSU-2 is a 2.5-kW DC to DC, PFC power supply with 12 VDC (main) and 12 VDC (standby) output.

Figure 17: NCS1K4-DC-PSU-2

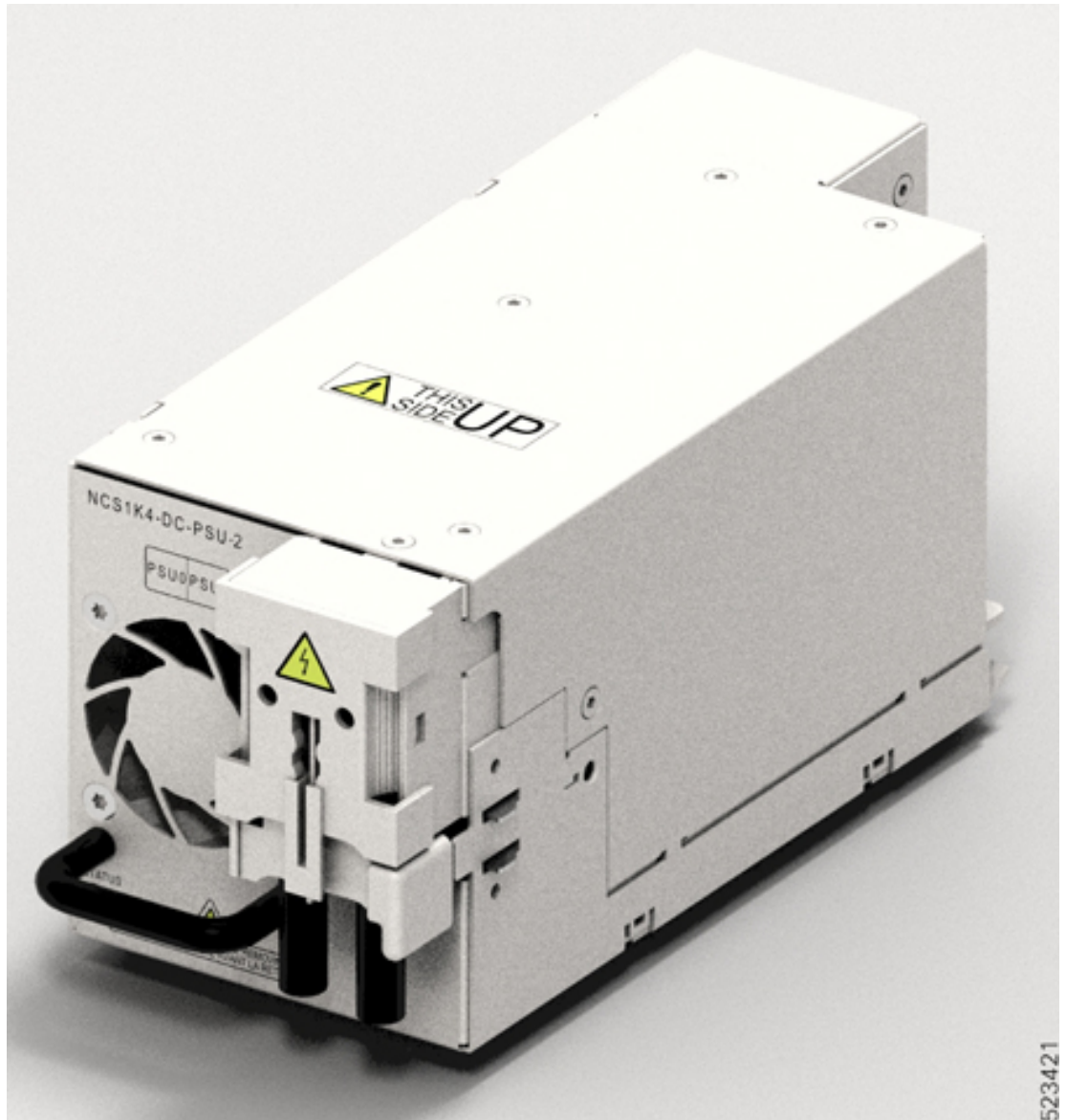

- **NCS1K4-AC-PSU**

NCS1K4-AC-PSU is a 2-kW AC to DC, PFC power supply that converts standard AC power into a main output of 12 VDC.

- **NCS1K4-DC-PSU**

NCS1K4-DC-PSU is a 2-kW DC to DC, PFC power supply with 12 VDC (main) and 12 VDC (standby) output.

Air Filter

The air filter removes dust from the air that the fan units draw into the chassis. If the air filters become damaged, dirty, or clogged with dust, you must replace them with a new air filter. Failure to replace a compromised air filter can result in insufficient air circulation through the chassis and temperature-related environmental alarms.

The Cisco NCS 1014 air filter has the following components:

- Two air filter side brackets
- One air filter frame
- One air filter

You must order all the three components for the first-time installation. After first-time installation of the air filter unit, replace only the air filter. You reuse the air filter side brackets and the frame.



Note First inspection of the air filter must be performed six months after the first installation of the air filter. Air filters must be inspected every three months after the initial six-month inspection and replaced if found to be dirty. Do not reuse the cleaned air filters. Replace them with a new air filter. We recommend having spare air filters in stock.

Supported Pluggables

Table 16: Feature History

Feature Name	Release	Description
Pluggables Support	Cisco IOS XR Release 24.3.1	<p>This client pluggable is supported on the QXP card:</p> <ul style="list-style-type: none"> • QDD-400G-LR4-S <p>This trunk pluggable is supported on the QXP card:</p> <ul style="list-style-type: none"> • QDD-400G-ZR-S <p>These client pluggables are supported on the 2.4TX card:</p> <ul style="list-style-type: none"> • QDD-2X100-CWDM4-S • QDD-2X100-LR4-S <p>These trunk pluggables are supported on the 2.4TX card:</p> <ul style="list-style-type: none"> • CIM8-CE-K9= • CIM8-LE-K9=

Feature Name	Release	Description
Pluggables Support	Cisco IOS XR Release 24.2.11	The following pluggables are supported on the NCS1K14-2.4-T-X-K9 card: <ul style="list-style-type: none"> • QDD-400G-LR4-S • QDD-4X100G-FR-S

2.4TX Line Card Pluggables

The 2.4TX line card supports the following pluggables:

Table 17: 2.4TX Line Card Pluggables

Client Pluggables	Trunk Pluggables
<ul style="list-style-type: none"> • QDD-400G-FR4-S • QDD-400G-AOCxM • QDD-400G-DR4-S • QDD-4X100G-LR-S • QDD-400G-LR4-S • QDD-4X100G-FR4-S • QDD-2X100-CWDM4-S • QDD-2X100-LR4-S 	<ul style="list-style-type: none"> • CIM8-C-K9= • CIM8-CE-K9= • CIM8-LE-K9=

2.4T Line Card Pluggables

The 2.4T line card supports the following pluggables:

Table 18: 2.4T Line Card Pluggables

Client Pluggables	Trunk Pluggables
<ul style="list-style-type: none"> • QDD-400G-FR4-S • QDD-400G-AOCxM • QDD-400G-DR4-S • QDD-4X100G-LR-S • QDD-2X100-CWDM4-S • QDD-2X100-LR4-S 	<ul style="list-style-type: none"> • CIM8-C-K9=

For more information on the 400G client pluggables, see [Cisco 400G QSFP-DD Cable and Transceiver Modules Data Sheet](#).

1.2T Line Card Pluggables

The 1.2T line card supports the following pluggables:

- QSFP-100G-SR4-S
- QSFP-100G-CWDM4-S
- QSFP-100G-SM-SR
- QSFP-100G-AOC-1M
- QSFP-100G-AOC-3M
- QSFP-100G-AOC-10M
- QSFP-100G-LR4-S
- QSFP-100G-CU1M
- QSFP-100G-CU2M
- QSFP-100G-CU3M
- QSFP-100G-CU5M
- QSFP-100G-DR-S
- QSFP-100G-FR-S
- QSFP-100G-LR-S
- ONS-QSFP28-LR4
- QSFP-40/100-SRBD
- QSFP-100G-ER4L-S

QXP Card Pluggables

The QXP card supports the following pluggables:

Table 19: QXP Line Card Pluggables

Client Pluggables	Trunk Pluggables
<ul style="list-style-type: none"> • QDD-400G-FR4-S • QDD-400G-DR4-S • QDD-400-AOCxM • QDD-4x100G-LR-S • QDD-400G-LR4-S 	<ul style="list-style-type: none"> • DP04QSDD-HK9 • DP04QSDD-LK9 • DP04QSDD-HE0 • QDD-400G-ZR-S • QDD-400G-ZRP-S



CHAPTER 2

Safety Guidelines

Before you perform any procedure in this publication, you must review the safety guidelines in this section to avoid injuring yourself or damaging the equipment. Note that this section contains *guidelines*, and does not include every potentially hazardous situation. During any installation procedure, always use caution and common sense.

Review the complete list of safety warnings available at Regulatory Compliance and Safety Information for *Cisco NCS 1014 Series*.

- [Standard Warning Statements, on page 27](#)
- [General Safety Guidelines for Personal Safety and Equipment Protection, on page 29](#)
- [Safety Precaution for Module Installation and Removal, on page 30](#)
- [Safety with Electricity, on page 31](#)
- [Power Connection Guidelines , on page 32](#)
- [Personal Safety Guidelines for Rack Mounting, on page 33](#)
- [Safety Precaution for Laser Radiation, on page 33](#)
- [Prevent Electrostatic Discharge Damage , on page 34](#)
- [Network Equipment-Building System \(NEBS\) Statements, on page 35](#)

Standard Warning Statements



Warning Statement 1015—Battery Handling

To reduce risk of fire, explosion, or leakage of flammable liquid or gas:

- Replace the battery only with the same or equivalent type recommended by the manufacturer.
- Do not dismantle, crush, puncture, use a sharp tool to remove, short the external contacts, or dispose of the battery in fire.
- Do not use if battery is warped or swollen.
- Do not store or use battery in a temperature $> 70^{\circ}$ Celsius.
- Do not store or use battery in low air pressure environment < 10.1 PSIA.

Statement 1015

**Warning Statement 1071**—Warning Definition

IMPORTANT SAFETY INSTRUCTIONS

Before you work on any equipment, be aware of the hazards involved with electrical circuitry and be familiar with standard practices for preventing accidents. Read the installation instructions before using, installing, or connecting the system to the power source. Use the statement number at the beginning of each warning statement to locate its translation in the translated safety warnings for this device.

SAVE THESE INSTRUCTIONS

**Note Statement 407**—Japanese Safety Instruction

You are strongly advised to read the safety instruction before using the product.

<https://www.cisco.com/web/JP/techdoc/pldoc/pldoc.html>

When installing the product, use the provided or designated connection cables/power cables/AC adapters.

〈製品仕様における安全上の注意〉
www.cisco.com/web/JP/techdoc/index.html

接続ケーブル、電源コードセット、ACアダプタ、バッテリーなどの部品は、必ず添付品または指定品をご使用ください。添付品・指定品以外をご使用になると故障や動作不良、火災の原因となります。また、電源コードセットは弊社が指定する製品以外の電気機器には使用できないためご注意ください。

**Warning Statement 1029**—Blank Faceplates and Cover Panels

Blank faceplates and cover panels serve three important functions: they reduce the risk of electric shock and fire, they contain electromagnetic interference (EMI) that might disrupt other equipment, and they direct the flow of cooling air through the chassis. Do not operate the system unless all cards, faceplates, front covers, and rear covers are in place.

**Warning Statement 9001**—Product Disposal

Ultimate disposal of this product should be handled according to all national laws and regulations.

**Warning Statement 1073**—No User-Serviceable Parts

There are no serviceable parts inside. To avoid risk of electric shock, do not open.

**Warning****Statement 1074**—Comply with Local and National Electrical Codes

To reduce risk of electric shock or fire, installation of the equipment must comply with local and national electrical codes.

**Warning****Statement 1089**—Instructed and Skilled Person Definitions

An instructed person is someone who has been instructed and trained by a skilled person and takes the necessary precautions when working with equipment.

A skilled person or qualified personnel is someone who has training or experience in the equipment technology and understands potential hazards when working with equipment.

There are no serviceable parts inside. To avoid risk of electric shock, do not open.

**Warning****Statement 1090**—Installation by Skilled Person

Only a skilled person should be allowed to install, replace, or service this equipment. See statement 1089 for the definition of a skilled person.

There are no serviceable parts inside. To avoid risk of electric shock, do not open.

General Safety Guidelines for Personal Safety and Equipment Protection

Follow these safety guidelines:

- Never attempt to lift an object that might be too heavy for you to lift by yourself.
- Always unplug power cables when performing maintenance or working on the chassis, unless the replacement part is hot swappable and designed for online insertion and removal (OIR).
- Keep the work area clear and dust free during and after installation.
- Keep tools and chassis components away from walkways and equipment rack aisles.
- Do not wear loose clothing, jewelry (including rings and chains), or other items that could get caught in the equipment.
- Fasten your tie or scarf and sleeves.
- Operate Cisco equipment safely by using it in accordance with its electrical ratings and product usage instructions.
- Do not work alone if potentially hazardous conditions exist.
- Ensure that the installation of the router is in compliance with national and local electrical codes: in the United States, National Fire Protection Association (NFPA) 70, United States National Electrical Code;

in Canada, Canadian Electrical Code, part I, CSA C22.1; in other countries, International Electrotechnical Commission (IEC) 364, part 1 through part 7.

Safety Precaution for Module Installation and Removal

Ensure to observe the following safety precautions when you are working with the chassis modules.



Warning **Statement 1090**—Installation by Skilled Person

Only a skilled person should be allowed to install, replace, or service this equipment. See statement 1089 for the definition of a skilled person.

There are no serviceable parts inside. To avoid risk of electric shock, do not open.



Warning **Statement 1091**—Installation by an Instructed Person

Only an instructed person or skilled person should be allowed to install, replace, or service this equipment. See statement 1089 for the definition of an instructed or skilled person.

There are no serviceable parts inside. To avoid risk of electric shock, do not open.



Warning **Statement 1028**—More Than One Power Supply

This unit might have more than one power supply connection. To reduce risk of electric shock, remove all connections to de-energize the unit.

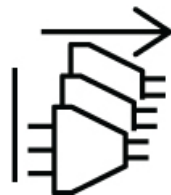

Warning **Statement 1073**—No User-Serviceable Parts

There are no serviceable parts inside. To avoid risk of electric shock, do not open.

Statement 1073—No User-Serviceable Parts



Warning **Statement 1073**—No User-Serviceable Parts

There are no serviceable parts inside. To avoid risk of electric shock, do not open.

Safety with Electricity



Warning **Statement 1005**—Circuit Breaker

This product relies on the building's installation for short-circuit (overcurrent) protection. To reduce risk of electric shock or fire, ensure that the protective device is rated not greater than: 20 A for AC and 40 A for DC.



Warning **Statement 1033**—Safety Extra-Low Voltage (SELV)—IEC 60950/ES1–IEC 62368 DC Power Supply

To reduce the risk of electric shock, connect the unit to a DC power source that complies with the SELV requirements in IEC 60950-based safety standards or ES1 and PS1 requirements in IEC 62368-based safety standards or to a Class 2 power supply.



Warning **Statement 1017**—Restricted Area

This unit is intended for installation in restricted access areas. Only skilled, instructed, or qualified personnel can access a restricted access area.



Warning **Statement 1022**—Disconnect Device

To reduce the risk of electric shock and fire, a readily accessible disconnect device must be incorporated in the fixed wiring.



Warning **Statement 1028**—More Than One Power Supply

This unit might have more than one power supply connection. To reduce risk of electric shock, remove all connections to de-energize the unit.

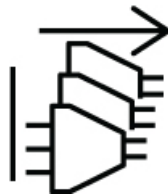



Warning **Statement 1029**—Blank Faceplates and Cover Panels

Blank faceplates and cover panels serve three important functions: they reduce the risk of electric shock and fire, they contain electromagnetic interference (EMI) that might disrupt other equipment, and they direct the flow of cooling air through the chassis. Do not operate the system unless all cards, faceplates, front covers, and rear covers are in place.



Warning **Statement 1046**—Installing or Replacing the Unit

To reduce risk of electric shock, when installing or replacing the unit, the ground connection must always be made first and disconnected last.

If your unit has modules, secure them with the provided screws.

Power Connection Guidelines

Check the power at your site to ensure you are receiving clean power (free of spikes and noise).

Ensure to observe the following safety guidelines while connecting the device power supplies.



Warning **Statement 1024**—Ground Conductor

This equipment must be grounded. To reduce the risk of electric shock, never defeat the ground conductor or operate the equipment in the absence of a suitably installed ground conductor. Contact the appropriate electrical inspection authority or an electrician if you are uncertain that suitable grounding is available.



Warning **Statement 1101**—Connected To Grounded Outlet

In the Scandinavian countries (Denmark, Finland, Iceland, Norway, and Sweden) the appliance must be connected to a grounded outlet.

Personal Safety Guidelines for Rack Mounting



Warning **Statement 1006**—Chassis Warning for Rack-Mounting and Servicing

To prevent bodily injury when mounting or servicing this unit in a rack, you must take special precautions to ensure that the system remains stable. The following guidelines are provided to ensure your safety:

- This unit should be mounted at the bottom of the rack if it is the only unit in the rack.
 - When mounting this unit in a partially filled rack, load the rack from the bottom to the top with the heaviest component at the bottom of the rack.
 - If the rack is provided with stabilizing devices, install the stabilizers before mounting or servicing the unit in the rack.
-



Warning **Statement 1032**—Lifting the Chassis

To prevent personal injury or damage to the chassis, never attempt to lift or tilt the chassis using the handles on modules, such as power supplies, fans, or cards. These types of handles are not designed to support the weight of the unit.



Warning **Statement 1098**—Lifting Requirement

2 people are required to lift the heavy parts of the product. To prevent injury, keep your back straight and lift with your legs, not your back.

Safety Precaution for Laser Radiation

Cisco NCS 1014 is classified as Hazard Level 1M as per IEC 60825-2 and Laser Class 1/1M as per IEC 60825-1, since it may include Class 1 or Class 1M Laser sources.

Figure 18: Class 1M Laser Product Label



Take note of the following optical connection warnings:



Warning **Statement 1051**—Laser Radiation

Invisible laser radiation may be emitted from disconnected fibers or connectors. Do not stare into beams or view directly with optical instruments.



Warning **Statement 1055**—Class 1/1M Laser

Invisible laser radiation is present. Do not expose to users of telescopic optics. This applies to Class 1/1M laser products.



Prevent Electrostatic Discharge Damage

Electrostatic discharge (ESD) can damage equipment and impair electrical circuitry. ESD may occur when electronic printed circuit cards are improperly handled and can cause complete or intermittent failures. When removing and replacing modules, always follow these ESD prevention procedures:

- Ensure that the device chassis is electrically connected to earth ground.
- Wear an ESD-preventive wrist strap, ensuring that it makes good skin contact.
- Handle components by only their handles or edges; do not touch the printed circuit boards or connectors.
- Avoid contact between the printed circuit boards and clothing. The wrist strap only protects components from ESD voltages on the body; ESD voltages on clothing can still cause damage.

Network Equipment-Building System (NEBS) Statements

NEBS describes the environment of a typical United States Regional Bell Operating Company (RBOC) central office. NEBS is the most common set of safety, spatial, and environmental design standards applied to telecommunications equipment in the United States. It is not a legal or regulatory requirement, but rather an industry requirement.

The following NEBS statements apply to Cisco NCS 1014:



Warning **Statement 7003**—Shielded Cable Shielded Cable Requirements for Intrabuilding Lightning Surge

The intrabuilding port(s) of the equipment or subassembly must use shielded intrabuilding cabling/wiring that is grounded at both ends.

The following port(s) are considered intrabuilding ports on this equipment:

RJ-45 Copper Ethernet Port



Warning **Statement 7005**—Intrabuilding Lightning Surge and AC Power Fault

The intrabuilding port(s) of the equipment or subassembly must not be metallically connected to interfaces that connect to the outside plant (OSP) or its wiring. These interfaces are designed for use as intrabuilding interfaces only (Type 2 or Type 4 ports as described in GR-1089-CORE) and require isolation from the exposed OSP cabling. The addition of primary protectors is not sufficient protection to connect these interfaces metallically to OSP wiring.

This statement applies to the intrabuilding ports listed below:

RJ-45 Copper Ethernet Port



Warning **Statement 7011**—Surge Protection Device Requirements for GR-1089 Antenna Ports

Protect equipment antenna ports, that are classified as Type 6 according to GR-1089-CORE, with lightning surge protectors that are rated at a minimum of 600 V peak surge of 1.2/50 uS duration.

Connecting a Cable to the GNSS Antenna Interface

- GNSS modules have built-in ESD protections on all pins, including the RF-input pin. However, additional surge protection is required if an outdoor antenna is being connected. The Lightning Protector must be able to provide a low clamping voltage (less than 600V).
- A lightning protection must be mounted at the place where the antenna cable enters the building. The primary lightning protection must be capable of conducting all potentially dangerous electrical energy to PE (Protective Earth).
- Surge arrestors should support DC-pass and suitable for the GPS frequency range (1.575GHz) with low attenuation.



Warning **Statement 7012**—Equipment Interfacing with AC Power Ports

Connect this equipment to AC mains that are provided with a surge protective device (SPD) at the service equipment that complies with NFPA 70, the National Electrical Code (NEC).



Note **Statement 7013**—Equipment Grounding Systems—Common Bonding Network (CBN)

This equipment is suitable for installations using the CBN.



Note **Statement 7016**—Battery Return Conductor

Treat the battery return conductor of this equipment as Isolated DC return (DC-I).



Note **Statement 8015**—Installation Location Network Telecommunications Facilities

This equipment is suitable for installation in network telecommunications facilities.



Note **Statement 8016**—Installation Location Where the National Electric Code (NEC) Applies

This equipment is suitable for installation in locations where the NEC applies.



Note **Statement 7018**—System Recover Time

The equipment is designed to boot up in less than 30 minutes provided the neighboring devices are fully operational.



CHAPTER 3

Prepare to Install Cisco NCS 1014

This chapter explains how to prepare for the Cisco NCS 1014 installation.

- [Shipping and Receiving, on page 37](#)
- [Unpack and Verify the Cisco NCS 1014 Chassis, on page 42](#)

Shipping and Receiving

You can order the Cisco NCS 1014 as an assembled chassis (NCS1K14-SYS) along with the components. You can order the spare modules as well. See [Product IDs](#) for all PIDs of the NCS 1014 components.

The shipped package contains the following:

- Cisco NCS 1014 chassis. See [Assembled Chassis](#).
- Accessory kit (53-100873-02) that has all the installation hardware.

Table 20: Accessory Kit Contents

Accessory Kit	Contents
53-100873-02	<p>This kit has the following items for chassis installation:</p> <ul style="list-style-type: none"> • Double hole 90-degree ground lug (1x). <p>Note We recommend that you use the 90-degree ground lug for NCS 1014.</p> <ul style="list-style-type: none"> • Double hole straight ground lug (1x) • M4 Phillips flat-head screws (12x) • M5 Pan head screws (2x) • 12–24 Pan head screws (24x) • External tooth washers (2x) • Left bracket (1x) • Right bracket (1x) • 23" rack to 19" rack adapter • ETSI rack to 19" rack adapter • Two-post left slide rail (1x) • Two-post right slide rail (1x) • Four-post left slide rail (1x) • Four-post right slide rail (1x)

- Spare Serial Number label.
- Two PSUs—AC or DC. Installation of PSUs is discussed in the [Install Cisco NCS 1014 Modules, on page 61](#) chapter.
- AC and DC power cables that you have ordered.

AC chassis—while ordering for an AC chassis, select the power cable type (straight, 90-degree, or jumper) and P1 connector (NEMA or CEE). Based on your choice, you will get a pair of 90 degree, straight, or jumper cables with NEMA or CEE connector for each PSU.

Table 21: Power Cables for the AC Chassis

Type of Cable	Voltage	P1 Connector	P2 Connector	PID	Specs	Cable Length (m)
Straight cable	240 V	NEMA L6-20P	IEC 60320 – C21	NCS1K4-AC-PSU-CBL=	16 A, 250 V	4.250
	240 V	CEE 7/7 (Europe)	IEC 60320 – C21	NCS1K4-AC-CBL-EU=	16 A, 250 V	4.250
90-degree cable	240 V	CEE 7/7 (Europe)	IEC 60320 – C21	NCS1K4-AC-CBL-EU=	16 A, 250 V	4.250
	240 V	NEMA L6-20P	IEC 60320 – C21	NCS1K4-AC-PSU-CBL	16 A, 250 V	4.250

Type of Cable	Voltage	P1 Connector	P2 Connector	PID	Specs	Cable Length (m)
Straight jumper	240 V	IEC 60320 – C14	IEC 60320 – C21	NCS1K4-CBL-4.25M=	16 A, 250 V	4.250
	240 V	IEC 60320 – C14	IEC 60320 – C21	NCS1K4-C21-C14-2M=	16 A, 250 V	2
Straight jumper	240 V	IEC 60320 – C20	IEC 60320 – C21	N1K4-C2021-5F-NA=	16 A, 250 V	1.6 (North America)
	240 V	IEC 60320 – C20	IEC 60320 – C21	N1K4-C2021-5F-EU=	16 A, 250 V	1.6 EU)
	240 V	IEC 60320 – C20	IEC 60320 – C21	N1K4-C2021-5F-IN=	16 A, 250 V	1.6 (India)
Straight jumper	240 V	IEC 60320 – C20	IEC 60320 – C21	N1K4-C2021-4M-NA=	16 A, 250 V	4.25 (North America)
	240 V	IEC 60320 – C20	IEC 60320 – C21	N1K4-C2021-4M-EU=	16 A, 250 V	4.25 (EU)
	240 V	IEC 60320 – C20	IEC 60320 – C21	N1K4-C2021-4M-IN=	16 A, 250 V	4.25 (India)

Figure 19: 90-degree Cable (CEE 7/7)

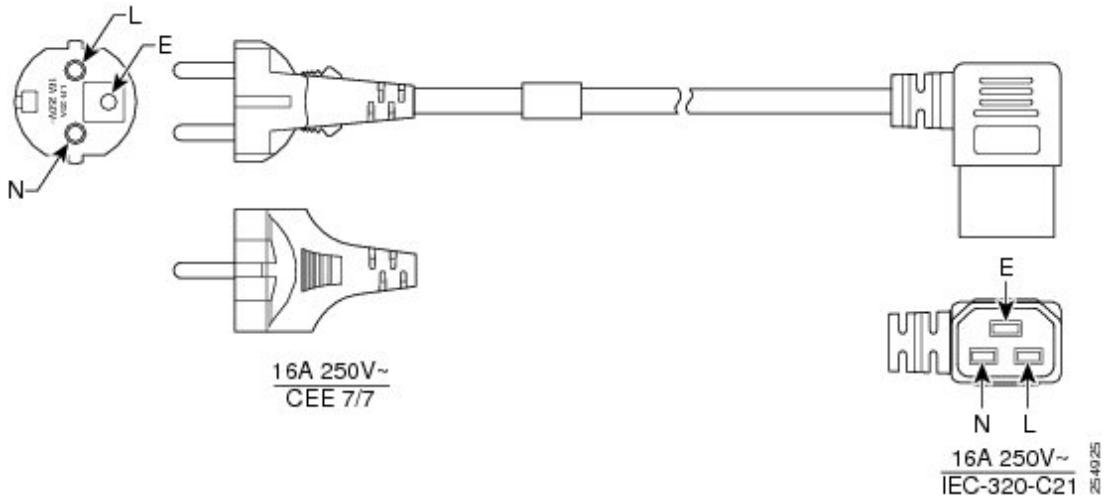

Figure 20: 90-degree Cable (NEMA L6-20P)

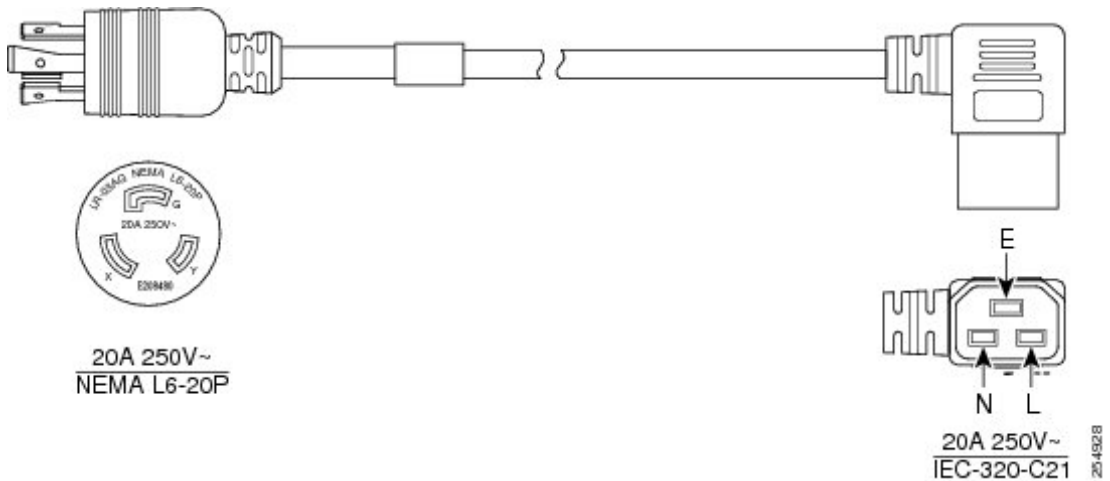

Figure 21: Straight Cable (NEMA L6-20P)

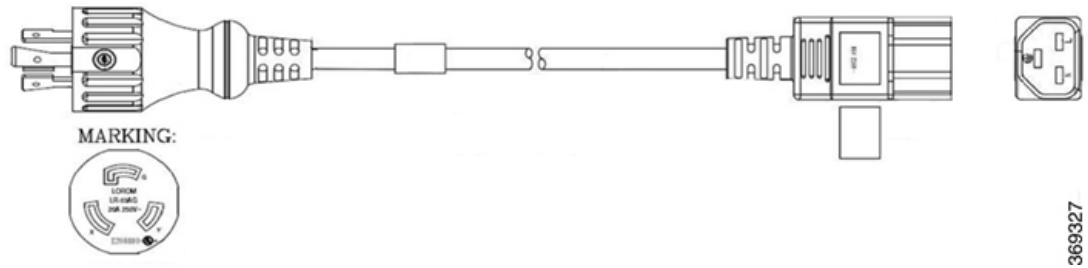
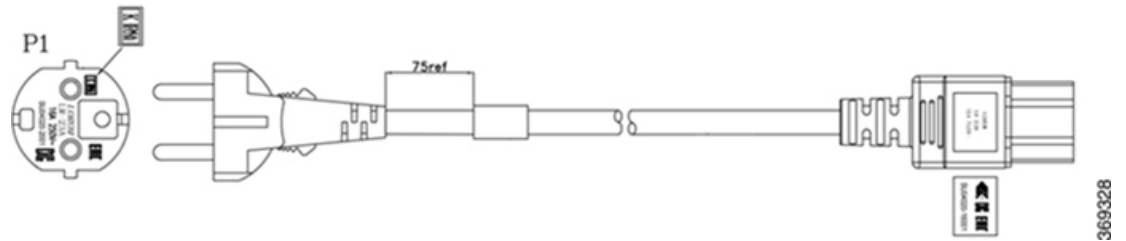

Figure 22: Straight Cable (CEE 7/7)



DC chassis—when you order for a DC chassis, you get four power lugs for each PSU (a pair of 90-degree and a pair of 180-degree lugs). The power lugs are included in the DC PSU package for spare-order. For Assemble-to-order, the power lugs are included in the Accessory kit.



Important We recommend that you use the 180-degree power lugs for ETSI racks to maintain a footprint of 600 mm. Ensure that there is a minimum gap of 50 mm for routing the cables.

Figure 23: DC Power Cable Lug (180-degree)

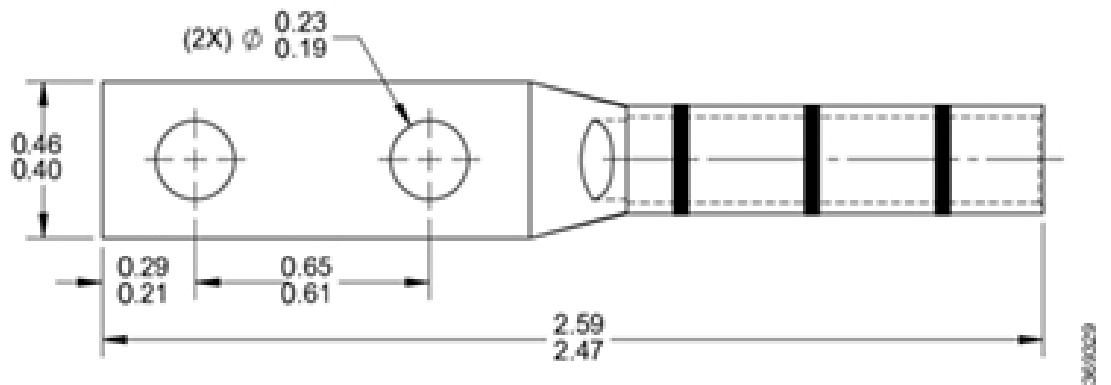
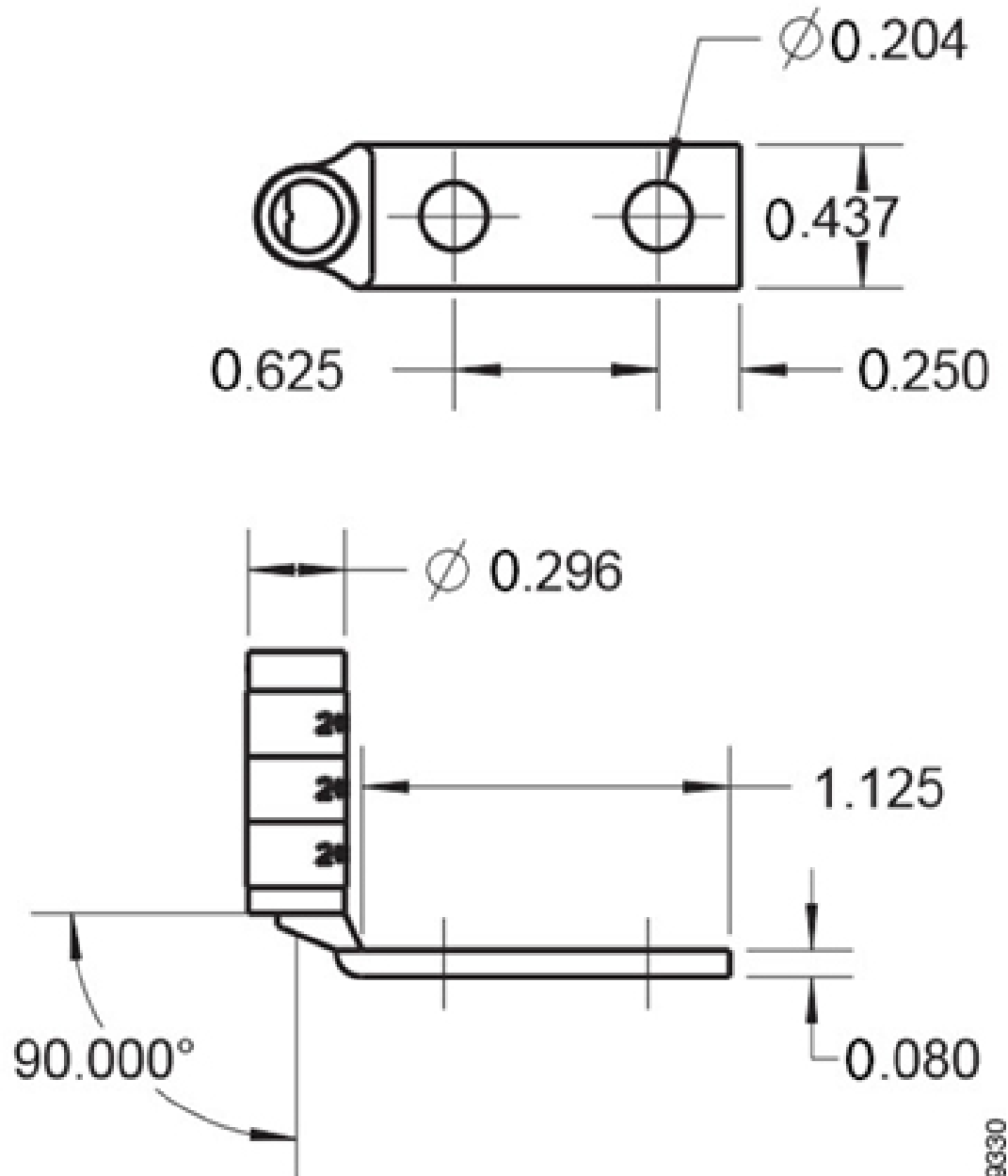

Figure 24: DC Power Cable Lug (90-degree)



369330

Assembled Chassis

The chassis is shipped in one of the following ways:

- **Chassis with Filler Cards and Line Cards**

You will receive the chassis with preinstalled line cards, based on the number of line cards that you have ordered, and filler cards in the rest of the cardslots. If you have preordered four line cards, then the chassis

does not contain any filler cards. Four fiber management brackets come in the package, for each of the line card or filler cards preinstalled in the chassis. The controller, SSD, and three fan modules are also preinstalled. The chassis package includes only the accessory kit and PSUs.

Figure 25: Chassis Shipped with Line Cards



- **Chassis with Only Filler Cards**

You will receive the chassis with four filler cards in the cardslots. The chassis package includes four fiber management brackets, one bracket for each of the filler cards. If you order one or more line cards as spare items, you will receive each of them separately, with an extra fiber management bracket in each package. The controller, SSD, and three fan modules are preinstalled. The chassis package includes only the accessory kit and PSUs. You must order the line cards separately.

Unpack and Verify the Cisco NCS 1014 Chassis

Use this procedure to unpack the shipment and verify that you have all the chassis modules that are required for installation.

Procedure

-
- Step 1** When you receive the Cisco NCS 1014 equipment at the installation site, open the top of the box.
 - Step 2** Remove accessories and foam inserts from the box. The box contains Cisco NCS 1014 chassis and other items that are needed for installation.
 - Step 3** To remove the chassis from the packaging, grasp the side of the chassis and lift it out of the box.

Use these lifting guidelines to avoid injury to yourself or damage to the equipment:

- Do not lift equipment alone. Have another person help you to lift the equipment.
A fully loaded chassis can weigh as much as 28.7 kg (63.3 lbs).
- Ensure that your footing is solid; balance the weight of the object between your feet.

- Lift the equipment slowly; never move suddenly or twist your body as you lift.
- Keep your back straight and lift with your legs, not your back. When bending down to lift equipment, bend at the knees (not at the waist), to reduce the strain on your lower back muscles.

Step 4

Verify the following:

- The Cisco NCS 1014 chassis is undamaged. Check the chassis for scratches, bends, discolorations, or deformations.
- The other modules that are shipped with the chassis or separately are undamaged.

Step 5

If you notice any damage to the chassis or the modules, call your Cisco sales engineer for a replacement.



CHAPTER 4

Install the Cisco NCS 1014 Chassis



This chapter contains procedures to install the Cisco NCS 1014 chassis.

- [Rack Compatibility](#), on page 45
- [General Power and Grounding Requirements](#), on page 47
- [Install the Cisco NCS 1014 Chassis on an EIA/ANSI/ETSI Rack](#), on page 49

Rack Compatibility

This section provides rack compatibility details for the Cisco NCS 1014.

Figure 26: Four Post Rack Type

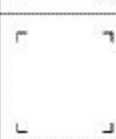
4 – Post Type (Hole EIA Universal)		Compatibility
All 23" Type rack		✓
19" Type rack L-Type Post		✓
19" Type Racks Flat-Post		✓
19" Type racks C-Type Post		✗
ETSI Type rack (Hole ETSI Universal)		✓

3041182

Figure 27: Four Post Rack Type

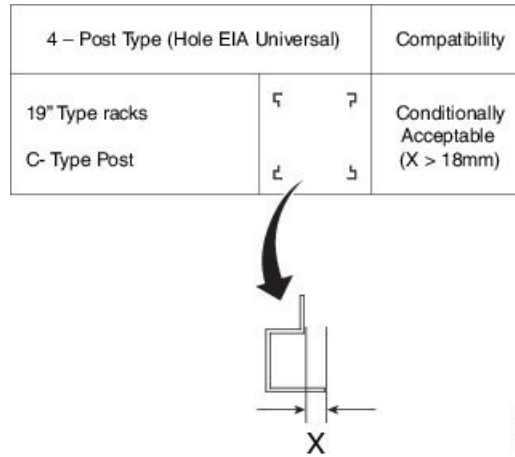

Figure 28: Two Post Rack Type

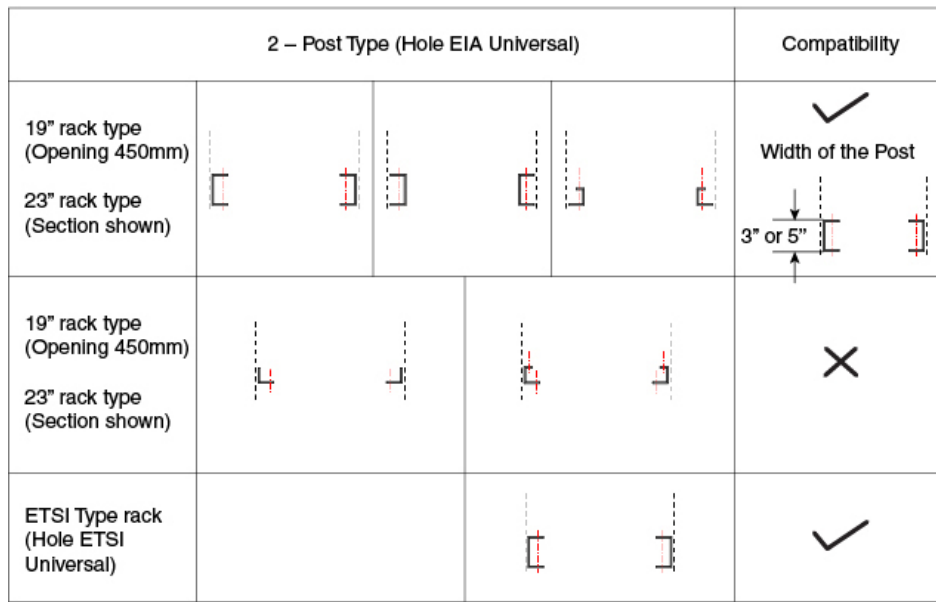
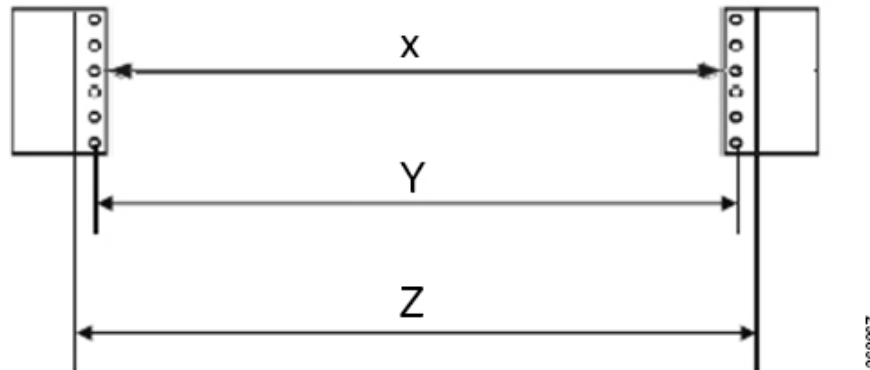

Figure 29: Rack Specification



Rack Type	Rack Front Opening X	Rack Mounting Hole Center-Center Y	Mounting Flange Dimension Z
19" racks	450.8mm (17.75")	465mm (18.312")	482.6mm (19")
23" racks	552.45mm (21.75")	566.7mm (22.312")	584.2mm (23")
ETSI racks	500.0mm(19.68")	515.0mm(20.276")	533.4mm(21")



Note The distance between the front and the rear post in a four post rack is 427 mm (closed position) and 707 mm (open position).

General Power and Grounding Requirements

General power and grounding requirements are:

- Installation of the routing system must follow national and local electrical codes:
 - In the United States: United States National Fire Protection Association (NFPA) 70 and United States National Electrical Code (NEC).
 - In Canada: Canadian Electrical Code, part I, CSA C22.1.
 - In other countries: International Electrotechnical Commission (IEC) 60364, parts 1 through 7.
- Two separate and independent AC or DC power sources are needed to provide 2N redundancy for system power. Each power source requires its own circuit breaker.
- Each power source must provide clean power to the site. If necessary, install a power conditioner.
- The site must provide short-circuit (over-current) protection for devices.
- Proper grounding is required at the site to ensure that equipment is not damaged by lightning and power surges.



Note Ground lug connection is mandatory for the AC chassis version too.

- Site power planning must include the power requirements for any external terminals and test equipment you will use with your system.



Note Be sure to review the safety warnings in the Cisco Network Convergence System *Regulatory Compliance and Safety Information for the Cisco Network Convergence System 1014* before attempting to install the chassis.

Ground the Cisco NCS 1014 Chassis

Use this task to ground the Cisco NCS 1014 chassis. In the installation of the chassis, connect the ground lug first.

The NCS 1014 chassis has one grounding point at the front. The following warning label is affixed on the chassis.



Warning High leakage current, earth connection essential before connecting supply.



Caution When terminating the frame ground, do not use soldering lug connectors, screwless (push-in) connectors, quick connect connectors, or other friction-fit connectors.

Before you begin

Install the Air Filter before installing the ground lug onto the Cisco NCS 1014 chassis. See [Install the Air Filter, on page 84](#).

Procedure

-
- Step 1** Verify that the office ground cable is connected to the top of the rack and the office ground, according to local site practice.
 - Step 2** Remove any paint and other nonconductive coatings from the surfaces between the shelf ground and bay frame ground point. Clean the mating surfaces and apply appropriate antioxidant compound to the bare conductors.
 - Step 3** Attach one end of the ground cable (no. 6 AWG cable) dual-hole lug connector.
 - Step 4** Align the dual-hole ground lug to the chassis ground point.

Figure 30: NCS 1014 Ground Lug

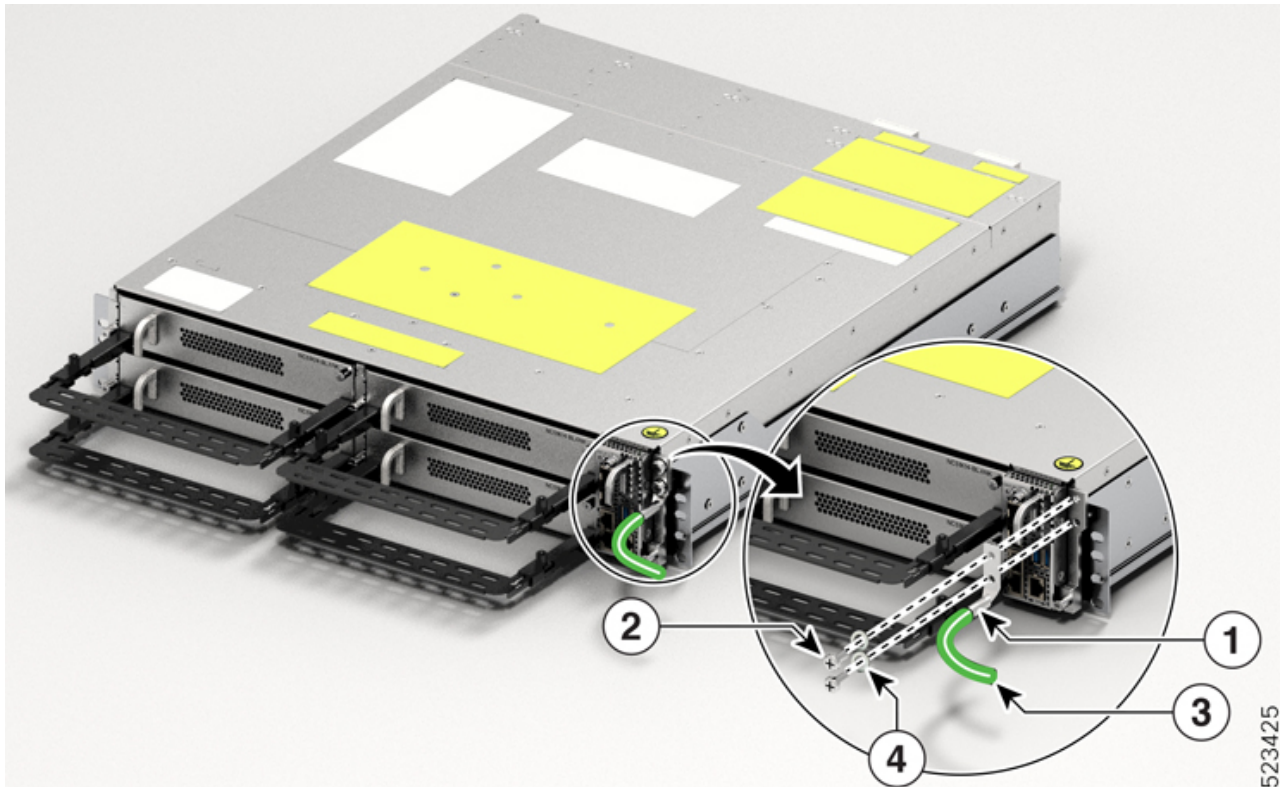

Callout	Accessory
1	Lug
2	M5 pan-head screw (48-1169-01)
3	Ground cable
4	Lock washer (49-100371-01)

The orientation of the lug cable is always at the bottom side.

Step 5 Tighten the M5 pan-head screw (48-1169-01) to a torque value of 3.1 N-m (27.4 lbs-in).

Step 6 Attach the other end of the ground cable to the bay frame using a dual-hole lug connector, according to the equipment rack frame specifications.

Install the Cisco NCS 1014 Chassis on an EIA/ANSI/ETSI Rack

Use this procedure to mount the Cisco NCS 1014 chassis on an EIA/ANSI/ETSI rack.

**Warning Rack Mount Instructions**

The following or similar rack-mount instructions are included with the installation instructions:

- **Elevated Operating Ambient**—If installed in a closed or multirack assembly, the operating temperature of the rack environment may be greater than room temperature. Therefore, consideration should be given to installing the equipment in an environment compatible with the maximum ambient temperature (T_{ma}) specified.
- **Reduced Air Flow**—Installation of the equipment in a rack should be such that the amount of air flow required for safe operation of the equipment is not compromised.
- **Mechanical Loading**—Mounting of the equipment in the rack should be such that a hazardous condition is not achieved due to uneven mechanical loading.
- **Circuit Overloading**—Consideration should be given to the connection of the equipment to the supply circuit and the effect that overloading of the circuits might have on overcurrent protection and supply wiring. Appropriate consideration of equipment nameplate ratings should be used when addressing this concern.
- **Reliable Earthing**—Reliable earthing of rack-mounted equipment should be maintained. Particular attention should be given to supply connections other than direct connections to the branch circuit (for example, use of power strips).

It is mandatory to fix the fiber management brackets for all the cards in the chassis before you install the Cisco NCS 1014 chassis onto the rack. See [Attach the Fiber Management Bracket](#) section for the detailed procedure.

Figure 31: Line Cards fitted with Fiber Management Bracket

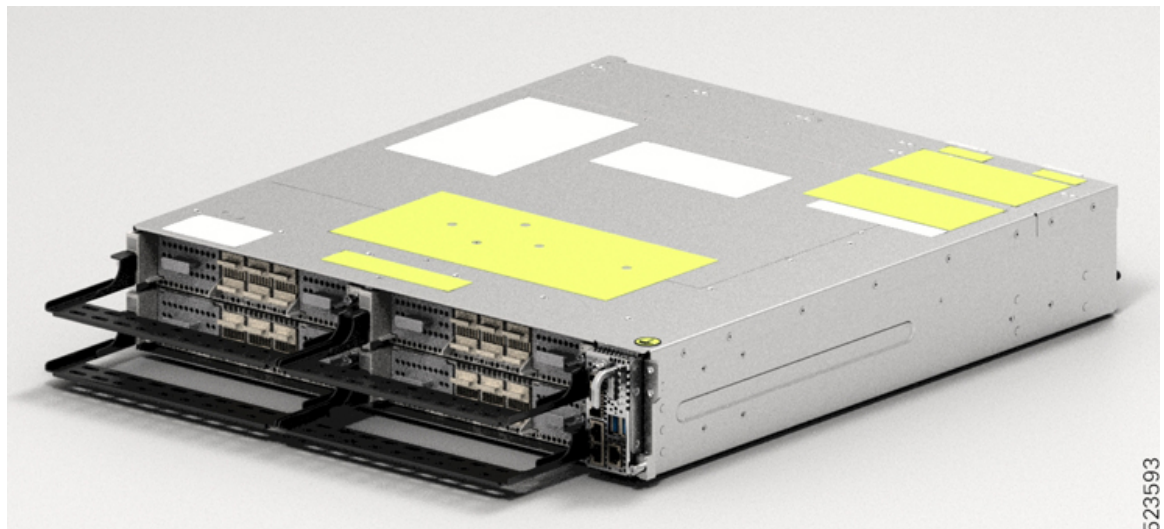

Note In ETSI racks, to maintain a footprint of 600 mm, do not install the cabinet door and maintain the horizontal bar of the fiber management bracket at the shortest length. See [Adjust the Fiber Management Bracket](#).



Caution Use the sliding rail only for first chassis positioning. You must fix the chassis with screws on the front side.



Caution Use only the fastening hardware provided with Cisco NCS 1014 to prevent loosening, deterioration, and electromechanical corrosion of the hardware and joined material.

Before you begin

Ensure that the rack is compatible. See the [Rack Compatibility, on page 45](#) section.

Procedure

Step 1 Attach the left and right mounting brackets to the chassis using the screws (48-2029-01) and tighten them to torque value of 1.5 N-m (13.3 lbs-in).

The left and right brackets are marked accordingly.

Figure 32: Fixing the Brackets

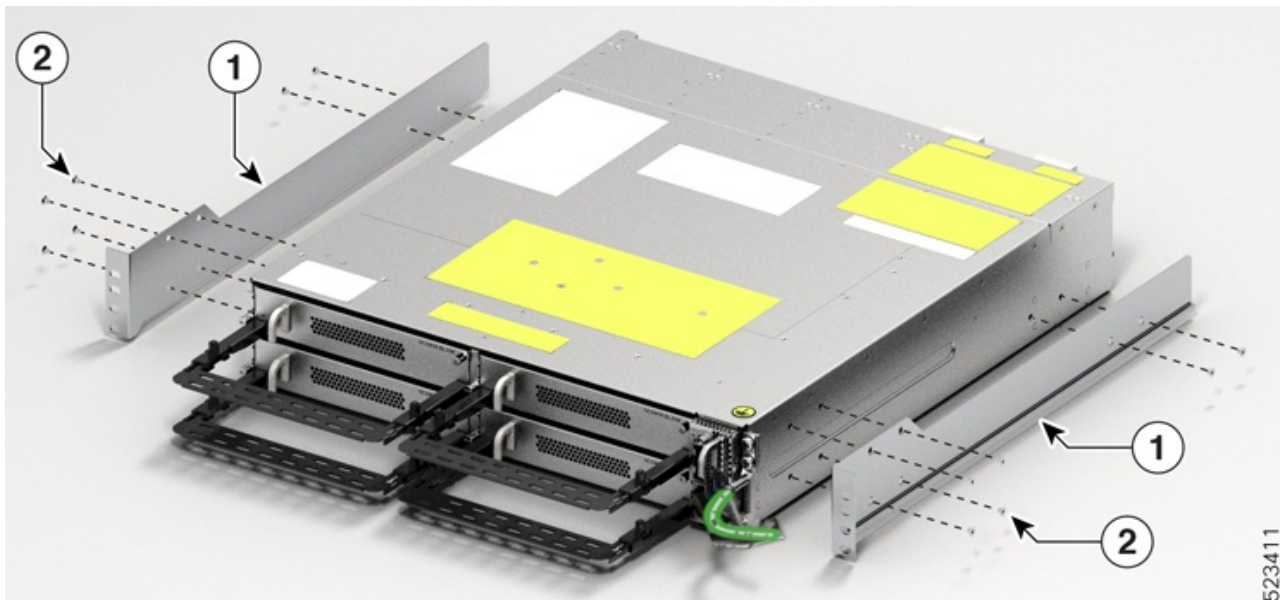

Callout	Component
1	Screws used for brackets
2	Right Bracket (700-116388-01) and Left Bracket (700-116386-01)

Step 2 Install the four post slider or two post slider on the rack.

a) [Install the Two Post Slider into an EIA/ANSI Rack](#)

- b) [Install the Four Post Slider into an EIA/ANSI Rack](#)
- c) [Install the Two Post Slider into an ETSI Rack](#)
- d) [Install the Four Post Slider into an ETSI Rack](#)

Step 3 Insert the chassis (with brackets) onto the sliders assembled on the rack.

Step 4 After completely inserting the chassis, fasten it with four screws (48-101524-01) on each side of the bracket.

See [Install the Air Filter, on page 84](#) for the air filter installation procedure, before you fasten the chassis to the rack.

Step 5 Using a number-2 Phillips screwdriver, tighten the screws to a torque value of 4.65 N-m (41 lbs-in).

Install the Two Post Slider into an EIA/ANSI Rack

Use this procedure to install the two post slider into an EIA/ANSI rack.

Procedure

- Step 1** Identify the two post slider and adjust the length of the slider (3" to 5").
Slide the inner sliders and adjust the length to mate with the rack surface.

Figure 33: Two Post Slider Identification

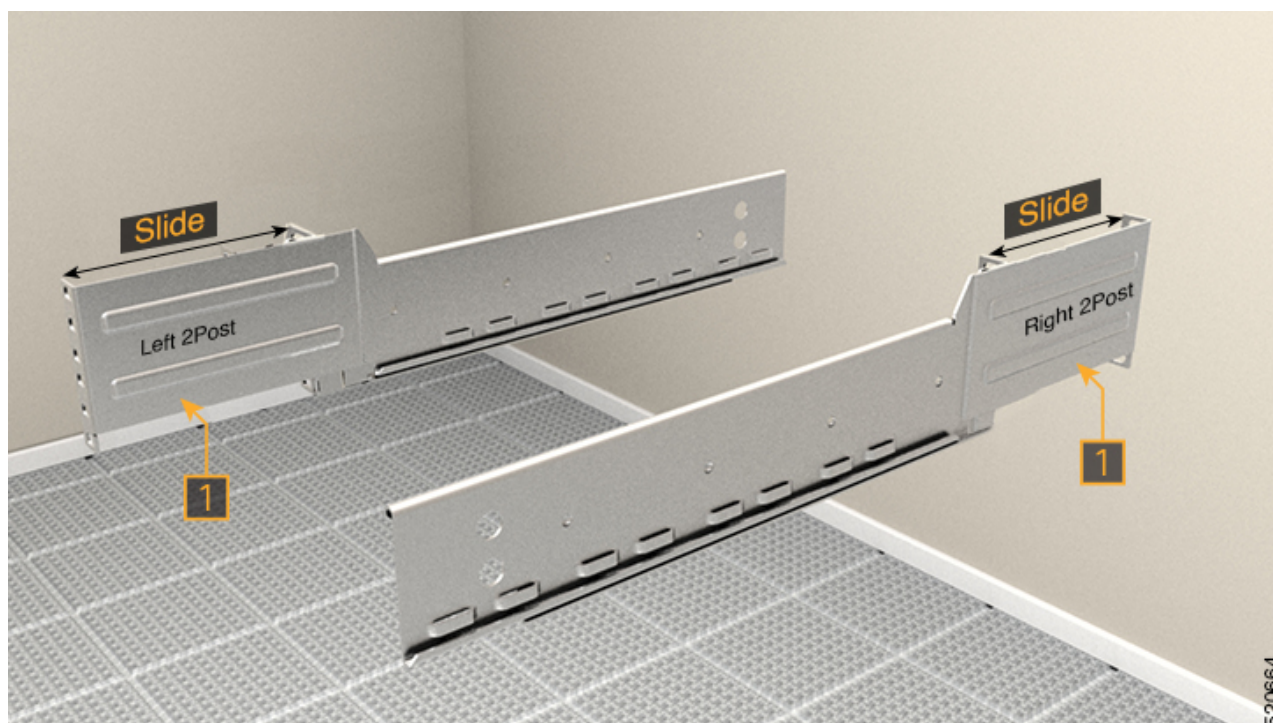

1

Check for marking on the sliders; the markings indicate the right and the left sliders.

- Step 2** Integrate the two post slider with the rack. Perform one of the following actions:

- For the 19" rack, you can directly fit the slider on to the rack. Perform the following steps:
 - a. On the front side, insert only the top-most screw of the slider (48-101524-01).
 - b. Tighten the screw to torque value of 4.65 N-m (41 lbs-in).
 - c. Similarly, on the rear side, insert three screws (48-101524-01) and tighten them to torque value of 4.65 N-m (41 lbs-in).
- For the 23" rack, you can fit the slider on to the rack using an adapter. Perform the following steps: (refer the following image).

The formed surface must always face the inner side of the rack post.

- a. On the front side of the adapter (towards the chassis), insert only the top-most screw of the slider (48-101524-01).
- b. Tighten the screw to torque value of 4.65 N-m (41 lbs-in).
- c. Similarly, on the rear side (towards the chassis), insert three screws (48-101524-01) and tighten them to torque value of 4.65 N-m (41 lbs-in).

For the adapter portion which is towards the rack, you must fit all the six screws on the front and rear side.

Figure 34: Two Post Slider Integration in the 19" Rack

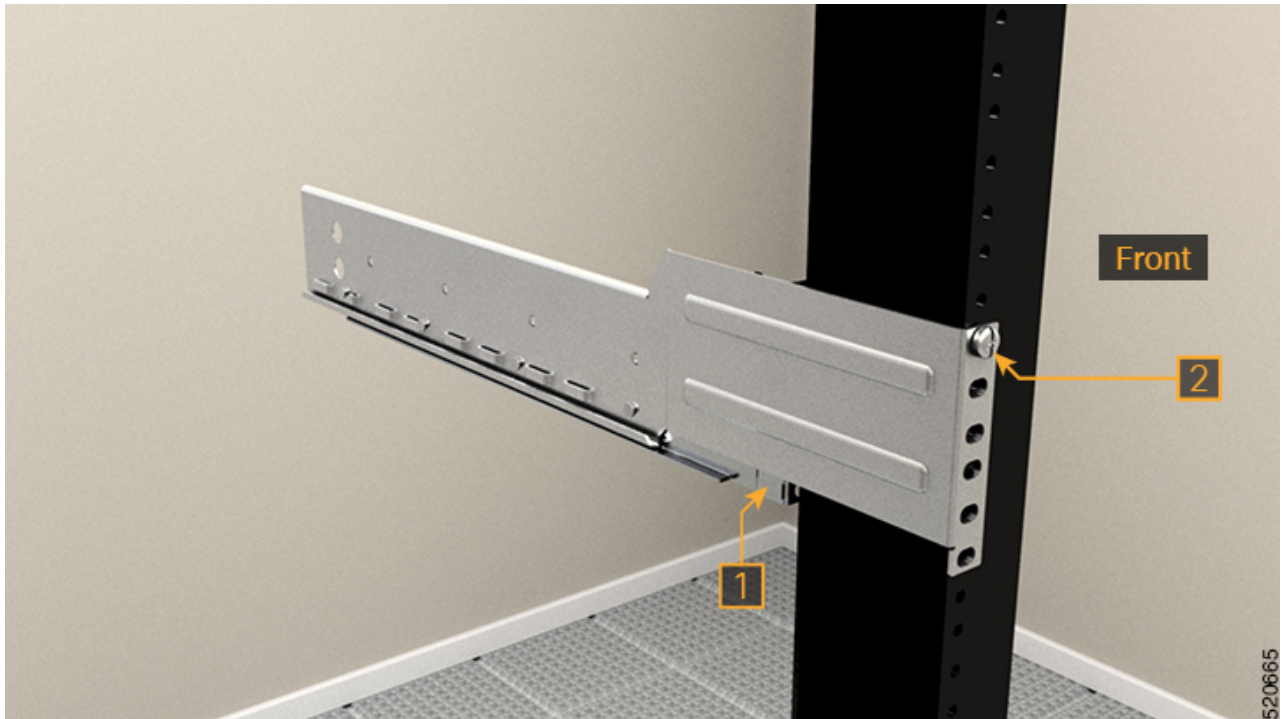

1	Inner surface of the sliding bracket.
2	Slider fixing screws (48-101524-01)

Figure 35: Two Post Slider Integration in the 23" Rack

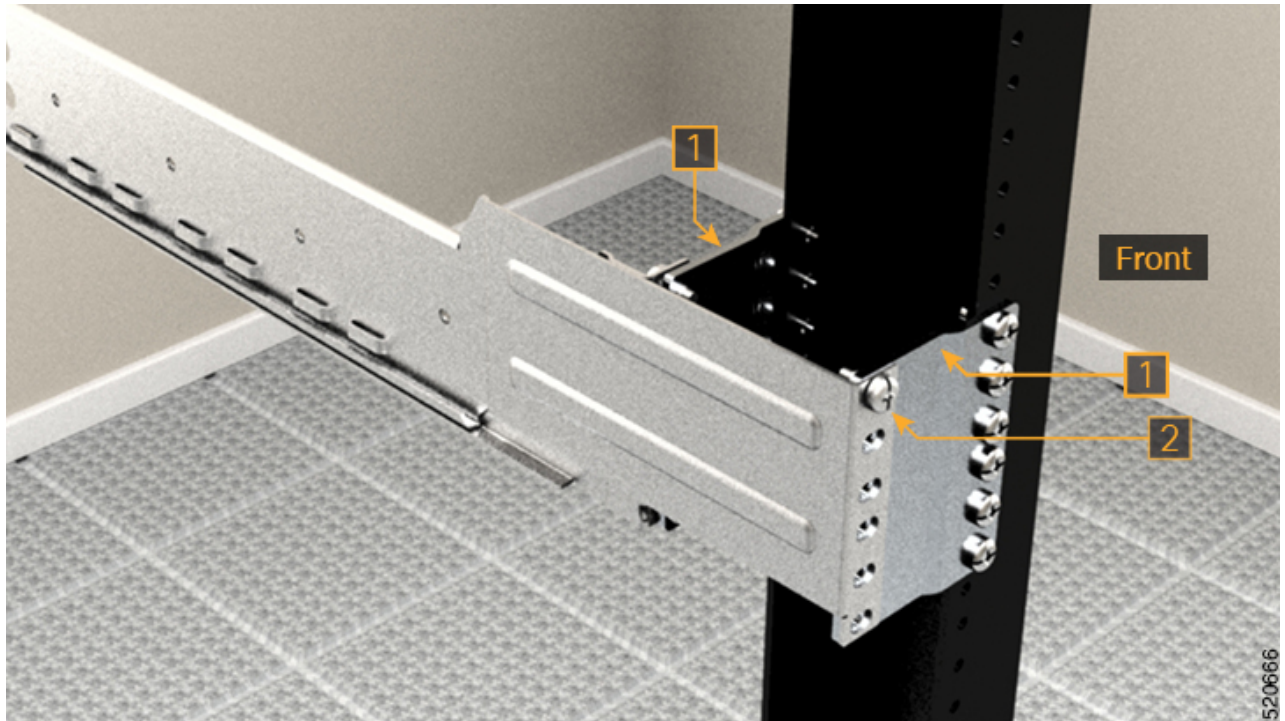

1	Adapter
2	Slider fixing screws (48-101524-01)

Install the Four Post Slider into an EIA/ANSI Rack

Use this procedure to install the four post slider into an EIA/ANSI rack.

Procedure

- Step 1** Identify the four post slider and adjust the length of the slider.
Slide the inner slider arm and adjust the length to mate with the rack surface.

Figure 36: Four Post Slider Identification

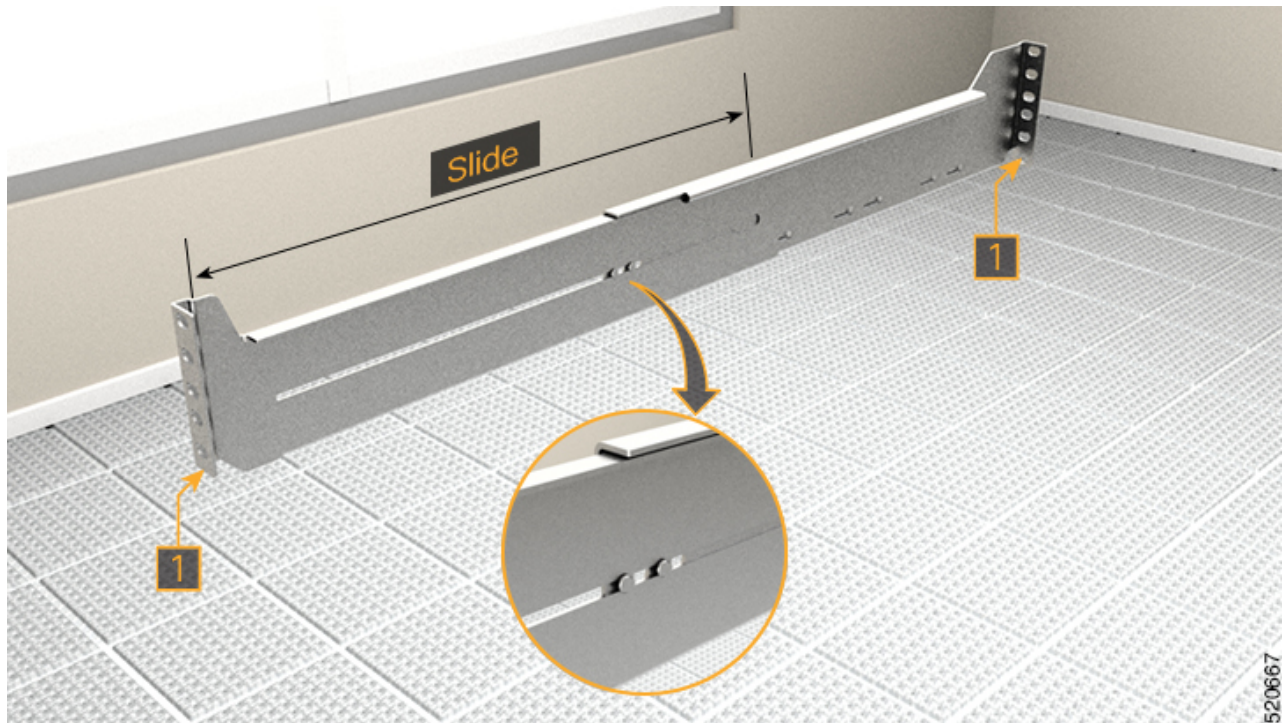

1	Slide and adjust the length of the slider arm.
---	--

Step 2

Integrate the four post slider with the rack. Perform one of the following actions:

- For the 19" rack, you can directly fit the slider on to the rack. Perform the following steps:
 - a. On the front side, insert only the top-most screw of the slider (48-101524-01).
 - b. Tighten the screw to torque value of 4.65 N-m (41 lbs-in).
 - c. Similarly, on the rear side, insert five screws (48-101524-01) and tighten them to torque value of 4.65 N-m (41 lbs-in).
- For the 23" rack, you can fit the slider on to the rack using an adapter. Perform the following steps: (refer the following image).

The formed surface must always face the inner side of the rack post.

- a. On the front side of the adapter (towards the chassis), insert only the top-most screw of the slider (48-101524-01).
- b. Tighten the screw to torque value of 4.65 N-m (41 lbs-in).
- c. Similarly, on the rear side (towards the chassis), insert five screws (48-101524-01) and tighten them to torque value of 4.65 N-m (41 lbs-in).

For the adapter portion which is towards the rack, you must fit all the six screws on the front and rear side.

Figure 37: Four Post Slider Integration in the 19" Rack



Figure 38: Four Post Slider Integration in the 23" Rack

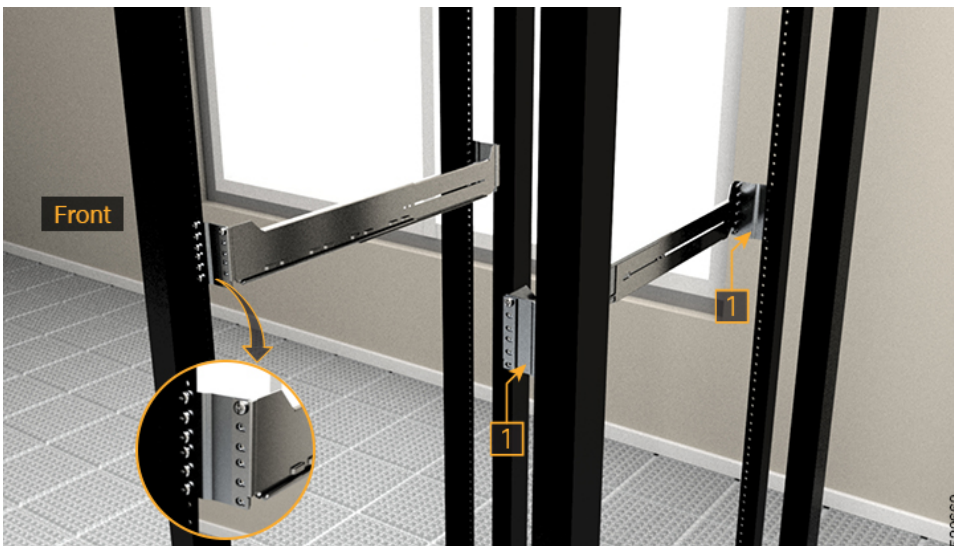

1	Adapter
---	---------

Install the Two Post Slider into an ETSI Rack

Use this procedure to install the two post slider into an ETSI rack.

Procedure

- Step 1** Identify the two post slider and adjust the length of the slider (3" to 5").
Slide the inner sliders and adjust the length to mate with the rack surface.

Figure 39: Two Post Slider Identification

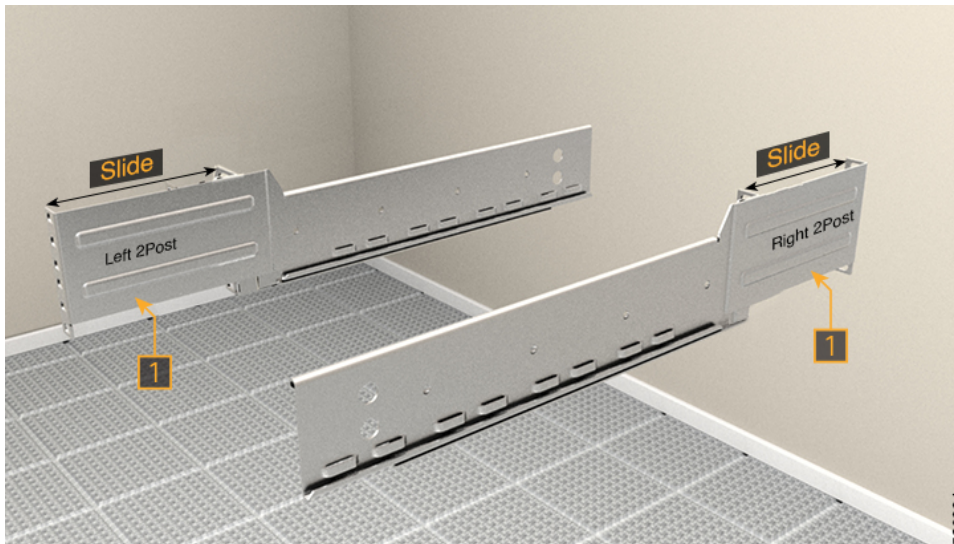

1	Check for marking on the sliders; slide the inner sliders to adjust the length.
---	---

- Step 2** Integrate the two post slider with the ETSI rack using an adapter.
The formed surface must always face the inner side of the rack post.
- a. On the front side, insert only the top-most screw of the slider (48-101524-01).
 - b. Tighten the screw to torque value of 4.65 N-m (41 lbs-in).
 - c. Similarly, on the rear side, insert three screws (48-101524-01) and tighten them to torque value of 4.65 N-m (41 lbs-in).

Figure 40: Two Post Slider Integration - ETSI Rack

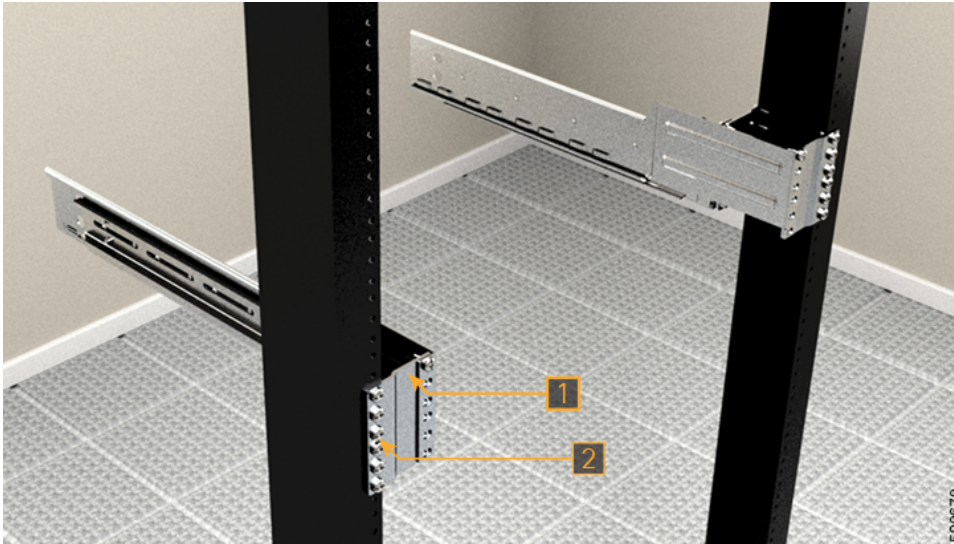

1	Adapter
2	Slider fixing screws (48-101524-01)

Install the Four Post Slider into an ETSI Rack

Use this procedure to install a four post slider into an ETSI rack.

Procedure

- Step 1** Identify the four post slider and adjust the length of the slider.
Slide the inner slider arm and adjust the length to mate with the rack surface.

Figure 41: Four Post Slider Identification

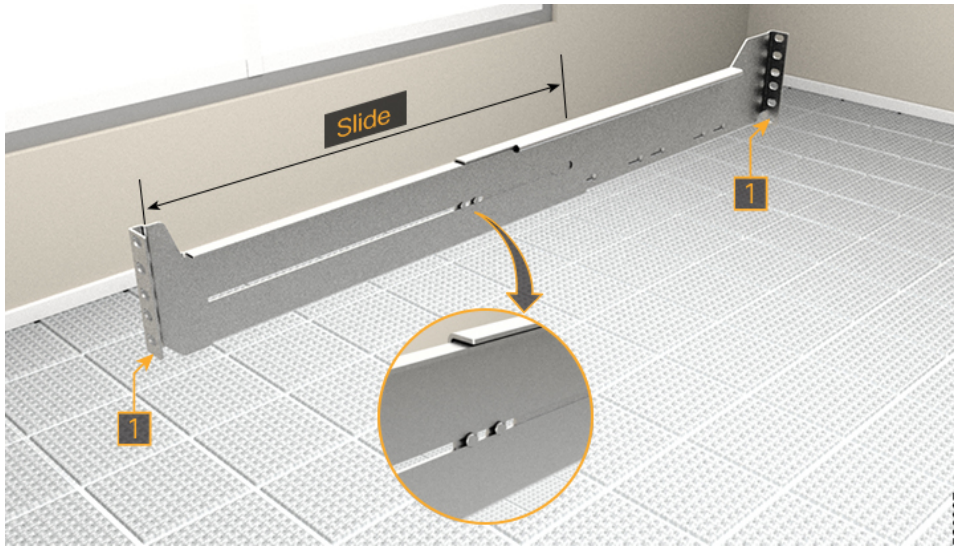

1	Slide and adjust the length of the slider arm.
---	--

Step 2

Integrate the four post slider with the ETSI rack using an adapter.

The formed surface must always face the inner side of the rack post.

- a. On the front side, insert only the top-most screw of the slider (48-101524-01).
- b. Tighten the screw to torque value of 4.65 N-m (41 lbs-in).
- c. Similarly, on the rear side, insert five screws (48-101524-01) and tighten them to torque value of 4.65 N-m (41 lbs-in).

Figure 42: Four Post Slider Integration in the ETSI Rack

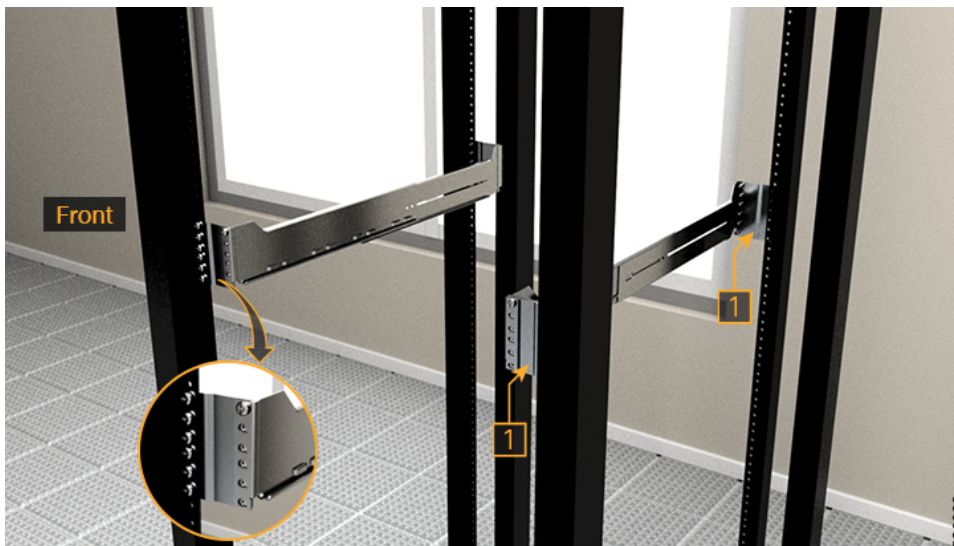

1	Adapter
---	---------



CHAPTER 5

Install Cisco NCS 1014 Modules

This chapter contains procedures to install the modules of Cisco NCS 1014.



Caution

All the modular slots in the NCS 1014 chassis should always be populated with respective modules (line cards, controllers, PSUs, and fan units). Empty line card slots should be populated with filler modules, which are shipped with the chassis. The replacement or upgrade of the modules (Online Insertion or Removal, OIR) should be performed only when the ambient temperature is below 30°C. The OIR of modules should be completed within five minutes to prevent overheating of the components.



WARNING: DO NOT INTRODUCE BODY OR OBJECT IN THE CHASSIS / PSU / FAN TRAY / LC SLOTS WHEN INSTALLING OR REMOVING A MODULE. EXPOSED CIRCUITRY IS AN ENERGY HAZARD.



ATTENTION: ÉVITEZ TOUT CONTACT ENTRE VOTRE CORPS OU UN OBJET EXTERNE ET L'INTÉRIEUR DU CHÂSSIS, DU BLOC D'ALIMENTATION, LA FENTE DE VENTILATION DU PLATEAU, OU DE LA FENTE PDS LORSQUE VOUS INSTALLEZ OU RETIREZ UN MODULE. LES CIRCUITS EXPOSÉS CONSTITUENT UN RISQUE D'ÉLECTROCUTION.

520496

Install the NCS1K14-2.4T-K9 Line Card and its Pluggables Quick Video

For a quick video demonstration, from attaching the fiber management brackets to installing the NCS1K14-2.4T-K9 line card and its pluggables, check out the [video](#).

- [Install the Solid State Drive \(SSD\), on page 62](#)
- [Install the Fan Unit, on page 63](#)
- [Install the Controller, on page 65](#)
- [Attach the Fiber Management Bracket, on page 68](#)
- [Adjust the Fiber Management Bracket, on page 70](#)
- [Install the Line Card, on page 71](#)
- [Install the Power Supply Units \(PSUs\), on page 73](#)
- [Install the Pluggables, on page 82](#)
- [Install the Air Filter, on page 84](#)

Install the Solid State Drive (SSD)

Use this procedure to install the SSD into the Cisco NCS 1014 chassis.

Procedure

Step 1 Before inserting the SSD into the slot, use the *UP* label to help you orient the module correctly.

Step 2 Grasp the front handle and slide the SSD into the slot.

Figure 43: Installing the SSD

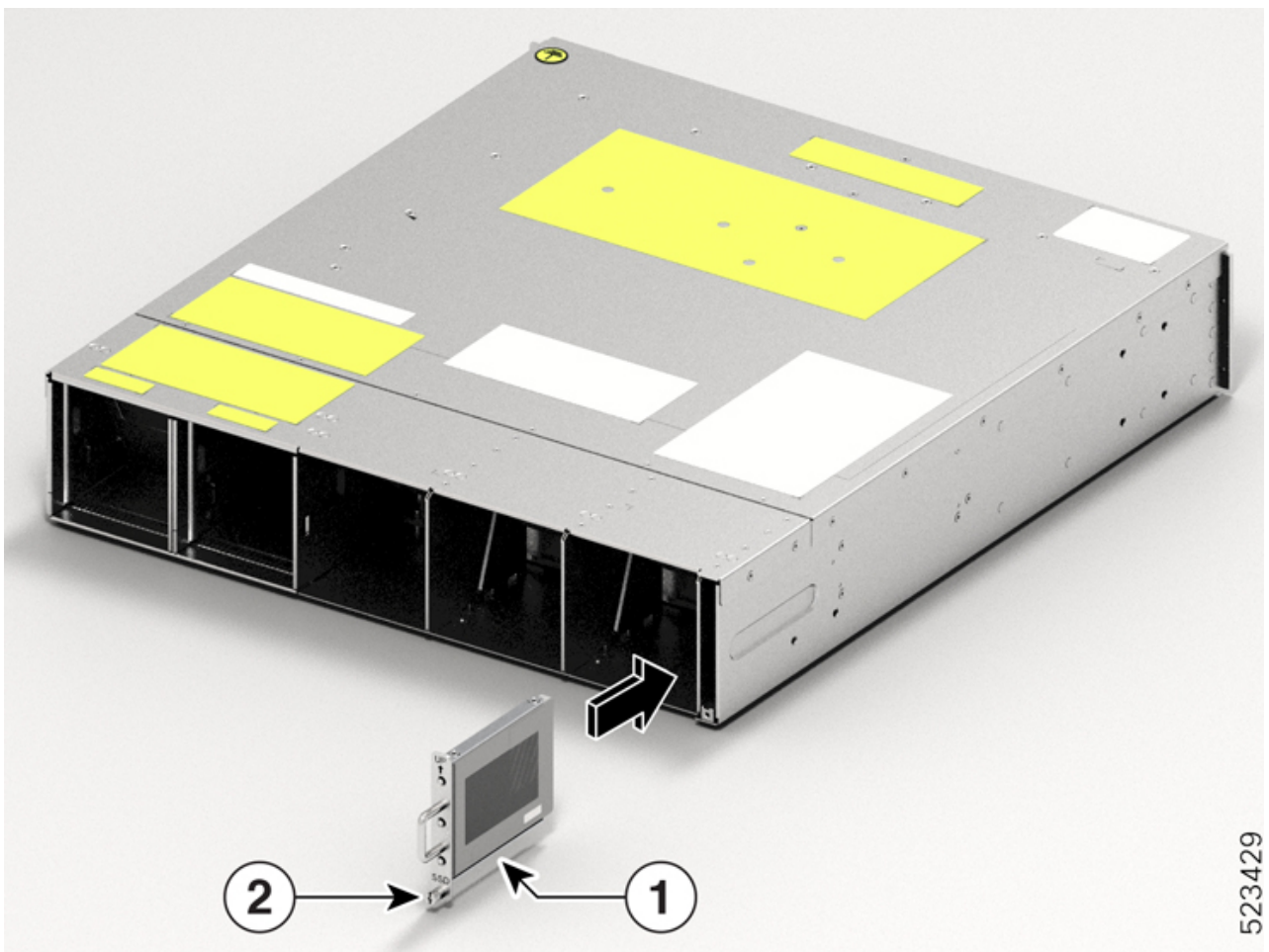

Callout	Component
1	SSD
2	M3 T15 screw

- Step 3** Using a T15 six lobe/slot screwdriver, tighten the lone captive screw to a torque value of 0.65 N-m (5.75 lbs-in).
-

Install the Fan Unit

Follow these steps to install the fan units into the Cisco NCS 1014 chassis.



WARNING: DO NOT INTRODUCE BODY OR OBJECT IN THE CHASSIS / PSU / FAN TRAY / LC SLOTS WHEN INSTALLING OR REMOVING A MODULE. EXPOSED CIRCUITRY IS AN ENERGY HAZARD.



ATTENTION: ÉVITEZ TOUT CONTACT ENTRE VOTRE CORPS OU UN OBJET EXTERNE ET L'INTÉRIEUR DU CHÂSSIS, DU BLOC D'ALIMENTATION, LA FENTE DE VENTILATION DU PLATEAU, OU DE LA FENTE PDS LORSQUE VOUS INSTALLEZ OU RETIREZ UN MODULE. LES CIRCUITS EXPOSÉS CONSTITUENT UN RISQUE D'ÉLECTROCUTION.

Procedure

- Step 1** Before inserting the fan unit, use the *This Side Up* label to help yourself orient the fan unit correctly.
- Step 2** Use one hand to support the fan unit. Then use the other hand to hold the front handle and insert the fan unit in to the slot.
- While inserting the fan unit, use your thumb to push the spring-loaded lever to the left and hold it in the unlock position.

Figure 44: Inserting a Fan Tray

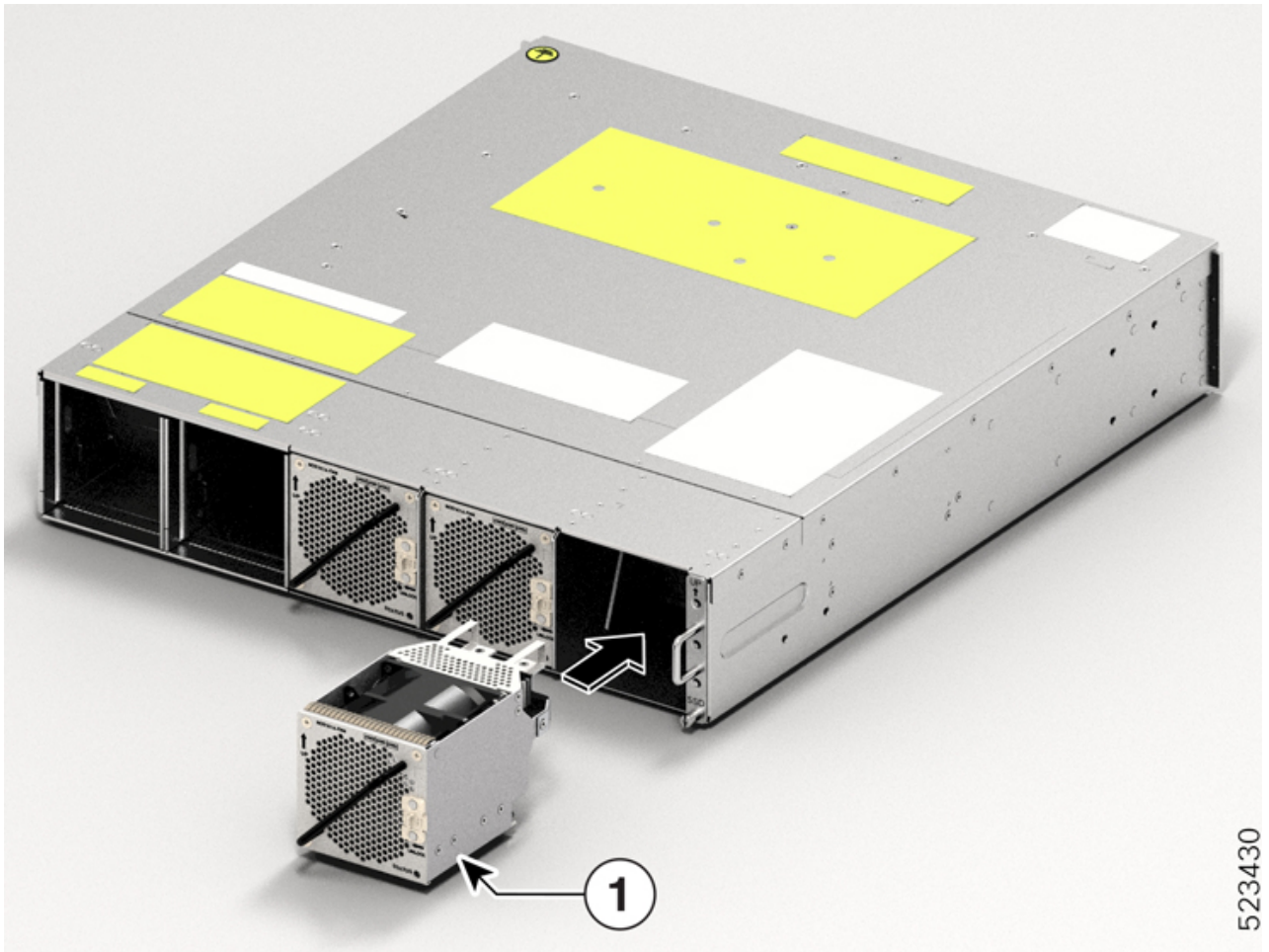

Callout	Component
1	Fan Tray

Step 3 Release the spring-loaded lever to lock the fan unit in its position.

Figure 45: Spring-loaded Lever in Released Condition

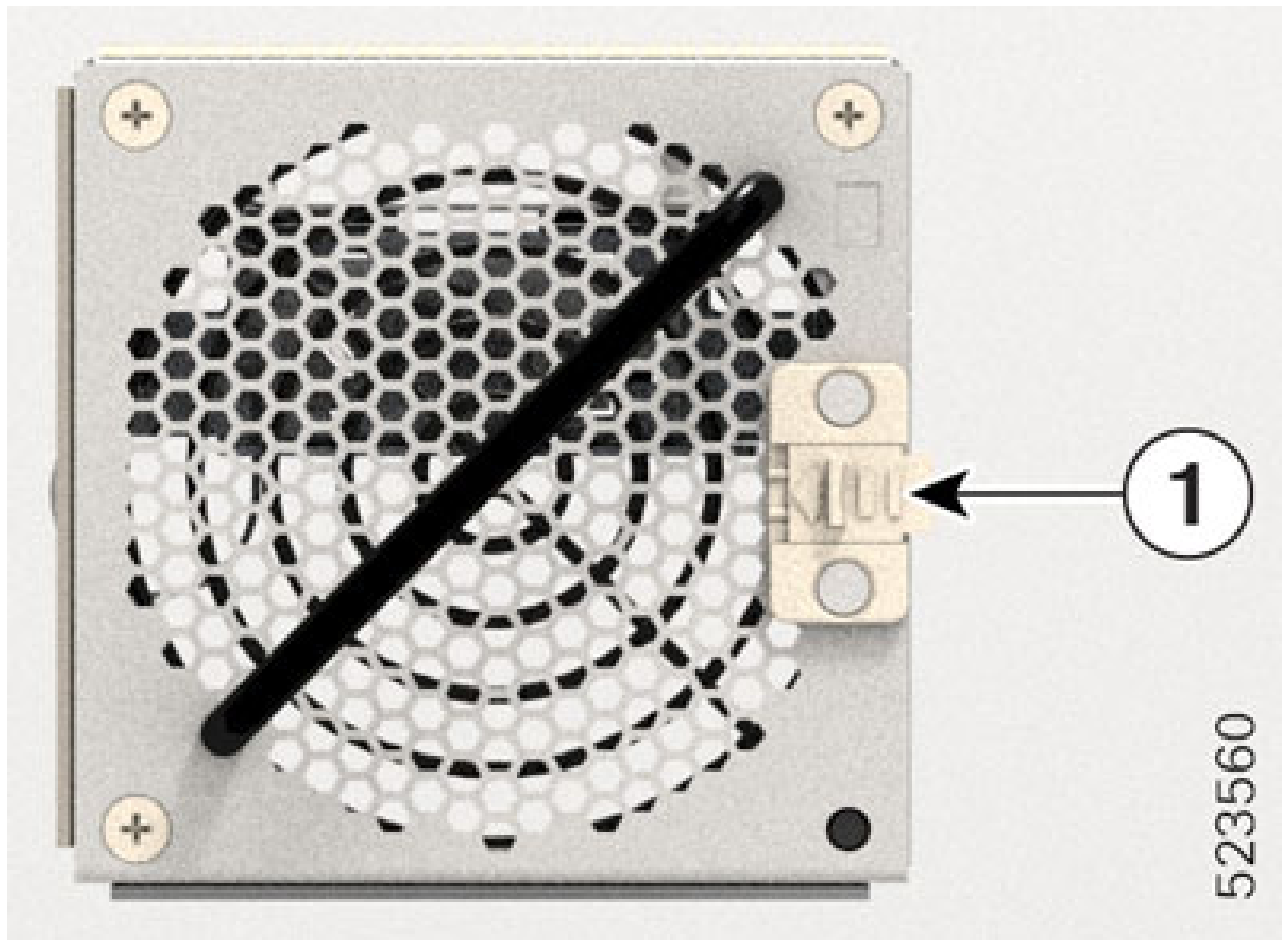

Callout	Component
1	Spring-loaded lever

Step 4 Repeat the above steps until you complete installing all the fan units.

Install the Controller

Follow these steps to install the controller into the Cisco NCS 1014 chassis.

Procedure

Step 1 Before inserting the controller, use the *This Side Up* label to help yourself orient the controller correctly.

Figure 46: Perspective View of NCS1K14-CNTRLR-K9 Controller



523413

Figure 47: Perspective View of NCS1K14-CNTLR-B-K9 Controller

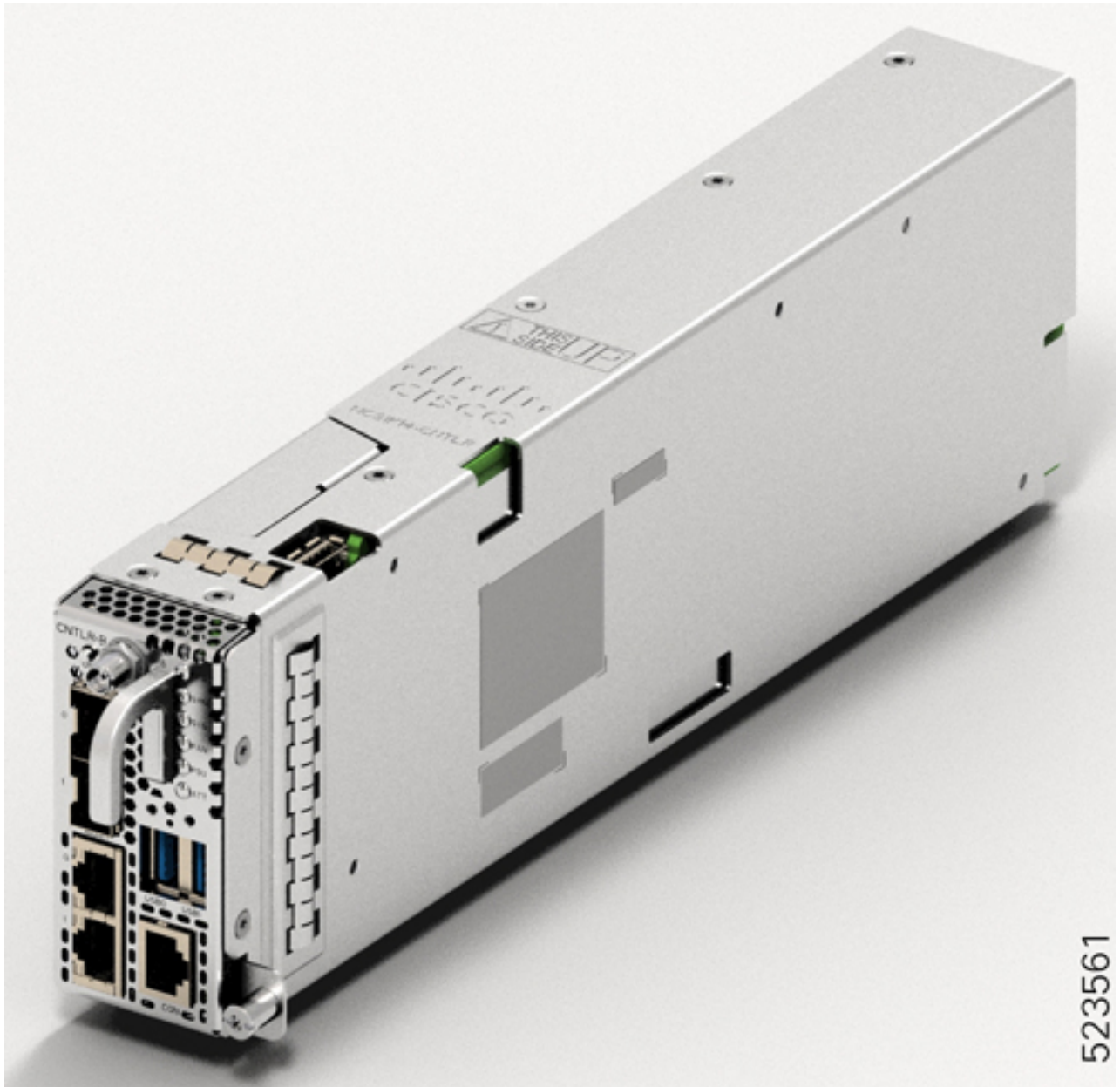

- Step 2** Slide the controller into the slot. To slide the controller:
- With one hand, support the controller at the bottom.
 - With the other hand, hold the front handle and push the controller into the slot.

Figure 48: Inserting the Controller

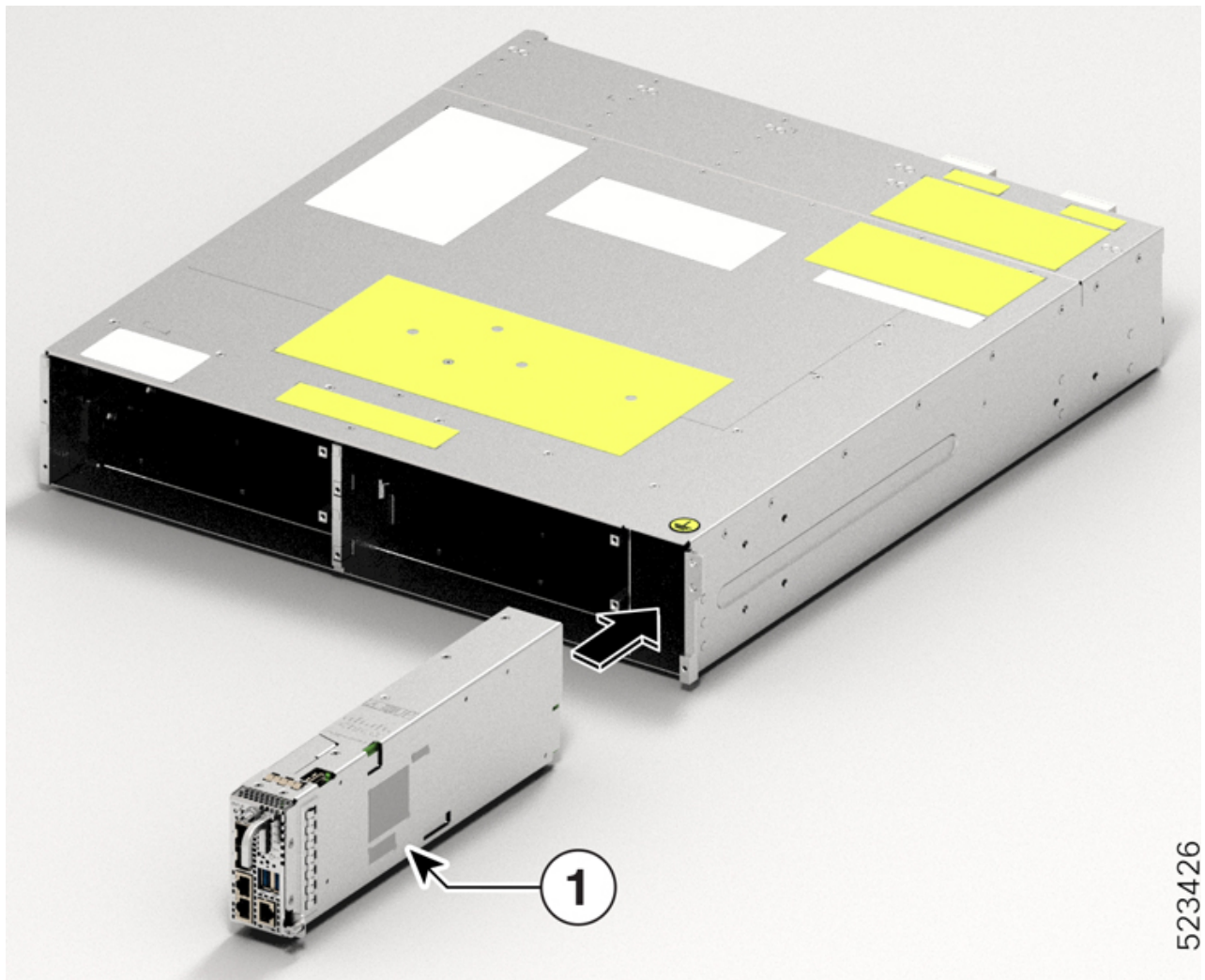

Callout	Module
1	Cisco NCS 1014 Controller Card (NCS1K14-CNTLR-K9)

Step 3 Using a T15 Torx screwdriver, tighten the two M3 T15 Torx screws to a torque value of 0.65 N-m (5.75 lbs-in).

Attach the Fiber Management Bracket

Use this procedure to attach a fiber management bracket to a line card or filler card.

The fiber management brackets are available in the package. Each line card or filler card comes with its own fiber management bracket. Do not interchange the fiber management brackets. The CCMD-16-C, CCMD-16-L,

and 1.2T cards have adjustable fiber management brackets. The 2.4T DWDM card has a fixed-length fiber management bracket.

Procedure

- Step 1** Attach the fiber management bracket to the card (line card or filler card). To attach:
- Orient the captive screws in the fiber management bracket to the line card.
Ensure that the fiber management bracket is in the correct orientation. Incorrect orientation obstructs accessibility to the ports.
 - Seat the bracket captive screws in the line card screw holes.

Figure 49: Attaching the Fiber Management Brackets to the 2.4T Card

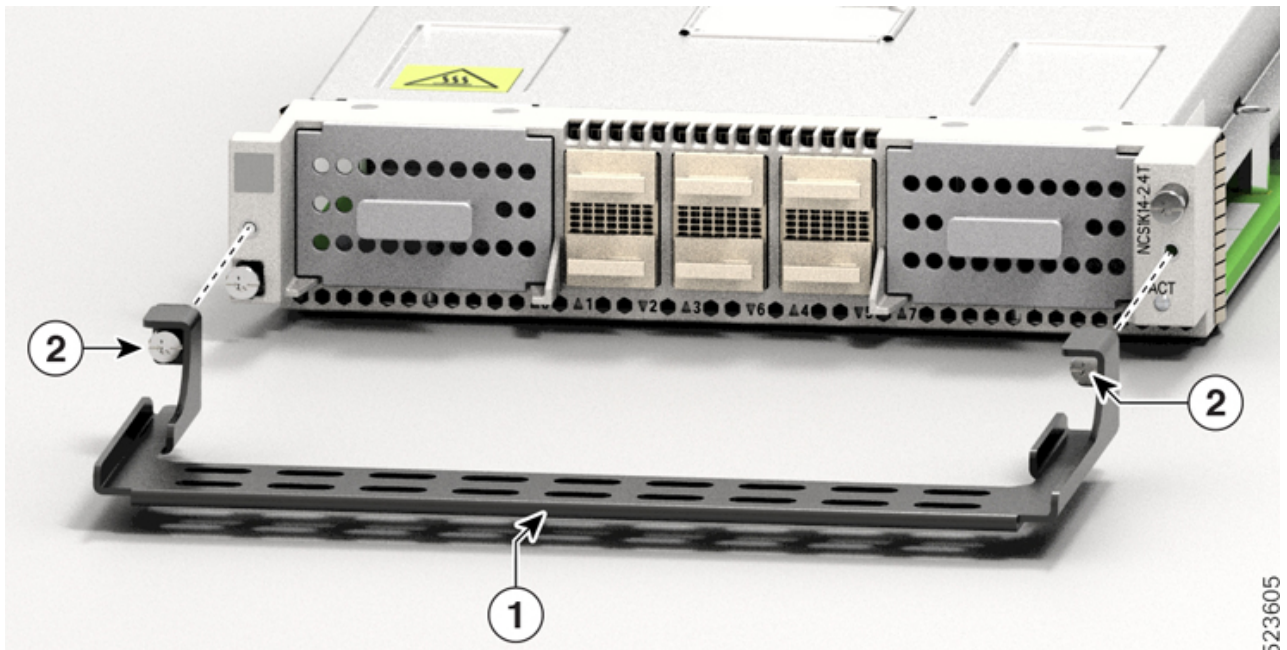

Table 22: 2.4T Card Accessories

Callout	Accessory
1	Fiber management bracket
2	Captive screws

- Step 2** Using a torque-limiting T15 Torx screwdriver, tighten the two M3 T15 Torx screws of the fiber management bracket to a torque value of 0.65 N-m (5.75 lbs-in).

We recommend that you do not remove the fiber management brackets after installing the line card into the chassis.

The subsequent section describes the procedure to adjust the length of the fiber management bracket.

Adjust the Fiber Management Bracket



Note This procedure is not applicable for the 2.4T line card that has a fixed-length fiber management bracket. You can skip this procedure.

Use this task to adjust the length of the fiber management bracket of the following cards:

- CCMD-16-C
- CCMD-16-L
- 1.2T
- Filler card



Note We recommend that you maintain the fiber management bracket in the shorter position for ETSI racks, to maintain a 600-mm footprint. We also recommend that you adjust the bracket length before installation.

Procedure

Step 1 Disengage the horizontal bar in the bracket. To do this, push down the plunger pins on both sides of the bracket.

Figure 50: Adjusting the Fiber Management Bracket

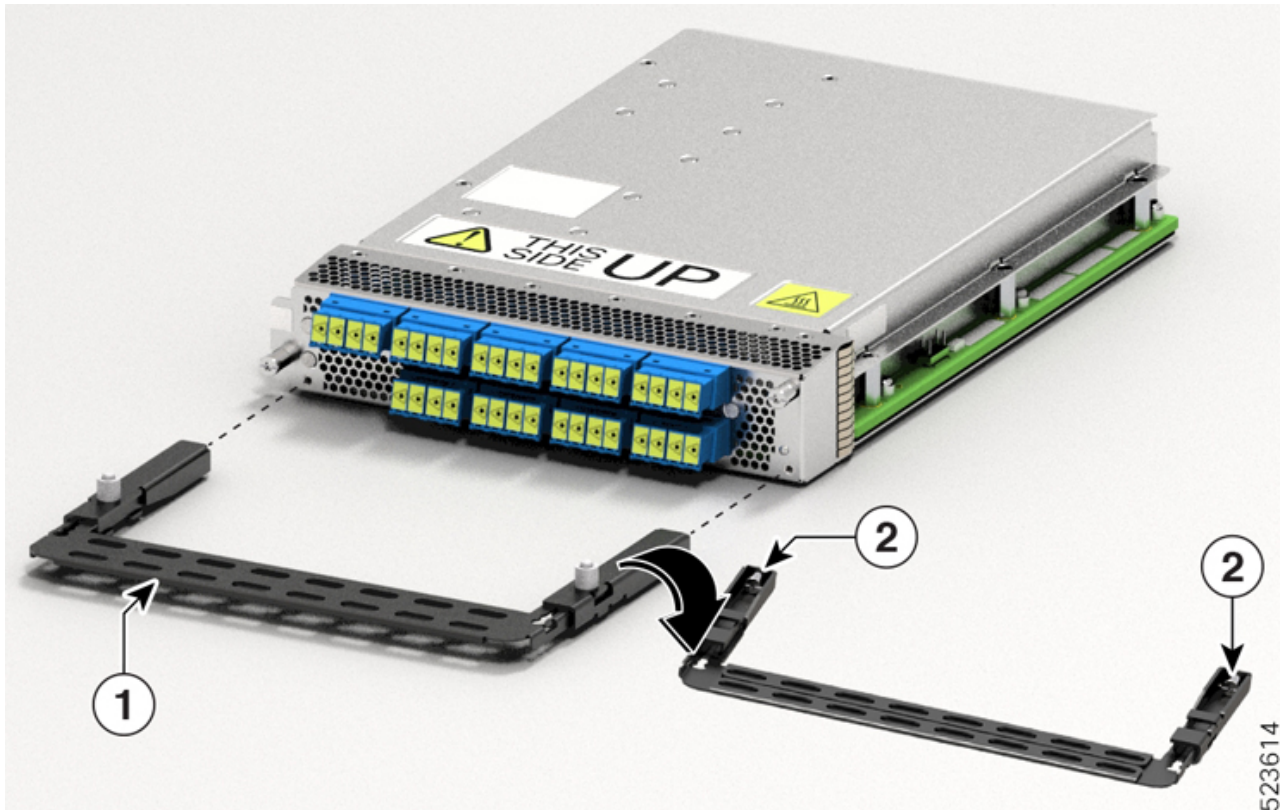

1	Horizontal bar
2	Plunger pins

Step 2 Pull the horizontal bar of the fiber management bracket outwards to increase the length of the bracket.

The plunger pins lock the bracket when the horizontal bar is fully extended.

You can verify whether the plunger pins are locked based on the visibility of their grooves.

- If both grooves are visible, the pins are disengaged.
- If no groove is visible, the bar is in the transient stage.
- If one groove is visible, the bar is correctly installed and locked.

Install the Line Card

Use this task to install a line card into the Cisco NCS 1014 chassis. The Cisco NCS 1014 chassis supports a maximum of four line cards.

Before you begin

It is mandatory to attach the fiber management brackets to the filler cards and line cards before you install the chassis onto a rack. For a detailed procedure, see [Attach the Fiber Management Bracket](#).



Note The following procedure presumes that you ordered the Cisco NCS 1014 chassis preinstalled with filler cards only.

The following procedure also applies to filler cards installation.

Procedure

- Step 1** Loosen the Torx screws of the filler card using a T15 Torx screwdriver.
- Step 2** Holding the fiber management bracket of the filler card with one hand and supporting it with the other, pull the filler card from the chassis.
- Step 3** Before inserting the line card into the slot, use the *This Side Up* label to help yourself orient the line card correctly.

Figure 51: Perspective View of NCS1K14-2.4T-K9 Line Card

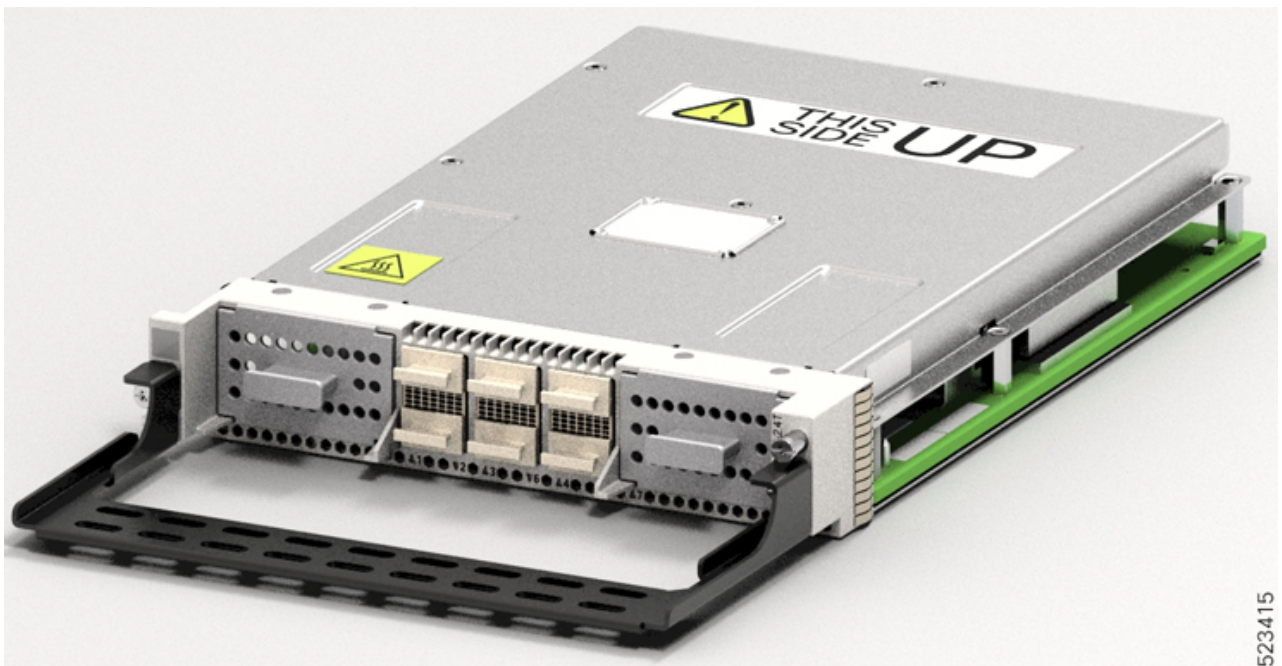

523415

- Step 4** Use both the hands while inserting a line card. To insert the line card, perform the following actions:
- Use one hand to support the bottom of the line card.
 - Use the other hand to hold the fiber management bracket.
 - With both hands, guide the line card into the slot.

Caution Use the fiber management brackets only for pulling out or pushing in the line cards or filler cards. Do not use the fiber management brackets to carry the cards. Always support the line card and filler card at the bottom with your hand.

Step 5 Slide the line card completely inside, into the slide guide till it engages in the chassis.

Step 6 Using the torque-limiting T-15 six lobe/slot screwdriver, tighten the two captive screws of the line card to a torque value of 0.44 N-m (3.89 lbs-in) to secure the line card.

Figure 52: Inserting the NCS1K14-2.4T-K9 Line Card

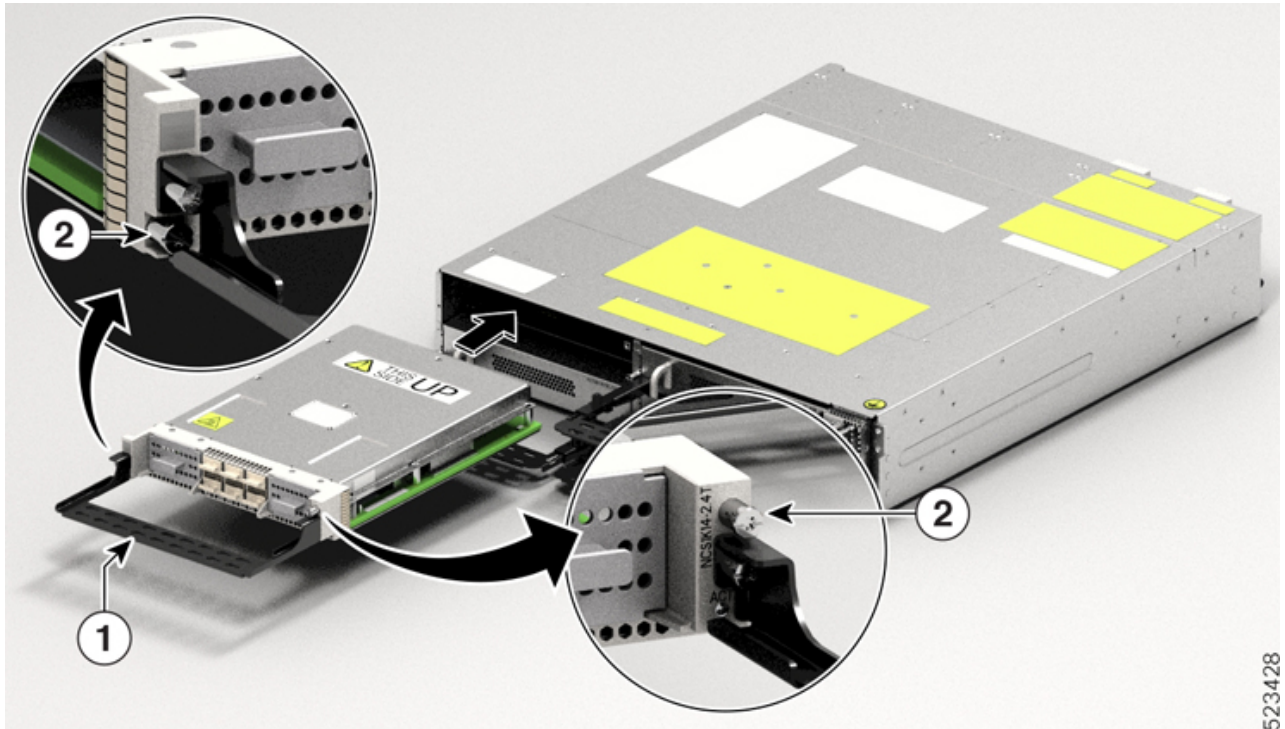

Callout	Accessory
1	Use the fiber management bracket for holding the line card.
2	Captive screws

Install the Power Supply Units (PSUs)

Use this procedure to install the PSUs into the Cisco NCS 1014 chassis.

Procedure

Step 1 Orient the PSU correctly before inserting. Check for the *This Side Up* label.

Figure 53: Perspective View of NCS1K4-DC-PSU-2

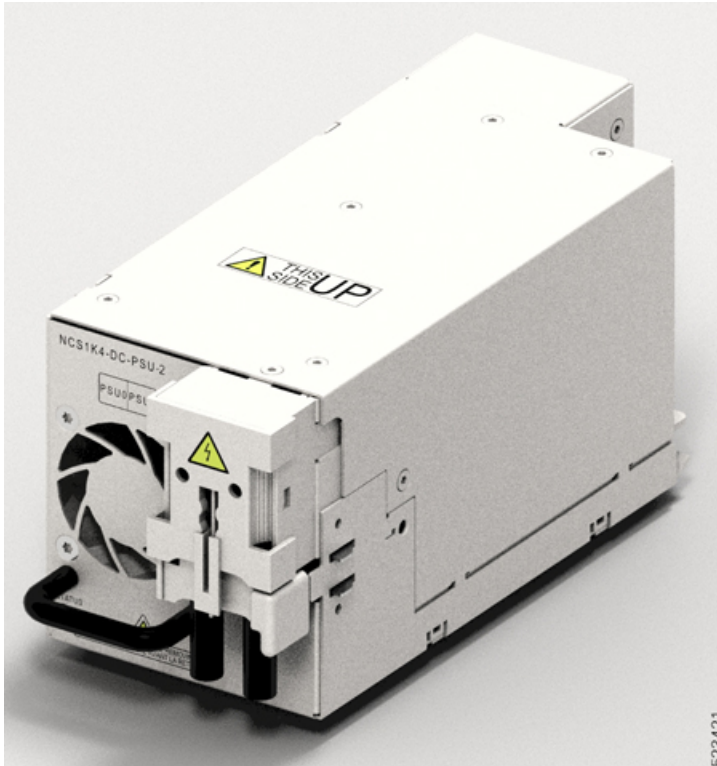
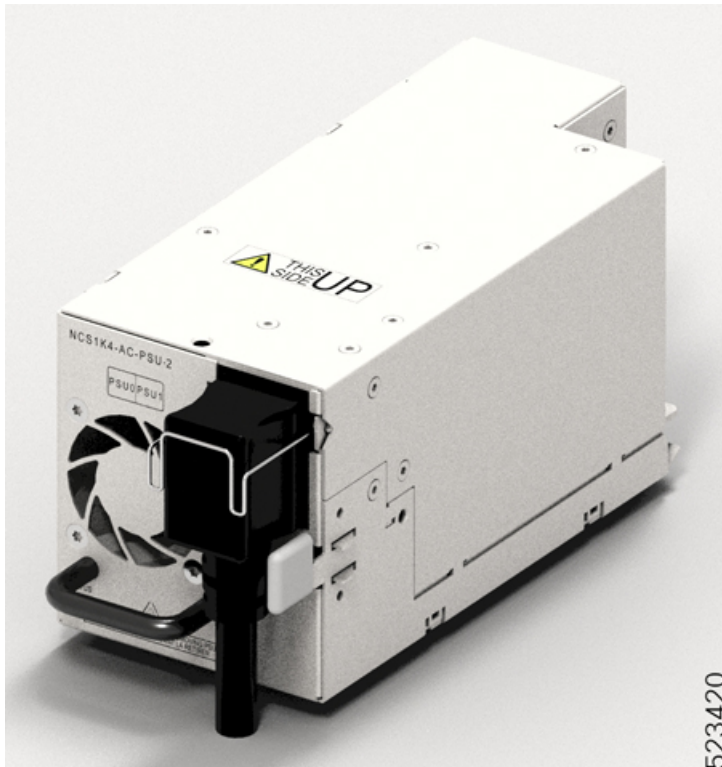

Figure 54: Perspective View of NCS1K4-AC-PSU-2



Step 2

Slide the PSU into the slot as follows:

- a. Support the PSU at the bottom with one hand.
- b. Hold the handle with your other hand.
- c. Push the PSU in until you hear a *click* sound; see the following figure for direction of insertion.

The click sound indicates that the unit has latched.

Note Press and release the locking latch only for removing the PSU.

Figure 55: Inserting the PSU

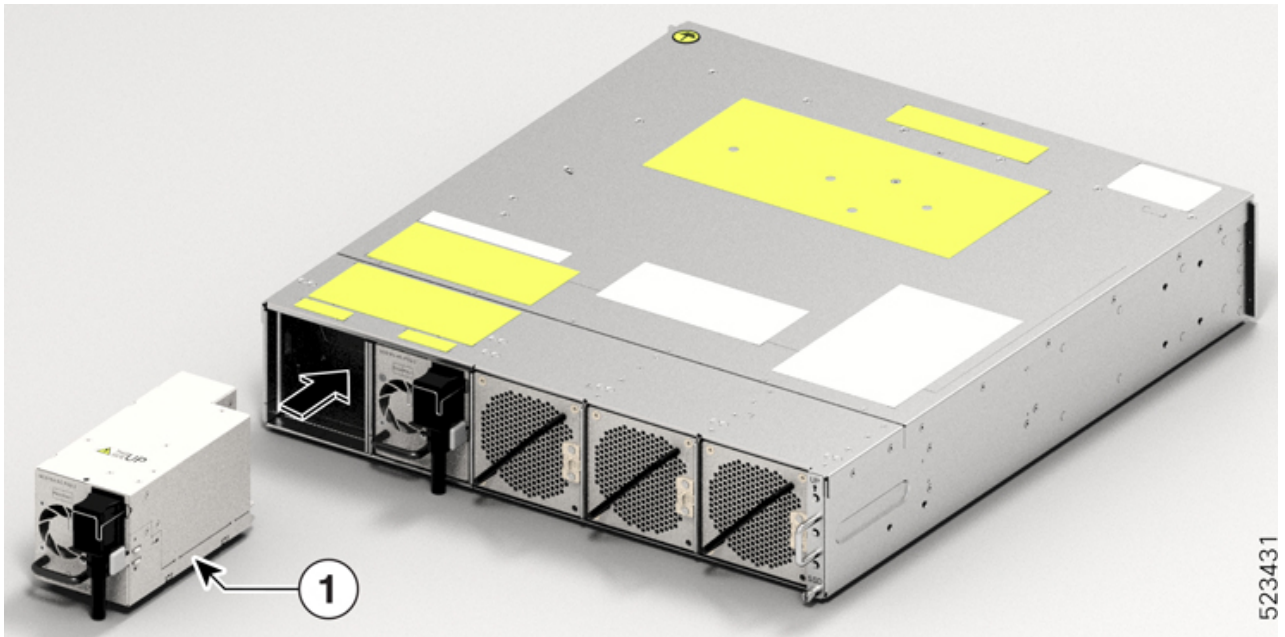

1	PSU
---	-----

Connect DC Power to the Cisco NCS 1014 Chassis



Caution

The Cisco NCS 1014 chassis relies on the protective devices in the building installation to protect against short circuit, overcurrent, and ground faults. Ensure that the protective devices comply with local and National Electrical Codes (NEC).

Figure 56: Rating Label for DC Power

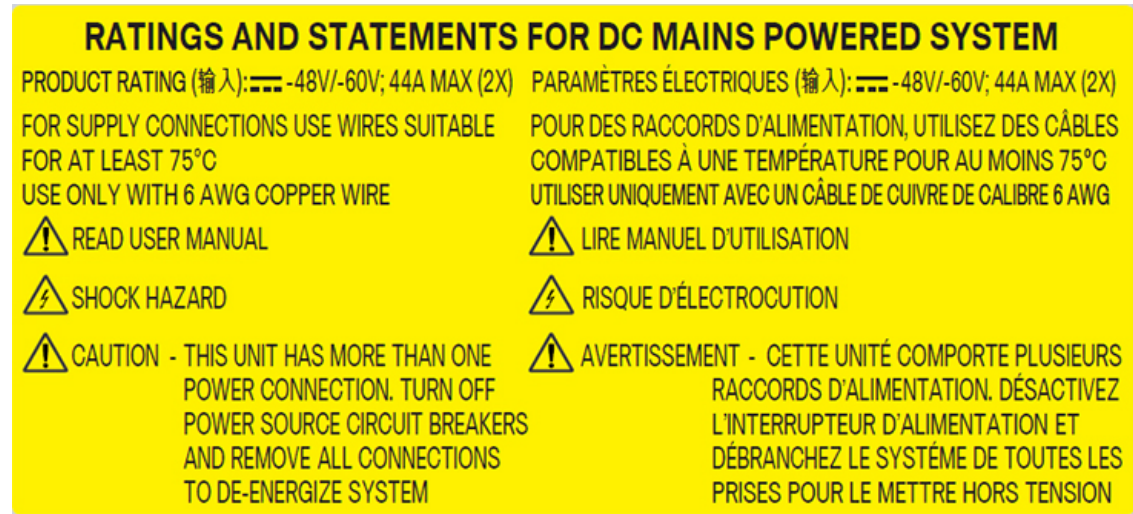

355972

Procedure

-
- Step 1** Verify that the correct fuse panel is installed in the top mounting space.
- Step 2** Measure and cut the cables as needed to reach the Cisco NCS 1014 chassis from the fuse panel.
- Step 3** Dress the power according to local practice.
- Step 4** Connect the office battery and return cables according to the fuse panel engineering specifications.
- Step 5** Affix the power lug on the unit with two screws. Tighten the screws using torque of 2.7 N-m ± 0.3 N-m (21.69–28.09 lbs-in.).

Caution Torque level greater than 3.0 N-m can damage the unit.

Use #6AWG cables. Ensure a minimum gap of 50 mm below the chassis for routing the cables. For ETSI racks, use 180-degree power lugs to maintain 600-mm footprint.

Figure 57: NCS1K4-DC-PSU-2 with 180-degree Power Lug Cable Connection

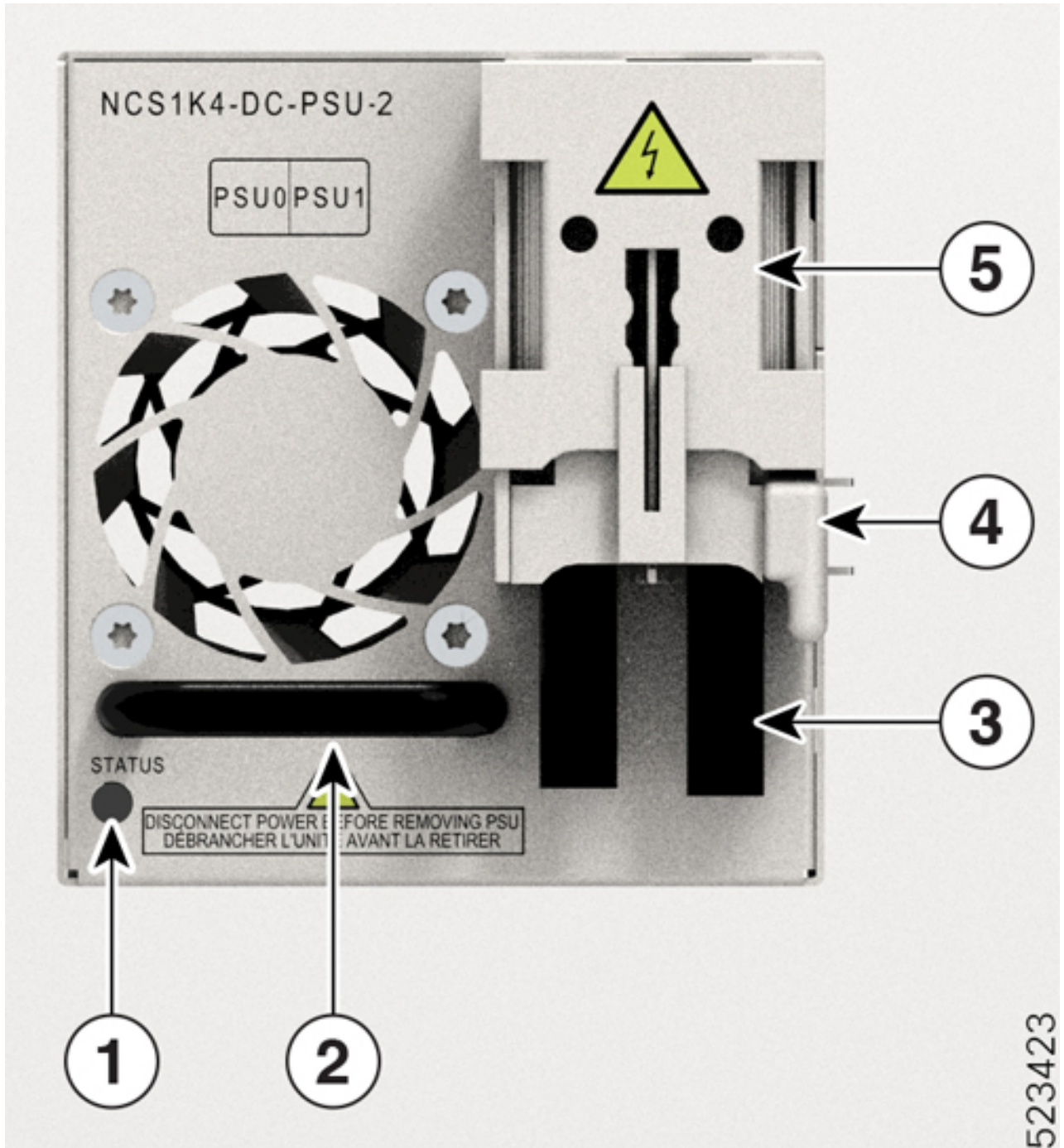

Callout	Component	Callout	Component
1	Status LED	4	Locking latch
2	PSU Handle	5	Protective cover

Callout	Component	Callout	Component
3	6AWG 180-degree exit cables		

Step 6 Use protection covers to keep the lugs in place.

Snap fit the protection cover towards the top for 90-degree lugs and push it down for straight (180-degree) lugs.

Connect AC Power to the Cisco NCS 1014 Chassis



Caution

The Cisco NCS 1014 chassis relies on the protective devices in the building installation to protect against short circuit, overcurrent, and ground faults. Ensure that the protective devices comply with local and National Electrical Codes.

Figure 58: Rating Label for AC Power

RATINGS AND STATEMENTS FOR AC MAINS POWERED SYSTEM

PRODUCT RATING (输入): 100-127V~; 15A MAX (2X); 50/60 Hz
200-240V~; 12A MAX (2X); 50/60 Hz

CHARACTÉRISTIQUES DU PRODUIT (输入): 100-127V~; 15A MAX (2X); 50/60 Hz
200-240V~; 12A MAX (2X); 50/60 Hz

<p> READ USER MANUAL</p> <p> SHOCK HAZARD</p> <p> CAUTION - THIS UNIT HAS MORE THAN ONE POWER CONNECTION. TURN OFF POWER SOURCE CIRCUIT BREAKERS AND REMOVE ALL CONNECTIONS TO DE-ENERGIZE SYSTEM</p> <p>WARNING - HIGH LEAKAGE CURRENT. EARTH CONNECTION ESSENTIAL BEFORE CONNECTING SUPPLY</p>	<p> LIRE MANUEL D'UTILISATION</p> <p> RISQUE D'ÉLECTROCUTION</p> <p> AVERTISSEMENT - CETTE UNITÉ COMPORTE PLUSIEUR RACCORDS D'ALIMENTATION. DÉACTIVEZ L'INTERRUPTEUR D'ALIMENTATION ET DÉBRANCHEZ LE SYSTÈME DE TOUTES LES PRISES POUR LE METTRE HORS TENSION</p> <p>AVERTISSEMENT - COURANT DE FUITE ÉLEVÉ. MISE À LA TERRE ESSENTIELLE AVANT DE BRANCHER L'APPAREIL</p>
--	---

355972

The voltage rating value for AC power ranges either 200–240 or 100–127 V~ depending on the standards in various countries.



Note

You need a dual pole breaker for the installation. The rating of the dual pole breaker for each feed is 16 A for input voltage 200–240 V~, and 20 A for input voltage 100–127 V~.

Procedure

Step 1 Verify that the AC cable is installed in the correct AC source panel. Ensure that either the fuse is removed or the circuit breaker is in the *off* position and locked out.

Step 2 Attach the AC power cable to the cable connector in the AC power module.

Note Ensure that there is a minimum gap of 50 mm for routing the cables. Use a 180-degree exit cable to maintain a footprint of 600 mm for ETSI racks.

Step 3 Close the cable retention clips to secure the power cables and to prevent their accidental removal.

Figure 59: NCS1K4-AC-PSU-2 with 180-Degree Cable Connection

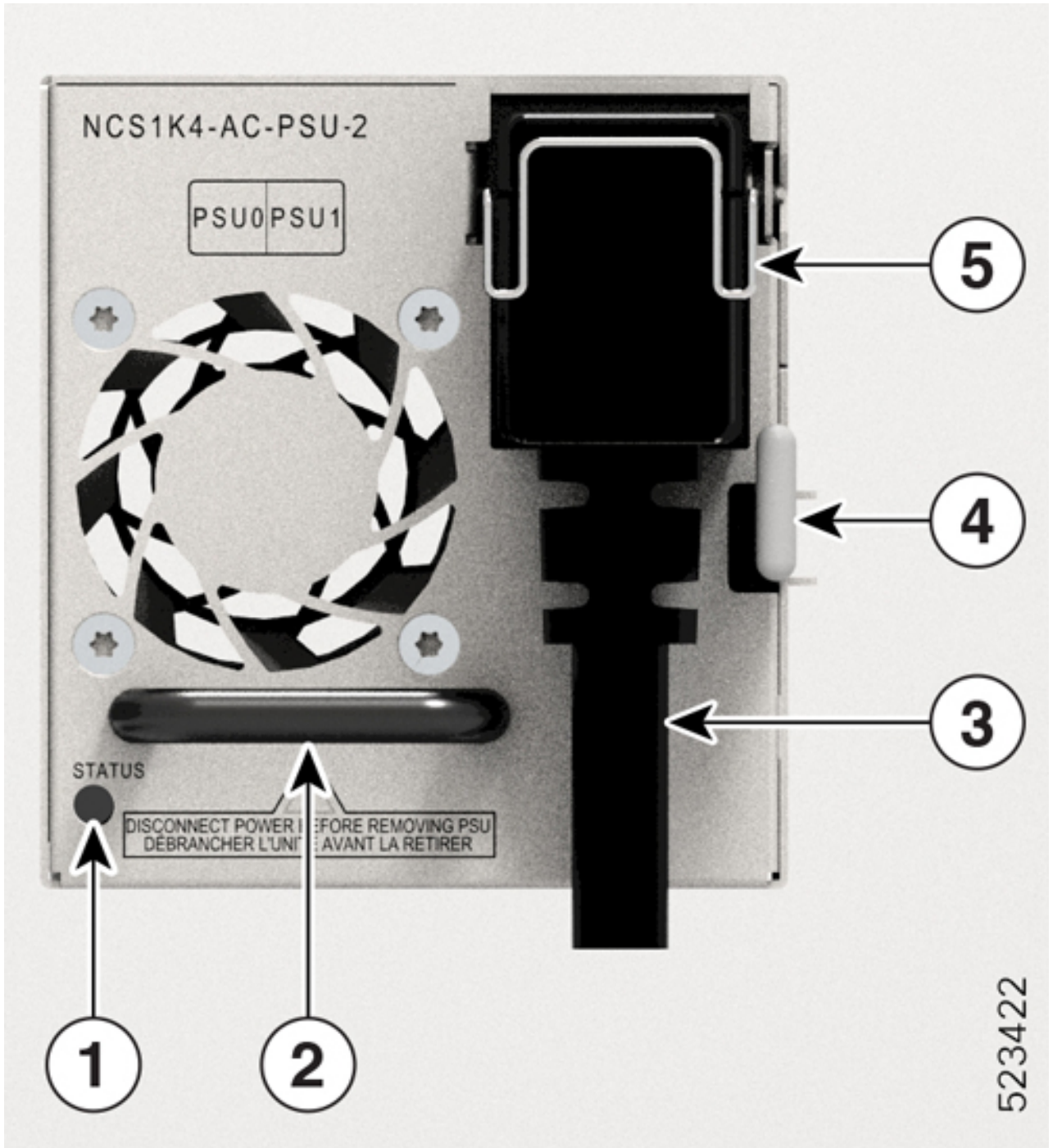

Callout	Component	Callout	Component
1	Status LED	4	Locking latch
2	PSU Handle	5	Protective cover

Callout	Component	Callout	Component
3	6AWG 180-degree exit cable		

Install the Pluggables

Use this task to install the pluggables on a line card. The line card ships with pluggable caps.



Caution To protect the line card, insert pluggable caps into the pluggable slots when no pluggable is inserted. Transceivers, fiber-optic cables, and optical ports on the line cards must stay clean and free of dust to maintain high signal accuracy and to prevent damage to the connectors. Cover them with pluggable cap when not in use.

Procedure

- Step 1** Remove the pluggable caps.
You can retain and reuse the pluggable caps.
- Step 2** Attach the optical fiber to the pluggables.
See the pluggable labels for Tx and Rx polarity to attach the optical fibers.
- Step 3** Orient the pluggable to the correct slot.
For installing the CIM8 module in the 2.4T line card, use the fiber management bracket for navigation support.

Figure 60: Inserting the CIM8 Module in the 2.4T Card

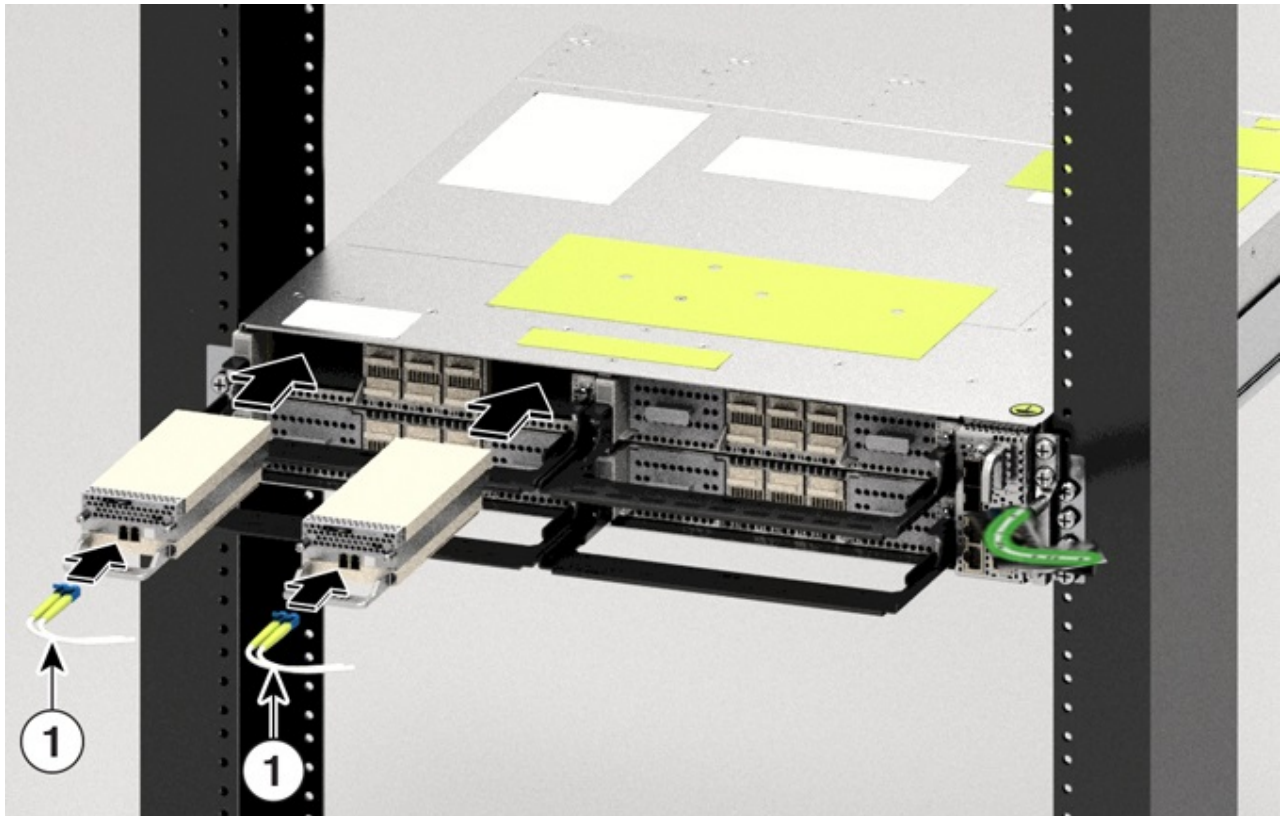

Step 4 Insert the pluggables until the pluggables fully engage in their respective ports to ensure proper connection to the line card.

While inserting the CIM8 module, ensure that the screws are protruding out as much as possible.

Step 5 If you are installing the CIM8 module in the 2.4T line card, tighten the two captive screws to secure it in the port, else skip to the next step.

See the CIM8 module label for the correct torque to apply to tighten the screws. Use the T15 Torx screwdriver to tighten the CIM8 module. You must avoid extra torque application on the CIM8 screw. Excess application of torque can damage the screws. Only after both screws are tightened properly, the system detects the CIM8 pluggable. Even for the OIR of CIM8, you must be careful to avoid any damage to the CIM8 screws.

Step 6 Check whether you have installed all the required pluggables before routing the cables.

Step 7 Route the cables emerging from the pluggables over the fiber management bracket.

Guidelines for managing the fibers and cables:

- Use Velcro tapes to tie the fibers to the fiber management bracket.
- Fibers from the left line cards must exit from the left and fibers from the right line cards must exit from the right.
- Fibers and cables from the controller must exit from the right. Maintain sufficient slack to extract the controller during online insertion and removal (OIR).
- Cables from the PSU must exit from the left (when viewed from the rear side).

Important For ETSI racks, route the 180-degree power cables in the 50-mm space below the chassis to maintain a chassis footprint of 600 mm.

- Ground cable must exit from the right.
 - Rest the fibers exiting from the pluggables on the cable support bracket. Pass a Velcro tape in the gap provided in the cable support bracket to tie the fibers.
-

Install the Air Filter

Use this procedure to install the air filter.

We recommend that you include the air filter installation as part of the chassis installation.

Precautions to take while installing air filters

- Ensure that you have not installed the ground lug onto the chassis.
- Ensure that the pull tabs of the pluggables do not get damaged during installation.
- Ensure that the Velcro of the fiber management bracket does not interfere with the air filter.
- To remove a chassis placed in the middle, in a stacked configuration, you must remove the air filters of the chassis above and below also to avoid accidental scratches on the surface of the chassis.
- Ensure the cables from the controller exit from the right. Maintain sufficient slack to enable easy removal and insertion of the controller during online insertion and removal (OIR).

Procedure

Step 1 After inserting the chassis in the rack, fix the air filter side brackets on either side of the chassis using the following actions:

- a. Check for the arrow indications on the side of the brackets.
- b. Using the Phillips screws on either side, bind the chassis and the air filter side brackets to the rack.
- c. Tighten the Phillips screws (48-101524-01) using a number-2 Phillips screwdriver, to a torque value of 4.65 N-m (41 lbs-in).

Note In case you are installing the air filter after you installed the chassis, then unscrew and remove the four screws on either side that bind the chassis to the rack. After fixing the air filter side brackets, you need only three screws on either side to bind the chassis and air filter side brackets to the rack.

Figure 61: Screws to Secure the Cisco NCS 1014 Chassis on to the Rack

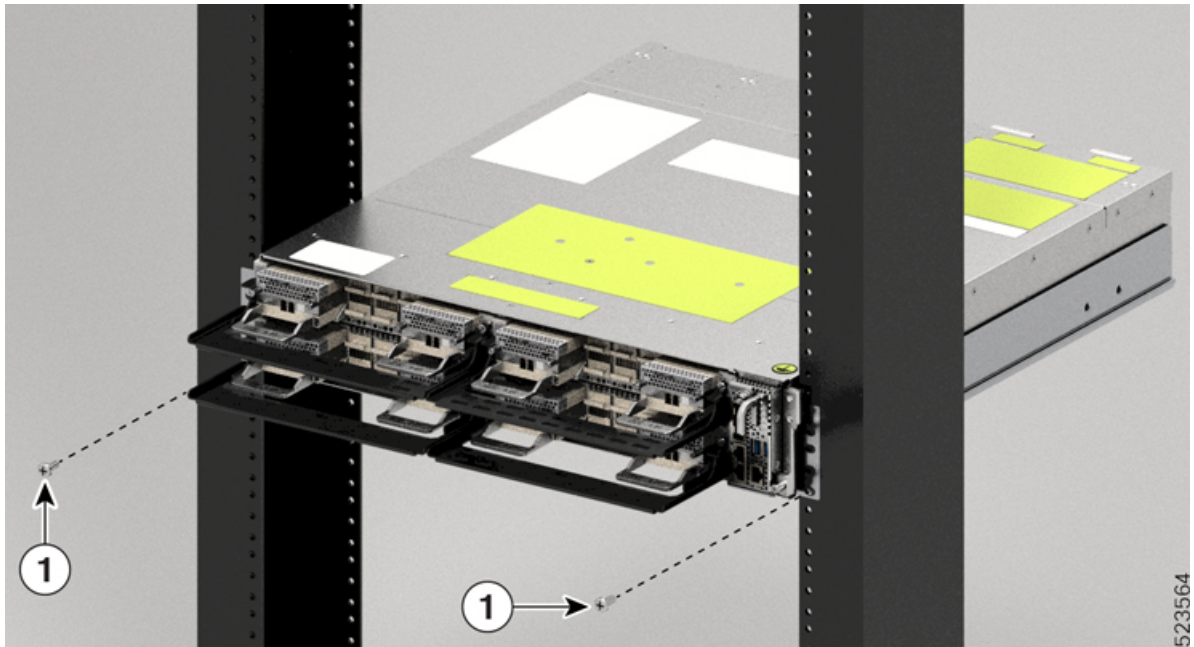

Callout	Component
1	Torx screw

Figure 62: Installing the Air Filter Side Brackets

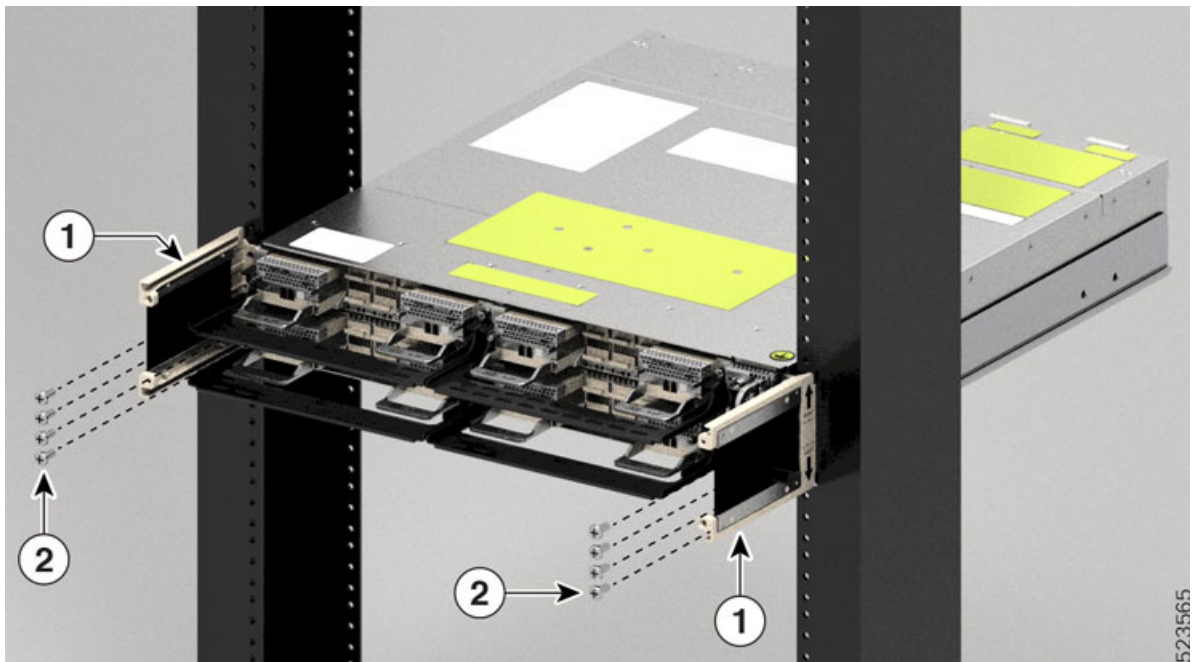

Callout	Component
1	Air filter side brackets
2	Torx screws

Step 2 Install the ground lug. See [Ground the Cisco NCS 1014 Chassis, on page 48](#).

Remember Install the ground lug before installing the air filter frame.

Step 3 Slide the air filter frame into the air filter side brackets.

Caution Make sure that you tagged the air filter frame to a specific chassis and not mixed with other chassis.

Caution Before placing the spare label on the air filter frame, verify that the serial number on the spare label matches with the serial number on top of the chassis. If the serial numbers do not match, there can be inconsistencies in inventory management.

Figure 63: Installing the Air Filter Frame

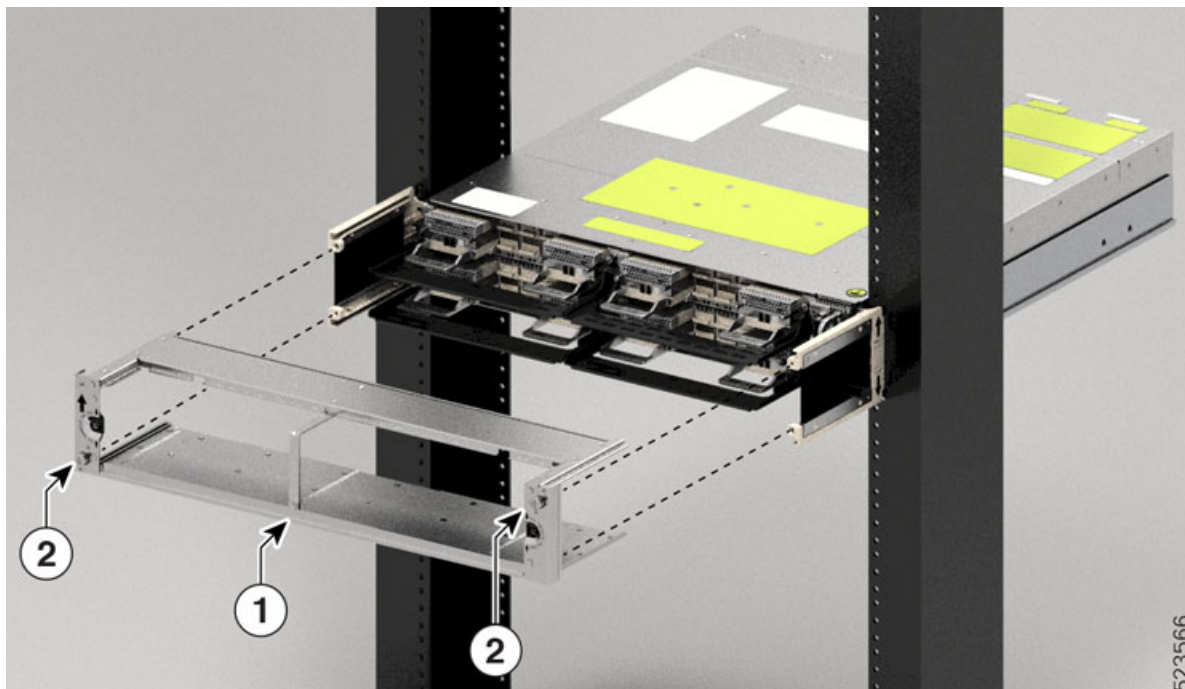

Callout	Component
1	Air filter frame
2	Captive screw

Step 4 Using a T15 Torx screwdriver, tighten the screws on either side (placed diagonally) to a torque value of 0.65 N-m (5.6 lbs-in).

Step 5 Orient the air filter correctly. The arrow must point upwards.

Figure 64: Installing the Air Filter

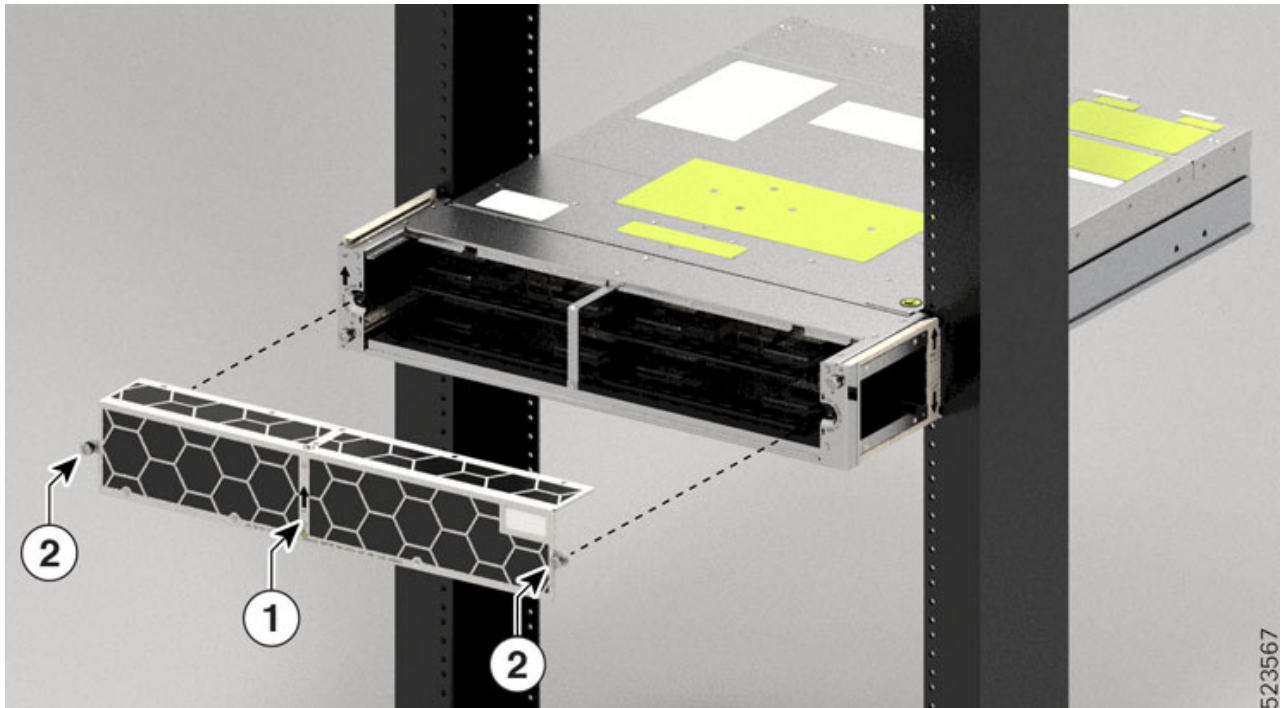

Callout	Component
1	Air filter arrow
2	Captive screws

Step 6 Push the air filter onto the frame and adjust so that it engages with the edges of the frame.

Step 7 Using a T15 Torx screwdriver, tighten the screw on either side of the air filter to a torque value of 0.65 N-m (5.6 lbs-in).

Figure 65: Installed Air Frame

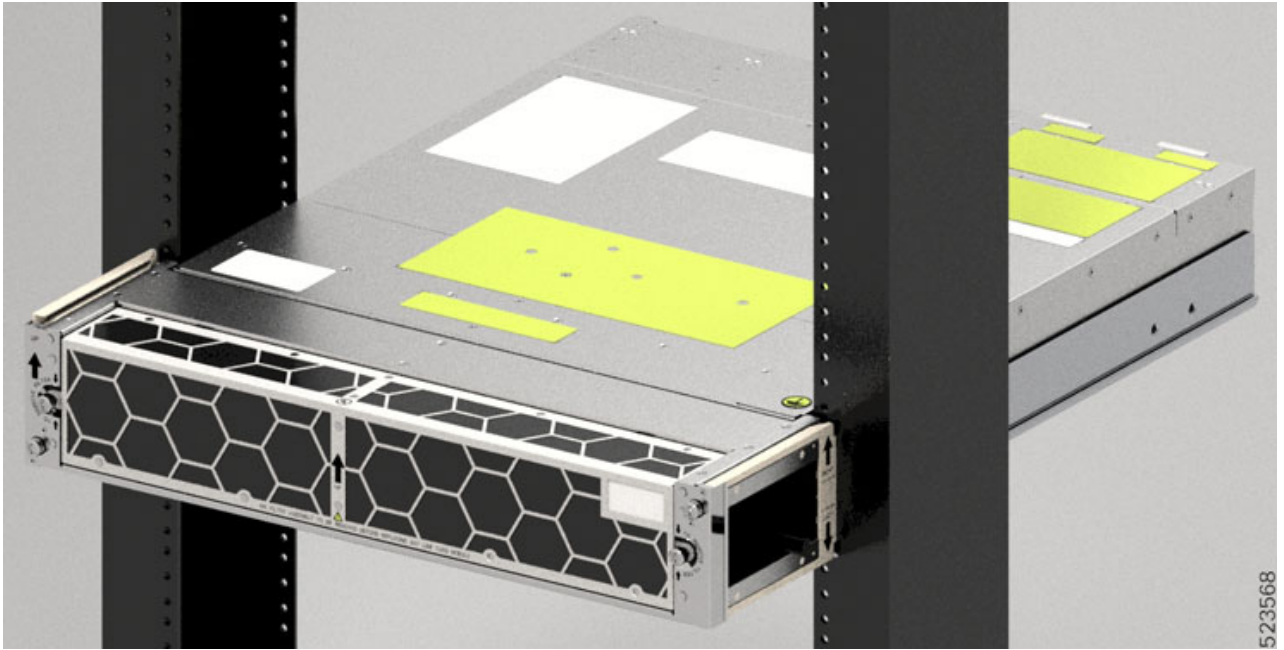



CHAPTER 6

Remove and Replace Cisco NCS 1014 Modules

This chapter describes the procedures to replace Cisco NCS 1014 modules.



Caution

All the modular slots in the NCS 1014 chassis should always be populated with respective modules (line-cards, controller, PSU & fan units). Empty line card slots to be populated with filler modules, which are shipped with the chassis. The replacement or upgrade of the modules (Online Insertion or Removal, OIR) to be performed only when the ambient temperature is below 30-degree C. The OIR of modules should be completed within five minutes to prevent overheating of the components.



WARNING: DO NOT INTRODUCE BODY OR OBJECT IN THE CHASSIS / PSU / FAN TRAY / LC SLOTS WHEN INSTALLING OR REMOVING A MODULE. EXPOSED CIRCUITRY IS AN ENERGY HAZARD.



ATTENTION: ÉVITEZ TOUT CONTACT ENTRE VOTRE CORPS OU UN OBJET EXTERNE ET L'INTÉRIEUR DU CHÂSSIS, DU BLOC D'ALIMENTATION, LA FENTE DE VENTILATION DU PLATEAU, OU DE LA FENTE PDS LORSQUE VOUS INSTALLEZ OU RETIREZ UN MODULE. LES CIRCUITS EXPOSÉS CONSTITUENT UN RISQUE D'ÉLECTROCUTION.

- [Remove and Replace the Pluggables in the 2.4T Line Card, on page 89](#)
- [Remove and Replace a Line Card, on page 90](#)
- [Remove and Replace the Power Supply Unit \(PSU\), on page 90](#)
- [Remove and Replace the Controller, on page 93](#)
- [Remove and Replace the Fan Module, on page 94](#)
- [Remove and Replace the Solid State Drive \(SSD\), on page 96](#)
- [Wipe Data in Disk Using Secure Erase, on page 98](#)

520-496

Remove and Replace the Pluggables in the 2.4T Line Card

Use this procedure to remove and replace the pluggables in the 2.4T DWDM line card.



Note

This procedure is applicable to replacing pluggables in other line cards too.

Procedure

-
- Step 1** Unfasten the Velcro tapes holding the fibers to the fiber management bracket and free up space to remove the required pluggable.
- Step 2** If you want to remove the CIM8 module, then loosen the two screws, else continue with the next step.
- Step 3** Use the pull tabs to pull out the required pluggable.
- Step 4** Remove the fibers from the required pluggable.
- Step 5** Repeat the previous steps until you complete removing all the required pluggables.
- Step 6** (Optional) Insert pluggable caps into the pluggable slots when the slots have no pluggable.
-

What to do next

[Install the Pluggables, on page 82](#)

Remove and Replace a Line Card

Use this procedure to remove and replace the line card or filler card in the Cisco NCS 1014 chassis.



Caution Perform the removal and replacement procedure for a line card or filler card only when the ambient temperature is below 30°C (80°F). Complete the procedure within five minutes to prevent overheating of the chassis components.

Procedure

-
- Step 1** Using the T-15 six lobe/slot screwdriver, loosen the captive screws available in the line card.
- Step 2** Holding the fiber management bracket with one hand and supporting the line card with the other, pull it from the slot.
- Caution** Use the fiber management brackets only for pulling out or pushing in the line cards or filler cards. Do not use the fiber management brackets to carry the cards. Always support the line card or filler card at the bottom with your hand.
-

What to do next

[Install the Line Card, on page 71](#)

Remove and Replace the Power Supply Unit (PSU)

Use this procedure to remove and replace a PSU in the Cisco NCS 1014 chassis.

Before you begin

Remove the connections to the power supply:

- Disconnect power from the breaker before disconnecting power from the power supply unit.
- Remove the cable retainers and the power cables, in case of an AC power supply unit.
- Remove the protection covers, fasteners, and lugs, in case of a DC power supply unit.

Procedure

Step 1 Press the locking latch towards the left to release the lock.

Figure 66: Locking Latch on the DC PSU

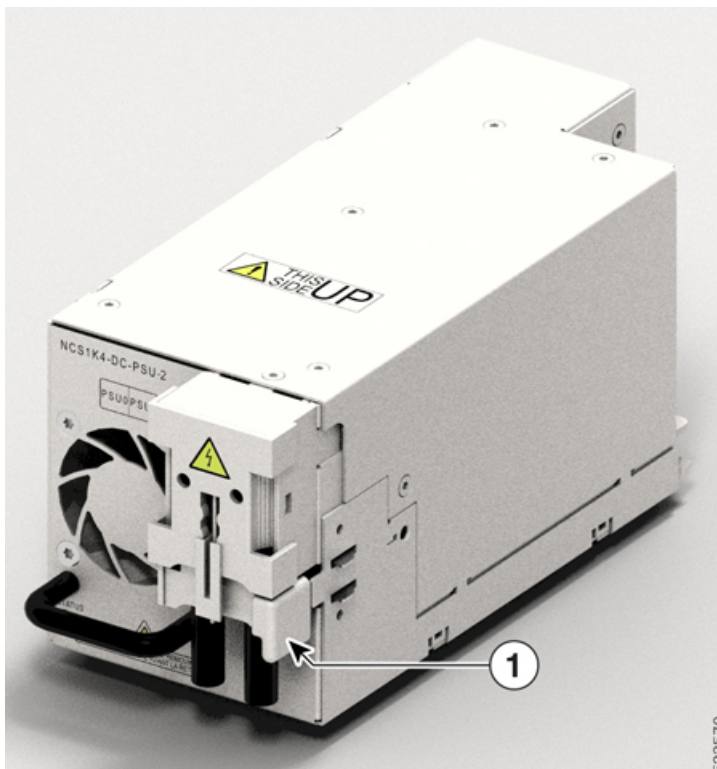

1	Locking latch
---	---------------

Figure 67: Locking Latch on the AC PSU

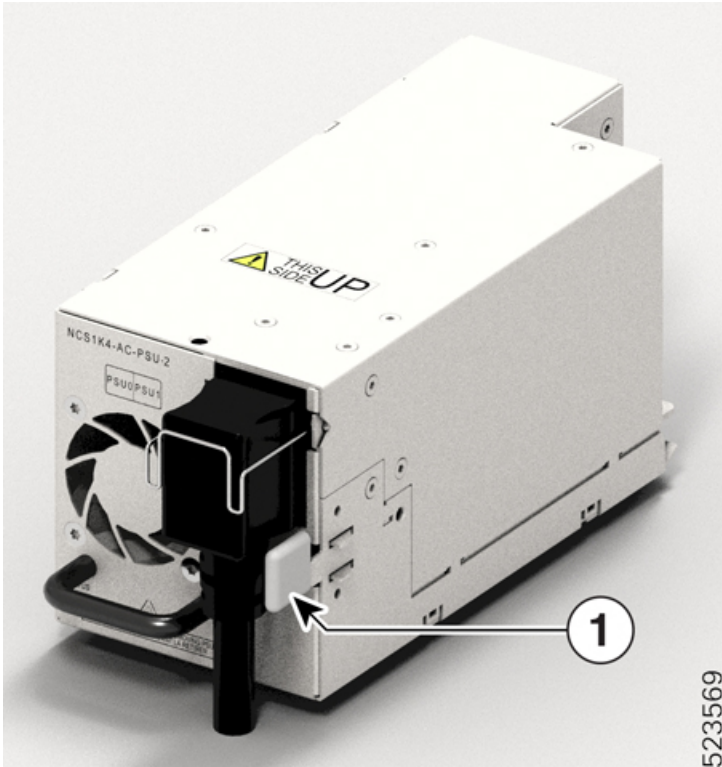

1	Locking latch
---	---------------

Step 2 Holding the handle with one hand and supporting the PSU with the other, gently pull out the PSU from the slot.

Figure 68: Removing the PSU

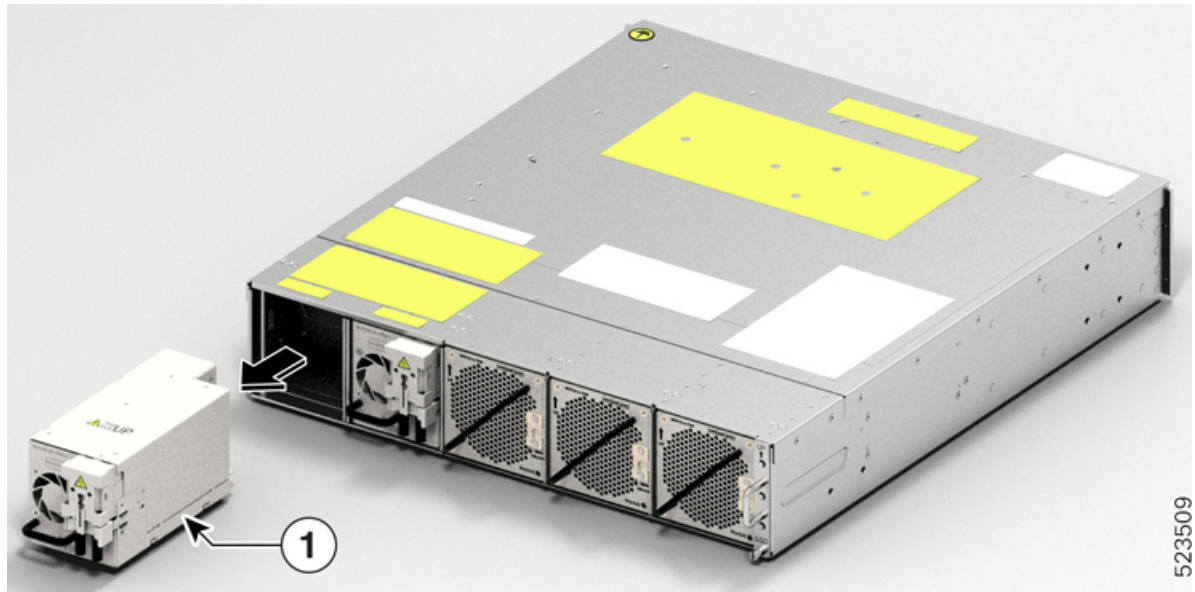

What to do next

[Install the Power Supply Units \(PSUs\), on page 73.](#)

Remove and Replace the Controller

Use this procedure to remove and replace the controller in the Cisco NCS 1014 chassis.

Procedure

- Step 1** Using a T15 six lobe/slot screwdriver, unfasten the two screws on the controller.
- Step 2** Holding the handle with one hand and supporting the controller with the other, gently pull the controller from the slot.

Figure 69: Removing the Controller

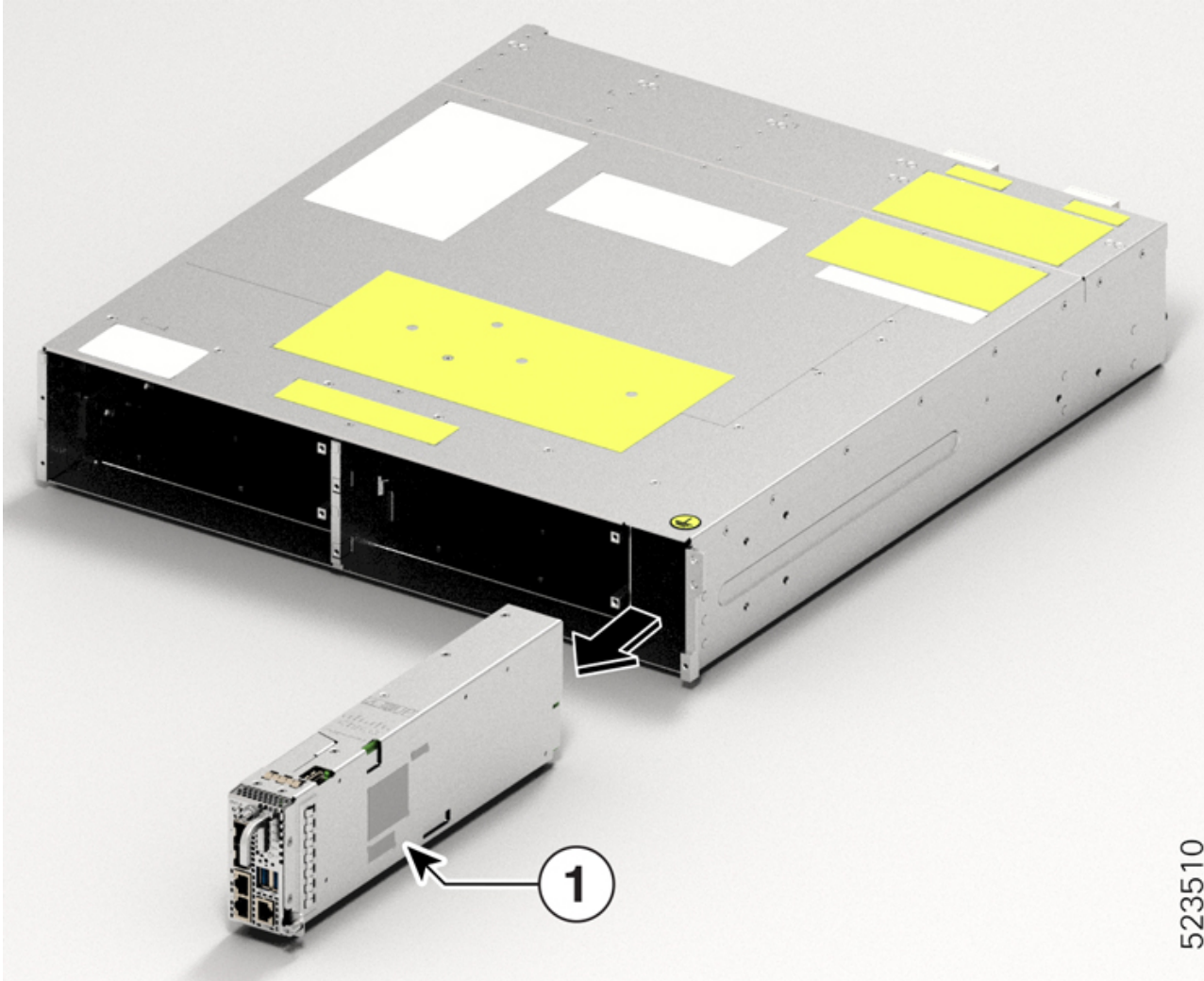

1	Controller Card
---	-----------------

What to do next

[Install the Controller](#)

Remove and Replace the Fan Module

Use this procedure to remove and replace a fan module in the Cisco NCS 1014 chassis.

**Caution**

Online insertion and removal (OIR) duration for the fan module at 30°C ambient temperature is five minutes.

Procedure

Step 1 Push and hold the spring-loaded lever toward the left with your thumb (unlock position).

Figure 70: Spring-Loaded Lever in Holding or Unlock Position

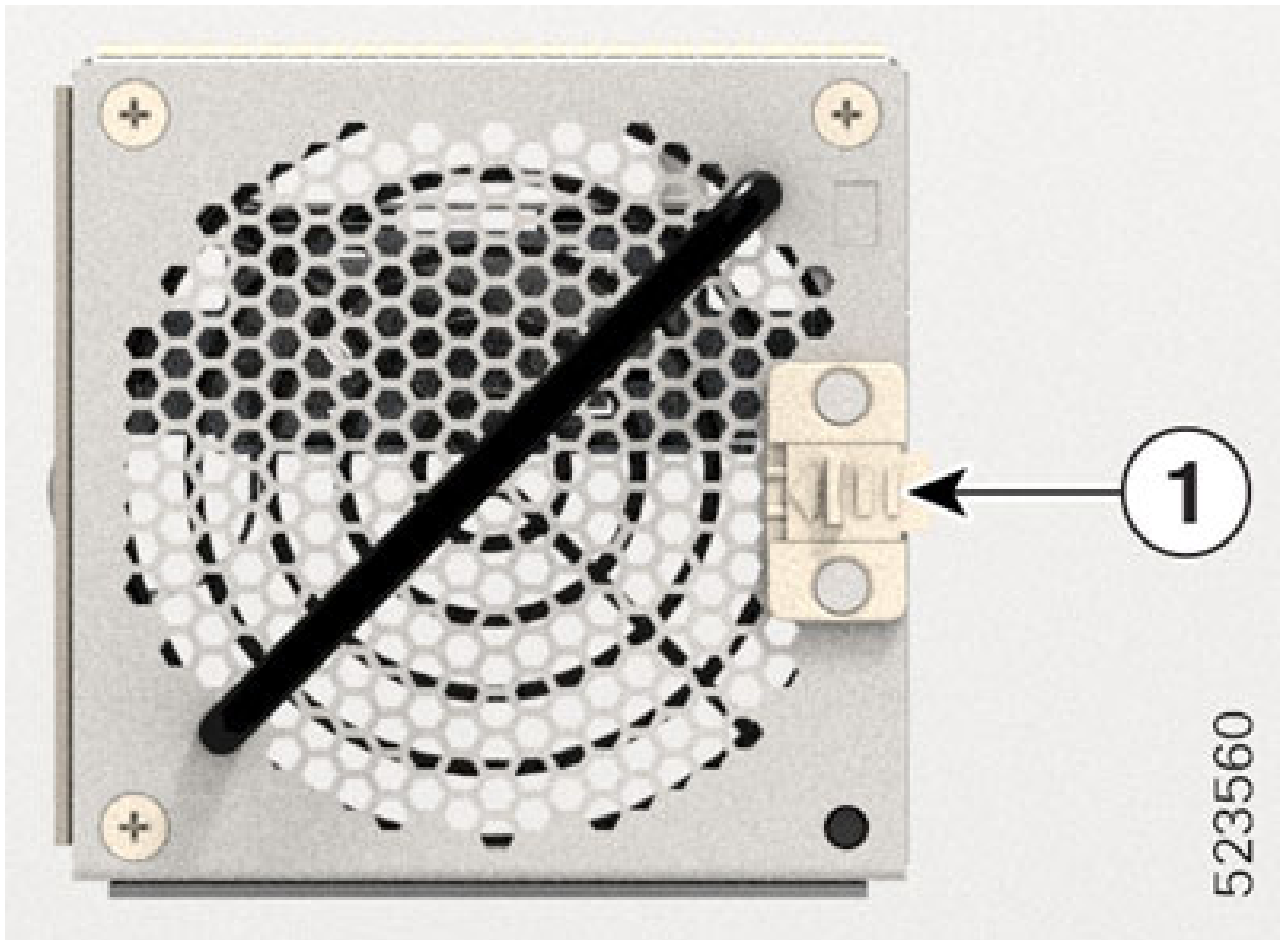

1

Spring-loaded lever

Step 2 Holding the handle with one hand and supporting the fan module with the other hand, gently pull it out of the chassis.

Figure 71: Removing the Fan Module

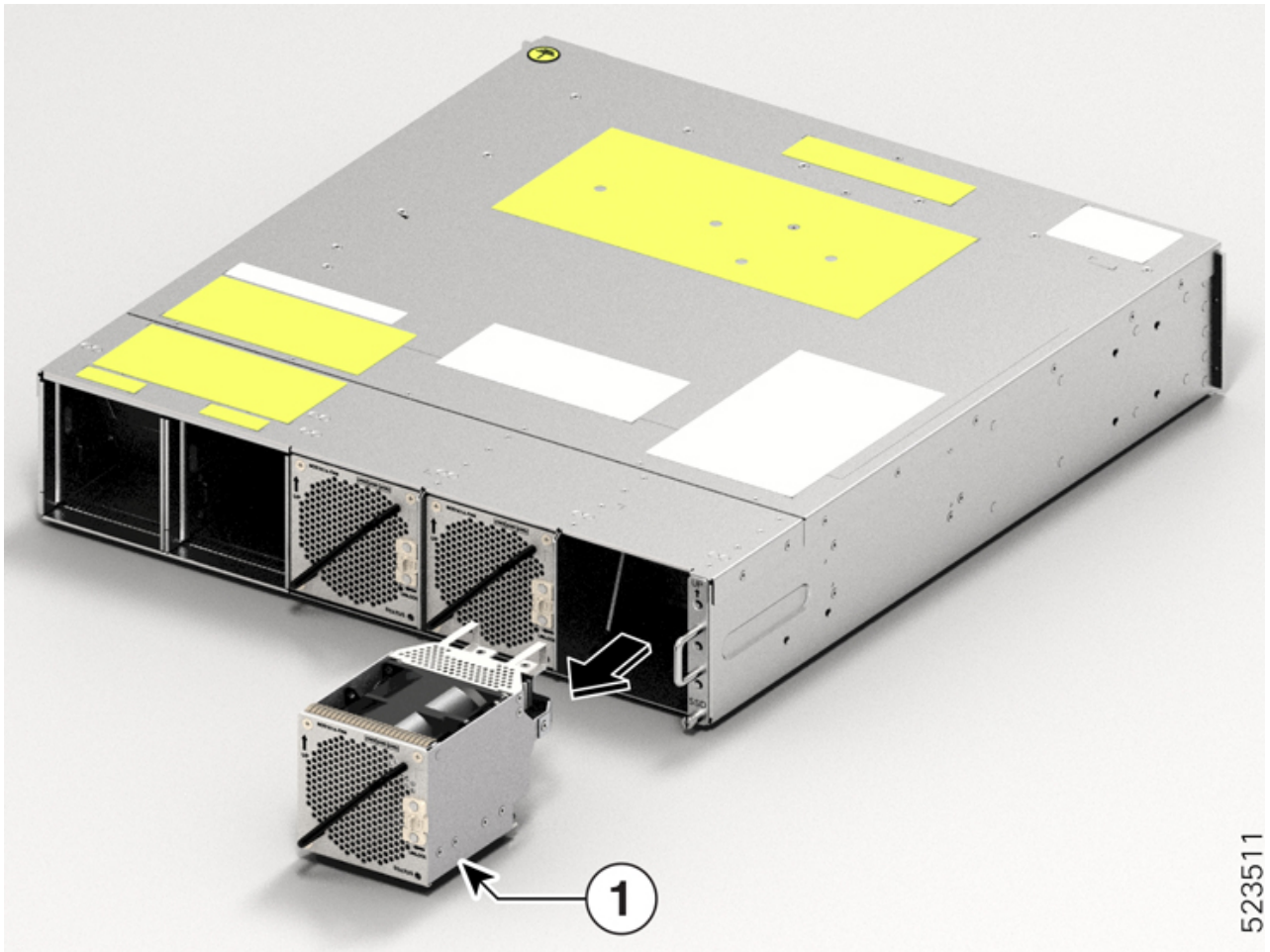

1	Fan module
---	------------

What to do next

[Install the Fan Unit.](#)

Remove and Replace the Solid State Drive (SSD)

Use this procedure to remove and replace the SSD in the Cisco NCS 1014 chassis.

Procedure

Step 1 Using a T15 six lobe/slot screwdriver, loosen the lone captive screw on the SSD.

Figure 72: Removing the SSD

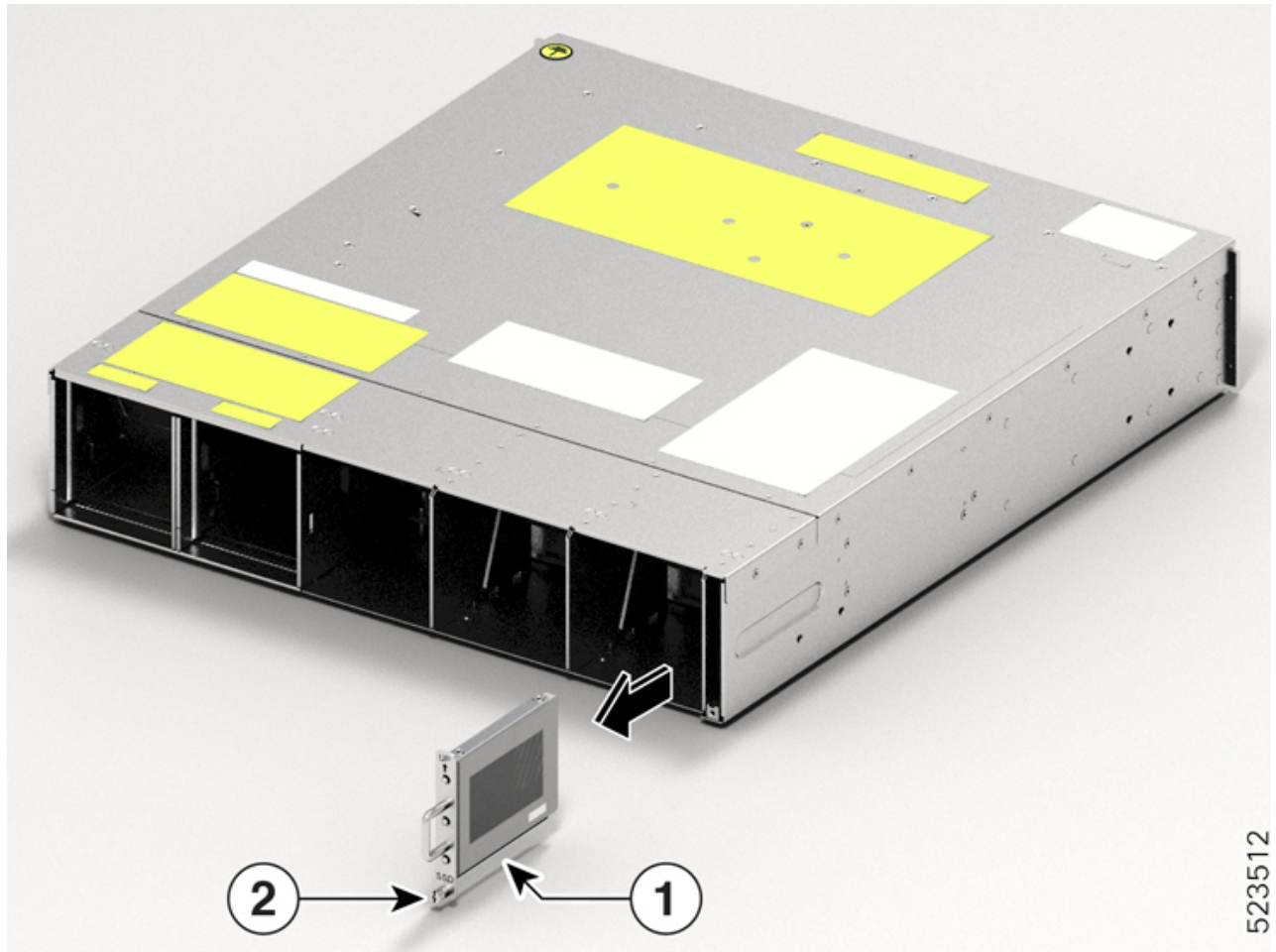

523512

Callout	Component
1	SSD
2	Captive screw

Step 2 Remove the SSD. To remove, gently pull out the SSD from the slot.

What to do next

[Install the Solid State Drive \(SSD\), on page 62](#)

Wipe Data in Disk Using Secure Erase

If the NCS 1014 unit becomes faulty and must be returned, contact Cisco TAC to open a Return Material Authorization (RMA) request. Before opening an RMA request, you can securely erase data in NCS 1014 disks using the Secure Erase feature.



Warning Use this procedure only during RMA.

Before you begin

Take out the NCS 1014 unit that you planned for RMA out of the data center and the network. Access NCS 1014 only using the console port.

Procedure

Step 1 When NCS 1014 boots (power cycle), the following message appears.

```
Version 2.19.1266. Copyright (C) 2023 American Megatrends, Inc.  
BIOS Date: 07/31/2023 14:01:08 Ver: 0ACHIO460  
Press <DEL> or <ESC> to enter setup.  
Press DEL or ESC key to enter BIOS.
```

Press **DEL** or **ESC** key to enter BIOS.

Step 2 Select the **Advanced** tab using the arrow keys.

The disk security details such as HDD Secure Erase are displayed in the Advanced tab.

Step 3 Select **HDD Secure Erase** to securely erase data.

The list of SSDs that support Secure Erase is displayed. D:13 is CPU SSD and D:14 is Chassis SSD.

Step 4 Select the SSD from which you want to erase data using the arrow keys.

Step 5 Select **Yes** in the Confirmation screens.

The system proceeds to securely erase data in the selected SDD after these confirmations.



CHAPTER 7

LEDs

This section provides details of the LEDs in the Cisco NCS 1014 modules, controller unit and line card.

- [Line Card LEDs, on page 99](#)
- [Controller LEDs, on page 105](#)
- [Power Supply Unit \(PSU\) LED, on page 108](#)
- [Fan Module LED, on page 109](#)

Line Card LEDs

The Cisco NCS 1014 line cards use LEDs to indicate the overall state of the cards and help you verify the status of specific connections, ports, and system components. The following topics identify these LEDs and explain what they mean.



Note

- "2.4T" refers to the NCS1K14-2.4T-K9 line card.
 - "CCMD-16-C" refers to the NCS1K14-CCMD-16-C C-band optical line card.
 - "CCMD-16-L" refers to the NCS1K14-CCMD-16-L optical line card.
 - "1.2T" refers to the NCS1K4-1.2T-K9 line card.
 - "2.4TX" refers to the NCS1K14-2.4T-X-K9 line card.
 - "QXP-K9" refers to the NCS1K4-QXP-K9 line card.
-

2.4T and 2.4TX Line Cards LED

The 2.4T and 2.4TX line cards have nine LEDs to indicate the line port alarm status.

Figure 73: 2.4T Line Card LEDs

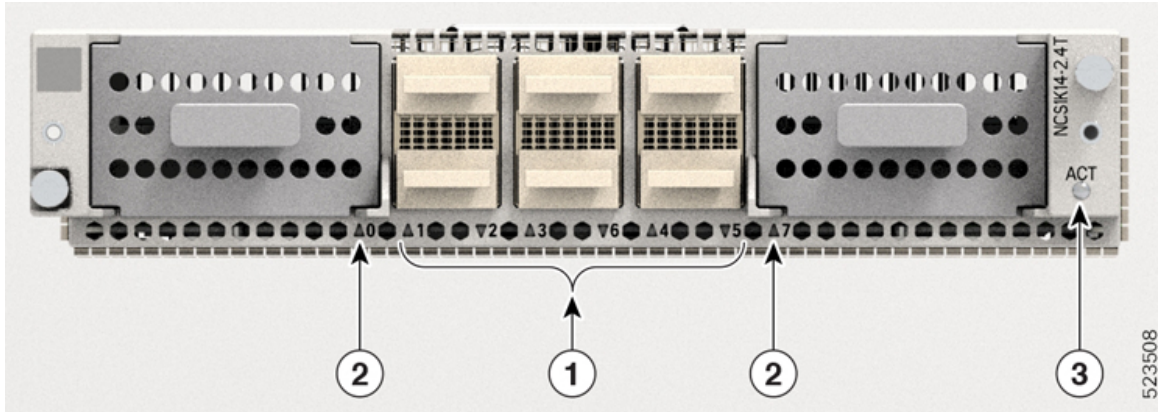
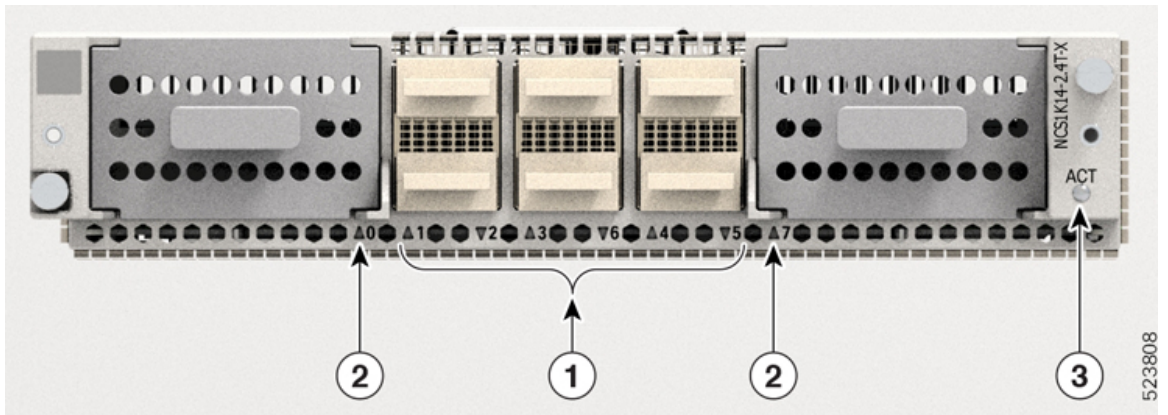

Figure 74: 2.4TX Line Card LEDs



Callout	LED
1	QSFP port (1–6) LEDs The card cage embeds the QSFP LEDs. The <i>triangles</i> appearing upwards and downwards indicate the status and position of the corresponding QSFP.
2	Trunk port (0 and 7) LEDs
3	ACT LED



Note The following LED status applies to both 2.4T and 2.4TX line cards.

Table 23: Status of the Line Card LEDs

LED	Color	Status
ACT LED ¹	Amber (solid)	The line card is booting. This color appears as soon as the line card is inserted into the chassis.
	Flashing Red	The line card is in the booting phase.
	Green	The line card is up and operational (not associated to the traffic status).
QSFP and Trunk port LEDs (0...7)	Off	The port remains not provisioned or switched off.
	Green	The module is operational and has no alarm.
	Amber (solid)	Minor alarm (such as low Rx or Tx power) that could lead to a traffic-impacting situation.
	Amber (flashing)	Used for troubleshooting. Identifies the faulty port of an LC. Use the controller optics command in the configuration mode to point to a faulty port in the line card. The port is configured in maintenance mode or the attention LED is enabled for this port. Use hw-module location to enable the attention LED for the port.
	Red	Major alarm that could lead to a traffic-impacting situation.

¹ ACT LED does not support Attention LED.

CCMD-16-C and CCMD-16-L Line Card LED

The CCMD-16-C and CCMD-16-L optical line cards have 18 LEDs each to indicate the system status and the status of the optical ports.

The following information applies to both CCMD-16-C and CCMD-16-L cards.

Figure 75: CCMD-16-C Optical Cards LEDs

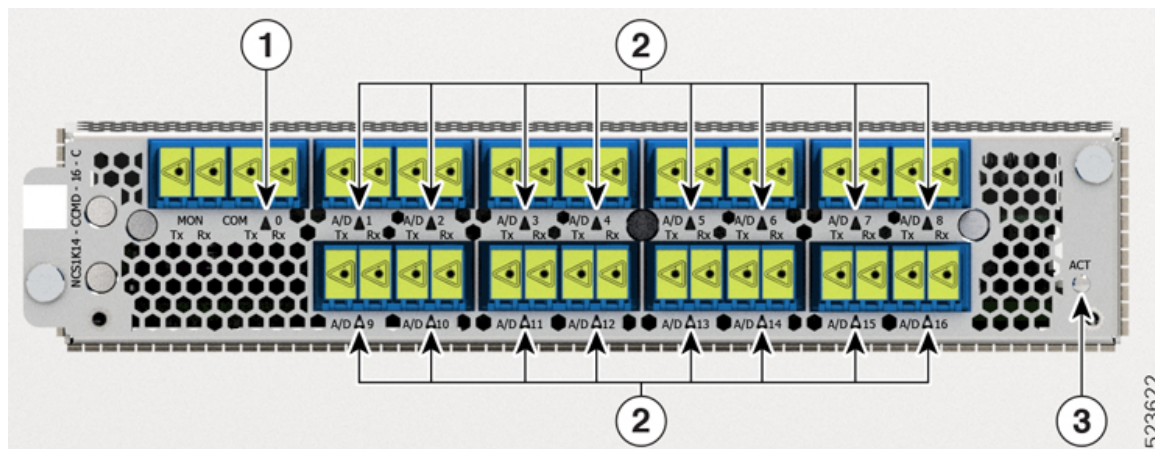

Callout	LED
1	COM
2	A/D-1...A/D-16
3	ACT

Table 24: Status of the CCMD-16-C and CCMD-16-L Optical Card LEDs

LED	Color	Status
ACT	Amber (solid)	The line card is booting. This color appears when you insert the line card into the chassis.
	Flashing Red	The line card is faulty.
	Green	The line card is up and operational—not associated to the traffic status.

LED	Color	Status
COM, A/D-1...A/D-16	Off	The port is not provisioned.
	Red	Major alarm that could lead to a traffic impacting situation.
	Green	The module is operational and has no alarm.
	Amber (solid)	Minor alarm (such as low Rx or Tx power) that could lead to a traffic impacting situation.
	Amber (flashing)	This is used for troubleshooting, to identify the faulty port of an LC. Use the controller optics command in the configuration mode to point to a faulty port in the LC. The port is configured in maintenance mode or the attention LED is enabled for this port. Note Attention LED is not supported on ACT LED.

1.2T Line Card LEDs

The 1.2T line card has 14 LEDs to indicate the line port alarm status.

Figure 76: 1.2T Line Card LEDs

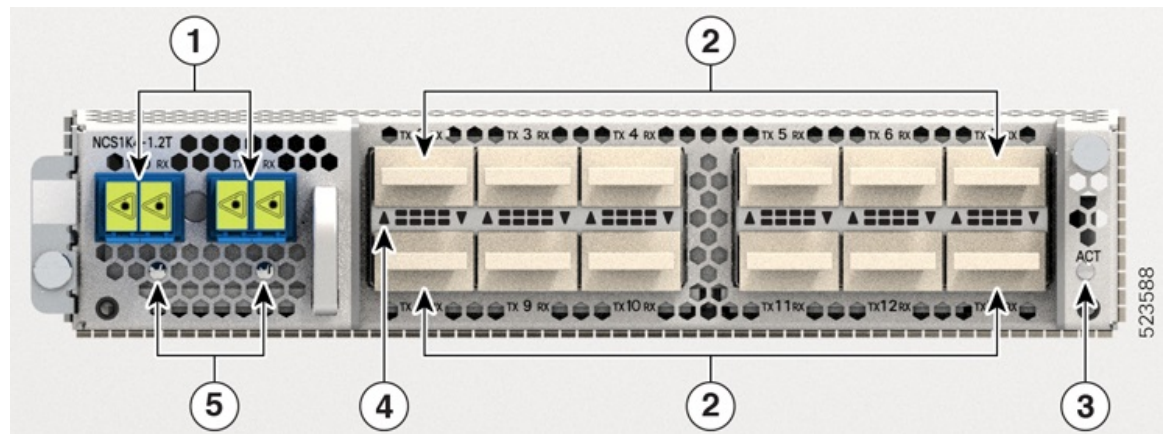

1	Trunk ports (0 and 1)
2	12 QSFP ports (2 to 13). Each QSFP port has Attention LED.
3	ACT LED
4	QSFP port LEDs The LEDs for the QSFPs are embedded in the card cage. The <i>triangles</i> shown upwards or downwards (in 1.2T and 1.2TL line cards) indicate the status of the corresponding QSFP.

5	Trunk port LEDs
---	-----------------

Table 25: Status of the Line Card LEDs

LED	Color	Status
Attention LED	Yellow Flashing	Used by the field engineers to identify a specific port in the line card. This is used for troubleshooting purposes. <ul style="list-style-type: none"> • Use the hw-module location locationattention-led all-ports command to turn on this LED on all the ports of the line card. • Use the hw-module location locationattention-led port-number command to turn on this LED on a specific port of the line card. • Use the show controllers optics rack/slot/instance/port in LED command to display the LED status of ports.
ACT LED	Amber (solid)	The line card is booting. This colour appears as soon as the line card is inserted in to the chassis.
	Flashing Red	The line card is in the booting phase.
	Green	The line card is up and operational (not associated to the traffic status).
QSFP and Trunk port LEDs	Off	The port has not been provisioned.
	Red	Major alarm that could lead to a traffic-impacting situation.
	Green	Indicates that the module is operational and has no alarm.
	Amber (solid)	Indicates a minor alarm (such as low Rx or Tx power), which could lead to a traffic impacting situation.
	Amber (flashing)	This is used for troubleshooting, to identify the faulty port of a line card. Use the controller optics command in the configuration mode to point to a faulty port in the line card. The port is configured in maintenance mode or the attention LED is enabled for this port. Note Attention LED is not supported on ACT LED.

QXP Line Card LED

The front view of the QXP-K9 line card is as below.

Figure 77: Front View of the QXP-K9 Line Card

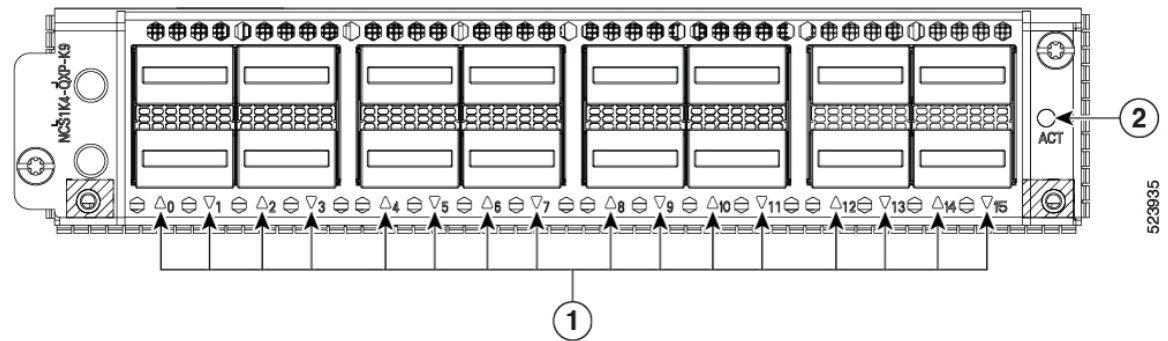

1	16 QSFP-DD ports (0 to 15)
2	ACT LED

Table 26: Status of the QXP-K9 Line Card LEDs

LED	Color	Status
ACT LED	Flashing Red	The line card is booting. This color appears as soon as the line card is inserted in to the chassis.
	Amber (solid)	Indicates that the line card is in the booting phase.
	Green	Indicates that the line card is up and operational (not associated to the traffic status).
QSFP-DD port LEDs	Off	This indicates that the port has not been provisioned.
	Red	Indicates a major alarm, which could be a traffic impacting situation.
	Green	Indicates that the module is operational and has no alarm.
	Amber (solid)	Indicates a minor alarm (such as low Rx or Tx power), which could lead to a traffic impacting situation.
	Amber (flashing)	This is used for troubleshooting, to identify the faulty port of a line card. Use the controller optics command in the configuration mode to point to a faulty port in the line card.

Controller LEDs

The controllers have six LEDs to indicate the system status and the status of the components.

Figure 78: CNTLR LEDs

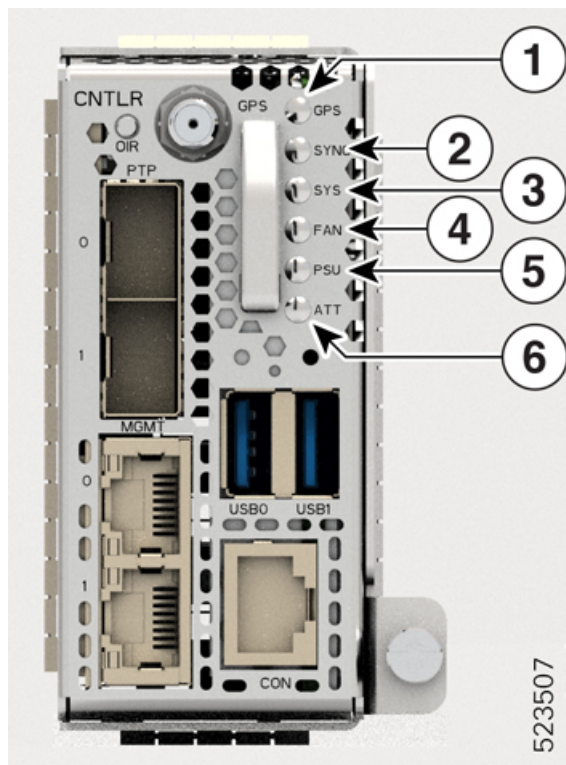
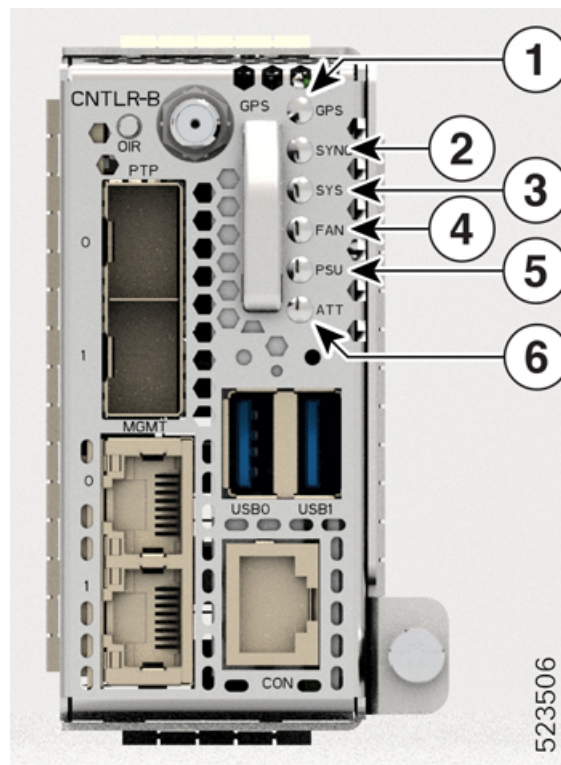

Figure 79: CNTLR-B LEDs



Callout	LED	Callout	LED
1	GPS LED	4	Fan Unit Status (FAN) LED
2	Synchronous Ethernet (SYNC) LED	5	Power Supply Unit Status (PSU) LED
3	System Status (SYS) LED	6	Attention (ATT) LED

Table 27: Status of the Controller LEDs

LED	Color	Status
GPS	Green	GPS phase locked.
	Yellow	GPS enabled.
	Off	GPS not enabled.
	Red	GPS is in use.

LED	Color	Status
SYNC	Green	Time core becomes synchronized to an external source including IEEE1588.
	Flashing green	System is in Synchronous Ethernet mode.
	Amber	Acquiring state or Holdover: Time core is in acquiring state or holdover mode.
	Off	Time core clock synchronization has become disabled or is in a free-running state.
SYS (during controller boot up)	Red	The controller unit is powering on.
	Red (flashing slowly)	BIOS loading.
	Amber (flashing slowly)	OS loading.
	Red (flashing fast)	Secure boot failure. Replace the controller unit.
	Amber (flashing fast)	XR loading.
SYS (controller is operational)	Red	Major or critical alarm is present.
	Amber	Minor alarm is present.
	Green	The module is operational and has no active alarms.
PSU	Green	All PSUs present in the chassis are in working condition.
	Red	Either a PSU is missing from its slot or is faulty.
FAN	Green	All fans present in the chassis are in working condition.
	Red	Either a fan is missing from its slot or is faulty.

LED	Color	Status
ATT	Blue (flashing)	Applicable during online insertion and removal (OIR) procedures. The system is cooling down.
	Blue	Used to identify a specific chassis in a rack or room. Use this LED for troubleshooting purposes. Run the hw-module attention led location command to turn on this LED.

Power Supply Unit (PSU) LED

The NCS1K4-AC-PSU-2 and NCS1K4-DC-PSU-2 units have one LED each to indicate their status.

Figure 80: Front View of 2.5-kW AC PSU

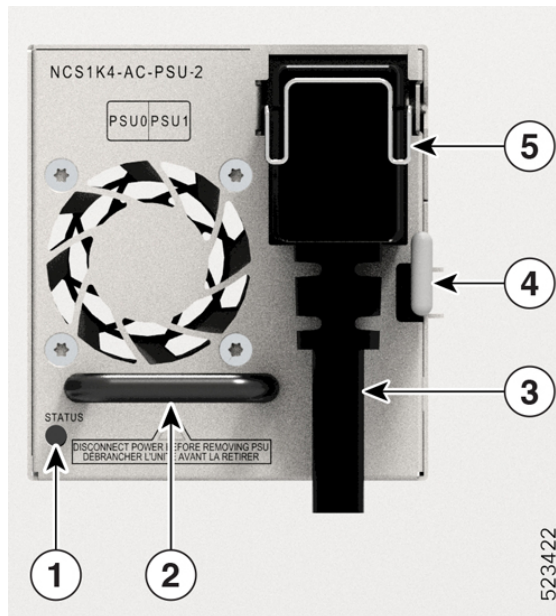
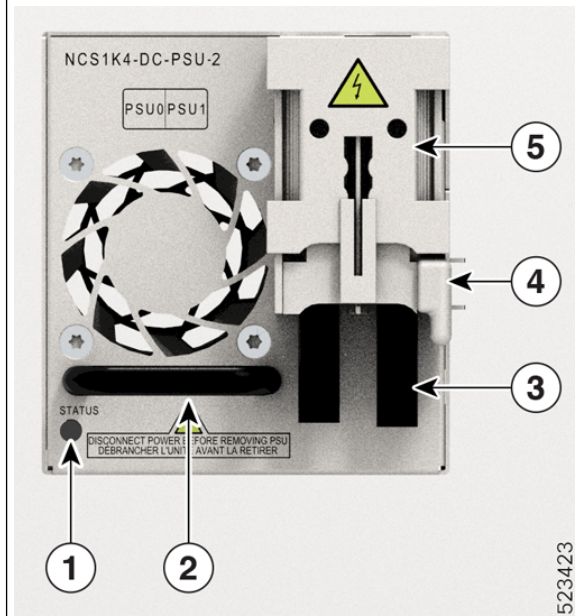

Figure 81: Front View of 2.5-kW DC PSU



1	PSU Unit (STATUS) LED	4	Locking latch
2	PSU Handle	5	Protective cover
3	6 AWG 180-degree exit cables		

Table 28: Status of the 2.5-kW PSU LED

Color	Status
Amber	There exists no input to the PSU, provided the other PSU is working.

Color	Status
Off	Both PSUs do not have input.
Green	The input to the PSU is valid.

For 2-kW PSU LEDs, see [Power Supply Unit LED](#)

Fan Module LED

Each fan module has one LED to indicate its status.

Figure 82: Front View of the Fan Module

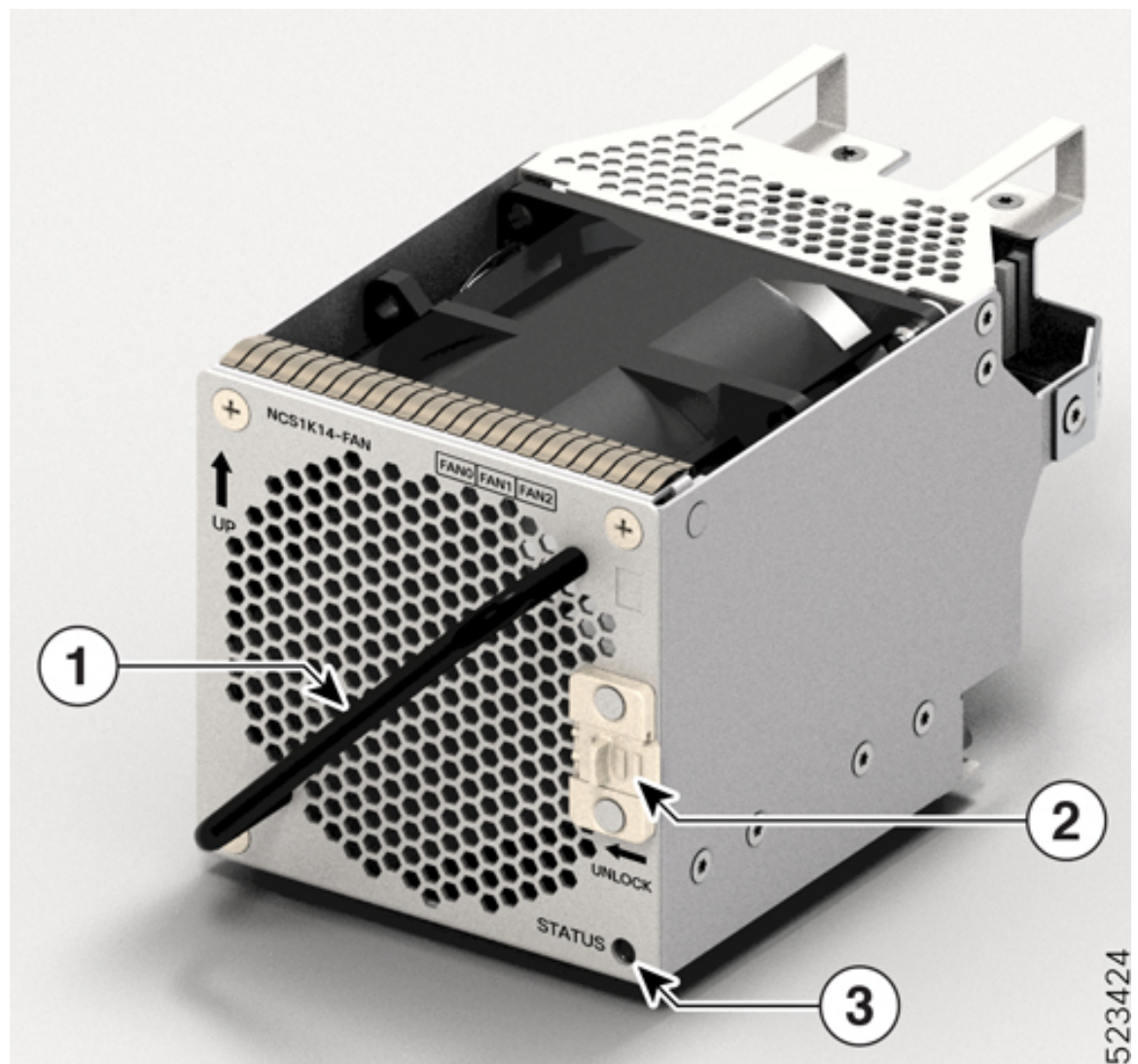

1	Cross-handle
---	--------------

2	Spring-loaded Lever
3	Fan Module (STATUS) LED

Table 29: Status of the Fan Module LED

LED	Color	Status
STATUS	Red	Fault found in the fan module. This status occurs for the following reasons: <ul style="list-style-type: none"> • Fan speed is out of range. • Or the inserted fan module does not power on. • Or the fan module is not present.
	Green	Fan module is working fine.



APPENDIX **A**

Product IDs

This chapter describes the list of Product IDs (PIDs) for Cisco NCS 1014 and its modules.

- [NCS 1014 Chassis and Modules PIDs, on page 111](#)
- [Optical Patch Cord PIDs, on page 113](#)

NCS 1014 Chassis and Modules PIDs

The following table lists the PIDs of the Cisco NCS 1014 chassis and its modules:

Table 30: PIDs for Cisco NCS 1014 Chassis and Its Modules

Product ID	Product Description
Chassis	
NCS1014	NCS 1014 Chassis with Timing Support
NCS1K14-SYS	NCS 1014 Assemble to Order
Modules	
NCS1K14-CNTRLR-K9	NCS 1014 Controller, 115200 bps Baud Rate
NCS1K14-CNTRLR-B-K9	NCS 1014 Controller, 9600 bps Baud Rate
NCS1K14-FAN	NCS 1014 Fan Module
NCS1K14-SSD	NCS 1014 SSD
NCS1K4-AC-PSU	NCS 1004 AC Power Supply Unit, 2.1 kW
NCS1K4-DC-PSU	NCS 1004 DC Power Supply Unit, 2.1 kW
NCS1K4-AC-PSU-2	NCS 1004 AC Power Supply Unit, 2.5 kW
NCS1K4-DC-PSU-2	NCS 1004 DC Power Supply Unit, 2.5 kW
NCS1K14-BLANK	NCS 1014 Blank Card
Line Cards	
NCS1K14-2.4T-K9=	NCS 1014 2.4T Line Card

Product ID	Product Description
NCS1K14-CCMD-16-C=	NCS 1000 16-port Colorless Direct attach LC with EDFA, C-band
NCS1K14-CCMD-16-L=	NCS 1000 16-port Colorless Direct attach LC with EDFA, L-band
NCS1K4-1.2T-K9=	NCS 1014 12x QSFP28 2 Trunk C-Band DWDM card
2.4T Trunk Pluggables	
CIM8-C-K9=	Coherent Interface Module 8, C-Band
CIM8-L-K9=	Coherent Interface Module 8, L-Band
2.4T Client Pluggables	
QDD-400G-FR4-S	IEEE 400GBase-FR4, 2 km over duplex SMF, 1270, 1290, 1310, 1330 nm
QDD-400G-AOCxM	400G QDD Active optical cable pluggable optics module
QDD-400G-DR4-S	IEEE 400GBase-DR4, 500 m over SMF, 1310 nm
QDD-4X100G-LR-S	4x100GBase-LR, 10 km over SMF, 1310 nm
1.2T Client Pluggables	
ONS-QSFP28-LR4	100G Base LR4, OTU4, 10 km over SMF, 1295.56, 1300.05, 1304.58, 1309.14 nm
QSFP-100G-AOC-1M	100G QDD Active optical cable pluggable optics module, 1 m
QSFP-100G-AOC-3M	100G QDD Active optical cable pluggable optics module, 3 m
QSFP-100G-AOC-10M	100G QDD Active optical cable pluggable optics module, 10 m
QSFP-100G-CU1M	100GBase-CR4 Passive copper cable, 1 m
QSFP-100G-CU2M	100GBase-CR4 Passive copper cable, 2 m
QSFP-100G-CU3M	100GBase-CR4 Passive copper cable, 3 m
QSFP-100G-CU5M	100GBase-CR4 Passive copper cable, 5 m
QSFP-100G-CWDM4-S	100GBase CWDM4, 2 km over SMF, 1271, 1291, 1311, 1331 nm
QSFP-100G-DR-S	100GBase-DR, 500 m over SMF, 1310 nm
QSFP-100G-ER4L-S	100GBase, 25-40 km over SMF, 1295, 1300, 1304, 1309 nm
QSFP-100G-FR-S	100GBase-FR, 2km over SMF, 1310 nm
QSFP-100G-LR4-S	100GBase-LR4, 10 km over SMF, 1295, 1300, 1304, 1309 nm
QSFP-100G-LR-S	100GBase-LR, 10 km over SMF, 1310 nm
QSFP-100G-SM-SR	100G CWDM4 Lite, 2 km over SMF, 1271, 1291, 1311, 1331 nm

Product ID	Product Description
QSFP-100G-SR4-S	100GBase-SR4, 100 m over OM4 MMF, 850 nm
QSFP-40/100-SRBD	100G and 40GBase-SR, BiDi, 100 m over OM4 MM, 855, 908 nm

Optical Patch Cord PIDs

This section lists the PIDs of the optical patch cords that are supported in the Cisco NCS 1014 line cards.

Breakout Cable

Figure 83: Breakout Cable

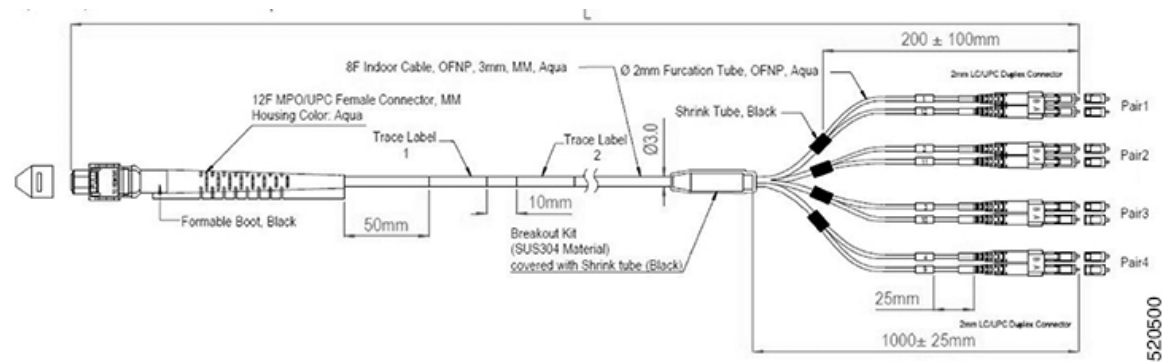

Note Use the breakout cable only for ETSI racks to maintain a 600-mm footprint. Ensure a minimum gap of 50 mm below the chassis for routing the cables.

The following table lists the PIDs and specifications of the breakout cables that are supported for the QSFP-100G-SR4-S pluggable in the 1.2T line card:

Table 31: PIDs and Specifications of the Breakout Cables

PID	MPN	Overall Length (m)
ONS-4X10-MMCBL-5=	BCJ7F3FM005CSO008	05 ± 0.30
ONS-4X10-MMCBL-10=	BCJ7F3FM010CSO008	10 ± 0.30
ONS-4X10-MMCBL-20=	BCJ7F3FM020CSO008	20 ± 0.60

Cable with Formable Boot and Standard Boot

Figure 84: Cable with Formable Boot and Standard Boot

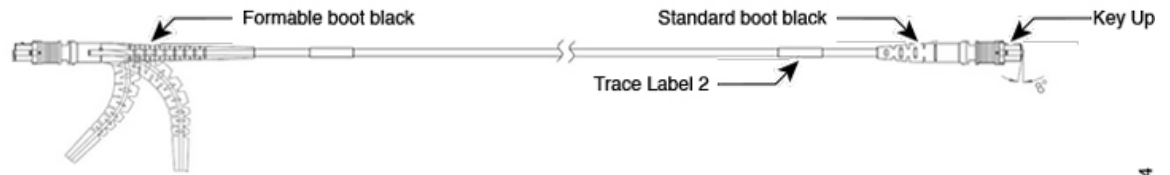

520624

You must use the formable boot on the side of the line card only.

The following table lists the PIDs and specifications of the cable with formable boot and standard boot that support the QDD-400G-DR4-S pluggable in the 2.4T line card:

Table 32: PIDs and Specifications of Cables with Formable Boot and Standard Boot

PID	MPN	Overall Length (m)
-ONS-FMPO-SM-5=	MDD3F 3GM005CSO001	05±0.30
-ONS-FMPO-SM-10=	MDD3F 3GM010CSO001	10±0.30
-ONS-FMPO-SM-20=	MDD3F 3GM020CSO001	20±0.60
-ONS-FMPO-SM-30=	MDD3F 3GM030CSO001	30±0.90
-ONS-FMPO-SM-40=	MDD3F 3GM040CSO001	40±1.20
-ONS-FMPO-SM-50=	MDD3F 3GM050CSO001	50±1.50
-ONS-FMPO-SM-60=	MDD3F 3GM060CSO001	60±1.50
-ONS-FMPO-SM-70=	MDD3F 3GM070CSO001	70±1.50
-ONS-FMPO-SM-80=	MDD3F 3GM080CSO001	80±1.50
-ONS-FMPO-SM-90=	MDD3F 3GM090CSO001	90±1.50
-ONS-FMPO-SM-100=	MDD3F 3GM100CSO001	100±1.50