



DLPs F300 to F399

DLP-F300 Install Fiber-Optic Cables for SNCP Configurations

Purpose	This task installs the fiber-optic cables to the SNCP ports at each node. See Chapter 5, “Turn Up a Network.” to provision and test SNCP configurations.
Tools/Equipment	Fiber-optic cables
Prerequisite Procedures	NTP-F119 Install the STM-N Cards, page 2-4 NTP-F231 Clean Fiber Connectors and Adapters, page 14-16
Required/As Needed	As needed
Onsite/Remote	Onsite
Security Level	None



Caution

To avoid loss of traffic, do not create an SNCP using two ports on the same card. You can create an SNCP on different ports on the same side of the shelf, but Cisco recommends using one port on one side of the shelf and another port on the opposite side.



Note

See [Table 16-1 on page 16-19](#) and [Table 16-2 on page 16-19](#) for OGI connector pinouts of STM-16 and STM-64 cards.

- Step 1** Plug the fiber into the transmit (Tx) connector of an STM-N card at one node and plug the other end of the fiber into the receive (Rx) connector of an STM-N card at the adjacent node. The card will display an SF LED if the transmit and receive fibers are mismatched (one fiber connects a receive port on one card to a receive port on another card, or the same situation with transmit ports).
- Step 2** Repeat [Step 1](#) until you have configured the ring.
- Step 3** Return to your originating procedure (NTP).
-

DLP-F301 Edit SNCP Dual-Ring Interconnect Circuit Hold-Off Timer

Purpose	This task changes the amount of time a path selector switch is delayed for circuits routed on an SNCP dual-ring interconnect (DRI) topology. Setting a switch hold-off time (HOT) prevents unnecessary back and forth switching when a circuit is routed through multiple SNCP selectors.
Tools/Equipment	None
Prerequisite Procedures	NTP-F152 Provision SNCP Nodes, page 5-13 DLP-F181 Log into CTC, page 16-34
Required/As Needed	As needed
Onsite/Remote	Onsite or remote
Security Level	Provisioning or higher

Note

Cisco recommends that you set the DRI port HOT value to zero and the circuit path selector HOT value to a number equal to or greater than zero.

-
- Step 1** From the View menu, choose **Go to Network View**.
- Step 2** Click the **Circuits** tab.
- Step 3** Click the SNCP circuit you want to edit, then click **Edit**.
- Step 4** In the Edit Circuit window, click the **SNCP Selectors** tab.
- Step 5** Create a hold-off time for the circuit source and destination ports:
- In the Hold-Off Timer area, double-click the cell of the circuit source port (top row), then type the new hold-off time. The range is 0 to 10,000 ms in increments of 100.
 - In the Hold-Off Timer area, double-click the cell of the circuit destination port (bottom row), then type the hold-off time entered in Step **a**.
- Step 6** Click **Apply**, then close the Edit Circuit window by choosing **Close** from the File menu.
- Step 7** Return to your originating procedure (NTP).
-

DLP-F302 Change Tunnel Type

Purpose	This task converts a traditional DCC tunnel to an IP-encapsulated tunnel or an IP-encapsulated tunnel to a traditional DCC tunnel.
Tools/Equipment	None
Prerequisite Procedures	DLP-F244 Create a DCC Tunnel, page 17-36 DLP-F166 Create an IP-Encapsulated Tunnel, page 16-9
Required/As Needed	As needed
Onsite/Remote	Onsite or remote
Security Level	Provisioning or higher

-
- Step 1** From the View menu, choose **Go to Network View**.
- Step 2** Click the **Provisioning > Overhead Circuits** tabs.
- Step 3** Click the circuit tunnel that you want to convert.
- Step 4** Click **Edit**.
- Step 5** In the Edit Circuit window, click the **Tunnel** tab.
- Step 6** In the Attributes area, complete the following:
- If you are converting a traditional DCC tunnel to an IP-encapsulated tunnel, check the **Change to IP Tunnel** check box and type the percentage of total DCC bandwidth used in the Maximum Bandwidth field (the minimum percentage is 10 percent).
 - If you are converting an IP tunnel to a traditional DCC tunnel, check the **Change to RS-DCC Tunnel** check box.
- Step 7** Click **Apply**.
- Step 8** In the confirmation dialog box, click **Yes** to continue.
- Step 9** In the Circuit Changed status box, click **OK** to acknowledge that the circuit change was successful.
- Step 10** Return to your originating procedure (NTP).
-

DLP-F303 Delete Overhead Circuits

Purpose	This task deletes overhead circuits. ONS 15600 SDH overhead circuits include DCC tunnels and IP-encapsulated tunnels.
Tools/Equipment	None
Prerequisite Procedures	DLP-F181 Log into CTC, page 16-34
Required/As Needed	As needed
Onsite/Remote	Onsite or remote
Security Level	Provisioning or higher



Caution

Deleting overhead circuits is service affecting if the circuit ports are in service. To put circuit ports out of service, see the “[DLP-F254 Change the Service State for a Port](#)” task on page 17-47.

-
- Step 1** From the View menu, choose **Go to Network View**.
- Step 2** Click the **Provisioning > Overhead Circuits** tabs.
- Step 3** Click the overhead circuit that you want to delete.
- Step 4** Click **Delete**.
- Step 5** In the confirmation dialog box, click **Yes** to continue.
- Step 6** Return to your originating procedure (NTP).
-

DLP-F304 Repair an IP Tunnel

Purpose	This task repairs circuits that are in the PARTIAL status as a result of node IP address changes.
Tools/Equipment	None
Prerequisite Procedures	See Chapter 6, “Create Circuits.” for circuit creation procedures.
Required/As Needed	As needed
Onsite/Remote	Onsite or remote
Security Level	Provisioning or higher

-
- Step 1** Obtain the original IP address of the node in question.
- Step 2** From the View menu, choose **Go to Network View**.
- Step 3** From the Tools menu, choose **Overhead Circuits > Repair IP Circuits**.
- Step 4** Review the text in the IP Repair wizard and click **Next**.
- Step 5** In the Node IP address area, complete the following:
- Node—Choose the node that has a PARTIAL circuit.
 - Old IP Address—Type the node’s original IP address.
- Step 6** Click **Next**.
- Step 7** Click **Finish**.
- Step 8** Return to your originating procedure (NTP).
-

DLP-F305 Provision Path Trace on Circuit Source and Destination Ports

Purpose	This task creates a path trace on VC circuit source ports and destination.
Tools/Equipment	ONS 15600 SDH cards capable of transmitting and receiving path trace must be installed at the circuit source and destination ports. See Table 18-1 for a list of cards.
Prerequisite Procedures	DLP-F181 Log into CTC, page 16-34
Required/As Needed	As needed
Onsite/Remote	Onsite or remote
Security Level	Provisioning or higher



Note

This task assumes you are setting up path trace on a bidirectional circuit and setting up transmit strings at the circuit source and destination.

- Step 1** From the View menu, choose **Go to Network View**.
- Step 2** Click the **Circuits** tab.
- Step 3** For the VC circuit you want to monitor, verify that the source and destination ports are on a card that can transmit and receive the path trace string. [Table 18-1](#) provides a list of cards that support path trace.

Table 18-1 **ONS 15600 SDH Cards for Path Trace**

J1 Function	Cards
Transmit and Receive	ASAP (Gigabit Ethernet ports)
Receive Only	ASAP (Optical ports) OC48/STM16 LR/LH 16 Port 1550 OC48/STM16 SR/SH 16 Port 1310 OC192/STM64 LR/LH 4 Port 1550 OC192/STM64 SR/SH 4 Port 1310 OC192/STM64 4 Port ITU C-Band

Step 4 Choose the VC circuit you want to trace, then click **Edit**.

Step 5 In the Edit Circuit window, click the **Show Detailed Map** check box at the bottom of the window. A detailed map of the source and destination ports appears.

Step 6 Provision the circuit source transmit string:

- a. On the detailed circuit map, right-click the circuit source port (the square on the left or right of the source node icon) and choose **Edit J1 Path Trace (port)** from the shortcut menu. [Figure 18-1](#) shows an example.

Figure 18-1 Selecting the Edit Path Trace Option

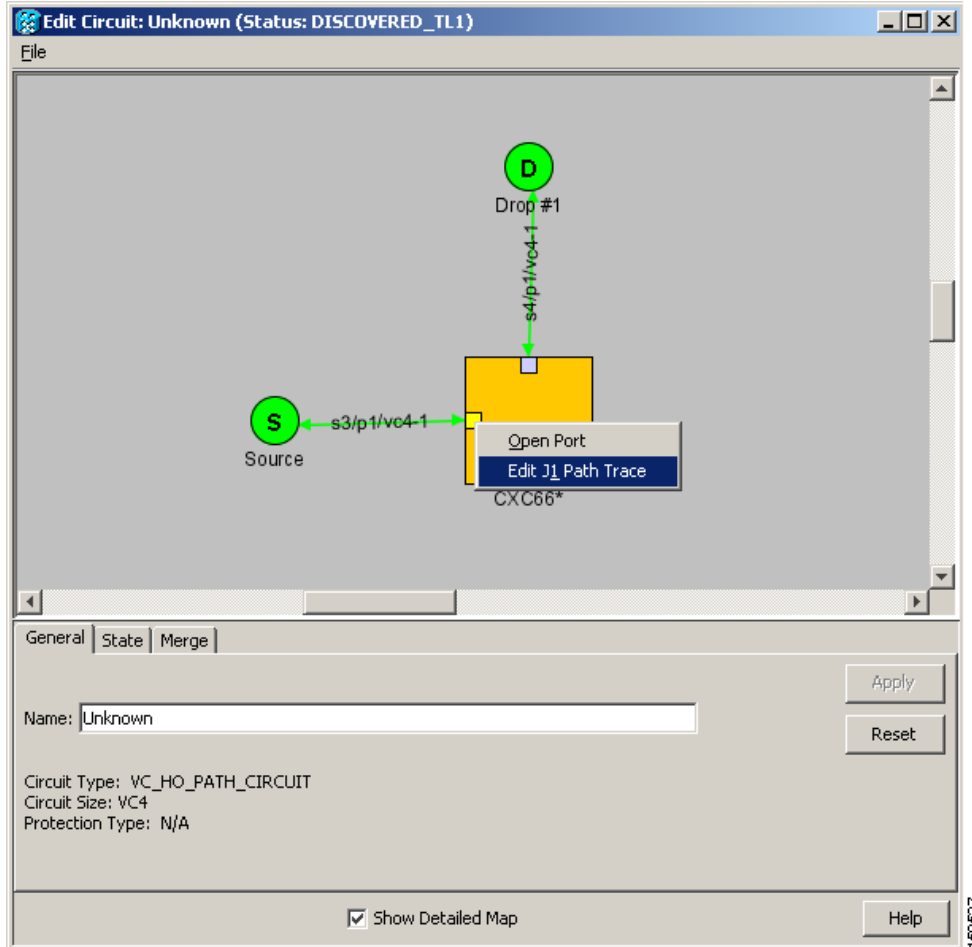

- b. In the New Expected String field, enter the circuit source transmit string. Enter a string that makes the source port easy to identify, such as the node IP address, node name, circuit name, or another string. If the New Expected String field is left blank, the J1 transmits a string of null characters.
- c. Click **Apply**, then click **Close**.

Step 7 Provision the circuit destination transmit string:

- a. On the detailed circuit map, right-click the circuit destination port and choose **Edit Path Trace** from the shortcut menu (Figure 18-1).
- b. In the New Expected String field, enter the string that you want the circuit destination to transmit. Enter a string that makes the destination port easy to identify, such as the node IP address, node name, circuit name, or another string. If the New Expected String field is left blank, the J1 transmits a string of null characters.
- c. Click **Apply**.

Step 8 Provision the circuit destination expected string:

- a. On the Circuit Path Trace window, enable the path trace expected string by choosing **Auto** or **Manual** from the Path Trace Mode drop-down list:

- Auto—The first string received from the source port is automatically provisioned as the current expected string. An alarm is raised when a string that differs from the baseline is received.
 - Manual—The string entered in the Current Expected String field is the baseline. An alarm is raised when a string that differs from the Current Expected String is received.
- b. If you set the Path Trace Mode field to Manual, enter the string that the circuit destination should receive from the circuit source in the New Expected String field. If you set Path Trace Mode to Auto, skip this step.
 - c. Click the **Disable AIS and RDI if TIM-P is detected** check box if you want to suppress the alarm indication signal (AIS) and remote defect indication (RDI) when the VC Path Trace Identifier Mismatch Path (TIM-P) alarm appears. Refer to the *Cisco ONS 15600 SDH Troubleshooting Guide* for descriptions of alarms and conditions.
 - d. (Check box visibility depends on card selection.) Click the **Disable AIS on C2 Mis-Match** check box if you want to suppress the AIS when a C2 mismatch occurs.
 - e. Click **Apply**, then click **Close**.



Note It is not necessary to set the format (16 or 64 bytes) for the circuit destination expected string; the path trace process automatically determines the format.

Step 9 Provision the circuit source expected string:

- a. In the Edit Circuit window (with Show Detailed Map chosen; see [Figure 18-1 on page 18-6](#)), right-click the circuit source port and choose **Edit Path Trace** from the shortcut menu.
- b. In the Circuit Path Trace window, enable the path trace expected string by choosing **Auto** or **Manual** from the Path Trace Mode drop-down list:
 - Auto—Uses the first string received from the port at the other path trace end as the baseline string. An alarm is raised when a string that differs from the baseline is received.
 - Manual—Uses the Current Expected String field as the baseline string. An alarm is raised when a string that differs from the Current Expected String is received.
- c. If you set the Path Trace Mode field to Manual, enter the string that the circuit source should receive from the circuit destination in the New Expected String field. If you set Path Trace Mode to Auto, skip this step.
- d. Click the **Disable AIS and RDI if TIM-P is detected** check box if you want to suppress the AIS and RDI when the TIM-P alarm appears. Refer to the *Cisco ONS 15600 SDH Troubleshooting Guide* for descriptions of alarms and conditions.
- e. (Check box visibility depends on card selection.) Click the **Disable AIS on C2 Mis-Match** check box if you want to suppress the AIS when a C2 mismatch occurs.
- f. Click **Apply**.



Note It is not necessary to set the format (16 or 64 bytes) for the circuit source expected string; the path trace process automatically determines the format.

Step 10 After you set up the path trace, the received string appears in the Received field on the path trace setup window. The following options are available:

- Click **Hex Mode** to display path trace in hexadecimal format. The button name changes to ASCII Mode. Click it to return the path trace to ASCII format.
- Click the **Reset** button to reread values from the port.

- Click **Default** to return to the path trace default settings (Path Trace Mode is set to Off and the New Transmit and New Expected Strings are null).

**Caution**

Clicking Default will generate alarms if the port on the other end is provisioned with a different string.

The expect and receive strings are updated every few seconds if the Path Trace Mode field is set to Auto or Manual.

Step 11 Click **Close**.

The detailed circuit window indicates path trace with an M (manual path trace) or an A (automatic path trace) at the circuit source and destination ports.

Step 12 Return to your originating procedure (NTP).

DLP-F306 Provision Path Trace on STM-N Ports

Purpose	This task monitors a path trace on STM-N ports within the circuit path.
Tools/Equipment	The STM-N ports you want to monitor must be on STM-N cards capable of receiving path trace. See Table 18-1 on page 18-5 .
Prerequisite Procedures	DLP-F305 Provision Path Trace on Circuit Source and Destination Ports, page 18-4 DLP-F181 Log into CTC, page 16-34
Required/As Needed	As needed
Onsite/Remote	Onsite or remote
Security Level	Provisioning or higher

Step 1 From the View menu, choose **Go to Other Node**. In the Select Node dialog box, choose the node where path trace was provisioned on the circuit source and destination ports.

Step 2 Click **Circuits**.

Step 3 Choose the VC circuit that has path trace provisioned on the source and destination ports, then click **Edit**.

Step 4 In the Edit Circuit window, click the **Show Detailed Map** check box at the bottom of the window. A detailed circuit graphic showing source and destination ports appears.

Step 5 In the detailed circuit map right-click the circuit STM-N port (the square on the left or right of the source node icon) and choose **Edit Path Trace** from the shortcut menu.



Note The STM-N port must be on a receive-only card listed in [Table 18-1 on page 18-5](#). If not, the Edit Path Trace menu item will not appear.

Step 6 In the Circuit Path Trace window, enable the path trace expected string by choosing **Auto** or **Manual** from the Path Trace Mode drop-down list:

- **Auto**—Uses the first string received from the port at the other path trace end as the current expected string. An alarm is raised when a string that differs from the baseline is received. For STM-N ports, Auto is recommended because Manual mode requires you to trace the circuit on the Edit Circuit window to determine whether the port is the source or destination path.
 - **Manual**—Uses the Current Expected String field as the baseline string. An alarm is raised when a string that differs from the Current Expected String is received.
- Step 7** If you set the Path Trace Mode field to Manual, enter the string that the STM-N port should receive in the New Expected String field. To do this, trace the circuit path on the detailed circuit window to determine whether the port is in the circuit source or destination path, then set the New Expected String to the string transmitted by the circuit source or destination. If you set the Path Trace Mode field to Auto, skip this step.
- Step 8** Click **Apply**, then click **Close**.
- Step 9** Return to your originating procedure (NTP).

DLP-F307 Create Login Node Groups

Purpose	This task creates a login node group to display ONS 15600 SDH nodes that have an IP connection but not a DCC connection to the login node.
Tools/Equipment	None
Prerequisite Procedures	DLP-F181 Log into CTC, page 16-34 NTP-F129 Log into the ONS 15600 SDH GUI, page 3-5
Required/As Needed	As needed
Onsite/Remote	Onsite or remote
Security Level	Provisioning or higher

- Step 1** From the Edit menu in node view, choose **Preferences**.
- Step 2** Click the **Login Node Group** tab.
- Step 3** Click **Create Group**.
- Step 4** In the Create Login Group Name dialog box, enter a name for the group.
- Step 5** Click **OK**.
- Step 6** In the Members area, type the IP address (or node name) of a node you want to add to the group. Click **Add**. Repeat this step for each node that you want to add to the group.
- Step 7** Click **OK**.

The next time you log into an ONS 15600 SDH, the login node group will be available in the Additional Nodes list of the Login dialog box. For example, in [Figure 18-2](#), a login node group is created that contains the IP addresses for Nodes 1, 4, and 5. During login, if you choose this group from the Additional Nodes list and Disable Network Discovery is not selected, all nodes in the figure appear. If the login group and Disable Network Discovery are both selected, Nodes 1, 4, and 5 appear. You can create as many login groups as you need. The groups are stored in the CTC preferences file and are not visible to other users.

Figure 18-2 Login Node Group

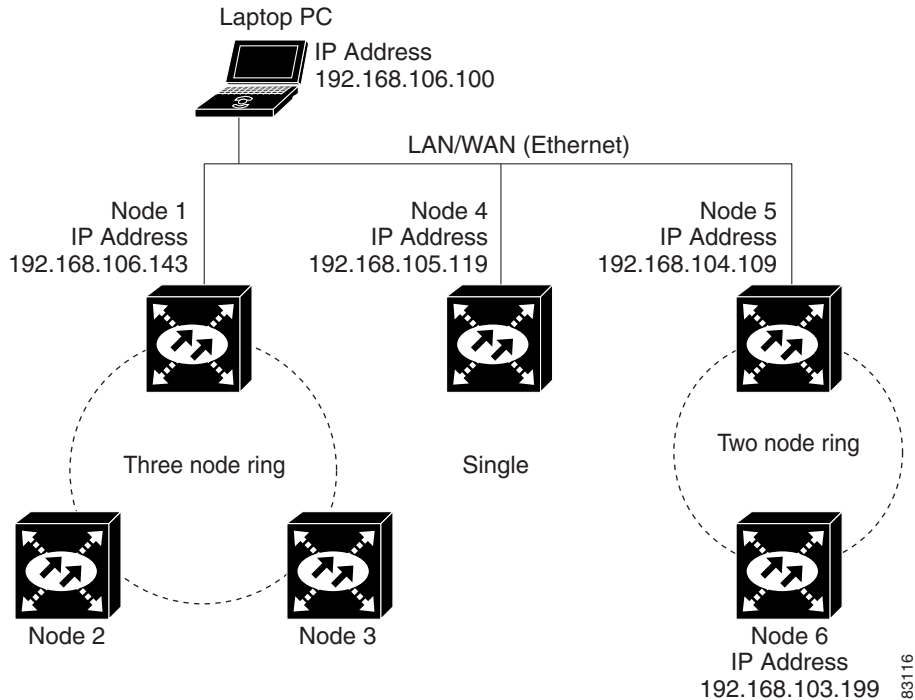

Step 8 Return to your originating procedure (NTP).

DLP-F308 Delete a Node from the Current Session or Login Group

Purpose	This task removes a node from the current CTC session or login node group. To remove a node from a login node group that is not the current one, see “DLP-F312 Delete a Node from a Specified Login Node Group” task on page 18-13.
Tools	None
Prerequisite Procedures	DLP-F181 Log into CTC, page 16-34
Required/As Needed	As needed
Onsite/Remote	Onsite or remote
Security Level	Provisioning or higher

- Step 1** From the View menu, choose **Go to Network View**.
- Step 2** Click the node that you want to delete.
- Step 3** From the File menu, click **Delete Selected Node**.
- After a few seconds, the node disappears from the network view map.
- Step 4** Return to your originating procedure (NTP).

DLP-F309 Configure the CTC Alerts Dialog Box for Automatic Popup

Purpose	This task sets up the CTC Alerts dialog box to open for all alerts, for circuit deletion errors only, or never. The CTC Alerts dialog box displays information about network disconnection, Send-PDIP inconsistency, circuit deletion status, condition retrieval errors, and software download failure.
Tools	None
Prerequisite Procedures	DLP-F181 Log into CTC, page 16-34
Required/As Needed	As needed
Onsite/Remote	Onsite or remote
Security Level	Provisioning or higher

-
- Step 1** Click the CTC Alerts toolbar icon.
- Step 2** In the CTC Alerts dialog box, choose one of the following:
- **All alerts**—Sets the CTC Alerts dialog box to open automatically for all notifications.
 - **Error alerts only**—Sets the CTC Alerts dialog box to open automatically for circuit deletion errors only.
 - **Never**—Sets the CTC Alerts dialog box to never open automatically.
- Step 3** Click **Close**.
- Step 4** Return to your originating procedure (NTP).
-

DLP-F310 Change the JRE Version

Purpose	This task changes the Java Runtime Environment (JRE) version, which is useful if you would like to upgrade to a later JRE version from an earlier one without using the software CD. This does not affect the browser default version. After selecting the desired JRE version, you must exit CTC. The next time you log into a node, the new JRE version will be used.
Tools	None
Prerequisite Procedures	DLP-F181 Log into CTC, page 16-34
Required/As Needed	As needed
Onsite/Remote	Onsite or remote
Security Level	Provisioning or higher



Note JRE 5.0 is required to run Software R8.0.

- Step 1** From the Edit menu, choose **Preferences**.
- Step 2** Click the **JRE** tab. The JRE tab shows the current JRE version and the recommended version.
- Step 3** Click the **Browse** button and navigate to the JRE directory on your computer.

- Step 4** Choose the JRE version.
 - Step 5** Click **OK**.
 - Step 6** From the File menu, choose **Exit**.
 - Step 7** In the confirmation dialog box, click **Yes**.
 - Step 8** Return to your originating procedure (NTP).
-

DLP-F311 Remove Pass-through Connections

Purpose	This task removes pass-through connections from a node deleted from a ring.
Tools/Equipment	None
Prerequisite Procedures	DLP-F181 Log into CTC, page 16-34
Required/As Needed	As needed
Onsite/Remote	Onsite or remote
Security Level	Provisioning or higher

- Step 1** Log into the deleted node.
- Step 2** In the CTC Login dialog box, check the **Disable Network Discovery** check box.
- Step 3** Choose **None** from the Additional Nodes drop-down list.
- Step 4** Click the **Login** button.
- Step 5** Click the **Circuits** tab. All internode circuits are shown as PARTIAL.
- Step 6** Refer to the diagram or CTC printout you created in the “[NTP-F215 Remove an MS-SPRing Node](#)” procedure on page 13-5 or the “[NTP-F217 Remove an SNCP Node](#)” procedure on page 13-11. Find the circuits on the line cards of the removed node.
- Step 7** Click the **Filter** button.
- Step 8** Type the slot and port of a trunk card on the removed node.
- Step 9** Click **OK**.
- Step 10** In the Circuits tab, select all PARTIAL circuits that pass the filter and click the **Delete** button.



Note To select more than one circuit, press the **Shift** key and simultaneously click on all circuits to be deleted.

- Step 11** Repeat Steps 6 through 10 for the other trunk card.
 - Step 12** Log out of CTC.
 - Step 13** Return to your originating procedure (NTP).
-

DLP-F312 Delete a Node from a Specified Login Node Group

Purpose	This task removes a node from a login node group.
Tools	None
Prerequisite Procedures	DLP-F181 Log into CTC, page 16-34
Required/As Needed	As needed
Onsite/Remote	Onsite or remote
Security Level	Provisioning or higher

-
- Step 1** From the CTC Edit menu, choose **Preferences**.
- Step 2** In the Preferences dialog box, click the **Login Node Groups** tab.
- Step 3** Click the login node group tab containing the node you want to remove.
- Step 4** Click the node you want to remove, then click **Remove**.
- Step 5** Click **OK**.
- Step 6** Return to your originating procedure (NTP).
-

DLP-F313 Change a Circuit Service State

Purpose	This task changes the service state of a circuit.
Tools/Equipment	None
Prerequisite Procedures	DLP-F181 Log into CTC, page 16-34
Required/As Needed	As needed
Onsite/Remote	Onsite or remote
Security Level	Provisioning or higher

-
- Step 1** From the View menu, choose **Go to Network View**.
- Step 2** Click the **Circuits** tab.
- Step 3** Click the circuit with the state that you want to change.
- Step 4** From the Tools menu, choose **Circuits > Set Circuit State**.
- Step 5** In the Set Circuit State dialog box, choose the administrative state from the Target Circuit Admin State drop-down list:
- **Unlocked**—Puts the circuit cross-connects in the Unlocked-enabled service state.
 - **Locked,disabled**—Puts the circuit cross-connects in the Locked-enabled,disabled service state. Traffic is not passed on the circuit.
 - **Unlocked,automaticInService**—Puts the circuit cross-connects in the Unlocked-disabled,automaticInService service state and suppresses alarms and conditions. When the connections receive a valid signal, the service state automatically changes to Unlocked-enabled.

- **Locked,maintenance**—Puts the circuit cross-connects in the Locked-enabled,maintenance service state. The maintenance state does not interrupt traffic flow; it suppresses alarms and conditions and allows loopbacks to be performed on the circuit. Use Locked,maintenance for circuit testing or to suppress circuit alarms temporarily. Change the administrative state to Unlocked; Unlocked,automaticInService; or Locked,disabled when testing is complete.



Note Alternatively, you can choose the circuit on the Circuits tab, click the Edit button, then click the State tab on the Edit Circuits window.

For additional information about circuit service states, refer to the “Circuits and Tunnels” chapter in the *Cisco ONS 15600 SDH Reference Manual*.

- Step 6** If you want to apply the state to the circuit source and destination ports, check the **Apply to Drop Ports** check box.



Note CTC will not allow you to change a drop port service state from Unlocked-enabled to Locked-enabled,disabled. You must first change a port to the Locked-enabled,maintenance service state before putting it in the Locked-enabled,disabled service state.

- Step 7** Click **Apply**.

- Step 8** If the Apply to Ports Results dialog box appears, view the results and click **OK**.

CTC will not change the service state of the circuit source and destination port in certain circumstances. For example, if a port is in loopback (Locked-enabled,loopback & maintenance), CTC will not change the port to Unlocked-enabled. In another example, if the circuit size is smaller than the port, CTC will not change the port service state from Unlocked-enabled to Locked-enabled,disabled. If CTC cannot change the port service state, you must change the port service state manually. For more information, see the “[DLP-F254 Change the Service State for a Port](#)” task on page 17-47.

- Step 9** Return to your originating procedure (NTP).

DLP-F314 Provision MS-DCC Terminations

Purpose	This task creates the MS-DCC terminations required for alarms, administration, data, signal control information, and messages. In this task, you can also set up the node so that it has direct IP access to a far-end non-ONS node over the DCC network.
Tools/Equipment	None
Prerequisite Procedures	DLP-F181 Log into CTC , page 16-34
Required/As Needed	As needed
Onsite/Remote	Onsite or remote
Security Level	Provisioning or higher

**Note**

The RS-DCCs and MS-DCCs should not be provisioned between SONET (ANSI) and SDH (ETSI) nodes using CTC or TL1 because they cannot operate between SONET and SDH nodes. These communication channels should be provisioned on similar nodes, such as SONET-to-SONET or SDH-to-SDH. To establish communication channels between SONET and SDH nodes, create a DCC tunnel. See the [“DLP-F244 Create a DCC Tunnel” task on page 17-36](#) to create a DCC tunnel.

**Note**

When MS-DCC is provisioned, an RS-DCC termination is allowed on the same port, but is not recommended. RS-DCC and MS-DCC are only needed on the same port during a software upgrade if the software version does not support MS-DCC. Changing configuration of a port having MS-DCC termination to RS-DCC termination is allowed. During this procedure both MS-DCC and RS-DCC terminations can be present on the same port. Once the RS-DCC termination is configured see [“DLP-F253 Provision RS-DCC Terminations” task on page 17-45](#) delete the MS-DCC terminations as specified in [“DLP-F322 Delete an MS-DCC Termination” task on page 18-20](#), and enable the OSPF on RS-DCC termination if not enabled see [“DLP-F319 Change an RS-DCC Termination” task on page 18-19](#).

Step 1 In node view, click the **Provisioning > Comm Channels > MS-DCC** tabs.

Step 2 Click **Create**.

Step 3 In the Create MS-DCC Terminations dialog box, click the ports where you want to create the MS-DCC termination. To select more than one port, press the Shift key or the Ctrl key.

**Note**

MS-DCC refers to the multiplex section DCC, which is used for ONS 15600 SDH DCC terminations. The SDH MS-DCCs and the RS-DCC (when not used as a DCC termination by the ONS 15600 SDH) can be provisioned as DCC tunnels. See the [“DLP-F244 Create a DCC Tunnel” task on page 17-36](#).

Step 4 In the Port Admin State area, click **Set to unlocked** to put the port in service.

Step 5 Verify that the Disable OSPF on DCC Link check box is unchecked.

Step 6 If the RS-DCC termination is to include a non-ONS node, check the **Far End is Foreign** check box. This automatically sets the far-end node IP address to 0.0.0.0, which means that any address can be specified by the far end. To change the default to a specific the IP address, see the [“DLP-F320 Change an MS-DCC Termination” task on page 18-19](#).

Step 7 In the Layer 3 area, perform one of the following:

- Check the IP box only—If the MS-DCC is between the ONS 15600 SDH and another ONS node and only ONS nodes reside on the network. The MS-DCC will use point-to-point protocol (PPP).
- Check the IP and OSI boxes—If the MS-DCC is between the ONS 15600 SDH and another ONS node and third party NEs that use the OSI protocol stack are on the same network. The MS-DCC will use PPP.

**Note**

Checking only the OSI box (LAP-D) is not available for MS-DCCs.

Step 8 If you checked OSI, complete the following steps. If you checked IP only, continue with [Step 9](#).

- a. Click **Next**.

- b. Provision the following fields:
- Router—Sets the OSI router.
 - ESH—Sets the End System Hello propagation frequency. End system NEs transmit ESHs to inform other ESs and ISs about the NSAPs it serves. The default is 10 seconds. The range is 10 to 1000 seconds.
 - ISH—Sets the Intermediate System Hello PDU propagation frequency. Intermediate system NEs send ISHs to other ESs and ISs to inform them about the IS NETs it serves. The default is 10 seconds. The range is 10 to 1000 seconds.
 - IIS—Sets the Intermediate System to Intermediate System Hello PDU propagation frequency. The IS-IS Hello PDUs establish and maintain adjacencies between ISs. The default is 3 seconds. The range is 1 to 600 seconds.
 - IS-IS Cost—Sets the cost for sending packets on the LAN subnet. The IS-IS protocol uses the cost to calculate the shortest routing path. The default metric cost for LAN subnets is 20. It normally should not be changed.

Step 9 Click **Finish**.



Note MS-DCC Termination Failure (EOC-L) and Loss of Signal (LOS) alarms appear until you create all network DCC terminations and put the DCC termination STM-N ports in service.

Step 10 Return to your originating procedure (NTP).

DLP-F315 Provision a Proxy Tunnel

Purpose	This task sets up a proxy tunnel to communicate with a non-ONS far-end node. Proxy tunnels are only necessary when the proxy server is enabled and a foreign DCC termination exists, or if static routes exist so that the DCC network is used to access remote networks or devices. You can provision a maximum of 12 proxy server tunnels.
Tools/Equipment	None
Prerequisite Procedures	DLP-F181 Log into CTC, page 16-34 DLP-F253 Provision RS-DCC Terminations, page 17-45
Required/As Needed	As needed
Onsite/Remote	Onsite or remote
Security Level	Superuser only



Note If the proxy server is disabled, you cannot set up a proxy tunnel.

Step 1 Click the **Provisioning > Network > Proxy** subtabs.

Step 2 Click **Create**.

Step 3 In the Create Tunnel dialog box, complete the following:

- Source Address—Type the IP address of the source node (32 bit length) or source subnet (any other length).
- Length—Choose the length of the source subnet mask.
- Destination Address—Type the IP address of the destination node (32 bit length) or destination subnet (any other length).
- Length—Choose the length of the destination subnet mask.

Step 4 Click **OK**.

Step 5 Continue with your originating procedure (NTP).

DLP-F316 Provision a Firewall Tunnel

Purpose	This task provisions destinations that will not be blocked by the firewall. Firewall tunnels are only necessary when the proxy server is enabled and a foreign DCC termination exists, or if static routes exist so that the DCC network is used to access remote networks or devices. You can provision a maximum of 12 firewall tunnels.
Tools/Equipment	None
Prerequisite Procedures	DLP-F181 Log into CTC, page 16-34 DLP-F253 Provision RS-DCC Terminations, page 17-45
Required/As Needed	As needed
Onsite/Remote	Onsite or remote
Security Level	Superuser only



Note If the proxy server is configured as proxy-only or is disabled, you cannot set up a firewall tunnel.

Step 1 Click the **Provisioning > Network > Firewall** subtabs.

Step 2 Click **Create**.

Step 3 In the Create Tunnel dialog box, complete the following:

- Source Address—Type the IP address of the source node (32 bit length) or source subnet (any other length).
- Length—Choose the length of the source subnet mask.
- Destination Address—Type the IP address of the destination node (32 bit length) or destination subnet (any other length).
- Length—Choose the length of the destination subnet mask.

Step 4 Click **OK**.

Step 5 Continue with your originating procedure (NTP).

DLP-F317 Delete a Proxy Tunnel

Purpose	This task removes a proxy tunnel.
Tools/Equipment	None
Prerequisite Procedures	DLP-F181 Log into CTC, page 16-34
Required/As Needed	As needed
Onsite/Remote	Onsite or remote
Security Level	Superuser only

-
- Step 1** Click the **Provisioning > Network > Proxy** subtabs.
- Step 2** Click the proxy tunnel that you want to delete.
- Step 3** Click **Delete**.
- Step 4** Return to your originating procedure (NTP).
-

DLP-F318 Delete a Firewall Tunnel

Purpose	This task removes a firewall tunnel.
Tools/Equipment	None
Prerequisite Procedures	DLP-F181 Log into CTC, page 16-34
Required/As Needed	As needed
Onsite/Remote	Onsite or remote
Security Level	Superuser only

-
- Step 1** Click the **Provisioning > Network > Firewall** subtabs.
- Step 2** Click the firewall tunnel that you want to delete.
- Step 3** Click **Delete**.
- Step 4** Return to your originating procedure (NTP).
-

DLP-F319 Change an RS-DCC Termination

Purpose	This task modifies an RS-DCC termination. You can enable or disable Open Shortest Path First (OSPF) and enable or disable the foreign node setting.
Tools/Equipment	None
Prerequisite Procedures	DLP-F181 Log into CTC, page 16-34
Required/As Needed	As needed
Onsite/Remote	Onsite or remote
Security Level	Provisioning or higher

-
- Step 1** Click the **Provisioning > Comm Channels > RS-DCC** tabs.
- Step 2** Click the RS-DCC that you want to change.
- Step 3** Click **Edit**.
- Step 4** In the RS-DCC Termination Editor dialog box, complete the following as necessary:
- **Disable OSPF on RS-DCC Link**—If checked, OSPF is disabled on the link. OSPF should be disabled only when the slot and port connect to third-party equipment that does not support OSPF.
 - **Far End is Foreign**—Check this box to specify that the RS-DCC termination is a non-ONS node.
 - **Far End IP**—If you checked the Far End is Foreign check box, type the IP address of the far-end node or leave the 0.0.0.0 default. An IP address of 0.0.0.0 means that any address can be used by the far end.
- Step 5** Click **OK**.
- Step 6** Return to your originating procedure (NTP).
-

DLP-F320 Change an MS-DCC Termination

Purpose	This task modifies an SDH MS-DCC termination. You can enable or disable OSPF and enable or disable the foreign node setting.
Tools/Equipment	None
Prerequisite Procedures	DLP-F181 Log into CTC, page 16-34
Required/As Needed	As needed
Onsite/Remote	Onsite or remote
Security Level	Provisioning or higher

-
- Step 1** Click the **Provisioning > Comm Channels > MS-DCC** tabs.
- Step 2** Click the MS-DCC that you want to change.
- Step 3** Click **Edit**.
- Step 4** In the MS-DCC Termination Editor dialog box, complete the following as necessary:
- **Disable OSPF on MS-DCC Link**—If checked, OSPF is disabled on the link. OSPF should be disabled only when the slot and port connect to third-party equipment that does not support OSPF.

- Far End is Foreign—Check this box to specify that the MS-DCC termination is a non-ONS node.
- Far end IP—If you checked the Far End is Foreign check box, type the IP address of the far-end node or leave the 0.0.0.0 default. An IP address of 0.0.0.0 means that any address can be used by the far end.

Step 5 Click **OK**.

Step 6 Return to your originating procedure (NTP).

DLP-F321 Delete an RS-DCC Termination

Purpose	This task deletes an RS-DCC termination.
Tools/Equipment	None
Prerequisite Procedures	DLP-F181 Log into CTC, page 16-34
Required/As Needed	As needed
Onsite/Remote	Onsite or remote
Security Level	Provisioning or higher



Note

Deleting an RS-DCC termination might cause you to lose visibility of nodes that do not have other data communications channels (DCCs) or network connections to the CTC computer.



Note

If you have circuits traversing the fiber on which you delete a DCC termination, the circuits will go to an Incomplete state.

Step 1 In node view, click the **Provisioning > Comm Channel > RS-DCC** tabs.

Step 2 Click the RS-DCC termination to be deleted and click **Delete**. The Delete RS-DCC Termination dialog box appears.

Step 3 Click **Yes** in the confirmation dialog box. Confirm that the changes appear; if not, repeat the task.

Step 4 Return to your originating procedure (NTP).

DLP-F322 Delete an MS-DCC Termination

Purpose	This task deletes an SDH MS-DCC termination.
Tools/Equipment	None
Prerequisite Procedures	DLP-F181 Log into CTC, page 16-34
Required/As Needed	As needed
Onsite/Remote	Onsite or remote
Security Level	Provisioning or higher

**Caution**

Deleting a DCC termination can cause you to lose visibility of nodes that do not have other DCCs or network connections to the CTC computer.

-
- Step 1** Click the **Provisioning > Comm Channel > MS-DCC** tabs.
- Step 2** Click the MS-DCC termination to be deleted and click **Delete**. The Delete MS-DCC Termination dialog box appears.
- Step 3** Click **Yes** in the confirmation dialog box. Confirm that the changes appear; if not, repeat the task.
- Step 4** Return to your originating procedure (NTP).
-

DLP-F323 Use the Reinitialization Tool to Clear the Database and Upload Software (UNIX)

Purpose	This task reinitializes the ONS 15600 SDH using the CTC reinitialization (reinit) tool on a UNIX computer. Reinitialization uploads a new software package to the TSC cards, clears the node database, and restores the factory default parameters.
Tools/Equipment	Cisco ONS 15600 SDH System Software CD, Version 8.0 JRE 5.0 must be installed on the computer to log into the node at the completion of the reinitialization. The reinitialization tool can run on JRE 1.3.1_02, JRE 1.4.2, or JRE 5.0.
Prerequisite procedures	DLP-F181 Log into CTC, page 16-34
Required/As needed	As needed
Onsite/Remote	Onsite or remote
Security Level	Superuser only

**Note**

Restoring a node to the factory configuration deletes all cross-connects on the node.

-
- Step 1** Insert the Cisco ONS 15600 SDH System Software CD, Version 8.0, into the computer CD-ROM drive. If the CTC Installation Wizard appears, click **Cancel**.
- Step 2** To find the recovery tool file, go to the CISCO15600 SDH directory on the CD (usually /cdrom/cdrom0/CISCO15600SDH).
- Step 3** If you are using a file explorer, double-click the RE-INIT.jar file. If you are working with a command line interface, run **java -jar RE-INIT.jar**. The NE Reinitialization window appears.
- Step 4** Complete the following fields:
- **GNE IP**—If the node you are reinitializing is accessed through another node configured as a gateway network element (GNE), enter the GNE IP address. If you have a direct connection to the node, leave this field blank.
 - **Node IP**—Enter the node name or IP address of the node that you are reinitializing.
 - **User ID**—Enter the user ID needed to access the node.

- Password—Enter the password for the user ID.
- Upload Package—Check this box to send the software package file to the node. If unchecked, the software stored on the node is not modified.
- Force Upload—Check this box to send the software package file to the node even if the node is running the same software version. If unchecked, reinitialization will not send the software package if the node is already running the same version.
- Activate/Revert—Check this box to activate the uploaded software (if the software is a later than the installed version) or revert to the uploaded software (if the software is earlier than the installed version) as soon as the software file is uploaded. If unchecked, the software is not activated or reverted after the upload, allowing you to initiate the functions later from the node view Maintenance > Software tabs.
- Re-init Database—Check this box to send a new database to the node. (This is equivalent to the CTC database restore operation.) If unchecked, the node database is not modified.
- Confirm—Check this box if you want a warning message displayed before any operation is performed. If unchecked, reinitialization does not display a warning message.
- Search Path—Enter the path to the CISCO15600SDH folder on the CD drive.

Step 5 Click **Go**.



Caution

Before continuing with the next step, verify that the database to upload is correct. You cannot reverse the upload process after you click Yes.

Step 6 Review the information on the Confirm NE Re-Initialization dialog box, then click **Yes** to start the reinitialization.

The reinitialization begins. After the software is downloaded and activated, and the database is uploaded to the TSC cards, “Complete” appears in the status bar and the TSC cards will reboot. Wait a few minutes for the reboot to complete.

Step 7 After the reboot is complete, log into the node using the “[DLP-F181 Log into CTC](#)” task on page 16-34.

Step 8 Complete the “[NTP-F133 Set Up Date, Time, and Contact Information](#)” procedure on page 4-4.

Step 9 Return to your originating procedure (NTP).

DLP-F324 Provision ASAP Ethernet Ports

Purpose	This task provisions ASAP Ethernet ports to carry traffic.
Tools/Equipment	None
Prerequisite Procedures	DLP-F181 Log into CTC , page 16-34
Required/As Needed	As needed
Onsite/Remote	Onsite or remote
Security Level	Provisioning or higher

Step 1 In the node view, double-click the ASAP card graphic to open the card.

Step 2 Click the **Provisioning > Ethernet > Ports** tabs.

- Step 3** For each port, provision the following parameters:
- Port Name—If you want to label the port, type the port name.
 - Admin State—Choose **Unlocked** to put the port in service.
 - Enable Flow Control—Check this check box to enable flow control on the port (default). If you do not want to enable flow control, uncheck the box. The ASAP attempts to negotiate symmetrical flow control with the attached device.
- Step 4** Click **Apply**.
- Step 5** Refresh the Ethernet statistics:
- a. Click the **Performance > Ethernet > Ether Ports > Statistics** tabs.
 - b. Click **Refresh**.
-  **Note** Reprovisioning an Ethernet port on the ASAP card does not reset the Ethernet statistics for that port.
- Step 6** Return to your originating procedure (NTP).
-

DLP-F325 Provision ASAP POS Ports

Purpose	This task provisions ASAP packet-over-SDH (POS) ports to carry traffic.
Tools/Equipment	None
Prerequisite Procedures	DLP-F181 Log into CTC, page 16-34
Required/As Needed	As needed
Onsite/Remote	Onsite or remote
Security Level	Provisioning or higher

- Step 1** In the node view, double-click the ASAP card graphic to open the card.
- Step 2** Click the **Provisioning > Ethernet > POS Ports** tabs.
- Step 3** For each POS port, provision the following parameters:
- Port Name—If you want to label the port, type the port name.
 - Admin State—Choose **Unlocked** to put the port in service.
 - Framing Type—Choose **GPF-F** POS framing (the default), **HDLC** POS, or **X.86** framing. The framing type needs to match the framing type of the POS device at the end of the SDH circuit.
 - Encap CRC—With frame-mapped generic framing procedure (GFP-F) framing, the user can configure a **32-bit** cyclic redundancy check (CRC), **16-bit** CRC, or **none** (no CRC). High-level data link control (HDLC) framing provides a set 32-bit CRC. The CRC should be set to match the CRC of the POS device on the end of the SDH circuit.



Note The ASAP uses LEX encapsulation, which is the primary POS encapsulation used in ONS Ethernet cards.



Note An Encapsulation Mismatch Path (ENCAP-MISMATCH-P) alarm appears when a point-to-point circuit is created between two Ethernet card ports with incompatible encapsulation payload types.

- Step 4** Click **Apply**.
- Step 5** Refresh the POS statistics:
- a. Click the **Performance > Ethernet > POS Ports > Statistics** tabs.
 - b. Click **Refresh**.
- Step 6** Return to your originating procedure (NTP).
-

DLP-F326 View ASAP STM-N PM Parameters

Purpose	This task enables you to view performance monitoring (PM) counts on an ASAP card to detect possible performance problems.
Tools/Equipment	None
Prerequisite Procedures	DLP-F181 Log into CTC, page 16-34
Required/As Needed	As needed
Onsite/Remote	Onsite or remote
Security Level	Retrieve or higher

- Step 1** In node view, double-click the ASAP card where you want to view PM counts. The card view appears.
- Step 2** Click the **Performance > Optical** tabs ([Figure 18-3](#)).

Figure 18-3 Viewing ASAP Card Performance Monitoring Information

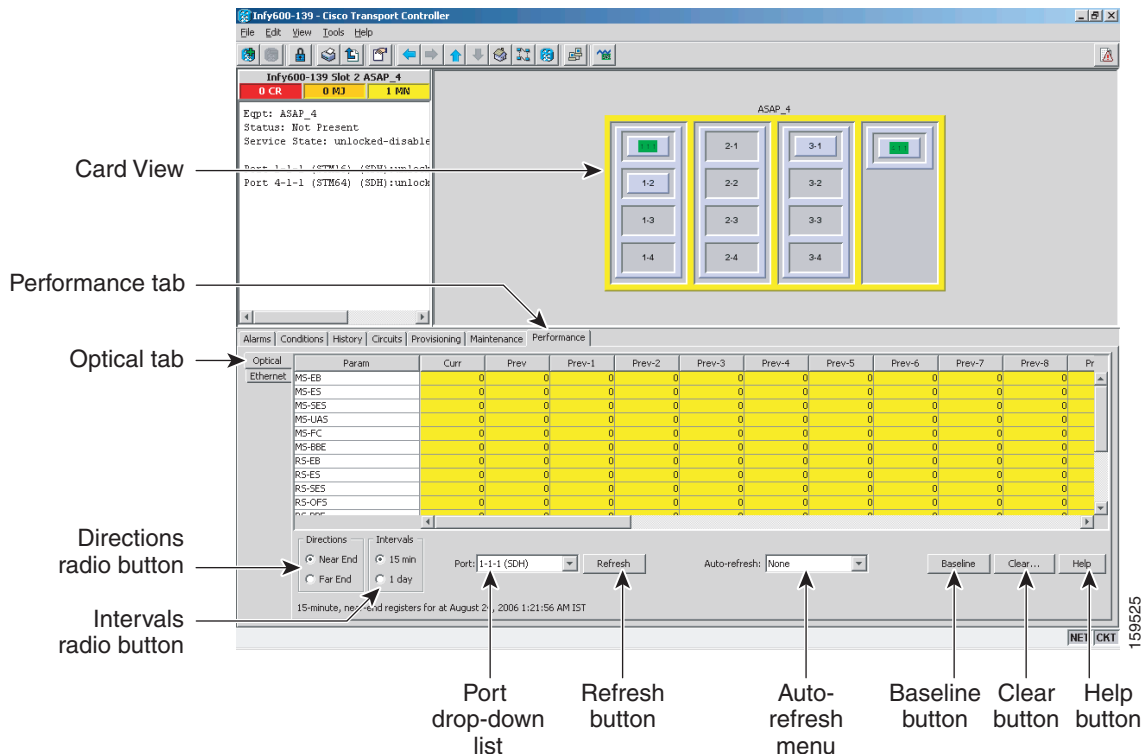

- Step 3** In the Port drop-down list, choose the port that you want to monitor.
- Step 4** Click **Refresh**.
- Step 5** View the PM parameter names that appear in the Param column. The PM parameter values appear in the Curr (current) and Prev-*n* (previous) columns. For PM parameter definitions, refer to the “Performance Monitoring” chapter in the *Cisco ONS 15600 SDH Reference Manual*.
- Step 6** To monitor another port on a multiport card, choose another port from the Port drop-down list and click **Refresh**.
- Step 7** Return to your originating procedure (NTP).

DLP-F327 View ASAP Ether Ports Statistics PM Parameters

Purpose	This task enables you to view current statistical PM counts on an ASAP card and port to detect possible performance problems.
Tools/Equipment	None
Prerequisite Procedures	DLP-F181 Log into CTC, page 16-34
Required/As Needed	As needed
Onsite/Remote	Onsite or remote
Security Level	Retrieve or higher

- Step 1** In node view, double-click the card where you want to view PM counts. The card view appears.
- Step 2** Click the **Performance > Ethernet > Ether Ports > Statistics** tabs (Figure 18-4).

Figure 18-4 Ether Ports Statistics in the Card View Performance Window

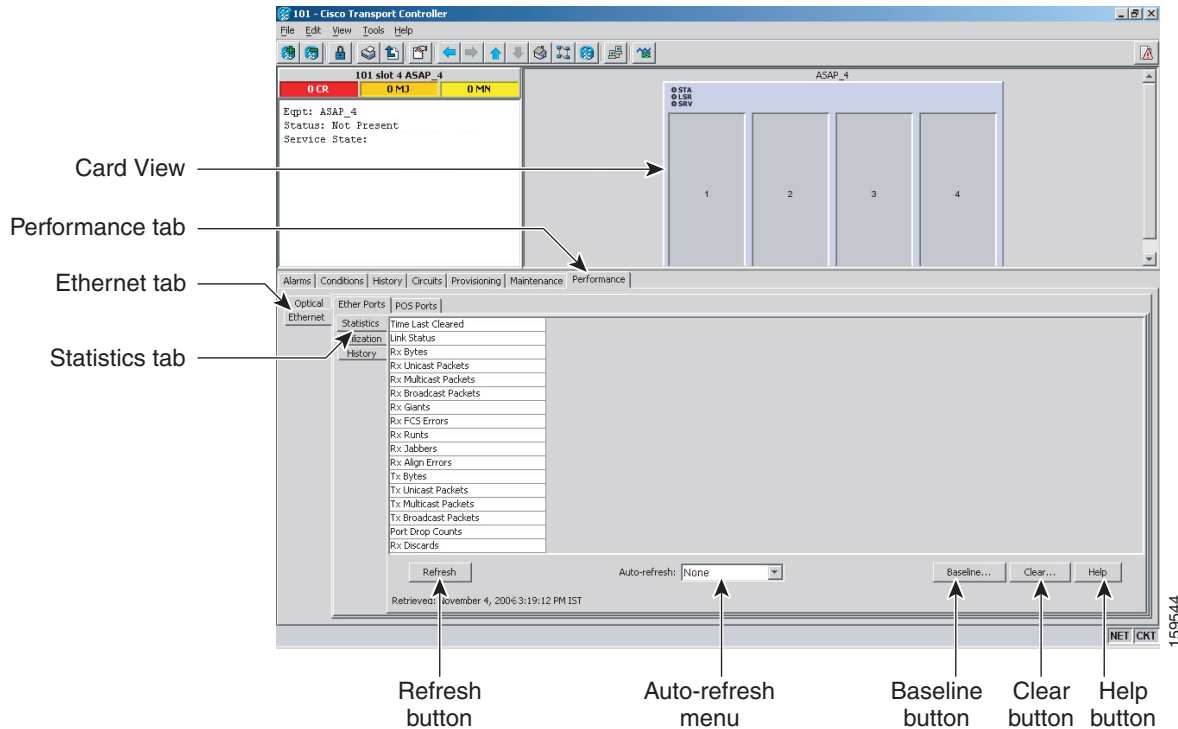

- Step 3** Click **Refresh**. Performance monitoring statistics appear for each port on the card.
- Step 4** View the PM parameter names appear in the Param column. The current PM parameter values appear in the Port # columns. For PM parameter definitions, refer to the “Performance Monitoring” chapter in the *Cisco ONS 15600 SDH Reference Manual*.



Note To refresh, reset, or clear PM counts, see the “[NTP-F184 Change the PM Display](#)” procedure on [page 8-2](#).

- Step 5** Return to your originating procedure (NTP).

DLP-F328 View ASAP Ether Ports Utilization PM Parameters

Purpose	This task enables you to view line utilization PM counts on an ASAP card and port to detect possible performance problems.
Tools/Equipment	None
Prerequisite Procedures	DLP-F181 Log into CTC, page 16-34
Required/As Needed	As needed
Onsite/Remote	Onsite or remote
Security Level	Retrieve or higher

- Step 1** In node view, double-click the ASAP card where you want to view PM counts. The card view appears.
- Step 2** Click the **Performance > Ethernet > Ether Ports > Utilization** tabs ([Figure 18-5](#)).

Figure 18-5 Ether Ports Utilization in the Card View Performance Window

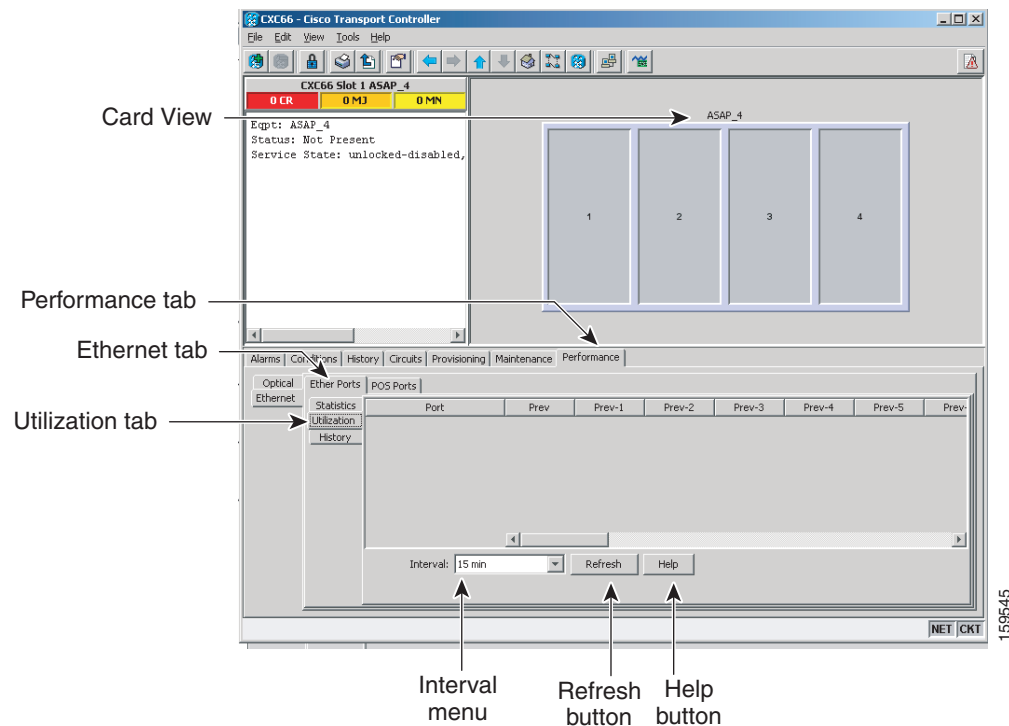

- Step 3** Click **Refresh**. Performance monitoring utilization values appear for each port on the card.
- Step 4** View the Port # column for the port that you want to monitor.
- Step 5** The transmit (Tx) and receive (Rx) bandwidth utilization values for the previous time intervals appear in the Prev-*n* columns. For PM parameter definitions, refer to the “Performance Monitoring” chapter in the *Cisco ONS 15600 SDH Reference Manual*.



Note To refresh, reset, or clear PM counts, see the [“NTP-F184 Change the PM Display” procedure on page 8-2](#).

Step 6 Return to your originating procedure (NTP).

DLP-F329 View ASAP POS Ports Statistics PM Parameters

Purpose	This task enables you to view POS port PM counts at selected time intervals on an ASAP card and port to detect possible performance problems.
Tools/Equipment	None
Prerequisite Procedures	DLP-F181 Log into CTC, page 16-34
Required/As Needed	As needed
Onsite/Remote	Onsite or remote
Security Level	Retrieve or higher

Step 1 In node view, double-click the ASAP card where you want to view PM counts. The card view appears.

Step 2 Click the **Performance > Ethernet > POS Ports > Statistics** tabs (Figure 18-6).

Figure 18-6 POS Ports Statistics in the Card View Performance Window

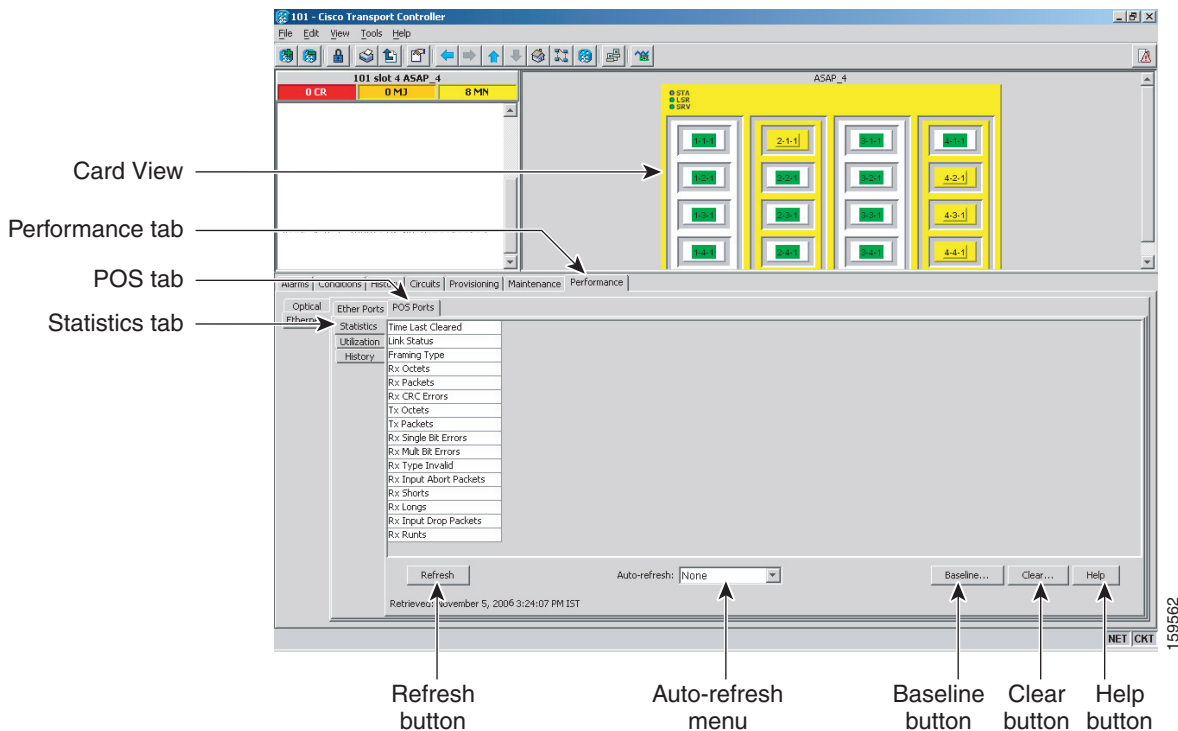

Step 3 Click **Refresh**. Performance monitoring statistics appear for each port on the card.

Step 4 View the PM parameter names that appear in the Param column. The PM parameter values appear in the Port # columns. For PM parameter definitions refer to the “Performance Monitoring” chapter in the *Cisco ONS 15600 SDH Reference Manual*.



Note To refresh, reset, or clear PM counts, see the “NTP-F184 Change the PM Display” procedure on page 8-2.

Step 5 Return to your originating procedure (NTP).

DLP-F330 View ASAP POS Ports Utilization PM Parameters

Purpose	This task enables you to view POS port utilization PM counts on an ASAP card and ports to detect possible performance problems.
Tools/Equipment	None
Prerequisite Procedures	DLP-F181 Log into CTC, page 16-34
Required/As Needed	As needed
Onsite/Remote	Onsite or remote
Security Level	Retrieve or higher

Step 1 In node view, double-click the ASAP card where you want to view PM counts. The card view appears.

Step 2 Click the **Performance > Ethernet > POS Ports > Utilization** tabs ([Figure 18-7](#)).

Figure 18-7 POS Ports Utilization in the Card View Performance Window

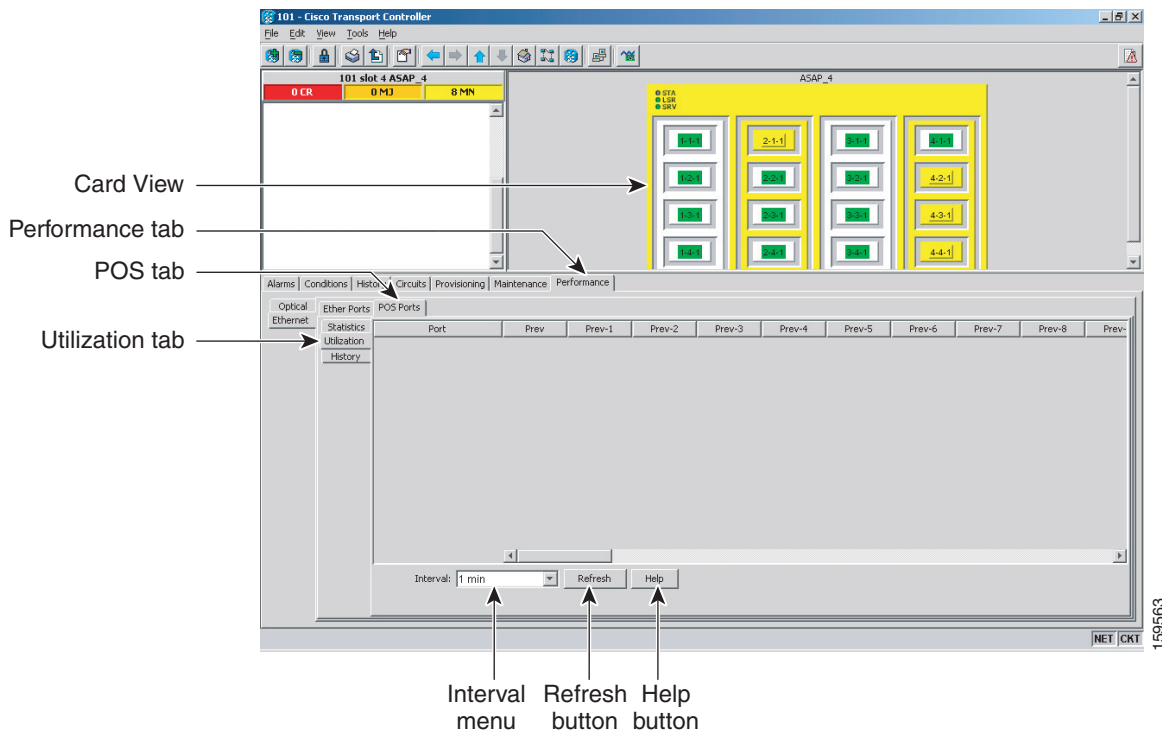

Step 3 Click **Refresh**. Performance monitoring utilization values for each port on the card appear.

- Step 4** View the Port # column for the port that you want to monitor.
- Step 5** The Tx and Rx bandwidth utilization values for the previous time intervals appear in the Prev-*n* columns. For PM parameter definitions, refer to the “Performance Monitoring” chapter in the *Cisco ONS 15600 SDH Reference Manual*.



Note To refresh, reset, or clear PM counts, see the “[NTP-F184 Change the PM Display](#)” procedure on [page 8-2](#).

- Step 6** Return to your originating procedure (NTP).

DLP-F331 View ASAP POS Ports History PM Parameters

Purpose	This task enables you to view historical PM counts at selected time intervals on an ASAP card and port to detect possible performance problems.
Tools/Equipment	None
Prerequisite Procedures	DLP-F181 Log into CTC , page 16-34
Required/As Needed	As needed
Onsite/Remote	Onsite or remote
Security Level	Retrieve or higher

- Step 1** In node view, double-click the ASAP card where you want to view PM counts. The card view appears.
- Step 2** Click the **Performance > Ethernet > POS Ports > History** tabs ([Figure 18-8](#)).

Figure 18-8 Ethernet POS Ports History in the Card View Performance Window

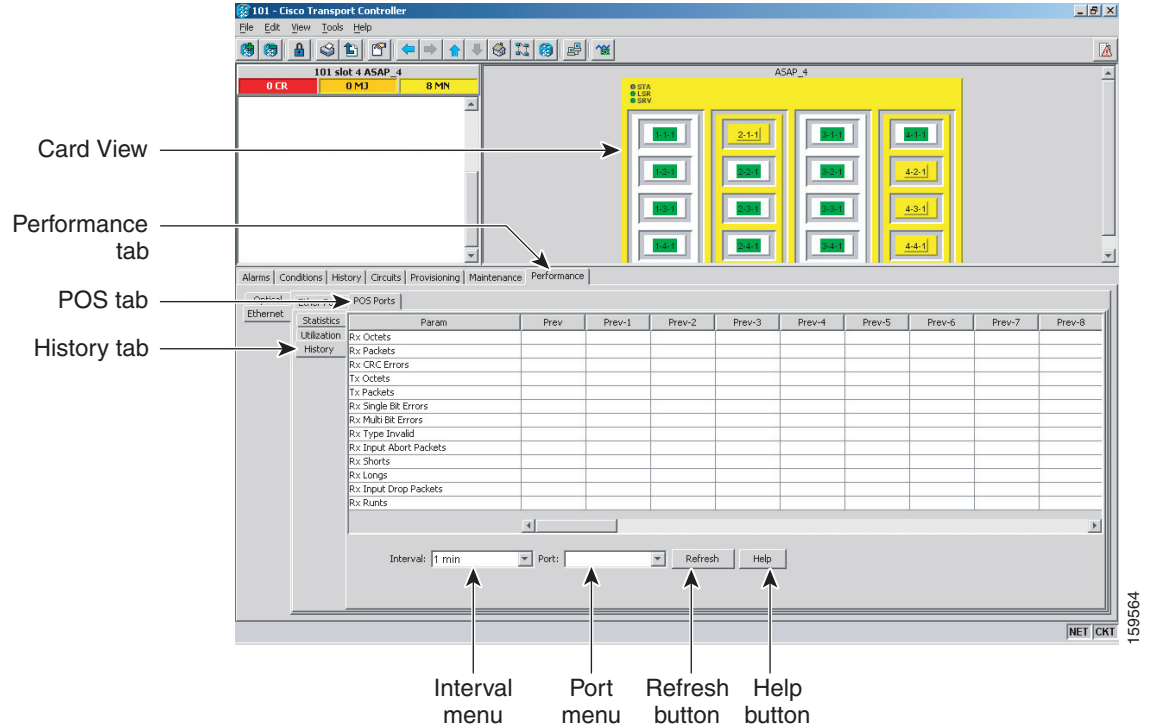

- Step 3** Click **Refresh**. Performance monitoring statistics appear for each port on the card.
- Step 4** View the PM parameter names that appear in the Param column. The PM parameter values appear in the Prev-*n* columns. For PM parameter definitions, refer to the “Performance Monitoring” chapter in the *Cisco ONS 15600 SDH Reference Manual*.



Note To refresh, reset, or clear PM counts, see the “[NTP-F184 Change the PM Display](#)” procedure on [page 8-2](#).

- Step 5** Return to your originating procedure (NTP).

DLP-F332 Change Node Access and PM Clearing Privilege

Purpose	This task provisions the physical access points and shell programs used to connect to the ONS 15600 SDH and sets the user security level that can clear node performance monitoring data.
Tools/Equipment	None
Prerequisite Procedures	DLP-F181 Log into CTC, page 16-34
Required/As Needed	As needed
Onsite/Remote	Onsite or remote
Security Level	Superuser only

-
- Step 1** In node view, click the **Provisioning > Security > Access** tabs.
- Step 2** In the Access area, provision the following:
- LAN access—Choose one of the following options to set the access paths to the node:
 - **No LAN Access**—Allows access to the node only through data communications channel (DCC) connections. Access through the TSC RJ-45 port and backplane is not permitted.
 - **Front only**—Allows access through the TSC RJ-45 port. Access through the DCC and the backplane is not permitted.
 - **Backplane only**—Allows access through DCC connections and the backplane. Access through the TSC RJ-45 port is not allowed.
 - **Front and Backplane**—Allows access through DCC, TSC RJ-45, and backplane connections.
 - Restore Timeout—Sets a time delay for enabling of front and backplane access when DCC connections are lost and “DCC only” is chosen in LAN Access. Front and backplane access is enabled after the restore timeout period has passed. Front and backplane access is disabled as soon as DCC connections are restored.
- Step 3** In the Shell Access area, set the shell program used to access the node:
- Access State: Allows you to set the shell program access mode to Disable (disables shell access), Non-Secure, or Secure. Secure mode allows access to the node using the Secure Shell (SSH) program. SSH is a terminal-remote host Internet protocol that uses encrypted links.
 - Telnet Port: Allows access to the node using the Telnet port. Telnet is the terminal-remote host Internet protocol developed for the Advanced Agency Research Project Network (ARPANET). Port 23 is the default.
 - Enable Shell Password: If checked, enables the SSH password. To disable the password, you must uncheck the check box and click Apply. You must type the password in the confirmation dialog box and click OK to disable it.
- Step 4** In the TL1 Access area, select the desired level of TL1 access. Disabled completely disables all TL1 access; Non-Secure, and Secure allows access using SSH.
- Step 5** In the PM Clearing Privilege field, choose the minimum security level that can clear node PM data: PROVISIONING or SUPERUSER.
- Step 6** Select the Enable Craft Port check box to turn on the shelf controller serial ports.
- Step 7** Select the EMS access state from the list. Available states are Non-Secure and Secure (allows access using SSH).
- In the TCC CORBA (IIOP/SSLIOP) Listener Port area, choose a listener port option:
- **Default - TCC Fixed**—Uses Port 57790 to connect to ONS 15454s on the same side of the firewall or if no firewall is used (default). This option can be used for access through a firewall if Port 57790 is open.
 - **Standard Constant**—Uses Port 683 (IIOP) or Port 684 (SSLIOP), the Common Object Request Broker Architecture (CORBA) default port number.
 - **Other Constant**—If the default port is not used, type the Internet Inter-ORB Protocol (IIOP) or SSLIOP port specified by your firewall administrator.
- Step 8** In the SNMP Access area, set the Simple Network Management Protocol (SNMP) access state to Non-Secure or Disabled (disables SNMP access).
- Step 9** Click **Apply**.

Step 10 Return to your originating procedure (NTP).

DLP-F333 Install the ASAP Carrier Modules

Purpose	This procedure explains how to install the carrier modules in the ONS 15600 SDH shelf.
Tools/Equipment	ASAP carrier modules
Prerequisite Procedures	NTP-F118 Install the Common Control Cards, page 2-2
Required/As Needed	As needed
Onsite/Remote	Onsite
Security Level	None



Warning

During this procedure, wear grounding wrist straps to avoid ESD damage to the card. Do not directly touch the midplane with your hand or any metal tool, or you could shock yourself. Statement 181



Caution

Always use the supplied ESD wristband when working with a powered ONS 15600 SDH. Plug the wristband cable into the ESD jack located on the lower-left outside edge of the shelf.



Warning

Class 1 laser product. Statement 1008



Warning

Invisible laser radiation may be emitted from the end of the unterminated fiber cable or connector. Do not view directly with optical instruments. Viewing the laser output with certain optical instruments (for example, eye loupes, magnifiers, and microscopes) within a distance of 100 mm may pose an eye hazard. Statement 1056



Warning

Use of controls, adjustments, or performing procedures other than those specified may result in hazardous radiation exposure. Statement 1057



Note

For information about the ASAP card, refer to the *Cisco ONS 15600 SDH Reference Manual*.

Step 1 Remove the carrier module from the box and antistatic sleeve.



Caution

Setting an ASAP carrier module on its connectors can cause damage to the connectors.

Step 2 Slide the module along the top and bottom guide rails into the correct slot: Slots 1 to 4 and 11 to 14 are available for traffic cards. Insert the card until it contacts the backplane.

Step 3 Close the ejectors.

- Step 4** Verify the LED activity on the card faceplate:
1. The STAT, SRV, and LASER ON LEDs turn on for 20 seconds.
 2. The STAT LED blinks and the other LEDs turn on for 30 to 50 seconds.
 3. All LEDs blink once and the SRV and LASER ON LEDs illuminate.



Note If the LEDs do not turn on, check that the power breakers on the power distribution unit (PDU) are on. Refer to the *Cisco ONS 15600 SDH Troubleshooting Guide*.



Note If you insert a card into a slot provisioned for a different card, all red LEDs turn on and you will see a mismatched equipment (MEA) alarm for that slot when you open Cisco Transport Controller (CTC).

- Step 5** After you have logged into CTC, verify that the card appears in the correct slot on the CTC node view. See [Chapter 3, “Connect the PC and Log into the GUI”](#) for CTC information and setup instructions.
- Step 6** Return to your originating procedure (NTP).

DLP-F334 Verify Pass-Through Circuits

Purpose	This task verifies that circuits passing through a node that will be removed enter and exit the node on the same virtual container (VC).
Tools/Equipment	None
Prerequisite Procedures	DLP-F181 Log into CTC, page 16-34
Required/As Needed	As needed
Onsite/Remote	Onsite or remote
Security Level	Provisioning or higher

- Step 1** In the Circuits window, choose a circuit that passes through the node that will be removed and click **Edit**.
- Step 2** In the Edit Circuits window, check **Show Detailed Map**.
- Step 3** Verify that the VC mapping on the node’s east and west ports is the same. For example, if a circuit is mapping on the west port s2/p1/VC4-1 (Slot 2, Port 1, VC4-1), verify that the mapping is VC4-1 on the east port. If the circuit displays different VCs on the east and west ports, write down the name of the circuit.
- Step 4** Repeat Steps 1 to 3 for each circuit in the Circuits tab.
- Step 5** Delete and recreate each circuit recorded in Step 3 that entered/exited the node on different VCs. To delete the circuit, see the [“DLP-F293 Delete Circuits” task on page 17-81](#). To create the circuit, see [Chapter 6, “Create Circuits.”](#)
- Step 6** Return to your originating procedure (NTP).

DLP-F335 Preprovision an SFP

Purpose	This procedure preprovisions Small Form-factor Pluggables (SFPs), which are referred to as pluggable port modules (PPMs) in CTC. Cisco-approved STM-1, STM-4, STM-16, Ethernet, and multirate PPMs are compatible with the ONS 15600 SDH. See the <i>Cisco ONS 15600 SDH Reference Manual</i> for a list of acceptable SFPs.
Tools/Equipment	None
Prerequisite Procedures	None
Required/As Needed	As needed
Onsite/Remote	Onsite or remote
Security Level	Provisioning or higher



Note

If you preprovision a multirate SFP, you must next select the line rate using the “[DLP-F390 Provision an Optical Line Rate and Wavelength](#)” task on page 18-104.

-
- Step 1** Complete the “[DLP-F181 Log into CTC](#)” task on page 16-34 to log into an ONS 15600 SDH on the network.
- Step 2** Click the **Alarms** tab:
- Verify that the alarm filter is not turned on. See the “[DLP-F288 Disable Alarm Filtering](#)” task on page 17-78 as necessary.
 - Verify that no unexplained conditions appear on the network. If unexplained conditions appear, resolve them before continuing. Refer to the *Cisco ONS 15600 SDH Troubleshooting Guide* for procedures to clear alarms.
 - Complete the “[DLP-F379 Export CTC Data](#)” task on page 18-88 to export alarm and condition information.
- Step 3** In node view, double-click the ASAP card where you want to provision PPM settings.
- Step 4** Click the **Provisioning > Pluggable Port Modules** tabs.
- Step 5** In the Pluggable Port Modules pane, click **Create**. The Create PPM dialog box appears.
- Step 6** In the Create PPM dialog box, complete the following:
- PPM—Click the slot number where you want to preprovision the SFP from the drop-down list.
 - PPM Type—Click the number of ports supported by your SFP from the drop-down list. If only one port is supported, **PPM (1 port)** is the only option.
- Step 7** Click **OK**. The newly created port appears on the Pluggable Port Modules pane. The row on the Pluggable Port Modules pane turns light blue and the Actual Equipment Type column lists the preprovisioned PPM as unknown until the actual SFP is installed. After the SFP is installed, the row on the pane turns white and the column lists the equipment name.
- Step 8** Verify that the PPM appears in the list on the Pluggable Port Modules pane. If it does not, repeat Steps 5 through 8.
- Step 9** On the Provisioning tab, click the **Line** subtab. If applicable for the PPM you are preprovisioning, use the **Reach** and **Wavelength** columns to configure these parameters as needed.



Note Only the parameters that are editable for the PPMs on a particular platform type are provisionable. For example, some platforms may not have PPMs with configurable wavelengths or reaches. In this case, wavelength and reach are not provisionable.

- Step 10** Repeat Steps 1 to 10 create a second PPM.
- Step 11** Click **OK**.
- Step 12** When you are ready to install the SFP, complete the “[DLP-F387 Install an SFP/XFP](#)” task on [page 18-101](#).
- Step 13** Return to your originating procedure (NTP).

DLP-F336 Print CTC Data

Purpose	This task prints CTC windows and CTC table data such as alarms and inventory.
Equipment/Tools	A printer must be connected to the CTC computer
Prerequisite Procedures	DLP-F181 Log into CTC , page 16-34
Required/As Needed	As needed
Onsite/Remote	Onsite or remote
Security Level	Retrieve or higher

- Step 1** From the CTC File menu, click **Print**.
- Step 2** In the Print dialog box ([Figure 18-9](#)), choose an option:
- Entire Frame—Prints the entire CTC window including the graphical view of the card, node, or network.
 - Tabbed View—Prints the lower half of the CTC window.
 - Table Contents—Prints CTC data in table format; this option is only available for CTC table data (see [Table A-6 on page A-10](#)). It does not apply to:
 - Provisioning > General window
 - Provisioning > SNMP window
 - Provisioning > Timing window
 - Provisioning > Network > Internal Subnet window
 - Provisioning > Network > General window
 - Provisioning > Security > Policy window
 - Provisioning > Security > Access window
 - Provisioning > Security > Legal Disclaimer window
 - Provisioning > OSI > Main Setup window
 - Provisioning > OSI > TARP > Config window
 - Maintenance > Database window

- Maintenance > Protection window
- Maintenance > Diagnostic window
- Maintenance > Preferred Copy window
- Maintenance > Timing > Source window

The Table Contents option prints all the data contained in a table and the table column headings. For example, if you print the History window Table Contents view, you print all data included in the table whether or not items appear in the window.

**Tip**

When you print using the Tabbed View option, it can be difficult to distinguish whether the printout applies to the network, node, or card view. To determine the view, compare the tabs on the printout. The network, node, and card views are identical except that network view does not contain an Inventory or Performance tab.

Figure 18-9 Selecting CTC Data for Print

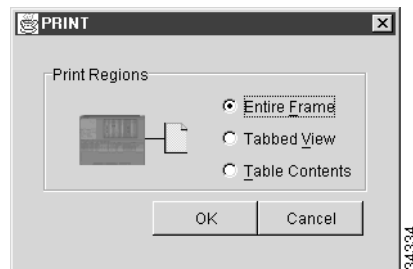

- Step 3** Click **OK**.
- Step 4** In the Windows Print dialog box, choose a printer and click **OK**.
- Step 5** Return to your originating procedure (NTP).

DLP-F337 View ASAP Ether Ports History PM Parameters

Purpose	This task enables you to view historical PM counts at selected time intervals on an ASAP card and port to detect possible performance problems.
Tools/Equipment	None
Prerequisite Procedures	DLP-F181 Log into CTC, page 16-34
Required/As Needed	As needed
Onsite/Remote	Onsite or remote
Security Level	Retrieve or higher

- Step 1** In node view, double-click the ASAP card where you want to view PM counts. The card view appears.
- Step 2** Click the **Performance > Ethernet > Ether Ports > History** tabs ([Figure 18-10](#)).

Figure 18-10 Ethernet Ether Ports History on the Card View Performance Window

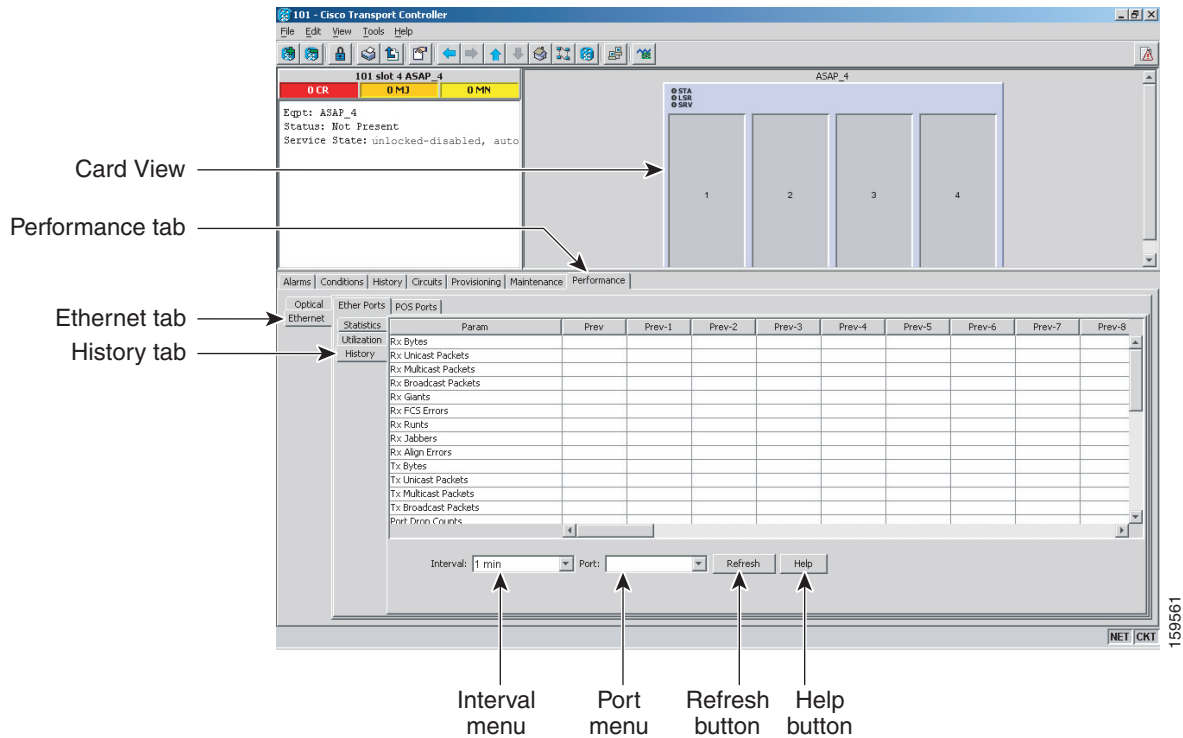

- Step 3** Click **Refresh**. Performance monitoring statistics for each port on the card appear.
- Step 4** View the PM parameter names that appear in the Param column. The PM parameter values appear in the Prev-*n* columns. For PM parameter definitions, refer to the “Performance Monitoring” chapter in the *Cisco ONS 15600 SDH Reference Manual*.



Note To refresh, reset, or clear PM counts, see the [NTP-F184 Change the PM Display, page 8-2](#).

- Step 5** Return to your originating procedure (NTP).

DLP-F338 Create a Two-Fiber MS-SPRing Using the MS-SPRing Wizard

Purpose	This task creates a two-fiber multiplex section-shared protection ring (MS-SPRing) at each MS-SPRing-provisioned node using the CTC MS-SPRing wizard. The MS-SPRing wizard checks to see that each node is ready for MS-SPRing provisioning, then provisions all the nodes at one time.
Tools/Equipment	None
Prerequisite Procedures	DLP-F293 Delete Circuits, page 17-81 DLP-F181 Log into CTC, page 16-34
Required/As Needed	As needed

Onsite/Remote	Onsite or remote
Security Level	Provisioning or higher

-
- Step 1** From the View menu, choose **Go to Network View**.
- Step 2** Click the **Provisioning > MS-SPRing** tabs.
- Step 3** Click **Create MS-SPRing**.
- Step 4** In the MS-SPRing Creation dialog box, set the MS-SPRing properties:
- Ring Type—Choose **two-fiber**.
 - Speed—Choose the MS-SPRing ring speed: **STM-4**, **STM-16**, or **STM-64**. The speed must match the STM-N speed of the MS-SPRing trunk (span) ports.
 - Ring Name—Assign a ring name. The name can be from 1 to 6 characters in length. Any alphanumeric string is permissible, and uppercase and lowercase letters can be combined. Do not use the character string All in either uppercase or lowercase letters; this is a TL1 keyword and will be rejected. Do not choose a name that is already assigned to another MS-SPRing.
 - Reversion time—Set the amount of time that will pass before the traffic reverts to the original working path following a ring switch. The default is 5 minutes. Ring reversion can be set to Never.
- Step 5** Click **Next**. If the network graphic appears, go to Step 6.
- If CTC determines that an MS-SPRing cannot be created, for example, not enough optical cards are installed or it finds circuits with SNCP selectors, a “Cannot Create MS-SPRing” message appears. If this occurs, complete the following steps:
- a. Click **OK**.
 - b. In the Create MS-SPRing window, click **Excluded Nodes**. Review the information explaining why the MS-SPRing could not be created, then click **OK**.
 - c. Depending on the problem, click **Back** to start over or click **Cancel** to cancel the operation.
 - d. Complete the NTP-F147 Provision MS-SPRing Nodes, page 5-6 making sure all steps are completed accurately, then start this procedure again.
- Step 6** In the network graphic, double-click an MS-SPRing span line. If the span line is DCC-connected to other MS-SPRing ports that constitute a complete ring, the lines turn blue. If the lines do not form a complete ring, double-click the span lines until a complete ring is formed. When the ring is DCC-connected, go to Step 7.
- Step 7** Click **Finish**. If the MS-SPRing window appears with the MS-SPRing you created, go to Step 8. If a “Cannot Create MS-SPRing” or “Error While Creating MS-SPRing” message appears:
- a. Click **OK**.
 - b. In the Create MS-SPRing window, click **Excluded Nodes**. Review the information explaining why the MS-SPRing could not be created, then click **OK**.
 - c. Depending on the problem, click **Back** to start over or click **Cancel** to cancel the operation.
 - d. Complete the NTP-F147 Provision MS-SPRing Nodes, page 5-6 making sure all steps are completed accurately, then start this procedure again.



Note Some or all of the following alarms might briefly appear during MS-SPRing setup:
E-W-MISMATCH, RING-MISMATCH, APSCIMP, APSCDFLTk, and MSSP-OOSYNC.

- Step 8** Verify the following:

- On the network view graphic, a green span line appears between all MS-SPRing nodes.
- All E-W-MISMATCH, RING-MISMATCH, APSCIMP, APSCDFLTK, and MSSP-OOSYNC alarms are cleared. See the *Cisco ONS 15600 SDH Troubleshooting Guide* for alarm troubleshooting procedures.



Note The numbers in parentheses after the node name are the MS-SPRing node IDs assigned by CTC. Every ONS 15600 SDH in an MS-SPRing is given a unique node ID, 0 through 31. To change it, complete the “[DLP-F340 Change an MS-SPRing Node ID](#)” task on page 18-41.

Step 9 Return to your originating procedure (NTP).

DLP-F339 Create a Two-Fiber MS-SPRing Manually

Purpose	This task creates a two-fiber MS-SPRing at each MS-SPRing-provisioned node without using the MS-SPRing wizard.
Tools/Equipment	None
Prerequisite Procedures	NTP-F147 Provision MS-SPRing Nodes DLP-F181 Log into CTC, page 16-34
Required/As Needed	Required
Onsite/Remote	Onsite or remote
Security Level	Provisioning or higher

Step 1 In node view, click the **Provisioning > MS-SPRing** tabs.

Step 2 Click **Create**.

Step 3 In the Suggestion dialog box, click **OK**.

Step 4 In the Create MS-SPRing dialog box, set the MS-SPRing properties:

- Ring Type—Choose **two-fiber**.
- Ring Name—Assign a ring name. You must use the same ring name for each node in the MS-SPRing. Any alphanumeric character string is permissible, and uppercase and lowercase letters can be combined. Do not use the character string All in either uppercase or lowercase letters; this is a TL1 keyword and will be rejected. Do not choose a name that is already assigned to another MS-SPRing.
- Node ID—Choose a Node ID from the drop-down list (0 through 31). The Node ID identifies the node to the MS-SPRing. Nodes in the same MS-SPRing must have unique Node IDs.
- Reversion time—Set the amount of time that will pass before the traffic reverts to the original working path. The default is 5 minutes. All nodes in a MS-SPRing must have the same reversion time setting.
- West Line—Assign the west MS-SPRing port for the node from the drop-down list.



Note The east and west ports must match the fiber connections and DCC terminations set up in the “[NTP-F147 Provision MS-SPRing Nodes](#)” procedure on page 5-6.

- East Line—Assign the east MS-SPRing port for the node from the drop-down list.

Step 5 Click **OK**.



Note Some or all of the following alarms will appear until all the MS-SPRing nodes are provisioned: E-W MISMATCH, RING MISMATCH, APSCIMP, APSDFLTK, and MSSP-OOSYNC. The alarms will clear after you configure all the nodes in the MS-SPRing.

Step 6 From the View menu, choose **Go to Other Node**.

Step 7 In the Select Node dialog box, choose the next node that you want to add to the MS-SPRing.

Step 8 Repeat Steps 1 through 7 at each node that you want to add to the MS-SPRing. When all nodes have been added, continue with Step 9.

Step 9 From the View menu, choose **Go to Network View**. After 10 to 15 seconds, verify the following:

- A green span line appears between all BLSR nodes.
- All E-W MISMATCH, RING MISMATCH, APSCIMP, APSDFLTK, and MSSP-OOSYNC alarms are cleared.

Step 10 Return to your originating procedure (NTP).

DLP-F340 Change an MS-SPRing Node ID

Purpose	This task changes an MS-SPRing node ID.
Tools/Equipment	None
Prerequisite Procedures	DLP-F181 Log into CTC, page 16-34
Required/As Needed	As needed
Onsite/Remote	Onsite or remote
Security Level	Provisioning or higher

Step 1 From the View menu, choose **Go to Network View**.

Step 2 On the network map, double-click the node with the node ID you want to change.

Step 3 From node view, click the **Provisioning > MS-SPRing** tabs.

Step 4 Choose a Node ID number. Do not choose a number already assigned to another node in the same MS-SPRing.

Step 5 Click **Apply**.

Step 6 Return to your originating procedure (NTP).

DLP-F341 MS-SPRing Exercise Ring Test

Purpose	This task tests the MS-SPRing ring functionality without switching traffic. Ring exercise conditions (including the K-byte pass-through) are reported and cleared within 10 to 15 seconds.
Tools/Equipment	None
Prerequisite Procedures	DLP-F181 Log into CTC, page 16-34
Required/As Needed	As needed
Onsite/Remote	Onsite
Security Level	Provisioning or higher

Step 1 From the View menu, choose **Go To Network View**.

Step 2 Click the **Provisioning > MS-SPRing** tabs.

Step 3 Click the row of the MS-SPRing you will exercise, then click **Edit**.

Step 4 Exercise the west port:

- a. Right-click the west port of any MS-SPRing node and choose **Set West Protection Operation**. (To move a graphic icon, press **Ctrl** while you drag and drop it to a new location.)



Note For two-fiber MS-SPRings, the squares on the node icons represent the MS-SPRing working and protect channels. You can right-click either channel.

- b. In the Set West Protection Operation dialog box, choose **EXERCISE RING** from the drop-down list.
- c. Click **OK**.
- d. In the Confirm MS-SPRing Operation dialog box, click **Yes**.

On the network view graphic, an E appears on the working MS-SPRing channel where you invoked the protection switch. The E will appear for 10 to 15 seconds, then disappear.

Step 5 Exercise the east port:

- a. Right-click the east port of any MS-SPRing node and choose **Set East Protection Operation**.



Note For two-fiber MS-SPRings, the squares on the node icons represent the MS-SPRing working and protect channels. You can right-click either channel.

- b. In the Set East Protection Operation dialog box, choose **EXERCISE RING** from the drop-down list.
- c. Click **OK**.
- d. In the Confirm MS-SPRing Operation dialog box, click **Yes**.

On the network view graphic, an E appears on the MS-SPRing channel where you invoked the exercise. The E will appear for 10 to 15 seconds, then disappear.

Step 6 In the Cisco Transport Controller window, click the **History** tab. Verify that an Exercising Ring Successfully (EXERCISING-RING) condition appears for the node where you exercised the ring. Other conditions that appear include KB-PASSTHR and FE-EXERCISING-RING.

If you do not see any MS-SPRing exercise conditions, click the **Filter** button and verify that filtering is not turned on. Also, check that alarms and conditions are not suppressed for a node or MS-SPRing drop cards. See the “[NTP-F195 Suppress and Restore Alarm Reporting](#)” procedure on page 9-7 for more information.

- Step 7** Click the **Alarms** tab.
- Verify that the alarm filter is not on. See the “[DLP-F288 Disable Alarm Filtering](#)” task on page 17-78 for instructions.
 - Verify that no unexplained alarms appear on the network. If unexplained alarms appear, resolve them before continuing. Refer to the *Cisco ONS 15600 Troubleshooting Guide* for alarm clearing procedures.
- Step 8** From the File menu, choose **Close** to close the MS-SPRing window.
- Step 9** Return to your originating procedure (NTP).
-

DLP-F342 MS-SPRing Switch Test

Purpose	This task verifies that protection switching is working correctly in an MS-SPRing.
Tools/Equipment	None
Prerequisite Procedures	DLP-F181 Log into CTC , page 16-34
Required/As Needed	Required
Onsite/Remote	Onsite
Security Level	Provisioning or higher

- Step 1** From the View menu, choose **Go to Network View**.
- Step 2** Click the **Provisioning > MS-SPRing** tabs.
- Step 3** Click the row of the MS-SPRing you will switch, then click **Edit**.
- Step 4** Initiate a Force Ring switch on the west port:

- Right-click any MS-SPRing node west port and choose **Set West Protection Operation**. (To move a graphic icon, click it, then press **Ctrl** while you drag and drop it to a new location.)



Note For two-fiber MS-SPRings, the squares on the node icons represent the MS-SPRing working and protect channels. You can right-click either channel.

- In the Set West Protection Operation dialog box, choose **FORCE RING** from the drop-down list.
- Click **OK**.
- Click **Yes** in the two Confirm MS-SPRing Operation dialog boxes that appear.

On the network view graphic, an F appears on the MS-SPRing channel where you invoked the Force Ring switch. The MS-SPRing span lines turn purple where the switch was invoked, and all span lines between other MS-SPRing nodes turn green.

- Step 5** Verify the conditions:
- Click the **Conditions** tab.
 - Click **Retrieve**.
 - Verify that the following conditions are reported on the node where you invoked the Force Ring switch on the west port:
 - FORCE-REQ-RING—A Force Switch Request On Ring condition is reported against the span's working slot on the west side of the node.
 - RING-SW-EAST—A Ring Switch Active on the east side condition is reported against the working span on the east side of the node.
-  **Note** Make sure the Filter button in the lower right corner of the window is off. Click the Node column to sort conditions by node.
- Verify that the following conditions are reported on the node that is connected to the West line of the node where you performed the switch:
 - FE-FRCDWKSWPR-RING—A Far-End Working Facility Forced to Switch to Protection condition is reported against the working span on the east side of the node.
 - RING-SW-WEST—A Ring Switch Active on the west side condition is reported against the working span on the west side of the node.
- Step 6** (Optional) If you remapped the K3 byte to run an ONS 15600 SDH MS-SPRing through third-party equipment, check the following condition. Verify a FULLPASSTHR-BI condition reported on other nodes that are not connected to the west side of the node where you invoked the Force Ring switch.
- Step 7** Verify the MS-SPRing line status on each node:
- From the View menu, choose **Go to Node View**.
 - Click the **Maintenance > MS-SPRing** tabs.
 - Verify the following:
 - The line states are shown as Stby/Stby on the west side of the node and Act/Act on the east side of the node where you invoked the Force Ring switch.
 - The line states are shown as Stby/Stby on the east side of the node and Act/Act on the west side of the node that is connected to the west line of the node where you invoked the Force Ring switch.
 - The line states are shown as Act/Act on both the east and west sides of the remaining nodes in the ring.
- Step 8** From the View menu, choose **Go to Network View**.
- Step 9** Click the **Alarms** tab.
- Verify that the alarm filter is not on. See the [“DLP-F288 Disable Alarm Filtering” task on page 17-78](#) for instructions.
 - Verify that no unexplained alarms appear on the network. If unexplained alarms appear, resolve them before continuing. Refer to the *Cisco ONS 15600 Troubleshooting Guide* for procedures.
- Step 10** Display the MS-SPRing window where you invoked the Force Ring switch (the window might be hidden by the CTC window).

Step 11 Clear the switch on the west port:

- a. Right-click the west port of the MS-SPRing node where you invoked the Force Ring switch and choose **Set West Protection Operation**.
- b. In the Set West Protection Operation dialog box, choose **CLEAR** from the drop-down list.
- c. Click **OK**.
- d. Click **Yes** in the Confirm MS-SPRing Operation dialog box.

On the network view graphic, the Force Ring switch is removed, the F indicating the switch is removed, and the span lines between MS-SPRing nodes will be purple and green. The span lines might take a few moments to change color.

Step 12 In network view, click the **Conditions** tab. Verify that all conditions raised in this procedure are cleared from the network. If unexplained conditions appear, resolve them before continuing.

Step 13 Verify the MS-SPRing line status on each node:

- a. From the View menu, choose **Go to Node View**.
- a. Click the **Maintenance > MS-SPRing** tabs.
- b. Verify that the line states are shown as Act/Stby on both the east and west sides of each node in the ring.

Step 14 Initiate a Force Ring switch on the east port:

- a. Right-click the east port of MS-SPRing node and choose **Set East Protection Operation**.
- b. In the Set East Protection Operation dialog box, choose **FORCE RING** from the drop-down list.
- c. Click **OK**.
- d. Click **Yes** in the two Confirm MS-SPRing Operation dialog boxes that appear.

On the network view graphic, an F appears on the working MS-SPRing channel where you invoked the Force Ring switch. The MS-SPRing span lines are purple where the Force Ring switch was invoked, and all span lines between other MS-SPRing nodes are green. The span lines might take a few moments to change color.

Step 15 Verify the conditions:

- a. Click the **Conditions** tab.
- b. Click **Retrieve**.
- c. Verify that the following conditions are reported on the node where you invoked the Force Ring switch on the east port:
 - **FORCE-REQ-RING**—A Force Switch Request On Ring condition is reported against the span's working slot on the east side of the node.
 - **RING-SW-WEST**—A Ring Switch Active on the west side condition is reported against the working span on the east side of the node.



Note Make sure the Filter button in the lower right corner of the window is off. Click the Node column to sort conditions by node.

- d. Verify that the following conditions are reported on the node that is connected to the East line of the node where you performed the switch:
 - **FE-FRCDWKS WPR-RING**—A Far-End Working Facility Forced to Switch to Protection condition is reported against the working span on the west side of the node.

- RING-SW-EAST—A Ring Switch Active on the east side condition is reported against the working span on the west side of the node.
- Step 16** (Optional) If you remapped the K3 byte to run an ONS 15600 SDH MS-SPRing through third-party equipment, verify a FULLPASSTHR-BI condition reported on other nodes that are not connected to the west side of the node where you invoked the Force Ring switch.
- Step 17** Verify the MS-SPRing line status on each node:
- a. From the View menu, choose **Go to Node View**.
 - b. Click the **Maintenance > MS-SPRing** tabs. Verify the following:
 - The line states are shown as Stby/Stby on the east side of the node and Act/Act on the west side of the node where you invoked the Force Ring switch.
 - The line states are shown as Stby/Stby on the west side of the node and Act/Act on the east side of the node that is connected to the east line of the node where you invoked the Force Ring switch.
 - The line states are shown as Act/Act on both east and west sides of the remaining nodes in the ring.
- Step 18** From the View menu, choose **Go To Network View**.
- Step 19** Click the **Alarms** tab.
- a. Verify that the alarm filter is not on. See the [“DLP-F288 Disable Alarm Filtering” task on page 17-78](#) for instructions.
 - b. Verify that no unexplained alarms appear on the network. If unexplained alarms appear, resolve them before continuing. Refer to the *Cisco ONS 15600 Troubleshooting Guide* for procedures.
- Step 20** Display the MS-SPRing window where you invoked the Force Ring switch (the window might be hidden by the CTC window).
- Step 21** Clear the switch on the east port:
- a. Right-click the east port of the MS-SPRing node where you invoked the Force Ring switch and choose **Set East Protection Operation**.
 - b. In the Set East Protection Operation dialog box, choose **CLEAR** from the drop-down list.
 - c. Click **OK**.
 - d. Click **Yes** in the Confirm MS-SPRing Operation dialog box.
- On the network view graphic, the Force Ring switch is removed, the F indicating the switch is removed, and the span lines between MS-SPRing nodes will be purple and green. The span lines might take a few moments to change color.
- Step 22** From network view, click the **Conditions** tab. Verify that all conditions raised in this procedure are cleared from the network. If unexplained conditions appear, resolve them before continuing.
- Step 23** Verify the MS-SPRing line status on each node:
- a. From the View menu, choose **Go to Node View**.
 - b. Click the **Maintenance > MS-SPRing** tabs.
 - c. Verify that the line states are shown as Act/Stby on both the east and west sides of each node in the ring.
- Step 24** From the File menu, choose **Close** to close the MS-SPRing window.
- Step 25** Return to your originating procedure (NTP).
-

DLP-F343 Provision an STM-N Circuit Route

Purpose	This task provisions the circuit route for manually routed STM-N circuits.
Tools/Equipment	None
Prerequisite Procedures	DLP-F181 Log into CTC, page 16-34 The Circuit Creation Wizard must be open.
Required/As Needed	As needed
Onsite/Remote	Onsite or remote
Security Level	Provisioning or higher

-
- Step 1** In the Circuit Creation wizard in the Route Review/Edit area, click the source node icon if it is not already selected.
- Step 2** Starting with a span on the source node, click the arrow of the span you want the circuit to travel. To reverse the direction of the arrow, click the arrow twice.
The arrow turns white. In the Selected Span area, the From and To fields provide span information. The source VC appears.
- Step 3** If you want to change the source VC, adjust the Source VC field; otherwise, continue with [Step 4](#).
- Step 4** Click **Add Span**. The span is added to the Included Spans list and the span arrow turns blue.
- Step 5** Repeat Steps [2](#) through [4](#) until the circuit is provisioned from the source to the destination node through all intermediary nodes. If Fully Protected Path is checked in the Circuit Routing Preferences area, you must:
- Add two spans for all SNCP or unprotected portions of the circuit route from the source to the destination.
 - Add one span for all MS-SPRing or 1+1 portions of route from the source to the destination.
 - Add primary spans for MS-SPRing-DRI from the source to the destination through the primary nodes, and then add spans through the secondary nodes as an alternative route. The circuit map shows all span types: unprotected, MS-SPRing, and PCA. PCA spans can only be chosen as part of the secondary path.
- Step 6** Return to your originating procedure (NTP).
-

DLP-F344 Initiate an MS-SPRing Manual Ring Switch

Purpose	This task performs an MS-SPRing Manual ring switch. A Manual ring switch will switch traffic off a span if there is no higher priority switch (Force or lock out) and no signal degrade (SD) or signal failure (SF) conditions.
Tools/Equipment	None
Prerequisite Procedures	DLP-F181 Log into CTC, page 16-34
Required/As Needed	As needed

Onsite/Remote	Onsite
Security Level	Provisioning or higher



Caution Traffic is not protected during a manual ring protection switch.

Step 1 From the View menu, choose **Go To Network View**.

Step 2 Click the **Provisioning > MS-SPRing** tabs.

Step 3 Choose the MS-SPRing and click **Edit**.



Tip To move an icon to a new location, for example, to see MS-SPRing channel (port) information more clearly, click an icon, and drag and drop it in a new location.

Step 4 Right-click any MS-SPRing node channel (port) and choose **Set West Protection Operation** (if you chose a west channel) or **Set East Protection Operation** (if you chose an east channel).



Note The squares on the node icons represent the MS-SPRing working and protect channels. You can right-click either channel. For four-fiber MS-SPRings, the squares represent ports. Right-click either working port.

Step 5 In the Set West Protection Operation dialog box or the Set East Protection Operation dialog box, choose **MANUAL RING** from the drop-down list. Click **OK**.

Step 6 Click **Yes** in the two Confirm MS-SPRing Operation dialog boxes.

Step 7 Verify that the channel (port) displays the letter “M” for Manual ring. Also verify that the span lines between the nodes where the Manual switch was invoked turn purple, and that the span lines between all other nodes turn green on the network view map. This confirms the Manual switch.

Step 8 From the File menu, choose **Close**.

Step 9 Return to your originating procedure (NTP).

DLP-F345 Clear an MS-SPRing Manual Ring Switch

Purpose	This task clears a manual ring switch.
Tools/Equipment	None
Prerequisite Procedures	DLP-F181 Log into CTC, page 16-34
Required/As Needed	As needed
Onsite/Remote	Onsite
Security Level	Provisioning or higher

Step 1 From the View menu, choose **Go To Network View**.

Step 2 Click the **Provisioning > MS-SPRing** tabs.

Step 3 Choose the MS-SPRing and click **Edit**.

**Tip**

To move an icon to a new location, for example, to see MS-SPRing channel (port) information more clearly, click an icon on the Edit MS-SPRing network graphic and while pressing **Ctrl**, drag the icon to a new location.

-
- Step 4** Right-click the MS-SPRing node channel (port) where the manual ring switch was applied and choose **Set West Protection Operation** or **Set East Protection Operation**, as applicable.
- Step 5** In the dialog box, choose **CLEAR** from the drop-down list. Click **OK**.
- Step 6** Click **Yes** in the Confirm MS-SPRing Operation dialog box. The letter “M” is removed from the channel (port) and the span turns green on the network view map.
- Step 7** From the File menu, choose **Close**.
- Step 8** Return to your originating procedure (NTP).
-

DLP-F346 Create an MS-SPRing on a Single Node

Purpose	This task creates an MS-SPRing on a single node. Use this task to add a node to an existing MS-SPRing or to delete and then recreate an MS-SPRing temporarily on one node.
Tools/Equipment	None
Prerequisite Procedures	DLP-F181 Log into CTC, page 16-34
Required/As Needed	As needed
Onsite/Remote	Onsite
Security Level	Provisioning or higher

-
- Step 1** In node view, click the **Provisioning > MS-SPRing** tabs.
- Step 2** In the Suggestion dialog box, click **OK**.
- Step 3** In the Create MS-SPRing dialog box, enter the MS-SPRing information:
- Ring Type—Enter the ring type (2 Fiber) of the MS-SPRing.
 - Ring Name—Enter the MS-SPRing name. If the node is being added to an MS-SPRing, use the MS-SPRing ring name.
 - Node ID—Enter the node ID. If the node is being added to an MS-SPRing, use an ID that is not used by other MS-SPRing nodes in that ring.
 - Ring Reversion—Enter the ring reversion time of the existing MS-SPRing.
 - West Line—Enter the slot on the node that will connect to the existing MS-SPRing through the node’s west line (port).
 - East Line—Enter the slot on the node that will connect to the existing MS-SPRing through the node’s east line (port).
- Step 4** Click **OK**.



Note The MS-SPRing is incomplete and alarms are present until the node is connected to other MS-SPRing nodes.

Step 5 Return to your originating procedure (NTP).

DLP-F347 Initiate an MS-SPRing Force Ring Switch

Purpose	Use this task to perform an MS-SPRing Force switch on an MS-SPRing port. A Force ring switch will switch traffic off a span if there is no signal degrade (SD), signal failure (SF), or lockout switch present on the span.
Tools/Equipment	None
Prerequisite Procedures	DLP-F181 Log into CTC, page 16-34
Required/As Needed	As needed
Onsite/Remote	Onsite
Security Level	Provisioning or higher



Caution The Force Switch Away command overrides normal protective switching mechanisms. Applying this command incorrectly can cause traffic outages.



Caution Traffic is not protected during a Force protection switch.

- Step 1** From the View menu, choose **Go to Network View**.
- Step 2** Click the **Provisioning > MS-SPRing** tabs. Select the MS-SPRing.
- Step 3** Click **Edit**.
- Step 4** To apply a Force switch to the west line:
- Right-click the west MS-SPRing port where you want to switch the MS-SPRing traffic and choose **Set West Protection Operation**.



Note If node icons overlap, drag and drop the icons to a new location. You can also return to network view and change the positions of the network node icons, because MS-SPRing node icons are based on the network view node icon positions.



Note For two-fiber MS-SPRings, the squares on the node icons represent the MS-SPRing working and protect channels. You can right-click either channel.

- In the Set West Protection Operation dialog box, choose **FORCE RING** from the drop-down list. Click **OK**.
- Click **Yes** in the two Confirm MS-SPRing Operation dialog boxes that appear.

On the network graphic, an F appears on the working MS-SPRing channel where you invoked the protection switch. The span lines change color to reflect the forced traffic. Green span lines indicate the new MS-SPRing path, and the lines between the protection switch are purple.

Performing a Force switch generates several conditions including FORCED-REQ-RING and WKSWPR.

Step 5 To apply a Force switch to the east line:

- a. Right-click the east MS-SPRing port and choose **Set East Protection Operation**.



Note If node icons overlap, drag and drop the icons to a new location or return to network view and change the positions of the network node icons. MS-SPRing node icons are based on the network view node icon positions.



Note For two-fiber MS-SPRings, the squares on the node icons represent the MS-SPRing working and protect channels. You can right-click either channel.

- b. In the Set East Protection Operation dialog box, choose **FORCE RING** from the drop-down list. Click **OK**.
- c. Click **Yes** in the two Confirm MS-SPRing Operation dialog boxes that appear.

On the network graphic, an F appears on the working MS-SPRing channel where you invoked the protection switch. The span lines change color to reflect the forced traffic. Green span lines indicate the new MS-SPRing path, and the lines between the protection switch are purple.

Performing a Force switch generates several conditions including FORCED-REQ-RING and WKSWPR.

Step 6 From the File menu, choose **Close**.

Step 7 Return to your originating procedure (NTP).

DLP-F348 View Circuit Information

Purpose	This task enables you to view information about circuits, such as name, type, size, and direction.
Tools/Equipment	None
Prerequisite Procedures	DLP-F181 Log into CTC, page 16-34
Required/As Needed	As needed
Onsite/Remote	Onsite or remote
Security Level	Retrieve or higher

Step 1 Navigate to the appropriate CTC view:

- To view circuits for an entire network, from the View menu, choose **Go To Network View**.
- To view circuits that originate, terminate, or pass through a specific node, from the View menu, choose **Go To Other Node**, then choose the node you want to search and click **OK**.
- To view circuits that originate, terminate, or pass through a specific card, in node view, double-click the card containing the circuits you want to view.



Note In node or card view, you can change the scope of the circuits that are displayed by choosing Card (in card view), Node, or Network from the Scope drop-down list in the bottom right corner of the Circuits window.

Step 2 Click the **Circuits** tab. The Circuits tab has the following information:

- **Name**—Name of the circuit. The circuit name can be manually assigned or automatically generated.
- **Type**—For the ONS 15600 SDH, the circuit type is STS (STS circuit).
- **Size**—VT circuit size is 1.5. STS circuit sizes can be 1, 3c, 6c, 9c, 12c, 24c, 48c, or 192c.
- **OCHNC Wlen**—(ONS 15454 dense wavelength division multiplexing [DWDM] only) For OCHNCs, the wavelength provisioned for the optical channel network connection. Refer to the *Cisco ONS 15454 DWDM Procedure Guide*.
- **Direction**—The circuit direction, either two-way or one-way.
- **OCHNC Dir**—(ONS 15454 DWDM only) For OCHNCs, the direction of the optical channel network connection, either East to West or West to East. Refer to the *Cisco ONS 15454 DWDM Procedure Guide*.
- **Protection**—The protection type; see [Table 18-2](#).

Table 18-2 **Circuit Protection Types**

Protection Type	Description
1+1	The circuit is protected by a 1+1 protection group.
2F MS-SPRing	The circuit is protected by a 2-fiber MS-SPRing.
2F-PCA	The circuit is routed on a protection channel access (PCA) path on a two-fiber MS-SPRing. PCA circuits are unprotected.
DRI	The circuit is protected by dual-ring interconnect (DRI).
N/A	A circuit with connections on the same node is not protected.
PCA	The circuit is routed on a PCA path on both two-fiber and four-fiber MS-SPRings. PCA circuits are unprotected.
Protected	The circuit is protected by diverse SDH topologies, for example an MS-SPRing and an SNCP, or an SNCP and 1+1.
Unknown	A circuit has a source and destination on different nodes and communication is down between the nodes. This protection type appears if not all circuit components are known.
Unprot (black)	A circuit with a source and destination on different nodes is not protected.
Unprot (red)	A circuit created as a fully protected circuit is no longer protected due to a system change, such as removal of an MS-SPRing or 1+1 protection group.
SNCP	The circuit is protected by an SNCP.

- **Status**—The circuit status. [Table 18-3](#) lists the circuit statuses that can appear.

Table 18-3 **ONS 15600 SDH Circuit Status**

Status	Definition/Activity
CREATING	CTC is creating a circuit.
DISCOVERED	CTC created a circuit. All components are in place and a complete path exists from circuit source to destination.
DELETING	CTC is deleting a circuit.
PARTIAL	<p>A CTC-created circuit is missing a connection or circuit span (network link), a complete path from source to destination(s) does not exist, or a MAC address change occurred on one of the circuit nodes and the circuit is in need of repair (in the ONS 15454, the MAC address resides on the alarm interface panel (AIP); in the ONS 15600 SDH, the MAC address resides on the backplane EEPROM).</p> <p>In CTC, circuits are represented using cross-connects and network spans. If a network span is missing from a circuit, the circuit status is PARTIAL. However, a PARTIAL status does not necessarily mean a circuit traffic failure has occurred, because traffic might flow on a protect path.</p> <p>Network spans are in one of two states: up or down. On CTC circuit and network maps, up spans appear as green lines, and down spans appear as gray lines. If a failure occurs on a network span during a CTC session, the span remains on the network map but its color changes to gray to indicate that the span is down. If you restart your CTC session while the failure is active, the new CTC session cannot discover the span and its span line does not appear on the network map.</p> <p>Subsequently, circuits routed on a network span that goes down appear as DISCOVERED during the current CTC session, but appear as PARTIAL to users who log in after the span failure.</p>
DISCOVERED_TL1	A TL1-created circuit or a TL1-like, CTC-created circuit is complete. A complete path from source to destination(s) exists.
PARTIAL_TL1	A TL1-created circuit or a TL1-like, CTC-created circuit is missing a cross-connect or circuit span (network link), and a complete path from source to destination(s) does not exist.
CONVERSION_PENDING	An existing circuit in a topology upgrade is set to this status. The circuit returns to the DISCOVERED status when the topology upgrade is complete. For more information about topology upgrades, refer to the <i>Cisco ONS 15600 SDH Reference Manual</i> .

Table 18-3 ONS 15600 SDH Circuit Status (continued)

Status	Definition/Activity
PENDING_MERGE	Any new circuits created to represent an alternate path in a topology upgrade are set to this status to indicate that it is a temporary circuit. These circuits can be deleted if a topology upgrade fails. For more information about topology upgrades, refer to the <i>Cisco ONS 15600 SDH Reference Manual</i> .
DROP_PENDING	A circuit is set to this status when a new circuit drop is being added.

- **Source**—The circuit source in the format: *node/slot/port/STS*. If an ASAP PPM port is the circuit source, the port format is *PIM-PPM-port*, where PIM and PPM values are 1 through 4 (for example, p1-1-1). PPMs have only one port.
- **Destination**—The circuit destination in the format: *node/slot/port/STS*. If an ASAP PPM port is the circuit destination, the port format is *PIM-PPM-port*, where PIM and PPM values are 1 through 4 (for example, p1-1-1). PPMs have only one port.
- **# of VLANs**—(Future use) The number of VLANs used by an Ethernet circuit.
- **# of Spans**—The number of internode links that constitute the circuit. Right-clicking the column shows a shortcut menu from which you can choose Span Details to show or hide circuit span detail.
- **State**—The circuit service state, which is an aggregate of its cross-connects. The service states are Unlocked, Locked, or Locked-partial. For more information about circuit service states, refer to the “Administrative and Service States” appendix of the *Cisco ONS 15600 SDH Reference Manual*.
 - Unlocked—All cross-connects are in service and operational.
 - Locked—All cross-connects are Locked-enabled,maintenance or Locked-enabled,disabled.
 - Locked-partial—At least one cross-connect is Unlocked-enabled and others are in the Locked-enabled,maintenance and/or Locked-enabled,disabled service states.

Step 3 Return to your originating procedure (NTP).

DLP-F349 Install Fiber-Optic Cables for MS-SPRing Configurations

Purpose	This task installs the fiber-optics to the east and west MS-SPRing ports at each node. See Chapter 5, “Turn Up a Network” to provision and test MS-SPRing configurations.
Tools/Equipment	Fiber-optic cables
Prerequisite Procedures	NTP-F119 Install the STM-N Cards, page 2-4 NTP-F231 Clean Fiber Connectors and Adapters, page 14-16
Required/As Needed	As needed
Onsite/Remote	Onsite
Security Level	None

**Caution**

Do not provision the MS-SPRing east and west ports on the same STM-N card.

**Note**

To avoid error, connect fiber-optic cable so that the farthest slot to the right represents the east port, and the farthest slot to the left represents the west port. Fiber connected to an east port at one node must plug into the west port on an adjacent node.

**Note**

See [Table 16-1 on page 16-19](#) and [Table 16-2 on page 16-19](#) for OGI connector pinouts of STM-N cards.

- Step 1** Plan your fiber connections. Use the same plan for all MS-SPRing nodes. MS-SPRing configuration is achieved by correctly cabling the transmit and receive fibers of each node to the others.
- Step 2** Plug the fiber into the Tx connector of an STM-N port at one node and plug the other end into the Rx connector of an STM-N port at the adjacent node. The card displays an SF LED if the transmit and receive fibers are mismatched.
- Step 3** Repeat [Step 2](#) until you have configured the ring.

[Figure 18-11](#) shows fiber connections for a two-fiber MS-SPRing with trunk ports in Slot 2, Port 7 (west) and Slot 12, Port 11 (east).

Figure 18-11 Connecting Fiber to a Four-Node, Two-Fiber MS-SPRing

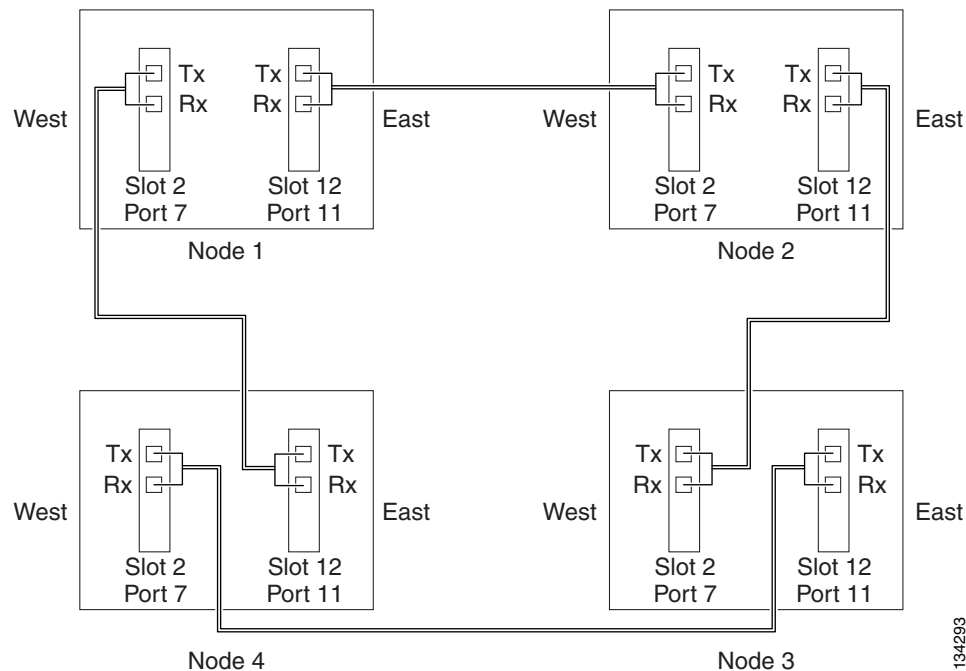

134293

**Note**

To provision an MS-SPRing, see [Chapter 5, “Turn Up a Network”](#)

Step 4 Return to your originating procedure (NTP).

DLP-F350 Delete an MS-SPRing from a Single Node

Purpose	This task deletes an MS-SPRing from a node after you remove the node from the MS-SPRing.
Tools/Equipment	None
Prerequisite Procedures	DLP-F181 Log into CTC, page 16-34
Required/As Needed	As needed
Onsite/Remote	Onsite or remote
Security Level	Provisioning or higher

- Step 1** In node view, display the node that was removed from the MS-SPRing:
- If the node that was removed is connected to the same LAN as your computer, from the File menu, choose **Add Node**, then enter the node name or IP address.
 - If the node that was removed is not connected to the same LAN as your computer, you must connect to the node using a direct connection. See [Chapter 3, “Connect the PC and Log into the GUI”](#) for procedures.
- Step 2** Click the **Provisioning > MS-SPRing** tabs.
- Step 3** Highlight the ring and click **Delete**.
- Step 4** In the Suggestion dialog box, click **OK**.
- Step 5** In the confirmation message, confirm that this is the ring you want to delete. If so, click **Yes**.
- Step 6** Return to your originating procedure (NTP).
-

DLP-F351 Roll the Source or Destination of One Optical Circuit

Purpose	This task reroutes traffic from one source or destination to another on the same circuit, thus changing the original source or destination.
Tools/Equipment	None
Prerequisite Procedures	DLP-F181 Log into CTC, page 16-34
Required/As Needed	As needed
Onsite/Remote	Onsite or remote
Security Level	Provisioning or higher

- Step 1** From the View menu, choose **Go To Network View**.
- Step 2** Click the **Circuits** tab.
- Step 3** Click the circuit that you want to roll. The circuit must have a DISCOVERED status for you to start a roll.

- Step 4** From the Tools menu, choose **Circuits > Roll Circuit**.
- Step 5** In the Roll Attributes area, complete the following (Figure 18-12):
- From the Circuit Roll Mode drop-down list, choose **Auto** to create an automatic roll (required for a 1-way source roll) or **Manual** to create a manual roll (required for a 1-way destination roll).
 - From the Circuit Roll Type drop-down list, choose **Single** to indicate that you want to roll one cross-connect on the chosen circuit.

Figure 18-12 Selecting Single Roll Attributes

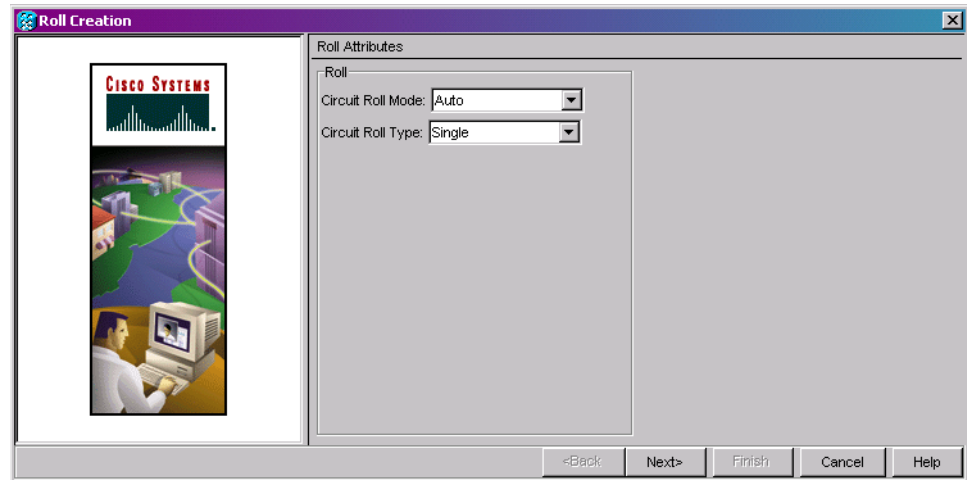

- Step 6** Click **Next**.
- Step 7** In the Pivot/Fixed Point 1 window, click the square in the graphic image that represents the facility that you want to keep (Figure 18-13).

This facility is the fixed location in the cross-connect involved in the roll process. The identifier appears in the text box below the graphic image. The facility that is not selected is the Roll From path. The Roll From path is deleted after the roll is completed.

Figure 18-13 Selecting a Path

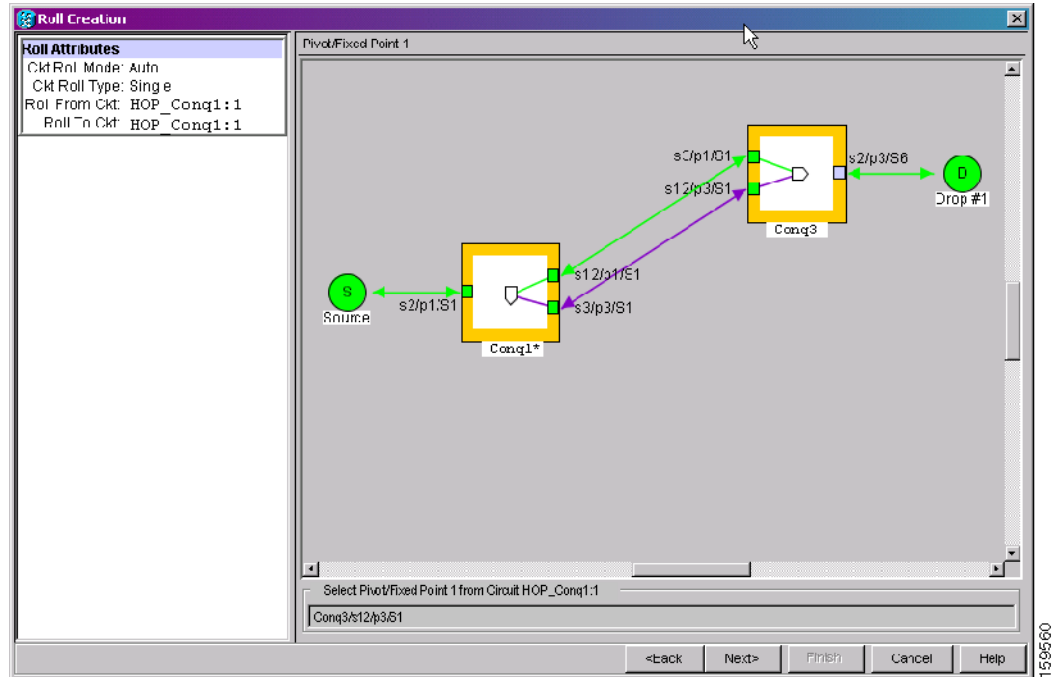

Step 8 Click **Next**.

Step 9 In the Select New End Point area, choose the **Slot**, **Port**, and **VC3 or VC4** from the drop-down lists to select the Roll To facility (Figure 18-14).

Figure 18-14 Selecting a New Endpoint

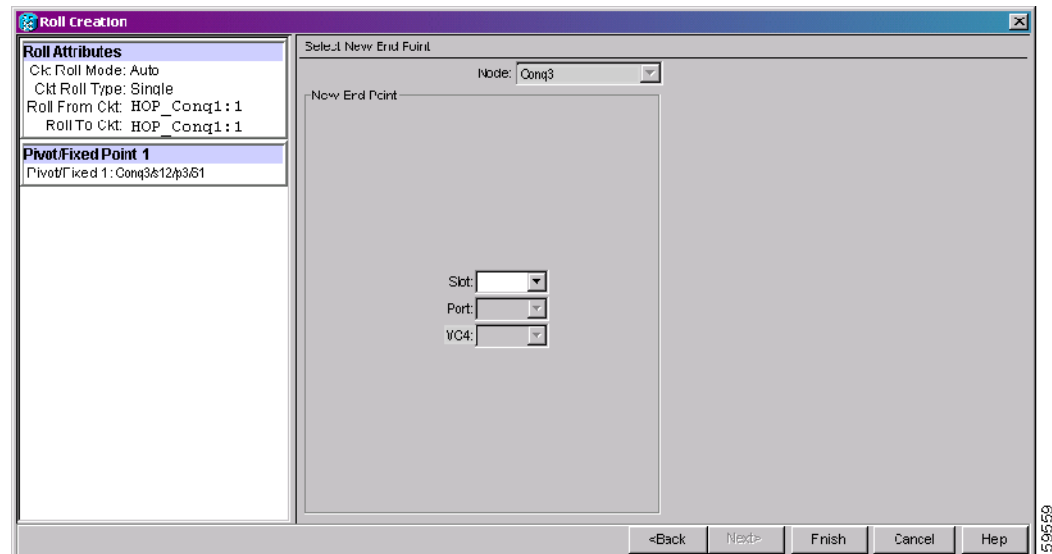

Step 10 Click **Finish**. On the Circuits tab, the circuit status for the Roll From port changes from DISCOVERED to ROLL_PENDING.

Step 11 Click the **Rolls** tab (Figure 18-15). For the pending roll, view the Roll Valid Signal status. When one of the following conditions are met, continue with Step 12.

- If the Roll Valid Signal status is true, a valid signal was found on the new port.
- If the Roll Valid Signal status is false, a valid signal was not found. Wait until the signal is found before continuing with the next step. If the signal is not found, refer to the “General Troubleshooting” chapter in the *Cisco ONS 15600 SDH Troubleshooting Guide*. To cancel the roll, see the “DLP-F357 Cancel a Roll” task on page 18-70.
- The roll is a one-way destination roll and the Roll Valid Signal is false. It is not possible to get a Roll Valid Signal status of true for a one-way destination roll.



Note You cannot cancel an automatic roll after a valid signal is found.

- You can force a signal onto the Roll To circuit by using the Force Valid Signal button. If you choose Force Valid Signal, traffic on the circuit that is involved in the roll might drop depending on conditions at the other end of the circuit when the roll is completed. You must force a signal if the circuits do not have a signal or have a bad signal and you want to complete the roll.



Note For a one-way destination roll in manual mode, you do not need to force the valid signal.

Figure 18-15 Viewing the Rolls Tab

Circuits	Roll From Circuit	Roll To Circuit	Roll State	Roll Valid Signal	Roll Mode	Roll Path	Roll From Path	Roll To Path
Rolls	Roll Circuit	Roll Circuit	ROLL_PENDING	false	Auto	TECHDOC	TECHDOC	TECHDOC

Step 12 If you selected Manual in Step 5, click the rolled facility on the Rolls tab and then click **Complete**. If you selected Auto, continue with Step 13.

Step 13 For both Manual and Auto rolls, click **Finish** to complete the circuit roll process. The roll clears from the Rolls tab and the rolled circuit now appears on the Circuits tab in the DISCOVERED status.

Step 14 Return to your originating procedure (NTP).

DLP-F352 Roll One Cross-Connect from an Optical Circuit to a Second Optical Circuit

Purpose	This task reroutes a cross-connect on one circuit onto another circuit resulting in a new destination.
Tools/Equipment	None
Prerequisite Procedures	DLP-F181 Log into CTC, page 16-34 “DLP-F253 Provision RS-DCC Terminations” task on page 17-45 for the ports involved in the roll
Required/As Needed	As needed
Onsite/Remote	Onsite or remote
Security Level	Provisioning or higher

Step 1 From the View menu, choose **Go To Network View**.

Step 2 Click the **Circuits** tab.

Step 3 Press **Ctrl** and click the two circuits that you want to use in the roll process.

The circuits must have a DISCOVERED status; in addition, they must be the same size and direction for you to start a roll. The planned Roll To circuit must not carry traffic. The Roll To facility should be DCC connected to the source node of the Roll To circuit.

Step 4 From the Tools menu, choose **Circuits > Roll Circuit**.

Step 5 In the Roll Attributes area, complete the following ([Figure 18-16](#)):

- a. From the Circuit Roll Mode drop-down list, choose **Auto** to create an automatic roll (required for a 1-way source roll) or **Manual** to create a manual roll (required for 1-way destination roll).
- b. From the Circuit Roll Type drop-down list, choose **Single** to indicate that you want to roll a single connection from the Roll From circuit to the Roll To circuit.
- c. In the Roll From Circuit area, click the circuit that contains the Roll From connection.

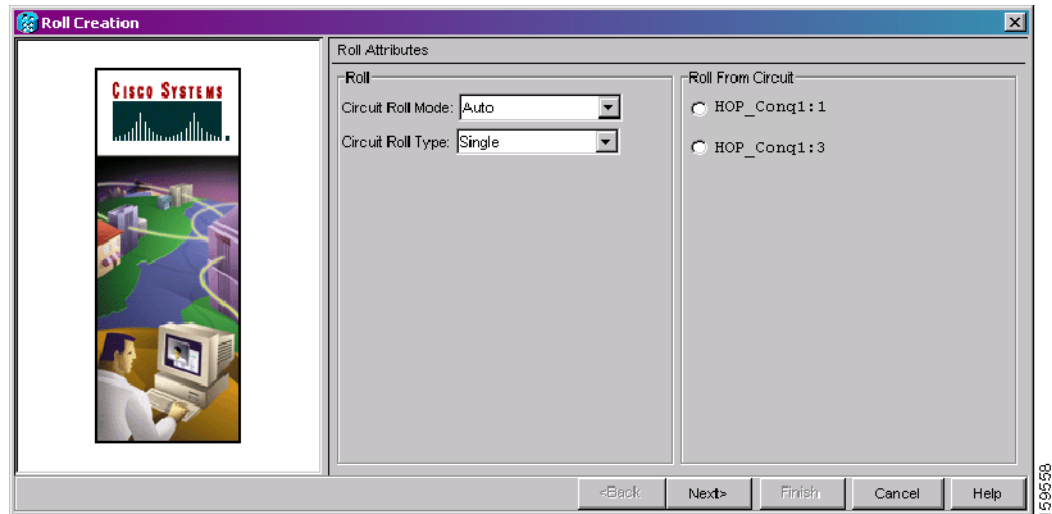
Figure 18-16 Selecting Roll Attributes for a Single Roll onto a Second Circuit

Step 6 Click **Next**.

Step 7 In the Pivot/Fixed Point 1 window, click the square representing the facility that you want to keep (Figure 18-13 on page 18-58).

This facility is the fixed location in the cross-connect involved in the roll process. The identifier appears in the text box below the graphic image. The facility that is not selected is the Roll From path. The Roll From path is deleted after the roll is completed.

Step 8 Click **Next**.

Step 9 In the Select New End Point area, choose the **Slot**, **Port**, and **VC3 or VC4** from the drop-down lists to identify the Roll To facility on the connection being rolled.

Step 10 Click **Finish**.

The statuses of the Roll From and Roll To circuits change from DISCOVERED to ROLL_PENDING in the Circuits tab.

Step 11 Click the **Rolls** tab. For the pending roll, view the Roll Valid Signal status. When one of the following conditions are met, continue with Step 12.

- If the Roll Valid Signal status is true, a valid signal was found on the new port.
- If the Roll Valid Signal status is false, a valid signal was not found. Wait until the signal is found before continuing with the next step. If the signal is not found, refer to the “General Troubleshooting” chapter in the *Cisco ONS 15600 SDH Troubleshooting Guide*. To cancel the roll, see the “DLP-F357 Cancel a Roll” task on page 18-70.
- The roll is a one-way destination roll and the Roll Valid Signal is false. It is not possible to get a “true” Roll Valid Signal status for a one-way destination roll.



Note You cannot cancel an automatic roll after a valid signal is found.

- A roll can be forced onto the Roll To Circuit destination without a valid signal by using the Force Valid Signal button. If you choose Force Valid Signal, traffic on the circuit that is involved in the roll will be dropped once the roll is completed.

- Step 12** If you selected Manual in [Step 5](#), click the roll on the Rolls tab and click **Complete** to route the traffic to the new port. If you selected Auto, continue with [Step 13](#).
- Step 13** For both manual and automatic rolls, click **Finish** to complete the circuit roll process.
The roll is cleared from the Rolls tab and the new rolled circuit on Circuits tab returns to the DISCOVERED status.
- Step 14** Return to your originating procedure (NTP).

DLP-F353 Roll Two Cross-Connects on One Optical Circuit Using Automatic Routing

Purpose	This task reroutes the network path while maintaining the same source and destination. This task allows CTC to automatically select a Roll To path.
Tools/Equipment	None
Prerequisite Procedures	DLP-F181 Log into CTC, page 16-34
Required/As Needed	As needed
Onsite/Remote	Onsite or remote
Security Level	Provisioning or higher



Note

This task optionally uses automatic routing. Automatic routing is not available if both the Automatic Circuit Routing NE default and the Network Circuit Automatic Routing Overridable NE default are set to FALSE. For a full description of these defaults see Appendix C, “Network Element Defaults,” in the *Cisco ONS 15600 SDH Reference Manual*.

- Step 1** From the View menu, choose **Go To Network View**.
- Step 2** Click the **Circuits tab**.
- Step 3** Click the circuit that has the connections that you want to roll. The circuit must have a DISCOVERED status for you to start a roll.
- Step 4** From the Tools menu, choose **Circuits > Roll Circuit**.
- Step 5** In the Roll Attributes area, complete the following ([Figure 18-17](#)):
- From the Circuit Roll Mode drop-down list, choose **Auto** to create an automatic roll or **Manual** to create a manual roll.
 - From the Circuit Type drop-down list, choose **Dual** to indicate that you want to roll two connections on the chosen circuit.

Figure 18-17 Selecting Dual Roll Attributes

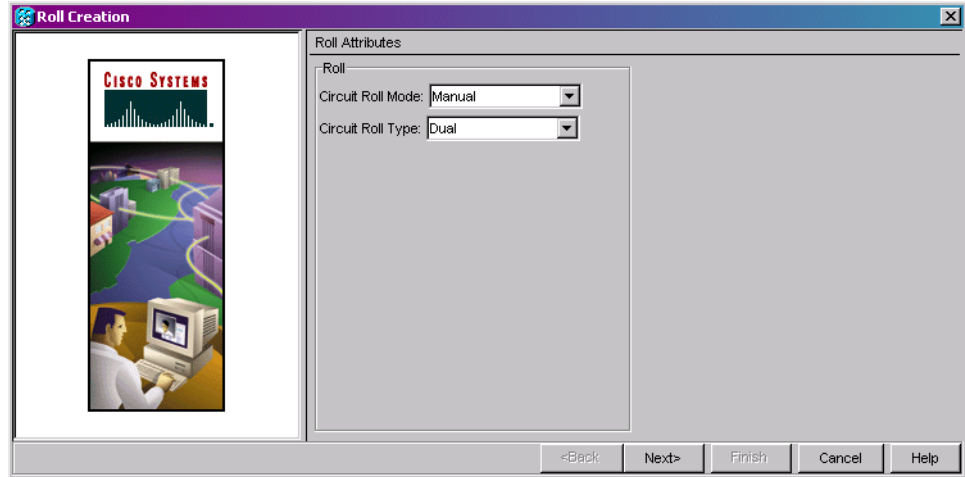

Step 6 Click **Next**.

Step 7 In the Pivot/Fixed Point 1 window, click the square representing the fixed path of the first connection to be rolled (Figure 18-13 on page 18-58).

This path is a fixed point in the cross connection involved in the roll process. The path identifier appears in the text box below the graphic image. The path that is not selected contains the Roll From path. The Roll From path is deleted after the roll is completed.

Step 8 Click **Next**.

Step 9 Complete one of the following:

- If multiple Roll From paths exist, the Select Roll From dialog box appears. Select the path from which you want to roll traffic and click **OK**.
- If multiple Roll From paths do not exist, continue with [Step 10](#). The circuit status for the Roll To path changes states from DISCOVERED to ROLL_PENDING.

Step 10 In the Pivot/Fixed Point 2 window, click the square that represents the fixed path of the second connection to be rolled.

The path that is not selected is the Roll From path. The Roll From path is deleted after the roll is completed. The path identifier appears in the text box below the graphic image.

Step 11 Click **Next**.

Step 12 In the Circuit Routing Preferences area, check **Route Automatically** to allow CTC to find the route (Figure 18-18). If you check Route Automatically, the following options are available:

- Using Required Nodes/Spans—If checked, you can specify nodes and spans to include or exclude in the CTC-generated circuit route in [Step 15](#).
- Review Route Before Creation—If checked, you can review and edit the circuit route before the circuit is created.

Figure 18-18 Setting Roll Routing Preferences

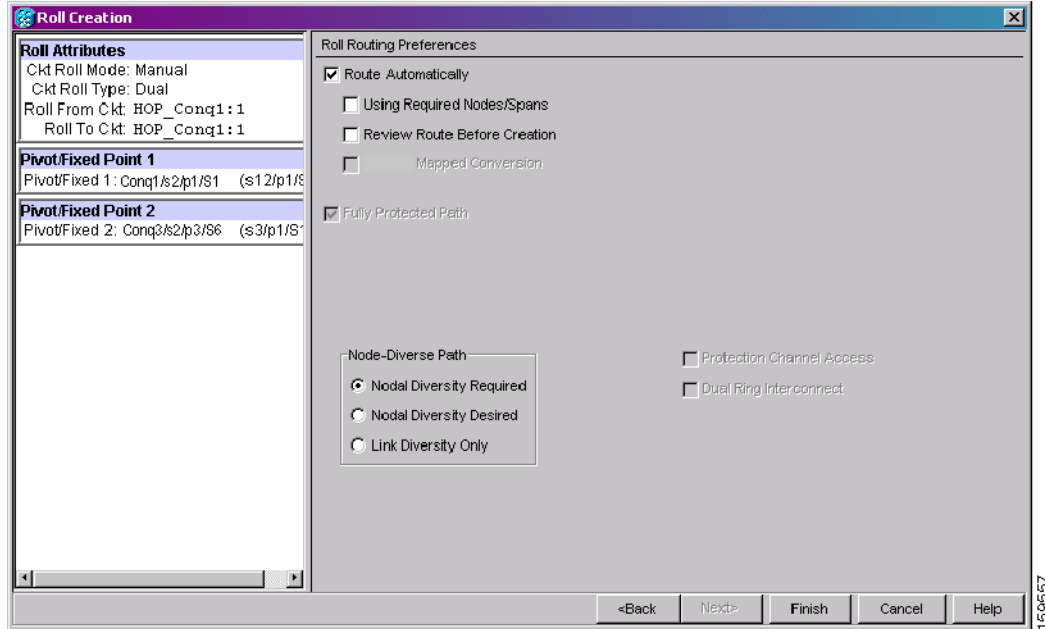

Step 13 To route the circuit over a protected path, check **Fully Protected Path**. (If you do not want to route the circuit on a protected path, continue with [Step 14](#).) CTC creates a primary and alternate circuit route (virtual SNCP) based on the following nodal diversity options. Select one of the following choices and follow subsequent window prompts to complete the routing:

- **Nodal Diversity Required**—Ensures that the primary and alternate paths within path-protected mesh network (PPMN) portions of the complete circuit path are nodally diverse.
- **Nodal Diversity Desired**—Specifies that node diversity should be attempted, but if node diversity is not possible, CTC creates link diverse paths for the PPMN portion of the complete circuit path.
- **Link Diversity Only**—Specifies that only link-diverse primary and alternate paths for PPMN portions of the complete circuit path are needed. The paths might be node-diverse, but CTC does not check for node diversity.

Step 14 If you checked Route Automatically in [Step 12](#):

- If you checked Using Required Nodes/Spans, continue with [Step 15](#).
- If you checked only Review Route Before Creation, continue with [Step 16](#).
- If you did not check Using Required Nodes/Spans or Review Route Before Creation, continue with [Step 17](#).

Step 15 If you checked Using Required Nodes/Spans in [Step 12](#):

- a. In the Roll Route Constraints area, click a node or span on the circuit map.
- b. Click **Include** to include the node or span in the circuit. Click **Exclude** to exclude the node/span from the circuit. The order in which you select included nodes and spans sets the circuit sequence. Click spans twice to change the circuit direction.
- c. Repeat [Step b](#) for each node or span you wish to include or exclude.
- d. Review the circuit route. To change the circuit routing order, select a node in the Required Nodes/Lines or Excluded Nodes Links lists, then click the **Up** or **Down** buttons to change the circuit routing order. Click **Remove** to remove a node or span.

- Step 16** If you checked Review Route Before Creation in [Step 12](#):
- In the Roll Route Review and Edit area, review the circuit route. To add or delete a circuit span, select a node on the circuit route. Blue arrows show the circuit route. Green arrows indicate spans that you can add. Click a span arrowhead, then click **Include** to include the span or **Remove** to remove the span.
 - If the provisioned circuit does not reflect the routing and configuration you want, click **Back** to verify and change circuit information.

Step 17 Click **Finish**.

In the Circuits tab, verify that a new circuit appears. This circuit is the Roll To circuit. It is designated with the Roll From circuit name appended with ROLL**.

Step 18 Click the **Rolls** tab. Two new rolls now appear. For each pending roll, view the Roll Valid Signal status. When one of the following requirements is met, continue with [Step 19](#).

- If the Roll Valid Signal status is true, a valid signal was found on the new port.
- If the Roll Valid Signal status is false, a valid signal was not found. Wait until the signal is found before continuing with the next step. If a valid signal is not found, refer to the *Cisco ONS 15600 SDH Troubleshooting Guide*. To cancel the roll, see the “[DLP-F357 Cancel a Roll](#)” task on page 18-70.
- The roll is a one-way destination roll and the Roll Valid signal status is false. It is not possible to get a Roll Valid Signal status of true for a one-way destination roll.



Note If you have completed a roll, you cannot cancel the sibling roll. You must cancel the two rolls together.



Note You cannot cancel an automatic roll after a valid signal is found.

- A roll can be forced onto the Roll To Circuit destination without a valid signal by using the Force Valid Signal button. If you choose Force Valid Signal, traffic on the circuit that is involved in the roll will be dropped once the roll is completed.

Step 19 If you selected Manual in [Step 5](#), click both rolls on the Rolls tab and click **Complete** to route the traffic to the new port. If you selected Auto, continue with [Step 20](#).



Note You cannot complete a roll if you cancelled the sibling roll. You must complete the two rolls together.

Step 20 For both manual and automatic rolls, click **Finish** to complete circuit roll process.

Step 21 Return to your originating procedure (NTP).

DLP-F354 Roll Two Cross-Connects on One Optical Circuit Using Manual Routing

Purpose	This task reroutes a network path of an optical circuit using manual routing.
Tools/Equipment	None
Prerequisite Procedures	DLP-F181 Log into CTC, page 16-34
Required/As Needed	As needed
Onsite/Remote	Onsite or remote
Security Level	Provisioning and higher

-
- Step 1** From the View menu, choose **Go To Network View**.
- Step 2** Click the **Circuits** tab.
- Step 3** Click the circuit that you want to roll to a new path. The circuit must have a DISCOVERED status for you to start a roll.
- Step 4** From the Tools menu, choose **Circuits > Roll Circuit**.
- Step 5** In the Roll Attributes area, complete the following ([Figure 18-17 on page 18-63](#)):
- From the Circuit Roll Mode drop-down list, choose **Auto** to create an automatic roll or **Manual** to create a manual roll.
 - From the Circuit Type drop-down list, choose **Dual** to indicate that you want to roll two connections on the chosen circuit.
- Step 6** Click **Next**.
- Step 7** In the Pivot/Fixed Point 1 window, click the square representing the fixed path of the first cross-connect to be rolled ([Figure 18-13 on page 18-58](#)).
- This path is a fixed point in the cross-connect involved in the roll process. The path identifier appears in the text box below the graphic image. The path that is not selected contains the Roll From path. The Roll From path is deleted after the roll is completed.
- Step 8** Click **Next**.
- Step 9** Complete one of the following:
- If multiple Roll From paths exist, the Select Roll From dialog box appears. Select the path from which you want to roll traffic and click **OK**, then click **Next** ([Figure 18-18 on page 18-64](#)).
 - If multiple Roll From paths do not exist, click **Next** and continue with [Step 10](#). The circuit status for the Roll From path changes from DISCOVERED to ROLL_PENDING.
- Step 10** In the Pivot/Fixed Point 2 window, click the square that represents the fixed path of the second connection to be rolled.
- The path that is not selected is the Roll From path. The Roll From path is deleted after the roll is complete. The path identifier appears in the text box below the graphic image.
- Step 11** Click **Next**.
- Step 12** In the Circuit Routing Preferences area, uncheck **Route Automatically**.
- Step 13** Set the circuit path protection:

- To route the circuit on a protected path, leave **Fully Protected Path** checked and continue with [Step 14](#).
- To create an unprotected circuit, uncheck **Fully Protected Path** and continue with [Step 15](#).

Step 14 If you checked Fully Protected Path, choose one of the following:

- **Nodal Diversity Required**—Ensures that the primary and alternate paths within the SNCP portions of the complete circuit path are nodally diverse.
- **Nodal Diversity Desired**—Specifies that node diversity is preferred, but if node diversity is not possible, CTC creates fiber-diverse paths for the SNCP portion of the complete circuit path.
- **Link Diversity Only**—Specifies that only fiber-diverse primary and alternate paths for SNCP portions of the complete circuit path are needed. The paths might be node-diverse, but CTC does not check for node diversity.

Step 15 Click **Next**. Beneath Route Review and Edit, node icons appear for you to route the circuit manually. The green arrows pointing from the source node to other network nodes indicate spans that are available for routing the circuit.

Step 16 Complete the “[DLP-F343 Provision an STM-N Circuit Route](#)” task on page 18-47.

Step 17 Click **Finish**. In the Circuits tab, verify that a new circuit appears.

This circuit is the Roll To circuit. It is designated with the Roll From circuit name appended with ROLL**.

Step 18 Click the **Rolls** tab. Two new rolls now appear on the Rolls tab. For each pending roll, view the Roll Valid Signal status. When one of the following conditions are met, continue with [Step 19](#).

- If the Roll Valid Signal status is true, a valid signal was found on the new port.
- If the Roll Valid Signal status is false, a valid signal was not found. Wait until the signal is found before continuing with the next step. If the signal is not found, refer to the “General Troubleshooting” chapter in the *Cisco ONS 15600 SDH Troubleshooting Guide*. To cancel the roll, see the “[DLP-F357 Cancel a Roll](#)” task on page 18-70.
- The roll is a one-way destination roll and the Roll Valid signal status is false. It is not possible to get a Roll Valid Signal status of true for a one-way destination roll.



Note You cannot cancel an automatic roll after a valid signal is found.

- A roll can be forced onto the Roll To Circuit destination without a valid signal by using the Force Valid Signal button. If you choose Force Valid Signal, traffic on the circuit that is involved in the roll will be dropped once the roll is completed.

Step 19 If you selected Manual in [Step 5](#), click each roll and click **Complete** to route the traffic to the new port. If you selected Auto, continue with [Step 20](#).



Note You cannot complete a roll if you cancelled the sibling roll. You must complete the two rolls together.

Step 20 For both manual and automatic rolls, click **Finish** to complete the circuit roll process.

Step 21 Return to your originating procedure (NTP).

DLP-F355 Roll Two Cross-Connects from One Optical Circuit to a Second Optical Circuit

Purpose	This task reroutes a network path using two optical circuits by allowing CTC to select the Roll To path on the second circuit automatically.
Tools/Equipment	None
Prerequisite Procedures	DLP-F181 Log into CTC, page 16-34
Required/As Needed	As needed
Onsite/Remote	Onsite or remote
Security Level	Provisioning and higher

Step 1 From the View menu, choose **Go To Network View**.

Step 2 Click the **Circuits** tab.

Step 3 Press **Ctrl** and click the two circuits that you want to use in the roll process.

The Roll From path will be on one circuit and the Roll To path will be on the other circuit. The circuits must have a DISCOVERED status and must be the same size and direction for you to start a roll. The planned Roll To circuit must not carry traffic. The first Roll To path must be DCC connected to the source node of the Roll To circuit, and the second Roll To path must be DCC connected to the destination node of the Roll To circuit.

Step 4 From the Tools menu, choose **Circuits > Roll Circuit**.

Step 5 In the Roll Attributes area, complete the following:

- a. From the Circuit Roll Mode drop-down list, choose **Auto** to create an automatic roll (required for a 1-way source roll) or **Manual** to create a manual roll (required for 1-way destination roll).
- b. From the Circuit Roll Type drop-down list, choose **Dual**.
- c. In the Roll From Circuit area, click the circuit that contains the Roll From path.

Step 6 Click **Next**.

Step 7 In the Pivot/Fixed Point 1 window, click the square representing the fixed path of the first cross-connect to be rolled ([Figure 18-13 on page 18-58](#)).

This path is a fixed point in the cross-connect involved in the roll process. The path identifier appears in the text box below the graphic image. The path that is not selected contains the Roll From path. The Roll From path is deleted after the roll is completed.

Step 8 Click **Next**.



Step 9 Complete one of the following:

- If multiple Roll From paths exist, the Select Roll From dialog box appears. Select the path from which you want to roll traffic and click **OK** ([Figure 18-18 on page 18-64](#)).
- If multiple Roll From paths do not exist, continue with [Step 10](#).

The circuit status for the Roll From path changes from DISCOVERED to ROLL PENDING.

Step 10 In the Pivot/Fixed Point 2 window, click the square that represents the fixed path of the second connection to be rolled.

The path that is not selected is the Roll From path. The Roll From path is deleted after the roll is completed. The path identifier appears in the text box below the graphic image.

- Step 11** Click **Next**.
- Step 12** Click **Finish**. In the Circuits tab, the Roll From and Roll To circuits change from the DISCOVERED status to ROLL RENDING.
- Step 13** Click the **Rolls** tab. Two new rolls now appear on the Rolls tab. For each pending roll, view the Roll Valid Signal status. When one of the following conditions are met, continue with [Step 14](#).
- If the Roll Valid Signal status is true, a valid signal was found on the new port.
 - If the Roll Valid Signal status is false, a valid signal was not found. Wait until the signal is found before continuing with the next step. If the signal is not found, refer to the “General Troubleshooting” chapter in the *Cisco ONS 15600 SDH Troubleshooting Guide*. To cancel the roll, see the “[DLP-F357 Cancel a Roll](#)” task on page 18-70.
 - The roll is a one-way destination roll and the Roll Valid signal status is false. It is not possible to get a Roll Valid Signal status of true for a one-way destination roll.
-
-  **Note** You cannot cancel an automatic roll after a valid signal is found.
-
- A roll can be forced onto the Roll To Circuit destination without a valid signal by using the Force Valid Signal button. If you choose Force Valid Signal, traffic on the circuit that is involved in the roll will be dropped once the roll is completed.
- Step 14** If you selected Manual in [Step 5](#), click both rolls on the Rolls tab and click **Complete** to route the traffic to the new port. If you selected Auto, continue with [Step 15](#).
-
-  **Note** You cannot complete a roll if you cancelled the sibling roll. You must complete the two rolls together.
-
- Step 15** For both manual and automatic rolls, click **Finish** to complete the circuit roll process.
- Step 16** Return to your originating procedure (NTP).
-

DLP-F356 Delete a Roll

Purpose	This task deletes a roll. Use caution when selecting this option, traffic may be affected. Delete a roll only if it cannot be completed or cancelled in normal ways. Circuits may have a PARTIAL status when this option is selected. See Table 18-3 on page 18-53 for a description of circuit statuses.
Tools/Equipment	None
Prerequisite Procedures	DLP-F181 Log into CTC, page 16-34
Required/As Needed	As needed
Onsite/Remote	Onsite or remote
Security Level	Provisioning or higher

- Step 1** From the View menu, choose **Go To Network View**.
- Step 2** Click the **Circuits > Rolls** tabs.

- Step 3** Click the rolled circuit that you want to delete.
- Step 4** From the Tools menu, choose **Circuits > Delete Rolls**.
- Step 5** In the confirmation dialog box, click **Yes**.
- Step 6** Return to your originating procedure (NTP).
-

DLP-F357 Cancel a Roll

Purpose	This task cancels a roll. When the roll mode is Manual, you can only cancel a roll before you click the Complete button. When the roll mode is Auto, cancel roll is only allowed before a good signal is detected by the node or before clicking the Force Valid Signal button. A dual or single roll can be cancelled before the roll state changes to ROLL_COMPLETED.
Tools/Equipment	None
Prerequisite Procedures	DLP-F181 Log into CTC, page 16-34 NTP-F181 Bridge and Roll Traffic, page 7-5
Required/As Needed	As needed
Onsite/Remote	Onsite or remote
Security Level	Provisioning or higher



Caution

If you click cancel while performing a Dual roll in Manual mode and have a valid signal detected on both rolls, you will see a dialog box stating that this can cause a traffic hit and asking if you want to continue with the cancellation. Cisco does not recommend cancelling a dual roll once a valid signal has been detected. To return the circuit to the original state, Cisco recommends completing the roll, then using bridge and roll again to roll the circuit back.

- Step 1** From the node or network view, click the **Circuits > Rolls** tabs.
- Step 2** Click the rolled circuit that you want to cancel.
- Step 3** Click **Cancel**.
- Step 4** Return to your originating procedure (NTP).
-

DLP-F358 Provision a Multirate PPM

Purpose	This task provisions multirate PPMs in CTC.
Tools/Equipment	None
Prerequisite Procedures	DLP-F181 Log into CTC, page 16-34
Required/As Needed	Required for 4PIO modules
Onsite/Remote	Onsite or remote
Security Level	Provisioning or higher

**Note**

The ASAP card hosts up to four 4PIO modules. Each 4PIO hosts four SFPs, which provide a fiber interface that must be provisioned as STM-1, STM-4, STM-16, or Gigabit Ethernet. SFPs are called pluggable port modules (PPMs) in CTC.

-
- Step 1** In node view, double-click the ASAP card where you want to provision PPM settings.
- Step 2** Click the **Provisioning > Pluggable Port Modules** tabs.
- Step 3** In the Pluggable Port Modules area, click **Create**. The Create PPM dialog box appears.
- Step 4** In the Create PPM dialog box, complete the following:
- PPM—Click the slot number where the SFP is installed from the drop-down list.
 - PPM Type—Click the number of ports supported by your SFP from the drop-down list. If only one port is supported, **PPM (1 port)** is the only option.
- Step 5** Click **OK**. The newly created port appears in the Pluggable Port Modules area. The row on the Pluggable Port Modules area turns light blue if the PPM is provisioned strictly as an optical PPM, or green if it is provisioned as a DWDM PPM. The Actual Equipment Type column lists the equipment name.
- Step 6** Verify that the PPM appears in the list in the Pluggable Port Modules area. If it does not, repeat Steps 3 through 5.
- Step 7** Repeat the task to provision a second PPM.
- Step 8** Click **OK**.
- Step 9** Continue with the [“DLP-F390 Provision an Optical Line Rate and Wavelength” task on page 18-104](#) to provision the line rate.
- Step 10** Return to your originating procedure (NTP).
-

DLP-F359 Change the Optical Line Rate

Purpose	This task changes PPM port rates for the ASAP card. Perform this task if you want to change the port rate on a multirate SFP that is already provisioned.
Tools/Equipment	None
Prerequisite Procedures	DLP-F181 Log into CTC, page 16-34
Required/As Needed	As needed
Onsite/Remote	Onsite or remote
Security Level	Provisioning or higher

-
- Step 1** In node view, double-click the ASAP card where you want to edit the PPM port rate.
- Step 2** Click the **Provisioning > Pluggable Port Modules** tabs.
- Step 3** Click the port with the port rate that you want to change in the Pluggable Ports area. The highlight changes to dark blue.
- Step 4** Click **Edit**. The Edit Port Rate dialog box appears.
- Step 5** In the Change To field, use the drop-down list to select the new port rate and click **OK**.

- Step 6** Click **Yes** in the Confirm Port Rate Change dialog box.
- Step 7** Return to your originating procedure (NTP).
-

DLP-F360 Delete a PPM

Purpose	This task deletes PPM provisioning for SFPs/XFPs on the ASAP card.
Tools/Equipment	None
Prerequisite Procedures	DLP-F181 Log into CTC , page 16-34
Required/As Needed	As needed
Onsite/Remote	Onsite or remote
Security Level	Provisioning or higher

- Step 1** Determine if you can delete the PPM. You cannot delete a port on a PPM if it is in service, part of a protection group, has a communications channel termination in use, is a timing source, has circuits, or has overhead circuits. As needed, complete the following procedures and task:
- [NTP-F204 Modify or Delete Optical 1+1 Port Protection Settings](#), page 11-4
 - [NTP-F205 Change Node Timing](#), page 11-5
 - [NTP-F209 Modify or Delete Communications Channel Terminations](#), page 11-8
 - [NTP-F177 Modify and Delete Circuits](#), page 7-2
 - [NTP-F178 Modify and Delete Overhead Circuits and Server Trails](#), page 7-3
 - [DLP-F254 Change the Service State for a Port](#), page 17-47
- Step 2** In node view, double-click the ASAP card where you want to delete PPM settings.
- Step 3** Click the **Provisioning > Pluggable Port Modules** tabs.
- Step 4** To delete a PPM and the associated ports:
- Click the PPM line that appears in the Pluggable Port Modules area. The highlight changes to dark blue.
 - Click **Delete**. The Delete PPM dialog box appears.
 - Click **Yes**. The PPM provisioning is removed from the Pluggable Port Modules area and the Pluggable Ports area.
- Step 5** Verify that the PPM provisioning is deleted:
- If the PPM was preprovisioned, CTC shows an empty slot in CTC after it is deleted.
 - If the SFP/XFP, 1PIO, or 4PIO (PIM) is physically present when you delete the PPM provisioning, CTC transitions to the deleted state, the ports (if any) are deleted, and the PPM is represented as a gray graphic in CTC. The SFP/XFP or PIM can be provisioned again in CTC, or the equipment can be removed, in which case the removal causes the graphic to disappear.
- Step 6** If you need to remove the SFP/XFP, see the [“DLP-F388 Remove an SFP/XFP” procedure on page 18-102](#). If you need to remove the 1PIO or 4PIO where the SFP/XFP is installed, see the [“DLP-F389 Remove a 1PIO or 4PIO \(PIM\) Module” procedure on page 18-103](#).

Step 7 Return to your originating procedure (NTP).

DLP-F361 Provision OSI Routing Mode

Purpose	This task provisions the Open System Interconnection (OSI) routing mode. Complete this task when the ONS 15600 SDH is connected to networks with third party network elements (NEs) that use the OSI protocol stack for data communications network (DCN) communication.
Tools/Equipment	None
Prerequisite Procedures	NTP-F131 Verify Card Installation, page 4-2
Required/As Needed	As needed
Onsite/Remote	Onsite
Security Level	Provisioning or higher



Caution

Do not complete this task until you confirm the role of the node within the network. It will be either an Intermediated System (IS) Level 1 or an IS Level 1/Level 2. This decision must be carefully considered. For additional information about OSI provisioning, refer to the “Management Network Connectivity” chapter of the *Cisco ONS 15600 SDH Reference Manual*.



Caution

Link State Protocol (LSP) buffers must be the same at all NEs within the network, or loss of visibility might occur. Do not modify the LSP buffers unless you confirm that all NEs within the OSI have the same buffer size.



Caution

LSP buffer sizes cannot be greater than the Link Access Protocol on the D Channel (LAP-D) maximum transmission unit (MTU) size within the OSI area.



Note

For ONS 15600 SDHs, twelve virtual routers can be provisioned. The node primary Network Service Access Point (NSAP) address is also the Router 1 primary manual area address. To edit the primary NSAP, you must edit the Router 1 primary manual area address. After you enable Router 1 on the Routers subtab, the Change Primary Area Address button is available to edit the address.

- Step 1** Complete the “[DLP-F181 Log into CTC](#)” task on page 16-34 at the node where you want to provision the OSI routing mode. If you are already logged in, continue with Step 2.
- Step 2** In node view, click the **Provisioning > OSI** tabs.
- Step 3** Choose a routing mode:
- **Intermediate System Level 1**—The ONS 15600 SDH performs OSI IS functions. It communicates with IS and End System (ES) nodes that reside within its OSI area. It depends upon an IS L1/L2 node to communicate with IS and ES nodes that reside outside its OSI area.

- **Intermediate System Level 1/Level 2**—The ONS 15600 SDH performs IS functions. It communicates with IS and ES nodes that reside within its OSI area. It also communicates with IS L1/L2 nodes that reside in other OSI areas. Before choosing this option, verify the following:
 - The node is connected to another IS Level 1/Level 2 node that resides in a different OSI area.
 - The node is connected to all nodes within its area that are provisioned as IS L1/L2.

Step 4 If needed, change the LSP data buffers:

- **L1 LSP Buffer Size**—Adjusts the Level 1 link state PDU buffer size. The default is 512. It should not be changed.
- **L2 LSP Buffer Size**—Adjusts the Level 2 link state PDU buffer size. The default is 512. It should not be changed.

Step 5 Return to your originating procedure (NTP).

DLP-F362 Provision or Modify TARP Operating Parameters

Purpose	This task provisions or modifies the Target Identifier Address Resolution Protocol (TARP) operating parameters including TARP PDU propagation, timers, and loop detection buffer (LDB).
Tools/Equipment	None
Prerequisite procedures	DLP-F181 Log into CTC, page 16-34
Required/As needed	As needed
Onsite/Remote	Onsite or remote
Security Level	Superuser only

Step 1 In node view, click the **Provisioning > OSI > TARP > Config** tabs.

Step 2 Provision the following parameters, as needed:

- **TARP PDUs L1 Propagation**—If checked (default), TARP Type 1 PDUs that are received by the node and are not excluded by the LDB are propagated to other NEs within the Level 1 OSI area. (Type 1 PDUs request a protocol address that matches a target identifier [TID] within a Level 1 routing area.) The propagation does not occur if the NE is the target of the Type 1 PDU, and PDUs are not propagated to the NE from which the PDU was received.



Note This parameter is not used when the Node Routing Area (Provisioning > OSI > Main Setup tab) is set to End System.

- **TARP PDUs L2 Propagation**—If checked (default), TARP Type 2 PDUs received by the node that are not excluded by the LDB are propagated to other NEs within the Level 2 OSI areas. (Type 2 PDUs request a protocol address that matches a TID within a Level 2 routing area.) The propagation occurs if the NE is not the target of the Type 2 PDU, and PDUs are not propagated to the NE from which the PDU was received.



Note This parameter is only used when the Node Routing Area is provisioned to Intermediate System Level 1/Level 2.

- TARP PDUs Origination—If checked (default), the node performs all TARP origination functions including:
 - TID to NSAP resolution requests (originate TARP Type 1 and Type 2 PDUs)
 - NSAP to TID requests (originate Type 5 PDUs)
 - TARP address changes (originate Type 4 PDUs)



Note TARP Echo and NSAP to TID is not supported.

- TARP Data Cache—If checked (default), the node maintains a TARP data cache (TDC). The TDC is a database of TID to NSAP pairs created from TARP Type 3 PDUs received by the node and modified by TARP Type 4 PDUs (TID to NSAP updates or corrections). TARP 3 PDUs are responses to Type 1 and Type 2 PDUs. The TDC can also be populated with static entries entered on the TARP > Static TDC tab.



Note This parameter is only used when the TARP PDUs Origination parameter is enabled.

- L2 TARP Data Cache—If checked (default), the TIDs and NSAPs of NEs originating Type 2 requests are added to the TDC before the node propagates the requests to other NEs.



Note This parameter is designed for Intermediate System Level 1/Level 2 nodes that are connected to other Intermediate System Level 1/Level 2 nodes. Enabling the parameter for Intermediate System Level 1 nodes is not recommended.

- LDB—If checked (default), enables the TARP loop detection buffer. The LDB prevents TARP PDUs from being sent more than once on the same subnet.



Note The LDB parameter is not used if the Node Routing Mode is provisioned to End System or if the TARP PDUs L1 Propagation parameter is not enabled.

- LAN TARP Storm Suppression—If checked (default), enables TARP storm suppression. This function prevents redundant TARP PDUs from being unnecessarily propagated across the LAN network.
- Send Type 4 PDU on Startup—If checked, a TARP Type 4 PDU is originated during the initial ONS 15600 SDH startup. Type 4 PDUs indicate that a TID or NSAP change has occurred at the NE. (The default setting is not enabled.)
- Type 4 PDU Delay—Sets the amount of time that will pass before the Type 4 PDU is generated when Send Type 4 PDU on Startup is enabled. 60 seconds is the default. The range is 0 to 255 seconds.



Note The Send Type 4 PDU on Startup and Type 4 PDU Delay parameters are not used if TARP PDUs Origination is not enabled.

- LDB Entry—Sets the TARP loop detection buffer timer. The LDB buffer time is assigned to each LDB entry for which the TARP sequence number (tar-seq) is zero. The default is 5 minutes. The range is 1 to 10 minutes.

- LDB Flush—Sets the frequency period for flushing the LDB. The default is 5 minutes. The range is 0 to 1440 minutes.
- T1—Sets the amount of time to wait for a response to a Type 1 PDU. Type 1 PDUs seek a specific NE TID within an OSI Level 1 area. The default is 15 seconds. The range is 0 to 3600 seconds.
- T2—Sets the amount of time to wait for a response to a Type 2 PDU. TARP Type 2 PDUs seek a specific NE TID value within OSI Level 1 and Level 2 areas. The default is 25 seconds. The range is 0 to 3600 seconds.
- T3—Sets the amount of time to wait for an address resolution request. The default is 40 seconds. The range is 0 to 3600 seconds.
- T4—Sets the amount of time to wait for an error recovery. This timer begins after the T2 timer expires without finding the requested NE TID. The default is 20 seconds. The range is 0 to 3600 seconds.



Note Timers T1, T2, and T4 are not used if TARP PDUs Origination is not enabled.

Step 3 Click **Apply**.

Step 4 Return to your originating procedure (NTP).

DLP-F363 Add a Static TID-to-NSAP Entry to the TARP Data Cache

Purpose	This task adds a static TID-to-NSAP entry to the TDC. The static entries are required for NEs that do not support TARP and are similar to static routes. For a specific TID, you must force a specific NSAP.
Tools/Equipment	None
Prerequisite procedures	DLP-F181 Log into CTC, page 16-34
Required/As needed	As needed
Onsite/Remote	Onsite or remote
Security Level	Provisioner or higher

Step 1 In node view, click the **Provisioning > OSI > TARP > Static TDC** tabs.

Step 2 Click **Add Static Entry**.

Step 3 In the Add Static Entry dialog box, enter the following:

- TID—Enter the TID of the NE. (For ONS nodes, the TID is the Node Name parameter on the node view Provisioning > General tab.)
- NSAP—Enter the OSI NSAP address in the NSAP field or, if preferred, click **Use Mask** and enter the address in the Masked NSAP Entry dialog box.

Step 4 Click **OK** to close the Masked NSAP Entry dialog box, if used, and then click **OK** to close the Add Static Entry dialog box.

Step 5 Return to your originating procedure (NTP).

DLP-F364 Remove a Static TID-to-NSAP Entry from the TARP Data Cache

Purpose	This task removes a static TID-to-NSAP entry from the TDC.
Tools/Equipment	None
Prerequisite procedures	DLP-F181 Log into CTC, page 16-34
Required/As needed	As needed
Onsite/Remote	Onsite or remote
Security Level	Provisioner or higher

-
- Step 1** In node view, click the **Provisioning > OSI > TARP > Static TDC** tabs.
- Step 2** Click the static entry that you want to delete.
- Step 3** Click **Delete Static Entry**.
- Step 4** In the Delete TDC Entry dialog box, click **Yes**.
- Step 5** Return to your originating procedure (NTP).
-

DLP-F365 Add a TARP Manual Adjacency Table Entry

Purpose	This task adds an entry to the TARP manual adjacency table (MAT). Entries are added to the MAT when the ONS 15600 SDH must communicate across routers or non-SDH NEs that lack TARP capability.
Tools/Equipment	None
Prerequisite procedures	DLP-F181 Log into CTC, page 16-34
Required/As needed	As needed
Onsite/Remote	Onsite or remote
Security Level	Provisioning or higher

-
- Step 1** In the node view, click the **Provisioning > OSI > TARP > MAT** tabs.
- Step 2** Click **Add**.
- Step 3** In the Add TARP Manual Adjacency Table Entry dialog box, enter the following:
- **Level**—Sets the TARP Type Code that will be sent:
 - **Level 1**—Indicates that the adjacency is within the same area as the current node. The entry generates Type 1 PDUs.
 - **Level 2**—Indicates that the adjacency is in a different area than the current node. The entry generates Type 2 PDUs.
 - **NSAP**—Enter the OSI NSAP address in the NSAP field or, if preferred, click **Use Mask** and enter the address in the Masked NSAP Entry dialog box.
- Step 4** Click **OK** to close the Masked NSAP Entry dialog box, if used, and then click **OK** to close the Add Static Entry dialog box.

Step 5 Return to your originating procedure (NTP).

DLP-F366 Provision OSI Routers

Purpose	This task enables an OSI router and edits its primary manual area address.
Tools/Equipment	None
Prerequisite Procedures	NTP-F131 Verify Card Installation, page 4-2
Required/As Needed	As needed
Onsite/Remote	Onsite or remote
Security Level	Provisioning or higher



Note

Router 1 must be enabled before you can enable and edit the primary manual area addresses for Routers 2 through 12.



Note

The Router 1 manual area address, System ID, and Selector “00” create the node NSAP address. Changing the Router 1 manual area address changes the node’s NSAP address.



Note

The System ID for Router 1 is the node MAC address. The System IDs for Routers 2 through 12 are created by adding 1 through 12 respectively to the Router 1 System ID. You cannot edit the System IDs.

Step 1 Complete the “[DLP-F181 Log into CTC](#)” task on page 16-34 at the node of the OSI routers that you want to provision.

Step 2 Click the **Provisioning > OSI > Routers > Setup** tabs.

Step 3 Chose the router you want provision and click **Edit**. The OSI Router Editor dialog box appears.

Step 4 In the OSI Router Editor dialog box:

- a. Check **Enable Router** to enable the router and make its primary area address available for editing.
- b. Click the manual area address, then click **Edit**.
- c. In the Edit Manual Area Address dialog box, edit the primary area address in the Area Address field. If you prefer, click **Use Mask** and enter the edits in the Masked NSAP Entry dialog box. The address (hexadecimal format) can be 8 to 24 alphanumeric characters (0–9, a–f) in length.
- d. Click **OK** successively to close the following dialog boxes: Masked NSAP Entry (if used), Edit Manual Area Address, and OSI Router Editor.

Step 5 Return to your originating procedure (NTP).

DLP-F367 Provision Additional Manual Area Addresses

Purpose	This task provisions the OSI manual area addresses. One primary and two additional manual areas can be created for each virtual router.
Tools/Equipment	None
Prerequisite Procedures	NTP-F131 Verify Card Installation, page 4-2 DLP-F366 Provision OSI Routers, page 18-78
Required/As Needed	As needed
Onsite/Remote	Onsite or remote
Security Level	Provisioning or higher

-
- Step 1** Click the **Provisioning > OSI > Routers > Setup** tabs.
- Step 2** Chose the router where you want provision an additional manual area address and click **Edit**. The OSI Router Editor dialog box appears.
- Step 3** In the OSI Router Editor dialog box:
- Check **Enable Router** to enable the router and make its primary area address available for editing.
 - Click the manual area address, then click **Add**.
 - In the Add Manual Area Address dialog box, enter the primary area address in the Area Address field. If you prefer, click **Use Mask** and enter the address in the Masked NSAP Entry dialog box. The address (hexadecimal format) can be 2to 24 alphanumeric characters (0–9, a–f) in length.
 - Click **OK** successively to close the following dialog boxes: Masked NSAP Entry (if used), Add Manual Area Address, and OSI Router Editor.
- Step 4** Return to your originating procedure (NTP).
-

DLP-F368 Enable the OSI Subnet on the LAN Interface

Purpose	This task enables the OSI subnetwork point of attachment on the LAN interface.
Tools/Equipment	None
Prerequisite Procedures	NTP-F131 Verify Card Installation, page 4-2
Required/As Needed	As needed
Onsite/Remote	Onsite or remote
Security Level	Provisioning or higher



Note

OSI subnetwork points of attachment are enabled on DCCs when you create DCCs. See the “[DLP-F253 Provision RS-DCC Terminations](#)” task on page 17-45 and the “[DLP-F314 Provision MS-DCC Terminations](#)” task on page 18-14.



Note

If Secure Mode is on, the OSI Subnet is enabled on the backplane LAN port, not the TSC port.

-
- Step 1** Complete the “[DLP-F181 Log into CTC](#)” task on page 16-34 at the node whose OSI routers you want to provision.
- Step 2** Click the **Provisioning > OSI > Routers > Subnet** tabs.
- Step 3** Click **Enable LAN Subnet**.
- Step 4** In the Enable LAN Subnet dialog box, complete the following fields:
- ESH—Sets the End System Hello (ESH) propagation frequency on ONS nodes that can be provisioned as end system NEs. The field is not used by the ONS 15600 SDH.
 - ISH—Sets the Intermediate System Hello PDU propagation frequency. Intermediate system NEs send ISHs to other ESs and ISs to inform them about the IS NETs it serves. The default is 10 seconds. The range is 10 to 1000 seconds.
 - IIS—Sets the Intermediate System to Intermediate System Hello PDU propagation frequency. The IS-IS Hello PDUs establish and maintain adjacencies between ISs. The default is 3 seconds. The range is 1 to 600 seconds.
 - IS-IS Cost—Sets the cost for sending packets on the LAN subnet. The IS-IS protocol uses the cost to calculate the shortest routing path. The default IS-IS cost for LAN subnets is 20. It normally should not be changed.
 - DIS Priority—Sets the designated intermediate system (DIS) priority. In IS-IS networks, one router is elected to serve as the DIS (LAN subnets only). Cisco router DIS priority is 64. For the ONS 15454 LAN subnet, the default DIS priority is 63. It normally should not be changed.
- Step 5** Click **OK**.
- Step 6** Return to your originating procedure (NTP).
-

DLP-F369 Create an IP-Over-CLNS Tunnel

Purpose	This task creates an IP-over-Connectionless Network Layer Service (CLNS) tunnel to allow ONS 15600 SDHs to communicate across equipment and networks that use the OSI protocol stack.
Tools/Equipment	None
Prerequisite Procedures	NTP-F131 Verify Card Installation, page 4-2
Required/As Needed	As needed
Onsite/Remote	Onsite or remote
Security Level	Provisioning or higher



Caution

IP-over-CLNS tunnels require two endpoints. You will create one point on an ONS 15600 SDH. The other end point is generally provisioned on non-ONS equipment including routers and other vendor NEs. Before you begin, verify that you have the capability to create an OSI-over-IP tunnel on the other equipment location.

- Step 1** Complete the “[DLP-F181 Log into CTC](#)” task on page 16-34 at the node of the OSI routers that you want to provision.
- Step 2** Click the **Provisioning > OSI > Tunnels** tabs.

Step 3 Click **Create**.

Step 4 In the Create IP Over OSI Tunnel dialog box, complete the following fields:

- Tunnel Type—Choose a tunnel type:
 - **Cisco**—Creates the proprietary Cisco IP tunnel. Cisco IP tunnels add the CLNS header to the IP packets.
 - **GRE**—Creates a Generic Routing Encapsulation tunnel. GRE tunnels add the CLNS header and a GRE header to the IP packets.

The Cisco proprietary tunnel is slightly more efficient than the GRE tunnel because it does not add the GRE header to each IP packet. The two tunnel types are not compatible. Most Cisco routers support the Cisco IP tunnel, while only a few support both GRE and Cisco IP tunnels. You generally should create Cisco IP tunnels if you are tunneling between two Cisco routers or between a Cisco router and an ONS node.



Caution

Always verify that the IP-over-CLNS tunnel type you choose is supported by the equipment at the other end of the tunnel.

- Node Address—Enter the IP address of the IP-over-CLNS tunnel destination.
- Subnet Mask—Enter the IP address subnet mask of the IP-over-CLNS destination.
- OSPF Cost—Enter the Open Shortest Path First (OSPF) cost for sending packets across the IP-over-CLNS tunnel. The OSPF cost is used by OSPF routers to calculate the shortest path. The default is 110. Normally, it is not be changed unless you are creating multiple tunnel routes and want to prioritize routing by assigning different metrics.
- NSAP—Enter the destination NE or OSI router NSAP address.

Step 5 Click **OK**.

Step 6 Provision the other tunnel endpoint using the documentation for the other equipment.

Step 7 Return to your originating procedure (NTP).

DLP-F370 Remove a TARP Manual Adjacency Table Entry

Purpose	This task removes an entry from the TARP manual adjacency table.
Tools/Equipment	None
Prerequisite procedures	DLP-F181 Log into CTC, page 16-34
Required/As needed	As needed
Onsite/Remote	Onsite or remote
Security Level	Provisioning or higher



Caution

If TARP manual adjacency is the only means of communication to a group of nodes, loss of visibility will occur when the adjacency table entry is removed.

Step 1 In node view, click the **Provisioning > OSI > TARP > MAT** tabs.

- Step 2** Click the MAT entry that you want to delete.
- Step 3** Click **Remove**.
- Step 4** In the Delete TDC Entry dialog box, click **OK**.
- Step 5** Return to your originating procedure (NTP).

DLP-F371 Change the OSI Routing Mode

Purpose	This task changes the OSI routing mode.
Tools/Equipment	None
Prerequisite procedures	DLP-F181 Log into CTC, page 16-34
Required/As needed	As needed
Onsite/Remote	Onsite or remote
Security Level	Provisioning or higher



Caution

Do not complete this procedure until you confirm the role of the node within the network. It will be either an IS Level 1 or an IS Level 1/Level 2. This decision must be carefully considered. For additional information about OSI provisioning, refer to the “Management Network Connectivity” chapter of the *Cisco ONS 15600 SDH Reference Manual*.



Caution

LSP buffers must be the same at all NEs within the network, or loss of visibility could occur. Do not modify the LSP buffers unless you are sure that all NEs within the OSI have the same buffer size.



Caution

LSP buffer sizes cannot be greater than the LAP-D MTU size within the OSI area.

- Step 1** Verify that all L1/L2 virtual routers on the NE must reside in the same area. This means that all neighboring virtual routers must have at least one common area address.
- Step 2** In node view, click the **Provisioning > OSI > Main Setup** tabs.
- Step 3** Choose one of the following routing modes:
- **Intermediate System Level 1**—The ONS 15600 SDH performs OSI IS functions. It communicates with IS and ES nodes that reside within its OSI area. It depends upon an IS L1/L2 node to communicate with IS and ES nodes that reside outside its OSI area.
 - **Intermediate System Level 1/Level 2**—The ONS 15600 SDH performs IS functions. It communicates with IS and ES nodes that reside within its OSI area. It also communicates with IS L1/L2 nodes that reside in other OSI areas. Before choosing this option, verify the following:
 - The node is connected to another IS Level 1/Level 2 node that resides in a different OSI area.
 - The node is connected to all nodes within its area that are provisioned as IS L1/L2.



Note Changing a routing mode should be carefully considered. Additional information about OSI systems and protocols are provided in the “Management Network Connectivity” chapter of the *Cisco ONS 15600 SDH Reference Manual*.

- Step 4** Although Cisco does not recommend changing the Link State Protocol Data Unit (LSP) buffer sizes, you can adjust the buffers in the following fields:
- L1 LSP Buffer Size—Adjusts the Level 1 link state PDU buffer size.
 - L2 LSP Buffer Size—Adjusts the Level 2 link state PDU buffer size.
- Step 5** Return to your originating procedure (NTP).

DLP-F372 Edit the OSI Router Configuration

Purpose	This task allows you to edit the OSI router configuration, including enabling and disabling OSI routers, editing the primary area address, and creating or editing additional area addresses.
Tools/Equipment	None
Prerequisite procedures	DLP-F181 Log into CTC, page 16-34
Required/As needed	As needed
Onsite/Remote	Onsite or remote
Security Level	Provisioning or higher

- Step 1** Click the **Provisioning > OSI > Routers > Setup** tabs.
- Step 2** Chose the router you want provision and click **Edit**.
- Step 3** In the OSI Router Editor dialog box:
- a. Check or uncheck the Enabled box to enable or disable the router.



Note Router 1 must be enabled before you can enable Routers 2 through 12.

- b. For enabled routers, edit the primary area address, if needed. The address can be between 8 and 24 alphanumeric characters in length.
 - c. If you want to add or edit an area address to the primary area, enter the address at the bottom of the Multiple Area Addresses area. The area address can be 2 to 26 numeric characters (0–9) in length. Click **Add**.
 - d. Click **OK**.
- Step 4** Return to your originating procedure (NTP).

DLP-F373 Edit the OSI Subnetwork Point of Attachment

Purpose	This task allows you to view and edit the OSI subnetwork point of attachment parameters. The parameters are initially provisioned when you create a regenerator section DCC (RS-DCC) or multiplex section DCC (MS-DCC), or when you enable the LAN subnet.
Tools/Equipment	None
Prerequisite procedures	DLP-F181 Log into CTC, page 16-34
Required/As needed	As needed
Onsite/Remote	Onsite or remote
Security Level	Provisioning or higher

-
- Step 1** In the node view, click the **Provisioning > OSI > Routers > Subnet** tabs.
- Step 2** Choose the subnet you want to edit, then click **Edit**.
- Step 3** In the Edit *subnet type* Subnet *slot/port* dialog box, edit the following fields:
- ESH—The End System Hello PDU propagation frequency. The field is not used by the ONS 15600 SDH.
 - ISH—The Intermediate System Hello PDU propagation frequency. An intermediate system NE sends ISHs to other ESs and ISs to inform them about the NETs it serves. The default is 10 seconds. The range is 10 to 1000 seconds.
 - IIH—The Intermediate System to Intermediate System Hello PDU propagation frequency. The IS-IS Hello PDUs establish and maintain adjacencies between ISs. The default is 3 seconds. The range is 1 to 600 seconds.



Note The IS-IS Cost and DIS Priority parameters are provisioned when you create or enable a subnet. You cannot change the parameters after the subnet is created. To change the DIS Priority and IS-IS Cost parameters, delete the subnet and create a new one.

Click **OK**.

- Step 4** Return to your originating procedure (NTP).
-

DLP-F374 Edit an IP-Over-CLNS Tunnel

Purpose	This task allows you to edit the parameters of an IP-over-CLNS tunnel.
Tools/Equipment	None
Prerequisite procedures	DLP-F369 Create an IP-Over-CLNS Tunnel, page 18-80 DLP-F181 Log into CTC, page 16-34
Required/As needed	As needed
Onsite/Remote	Onsite or remote
Security Level	Provisioning or higher

**Caution**

Changing the IP or NSAP addresses on an IP-over-CLNS tunnel can cause loss of NE visibility or NE isolation. Do not change network addresses until you verify the changes with your network administrator.

Step 1 Click the **Provisioning > OSI > Tunnels** tabs.

Step 2 Click **Edit**.

Step 3 In the Edit IP Over OSI Tunnel dialog box, complete the following fields:

- Tunnel Type—Edit the tunnel type:
 - **Cisco**—Creates the proprietary Cisco IP tunnel. Cisco IP tunnels add the CLNS header to the IP packets.
 - **GRE**—Creates a Generic Routing Encapsulation tunnel. GRE tunnels add the CLNS header and a GRE header to the IP packets.

The Cisco proprietary tunnel is slightly more efficient than the GRE tunnel because it does not add the GRE header to each IP packet. The two tunnel types are not compatible. Most Cisco routers support the Cisco IP tunnel, while only a few support both GRE and Cisco IP tunnels. You generally should create Cisco IP tunnels if you are tunneling between two Cisco routers or between a Cisco router and an ONS node.

**Caution**

Always verify that the IP-over-CLNS tunnel type you choose is supported by the equipment at the other end of the tunnel.

- Node Address—Enter the IP address of the IP-over-CLNS tunnel destination.
- Subnet Mask—Enter the IP address subnet mask of the IP-over-CLNS destination.
- OSPF Cost—Enter the OSPF cost for sending packets across the IP-over-CLNS tunnel. The OSPF cost is used by OSPF routers to calculate the shortest path. The default is 110. Normally, it is not be changed unless you are creating multiple tunnel routes and want to prioritize routing by assigning different metrics.
- NSAP—Enter the destination NE or OSI router NSAP address.

Step 4 Click **OK**.

Step 5 Return to your originating procedure (NTP).

DLP-F375 Delete an IP-Over-CLNS Tunnel

Purpose	This task allows you to delete an IP-over-CLNS tunnel.
Tools/Equipment	None
Prerequisite procedures	DLP-F181 Log into CTC, page 16-34
Required/As needed	As needed
Onsite/Remote	Onsite or remote
Security Level	Provisioning or higher

**Caution**

Deleting an IP-over-CLNS tunnel might cause the nodes to lose visibility or cause node isolation. If node isolation occurs, onsite provisioning might be required to regain connectivity. Always confirm tunnel deletions with your network administrator.

-
- Step 1** Click the **Provisioning > OSI > Tunnels** tabs.
- Step 2** Choose the IP-over-CLNS tunnel that you want to delete.
- Step 3** Click **Delete**.
- Step 4** Click **OK**.
- Step 5** Return to your originating procedure (NTP).
-

DLP-F376 View IS-IS Routing Information Base

Purpose This task allows you to view the IS-IS protocol routing information base (RIB). IS-IS is an OSI routing protocol that floods the network with information about NEs on the network. Each NE uses the information to build a complete and consistent picture of a network topology. The IS-IS RIB shows the network view from the perspective of the IS node.

Tools/Equipment None

Prerequisite procedures [DLP-F181 Log into CTC, page 16-34](#)

Required/As needed As needed

Onsite/Remote Onsite or remote

Security Level Provisioning or higher

-
- Step 1** In the node view, click the **Maintenance > OSI > IS-IS RIB** tabs.
- Step 2** View the following RIB information for Router 1:
- **Subnet Type**—Indicates the OSI subnetwork point of attachment type used to access the destination address. Subnet types include RS-DCC, MS-DCC, GCC, OSC, and LAN.
 - **Location**—Indicates the OSI subnetwork point of attachment. For DCC subnets, the slot and port are displayed. LAN subnets are shown as LAN.
 - **Destination Address**—The destination NSAP of the IS.
 - **MAC Address**—For destination NEs that are accessed by LAN subnets, the NE MAC address.
- Step 3** If additional routers are enabled, you can view their RIBs by choosing the router number in the Router field and clicking **Refresh**.
- Step 4** Return to your originating procedure (NTP).
-

DLP-F377 View ES-IS Routing Information Base

Purpose	This task allows you to view the End System to Intermediate System (ES-IS) protocol RIB. ES-IS is an OSI protocol that defines how end systems (hosts) and intermediate systems (routers) learn about each other. For ESs, the ES-IS RIB shows the IS used to access the OSI network. For ISs, the only OSI level that can be provisioned on the ONS 15600 SDH, the ES-IS RIB shows the ESs connected to the IS node.
Tools/Equipment	None
Prerequisite procedures	DLP-F181 Log into CTC, page 16-34
Required/As needed	As needed
Onsite/Remote	Onsite or remote
Security Level	Provisioning or higher

-
- Step 1** In the node view, click the **Maintenance > OSI > ES-IS RIB** tabs.
- Step 2** View the following RIB information for Router 1:
- Subnet Type—Indicates the OSI subnetwork point of attachment type used to access the destination address. Subnet types include RS-DCC, MS-DCC, GCC, OSC, and LAN.
 - Location—Indicates the subnet interface. For DCC subnets, the slot and port are displayed. LAN subnets are shown as LAN.
 - Destination Address—The destination IS NSAP.
 - MAC Address—For destination NEs that are accessed by LAN subnets, the NE MAC address.
- Step 3** If additional routers are enabled, you can view their RIBs by choosing the router number in the Router field and clicking **Refresh**.
- Step 4** Return to your originating procedure (NTP).
-

DLP-F378 Manage the TARP Data Cache

Purpose	This task allows you to view and manage the TDC. The TDC facilitates TARP processing by storing a list of TID to NSAP mappings.
Tools/Equipment	None
Prerequisite procedures	DLP-F181 Log into CTC, page 16-34
Required/As needed	As needed
Onsite/Remote	Onsite or remote
Security Level	Provisioning or higher

-
- Step 1** In the node view, click the **Maintenance > OSI > TDC** tabs.
- Step 2** View the following TDC information:
- TID—The target identifier of the originating NE. For ONS 15600 SDHs, the TID is the name entered in the Node Name/TID field on the Provisioning > General tab.

- NSAP/NET—The Network Service Access Point or Network Element Title of the originating NE.
- Type—Indicates how the TDC entry was created:
 - **Dynamic**—The entry was created through the TARP propagation process.
 - **Static**—The entry was manually created and is a static entry.

Step 3 If you want to query the network for an NSAP that matches a TID, complete the following steps. Otherwise, continue with [Step 4](#).



Note The TID to NSAP function is not available if the TDC is not enabled on the Provisioning > OSI > TARP subtab.

- a. Click the **TID to NSAP** button.
- b. In the TID to NSAP dialog box, enter the TID you want to map to an NSAP.
- c. Click **OK**, then click **OK** on the information message.
- d. On the TDC tab, click **Refresh**.

If TARP finds the TID in its TDC it returns the matching NSAP. If not, TARP sends PDUs across the network. Replies will return to the TDC later, and a check TDC later message is displayed.

Step 4 If you want to delete all the dynamically generated TDC entries, click the **Flush Dynamic Entries** button. If not, continue with [Step 5](#).

Step 5 Return to your originating procedure (NTP).

DLP-F379 Export CTC Data

Purpose	This task exports CTC table data for use by other applications such as spreadsheets, word processors, and database management applications. You can also export data from the Edit Circuits window.
Equipment/Tools	None
Prerequisite Procedures	DLP-F181 Log into CTC, page 16-34
Required/As Needed	As needed
Onsite/Remote	Onsite or remote
Security Level	Retrieve or higher

Step 1 Click the CTC tab containing the information you want to export (for example, the Alarms or Circuits tab).

Step 2 If you want to export detailed circuit information, complete the following:

- a. In the Circuits window, choose a circuit and click **Edit** to open it in the Edit Circuits window.
- b. In the Edit Circuits window, choose the desired tab: Drops, SNCP Selectors, SNCP Switch Counts, State, or Merge.



Note Depending upon your configuration, you may or may not see all of the above tabs when you click Edit.

Step 3 From the CTC File menu, click **Export**.

Step 4 In the Export dialog box choose a format for the data (Figure 18-19):

- **As HTML**—Saves the data as an HTML file. The file can be viewed with a web browser without running CTC.
- **As CSV**—Saves the CTC table values as text, separated by commas. You can import CSV data into spreadsheets and database management programs.
- **As TSV**—Saves the CTC table values as text, separated by tabs. You can import TSV data into spreadsheets and database management programs.

Figure 18-19 Selecting CTC Data for Export

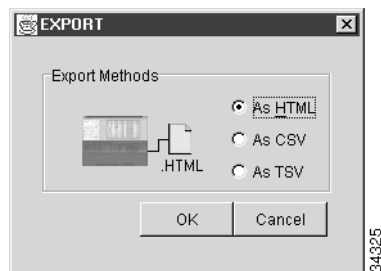

Step 5 If you want to open a file in a text editor or word processor application, procedures vary; typically you can use the **File > Open** command to display the CTC data, or you can double-click the file name and choose an application such as Notepad.

Text editor and word processor applications display the data exactly as it is exported, including comma or tab separators. All applications that open the data files allow you to format the data.

Step 6 If you want to open the file in spreadsheet and database management applications, procedures vary; typically you need to open the application and choose **File > Import**, then choose a delimited file to display the data in cells.

Spreadsheet and database management programs also allow you to manage the exported data.



Note An exported file cannot be opened in CTC.

As the export operation applies to tabular data only, it is not available for the following CTC tabs and subtabs:

- Provisioning > General window
- Provisioning > SNMP window
- Provisioning > Timing window
- Provisioning > Network > Internal Subnet window
- Provisioning > Network > General window
- Provisioning > Security > Policy window
- Provisioning > Security > Access window
- Provisioning > Security > Legal Disclaimer window
- Provisioning > OSI > Main Setup window
- Provisioning > OSI > TARP > Config window

- Maintenance > Database window
- Maintenance > Protection window
- Maintenance > Diagnostic window
- Maintenance > Preferred Copy window
- Maintenance > Timing > Source window

Step 7 Click **OK**.

Step 8 In the Save dialog box, enter a file name in one of the following formats:

- *filename.htm* for HTML files
- *filename.csv* for CSV files
- *filename.tsv* for TSV files

Step 9 Navigate to a directory where you want to store the file.

Step 10 Click **OK**.

Step 11 Return to your originating procedure (NTP).

DLP-F380 Configure the Node for RADIUS Authentication

Purpose	This task allows you to configure a node for Remote Authentication Dial In User Service (RADIUS) authentication. RADIUS validates remote users who are attempting to connect to the network.
Tools/Equipment	None
Prerequisite procedures	DLP-F181 Log into CTC, page 16-34
	Before configuring the node for RADIUS authentication, you must first add the node as a network device on the RADIUS server. Refer to the <i>User Guide for Cisco Secure ACS for Windows Server</i> for more information about configuring a RADIUS server.
Required/As needed	As needed
Onsite/Remote	Onsite or remote
Security Level	Superuser only



Caution

Do not configure a node for RADIUS authentication until after you have added that node to the RADIUS server and added the RADIUS server to the list of authenticators. If you do not add the node to a RADIUS server prior to activating RADIUS authentication, no user will be able to access the node. Refer to the *User Guide for Cisco Secure ACS for Windows Server* for more information about adding a node to a RADIUS server.



Note

The following Cisco vendor-specific attribute (VSA) needs to be specified when adding users to the RADIUS server:
 shell:priv-lvl=N, where N is:
 0 for Retrieve User

- 1 for Maintenance User
- 2 for Provisioning User
- 3 for Super User

Step 1 In node view, click the **Provisioning > Security > RADIUS Server** tabs (Figure 18-20).

Figure 18-20 RADIUS Server Tab

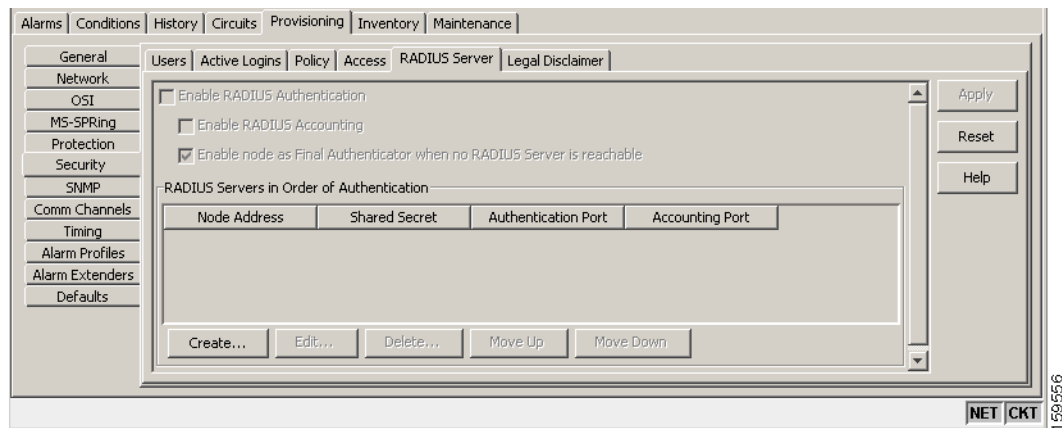

Step 2 Click **Create** to add a RADIUS server to the list of authenticators. The Create RADIUS Server Entry window appears (Figure 18-21).

Figure 18-21 Create RADIUS Server Entry Window

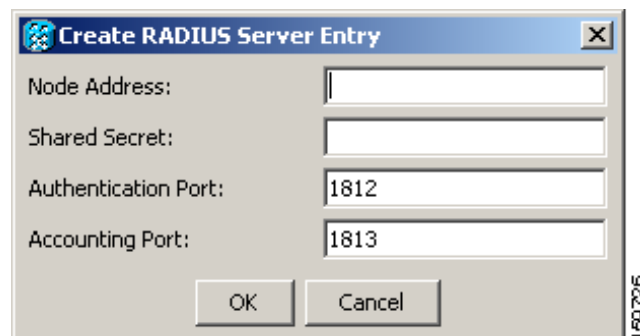

Step 3 Enter the RADIUS server IP address in the node Address field. If the node is an end network element (ENE), enter the IP address of the gateway network element (GNE) in this field.

The GNE passes authentication requests from the ENEs in its network to the RADIUS server, which grants authentication if the GNE is listed as a client on the server.



Caution

Because the ENE nodes use the GNE to pass authentication requests to the RADIUS server, you must add the ENEs to the RADIUS server individually for authentication. If you do not add the ENE node to a RADIUS server prior to activating RADIUS authentication, no user will be able to access the node. Refer to the *User Guide for Cisco Secure ACS for Windows Server* for more information about adding a node to a RADIUS server.

- Step 4** Enter the shared secret in the Shared Secret field. A shared secret is a text string that serves as a password between a RADIUS client and RADIUS server.
- Step 5** Enter the RADIUS authentication port number in the Authentication Port field. The default port is 1812. If the node is an ENE, set the authentication port to a number within the range of 1860 to 1869.
- Step 6** Enter the RADIUS accounting port in the Accounting Port field. The default port is 1813. If the node is an ENE, set the accounting port to a number within the range of 1870 to 1879.
- Step 7** Click **OK**. The RADIUS server is added to the list of RADIUS authenticators.



Note You can add up to 10 RADIUS servers to a node's list of authenticators.

- Step 8** Click **Edit** to make changes to an existing RADIUS server. You can change the IP address, the shared secret, the authentication port, and the accounting port.
- Step 9** Click **Delete** to delete the selected RADIUS server.
- Step 10** Click **Move Up** or **Move Down** to reorder the list of RADIUS authenticators. The node requests authentication from the servers sequentially from top to bottom. If one server is unreachable, the node will request authentication from the next RADIUS server on the list.
- Step 11** Click the **Enable RADIUS Authentication** check box to activate remote-server authentication for the node.
- Step 12** Click the **Enable RADIUS Accounting** check box if you want to show RADIUS authentication information in the audit trail.
- Step 13** Click the **Enable node as Final Authenticator when no RADIUS Server is reachable** check box if you want the node to be the final authenticator. This means that if every RADIUS authenticator is unavailable, the node will authenticate the login rather than locking the user out.
- Step 14** Click **Apply** to save all changes or **Reset** to clear all changes.
- Step 15** Return to your originating procedure (NTP).
-

DLP-F381 Delete a Server Trail

Purpose	This task deletes a server trail.
Tools/Equipment	None
Prerequisite Procedures	See Chapter 6, "Create Circuits" for server trail creation procedures.
Required/As Needed	As needed
Onsite/Remote	Onsite or remote
Security Level	Provisioning or higher



Note Deleting server trails do not impact the circuits provisioned over it as server trail is a logical link. Deleting a server trail is recommended when migrating from IPv4 to IPv6 because the server trails created on a IPv4 network will not work in an IPv6 network. You can recreate server trails after migrating to IPv6 network without deleting the circuits. When you delete a server trail, the circuit state becomes PARTIAL.

-
- Step 1** From the View menu, choose **Go to Network View**.
- Step 2** Click the **Provisioning > Server Trails** tabs.
- Step 3** Click the server trail that you want to delete.
- Step 4** Click **Delete**.
- Step 5** In the confirmation dialog box, click **Yes**.



Note You can use the server trail audit log to recreate a server trail that you may have accidentally deleted. The server trail audit log includes the following parameters:

- Server trail ID
- Peer IP address
- Circuit size
- Protection type
- Number of trails
- Starting VC4/VC3
- SRLG value

You can look at the audit log of the source or destination node and find the entry for the delete call. This log entry has the VC4/VC3 path definitions on the node, peer IP address, and server trail ID. You can then look at the audit log of the peer IP address, locate the delete call for the specific server trail ID, and find the VC4/VC3 path definitions on the node. This would provide you with the required information to recreate the server trail.



Note It is recommended that you delete one server trail at a time as the deletion of multiple trails together may cause CTC to hang and is a time consuming task.

- Step 6** Return to your originating procedure (NTP).
-

DLP-F382 Grant Superuser Privileges to a Provisioning User

Purpose	This task enables a provisioning-level user to perform tasks such as retrieving audit logs, restoring databases, and activating and reverting software loads.
Tools/Equipment	None
Prerequisite Procedures	DLP-F181 Log into CTC, page 16-34
Required/As Needed	As needed
Onsite/Remote	Onsite or remote
Security Level	Superuser only

-
- Step 1** In node view, click the **Provisioning > Defaults** tabs.

- Step 2** In the Node Defaults area, choose **NODE. security.grantPermission.***.
- Step 3** Click in the Default Value column for the default property you are changing and choose **Provisioning** from the drop-down list.



Note If you click **Reset** before you click **Apply**, all values will return to their original settings.

- Step 4** Click **Apply**.
- A pencil icon appears next to the default name that will be changed as a result of editing the defaults file.



Note You must close your current CTC session and restart a new CTC session for the changes to take effect.

- Step 5** Return to your originating procedure (NTP).
-

DLP-F383 Download an Alarm Severity Profile

Purpose	This task downloads a custom alarm severity profile from a network-drive accessible CD-ROM, floppy disk, or hard disk location.
Tools/Equipment	None
Prerequisite Procedures	DLP-F181 Log into CTC, page 16-34
Required/As Needed	As needed
Onsite/Remote	Onsite or remote
Security Level	Provisioning or higher

- Step 1** To access the alarm profile editor from network view, click the **Provisioning > Alarm Profiles** tabs
- Step 2** To access the profile editor from node view, click the **Provisioning > Alarm Profiles > Alarm Profile Editor** tabs.
- Step 3** To access the profile editor from a card view, click the **Provisioning > Alarm Profiles > Alarm Profile Editor** tabs.
- Step 4** Click **Load**.
- Step 5** If you want to download a profile that exists on the node, click **From Node** in the Load Profile(s) dialog box and complete the following steps:
- Click the node name you are logged into in the Node Names list.
 - Click the name of the profile in the Profile Names list, such as Default.
- Step 6** If you want to download a profile that is stored locally or on a network drive, click **From File** in the Load Profile(s) dialog box. Then complete the following steps:
- Click **Browse**.
 - Navigate to the file location in the Open dialog box.
 - Click **Open**.



Note The Default alarm profile list contains alarm and condition severities that correspond when applicable to default values established in Telcordia GR-474-CORE.



Note All default or user-defined severity settings that are Critical (CR) or Major (MJ) are demoted to Minor (MN) in Non-Service-Affecting (NSA) situations as defined in Telcordia GR-474.

- Step 7** Click **OK**. The downloaded profile appears at the right side of the Alarm Profiles window.
- Step 8** Right-click anywhere in the downloaded profile column to view the profile editing shortcut menu.
- Step 9** Click **Store**.
- Step 10** In the Store Profile(s) dialog box, click **To Node(s)** and complete the following steps:
- a. Choose the nodes where you want to save the profile:
 - If you want to save the profile to only one node, click the node in the Node Names list.
 - If you want to save the profile to all nodes, click **Select All**.
 - If you do not want to save the profile to any nodes, click **Select None**.
 - If you want to update alarm profile information, click **Synchronize**.
 - b. Click **OK**.
- Step 11** Return to your originating procedure (NTP).

DLP-F384 Install the ASAP 1PIO and 4PIO (PIM) Modules

Purpose	This procedure explains how to install the 4-port I/O modules (4PIOs) and 1-port I/O modules (1PIOs), also known as Pluggable Interface Modules (PIMs), in the carrier modules of the ASAP card.
Tools/Equipment	4PIO modules and/or 1PIO modules #2 Phillips screwdriver
Prerequisite Procedures	DLP-F333 Install the ASAP Carrier Modules, page 18-33
Required/As Needed	As needed
Onsite/Remote	Onsite
Security Level	None



Warning

During this procedure, wear grounding wrist straps to avoid ESD damage to the card. Do not directly touch the midplane with your hand or any metal tool, or you could shock yourself. Statement 181



Caution

Always use the supplied ESD wristband when working with a powered ONS 15600 SDH. Plug the wristband cable into the ESD jack located on the lower-left outside edge of the shelf.

**Warning****Class 1 laser product.** Statement 1008**Warning****Invisible laser radiation may be emitted from the end of the unterminated fiber cable or connector. Do not view directly with optical instruments. Viewing the laser output with certain optical instruments (for example, eye loupes, magnifiers, and microscopes) within a distance of 100 mm may pose an eye hazard.** Statement 1056**Warning****Use of controls, adjustments, or performing procedures other than those specified may result in hazardous radiation exposure.** Statement 1057**Note**For information about the ASAP card, refer to the *Cisco ONS 15600 SDH Reference Manual*.

- Step 1** Remove the 1PIO or 4PIO module from the box and antistatic sleeve.
- Step 2** Identify the slot on the ASAP card where you want to install the 1PIO or 4PIO module.
- Step 3** Carefully slide the module along the top and bottom guide rails into the correct slot.
- Step 4** Tighten the screws at the top right and bottom left of the module. You can either hand-tighten the screws or remove the screw covers and use a Phillips screwdriver to tighten the screws.

Figure 18-22 shows the 1PIO module faceplate.

Figure 18-22 1PIO Module Faceplate

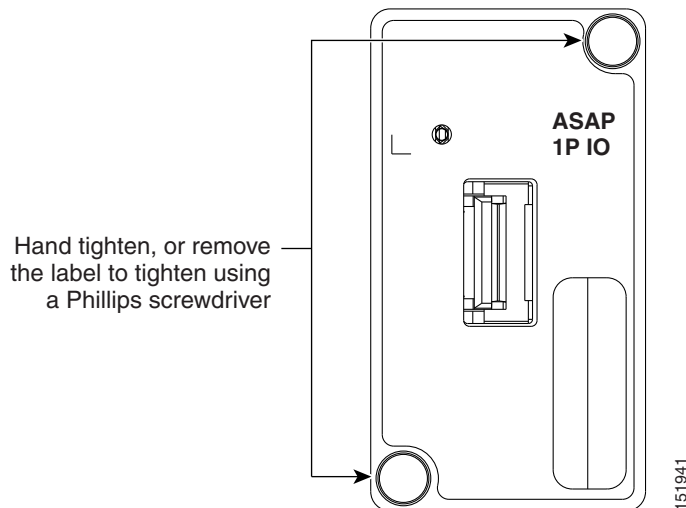
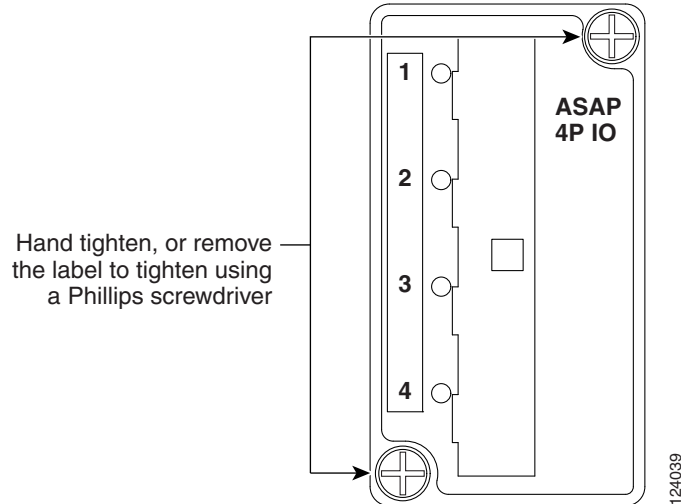

Figure 18-23 shows the 4PIO module faceplate.

Figure 18-23 4PIO Module Faceplate**Note**

The LEDs located on the 1PIO and 4PIO will not light until a fixed rate SFP/XFP (PPM) is installed in the associated PPM slot or a multirate optical (MRO) PPM is installed and an optical rate is provisioned. If the port on the PPM does not have a raised alarm, the associated LED will be green in color (meaning the port administrative state is Unlocked-automaticInservice). If the port has an alarm, the LED will be amber in color (meaning the administrative state is Unlocked and a valid signal is not present).

**Note**

If you insert a card into a slot that is provisioned for a different card, all red LEDs turn on and you will see an MEA alarm for that slot when you open CTC.

- Step 5** After you have logged into CTC, verify that the card appears in the card view. See [Chapter 3, “Connect the PC and Log into the GUI”](#) for CTC information and setup instructions.
- Step 6** Return to your originating procedure (NTP).

DLP-F385 Consolidate Links in Network View

Purpose	This task consolidates the data communications channel (DCC), GSS, OTS, and server trail links in the CTC network view.
Tools/Equipment	None
Prerequisite procedures	DLP-F181 Log into CTC, page 16-34
Required/As needed	As needed
Onsite/Remote	Onsite or remote
Security Level	Retrieve or higher



Note Global consolidation persists when CTC is launched again but local consolidation does not.

- Step 1** From the View menu, choose **Go to Network View**. CTC shows the link icons by default.
- Step 2** Perform one or more of the following steps as needed:
- To toggle link icons on and off, go to [Step 3](#).
 - To combine all links in network view, go to [Step 4](#).
 - To consolidate a link or links between two nodes, go to [Step 5](#).
 - To view information about a consolidated link, go to [Step 6](#)
 - To access an individual link within a consolidated link, go to [Step 7](#).
 - To expand consolidated links, go to [Step 8](#).
 - To filter consolidated links by class, go to [Step 9](#).
- Step 3** Right-click on the network map and choose **Show Link Icons** to toggle the link icons on and off.
- Step 4** To consolidate all the links on the network map (global consolidation):
- a. Right-click anywhere on the network map.
 - b. Choose **Collapse/Expand Links** from the shortcut menu. The Collapse/Expand Links dialog box appears.
 - c. Click the check boxes for the link classes you want to consolidate.
 - d. Click **OK**. The selected link classes are consolidated on the network map.
- Step 5** To consolidate a link or links between two nodes:
- a. Right-click the link on the network map.
 - b. Choose **Collapse Link** from the shortcut menu. The selected link type consolidates to show only one link.



Note The links consolidate by class. For example, if you select a DCC link for consolidation only the DCC links will consolidate, leaving any other link classes expanded.

[Figure 18-24](#) shows a network view with unconsolidated DCC and PPC links.

Figure 18-24 Unconsolidated Links in Network View

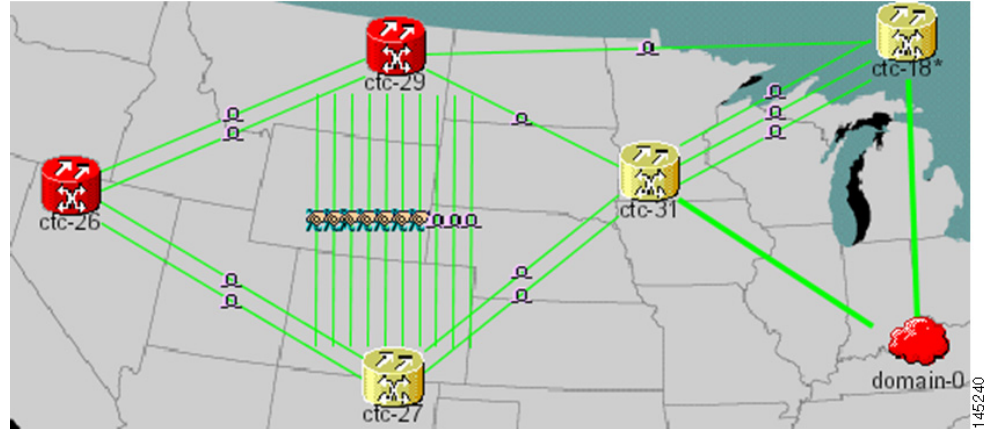

Figure 18-25 shows a network view with globally consolidated links.

Figure 18-25 Consolidated Links in Network View

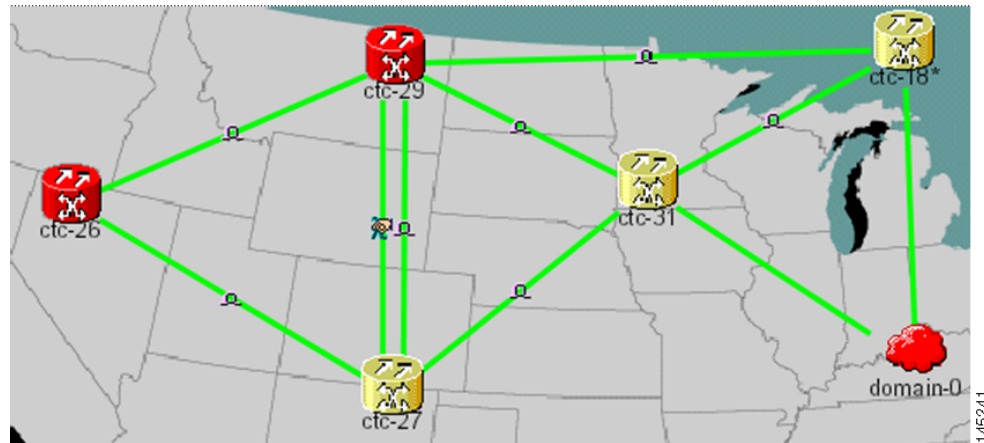
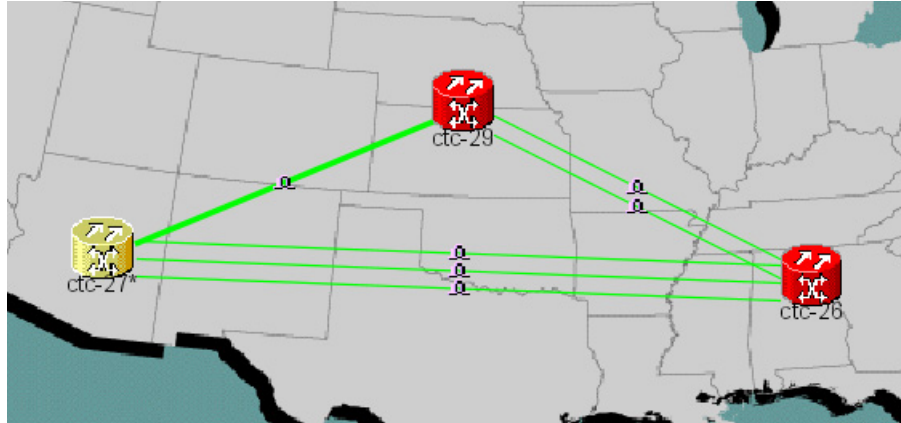

Figure 18-26 shows a different network view with local DCC link consolidation between two nodes.

Figure 18-26 Network View with Local Link Consolidation



- Step 6** To view information about the consolidated link, move the mouse over the link (the tooltip displays the number of links and the link class), or click the link to display detailed information on the left side of the window.
- Step 7** To access an individual link within a consolidated link (for example, if you need to perform a span upgrade):
- Right-click the consolidated link. A shortcut menu appears with a list of the individual links.
 - Place the mouse over the selected link. A cascading menu appears where you can select an action for the individual link or navigate to one of the nodes where the link is attached.
- Step 8** To expand locally consolidated links, right-click the consolidated link and choose **Expand [link class] Links** from the shortcut menu where *link class* is DCC, GCC, OTS, PPC, or Server Trail.
- Step 9** To filter the links by class:
- Click the **Link Filter** button in the upper right area of the window. The Link Filter dialog box appears.
The link classes that appear in the Link Filter are determined by the selected Network Scope (Table 18-4) located in the toolbar.

Table 18-4 Link Classes By Network Scope

Network Scope	Displayed Link Classes
ALL	DCC, GCC, OTS, PPC, Server Trail
DWDM	GCC, OTS, PPC
TDM	DCC, PPC, Server Trail

- Check the boxes next to the links that you want to display.
 - Click **OK**.
- Step 10** Return to your originating procedure (NTP).

DLP-F386 Adjust the Java Virtual Memory Heap Size

Purpose	This task allows you to adjust the Java Virtual Memory (JVM) heap size from the default 256 MB to the maximum of 512 MB in order to improve CTC performance.
Tools/Equipment	None
Prerequisite Procedures	None
Required/As Needed	As needed
Onsite/Remote	Onsite or remote
Security Level	Provisioning or higher

-
- Step 1** From the Windows task bar, click **Start > Settings > Control Panel**. The Windows Control Panel appears.
- Step 2** Double-click **System**. The System Properties window appears.
- Step 3** Click the **Advanced** tab.
- Step 4** Click **Environmental Variables**. The Environmental Variables dialog box appears.
- Step 5** In the User Variables area, click **New**. The New User Variable dialog box appears.
- Step 6** Type **CTC_HEAP** in the Variable Name field.
- Step 7** Type **512** in the Variable Value field.
- Step 8** Click **OK**.
- Step 9** Reboot your PC.
- Step 10** Return to your originating procedure (NTP).
-

DLP-F387 Install an SFP/XFP

Purpose	This task installs XFPs on the 1PIO modules and installs SFPs on the 4PIO modules (PIMs) on the ASAP card.
Tools/Equipment	SFPs/XFPs appropriate for your network
Prerequisite Procedures	DLP-F333 Install the ASAP Carrier Modules, page 18-33 DLP-F384 Install the ASAP 1PIO and 4PIO (PIM) Modules, page 18-95
Required/As Needed	As needed
Onsite/Remote	Onsite
Security Level	Provisioning or higher



Note SFPs and XFPs are generically called pluggable port modules (PPMs) in the CTC software interface.

-
- Step 1** Verify that the SFP or XFP is correct for your network and ASAP card. Refer to the “Card Reference” chapter in the *Cisco ONS 15600 SDH Reference Manual* for more information about SFPs and XFPs.

- Step 2** If you are installing an SFP, orient the SFP so that the Cisco serial number label is facing away from the shelf (to the right). If you are installing an XFP, orient the XFP to the left.
- Step 3** Unlatch the bail clasp before inserting it into the slot.
- Step 4** Slide the SFP or XFP into the slot on the 1PIO or 4PIO (as appropriate) and move the bail clasp to secure the SFP or XFP.

**Caution**

Do not remove the protective caps until you are ready to attach the network fiber-optic cable.

**Note**

Multirate SFPs must be provisioned in CTC; single-rate PPMs do not need to be provisioned. As needed, complete the [“DLP-F358 Provision a Multirate PPM” task on page 18-70](#).

- Step 5** Return to your originating procedure (NTP).
-

DLP-F388 Remove an SFP/XFP

Purpose	This task removes an XFP from a 1PIO module and removes an SFP from a 4PIO module on the ASAP card.
Tools/Equipment	None
Prerequisite Procedures	DLP-F384 Install the ASAP 1PIO and 4PIO (PIM) Modules, page 18-95
Required/As Needed	As needed
Onsite/Remote	Onsite or remote
Security Level	Provisioning or higher

- Step 1** Disconnect the network fiber cable from the SFP/XFP.
- Step 2** Release the SFP/XFP from the 1PIO or 4PIO slot by unlatching the bail clasp and swinging it to the left.
- Step 3** Slide the SFP/XFP out of the slot.
- Step 4** As needed, complete the [“DLP-F360 Delete a PPM” task on page 18-72](#) to delete an SFP/XFP (PPM) from CTC.
- Step 5** Return to your originating procedure (NTP).
-

DLP-F389 Remove a 1PIO or 4PIO (PIM) Module

Purpose	This procedure explains how to remove the 1PIO or 4PIO (PIM) in the carrier modules of the ASAP card.
Tools/Equipment	#2 Phillips screwdriver
Prerequisite Procedures	DLP-F384 Install the ASAP 1PIO and 4PIO (PIM) Modules, page 18-95
Required/As Needed	As needed
Onsite/Remote	Onsite
Security Level	None

Warning

During this procedure, wear grounding wrist straps to avoid ESD damage to the card. Do not directly touch the midplane with your hand or any metal tool, or you could shock yourself. Statement 181

Warning

Class 1 laser product.Statement 1008

Warning

Invisible laser radiation may be emitted from the end of the unterminated fiber cable or connector. Do not view directly with optical instruments. Viewing the laser output with certain optical instruments (for example, eye loupes, magnifiers, and microscopes) within a distance of 100 mm may pose an eye hazard. Statement 1056

Warning

Use of controls, adjustments, or performing procedures other than those specified may result in hazardous radiation exposure. Statement 1057

Caution

Always use the supplied ESD wristband when working with a powered ONS 15600 SDH. Plug the wristband cable into the ESD jack located on the lower-left outside edge of the shelf.

Note

For information about the ASAP card, refer to the *Cisco ONS 15600 SDH Reference Manual*.

- Step 1** Determine which 1PIO or 4PIO module you want to remove.
- Step 2** To remove the module, use your hand to loosen and remove the screws at the top right and bottom left of the module. You can also remove the screw covers and use a Phillips screwdriver to loosen the screws so you can remove them.
- Step 3** Carefully pull the module along the top and bottom guide rails and out of the correct slot.
- Step 4** Log into CTC and verify that the PIM (1PIO or 4PIO) does not appear in CTC card view. See [Chapter 3, “Connect the PC and Log into the GUI”](#) for CTC information and setup instructions.
- Step 5** Return to your originating procedure (NTP).

DLP-F390 Provision an Optical Line Rate and Wavelength

Purpose	This task provisions the line rate and wavelength of a multirate PPM. Single-rate SFPs and XFPs do not need line rate provisioning.
Tools/Equipment	None
Prerequisite Procedures	DLP-F181 Log into CTC, page 16-34
Required/As Needed	Required
Onsite/Remote	Onsite or remote
Security Level	Provisioning or higher

-
- Step 1** In node view, double-click the ASAP card where you want to provision the line rate.
- Step 2** Click the **Provisioning > Pluggable Port Modules** tabs.
- Step 3** In the Pluggable Ports area, click **Create**. The Create Port dialog box appears.
- Step 4** In the Create Port dialog box, complete the following:
- **Port**—Click the PPM number and port number from the drop-down list. The first number indicates the PPM and the second number indicates the port number on the PPM. For example, the first PPM with one port displays as 1-1 and the second PPM with one port displays as 2-1. When a 4PIO or 1PIO (PIM) is present on an ASAP card, the port is identified as *PIM#-PPM#-Port#* (for example 4-4-1). The PIM number can be 1 to 4, the PPM number can be 1 to 4, but the port number is always 1.
 - **Port Type**—Click the type of port from the drop-down list. The port type list displays the supported port rates on your PPM. See [Table 18-5](#) for definitions of the supported rates on the ASAP card.

Table 18-5 PPM Port Types

Card	PIO (PIM)	Port Type
ASAP	4PIO	<ul style="list-style-type: none"> • STM-1—155 Mbps • STM-4—622 Mbps • STM-16—2.48 Gbps • ETHER—Gigabit Ethernet
	1PIO	<ul style="list-style-type: none"> • STM-64—9.953 Gbps

- Step 5** Click **OK**.
- Step 6** Click the **Provisioning > Optical > Line** tabs.
- Step 7** Find the port where you want to set the wavelength frequency of the PPM.
- Step 8** In the Wavelength drop-down box, select the desired frequency. See [Table 18-6 on page 18-109](#) for definitions of the supported wavelengths on the ASAP card. The supported wavelengths depend on whether the PPM is used for dense wavelength division multiplexing (DWDM).
- Step 9** Click **OK**.
- Step 10** Repeat Steps 3 through 9 to configure the PPM port rates and wavelengths as needed.
- Step 11** Click **OK**. The row on the Pluggable Ports area turns white.

Step 12 Return to your originating procedure (NTP).

DLP-F391 Install Alarm Wires on the CAP/CAP2

Purpose	This task installs the alarm wires on the customer access panel (CAP/CAP2).
Tools/Equipment	Wire-wrap tool (suitable for #22 to #28 AWG alarm wires) #22 to #28 AWG wires Audible alarm cable with DB-15 connector
Prerequisite Procedures	NTP-F113 Install the Bay Power and Ground, page 1-10
Required/As Needed	As needed
Onsite/Remote	Onsite
Security Level	None

Step 1 Wrap the alarm wires on the appropriate wire-wrap pins according to local site practice. [Figure 18-27](#) shows the backplane of the ONS 15600 SDH shelf and the location of the alarm pin field on the CAP/CAP2.

Figure 18-27 Rear of the ONS 15600 SDH, Including the CAP/CAP2

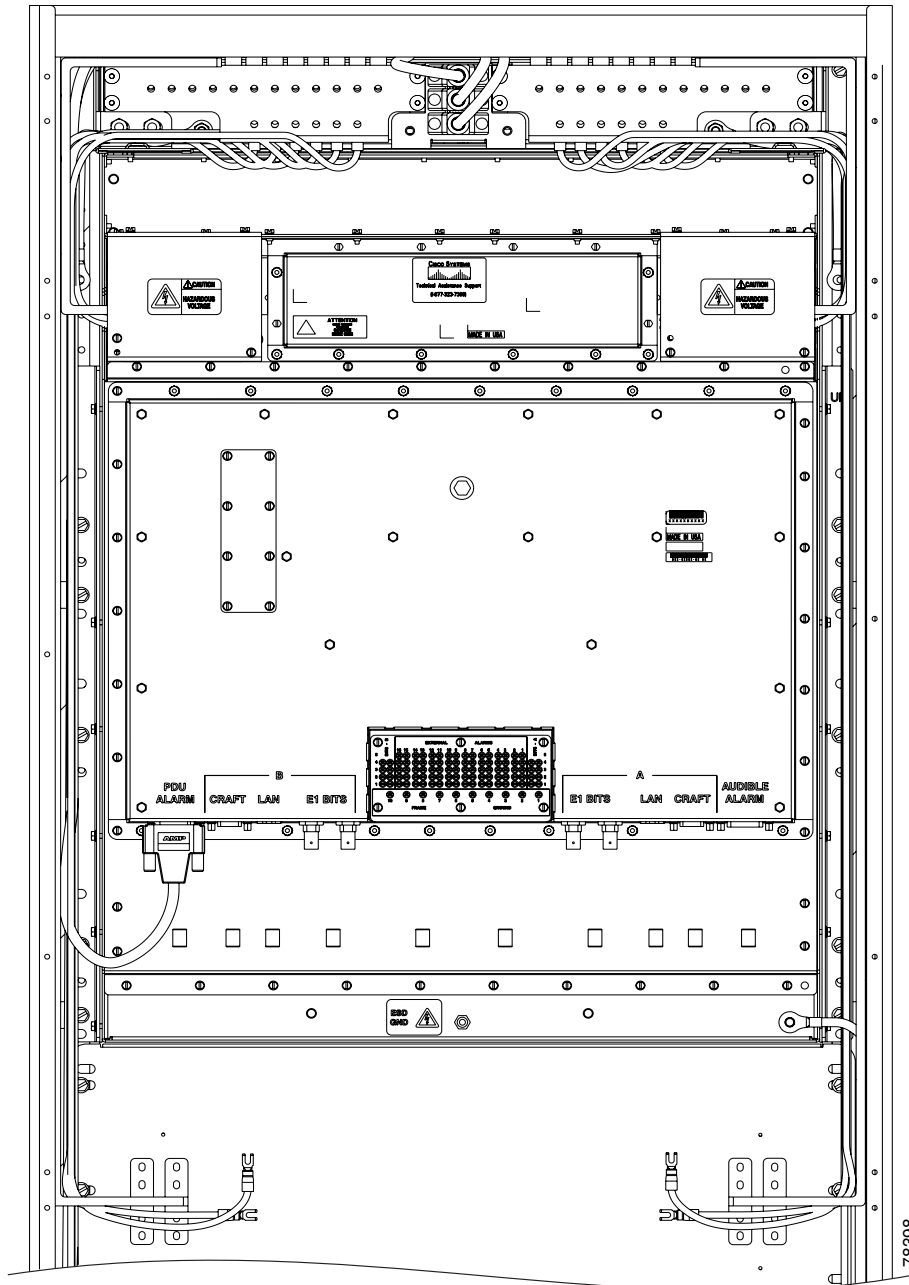

Figure 18-28 shows the CAP/CAP2 faceplate in detail.

Figure 18-28 CAP/CAP2 Faceplate and Connections

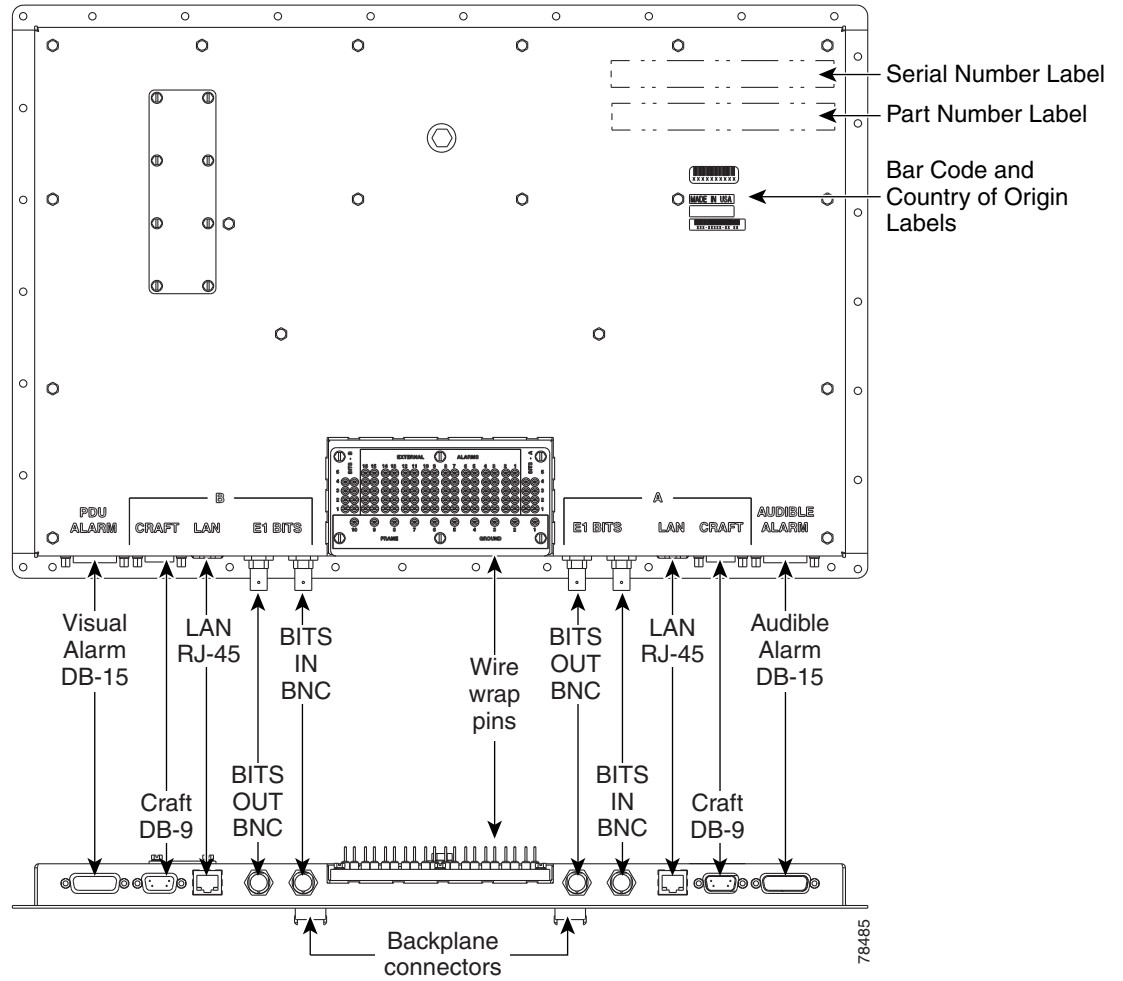
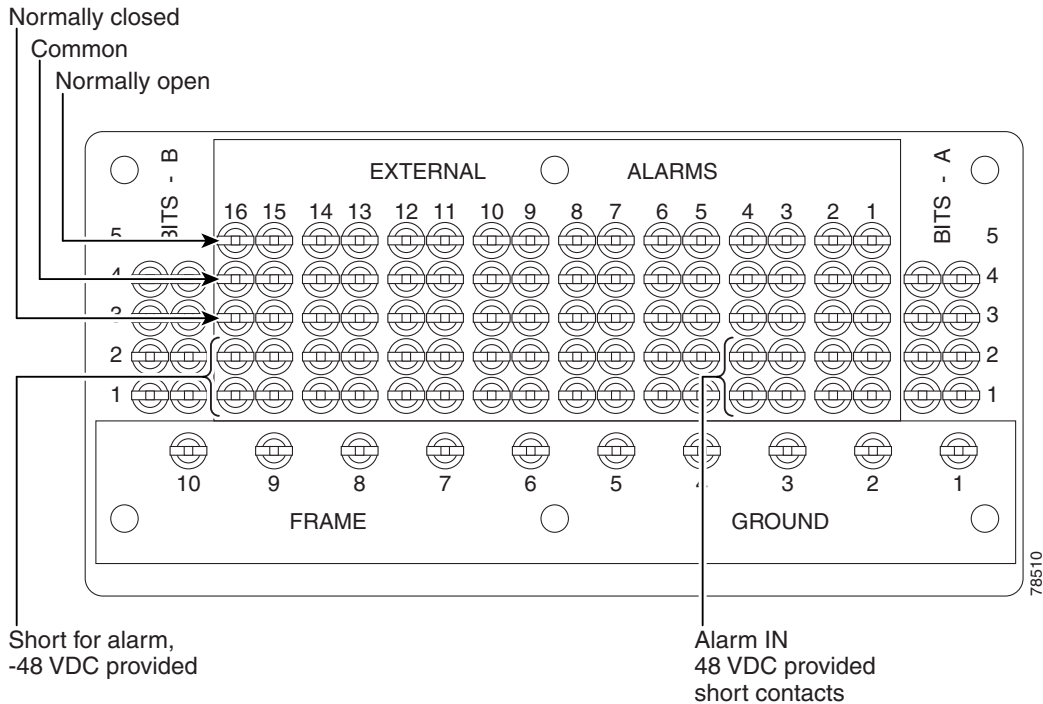

Figure 18-29 shows alarm pin assignments.

Figure 18-29 Alarm Pin Assignments on the CAP/CAP2



See [Chapter 9, “Manage Alarms”](#) for instructions about assigning alarms to these pins.

Lace or tie wrap cables to the tie wrap features that are located below the connector pattern, according to local site practice.

- Step 2** To install the audible alarm cable, connect a DB-15 connector to the Audible Alarm plug at the lower right of the CAP/CAP2. Connect the other end of the cable to the appropriate audible inputs of the connecting central office alarm circuit.
- Step 3** Return to your originating procedure (NTP).

DLP-F392 Change Line Transmission Settings for STM-N Cards

Purpose	This task changes line transmission settings for STM-N cards.
Tools/Equipment	None
Prerequisite Procedures	DLP-F181 Log into CTC, page 16-34
Required/As Needed	As needed
Onsite/Remote	Onsite or remote
Security Level	Provisioning or higher



Note

For the default values and domains of user-provisionable card settings, refer to the "Network Element Defaults" appendix in the *Cisco ONS 15600 SDH Reference Manual*.

- Step 1** On the shelf graphic, double-click the STM-N card that you want to provision. The card view appears.
- Step 2** For STM-16 or STM-64 cards, click the **Provisioning > Line** tabs. For the ASAP card, click the **Provisioning > Optical > Line** tabs.
- Step 3** As needed, provision the options in [Table 18-6](#) for each STM-N port. (Some options might not be available on every card.)

Table 18-6 STM-N Card Line Settings

Heading	Description	Options
Port	Identifies the port number.	<ul style="list-style-type: none"> For an STM-16 card: 1–16 For an STM-64 card: 1–4 For an ASAP card: Up to 16 ports, denoted by either a 4PIO (PIM) or 1PIO, followed by port number or (PIM). (Example: 1-3-1 denotes the third port on 4PIO [PIM] Module 1. For a 1PIO, 3-1-1 denotes the port on 1PIO [PIM] Module 3)
Port Name	Provides the ability to assign the specified port a name.	User-defined; name can be up to 32 alphanumeric/special characters (blank by default)
SF BER	Sets the signal fail bit error rate.	<ul style="list-style-type: none"> 1E-3 1E-4 (default) 1E-5
SD BER	Sets the signal degrade bit error rate.	<ul style="list-style-type: none"> 1E-5 1E-6 1E-7 (default) 1E-8 1E-9
Provides Sync	(Display only) Indicates that the port has been provisioned as a network element (NE) timing reference on another node.	<ul style="list-style-type: none"> Yes (checked) No (unchecked)
Send Do Not Use	When checked, sends a do not use (DUS) message on the S1 byte	<ul style="list-style-type: none"> Yes (checked) No (unchecked; default)
MS-SPRing Ext. Byte	Chosen extended byte carries information that governs multiplex section shared protection ring (MS-SPRing) protection switches.	<ul style="list-style-type: none"> K3 Z2 E2 F1

Table 18-6 STM-N Card Line Settings (continued)

Heading	Description	Options
Admin State	Sets the port service state unless network conditions prevent the change.	<ul style="list-style-type: none"> • Unlocked—Puts the port in service. The port service state changes to Unlocked-enabled. • Unlocked,automaticInService—Puts the port in automatic in-service. The port service state changes to Unlocked-disabled,automaticInService. • Locked,disabled—Removes the port from service and disables it. The port service state changes to Locked-enabled,disabled. • Locked,maintenance—Removes the port from service for maintenance. The port service state changes to Locked-enabled,maintenance. <p>Note CTC will not allow you to change a port service state from Unlocked-enabled to Locked-enabled,disabled. You must first change a port to the Locked-enabled,maintenance service state before putting it in the Locked-enabled,disabled service state.</p>
AINS Soak	Sets the automatic in-service soak period.	Duration of valid input signal, in hh.mm format, after which the card becomes Unlocked-enabled automatically (0 to 48 hours, in 15-minute increments).
SyncMsgIn	Enables synchronization status messages (S1 byte), which allow the node to choose the best timing source.	<ul style="list-style-type: none"> • Yes (checked; default) • No (unchecked)
Port Rate	(ASAP card only.) Displays the port rate set for the PPM.	<ul style="list-style-type: none"> • STM-1 • STM-4 • STM-16 • STM-64 • Ether
Type	Defines the port as SDH or SONET. Sync Msg In and Send Do Not Use must be disabled before the port can be set to SONET.	<ul style="list-style-type: none"> • SDH (default) • SONET

Table 18-6 *STM-N Card Line Settings (continued)*

Heading	Description	Options
Service State	Identifies the autonomously generated state that gives the overall condition of the port. Service states appear in the format: Primary State-Primary State Qualifier, Secondary State.	<ul style="list-style-type: none"> • Unlocked-enabled—The port is fully operational and performing as provisioned. • Unlocked-disabled,automaticInService—The port is out-of-service, but traffic is carried. Alarm reporting is suppressed. The ONS node monitors the ports for an error-free signal. After an error-free signal is detected, the port stays in the Unlocked-disabled,automaticInService state for the duration of the soak period. After the soak period ends, the port service state changes to Unlocked-enabled. • Locked-enabled,disabled—The port is out-of-service and unable to carry traffic. • Locked-enabled,maintenance—The port is out-of-service for maintenance. Alarm reporting is suppressed, but traffic is carried and loopbacks are allowed.
SyncStatusMsg	Allows you to view the incoming synchronization status message by clicking Show .	<ul style="list-style-type: none"> • SETS • STU • G811 • G812T • G812L • DUS_SDH (Do not use for timing synchronization)
Reach	(ASAP card only) Provisions the reach value.	<p>(The options that appear in the drop-down list depend on the card.)</p> <ul style="list-style-type: none"> • Auto Provision—Allows the system to automatically provision the reach from the PPM reach value on the hardware. • SR—Short reach, up to 2 km distance • SR-1—Up to 2 km distance • IR-1—Intermediate reach, up to 15 km distance • IR-2—Up to 40 km distance • LR-1—Long reach, up to 40 km distance) • LR-2—Up to 80 km distance • LR-3—Up to 80 km distance

Table 18-6 STM-N Card Line Settings (continued)

Heading	Description	Options
Band	(STM-64-4-DWDM card only) Sets the ITU band (in this case, C-band) for this card.	C
Wavelength	(ASAP and STM-64-4-DWDM card only) Sets the wavelength frequency (nm).	ASAP card: <ul style="list-style-type: none"> • First Tunable Wavelength • 1310 • 1550 • 1470 • 1490 • 1510 • 1530 • 1570 • 1590 • 1610 Dense wavelength division multiplexing (DWDM) PPMs also have the following options: <ul style="list-style-type: none"> • 1530.33 to 1560.61 • ITU spacing

Step 4 Click **Apply**.

Step 5 Return to your originating procedure (NTP).

DLP-F393 Change Threshold Settings for STM-N Ports

Purpose	This task changes threshold settings for STM-N ports.
Tools/Equipment	None
Prerequisite Procedures	DLP-F181 Log into CTC, page 16-34
Required/As Needed	As needed
Onsite/Remote	Onsite or remote
Security Level	Provisioning or higher



Note

For the default values and domains of user-provisionable card settings, refer to the "Network Element Defaults" appendix in the *Cisco ONS 15600 SDH Reference Manual*.

- Step 1** On the shelf graphic, double-click the STM-16, STM-64, or ASAP card that you want to provision. The card view appears.
- Step 2** As needed, complete the following:
- Click **Line**, **Section**, **Path**, or **Physical** to provision the line, section, path, and physical options in [Table 18-7](#) for each STM-N port.
 - Change the selection to Near End/Far End, 15 Min/1Day as necessary.
 - Click **Refresh** to view or modify the thresholds for each selection.



Note Far End section thresholds are not available for the STM-64 card.

Table 18-7 SDH Threshold Options (Line, Section, and Path)

Heading	Description	Options
Port	Port number	1–16 for an STM-16 card, 1–4 for an STM-64 card, 1-1-1 to 4-4-1 for an ASAP port number
CV	Coding violations	Numeric. Can be set for 15-minute or one-day intervals for Line, Section, or Path (Near and Far End). Select the bullet and click Refresh .
ES	Errored seconds	Numeric. Can be set for 15-minute or one-day intervals for Line, Section, or Path (Near and Far End). Select the bullet and click Refresh . Numeric. The defaults (15 min/1 day) are:
SES	Severely errored seconds	Numeric. Can be set for 15-minute or one-day intervals for Line, Section, or Path (Near and Far End). Select the bullet and click Refresh .
SEFS	Severely errored framing seconds	Numeric. Can be set for 15-minute or one-day intervals for Section (Near and Far End). Select the bullet and click Refresh .
FC	Failure count	Numeric. Can be set for 15-minute or one-day intervals for Line or Path (Near and Far End). Select the bullet and click Refresh .
UAS	Unavailable seconds	Numeric. Can be set for 15-minute or one-day intervals for Line or Path (Near and Far End). Select the bullet and click Refresh .
PSC	Protection Switching Count (Line)	Numeric. Can be set for 15-minute or one-day intervals for Line (Near End). Select the bullet and click Refresh .
PSD	Protection Switch Duration (Line)	Numeric. Can be set for 15-minute or one-day intervals for Line (Near End). Select the bullet and click Refresh .
PSC-W	Protection Switching Count (Working Line)	Numeric. Can be set for 15-minute or one-day intervals for Line (Near End). Select the bullet and click Refresh .

Table 18-7 SDH Threshold Options (Line, Section, and Path) (continued)

Heading	Description	Options
PSD-W	Protection Switch Duration (Working Line)	Numeric. Can be set for 15-minute or one-day intervals for Line (Near End). Select the bullet and click Refresh .
PSC-S	(Line) Sets the threshold for the span protection switching count. (PSC-S does not increment on STM-1 cards.)	Numeric. Can be set for 15-minute or one-day intervals for Line (Near End). Select the bullet and click Refresh .
PSD-S	(Line) Sets the threshold for the span protection switching duration. (PSD-S does not increment on STM-1 cards.)	Numeric. Can be set for 15-minute or one-day intervals for Line (Near End). Select the bullet and click Refresh .
PSC-R	(Line) Sets the threshold for the ring protection switching count. (PSC-R does not increment on STM-1 cards.)	Numeric. Can be set for 15-minute or one-day intervals for Line (Near End). Select the bullet and click Refresh .
PSD-R	(Line) Sets the threshold for the ring protection switching duration. (PSD-R does not increment on STM-1 cards.)	Numeric. Can be set for 15-minute or one-day intervals for Line (Near End). Select the bullet and click Refresh .

Step 3 Click **Apply**.

Step 4 Return to your originating procedure (NTP).

DLP-F394 Change Optics Threshold Settings for STM-N Ports

Purpose	This task changes optics threshold settings for STM-N ports.
Tools/Equipment	None
Prerequisite Procedures	DLP-F181 Log into CTC, page 16-34
Required/As Needed	As needed
Onsite/Remote	Onsite or remote
Security Level	Provisioning or higher



Note

For the default values and domains of user-provisionable card settings, refer to the "Network Element Defaults" appendix in the *Cisco ONS 15600 SDH Reference Manual*.

Step 1 On the shelf graphic, double-click the STM-16, STM-64, or ASAP card that you want to provision. The card view appears.

Step 2 As needed, complete the following:

- a. Click **Optics Thresholds** to provision the options in [Table 18-8](#) for each STM-N port.
- b. Select the **TCA** (threshold crossing alert) or **Alarm** radio button.

- c. Select a **15 Min** or **1 Day** performance monitoring interval radio button (available for TCA only), and then click **Refresh**.
- d. Click **Refresh** to view or modify the thresholds for each selection.

Table 18-8 Optics Threshold Options

Heading	Description	Options
Port	Port number	1–16 for an STM-16 card, 1–4 for an STM-64 card, 1-1-1 to 4-4-1 for an ASAP port number
LBC-HIGH	Laser bias current–maximum. Maximum threshold for LBC.	Numeric percentage of the baseline value
LBC-LOW	Laser bias current–minimum. Minimum threshold for LBC.	Numeric percentage of the baseline value
OPT-HIGH	Optical power transmitted–maximum. Maximum threshold for OPT.	Numeric percentage of the baseline value
OPT-LOW	Optical power transmitted–minimum. Minimum threshold for OPT.	Numeric percentage of the baseline value
OPR-HIGH	Optical power received–maximum. Maximum threshold for OPR.	Numeric percentage of the baseline value
OPR-LOW	Optical power received–minimum. Minimum threshold for OPR.	Numeric percentage of the baseline value
Set OPR	Setting the optical power received (OPR) establishes the received power level as 100 percent. If the receiver power decreases, then the OPR percentage decreases to reflect the loss in receiver power. For example, if the receiver power decreases 3 dBm, the OPR decreases 50 percent.	Click Set .
Types	Sets the threshold values of alerts that trigger an alarm or TCA response. To view the provisionable thresholds that generate an Alarm or TCA, choose the type and click Refresh .	<ul style="list-style-type: none"> • TCA (threshold crossing alert) • Alarm
Intervals	Sets the time interval for collecting parameter counts. To change the time interval, choose an interval and click Refresh .	<ul style="list-style-type: none"> • 15 Min • 1 Day

Step 3 Click **Apply**.



Note See [Chapter 9, “Manage Alarms”](#) for information about the Alarm Behavior tab, including alarm profiles and alarm suppression.

DLP-F395 Change the STM-N Port ALS Maintenance Settings

Purpose	This task changes the automatic laser shutdown (ALS) maintenance settings for the STM-N ports. This feature is available for STM-16, STM-64, and ASAP cards.
Tools/Equipment	None
Prerequisite Procedures	DLP-F181 Log into CTC, page 16-34
Required/As Needed	As needed
Onsite/Remote	Onsite or remote
Security Level	Provisioning or higher



Note For the default values and domains of user-provisionable card settings, refer to the “Network Element Defaults” appendix in the *Cisco ONS 15600 SDH Reference Manual*.

- Step 1** In node view, double-click the STM-16, STM-64, or ASAP card where you want to change the ALS maintenance settings.
- Step 2** Click the **Maintenance > ALS** tabs.
- Step 3** Modify any of the settings described in [Table 18-9](#) by clicking in the field you want to modify. In some fields you can choose an option from a drop-down list; in others you can type a value or select and deselect a check box. The provisionable parameters are listed in the options column in the table.
- Step 4** Click **Apply**. If the change affects traffic, a warning message appears. Click **Yes** to complete the change.

Table 18-9 STM-N Maintenance Settings

Parameter	Description	Options
Port number	(Display only) Port number	—
ALS Mode	Automatic laser shutdown mode. ALS provides the ability to shut down the TX laser when the RX detects a loss of signal (LOS).	From the drop-down list, choose one of the following: <ul style="list-style-type: none"> • Disable—Deactivates ALS. • Auto Restart—(Default) ALS is active. The power is automatically shut down when needed and the laser automatically tries to restart using a probe pulse until the cause of the failure is repaired. • Manual Restart—ALS is active, but the laser must be manually restarted when conditions that caused the outage are resolved. • Manual Restart for Test—Manually restarts the laser for testing.

Table 18-9 STM-N Maintenance Settings (continued)

Parameter	Description	Options
Recovery Pulse Duration	Sets the recovery laser pulse duration, in seconds, for the initial, recovery optical power pulse following a laser shutdown.	Numeric. For the default values and domains of user-provisionable card settings, refer to the “Network Element Defaults” appendix in the <i>Cisco ONS 15600 SDH Reference Manual</i> .
Recovery Pulse Interval	Sets the recovery laser pulse interval, in seconds. This is the period of time that must past before the recover pulse is repeated.	Numeric. For the default values and domains of user-provisionable card settings, refer to the “Network Element Defaults” appendix in the <i>Cisco ONS 15600 SDH Reference Manual</i> .
Currently Shutdown	(Display only) Displays the current status of the laser.	Numeric. For the default values and domains of user-provisionable card settings, refer to the “Network Element Defaults” appendix in the <i>Cisco ONS 15600 SDH Reference Manual</i> .
Request Laser Restart	If checked, allows you to restart the laser for maintenance. Note Restarting a laser might be traffic-affecting.	Checked or unchecked

Step 5 Return to your originating procedure (NTP).

DLP-F396 Clear All PM Thresholds

Purpose	This task clears and resets all PM thresholds to the default values.
Tools/Equipment	None
Prerequisite Procedures	DLP-F181 Log into CTC, page 16-34
Required/As Needed	As needed
Onsite/Remote	Onsite or remote
Security Level	Superuser only



Caution

Pressing the Reset button can mask problems if used incorrectly. This button is commonly used for testing purposes.

- Step 1** In node view, double-click the card where you want to view PM thresholds. The card view appears.
- Step 2** Click the **Provisioning > Threshold** tabs. The subtab names vary depending on the card selected.
- Step 3** Click **Reset to Default**.

- Step 4** Click **Yes** in the Reset to default dialog box.
- Step 5** Verify that the PM thresholds have been reset.
- Step 6** Return to your originating procedure (NTP).
-

DLP-F397 Provision the Designated SOCKS Servers

Purpose	This task identifies the ONS 15600 SDH SOCKS servers in SOCKS-proxy-enabled networks. Identifying the SOCKS servers reduces the amount of time required to log into a node and have all NEs appear in network view (NE discovery time). The task is recommended when the combined CTC login and NE discovery time is greater than five minutes in networks with SOCKS proxy enabled. Long (or failed) login and NE discovery times can occur in networks that have a high ENE-to-GNE ratio and a low number of ENEs with LAN connectivity.
Tools/Equipment	None
Prerequisite Procedures	DLP-F181 Log into CTC, page 16-34
Required/As Needed	Required
Onsite/Remote	Onsite or remote
Security Level	Superuser only



Note

To complete this task, you must have either the IP addresses or DNS names of all ONS 15454s in the network with LAN access that have SOCKS proxy enabled.



Note

SOCKS proxy servers can be any accessible ONS network nodes that have LAN access, including the ONS 15310-MA, ONS 15310-CL, ONS 15327, ONS 15454, ONS 15454 SDH, ONS 15600, and ONS 15600 SDH nodes.



Note

You must repeat this task any time that changes to SOCKS proxy server nodes occur, for example, whenever LAN connectivity is added to or removed from a node, or when nodes are added or removed from the network.



Note

If you cannot log into a network node, complete the “[DLP-F181 Log into CTC](#)” task on page 16-34 choosing the Disable Network Discovery option. Complete this task, then login again with network discovery enabled.

- Step 1** From the CTC Edit menu, choose **Preferences**.
- Step 2** In the Preferences dialog box, click the **SOCKS** tab.
- Step 3** In the Designated SOCKS Server field, type the IP address or DNS node name of the first ONS 15600 SDH SOCKS server. The ONS 15600 SDH that you enter must have SOCKS proxy server enabled, and it must have LAN access.

- Step 4** Click **Add**. The node is added to the SOCKS server list. If you need to remove a node on the list, click **Remove**.
- Step 5** Repeat Steps 3 and 4 to add all qualified ONS 15600 SDH nodes within the network. All ONS nodes that have SOCKS proxy enabled and are connected to the LAN should be added.
- Step 6** Click **Check All Servers**. A check is conducted to verify that all nodes can perform as SOCKS servers. If so, a check is placed next to the node IP address or node name in the SOCKS server list. An X placed next to the node indicates one or more of the following:
- The entry does not correspond to a valid DNS name.
 - The numeric IP address is invalid.
 - The node cannot be reached.
 - The node can be reached, but the SOCKS port cannot be accessed, for example, a firewall problem might exist.
- Step 7** Click **Apply**. The list of ONS 15600 SDH nodes, including ones that received an X in Step 6, are added as SOCKS servers.
- Step 8** Click **OK** to close the Preferences dialog box.
- Step 9** Return to your originating procedure (NTP).
-

DLP-F398 Install the CTC Launcher Application from a Release 8.0 Software CD

Purpose	This task installs the CTC Launcher from a Release 8.0 software CD.
Tools/Equipment	None
Prerequisite Procedures	DLP-F181 Log into CTC, page 16-34
Required/As Needed	As needed
Onsite/Remote	Onsite or remote
Security Level	None

- Step 1** Insert the Cisco ONS 15454, Cisco ONS 15454 SDH, Cisco ONS 15310-CL, Cisco ONS 15310-MA, or Cisco ONS 15600 Software Release 8.0 CD into your CD drive.
- Step 2** Navigate to the CtcLauncher directory.
- Step 3** Save the StartCTC.exe file to a local hard drive.
- Step 4** Return to your originating procedure (NTP).
-

DLP-F399 Install the CTC Launcher Application from a Release 8.0 Node

Purpose	This task installs the CTC Launcher from an ONS 15454 node running Software R8.0
Tools/Equipment	None
Prerequisite Procedures	DLP-F181 Log into CTC, page 16-34

Required/As Needed	As needed
Onsite/Remote	Onsite or remote
Security Level	None

Step 1 Using a web browser, go to the following address, where node name is the DNS name of a node you are going to access:

`http://<node-name>/fs/StartCTC.exe`

The browser File Download window opens.

Step 2 Click **Save** and navigate to the location where you want to save the StartCTC.exe file to a local hard drive.

Step 3 Click **Save**.

Step 4 Return to your originating procedure (NTP).
