



CHAPTER 3

Electrical Cards

This chapter describes Cisco ONS 15454 electrical card features and functions. For installation and card turn-up procedures, refer to the *Cisco ONS 15454 Procedure Guide*. For information on the electrical interface assemblies (EIAs), see the “[1.5 Electrical Interface Assemblies](#)” section on page 1-14.

Chapter topics include:

- [3.1 Electrical Card Overview, page 3-1](#)
- [3.2 EC1-12 Card, page 3-3](#)
- [3.3 DS1-14 and DS1N-14 Cards, page 3-5](#)
- [3.4 DS1/E1-56 Card, page 3-9](#)
- [3.5 DS3-12 and DS3N-12 Cards, page 3-12](#)
- [3.6 DS3/EC1-48 Card, page 3-15](#)
- [3.7 DS3i-N-12 Card, page 3-18](#)
- [3.8 DS3-12E and DS3N-12E Cards, page 3-20](#)
- [3.9 DS3XM-6 Card, page 3-24](#)
- [3.10 DS3XM-12 Card, page 3-26](#)

3.1 Electrical Card Overview

Each card is marked with a symbol that corresponds to a slot (or slots) on the ONS 15454 shelf assembly. The cards are then installed into slots displaying the same symbols. See the “[1.17 Cards and Slots](#)” section on page 1-68 for a list of slots and symbols.

3.1.1 Card Summary

[Table 3-1](#) lists the Cisco ONS 15454 electrical cards.

Table 3-1 Cisco ONS 15454 Electrical Cards

Card Name	Description	For Additional Information
EC1-12	The EC1-12 card provides 12 Telcordia-compliant, GR-253 STS-1 electrical ports per card. Each port operates at 51.840 Mbps over a single 750-ohm, 728A or equivalent coaxial span.	See the “ 3.2 EC1-12 Card ” section on page 3-3.
DS1-14	The DS1-14 card provides 14 Telcordia-compliant GR-499 DS-1 ports. Each port operates at 1.544 Mbps over a 100-ohm, twisted-pair copper cable.	See the “ 3.3 DS1-14 and DS1N-14 Cards ” section on page 3-5.
DS1N-14	The DS1N-14 card supports the same features as the DS1-14 card but can also provide 1:N (N <= 5) protection.	See the “ 3.3 DS1-14 and DS1N-14 Cards ” section on page 3-5.
DS1/E1-56	The DS1/E1-56 card provides 56 Telcordia-compliant, GR-499 DS-1 ports per card, or 56 E1 ports per card. Each port operates at 1.544 Mbps (DS-1) or 2.048 Mbps (E1). The DS1/E1-56 card operates as a working or protect card in 1:N protection schemes, where N <= 2.	See the “ 3.4 DS1/E1-56 Card ” section on page 3-9.
DS3-12	The DS3-12 card provides 12 Telcordia-compliant GR-499 DS-3 ports per card. Each port operates at 44.736 Mbps over a single 75-ohm, 728A or equivalent coaxial span.	See the “ 3.5 DS3-12 and DS3N-12 Cards ” section on page 3-12.
DS3N-12	The DS3N-12 card supports the same features as the DS3-12 but can also provide 1:N (N <= 5) protection.	See the “ 3.5 DS3-12 and DS3N-12 Cards ” section on page 3-12.
DS3/EC1-48	The DS3/EC1-48 provides 48 Telcordia-compliant ports per card. Each port operates at 44.736 Mbps over a single 75-ohm, 728A or equivalent coaxial span.	See the “ 3.6 DS3/EC1-48 Card ” section on page 3-15.
DS3-12E	The DS3-12E card provides 12 Telcordia-compliant ports per card. Each port operates at 44.736 Mbps over a single 75-ohm, 728A or equivalent coaxial span. The DS3-12E card provides enhanced performance monitoring functions.	See the “ 3.8 DS3-12E and DS3N-12E Cards ” section on page 3-20.
DS3N-12E	The DS3N-12E card supports the same features as the DS3-12E but can also provide 1:N (N <= 5) protection.	See the “ 3.8 DS3-12E and DS3N-12E Cards ” section on page 3-20.
DS3XM-6 (Transmux)	The DS3XM-6 card provides six Telcordia-compliant GR-499-CORE M13 multiplexing functions. The DS3XM-6 converts six framed DS-3 network connections to 28x6 or 168 VT1.5s.	See the “ 3.9 DS3XM-6 Card ” section on page 3-24.
DS3XM-12 (Transmux)	The DS3XM-12 card provides 12 Telcordia-compliant GR-499-CORE M13 multiplexing functions. The DS3XM-12 converts twelve framed DS-3 network connections to 28x12 or 168 VT1.5s.	See the “ 3.10 DS3XM-12 Card ” section on page 3-26.

3.1.2 Card Compatibility

Table 3-2 lists the CTC software compatibility for each electrical card. See Table 2-4 on page 2-4 for a list of cross-connect cards that are compatible with each electrical card.

Note

“Yes” indicates that this card is fully or partially supported by the indicated software release. Refer to the individual card reference section for more information about software limitations for this card.

Table 3-2 Electrical Card Software Release Compatibility

Electrical Card	R2.2.2	R3.0.1	R3.1	R3.2	R3.3	R3.4	R4.0	R4.1	R4.5	R4.6	R4.7	R5.0	R6.0	R7.0	R7.2
EC1-12	Yes	Yes	Yes	Yes	Yes	Yes	Yes	Yes	—	Yes	—	Yes	Yes	Yes	Yes
DS1-14	Yes	Yes	Yes	Yes	Yes	Yes	Yes	Yes	—	Yes	—	Yes	Yes	Yes	Yes
DS1N-14	Yes	Yes	Yes	Yes	Yes	Yes	Yes	Yes	—	Yes	—	Yes	Yes	Yes	Yes
DS1/E1-56	—	—	—	—	—	—	—	—	—	—	—	—	Yes	Yes	Yes
DS3-12	Yes	Yes	Yes	Yes	Yes	Yes	Yes	Yes	—	Yes	—	Yes	Yes	Yes	Yes
DS3N-12	Yes	Yes	Yes	Yes	Yes	Yes	Yes	Yes	—	Yes	—	Yes	Yes	Yes	Yes
DS3-12E	Yes	Yes	Yes	Yes	Yes	Yes	Yes	Yes	—	Yes	—	Yes	Yes	Yes	Yes
DS3N-12E	Yes	Yes	Yes	Yes	Yes	Yes	Yes	Yes	—	Yes	—	Yes	Yes	Yes	Yes
DS3XM-6 (Transmux)	Yes	Yes	Yes	Yes	Yes	Yes	Yes	Yes	—	Yes	—	Yes	Yes	Yes	Yes
DS3XM-12 (Transmux)	—	—	—	—	—	—	—	—	—	—	—	Yes	Yes	Yes	Yes
DS3/EC1-48	—	—	—	—	—	—	—	—	—	—	—	Yes	Yes	Yes	Yes
DS3i-N-12	—	—	—	—	—	—	—	Yes (4.1.2)	—	Yes	—	Yes	Yes	Yes	Yes

3.2 EC1-12 Card

Note

For hardware specifications, see the “A.5.1 EC1-12 Card Specifications” section on page A-15.

The EC1-12 card provides 12 Telcordia-compliant, GR-253 STS-1 electrical ports per card. Each port operates at 51.840 Mbps over a single 75-ohm, 728A or equivalent coaxial span.

STS path selection for UNEQ-P, AIS-P, and bit error rate (BER) thresholds is done on the SONET ring interfaces (optical cards) in conjunction with the STS cross-connect. The EC1-12 terminates but does not select the 12 working STS-1 signals from the backplane. The EC1-12 maps each of the 12 received EC1 signals into 12 STS-1s with visibility into the SONET path overhead.

An EC1-12 card can be 1:1 protected with another EC1-12 card but cannot protect more than one EC1-12 card. You must install the EC1-12 in an even-numbered slot to serve as a working card and in an odd-numbered slot to serve as a protect card.

3.2.1 EC1-12 Slots and Connectors

You can install the EC1-12 card in Slots 1 to 6 or 12 to 17 on the ONS 15454. Each EC1-12 interface features DSX-level (digital signal cross-connect frame) outputs supporting distances up to 450 feet (137 meters) depending on facility conditions. See the “[7.2 Electrical Card Protection and the Backplane](#)” section on page 7-5 for more information about electrical card slot protection and restrictions.

3.2.2 EC1-12 Faceplate and Block Diagram

Figure 3-1 shows the EC1-12 faceplate and a block diagram of the card.

Figure 3-1 EC1-12 Faceplate and Block Diagram

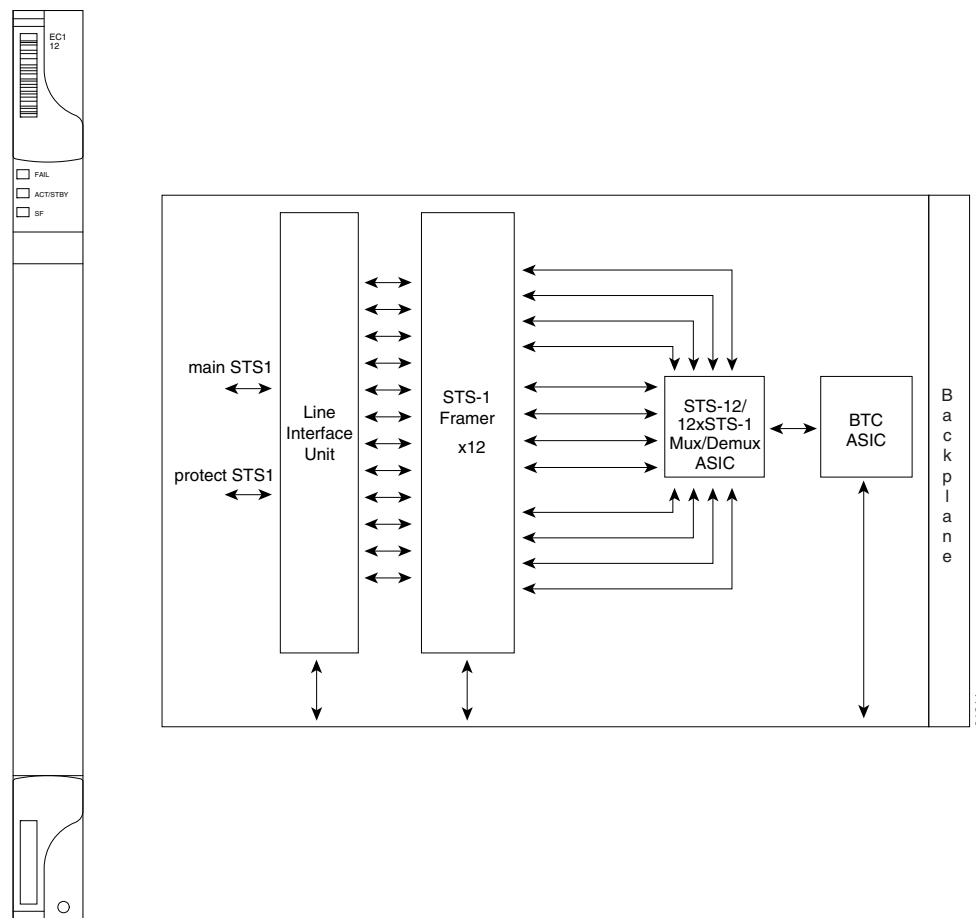

3.2.3 EC1-12 Hosted by XCVT, XC10G, or XC-VXC-10G

All 12 STS-1 payloads from an EC1-12 card are carried to the XCVT, XC10G, or XC-VXC-10G card where the payload is further aggregated for efficient transport. XCVT cards can host a maximum of 288 bidirectional STS-1s. The XC10G and XC-VXC-10G cards can host up to 1152 bidirectional STS-1s.

3.2.4 EC1-12 Card-Level Indicators

Table 3-3 describes the three card-level LEDs on the EC1-12 card.

Table 3-3 EC1-12 Card-Level Indicators

Card-Level Indicators	Description
Red FAIL LED	The red FAIL LED indicates that the EC1-12 card processor is not ready. Replace the unit if the FAIL LED persists.
Green ACT LED	The green ACT LED indicates that the EC1-12 card is operational and ready to carry traffic.
Amber SF LED	The amber SF LED indicates a signal failure or condition such as loss of signal (LOS), loss of frame (LOF) or high BER on one or more card ports.

3.2.5 EC1-12 Port-Level Indicators

You can obtain the status of the EC1-12 card ports by using the LCD screen on the ONS 15454 fan tray. Use the LCD to view the status of any port or card slot; the screen displays the number and severity of alarms for a given port or slot.

3.3 DS1-14 and DS1N-14 Cards



Note

For hardware specifications, see the “A.5.2 DS1-14 and DS1N-14 Card Specifications” section on page A-16.

The ONS 15454 DS1-14 card provides 14 Telcordia-compliant, GR-499 DS-1 ports. Each port operates at 1.544 Mbps over a 100-ohm, twisted-pair copper cable. The DS1-14 card can function as a working or protect card in 1:1 protection schemes and as a working card in 1:N protection schemes. Each DS1-14 port has digital signal cross-connect frame (DSX)-level outputs supporting distances up to 655 feet (200 meters).

The DS1-14 card supports 1:1 protection. The DS1-14 can be a working card in a 1:N protection scheme with the proper backplane EIA and wire-wrap or AMP Champ connectors. You can also provision the DS1-14 to monitor for line and frame errors in both directions.

You can group and map DS1-14 card traffic in STS-1 increments to any other card in an ONS 15454 except DS-3 cards. Each DS-1 is asynchronously mapped into a SONET VT1.5 payload and the card carries a DS-1 payload intact in a VT1.5. For performance monitoring purposes, you can gather bidirectional DS-1 frame-level information (LOF, parity errors, cyclic redundancy check [CRC] errors, and so on).

3.3.1 DS1N-14 Features and Functions

The DS1N-14 card supports the same features as the DS1-14 card in addition to enhanced protection schemes. The DS1N-14 is capable of 1:N ($N \leq 5$) protection with the proper backplane EIA and wire-wrap or AMP Champ connectors. The DS1N-14 card can function as a working or protect card in 1:1 or 1:N protection schemes.

If you use the DS1N-14 as a standard DS-1 card in a 1:1 protection group, you can install the DS1N-14 card in Slots 1 to 6 or 12 to 17 on the ONS 15454. If you use the card's 1:N functionality, you must install a DS1N-14 card in Slots 3 and 15. Each DS1N-14 port features DS-n-level outputs supporting distances of up to 655 feet (200 meters) depending on facility conditions.

3.3.2 DS1-14 and DS1N-14 Slot Compatibility

You can install the DS1-14 card in Slots 1 to 6 or 12 to 17 on the ONS 15454.

3.3.3 DS1-14 and DS1N-14 Faceplate and Block Diagram

[Figure 3-2](#) shows the DS1-14 faceplate and the block diagram of the card.

Figure 3-2 DS1-14 Faceplate and Block Diagram

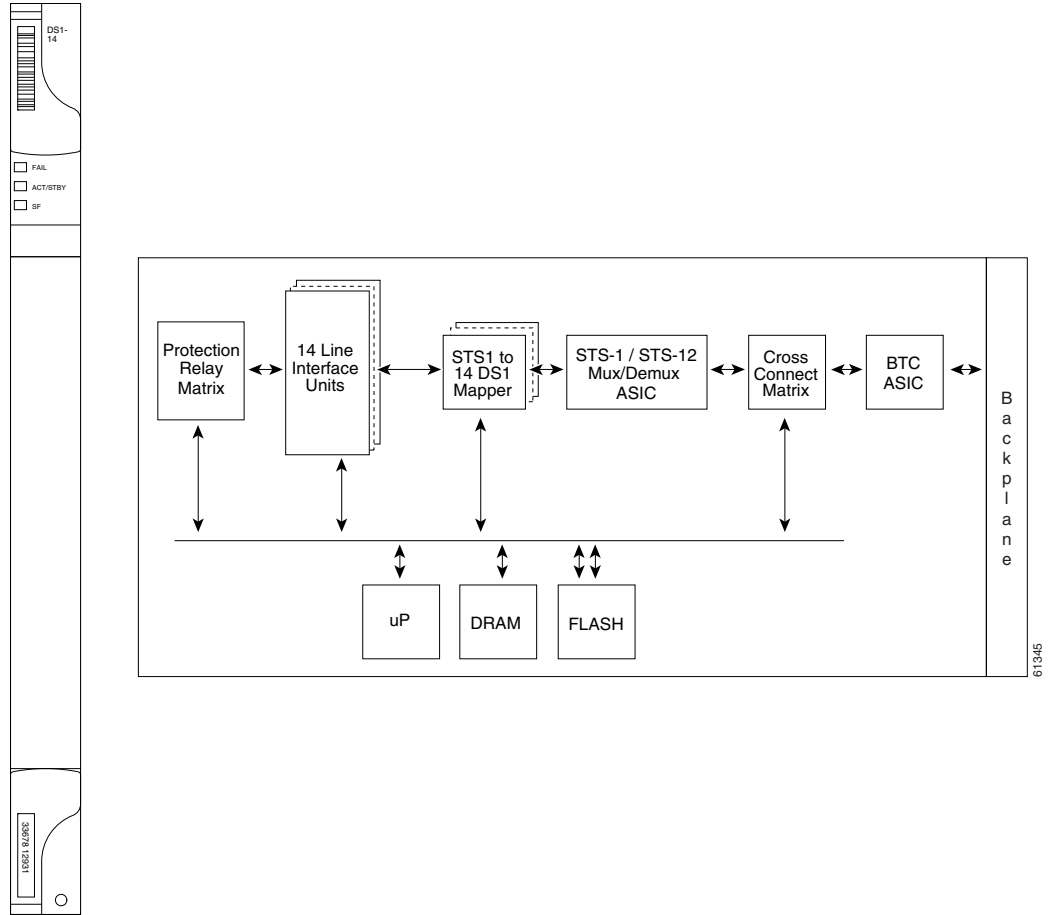
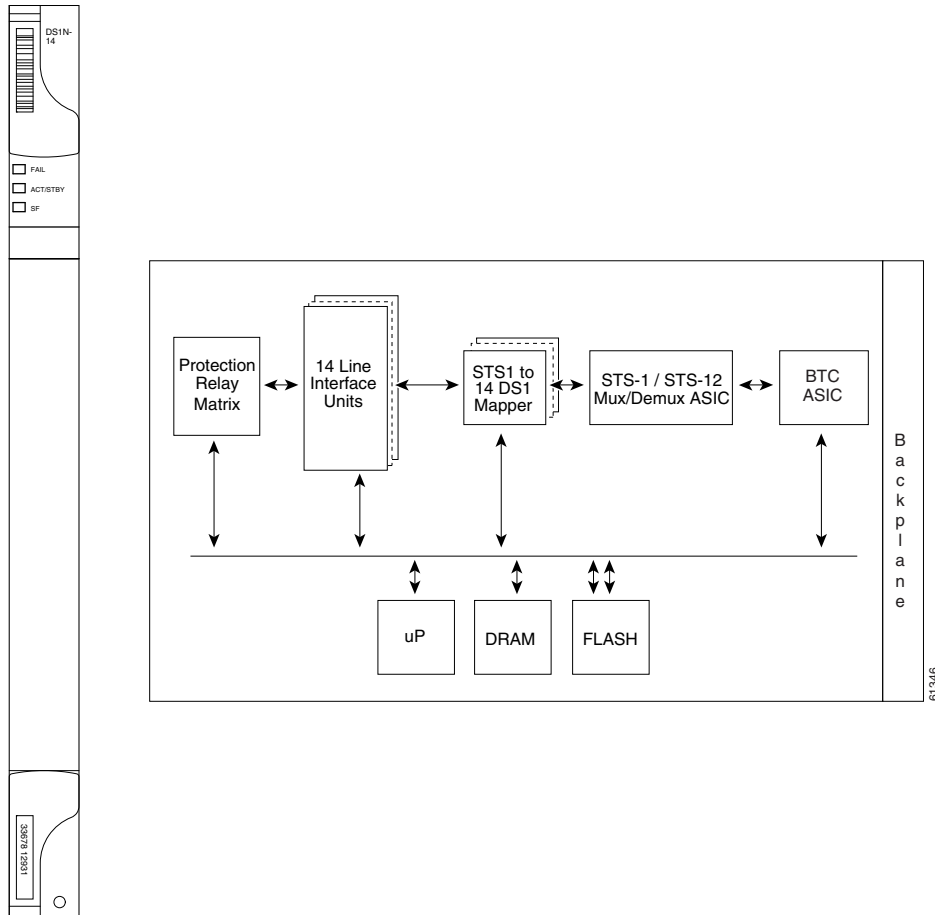

Figure 3-3 shows the DS1N-14 faceplate and a block diagram of the card.

Figure 3-3 DS1N-14 Faceplate and Block Diagram



3.3.4 DS1-14 and DS1N-14 Hosted by XCVT, XC10G, or XC-VXC-10G

All 14 VT1.5 payloads from DS1-14 and DS1N-14 cards are carried in a single STS-1 to the XCVT, XC10G, or XC-VXC-10G cards, where the payload is further aggregated for efficient STS-1 transport. The XC10G and XCVT cards manage up to 336 bidirectional VT1.5 ports. The XC-VXC-10G card can manage up to 2688 bidirectional VT1.5 ports

3.3.5 DS1-14 and DS1N-14 Card-Level Indicators

Table 3-4 describes the three card-level LEDs on the DS1-14 and DS1N-14 card faceplates.

Table 3-4 DS1-14 and DS1N-14 Card-Level Indicators

Card-Level Indicators	Description
Red FAIL LED	The red FAIL LED indicates that the card processor is not ready. Replace the card if the red FAIL LED persists.
ACT/STBY LED Green (Active) Amber (Standby)	The green/amber ACT/STBY LED indicates whether the card is operational and ready to carry traffic (green) or in standby mode (amber).
Amber SF LED	The amber SF LED indicates a signal failure or condition such as LOS, LOF, or high BERs on one or more card ports.

3.3.6 DS1-14 and DS1N-14 Port-Level Indicators

You can obtain the status of the DS1-14 and DS1N-14 card ports by using the LCD screen on the ONS 15454 fan-tray assembly. Use the LCD to view the status of any port or card slot; the screen displays the number and severity of alarms for a given port or slot.

3.4 DS1/E1-56 Card

Note

For hardware specifications, see the [“A.5.3 DS1/E1-56 Card Specifications” section on page A-18](#).

The ONS 15454 DS1/E1-56 card provides 56 Telcordia-compliant, GR-499 DS-1 ports per card, or 56 E1 ports per card. Each port operates at 1.544 Mbps (DS-1) or 2.048 Mbps (E1). The DS1/E1-56 card operates as a working or protect card in 1:N protection schemes, where $N \leq 2$. The DS1/E1-56 card can be used with the XCVT, XC10G, or XC-VXC-10G cross-connect cards.

Note

The DS1/E1-56 card does not support VT-2 (virtual tributary-2) circuit creation on E1 ports.

Caution

When a protection switch moves traffic from the active (or working) DS1/E1-56 card to the standby (or protect) DS1/E1-56 card, ports on the now standby (or protect) card cannot be moved to Out of Service state. Traffic is dropped if the ports are in Out of Service state.

3.4.1 DS1/E1-56 Slots and Connectors

For SONET applications, the DS1/E1-56 card requires a high-density (HD) shelf (15454-SA-HD), UBIC EIA, and Software Release 6.0 or greater.

Note

The UBIC-H EIA supports the termination of both DS-1 and E-1 signals when used with the appropriate cables. The UBIC-V EIA only supports the termination of DS-1 signals.

**Note**

The DS1/E1-56 card supports an errorless software-initiated cross-connect card switch when used in a shelf equipped with XC-VXC-10G and TCC2/TCC2P cards.

You can install the DS1/E1-56 card in Slots 1 to 3 or 15 to 17 on the ONS 15454, but installing this card in certain slots will block the use of other slots. [Table 3-5](#) shows which slots become unusable for other electrical cards when the DS1/E1-56 card is installed in a particular slot.

Table 3-5 DS1/E1-56 Slot Restrictions

Slot	Additional Unusable Slots for Electrical Cards
1	5 and 6
2	3 or 4 (except another DS1/E1-56 protect card can be installed in Slot 3)
3	—
15	—
16	14 and 15 (except another DS1/E1-56 protect card can be installed in Slot 15)
17	12 and 13

With the proper backplane EIA, the card supports SCSI (UBIC) connectors. See the [“7.2 Electrical Card Protection and the Backplane”](#) section on page 7-5 for more information about electrical card slot protection and restrictions.

3.4.2 DS1/E1-56 Faceplate and Block Diagram

[Figure 3-4](#) shows the DS1/E1-56 faceplate and a block diagram of the card.

Figure 3-4 DS1/E1-56 Faceplate and Block Diagram

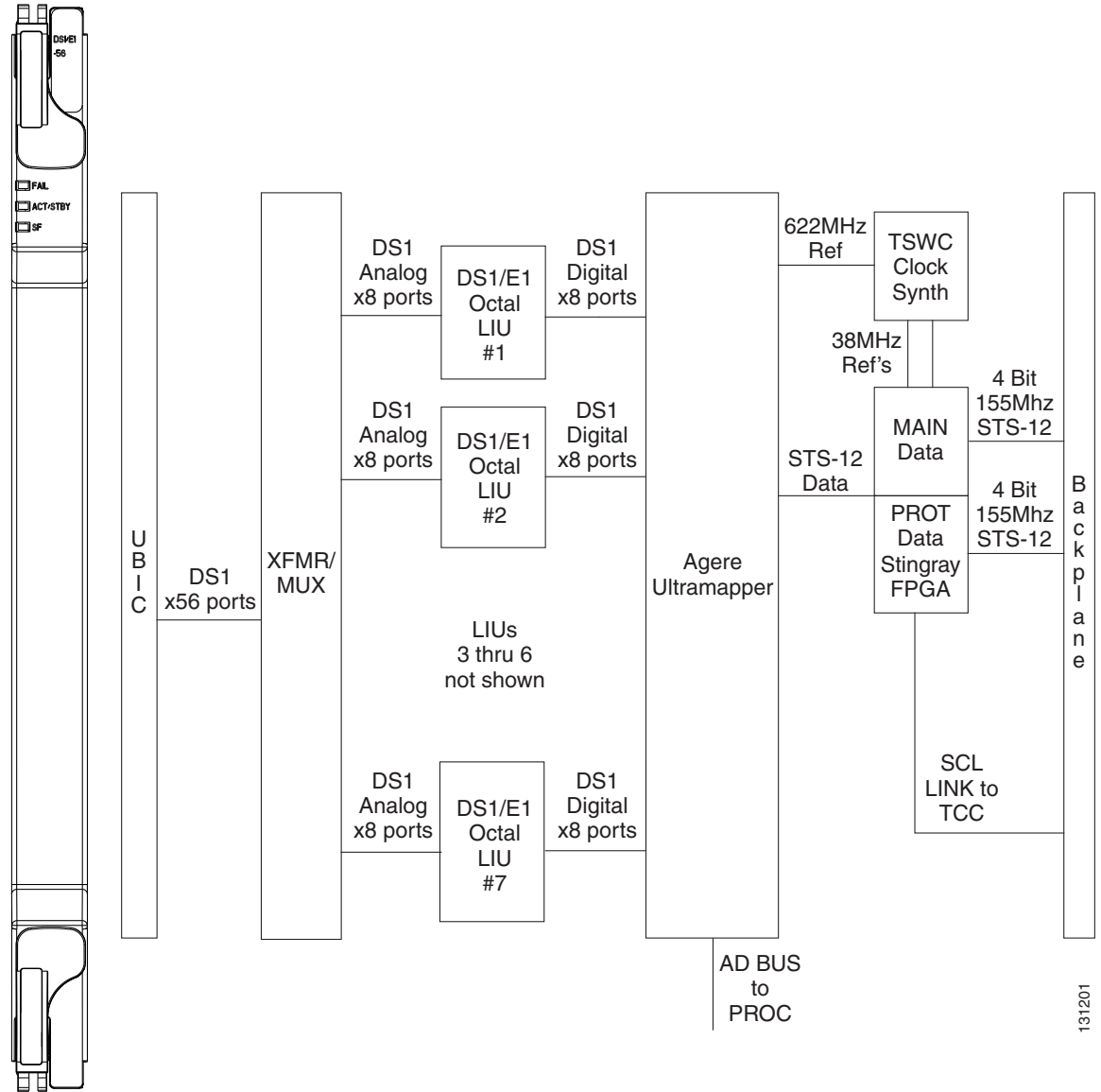

131201

3.4.3 DS1/E1-56 Card-Level Indicators

The DS1/E1-56 card has three card-level LED indicators (Table 3-6).

Table 3-6 DS1/E1-56 Card-Level Indicators

Card-Level Indicators	Description
Red FAIL LED	Indicates that the card processor is not ready. This LED is on during reset. The FAIL LED flashes during the boot process. Replace the card if the red FAIL LED persists in flashing.
ACT/STBY LED Green (Active) Amber (Standby)	When the ACT/STBY LED is green, the card is operational and ready to carry traffic. When the ACT/STBY LED is amber, the card is operational and in standby (protect) mode.
Amber SF LED	Indicates a signal failure or condition such as LOS or LOF on one or more card ports.

3.4.4 DS1/E1-56 Port-Level Indicators

You can obtain the status of the DS1/E1-56 card ports by using the LCD screen on the ONS 15454 fan-tray assembly. Use the LCD to view the status of any port or card slot; the screen displays the number and severity of alarms for a given port or slot.

3.5 DS3-12 and DS3N-12 Cards

Note

For hardware specifications, see the [“A.5.5 DS3-12 and DS3N-12 Card Specifications”](#) section on [page A-20](#).

Note

Any new features that are available as part of this software release are not enabled for this card.

The ONS 15454 DS3-12 card provides 12 Telcordia-compliant, GR-499 DS-3 ports per card. Each port operates at 44.736 Mbps over a single 75-ohm 728A or equivalent coaxial span. The DS3-12 card operates as a working or protect card in 1:1 protection schemes and as a working card in 1:N protection schemes.

The DS3-12 card supports 1:1 protection with the proper backplane EIA. EIAs are available with BNC, SMB, or SCSI (UBIC) connectors.

Caution

When a protection switch moves traffic from the DS3-12 working/active card to the DS3-12 protect/standby card, ports on the now active/standby card cannot be taken out of service. Lost traffic can result if you take a port out of service, even if the DS3-12 standby card no longer carries traffic.

Other than protection capabilities, the DS3-12 and DS3N-12 cards are identical. The DS3N-12 can operate as the protect card in a 1:N (N <= 5) DS3 protection group. It has additional circuitry that is not present on the basic DS3-12 card that allows it to protect up to five working DS3-12 cards. The basic DS3-12 card can only function as the protect card for one other DS3-12 card.

3.5.1 DS3-12 and DS3N-12 Slots and Connectors

You can install the DS3-12 or DS3N-12 card in Slots 1 to 6 or 12 to 17 on the ONS 15454. Each DS3-12 or DS3N-12 card port features DSX-level outputs supporting distances up to 137 meters (450 feet) depending on facility conditions. With the proper backplane EIA, the card supports BNC or SMB connectors. See the “7.2 Electrical Card Protection and the Backplane” section on page 7-5 for more information about electrical card slot protection and restrictions.

3.5.2 DS3-12 and DS3N-12 Faceplate and Block Diagram

Figure 3-5 shows the DS3-12 faceplate and a block diagram of the card.

Figure 3-5 DS3-12 Faceplate and Block Diagram

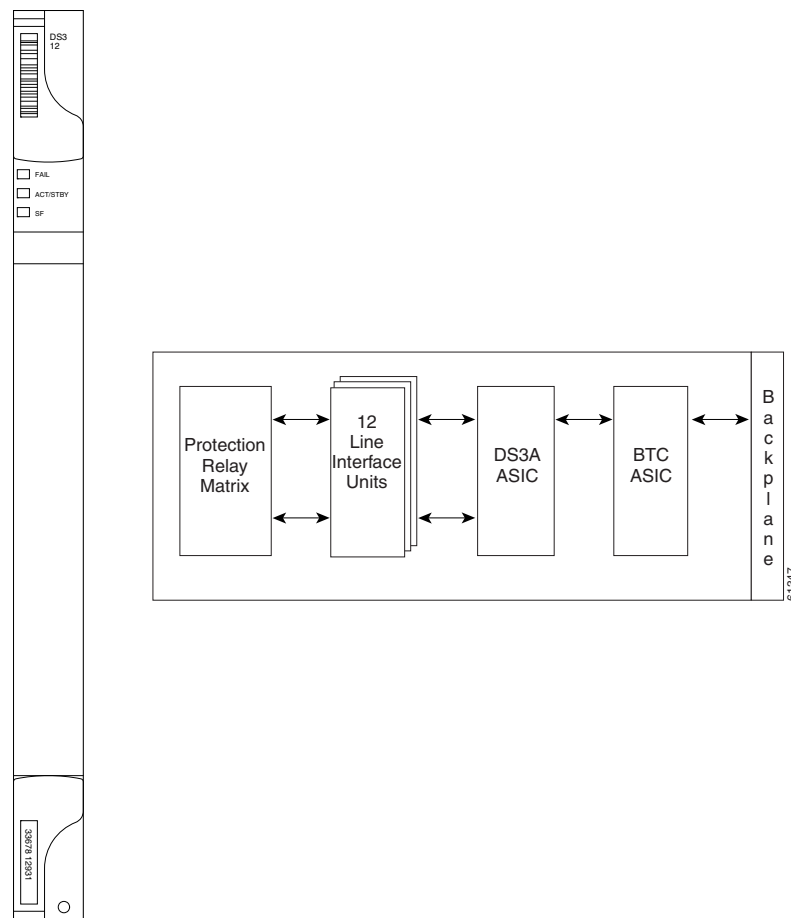
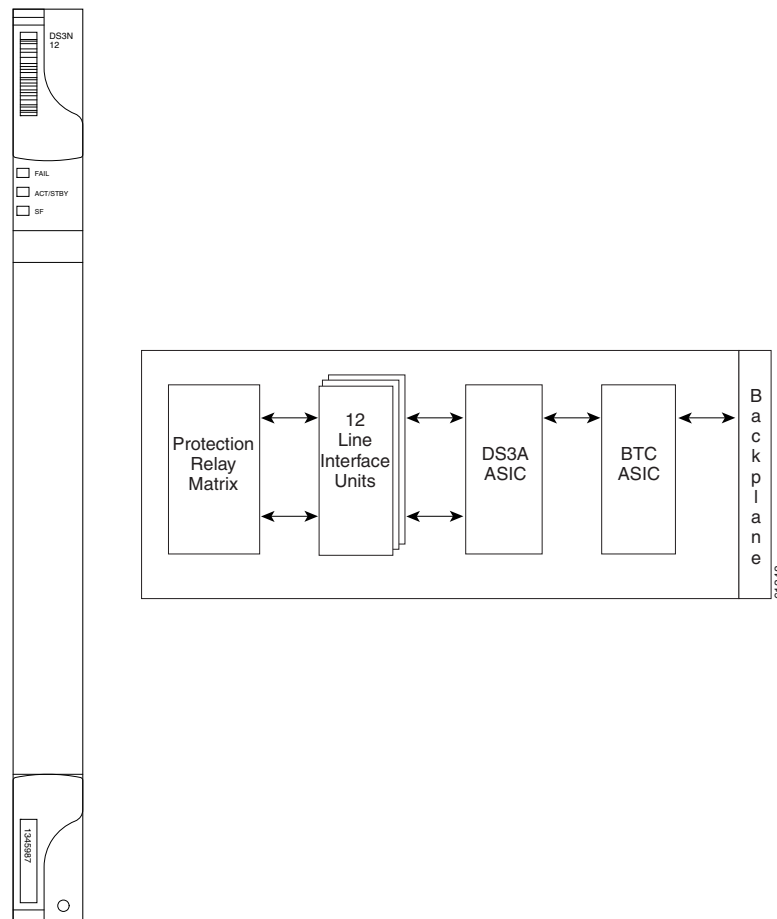

Figure 3-6 shows the DS3N-12 faceplate and a block diagram of the card.

Figure 3-6 DS3N-12 Faceplate and Block Diagram



3.5.3 DS3-12 and DS3N-12 Card-Level Indicators

Table 3-7 describes the three card-level LEDs on the DS3-12 and DS3N-12 card faceplates.

Table 3-7 DS3-12 and DS3N-12 Card-Level Indicators

Card-Level Indicators	Description
Red FAIL LED	The red FAIL LED indicates that the card processor is not ready. Replace the card if the red FAIL LED persists.
ACT/STBY LED Green (Active) Amber (Standby)	When the ACT/STBY LED is green, the card is operational and ready to carry traffic. When the ACT/STBY LED is amber, the card is operational and in standby (protect) mode.
Amber SF LED	The amber SF LED indicates a signal failure or condition such as port LOS.

3.5.4 DS3-12 and DS3N-12 Port-Level Indicators

You can find the status of the 12 DS3-12 and 12 DS3N-12 card ports by using the LCD screen on the ONS 15454 fan-tray assembly. Use the LCD to view the status of any port or card slot; the screen displays the number and severity of alarms for a given port or slot.

3.6 DS3/EC1-48 Card



Note

For hardware specifications, see the “[A.5.4 DS3/EC1-48 Card Specifications](#)” section on page A-19.

The ONS 15454 DS3/EC1-48 card provides 48 Telcordia-compliant, GR-499 DS-3 ports per card. Each port operates at 44.736 Mbps over a single 75-ohm 728A or equivalent coaxial span. The DS3/EC1-48 card operates as a working or protect card in 1:N protection schemes, where $N \leq 2$.



Caution

When a protection switch moves traffic from the DS3/EC1-48 working/active card to the DS3/EC1-48 protect/standby card, ports on the now active/standby card cannot be taken out of service. Lost traffic can result if you take a port out of service, even if the DS3/EC1-48 standby card no longer carries traffic.

3.6.1 DS3/EC1-48 Slots and Connectors

For SONET applications, the DS3/EC1-48 card requires an HD shelf (15454-SA-HD) and EIA (UBIC, MiniBNC); Software Release 5.0 or greater; and XC10G or XC-VXC-10G cards.



Note

The DS3/EC1-48 card supports an errorless software-initiated cross-connect card switch when used in a shelf equipped with XC-VXC-10G and TCC2/TCC2P cards.

You can install the DS3/EC1-48 card in Slots 1 to 3 or 15 to 17 on the ONS 15454, but installing this card in certain slots will block the use of other slots. [Table 3-8](#) shows which slots become unusable for other electrical cards when the DS3/EC1-48 card is installed in a particular slot.

Table 3-8 DS3/EC1-48 Slot Restrictions

Slot	Additional Unusable Slots for Electrical Cards
1	5 and 6
2	3 or 4 (except another DS3/EC1-48 card can be installed in Slot 3)
3	—
15	—
16	14 and 15 (except another DS3/EC1-48 card can be installed in Slot 15)
17	12 and 13



Caution

Do not install low-density DS-1 cards in the same side of the shelf as DS3/EC1-48 cards.

**Caution**

Do not install a DS3/EC1-48 card in Slots 1 or 2 if you have installed an MXP_2.5G_10G card in Slot 3. Likewise, do not install a DS3/EC1-48 card in Slots 16 or 17 if you have installed an MXP_2.5G_10G card in Slot 15. If you do, the cards will interact and cause DS-3 bit errors.

With the proper backplane EIA, the card supports BNC or SCSI (UBIC) connectors. See the [“7.2 Electrical Card Protection and the Backplane”](#) section on page 7-5 for more information about electrical card slot protection and restrictions.

3.6.2 DS3/EC1-48 Faceplate and Block Diagram

[Figure 3-7](#) shows the DS3/EC1-48 faceplate and a block diagram of the card.

Figure 3-7 DS3/EC1-48 Faceplate and Block Diagram

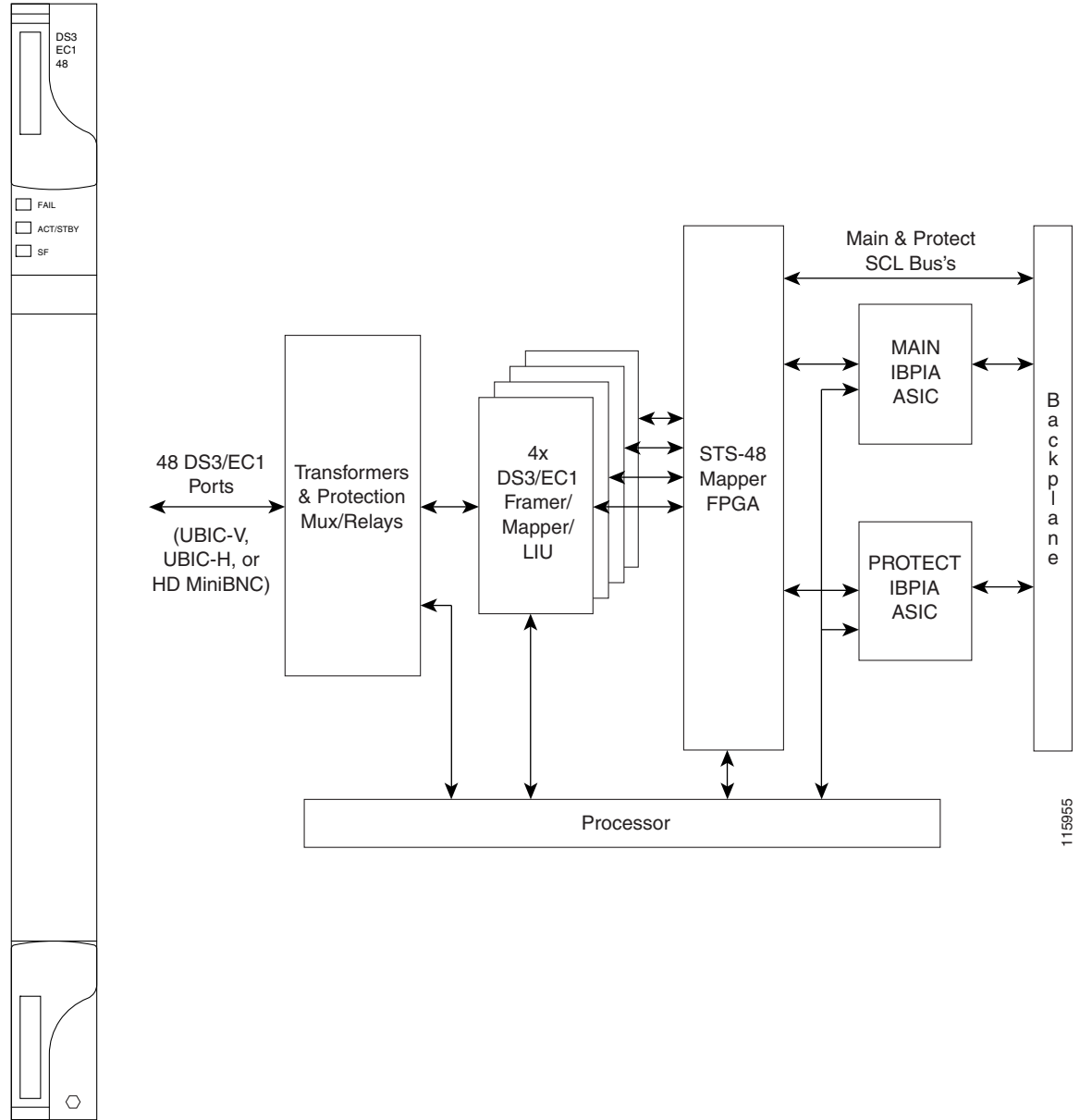

3.6.3 DS3/EC1-48 Card-Level Indicators

The DS3/EC1-48 card has three card-level LED indicators ([Table 3-9](#)).

Table 3-9 DS3/EC1-48 Card-Level Indicators

Card-Level Indicators	Description
Red FAIL LED	Indicates that the card processor is not ready. This LED is on during reset. The FAIL LED flashes during the boot process. Replace the card if the red FAIL LED persists in flashing.
ACT/STBY LED Green (Active) Amber (Standby)	When the ACT/STBY LED is green, the card is operational and ready to carry traffic. When the ACT/STBY LED is amber, the card is operational and in standby (protect) mode.
Amber SF LED	Indicates a signal failure or condition such as LOS or LOF on one or more card ports.

3.6.4 DS3/EC1-48 Port-Level Indicators

You can obtain the status of the DS3/EC1-48 card ports by using the LCD screen on the ONS 15454 fan-tray assembly. Use the LCD to view the status of any port or card slot; the screen displays the number and severity of alarms for a given port or slot.

3.7 DS3i-N-12 Card



Note

For hardware specifications, see the [“A.5.6 DS3i-N-12 Card Specifications”](#) section on page A-21.

The 12-port ONS 15454 DS3i-N-12 card provides 12 ITU-T G.703, ITU-T G.704, and Telcordia GR-499-CORE compliant DS-3 ports per card. Each port operates at 44.736 Mbps over a 75-ohm coaxial cable. The DS3i-N-12 card supports 1:1 or 1:N protection with the proper backplane EIA. The DS3i-N-12 card works with the XCVT, XC10G, and XC-VXC-10G cross-connect cards. Four sets of three adjacent DS-3 signals (Port 1 through Port 3, Port 4 through Port 6, Port 7 through Port 9, and Port 10 through Port 12) are mapped to VC3s into a VC4 and transported as an STC-3c.

The DS3i-N-12 can also aggregate DS3 and E1 traffic and transport it between SONET and SDH networks through AU4/STS 3 trunks, with the ability to add and drop DS3s to an STS3 trunk at intermediate nodes.

3.7.1 DS3i-N-12 Slots and Connectors

You can install the DS3i-N-12 card in Slots 1 to 6 and 12 to 17. The DS3i-N-12 can operate as the protect card in a 1:N (N <= 5) DS-3 protection group on a half-shelf basis, with protection cards in Slots 3 and 15. It has circuitry that allows it to protect up to five working DS3i-N-12 cards. With the proper backplane EIA, the card supports BNC or SMB connectors. See the [“7.2 Electrical Card Protection and the Backplane”](#) section on page 7-5 for more information about electrical card slot protection and restrictions.

[Figure 3-8](#) shows the DS3i-N-12 faceplate and block diagram.

Figure 3-8 DS3i-N-12 Faceplate and Block Diagram

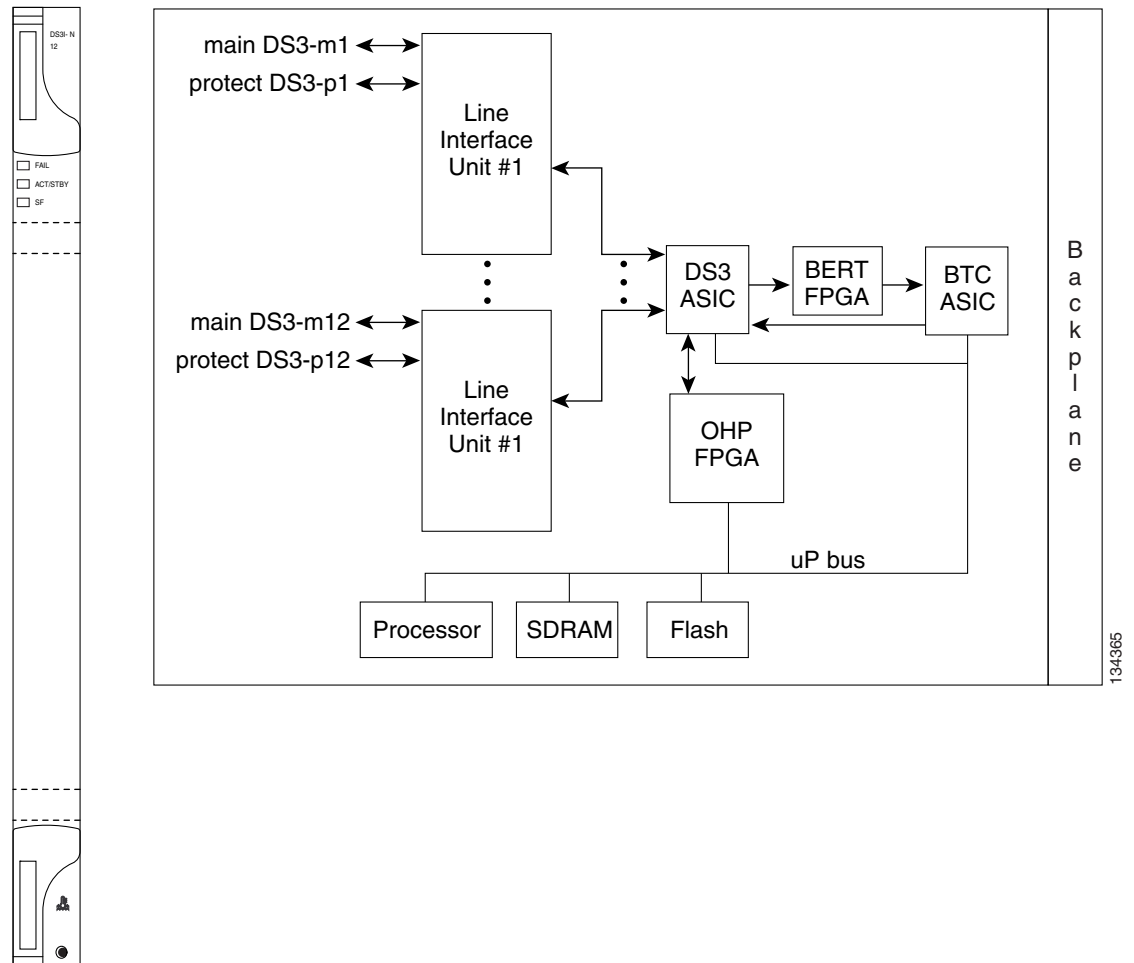

The following list summarizes the DS3i-N-12 card features:

- Provisionable framing format (M23, C-bit, or unframed)
- Autorecognition and provisioning of incoming framing
- VC-3 payload mapping as per ITU-T G.707, mapped into VC-4 and transported as STS-3c
- Idle signal (“1100”) monitoring as per Telcordia GR-499-CORE
- P-bit monitoring
- C-bit parity monitoring
- X-bit monitoring
- M-bit monitoring
- F-bit monitoring
- Far-end block error (FEBE) monitoring
- Far-end alarm and control (FEAC) status and loop code detection
- Path trace byte support with TIM-P alarm generation

3.7.2 DS3i-N-12 Card-Level Indicators

Table 3-10 describes the three LEDs on the DS3i-N-12 card faceplate.

Table 3-10 DS3i-N-12 Card-Level Indicators

Card-Level LEDs	Description
Red FAIL LED	Indicates that the card processor is not ready. This LED is on during reset. The FAIL LED flashes during the boot process. Replace the card if the red FAIL LED persists in flashing.
ACT/STBY LED Green (Active) Amber (Standby)	When the ACT/STBY LED is green, the DS3i-N-12 card is operational and ready to carry traffic. When the ACT/STBY LED is amber, the DS3i-N-12 card is operational and in standby (protect) mode.
Amber SF LED	Indicates a signal failure or condition such as LOS or LOF on one or more card ports.

3.7.3 DS3i-N-12 Port-Level Indicators

You can find the status of the DS3i-N-12 card ports by using the LCD screen on the ONS 15454 fan-tray assembly. Use the LCD to view the status of any port or card slot; the screen displays the number and severity of alarms for a given port or slot. Refer to the *Cisco ONS 15454 Troubleshooting Guide* for a complete description of the alarm messages.

3.8 DS3-12E and DS3N-12E Cards



Note

For hardware specifications, see the [“A.5.7 DS3-12E and DS3N-12E Card Specifications”](#) section on page A-22.

The ONS 15454 DS3-12E card provides 12 Telcordia-compliant GR-499 DS-3 ports per card. Each port operates at 44.736 Mbps over a single 75-ohm 728A or equivalent coaxial span. The DS3-12E card provides enhanced performance monitoring functions. The DS3-12E can detect several different errored logic bits within a DS3 frame. This function allows the ONS 15454 to identify a degrading DS3 facility caused by upstream electronics (DS3 Framer). In addition, DS3 frame format autodetection and J1 path trace are supported. By monitoring additional overhead in the DS3 frame, subtle network degradations can be detected.

The following list summarizes DS3-12E card features:

- Provisionable framing format M23, C-bit or unframed
- Autorecognition and provisioning of incoming framing
- P-bit monitoring
- C-bit parity monitoring
- X-bit monitoring
- M-bit monitoring
- F-bit monitoring

- FEBE monitoring
- FEAC status and loop code detection
- Path trace byte support with TIM-P alarm generation

The DS3-12E supports a 1:1 protection scheme, meaning it can operate as the protect card for one other DS3-12E card.

The DS3N-12E can operate as the protect card in a 1:N ($N \leq 5$) DS3 protection group. It has additional circuitry not present on the basic DS3-12E card that allows it to protect up to five working DS3-12E cards. The basic DS3-12E card can only function as the protect card for one other DS3-12E card.

3.8.1 DS3-12E and DS3N-12E Slots and Connectors

You can install the DS3-12E and DS3N-12E cards in Slots 1 to 6 or 12 to 17 on the ONS 15454. Each DS3-12E and DS3N-12E port features DSX-level outputs supporting distances up to 137 meters (450 feet). With the proper backplane EIA, the card supports BNC or SMB connectors. See the [“7.2 Electrical Card Protection and the Backplane”](#) section on page 7-5 for more information about electrical card slot protection and restrictions.

3.8.2 DS3-12E Faceplate and Block Diagram

[Figure 3-9](#) shows the DS3-12E faceplate and a block diagram of the card.

Figure 3-9 DS3-12E Faceplate and Block Diagram

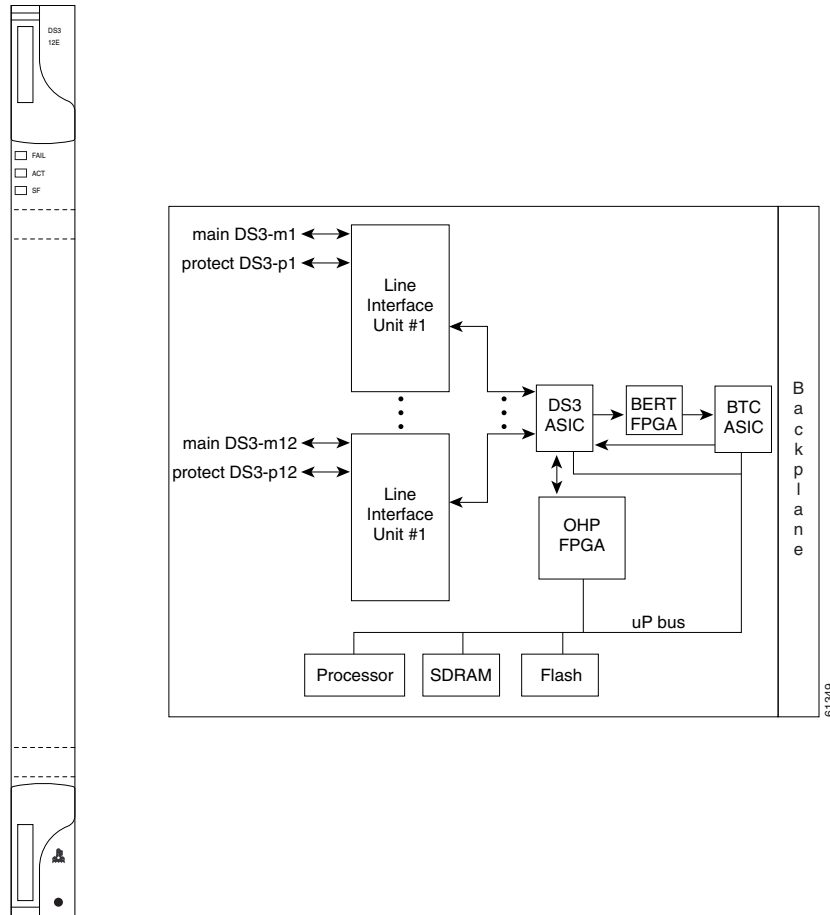
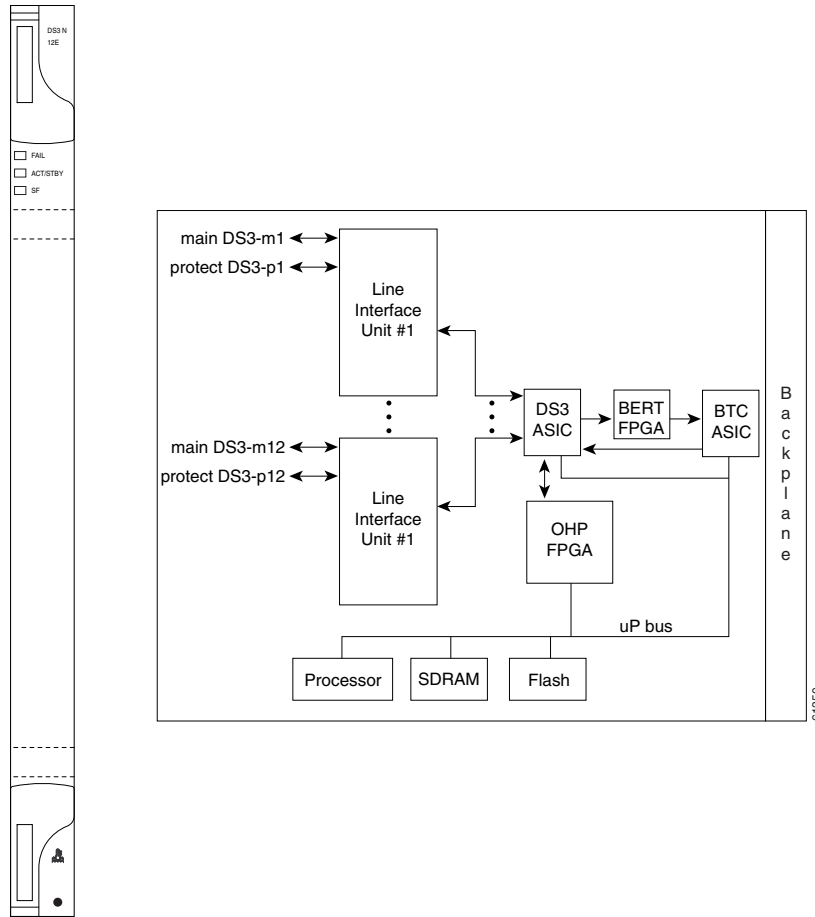

Figure 3-10 shows the DS3N-12E faceplate and a block diagram of the card.

Figure 3-10 DS3N-12E Faceplate and Block Diagram



3.8.3 DS3-12E and DS3N-12E Card-Level Indicators

Table 3-11 describes the three card-level LEDs on the DS3-12E and DS3N-12E card faceplates.

Table 3-11 DS3-12E and DS3N-12E Card-Level Indicators

Card-Level Indicators	Description
Red FAIL LED	The red FAIL LED indicates that the card processor is not ready. Replace the card if the red FAIL LED persists.
ACT/STBY LED Green (Active) Amber (Standby)	When the ACT/STBY LED is green, the card is operational and ready to carry traffic. When the ACT/STBY LED is amber, the card is operational and in standby (protect) mode.
Amber SF LED	The amber SF LED indicates a signal failure or condition such as port LOS or AIS.

3.8.4 DS3-12E and DS3N-12E Port-Level Indicators

You can find the status of the DS3-12E and DS3N-12E card ports by using the LCD screen on the ONS 15454 fan-tray assembly. Use the LCD to quickly view the status of any port or card slot; the screen displays the number and severity of alarms for a given port or slot.

3.9 DS3XM-6 Card

**Note**

For hardware specifications, see the [“A.5.9 DS3XM-6 Card Specifications”](#) section on page A-24.

The DS3XM-6 card, commonly referred to as a transmux card, provides six Telcordia-compliant, GR-499-CORE M13 multiplexing ports. The DS3XM-6 converts six framed DS-3 network connections to 28 x6 or 168 VT1.5s. DS3XM-6 cards operate at the VT1.5 level.

3.9.1 DS3XM-6 Slots and Connectors

The DS3XM-6 card supports 1:1 protection with the proper backplane EIA. EIAs are available with BNC or SMB connectors.

You can install the DS3XM-6 in Slots 1 to 6 or 12 to 17. Each DS3XM-6 port features DSX-level outputs supporting distances up to 137 meters (450 feet) depending on facility conditions. See [“7.2 Electrical Card Protection and the Backplane”](#) section on page 7-5 for more information about electrical card slot protection and restrictions.

3.9.2 DS3XM-6 Faceplate and Block Diagram

[Figure 3-11](#) shows the DS3XM-6 faceplate and a block diagram of the card.

Figure 3-11 DS3XM-6 Faceplate and Block Diagram

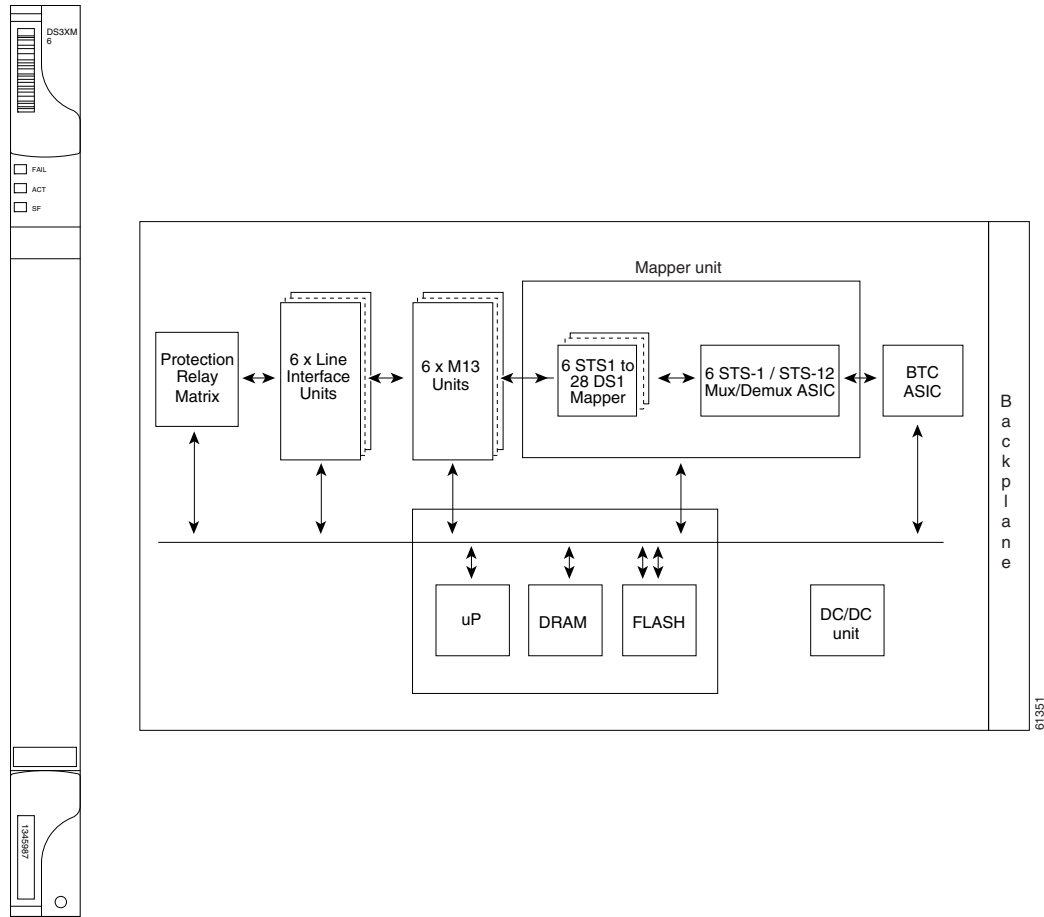

3.9.3 DS3XM-6 Hosted By XCVT, XC10G, XC-VXC-10G

The DS3XM-6 card works in conjunction with the XCVT, XC10G, XC-VXC-10G card. A single DS3XM-6 can demultiplex six DS-3 signals into 168 VT1.5s that the XCVT card then manages and cross connects. XCVT cards host a maximum of 336 bidirectional VT1.5s on two DS3XM-6 cards. In most network configurations, two DS3XM-6 cards are paired together as working and protect cards.

3.9.4 DS3XM-6 Card-Level Indicators

Table 3-12 describes the three card-level LEDs on the DS3XM-6 card faceplate.

Table 3-12 DS3XM-6 Card-Level Indicators

Card-Level Indicators	Description
Red FAIL LED	The red FAIL LED indicates that the card processor is not ready. Replace the card if the red FAIL LED persists.
ACT/STBY LED Green (Active) Amber (Standby)	When the ACT/STBY LED is green, the DS3XM-6 card is operational and ready to carry traffic. When the ACT/STBY LED is amber, the DS3XM-6 card is operational and in standby in a 1:1 protection group.
Amber SF LED	The amber SF LED indicates a signal failure or condition such as LOS, LOF, or high BER on one or more card ports.

3.9.5 DS3XM-6 Port-Level Indicators

You can find the status of the six DS3XM-6 card ports by using the LCD screen on the ONS 15454 fan-tray assembly. Use the LCD to quickly view the status of any port or card slot; the screen displays the number and severity of alarms for a given port or slot.

3.10 DS3XM-12 Card



Note

For hardware specifications, see the [“A.5.8 DS3XM-12 Card Specifications” section on page A-23](#).

The DS3XM-12 card, commonly referred to as a transmux card, provides twelve Telcordia-compliant, GR-499-CORE M13 multiplexing ports. The DS3XM-12 converts up to 12 framed DS-3 network connections to 12 x 28 VT1.5s.

3.10.1 Backplane Configurations

The DS3XM-12 card has 12 framed DS-3 physical ports (known as “ported” mode). The card also supports a maximum of 12 “portless” DS3-mapped STS1 interfaces depending on the type of cross-connect used. Each physical port corresponds to two portless ports. If a circuit is provisioned to a physical port, its associated portless pair becomes unavailable and vice versa. See the [“11.4 Portless Transmux” section on page 11-15](#) for more information.

The DS3XM-12 card is compatible with the XCVT, XC10G, and XC-VXC-10G cross-connect cards.



Note

The DS3XM-12 card supports an errorless software-initiated cross-connect card switch when used in a shelf equipped with XC-VXC-10G and TCC2/TCC2P cards.



Caution

During an upgrade of the DS3XM-6 card to DS3XM-12 card, the DS-3XM-12 card (in slots 1 to 5) encounters an insufficient cable loss of margin when the LBO setting on the DS-3 input ports are set between 225 to 450 feet cable lengths.

The DS3XM-12 supports three different backplane throughput configurations:

- STS-48 when an XC10G or XC-VXC-10G card is used. This configuration supports the OC-48 rate in any slot.
- STS-48 for the Slots 5, 6, 12, and 13 when an XCVT card is used.
- STS-12 for Slot 1 through 4, and 7 through 12 slots when an XCVT card is used. This configuration is bandwidth-limiting in the portless mode of operation.

The backplane throughput configuration is selected in CTC card view using the Maintenance > Card tab.

3.10.2 Ported Mode

The “ported” mode supports up to 12 framed DS-3 bidirectional mapped signals to each DS3XM-12 card, where the traffic is demultiplexed and mapped into a VT1.5 payload. This payload is then mapped and multiplexed up to a bidirectional STS-1.

3.10.3 Portless Mode

The “portless” mode allows for IXC hand off connections through a standard SONET fiber optical interface with DS-3-mapped STS-1s as a payload. This physical connection is accomplished with any of the OC-N cards. The system cross-connect grooms the DS-3 mapped STS1 traffic to the appropriate DS3XM-12 card, where the traffic is demultiplexed and mapped into a VT1.5 payload. This payload is then mapped and multiplexed up to a higher rate STS-1. See the “[11.4 Portless Transmux](#)” section on [page 11-15](#) for more information.

3.10.4 Shelf Configurations

The DS3XM-12 card supports the XCVT, XC10G, and XC-VXC-10G cards. The DS3XM-12 card is supported in any of the multiservice slots (Slots 1 through 6 and 12 through 17).

The DS3XM-12 card operates at the VT1.5 level and supports a maximum of 6 or 12 ports of “portless” (DS-3-mapped STS1s) interface, depending on the shelf configuration (see [Table 3-13](#)).

Table 3-13 DS3XM-12 Shelf Configurations

Port Maximums	Slots 1 through 4, and 14 through 17 (XCVT Card)	Slots 5, 6, 12, and 13 (XCVT, XC10G, or XC-VXC-10G Cards)	XC10G/XC-VXC-10G Shelf (any multiservice slot)
Portless Ports	6	12	12
Ported Ports	12	12	12



Caution

Do not install low-density DS-1 cards in the same side of the shelf as DS3XM-12 cards.

3.10.5 Protection Modes

The DS3XM-12 card supports 1:1 and 1:N protection groups, where $N \leq 5$. However, $N \leq 7$ if one of the following conditions is true:

- Only portless connections are used.
- A combination of ported and portless connections is used but all the ported cards being protected are on the same side of the chassis as the protecting card.

These protection groups can be implemented in the ONS 15454 SONET platform for both the A and B sides and do not require a special protect card.

In 1:N protection, the protect card must be in Slot 3 or 15. In 1:1 protection, the working and protect cards must be in adjacent slots. The protection switches cause a traffic hit of no more than 50 ms. See the [“7.2 Electrical Card Protection and the Backplane”](#) section on page 7-5 for more information about electrical card slot protection and restrictions.

3.10.6 Card Features

Table 3-14 summarizes the DS3XM-12 features.

Table 3-14 DS3XM-12 Features

Feature	Description
Protection	1:1 and 1:N protection (“ported” and “portless”)
Upgrade	<ul style="list-style-type: none"> • Errorless software upgrade • In-service upgrade of legacy DS3XM-6 to DS3XM-12 (> 60 ms hit)
Performance Monitoring	<ul style="list-style-type: none"> • DS-3 M2-3 near-end performance monitoring (PM) parameters • DS-3 C-bit near end and far end PM parameters • DS-1 near end PM parameters • DS-1 Extended Super Frame (ESF) PM far end parameters based on FDL PRM messages • 1989 AT&T TR 54016 DS1 ESF PM • SPRM and NPRM DS1 PM parameters
Loopbacks	<ul style="list-style-type: none"> • DS3 terminal and facility • DS1 facility • DS1 terminal • FEAC based DS1 and DS3 loopbacks (TX and RX) • DS1 ESF-FDL TX line and payload loopbacks • DS1 SF (D4) “in-band” TX loopbacks • AT&T TR 54016 ESF DS1 TX line and payload loopbacks
DS1 Auto-Frame Detection	DS1 frame autodetection and autoprovisioning
Manual DS1 frame provisioning	Works in conjunction with the DS1 autoprovisioning and gives you override capability

Table 3-14 DS3XM-12 Features

Feature	Description
Manual DS3 frame provisioning	Legacy feature (C-Bit and M23 frame formats are supported)
J1	Legacy feature (extended to 6 additional ports)
J2	336 J2 strings are supported
Portless	Supports DS3 data from the backplane in addition to the DS3 data from the line interface unit
Diagnostics	Power-up diagnostics on working and protect cards

3.10.7 DS3XM-12 Slots and Connectors

The DS3XM-12 card can be used with BNC, SMB, SCSI (UBIC), or MiniBNC EIA connectors.

The card can be installed in Slots 1 to 6 or 12 to 17. Each DS3XM-12 port features DSX-level outputs supporting distances up to 137 meters (450 feet) depending on facility conditions.

3.10.8 DS3XM-12 Faceplate and Block Diagram

[Figure 3-12](#) shows the DS3XM-12 faceplate and a block diagram of the card.

Figure 3-12 DS3XM-12 Faceplate and Block Diagram

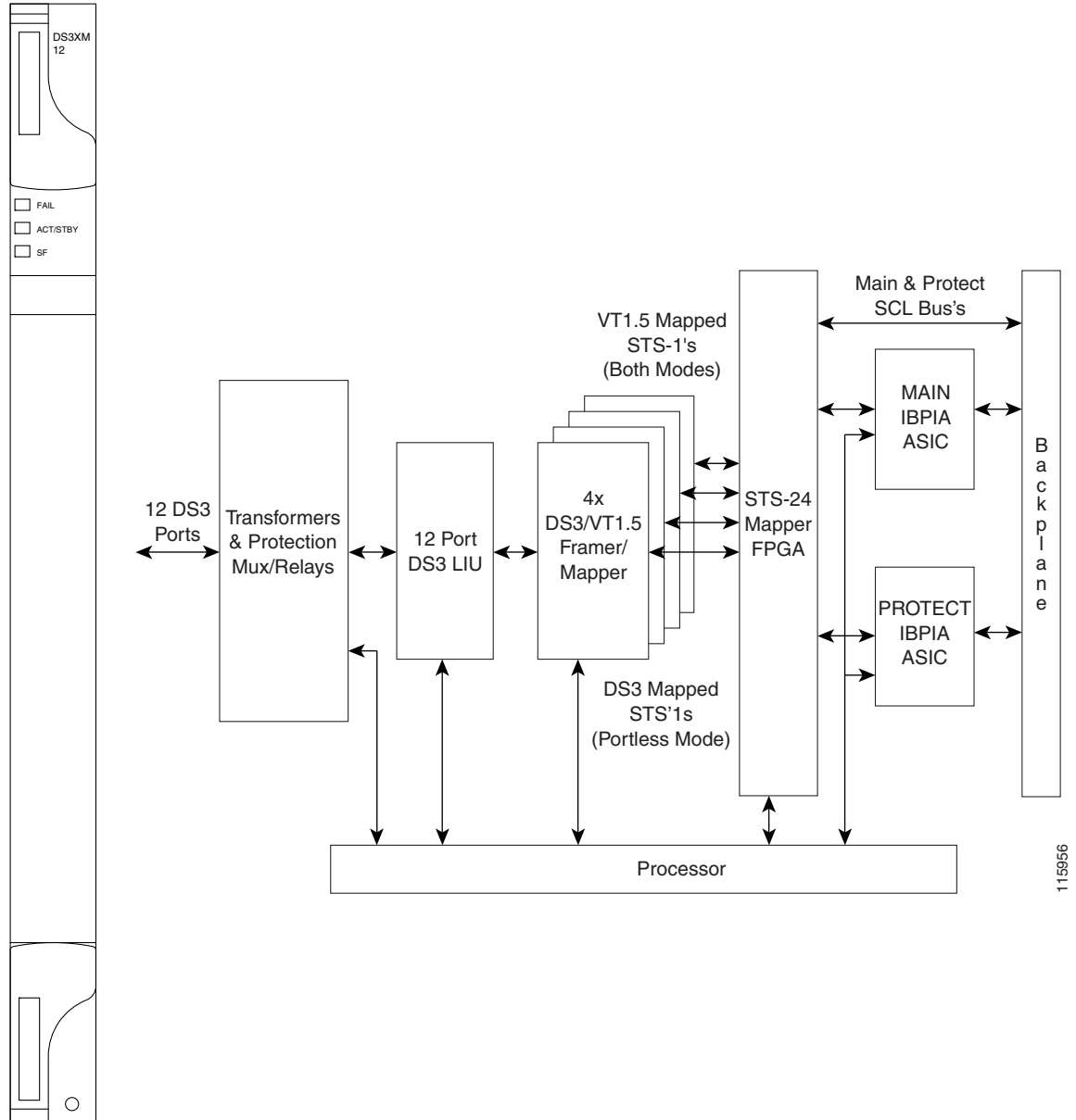

3.10.9 DS3XM-12 Card-Level Indicators

Table 3-15 describes the three card-level LEDs on the DS3XM-12 card faceplate.

Table 3-15 DS3XM-12 Card-Level Indicators

Card-Level Indicators	Description
Red FAIL LED	The red FAIL LED indicates that the card processor is not ready. It is steady while the self-test runs, and blinks during provisioning. Replace the card if the red FAIL LED persists.
ACT/STBY LED Green (Active) Amber (Standby)	When the ACT/STBY LED is green, the DS3XM-12 card is operational and ready to carry traffic. When the ACT/STBY LED is amber, the DS3XM-12 card is operational and in standby in a 1:1 protection group.
Amber SF LED	The amber SF LED indicates a signal failure or condition such as LOS, LOF, or high BER on one or more card ports.

3.10.10 DS3XM-12 Port-Level Indicators

You can find the status of the twelve DS3XM-12 card ports by using the LCD screen on the ONS 15454 fan-tray assembly. Use the LCD to quickly view the status of any port or card slot; the screen displays the number and severity of alarms for a given port or slot.

