



Cisco Network Convergence System 6000 Series Routers Migration Guide

First Published: 2018-10-01

Last Modified: 2020-08-13

Americas Headquarters

Cisco Systems, Inc.
170 West Tasman Drive
San Jose, CA 95134-1706
USA
<http://www.cisco.com>
Tel: 408 526-4000
800 553-NETS (6387)
Fax: 408 527-0883

THE SPECIFICATIONS AND INFORMATION REGARDING THE PRODUCTS IN THIS MANUAL ARE SUBJECT TO CHANGE WITHOUT NOTICE. ALL STATEMENTS, INFORMATION, AND RECOMMENDATIONS IN THIS MANUAL ARE BELIEVED TO BE ACCURATE BUT ARE PRESENTED WITHOUT WARRANTY OF ANY KIND, EXPRESS OR IMPLIED. USERS MUST TAKE FULL RESPONSIBILITY FOR THEIR APPLICATION OF ANY PRODUCTS.

THE SOFTWARE LICENSE AND LIMITED WARRANTY FOR THE ACCOMPANYING PRODUCT ARE SET FORTH IN THE INFORMATION PACKET THAT SHIPPED WITH THE PRODUCT AND ARE INCORPORATED HEREIN BY THIS REFERENCE. IF YOU ARE UNABLE TO LOCATE THE SOFTWARE LICENSE OR LIMITED WARRANTY, CONTACT YOUR CISCO REPRESENTATIVE FOR A COPY.

The Cisco implementation of TCP header compression is an adaptation of a program developed by the University of California, Berkeley (UCB) as part of UCB's public domain version of the UNIX operating system. All rights reserved. Copyright © 1981, Regents of the University of California.

NOTWITHSTANDING ANY OTHER WARRANTY HEREIN, ALL DOCUMENT FILES AND SOFTWARE OF THESE SUPPLIERS ARE PROVIDED "AS IS" WITH ALL FAULTS. CISCO AND THE ABOVE-NAMED SUPPLIERS DISCLAIM ALL WARRANTIES, EXPRESSED OR IMPLIED, INCLUDING, WITHOUT LIMITATION, THOSE OF MERCHANTABILITY, FITNESS FOR A PARTICULAR PURPOSE AND NON-INFRINGEMENT OR ARISING FROM A COURSE OF DEALING, USAGE, OR TRADE PRACTICE.

IN NO EVENT SHALL CISCO OR ITS SUPPLIERS BE LIABLE FOR ANY INDIRECT, SPECIAL, CONSEQUENTIAL, OR INCIDENTAL DAMAGES, INCLUDING, WITHOUT LIMITATION, LOST PROFITS OR LOSS OR DAMAGE TO DATA ARISING OUT OF THE USE OR INABILITY TO USE THIS MANUAL, EVEN IF CISCO OR ITS SUPPLIERS HAVE BEEN ADVISED OF THE POSSIBILITY OF SUCH DAMAGES.

Any Internet Protocol (IP) addresses and phone numbers used in this document are not intended to be actual addresses and phone numbers. Any examples, command display output, network topology diagrams, and other figures included in the document are shown for illustrative purposes only. Any use of actual IP addresses or phone numbers in illustrative content is unintentional and coincidental.

All printed copies and duplicate soft copies of this document are considered uncontrolled. See the current online version for the latest version.

Cisco has more than 200 offices worldwide. Addresses and phone numbers are listed on the Cisco website at www.cisco.com/go/offices.

Cisco and the Cisco logo are trademarks or registered trademarks of Cisco and/or its affiliates in the U.S. and other countries. To view a list of Cisco trademarks, go to this URL: <https://www.cisco.com/c/en/us/about/legal/trademarks.html>. Third-party trademarks mentioned are the property of their respective owners. The use of the word partner does not imply a partnership relationship between Cisco and any other company. (1721R)

© 2018 Cisco Systems, Inc. All rights reserved.



CONTENTS

CHAPTER 1	Fabric Overview	1
	Fabric Overview	1

CHAPTER 2	Migrating to a Back-to-Back System	5
	Prerequisites	5
	Required Tools and Equipment	6
	Migrating RACK0 Fabric Planes to Back-to-Back Mode	7
	Adding RACK1 to Back-to-Back Mode	10
	Cabling Overview	11
	Cable Routing Considerations	11
	General Cabling Procedures	12
	MPO-24 Cable Specifications	13
	Cabling the Ethernet Control Plane	15
	Cabling the Fabric	16

CHAPTER 3	Migrating 1T Single Chassis to 2T Single Chassis	19
	Prerequisites	19
	Required Tools and Equipment	19
	Migrating 1T Single Chassis to 2T Single Chassis	20

CHAPTER 4	Migrating 1T Multi-Chassis to 2T Multi-Chassis	23
	Prerequisites	23
	Required Tools and Equipment	24
	Shut Down the Fabric Plane	24
	Replace 1T FC with 2T FC2 in the FCC	25
	Replace Legacy S13 Card with Universal Fabric Cards in the LCC	26

Unshut the Fabric Cards	27
Verify the CXPs in the Fabric Cards	28
Unshut the Fabric Plane	30

APPENDIX A

Cabling a Multi-Chassis Configuration	33
About the Cisco NCS 6000 Multi-Chassis System	33
Prerequisites	35
Cabling Requirements	35
MPO-24 Cable Specifications	36
Required Tools and Equipment	38
Cabling Overview	39
Cable Routing Considerations	39
General Cabling Procedures	39
Safety Guidelines	40
Cabling the Ethernet Control Plane Network	41
Cabling the Control Plane for a 2+1 Multi-Chassis system	41
Cabling the Control Plane for a 2+2 Multi-Chassis System	42
Cabling the Control Plane for a 2+1 Multi-Chassis System with ECP	45
Cabling the Control Plane for a 4+1 Multi-Chassis System with ECP	47
Cabling the Fabric	49
Multi-Chassis 2+1 Configuration	49
Prerequisites	49
Configuring a 2+1 Configuration with Six S2 FCs	50
2+1 Software Configuration (Six S2 Fabric Cards)	52
Configuring a 2+1 Configuration with 12 S2 FCs	52
2+1 Software Configuration (12 S2 Fabric Cards)	55
Multi-Chassis 2+2 Configuration	56
Prerequisites	56
Configuring a 2+2 Configuration with 12 S2 Fabric Cards	56
2+2 Software Configuration (12 S2 Fabric Cards)	60
Configuring a 2+2 Configuration with 24 S2 Fabric Cards	60
2+2 Software Configuration (24 S2 Fabric Cards)	64
Multi-Chassis 4+2 Configuration	65
Prerequisites	65

Configuring a 4+2 Configuration with 12 S2 Fabric Cards	65
4+2 Software Configuration (12 S2 Fabric Cards)	71
Configuring a 4+2 Configuration with 24 S2 Fabric Cards	71
4+2 Software Configuration (24 S2 Fabric Cards)	77
Multi-Chassis 8+2 Configuration	78
Prerequisites	78
Configuring a 8+2 Configuration with 24 S2 Fabric Cards	78
8+2 Software Configuration (24 S2 Fabric Cards)	87

APPENDIX B

Commands for Router Health Check	89
Sysadmin VM Health Check	89
XR VM Health Check	90
Fabric Health Check	91



CHAPTER 1

Fabric Overview

This chapter provides an overview of the Cisco NCS 6000 switch fabric and the fabric planes in Back-to-Back and Multi-Chassis systems.

- [Fabric Overview, on page 1](#)

Fabric Overview

The Cisco NCS 6000 switch fabric is a three-stage cell based architecture with six fabric planes.

In a back-to-back system, the Universal Fabric Card (UFC) in the Cisco NCS 6008 Line Card Chassis (LCC) implements all 3 stage. The Cisco NCS 6000 back-to-back system has six fabric planes that support data traffic between the lines connected to the LCCs. The fabric planes are numbered 0 through 5.

In a multi-chassis system, Stage 1 and Stage 3 (S13) of the fabric are implemented in the Cisco NCS 6008 Line Card Chassis (LCC). Stage 2 (S2) of the fabric is implemented in the Cisco NCS 6000 Fabric Card Chassis (FCC). Inter-stage connections between the LCC the FCC are implemented through a number of bi-directional optical links.

The following figure shows a simplified view of the relationship between the line cards and the fabric. The fabric planes are numbered 0 through 5.

Figure 1: Relationship of Line Cards and Fabric Cards

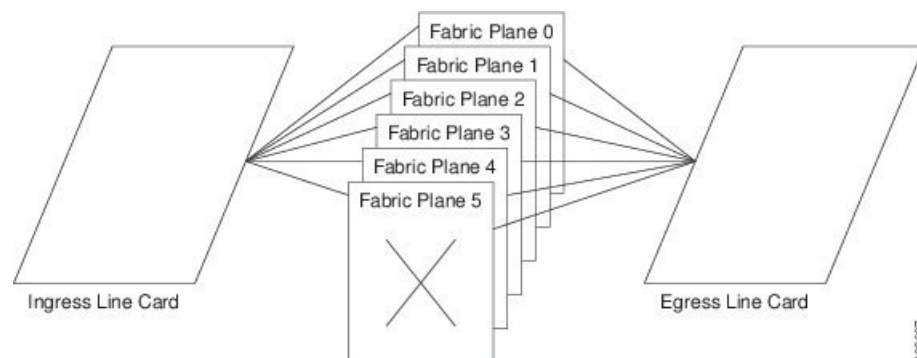

For multi-chassis systems, each fabric plane is divided into three components or stages, which are numbered S1, S2, and S3. Data arrives at the S1 stage in an LCC, passes over the fabric cables to the S2 stage in the FCC, and then passes over the fabric cables again to the S3 stage in the destination LCC. The following figure shows a simplified view between the LCC and the FCC.

Figure 2: Fabric Plane Stages

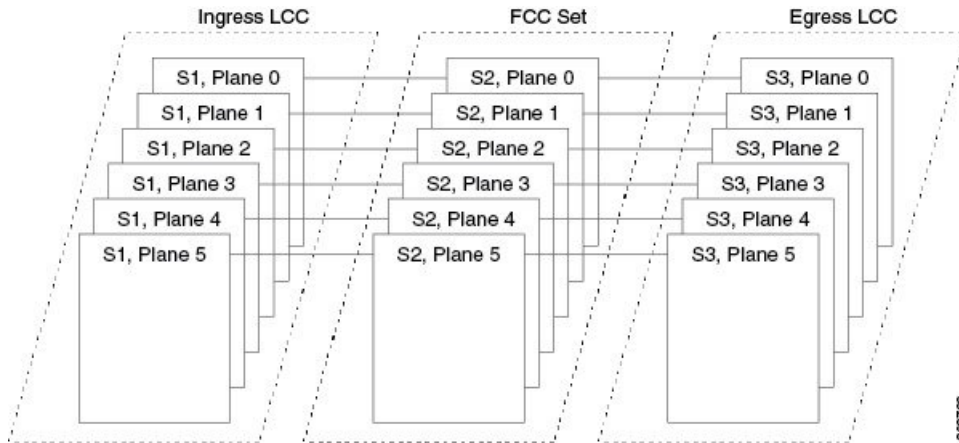

LCC

In a back-to-back configuration, each LCC uses six Universal Fabric Cards (UFCs) with 16 CXP modules each.

In a multi-chassis configuration, the LCC uses either six S13 multi-chassis (MC) fabric cards with 16 CXP modules each that connect to the S2 fabric cards on the FCC (for 1T mode), or six Universal Fabric Cards (UFCs) with 16 CXP2 modules each that connect to the 2nd generation S2 fabric cards on the FCC (for 2T mode).

The planes do not interconnect with each other but operate independently. Because there are a total of six fabric cards in the LCC, the fabric is referred to as having six planes. For example: Slot 0 in LCC0, LCC1, and so forth are all part of plane 0.

The following figure shows the location of the fabric cards in the LCC and how the CXP connectors are labeled. The fabric planes are numbered S0 through S5 and are installed in slot numbers 0 through 5. Each fabric cable connects to one of the FC connectors (0 through 15), and to a single S2 FC in an FCC.

Figure 3: How S13/UFC Cards are Numbered in the LCC (0 through 5)

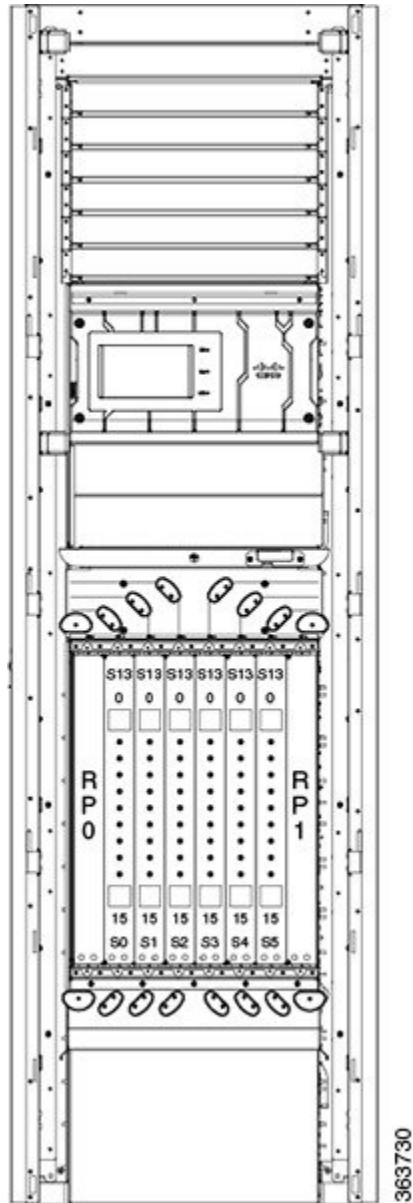

FCC

The Fabric Card Chassis (FCC) supports up to 12 S2 fabric cards. When multiple FCCs are installed in a multi-chassis system, the S2 fabric cards are distributed across the FCCs. Depending on the maximum number of LCC in the multi-chassis system, each Stage 2 fabric plane consists of one or more S2 fabric cards. Each S2 fabric card supports up to 32 CXP modules. Each 2nd generation S2 fabric card (S2 FC2) supports up to 32 CXP2 modules. The S2 FC's that belong to a plane can be placed in any FCC but it is recommended to distribute the planes evenly among all the FCCs. As more FCCs are added, the planes are distributed among the FCCs.

Depending on the size of the system (i.e. the number of LCCs you want to connect to), a number of S2 FCs can be grouped together as part of the plane. You can have as few as six S2 fabric cards installed in the FCC (only 6 FC slots populated), or as many as 12 S2 fabric cards for a fully populated chassis.

The following figure shows 12 SC FCs installed in an FCC and how the CXP connectors are labeled. Unlike the fabric planes in an LCC, the FCC slots are not preconfigured for specific plane numbers. The plane number served by a slot is defined during the system configuration. This approach provides the flexibility to distribute the fabric planes between FCCs.

Figure 4: How S2 Cards are Numbered in the FCC (0 through 11)

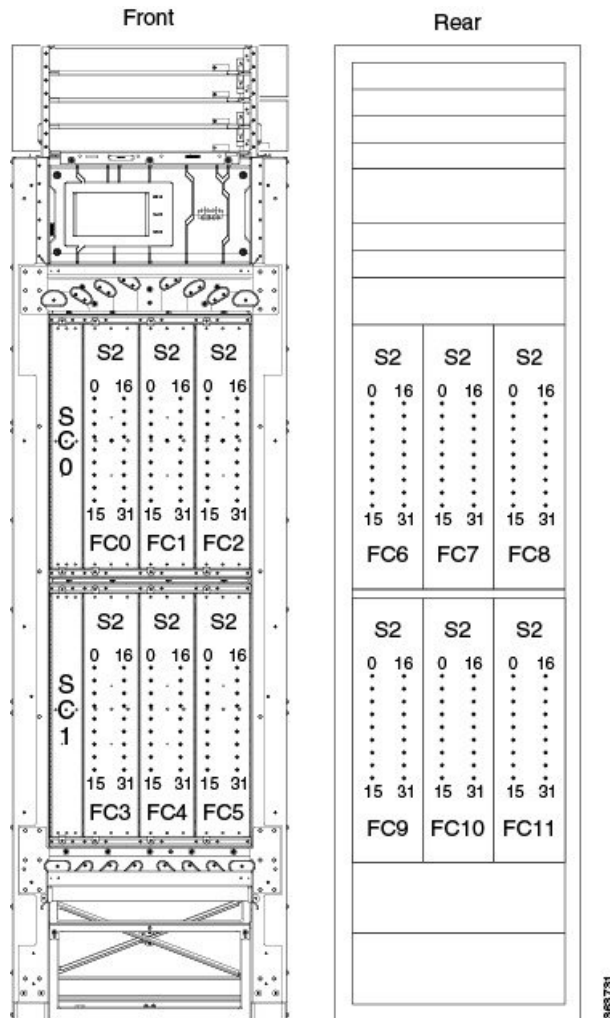



CHAPTER 2

Migrating to a Back-to-Back System

The Universal Fabric Card (UFC) supports a back-to-back configuration between two Cisco NCS 6000 LCCs. The back-to-back configuration is supported on Cisco IOS XR release 6.2.1 and later releases. This chapter describes how to migrate two Cisco NCS 6000 LCC routers from single-chassis to a back-to-back configuration.

- [Prerequisites, on page 5](#)
- [Required Tools and Equipment, on page 6](#)
- [Migrating RACK0 Fabric Planes to Back-to-Back Mode, on page 7](#)
- [Adding RACK1 to Back-to-Back Mode, on page 10](#)
- [Cabling Overview, on page 11](#)
- [Cabling the Ethernet Control Plane, on page 15](#)
- [Cabling the Fabric, on page 16](#)

Prerequisites

- Before you perform any procedures, review the safety guidelines in the [Cisco Network Convergence System 6000 Series Routers Hardware Installation Guide](#) to avoid injuring yourself or damaging the equipment.
- Before cabling the system, install each line card chassis (LCC) in the planned location. Ensure that you have adequate floor space to cable the back-to-back configuration and an environment that meets the recommended specifications. For more information, see the [Cisco Network Convergence System 6000 Series Routers Site Planning Guide](#).
- Verify that both single chassis routers (RACK0 and RACK1) are running Cisco IOS XR release 6.2.1 or later (with all applicable SMUs and packages).
- From each chassis, use the **show chassis** command from SysAdmin VM and make note of each chassis serial number.



Note The chassis serial number can also be found on the label on the chassis front/rear face plate.

- Perform the Router Health check on both routers to ensure that any errors or exception are resolved prior to migrating to back-to-back mode. See [Commands for Router Health Check, on page 89](#).

- Verify that field-programmable device (FPD) upgrades are completed for all FPDs on both routers by using the **show hw-module fpd** command. For any FPD components that show status as NEED UPGD, use the **upgrade hw-module location *location* fpd** command. For any FPD components that show status as RLOAD REQ, use the **hw-module location *location* reload** command.
- Create a backup of the RACK0 running configuration using the **copy running-config** command in both System Admin EXEC mode and XR EXEC mode.

Required Tools and Equipment

For a fully-loaded back-to-back configuration, the following Cisco NCS 6000 hardware is required:

- 2 Cisco NCS 6000 routers (NCS-6008)
- 4 Fan Trays (NC6-FANTRAY or NC6-FANTRAY-2)



Caution Both fan trays installed in a chassis must be the same type. Do not install NC6-FANTRAY and NC6-FANTRAY-2 fan trays in the chassis.

- 4 Power Trays, with 6 PEM for each Power Tray (NCS-AC-PWRTRAY)
- 4 Route Processors (NC6-RP)

For the Route Processor Ethernet Control connections between RACK0 and RACK1:

- 8 SFP+ optics (SFP-10G-SR)
- 4 LC-to-LC OM3 Multimode cables

- 12 Universal Fabric Cards (NC6-FC2-U)

For the Fabric Card connections between RACK0 and RACK1:

- 2 optical module set that includes 96 CXP-100G-SR12 modules each (NCS-FAB-OPT)
- 96 MTP-24 100G Multimode cables



Note Install a CXP transceiver module or an EMI/dust plug (supplied) in all CXP ports. Do not operate the FC with an open port.

- Supported line cards:
 - NC6-10X100G-M-P—10-port 100Gbps CXP
 - NC6-10X100G-L-P—10-port 100Gbps CXP
 - NC6-10X100G-M-K—10-port 100Gbps CPAK
 - NC6-2/10X100G-L-K—10-port 100Gbps CPAK
 - NC6-60X10GE-L-S—60-port 10Gbps SFP+

- NC6-60X10GE-M-S—60-port 10Gbps SFP+



Note The 20-port 100Gbps Line Card (NC6-20X100GE-L-C, NC6-20X100GE-M-C) is not supported in back-to-back configuration.

Additional required tool and equipment:

- ESD (Electrostatic Discharge) wrist strap (for inserting a optical modules)
- Number-2 Phillips screwdriver
- Cable Director (P/N 2123610-1), to provide support and strain relief for fabric cable connections (provided by Cisco approved vendor Tyco Electronics)
- Supply of Velcro tie wraps (to bundle cables)
- Ladder

Migrating RACK0 Fabric Planes to Back-to-Back Mode



Note This procedure must be completed for each fabric plane, one at a time, on RACK0.

To migrate to back-to-back mode using the Universal Fabric Cards (UFC), perform the following steps on RACK0:

Before you begin

Review and perform all tasks in the safety guidelines, prerequisites, and required equipment sections before performing this task.

Step 1 From SysAdmin VM configuration mode, shut down the fabric plane.

Example:

```
sysadmin-vm:0_RP0# config
sysadmin-vm:0_RP0(config)# controller fabric plane 0 shutdown
sysadmin-vm:0_RP0(config)# commit
sysadmin-vm:0_RP0(config)# exit
```

Step 2 Use the **show controller fabric plane all detail** command to verify that the fabric plane Admin State and Plane State are down.

Example:

```
sysadmin-vm:0_RP0# show controller fabric plane all detail

Plane Admin Plane  Plane  up->dn  up->mcast Total  Down  PPU
```

Id	State	State	Mode	counter	counter	Bundles	Bundles	State
0	DN	DN	SC	0	0	16	0	NA
1	UP	UP	SC	0	0	16	0	NA
2	UP	UP	SC	0	0	16	0	NA
3	UP	UP	SC	0	0	16	0	NA
4	UP	UP	SC	0	0	16	0	NA
5	UP	UP	SC	0	0	16	0	NA

Step 3 From SysAdmin VM configuration mode, power off the fabric card.

Example:

```
sysadmin-vm:0_RP0# config
sysadmin-vm:0_RP0(config)# hw-module shutdown location 0/FC0
sysadmin-vm:0_RP0(config)# commit
sysadmin-vm:0_RP0(config)# exit
```

Step 4 Use the **show platform location** command to verify that the fabric card is powered off.

Example:

```
sysadmin-vm:0_RP0# # show platform location 0/FC0
Mon Dec 5 23:54:02.366 UTC
Location Card Type HW State SW State Config State
-----
0/FC0 NC6-FC POWERED_OFF N/A NSHUT
```

Step 5 Remove the legacy fabric card following the steps in the [Removing a Fabric Card](#) section.

Step 6 Install the UFC following the steps in the [Installing a Fabric Card](#) section.

Note Do not connect any cables to the UFC.

Step 7 From SysAdmin VM configuration mode, change the fabric plane mode to B2B.

Example:

```
sysadmin-vm:0_RP0# config
sysadmin-vm:0_RP0(config)# controller fabric plane 0 b2b
sysadmin-vm:0_RP0(config)# commit
sysadmin-vm:0_RP0(config)# exit
```

Step 8 Use the **show controller fabric plane all detail** command to verify that the fabric plane mode is B2B and that Admin State and Oper State are down.

Example:

```
sysadmin-vm:0_RP0# show controller fabric plane all detail

Plane Admin Plane Plane up->dn up->mcast Total Down PPU
Id State State Mode counter counter Bundles Bundles State
-----
0 DN DN B2B 0 0 16 0 NA
1 UP UP SC 0 0 16 0 NA
2 UP UP SC 0 0 16 0 NA
3 UP UP SC 0 0 16 0 NA
4 UP UP SC 0 0 16 0 NA
```

```
5      UP      UP      SC          0          0      16      0      NA
```

Step 9 From SysAdmin VM configuration mode, unshut the fabric card.

Example:

```
sysadmin-vm:0_RP0# config
sysadmin-vm:0_RP0(config)# no hw-module shutdown location 0/FC0

O/RP0/ADMIN0:Dec 5 11:27:52.757 : shelf_mgr[2921]: %INFRA-SHELF_MGR-6-CARD_HW_OPERATIONAL :
Card: 0/FC0 hardware state going to Operational
O/RP0/ADMIN0:Dec 5 11:28:09.532 : confd_helper[2900]: %MGBL-CONFD_HELPER-5-SYSADMIN_COMMIT :
A sysadmin configuration change has been committed. Use 'show configuration commit list'
in admin mode for more details
LC/0/0/CPU0:Dec 5 11:28:15.538 : fia_driver[246]: %PLATFORM-CIH-5-ASIC_ERROR_THRESHOLD : fia[2]:
A link-err error has occurred. CMIC.CMIC_CMC0_IRQ_STAT3.RTP.Interrupt_Register.LinkMaskChange
Threshold has been exceeded
LC/0/5/CPU0:Dec 5 11:28:15.740 : fia_driver[216]: %PLATFORM-CIH-5-ASIC_ERROR_THRESHOLD : fia[4]:
A link-err error has occurred. CMIC.CMIC_CMC0_IRQ_STAT3.RTP.Interrupt_Register.LinkMaskChange
Threshold has been exceeded
LC/0/2/CPU0:Dec 5 11:28:15.927 : fia_driver[293]: %PLATFORM-CIH-5-ASIC_ERROR_THRESHOLD : fia[3]:
A link-err error has occurred. CMIC.CMIC_CMC0_IRQ_STAT3.RTP.Interrupt_Register.LinkMaskChange
Threshold has been exceeded
O/RP0/ADMIN0:Dec 5 11:28:17.401 : fsdbagg[4620]: %FABRIC-FSDB_AGG-5-PLANE_UPDOWN : [4620] :
Plane 0 state changed to UP

sysadmin-vm:0_RP0(config)# commit
sysadmin-vm:0_RP0(config)# exit
```

Step 10 Use the **show platform location** command to verify that the fabric card is operational.

Example:

```
sysadmin-vm:0_RP0# show platform location 0/FC0
Mon Dec 5 23:54:02.366 UTC
Location Card Type HW State SW State Config State
-----
0/FC0 NC6-FC2-U OPERATIONAL N/A NSHUT
```

Step 11 Use the **show hw-module fpd** command to verify the status of all FPDs. Verify that no FPD components require an upgrade (as indicated by NEED UPGD in the Status field) and that the Running and Programmed fields display the same version. See the [Prerequisites](#) section for FPD upgrade information.

Step 12 From SysAdmin VM configuration mode, unshut the fabric plane.

Example:

```
sysadmin-vm:0_RP0# config
sysadmin-vm:0_RP0(config)# no controller fabric plane 0 shutdown
sysadmin-vm:0_RP0(config)# commit
sysadmin-vm:0_RP0(config)# exit
```

Step 13 Use the **show controller fabric plane all detail** command to verify that the Plane Mode is B2B and that Admin State and Plane State are up.

Example:

```
sysadmin-vm:0_RP0# show controller fabric plane all detail
```

Plane Id	Admin State	Plane State	Plane Mode	up->dn counter	up->mcast counter	Total Bundles	Down Bundles	PPU State
0	UP	UP	B2B	0	0	16	0	NA
1	UP	UP	SC	0	0	16	0	NA
2	UP	UP	SC	0	0	16	0	NA
3	UP	UP	SC	0	0	16	0	NA
4	UP	UP	SC	0	0	16	0	NA
5	UP	UP	SC	0	0	16	0	NA

Step 14 Perform the Router Health Check. See [Commands for Router Health Check, on page 89](#).

What to do next

Repeat these steps for each remaining fabric plane (FC1, FC2, FC3, FC4, and FC5) until all six fabric planes have been migrated to back-to-back mode.

Go to the next section to add RACK1 to back-to-back mode.

Adding RACK1 to Back-to-Back Mode

To add RACK1 to back-to-back mode, perform the following steps:

Before you begin

Review and perform all tasks in the safety guidelines, prerequisites, and required equipment sections before performing this task.

Use the **show chassis** command and make note of serial number for the chassis.

Perform all steps in the [Migrating RACK0 Fabric Planes to Back-to-Back Mode](#) for each fabric plane on RACK0.

- Step 1** Power off RACK1.
- Step 2** Remove all line cards following the steps in the [Removing a Line Card](#) section.
- Step 3** Remove all legacy fabric cards following the steps in the [Removing a Fabric Card](#) section.
- Step 4** Install the Universal Fabric Cards (UFCs) following the steps in the [Installing a Fabric Card](#) section.
- Step 5** Power on RACK1.
- Step 6** Use the **show hw-module fpd** command to verify the status of all FPDs. Verify that no FPD components require an upgrade (as indicated by NEED UPGD in the Status field) and that the Running and Programmed fields display the same version. See the [Prerequisites](#) section for FPD upgrade information.
- Step 7** Power off RACK1.
- Step 8** From SysAdmin VM configuration mode on RACK0, configure the chassis serial numbers.

Example:

```
sysadmin-vm:0_RP0# config
sysadmin-vm:0_RP0(config)# chassis serial NNN#####NA
sysadmin-vm:0_RP0(config)# rack 0
```



```

sysadmin-vm:0_RP0(config)# chassis serial NNN#####NB
sysadmin-vm:0_RP0(config)# rack 1
sysadmin-vm:0_RP0(config)# commit

```

Step 9 Connect the Ethernet Control between RACK0 and RACK1.

See the [Cabling the Ethernet Control Plane](#) section.

Step 10 Connect the Fabric between RACK0 and RACK1.

See the [Cabling the Fabric](#) section.

Step 11 When all Ethernet Control and Fabric connections have been made, power on RACK1.

Step 12 Use the **show platform** command to verify that the fabric card is operational.

Example:

```

sysadmin-vm:0_RP0# show platform
Mon Dec 6 00:54:02.366 UTC
Location  Card Type                HW State    SW State    Config State
-----
0/FC0     NC6-FC                    OPERATIONAL OPERATIONAL NSHUT
0/FC1     NC6-FC                    OPERATIONAL OPERATIONAL NSHUT
0/FC2     NC6-FC                    OPERATIONAL OPERATIONAL NSHUT
0/FC3     NC6-FC                    OPERATIONAL OPERATIONAL NSHUT
0/FC4     NC6-FC                    OPERATIONAL OPERATIONAL NSHUT
0/FC5     NC6-FC                    OPERATIONAL OPERATIONAL NSHUT
0/3       NC6-10X100G-M            OPERATIONAL OPERATIONAL NSHUT
. . .

```

Step 13 Perform the Router Health Check. See [Commands for Router Health Check, on page 89](#).

Step 14 Install the line cards following the steps in the [Installing a Line Card](#) section.

Both RACK0 and RACK1 are in back-to-back mode.

Cabling Overview

Cable Routing Considerations

Cabling Routing

Whether the cables will be run overhead or under the floor, consider the airflow and cable characteristics of the combined cable sets to ensure that your cable management structures support the total capacity of cables for the Cisco NCS 6000 back-to-back system installation.

Raised Floor Installations

To plan cable routing in an installation with a raised floor, consider all the characteristics of each cable required for the installation. Allow slack for cabling so that cables can be pooled under the floor for future expansion without exceeding bend radius or cable length limitations. Riser cables are not rated for installation in air plenum passages, nor are they designed for use in LSZH (low smoke zero halogen) applications.

Cable Characteristics

Plan your cable runs, consider the characteristics of each cable, such as the cable length limitations, combined diameter of bundled cables (such as power cables), weight of the cable groups, and bend radius of the cable or cables. Couple these considerations with the cable infrastructure available (or needed) at your facility. The infrastructure could include structures like the overhead cabling monorail or J-hook system, sleeve and riser diameters, and distances between floors or elements of the Cisco NCS 6000 back-to-back system.

Analyze the cabling infrastructures, risers, and racking available in your facility to determine if the capacity of the cabling management systems at your facility will accommodate the required capacities of the back-to-back system cabling.

Cable Length

The limit of the cables is 100 meters (328 feet). Consider this distance when planning the physical locations of the LCCs. For more information on the range of lengths available for the OM4 fabric cables, contact a Cisco approved vendor such as Tyco Electronics or Molex.

Cable Bend Radius

Exceeding the bend radius allowed for a cable can break the glass in the cable or cause attenuation or loss of signal. Do not bend a cable more than the allowable bend radius.

See the [Cisco Network Convergence System 6000 Series Routers Site Planning Guide](#) for information on planning component locations and cable runs.

General Cabling Procedures

Observe these procedures as you attach every cable:

- Strap the bundles to the horizontal cable management brackets on the chassis.
 - Four horizontal cable management brackets are preinstalled on the LCC (two on the front side and two on the rear side of each chassis).
- Handle all fiber-optic cables carefully.
 - Do not allow a fiber-optic cable to bend in a radius smaller than the allowable bend radius specified for that cable type.
 - Fiber-optic cables are glass. Do not step on fiber-optic cables or handle them roughly. Do not twist or stretch the cables.
 - To keep optical connections clean, do not remove the cable dust cover until immediately before you install the cable.
 - After you install a cable, immediately reserve each dust cover for storage by office personnel in a dust-free storage area. After all of the cables have been installed ensure that all the reserved dust covers are stored by office personnel in a dust free area for future use.
 - Install clean dust covers on every unused connection.
 - Consider labeling the chassis interconnection cables or creating a diagram of the cabling to ensure that the cables are connected correctly during system installation.
 - Consider labeling the chassis. Consider whether each chassis need to be physically positioned in sequence. Label each cable with the location of each termination as you install each cable

MPO-24 Cable Specifications



Note Cisco provides the optical modules but does not provide the cables. You can order these cables from a Cisco approved vendor such as Tyco Electronics or Molex. To obtain the optics, please contact your Cisco sales representative for further information.



Note The CXP pluggable transceiver module has 12 dedicated transmit (Tx) channels and 12 receive (Rx) channels per transceiver with data rates up to 10.3125 Gbps and OTN rates up to 11.25 Gbps. The CXP module provides 2-wire serial (I2C) management interface and digital diagnostics, including Tx and Rx optical power monitoring per wavelength. The CXP module uses a 24-fiber MPO connector that supports bidirectional transmission across the fibers (12 Tx + 12 Rx).



Note Install a CXP transceiver module or an EMI/dust plug (supplied) in all CXP ports. Do not operate the fabric card with an open port.

The following figure shows the MPO-24 connector pinouts.

Figure 5: MPO-24 Connector Pinouts

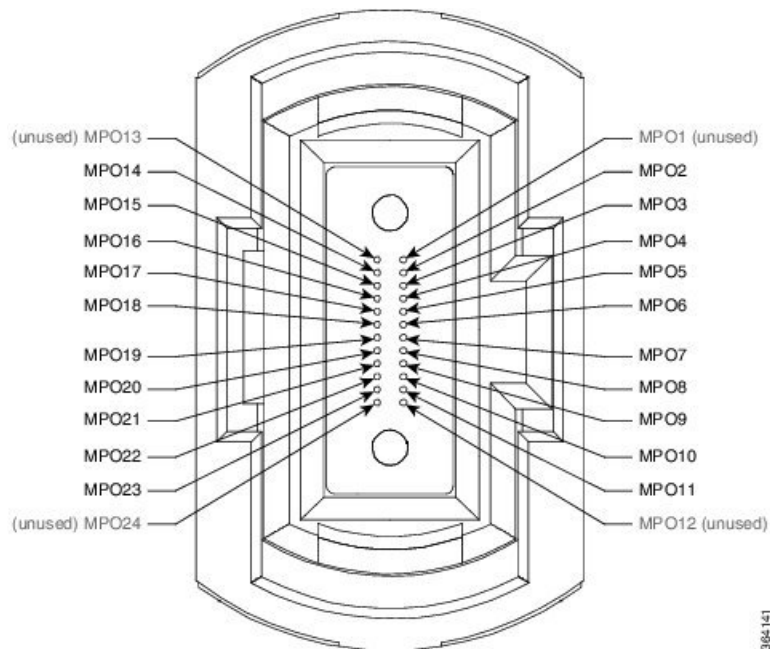

The following figure shows the MPO-24 connector fiber assignments.

Figure 6: MPO-24 Connector Fiber Assignments

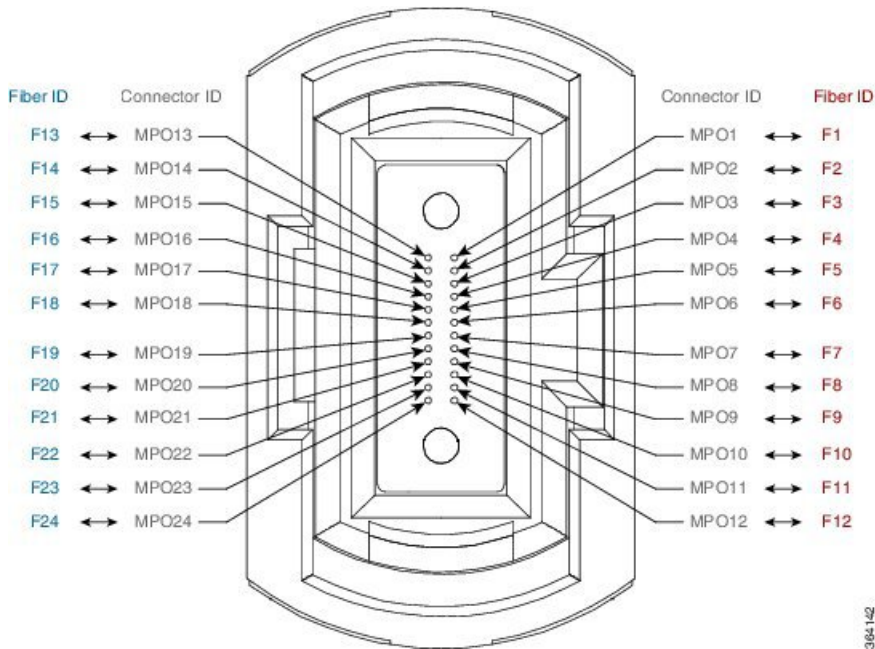

The following table lists the 100G to 100G crossover cable connections.

Table 1: Crossover Cable Connections

MPO Connector		CXP Module		Connector		CXP Module	
Connector ID	Fiber ID	Pin	Transmit (TX) Receive (RX)	Connector ID	Fiber ID	Pin	Transmit (TX) Receive (RX)
MPO1	F1	1	RX	MPO1	F13	1	RX
MPO2	F2	2	RX	MPO2	F14	2	RX
MPO3	F3	3	RX	MPO3	F15	3	RX
MPO4	F4	4	RX	MPO4	F16	4	RX
MPO5	F5	5	RX	MPO5	F17	5	RX
MPO6	F6	6	RX	MPO6	F18	6	RX
MPO7	F7	7	RX	MPO7	F19	7	RX
MPO8	F8	8	RX	MPO8	F20	8	RX
MPO9	F9	9	RX	MPO9	F21	9	RX
MPO10	F10	10	RX	MPO10	F22	10	RX
MPO11	F11	11	RX	MPO11	F23	11	RX
MPO12	F12	12	RX	MPO12	F24	12	RX

MPO Connector		CXP Module		Connector		CXP Module	
Connector ID	Fiber ID	Pin	Transmit (TX) Receive (RX)	Connector ID	Fiber ID	Pin	Transmit (TX) Receive (RX)
MPO13	F13	13	TX	MPO13	F1	13	TX
MPO14	F14	14	TX	MPO14	F2	14	TX
MPO15	F15	15	TX	MPO15	F3	15	TX
MPO16	F16	16	TX	MPO16	F4	16	TX
MPO17	F17	17	TX	MPO17	F5	17	TX
MPO18	F18	18	TX	MPO18	F6	18	TX
MPO19	F19	19	TX	MPO19	F7	19	TX
MPO20	F20	20	TX	MPO20	F8	20	TX
MPO21	F21	21	TX	MPO21	F9	21	TX
MPO22	F22	22	TX	MPO22	F10	22	TX
MPO23	F23	23	TX	MPO23	F11	23	TX
MPO24	F24	24	TX	MPO24	F12	24	TX

Cabling the Ethernet Control Plane

This section describes how to cable the Ethernet control plane between the RACK0 and RACK1 in mesh configuration to ensure Ethernet control plane failover connectivity across both racks. The Ethernet control plane carries all the signaling, routing updates, system configuration, and management packets for the NCS 6000.



Note See the [Required Tools and Equipment](#) section for more information on the required equipment.

The following figure shows the Ethernet control plane connections.

Figure 7: Cabling the Ethernet Control Plane in Back-to-Back Mode

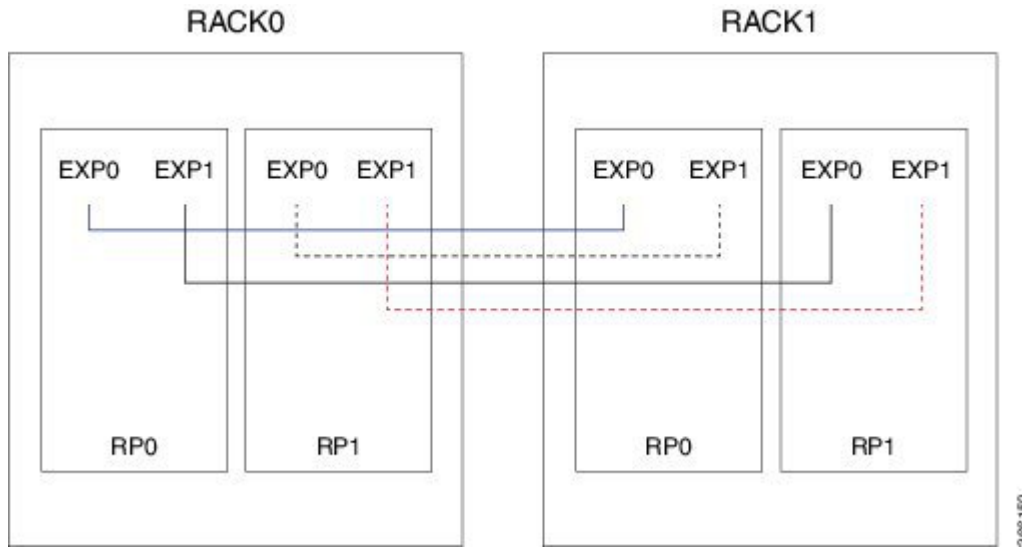

Table 2: Ethernet Control Plane Cabling for Back-to-Back Mode

RACK0	RACK1
RP0, EXP0	RP0, EXP0
RP0, EXP1	RP1, EXP0
RP1, EXP0	RP0, EXP1
RP1, EXP1	RP1, EXP1

Cabling the Fabric

This section describes how to cable the UFCs between RACK0 and RACK1 for back-to-back mode.



Note See the [Required Tools and Equipment](#) section for more information on the required equipment.

The fabric provides the data connection for router traffic between all the CXP optical ports in the line card chassis. The fabric cabling must be completed to enable data communications.

The following figure shows the fabric connections for one fabric plane. To complete the configuration, you must repeat the cabling for the remaining five fabric planes until all fabric cards are connected.

Figure 8: Cabling Fabric Plane 0 in Back-to-Back Mode

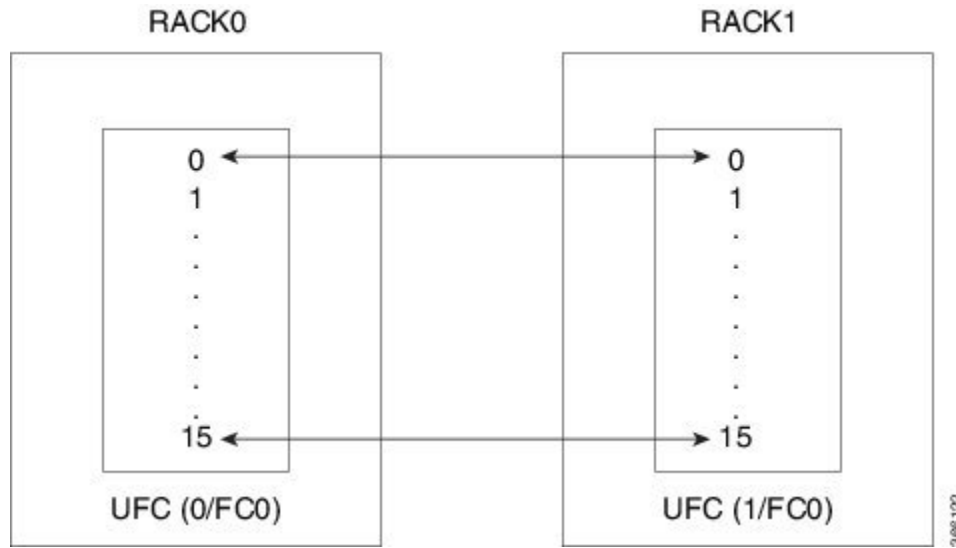

Table 3: Cabling the Fabric for Back-to-Back Mode

Plane 0	Plane 1	<...>	Plane 5
RACK0 slot/port to RACK1 slot/port			
0/FC0/0 to 1/FC0/0	0/FC1/0 to 1/FC1/0	<...>	0/FC5/0 to 1/FC5/0
0/FC0/1 to 1/FC0/1	0/FC1/1 to 1/FC1/1	<...>	0/FC5/1 to 1/FC5/1
0/FC0/2 to 1/FC0/2	0/FC1/2 to 1/FC1/2	<...>	0/FC5/2 to 1/FC5/2
0/FC0/3 to 1/FC0/3	0/FC1/3 to 1/FC1/3	<...>	0/FC5/3 to 1/FC5/3
0/FC0/4 to 1/FC0/4	0/FC1/4 to 1/FC1/4	<...>	0/FC5/4 to 1/FC5/4
0/FC0/5 to 1/FC0/5	0/FC1/5 to 1/FC1/5	<...>	0/FC5/5 to 1/FC5/5
0/FC0/6 to 1/FC0/6	0/FC1/6 to 1/FC1/6	<...>	0/FC5/6 to 1/FC5/6
0/FC0/7 to 1/FC0/7	0/FC1/7 to 1/FC1/7	<...>	0/FC5/7 to 1/FC5/7
0/FC0/8 to 1/FC0/8	0/FC1/8 to 1/FC1/8	<...>	0/FC5/8 to 1/FC5/8
0/FC0/9 to 1/FC0/9	0/FC1/9 to 1/FC1/9	<...>	0/FC5/9 to 1/FC5/9
0/FC0/10 to 1/FC0/10	0/FC1/10 to 1/FC1/10	<...>	0/FC5/10 to 1/FC5/10
0/FC0/11 to 1/FC0/11	0/FC1/11 to 1/FC1/11	<...>	0/FC5/11 to 1/FC5/11
0/FC0/12 to 1/FC0/12	0/FC1/12 to 1/FC1/12	<...>	0/FC5/12 to 1/FC5/12
0/FC0/13 to 1/FC0/13	0/FC1/13 to 1/FC1/13	<...>	0/FC5/13 to 1/FC5/13
0/FC0/14 to 1/FC0/14	0/FC1/14 to 1/FC1/14	<...>	0/FC5/14 to 1/FC5/14

Plane 0	Plane 1	<...>	Plane 5
RACK0 slot/port to RACK1 slot/port			
0/FC0/15 to 1/FC0/15	0/FC1/15 to 1/FC1/15	<...>	0/FC5/15 to 1/FC5/15



CHAPTER 3

Migrating 1T Single Chassis to 2T Single Chassis

- [Prerequisites](#), on page 19
- [Required Tools and Equipment](#), on page 19
- [Migrating 1T Single Chassis to 2T Single Chassis](#), on page 20

Prerequisites

- Before you perform any procedures, review the safety guidelines in the [Cisco Network Convergence System 6000 Series Routers Hardware Installation Guide](#) to avoid injuring yourself or damaging the equipment.
- Before cabling the system, install each line card chassis (LCC) in the planned location. For more information, see the [Cisco Network Convergence System 6000 Series Routers Site Planning Guide](#).
- Verify that the LCC is running Cisco IOS XR release 6.2.2 or later (with all applicable SMUs and packages).
- Perform the Router Health check on the router to ensure that any errors or exception are resolved prior to migrating to 2T single-chassis mode. See [Commands for Router Health Check](#), on page 89.
- Verify that field-programmable device (FPD) upgrades are completed for all FPDs on both routers by using the **show hw-module fpd** command. For any FPD components that show status as NEED UPGD, use the **upgrade hw-module location location fpd** command. For any FPD components that show status as RLOAD REQ, use the **hw-module location location reload** command.
- Create a backup of the running configuration using the **copy running-config** command in both System Admin EXEC mode and XR EXEC mode.
- Install NC6-FANTRAY-2 Fan Trays. See the [Replacing the Fan Tray](#) section in the [Cisco Network Convergence System 6000 Series Routers Hardware Installation Guide](#).

Required Tools and Equipment

For a 2T single-chassis configuration, the following Cisco NCS 6000 hardware is required:

- Cisco NCS 6000 router (NCS-6008)
- Two NC6-FANTRAY-2 Fan Trays

- Six Universal Fabric Cards (NC6-FC2-U)
- Supported line cards:
 - NC6-20X100GE-L-C—20-port 100Gbps Line Card with 12 QSFP28 and 8 CPAK
 - NC6-20X100GE-M-C—20-port 100Gbps Line Card with 12 QSFP28 and 8 CPAK

Additional required tool and equipment:

- ESD (Electrostatic Discharge) wrist strap (for inserting a CXP module)
- Number-2 Phillips screwdriver
- Cable Director (P/N 2123610-1), to provide support and strain relief for fabric cable connections (provided by Cisco approved vendor Tyco Electronics)
- Supply of Velcro tie wraps (to bundle cables)
- Ladder

Migrating 1T Single Chassis to 2T Single Chassis



Note This procedure must be completed for each fabric plane, one at a time.

Before you begin

Review and perform all tasks in the safety guidelines, prerequisites, and required equipment sections before performing this task.

Step 1 From SysAdmin VM configuration mode, shut down the fabric plane.

Example:

```
sysadmin-vm:0_RP0# config
sysadmin-vm:0_RP0(config)# controller fabric plane 0 shutdown
sysadmin-vm:0_RP0(config)# commit
sysadmin-vm:0_RP0(config)# exit
```

Step 2 Use the **show controller fabric plane all detail** command to verify that the fabric plane Admin State and Plane State are down.

Example:

```
sysadmin-vm:0_RP0# show controller fabric plane all detail
Plane Admin Plane  Plane  up->dn  up->mcast  Total  Down  PPU
Id   State State  Mode  counter  counter  Bundles  Bundles  State
-----
0    DN  DN   SC      0         0         16      0      NA
1    UP    UP    SC      0         0         16      0      NA
2    UP    UP    SC      0         0         16      0      NA
```

3	UP	UP	SC	0	0	16	0	NA
4	UP	UP	SC	0	0	16	0	NA
5	UP	UP	SC	0	0	16	0	NA

Step 3 From SysAdmin VM configuration mode, power off the fabric card.

Example:

```
sysadmin-vm:0_RP0# config
sysadmin-vm:0_RP0(config)# hw-module shutdown location 0/FC0
sysadmin-vm:0_RP0(config)# commit
sysadmin-vm:0_RP0(config)# exit
```

Step 4 Use the show platform location command to verify that the fabric card is powered off.

Example:

```
sysadmin-vm:0_RP0# show platform location 0/FC0

Mon Dec 5 23:54:02.366 UTC
Location  Card Type                HW State      SW State      Config State
-----
0/FC0     NC6-FC                POWERED_OFF   N/A           NSHUT
```

Step 5 Remove the legacy fabric card following the steps in the [Removing a Fabric Card](#) section.

Step 6 Install the UFC following the steps in the [Installing a Fabric Card](#) section.

Note Do not connect any cables to the UFC.

Step 7 From SysAdmin VM configuration mode, unshut the fabric card.

Example:

```
sysadmin-vm:0_RP0# config
sysadmin-vm:0_RP0(config)# no hw-module shutdown location 0/FC0
0/RP0/ADMIN0:Dec 5 11:27:52.757 : shelf_mgr[2921]: %INFRA-SHELF_MGR-6-CARD_HW_OPERATIONAL :
Card: 0/FC0 hardware state going to Operational
0/RP0/ADMIN0:Dec 5 11:28:09.532 : confd_helper[2900]: %MGBL-CONFD_HELPER-5-SYSADMIN_COMMIT :
A sysadmin configuration change has been committed. Use 'show configuration commit list'
in admin mode for more details
LC/0/0/CPU0:Dec 5 11:28:15.538 : fia_driver[246]: %PLATFORM-CIH-5-ASIC_ERROR_THRESHOLD : fia[2]:
A link-err error has occurred. CMIC.CMIC_CMC0_IRQ_STAT3.RTP.Interrupt_Register.LinkMaskChange
Threshold has been exceeded
LC/0/5/CPU0:Dec 5 11:28:15.740 : fia_driver[216]: %PLATFORM-CIH-5-ASIC_ERROR_THRESHOLD : fia[4]:
A link-err error has occurred. CMIC.CMIC_CMC0_IRQ_STAT3.RTP.Interrupt_Register.LinkMaskChange
Threshold has been exceeded
LC/0/2/CPU0:Dec 5 11:28:15.927 : fia_driver[293]: %PLATFORM-CIH-5-ASIC_ERROR_THRESHOLD : fia[3]:
A link-err error has occurred. CMIC.CMIC_CMC0_IRQ_STAT3.RTP.Interrupt_Register.LinkMaskChange
Threshold has been exceeded
0/RP0/ADMIN0:Dec 5 11:28:17.401 : fsdbagg[4620]: %FABRIC-FSDB_AGG-5-PLANE_UPDOWN : [4620] :
Plane 0 state changed to UP
sysadmin-vm:0_RP0(config)# commit
sysadmin-vm:0_RP0(config)# exit
```

Step 8 Use the show platform location command to verify that the fabric card is operational.

Example:

```

sysadmin-vm:0_RP0# show platform location 0/FC0

Mon Dec 5 23:54:02.366 UTC
Location  Card Type                HW State  SW State  Config State
-----
0/FC0     NC6-FC2-U                OPERATIONAL  N/A      NSHUT

```

Step 9 Use the **show hw-module fpd** command to verify the status of all FPDs.

Verify that no FPD components require an upgrade (as indicated by NEED UPGD in the Status field) and that the Running and Programmed fields display the same version. See the Prerequisites section for FPD upgrade information.

Step 10 From SysAdmin VM configuration mode, unshut the fabric plane.

Example:

```

sysadmin-vm:0_RP0# config
sysadmin-vm:0_RP0(config)# no controller fabric plane 0 shutdown
sysadmin-vm:0_RP0(config)# commit
sysadmin-vm:0_RP0(config)# exit

```

Step 11 Use the **show controller fabric plane all detail** command to verify that Admin State and Plane State are up.

Example:

```

sysadmin-vm:0_RP0# show controller fabric plane all detail
Plane Admin Plane  Plane  up->dn  up->mcast  Total  Down  PPU
Id      State State  Mode   counter counter  Bundles Bundles State
-----
0       UP    UP    SC      0        0        16     0     NA
1       UP    UP    SC      0        0        16     0     NA
2       UP    UP    SC      0        0        16     0     NA
3       UP    UP    SC      0        0        16     0     NA
4       UP    UP    SC      0        0        16     0     NA
5       UP    UP    SC      0        0        16     0     NA

```

Step 12 Perform the Router Health Check. See [Commands for Router Health Check, on page 89](#).

What to do next

1. Repeat these steps for each remaining fabric plane (FC1, FC2, FC3, FC4, and FC5) until all six fabric planes have been migrated.
2. After all fabric planes have been migrated, you can install the 2T line card. Do the following:
 - a. [Verify Power Requirements](#)
 - b. [Remove Line Card Slice Configurations](#)
 - c. [Remove 1T Line Cards](#)
 - d. [Install 2T Line Cards](#)



CHAPTER 4

Migrating 1T Multi-Chassis to 2T Multi-Chassis

This chapter describes how to migrate the Cisco NCS 6000 LCC and NCS 6000 FCC routers from a 1T Multi-Chassis system to a 2T Multi-Chassis system. These procedures must be completed for each fabric plane, one at a time.



Note

You do not need to replace the fabric cards in the FCC and LCC at the same time. You can replace the fabric cards in the FCC and continue to use the S13 FC on the LCC (in 1T MC mode). However, you must migrate the fabric cards in the FCC to 2T before you migrate the fabric cards in the LCC.

- [Prerequisites, on page 23](#)
- [Required Tools and Equipment, on page 24](#)
- [Shut Down the Fabric Plane, on page 24](#)
- [Replace 1T FC with 2T FC2 in the FCC, on page 25](#)
- [Replace Legacy S13 Card with Universal Fabric Cards in the LCC, on page 26](#)
- [Unshut the Fabric Cards, on page 27](#)
- [Verify the CXPs in the Fabric Cards, on page 28](#)
- [Unshut the Fabric Plane, on page 30](#)

Prerequisites

- Before you perform any procedures, review the safety guidelines in the [Cisco Network Convergence System 6000 Series Routers Hardware Installation Guide](#) to avoid injuring yourself or damaging the equipment.
- Before cabling the system, install each chassis in the planned location. Ensure that you have adequate floor space to cable the multi-chassis configuration and an environment that meets the recommended specifications. For more information, see the [Cisco Network Convergence System 6000 Series Routers Site Planning Guide](#).
- Perform the Router Health check on the router to ensure that any errors or exception are resolved prior to migrating to 2T multi-chassis mode. See [Commands for Router Health Check, on page 89](#).
- Verify that the LCC and FCC are running Cisco IOS XR release 6.3.2 or later (with all applicable SMUs and packages).

- Install NC6-FANTRAY-2 Fan Trays in the LCC. See the [Replacing the Fan Tray](#) section in the *Cisco Network Convergence System 6000 Series Routers Hardware Installation Guide*.
- Verify that field-programmable device (FPD) upgrades are completed for all FPDs on both routers by using the **show hw-module fpd** command. For any FPD components that show status as NEED UPGD, use the **upgrade hw-module location location fpd** command. For any FPD components that show status as RLOAD REQ, use the **hw-module location location reload** command.
- Create a backup of the running configuration using the **copy running-config** command in both System Admin EXEC mode and XR EXEC mode.

Required Tools and Equipment

To migrate from 1T multi-chassis to 2T multi-chassis, make sure you have the following:

- For each Cisco NCS 6000 fabric card chassis (FCC)
 - 2nd generation S2 Fabric Card (NCS-F-FC2)
- For each Cisco NCS 6000 line card chassis (LCC)
 - Version 2 fan trays (NC6-FANTRAY-2) in each LCC
 - Universal Fabric Cards (NC6-FC2-U)
 - 20-port 100Gbps Line Cards (NC6-20X100GE-L-C, NC6-20X100GE-M-C)—required for 2T operation
- For each LCC and FCC, you will need 2 optical module sets (NCS-FAB-OPT2) that includes 96 ONS-CXP2-SR25 modules each.

Additional required tool and equipment:

- ESD (Electrostatic Discharge) wrist strap (for inserting a CXP module)
- Number-2 Phillips screwdriver
- Cable Director (P/N 2123610-1), to provide support and strain relief for fabric cable connections (provided by Cisco approved vendor Tyco Electronics)
- Supply of Velcro tie wraps (to bundle cables)
- Ladder

Shut Down the Fabric Plane

Before you begin

Review and perform all tasks in the safety guidelines, prerequisites, and required equipment sections before performing this task.

Step 1 From SysAdmin configuration mode, shut down the fabric plane.

Example:

```
sysadmin# config
sysadmin(config)# controller fabric plane 0 shutdown
sysadmin(config)# commit
sysadmin(config)# exit
sysadmin#
```

Step 2 Use the **show controller fabric plane 0 detail** command to verify that the fabric plane Admin State and Plane State are down.

Example:

```
sysadmin-vm:0_RP0# show controller fabric plane 0 detail
```

Plane Id	Admin State	Plane State	Plane Mode	up->dn counter	up->mcast counter	Total Bundles	Down Bundles	PPU State
0	DN	DN	SC	0	0	16	0	NA

Step 3 Use the **show controller fabric plane all statistics** command to verify that traffic is flowing on other all fabric planes.

Example:

```
sysadmin# show controller fabric plane all statistics
```

Plane	In Cells	Out Cells	CE Cells	UCE Cells	PE Cells
0	0	0	0	0	0
1	7430639921442	7430639772529	0	0	0
2	14327261472715	14327261187106	0	0	0
3	14838472309926	14838472030539	0	0	0
4	14843483869980	14843483591078	0	0	0
5	5458575703053	5458575605025	0	0	0

Replace 1T FC with 2T FC2 in the FCC

Step 1 Use the **show running-config controller fabric plane 0** command to identify FCC fabric cards in this fabric plane.

Note In a multi-chassis configuration, there could be up to 4 cards (locations) spread over multiple FCC racks.

Example:

```
sysadmin-vm:1_RP0# show running-config controller fabric plane 0
Mon Oct 12 17:30:43.903 UTC-07:00
controller fabric plane 0
shutdown
```

```

instance 0
  location F0/FC0
!
instance 1
  location F0/FC1
!
instance 2
  location F0/FC2
!
instance 3
  location F0/FC3
!
!
sysadmin-vm:1_RP0#

```

Step 2 For each fabric card identified in the previous step, do the following:

a) a. Shut down the fabric card.

Example:

```

sysadmin# config
sysadmin(config)# hw-module shutdown location F0/FC0
sysadmin(config)# commit
sysadmin(config)# exit
sysadmin # show platform location F0/FC0
Mon Oct 12 17:32:43.903 UTC-07:00
Location Card Type HW State SW State Config State
-----
F0/FC0 NCS-F-FC POWERED_OFF N/A NSHUT

```

- b) Remove the 1T (legacy) fabric card ([Removing an S2 Fabric Card](#))
- c) Install the 2T fabric card ([Installing an S2 Fabric Card](#))
- d) Insert CXP2 in 2T fabric card ([Guidelines for Handling CXP2 Optical Modules](#))
- e) Move the OM4 cables from the 1T FC to the same port position on the 2T FC.
- f) Repeat a through e for each fabric card in this fabric plane.

Replace Legacy S13 Card with Universal Fabric Cards in the LCC

For each fabric card slot, do the following:

Step 1 From SysAdmin VM configuration mode, shut down the fabric card.

Example:

```

sysadmin-vm:0_RP0# config
sysadmin-vm:0_RP0(config)# hw-module shutdown location 0/FC0
sysadmin-vm:0_RP0(config)# commit
sysadmin-vm:0_RP0(config)# exit

```

Step 2 Use the show platform location command to verify that the fabric card is powered off.

Example:

```
sysadmin-vm:0_RP0# # show platform location 0/FC0
Mon Dec 5 23:54:02.366 UTC
Location  Card Type                HW State      SW State      Config State
-----
0/FC0     NC6-FC                          POWERED_OFF   N/A           NSHUT
```

Step 3 Remove the legacy S13 fabric card on 0/FC0 ([Removing a Fabric Card](#))

Step 4 Install the Universal Fabric Card (UFC) ([Installing a Fabric Card](#))

Step 5 Insert CXP2 in UFC ([Guidelines for Handling CXP2 Optical Modules](#))

Step 6 Move the OM4 cables from the legacy S13 fabric card to the same port position on the UFC.

Step 7 Repeat 1 through 5 for each fabric card slot (FC0) in LCC racks 1, 2, 3, 4, and 5.

Note You can skip this step and continue to use the (legacy) S13 FC in any LCC rack that will not be using 2T line cards.

Unshut the Fabric Cards

Step 1 On the FCC, for each fabric card that was shutdown, do the following:

- a) From SysAdmin configuration mode, unshut the fabric card.

Example:

```
sysadmin# config
sysadmin(config)# no hw-module shutdown location F0/FC0
sysadmin(config)# commit
sysadmin(config)# exit
```

- b) Verify that front panel STATUS LEDs are green.
- c) Use the **show platform location** command to verify that the fabric card is operational.

Example:

```
sysadmin-vm:0_RP0# show platform location F0/FC0
Mon Dec 5 23:54:02.366 UTC
Location  Card Type                HW State      SW State      Config State
-----
F0/FC0     NCS-F-FC2              OPERATIONAL   N/A           NSHUT
```

Step 2 On the LCC, do the following:

- a) From SysAdmin VM configuration mode, unshut the fabric card.

Example:

```
sysadmin-vm:0_RP0# config
```

```

sysadmin-vm:0_RP0(config)# no hw-module shutdown location 0/FC0
sysadmin-vm:0_RP0(config)# commit
sysadmin-vm:0_RP0(config)# exit

```

- b) Verify that front panel STATUS LEDs are green.
- c) Use the **show platform location** command to verify that the fabric card is operational.

Example:

```

sysadmin-vm:0_RP0# show platform location 0/FC0
Mon Dec 5 23:54:02.366 UTC

```

Location	Card Type	HW State	SW State	Config State
0/FC0	NC6-FC2-U	OPERATIONAL	N/A	NSHUT

Verify the CXPs in the Fabric Cards

After all of the 2T fabric cards in the FCC and LCC are in Operational state, verify that all CXPs on the migrated 2T fabric cards have initialized.



Note To avoid traffic drops, perform this procedure before unshutting the fabric plane.



Note This process can take 3 to 5 minutes to complete.

- Step 1** On the FCC, enter the **show controller fabric cxp summary rack** *rack-number* command. Verify that all CXP modules are initialized properly.

Example:

```

sysadmin-vm:0_RP0# show controller fabric cxp summary rack F0
Mon Aug 13 13:07:17.635 UTC-05:30

```

```

=====
Fabric side CXP Port Initialization Status Summary
=====

```

```

Active functional role of the Rack [R/S] : F0/SC0

```

```

. - CXP is not present
p - CXP is not powered
I - CXP is not Initialized
U - CXP is not Supported
V - CXP in recovery
T - One or more Tx channel is disabled on the CXP
R - One or more Rx channel is disabled on the CXP
G - CXP is Initialized properly

```

```

Maximum CXP port number [0-31] per slot

```

```

+-----+-----+-----+-----+-----+-----+-----+-----+-----+-----+-----+-----+-----+-----+-----+
| Slot | 0 | 1 | 2 | 3 | 4 | 5 | 6 | 7 | 8 | 9 |10 |11 |12 |13 |14 |15 |
+-----+-----+-----+-----+-----+-----+-----+-----+-----+-----+-----+-----+-----+-----+-----+
| F0/FC0 | G | G | G | G | G | G | G | G | G | G | G | G | G | G | G |
+-----+-----+-----+-----+-----+-----+-----+-----+-----+-----+-----+-----+-----+-----+-----+
| F0/FC1 | G | G | G | G | G | G | G | G | G | G | G | G | G | G | G |
+-----+-----+-----+-----+-----+-----+-----+-----+-----+-----+-----+-----+-----+-----+-----+
| F0/FC2 | G | G | G | G | G | G | G | G | G | G | G | G | G | G | G |
+-----+-----+-----+-----+-----+-----+-----+-----+-----+-----+-----+-----+-----+-----+-----+
| F0/FC3 | G | G | G | G | G | G | G | G | G | G | G | G | G | G | G |
+-----+-----+-----+-----+-----+-----+-----+-----+-----+-----+-----+-----+-----+-----+-----+
| F0/FC4 | G | G | G | G | G | G | G | G | G | G | G | G | G | G | G |
+-----+-----+-----+-----+-----+-----+-----+-----+-----+-----+-----+-----+-----+-----+-----+
| Slot |16 |17 |18 |19 |20 |21 |22 |23 |24 |25 |26 |27 |28 |29 |30 |31 |
+-----+-----+-----+-----+-----+-----+-----+-----+-----+-----+-----+-----+-----+-----+-----+
| F0/FC0 | G | G | G | G | G | G | G | G | G | G | G | G | G | G | G |
+-----+-----+-----+-----+-----+-----+-----+-----+-----+-----+-----+-----+-----+-----+-----+
| F0/FC1 | G | G | G | G | G | G | G | G | G | G | G | G | G | G | G |
+-----+-----+-----+-----+-----+-----+-----+-----+-----+-----+-----+-----+-----+-----+-----+
| F0/FC2 | G | G | G | G | G | G | G | G | G | G | G | G | G | G | G |
+-----+-----+-----+-----+-----+-----+-----+-----+-----+-----+-----+-----+-----+-----+-----+
| F0/FC3 | G | G | G | G | G | G | G | G | G | G | G | G | G | G | G |
+-----+-----+-----+-----+-----+-----+-----+-----+-----+-----+-----+-----+-----+-----+-----+
| F0/FC4 | G | G | G | G | G | G | G | G | G | G | G | G | G | G | G |
+-----+-----+-----+-----+-----+-----+-----+-----+-----+-----+-----+-----+-----+-----+-----+
sysadmin-vm:1_RP1#
    
```

Step 2 On the LCC, enter the **show controller fabric cxp summary rack** *rack-number* command.
 Verify that all CXP modules are initialized properly.

Example:

```

sysadmin-vm:0_RP0# show controller fabric cxp summary rack 0
Mon Aug 13 13:08:17.140 UTC-05:30
=====
Fabric side CXP Port Initialization Status Summary
=====
Active functional role of the Rack [R/S] : 0/RP0
. - CXP is not present
p - CXP is not powered
I - CXP is not Initialized
U - CXP is not Supported
V - CXP in recovery
T - One or more Tx channel is disabled on the CXP
R - One or more Rx channel is disabled on the CXP
G - CXP is Initialized properly

Maximum CXP port number [0-15] per slot
+-----+-----+-----+-----+-----+-----+-----+-----+-----+-----+-----+-----+-----+-----+-----+
| Slot | 0 | 1 | 2 | 3 | 4 | 5 | 6 | 7 | 8 | 9 |10 |11 |12 |13 |14 |15 |
+-----+-----+-----+-----+-----+-----+-----+-----+-----+-----+-----+-----+-----+-----+-----+
| 0/FC0 | G | G | G | G | G | G | G | G | G | G | G | G | G | G | G |
+-----+-----+-----+-----+-----+-----+-----+-----+-----+-----+-----+-----+-----+-----+-----+
| 0/FC1 | G | G | G | G | G | G | G | G | G | G | G | G | G | G | G |
+-----+-----+-----+-----+-----+-----+-----+-----+-----+-----+-----+-----+-----+-----+-----+
| 0/FC2 | G | G | G | G | G | G | G | G | G | G | G | G | G | G | G |
+-----+-----+-----+-----+-----+-----+-----+-----+-----+-----+-----+-----+-----+-----+-----+
| 0/FC3 | G | G | G | G | G | G | G | G | G | G | G | G | G | G | G |
+-----+-----+-----+-----+-----+-----+-----+-----+-----+-----+-----+-----+-----+-----+-----+
| 0/FC4 | G | G | G | G | G | G | G | G | G | G | G | G | G | G | G |
+-----+-----+-----+-----+-----+-----+-----+-----+-----+-----+-----+-----+-----+-----+-----+
    
```

```
sysadmin-vm:1_RP1#
```

Unshut the Fabric Plane

Step 1 From SysAdmin configuration mode, unshut the fabric plane.

Example:

```
sysadmin# config
sysadmin(config)# no controller fabric plane 0 shutdown
sysadmin(config)# commit
sysadmin(config)# exit
sysadmin#
```

Step 2 Use the `show controller fabric plane all statistics` command to verify that traffic is flowing on the fabric plane.

Example:

```
sysadmin# show controller fabric plane all statistics
```

Plane	In Cells	Out Cells	CE Cells	UCE Cells	PE Cells
0	3992144	3977252	0	0	0
1	7430639921442	7430639772529	0	0	0
2	14327261472715	14327261187106	0	0	0
3	14838472309926	14838472030539	0	0	0
4	14843483869980	14843483591078	0	0	0
5	5458575703053	5458575605025	0	0	0

Step 3 Use the `show controller fabric plane 0 detail` command to verify that the fabric plane Admin State and Plane State are operationally UP.

Example:

```
sysadmin# show controller fabric plane 0 detail
```

Plane Id	Admin State	Plane State	Plane Mode	up->dn counter	up->mcast counter	Total Bundles	Down Bundles	PPU State
0	UP	UP	MC	0	3	80	0	NA
1	UP	UP	MC	0	1	80	0	NA
2	UP	UP	MC	0	1	80	0	NA
3	UP	UP	MC	10	29	80	0	NA
4	UP	UP	MC	10	25	80	0	NA
5	UP	UP	MC	11	30	80	0	NA

Step 4 Perform the Router Health Check. See [Commands for Router Health Check, on page 89](#).

What to do next

1. Repeat these steps for each remaining fabric plane (FC1, FC2, FC3, FC4, and FC5) until all six fabric planes have been migrated.
2. After all fabric planes have been migrated, you can install the 2T line card. Do the following:
 - a. [Verify Power Requirements](#)
 - b. [Remove Line Card Slice Configurations](#)
 - c. [Remove 1T Line Cards](#)
 - d. [Install 2T Line Cards](#)



APPENDIX **A**

Cabling a Multi-Chassis Configuration

This appendix provides an overview of the Cisco NCS 6000 Multi-Chassis system and describes how to physically cable the fabric planes between each LCC and FCC in the system.

The Cisco NCS 6000 Multi-Chassis system currently supports these multi-chassis configurations:

- 2+1—Two LCCs + one FCC (with six or twelve FCs)
- 2+2—Two LCCs + two FCC (with six or twelve FCs in each FCC)
- 4+2—Four LCCs + two FCCs (with six or twelve FCs in each FCC)
- 8+2—Eight LCCs + two FCCs (with twelve FCs in each FCC)

The Cisco NCS 6000 Multi-Chassis system with ECP currently supports these multi-chassis configurations:

- 2+1—Two LCCs + one FCC (with six or twelve FCs)
- 4+1—Four LCCs + one FCC (with six or twelve FCs)

The control plane cabling connections with ECP for the above mentioned configurations are explained in the sections "[Cabling the Control Plane for a 2+1 Multi-Chassis System with ECP, on page 45](#)" and "[Cabling the Control Plane for a 4+1 Multi-Chassis System with ECP, on page 47](#)". Cabling the fabric and other software configurations remain the same as the basic multi-chassis setup.

- [About the Cisco NCS 6000 Multi-Chassis System, on page 33](#)
- [Prerequisites, on page 35](#)
- [Cabling Requirements, on page 35](#)
- [Required Tools and Equipment, on page 38](#)
- [Cabling Overview , on page 39](#)
- [Cabling the Ethernet Control Plane Network , on page 41](#)
- [Cabling the Fabric, on page 49](#)

About the Cisco NCS 6000 Multi-Chassis System

This section provides an overview of the Cisco NCS 6000 Multi-Chassis system and describes what is required to interconnect the system components. The Cisco NCS 6000 Multi-Chassis system is also referred to as the “multi-chassis system” throughout this chapter.

The Cisco NCS 6000 Multi-Chassis system is a highly scalable routing platform designed for service providers to build next generation multi-service networks that provide video, data and voice services. The multi-chassis system consists of two major components: The line card chassis (LCC) and fabric card chassis (FCC). The LCC has 16 slots: eight line card (LC) slots, six fabric card slots, and two RP slots. The FCC has 14 slots: 12 fabric card slots and two slots for the SC or SC-SW shelf controller cards.

The interconnectivity of FCCs and the LCCs allows the system capacity of the NCS 6000 to scale from 8 Tbps to 128 Tbps of data.

Multi-Chassis System with ECP

The 2+1 Cisco NCS 6000 multi-chassis system with ECP consists of two line card chassis (LCC) and one fabric card chassis (FCC), interconnected with ECP. This multi-chassis configuration provides an aggregate bandwidth of 16 Tbps (with first generation line cards) and 32 Tbps (with 2T line cards). When the 2+1 Cisco NCS 6000 multi-chassis system is used with the ECP (External Control Plane), users can create up to 8 SDRs (secure domain routers).

The 4+1 Cisco NCS 6000 multi-chassis system with ECP consists of four line card chassis (LCC) and one fabric card chassis (FCC), interconnected with ECP. This multi-chassis configuration provides an aggregate bandwidth of 32 Tbps (with first generation line cards) and 64 Tbps (with 2T line cards). When the 4+1 Cisco NCS 6000 multi-chassis system is used with the ECP (External Control Plane), users can create up to 8 SDRs (secure domain routers).

Multi-Chassis System Hardware Requirements

The multi-chassis (MC) system is described as 1T or 2T, depending on the installed fabric cards and line cards. In a 1T system, each line card delivers up to 1 Tbps throughput. In a 2T system, each line card delivers up to 2 Tbps throughput. The following table lists the 1T and 2T multi-chassis hardware requirements.

Component	1T Multi-Chassis	2T Multi-Chassis
Fabric Card Chassis (FCC)		
S2 Fabric Cards	NCS-F-FC	NCS-F-FC2
Fabric Card Optics	CXP	CXP2
Line Card Chassis (LCC)		
S13 Fabric Cards	NC6-FC-MC	NC6-FC2-U
Fabric Card Optics	CXP	CXP2
Fan Tray	NC6-FANTRAY	NC6-FANTRAY-2
Line Cards	NC6-10X100G-L-K NC6-10X100G-M-K NC6-10X100G-L-P NC6-10X100G-M-P NC6-60X10GE-L-S NC6-60X10GE-M-S	NC6-20X100GE-L-C NC6-20X100GE-M-C

Prerequisites

Before cabling the system, install each line card chassis (LCC) and fabric card chassis (FCC) in the planned location. Ensure that you have adequate floor space to cable the multi-chassis system and an environment that meets the recommended specifications. For more information, see [Cisco Network Convergence System 6000 Series Routers Site Planning Guide](#).

Cabling Requirements

The following cables and optics are required to interconnect the LCC and FCC in a Cisco NCS 6000 Multi-Chassis system.



Note Cisco provides the optical modules but does not provide the cables specified below. You can order these cables from a Cisco approved vendor such as Tyco Electronics or Molex. To obtain the optics, please contact your Cisco sales representative for further information.

For connections from each route processor (RP) and SC (or SC portion of the SC-SW) card:

- Four 10G-SFP modules and two cables

Use SFP-10G-SR transceiver modules and 62.5/125 or 50/125 multi-mode fiber (MPO) cables, or SFP-10G-LR modules and 9/125 single-mode fiber (SMF) cables

For connections between the SC-SW cards in the FCC:

- QSFP-40GE-LR4 (long-reach) optical modules and standard SMF cables (recommended optic), or QSFP-40GE-SR4 (short-reach) MMF optical modules and MPO-12 ribbon cables

For connecting the fabric:

- 96 MPO-24 crossover cables for each LCC
- Two CXP optical module sets for each LCC. Each set includes 96 optical modules, for a total of 192 modules:
 - NCS-FAB-OPT—Includes 96 CXP-100G-SR12 modules for 1T multi-chassis systems.
 - NCS-FAB-OPT2—Includes 96 ONS-CXP2-SR25 modules for 2T multi-chassis systems.



Note The CXP and CXP2 modules use a 24-fiber MPO connector that supports bidirectional transmission across the fibers (12 Tx + 12 Rx), and provide 2-wire serial (I2C) management interface and digital diagnostics, including Tx and Rx optical power monitoring per wavelength.

The CXP pluggable transceiver module has 12 dedicated transmit (Tx) channels and 12 receive (Rx) channels per transceiver with data rates up to 10.3125 Gbps and OTN rates up to 11.25 Gbps.

The CXP2 pluggable transceiver module has 12 dedicated transmit (Tx) channels and 12 receive (Rx) channels per transceiver with data rates up to 25 Gbps. CXP2 supports data rates up to 10.3125 Gbps and OTN rates up to 11.25 Gbps when connected to legacy CXP transceiver modules.

MPO-24 Cable Specifications

The following figure shows the MPO-24 connector pinouts.

Figure 9: MPO-24 Connector Pinouts

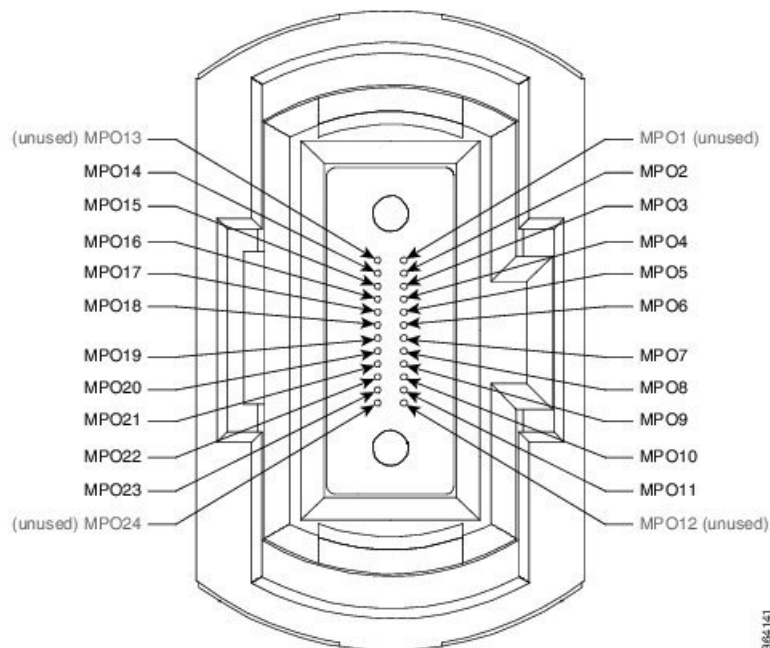

The following figure shows the MPO-24 connector fiber assignments.

Figure 10: MPO-24 Connector Fiber Assignments

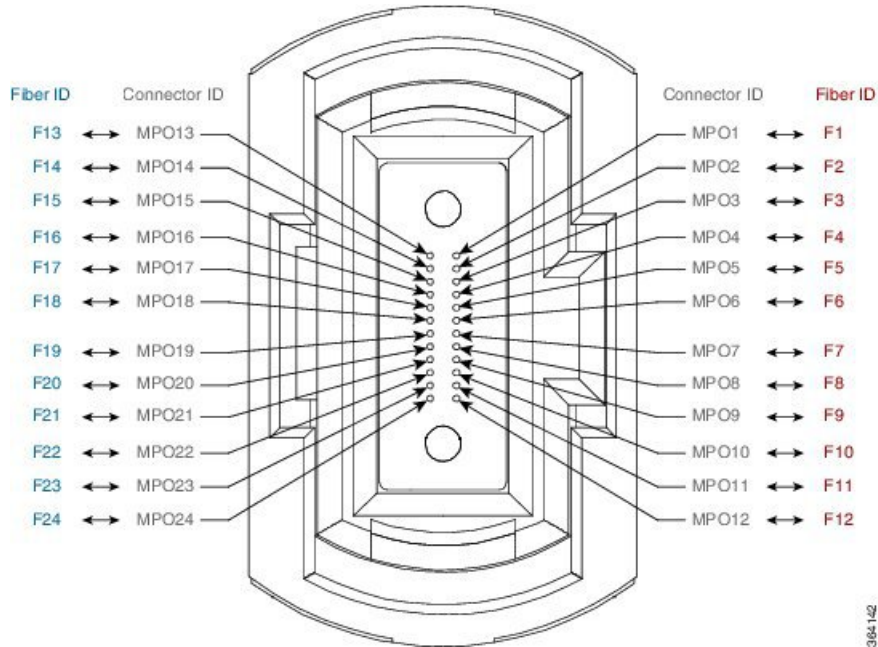

The following table lists the 100G to 100G crossover cable connections.

Table 4: Crossover Cable Connections

MPO Connector		CXP Module		Connector		CXP Module	
Connector ID	Fiber ID	Pin	Transmit (TX) Receive (RX)	Connector ID	Fiber ID	Pin	Transmit (TX) Receive (RX)
MPO1	F1	1	RX	MPO1	F13	1	RX
MPO2	F2	2	RX	MPO2	F14	2	RX
MPO3	F3	3	RX	MPO3	F15	3	RX
MPO4	F4	4	RX	MPO4	F16	4	RX
MPO5	F5	5	RX	MPO5	F17	5	RX
MPO6	F6	6	RX	MPO6	F18	6	RX
MPO7	F7	7	RX	MPO7	F19	7	RX
MPO8	F8	8	RX	MPO8	F20	8	RX
MPO9	F9	9	RX	MPO9	F21	9	RX
MPO10	F10	10	RX	MPO10	F22	10	RX
MPO11	F11	11	RX	MPO11	F23	11	RX
MPO12	F12	12	RX	MPO12	F24	12	RX

MPO Connector		CXP Module		Connector		CXP Module	
Connector ID	Fiber ID	Pin	Transmit (TX) Receive (RX)	Connector ID	Fiber ID	Pin	Transmit (TX) Receive (RX)
MPO13	F13	13	TX	MPO13	F1	13	TX
MPO14	F14	14	TX	MPO14	F2	14	TX
MPO15	F15	15	TX	MPO15	F3	15	TX
MPO16	F16	16	TX	MPO16	F4	16	TX
MPO17	F17	17	TX	MPO17	F5	17	TX
MPO18	F18	18	TX	MPO18	F6	18	TX
MPO19	F19	19	TX	MPO19	F7	19	TX
MPO20	F20	20	TX	MPO20	F8	20	TX
MPO21	F21	21	TX	MPO21	F9	21	TX
MPO22	F22	22	TX	MPO22	F10	22	TX
MPO23	F23	23	TX	MPO23	F11	23	TX
MPO24	F24	24	TX	MPO24	F12	24	TX

Required Tools and Equipment

- ESD (Electrostatic Discharge) wrist strap (for inserting a CXP or SFP module)
- Number-2 Phillips screwdriver
- (Optional) Medium flat-blade screwdriver (1/4 inch [60 to 70 mm]) used for opening the bale latches on small form-factor pluggable [SFP] or Gigabit Interface Converter [GBIC] transceivers
- Cable Director (P/N 2123610-1), to provide support and strain relief for fabric cable connections (provided by Cisco approved vendor Tyco Electronics)
- Supply of Velcro tie wraps (to bundle cables)
- Ladder

Cabling Overview

Cable Routing Considerations

Cabling Routing

Whether the cables will be run overhead or under the floor, consider the airflow and cable characteristics of the combined cable sets to ensure that your cable management structures support the total capacity of cables for the Cisco NCS 6000 Multi-Chassis system installation.

Raised Floor Installations

To plan cable routing in an installation with a raised floor, consider all the characteristics of each cable required for the installation. Allow slack for cabling so that cables can be pooled under the floor for future expansion without exceeding bend radius or cable length limitations. Riser cables are not rated for installation in air plenum passages, nor are they designed for use in LSZH (low smoke zero halogen) applications.

Cable Characteristics

Plan your cable runs, consider the characteristics of each cable, such as the cable length limitations, combined diameter of bundled cables (such as power cables), weight of the cable groups, and bend radius of the cable or cables. Couple these considerations with the cable infrastructure available (or needed) at your facility. The infrastructure could include structures like the overhead cabling monorail or J-hook system, sleeve and riser diameters, and distances between floors or elements of the Cisco NCS 6000 Multi-Chassis system.

Analyze the cabling infrastructures, risers, and racking available in your facility to determine if the capacity of the cabling management systems at your facility will accommodate the required capacities of the multi-chassis system cabling.

Cable Length

The limit of the cables is 100 meters (328 feet). Consider this distance when planning the physical locations of the LCCs and FCCs. For more information on the range of lengths available for the OM4 fabric cables, contact a Cisco approved vendor such as Tyco Electronics or Molex.

Cable Bend Radius

Exceeding the bend radius allowed for a cable can break the glass in the cable or cause attenuation or loss of signal. Do not bend a cable more than the allowable bend radius.

See the [Cisco Network Convergence System 6000 Series Routers Site Planning Guide](#) for information on planning component locations and cable runs.

General Cabling Procedures

Observe these procedures as you attach every cable:

- Strap the bundles to the horizontal cable management brackets on the chassis.

Four horizontal cable management brackets are preinstalled on both the LCC and FCC (two on the front side and two on the rear side of each chassis).

- Handle all fiber-optic cables carefully.
 - Do not allow a fiber-optic cable to bend in a radius smaller than the allowable bend radius specified for that cable type.
 - Fiber-optic cables are glass. Do not step on fiber-optic cables or handle them roughly. Do not twist or stretch the cables.
 - To keep optical connections clean, do not remove the cable dust cover until immediately before you install the cable.
 - After you install a cable, immediately reserve each dust cover for storage by office personnel in a dust-free storage area. After all of the cables have been installed ensure that all the reserved dust covers are stored by office personnel in a dust free area for future use.
 - Install clean dust covers on every unused connection.
 - Consider labeling the chassis interconnection cables or creating a diagram of the cabling to ensure that the cables are connected correctly during system installation.
 - Consider labeling the chassis. Consider whether each chassis need to be physically positioned in sequence. Label each cable with the location of each termination as you install each cable

Safety Guidelines

Before you perform any procedures, review the safety guidelines in this section to avoid injuring yourself or damaging the equipment. The following guidelines are for your safety and to protect equipment. The guidelines do not include all hazards. Be alert.

- Review the safety warnings listed in the [Regulatory and Compliance Guide for the Cisco NCS 6000 Series Routers](#) before installing, configuring, or troubleshooting any installed card.
- Never attempt to lift an object that might be too heavy for you to lift by yourself.
- Keep the work area clear and dust free during and after installation. Do not allow dirt or debris to enter into any laser-based components.
- Keep tools and router components away from walk areas.
- Do not wear loose clothing, jewelry, or other items that could get caught in the router while working with cards, modules, and their associated components.
- Cisco equipment operates safely when used in accordance with its specifications and product-usage instructions.
- Do not work alone if potentially hazardous conditions exist.
- The installation must follow national and local electrical codes: in the United States, National Fire Protection Association (NFPA) 70, United States National Electrical Code; in Canada, Canadian Electrical Code, part I, CSA C22.1; in other countries, International Electrotechnical Commission (IEC) 60364, part 1 through part 7.

Cabling the Ethernet Control Plane Network

This section describes how to cable the control plane network for the Cisco NCS 6000 Multi-Chassis system. These connections control the network connectivity for the multi-chassis system. The following cabling configurations are described:

The control plane network carries all the signaling, routing updates, system configuration and management packets for the NCS 6000. The control network must be cabled before the NCS 6000 system can become fully operational.

The control plane of the multi-chassis system is connected between the LCC and FCC with four paths per LCC (two per RP). The ports between the LCC and FCC are connected with SFP+ modules. Each RP on the LCC has 10GE connections that connect to each of the two SC-SW cards in the FCCs. The SC-SW cards provide the control plane network between all chassis.

Each SC-SW card has 56 10GE connections and two 40GE connections. Two SC-SW cards are used for redundancy purposes. These cards interconnect to each other through their 40GE QSFP optical ports. Each RP and each SC in a multi-chassis system connects to both switches. Note that an SC must be externally connected to both SC-SW switch cards though a 10GE port even if the SC and SC-SW cards are installed in the same FCC.

Cabling the Control Plane for a 2+1 Multi-Chassis system

The following figure shows the control plane cabling for a 2+1 multi-chassis system.



Note The RPs can be attached to any port on the SC-SW card.

Figure 11: Control Plane Cabling for a 2+1 Multi-Chassis System

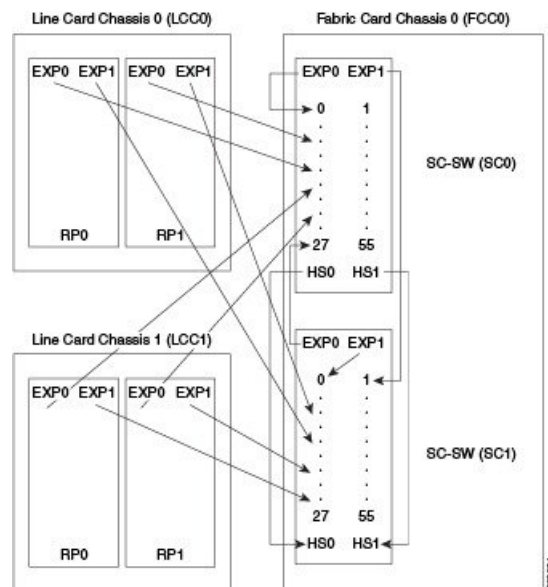

Table 5: RP Cards to SC-SW Card Connections (2+1 Configuration)

	From RP Port	To SC-SW Card
LCC0	RP0, EXP0	FCC0, SC0 any switch port
	RP1, EXP0	FCC0, SC0 any switch port
	RP0, EXP1	FCC0, SC1 any switch port
	RP1, EXP1	FCC0, SC1 any switch port
LCC1	RP0, EXP0	FCC0, SC0 any switch port
	RP1, EXP0	FCC0, SC0 any switch port
	RP0, EXP1	FCC0, SC1 any switch port
	RP1, EXP1	FCC0, SC1 any switch port

Table 6: FCC0 SC-SW to SC-SW Card Connections (2+1 Configuration)

From SC-SW Card	To SC-SW Card
SC0 EXP0	SC0, any switch port
SC0 EXP1	SC1, any switch port
SC1 EXP0	SC0, any switch port
SC1 EXP1	SC1, any switch port
SC0 HS0 (40GE)	SC1 HS0 (40GE)
SC0 HS1 (40GE)	SC1 HS1 (40GE)

Cabling the Control Plane for a 2+2 Multi-Chassis System

The following figure shows the control plane cabling for a 2+2 multi-chassis system.



Note The cabling may differ depending on the type of SFP modules that you use. For SFP-10G-SR (short-reach) transceiver modules, use 65/125 or 50/125 multi-mode cables. For SFP-10G-LR (long-reach) transceiver modules, use 9/125 single-mode cables. To connect the QSFP 40GE optical modules between the SC-SW cards, we recommend that you use QSFP supported cables.



Note Cabling the control plane for an $x+2$ (that is, 4+2 or 8+2), multi-chassis system is similar to that of a 2+2 multi-chassis system.

Figure 12: Control Plane Cabling for a 2+2 Multi-Chassis System

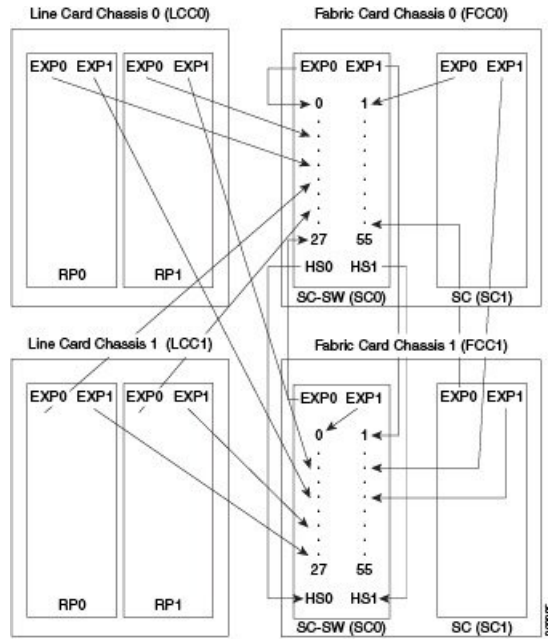

Table 7: RP Cards to SC-SW Card Connections (2+2 Configuration)

From Line Card Chassis	LCC RP Port	To SC-SW Cards in Fabric Card Chassis
LCC0	RP0, EXP0	FCC0, SC0 any switch port
	RP1, EXP0	FCC0, SC0 any switch port
	RP0, EXP1	FCC1, SC0 any switch port
	RP1, EXP1	FCC1, SC0 any switch port
LCC1	RP0, EXP0	FCC0, SC0 any switch port
	RP1, EXP0	FCC0, SC0 any switch port
	RP0, EXP1	FCC1, SC0 any switch port
	RP1, EXP1	FCC1, SC0 any switch port

Table 8: RP Cards to SC-SW Card Connections (8+2 Configuration)

From Line Card Chassis	LCC RP Port	To SC-SW Cards in Fabric Card Chassis
LCC0	RP0, EXP0	FCC0, SC0 any switch port
	RP1, EXP0	FCC0, SC0 any switch port
	RP0, EXP1	FCC1, SC0 any switch port
	RP1, EXP1	FCC1, SC0 any switch port
LCC1	RP0, EXP0	FCC0, SC0 any switch port
	RP1, EXP0	FCC0, SC0 any switch port
	RP0, EXP1	FCC1, SC0 any switch port
	RP1, EXP1	FCC1, SC0 any switch port
LCC2, LCC3, LCC4, LCC5, LCC6, and LCC7	RP0, EXP0	FCC0, SC0 any switch port
	RP1, EXP0	FCC0, SC0 any switch port
	RP0, EXP0	FCC1, SC0 any switch port
	RP1, EXP0	FCC1, SC0 any switch port

Table 9: SC-SW and SC Card Connections (2+2 and 8+2 Configuration)

From SC-SW Card	To SC-SW Card
FCC0, SC0 EXP0	FCC0, SC0 any switch port
FCC0, SC0 EXP1	FCC1, SC0 any switch port
FCC1, SC0 EXP0	FCC0, SC0 any switch port
FCC1, SC0 EXP1	FCC1, SC0 any switch port
FCC0, SC0 HS0 (40GE)	FCC1, SC0 HS0 (40GE)
FCC0, SC0 HS1 (40GE)	FCC1, SC0 HS1 (40GE)
From SC Card	To SC-SW Card
FCC0, SC1 EXP0	FCC0, SC0 any switch port
FCC0, SC1 EXP1	FCC1, SC0 any switch port
FCC1, SC1 EXP0	FCC0, SC0 any switch port
FCC1, SC1 EXP1	FCC1, SC0 any switch port

Cabling the Control Plane for a 2+1 Multi-Chassis System with ECP

The following figure shows the control plane cabling for a 2+1 multi-chassis system with ECP.



Note The RPs can be attached to any port on the SC-SW card.

Figure 13: Control Plane Cabling for a 2+1 Multi-Chassis System with ECP

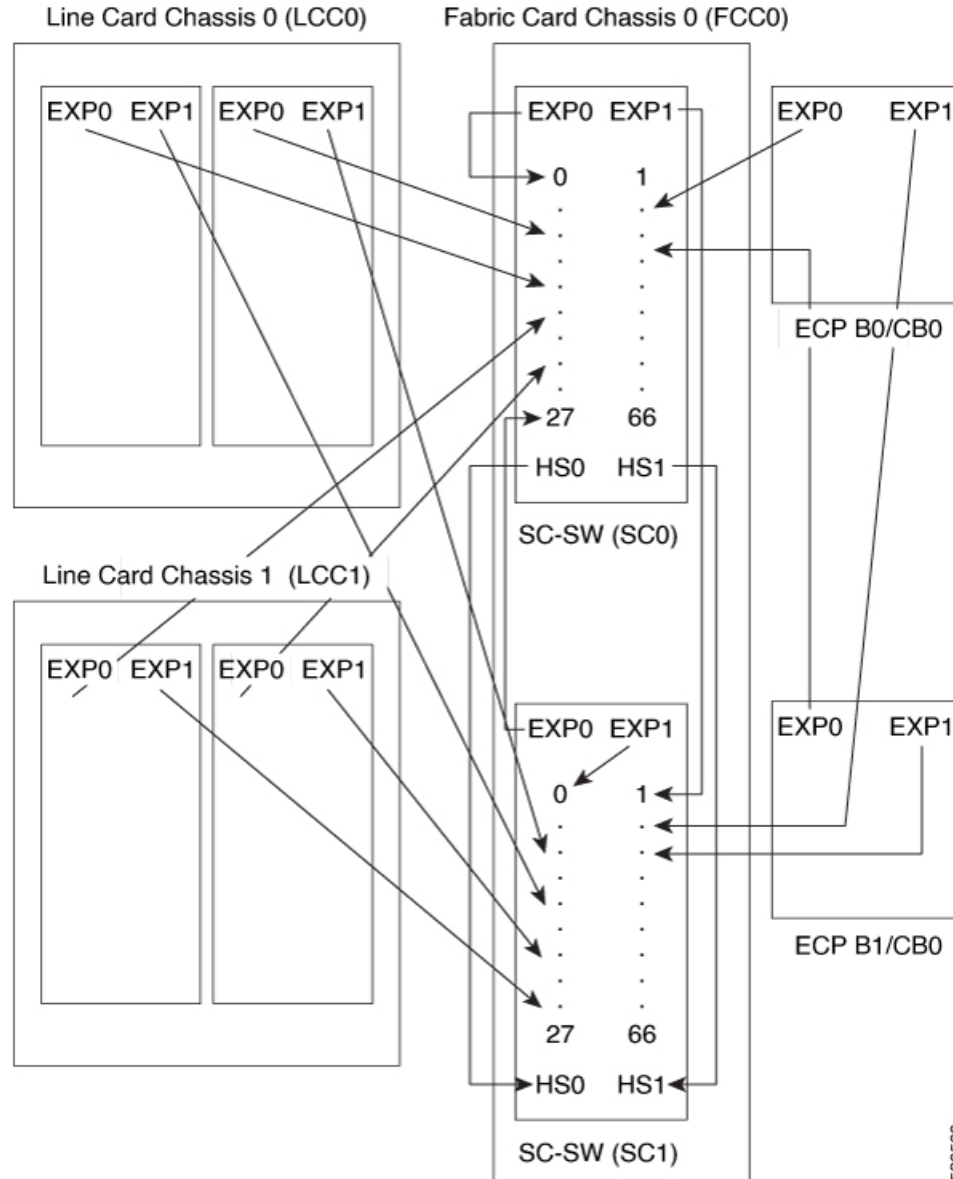

520599

Table 10: RP Cards to SC-SW Card Connections (2+1 Configuration)

	From RP Port	To SC-SW Card
LCC0	RP0, EXP0	FCC0, SC0 any switch port
	RP1, EXP0	FCC0, SC0 any switch port
	RP0, EXP1	FCC0, SC1 any switch port
	RP1, EXP1	FCC0, SC1 any switch port
LCC1	RP0, EXP0	FCC0, SC0 any switch port
	RP1, EXP0	FCC0, SC0 any switch port
	RP0, EXP1	FCC0, SC1 any switch port
	RP1, EXP1	FCC0, SC1 any switch port

Table 11: FCC0 SC-SW to SC-SW Card Connections (2+1 Configuration)

From SC-SW Card	To SC-SW Card
SC0 EXP0	SC0, any switch port
SC0 EXP1	SC1, any switch port
SC1 EXP0	SC0, any switch port
SC1 EXP1	SC1, any switch port
SC0 HS0 (40GE)	SC1 HS0 (40GE)
SC0 HS1 (40GE)	SC1 HS1 (40GE)

Table 12: ECP B/CB to SC-SW Card Connections (2+1 Configuration)

ECP B/CB Card	To SC-SW Card
B0/CB0, EXP0	FCC0, SC0 any switch port
B0/CB0, EXP1	FCC0, SC1 any switch port
B1/CB0, EXP0	FCC0, SC0 any switch port
B1/CB0, EXP1	FCC0, SC1 any switch port

Cabling the Control Plane for a 4+1 Multi-Chassis System with ECP

The following figure shows the control plane cabling for a 4+1 multi-chassis system with ECP.



Note The RPs can be attached to any port on the SC-SW card.

Figure 14: Control Plane Cabling for a 4+1 Multi-Chassis System with ECP

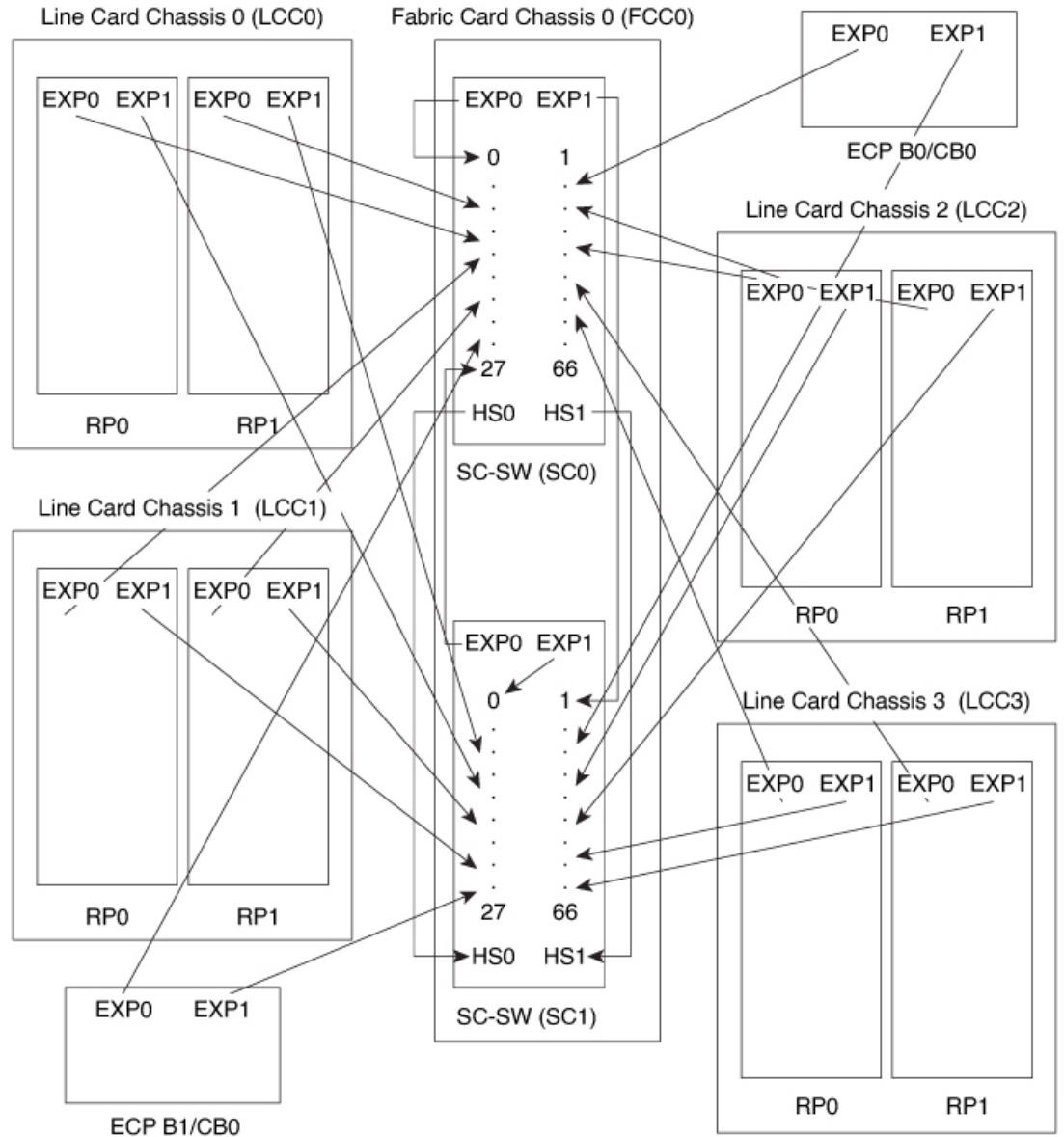

520060

Table 13: RP Cards to SC-SW Card Connections (4+1 Configuration)

	From RP Port	To SC-SW Card
LCC0	RP0, EXP0	FCC0, SC0 any switch port
	RP1, EXP0	FCC0, SC0 any switch port
	RP0, EXP1	FCC0, SC1 any switch port
	RP1, EXP1	FCC0, SC1 any switch port
LCC1	RP0, EXP0	FCC0, SC0 any switch port
	RP1, EXP0	FCC0, SC0 any switch port
	RP0, EXP1	FCC0, SC1 any switch port
	RP1, EXP1	FCC0, SC1 any switch port
LCC2	RP0, EXP0	FCC0, SC0 any switch port
	RP1, EXP0	FCC0, SC0 any switch port
	RP0, EXP1	FCC0, SC1 any switch port
	RP1, EXP1	FCC0, SC1 any switch port
LCC3	RP0, EXP0	FCC0, SC0 any switch port
	RP1, EXP0	FCC0, SC0 any switch port
	RP0, EXP1	FCC0, SC1 any switch port
	RP1, EXP1	FCC0, SC1 any switch port

Table 14: FCC0 SC-SW to SC-SW Card Connections (4+1 Configuration)

From SC-SW Card	To SC-SW Card
SC0 EXP0	SC0, any switch port
SC0 EXP1	SC1, any switch port
SC1 EXP0	SC0, any switch port
SC1 EXP1	SC1, any switch port
SC0 HS0 (40GE)	SC1 HS0 (40GE)
SC0 HS1 (40GE)	SC1 HS1 (40GE)

Table 15: ECP B/CB to SC-SW Card Connections (4+1 Configuration)

ECP B/CB Card	To SC-SW Card
B0/CB0, EXP0	FCC0, SC0 any switch port
B0/CB0, EXP1	FCC0, SC1 any switch port
B1/CB0, EXP0	FCC0, SC0 any switch port
B1/CB0, EXP1	FCC0, SC1 any switch port

Cabling the Fabric

This section describes how to configure the fabric cabling between the LCCs and the fabric components in the FCCs. The fabric provides the data connection for router traffic between all the CXP optical ports in the LCCs. The fabric cabling must be completed to enable data communications through the Cisco NCS 6000 Multi-Chassis system.

Multi-Chassis 2+1 Configuration

This section describes how to configure a multi-chassis 2+1 configuration. In this configuration, two LCCs (LCC0 and LCC1) connect to one FCC. The configuration differs depending on the number of S2 FCs that are installed in the FCC. The configurations described here include:



Note

At the LCC end of a fabric cable, the plane number is determined by the slot to which the cable is connected. The other end of each fabric cable must connect to the S2 fabric card designated for the same plane number.

Prerequisites

For connecting the fabric, you need the following:

- 192 MPO-24 fiber cables (96 per LCC)
- Optical module sets:
 - **In 1T multi-chassis 2+1 mode:** Four CXP optical module sets (Cisco PID NCS-FAB-OPT). Two sets are required per LCC: one set plugs into the LCC and the other set plugs into the FCC. Each set includes 96 CXP-100G-SR12 modules for a total of 384 modules.
 - **In 2T multi-chassis 2+1 mode:** Four CXP2 optical module sets (Cisco PID NCS-FAB-OPT2). Two sets are required per LCC: one set plugs into the LCC and the other set plugs into the FCC. Each set includes 96 ONS-CXP2-SR25 modules for a total of 384 modules.

Configuring a 2+1 Configuration with Six S2 FCs

The following figure shows two line card chassis (LCC0 and LCC1) connected to one fabric card chassis (FCC0) that has six S2 FCs installed. The figure shows the 2+1 connections for one fabric plane. To complete the configuration, you must repeat the cabling for the remaining five fabric planes until all six S2 cards are connected.

Figure 15: Cisco NCS 6000 Multi-Chassis 2+1 Configuration (Six S2 Fabric Cards)

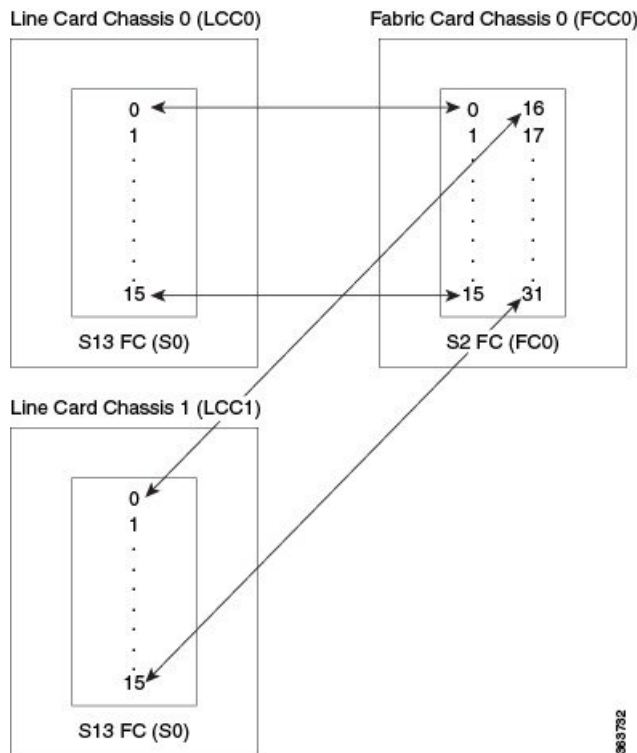

383732

Table 16: Cabling Plan for LCC0 in a 2+1 Multi-Chassis Configuration with Six S2 Fabric Cards

Plane 0		Plane 1		Plane 2		Plane 3		Plane 4		Plane 5	
LCC0 (S13) slot/port	FCC (S2) slot/port/chassis	LCC0 (S13) slot/port	FCC (S2) slot/port/chassis	LCC0 (S13) slot/port	FCC (S2) slot/port/chassis	LCC0 (S13) slot/port	FCC (S2) slot/port/chassis	LCC0 (S13) slot/port	FCC (S2) slot/port/chassis	LCC0 (S13) slot/port	FCC (S2) slot/port/chassis
S0/0 to FC0/0		S1/0 to FC1/0		S2/0 to FC2/0		S3/0 to FC3/0		S4/0 to FC4/0		S5/0 to FC5/0	
S0/1 to FC0/1		S1/1 to FC1/1		S2/1 to FC2/1		S3/1 to FC3/1		S4/1 to FC4/1		S5/1 to FC5/1	
S0/2 to FC0/2		S1/2 to FC1/2		S2/2 to FC2/2		S3/2 to FC3/2		S4/2 to FC4/2		S5/2 to FC5/2	
S0/3 to FC0/3		S1/3 to FC1/3		S2/3 to FC2/3		S3/3 to FC3/3		S4/3 to FC4/3		S5/3 to FC5/3	
S0/4 to FC0/4		S1/4 to FC1/4		S2/4 to FC2/4		S3/4 to FC3/4		S4/4 to FC4/4		S5/4 to FC5/4	
S0/5 to FC0/5		S1/5 to FC1/5		S2/5 to FC2/5		S3/5 to FC3/5		S4/5 to FC4/5		S5/5 to FC5/5	

Plane 0		Plane 1		Plane 2		Plane 3		Plane 4		Plane 5	
LCC0 (S13) slot/port	FCC (S2) slot/port/chassis	LCC0 (S13) slot/port	FCC (S2) slot/port/chassis	LCC0 (S13) slot/port	FCC (S2) slot/port/chassis	LCC0 (S13) slot/port	FCC (S2) slot/port/chassis	LCC0 (S13) slot/port	FCC (S2) slot/port/chassis	LCC0 (S13) slot/port	FCC (S2) slot/port/chassis
S0/6 to FC0/6		S1/6 to FC1/6		S2/6 to FC2/6		S3/6 to FC3/6		S4/6 to FC4/6		S5/6 to FC5/6	
S0/7 to FC0/7		S1/7 to FC1/7		S2/7 to FC2/7		S3/7 to FC3/7		S4/7 to FC4/7		S5/7 to FC5/7	
S0/8 to FC0/8		S1/8 to FC1/8		S2/8 to FC1/8		S3/8 to FC3/8		S4/8 to FC4/8		S5/8 to FC5/8	
S0/9 to FC0/9		S1/9 to FC1/9		S2/9 to FC2/9		S3/9 to FC3/9		S4/9 to FC4/9		S5/9 to FC5/9	
S0/10 to FC0/10		S1/10 to FC1/10		S2/10 to FC2/10		S3/10 to FC3/10		S4/10 to FC4/10		S5/10 to FC5/10	
S0/11 to FC0/11		S1/11 to FC1/11		S2/11 to FC2/11		S3/11 to FC3/11		S4/11 to FC4/11		S5/11 to FC5/11	
S0/12 to FC0/12		S1/12 to FC1/12		S2/12 to FC2/12		S3/12 to FC3/12		S4/12 to FC4/12		S5/12 to FC5/12	
S0/13 to FC0/13		S1/13 to FC1/13		S2/13 to FC2/13		S3/13 to FC3/13		S4/13 to FC4/13		S5/13 to FC5/13	
S0/14 to FC0/14		S1/14 to FC1/14		S2/14 to FC2/14		S3/14 to FC3/14		S4/14 to FC4/14		S5/14 to FC5/14	
S0/15 to FC0/15		S1/15 to FC1/15		S2/15 to FC2/15		S3/15 to FC3/15		S4/15 to FC4/15		S5/15 to FC5/15	

Table 17: Cabling Plan for LCC1 in a 2+1 Multi-Chassis Configuration with Six S2 Fabric Cards

Plane 0		Plane 1		Plane 2		Plane 3		Plane 4		Plane 5	
LCC1 (S13) slot/port	FCC (S2) slot/port/chassis	LCC1 (S13) slot/port	FCC (S2) slot/port/chassis	LCC1 (S13) slot/port	FCC (S2) slot/port/chassis	LCC1(S13) slot/port	FCC (S2) slot/port/chassis	LCC1 (S13) slot/port	FCC (S2) slot/port/chassis	LCC1 (S13) slot/port	FCC (S2) slot/port/chassis
S0/0 to FC0/16		S1/0 to FC1/16		S2/0 to FC2/16		S3/0 to FC3/16		S4/0 to FC4/16		S5/0 to FC5/16	
S0/1 to FC0/17		S1/1 to FC1/17		S2/1 to FC2/17		S3/1 to FC3/17		S4/1 to FC4/17		S5/1 to FC5/17	
S0/2 to FC0/18		S1/2 to FC1/18		S2/2 to FC2/18		S3/2 to FC3/18		S4/2 to FC4/18		S5/2 to FC5/18	
S0/3 to FC0/19		S1/3 to FC1/19		S2/3 to FC2/19		S3/3 to FC3/19		S4/3 to FC4/19		S5/3 to FC5/19	
S0/4 to FC0/20		S1/4 to FC1/20		S2/4 to FC2/20		S3/4 to FC3/20		S4/4 to FC4/20		S5/4 to FC5/20	
S0/5 to FC0/21		S1/5 to FC1/21		S2/5 to FC2/21		S3/5 to FC3/21		S4/5 to FC4/21		S5/5 to FC5/21	
S0/6 to FC0/22		S1/6 to FC1/22		S2/6 to FC2/22		S3/6 to FC3/22		S4/6 to FC4/22		S5/6 to FC5/22	
S0/7 to FC0/23		S1/7 to FC1/23		S2/7 to FC2/23		S3/7 to FC3/23		S4/7 to FC4/23		S5/7 to FC5/23	
S0/8 to FC0/24		S1/8 to FC1/24		S2/8 to FC2/24		S3/8 to FC3/24		S4/8 to FC4/24		S5/8 to FC5/24	
S0/9 to FC0/25		S1/9 to FC1/25		S2/9 to FC2/25		S3/9 to FC3/25		S4/9 to FC4/25		S5/9 to FC5/25	
S0/10 to FC0/26		S1/10 to FC1/26		S2/10 to FC2/26		S3/10 to FC3/26		S4/10 to FC4/26		S5/10 to FC5/26	

Plane 0		Plane 1		Plane 2		Plane 3		Plane 4		Plane 5	
LCC1 (S13) slot/port	FCC (S2) slot/port/chassis	LCC1 (S13) slot/port	FCC (S2) slot/port/chassis	LCC1 (S13) slot/port	FCC (S2) slot/port/chassis	LCC1(S13) slot/port	FCC (S2) slot/port/chassis	LCC1 (S13) slot/port	FCC (S2) slot/port/chassis	LCC1 (S13) slot/port	FCC (S2) slot/port/chassis
S0/11 to FC0/27		S1/11 to FC1/27		S2/11 to FC2/27		S3/11 to FC3/27		S4/11 to FC4/27		S5/11 to FC5/27	
S0/12 to FC0/28		S1/12 to FC1/28		S2/12 to FC2/28		S3/12 to FC3/28		S4/12 to FC4/28		S5/12 to FC5/28	
S0/13 to FC0/29		S1/13 to FC1/29		S2/13 to FC2/29		S3/13 to FC3/29		S4/13 to FC4/29		S5/13 to FC5/29	
S0/14 to FC0/30		S1/14 to FC1/30		S2/14 to FC2/30		S3/14 to FC3/30		S4/14 to FC4/30		S5/14 to FC5/30	
S0/15 to FC0/31		S1/15 to FC1/31		S2/15 to FC2/31		S3/15 to FC3/31		S4/15 to FC4/31		S5/15 to FC5/31	

2+1 Software Configuration (Six S2 Fabric Cards)

An explicit admin configuration is required to specify an ordered list of S2 connections assigned for a plane. Each S2 connection is specified as an instance. The instances are contiguous, starting from 0.

```
controller fabric plane 0
instance 0
location F0/FC0
```

```
controller fabric plane 1
instance 0
location F0/FC1
```

```
controller fabric plane 2
instance 0
location F0/FC2
```

```
controller fabric plane 3
instance 0
location F0/FC3
```

```
controller fabric plane 4
instance 0
location F0/FC4
```

```
controller fabric plane 5
instance 0
location F0/FC5
```

Configuring a 2+1 Configuration with 12 S2 FCs

The following figure shows two line card chassis (LCC0 and LCC1) connected to one fabric card chassis (FCC0) that has 12 S2 FCs installed. The advantage of installing 12 S2 FCs cards instead of 6 S2 FCs cards is that only half of the available S2 ports are used. This allows up to two additional LCCs to be added later without having to re-cable the initial 2 LCCs.

The figure below shows the connections for one fabric plane. To complete the configuration, you must repeat the cabling for the remaining five fabric planes until all 12 S2 FCs cards are connected.

Figure 16: Cisco NCS 6000 Multi-Chassis 2+1 Configuration (12 S2 FCs)

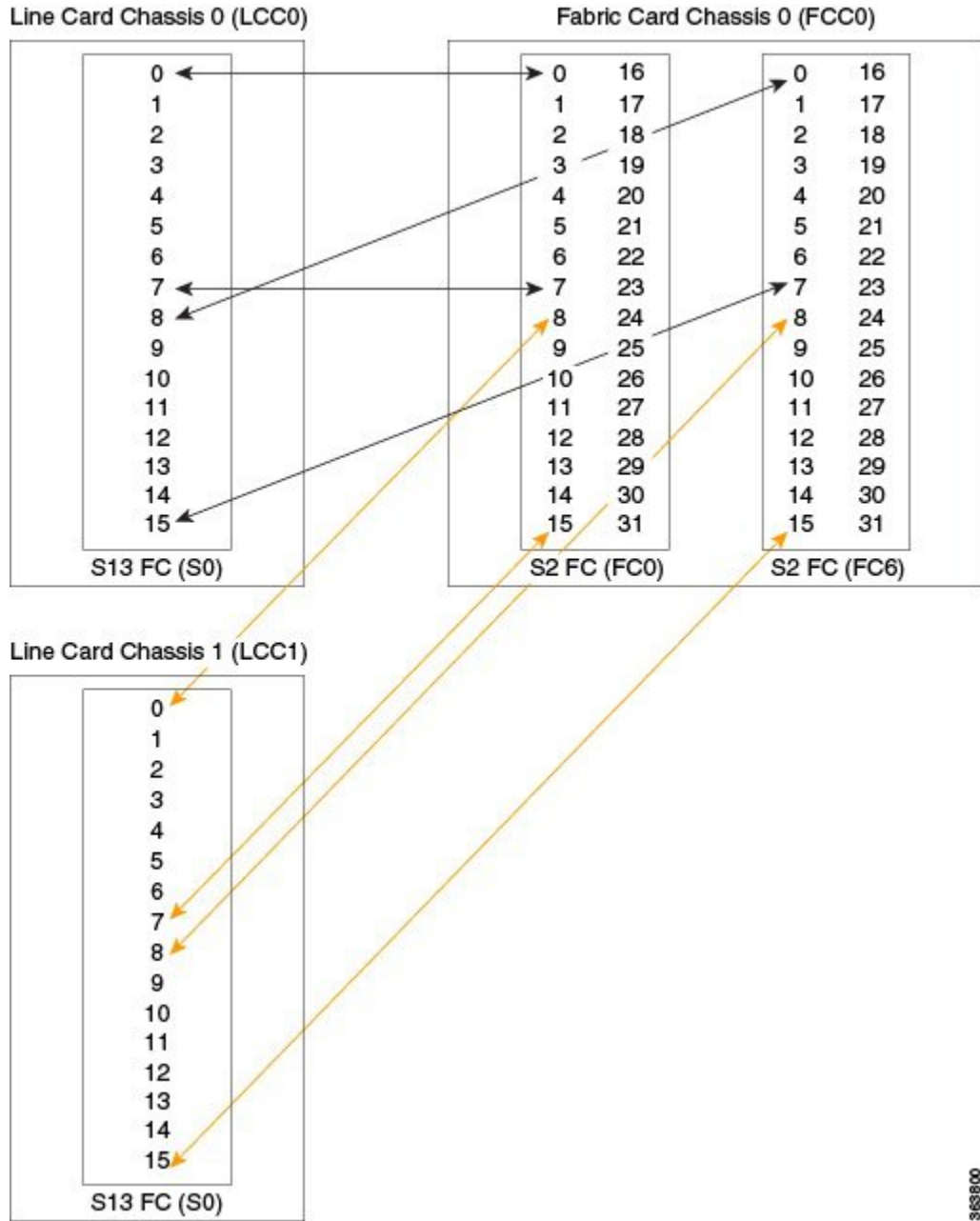

869800

Table 18: Cabling Plan for LCC0 in a 2+1 Multi-Chassis Configuration with 12 S2 Cards

Plane 0		Plane 1		Plane 2		Plane 3		Plane 4		Plane 5	
LCC0 (S13) slot/port	FCC (S2) slot/port/chassis	LCC0 (S13) slot/port	FCC (S2) slot/port/chassis	LCC0 (S13) slot/port	FCC (S2) slot/port/chassis	LCC0 (S13) slot/port	FCC (S2) slot/port/chassis	LCC0 (S13) slot/port	FCC (S2) slot/port/chassis	LCC0 (S13) slot/port	FCC (S2) slot/port/chassis
S0/0 to FC0/0		S1/0 to FC1/0		S2/0 to FC2/0		S3/0 to FC3/0		S4/0 to FC4/0		S5/0 to FC5/0	

Plane 0		Plane 1		Plane 2		Plane 3		Plane 4		Plane 5	
LCC0 (S13) slot/port	FCC (S2) slot/port/chassis	LCC0 (S13) slot/port	FCC (S2) slot/port/chassis	LCC0 (S13) slot/port	FCC (S2) slot/port/chassis	LCC0 (S13) slot/port	FCC (S2) slot/port/chassis	LCC0 (S13) slot/port	FCC (S2) slot/port/chassis	LCC0 (S13) slot/port	FCC (S2) slot/port/chassis
S0/1 to FC0/1		S1/1 to FC1/1		S2/1 to FC2/1		S3/1 to FC3/1		S4/1 to FC4/1		S5/1 to FC5/1	
S0/2 to FC0/2		S1/2 to FC1/2		S2/2 to FC2/2		S3/2 to FC3/2		S4/2 to FC4/2		S5/2 to FC5/2	
S0/3 to FC0/3		S1/3 to FC1/3		S2/3 to FC2/3		S3/3 to FC3/3		S4/3 to FC4/3		S5/3 to FC5/3	
S0/4 to FC0/4		S1/4 to FC1/4		S2/4 to FC2/4		S3/4 to FC3/4		S4/4 to FC4/4		S5/4 to FC5/4	
S0/5 to FC0/5		S1/5 to FC1/5		S2/5 to FC2/5		S3/5 to FC3/5		S4/5 to FC4/5		S5/5 to FC5/5	
S0/6 to FC0/6		S1/6 to FC1/6		S2/6 to FC2/6		S3/6 to FC3/6		S4/6 to FC4/6		S5/6 to FC5/6	
S0/7 to FC0/7		S1/7 to FC1/7		S2/7 to FC2/7		S3/7 to FC3/7		S4/7 to FC4/7		S5/7 to FC5/7	
S0/8 to FC6/0		S1/8 to FC7/0		S2/8 to FC8/0		S3/8 to FC9/0		S4/8 to FC10/0		S5/8 to FC11/0	
S0/9 to FC6/1		S1/9 to FC7/1		S2/9 to FC8/1		S3/9 to FC9/1		S4/9 to FC10/1		S5/9 to FC11/1	
S0/10 to FC6/2		S1/10 to FC7/2		S2/10 to FC8/2		S3/10 to FC9/2		S4/10 to FC10/2		S5/10 to FC11/2	
S0/11 to FC6/3		S1/11 to FC7/3		S2/11 to FC8/3		S3/11 to FC9/3		S4/11 to FC10/3		S5/11 to FC11/3	
S0/12 to FC6/4		S1/12 to FC7/4		S2/12 to FC8/4		S3/12 to FC9/4		S4/12 to FC10/4		S5/12 to FC11/4	
S0/13 to FC6/5		S1/13 to FC7/5		S2/13 to FC8/5		S3/13 to FC9/5		S4/13 to FC10/5		S5/13 to FC11/5	
S0/14 to FC6/6		S1/14 to FC7/6		S2/14 to FC8/6		S3/14 to FC9/6		S4/14 to FC10/6		S5/14 to FC11/6	
S0/15 to FC6/7		S1/15 to FC7/7		S2/15 to FC8/7		S3/15 to FC9/7		S4/15 to FC10/7		S5/15 to FC11/7	

Table 19: Cabling Plan for LCC1 in a 2+1 Multi-Chassis Configuration with 12 S2 Cards

Plane 0		Plane 1		Plane 2		Plane 3		Plane 4		Plane 5	
LCC1 (S13) slot/port	FCC (S2) slot/port/chassis	LCC1 (S13) slot/port	FCC (S2) slot/port/chassis	LCC1 (S13) slot/port	FCC (S2) slot/port/chassis	LCC1(S13) slot/port	FCC (S2) slot/port/chassis	LCC1 (S13) slot/port	FCC (S2) slot/port/chassis	LCC1 (S13) slot/port	FCC (S2) slot/port/chassis
S0/0 to FC0/8		S1/0 to FC1/8		S2/0 to FC2/8		S3/0 to FC3/8		S4/0 to FC4/8		S5/0 to FC5/8	
S0/1 to FC0/9		S1/1 to FC1/9		S2/1 to FC2/9		S3/1 to FC3/9		S4/1 to FC4/9		S5/1 to FC5/9	
S0/2 to FC0/10		S1/2 to FC1/10		S2/2 to FC2/10		S3/2 to FC3/10		S4/2 to FC4/10		S5/2 to FC5/10	
S0/3 to FC0/11		S1/3 to FC1/11		S2/3 to FC2/11		S3/3 to FC3/11		S4/3 to FC4/11		S5/3 to FC5/11	
S0/4 to FC0/12		S1/4 to FC1/12		S2/4 to FC2/12		S3/4 to FC3/12		S4/4 to FC4/12		S5/4 to FC5/12	
S0/5 to FC0/13		S1/5 to FC1/13		S2/5 to FC2/13		S3/5 to FC3/13		S4/5 to FC4/13		S5/5 to FC5/13	

Plane 0		Plane 1		Plane 2		Plane 3		Plane 4		Plane 5	
LCC1 (S13) slot/port	FCC (S2) slot/port/chassis	LCC1 (S13) slot/port	FCC (S2) slot/port/chassis	LCC1 (S13) slot/port	FCC (S2) slot/port/chassis	LCC1(S13) slot/port	FCC (S2) slot/port/chassis	LCC1 (S13) slot/port	FCC (S2) slot/port/chassis	LCC1 (S13) slot/port	FCC (S2) slot/port/chassis
S0/6 to FC0/14		S1/6 to FC1/14		S2/6 to FC2/14		S3/6 to FC3/14		S4/6 to FC4/14		S5/6 to FC5/14	
S0/7 to FC0/15		S1/7 to FC1/15		S2/7 to FC2/15		S3/7 to FC3/15		S4/7 to FC4/15		S5/7 to FC5/15	
S0/8 to FC6/8		S1/8 to FC7/8		S2/8 to FC8/8		S3/8 to FC9/8		S4/8 to FC10/8		S5/8 to FC11/8	
S0/9 to FC6/9		S1/9 to FC7/9		S2/9 to FC8/9		S3/9 to FC9/9		S4/9 to FC10/9		S5/9 to FC11/9	
S0/10 to FC6/10		S1/10 to FC7/10		S2/10 to FC8/10		S3/10 to FC9/10		S4/10 to FC10/10		S5/10 to FC11/10	
S0/11 to FC6/11		S1/11 to FC7/11		S2/11 to FC8/11		S3/11 to FC9/11		S4/11 to FC10/11		S5/11 to FC11/11	
S0/12 to FC6/12		S1/12 to FC7/12		S2/12 to FC8/12		S3/12 to FC9/12		S4/12 to FC10/12		S5/12 to FC11/12	
S0/13 to FC6/13		S1/13 to FC7/13		S2/13 to FC8/13		S3/13 to FC9/13		S4/13 to FC10/13		S5/13 to FC11/13	
S0/14 to FC6/14		S1/14 to FC7/14		S2/14 to FC8/14		S3/14 to FC9/14		S4/14 to FC10/14		S5/14 to FC11/14	
S0/15 to FC6/15		S1/15 to FC7/15		S2/15 to FC8/15		S3/15 to FC9/15		S4/15 to FC10/15		S5/15 to FC11/15	

2+1 Software Configuration (12 S2 Fabric Cards)

An explicit admin configuration is required to specify an ordered list of S2 connections assigned for a plane. Each S2 connection is specified as an instance. The instances are contiguous, starting from 0.

```

controller fabric plane 0
instance 0
location F0/FC0
instance 1
location F0/FC6

controller fabric plane 1
instance 0
location F0/FC1
instance 1
location F0/FC7

controller fabric plane 2
instance 0
location F0/FC2
instance 1
location F0/FC8

controller fabric plane 3
instance 0
location F0/FC3
instance 1
location F0/FC9

controller fabric plane 4
instance 0
location F0/FC4

```

```

instance 1
location F0/FC10

controller fabric plane 5
instance 0
location F0/FC5
instance 1
location F0/FC11

```

Multi-Chassis 2+2 Configuration

This section describes how to configure a multi-chassis 2+2 configuration. In this configuration, two line card chassis (LCC0 and LCC1) are connected to two fabric card chassis (FCC0 and FCC1).

Prerequisites

For connecting the fabric, you need the following:

- 192 MPO-24 fiber cables (96 per LCC)
- Optical module sets:
 - **In 1T multi-chassis 2+2 mode:** Four CXP optical module sets (Cisco PID NCS-FAB-OPT). Two sets are required per LCC: one set plugs into the LCC and the other set plugs into the FCC. Each set includes 96 CXP-100G-SR12 modules for a total of 384 modules.
 - **In 2T multi-chassis 2+2 mode:** Four CXP2 optical module sets (Cisco PID NCS-FAB-OPT2). Two sets are required per LCC: one set plugs into the LCC and the other set plugs into the FCC. Each set includes 96 ONS-CXP2-SR25 modules for a total of 384 modules.

Configuring a 2+2 Configuration with 12 S2 Fabric Cards

The following shows two line card chassis (LCC0 and LCC1) connected to two fabric card chassis (FCC0 and FCC1). In this configuration, there are 6 FCs in each fabric card chassis; in total 12 FCs are installed. The figure shows the 2+2 connections for two fabric planes. To complete the configuration, you must repeat the cabling for the remaining four fabric planes until all 12 S2 cards are connected.

Figure 17: Cisco NCS 6000 Multi-Chassis 2+2 Configuration with 12 S2 FC's

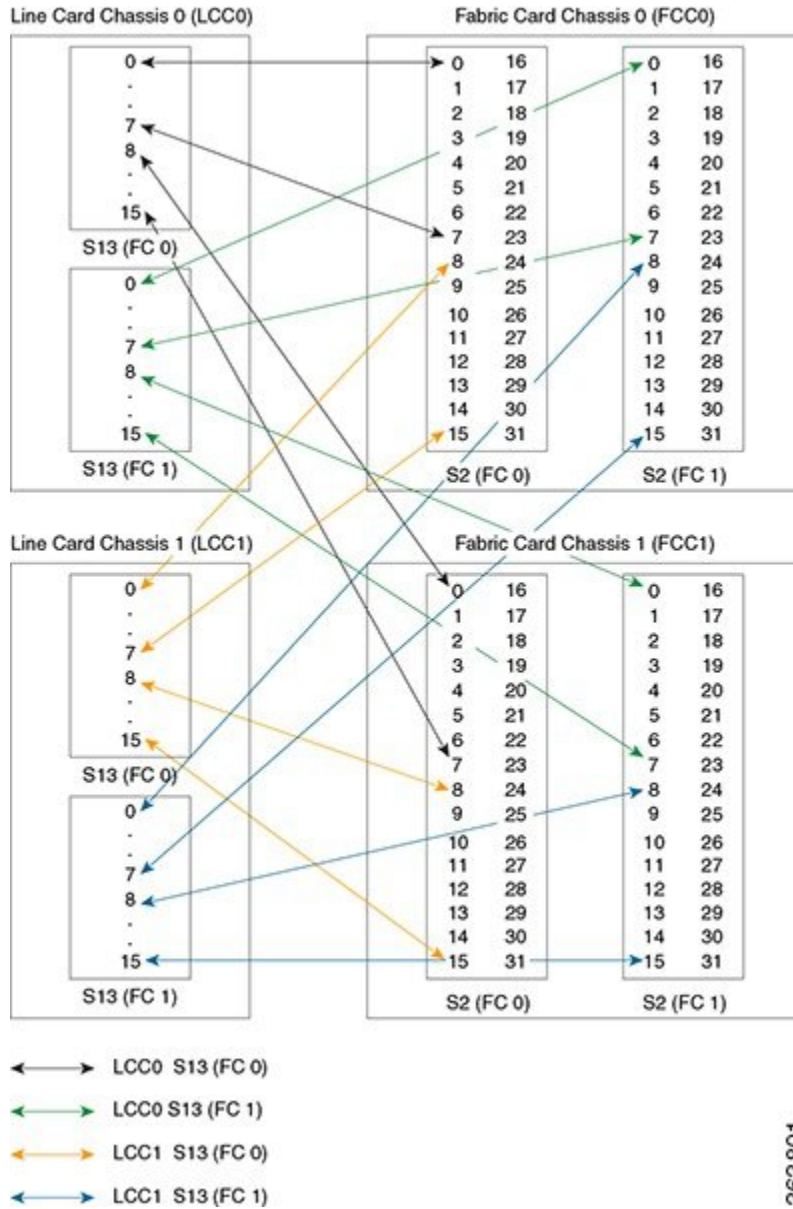

The following table shows the cabling plan for a 2+2 multi-chassis configuration with 12 SC FCs installed. FCC0 has a fabric instance 0 for planes 0 through 5 in FCC0 (6 SC FCs in slots 0 through 5), and fabric instance 1 in FCC1 (also in slots 0 through 5). Other mappings are possible (for example, you can put both instances of planes 0 through 2 in FCC0, and planes 3 through 5 in FCC1 but the following table and software configuration assume that instance 0 is in FCC0 and instance 1 is in FCC1).

Table 20: Cabling Plan for LCC0 in a 2+2 Multi-Chassis Configuration with 12 S2 Fabric Cards

Plane 0		Plane 1		Plane 2		Plane 3		Plane 4		Plane 5	
LCC0 (S13) slot/port	FCC (S2) slot/port/chassis	LCC0 (S13) slot/port	FCC (S2) slot/port/chassis	LCC0 (S13) slot/port	FCC (S2) slot/port/chassis	LCC0 (S13) slot/port	FCC (S2) slot/port/chassis	LCC0 (S13) slot/port	FCC (S2) slot/port/chassis	LCC0 (S13) slot/port	FCC (S2) slot/port/chassis
S0/0 to FC0/0 (FCC0)		S1/0 to FC1/0 (FCC0)		S2/0 to FC2/0 (FCC0)		S3/0 to FC3/0 (FCC0)		S4/0 to FC4/0 (FCC0)		S5/0 to FC5/0 (FCC0)	
S0/1 to FC0/1 (FCC0)		S1/1 to FC1/1 (FCC0)		S2/1 to FC2/1 (FCC0)		S3/1 to FC3/1 (FCC0)		S4/1 to FC4/1 (FCC0)		S5/1 to FC5/1 (FCC0)	
S0/2 to FC0/2 (FCC0)		S1/2 to FC1/2 (FCC0)		S2/2 to FC2/2 (FCC0)		S3/2 to FC3/2 (FCC0)		S4/2 to FC4/2 (FCC0)		S5/2 to FC5/2 (FCC0)	
S0/3 to FC0/3 (FCC0)		S1/3 to FC1/3 (FCC0)		S2/3 to FC2/3 (FCC0)		S3/3 to FC3/3 (FCC0)		S4/3 to FC4/3 (FCC0)		S5/3 to FC5/3 (FCC0)	
S0/4 to FC0/4 (FCC0)		S1/4 to FC1/4 (FCC0)		S2/4 to FC2/4 (FCC0)		S3/4 to FC3/4 (FCC0)		S4/4 to FC4/4 (FCC0)		S5/4 to FC5/4 (FCC0)	
S0/5 to FC0/5 (FCC0)		S1/5 to FC1/5 (FCC0)		S2/5 to FC2/5 (FCC0)		S3/5 to FC3/5 (FCC0)		S4/5 to FC4/5 (FCC0)		S5/5 to FC5/5 (FCC0)	
S0/6 to FC0/6 (FCC0)		S1/6 to FC1/6 (FCC0)		S2/6 to FC2/6 (FCC0)		S3/6 to FC3/6 (FCC0)		S4/6 to FC4/6 (FCC0)		S5/6 to FC5/6 (FCC0)	
S0/7 to FC0/7 (FCC0)		S1/7 to FC1/7 (FCC0)		S2/7 to FC2/7 (FCC0)		S3/7 to FC3/7 (FCC0)		S4/7 to FC4/7 (FCC0)		S5/7 to FC5/7 (FCC0)	
S0/8 to FC0/0 (FCC1)		S1/8 to FC1/0 (FCC1)		S2/8 to FC2/0 (FCC1)		S3/8 to FC3/0 (FCC1)		S4/8 to FC4/0 (FCC1)		S5/8 to FC5/0 (FCC1)	
S0/9 to FC0/2 (FCC1)		S1/9 to FC1/1 (FCC1)		S2/9 to FC2/1 (FCC1)		S3/9 to FC3/1 (FCC1)		S4/9 to FC4/1 (FCC1)		S5/9 to FC5/1 (FCC1)	
S0/10 to FC0/2 (FCC1)		S1/10 to FC1/2 (FCC1)		S2/10 to FC2/2 (FCC1)		S3/10 to FC3/2 (FCC1)		S4/10 to FC4/2 (FCC1)		S5/10 to FC5/2 (FCC1)	
S0/11 to FC0/3 (FCC1)		S1/11 to FC1/3 (FCC1)		S2/11 to FC2/3 (FCC1)		S3/11 to FC3/3 (FCC1)		S4/11 to FC4/3 (FCC1)		S5/11 to FC5/3 (FCC1)	
S0/12 to FC0/4 (FCC1)		S1/12 to FC1/4 (FCC1)		S2/12 to FC2/4 (FCC1)		S3/12 to FC3/4 (FCC1)		S4/12 to FC4/4 (FCC1)		S5/12 to FC5/4 (FCC1)	
S0/13 to FC0/5 (FCC1)		S1/13 to FC1/5 (FCC1)		S2/13 to FC2/5 (FCC1)		S3/13 to FC3/5 (FCC1)		S4/13 to FC4/5 (FCC1)		S5/13 to FC5/5 (FCC1)	
S0/14 to FC0/5 (FCC1)		S1/14 to FC1/6 (FCC1)		S2/14 to FC2/6 (FCC1)		S3/14 to FC3/6 (FCC1)		S4/14 to FC4/6 (FCC1)		S5/14 to FC5/6 (FCC1)	
S0/15 to FC0/7 (FCC1)		S1/15 to FC1/7 (FCC1)		S2/15 to FC2/7 (FCC1)		S3/15 to FC3/7 (FCC1)		S4/15 to FC4/7 (FCC1)		S5/15 to FC5/7 (FCC1)	

Table 21: Cabling Plan for LCC1 in a 2+2 Multi-Chassis Configuration with 12 S2 Fabric Cards

Plane 0		Plane 1		Plane 2		Plane 3		Plane 4		Plane 5	
LCC1 (S13) slot/port	FCC (S2) slot/port/chassis	LCC1 (S13) slot/port	FCC (S2) slot/port/chassis	LCC1 (S13) slot/port	FCC (S2) slot/port/chassis	LCC1(S13) slot/port	FCC (S2) slot/port/chassis	LCC1 (S13) slot/port	FCC (S2) slot/port/chassis	LCC1 (S13) slot/port	FCC (S2) slot/port/chassis
S0/0 to FC0/8 (FCC0)		S1/0 to FC1/8 (FCC0)		S2/0 to FC2/8 (FCC0)		S3/0 to FC3/8 (FCC0)		S4/0 to FC4/8 (FCC0)		S5/0 to FC5/8 (FCC0)	
S0/1 to FC0/9 (FCC0)		S1/1 to FC1/9 (FCC0)		S2/1 to FC2/9 (FCC0)		S3/1 to FC3/9 (FCC0)		S4/1 to FC4/9 (FCC0)		S5/1 to FC5/9 (FCC0)	
S0/2 to FC0/10 (FCC0)		S1/2 to FC1/10 (FCC0)		S2/2 to FC2/10 (FCC0)		S3/2 to FC3/10 (FCC0)		S4/2 to FC4/10 (FCC0)		S5/2 to FC5/10 (FCC0)	
S0/3 to FC0/11 (FCC0)		S1/3 to FC1/11 (FCC0)		S2/3 to FC2/11 (FCC0)		S3/3 to FC3/11 (FCC0)		S4/3 to FC4/11 (FCC0)		S5/3 to FC5/11 (FCC0)	
S0/4 to FC0/12 (FCC0)		S1/4 to FC1/12 (FCC0)		S2/4 to FC2/12 (FCC0)		S3/4 to FC3/12 (FCC0)		S4/4 to FC4/12 (FCC0)		S5/4 to FC5/12 (FCC0)	
S0/5 to FC0/13 (FCC0)		S1/5 to FC1/13 (FCC0)		S2/5 to FC2/13 (FCC0)		S3/5 to FC3/13 (FCC0)		S4/5 to FC4/13 (FCC0)		S5/5 to FC5/13 (FCC0)	
S0/6 to FC0/14 (FCC0)		S1/6 to FC1/14 (FCC0)		S2/6 to FC2/14 (FCC0)		S3/6 to FC3/14 (FCC0)		S4/6 to FC4/14 (FCC0)		S5/6 to FC5/14 (FCC0)	
S0/7 to FC0/15 (FCC0)		S1/7 to FC1/15 (FCC0)		S2/7 to FC2/15 (FCC0)		S3/7 to FC3/15 (FCC0)		S4/7 to FC4/15 (FCC0)		S5/7 to FC5/15 (FCC0)	
S0/8 to FC0/8 (FCC1)		S1/8 to FC1/8 (FCC1)		S2/8 to FC2/8 (FCC1)		S3/8 to FC3/8 (FCC1)		S4/8 to FC4/8 (FCC1)		S5/8 to FC5/8 (FCC1)	
S0/9 to FC0/9 (FCC1)		S1/9 to FC1/9 (FCC1)		S2/9 to FC2/9 (FCC1)		S3/9 to FC3/9 (FCC1)		S4/9 to FC4/9 (FCC1)		S5/9 to FC5/9 (FCC1)	
S0/10 to FC0/10 (FCC1)		S1/10 to FC1/10 (FCC1)		S2/10 to FC2/10 (FCC1)		S3/10 to FC3/10 (FCC1)		S4/10 to FC4/10 (FCC1)		S5/10 to FC5/10 (FCC1)	
S0/11 to FC0/11 (FCC1)		S1/11 to FC1/11 (FCC1)		S2/11 to FC2/11 (FCC1)		S3/11 to FC3/11 (FCC1)		S4/11 to FC4/11 (FCC1)		S5/11 to FC5/11 (FCC1)	
S0/12 to FC0/12 (FCC1)		S1/12 to FC1/12 (FCC1)		S2/12 to FC2/12 (FCC1)		S3/12 to FC3/12 (FCC1)		S4/12 to FC4/12 (FCC1)		S5/12 to FC5/12 (FCC1)	
S0/13 to FC0/13 (FCC1)		S1/13 to FC1/13 (FCC1)		S2/13 to FC2/13 (FCC1)		S3/13 to FC3/13 (FCC1)		S4/13 to FC4/13 (FCC1)		S5/13 to FC5/13 (FCC1)	
S0/14 to FC0/14 (FCC1)		S1/14 to FC1/14 (FCC1)		S2/14 to FC2/14 (FCC1)		S3/14 to FC3/14 (FCC1)		S4/14 to FC4/14 (FCC1)		S5/14 to FC5/14 (FCC1)	
S0/15 to FC0/15 (FCC1)		S1/15 to FC1/15 (FCC1)		S2/15 to FC2/15 (FCC1)		S3/15 to FC3/15 (FCC1)		S4/15 to FC4/15 (FCC1)		S5/15 to FC5/15 (FCC1)	

2+2 Software Configuration (12 S2 Fabric Cards)

An explicit admin configuration is required to specify an ordered list of S2 connections assigned for a plane. Each S2 connection is specified as an instance. The instances are contiguous, starting from 0.

```
controller fabric plane 0
instance 0
location F0/FC0
instance 1
location F1/FC0

controller fabric plane 1
instance 0
location F0/FC1
instance 1
location F1/FC1

controller fabric plane 2
instance 0
location F0/FC2
instance 1
location F1/FC2

controller fabric plane 3
instance 0
location F0/FC3
instance 1
location F1/FC3

controller fabric plane 4
instance 0
location F0/FC4
instance 1
location F1/FC4

controller fabric plane 5
instance 0
location F0/FC5
instance 1
location F1/FC5
```

Configuring a 2+2 Configuration with 24 S2 Fabric Cards

The following figure shows four line card chassis (LCC0 and LCC1) connected to two fabric card chassis (FCC0 and FCC1). In this configuration, there are 12 FCs in each fabric card chassis; in total 24 FCs are installed. The figure shows the 2+2 connections for two fabric planes. To complete the configuration, you must repeat the cabling for the remaining four fabric planes until all 24 S2 cards are connected.

Figure 18: Cisco NCS 6000 Multi-Chassis 2+2 Configuration with 24 S2 FC's

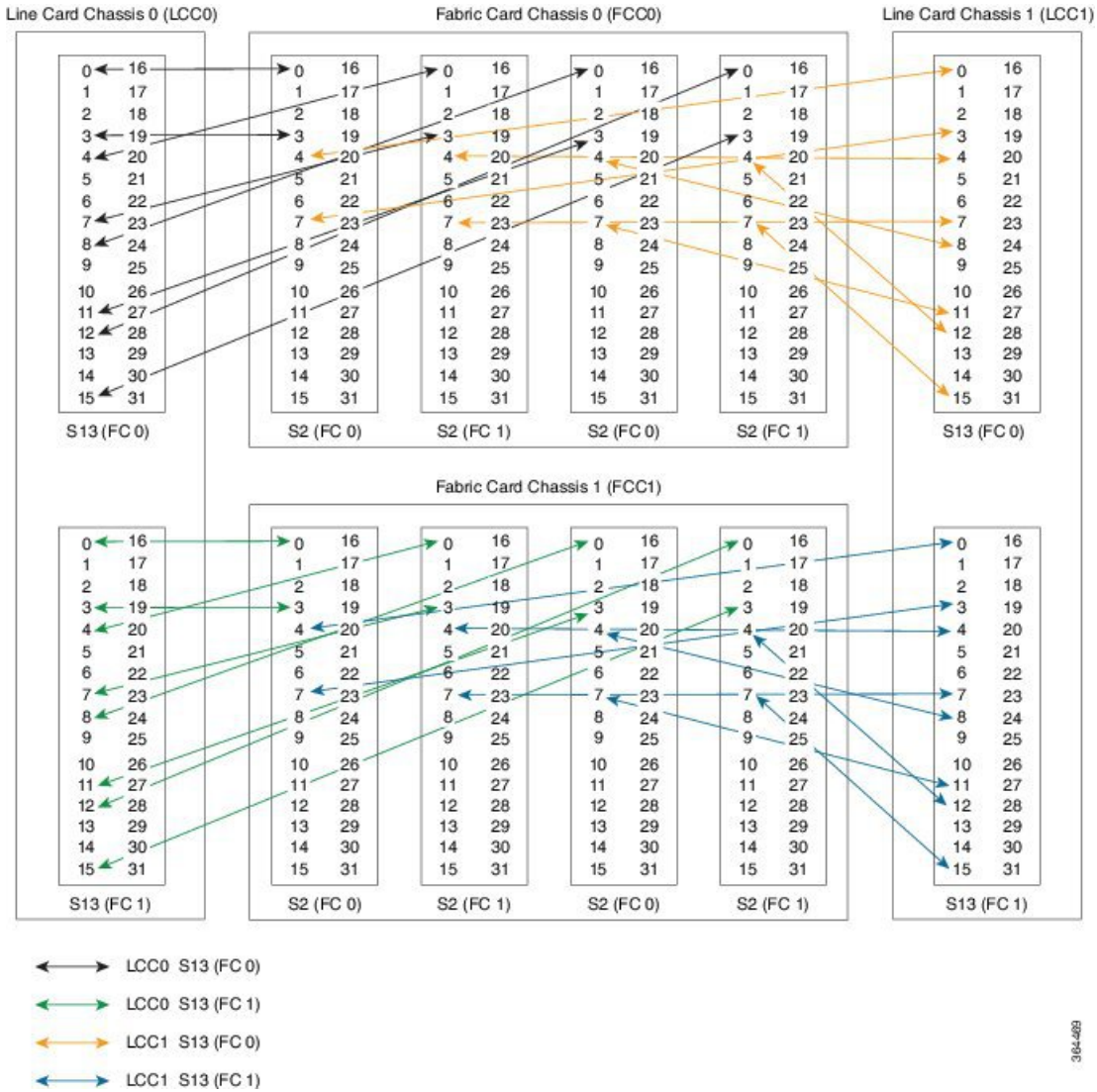

The following table shows the cabling plan for a 2+2 multi-chassis configuration with 24 SC FCs installed. The FCC0 has the fabric instances 0 through 5 for planes 0, 2, and 4. The FCC1 has the fabric instances 0 through 5 for planes 1, 3, and 5.

Table 22: Cabling Plan for LCC0 in a 2+2 Multi-Chassis Configuration with 24 S2 Fabric Cards

Plane 0		Plane 1		Plane 2		Plane 3		Plane 4		Plane 5	
LCC0 (S13) slot/port	FCC (S2) slot/port/chassis	LCC0 (S13) slot/port	FCC (S2) slot/port/chassis	LCC0 (S13) slot/port	FCC (S2) slot/port/chassis	LCC0 (S13) slot/port	FCC (S2) slot/port/chassis	LCC0 (S13) slot/port	FCC (S2) slot/port/chassis	LCC0 (S13) slot/port	FCC (S2) slot/port/chassis
S0/0 to FC0/0 (FCC0)		S1/0 to FC0/0 (FCC1)		S2/0 to FC4/0 (FCC0)		S3/0 to FC4/0 (FCC1)		S4/0 to FC8/0 (FCC0)		S5/0 to FC8/0 (FCC1)	

Plane 0		Plane 1		Plane 2		Plane 3		Plane 4		Plane 5	
LCC0 (S13) slot/port	FCC (S2) slot/port/chassis	LCC0 (S13) slot/port	FCC (S2) slot/port/chassis	LCC0 (S13) slot/port	FCC (S2) slot/port/chassis	LCC0 (S13) slot/port	FCC (S2) slot/port/chassis	LCC0 (S13) slot/port	FCC (S2) slot/port/chassis	LCC0 (S13) slot/port	FCC (S2) slot/port/chassis
S0/1 to FC0/1 (FCC0)		S1/1 to FC0/1 (FCC1)		S2/1 to FC4/1 (FCC0)		S3/1 to FC4/1 (FCC1)		S4/1 to FC8/1 (FCC0)		S5/1 to FC8/1 (FCC1)	
S0/2 to FC0/2 (FCC0)		S1/2 to FC0/2 (FCC1)		S2/2 to FC4/2 (FCC0)		S3/2 to FC4/2 (FCC1)		S4/2 to FC8/2 (FCC0)		S5/2 to FC8/2 (FCC1)	
S0/3 to FC0/3 (FCC0)		S1/3 to FC0/3 (FCC1)		S2/3 to FC4/3 (FCC0)		S3/3 to FC4/3 (FCC1)		S4/3 to FC8/3 (FCC0)		S5/3 to FC8/3 (FCC1)	
S0/4 to FC1/0 (FCC0)		S1/4 to FC1/0 (FCC1)		S2/4 to FC5/0 (FCC0)		S3/4 to FC5/0 (FCC1)		S4/4 to FC9/0 (FCC0)		S5/4 to FC9/0 (FCC1)	
S0/5 to FC1/1 (FCC0)		S1/5 to FC1/1 (FCC1)		S2/5 to FC5/1 (FCC0)		S3/5 to FC5/1 (FCC1)		S4/5 to FC9/1 (FCC0)		S5/5 to FC9/1 (FCC1)	
S0/6 to FC1/2 (FCC0)		S1/6 to FC1/2 (FCC1)		S2/6 to FC5/2 (FCC0)		S3/6 to FC5/2 (FCC1)		S4/6 to FC9/2 (FCC0)		S5/6 to FC9/2 (FCC1)	
S0/7 to FC1/3 (FCC0)		S1/7 to FC1/3 (FCC1)		S2/7 to FC5/3 (FCC0)		S3/7 to FC5/3 (FCC1)		S4/7 to FC9/3 (FCC0)		S5/7 to FC9/3 (FCC1)	
S0/8 to FC2/0 (FCC0)		S1/8 to FC2/0 (FCC1)		S2/8 to FC6/0 (FCC0)		S3/8 to FC6/0 (FCC1)		S4/8 to FC10/0 (FCC0)		S5/8 to FC10/0 (FCC1)	
S0/9 to FC2/1 (FCC0)		S1/9 to FC2/1 (FCC1)		S2/9 to FC6/1 (FCC0)		S3/9 to FC6/1 (FCC1)		S4/9 to FC10/1 (FCC0)		S5/9 to FC10/1 (FCC1)	
S0/10 to FC2/2 (FCC0)		S1/10 to FC2/2 (FCC1)		S2/10 to FC6/2 (FCC0)		S3/10 to FC6/2 (FCC1)		S4/10 to FC10/2 (FCC0)		S5/10 to FC10/2 (FCC1)	
S0/11 to FC2/3 (FCC0)		S1/11 to FC2/3 (FCC1)		S2/11 to FC6/3 (FCC0)		S3/11 to FC6/3 (FCC1)		S4/11 to FC10/3 (FCC0)		S5/11 to FC10/3 (FCC1)	
S0/12 to FC3/0 (FCC0)		S1/12 to FC3/0 (FCC1)		S2/12 to FC7/0 (FCC0)		S3/12 to FC7/0 (FCC1)		S4/12 to FC11/0 (FCC0)		S5/12 to FC11/0 (FCC1)	
S0/13 to FC3/1 (FCC0)		S1/13 to FC3/1 (FCC1)		S2/13 to FC7/1 (FCC0)		S3/13 to FC7/1 (FCC1)		S4/13 to FC11/1 (FCC0)		S5/13 to FC11/1 (FCC1)	
S0/14 to FC3/2 (FCC0)		S1/14 to FC3/2 (FCC1)		S2/14 to FC7/2 (FCC0)		S3/14 to FC7/2 (FCC1)		S4/14 to FC11/2 (FCC0)		S5/14 to FC11/2 (FCC1)	
S0/15 to FC3/3 (FCC0)		S1/15 to FC3/3 (FCC1)		S2/15 to FC7/3 (FCC0)		S3/15 to FC7/3 (FCC1)		S4/15 to FC11/3 (FCC0)		S5/15 to FC11/3 (FCC1)	

Table 23: Cabling Plan for LCC1 in a 2+2 Multi-Chassis Configuration with 24 S2 Fabric Cards

Plane 0		Plane 1		Plane 2		Plane 3		Plane 4		Plane 5	
LCC1 (S13) slot/port	FCC (S2) slot/port/chassis	LCC1 (S13) slot/port	FCC (S2) slot/port/chassis	LCC1 (S13) slot/port	FCC (S2) slot/port/chassis	LCC1(S13) slot/port	FCC (S2) slot/port/chassis	LCC1 (S13) slot/port	FCC (S2) slot/port/chassis	LCC1 (S13) slot/port	FCC (S2) slot/port/chassis
S0/0 to FC0/4 (FCC0)		S1/0 to FC0/4 (FCC1)		S2/0 to FC4/4 (FCC0)		S3/0 to FC4/4 (FCC1)		S4/0 to FC8/4 (FCC0)		S5/0 to FC8/4 (FCC1)	
S0/1 to FC0/5 (FCC0)		S1/1 to FC0/5 (FCC1)		S2/1 to FC4/5 (FCC0)		S3/1 to FC4/5 (FCC1)		S4/1 to FC8/5 (FCC0)		S5/1 to FC8/5 (FCC1)	
S0/2 to FC0/6 (FCC0)		S1/2 to FC0/6 (FCC1)		S2/2 to FC4/6 (FCC0)		S3/2 to FC4/6 (FCC1)		S4/2 to FC8/6 (FCC0)		S5/2 to FC8/6 (FCC1)	
S0/3 to FC0/7 (FCC0)		S1/3 to FC0/7 (FCC1)		S2/3 to FC4/7 (FCC0)		S3/3 to FC4/7 (FCC1)		S4/3 to FC8/7 (FCC0)		S5/3 to FC8/7 (FCC1)	
S0/4 to FC1/4 (FCC0)		S1/4 to FC1/4 (FCC1)		S2/4 to FC5/4 (FCC0)		S3/4 to FC5/4 (FCC1)		S4/4 to FC9/4 (FCC0)		S5/4 to FC9/4 (FCC1)	
S0/5 to FC1/5 (FCC0)		S1/5 to FC1/5 (FCC1)		S2/5 to FC5/5 (FCC0)		S3/5 to FC5/5 (FCC1)		S4/5 to FC9/5 (FCC0)		S5/5 to FC9/5 (FCC1)	
S0/6 to FC1/6 (FCC0)		S1/6 to FC1/6 (FCC1)		S2/6 to FC5/6 (FCC0)		S3/6 to FC5/6 (FCC1)		S4/6 to FC9/6 (FCC0)		S5/6 to FC9/6 (FCC1)	
S0/7 to FC1/7 (FCC0)		S1/7 to FC1/7 (FCC1)		S2/7 to FC5/7 (FCC0)		S3/7 to FC5/7 (FCC1)		S4/7 to FC9/7 (FCC0)		S5/7 to FC9/7 (FCC1)	
S0/8 to FC2/4 (FCC0)		S1/8 to FC2/4 (FCC1)		S2/8 to FC6/4 (FCC0)		S3/8 to FC6/4 (FCC1)		S4/8 to FC10/4 (FCC0)		S5/8 to FC10/4 (FCC1)	
S0/9 to FC2/5 (FCC0)		S1/9 to FC2/5 (FCC1)		S2/9 to FC6/5 (FCC0)		S3/9 to FC6/5 (FCC1)		S4/9 to FC10/5 (FCC0)		S5/9 to FC10/5 (FCC1)	
S0/10 to FC2/6 (FCC0)		S1/10 to FC2/6 (FCC1)		S2/10 to FC6/6 (FCC0)		S3/10 to FC6/6 (FCC1)		S4/10 to FC10/6 (FCC0)		S5/10 to FC10/6 (FCC1)	
S0/11 to FC2/7 (FCC0)		S1/11 to FC2/7 (FCC1)		S2/11 to FC6/7 (FCC0)		S3/11 to FC6/7 (FCC1)		S4/11 to FC10/7 (FCC0)		S5/11 to FC10/7 (FCC1)	
S0/12 to FC3/4 (FCC0)		S1/12 to FC3/4 (FCC1)		S2/12 to FC7/4 (FCC0)		S3/12 to FC7/4 (FCC1)		S4/12 to FC11/4 (FCC0)		S5/12 to FC11/4 (FCC1)	
S0/13 to FC3/5 (FCC0)		S1/13 to FC3/5 (FCC1)		S2/13 to FC7/5 (FCC0)		S3/13 to FC7/5 (FCC1)		S4/13 to FC11/5 (FCC0)		S5/13 to FC11/5 (FCC1)	
S0/14 to FC3/6 (FCC0)		S1/14 to FC3/6 (FCC1)		S2/14 to FC7/6 (FCC0)		S3/14 to FC7/6 (FCC1)		S4/14 to FC11/6 (FCC0)		S5/14 to FC11/6 (FCC1)	
S0/15 to FC3/7 (FCC0)		S1/15 to FC3/7 (FCC1)		S2/15 to FC7/7 (FCC0)		S3/15 to FC7/7 (FCC1)		S4/15 to FC11/7 (FCC0)		S5/15 to FC11/7 (FCC1)	

2+2 Software Configuration (24 S2 Fabric Cards)

An explicit admin configuration is required to specify an ordered list of S2 connections assigned for a plane. Each S2 connection is specified as an instance. The instances are contiguous, starting from 0.

```
controller fabric plane 0
instance 0
location F0/FC0
instance 1
location F0/FC1
instance 2
location F0/FC2
instance 3
location F0/FC3
```

```
controller fabric plane 1
instance 0
location F1/FC0
instance 1
location F1/FC1
instance 2
location F1/FC2
instance 3
location F1/FC3
```

```
controller fabric plane 2
instance 0
location F0/FC4
instance 1
location F0/FC5
instance 2
location F0/FC6
instance 3
location F0/FC7
```

```
controller fabric plane 3
instance 0
location F1/FC4
instance 1
location F1/FC5
instance 2
location F1/FC6
instance 3
location F1/FC7
```

```
controller fabric plane 4
instance 0
location F0/FC8
instance 1
location F0/FC9
instance 2
location F0/FC10
instance 3
location F0/FC11
```

```
controller fabric plane 5
instance 0
location F1/FC8
instance 1
location F1/FC9
instance 2
location F1/FC10
```

```
instance 3
location F1/FC11
```

Multi-Chassis 4+2 Configuration

This section describes how to configure a multi-chassis 4+2 configuration. In this configuration, four line card chassis (LCC0, LCC1, LCC2, and LCC3) are connected to two fabric card chassis (FCC0 and FCC1).

Prerequisites

For connecting the fabric, you need the following:

- 384 MPO-24 fiber cables (96 per LCC)
- Optical module sets:
 - **In 1T multi-chassis 4+2 mode:** Eight CXP optical module sets (Cisco PID NCS-FAB-OPT). Two sets are required per LCC: one set plugs into the LCC and the other set plugs into the FCC. Each set includes 96 CXP-100G-SR12 modules for a total of 768 modules.
 - **In 2T multi-chassis 4+2 mode:** Eight CXP2 optical module sets (Cisco PID NCS-FAB-OPT2). Two sets are required per LCC: one set plugs into the LCC and the other set plugs into the FCC. Each set includes 96 ONS-CXP2-SR25 modules for a total of 768 modules.

Configuring a 4+2 Configuration with 12 S2 Fabric Cards

The following figure shows four line card chassis (LCC0, LCC1, LCC2, and LCC3) connected to two fabric card chassis (FCC0 and FCC1). In this configuration, there are 6 FCs in each fabric card chassis; in total 12 FCs are installed. The figure shows the 4+2 connections for two fabric plane. To complete the configuration, you must repeat the cabling for the remaining four fabric planes until all 12 S2 cards are connected.

Figure 19: Cisco NCS 6000 Multi-Chassis 4+2 Configuration with 12 S2 FC's

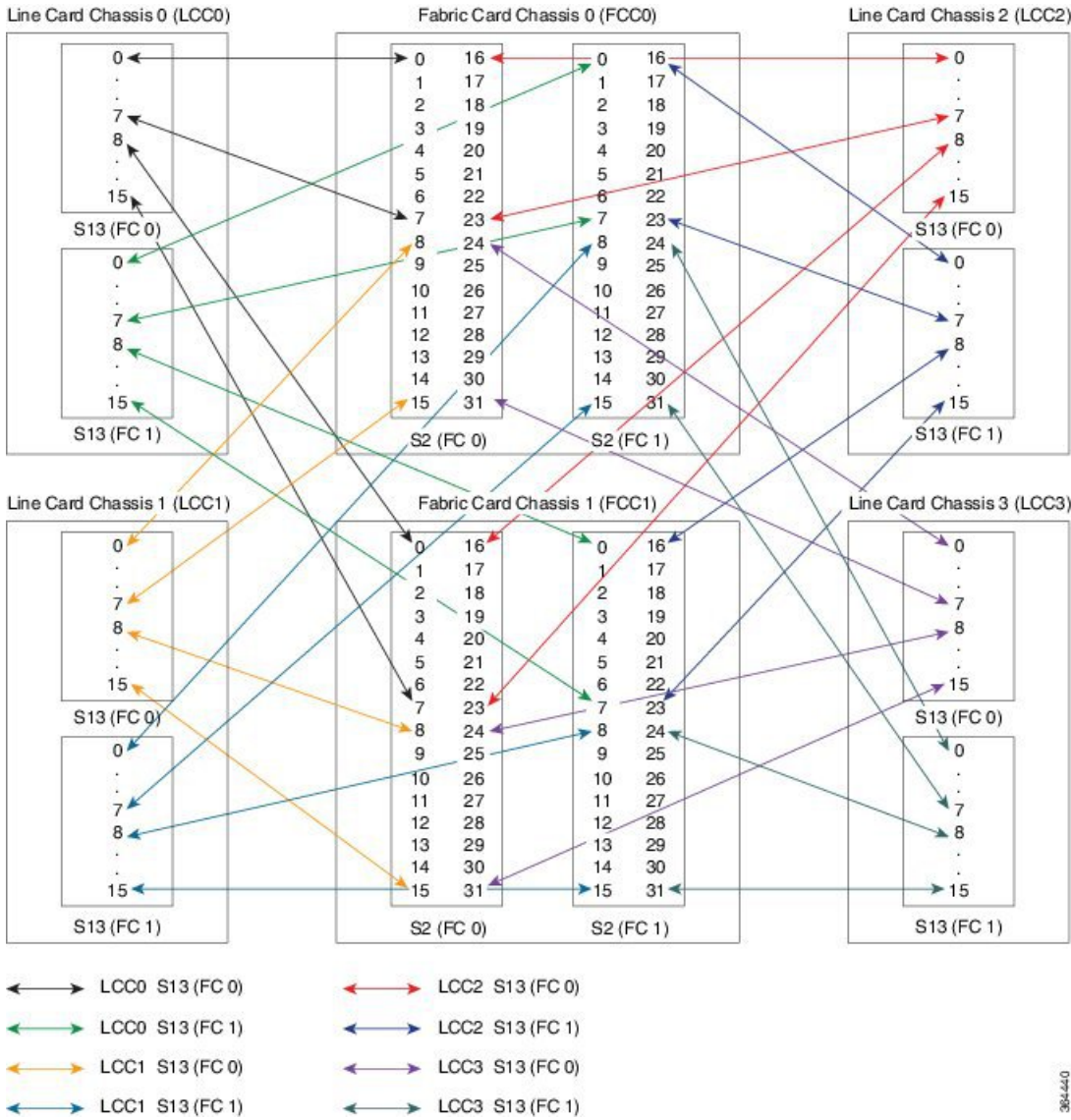

The following tables show the cabling plan for a 4+2 multi-chassis configuration with 12 SC FCs installed. FCC0 has a fabric instance 0 for planes 0 through 5 in FCC0 (6 SC FCs in slots 0 through 5), and fabric instance 1 in FCC1 (also in slots 0 through 5). Other mappings are possible (for example, you can put both instances of planes 0 through 2 in FCC0, and planes 3 through 5 in FCC1 but the following table and software configuration assume that instance 0 is in FCC0 and instance 1 is in FCC1).

Table 24: Cabling Plan for LCC0 in a 4+2 Multi-Chassis Configuration with 12 S2 Fabric Cards

Plane 0		Plane 1		Plane 2		Plane 3		Plane 4		Plane 5	
LCC0 (S13) slot/port	FCC (S2) slot/port/chassis	LCC0 (S13) slot/port	FCC (S2) slot/port/chassis	LCC0 (S13) slot/port	FCC (S2) slot/port/chassis	LCC0 (S13) slot/port	FCC (S2) slot/port/chassis	LCC0 (S13) slot/port	FCC (S2) slot/port/chassis	LCC0 (S13) slot/port	FCC (S2) slot/port/chassis
S0/0 to FC0/0 (FCC0)		S1/0 to FC1/0 (FCC0)		S2/0 to FC2/0 (FCC0)		S3/0 to FC3/0 (FCC0)		S4/0 to FC4/0 (FCC0)		S5/0 to FC5/0 (FCC0)	
S0/1 to FC0/1 (FCC0)		S1/1 to FC1/1 (FCC0)		S2/1 to FC2/1 (FCC0)		S3/1 to FC3/1 (FCC0)		S4/1 to FC4/1 (FCC0)		S5/1 to FC5/1 (FCC0)	
S0/2 to FC0/2 (FCC0)		S1/2 to FC1/2 (FCC0)		S2/2 to FC2/2 (FCC0)		S3/2 to FC3/2 (FCC0)		S4/2 to FC4/2 (FCC0)		S5/2 to FC5/2 (FCC0)	
S0/3 to FC0/3 (FCC0)		S1/3 to FC1/3 (FCC0)		S2/3 to FC2/3 (FCC0)		S3/3 to FC3/3 (FCC0)		S4/3 to FC4/3 (FCC0)		S5/3 to FC5/3 (FCC0)	
S0/4 to FC0/4 (FCC0)		S1/4 to FC1/4 (FCC0)		S2/4 to FC2/4 (FCC0)		S3/4 to FC3/4 (FCC0)		S4/4 to FC4/4 (FCC0)		S5/4 to FC5/4 (FCC0)	
S0/5 to FC0/5 (FCC0)		S1/5 to FC1/5 (FCC0)		S2/5 to FC2/5 (FCC0)		S3/5 to FC3/5 (FCC0)		S4/5 to FC4/5 (FCC0)		S5/5 to FC5/5 (FCC0)	
S0/6 to FC0/6 (FCC0)		S1/6 to FC1/6 (FCC0)		S2/6 to FC2/6 (FCC0)		S3/6 to FC3/6 (FCC0)		S4/6 to FC4/6 (FCC0)		S5/6 to FC5/6 (FCC0)	
S0/7 to FC0/7 (FCC0)		S1/7 to FC1/7 (FCC0)		S2/7 to FC2/7 (FCC0)		S3/7 to FC3/7 (FCC0)		S4/7 to FC4/7 (FCC0)		S5/7 to FC5/7 (FCC0)	
S0/8 to FC0/0 (FCC1)		S1/8 to FC1/0 (FCC1)		S2/8 to FC2/0 (FCC1)		S3/8 to FC3/0 (FCC1)		S4/8 to FC4/0 (FCC1)		S5/8 to FC5/0 (FCC1)	
S0/9 to FC0/2 (FCC1)		S1/9 to FC1/1 (FCC1)		S2/9 to FC2/1 (FCC1)		S3/9 to FC3/1 (FCC1)		S4/9 to FC4/1 (FCC1)		S5/9 to FC5/1 (FCC1)	
S0/10 to FC0/2 (FCC1)		S1/10 to FC1/2 (FCC1)		S2/10 to FC2/2 (FCC1)		S3/10 to FC3/2 (FCC1)		S4/10 to FC4/2 (FCC1)		S5/10 to FC5/2 (FCC1)	
S0/11 to FC0/3 (FCC1)		S1/11 to FC1/3 (FCC1)		S2/11 to FC2/3 (FCC1)		S3/11 to FC3/3 (FCC1)		S4/11 to FC4/3 (FCC1)		S5/11 to FC5/3 (FCC1)	
S0/12 to FC0/4 (FCC1)		S1/12 to FC1/4 (FCC1)		S2/12 to FC2/4 (FCC1)		S3/12 to FC3/4 (FCC1)		S4/12 to FC4/4 (FCC1)		S5/12 to FC5/4 (FCC1)	
S0/13 to FC0/5 (FCC1)		S1/13 to FC1/5 (FCC1)		S2/13 to FC2/5 (FCC1)		S3/13 to FC3/5 (FCC1)		S4/13 to FC4/5 (FCC1)		S5/13 to FC5/5 (FCC1)	
S0/14 to FC0/5 (FCC1)		S1/14 to FC1/6 (FCC1)		S2/14 to FC2/6 (FCC1)		S3/14 to FC3/6 (FCC1)		S4/14 to FC4/6 (FCC1)		S5/14 to FC5/6 (FCC1)	
S0/15 to FC0/7 (FCC1)		S1/15 to FC1/7 (FCC1)		S2/15 to FC2/7 (FCC1)		S3/15 to FC3/7 (FCC1)		S4/15 to FC4/7 (FCC1)		S5/15 to FC5/7 (FCC1)	

Table 25: Cabling Plan for LCC1 in a 4+2 Multi-Chassis Configuration with 12 S2 Fabric Cards

Plane 0		Plane 1		Plane 2		Plane 3		Plane 4		Plane 5	
LCC1 (S13) slot/port	FCC (S2) slot/port/chassis	LCC1 (S13) slot/port	FCC (S2) slot/port/chassis	LCC1 (S13) slot/port	FCC (S2) slot/port/chassis	LCC1(S13) slot/port	FCC (S2) slot/port/chassis	LCC1 (S13) slot/port	FCC (S2) slot/port/chassis	LCC1 (S13) slot/port	FCC (S2) slot/port/chassis
S0/0 to FC0/8 (FCC0)		S1/0 to FC1/8 (FCC0)		S2/0 to FC2/8 (FCC0)		S3/0 to FC3/8 (FCC0)		S4/0 to FC4/8 (FCC0)		S5/0 to FC5/8 (FCC0)	
S0/1 to FC0/9 (FCC0)		S1/1 to FC1/9 (FCC0)		S2/1 to FC2/9 (FCC0)		S3/1 to FC3/9 (FCC0)		S4/1 to FC4/9 (FCC0)		S5/1 to FC5/9 (FCC0)	
S0/2 to FC0/10 (FCC0)		S1/2 to FC1/10 (FCC0)		S2/2 to FC2/10 (FCC0)		S3/2 to FC3/10 (FCC0)		S4/2 to FC4/10 (FCC0)		S5/2 to FC5/10 (FCC0)	
S0/3 to FC0/11 (FCC0)		S1/3 to FC1/11 (FCC0)		S2/3 to FC2/11 (FCC0)		S3/3 to FC3/11 (FCC0)		S4/3 to FC4/11 (FCC0)		S5/3 to FC5/11 (FCC0)	
S0/4 to FC0/12 (FCC0)		S1/4 to FC1/12 (FCC0)		S2/4 to FC2/12 (FCC0)		S3/4 to FC3/12 (FCC0)		S4/4 to FC4/12 (FCC0)		S5/4 to FC5/12 (FCC0)	
S0/5 to FC0/13 (FCC0)		S1/5 to FC1/13 (FCC0)		S2/5 to FC2/13 (FCC0)		S3/5 to FC3/13 (FCC0)		S4/5 to FC4/13 (FCC0)		S5/5 to FC5/13 (FCC0)	
S0/6 to FC0/14 (FCC0)		S1/6 to FC1/14 (FCC0)		S2/6 to FC2/14 (FCC0)		S3/6 to FC3/14 (FCC0)		S4/6 to FC4/14 (FCC0)		S5/6 to FC5/14 (FCC0)	
S0/7 to FC0/15 (FCC0)		S1/7 to FC1/15 (FCC0)		S2/7 to FC2/15 (FCC0)		S3/7 to FC3/15 (FCC0)		S4/7 to FC4/15 (FCC0)		S5/7 to FC5/15 (FCC0)	
S0/8 to FC0/8 (FCC1)		S1/8 to FC1/8 (FCC1)		S2/8 to FC2/8 (FCC1)		S3/8 to FC3/8 (FCC1)		S4/8 to FC4/8 (FCC1)		S5/8 to FC5/8 (FCC1)	
S0/9 to FC0/9 (FCC1)		S1/9 to FC1/9 (FCC1)		S2/9 to FC2/9(FCC1)		S3/9 to FC3/9 (FCC1)		S4/9 to FC4/9 (FCC1)		S5/9 to FC5/9 (FCC1)	
S0/10 to FC0/10 (FCC1)		S1/10 to FC1/10 (FCC1)		S2/10 to FC2/10 (FCC1)		S3/10 to FC3/10 (FCC1)		S4/10 to FC4/10 (FCC1)		S5/10 to FC5/10 (FCC1)	
S0/11 to FC0/11 (FCC1)		S1/11 to FC1/11 (FCC1)		S2/11 to FC2/11 (FCC1)		S3/11 to FC3/11 (FCC1)		S4/11 to FC4/11 (FCC1)		S5/11 to FC5/11 (FCC1)	
S0/12 to FC0/12 (FCC1)		S1/12 to FC1/12(FCC1)		S2/12 to FC2/12 (FCC1)		S3/12 to FC3/12 (FCC1)		S4/12 to FC4/12 (FCC1)		S5/12 to FC5/12 (FCC1)	
S0/13 to FC0/13 (FCC1)		S1/13 to FC1/13 (FCC1)		S2/13 to FC2/13 (FCC1)		S3/13 to FC3/13 (FCC1)		S4/13 to FC4/13 (FCC1)		S5/13 to FC5/13 (FCC1)	
S0/14 to FC0/14 (FCC1)		S1/14 to FC1/14 (FCC1)		S2/14 to FC2/14 (FCC1)		S3/14 to FC3/14 (FCC1)		S4/14 to FC4/14 (FCC1)		S5/14 to FC5/14 (FCC1)	
S0/15 to FC0/15 (FCC1)		S1/15 to FC1/15 (FCC1)		S2/15 to FC2/15 (FCC1)		S3/15 to FC3/15 (FCC1)		S4/15 to FC4/15 (FCC1)		S5/15 to FC5/15 (FCC1)	

Table 26: Cabling Plan for LCC2 in a 4+2 Multi-Chassis Configuration with 12 S2 Fabric Cards

Plane 0		Plane 1		Plane 2		Plane 3		Plane 4		Plane 5	
LCC2 (S13) slot/port	FCC (S2) slot/port/chassis	LCC2 (S13) slot/port	FCC (S2) slot/port/chassis	LCC2 (S13) slot/port	FCC (S2) slot/port/chassis	LCC2 (S13) slot/port	FCC (S2) slot/port/chassis	LCC2 (S13) slot/port	FCC (S2) slot/port/chassis	LCC2 (S13) slot/port	FCC (S2) slot/port/chassis
S0/0 to FC0/16 (FCC0)		S1/0 to FC1/16 (FCC0)		S2/0 to FC2/16 (FCC0)		S3/0 to FC3/16 (FCC0)		S4/0 to FC4/16 (FCC0)		S5/0 to FC5/16 (FCC0)	
S0/1 to FC0/17 (FCC0)		S1/1 to FC1/17 (FCC0)		S2/1 to FC2/17 (FCC0)		S3/1 to FC3/17 (FCC0)		S4/1 to FC4/17 (FCC0)		S5/1 to FC5/17 (FCC0)	
S0/2 to FC0/18 (FCC0)		S1/2 to FC1/18 (FCC0)		S2/2 to FC2/18 (FCC0)		S3/2 to FC3/18 (FCC0)		S4/2 to FC4/18 (FCC0)		S5/2 to FC5/18 (FCC0)	
S0/3 to FC0/19 (FCC0)		S1/3 to FC1/19 (FCC0)		S2/3 to FC2/19 (FCC0)		S3/3 to FC3/19 (FCC0)		S4/3 to FC4/19 (FCC0)		S5/3 to FC5/19 (FCC0)	
S0/4 to FC0/20 (FCC0)		S1/4 to FC1/20 (FCC0)		S2/4 to FC2/20 (FCC0)		S3/4 to FC3/20 (FCC0)		S4/4 to FC4/20 (FCC0)		S5/4 to FC5/20 (FCC0)	
S0/5 to FC0/21 (FCC0)		S1/5 to FC1/21 (FCC0)		S2/5 to FC2/21 (FCC0)		S3/5 to FC3/21 (FCC0)		S4/5 to FC4/21 (FCC0)		S5/5 to FC5/21 (FCC0)	
S0/6 to FC0/22 (FCC0)		S1/6 to FC1/22 (FCC0)		S2/6 to FC2/22 (FCC0)		S3/6 to FC3/22 (FCC0)		S4/6 to FC4/22 (FCC0)		S5/6 to FC5/22 (FCC0)	
S0/7 to FC0/23 (FCC0)		S1/7 to FC1/23 (FCC0)		S2/7 to FC2/23 (FCC0)		S3/7 to FC3/23 (FCC0)		S4/7 to FC4/23 (FCC0)		S5/7 to FC5/23 (FCC0)	
S0/8 to FC0/16 (FCC1)		S1/8 to FC1/16 (FCC1)		S2/8 to FC2/16 (FCC1)		S3/8 to FC3/16 (FCC1)		S4/8 to FC4/16 (FCC1)		S5/8 to FC5/16 (FCC1)	
S0/9 to FC0/17 (FCC1)		S1/9 to FC1/17 (FCC1)		S2/9 to FC2/17 (FCC1)		S3/9 to FC3/17 (FCC1)		S4/9 to FC4/17 (FCC1)		S5/9 to FC5/17 (FCC1)	
S0/10 to FC0/18 (FCC1)		S1/10 to FC1/18 (FCC1)		S2/10 to FC2/18 (FCC1)		S3/10 to FC3/18 (FCC1)		S4/10 to FC4/18 (FCC1)		S5/10 to FC5/18 (FCC1)	
S0/11 to FC0/19 (FCC1)		S1/11 to FC1/19 (FCC1)		S2/11 to FC2/19 (FCC1)		S3/11 to FC3/19 (FCC1)		S4/11 to FC4/19 (FCC1)		S5/11 to FC5/19 (FCC1)	
S0/12 to FC0/20 (FCC1)		S1/12 to FC1/20 (FCC1)		S2/12 to FC2/20 (FCC1)		S3/12 to FC3/20 (FCC1)		S4/12 to FC4/20 (FCC1)		S5/12 to FC5/20 (FCC1)	
S0/13 to FC0/21 (FCC1)		S1/13 to FC1/21 (FCC1)		S2/13 to FC2/21 (FCC1)		S3/13 to FC3/21 (FCC1)		S4/13 to FC4/21 (FCC1)		S5/13 to FC5/21 (FCC1)	
S0/14 to FC0/22 (FCC1)		S1/14 to FC1/22 (FCC1)		S2/14 to FC2/22 (FCC1)		S3/14 to FC3/22 (FCC1)		S4/14 to FC4/22 (FCC1)		S5/14 to FC5/22 (FCC1)	
S0/15 to FC0/23 (FCC1)		S1/15 to FC1/23 (FCC1)		S2/15 to FC2/23 (FCC1)		S3/15 to FC3/23 (FCC1)		S4/15 to FC4/23 (FCC1)		S5/15 to FC5/23 (FCC1)	

Table 27: Cabling Plan for LCC3 in a 4+2 Multi-Chassis Configuration with 12 S2 Fabric Cards

Plane 0		Plane 1		Plane 2		Plane 3		Plane 4		Plane 5	
LCC3 (S13) slot/port	FCC (S2) slot/port/chassis	LCC3 (S13) slot/port	FCC (S2) slot/port/chassis	LCC3 (S13) slot/port	FCC (S2) slot/port/chassis	LCC3(S13) slot/port	FCC (S2) slot/port/chassis	LCC3 (S13) slot/port	FCC (S2) slot/port/chassis	LCC3 (S13) slot/port	FCC (S2) slot/port/chassis
S0/0 to FC0/24 (FCC0)		S1/0 to FC1/24 (FCC0)		S2/0 to FC2/24 (FCC0)		S3/0 to FC3/24 (FCC0)		S4/0 to FC4/24 (FCC0)		S5/0 to FC5/24 (FCC0)	
S0/1 to FC0/25 (FCC0)		S1/1 to FC1/25 (FCC0)		S2/1 to FC2/25 (FCC0)		S3/1 to FC3/25 (FCC0)		S4/1 to FC4/25 (FCC0)		S5/1 to FC5/25 (FCC0)	
S0/2 to FC0/26 (FCC0)		S1/2 to FC1/26 (FCC0)		S2/2 to FC2/26 (FCC0)		S3/2 to FC3/26 (FCC0)		S4/2 to FC4/26 (FCC0)		S5/2 to FC5/26 (FCC0)	
S0/3 to FC0/27 (FCC0)		S1/3 to FC1/27 (FCC0)		S2/3 to FC2/27 (FCC0)		S3/3 to FC3/27 (FCC0)		S4/3 to FC4/27 (FCC0)		S5/3 to FC5/27 (FCC0)	
S0/4 to FC0/28 (FCC0)		S1/4 to FC1/28 (FCC0)		S2/4 to FC2/28 (FCC0)		S3/4 to FC3/28 (FCC0)		S4/4 to FC4/28 (FCC0)		S5/4 to FC5/28 (FCC0)	
S0/5 to FC0/29 (FCC0)		S1/5 to FC1/29 (FCC0)		S2/5 to FC2/29 (FCC0)		S3/5 to FC3/29 (FCC0)		S4/5 to FC4/29 (FCC0)		S5/5 to FC5/29 (FCC0)	
S0/6 to FC0/30 (FCC0)		S1/6 to FC1/30 (FCC0)		S2/6 to FC2/30 (FCC0)		S3/6 to FC3/30 (FCC0)		S4/6 to FC4/30 (FCC0)		S5/6 to FC5/30 (FCC0)	
S0/7 to FC0/31 (FCC0)		S1/7 to FC1/31 (FCC0)		S2/7 to FC2/31 (FCC0)		S3/7 to FC3/31 (FCC0)		S4/7 to FC4/31 (FCC0)		S5/7 to FC5/31 (FCC0)	
S0/8 to FC0/24 (FCC1)		S1/8 to FC1/24 (FCC1)		S2/8 to FC2/24 (FCC1)		S3/8 to FC3/24 (FCC1)		S4/8 to FC4/24 (FCC1)		S5/8 to FC5/24 (FCC1)	
S0/9 to FC0/25 (FCC1)		S1/9 to FC1/25 (FCC1)		S2/9 to FC2/25 (FCC1)		S3/9 to FC3/25 (FCC1)		S4/9 to FC4/25 (FCC1)		S5/9 to FC5/25 (FCC1)	
S0/10 to FC0/26 (FCC1)		S1/10 to FC1/26 (FCC1)		S2/10 to FC2/26 (FCC1)		S3/10 to FC3/26 (FCC1)		S4/10 to FC4/26 (FCC1)		S5/10 to FC5/26 (FCC1)	
S0/11 to FC0/27 (FCC1)		S1/11 to FC1/27 (FCC1)		S2/11 to FC2/27 (FCC1)		S3/11 to FC3/27 (FCC1)		S4/11 to FC4/27 (FCC1)		S5/11 to FC5/27 (FCC1)	
S0/12 to FC0/28 (FCC1)		S1/12 to FC1/28 (FCC1)		S2/12 to FC2/28 (FCC1)		S3/12 to FC3/28 (FCC1)		S4/12 to FC4/28 (FCC1)		S5/12 to FC5/28 (FCC1)	
S0/13 to FC0/29 (FCC1)		S1/13 to FC1/29 (FCC1)		S2/13 to FC2/29 (FCC1)		S3/13 to FC3/29 (FCC1)		S4/13 to FC4/29 (FCC1)		S5/13 to FC5/29 (FCC1)	
S0/14 to FC0/30 (FCC1)		S1/14 to FC1/30 (FCC1)		S2/14 to FC2/30 (FCC1)		S3/14 to FC3/30 (FCC1)		S4/14 to FC4/30 (FCC1)		S5/14 to FC5/30 (FCC1)	
S0/15 to FC0/31 (FCC1)		S1/15 to FC1/31 (FCC1)		S2/15 to FC2/31 (FCC1)		S3/15 to FC3/31 (FCC1)		S4/15 to FC4/31 (FCC1)		S5/15 to FC5/31 (FCC1)	

4+2 Software Configuration (12 S2 Fabric Cards)

An explicit admin configuration is required to specify an ordered list of S2 connections assigned for a plane. Each S2 connection is specified as an instance. The instances are contiguous, starting from 0.

```
controller fabric plane 0
instance 0
location F0/FC0
instance 1
location F1/FC0

controller fabric plane 1
instance 0
location F0/FC1
instance 1
location F1/FC1

controller fabric plane 2
instance 0
location F0/FC2
instance 1
location F1/FC2

controller fabric plane 3
instance 0
location F0/FC3
instance 1
location F1/FC3

controller fabric plane 4
instance 0
location F0/FC4
instance 1
location F1/FC4

controller fabric plane 5
instance 0
location F0/FC5
instance 1
location F1/FC5
```

Configuring a 4+2 Configuration with 24 S2 Fabric Cards

The following figure shows four line card chassis (LCC0, LCC1, LCC2, and LCC3) connected to two fabric card chassis (FCC0 and FCC1). In this configuration, there are 12 FCs in each fabric card chassis; in total 24 FCs are installed. The figure shows the 4+2 connections for one fabric plane. To complete the configuration, you must repeat the cabling for the remaining five fabric planes until all 24 S2 cards are connected.

Figure 20: Cisco NCS 6000 Multi-Chassis 4+2 Configuration with 24 S2 FC's

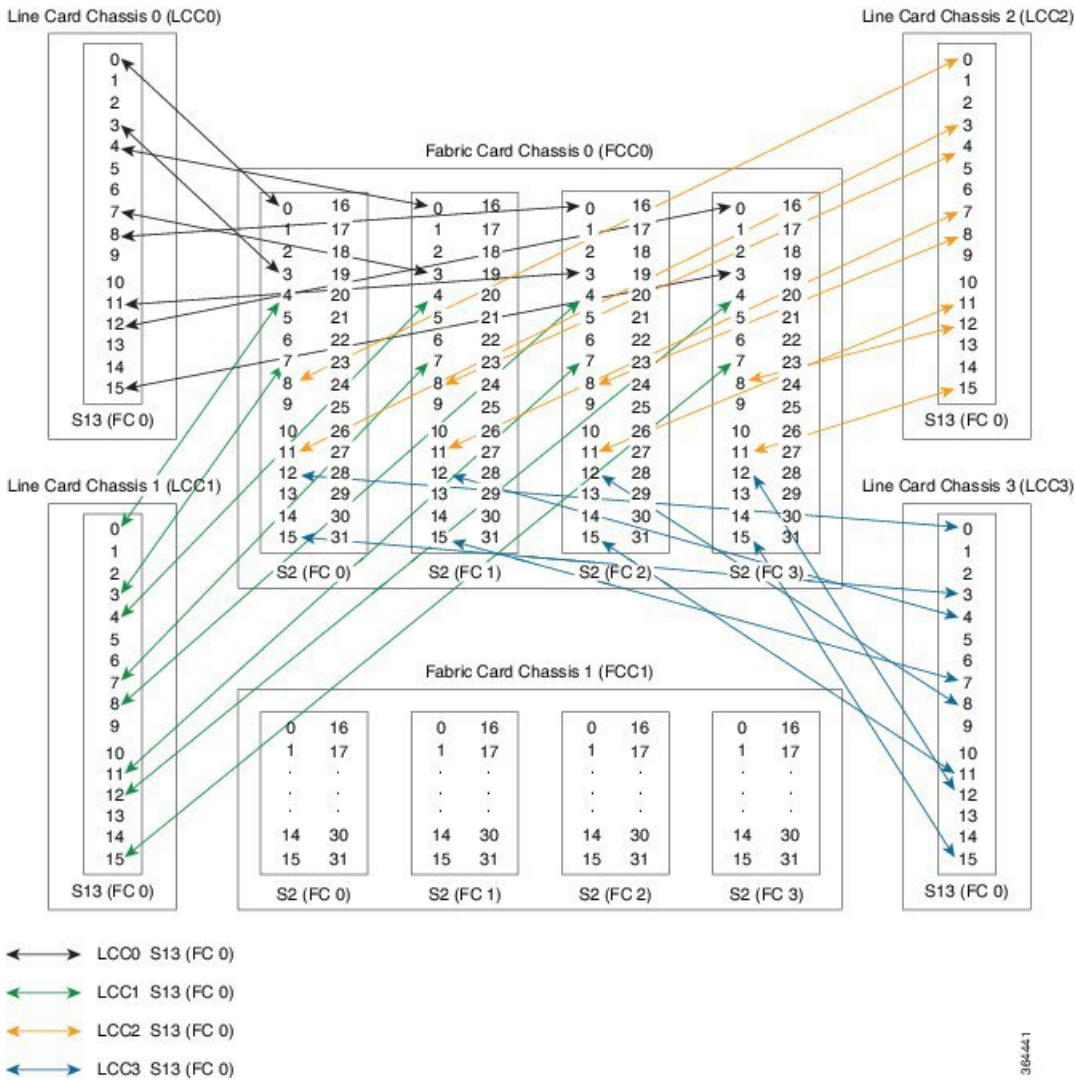

The following tables show the cabling plan for a 4+2 multi-chassis configuration with 24 SC FCs installed. The FCC0 has the fabric instances 0 through 5 for planes 0, 2, and 4. The FCC1 has the fabric instances 0 through 5 for planes 1, 3, and 5.

Table 28: Cabling Plan for LCC0 in a 4+2 Multi-Chassis Configuration with 24 S2 Fabric Cards

Plane 0		Plane 1		Plane 2		Plane 3		Plane 4		Plane 5	
LCC0 (S13) slot/port	FCC (S2) slot/port/chassis	LCC0 (S13) slot/port	FCC (S2) slot/port/chassis	LCC0 (S13) slot/port	FCC (S2) slot/port/chassis	LCC0 (S13) slot/port	FCC (S2) slot/port/chassis	LCC0 (S13) slot/port	FCC (S2) slot/port/chassis	LCC0 (S13) slot/port	FCC (S2) slot/port/chassis
S0/0 to FC0/0 (FCC0)		S1/0 to FC0/0 (FCC1)		S2/0 to FC4/0 (FCC0)		S3/0 to FC4/0 (FCC1)		S4/0 to FC8/0 (FCC0)		S5/0 to FC8/0 (FCC1)	

Plane 0		Plane 1		Plane 2		Plane 3		Plane 4		Plane 5	
LCC0 (S13) slot/port	FCC (S2) slot/port/chassis	LCC0 (S13) slot/port	FCC (S2) slot/port/chassis	LCC0 (S13) slot/port	FCC (S2) slot/port/chassis	LCC0 (S13) slot/port	FCC (S2) slot/port/chassis	LCC0 (S13) slot/port	FCC (S2) slot/port/chassis	LCC0 (S13) slot/port	FCC (S2) slot/port/chassis
S0/1 to FC0/1 (FCC0)		S1/1 to FC0/1 (FCC1)		S2/1 to FC4/1 (FCC0)		S3/1 to FC4/1 (FCC1)		S4/1 to FC8/1 (FCC0)		S5/1 to FC8/1 (FCC1)	
S0/2 to FC0/2 (FCC0)		S1/2 to FC0/2 (FCC1)		S2/2 to FC4/2 (FCC0)		S3/2 to FC4/2 (FCC1)		S4/2 to FC8/2 (FCC0)		S5/2 to FC8/2 (FCC1)	
S0/3 to FC0/3 (FCC0)		S1/3 to FC0/3 (FCC1)		S2/3 to FC4/3 (FCC0)		S3/3 to FC4/3 (FCC1)		S4/3 to FC8/3 (FCC0)		S5/3 to FC8/3 (FCC1)	
S0/4 to FC1/0 (FCC0)		S1/4 to FC1/0 (FCC1)		S2/4 to FC5/0 (FCC0)		S3/4 to FC5/0 (FCC1)		S4/4 to FC9/0 (FCC0)		S5/4 to FC9/0 (FCC1)	
S0/5 to FC1/1 (FCC0)		S1/5 to FC1/1 (FCC1)		S2/5 to FC5/1 (FCC0)		S3/5 to FC5/1 (FCC1)		S4/5 to FC9/1 (FCC0)		S5/5 to FC9/1 (FCC1)	
S0/6 to FC1/2 (FCC0)		S1/6 to FC1/2 (FCC1)		S2/6 to FC5/2 (FCC0)		S3/6 to FC5/2 (FCC1)		S4/6 to FC9/2 (FCC0)		S5/6 to FC9/2 (FCC1)	
S0/7 to FC1/3(FCC0)		S1/7 to FC1/3 (FCC1)		S2/7 to FC5/3(FCC0)		S3/7 to FC5/3(FCC1)		S4/7 to FC9/3(FCC0)		S5/7 to FC9/3(FCC1)	
S0/8 to FC2/0 (FCC0)		S1/8 to FC2/0 (FCC1)		S2/8 to FC6/0 (FCC0)		S3/8 to FC6/0 (FCC1)		S4/8 to FC10/0 (FCC0)		S5/8 to FC10/0 (FCC1)	
S0/9 to FC2/1 (FCC0)		S1/9 to FC2/1 (FCC1)		S2/9 to FC6/1 (FCC0)		S3/9 to FC6/1 (FCC1)		S4/9 to FC10/1 (FCC0)		S5/9 to FC10/1 (FCC1)	
S0/10 to FC2/2 (FCC0)		S1/10 to FC2/2 (FCC1)		S2/10 to FC6/2 (FCC0)		S3/10 to FC6/2 (FCC1)		S4/10 to FC10/2 (FCC0)		S5/10 to FC10/2 (FCC1)	
S0/11 to FC2/3 (FCC0)		S1/11 to FC2/3 (FCC1)		S2/11 to FC6/3 (FCC0)		S3/11 to FC6/3 (FCC1)		S4/11 to FC10/3 (FCC0)		S5/11 to FC10/3 (FCC1)	
S0/12 to FC3/0 (FCC0)		S1/12 to FC3/0 (FCC1)		S2/12 to FC7/0 (FCC0)		S3/12 to FC7/0 (FCC1)		S4/12 to FC11/0 (FCC0)		S5/12 to FC11/0 (FCC1)	
S0/13 to FC3/1 (FCC0)		S1/13 to FC3/1 (FCC1)		S2/13 to FC7/1 (FCC0)		S3/13 to FC7/1 (FCC1)		S4/13 to FC11/1 (FCC0)		S5/13 to FC11/1 (FCC1)	
S0/14 to FC3/2 (FCC0)		S1/14 to FC3/2 (FCC1)		S2/14 to FC7/2 (FCC0)		S3/14 to FC7/2 (FCC1)		S4/14 to FC11/2 (FCC0)		S5/14 to FC11/2 (FCC1)	
S0/15 to FC3/3 (FCC0)		S1/15 to FC3/3 (FCC1)		S2/15 to FC7/3 (FCC0)		S3/15 to FC7/3 (FCC1)		S4/15 to FC11/3 (FCC0)		S5/15 to FC11/3 (FCC1)	

Table 29: Cabling Plan for LCC1 in a 4+2 Multi-Chassis Configuration with 24 S2 Fabric Cards

Plane 0		Plane 1		Plane 2		Plane 3		Plane 4		Plane 5	
LCC1 (S13) slot/port	FCC (S2) slot/port/chassis	LCC1 (S13) slot/port	FCC (S2) slot/port/chassis	LCC1 (S13) slot/port	FCC (S2) slot/port/chassis	LCC1(S13) slot/port	FCC (S2) slot/port/chassis	LCC1 (S13) slot/port	FCC (S2) slot/port/chassis	LCC1 (S13) slot/port	FCC (S2) slot/port/chassis
S0/0 to FC0/4 (FCC0)		S1/0 to FC0/4 (FCC1)		S2/0 to FC4/4 (FCC0)		S3/0 to FC4/4 (FCC1)		S4/0 to FC8/4 (FCC0)		S5/0 to FC8/4 (FCC1)	
S0/1 to FC0/5 (FCC0)		S1/1 to FC0/5 (FCC1)		S2/1 to FC4/5 (FCC0)		S3/1 to FC4/5 (FCC1)		S4/1 to FC8/5 (FCC0)		S5/1 to FC8/5 (FCC1)	
S0/2 to FC0/6 (FCC0)		S1/2 to FC0/6 (FCC1)		S2/2 to FC4/6 (FCC0)		S3/2 to FC4/6 (FCC1)		S4/2 to FC8/6 (FCC0)		S5/2 to FC8/6 (FCC1)	
S0/3 to FC0/7 (FCC0)		S1/3 to FC0/7 (FCC1)		S2/3 to FC4/7 (FCC0)		S3/3 to FC4/7 (FCC1)		S4/3 to FC8/7 (FCC0)		S5/3 to FC8/7 (FCC1)	
S0/4 to FC1/4 (FCC0)		S1/4 to FC1/4 (FCC1)		S2/4 to FC5/4 (FCC0)		S3/4 to FC5/4 (FCC1)		S4/4 to FC9/4 (FCC0)		S5/4 to FC9/4 (FCC1)	
S0/5 to FC1/5 (FCC0)		S1/5 to FC1/5 (FCC1)		S2/5 to FC5/5 (FCC0)		S3/5 to FC5/5 (FCC1)		S4/5 to FC9/5 (FCC0)		S5/5 to FC9/5 (FCC1)	
S0/6 to FC1/6 (FCC0)		S1/6 to FC1/6 (FCC1)		S2/6 to FC5/6 (FCC0)		S3/6 to FC5/6 (FCC1)		S4/6 to FC9/6 (FCC0)		S5/6 to FC9/6 (FCC1)	
S0/7 to FC1/7 (FCC0)		S1/7 to FC1/7 (FCC1)		S2/7 to FC5/7 (FCC0)		S3/7 to FC5/7 (FCC1)		S4/7 to FC9/7 (FCC0)		S5/7 to FC9/7 (FCC1)	
S0/8 to FC2/4 (FCC0)		S1/8 to FC2/4 (FCC1)		S2/8 to FC6/4 (FCC0)		S3/8 to FC6/4 (FCC1)		S4/8 to FC10/4 (FCC0)		S5/8 to FC10/4 (FCC1)	
S0/9 to FC2/5 (FCC0)		S1/9 to FC2/5 (FCC1)		S2/9 to FC6/5 (FCC0)		S3/9 to FC6/5 (FCC1)		S4/9 to FC10/5 (FCC0)		S5/9 to FC10/5 (FCC1)	
S0/10 to FC2/6 (FCC0)		S1/10 to FC2/6 (FCC1)		S2/10 to FC6/6 (FCC0)		S3/10 to FC6/6 (FCC1)		S4/10 to FC10/6 (FCC0)		S5/10 to FC10/6 (FCC1)	
S0/11 to FC2/7 (FCC0)		S1/11 to FC2/7 (FCC1)		S2/11 to FC6/7 (FCC0)		S3/11 to FC6/7 (FCC1)		S4/11 to FC10/7 (FCC0)		S5/11 to FC10/7 (FCC1)	
S0/12 to FC3/4 (FCC0)		S1/12 to FC3/4 (FCC1)		S2/12 to FC7/4 (FCC0)		S3/12 to FC7/4 (FCC1)		S4/12 to FC11/4 (FCC0)		S5/12 to FC11/4 (FCC1)	
S0/13 to FC3/5 (FCC0)		S1/13 to FC3/5 (FCC1)		S2/13 to FC7/5 (FCC0)		S3/13 to FC7/5 (FCC1)		S4/13 to FC11/5 (FCC0)		S5/13 to FC11/5 (FCC1)	
S0/14 to FC3/6 (FCC0)		S1/14 to FC3/6 (FCC1)		S2/14 to FC7/6 (FCC0)		S3/14 to FC7/6 (FCC1)		S4/14 to FC11/6 (FCC0)		S5/14 to FC11/6 (FCC1)	
S0/15 to FC3/7 (FCC0)		S1/15 to FC3/7 (FCC1)		S2/15 to FC7/7 (FCC0)		S3/15 to FC7/7 (FCC1)		S4/15 to FC11/7 (FCC0)		S5/15 to FC11/7 (FCC1)	

Table 30: Cabling Plan for LCC2 in a 4+2 Multi-Chassis Configuration with 24 S2 Fabric Cards

Plane 0		Plane 1		Plane 2		Plane 3		Plane 4		Plane 5	
LCC2 (S13) slot/port	FCC (S2) slot/port/chassis	LCC2 (S13) slot/port	FCC (S2) slot/port/chassis	LCC2 (S13) slot/port	FCC (S2) slot/port/chassis	LCC2 (S13) slot/port	FCC (S2) slot/port/chassis	LCC2 (S13) slot/port	FCC (S2) slot/port/chassis	LCC2 (S13) slot/port	FCC (S2) slot/port/chassis
S0/0 to FC0/8 (FCC0)		S1/0 to FC0/8 (FCC1)		S2/0 to FC4/8 (FCC0)		S3/0 to FC4/8 (FCC1)		S4/0 to FC8/8 (FCC0)		S5/0 to FC8/8 (FCC1)	
S0/1 to FC0/9 (FCC0)		S1/1 to FC0/9 (FCC1)		S2/1 to FC4/9 (FCC0)		S3/1 to FC4/9 (FCC1)		S4/1 to FC8/9 (FCC0)		S5/1 to FC8/9 (FCC1)	
S0/2 to FC0/10 (FCC0)		S1/2 to FC0/10 (FCC1)		S2/2 to FC4/10 (FCC0)		S3/2 to FC4/10 (FCC1)		S4/2 to FC8/10 (FCC0)		S5/2 to FC8/10 (FCC1)	
S0/3 to FC0/11 (FCC0)		S1/3 to FC0/11 (FCC1)		S2/3 to FC4/11 (FCC0)		S3/3 to FC4/11 (FCC1)		S4/3 to FC8/11 (FCC0)		S5/3 to FC8/11 (FCC1)	
S0/4 to FC1/8 (FCC0)		S1/4 to FC1/8 (FCC1)		S2/4 to FC5/8 (FCC0)		S3/4 to FC5/8 (FCC1)		S4/4 to FC9/8 (FCC0)		S5/4 to FC9/8 (FCC1)	
S0/5 to FC1/9 (FCC0)		S1/5 to FC1/9 (FCC1)		S2/5 to FC5/9 (FCC0)		S3/5 to FC5/9 (FCC1)		S4/5 to FC9/9 (FCC0)		S5/5 to FC9/9 (FCC1)	
S0/6 to FC1/10 (FCC0)		S1/6 to FC1/10 (FCC1)		S2/6 to FC5/10 (FCC0)		S3/6 to FC5/10 (FCC1)		S4/6 to FC9/10 (FCC0)		S5/6 to FC9/10 (FCC1)	
S0/7 to FC1/11 (FCC0)		S1/7 to FC1/11 (FCC1)		S2/7 to FC5/11 (FCC0)		S3/7 to FC5/11 (FCC1)		S4/7 to FC9/11 (FCC0)		S5/7 to FC9/11 (FCC1)	
S0/8 to FC2/8 (FCC0)		S1/8 to FC2/8 (FCC1)		S2/8 to FC6/8 (FCC0)		S3/8 to FC6/8 (FCC1)		S4/8 to FC10/8 (FCC0)		S5/8 to FC10/8 (FCC1)	
S0/9 to FC2/9 (FCC0)		S1/9 to FC2/9 (FCC1)		S2/9 to FC6/9 (FCC0)		S3/9 to FC6/9 (FCC1)		S4/9 to FC10/9 (FCC0)		S5/9 to FC10/9 (FCC1)	
S0/10 to FC2/10 (FCC0)		S1/10 to FC2/10 (FCC1)		S2/10 to FC6/10 (FCC0)		S3/10 to FC6/10 (FCC1)		S4/10 to FC10/10 (FCC0)		S5/10 to FC10/10 (FCC1)	
S0/11 to FC2/11 (FCC0)		S1/11 to FC2/11 (FCC1)		S2/11 to FC6/11 (FCC0)		S3/11 to FC6/11 (FCC1)		S4/11 to FC10/11 (FCC0)		S5/11 to FC10/11 (FCC1)	
S0/12 to FC3/8 (FCC0)		S1/12 to FC3/8 (FCC1)		S2/12 to FC7/8 (FCC0)		S3/12 to FC7/8 (FCC1)		S4/12 to FC11/8 (FCC0)		S5/12 to FC11/8 (FCC1)	
S0/13 to FC3/9 (FCC0)		S1/13 to FC3/9 (FCC1)		S2/13 to FC7/9 (FCC0)		S3/13 to FC7/9 (FCC1)		S4/13 to FC11/9 (FCC0)		S5/13 to FC11/9 (FCC1)	
S0/14 to FC3/10 (FCC0)		S1/14 to FC3/10 (FCC1)		S2/14 to FC7/10 (FCC0)		S3/14 to FC7/10 (FCC1)		S4/14 to FC11/10 (FCC0)		S5/14 to FC11/10 (FCC1)	
S0/15 to FC3/11 (FCC0)		S1/15 to FC3/11 (FCC1)		S2/15 to FC7/11 (FCC0)		S3/15 to FC7/11 (FCC1)		S4/15 to FC11/11 (FCC0)		S5/15 to FC11/11 (FCC1)	

Table 31: Cabling Plan for LCC3 in a 4+2 Multi-Chassis Configuration with 24 S2 Fabric Cards

Plane 0		Plane 1		Plane 2		Plane 3		Plane 4		Plane 5	
LCC3 (S13) slot/port	FCC (S2) slot/port/chassis	LCC3 (S13) slot/port	FCC (S2) slot/port/chassis	LCC3 (S13) slot/port	FCC (S2) slot/port/chassis	LCC3(S13) slot/port	FCC (S2) slot/port/chassis	LCC3 (S13) slot/port	FCC (S2) slot/port/chassis	LCC3 (S13) slot/port	FCC (S2) slot/port/chassis
S0/0 to FC0/12 (FCC0)		S1/0 to FC0/12 (FCC1)		S2/0 to FC4/12 (FCC0)		S3/0 to FC4/12 (FCC1)		S4/0 to FC8/12 (FCC0)		S5/0 to FC8/12 (FCC1)	
S0/1 to FC0/13 (FCC0)		S1/1 to FC0/13 (FCC1)		S2/1 to FC4/13 (FCC0)		S3/1 to FC4/13 (FCC1)		S4/1 to FC8/13 (FCC0)		S5/1 to FC8/13 (FCC1)	
S0/2 to FC0/14 (FCC0)		S1/2 to FC0/14 (FCC1)		S2/2 to FC4/14 (FCC0)		S3/2 to FC4/14 (FCC1)		S4/2 to FC8/14 (FCC0)		S5/2 to FC8/14 (FCC1)	
S0/3 to FC0/15 (FCC0)		S1/3 to FC0/15 (FCC1)		S2/3 to FC4/15 (FCC0)		S3/3 to FC4/15 (FCC1)		S4/3 to FC8/15 (FCC0)		S5/3 to FC8/15 (FCC1)	
S0/4 to FC1/12 (FCC0)		S1/4 to FC1/12 (FCC1)		S2/4 to FC5/12 (FCC0)		S3/4 to FC5/12 (FCC1)		S4/4 to FC9/12 (FCC0)		S5/4 to FC9/12 (FCC1)	
S0/5 to FC1/13 (FCC0)		S1/5 to FC1/13 (FCC1)		S2/5 to FC5/13 (FCC0)		S3/5 to FC5/13 (FCC1)		S4/5 to FC9/13 (FCC0)		S5/5 to FC9/13 (FCC1)	
S0/6 to FC1/14 (FCC0)		S1/6 to FC1/14 (FCC1)		S2/6 to FC5/14 (FCC0)		S3/6 to FC5/14 (FCC1)		S4/6 to FC9/14 (FCC0)		S5/6 to FC9/14 (FCC1)	
S0/7 to FC1/15 (FCC0)		S1/7 to FC1/15 (FCC1)		S2/7 to FC5/15 (FCC0)		S3/7 to FC5/15 (FCC1)		S4/7 to FC9/15 (FCC0)		S5/7 to FC9/15 (FCC1)	
S0/8 to FC2/12 (FCC0)		S1/8 to FC2/12 (FCC1)		S2/8 to FC6/12 (FCC0)		S3/8 to FC6/12 (FCC1)		S4/8 to FC10/12 (FCC0)		S5/8 to FC10/12 (FCC1)	
S0/9 to FC2/13 (FCC0)		S1/9 to FC2/13 (FCC1)		S2/9 to FC6/13 (FCC0)		S3/9 to FC6/13 (FCC1)		S4/9 to FC10/13 (FCC0)		S5/9 to FC10/13 (FCC1)	
S0/10 to FC2/14 (FCC0)		S1/10 to FC2/14 (FCC1)		S2/10 to FC6/14 (FCC0)		S3/10 to FC6/14 (FCC1)		S4/10 to FC10/14 (FCC0)		S5/10 to FC10/14 (FCC1)	
S0/11 to FC2/15 (FCC0)		S1/11 to FC2/15 (FCC1)		S2/11 to FC6/15 (FCC0)		S3/11 to FC6/15 (FCC1)		S4/11 to FC10/15 (FCC0)		S5/11 to FC10/15 (FCC1)	
S0/12 to FC3/12 (FCC0)		S1/12 to FC3/12 (FCC1)		S2/12 to FC7/12 (FCC0)		S3/12 to FC7/12 (FCC1)		S4/12 to FC11/12 (FCC0)		S5/12 to FC11/12 (FCC1)	
S0/13 to FC3/13 (FCC0)		S1/13 to FC3/13 (FCC1)		S2/13 to FC7/13 (FCC0)		S3/13 to FC7/13 (FCC1)		S4/13 to FC11/13 (FCC0)		S5/13 to FC11/13 (FCC1)	
S0/14 to FC3/14 (FCC0)		S1/14 to FC3/14 (FCC1)		S2/14 to FC7/14 (FCC0)		S3/14 to FC7/14 (FCC1)		S4/14 to FC11/14 (FCC0)		S5/14 to FC11/14 (FCC1)	
S0/15 to FC3/15 (FCC0)		S1/15 to FC3/15 (FCC1)		S2/15 to FC7/15 (FCC0)		S3/15 to FC7/15 (FCC1)		S4/15 to FC11/15 (FCC0)		S5/15 to FC11/15 (FCC1)	

4+2 Software Configuration (24 S2 Fabric Cards)

An explicit admin configuration is required to specify an ordered list of S2 connections assigned for a plane. Each S2 connection is specified as an instance. The instances are contiguous, starting from 0.

```
controller fabric plane 0
instance 0
location F0/FC0
instance 1
location F0/FC1
instance 2
location F0/FC2
instance 3
location F0/FC3

controller fabric plane 1
instance 0
location F1/FC0
instance 1
location F1/FC1
instance 2
location F1/FC2
instance 3
location F1/FC3

controller fabric plane 2
instance 0
location F0/FC4
instance 1
location F0/FC5
instance 2
location F0/FC6
instance 3
location F0/FC7

controller fabric plane 3
instance 0
location F1/FC4
instance 1
location F1/FC5
instance 2
location F1/FC6
instance 3
location F1/FC7

controller fabric plane 4
instance 0
location F0/FC8
instance 1
location F0/FC9
instance 2
location F0/FC10
instance 3
location F0/FC11

controller fabric plane 5
instance 0
location F1/FC8
instance 1
location F1/FC9
instance 2
location F1/FC10
```

```
instance 3
location F1/FC11
```

Multi-Chassis 8+2 Configuration

This section describes how to configure a multi-chassis 8+2 configuration. In this configuration, eight line card chassis (LCC0, LCC1, LCC2, LCC3, LCC4, LCC5, LCC6, and LCC7) are connected to two fabric card chassis (FCC0 and FCC1).

Prerequisites

For connecting the fabric, you need the following:

- 768 MPO-24 fiber cables per system
- Optical module sets:
 - **In 1T multi-chassis 8+2 mode:** Eight CXP optical module sets (Cisco PID NCS-FAB-OPT). Two sets are required per LCC: one set plugs into the LCC and the other set plugs into the FCC. Each set includes 96 CXP-100G-SR12 modules for a total of 1536 modules.
 - **In 2T multi-chassis 8+2 mode:** Eight CXP2 optical module sets (Cisco PID NCS-FAB-OPT2). Two sets are required per LCC: one set plugs into the LCC and the other set plugs into the FCC. Each set includes 96 ONS-CXP2-SR25 modules for a total of 1536 modules.



Note If a 1T LCC is preferred, then ONS-100G-SR12 module can be used for that particular LCC.

Configuring a 8+2 Configuration with 24 S2 Fabric Cards

In this configuration, there are 12 FCs in each fabric card chassis; in total 24 FCs are installed.

To complete the configuration, you must repeat the cabling for the remaining five fabric planes until all 24 S2 cards are connected.

The following tables show the cabling plan for a 8+2 multi-chassis configuration with 24 SC FCs installed. The FCC0 has the fabric instances 0 through 5 for planes 0, 2, and 4. The FCC1 has the fabric instances 0 through 5 for planes 1, 3, and 5.

Table 32: Cabling Plan for LCC0 in a 8+2 Multi-Chassis Configuration with 24 S2 Fabric Cards

Plane 0		Plane 1		Plane 2		Plane 3		Plane 4		Plane 5	
LCC0 (S13) slot/port	FCC (S2) slot/port/chassis	LCC0 (S13) slot/port	FCC (S2) slot/port/chassis	LCC0 (S13) slot/port	FCC (S2) slot/port/chassis	LCC0 (S13) slot/port	FCC (S2) slot/port/chassis	LCC0 (S13) slot/port	FCC (S2) slot/port/chassis	LCC0 (S13) slot/port	FCC (S2) slot/port/chassis
S0/0 to FC0/0 (FCC0)		S1/0 to FC0/0 (FCC1)		S2/0 to FC4/0 (FCC0)		S3/0 to FC4/0 (FCC1)		S4/0 to FC8/0 (FCC0)		S5/0 to FC8/0 (FCC1)	
S0/1 to FC0/1 (FCC0)		S1/1 to FC0/1 (FCC1)		S2/1 to FC4/1 (FCC0)		S3/1 to FC4/1 (FCC1)		S4/1 to FC8/1 (FCC0)		S5/1 to FC8/1 (FCC1)	

Plane 0		Plane 1		Plane 2		Plane 3		Plane 4		Plane 5	
LCC0 (S13) slot/port	FCC (S2) slot/port/chassis	LCC0 (S13) slot/port	FCC (S2) slot/port/chassis	LCC0 (S13) slot/port	FCC (S2) slot/port/chassis	LCC0 (S13) slot/port	FCC (S2) slot/port/chassis	LCC0 (S13) slot/port	FCC (S2) slot/port/chassis	LCC0 (S13) slot/port	FCC (S2) slot/port/chassis
S0/2 to FC0/2 (FCC0)		S1/2 to FC0/2 (FCC1)		S2/2 to FC4/2 (FCC0)		S3/2 to FC4/2 (FCC1)		S4/2 to FC8/2 (FCC0)		S5/2 to FC8/2 (FCC1)	
S0/3 to FC0/3 (FCC0)		S1/3 to FC0/3 (FCC1)		S2/3 to FC4/3 (FCC0)		S3/3 to FC4/3 (FCC1)		S4/3 to FC8/3 (FCC0)		S5/3 to FC8/3 (FCC1)	
S0/4 to FC1/0 (FCC0)		S1/4 to FC1/0 (FCC1)		S2/4 to FC5/0 (FCC0)		S3/4 to FC5/0 (FCC1)		S4/4 to FC9/0 (FCC0)		S5/4 to FC9/0 (FCC1)	
S0/5 to FC1/1 (FCC0)		S1/5 to FC1/1 (FCC1)		S2/5 to FC5/1 (FCC0)		S3/5 to FC5/1 (FCC1)		S4/5 to FC9/1 (FCC0)		S5/5 to FC9/1 (FCC1)	
S0/6 to FC1/2 (FCC0)		S1/6 to FC1/2 (FCC1)		S2/6 to FC5/2 (FCC0)		S3/6 to FC5/2 (FCC1)		S4/6 to FC9/2 (FCC0)		S5/6 to FC9/2 (FCC1)	
S0/7 to FC1/3(FCC0)		S1/7 to FC1/3 (FCC1)		S2/7 to FC5/3(FCC0)		S3/7 to FC5/3(FCC1)		S4/7 to FC9/3(FCC0)		S5/7 to FC9/3(FCC1)	
S0/8 to FC2/0 (FCC0)		S1/8 to FC2/0 (FCC1)		S2/8 to FC6/0 (FCC0)		S3/8 to FC6/0 (FCC1)		S4/8 to FC10/0 (FCC0)		S5/8 to FC10/0 (FCC1)	
S0/9 to FC2/1 (FCC0)		S1/9 to FC2/1 (FCC1)		S2/9 to FC6/1 (FCC0)		S3/9 to FC6/1 (FCC1)		S4/9 to FC10/1 (FCC0)		S5/9 to FC10/1 (FCC1)	
S0/10 to FC2/2 (FCC0)		S1/10 to FC2/2 (FCC1)		S2/10 to FC6/2 (FCC0)		S3/10 to FC6/2 (FCC1)		S4/10 to FC10/2 (FCC0)		S5/10 to FC10/2 (FCC1)	
S0/11 to FC2/3 (FCC0)		S1/11 to FC2/3 (FCC1)		S2/11 to FC6/3 (FCC0)		S3/11 to FC6/3 (FCC1)		S4/11 to FC10/3 (FCC0)		S5/11 to FC10/3 (FCC1)	
S0/12 to FC3/0 (FCC0)		S1/12 to FC3/0 (FCC1)		S2/12 to FC7/0 (FCC0)		S3/12 to FC7/0 (FCC1)		S4/12 to FC11/0 (FCC0)		S5/12 to FC11/0 (FCC1)	
S0/13 to FC3/1 (FCC0)		S1/13 to FC3/1 (FCC1)		S2/13 to FC7/1 (FCC0)		S3/13 to FC7/1 (FCC1)		S4/13 to FC11/1 (FCC0)		S5/13 to FC11/1 (FCC1)	
S0/14 to FC3/2 (FCC0)		S1/14 to FC3/2 (FCC1)		S2/14 to FC7/2 (FCC0)		S3/14 to FC7/2 (FCC1)		S4/14 to FC11/2 (FCC0)		S5/14 to FC11/2 (FCC1)	
S0/15 to FC3/3 (FCC0)		S1/15 to FC3/3 (FCC1)		S2/15 to FC7/3 (FCC0)		S3/15 to FC7/3 (FCC1)		S4/15 to FC11/3 (FCC0)		S5/15 to FC11/3 (FCC1)	

Table 33: Cabling Plan for LCC1 in a 8+2 Multi-Chassis Configuration with 24 S2 Fabric Cards

Plane 0		Plane 1		Plane 2		Plane 3		Plane 4		Plane 5	
LCC1 (S13) slot/port	FCC (S2) slot/port/chassis	LCC1 (S13) slot/port	FCC (S2) slot/port/chassis	LCC1 (S13) slot/port	FCC (S2) slot/port/chassis	LCC1(S13) slot/port	FCC (S2) slot/port/chassis	LCC1 (S13) slot/port	FCC (S2) slot/port/chassis	LCC1 (S13) slot/port	FCC (S2) slot/port/chassis
S0/0 to FC0/4 (FCC0)		S1/0 to FC0/4 (FCC1)		S2/0 to FC4/4 (FCC0)		S3/0 to FC4/4 (FCC1)		S4/0 to FC8/4 (FCC0)		S5/0 to FC8/4 (FCC1)	
S0/1 to FC0/5 (FCC0)		S1/1 to FC0/5 (FCC1)		S2/1 to FC4/5 (FCC0)		S3/1 to FC4/5 (FCC1)		S4/1 to FC8/5 (FCC0)		S5/1 to FC8/5 (FCC1)	
S0/2 to FC0/6 (FCC0)		S1/2 to FC0/6 (FCC1)		S2/2 to FC4/6 (FCC0)		S3/2 to FC4/6 (FCC1)		S4/2 to FC8/6 (FCC0)		S5/2 to FC8/6 (FCC1)	
S0/3 to FC0/7 (FCC0)		S1/3 to FC0/7 (FCC1)		S2/3 to FC4/7 (FCC0)		S3/3 to FC4/7 (FCC1)		S4/3 to FC8/7 (FCC0)		S5/3 to FC8/7 (FCC1)	
S0/4 to FC1/4 (FCC0)		S1/4 to FC1/4 (FCC1)		S2/4 to FC5/4 (FCC0)		S3/4 to FC5/4 (FCC1)		S4/4 to FC9/4 (FCC0)		S5/4 to FC9/4 (FCC1)	
S0/5 to FC1/5 (FCC0)		S1/5 to FC1/5 (FCC1)		S2/5 to FC5/5 (FCC0)		S3/5 to FC5/5 (FCC1)		S4/5 to FC9/5 (FCC0)		S5/5 to FC9/5 (FCC1)	
S0/6 to FC1/6 (FCC0)		S1/6 to FC1/6 (FCC1)		S2/6 to FC5/6 (FCC0)		S3/6 to FC5/6 (FCC1)		S4/6 to FC9/6 (FCC0)		S5/6 to FC9/6 (FCC1)	
S0/7 to FC1/7 (FCC0)		S1/7 to FC1/7 (FCC1)		S2/7 to FC5/7 (FCC0)		S3/7 to FC5/7 (FCC1)		S4/7 to FC9/7 (FCC0)		S5/7 to FC9/7 (FCC1)	
S0/8 to FC2/4 (FCC0)		S1/8 to FC2/4 (FCC1)		S2/8 to FC6/4 (FCC0)		S3/8 to FC6/4 (FCC1)		S4/8 to FC10/4 (FCC0)		S5/8 to FC10/4 (FCC1)	
S0/9 to FC2/5 (FCC0)		S1/9 to FC2/5 (FCC1)		S2/9 to FC6/5 (FCC0)		S3/9 to FC6/5 (FCC1)		S4/9 to FC10/5 (FCC0)		S5/9 to FC10/5 (FCC1)	
S0/10 to FC2/6 (FCC0)		S1/10 to FC2/6 (FCC1)		S2/10 to FC6/6 (FCC0)		S3/10 to FC6/6 (FCC1)		S4/10 to FC10/6 (FCC0)		S5/10 to FC10/6 (FCC1)	
S0/11 to FC2/7 (FCC0)		S1/11 to FC2/7 (FCC1)		S2/11 to FC6/7 (FCC0)		S3/11 to FC6/7 (FCC1)		S4/11 to FC10/7 (FCC0)		S5/11 to FC10/7 (FCC1)	
S0/12 to FC3/4 (FCC0)		S1/12 to FC3/4 (FCC1)		S2/12 to FC7/4 (FCC0)		S3/12 to FC7/4 (FCC1)		S4/12 to FC11/4 (FCC0)		S5/12 to FC11/4 (FCC1)	
S0/13 to FC3/5 (FCC0)		S1/13 to FC3/5 (FCC1)		S2/13 to FC7/5 (FCC0)		S3/13 to FC7/5 (FCC1)		S4/13 to FC11/5 (FCC0)		S5/13 to FC11/5 (FCC1)	
S0/14 to FC3/6 (FCC0)		S1/14 to FC3/6 (FCC1)		S2/14 to FC7/6 (FCC0)		S3/14 to FC7/6 (FCC1)		S4/14 to FC11/6 (FCC0)		S5/14 to FC11/6 (FCC1)	
S0/15 to FC3/7 (FCC0)		S1/15 to FC3/7 (FCC1)		S2/15 to FC7/7 (FCC0)		S3/15 to FC7/7 (FCC1)		S4/15 to FC11/7 (FCC0)		S5/15 to FC11/7 (FCC1)	

Table 34: Cabling Plan for LCC2 in a 8+2 Multi-Chassis Configuration with 24 S2 Fabric Cards

Plane 0		Plane 1		Plane 2		Plane 3		Plane 4		Plane 5	
LCC2 (S13) slot/port	FCC (S2) slot/port/chassis	LCC2 (S13) slot/port	FCC (S2) slot/port/chassis	LCC2 (S13) slot/port	FCC (S2) slot/port/chassis	LCC2 (S13) slot/port	FCC (S2) slot/port/chassis	LCC2 (S13) slot/port	FCC (S2) slot/port/chassis	LCC2 (S13) slot/port	FCC (S2) slot/port/chassis
S0/0 to FC0/8 (FCC0)		S1/0 to FC0/8 (FCC1)		S2/0 to FC4/8 (FCC0)		S3/0 to FC4/8 (FCC1)		S4/0 to FC8/8 (FCC0)		S5/0 to FC8/8 (FCC1)	
S0/1 to FC0/9 (FCC0)		S1/1 to FC0/9 (FCC1)		S2/1 to FC4/9 (FCC0)		S3/1 to FC4/9 (FCC1)		S4/1 to FC8/9 (FCC0)		S5/1 to FC8/9 (FCC1)	
S0/2 to FC0/10 (FCC0)		S1/2 to FC0/10 (FCC1)		S2/2 to FC4/10 (FCC0)		S3/2 to FC4/10 (FCC1)		S4/2 to FC8/10 (FCC0)		S5/2 to FC8/10 (FCC1)	
S0/3 to FC0/11 (FCC0)		S1/3 to FC0/11 (FCC1)		S2/3 to FC4/11 (FCC0)		S3/3 to FC4/11 (FCC1)		S4/3 to FC8/11 (FCC0)		S5/3 to FC8/11 (FCC1)	
S0/4 to FC1/8 (FCC0)		S1/4 to FC1/8 (FCC1)		S2/4 to FC5/8 (FCC0)		S3/4 to FC5/8 (FCC1)		S4/4 to FC9/8 (FCC0)		S5/4 to FC9/8 (FCC1)	
S0/5 to FC1/9 (FCC0)		S1/5 to FC1/9 (FCC1)		S2/5 to FC5/9 (FCC0)		S3/5 to FC5/9 (FCC1)		S4/5 to FC9/9 (FCC0)		S5/5 to FC9/9 (FCC1)	
S0/6 to FC1/10 (FCC0)		S1/6 to FC1/10 (FCC1)		S2/6 to FC5/10 (FCC0)		S3/6 to FC5/10 (FCC1)		S4/6 to FC9/10 (FCC0)		S5/6 to FC9/10 (FCC1)	
S0/7 to FC1/11 (FCC0)		S1/7 to FC1/11 (FCC1)		S2/7 to FC5/11 (FCC0)		S3/7 to FC5/11 (FCC1)		S4/7 to FC9/11 (FCC0)		S5/7 to FC9/11 (FCC1)	
S0/8 to FC2/8 (FCC0)		S1/8 to FC2/8 (FCC1)		S2/8 to FC6/8 (FCC0)		S3/8 to FC6/8 (FCC1)		S4/8 to FC10/8 (FCC0)		S5/8 to FC10/8 (FCC1)	
S0/9 to FC2/9 (FCC0)		S1/9 to FC2/9 (FCC1)		S2/9 to FC6/9 (FCC0)		S3/9 to FC6/9 (FCC1)		S4/9 to FC10/9 (FCC0)		S5/9 to FC10/9 (FCC1)	
S0/10 to FC2/10 (FCC0)		S1/10 to FC2/10 (FCC1)		S2/10 to FC6/10 (FCC0)		S3/10 to FC6/10 (FCC1)		S4/10 to FC10/10 (FCC0)		S5/10 to FC10/10 (FCC1)	
S0/11 to FC2/11 (FCC0)		S1/11 to FC2/11 (FCC1)		S2/11 to FC6/11 (FCC0)		S3/11 to FC6/11 (FCC1)		S4/11 to FC10/11 (FCC0)		S5/11 to FC10/11 (FCC1)	
S0/12 to FC3/8 (FCC0)		S1/12 to FC3/8 (FCC1)		S2/12 to FC7/8 (FCC0)		S3/12 to FC7/8 (FCC1)		S4/12 to FC11/8 (FCC0)		S5/12 to FC11/8 (FCC1)	
S0/13 to FC3/9 (FCC0)		S1/13 to FC3/9 (FCC1)		S2/13 to FC7/9 (FCC0)		S3/13 to FC7/9 (FCC1)		S4/13 to FC11/9 (FCC0)		S5/13 to FC11/9 (FCC1)	
S0/14 to FC3/10 (FCC0)		S1/14 to FC3/10 (FCC1)		S2/14 to FC7/10 (FCC0)		S3/14 to FC7/10 (FCC1)		S4/14 to FC11/10 (FCC0)		S5/14 to FC11/10 (FCC1)	
S0/15 to FC3/11 (FCC0)		S1/15 to FC3/11 (FCC1)		S2/15 to FC7/11 (FCC0)		S3/15 to FC7/11 (FCC1)		S4/15 to FC11/11 (FCC0)		S5/15 to FC11/11 (FCC1)	

Table 35: Cabling Plan for LCC3 in a 8+2 Multi-Chassis Configuration with 24 S2 Fabric Cards

Plane 0		Plane 1		Plane 2		Plane 3		Plane 4		Plane 5	
LCC3 (S13) slot/port	FCC (S2) slot/port/chassis	LCC3 (S13) slot/port	FCC (S2) slot/port/chassis	LCC3 (S13) slot/port	FCC (S2) slot/port/chassis	LCC3(S13) slot/port	FCC (S2) slot/port/chassis	LCC3 (S13) slot/port	FCC (S2) slot/port/chassis	LCC3 (S13) slot/port	FCC (S2) slot/port/chassis
S0/0 to FC0/12 (FCC0)		S1/0 to FC0/12 (FCC1)		S2/0 to FC4/12 (FCC0)		S3/0 to FC4/12 (FCC1)		S4/0 to FC8/12 (FCC0)		S5/0 to FC8/12 (FCC1)	
S0/1 to FC0/13 (FCC0)		S1/1 to FC0/13 (FCC1)		S2/1 to FC4/13 (FCC0)		S3/1 to FC4/13 (FCC1)		S4/1 to FC8/13 (FCC0)		S5/1 to FC8/13 (FCC1)	
S0/2 to FC0/14 (FCC0)		S1/2 to FC0/14 (FCC1)		S2/2 to FC4/14 (FCC0)		S3/2 to FC4/14 (FCC1)		S4/2 to FC8/14 (FCC0)		S5/2 to FC8/14 (FCC1)	
S0/3 to FC0/15 (FCC0)		S1/3 to FC0/15 (FCC1)		S2/3 to FC4/15 (FCC0)		S3/3 to FC4/15 (FCC1)		S4/3 to FC8/15 (FCC0)		S5/3 to FC8/15 (FCC1)	
S0/4 to FC1/12 (FCC0)		S1/4 to FC1/12 (FCC1)		S2/4 to FC5/12 (FCC0)		S3/4 to FC5/12 (FCC1)		S4/4 to FC9/12 (FCC0)		S5/4 to FC9/12 (FCC1)	
S0/5 to FC1/13 (FCC0)		S1/5 to FC1/13 (FCC1)		S2/5 to FC5/13 (FCC0)		S3/5 to FC5/13 (FCC1)		S4/5 to FC9/13 (FCC0)		S5/5 to FC9/13 (FCC1)	
S0/6 to FC1/14 (FCC0)		S1/6 to FC1/14 (FCC1)		S2/6 to FC5/14 (FCC0)		S3/6 to FC5/14 (FCC1)		S4/6 to FC9/14 (FCC0)		S5/6 to FC9/14 (FCC1)	
S0/7 to FC1/15 (FCC0)		S1/7 to FC1/15 (FCC1)		S2/7 to FC5/15 (FCC0)		S3/7 to FC5/15 (FCC1)		S4/7 to FC9/15 (FCC0)		S5/7 to FC9/15 (FCC1)	
S0/8 to FC2/12 (FCC0)		S1/8 to FC2/12 (FCC1)		S2/8 to FC6/12 (FCC0)		S3/8 to FC6/12 (FCC1)		S4/8 to FC10/12 (FCC0)		S5/8 to FC10/12 (FCC1)	
S0/9 to FC2/13 (FCC0)		S1/9 to FC2/13 (FCC1)		S2/9 to FC6/13 (FCC0)		S3/9 to FC6/13 (FCC1)		S4/9 to FC10/13 (FCC0)		S5/9 to FC10/13 (FCC1)	
S0/10 to FC2/14 (FCC0)		S1/10 to FC2/14 (FCC1)		S2/10 to FC6/14 (FCC0)		S3/10 to FC6/14 (FCC1)		S4/10 to FC10/14 (FCC0)		S5/10 to FC10/14 (FCC1)	
S0/11 to FC2/15 (FCC0)		S1/11 to FC2/15 (FCC1)		S2/11 to FC6/15 (FCC0)		S3/11 to FC6/15 (FCC1)		S4/11 to FC10/15 (FCC0)		S5/11 to FC10/15 (FCC1)	
S0/12 to FC3/12 (FCC0)		S1/12 to FC3/12 (FCC1)		S2/12 to FC7/12 (FCC0)		S3/12 to FC7/12 (FCC1)		S4/12 to FC11/12 (FCC0)		S5/12 to FC11/12 (FCC1)	
S0/13 to FC3/13 (FCC0)		S1/13 to FC3/13 (FCC1)		S2/13 to FC7/13 (FCC0)		S3/13 to FC7/13 (FCC1)		S4/13 to FC11/13 (FCC0)		S5/13 to FC11/13 (FCC1)	
S0/14 to FC3/14 (FCC0)		S1/14 to FC3/14 (FCC1)		S2/14 to FC7/14 (FCC0)		S3/14 to FC7/14 (FCC1)		S4/14 to FC11/14 (FCC0)		S5/14 to FC11/14 (FCC1)	
S0/15 to FC3/15 (FCC0)		S1/15 to FC3/15 (FCC1)		S2/15 to FC7/15 (FCC0)		S3/15 to FC7/15 (FCC1)		S4/15 to FC11/15 (FCC0)		S5/15 to FC11/15 (FCC1)	

Table 36: Cabling Plan for LCC4 in a 8+2 Multi-Chassis Configuration with 24 S2 Fabric Cards

Plane 0		Plane 1		Plane 2		Plane 3		Plane 4		Plane 5	
LCC4 (S13) slot/port	FCC (S2) slot/port/chassis	LCC4 (S13) slot/port	FCC (S2) slot/port/chassis	LCC4 (S13) slot/port	FCC (S2) slot/port/chassis	LCC4(S13) slot/port	FCC (S2) slot/port/chassis	LCC4 (S13) slot/port	FCC (S2) slot/port/chassis	LCC4 (S13) slot/port	FCC (S2) slot/port/chassis
S0/0 to FC0/16 (FCC0)		S1/0 to FC0/16 (FCC1)		S2/0 to FC4/16 (FCC0)		S3/0 to FC4/16 (FCC1)		S4/0 to FC8/16 (FCC0)		S5/0 to FC8/16 (FCC1)	
S0/1 to FC0/17 (FCC0)		S1/1 to FC0/17 (FCC1)		S2/1 to FC4/17 (FCC0)		S3/1 to FC4/17 (FCC1)		S4/1 to FC8/17 (FCC0)		S5/1 to FC8/17 (FCC1)	
S0/2 to FC0/18 (FCC0)		S1/2 to FC0/18 (FCC1)		S2/2 to FC4/18 (FCC0)		S3/2 to FC4/18 (FCC1)		S4/2 to FC8/18 (FCC0)		S5/2 to FC8/18 (FCC1)	
S0/3 to FC0/19 (FCC0)		S1/3 to FC0/19 (FCC1)		S2/3 to FC4/19 (FCC0)		S3/3 to FC4/19 (FCC1)		S4/3 to FC8/19 (FCC0)		S5/3 to FC8/19 (FCC1)	
S0/4 to FC1/16 (FCC0)		S1/4 to FC1/16 (FCC1)		S2/4 to FC5/16 (FCC0)		S3/4 to FC5/16 (FCC1)		S4/4 to FC9/16 (FCC0)		S5/4 to FC9/16 (FCC1)	
S0/5 to FC1/17 (FCC0)		S1/5 to FC1/13 (FCC1)		S2/5 to FC5/13 (FCC0)		S3/5 to FC5/13 (FCC1)		S4/5 to FC9/13 (FCC0)		S5/5 to FC9/13 (FCC1)	
S0/6 to FC1/18 (FCC0)		S1/6 to FC1/18 (FCC1)		S2/6 to FC5/18 (FCC0)		S3/6 to FC5/18 (FCC1)		S4/6 to FC9/18 (FCC0)		S5/6 to FC9/18 (FCC1)	
S0/7 to FC1/19 (FCC0)		S1/7 to FC1/19 (FCC1)		S2/7 to FC5/19 (FCC0)		S3/7 to FC5/19 (FCC1)		S4/7 to FC9/19 (FCC0)		S5/7 to FC9/19 (FCC1)	
S0/8 to FC2/16 (FCC0)		S1/8 to FC2/16 (FCC1)		S2/8 to FC6/16 (FCC0)		S3/8 to FC6/16 (FCC1)		S4/8 to FC10/16 (FCC0)		S5/8 to FC10/16 (FCC1)	
S0/9 to FC2/17 (FCC0)		S1/9 to FC2/17 (FCC1)		S2/9 to FC6/17 (FCC0)		S3/9 to FC6/17 (FCC1)		S4/9 to FC10/17 (FCC0)		S5/9 to FC10/17 (FCC1)	
S0/10 to FC2/18 (FCC0)		S1/10 to FC2/18 (FCC1)		S2/10 to FC6/18 (FCC0)		S3/10 to FC6/18 (FCC1)		S4/10 to FC10/18 (FCC0)		S5/10 to FC10/18 (FCC1)	
S0/11 to FC2/19 (FCC0)		S1/11 to FC2/19 (FCC1)		S2/11 to FC6/19 (FCC0)		S3/11 to FC6/19 (FCC1)		S4/11 to FC10/19 (FCC0)		S5/11 to FC10/19 (FCC1)	
S0/12 to FC3/16 (FCC0)		S1/12 to FC3/16 (FCC1)		S2/12 to FC7/16 (FCC0)		S3/12 to FC7/16 (FCC1)		S4/12 to FC11/16 (FCC0)		S5/12 to FC11/16 (FCC1)	
S0/13 to FC3/17 (FCC0)		S1/13 to FC3/17 (FCC1)		S2/13 to FC7/17 (FCC0)		S3/13 to FC7/17 (FCC1)		S4/13 to FC11/17 (FCC0)		S5/13 to FC11/17 (FCC1)	
S0/14 to FC3/18 (FCC0)		S1/14 to FC3/18 (FCC1)		S2/14 to FC7/18 (FCC0)		S3/14 to FC7/18 (FCC1)		S4/14 to FC11/18 (FCC0)		S5/14 to FC11/18 (FCC1)	
S0/15 to FC3/19 (FCC0)		S1/15 to FC3/19 (FCC1)		S2/15 to FC7/19 (FCC0)		S3/15 to FC7/19 (FCC1)		S4/15 to FC11/19 (FCC0)		S5/15 to FC11/19 (FCC1)	

Table 37: Cabling Plan for LCC5 in a 8+2 Multi-Chassis Configuration with 24 S2 Fabric Cards

Plane 0		Plane 1		Plane 2		Plane 3		Plane 4		Plane 5	
LCC5 (S13) slot/port	FCC (S2) slot/port/chassis	LCC5 (S13) slot/port	FCC (S2) slot/port/chassis	LCC5 (S13) slot/port	FCC (S2) slot/port/chassis	LCC5(S13) slot/port	FCC (S2) slot/port/chassis	LCC5 (S13) slot/port	FCC (S2) slot/port/chassis	LCC5 (S13) slot/port	FCC (S2) slot/port/chassis
S0/0 to FC0/20 (FCC0)		S1/0 to FC0/20 (FCC1)		S2/0 to FC4/20 (FCC0)		S3/0 to FC4/20 (FCC1)		S4/0 to FC8/20 (FCC0)		S5/0 to FC8/20 (FCC1)	
S0/1 to FC0/21 (FCC0)		S1/1 to FC0/21 (FCC1)		S2/1 to FC4/21 (FCC0)		S3/1 to FC4/21 (FCC1)		S4/1 to FC8/21 (FCC0)		S5/1 to FC8/21 (FCC1)	
S0/2 to FC0/22 (FCC0)		S1/2 to FC0/22 (FCC1)		S2/2 to FC4/22 (FCC0)		S3/2 to FC4/22 (FCC1)		S4/2 to FC8/22 (FCC0)		S5/2 to FC8/22 (FCC1)	
S0/3 to FC0/23 (FCC0)		S1/3 to FC0/23 (FCC1)		S2/3 to FC4/23 (FCC0)		S3/3 to FC4/23 (FCC1)		S4/3 to FC8/23 (FCC0)		S5/3 to FC8/23 (FCC1)	
S0/4 to FC1/20 (FCC0)		S1/4 to FC1/24 (FCC1)		S2/4 to FC5/24 (FCC0)		S3/4 to FC5/24 (FCC1)		S4/4 to FC9/24 (FCC0)		S5/4 to FC9/24 (FCC1)	
S0/5 to FC1/21 (FCC0)		S1/5 to FC1/25 (FCC1)		S2/5 to FC5/25 (FCC0)		S3/5 to FC5/25 (FCC1)		S4/5 to FC9/25 (FCC0)		S5/5 to FC9/25 (FCC1)	
S0/6 to FC1/22 (FCC0)		S1/6 to FC1/26 (FCC1)		S2/6 to FC5/26 (FCC0)		S3/6 to FC5/26 (FCC1)		S4/6 to FC9/26 (FCC0)		S5/6 to FC9/26 (FCC1)	
S0/7 to FC1/23 (FCC0)		S1/7 to FC1/27 (FCC1)		S2/7 to FC5/27 (FCC0)		S3/7 to FC5/27 (FCC1)		S4/7 to FC9/27 (FCC0)		S5/7 to FC9/27 (FCC1)	
S0/8 to FC2/20 (FCC0)		S1/8 to FC2/20 (FCC1)		S2/8 to FC6/20 (FCC0)		S3/8 to FC6/20 (FCC1)		S4/8 to FC10/20 (FCC0)		S5/8 to FC10/20 (FCC1)	
S0/9 to FC2/21 (FCC0)		S1/9 to FC2/21 (FCC1)		S2/9 to FC6/21 (FCC0)		S3/9 to FC6/21 (FCC1)		S4/9 to FC10/21 (FCC0)		S5/9 to FC10/21 (FCC1)	
S0/10 to FC2/22 (FCC0)		S1/10 to FC2/22 (FCC1)		S2/10 to FC6/22 (FCC0)		S3/10 to FC6/22 (FCC1)		S4/10 to FC10/22 (FCC0)		S5/10 to FC10/22 (FCC1)	
S0/11 to FC2/23 (FCC0)		S1/11 to FC2/23 (FCC1)		S2/11 to FC6/23 (FCC0)		S3/11 to FC6/23 (FCC1)		S4/11 to FC10/23 (FCC0)		S5/11 to FC10/23 (FCC1)	
S0/12 to FC3/20 (FCC0)		S1/12 to FC3/20 (FCC1)		S2/12 to FC7/20 (FCC0)		S3/12 to FC7/20 (FCC1)		S4/12 to FC11/20 (FCC0)		S5/12 to FC11/20 (FCC1)	
S0/13 to FC3/21 (FCC0)		S1/13 to FC3/21 (FCC1)		S2/13 to FC7/21 (FCC0)		S3/13 to FC7/21 (FCC1)		S4/13 to FC11/21 (FCC0)		S5/13 to FC11/21 (FCC1)	
S0/14 to FC3/22 (FCC0)		S1/14 to FC3/22 (FCC1)		S2/14 to FC7/22 (FCC0)		S3/14 to FC7/22 (FCC1)		S4/14 to FC11/22 (FCC0)		S5/14 to FC11/22 (FCC1)	
S0/15 to FC3/23 (FCC0)		S1/15 to FC3/23 (FCC1)		S2/15 to FC7/23 (FCC0)		S3/15 to FC7/23 (FCC1)		S4/15 to FC11/23 (FCC0)		S5/15 to FC11/23 (FCC1)	

Table 38: Cabling Plan for LCC6 in a 8+2 Multi-Chassis Configuration with 24 S2 Fabric Cards

Plane 0		Plane 1		Plane 2		Plane 3		Plane 4		Plane 5	
LCC6 (S13) slot/port	FCC (S2) slot/port/chassis	LCC6 (S13) slot/port	FCC (S2) slot/port/chassis	LCC6 (S13) slot/port	FCC (S2) slot/port/chassis	LCC6(S13) slot/port	FCC (S2) slot/port/chassis	LCC6 (S13) slot/port	FCC (S2) slot/port/chassis	LCC6 (S13) slot/port	FCC (S2) slot/port/chassis
S0/0 to FC0/24 (FCC0)		S1/0 to FC0/24 (FCC1)		S2/0 to FC4/24 (FCC0)		S3/0 to FC4/24 (FCC1)		S4/0 to FC8/24 (FCC0)		S5/0 to FC8/24 (FCC1)	
S0/1 to FC0/25 (FCC0)		S1/1 to FC0/25 (FCC1)		S2/1 to FC4/25 (FCC0)		S3/1 to FC4/25 (FCC1)		S4/1 to FC8/25 (FCC0)		S5/1 to FC8/25 (FCC1)	
S0/2 to FC0/26 (FCC0)		S1/2 to FC0/26 (FCC1)		S2/2 to FC4/26 (FCC0)		S3/2 to FC4/26 (FCC1)		S4/2 to FC8/26 (FCC0)		S5/2 to FC8/26 (FCC1)	
S0/3 to FC0/27 (FCC0)		S1/3 to FC0/27 (FCC1)		S2/3 to FC4/27 (FCC0)		S3/3 to FC4/27 (FCC1)		S4/3 to FC8/27 (FCC0)		S5/3 to FC8/27 (FCC1)	
S0/4 to FC1/24 (FCC0)		S1/4 to FC1/24 (FCC1)		S2/4 to FC5/24 (FCC0)		S3/4 to FC5/24 (FCC1)		S4/4 to FC9/24 (FCC0)		S5/4 to FC9/24 (FCC1)	
S0/5 to FC1/25 (FCC0)		S1/5 to FC1/25 (FCC1)		S2/5 to FC5/25 (FCC0)		S3/5 to FC5/25 (FCC1)		S4/5 to FC9/25 (FCC0)		S5/5 to FC9/25 (FCC1)	
S0/6 to FC1/26 (FCC0)		S1/6 to FC1/26 (FCC1)		S2/6 to FC5/26 (FCC0)		S3/6 to FC5/26 (FCC1)		S4/6 to FC9/26 (FCC0)		S5/6 to FC9/26 (FCC1)	
S0/7 to FC1/27 (FCC0)		S1/7 to FC1/27 (FCC1)		S2/7 to FC5/27 (FCC0)		S3/7 to FC5/27 (FCC1)		S4/7 to FC9/27 (FCC0)		S5/7 to FC9/27 (FCC1)	
S0/8 to FC2/24 (FCC0)		S1/8 to FC2/24 (FCC1)		S2/8 to FC6/24 (FCC0)		S3/8 to FC6/24 (FCC1)		S4/8 to FC10/24 (FCC0)		S5/8 to FC10/24 (FCC1)	
S0/9 to FC2/25 (FCC0)		S1/9 to FC2/25 (FCC1)		S2/9 to FC6/25 (FCC0)		S3/9 to FC6/25 (FCC1)		S4/9 to FC10/25 (FCC0)		S5/9 to FC10/25 (FCC1)	
S0/10 to FC2/26 (FCC0)		S1/10 to FC2/26 (FCC1)		S2/10 to FC6/26 (FCC0)		S3/10 to FC6/26 (FCC1)		S4/10 to FC10/26 (FCC0)		S5/10 to FC10/26 (FCC1)	
S0/11 to FC2/27 (FCC0)		S1/11 to FC2/27 (FCC1)		S2/11 to FC6/27 (FCC0)		S3/11 to FC6/27 (FCC1)		S4/11 to FC10/27 (FCC0)		S5/11 to FC10/27 (FCC1)	
S0/12 to FC3/24 (FCC0)		S1/12 to FC3/24 (FCC1)		S2/12 to FC7/24 (FCC0)		S3/12 to FC7/24 (FCC1)		S4/12 to FC11/24 (FCC0)		S5/12 to FC11/24 (FCC1)	
S0/13 to FC3/25 (FCC0)		S1/13 to FC3/25 (FCC1)		S2/13 to FC7/25 (FCC0)		S3/13 to FC7/25 (FCC1)		S4/13 to FC11/25 (FCC0)		S5/13 to FC11/25 (FCC1)	
S0/14 to FC3/26 (FCC0)		S1/14 to FC3/26 (FCC1)		S2/14 to FC7/26 (FCC0)		S3/14 to FC7/26 (FCC1)		S4/14 to FC11/26 (FCC0)		S5/14 to FC11/26 (FCC1)	
S0/15 to FC3/27 (FCC0)		S1/15 to FC3/27 (FCC1)		S2/15 to FC7/27 (FCC0)		S3/15 to FC7/27 (FCC1)		S4/15 to FC11/27 (FCC0)		S5/15 to FC11/27 (FCC1)	

Table 39: Cabling Plan for LCC7 in a 8+2 Multi-Chassis Configuration with 24 S2 Fabric Cards

Plane 0		Plane 1		Plane 2		Plane 3		Plane 4		Plane 5	
LCC7 (S13) slot/port	FCC (S2) slot/port/chassis	LCC7 (S13) slot/port	FCC (S2) slot/port/chassis	LCC7 (S13) slot/port	FCC (S2) slot/port/chassis	LCC7(S13) slot/port	FCC (S2) slot/port/chassis	LCC7 (S13) slot/port	FCC (S2) slot/port/chassis	LCC7 (S13) slot/port	FCC (S2) slot/port/chassis
S0/0 to FC0/28 (FCC0)		S1/0 to FC0/28 (FCC1)		S2/0 to FC4/28 (FCC0)		S3/0 to FC4/28 (FCC1)		S4/0 to FC8/28 (FCC0)		S5/0 to FC8/28 (FCC1)	
S0/1 to FC0/29 (FCC0)		S1/1 to FC0/29 (FCC1)		S2/1 to FC4/29 (FCC0)		S3/1 to FC4/29 (FCC1)		S4/1 to FC8/29 (FCC0)		S5/1 to FC8/29 (FCC1)	
S0/2 to FC0/30 (FCC0)		S1/2 to FC0/30 (FCC1)		S2/2 to FC4/30 (FCC0)		S3/2 to FC4/30 (FCC1)		S4/2 to FC8/30 (FCC0)		S5/2 to FC8/30 (FCC1)	
S0/3 to FC0/31 (FCC0)		S1/3 to FC0/31 (FCC1)		S2/3 to FC4/31 (FCC0)		S3/3 to FC4/31 (FCC1)		S4/3 to FC8/31 (FCC0)		S5/3 to FC8/31 (FCC1)	
S0/4 to FC1/28 (FCC0)		S1/4 to FC1/28 (FCC1)		S2/4 to FC5/28 (FCC0)		S3/4 to FC5/28 (FCC1)		S4/4 to FC9/28 (FCC0)		S5/4 to FC9/28 (FCC1)	
S0/5 to FC1/29 (FCC0)		S1/5 to FC1/29 (FCC1)		S2/5 to FC5/29 (FCC0)		S3/5 to FC5/29 (FCC1)		S4/5 to FC9/29 (FCC0)		S5/5 to FC9/29 (FCC1)	
S0/6 to FC1/30 (FCC0)		S1/6 to FC1/30 (FCC1)		S2/6 to FC5/30 (FCC0)		S3/6 to FC5/30 (FCC1)		S4/6 to FC9/30 (FCC0)		S5/6 to FC9/30 (FCC1)	
S0/7 to FC1/31 (FCC0)		S1/7 to FC1/31 (FCC1)		S2/7 to FC5/31 (FCC0)		S3/7 to FC5/31 (FCC1)		S4/7 to FC9/31 (FCC0)		S5/7 to FC9/31 (FCC1)	
S0/8 to FC2/28 (FCC0)		S1/8 to FC2/28 (FCC1)		S2/8 to FC6/28 (FCC0)		S3/8 to FC6/28 (FCC1)		S4/8 to FC10/28 (FCC0)		S5/8 to FC10/28 (FCC1)	
S0/9 to FC2/29 (FCC0)		S1/9 to FC2/29 (FCC1)		S2/9 to FC6/29 (FCC0)		S3/9 to FC6/29 (FCC1)		S4/9 to FC10/25 (FCC0)		S5/9 to FC10/29 (FCC1)	
S0/10 to FC2/30 (FCC0)		S1/10 to FC2/30 (FCC1)		S2/10 to FC6/30 (FCC0)		S3/10 to FC6/30 (FCC1)		S4/10 to FC10/30 (FCC0)		S5/10 to FC10/30 (FCC1)	
S0/11 to FC2/31 (FCC0)		S1/11 to FC2/31 (FCC1)		S2/11 to FC6/31 (FCC0)		S3/11 to FC6/31 (FCC1)		S4/11 to FC10/31 (FCC0)		S5/11 to FC10/31 (FCC1)	
S0/12 to FC3/28 (FCC0)		S1/12 to FC3/28 (FCC1)		S2/12 to FC7/28 (FCC0)		S3/12 to FC7/28 (FCC1)		S4/12 to FC11/28 (FCC0)		S5/12 to FC11/28 (FCC1)	
S0/13 to FC3/29 (FCC0)		S1/13 to FC3/29 (FCC1)		S2/13 to FC7/29 (FCC0)		S3/13 to FC7/29 (FCC1)		S4/13 to FC11/29 (FCC0)		S5/13 to FC11/29 (FCC1)	
S0/14 to FC3/30 (FCC0)		S1/14 to FC3/30 (FCC1)		S2/14 to FC7/30 (FCC0)		S3/14 to FC7/30 (FCC1)		S4/14 to FC11/30 (FCC0)		S5/14 to FC11/30 (FCC1)	
S0/15 to FC3/31 (FCC0)		S1/15 to FC3/31 (FCC1)		S2/15 to FC7/31 (FCC0)		S3/15 to FC7/31 (FCC1)		S4/15 to FC11/31 (FCC0)		S5/15 to FC11/31 (FCC1)	

8+2 Software Configuration (24 S2 Fabric Cards)

An explicit admin configuration is required to specify an ordered list of S2 connections assigned for a plane. Each S2 connection is specified as an instance. The instances are contiguous, starting from 0.

```
controller fabric plane 0
instance 0
location F0/FC0
instance 1
location F0/FC1
instance 2
location F0/FC2
instance 3
location F0/FC3

controller fabric plane 1
instance 0
location F1/FC0
instance 1
location F1/FC1
instance 2
location F1/FC2
instance 3
location F1/FC3

controller fabric plane 2
instance 0
location F0/FC4
instance 1
location F0/FC5
instance 2
location F0/FC6
instance 3
location F0/FC7

controller fabric plane 3
instance 0
location F1/FC4
instance 1
location F1/FC5
instance 2
location F1/FC6
instance 3
location F1/FC7

controller fabric plane 4
instance 0
location F0/FC8
instance 1
location F0/FC9
instance 2
location F0/FC10
instance 3
location F0/FC11

controller fabric plane 5
instance 0
location F1/FC8
instance 1
location F1/FC9
instance 2
location F1/FC10
instance 3
location F1/FC11
```



APPENDIX **B**

Commands for Router Health Check

- [Sysadmin VM Health Check, on page 89](#)
- [XR VM Health Check, on page 90](#)
- [Fabric Health Check, on page 91](#)

Sysadmin VM Health Check

Use the commands in the following table in System Admin EXEC mode to ensure that any errors or exception are resolved prior to and after migration.

Command	Description
show chassis	Verify that both Data Plane and Control Plane are connected.
show platform	Verify that all nodes are operational.
show vm	Verify that all VMs are running (both Sysadmin and XR).
show install active	Verify that the packages are active on all nodes.
show install committed	Verify that the packages are committed on all nodes.
show controller switch reachable	Verify that all RPs and LCs inserted in the router are listed.
show controller switch mlap reachable	Verify that all RPs are listed.
show controller switch mlap statistics location <i>location</i>	Verify that all connected ports are in Active or Standby state; any ports in UP protocol state are unexpected.
Note Enter for every location.	
show controller switch summary location <i>location</i>	Verify that the Physical and Admin State of all the connected ports are UP .
show controller fabric plane all detail	Verify the Fabric Plane state and Bundle state.

Command	Description
show controller switch summary	Verify the state of Exp Eth 0 and Exp Eth 1 ports. One port must be in Active (Forwarding) state, and one port must be in Standby (Blocking) state. Note The state of the Ethernet port is decided by the system. Verify that the connected ports are in up, active, and forwarding state. If the states are not displayed correctly, check the control Ethernet cabling.
show controller fabric plane all statistics	Check for CE, UCE, and Parity Errors.
show controller fabric sfe s13 all	Check the S13 ASIC state.
show controller fabric sfe fia all	Check the FIA ASIC states.
show controller sfe driver rack rack_number	Check the software state of the UFC.
show sdr default-sdr pairing	Provides info on which is the SDR lead. Note By default, RACK0 RP node pair is set as SDR Lead.
show context location all	Checks for any crashes that might have occurred.

XR VM Health Check

Use the commands in the following table in XR EXEC mode to ensure that any errors or exception are resolved prior to and after migration.

Command	Description
show platform	Verify that each node CPU displays IOS XR RUN , and that the config state is NSHUT . Verify that all the slices of line cards (if present) are in UP state.
show redundancy summary	Verify Node and NSR status is Ready .
show processes blocked location node_ID	Check for blocked processes. Note The "lpts_fm" process would be the only process in blocked state.
show processes cpu location node_ID	Check the CPU utilization.
show controllers fia driver location node_ID	Check the software state of FIA.
show controllers pse summary location node_ID	Check the PPE Utilization, Block Initialization, and Alignment Status. Note The Routing and Packet drop checks are same as Classic XR.

Fabric Health Check

Use the commands in the following table in System Admin EXEC mode to check the state of the fabric.

Command	Description
show controller fabric cxp summary rack <i>rack_number</i>	Verify that all CXPs are initialized properly (indicated by a “G” for each CXP plugged into the UFC ports).
show controller fabric plane all detail	Verify the following: <ul style="list-style-type: none"> • Plane Mode is B2B (back-to-back), SC (single chassis), or MC (multi-chassis) • Plane State is UP
show controller sfe driver rack 0	Verify the following: <ul style="list-style-type: none"> • The ASIC State is NRML • The FGID DL is Done
show controller fabric fgid program-error all	Verify that all FGIDs are Ok .
show controller fabric link port fia tx state down show controller fabric link port fia rx state mismatch	Verify that Link down or Link mismatch are not displayed in the output.

