



Implementing MPLS Label Distribution Protocol

MPLS (Multi Protocol Label Switching) is a forwarding mechanism based on label switching. In an MPLS network, data packets are assigned labels and packet-forwarding decisions are taken based on the contents of the label. To switch labeled packets across the MPLS network, predetermined paths are established for various source-destination pairs. These predetermined paths are known as Label Switched Paths (LSPs). To establish LSPs, MPLS signaling protocols are used. Label Distribution Protocol (LDP) is an MPLS signaling protocol used for establishing LSPs. This module provides information about how to configure MPLS LDP.

To allow hashing for the Label Edge Router (LER) and Label Switched Routers (LSRs) with MPLS traffic or algorithm to use the inner ethernet fields of the source MAC and destination MAC addresses, use the **hw-module profile load-balance algorithm** command with a suitable load-balancing profile.

- [Prerequisites for Implementing MPLS Label Distribution Protocol, on page 1](#)
- [Restrictions for MPLS LDP, on page 2](#)
- [Overview of Label Distribution Protocol, on page 2](#)
- [Configuring Label Distribution Protocol, on page 2](#)
- [MPLS Label Distribution Protocol : Details, on page 10](#)
- [Controlling State Advertisements In An mLDP-Only Setup, on page 15](#)
- [Use Cases For Controlling State Advertisements, on page 17](#)

Prerequisites for Implementing MPLS Label Distribution Protocol

The following are the prerequisites to implement MPLS LDP:

- You must be in a user group associated with a task group that includes the proper task IDs. The command reference guides include the task IDs required for each command. If you suspect user group assignment is preventing you from using a command, contact your AAA administrator for assistance.
- You must be running Cisco IOS XR software.
- You must install a composite mini-image and the MPLS package.
- You must activate IGP.
- We recommend to use a lower session holdtime bandwidth such as neighbors so that a session down occurs before an adjacency-down on a neighbor. Therefore, the following default values for the hello times are listed:
 - Holdtime is 15 seconds.

- Interval is 5 seconds.

For example, the LDP session holdtime can be configured as 30 seconds by using the **holdtime** command.

Restrictions for MPLS LDP

- LDP statistics is not displayed in **show mpls forwarding command** output.
- When paths of different technologies are resolved over ECMP, it results in *heterogeneous* ECMP, leading to severe network traffic issues. Don't use ECMP for any combination of the following technologies:
 - LDP.
 - BGP-LU, including services over BGP-LU loopback peering or recursive services at Level-3.
 - VPNv4.
 - 6PE and 6VPE.
 - EVPN.
 - Recursive static routing.

Overview of Label Distribution Protocol

In IP forwarding, when a packet arrives at a router the router looks at the destination address in the IP header, performs a route lookup, and then forwards the packet to the next hop. MPLS is a forwarding mechanism in which packets are forwarded based on labels. Label Distribution Protocols assign, distribute, and install the labels in an MPLS environment. It is the set of procedures and messages by which Label Switched Routers (LSRs) establish LSPs through a network by mapping network-layer routing information directly to data-link layer switched paths. These LSPs may have an endpoint at a directly attached neighbor (comparable to IP hop-by-hop forwarding), or may have an endpoint at a network egress node, enabling switching via all intermediary nodes.

LSPs can be created statically, by RSVP traffic engineering (TE), or by LDP. LSPs created by LDP perform hop-by-hop path setup instead of an end-to-end path. LDP enables LSRs to discover their potential peer routers and to establish LDP sessions with those peers to exchange label binding information. Once label bindings are learned, the LDP is ready to set up the MPLS forwarding plane.

For more information about setting up LSPs, see [MPLS Label Distribution Protocol : Details, on page 10](#).

Configuring Label Distribution Protocol

Depending on the requirements, LDP requires some basic configuration tasks described in the following topics:

Configuring Label Distribution Protocol

This section explains the basic LDP configuration. LDP should be enabled on all interfaces that connects the router to potential LDP peer routers. You can enable LDP on an interface by specifying the interface under `mpls ldp` configuration mode.

Configuration Example

This example shows how to enable LDP over an interface.

```
RP/0/RP0/CPU0:Router(config)# mpls ldp
RP/0/RP0/CPU0:Router(config-ldp)# router-id 192.168.70.1
RP/0/RP0/CPU0:Router(config-ldp)# interface HundredGigE 0/9/0/0
RP/0/RP0/CPU0:Router(config-ldp-if)# commit
```

Configuring Label Distribution Protocol Discovery Parameters

LSRs that are running LDP send hello messages on all the LDP enabled interfaces to discover each other. So, the LSR that receives the LDP hello message on an interface is aware of the presence of the LDP router on that interface. If LDP hello messages are sent and received on an interface, there's an LDP adjacency across the link between the two LSRs that are running LDP. By default, hello messages are sent every 5 seconds with a hold time of 15 seconds. If the LSR doesn't receive a discovery hello from peer before the hold time expires, the LSR removes the peer LSR from the list of discovered LDP neighbors. The LDP discovery parameters can be configured to change the default parameters.

LDP session between LSRs that aren't directly connected is known as targeted LDP session. For targeted LDP sessions, LDP uses targeted hello messages to discover the extended neighbors. By default, targeted hello messages are sent every 10 seconds with a hold time of 90 seconds.

Configuration Example

This example shows how to configure the following LDP discovery parameters:

- hello hold time
- hello interval
- targeted hello hold time
- targeted hello interval

```
RP/0/RP0/CPU0:Router(config)# mpls ldp
RP/0/RP0/CPU0:Router(config-ldp)# router-id 192.168.70.1
RP/0/RP0/CPU0:Router(config-ldp)# discovery hello holdtime 30
RP/0/RP0/CPU0:Router(config-ldp)# discovery hello interval 10
RP/0/RP0/CPU0:Router(config-ldp)# discovery targeted-hello holdtime 120
RP/0/RP0/CPU0:Router(config-ldp)# discovery targeted-hello interval 15
RP/0/RP0/CPU0:Router(config-ldp)# commit
```

Verification

This section verifies the MPLS LDP discovery parameters configuration.

```
RP/0/RP0/CPU0:Router# show mpls ldp parameters
```

```

LDP Parameters:
Role: Active
Protocol Version: 1
Router ID: 192.168.70.1
Discovery:
Link Hellos:      Holdtime:30 sec, Interval:10 sec
Targeted Hellos: Holdtime:120 sec, Interval:15 sec
Quick-start: Enabled (by default)
Transport address:      IPv4: 192.168.70.1

```

Label Distribution Protocol Discovery for Targeted Hellos

LDP session between LSRs that aren't directly connected is known as targeted LDP session. For LDP neighbors which aren't directly connected, you should manually configure the LDP neighborship on both the routers.

Configuration Example

This example shows how to configure LDP for non-directly connected routers, Router 1, and Router 2.

```

RP/0/RP0/CPU0:Router1(config)# mpls ldp
RP/0/RP0/CPU0:Router1(config-ldp)# router-id 192.168.70.1
RP/0/RP0/CPU0:Router2(config-ldp)# address-family ipv4
RP/0/RP0/CPU0:Router2(config-ldp-af)# discovery targeted-hello accept
RP/0/RP0/CPU0:Router1(config-ldp-af)# neighbor 172.20.10.10 targeted
RP/0/RP0/CPU0:Router1(config-ldp-af)# interface HundredGigE 0/9/0/0
RP/0/RP0/CPU0:Router1(config-ldp-if)# commit

```

```

RP/0/RP0/CPU0:Router2(config)# mpls ldp
RP/0/RP0/CPU0:Router2(config-ldp)# router-id 172.20.10.10
RP/0/RP0/CPU0:Router2(config-ldp)# address-family ipv4
RP/0/RP0/CPU0:Router2(config-ldp-af)# discovery targeted-hello accept
RP/0/RP0/CPU0:Router2(config-ldp-af)# neighbor 192.168.70.1 targeted
RP/0/RP0/CPU0:Router2(config-ldp-af)# commit

```

Label Advertisement Control

LDP allows you to control the advertising and receiving of labels. You can control the exchange of label binding information by using label advertisement control (outbound filtering) or label acceptance control (inbound filtering).

Label Advertisement Control (Outbound Filtering)

Label Distribution Protocol advertises labels for all the prefixes to all its neighbors. When this is not desirable (for scalability and security reasons), you can configure LDP to perform outbound filtering for local label advertisement for one or more prefixes to one more peers. This feature is known as LDP outbound label filtering, or local label advertisement control. You can control the exchange of label binding information using the **mpls ldp label advertise** command. Using the optional keywords, you can advertise selective prefixes to all neighbors, advertise selective prefixes to defined neighbors, or disable label advertisement to all peers for all prefixes. Prefixes and peers advertised selectively are defined in the access list.

Configuration Example: Label Advertisement Control

This example shows how to configure outbound label advertisement control. In this example, neighbors are specified to advertise and receive label advertisements. Also an interface is specified for label advertisement.

```
RP/0/RP0/CPU0:Router(config)# mpls ldp
RP/0/RP0/CPU0:Router(config-ldp)# address-family ipv4
RP/0/RP0/CPU0:Router(config-ldp-af)# label local advertise to 10.0.0.1:0 for pfx_acl1
RP/0/RP0/CPU0:Router(config-ldp-af)# label local advertise interface TenGigE 0/0/0/5

RP/0/RP0/CPU0:Router(config-ldp-af)# commit
```

Label Acceptance Control (Inbound Filtering)

LDP accepts labels (as remote bindings) for all prefixes from all peers. LDP operates in liberal label retention mode, which instructs LDP to keep remote bindings from all peers for a given prefix. For security reasons, or to conserve memory, you can override this behavior by configuring label binding acceptance for set of prefixes from a given peer. The ability to filter remote bindings for a defined set of prefixes is also referred to as LDP inbound label filtering or label acceptance control.

Configuration Example : Label Acceptance Control (Inbound Filtering)

This example shows how to configure label acceptance control. In this example, an LSR is configured to accept and retain label bindings from neighbors for prefixes defined in access list .

```
RP/0/RP0/CPU0:Router(config)# mpls ldp
RP/0/RP0/CPU0:Router(config-ldp)# address-family ipv4
RP/0/RP0/CPU0:Router(config-ldp-af)# label remote accept from 192.168.1.1:0 for acl_1
RP/0/RP0/CPU0:Router(config-ldp-af)# label remote accept from 192.168.2.2:0 for acl_2
RP/0/RP0/CPU0:Router(config-ldp-af)# commit
```

Configuring Local Label Allocation Control

LDP creates label bindings for all IGP prefixes and receives label bindings for all IGP prefixes from all its peers. If an LSR receives label bindings from several peers for thousands of IGP prefixes, it consumes significant memory and CPU. In some scenarios, most of the LDP label bindings may not useful for any application and you may required to limit the allocation of local labels. This is accomplished using LDP local label allocation control, where an access list can be used to limit allocation of local labels to a set of prefixes. Limiting local label allocation provides several benefits, including reduced memory usage requirements, fewer local forwarding updates, and fewer network and peer updates.

Configuration Example

This example shows how to configure local label allocation using an IP access list to specify a set of prefixes that local labels can allocate and advertise.

```
RP/0/RP0/CPU0:Router(config)# mpls ldp
RP/0/RP0/CPU0:Router(config-ldp)# address-family ipv4
RP/0/RP0/CPU0:Router(config-ldp-af)# label local allocate for pfx_acl_1
RP/0/RP0/CPU0:Router(config-ldp-af)# commit
```

Configuring Downstream on Demand

By default, LDP uses downstream unsolicited mode in which label advertisements for all routes are received from all LDP peers. The downstream on demand feature adds support for downstream-on-demand mode, where the label is not advertised to a peer, unless the peer explicitly requests it. At the same time, since the peer does not automatically advertise labels, the label request is sent whenever the next-hop points out to a peer that no remote label has been assigned.

In downstream on demand configuration, an ACL is used to specify the set of peers for downstream on demand mode. For downstream on demand to be enabled, it needs to be configured on both peers of the session. If only one peer in the session has downstream-on-demand feature configured, then the session does not use downstream-on-demand mode.

Configuration Example

This example shows how to configure LDP Downstream on Demand.

```
RP/0/RP0/CPU0:Router(config)# mpls ldp
RP/0/RP0/CPU0:Router(config-ldp)# session downstream-on-demand with ACL1
RP/0/RP0/CPU0:Router(config-ldp)# commit
```

Configuring Explicit Null Label

Cisco MPLS LDP uses implicit or explicit null label as local label for routes or prefixes that terminate on the given LSR. These routes include all local, connected, and attached networks. By default, the null label is **implicit-null** that allows LDP control plane to implement penultimate hop popping (PHP) mechanism. When this is not desirable, you can configure **explicit-null** label that allows LDP control plane to implement ultimate hop popping (UHP) mechanism. You can configure explicit-null feature on the ultimate hop LSR. Access-lists can be used to specify the IP prefixes for which PHP is desired.

You can enforce implicit-null local label for a specific prefix by using the **implicit-null-override** command even if the prefix requires a non-null label to be allocated by default. For example, by default, an LSR allocates and advertises a non-null label for an IGP route. If you wish to terminate LSP for this route on penultimate hop of the LSR, you can enforce implicit-null label allocation and advertisement for this prefix using the **implicit-null-override** command.

Configuration Example: Explicit Null

This example shows how to configure explicit null label.

```
RP/0/RP0/CPU0:Router(config)# mpls ldp
RP/0/RP0/CPU0:Router(config-ldp)# address-family ipv4
RP/0/RP0/CPU0:Router(config-ldp-af)# label local advertise explicit-null
RP/0/RP0/CPU0:Router(config-ldp-af)# commit
```

Configuration Example: Implicit Null Override

This example shows how to configure implicit null override for a set of prefixes.

```
RP/0/RP0/CPU0:Router(config)# mpls ldp
RP/0/RP0/CPU0:Router(config-ldp)# address-family ipv4
```

```
RP/0/RP0/CPU0:Router(config-ldp-af)# label local advertise implicit-null-override for acl-1
RP/0/RP0/CPU0:Router(config-ldp-af)# commit
```

Label Distribution Protocol Auto-configuration

LDP auto-configuration allows you to automatically configure LDP on all interfaces for which the IGP protocol is enabled. Typically, LDP assigns and advertises labels for IGP routes and must often be enabled on all active interfaces by an IGP. During LDP manual configuration, you must define the set of interfaces under LDP which is a time-intensive procedure. LDP auto-configuration eliminates the need to specify the same list of interfaces under LDP and simplifies the configuration tasks.

Configuration Example: Enabling LDP Auto-Configuration for OSPF

This example shows how to enable LDP auto-configuration for a specified OSPF instance.

```
RP/0/RP0/CPU0:Router(config)# router ospf 190
RP/0/RP0/CPU0:Router(config-ospf)# mpls ldp auto-config
RP/0/RP0/CPU0:Router(config-ospf)# area 8
RP/0/RP0/CPU0:Router(config-ospf-ar)# interface HundredGigE 0/9/0/0
RP/0/RP0/CPU0:Router(config-ospf-ar-if)# commit
```

Configuring Session Protection

When a new link or node comes up after a link failure, IP converges earlier and much faster than MPLS LDP and may result in MPLS traffic loss until the MPLS convergence. If a link flaps, the LDP session also flaps due to loss of link discovery. LDP session protection minimizes traffic loss, provides faster convergence, and protects existing LDP (link) sessions. When session protection is enabled for a peer, LDP starts sending targeted hello (directed discovery) in addition to basic discovery link hellos. When the direct link goes down, the targeted hellos can still be forwarded to the peer LSR over an alternative path as long as there is one. So, the LDP session stays up after the link goes down.

You can configure LDP session protection to automatically protect sessions with all or a given set of peers (as specified by peer-acl). When configured, LDP initiates backup targeted hellos automatically for neighbors for which primary link adjacencies already exist. These backup targeted hellos maintain LDP sessions when primary link adjacencies go down.

Configuration Example

This example shows how to configure LDP session protection for peers specified by the access control list peer-acl-1 for a maximum duration of 60 seconds.

```
RP/0/RP0/CPU0:Router(config)# mpls ldp
RP/0/RP0/CPU0:Router(config-ldp)# session protection for peer-acl-1 duration 60
RP/0/RP0/CPU0:Router(config-ldp)# commit
```

Configuring Label Distribution Protocol- Interior Gateway Protocol (IGP) Synchronization

Lack of synchronization between LDP and Interior Gateway Protocol (IGP) can cause MPLS traffic loss. Upon link up, for example, IGP can advertise and use a link before LDP convergence has occurred or, a link may continue to be used in IGP after an LDP session goes down.

LDP IGP synchronization coordinates LDP and IGP so that IGP advertises links with regular metrics only when MPLS LDP is converged on that link. LDP considers a link converged when at least one LDP session is up and running on the link for which LDP has sent its applicable label bindings and received at least one label binding from the peer. LDP communicates this information to IGP upon link up or session down events and IGP acts accordingly, depending on sync state.

LDP-IGP synchronization is supported for both OSPF and ISIS protocols and is configured under the corresponding IGP protocol configuration mode. Under certain circumstances, it might be required to delay declaration of re-synchronization to a configurable interval. LDP provides a configuration option to delay declaring synchronization up for up to 60 seconds. LDP communicates this information to IGP upon linkup or session down events.

From the 7.1.1 release, you can configure multiple MPLS-TE tunnel end points on an LER using the TLV 132 function in IS-IS. You can configure a maximum of 63 IPv4 addresses or 15 IPv6 addresses on an LER.

Configuring LDP IGP Synchronization: Open Shortest Path First (OSPF) Example

This example shows how to configure LDP-IGP synchronization for an OSPF instance. The synchronization delay is configured as 30 seconds.

```
RP/0/RP0/CPU0:Router(config)# router ospf 100
RP/0/RP0/CPU0:Router(config-ospf)# mpls ldp sync
RP/0/RP0/CPU0:Router(config-ospf)# mpls ldp igp sync delay 30
RP/0/RP0/CPU0:Router(config-ospf)# commit
```

Configuring LDP IGP Synchronization: Intermediate System to Intermediate System (IS-IS)

This example shows how to configure LDP-IGP synchronization for IS-IS.

```
RP/0/RP0/CPU0:Router(config)# router isis 100
RP/0/RP0/CPU0:Router(config-isis)# interface HundredGigE 0/9/0/0
RP/0/RP0/CPU0:Router(config-isis-if)# address-family ipv4 unicast
RP/0/RP0/CPU0:Router(config-isis-if-af)# mpls ldp sync
RP/0/RP0/CPU0:Router(config-isis-if-af)# commit
```

Configuring Label Distribution Protocol Graceful Restart

LDP Graceful Restart provides a mechanism for LDP peers to preserve the MPLS forwarding state when the LDP session goes down. Without LDP Graceful Restart, when an established session fails, the corresponding forwarding states are cleaned immediately from the restart and peer nodes. In this case, LDP forwarding has to restart from the beginning, causing a potential loss of data and connectivity. If LDP graceful restart is configured, traffic can continue to be forwarded without interruption, even when the LDP session restarts. The LDP graceful restart capability is negotiated between two peers during session initialization time. During session initialization, a router advertises its ability to perform LDP graceful restart by sending the graceful restart typed length value (TLV). This TLV contains the reconnect time and recovery time. The values of the reconnect and recovery times indicate the graceful restart capabilities supported by the router. The reconnect time is the amount of time the peer router waits for the restarting router to establish a connection. When a router discovers that a neighboring router is restarting, it waits until the end of the recovery time before attempting to reconnect. Recovery time is the amount of time that a neighboring router maintains its information about the restarting router.

Configuration Example

This example shows how to configure LDP graceful restart. In this example, the amount of time that a neighboring router maintains the forwarding state about the gracefully restarting router is specified as 180 seconds. The reconnect time is configured as 169 seconds.

```
RP/0/RP0/CPU0:Router(config)# mpls ldp
RP/0/RP0/CPU0:Router(config-ldp)# interface HundredGigE 0/9/0/0
RP/0/RP0/CPU0:Router(config-ldp-if)# exit
RP/0/RP0/CPU0:Router(config-ldp)# graceful-restart
RP/0/RP0/CPU0:Router(config-ldp)# graceful-restart forwarding-state-holdtime 180
RP/0/RP0/CPU0:Router(config-ldp)# graceful-restart reconnect-timeout 169
RP/0/RP0/CPU0:Router(config-ldp)# commit
```

Configuring Label Distribution Protocol Nonstop Routing

LDP nonstop routing (NSR) functionality makes failures, such as Route Processor (RP) or Distributed Route Processor (DRP) fail over, invisible to routing peers with minimal to no disruption of convergence performance. By default, NSR is globally enabled on all LDP sessions except AToM.

A disruption in service may include any of these events:

- Route processor (RP) or distributed route processor (DRP) failover
- LDP process restart
- Minimum disruption restart (MDR)



Note Unlike graceful restart functionality, LDP NSR does not require protocol extensions and does not force software upgrades on other routers in the network, nor does LDP NSR require peer routers to support NSR. L2VPN configuration is not supported on NSR. Process failures of active LDP results in session loss and, as a result, NSR cannot be provided unless RP switchover is configured as a recovery action.

Configuration Example

This example shows how to configure LDP Non-Stop Routing.

```
RP/0/RP0/CPU0:Router(config)# mpls ldp
RP/0/RP0/CPU0:Router(config-ldp)# nsr
RP/0/RP0/CPU0:Router(config-ldp)# commit
```

Verification

```
RP/0/RP0/CPU0:Router# show mpls ldp nsr summary
Mon Dec 7 04:02:16.259 UTC
Sessions:
Total: 1, NSR-eligible: 1, Sync-ed: 0
(1 Ready)
```

MPLS Label Distribution Protocol : Details

This section provides detailed conceptual information about setting up LSPs, LDP graceful restart, and LDP session protection.

Setting Up Label Switched Paths

MPLS packets are forwarded between the nodes on the MPLS network using Label Switched Paths(LSPs). LSPs can be created statically or by using a label distribution protocol like LDP. Label Switched Paths created by LDP performs hop-by-hop path setup instead of an end-to-end path. LDP enables label switched routers (LSRs) to discover their potential peer routers and to establish LDP sessions with those peers to exchange label binding information.

The following figure illustrates the process of label binding exchange for setting up LSPs.

Figure 1: Setting Up Label Switched Paths

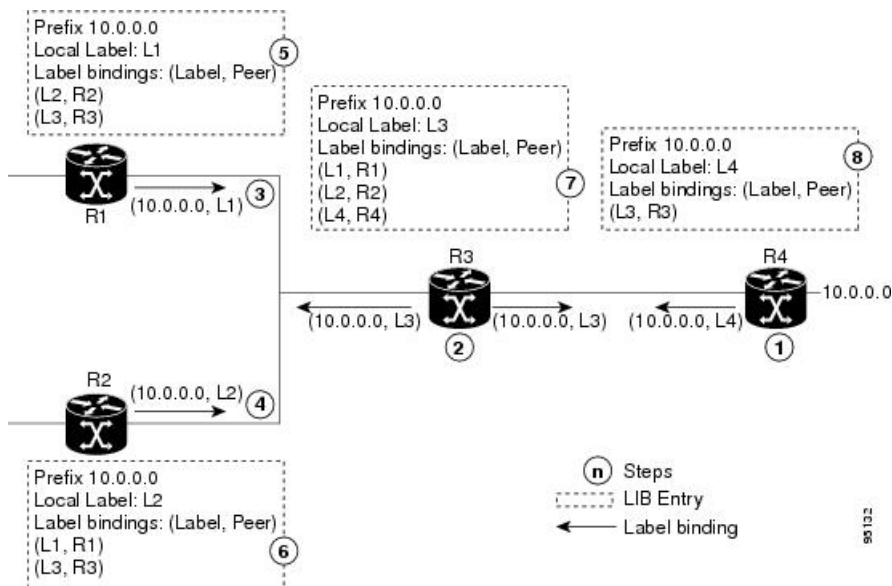

For a given network (10.0.0.0), hop-by-hop LSPs are set up between each of the adjacent routers (or, nodes) and each node allocates a local label and passes it to its neighbor as a binding:

1. R4 allocates local label L4 for prefix 10.0.0.0 and advertises it to its neighbors (R3).
2. R3 allocates local label L3 for prefix 10.0.0.0 and advertises it to its neighbors (R1, R2, R4).
3. R1 allocates local label L1 for prefix 10.0.0.0 and advertises it to its neighbors (R2, R3).
4. R2 allocates local label L2 for prefix 10.0.0.0 and advertises it to its neighbors (R1, R3).
5. R1's label information base (LIB) keeps local and remote labels bindings from its neighbors.
6. R2's LIB keeps local and remote labels bindings from its neighbors.
7. R3's LIB keeps local and remote labels bindings from its neighbors.
8. R4's LIB keeps local and remote labels bindings from its neighbors.

MPLS Forwarding

Once the label bindings are learned, MPLS forwarding plane is setup and packets are forwarded as shown in the following figure.

Figure 2: MPLS Forwarding

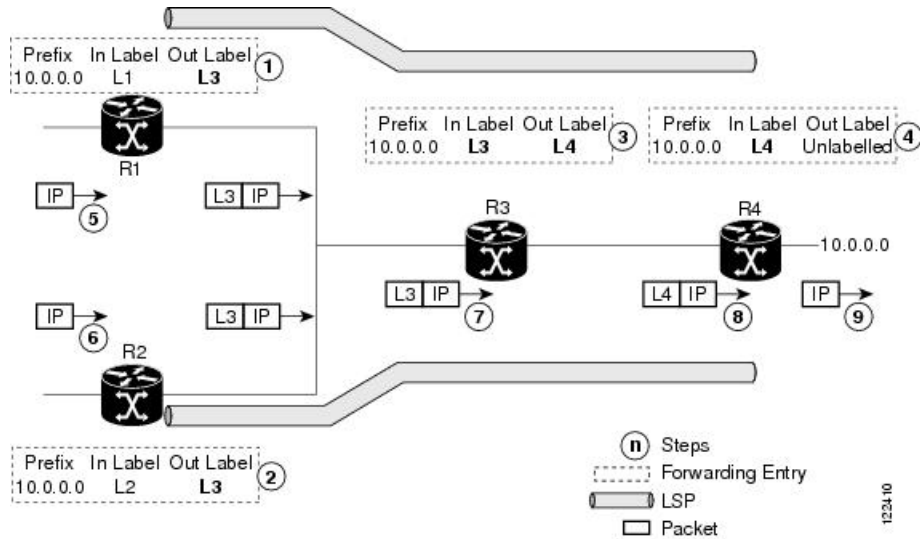

1. Because R3 is next hop for 10.0.0.0 as notified by the FIB, R1 selects label binding from R3 and installs forwarding entry (Layer 1, Layer 3).
2. Because R3 is next hop for 10.0.0.0 (as notified by FIB), R2 selects label binding from R3 and installs forwarding entry (Layer 2, Layer 3).
3. Because R4 is next hop for 10.0.0.0 (as notified by FIB), R3 selects label binding from R4 and installs forwarding entry (Layer 3, Layer 4).
4. Because next hop for 10.0.0.0 (as notified by FIB) is beyond R4, R4 uses NO-LABEL as the outbound and installs the forwarding entry (Layer 4); the outbound packet is forwarded IP-only.
5. Incoming IP traffic on ingress LSR R1 gets label-imposed and is forwarded as an MPLS packet with label L3.
6. Incoming IP traffic on ingress LSR R2 gets label-imposed and is forwarded as an MPLS packet with label L3.
7. R3 receives an MPLS packet with label L3, looks up in the MPLS label forwarding table and switches this packet as an MPLS packet with label L4.
8. R4 receives an MPLS packet with label L4, looks up in the MPLS label forwarding table and finds that it should be Unlabeled, pops the top label, and passes it to the IP forwarding plane.
9. IP forwarding takes over and forwards the packet onward.

Details of Label Distribution Protocol Graceful Restart

LDP (Label Distribution Protocol) graceful restart provides a control plane mechanism to ensure high availability and allows detection and recovery from failure conditions while preserving Nonstop Forwarding

(NSF) services. Graceful restart is a way to recover from signaling and control plane failures without impacting forwarding.

Without LDP graceful restart, when an established session fails, the corresponding forwarding states are cleaned immediately from the restarting and peer nodes. In this case LDP forwarding restarts from the beginning, causing a potential loss of data and connectivity.

The LDP graceful restart capability is negotiated between two peers during session initialization time, in FT SESSION TLV. In this typed length value (TLV), each peer advertises the following information to its peers:

Reconnect time

Advertises the maximum time that other peer will wait for this LSR to reconnect after control channel failure.

Recovery time

Advertises the maximum time that the other peer has on its side to reinstate or refresh its states with this LSR. This time is used only during session reestablishment after earlier session failure.

FT flag

Specifies whether a restart could restore the preserved (local) node state for this flag.

Once the graceful restart session parameters are conveyed and the session is up and running, graceful restart procedures are activated.

When configuring the LDP graceful restart process in a network with multiple links, targeted LDP hello adjacencies with the same neighbor, or both, make sure that graceful restart is activated on the session before any hello adjacency times out in case of neighbor control plane failures. One way of achieving this is by configuring a lower session hold time between neighbors such that session timeout occurs before hello adjacency timeout. It is recommended to set LDP session hold time using the following formula:

```
Session Holdtime <= (Hello holdtime - Hello interval) * 3
```

This means that for default values of 15 seconds and 5 seconds for link Hello holdtime and interval respectively, session hold time should be set to 30 seconds at most.

Phases in Graceful Restart

The graceful restart mechanism is divided into different phases:

Control communication failure detection

Control communication failure is detected when the system detects either:

- Missed LDP hello discovery messages
- Missed LDP keepalive protocol messages
- Detection of Transmission Control Protocol (TCP) disconnection with a peer

Forwarding state maintenance during failure

Persistent forwarding states at each LSR are achieved through persistent storage (checkpoint) by the LDP control plane. While the control plane is in the process of recovering, the forwarding plane keeps the forwarding states, but marks them as stale. Similarly, the peer control plane also keeps (and marks as stale) the installed forwarding rewrites associated with the node that is restarting. The combination of

local node forwarding and remote node forwarding plane states ensures NSF and no disruption in the traffic.

Control state recovery

Recovery occurs when the session is reestablished and label bindings are exchanged again. This process allows the peer nodes to synchronize and to refresh stale forwarding states.

Control Plane Failure

When a control plane failure occurs, connectivity can be affected. The forwarding states installed by the router control planes are lost, and the in-transit packets could be dropped, thus breaking NSF. The following figure illustrates control plane failure and recovery with graceful restart and shows the process and results of a control plane failure leading to loss of connectivity and recovery using graceful restart.

Figure 3: Control Plane Failure

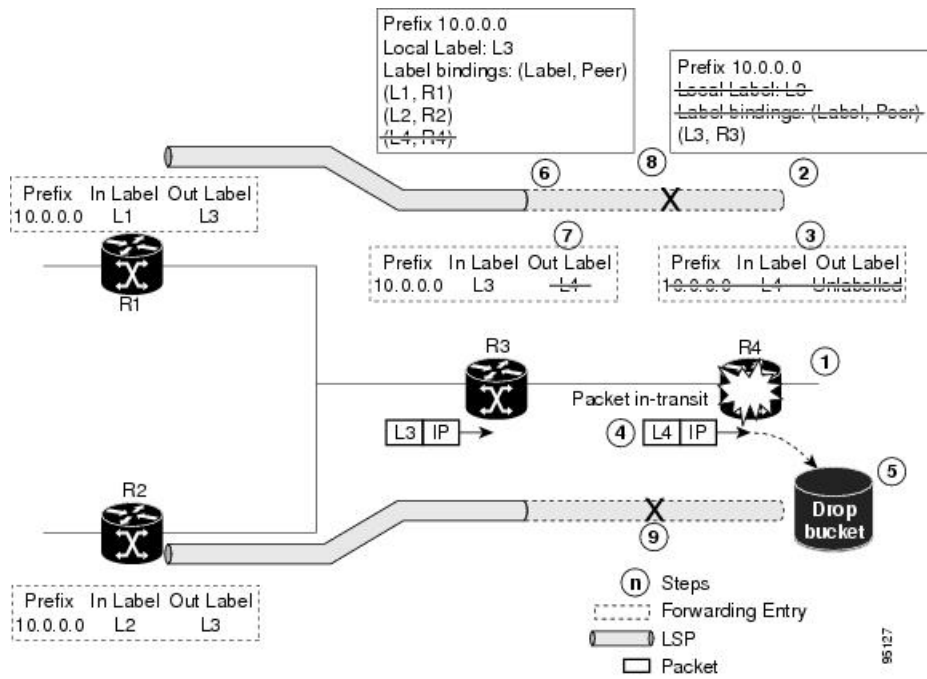

Recovery with Graceful Restart

Figure 4: Recovering with Graceful Restart

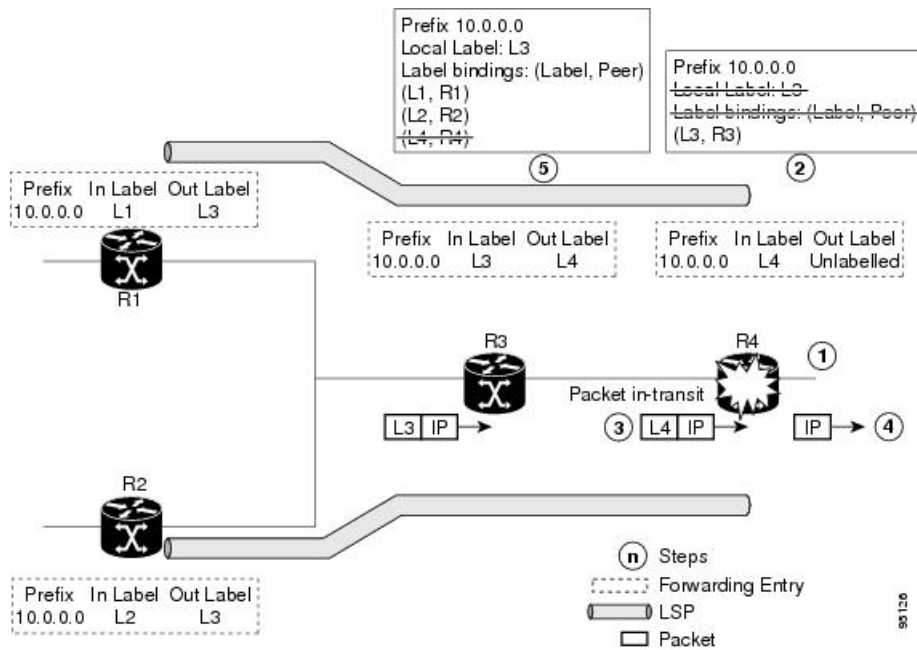

1. The R4 LSR control plane restarts.
2. LIB is lost when the control plane restarts.
3. The forwarding states installed by the R4 LDP control plane are immediately deleted.
4. Any in-transit packets flowing from R3 to R4 (still labeled with L4) arrive at R4.
5. The MPLS forwarding plane at R4 performs a lookup on local label L4 which fails. Because of this failure, the packet is dropped and NSF is not met.
6. The R3 LDP peer detects the failure of the control plane channel and deletes its label bindings from R4.
7. The R3 control plane stops using outgoing labels from R4 and deletes the corresponding forwarding state (rewrites), which in turn causes forwarding disruption.
8. The established LSPs connected to R4 are terminated at R3, resulting in broken end-to-end LSPs from R1 to R4.
9. The established LSPs connected to R4 are terminated at R3, resulting in broken LSPs end-to-end from R2 to R4.

When the LDP control plane recovers, the restarting LSR starts its forwarding state hold timer and restores its forwarding state from the checkpointed data. This action reinstates the forwarding state and entries and marks them as old.

The restarting LSR reconnects to its peer, indicated in the FT Session TLV, that it either was or was not able to restore its state successfully. If it was able to restore the state, the bindings are resynchronized.

The peer LSR stops the neighbor reconnect timer (started by the restarting LSR), when the restarting peer connects and starts the neighbor recovery timer. The peer LSR checks the FT Session TLV if the restarting

peer was able to restore its state successfully. It reinstates the corresponding forwarding state entries and receives binding from the restarting peer. When the recovery timer expires, any forwarding state that is still marked as stale is deleted.

If the restarting LSR fails to recover (restart), the restarting LSR forwarding state and entries will eventually timeout and is deleted, while neighbor-related forwarding states or entries are removed by the Peer LSR on expiration of the reconnect or recovery timers.

Details of Session Protection

LDP session protection lets you configure LDP to automatically protect sessions with all or a given set of peers (as specified by peer-acl). When configured, LDP initiates backup targeted hellos automatically for neighbors for which primary link adjacencies already exist. These backup targeted hellos maintain LDP sessions when primary link adjacencies go down.

The Session Protection figure illustrates LDP session protection between neighbors R1 and R3. The primary link adjacency between R1 and R3 is directly connected link and the backup; targeted adjacency is maintained between R1 and R3. If the direct link fails, LDP link adjacency is destroyed, but the session is kept up and running using targeted hello adjacency (through R2). When the direct link comes back up, there is no change in the LDP session state and LDP can converge quickly and begin forwarding MPLS traffic.

Figure 5: Session Protection

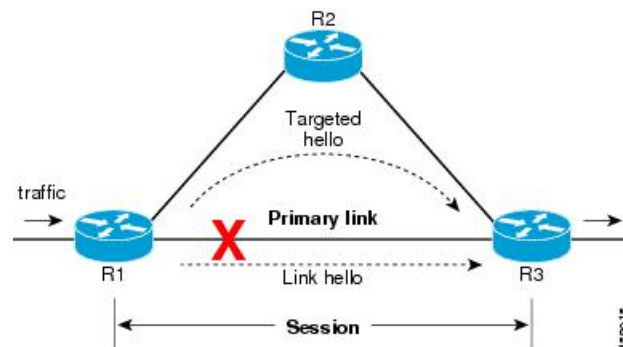

Note When LDP session protection is activated (upon link failure), protection is maintained for an unlimited period time.

Controlling State Advertisements In An mLDP-Only Setup

This function explains the controlling of state advertisements of non-negotiated Label Distribution Protocol (LDP) applications. This implementation is in conformance with RFC 7473 (Controlling State Advertisements of Non-negotiated LDP Applications).

The main purpose of documenting this function is to use it in a Multipoint LDP (mLDP)-only environment, wherein participating routers don't need to exchange any unicast binding information.

Non-Negotiated LDP Applications

The LDP capabilities framework enables LDP applications' capabilities exchange and negotiation, thereby enabling LSRs to send necessary LDP state. However, for the applications that existed prior to the definition of the framework (called *non-negotiated* LDP applications), there is no capability negotiation done. When an LDP session comes up, an LDP speaker may unnecessarily advertise its local state (without waiting for any capabilities exchange and negotiation). In other words, even when the peer session is established for Multipoint LDP (mLDP), the LSR advertises the state for these early LDP applications.

One example is *IPv4/IPv6 Prefix LSPs Setup* (used to set up Label Switched Paths [LSPs] for IP prefixes). Another example is *L2VPN P2P FEC 128 and FEC 129 PWs Signaling* (an LDP application that signals point-to-point [P2P] Pseudowires [PWs] for Layer 2 Virtual Private Networks [L2VPNs]).

In an mLDP-only setup, you can disable these non-negotiated LDP applications and avoid unnecessary LDP state advertisement. An LDP speaker that only runs mLDP announces to its peer(s) its disinterest (or non-support) in non-negotiated LDP applications. That is, it announces to its peers its disinterest to set up IP Prefix LSPs or to signal L2VPN P2P PW, at the time of session establishment.

Upon receipt of such a capability, the receiving LDP speaker, if supporting the capability, disables the advertisement of the state related to the application towards the sender of the capability. This new capability can also be sent later in a Capability message, either to disable a previously enabled application's state advertisement, or to enable a previously disabled application's state advertisement.

As a result, the flow of LDP state information in an mLDP-only setup is faster. When routers come up after a network event, the network convergence time is fast too.

IP Address Bindings In An mLDP Setup

An LSR typically uses peer IP address(es) to map an IP routing next hop to an LDP peer in order to implement its control plane procedures. mLDP uses a peer's IP address(es) to determine its upstream LSR to reach the root node, and to select the forwarding interface towards its downstream LSR. Hence, in an mLDP-only network, while it is desirable to disable advertisement of label bindings for IP (unicast) prefixes, disabling advertisement of IP address bindings will break mLDP functionality.

Uninteresting State - For the *Prefix-LSP* LDP application, *uninteresting* state refers to any state related to IP Prefix FEC, such as FEC label bindings and LDP Status. IP address bindings are not considered as an *uninteresting* state.

For the P2P-PW application LDP application, *uninteresting* state refers to any state related to P2P PW FEC 128 or FEC 129, such as FEC label bindings, MAC address withdrawal, and LDP PW status.

Control State Advertisement

To control advertisement of *uninteresting* state of non-negotiated LDP applications, the capability parameter TLV *State Advertisement Control Capability* is used. This TLV is only present in the Initialization and Capability messages, and the TLV can hold one or more State Advertisement Control (SAC) Elements.

As an example, consider two LSRs, S (LDP speaker) and P (LDP peer), that support all non-negotiated applications. S is participating (or set to participate) in an mLDP-only setup. Pointers for this scenario:

- By default, the LSRs will advertise state for all LDP applications to their peers, as soon as an LDP session is established.
- The **capabilities sac mldp-only** function is enabled on S.
- P receives an update from S via a Capability message that specifies to disable all four non-negotiated applications states.

- P's outbound policy towards S blocks and disables state for the unneeded applications.
- S only receives mLDP advertisements from specific mLDP-participating peers.

Use Cases For Controlling State Advertisements

Two use cases are explained, **mLDP-Based MVPN** and **Disable Prefix-LSPs On An L2VPN/PW tLDP Session**.

Disable Prefix-LSPs On An L2VPN/PW tLDP Session

A sample topology and relevant configurations are noted below.

Figure 6: L2VPN Xconnect Service Over Segment Routing

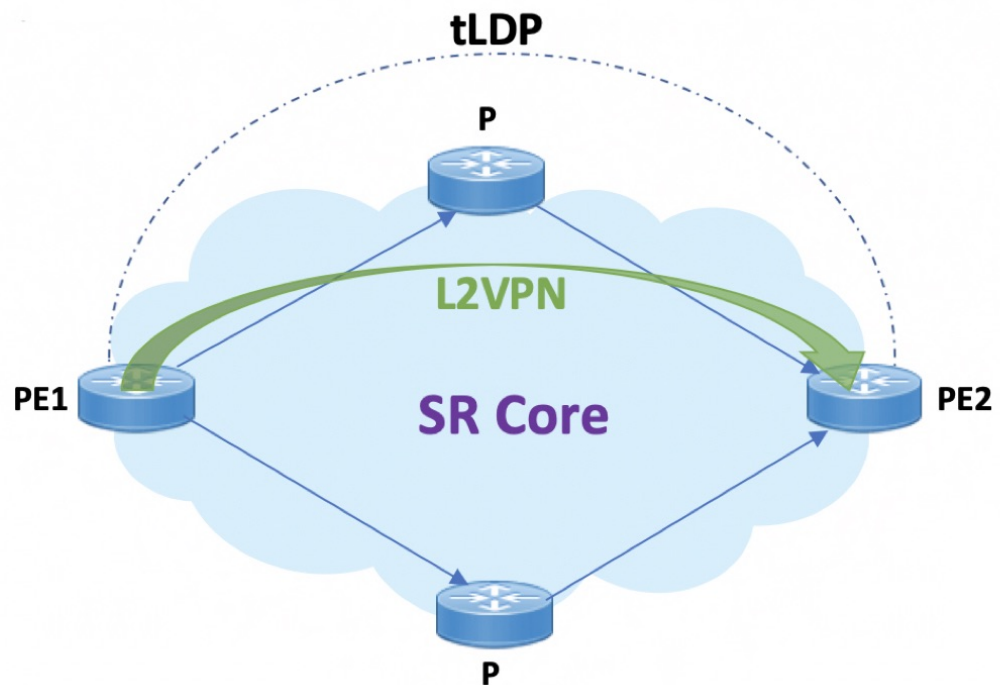

- The topology represents an L2VPN Xconnect service over a Segment Routing core setup.
- By default, Xconnect uses tLDP to signal service labels to remote PEs.
- By default, tLDP not only signals the service label, but also known (IPv4 and IPv6) label bindings to the tLDP peer, which is not required.
- The LDP SAC capabilities is an optional configuration enabled under LDP, and users can block IPv4 and IPv6 label bindings by applying configurations on PE1 and PE2.

Configuration

PE1 Configuration

Disable IPv4 prefix LSP binding advertisements on PE1:

```
PE1(config)# mpls ldp capabilities sac ipv4-disable
PE1(config)# commit
```

Disable IPv6-prefix LSP binding advertisements on PE1:

```
PE1(config)# mpls ldp capabilities sac ipv4-disable ipv6-disable
PE1(config)# commit
```



Note Whenever you disable a non-negotiated LDP application state on a router, you must include previously disabled non-negotiated LDP applications too, in the same command line. If not, the latest configuration overwrites the existing ones. You can see that `ipv4-disable` is added again, though it was already disabled.

PE2 Configuration

Enable SAC capability awareness on PE2, and make PE2 stop sending IPv4 prefix LSP binding advertisements to PE1:

```
PE2(config)#mpls ldp capabilities sac
PE2(config)#commit
```

Verification

On PE1, verify PE2's SAC capabilities:

```
PE1# show mpls ldp neighbor 198.51.100.1 detail

Peer LDP Identifier: 198.51.100.1:0
  TCP connection: 198.51.100.1:29132 - 192.0.2.1:646
  Graceful Restart: No
  Session Holdtime: 180 sec
  State: Oper; Msgs sent/rcvd: 14/14; Downstream-Unsolicited
  Up time: 00:03:30
  LDP Discovery Sources:
    IPv4: (1)
      Targeted Hello (192.0.2.1 -> 198.51.100.1, active)
    IPv6: (0)
  Addresses bound to this peer:
    IPv4: (3)
      203.0.113.1      209.165.201.1      10.0.0.1      198.51.100.1
      172.16.0.1
    IPv6: (0)
  Peer holdtime: 180 sec; KA interval: 60 sec; Peer state: Estab
  NSR: Disabled
  Clients: AToM
  Capabilities:
    Sent:
      0x508 (MP: Point-to-Multipoint (P2MP))
      0x509 (MP: Multipoint-to-Multipoint (MP2MP))
      0x50b (Typed Wildcard FEC)
      0x50d (State Advertisement Control)
      [ {IPv4-disable} ] (length 1)
    Received:
      0x508 (MP: Point-to-Multipoint (P2MP))
      0x509 (MP: Multipoint-to-Multipoint (MP2MP))
```

```
0x50b (Typed Wildcard FEC)
0x50d (State Advertisement Control)
```

Capabilities Sent SAC capability **ipv4-disable** is sent, and local IPv4 label bindings are not generated.

Capabilities Received The peer (PE2) understands SAC capability and won't send its local IPv4 label bindings to local PE.

On PE1, verify SAC capabilities:

```
PE1# show mpls ldp capabilities detail
```

| Type | Description | Owner |
|--------|---|------------|
| 0x50b | Typed Wildcard FEC Capability data: None | LDP |
| 0x3eff | Cisco IOS-XR Capability data: Length: 12 Desc : [host=PE1; platform=NCS 560; release=07.01.01] | LDP |
| 0x508 | MP: Point-to-Multipoint (P2MP) Capability data: None | mLDP |
| 0x509 | MP: Multipoint-to-Multipoint (MP2MP) Capability data: None | mLDP |
| 0x50d | State Advertisement Control Capability data: Length: 1 Desc : [{IPv4-disable}] | LDP |
| 0x703 | P2MP PW Capability data: None | L2VPN-AToM |

On PE1, verify that local and remote FEC bindings are removed.

```
PE1# show mpls ldp neighbor 198.51.100.1
Wed March 3 13:42:13.359 EDTs
```

mLDP-Based MVPN

A sample topology and relevant configurations are noted below.

Figure 7: mLDP-Based MVPN Over Segment Routing

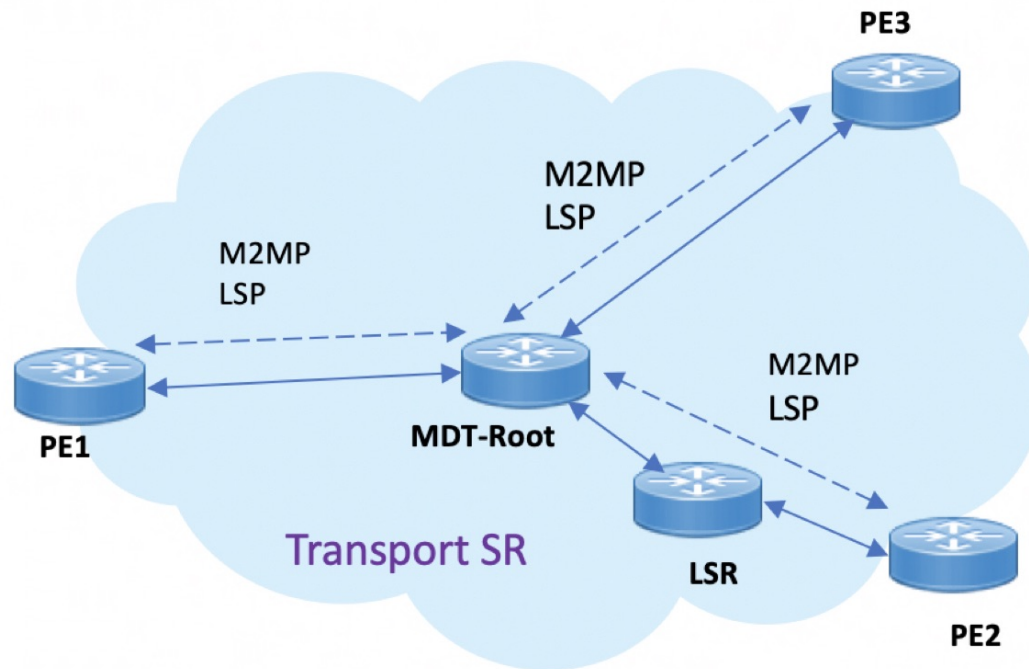

- The topology represents an MVPN profile 1 where an mLDP-based MVPN service is deployed over a Segment Routing core setup
- mLDP is required to signal MP2MP LSPs, whereas SR handles the transport.
- SAC capabilities are used to signal *mLDP-only* capability, which blocks unrequired unicast IPv4, IPv6, FEC128, and FEC129 related label binding advertisements.
- The **mldp-only** option is enabled on PE routers and P routers to remove unwanted advertisements.

Configuration

PE1 Configuration

Configure mLDP SAC capability on PE1.

```
PE1(config)# mpls ldp
PE1(config-ldp)# capabilities sac mldp-only
PE1(config-ldp)# commit
```

PE2 Configuration

Configure mLDP SAC capability on PE2.

```
PE2(config)# mpls ldp
PE2(config-ldp)# capabilities sac mldp-only
PE2(config-ldp)# commit
```

Verification

LDP peers (PE1 and PE2) are configured with **mldp-only** option, disabling all other SAC capabilities.

```
PE1# show running-config mpls ldp
```

```
mpls ldp
  capabilities sac mldp-only
  mldp
    address-family ipv4
    !
```

```
PE2# show running-config mpls ldp
```

```
mpls ldp
  capabilities sac mldp-only
  mldp
    address-family ipv4
    !
```

On PE1, verify PE2's SAC capabilities:

```
PE1# show mpls ldp neighbor 209.165.201.20 capabilities detail
```

```
Peer LDP Identifier: 209.165.201.20:0
Capabilities:
  Sent:
    0x508 (MP: Point-to-Multipoint (P2MP))
    0x509 (MP: Multipoint-to-Multipoint (MP2MP))
    0x50b (Typed Wildcard FEC)
    0x50d (State Advertisement Control)
    [ {IPv4-disable}{IPv6-disable}{FEC128-disable}{FEC129-disable} ] (length 4)
  Received:
    0x508 (MP: Point-to-Multipoint (P2MP))
    0x509 (MP: Multipoint-to-Multipoint (MP2MP))
    0x50b (Typed Wildcard FEC)
    0x50d (State Advertisement Control)
    [ {IPv4-disable}{IPv6-disable}{FEC128-disable}{FEC129-disable} ] (length 4)
```

Capabilities Sent shows that **mldp-only** option disables all other advertisements.

Capabilities Received shows that **mldp-only** is enabled on peer PE2 too.

