



Segment Routing Tree Segment Identifier

Tree Segment Identifier (Tree-SID) is a tree-building solution that uses a Segment Routing Path Computation Element (SR-PCE) using path computation element protocol (PCEP) to calculate the point-to-multipoint (P2MP) tree using SR policies. Tree-SID uses a single MPLS label for building a multicast replication tree in an SR network. Tree-SID does not require multicast control protocols such as RSVP, mLDP, and PIM.

A P2MP SR policy provides an SR-based TE solution for transporting multicast traffic. It works on existing data-plane (MPLS and IP) and supports TE capabilities and single/multi routing domains. At each node of the tree, the forwarding state is represented by the same segment (using a global Tree-SID specified from the SRLB range of labels). P2MP SR policy prevents transient loop and packet loss when updating the path of a P2MP SR policy.

A P2MP SR policy request contains the following:

- Policy name
- SID for the P2MP Tree (Tree-SID)
- Address of the root-node
- Addresses of the leaf-nodes
- TE optimization criteria (for example, TE or IGP metric) and constraints
- [Configure Segment Routing Tree-SID, on page 1](#)
- [Running Config, on page 3](#)
- [Multicast VPN: Tree-SID MVPN, on page 5](#)
- [Multicast: Cisco Nonstop Forwarding for Tree-SID, on page 20](#)
- [Multicast VPN IPv6: Dynamic Tree-SID Multicast VPN IPv6, on page 21](#)

Configure Segment Routing Tree-SID

To configure Segment Routing Tree-SID for Point-to-Multipoint (P2MP) SR policies, complete the following configurations:

1. Configure Path Computation Element Protocol (PCEP) Path Computation Client (PCC) on all nodes involved in the Tree-SID path (root, mid-point, leaf)
2. Configure Affinity Maps on the SR-PCE
3. Configure P2MP SR Policy on SR-PCE

4. Configure Multicast on the Root and Leaf Nodes

Configure PCEP PCC on All Nodes in Tree-SID Path

Configure all nodes involved in the Tree-SID path (root, mid-point, leaf) as PCEP PCC. For detailed PCEP PCC configuration information, see the [Configure the Head-End Router as PCEP PCC](#) section.

Configure Affinity Maps on the SR-PCE

Use the **affinity bit-map** *COLOR bit-position* command in PCE SR-TE sub-mode to define affinity maps. The bit-position range is from 0 to 255.

```
Router# configure
Router(config)# pce
Router(config-pce)# segment-routing traffic-eng
Router(config-pce-sr-te)# affinity bit-map RED 23
Router(config-pce-sr-te)# affinity bit-map BLUE 24
Router(config-pce-sr-te)# affinity bit-map CROSS 25
Router(config-pce-sr-te)#
```

Configure P2MP SR Policy on SR-PCE

Configure the end-point name and addresses, Tree-SID label, and constraints for the P2MP policy.

Use the **endpoint-set** *NAME* command in SR-PCE P2MP sub-mode to enter the name of the end-point set and to define the set of end-point addresses.

```
Router(config-pce-sr-te)# p2mp
Router(config-pce-sr-te-p2mp)# endpoint-set BAR
Router(config-pce-p2mp-ep-set)# ipv4 1.1.1.2
Router(config-pce-p2mp-ep-set)# ipv4 1.1.1.3
Router(config-pce-p2mp-ep-set)# ipv4 1.1.1.4
Router(config-pce-p2mp-ep-set)# exit
Router(config-pce-sr-te-p2mp)#
```

Use the **policy** *policy* command to configure the P2MP policy name and enter P2MP Policy sub-mode. Configure the source address, endpoint-set color, Tree-SID label, affinity constraints, and metric type.

```
Router(config-pce-sr-te-p2mp)# policy FOO
Router(config-pce-p2mp-policy)# source ipv4 1.1.1.6
Router(config-pce-p2mp-policy)# color 10 endpoint-set BAR
Router(config-pce-p2mp-policy)# treesid mpls 15200
Router(config-pce-p2mp-policy)# candidate-paths
Router(config-pce-p2mp-policy-path)# constraints
Router(config-pce-p2mp-policy-path)# affinity
Router(config-pce-p2mp-policy-path-affinity)# exclude BLUE
Router(config-pce-p2mp-policy-path-affinity)# exit
Router(config-pce-p2mp-policy-path)# exit
Router(config-pce-p2mp-policy-path)# preference 100
Router(config-pce-p2mp-policy-path-preference)# dynamic
Router(config-pce-p2mp-policy-path-info)# metric type te
Router(config-pce-p2mp-policy-path-info)# root
Router(config)#
```

Configure Multicast on the Root and Leaf Nodes

On the root node of the SR P2MP segment, use the **router pim** command to enter Protocol Independent Multicast (PIM) configuration mode to statically steer multicast flows into an SR P2MP policy.



Note Enter this configuration only on an SR P2MP segment. Multicast traffic cannot be steered into a P2P policy.

```
Router(config)# router pim
Router(config-pim)# vrf name
Router(config-pim-name)# address-family ipv4
Router(config-pim-name-ipv4)# sr-p2mp-policy FOO
Router(config-pim-name-ipv4-srp2mp)# static-group 235.1.1.5 1.1.1.6
Router(config-pim-name-ipv4-srp2mp)# root
Router(config)#
```

On the root and leaf nodes of the SR P2MP tree, use the **mdt static segment-routing** command to configure the multicast distribution tree (MDT) core as Tree-SID from the multicast VRF configuration submode.

```
Router(config)# multicast-routing
Router(config-mcast)# vrf TEST
Router(config-mcast-TEST)# address-family ipv4
Router(config-mcast-TEST-ipv4)# mdt static segment-routing
```

On the leaf nodes of an SR P2MP segment, use the **static sr-policy p2mp-policy** command to configure the static SR P2MP Policy from the multicast VRF configuration submode to statically decapsulate multicast flows.

```
Router(config)# multicast-routing
Router(config-mcast)# vrf TEST
Router(config-mcast-TEST)# address-family ipv4
Router(config-mcast-TEST-ipv4)# static sr-policy FOO
```

Running Config

The following example shows how to configure the end point addresses and P2MP SR policy with affinity constraints on SR-PCE.

```
pce
segment-routing
traffic-eng
affinity bit-map
RED 23
BLUE 24
CROSS 25
!
p2mp
endpoint-set BAR
ipv4 1.1.1.2
ipv4 1.1.1.3
ipv4 1.1.1.4
!
policy FOO
source ipv4 1.1.1.6
color 10 endpoint-set BAR
treesid mpls 15200
candidate-paths
preference 100
dynamic
metric
type te
```

Multicast VPN: Tree-SID MVPN

Table 1: Feature History Table

Feature Name	Release Information	Feature Description
Multicast VPN: Tree-SID MVPN	Release 7.8.1	<p>With this feature, you can use SR and MVPN for optimally transporting IP VPN multicast traffic over the SP network, using SR-PCE as a controller.</p> <p>With SR's minimal source router configuration requirement, its ability to implement policies with specific optimization objectives and constraints and use SR-PCE to dynamically generate optimal multicast trees (including when topology changes occur in the multicast tree), the SR-enabled SP network can transport IP multicast traffic efficiently.</p>

Prerequisites for Multicast VPN: Tree-SID MVPN

- The underlay OSPF/IS-IS network is configured, and OSPF/IS-IS adjacency is formed between routers, across the network.
- BGP is configured for the network, and BGP adjacency is formed between routers. BGP MVPN configuration information is provided in this feature document.
- To understand the benefits, know-how, and configuration of SR and SR-TE policies, see About Segment Routing and Configure SR-TE Policies.

Information About Multicast VPN: Tree-SID MVPN

Typically, a customer's IP VPN is spread across VPN sites. IP VPN customer traffic is sent from one site to another over a VPN Service Provider (SP) network.

When IP multicast traffic within a (BGP/MPLS) IP VPN is transported over an SP network (say, from **VPN1-Site-A** to **VPN1-Site-B**, as shown in the image), the SP network requires protocols and procedures to optimally transport multicast traffic from a multicast sender in Site-A to multicast receivers in Site-B.

This use case explains how to enable SR multicast for an SP network, and efficiently transport IP VPN multicast traffic (sent from **VPN1-Site-A** and) received at PE router A, through to PE routers D and E, towards receivers in sites **VPN1-Site-B** and **VPN1-Site-C**.

Figure 1: IP VPN Multicast Traffic Flow Over An SP Network

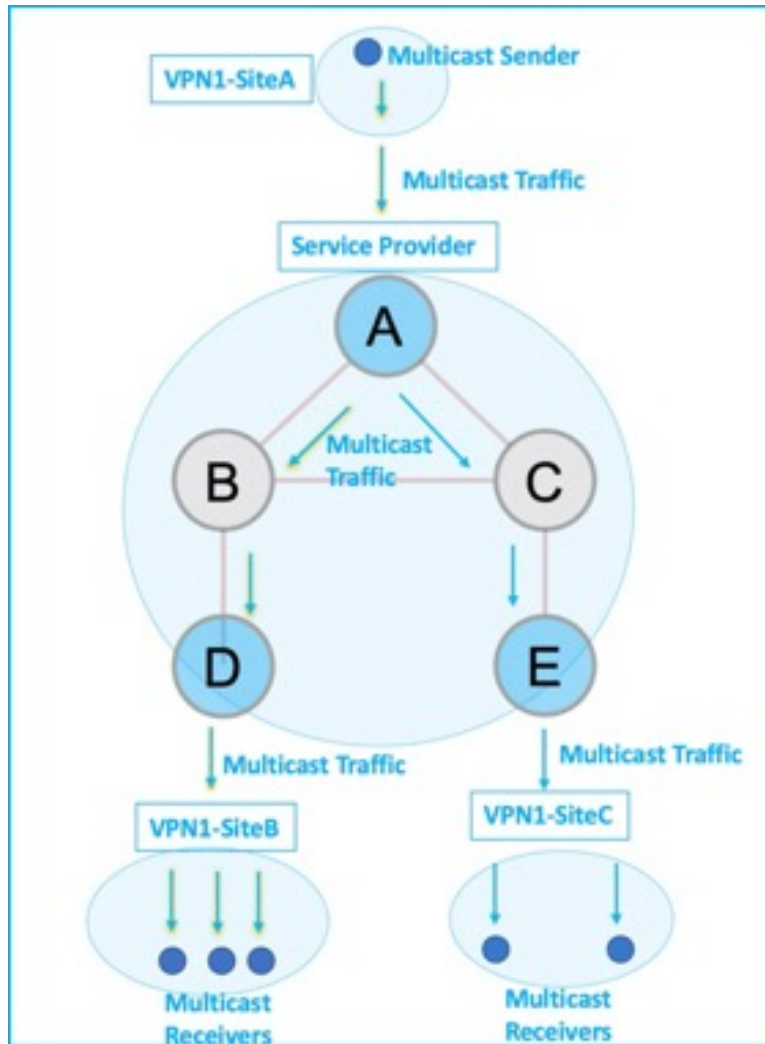

To enable the *Multicast VPN: Tree-SID MVPN* feature, the following protocols and software applications are used.

OSPF/IS-IS - The underlay network is created with OSPF/IS-IS routing protocol, and reachability is established across the network. See *Configure Segment Routing for IS-IS Protocol* and *Configure Segment Routing for OSPF Protocol* chapter for details.

BGP Multicast VPN (MVPN) – The PE routers (A, D, and E) are IP VPN end-points for IP multicast traffic arriving at the SP network (at PE router A) and exiting the SP network (at PE routers D and E). So, BGP MVPN is enabled on the PE routers. NSO is used to configure BGP MVPN on the PE routers.

BGP Auto-Discovery (AD) - To enable distributed VPN end-point discovery and C-multicast flow mapping and signalling, BGP AD function is configured on the PE routers. A BGP Auto-Discovery route contains multicast router (loopback IP address) and tree identity (segment ID) information. It carries the information in the Provider Multicast Service Interface (PMSI) Tunnel Attribute (PTA).

C-multicast states are signaled using BGP.

SR - To transport IP multicast traffic between the VPN end-points (PE routers A, D, and E), Provider (or P-) tunnels are used. In a P-tunnel, the PE devices are the tunnel end-points. P-tunnels can be generated using different technologies (RSVP-TE, P2MP LSPs, PIM trees, mLDP P2MP LSPs, and mLDP MP2MP LSPs). In this use case, Segment Routing (SR) is used for its benefits that were noted earlier.

With SR and SR-PCE, a Tree-SID Point-to-Multipoint (P2MP) segment is used to create P-Tunnels for MVPN. You can specify SR policy optimization objectives (such as *metrics*) and constraints (such as *affinity*) in an SR policy and send it to the SR-PCE controller, so that it can dynamically create SR multicast trees for traffic flow.

SR-PCE - This is a controller which, based on the provided SR policy information, computes optimal paths for a multicast tree, and deploys the tree forwarding state on the multicast routers. When a topology change occurs, SR-PCE automatically computes a new, optimal multicast tree, and deploys the new tree forwarding state on the multicast routers.

Overview of Multicast VPN: Tree-SID MVPN

The following sections provide an overview of Tree-SID MVPN. The topology remains the same, with PE routers A, D, and E acting as VPN end-points for carrying IP VPN multicast traffic.

Tree-SID MVPN Overview

1. For SR, A is designated as the SR head-end router, and D and E are designated as the SR end-points.

For multicast traffic, A is the root of the SR multicast tree, and D and E are leaf routers of the tree. B and C are the other multicast routers. The objective is to send the IP multicast traffic arriving at A to D and E, as needed

Figure 2: Multicast Tree

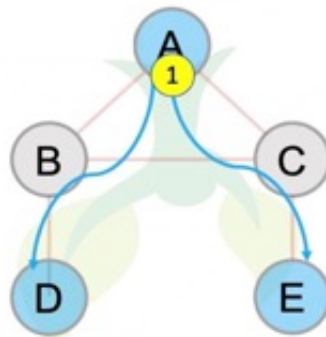

2. A discovers leaf routers' information through BGP MVPN.
3. Path Computation Element Protocol (PCEP) is used for the SR multicast policy communication between A and the SR-PCE server, and communication between PE routers and the SR-PCE server.
4. When the head-end router SR policy is created on A, and PCEP configurations are enabled on the SR-PCE server and all multicast routers, SR-PCE receives the SR policy and leaf router identity information from A.
5. Based on the policy information it receives, including TE objectives and constraints, SR-PCE builds multicast distribution trees in the underlay for efficient VPN traffic delivery.

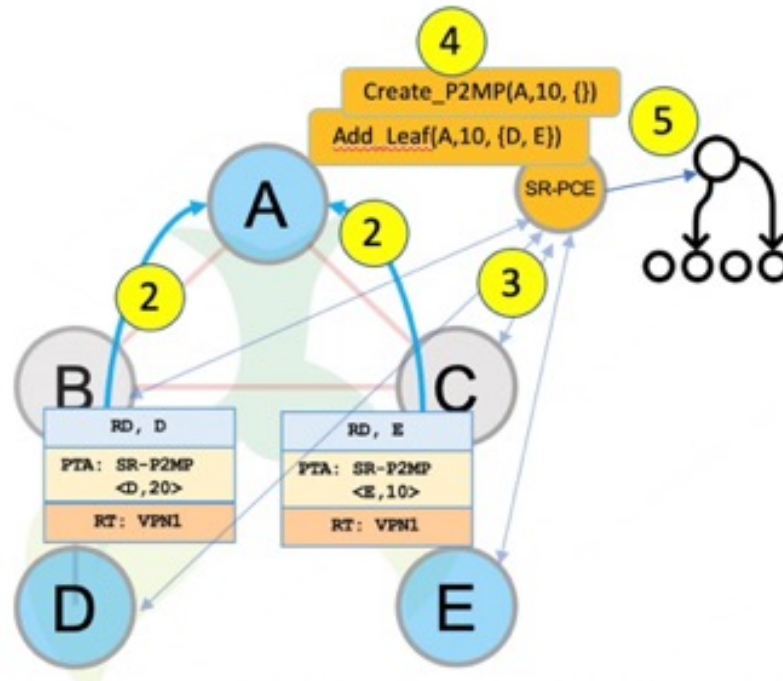

6. SR-PCE assigns an SID for the SR multicast tree policy, and deploys the multicast tree forwarding state on the multicast routers.
7. When IP multicast traffic is sent from VPN1-SiteA to PE router A, it steers it into the SR policy, and sends it towards D and E, which forward it to multicast traffic receivers in the sites VPN1-SiteB and VPN1-SiteC.
8. When a leaf/multicast router is added or removed, PE router A updates the SR multicast policy and sends it to SR-PCE. SR-PCE computes new multicast routes, and deploys the multicast tree forwarding state information on the multicast routers.

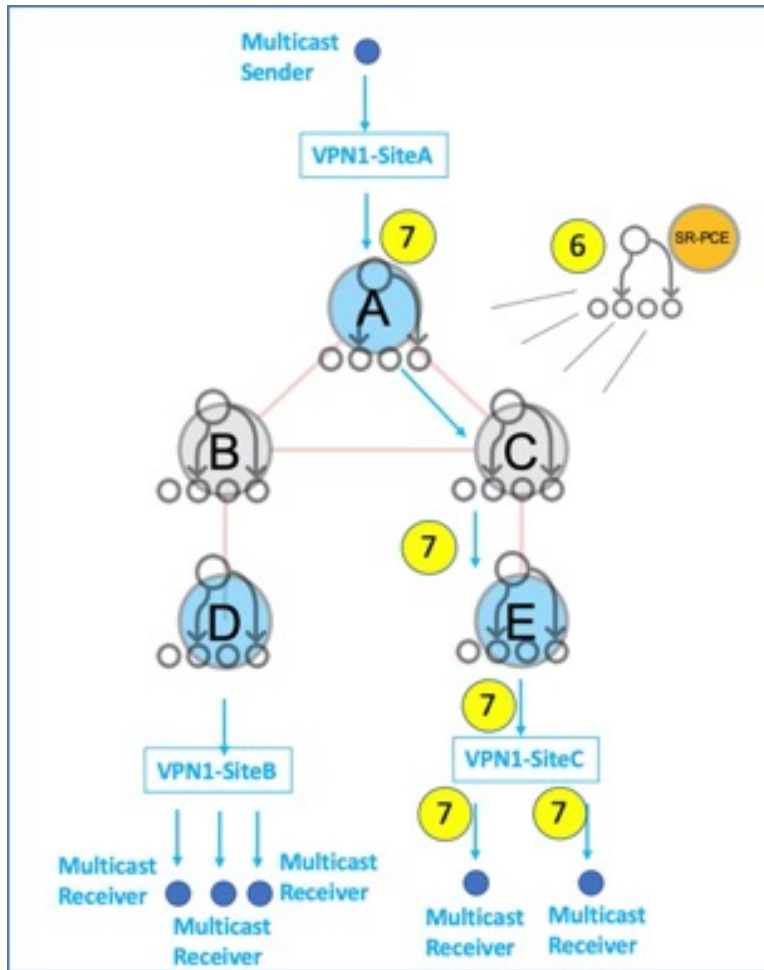

SR Multicast Tree Types

This is an overview of the types of SR multicast trees you can configure, depending on your requirement. You can create a full mesh, on-demand, or optimal multicast tree for IP VPN multicast flow in the SP network.

Figure 3: Full Mesh Multicast Tree

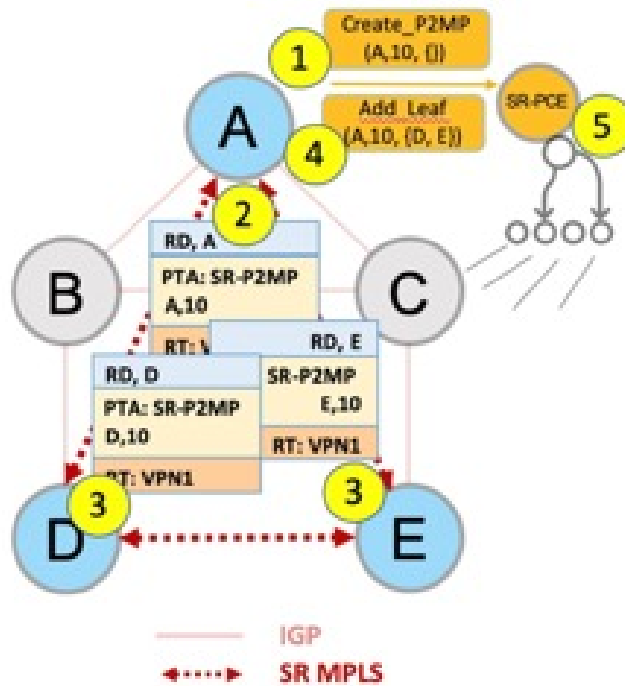

1. A assigns Tree-ID 10 and invokes a Create an SR multicast tree request by sending the multicast router and tree ID information (A, 10) towards SR-PCE.
2. A announces BGP AD Inclusive PMSI (I-PMSI) route with the PTA (A, 10). Inclusive PMSI - Traffic that is multicast by a PE router on an I-PMSI is received by all other PEs in the MVPN. I-PMSIs are generated by Inclusive P-tunnels .
3. A discovers VPN endpoints D and E from their BGP AD Type I-PMSI route messages.
4. A invokes an Add SR multicast leaf router request (for D and E) to SR-PCE.
5. SR-PCE computes and generates the multicast tree forwarding state information on all the routers that are part of the tree.

Figure 4: On-Demand SR Multicast Tree

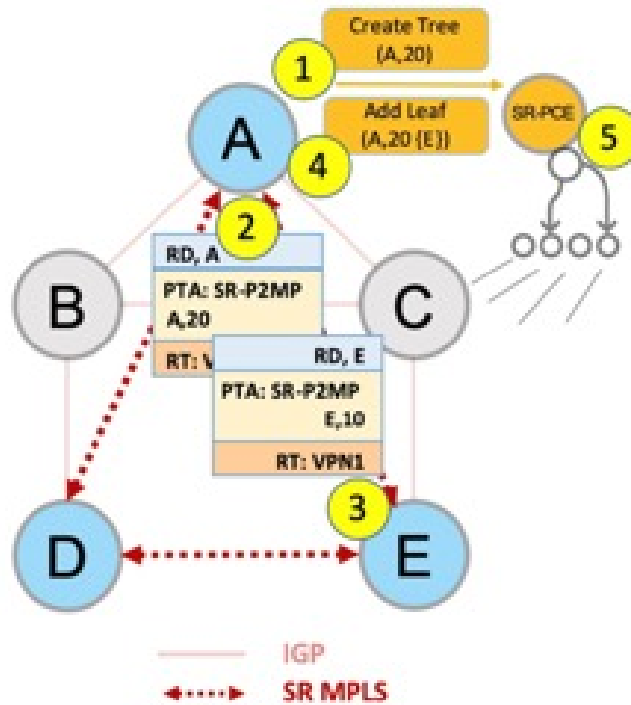

1. A assigns Tree-ID 20 and invokes a Create an SR multicast tree request by sending the multicast router and tree ID information (A, 20) towards SR-PCE.
2. A announces BGP AD Selective PMSI (or S-PMSI) route with PTA (A, 20). A sets the leaf-info-required to discover endpoint interest set.
Selective PMSI - Traffic multicast by a PE on an S-PMSI is received by some PEs in the MVPN. S-PMSIs are generated by Selective P-tunnels.
3. E has a receiver behind it, and announces a BGP-AD leaf route towards A. A discovers service endpoint E for the on-demand tree.
4. A invokes an Add SR multicast leaf router request (for E) to SR-PCE.
5. SR-PCE computes and generates the multicast tree information for all the routers that are part of the tree.

Figure 5: Optimal Multicast Tree

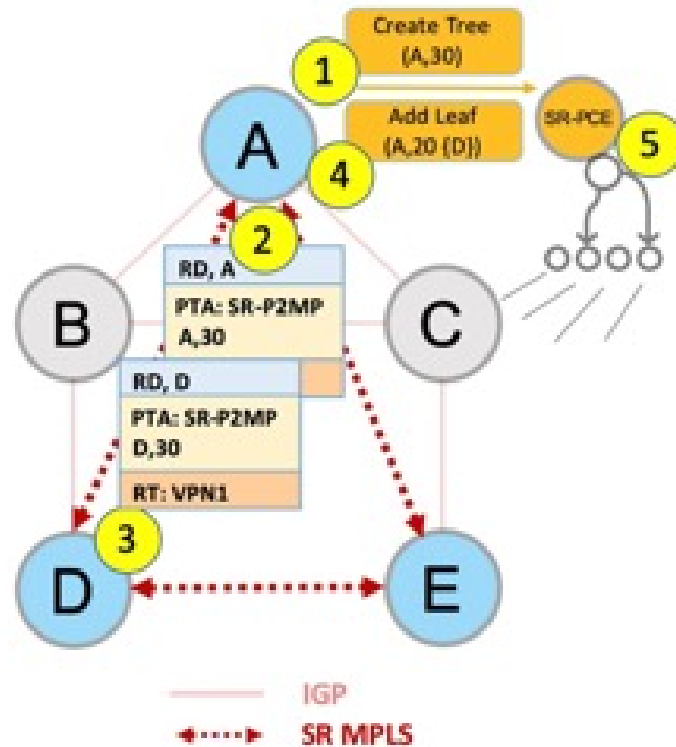

1. A decides to optimize a flow and assigns Tree-ID 30 and invokes a Create an SR multicast tree request by sending the multicast router and tree ID information (A, 30) towards SR-PCE.
2. A announces BGP AD I-PMSI route with PTA (A,30). A sets the leaf-info-required to discover endpoint interest set.
3. D has a receiver behind it, and announces a BGP-AD leaf route towards A. A discovers service endpoint D for optimized flow.
4. A invokes an Add SR multicast leaf router request (for D) to SR-PCE.
5. SR-PCE computes and generates the multicast tree information for all the routers that are part of the tree.

Configurations

Head End Router Configuration (Router A) - The following configuration is specific to the head end router.

Configure TE Constraints and Optimization Parameters

```
Router# configure terminal
Router(config)# segment-routing traffic-engineering
```

An affinity bit-map is created so that it can be applied to a link or interface.

```
Router(config-sr-te)# affinity-map name 10 bit-position 24
Router(config-sr-te)# commit
```

An affinity (or relationship) is created between the SR policy path and the link color so that SR-TE computes a path that includes or excludes links, as specified. The head-end router automatically follows the actions defined in the ODN template (for color 10) upon the arrival of VPN routes with a BGP color extended community that matches color 10.

```
Router(config)# segment-routing traffic-engineering
Router(config-sr-te)# on-demand color 10 dynamic
Router(config-sr-te-color-dyn)# affinity include-all name red
Router(config-sr-te-color-dyn)# affinity include-any name blue
Router(config-sr-te-color-dyn)# affinity exclude-any name green
Router(config-sr-te-color-dyn)# metric type te
Router(config-sr-te-color-dyn)# commit
```

The SR policy configuration on the head-end router A will be sent to the SR-PCE server, after a connection is established between A and SR-PCE.

Multicast Router Configuration

Configure PCEP Client on Multicast Routers

Associate each multicast router as a client of the SR-PCE server. The **pce address ipv4** command specifies the SR-PCE server's IP address.

```
Router# configure terminal
Router(config)# segment-routing traffic-engineering
Router(config-sr-te)# pcc pce address ipv4 3.3.3.3
Router(config-pcc-pce)# commit
```

SR PCE Server Configuration

Configure Label Range for Multicast Trees

Configure the label range to be used for transporting IP multicast traffic in SP network.

```
Router(config)# pce segment-routing traffic-eng p2mp label-range min 30000 max 60000
Router(config)# commit
```

Disable ECMP load splitting

To disable ECMP load splitting of different trees on the SR-PCE server, configure the **multipath-disable** command.

```
Router(config)# pce segment-routing traffic-eng p2mp multipath-disable
Router(config)# commit
```

Multicast Routing Configuration On PE Routers

The following MVPN configurations are required for VPN end-points, the 3 PE routers.

Configure Default MDT SR P2MP MVPN Profile

In this configuration, an MDT profile of the type *default* is created, and the SR multicast policy with color 10 will be used to send IP multicast traffic, as per the constraints and optimizations of the policy, through the multicast tree.

```
Router(config)# multicast-routing vrf cust1
Router(config-mcast-cust1)# address-family ipv4
Router(config-mcast-cust1-ipv4)# mdt default segment-routing mpls color 10
Router(config-mcast-cust1-ipv4)# commit
```

Configure Partitioned MDT SR P2MP MVPN Profile

In this configuration, an MDT profile of the type *partitioned* is created, and the SR multicast policy with color 10 will be used to send IP multicast traffic, as per the constraints and optimizations of the policy, through the multicast tree.

```
Router(config)# multicast-routing vrf cust1
Router(config-mcast-cust1)# address-family ipv4
Router(config-mcast-cust1-ipv4)# mdt partitioned segment-routing mpls color 10
Router(config-mcast-cust1-ipv4)# commit
```

The following Data MVPN configuration is required at the Ingress PE (router A) where the multicast flows need to be steered onto the *data* MDT for SR multicast traffic flow.

Note - Data MDT can be configured for *Default* and *Partitioned* profiles.

Configure Data MDT for SR P2MP MVPN

In this configuration, an MDT profile of the type *data* is created, and the SR multicast policy with color 10 will be used to send IP multicast traffic, as per the constraints and optimizations of the policy, through the multicast tree.

- As an alternative to the color keyword, you can specify a route policy in the **route-policy** command, and define the route policy separately (as mentioned in the next configuration).
- The **threshold** command specifies the threshold above which a multicast flow is switched onto the data MDT. The **immediate-switch** keyword enables an immediate switch of a multicast flow to the data MDT, without waiting for threshold limit to be crossed.
- The **customer-route-acl** keyword specifies an ACL to enable specific multicast flows to be put on to the data MDT.

```
Router(config)# multicast-routing vrf cust1
Router(config-mcast-cust1)# address-family ipv4
Router(config-mcast-cust1-ipv4)# mdt data segment-routing mpls 2 color 10
Router(config-mcast-cust1-ipv4)# commit
```

Route Policy Example

The route policy designates multicast flow-to-SR multicast policy mapping, with different colors.

- With this configuration, IP multicast flows for the 232.0.0.1 multicast group are steered into the SR multicast policy created with the on-demand color 10, while flows for 232.0.0.2 are steered into the policy created with color 20.
- Route policies can also be used to match other parameters, such as source address.

```
Router(config)# route-policy TSID-DATA
Router(config-rpl)# if destination in (232.0.0.1) then
Router(config-rpl-if)# set on-demand-color 10
Router(config-rpl-if)# pass
Router(config-rpl-if)# elseif destination in (232.0.0.2) then
Router(config-rpl-elseif)# set on-demand-color 20
Router(config-rpl-elseif)# pass
Router(config-rpl-elseif)# endif
Router(config-rpl)# end-policy
Router(config)# commit
```

Configure MVPN BGP Auto-Discovery for SR P2MP

The following configuration is required on all PE routers, and is mandatory for *default* MDT, *partitioned* MDT, and *data* MDT.

Configure the BGP Auto-Discovery function for transporting IP multicast traffic.

```
Router(config)# multicast-routing vrf cust1
Router(config-mcast-cust1)# address-family ipv4
Router(config-mcast-cust1-ipv4)# bgp auto-discovery segment-routing
Router(config-mcast-cust1-ipv4-bgp-ad)# commit
```

Verification

View MVPN Context Information - You can view MVPN VRF context information with these commands.

View Default MDT Configuration

This command displays SR multicast tree information, including the MDT details (of *default* type, etc), and customer VRF information (route target, route distinguisher, etc).

```
Router# show mvpn vrf vpn1 context

MVPN context information for VRF vpn1 (0x9541cf0)

RD: 1:10 (Valid, IID 0x1), VPN-ID: 0:0
Import Route-targets : 2
  RT:192.168.0.4:0, BGP-AD
  RT:192.168.0.4:17, BGP-AD
BGP Auto-Discovery Enabled (I-PMSI added)
SR P2MP Core-tree data:
  MDT Name: TRmdtvpn1, Handle: 0x4150, idb: 0x956fc30
  MTU: 1376, MaxAggr: 255, SW_Int: 30, AN_Int: 60
  RPF-ID: 3, C:0, O:1, D:0, CP:0
  Static Type : - / -
Def MDT ID: 524289 (0x93993f0), added: 1, HLI: 0x80001, Cfg: 1/0
  Part MDT ID: 0 (0x0), added: 0, HLI: 0x00000, Cfg: 0/0
  Ctrl Trees : 0/0/0, Ctrl ID: 0 (0x0), Ctrl HLI: 0x00000
```

View Partitioned MDT Configuration

This command displays SR multicast tree information, including the MDT details (of *partitioned* type, etc), and customer VRF information (route target, route distinguisher, etc).

```
Router# show mvpn vrf vpn1 context

MVPN context information for VRF vpn1 (0x9541cf0)

RD: 1:10 (Valid, IID 0x1), VPN-ID: 0:0
Import Route-targets : 2
  RT:192.168.0.4:0, BGP-AD
  RT:192.168.0.4:17, BGP-AD
BGP Auto-Discovery Enabled (I-PMSI added) , MS-PMSI sent
SR P2MP Core-tree data:
  MDT Name: TRmdtvpn1, Handle: 0x4210, idb: 0x956fc30
  MTU: 1376, MaxAggr: 255, SW_Int: 30, AN_Int: 60
  RPF-ID: 1, C:0, O:1, D:0, CP:0
  Static Type : - / -
  Def MDT ID: 0 (0x0), added: 0, HLI: 0x00000, Cfg: 0/0
Part MDT ID: 524292 (0x9399318), added: 1, HLI: 0x80004, Cfg: 1/0
  Ctrl Trees : 0/0/0, Ctrl ID: 0 (0x0), Ctrl HLI: 0x00000
```

View Partitioned MDT Ingress PE Configuration

This command displays SR multicast tree information on the PE router that receives the multicast traffic on the SP network. The information includes PE router details, MDT details, Tree-SID details, and the specified customer VRF information.

```
Router# show mvpn vrf vpn1 pe

MVPN Provider Edge Router information

VRF : vpn1

PE Address : 192.168.0.3 (0x9570240)
RD: 0:0:0 (null), RIB_HLI 0, RPF-ID 13, Remote RPF-ID 0, State: 0, S-PMSI: 2
PPMP_LABEL: 0, MS_PMSI_HLI: 0x00000, Bidir_PMSI_HLI: 0x00000, MLDP-added: [RD 0, ID 0,
```

```

Bidir ID 0, Remote Bidir ID 0], Counts(SHR/SRC/DM/DEF-MD): 0, 0, 0, 0, Bidir: GRE RP Count
0, MPLS RP Count ORSVP-TE added: [Leg 0, Ctrl Leg 0, Part tail 0 Def Tail 0, IR added:
[Def Leg 0, Ctrl Leg 0, Part Leg 0, Part tail 0, Part IR Tail Label 0
Tree-SID Added: [Def/Part Leaf 1, Def Egress 0, Part Egress 0, Ctrl Leaf 0]
  bgp_i_pmsi: 1,0/0 , bgp_ms_pmsi/Leaf-ad: 1/1, bgp_bidir_pmsi: 0, remote_bgp_bidir_pmsi:
0, PMSIs: I 0x9570378, 0x0, MS 0x94e29d0, Bidir Local: 0x0, Remote: 0x0, BSR/Leaf-ad 0x0/0,
Autorp-disc/Leaf-ad 0x0/0, Autorp-ann/Leaf-ad 0x0/0
IIDs: I/6: 0x1/0x0, B/R: 0x0/0x0, MS: 0x1, B/A/A: 0x0/0x0/0x0

Bidir RPF-ID: 14, Remote Bidir RPF-ID: 0
I-PMSI: Unknown/None (0x9570378)
I-PMSI rem: (0x0)
MS-PMSI: Tree-SID [524290, 192.168.0.3] (0x94e29d0)
Bidir-PMSI: (0x0)
Remote Bidir-PMSI: (0x0)
BSR-PMSI: (0x0)
A-Disc-PMSI: (0x0)
A-Ann-PMSI: (0x0)
RIB Dependency List: 0x0
Bidir RIB Dependency List: 0x0
  Sources: 0, RPs: 0, Bidir RPs: 0

```

View Partitioned MDT Egress PE Configuration

This command displays SR multicast tree information on the MVPN egress PE router that sends multicast traffic from the SP network towards multicast receivers in the destination sites. The information includes PE router, Tree-SID, MDT, and the specified customer VRF details.

```
Router# show mvpn vrf vpn1 pe
```

```
MVPN Provider Edge Router information
```

```

PE Address : 192.168.0.4 (0x9fa38f8)
RD: 1:10 (valid), RIB_HLI 0, RPF-ID 15, Remote RPF-ID 0, State: 1, S-PMSI: 2
  PMPM_LABEL: 0, MS_PMSI_HLI: 0x00000, Bidir_PMSI_HLI: 0x00000, MLDP-added: [RD 0, ID 0,
Bidir ID 0, Remote Bidir ID 0], Counts(SHR/SRC/DM/DEF-MD): 1, 1, 0, 0, Bidir: GRE RP Count
0, MPLS RP Count ORSVP-TE added: [Leg 0, Ctrl Leg 0, Part tail 0 Def Tail 0, IR added:
[Def Leg 0, Ctrl Leg 0, Part Leg 0, Part tail 0, Part IR Tail Label 0
Tree-SID Added: [Def/Part Leaf 0, Def Egress 0, Part Egress 1, Ctrl Leaf 0]
  bgp_i_pmsi: 1,0/0 , bgp_ms_pmsi/Leaf-ad: 1/0, bgp_bidir_pmsi: 0, remote_bgp_bidir_pmsi:
0, PMSIs: I 0x9f77388, 0x0, MS 0x9fa2f98, Bidir Local: 0x0, Remote: 0x0, BSR/Leaf-ad 0x0/0,
Autorp-disc/Leaf-ad 0x0/0, Autorp-ann/Leaf-ad 0x0/0
IIDs: I/6: 0x1/0x0, B/R: 0x0/0x0, MS: 0x1, B/A/A: 0x0/0x0/0x0

Bidir RPF-ID: 16, Remote Bidir RPF-ID: 0
I-PMSI: Unknown/None (0x9f77388)
I-PMSI rem: (0x0)
MS-PMSI: Tree-SID [524292, 192.168.0.4] (0x9fa2f98)
Bidir-PMSI: (0x0)
Remote Bidir-PMSI: (0x0)
BSR-PMSI: (0x0)
A-Disc-PMSI: (0x0)
A-Ann-PMSI: (0x0)
RIB Dependency List: 0x9f81370
Bidir RIB Dependency List: 0x0
  Sources: 1, RPs: 1, Bidir RPs: 0

```

View Data MDT Information

The commands in this section displays SR multicast tree information for *data* MDTs. The information includes cache, router-local, and remote MDT information.

View Data MDT Cache Information

```

Router# show pim vrf vpn1 mdt cache
Core Source      Cust (Source, Group)      Core Data      Expires
192.168.0.3      (26.3.233.1, 232.0.0.1) [tree-id 524292] never
192.168.0.4      (27.3.233.6, 232.0.0.1) [tree-id 524290] never

Leaf AD: 192.168.0.3

```

View Local MDTs Information

```

Router# show pim vrf vpn1 mdt sr-p2mp local

Tree Identifier          MDT Source          Cache DIP Local VRF Routes On-demand
[tree-id 524290 (0x80002)] 192.168.0.4      1      N      Y      1      10
Tree-SID Leaf: 192.168.0.3

```

View Remote MDTs Information

```

Router # show pim vrf vpn1 mdt sr-p2mp remote

Tree Identifier          MDT Source          Cache DIP Local VRF Routes On-demand
[tree-id 524290 (0x80002)] 192.168.0.4      1      N      N      1      0

```

View MRIB MPLS Forwarding Information

This command displays labels used for transporting IP multicast traffic, on a specified router.

```

Router# show mrrib mpls forwarding

LSP information (XTC) :
LSM-ID: 0x00000, Role: Head, Head LSM-ID: 0x80002
Incoming Label      : (18000)
Transported Protocol : <unknown>
Explicit Null       : None
IP lookup           : disabled

Outsegment Info #1 [H/Push, Recursive]:
OutLabel: 18000, NH: 192.168.0.3, Sel IF: GigabitEthernet0/2/0/0

LSP information (XTC) :
LSM-ID: 0x00000, Role: Tail, Peek
RPF-ID: 0x00011, Assoc-TIDs: 0xe0000011/0x0, MDT: TRmdtvpn1
Incoming Label      : 18001
Transported Protocol : <unknown>
Explicit Null       : None
IP lookup           : enabled

Outsegment Info #1 [T/Pop]:
No info.

```

SR-PCE Show Commands

View Tree Information On PCE Server

This command displays SR multicast tree information on the SR-PCE server.



Note A cleanup process that activates every 30 minutes will delete any inconsistent entries between the PCEs, which might result from network or config changes. Inconsistent entries are expected during that time frame.

```

Router# show pce lsp p2mp

```

```

Tree: sr_p2mp_root_192.168.0.1_tree_id_524290
Label: 18000 Operational: up Admin: up
Metric Type: TE
Transition count: 3
Uptime: 00:00:03 (since Fri Jan 24 14:57:51 PST 2020)
Source: 192.168.0.1
Destinations: 192.168.0.4
Nodes:
Node[0]: 192.168.0.2 (rtrM)
  Role: Transit
  Hops:
    Incoming: 18000 CC-ID: 4
    Outgoing: 18000 CC-ID: 4 (17.17.17.4) [rtrR]
Node[1]: 192.168.0.1 (rtrL1)
  Role: Ingress
  Hops:
    Incoming: 18000 CC-ID: 5
    Outgoing: 18000 CC-ID: 5 (12.12.12.2) [rtrM]
Node[2]: 192.168.0.4 (rtrR)
  Role: Egress
  Hops:
    Incoming: 18000 CC-ID: 6

```

For dynamic SR multicast trees created for MVPN, the **show** command has filters to view root multicast router and Tree-ID information. When the root router is specified, all multicast trees from that root are displayed. When root and Tree-ID are specified, only the specified tree information is displayed.

```
Router# show pce lsp p2mp root ipv4 10.1.1.1 524289
```

```

Tree: sr_p2mp_root_10.1.1.1_tree_id_524289, Root: 10.1.1.1 ID: 524289
Label: 20000 Operational: up Admin: up
PCC: 10.1.1.1
Local LFA FRR: Disabled
Metric Type: TE
Transition count: 11
Uptime: 00:03:37 (since Mon May 11 12:53:33 PDT 2020)
Destinations: 10.1.1.3, 10.1.1.4, 10.1.1.5
Nodes:
Node[0]: 10.1.1.1 (root1)
  Role: Ingress
  Hops:
    Incoming: 20000 CC-ID: 26
    Outgoing: 20000 CC-ID: 26 (192.168.114.4) [mid-4]
    Outgoing: 20000 CC-ID: 26 (192.168.112.2) [mid-2]
Node[1]: 10.1.1.4 (mid-4)
  Role: Egress
  Hops:
    Incoming: 20000 CC-ID: 27
Node[2]: 10.1.1.2 (mid-2)
  Role: Transit
  Hops:
    Incoming: 20000 CC-ID: 28
    Outgoing: 20000 CC-ID: 28 (192.168.123.3) [leaf-3]
    Outgoing: 20000 CC-ID: 28 (192.168.125.5) [leaf-5]
Node[3]: 10.1.1.3 (leaf-3)
  Role: Egress
  Hops:
    Incoming: 20000 CC-ID: 29
Node[4]: 10.1.1.5 (leaf-5)
  Role: Egress
  Hops:
    Incoming: 20000 CC-ID: 30

```

Multicast Tree Information on Routers

```
Router# show segment-routing traffic-eng p2mp policy
```

```
SR-TE P2MP policy database:
```

```
-----
```

```
Policy: sr_p2mp_root_192.168.0.1_tree_id_524290 LSM-ID: 0x2
```

```
Role: Leaf
```

```
Replication:
```

```
Incoming label: 18001 CC-ID: 6
```

```
Policy: sr_p2mp_root_192.168.0.4_tree_id_524290 LSM-ID: 0x80002 (PCC-initiated)
```

```
Color: 0
```

```
Role: Root
```

```
Replication:
```

```
Incoming label: 18000 CC-ID: 2
```

```
Interface: None [192.168.0.3!] Outgoing label: 18000 CC-ID: 2
```

```
Endpoints:
```

```
192.168.0.1, 192.168.0.2
```

For SR multicast policies originated locally on the router (root router of a dynamic MVPN multicast policy) additional policy information is displayed.

For dynamic SR multicast trees created for MVPN, the **show** command has filters for displaying root multicast router and Tree-ID information. When the root router is specified, all multicast trees for that root are displayed. When root and Tree-ID are specified, only the specified tree information is displayed.

```
Router# show segment-routing traffic-eng p2mp policy root ipv4 1.1$
```

```
SR-TE P2MP policy database:
```

```
-----
```

```
Policy: sr_p2mp_root_10.1.1.1_tree_id_524289 LSM-ID: 0x691
```

```
Root: 10.1.1.1, ID: 524289
```

```
Role: Transit
```

```
Replication:
```

```
Incoming label: 20000 CC-ID: 28
```

```
Interface: Bundle-Ether23 [192.168.123.3] Outgoing label: 20000 CC-ID: 28
```

```
Interface: Bundle-Ether25 [192.168.125.5] Outgoing label: 20000 CC-ID: 28
```

```
Policy: sr_p2mp_root_10.1.1.1_tree_id_524290 LSM-ID: 0x692
```

```
Root: 10.1.1.1, ID: 524290
```

```
Role: Transit
```

```
Replication:
```

```
Incoming label: 19999 CC-ID: 28
```

```
Interface: Bundle-Ether23 [192.168.123.3] Outgoing label: 19999 CC-ID: 28
```

```
Interface: Bundle-Ether25 [192.168.125.5] Outgoing label: 19999 CC-ID: 28
```

Multicast: Cisco Nonstop Forwarding for Tree-SID

Table 2: Feature History Table

Feature Name	Release Information	Feature Description
Multicast: Cisco Nonstop Forwarding for Tree-SID	Release 7.10.1	<p>Starting from this release, Multicast Nonstop Forwarding supports Tree-SID (Tree Segment Identifier). This ensures that traffic forwarding continues without interruptions whenever the active RSP fails over to the standby RSP.</p> <p>This feature prevents hardware or software failures on the control plane from disrupting the forwarding of existing packet flows through the router for Tree-SID. Thus, ensuring improved network availability, network stability, preventing routing flaps, and no loss of user sessions while the routing protocol information is being restored.</p> <p>The feature modifies the show mrib nsf private command.</p>



Note This section captures only the Cisco Nonstop Forwarding feature in relation with Tree-SID. For more information on the Cisco Nonstop Forwarding feature, see [Multicast Nonstop Forwarding](#).

Multicast now supports hitless Route Processor Fail Over (RPFO). During RPFO, the software deletes IP routes from the Static Tree-SID profile in the headend router. The Dynamic Tree-SID does not have this issue, because in this case, the BGP advertises the states that supports Nonstop Routing (NSR). To overcome this problem for static Tree-SID, there are checkpoints to check the feature in Protocol Independent Multicast (PIM). On switchover, the checkpoint reads to check if the feature is there or not and push Protocol Independent Multicast (PIM) to Cisco Nonstop Forwarding state.

Verification Steps

The **show mrib nsf private** command is enhanced to display the XTC info as well.

```
Router#show mrib nsf private
Mon Jul 31 13:27:05.056 UTC
IP MRIB Non-Stop Forwarding Status:
Multicast routing state: Normal
  NSF Lifetime:          00:03:00
  Respawn Count:        6
  Last NSF On triggered: Tue Jul 25 13:20:49 2023, 6d00h
  Last NSF Off triggered: Tue Jul 25 13:22:49 2023, 6d00h
  Last NSF ICD Notification sent: Tue Jul 25 13:22:49 2023, 6d00h
  Last Remote NSF On triggered: Tue Jul 25 13:10:18 2023, 6d00h
  Last Remote NSF Off triggered: Tue Jul 25 13:10:27 2023, 6d00h
  Last Label TE NSF On triggered: Tue Jul 25 13:10:18 2023, 6d00h
  Last Label TE NSF Off triggered: Tue Jul 25 13:10:27 2023, 6d00h
  Last Label mLDP NSF On triggered: Tue Jul 25 13:10:18 2023, 6d00h
  Last Label mLDP NSF Off triggered: Tue Jul 25 13:10:27 2023, 6d00h
  Last Label PIM NSF On triggered: Tue Jul 25 13:20:49 2023, 6d00h
  Last Label PIM NSF Off triggered: Tue Jul 25 13:22:49 2023, 6d00h
```

```

Last Label PIM6 NSF On triggered: Tue Jul 25 13:31:22 2023, 5d23h
Last Label PIM6 NSF Off triggered: Tue Jul 25 13:33:22 2023, 5d23h
Last Label XTC NSF On triggered: Tue Jul 25 13:41:51 2023, 5d23h
Last Label XTC NSF Off triggered: Tue Jul 25 13:41:52 2023, 5d23h

```

```

IP NSF :- Active: N, Assume N
MRIB connect timer: Inactive
NSF statistics:
  Enabled Cnt - 4, Disabled Cnt - 4
  Last Enabled: 6d00h, Last Disabled: 6d00h
Multicast COFO routing state: Normal
Current LMRIB clients: LDP RSVP_TE PIM PIM6 XTC
LMRIB NSF clients: LDP RSVP_TE PIM PIM6 XTC
Converged LMRIB clients: LDP RSVP_TE PIM PIM6 XTC

```

Multicast VPN IPv6: Dynamic Tree-SID Multicast VPN IPv6

Table 3: Feature History Table

Feature Name	Release Information	Feature Description
Multicast VPN: Dynamic Tree-SID Multicast VPN IPv6	Release 7.10.1	This feature allows Dynamic Tree Segment Identifier (Tree-SID) deployment where IPv6 Multicast payload is used for optimally transporting IP VPN multicast traffic over the provider network, using SR-PCE as a controller. This implementation supports IPv6 only for the Dynamic Tree-SID. Currently, the Static Tree-SID supports IPV4 payloads only, not the IPv6 payloads.

Overview of Multicast VPN: Tree-SID Multicast VPN

Typically, a customer's IP VPN is spread across VPN sites. IP VPN customer traffic is sent from one site to another over a VPN Service Provider (SP) network.

When IP Multicast traffic within a (BGP/MPLS) IP VPN is transported over a provider network (say, from **VPN1-Site-A** to **VPN1-Site-B**, as shown in the image), the provider network requires protocols and procedures to optimally transport multicast traffic from a multicast sender in Site-A to multicast receivers in Site-B.

This use case explains how to enable SR multicast for a provider network, and efficiently transport IP VPN multicast traffic (sent from **VPN1-Site-A** and) received at PE router A, through to PE routers D and E, toward receivers in sites **VPN1-Site-B** and **VPN1-Site-C**.

Figure 6: IP VPN Multicast Traffic Flow Over A Provider Network

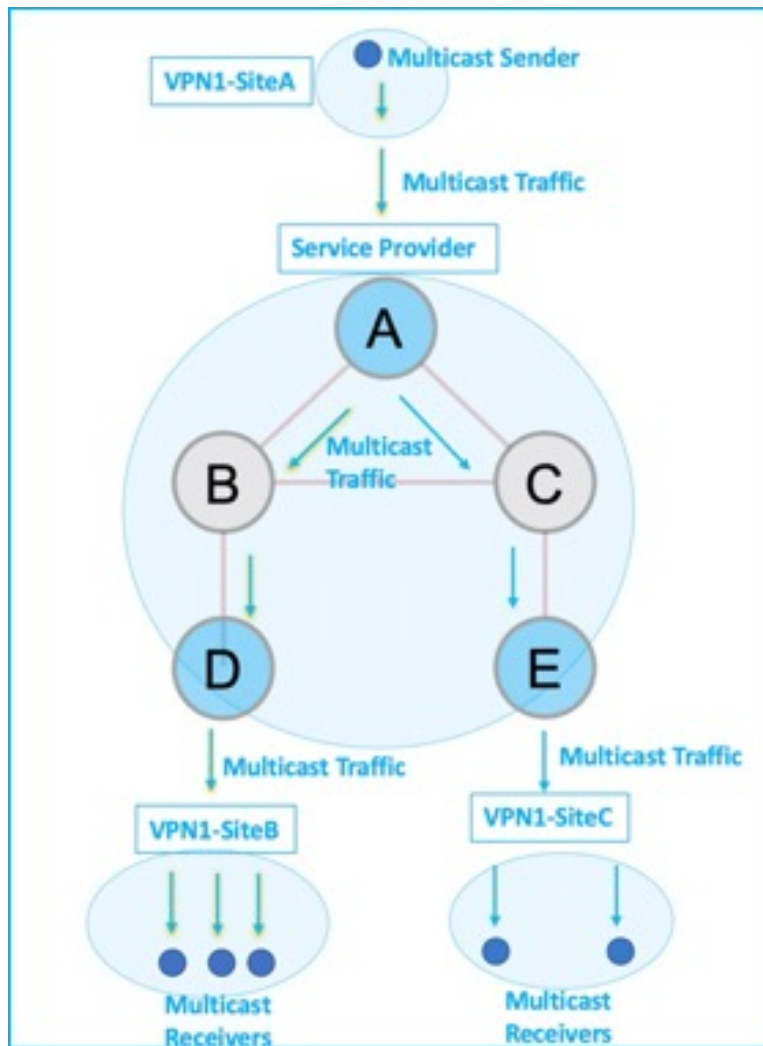

To enable the *Multicast VPN: Tree-SID multicast VPN* feature, the following protocols and software applications are used:

- **OSPF/IS-IS** - The underlay network is created with OSPF/IS-IS routing protocol, and reachability is established across the network. See *Configure Segment Routing for IS-IS Protocol* or *Configure Segment Routing for OSPF Protocol* chapter for details, within this Guide.
- **BGP Multicast VPN (multicast VPN)** – The PE routers (A, D, and E) are IP VPN endpoints for IP Multicast traffic arriving at the provider network (at PE router A) and exiting the provider network (at PE routers D and E). So, BGP multicast VPN is enabled on the PE routers. NSO is used to configure BGP multicast VPN on the PE routers. See, *Configure Segment Routing for BGP* chapter for details, within this guide
- **BGP Auto-Discovery (AD)** - To enable distributed VPN endpoint discovery and C-multicast flow mapping and signaling, BGP AD function is configured on the PE routers. A BGP Auto-Discovery route contains multicast router (loopback IP address) and tree identity (segment ID) information. It carries the

information in the Provider Multicast Service Interface (PMSI) Tunnel Attribute (PTA). See, *Configure Segment Routing for BGP* chapter for details, within this guide

- **C-multicast states** are signaled using BGP. See, *Configure Segment Routing for BGP* chapter for details, within this guide
- **SR** - To transport IP Multicast traffic between the VPN endpoints (PE routers A, D, and E), Provider (or P-) tunnels are used. In a P-tunnel, the PE devices are the tunnel endpoints. P-tunnels can be generated using different technologies (RSVP-TE, point-to-multipoint LSPs, PIM trees, mLDP point-to-multipoint LSPs, and mLDP MP2MP LSPs). In this use case, Segment Routing (SR) is used for its benefits that were noted earlier.
- With SR and SR-PCE, a Tree-SID point-to-multipoint (P2MP) segment is used to create P-Tunnels for multicast VPN. You can specify SR policy optimization objectives (such as *metrics*) and constraints (such as *affinity*) in an SR policy and send it to the SR-PCE controller, so that it can dynamically create SR multicast trees for traffic flow.
- **SR-PCE** - This is a controller which, based on the provided SR policy information, computes optimal paths for a multicast tree, and deploys the tree forwarding state on the multicast routers. When a topology change occurs, SR-PCE automatically computes a new, optimal multicast tree, and deploys the new tree forwarding state on the multicast routers.

Tree-SID multicast VPN

The topology remains the same, with PE routers A, D, and E acting as VPN endpoints for carrying IP VPN multicast traffic.

1. For SR, A is designated as the SR headend router, and D and E are designated as the SR endpoints.

For multicast traffic, A is the root of the SR multicast tree, and D and E are leaf routers of the tree. B and C are the other multicast routers. The objective is to send the IP Multicast traffic arriving at A to D and E, as needed.

Figure 7: Multicast Tree

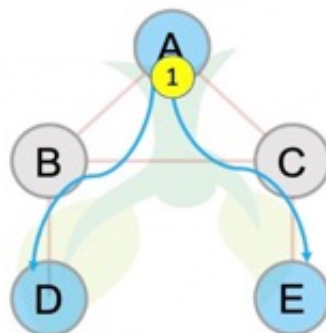

2. A discovers leaf routers' information through BGP multicast VPN.
3. Path Computation Element Protocol (PCEP) is used for the SR multicast policy communication between A and the SR-PCE server, and communication between PE routers and the SR-PCE server.

4. When the headend router SR policy is created on A, and PCEP configurations are enabled on the SR-PCE server and all multicast routers, SR-PCE receives the SR policy and leaf router identity information from A.
5. Based on the policy information it receives, including traffic engineering objectives and constraints, SR-PCE builds multicast distribution trees in the underlay for efficient VPN traffic delivery.

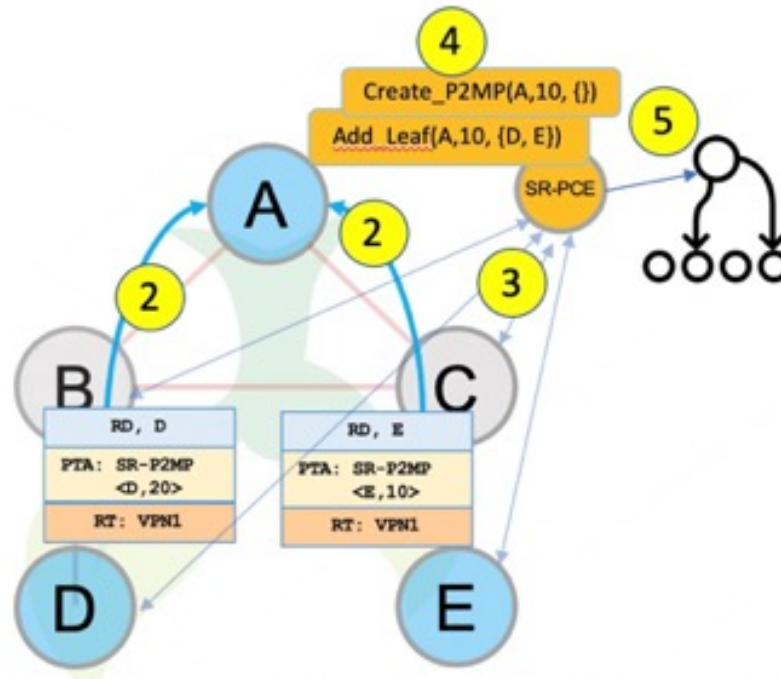

6. SR-PCE assigns an SID for the SR multicast tree policy, and deploys the multicast tree forwarding state on the multicast routers.
7. When IP Multicast traffic is sent from VPN1-SiteA to PE router A, it steers it into the SR policy, and sends it toward D and E, which forward it to multicast traffic receivers in the sites VPN1-SiteB and VPN1-SiteC.
8. When a leaf or multicast router is added or removed, PE router A updates the SR multicast policy and sends it to SR-PCE. SR-PCE computes new multicast routes, and deploys the multicast tree forwarding state information on the multicast routers.

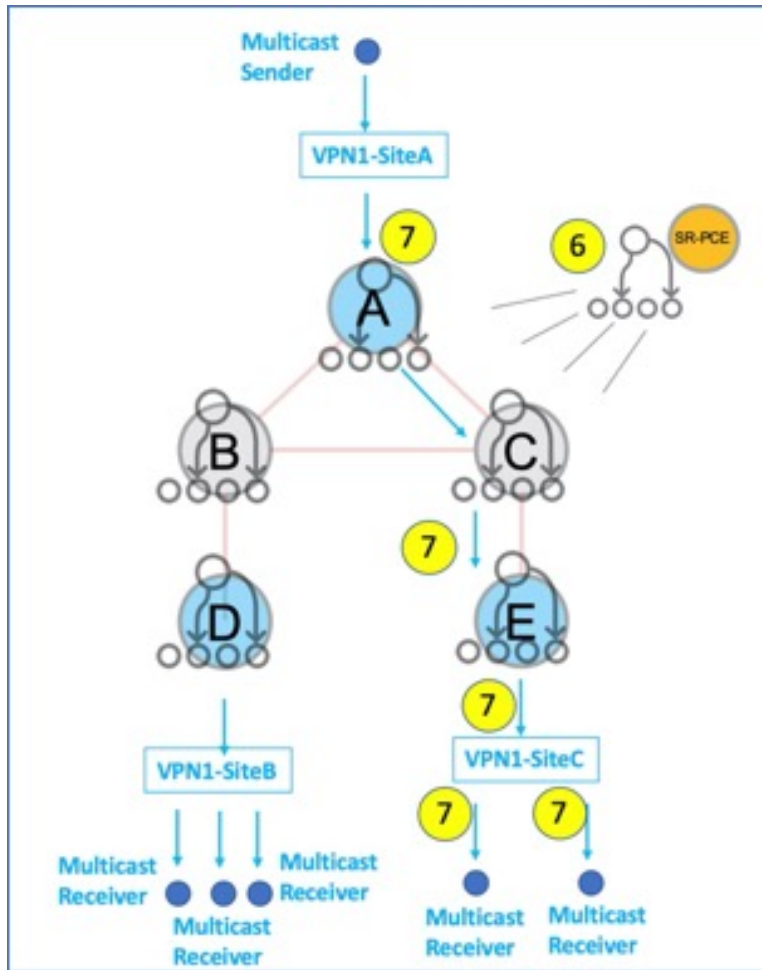

SR Multicast Tree Types

This is an overview of the types of SR multicast trees that you can configure, depending on your requirement. You can create the following tree types for IP VPN multicast flow in the provider network:

- Full Mesh Multicast Tree
- On-Demand SR Multicast Tree
- Optimal Multicast Tree
- **Full Mesh Multicast Tree**

Figure 8: Full Mesh Multicast Tree

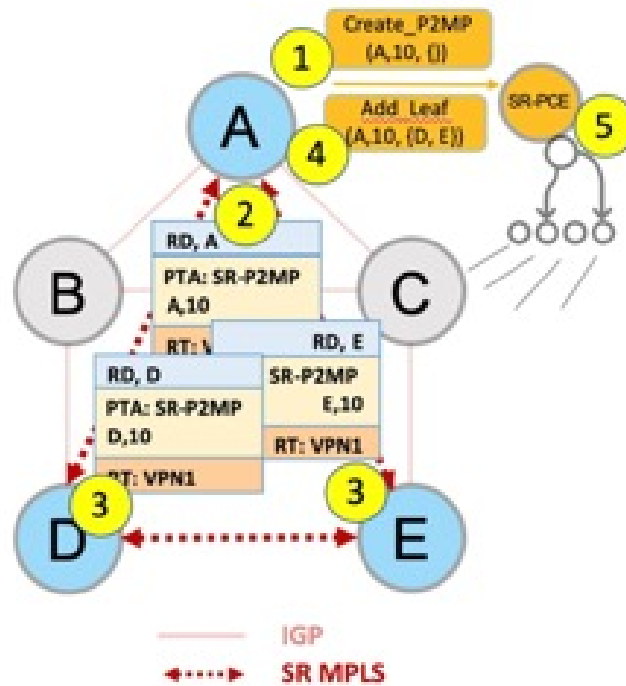

1. A assigns Tree-ID 10 and invokes a Create an SR multicast tree request by sending the multicast router and tree ID information (A, 10) toward SR-PCE.
2. A announces BGP AD Inclusive PMSI (I-PMSI) route with the PTA (A, 10). Inclusive PMSI - Traffic that is multicast by a PE router on an I-PMSI is received by all other PEs in the multicast VPN. I-PMSIs are generated by Inclusive P-tunnels.
3. A discovers VPN endpoints D and E from their BGP AD Type I-PMSI route messages.
4. A invokes an Add SR multicast leaf router request (for D and E) to SR-PCE.
5. SR-PCE computes and generates the multicast tree forwarding state information on all the routers that are part of the tree.

• On-Demand SR Multicast Tree

Figure 9: On-Demand SR Multicast Tree

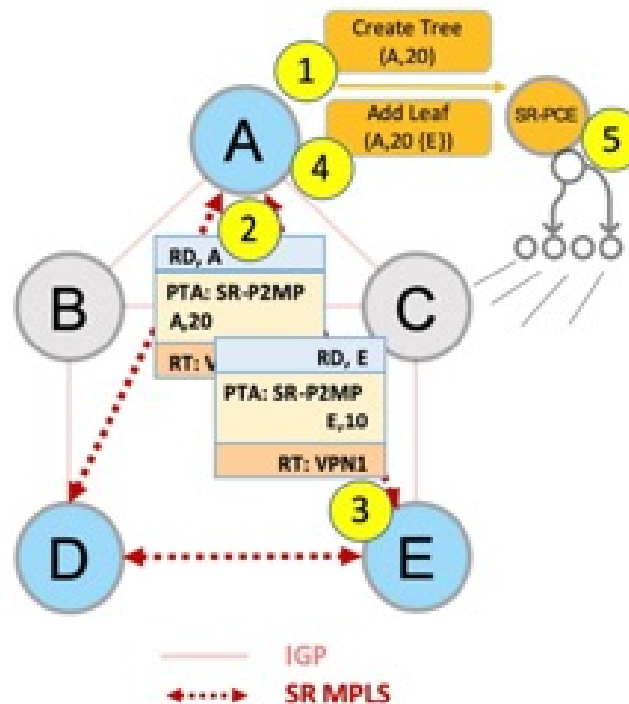

1. A assigns Tree-ID 20 and invokes a Create an SR multicast tree request by sending the multicast router and tree ID information (A, 20) toward SR-PCE.
2. A announces BGP AD Selective PMSI (or S-PMSI) route with PTA (A, 20). A sets the leaf-info-required to discover endpoint interest set.
Selective PMSI - Traffic multicast by a PE on an S-PMSI is received by some PEs in the multicast VPN. S-PMSIs are generated by Selective P-tunnels.
3. E has a receiver behind it, and announces a BGP-AD leaf route toward A. A discovers service endpoint E for the on-demand tree.
4. A invokes an Add SR multicast leaf router request (for E) to SR-PCE.
5. SR-PCE computes and generates the multicast tree information for all the routers that are part of the tree.

- **Optimal Multicast Tree**

Figure 10: Optimal Multicast Tree

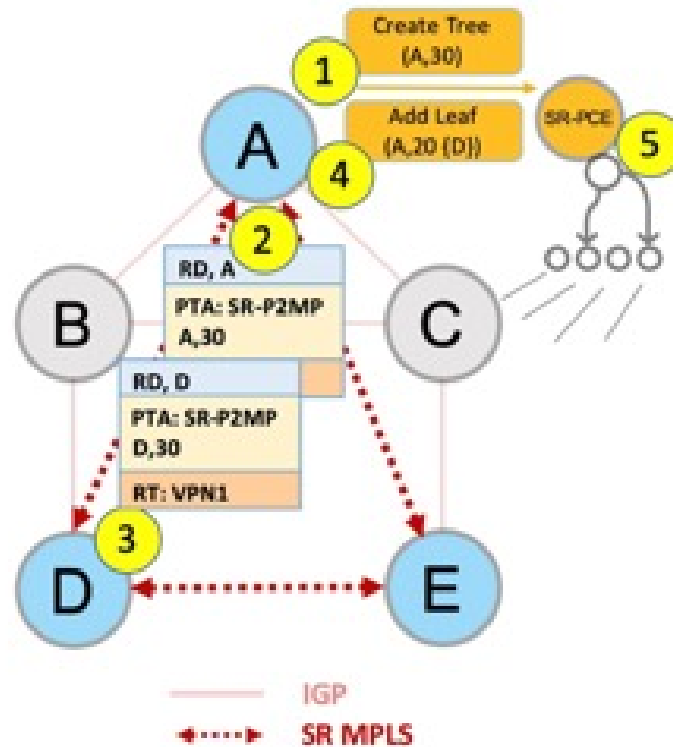

1. A decides to optimize a flow and assigns Tree-ID 30 and invokes a Create an SR multicast tree request by sending the multicast router and tree ID information (A, 30) toward SR-PCE.
2. A announces BGP AD I-PMSI route with PTA (A, 30). A sets the leaf-info-required to discover endpoint interest set.
3. D has a receiver behind it, and announces a BGP-AD leaf route toward A. A discovers service endpoint D for optimized flow.
4. A invokes an Add SR multicast leaf router request (for D) to SR-PCE.
5. SR-PCE computes and generates the multicast tree information for all the routers that are part of the tree.

Prerequisites for Tree-SID mVPN IPv6

Listed are the prerequisites for Tree-SID Multicast VPN IPv6:

- The underlay OSPF or IS-IS network is configured, and OSPF/IS-IS adjacency forms between routers, across the network.
- BGP is configured for the network, and BGP adjacency is formed between routers. BGP multicast VPN configuration information is provided in this feature document.

Restrictions to Tree-SID mVPN IPv6

Listed are the restrictions related to this feature:

- The following are not supported for MVPN SR P2MP:
 - SRv6 SR P2MP policies
 - Hitless RP failover
 - IPV6 Multicast payload
 - PCE redundancy
 - PIM Bidir is not supported
- The following are not supported for SR P2MP:
 - PCE server restart not supported for REST initiated SR P2MP policies
 - Co-existence of static MVPN SR P2MP profiles in a VRF of a PE.
 - Co-existence with other MVPN profiles (MLDP, P2MP RSVP-TE, Ingress Replication) that need BGP MVPN Auto-Discovery in a VRF of a PE.
 - PIM C-Multicast signaling (only BGP C-multicast is supported)

Configure Tree-SID mVPN IPv6

Configuration Examples

Following are examples to configure Tree-SID multicast VPN IPv6

- **Headend Router Configuration (Router A)** - The following configuration is specific to the headend router.
 - **Configure traffic engineering Constraints and Optimization Parameters**

```
Router# configure terminal
Router(config)# segment-routing traffic-engineering
```

An affinity bit-map is created so that it can be applied to a link or interface.

```
Router(config-sr-te)# affinity-map name 10 bit-position 24
Router(config-sr-te)# commit
```

An affinity (or relationship) is created between the SR policy path and the link color so that SR-TE computes a path that includes or excludes links, as specified. The headend router automatically follows the actions that are defined in the ODN template (for color 10) upon the arrival of VPN routes with a BGP color extended community that matches color 10.

```
Router(config)# segment-routing traffic-engineering
Router(config-sr-te)# on-demand color 10 dynamic
Router(config-sr-te-color-dyn)# affinity include-all name red
Router(config-sr-te-color-dyn)# affinity include-any name blue
Router(config-sr-te-color-dyn)# affinity exclude-any name green
Router(config-sr-te-color-dyn)# metric type te
Router(config-sr-te-color-dyn)# commit
```

The SR policy configuration on the headend router A will be sent to the SR-PCE server, after a connection is established between A and SR-PCE.

- **Multicast Router Configuration**

- **Configure PCEP Client on Multicast Routers** - Associate each multicast router as a client of the SR-PCE server. The `pce address ipv6` command specifies the SR-PCE server's IP address.

```
Router# configure terminal
Router(config)# segment-routing traffic-engineering
Router(config-sr-te)# pce pce address ipv6 10.3.3.3
Router(config-pcc-pce)# commit
```

- **SR PCE Server Configuration**

- **Configure Label Range for Multicast Trees** - Configure the label range to be used for transporting Cisco IOS IP Multicast traffic in provider network.

```
Router(config)# pce segment-routing traffic-eng p2mp label-range min 30000 max 60000
Router(config)# commit
```

- **Disable ECMP load splitting** - To disable ECMP load splitting of different trees on the SR-PCE server, configure the `multipath-disable` command.

```
Router(config)# pce segment-routing traffic-eng p2mp multipath-disable
Router(config)# commit
```

- **Multicast Routing Configuration On PE Routers** - The following multicast VPN configurations are required for VPN endpoints, the 3 PE routers.

- **Configure Default MDT SR point-to-multipoint multicast VPN Profile** - In this configuration, an MDT profile of the type *default* is created, and the SR multicast policy with color 10 will be used to send Cisco IOS IP Multicast traffic, as per the constraints and optimizations of the policy, through the multicast tree.

```
Router(config)# multicast-routing vrf cust1
Router(config-mcast-cust1)# address-family ipv6
Router(config-mcast-cust1-ipv6)# mdt default segment-routing mpls color 10
Router(config-mcast-cust1-ipv6)# commit
```

- **Configure Partitioned MDT SR point-to-multipoint multicast VPN Profile** - In this configuration, an MDT profile of the type *partitioned* is created, and the SR multicast policy with color 10 will be used to send Cisco IOS IP Multicast traffic, as per the constraints and optimizations of the policy, through the multicast tree.

```
Router(config)# multicast-routing vrf cust1
Router(config-mcast-cust1)# address-family ipv6
Router(config-mcast-cust1-ipv6)# mdt partitioned segment-routing mpls color 10
Router(config-mcast-cust1-ipv6)# commit
```

The following Data multicast VPN configuration is required at the Ingress PE (router A) where the multicast flows need to be steered onto the *data* MDT for SR multicast traffic flow.

Note - *Data* MDT can be configured for *Default* and *Partitioned* profiles.

- **Configure Data MDT for SR point-to-multipoint multicast VPN** - In this configuration, an MDT profile of the type *data* is created, and the SR multicast policy with color 10 will be used to send Cisco IOS IP Multicast traffic, as per the constraints and optimizations of the policy, through the multicast tree.

- As an alternative to the color keyword, you can specify a route policy in the **route-policy** command, and define the route policy separately (as mentioned in the next configuration).
- The **threshold** command specifies the threshold above which a multicast flow is switched onto the data MDT. The **immediate-switch** keyword enables an immediate switch of a multicast flow to the data MDT, without waiting for threshold limit to be crossed.
- The **customer-route-acl** keyword specifies an access control list to enable specific multicast flows to be put on to the data MDT.

```
Router(config)# multicast-routing vrf cust1
Router(config-mcast-cust1)# address-family ipv6
Router(config-mcast-cust1-ipv6)# mdt data segment-routing mpls 2 color 10
Router(config-mcast-cust1-ipv6)# commit
```

Route Policy Example

The route policy designates multicast flow-to-SR multicast policy mapping, with different colors.

- With this configuration, Cisco IOS IP Multicast flows for the 232.0.0.1 multicast group are steered into the SR multicast policy that is created with the on-demand color 10, while flows for 232.0.0.2 are steered into the policy created with color 20.
- Route policies can also be used to match other parameters, such as source address.

```
Router(config)# route-policy TSID-DATA
Router(config-rpl)# if destination in (232.0.0.1) then
Router(config-rpl-if)# set on-demand-color 10
Router(config-rpl-if)# pass
Router(config-rpl-if)# elseif destination in (232.0.0.2) then
Router(config-rpl-elseif)# set on-demand-color 20
Router(config-rpl-elseif)# pass
Router(config-rpl-elseif)# endif
Router(config-rpl)# end-policy
Router(config)# commit
```

Configure multicast VPN BGP Auto-Discovery for SR point-to-multipoint

The following configuration is required on all PE routers, and is mandatory for *default* MDT, *partitioned* MDT, and *data* MDT.

Configure the BGP Auto-Discovery function for transporting Cisco IOS IP Multicast traffic.

```
Router(config)# multicast-routing vrf cust1
Router(config-mcast-cust1)# address-family ipv6
Router(config-mcast-cust1-ipv6)# bgp auto-discovery segment-routing
Router(config-mcast-cust1-ipv6-bgp-ad)# commit
```

Verify Tree-SID mVPN IPv6 With TI-LFA

This section guides you through the verification options:

- **View multicast VPN Context Information** - You can view multicast VPN virtual routing and forwarding context information with these commands.
- **View Default MDT Configuration** - This command displays SR multicast tree information, including the MDT details (of *default* type, and so on), and customer virtual routing and forwarding information (route target, route distinguisher, and so on).

```
Router# show mvpn vrf vpn1 context
```

```
MVPN context information for VRF vpn1 (0x9541cf0)
```

```
RD: 1:10 (Valid, IID 0x1), VPN-ID: 0:0
```

```
Import Route-targets : 2
```

```
RT:192.168.0.4:0, BGP-AD
```

```
RT:192.168.0.4:17, BGP-AD
```

```
BGP Auto-Discovery Enabled (I-PMSI added)
```

```
SR P2MP Core-tree data:
```

```
MDT Name: TRmdtvpn1, Handle: 0x4150, idb: 0x956fc30
```

```
MTU: 1376, MaxAggr: 255, SW_Int: 30, AN_Int: 60
```

```
RPF-ID: 3, C:0, O:1, D:0, CP:0
```

```
Static Type : - / -
```

```
Def MDT ID: 524289 (0x93993f0), added: 1, HLI: 0x80001, Cfg: 1/0
```

```
Part MDT ID: 0 (0x0), added: 0, HLI: 0x00000, Cfg: 0/0
```

```
Ctrl Trees : 0/0/0, Ctrl ID: 0 (0x0), Ctrl HLI: 0x00000
```

- **View Partitioned MDT Configuration** - This command displays SR multicast tree information, including the MDT details (of *partitioned* type, and so on), and customer virtual routing and forwarding information (route target, route distinguisher, and so on).

```
Router# show mvpn vrf vpn1 context
```

```
MVPN context information for VRF vpn1 (0x9541cf0)
```

```
RD: 1:10 (Valid, IID 0x1), VPN-ID: 0:0
```

```
Import Route-targets : 2
```

```
RT:192.168.0.4:0, BGP-AD
```

```
RT:192.168.0.4:17, BGP-AD
```

```
BGP Auto-Discovery Enabled (I-PMSI added) , MS-PMSI sent
```

```
SR P2MP Core-tree data:
```

```
MDT Name: TRmdtvpn1, Handle: 0x4210, idb: 0x956fc30
```

```
MTU: 1376, MaxAggr: 255, SW_Int: 30, AN_Int: 60
```

```
RPF-ID: 1, C:0, O:1, D:0, CP:0
```

```
Static Type : - / -
```

```
Def MDT ID: 0 (0x0), added: 0, HLI: 0x00000, Cfg: 0/0
```

```
Part MDT ID: 524292 (0x9399318), added: 1, HLI: 0x80004, Cfg: 1/0
```

```
Ctrl Trees : 0/0/0, Ctrl ID: 0 (0x0), Ctrl HLI: 0x00000
```

- **View Partitioned MDT Ingress PE Configuration** - This command displays SR multicast tree information on the PE router that receives the multicast traffic on the provider network. The information includes PE router details, MDT details, Tree-SID details, and the specified customer virtual routing and forwarding information.

```
Router# show mvpn vrf vpn1 pe
```

```
MVPN Provider Edge Router information
```

```
VRF : vpn1
```

```
PE Address : 192.168.0.3 (0x9570240)
```

```
RD: 0:0:0 (null), RIB_HLI 0, RPF-ID 13, Remote RPF-ID 0, State: 0, S-PMSI: 2
```

```
PPMP_LABEL: 0, MS_PMSI_HLI: 0x00000, Bidir_PMSI_HLI: 0x00000, MLDP-added: [RD 0, ID
```

```
0, Bidir ID 0, Remote Bidir ID 0], Counts(SHR/SRC/DM/DEF-MD): 0, 0, 0, 0, Bidir: GRE
```

```
RP Count 0, MPLS RP Count ORSVP-TE added: [Leg 0, Ctrl Leg 0, Part tail 0 Def Tail 0,
```

```
IR added: [Def Leg 0, Ctrl Leg 0, Part Leg 0, Part tail 0, Part IR Tail Label 0
```

```
Tree-SID Added: [Def/Part Leaf 1, Def Egress 0, Part Egress 0, Ctrl Leaf 0]
```

```
bgp_i_pmsi: 1,0/0 , bgp_ms_pmsi/Leaf-ad: 1/1, bgp_bidir_pmsi: 0, remote_bgp_bidir_pmsi:
```

```
0, PMSIs: I 0x9570378, 0x0, MS 0x94e29d0, Bidir Local: 0x0, Remote: 0x0, BSR/Leaf-ad
```

```
0x0/0, Autorp-disc/Leaf-ad 0x0/0, Autorp-ann/Leaf-ad 0x0/0
```

```
IIDs: I/6: 0x1/0x0, B/R: 0x0/0x0, MS: 0x1, B/A/A: 0x0/0x0/0x0
```



```

Bidir RPF-ID: 14, Remote Bidir RPF-ID: 0
I-PMSI: Unknown/None (0x9570378)
I-PMSI rem: (0x0)
MS-PMSI: Tree-SID [524290, 192.168.0.3] (0x94e29d0)
Bidir-PMSI: (0x0)
Remote Bidir-PMSI: (0x0)
BSR-PMSI: (0x0)
A-Disc-PMSI: (0x0)
A-Ann-PMSI: (0x0)
RIB Dependency List: 0x0
Bidir RIB Dependency List: 0x0
Sources: 0, RPs: 0, Bidir RPs: 0

```

- **View Partitioned MDT Egress PE Configuration** - This command displays SR multicast tree information on the multicast VPN egress PE router that sends multicast traffic from the provider network toward multicast receivers in the destination sites. The information includes PE router, Tree-SID, MDT, and the specified customer virtual routing and forwarding details.

```
Router# show mvpn vrf vpn1 pe
```

```
MVPN Provider Edge Router information
```

```

PE Address : 192.168.0.4 (0x9fa38f8)
RD: 1:10 (valid), RIB_HLI 0, RPF-ID 15, Remote RPF-ID 0, State: 1, S-PMSI: 2
PPMP_LABEL: 0, MS_PMSI_HLI: 0x00000, Bidir_PMSI_HLI: 0x00000, MLDP-added: [RD 0, ID
0, Bidir ID 0, Remote Bidir ID 0], Counts(SHR/SRC/DM/DEF-MD): 1, 1, 0, 0, Bidir: GRE
RP Count 0, MPLS RP Count ORSVP-TE added: [Leg 0, Ctrl Leg 0, Part tail 0 Def Tail 0,
IR added: [Def Leg 0, Ctrl Leg 0, Part Leg 0, Part tail 0, Part IR Tail Label 0
Tree-SID Added: [Def/Part Leaf 0, Def Egress 0, Part Egress 1, Ctrl Leaf 0]
bgp_i_pmsi: 1,0/0 , bgp_ms_pmsi/Leaf-ad: 1/0, bgp_bidir_pmsi: 0, remote_bgp_bidir_pmsi:
0, PMSIs: I 0x9f77388, 0x0, MS 0x9fa2f98, Bidir Local: 0x0, Remote: 0x0, BSR/Leaf-ad
0x0/0, Autorp-disc/Leaf-ad 0x0/0, Autorp-ann/Leaf-ad 0x0/0
IIDs: I/6: 0x1/0x0, B/R: 0x0/0x0, MS: 0x1, B/A/A: 0x0/0x0/0x0

```

```

Bidir RPF-ID: 16, Remote Bidir RPF-ID: 0
I-PMSI: Unknown/None (0x9f77388)
I-PMSI rem: (0x0)
MS-PMSI: Tree-SID [524292, 192.168.0.4] (0x9fa2f98)
Bidir-PMSI: (0x0)
Remote Bidir-PMSI: (0x0)
BSR-PMSI: (0x0)
A-Disc-PMSI: (0x0)
A-Ann-PMSI: (0x0)
RIB Dependency List: 0x9f81370
Bidir RIB Dependency List: 0x0
Sources: 1, RPs: 1, Bidir RPs: 0

```

- **View Data MDT Information** - The commands in this section display SR multicast tree information for *data* MDTs. The information includes cache, router-local, and remote MDT information.

- **View Data MDT Cache Information**

```

Router# show pim vrf vpn1 mdt cache
Core Source      Cust (Source, Group)                Core Data      Expires
192.168.0.3      (10.3.4.1, 203.0.0.1)              [tree-id 524292] never
192.168.0.4      (10.3.4.6, 203.0.0.1)              [tree-id 524290] never

Leaf AD: 192.168.0.3

```

- **View Local MDTs Information**

```
Router# show pim vrf vpn1 mdt sr-p2mp local
```

```

Tree Identifier          MDT Source          Cache Count  DIP  Local VRF Routes  On-demand
[tree-id 524290 (0x80002)] 192.168.0.4 1      N    Y      1      10
Tree-SID Leaf: 192.168.0.3

```

• View Remote MDTs Information

```
Router # show pim vrf vpn1 mdt sr-p2mp remote
```

```

Tree Identifier          MDT Source          Cache Count  DIP  Local VRF Routes  On-demand
[tree-id 524290 (0x80002)] 192.168.0.4 1      N    N      1      0

```

• View MRIB MPLS Forwarding Information - This command displays labels that are used for transporting Cisco IOS IP Multicast traffic, on a specified router.

```
Router# show mrrib mpls forwarding
```

```

LSP information (XTC) :
  LSM-ID: 0x00000, Role: Head, Head LSM-ID: 0x80002
  Incoming Label       : (18000)
  Transported Protocol : <unknown>
  Explicit Null        : None
  IP lookup             : disabled

  Outsegment Info #1 [H/Push, Recursive]:
    OutLabel: 18000, NH: 192.168.0.3, Sel IF: GigabitEthernet0/2/0/0

```

```

LSP information (XTC) :
  LSM-ID: 0x00000, Role: Tail, Peek
  RPF-ID: 0x00011, Assoc-TIDs: 0xe0000011/0x0, MDT: TRmdtvpn1
  Incoming Label       : 18001
  Transported Protocol : <unknown>
  Explicit Null        : None
  IP lookup             : enabled

  Outsegment Info #1 [T/Pop]:
    No info.

```

• SR-PCE Show Commands

- **View Tree Information On PCE Server** - This command displays SR multicast tree information on the SR-PCE server.



Note A cleanup process that activates every 30 minutes will delete any inconsistent entries between the PCEs, which might result from network or config changes. Inconsistent entries are expected during that time frame.

```
Router# show pce lsp p2mp
```

```

Tree: sr_p2mp_root_192.168.0.1_tree_id_524290
Label: 18000      Operational: up  Admin: up
Metric Type: TE
Transition count: 3
Uptime: 00:00:03 (since Fri Jan 24 14:57:51 PST 2020)
Source: 192.168.0.1
Destinations: 192.168.0.4
Nodes:
  Node[0]: 192.168.0.2 (rtrM)
  Role: Transit
  Hops:

```

```

    Incoming: 18000 CC-ID: 4
    Outgoing: 18000 CC-ID: 4 (10.17.17.4) [rtrR]
Node[1]: 192.168.0.1 (rtrL1)
Role: Ingress
Hops:
    Incoming: 18000 CC-ID: 5
    Outgoing: 18000 CC-ID: 5 (10.12.12.2) [rtrM]
Node[2]: 192.168.0.4 (rtrR)
Role: Egress
Hops:
    Incoming: 18000 CC-ID: 6

```

For dynamic SR multicast trees created for multicast VPN, the **show** command has filters to view root multicast router and Tree-ID information. When the root router is specified, all multicast trees from that root are displayed. When root and Tree-ID are specified, only the specified tree information is displayed.

```

Router# show pce lsp p2mp root ipv6 10.1.1.1 524289

Tree: sr_p2mp_root_10.1.1.1_tree_id_524289, Root: 10.1.1.1 ID: 524289
Label: 20000 Operational: up Admin: up
PCC: 10.1.1.1
Local LFA FRR: Disabled
Metric Type: TE
Transition count: 11
Uptime: 00:03:37 (since Mon May 11 12:53:33 PDT 2020)
Destinations: 10.1.1.3, 10.1.1.4, 10.1.1.5
Nodes:
Node[0]: 10.1.1.1 (root1)
Role: Ingress
Hops:
    Incoming: 20000 CC-ID: 26
    Outgoing: 20000 CC-ID: 26 (192.168.114.4) [mid-4]
    Outgoing: 20000 CC-ID: 26 (192.168.112.2) [mid-2]
Node[1]: 10.1.1.4 (mid-4)
Role: Egress
Hops:
    Incoming: 20000 CC-ID: 27
Node[2]: 10.1.1.2 (mid-2)
Role: Transit
Hops:
    Incoming: 20000 CC-ID: 28
    Outgoing: 20000 CC-ID: 28 (192.168.123.3) [leaf-3]
    Outgoing: 20000 CC-ID: 28 (192.168.125.5) [leaf-5]
Node[3]: 10.1.1.3 (leaf-3)
Role: Egress
Hops:
    Incoming: 20000 CC-ID: 29
Node[4]: 10.1.1.5 (leaf-5)
Role: Egress
Hops:
    Incoming: 20000 CC-ID: 30

```

The following output shows that LFA FRR is enabled on the hop from rtrR to rtrM. Unlike typical multicast replication where the address displayed is the remote address on the link to a downstream router, the IP address 192.168.0.3 (displayed with an exclamation mark) is the router-ID of the downstream router rtrM. The output also displays the LFA FRR state for the multicast tree.

```

Router# show pce lsp p2mp

Tree: sr_p2mp_root_192.168.0.4_tree_id_524290
Label: 18000 Operational: up Admin: up
LFA FRR: Enabled
Metric Type: TE

```

```

Transition count: 1
Uptime: 3d19h (since Thu Feb 13 13:43:40 PST 2020)
Source: 192.168.0.4
Destinations: 192.168.0.1, 192.168.0.2
Nodes:
Node[0]: 192.168.0.3 (rtrM)
  Role: Transit
  Hops:
    Incoming: 18000 CC-ID: 1
    Outgoing: 18000 CC-ID: 1 (10.12.12.1) [rtrL1]
    Outgoing: 18000 CC-ID: 1 (10.15.15.2) [rtrL2]
Node[1]: 192.168.0.4 (rtrR)
  Role: Ingress
  Hops:
    Incoming: 18000 CC-ID: 2
    Outgoing: 18000 CC-ID: 2 (192.168.0.3!) [rtrM]
Node[2]: 192.168.0.1 (rtrL1)
  Role: Egress
  Hops:
    Incoming: 18000 CC-ID: 3
Node[3]: 192.168.0.2 (rtrL2)
  Role: Egress
  Hops:
    Incoming: 18000 CC-ID: 4

```

• Multicast Tree Information on Routers

```

Router# show segment-routing traffic-eng p2mp policy

SR-TE P2MP policy database:
-----
! - Replications with Fast Re-route

Policy: sr_p2mp_root_192.168.0.1_tree_id_524290 LSM-ID: 0x2
  Role: Leaf
  Replication:
    Incoming label: 18001 CC-ID: 6

Policy: sr_p2mp_root_192.168.0.4_tree_id_524290 LSM-ID: 0x80002 (PCC-initiated)
  Color: 0
  LFA FRR: Disabled
  Role: Root
  Replication:
    Incoming label: 18000 CC-ID: 2
    Interface: None [192.168.0.3!] Outgoing label: 18000 CC-ID: 2
  Endpoints:
    192.168.0.1, 192.168.0.2

```

For SR multicast policies originated locally on the router (root router of a dynamic multicast VPN multicast policy) additional policy information is displayed. The information includes color, end points, and whether LFA FRR is requested by the local application. When the SR-PCE server enables LFA FRR on a specific hop, the outgoing information shows the address of the next router with an exclamation mark and None is displayed for the outgoing interface.

For dynamic SR multicast trees created for multicast VPN, the **show** command has filters for displaying root multicast router and Tree-ID information. When the root router is specified, all multicast trees for that root are displayed. When root and Tree-ID are specified, only the specified tree information is displayed.

```

Router# show segment-routing traffic-eng p2mp policy root ipv6 1.1$

SR-TE P2MP policy database:
-----

```

! - Replications with Fast Re-route, * - Stale dynamic policies/endpoints

Policy: sr_p2mp_root_10.1.1.1_tree_id_524289 LSM-ID: 0x691

Root: 10.1.1.1, ID: 524289

Role: Transit

Replication:

Incoming label: 20000 CC-ID: 28

Interface: Bundle-Ether23 [192.168.123.3] Outgoing label: 20000 CC-ID: 28

Interface: Bundle-Ether25 [192.168.125.5] Outgoing label: 20000 CC-ID: 28

Policy: sr_p2mp_root_10.1.1.1_tree_id_524290 LSM-ID: 0x692

Root: 10.1.1.1, ID: 524290

Role: Transit

Replication:

Incoming label: 19999 CC-ID: 28

Interface: Bundle-Ether23 [192.168.123.3] Outgoing label: 19999 CC-ID: 28

Interface: Bundle-Ether25 [192.168.125.5] Outgoing label: 19999 CC-ID: 28

