



Cisco Unified Border Element Configuration Guide Through Cisco IOS XE 17.5

First Published: 2021-08-15

Last Modified: 2022-08-15

Americas Headquarters

Cisco Systems, Inc.
170 West Tasman Drive
San Jose, CA 95134-1706
USA
<http://www.cisco.com>
Tel: 408 526-4000
800 553-NETS (6387)
Fax: 408 527-0883

THE SPECIFICATIONS AND INFORMATION REGARDING THE PRODUCTS IN THIS MANUAL ARE SUBJECT TO CHANGE WITHOUT NOTICE. ALL STATEMENTS, INFORMATION, AND RECOMMENDATIONS IN THIS MANUAL ARE BELIEVED TO BE ACCURATE BUT ARE PRESENTED WITHOUT WARRANTY OF ANY KIND, EXPRESS OR IMPLIED. USERS MUST TAKE FULL RESPONSIBILITY FOR THEIR APPLICATION OF ANY PRODUCTS.

THE SOFTWARE LICENSE AND LIMITED WARRANTY FOR THE ACCOMPANYING PRODUCT ARE SET FORTH IN THE INFORMATION PACKET THAT SHIPPED WITH THE PRODUCT AND ARE INCORPORATED HEREIN BY THIS REFERENCE. IF YOU ARE UNABLE TO LOCATE THE SOFTWARE LICENSE OR LIMITED WARRANTY, CONTACT YOUR CISCO REPRESENTATIVE FOR A COPY.

The Cisco implementation of TCP header compression is an adaptation of a program developed by the University of California, Berkeley (UCB) as part of UCB's public domain version of the UNIX operating system. All rights reserved. Copyright © 1981, Regents of the University of California.

NOTWITHSTANDING ANY OTHER WARRANTY HEREIN, ALL DOCUMENT FILES AND SOFTWARE OF THESE SUPPLIERS ARE PROVIDED "AS IS" WITH ALL FAULTS. CISCO AND THE ABOVE-NAMED SUPPLIERS DISCLAIM ALL WARRANTIES, EXPRESSED OR IMPLIED, INCLUDING, WITHOUT LIMITATION, THOSE OF MERCHANTABILITY, FITNESS FOR A PARTICULAR PURPOSE AND NON-INFRINGEMENT OR ARISING FROM A COURSE OF DEALING, USAGE, OR TRADE PRACTICE.

IN NO EVENT SHALL CISCO OR ITS SUPPLIERS BE LIABLE FOR ANY INDIRECT, SPECIAL, CONSEQUENTIAL, OR INCIDENTAL DAMAGES, INCLUDING, WITHOUT LIMITATION, LOST PROFITS OR LOSS OR DAMAGE TO DATA ARISING OUT OF THE USE OR INABILITY TO USE THIS MANUAL, EVEN IF CISCO OR ITS SUPPLIERS HAVE BEEN ADVISED OF THE POSSIBILITY OF SUCH DAMAGES.

Any Internet Protocol (IP) addresses and phone numbers used in this document are not intended to be actual addresses and phone numbers. Any examples, command display output, network topology diagrams, and other figures included in the document are shown for illustrative purposes only. Any use of actual IP addresses or phone numbers in illustrative content is unintentional and coincidental.

All printed copies and duplicate soft copies of this document are considered uncontrolled. See the current online version for the latest version.

Cisco has more than 200 offices worldwide. Addresses and phone numbers are listed on the Cisco website at www.cisco.com/go/offices.

Cisco and the Cisco logo are trademarks or registered trademarks of Cisco and/or its affiliates in the U.S. and other countries. To view a list of Cisco trademarks, go to this URL: <https://www.cisco.com/c/en/us/about/legal/trademarks.html>. Third-party trademarks mentioned are the property of their respective owners. The use of the word partner does not imply a partnership relationship between Cisco and any other company. (1721R)

© 2024 Cisco Systems, Inc. All rights reserved.



CONTENTS

CHAPTER 1	Read Me First	1
	Short Description	2

CHAPTER 2	New and Changed Information	3
	New and Changed Information	3

CHAPTER 3	Supported Platforms	5
	Feature Comparison on Supported Platforms	7

PART I	CUBE Fundamentals and Basic Setup	11
---------------	--	-----------

CHAPTER 4	Overview of Cisco Unified Border Element	13
	Information About Cisco Unified Border Element	13
	SIP/H.323 Trunking	16
	Typical Deployment Scenarios for CUBE	17
	How to Configure Basic CUBE Features	18
	Enabling the CUBE Application on a Device	19
	Verifying the CUBE Application on the Device	21
	Configuring a Trusted IP Address List for Toll-Fraud Prevention	22

CHAPTER 5	Virtual CUBE	25
	Feature Information for Virtual CUBE	25
	Prerequisites for Virtual CUBE	26
	Hardware	26
	Software	26
	Features Supported with Virtual CUBE	27

Restrictions	27
Information about Virtual CUBE	27
Media	27
Virtual CUBE Licensing Requirements	28
Virtual CUBE with CSR1000V	28
Virtual CUBE with Catalyst 8000V	28
Install Virtual CUBE on ESXi	28
How to Enable Virtual CUBE	29
Troubleshooting Virtual CUBE	29

CHAPTER 6	Dial-Peer Matching	31
	Dial Peers in CUBE	31
	Configuring Inbound and Outbound Dial-Peer Matching for CUBE	33
	Preference for Dial-Peer Matching	34

CHAPTER 7	DTMF Relay	37
	Feature Information for DTMF Relay	37
	Information About DTMF Relay	38
	DTMF Tones	38
	DTMF Relay	38
	Configuring DTMF Relays	41
	Interoperability and Priority with Multiple DTMF Relay Methods	42
	DTMF Interoperability Table	42
	Verifying DTMF Relay	46

CHAPTER 8	Introduction to Codecs	51
	Why CUBE Needs Codecs	51
	Restrictions for Voice-Class Codec Transparent	52
	Voice Media Transmission	52
	Voice Activity Detection	53
	VoIP Bandwidth Requirements	54
	Supported Audio and Video Codecs	56
	How to Configure Codecs	57
	Configuring Audio and Video Codecs at the Dial Peer Level	57

Configuring Audio Codecs Using a Codec Voice Class and Preference Lists	59
Configuring Video Codecs Using Codec Voice Class	61
Verifying an Audio Call	62
Configuration Examples for Codecs	62

CHAPTER 9**Call Admission Control 65**

Configuring CAC Based on Total Calls, CPU or Memory	65
Example: Internal Error Code (IEC) for Default Call Rejection Based on CPU Utilization and Memory	67
Configuring CAC Based on Call Spike Detection	67
Configuring CAC Based on Maximum Calls per Destination	68
Bandwidth-Based Call Admission Control	69
Restrictions for Bandwidth-Based Call Admission Control	70
Information About Bandwidth-Based Call Admission Control	70
Maximum Bandwidth Calculation	70
Bandwidth Tables	70
How to Configure Bandwidth-Based Call Admission Control	72
Configuring Bandwidth-Based Call Admission Control at the Interface Level	72
Configuring Bandwidth-Based Call Admission Control at the Dial Peer Level	74
Configuring the Bandwidth-Based Call Admission Control SIP Error Response Code Mapping	75
Verifying Bandwidth-Based Call Admission Control	77
Troubleshooting Tips	78
Configuration Examples for Bandwidth-Based Call Admission Control	79
Example: Configuring Bandwidth-Based Call Admission Control at the Interface Level	79
Example: Configuring Bandwidth-Based Call Admission Control at the Dial Peer Level	79
Example: Configuring the Bandwidth-Based Call Admission Control SIP Error Response Code Mapping at the Global Level	80
Example: Configuring the Bandwidth-Based Call Admission Control SIP Error Response Code Mapping at the Dial Peer Level	80
Feature Information for Bandwidth-Based Call Admission Control	80

CHAPTER 10**Basic SIP Configuration 83**

Prerequisites for Basic SIP Configuration	83
Restrictions for Basic SIP Configuration	83

Information About Basic SIP Configuration **84**

- SIP Register Support **84**
- SIP Redirect Processing Enhancement **84**
- Sending SIP 300 Multiple Choice Messages **85**

How to Perform Basic SIP Configuration **85**

- Configuring SIP VoIP Services on a Cisco Gateway **86**
 - Shut Down or Enable VoIP Service on Cisco Gateways **86**
 - Shut Down or Enable VoIP Submodes on Cisco Gateways **86**
- Configuring SIP Register Support **87**
- Configuring SIP Redirect Processing Enhancement **89**
 - Configure Call-Redirect Processing Enhancement **89**
- Configuring SIP 300 Multiple Choice Messages **92**
 - Configuring Sending of SIP 300 Multiple Choice Messages **92**
- Configuring SIP Implementation Enhancements **93**
 - Interaction with Forking Proxies **93**
 - SIP Intra-Gateway Hairpinning **94**
- Verifying SIP Gateway Status **95**
- General Troubleshooting Tips **99**

Configuration Examples for Basic SIP Configuration **101**

- SIP Register Support Example **101**
- SIP Redirect Processing Enhancement Examples **103**
- SIP 300 Multiple Choice Messages Example **107**

Toll Fraud Prevention **108**

CHAPTER 11 SIP Binding 111

- Feature Information for SIP Binding **111**
- Information About SIP Binding **112**
 - Benefits of SIP Binding **112**
 - Source Address **113**
 - Voice Media Stream Processing **116**
- Configuring SIP Binding **118**
- Verifying SIP Binding **120**

CHAPTER 12 Media Path 127

Feature Information for Media Path	127
Media Flow-Through	128
Restrictions for Media Flow-Through	128
Configure Media Flow-Through	129
Media Flow-Around	130
Configure Media Flow-Around	130
Media Anti-Trombone	131
Prerequisites	132
Restrictions for Media Anti-Tromboning	132
Configuring Media Anti-Tromboning	132

CHAPTER 13**SIP Profiles 135**

Feature Information for SIP Profiles	135
Information About SIP Profiles	136
Important Characteristics of SIP Profiles	137
Restrictions for SIP Profiles	139
How to Configure SIP Profiles	139
Configuring a SIP Profile to Manipulate SIP Request or Response Headers	140
Configuring SIP Profiles for Copying Unsupported SDP Headers	141
Example: Configuring SIP Profile Rules (Attribute Passing)	143
Example: Configuring SIP Profile Rules (Parameter Passing)	143
Example: Configuration to Remove an Attribute	143
Configuring SIP Profile Using Rule Tag	143
Configuring a SIP Profile for Non-standard SIP Header	145
Upgrading or Downgrading SIP Profile Configurations	147
Configuring a SIP Profile as an Outbound Profile	148
Configuring a SIP Profile as an Inbound Profile	149
Verifying SIP Profiles	150
Troubleshooting SIP Profiles	151
Examples: Adding, Modifying, Removing SIP Profiles	152
Example: Adding a SIP, SDP, or Peer Header	152
Example: Modifying a SIP, SDP, or Peer Header	153
Example: Remove a SIP, SDP, or Peer Header	156
Example: Inserting SIP Profile Rules	157

Example: Upgrading and Downgrading SIP Profiles automatically	157
Example: Modifying Diversion Headers	158
Example: Sample SIP Profile Application on SIP Invite Message	159
Example: Sample SIP Profile for Non-Standard SIP Headers	160
Example: Copy a User-to-User from REFER Message	160

CHAPTER 14	SIP Out-of-Dialog OPTIONS Ping Group	163
	Information About SIP Out-Of-dialog OPTIONS Ping Group	163
	SIP Out-of-Dialog OPTIONS Ping Group Overview	163
	How to Configure SIP Out-Of-dialog OPTIONS Ping Group	164
	Configuring SIP Out-of-Dialog OPTIONS Ping Group	164
	Configuration Examples For SIP Out-of-Dialog OPTIONS Ping Group	166
	Additional References	168
	Feature Information for SIP Out-of-dialog OPTIONS Ping Group	169

CHAPTER 15	Configure TCL IVR Applications	171
	Tel IVR Overview	171
	Tel IVR Enhancements	172
	RTSP Client Implementation	172
	TCL IVR Prompts Played on IP Call Legs	173
	TCL Verbs	174
	TCL IVR Prerequisite Tasks	177
	TCL IVR Configuration Tasks List	177
	Configuring the Call Application for the Dial Peer	178
	Configuring TCL IVR on the Inbound POTS Dial Peer	180
	Configuring TCL IVR on the Inbound VoIP Dial Peer	182
	Verifying TCL IVR Configuration	184
	TCL IVR Configuration Examples	185
	TCL IVR for Gateway1 (GW1) Configuration Example	185
	TCL IVR for GW2 Configuration Example	188

CHAPTER 16	VoIP for IPv6	191
	Prerequisites for VoIP for IPv6	191
	Restrictions for Implementing VoIP for IPv6	191

Information About VoIP for IPv6	193
SIP Features Supported on IPv6	193
SIP Voice Gateways in VoIPv6	194
VoIPv6 Support on Cisco UBE	195
How to Configure VoIP for IPv6	199
Configuring VoIP for IPv6	199
Shutting Down or Enabling VoIPv6 Service on Cisco Gateways	200
Shutting Down or Enabling VoIPv6 Submodes on Cisco Gateways	201
Configuring the Protocol Mode of the SIP Stack	201
Verifying SIP Gateway Status	203
RTCP Pass-Through	205
Configuring IPv6 Support for Cisco UBE	205
Verifying RTP Pass-Through	206
Configuring the Source IPv6 Address of Signaling and Media Packets	207
Configuring the SIP Server	208
Configuring the Session Target	209
Configuring SIP Register Support	210
Configuring Outbound Proxy Server Globally on a SIP Gateway	212
Configuring UDP Checksum	213
Configuring IP Toll Fraud	214
Configuring the RTP Port Range for an Interface	215
Configuring Message Waiting Indicator Server Address	216
Configuring Voice Ports	217
Configuring Cisco UBE Mid-call Re-INVITE Consumption	218
Configuring Passthrough of Mid-call Signalling	218
Configuring Passthrough SIP Messages at Dial Peer Level	219
Configuring H.323 IPv4-to-SIPV6 Connections in a Cisco UBE	220
Configuration Examples for VoIP over IPv6	222
Example: Configuring the SIP Trunk	222
Troubleshooting Tips for VoIP for IPv6	223
Verifying and Troubleshooting Tips	223
Verifying Cisco UBE ANAT Call Flows	223
Verifying and Troubleshooting Cisco UBE ANAT Flow-Through Call	225
Verifying Cisco UBE ANAT Flow-Around Calls	230

Verifying VMWI SIP 235
 Verifying SDP Passthrough Configuration 236
 Feature Information for VoIP for IPv6 241

CHAPTER 17

Monitoring of Phantom Packets 247

Restrictions of Monitoring of Phantom Packets 247
 Information About Monitoring of Phantom Packets 248
 Monitoring of Phantom Packets 248
 How to Configure Monitoring of Phantom Packets 248
 Configuring Monitoring of Phantom Packets 248
 Configuration Examples For Monitoring of Phantom Packets 250
 Additional References for Configurable Pass-Through of SIP INVITE Parameters 250
 Feature Information for Monitoring of Phantom Packets 251

CHAPTER 18

Configurable SIP Parameters via DHCP 253

Finding Feature Information 253
 Prerequisites for Configurable SIP Parameters via DHCP 253
 Restrictions for Configurable SIP Parameters via DHCP 254
 Information About Configurable SIP Parameters via DHCP 254
 How to Configure SIP Parameters via DHCP 258
 Configuring the DHCP Client 258
 Configuring the DHCP Client Example 259
 Enabling the SIP Configuration 260
 Enabling the SIP Configuration Example 261
 Troubleshooting Tips 261
 Configuring a SIP Outbound Proxy Server 262
 Configuring a SIP Outbound Proxy Server in Voice Service VoIP Configuration Mode 262
 Configuring a SIP Outbound Proxy Server in Voice Service VoIP Configuration Mode Example 263
 Configuring a SIP Outbound Proxy Server and Session Target in Dial Peer Configuration Mode 263
 Configuring a SIP Outbound Proxy Server in Dial Peer Configuration Mode Example 264
 Feature Information for Configurable SIP Parameters via DHCP 265

PART II

Dial Peer Enhancements 267

CHAPTER 19	Matching Inbound Dial Peers by URI	269
	Configuring an Inbound Dial Peer to Match on URI	269
	Examples for Configuring an Inbound Dial Peer to Match on a URI	271
CHAPTER 20	URI-Based Dialing Enhancements	273
	Feature Information for URI-Based Dialing Enhancements	273
	Information About URI-Based Dialing Enhancements	274
	Call Flows for URI-Based Dialing Enhancements	274
	How to Configure URI-Based Dialing Enhancements	277
	Configuring Pass Through of SIP URI Headers	277
	Configuring Pass Through of Request URI and To Header URI (Global Level)	277
	Configuring Pass Through of Request URI and To Header URI (Dial Peer Level)	278
	Configuring Pass Through of 302 Contact Header	279
	Configuring Pass Through of 302 Contact Header (Global Level)	279
	Configuring Pass Through of 302 Contact Header (Dial Peer Level)	280
	Deriving of Session Target from URI	282
	Configuration Examples for URI-Based Dialing Enhancements	284
	Example: Configuring Pass Through of Request URI and To Header URI	284
	Example: Configuring Pass Through of Request URI and To Header URI (Global Level)	284
	Example: Configuring Pass Through of Request URI and To Header URI (Dial Peer Level)	284
	Example: Configuring Pass Through of 302 Contact Header	284
	Example: Configuring Pass Through of 302 Contact Header (Global Level)	284
	Example: Configuring Pass Through of 302 Contact Header (Dial Peer Level)	284
	Example: Deriving Session Target from URI	285
	Additional References for URI-Based Dialing Enhancements	285
CHAPTER 21	Multiple Pattern Support on a Voice Dial Peer	287
	Feature Information for Multiple Pattern Support on a Voice Dial Peer	287
	Restrictions for Multiple Pattern Support on a Voice Dial Peer	288
	Information About Multiple Pattern Support on a Voice Dial Peer	288
	Configuring Multiple Pattern Support on a Voice Dial Peer	288
	Verifying Multiple Pattern Support on a Voice Dial Peer	290
	Configuration Examples for Multiple Pattern Support on a Voice Dial Peer	292

CHAPTER 22	Outbound Dial-Peer Group as an Inbound Dial-Peer Destination 293
	Feature Information for Outbound Dial-Peer Group as an Inbound Dial-Peer Destination 293
	Restrictions 294
	Information About Outbound Dial-Peer Group as an Inbound Dial-Peer Destination 294
	Configuring Outbound Dial-Peer Group as an Inbound Dial-Peer Destination 295
	Verifying Outbound Dial-Peer Groups as an Inbound Dial-Peer Destination 297
	Troubleshooting Tips 298
	Configuration Examples for Outbound Dial Peer Group as an Inbound Dial-Peer Destination 299

CHAPTER 23	Inbound Leg Headers for Outbound Dial-Peer Matching 303
	Feature Information for Inbound Leg Headers for Outbound Dial-Peer Matching 303
	Prerequisites for Inbound Leg Headers for Outbound Dial-Peer Matching 304
	Restrictions for Inbound Leg Headers for Outbound Dial-Peer Matching 304
	Information About Inbound Leg Headers for Outbound Dial-Peer Matching 305
	Configuring Inbound Leg Headers for Outbound Dial-Peer Matching 305
	Verifying Inbound Leg Headers for Outbound Dial-Peer Matching 308
	Configuration Example: Inbound Leg Headers for Outbound Dial-Peer Matching 310

CHAPTER 24	Server Groups in Outbound Dial Peers 313
	Feature Information for Configuring Server Groups in Outbound Dial Peers 313
	Information About Server Groups in Outbound Dial Peers 314
	How to Configure Server Groups in Outbound Dial Peers 315
	Configuring Server Groups in Outbound Dial Peers 315
	Verifying Server Groups in Outbound Dial Peers 318
	Configuration Examples for Server Groups in Outbound Dial Peers 319

CHAPTER 25	Domain-Based Routing Support on the Cisco UBE 323
	Feature Information for Domain-Based Routing Support on the Cisco UBE 323
	Restrictions for Domain-Based Routing Support on the Cisco UBE 324
	Information About Domain-Based Routing Support on the Cisco UBE 324
	How to Configure Domain-Based Routing Support on the Cisco UBE 325
	Configuring Domain-Based Routing at Global Level 325
	Configuring Domain-Based Routing at Dial Peer Level 326

Verifying and Troubleshooting Domain-Based Routing Support on the Cisco UBE	327
Configuration Examples for Domain-Based Routing Support on the Cisco UBE	330
Example Configuring Domain-Based Routing Support on the Cisco UBE	330

CHAPTER 26**ENUM Enhancement per Kaplan Draft RFC 331**

Feature Information for ENUM Enhancement per Kaplan Draft RFC	331
Restrictions for ENUM Enhancement per Kaplan Draft RFC	332
Information About ENUM Enhancement per Kaplan Draft RFC	333
How to Configure ENUM Enhancement per Kaplan Draft RFC	333
Enabling Source-Based Routing	333
Testing the ENUM Request	334
Verifying the ENUM Request	334
Troubleshooting Tips	336
Configuration Examples for ENUM Enhancement per Kaplan Draft RFC	336

PART III**Multi-Tenancy 339****CHAPTER 27****Support for Multi-VRF 341**

Feature Information for VRF	341
Information About Voice-VRF	343
Information About Multi-VRF	343
VRF Preference Order	344
Restrictions	344
Recommendations	345
Configuring VRF	346
Create a VRF	346
Assign Interface to VRF	347
Create Dial-peers	348
Bind Dial-peers	349
Configure VRF-Specific RTP Port Ranges	351
Example: VRF with overlapping and non-overlapping RTP Port Range	353
Directory Number (DN) Overlap across Multiple-VRFs	354
Example: Associating Dial-peer Groups to Overcome DN Overlap	355
IP Overlap with VRF	357

Using Server Groups with VRF 358

Inbound Dial-Peer Matching Based on Multi-VRF 359

 Example: Inbound Dial-Peer Matching based on Multi-VRF 359

VRF Aware DNS for SIP Calls 361

High Availability with VRF 362

Configuration Examples 362

 Example: Configuring Multi-VRF in Standalone Mode 362

 Example: Configuring RG Infra High Availability with VRF 366

 Example: Configuring HSRP High Availability with VRF 373

 Example: Configuring Multi VRF where Media Flows Around the CUBE 380

 Example: Configuring Multi VRF where Media Flows Through the CUBE 388

Troubleshooting Tips 393

CHAPTER 28

Configuring Multi-Tenants on SIP Trunks 395

 Feature Information for Configuring Multi-Tenants on SIP Trunks 395

 Information About Configuring Multi-tenants on SIP Trunks 395

 How to Configure Multi-Tenants on SIP Trunks 399

 Configuring Multi-Tenants on SIP Trunks 399

 Example: SIP Trunk Registration in Multi-Tenant Configuration 401

PART IV

Codecs 403

CHAPTER 29

Codec Support and Restrictions 405

 Feature Information for Codec Support on CUBE 405

 OPUS Codec Support on CUBE 406

 Design Recommendations for Opus Codec 406

 Restrictions for Opus Codec Support on CUBE 407

 ISAC Codec Support on CUBE 408

 Restrictions for ISAC Codec Support on CUBE 408

 AAC-LD MP4A-LATM Codec Support on Cisco UBE 408

 Restrictions for AAC-LD MP4A-LATM Codec Support on Cisco UBE 409

CHAPTER 30

Codec Preference Lists 411

 Feature Information for Negotiation of an Audio Codec from a List of Codecs 411

Codecs Configured Using Preference Lists	412
Prerequisites for Codec Preference Lists	412
Restrictions for Codecs Preference Lists	413
How to Configure Codec Preference Lists	413
Configuring Audio Codecs Using a Codec Voice Class and Preference Lists	413
Disabling Codec Filtering	415
Troubleshooting Negotiation of an Audio Codec from a List of Codecs	416
Verifying Negotiation of an Audio Codec from a List of Codecs	417

PART V**DSP Services 421**

CHAPTER 31**Transcoding 423**

Configure LTI-Based Transcoding	424
Configuration Examples for LTI Based Transcoding	426
Configuring SCCP-based Transcoding (ISR-G2 devices only)	428
TLS for SCCP Connection for DSP Services	430
Configuring Secure Transcoding	431
Configuring the Certificate Authority	431
Configuring a Trustpoint for the Secure Universal Transcoder	432
Configuring DSPFARM Services	434
Associating SCCP to the Secure DSPFARM Profile	434
Registering the Secure Universal Transcoder to the CUBE	437
Configuration Examples for SCCP Based Transcoding	439

CHAPTER 32**Transrating 441**

Configuring Transrating for a Codec	441
-------------------------------------	-----

CHAPTER 33**Call Progress Analysis Over IP-to-IP Media Session 443**

Feature Information for Call Progress Analysis Over IP-IP Media Session	443
Restrictions for Call Progress Analysis Over IP-to-IP Media Session	444
Information About Call Progress Analysis Over IP-IP Media Session	445
Call Progress Analysis	445
CPA Events	445
How to Configure Call Progress Analysis Over IP-to-IP Media Session	446

Enabling CPA and Setting the CPA Parameters 446

Verifying the Call Progress Analysis Over IP-to-IP Media Session 448

Troubleshooting Tips 449

Configuration Examples for the Call Progress Analysis Over IP-to-IP Media Session 449

Example: Enabling CPA and Setting the CPA Parameters 449

CHAPTER 34

Voice Packetization 451

Configuring Transrating for a Codec 451

CHAPTER 35

Fax Detection for SIP Call and Transfer 453

Restrictions for Fax Detection for SIP Call and Transfer On Cisco IOS XE 453

Information About Fax Detection for SIP Call and Transfer 453

Local Redirect Mode 454

Refer Redirect Mode 455

Fax Detection with Cisco IOS XE High Availability 456

How to Configure Fax Detection for SIP Calls 456

Configure DSP Resource to Detect Fax Tone 456

Dial-peer Configuration to Redirect Fax Call 457

Verifying Fax Detection for SIP Calls 459

Troubleshooting Fax Detection for SIP Calls 460

Configuration Examples for Fax Detection for SIP Calls 460

Example: Configuring Local Redirect 460

Example: Configuring Refer Redirect 461

Feature Information for Fax Detection for SIP Call and Transfer 461

PART VI

Video 463

CHAPTER 36

Video Suppression 465

Feature Information for Video Suppression 465

Restrictions 465

Information About Video Suppression 466

Feature Behavior 466

Configuring Video Suppression 466

Troubleshooting Tips 467

PART VII**Media Services 469**

CHAPTER 37**Configuring RTCP Report Generation 471**

Prerequisites 471

Restrictions 471

Configuring RTCP Report Generation on Cisco UBE 472

Troubleshooting Tips 473

Feature Information for Configuring RTCP Report Generation 474

PART VIII**Media Recording 477**

CHAPTER 38**Network-Based Recording 479**

Feature Information for Network-Based Recording 479

Restrictions for Network-Based Recording 480

Information About Network-Based Recording Using CUBE 481

Deployment Scenarios for CUBE-based Recording 481

Open Recording Architecture 482

Network Layer 483

Capture and Media Processing Layer 483

Application Layer 483

Media Forking Topologies 484

Media Forking with Cisco UCM 484

Media Forking without Cisco UCM 484

SIP Recorder Interface 484

Metadata 484

How to Configure Network-Based Recording 485

Configuring Network-Based Recording (with Media Profile Recorder) 485

Configuring Network-Based Recording (without Media Profile Recorder) 488

Verifying the Network-Based Recording Using CUBE 490

Additional References for Network-Based Recording 505

CHAPTER 39**SIPREC (SIP Recording) 507**

Feature Information for SIPREC-based Recording 507

Prerequisites for SIPREC Recording	508
Restrictions for SIPREC Recording	508
Information About SIPREC Recording Using CUBE	509
Deployment	509
SIPREC High Availability Support	510
How to Configure SIPREC-Based Recording	510
Configuring SIPREC-Based Recording (with Media Profile Recorder)	510
Configuring SIPREC-Based Recording (without Media Profile Recorder)	513
Configuration Examples for SIPREC-based Recording	515
Example: Configuring SIPREC-based Recording with Media Profile Recorder	515
Example: Configuring SIPREC-based Recording without Media Profile Recorder	516
Validate SIPREC Functionality	516
Troubleshoot	517
Configuration Example for Metadata Variations with Different Mid-call Flows	521
Example: Complete SIP Recording Metadata Information Sent in INVITE or Re-INVITE	521
Example: Hold with Send-only / Recv-only Attribute in SDP	524
Example: Hold with Inactive Attribute in SDP	527
Example: Escalation	529
Example: De-escalation	531
Configuration Example for Metadata Variations with Different Transfer Flows	534
Example: Transfer of Re-INVITE/REFER Consume Scenario	534
Configuration Examples for Metadata Variations with Caller-ID UPDATE Flow	535
Example: Caller-ID UPDATE Request and Response Scenario	535
Configuration Example for Metadata Variations with Call Disconnect	536
Example: Disconnect while Sending Metadata with BYE	536

CHAPTER 40
Video Recording - Additional Configurations 537

Feature Information for Video Recording - Additional Configurations	537
Information About Additional Configurations for Video Recording	538
Full Intra-Frame Request	538
How to Configure Additional Configurations for Video Recording	538
Enabling FIR for Video Calls (Using RTCP of SIP INFO)	538
Configuring H.264 Packetization Mode	539
Monitoring Reference files or Intra Frames	540

Verifying Additional Configurations for Video Recording 541

CHAPTER 41

Third-Party GUID Capture for Correlation Between Calls and SIP-based Recording 543

Feature Information for Third-Party GUID Capture for Correlation Between Calls and SIP-based Recording 543

Restrictions for Third-Party GUID Capture for Correlation Between Calls and SIP-based Recording 544

Information About Third-Party GUID Capture for Correlation Between Calls and SIP-based recording 544

How to Capture Third-Party GUID for Correlation Between Calls and SIP-based Recording 544

Verifying Third-Party GUID Capture for Correlation Between Calls and SIP-based Recording 547

Configuration Examples for Third-Party GUID Capture for Correlation Between Calls and SIP-based Recording 548

CHAPTER 42

Cisco Unified Communications Gateway Services--Extended Media Forking 551

Feature Information for Cisco Unified Communications Gateway Services—Extended Media Forking 551

Restrictions for Extended Media Forking 552

Information About Cisco Unified Communications Gateway Services 552

Extended Media Forking (XMF) Provider and XMF Connection 552

XMF Call-Based Media Forking 553

XMF Connection-Based Media Forking 554

Extended Media Forking API with Survivability TCL 554

Media Forking for SRTP Calls 555

 Crypto Tag 555

 Example of SDP Data sent in an SRTP Call 556

Multiple XMF Applications and Recording Tone 556

Forking Preservation 558

How to Configure UC Gateway Services 558

 Configuring Cisco Unified Communication IOS Services on the Device 558

 Configuring the XMF Provider 561

 Verifying the UC Gateway Services 562

 Troubleshooting Tips 565

Configuration Examples for UC Gateway Services 565

 Example: Configuring Cisco Unified Communication IOS Services 565

Example: Configuring the XMF Provider 566
 Example: Configuring UC Gateway Services 566

PART IX

CUBE Media Proxy 567

CHAPTER 43

CUBE Media Proxy 569

Feature Information for CUBE Media Proxy 569
 Supported Platforms 570
 Restrictions for CUBE Media Proxy 570
 CUBE Media Proxy Using Unified CM Network-Based Recording 571
 SIPREC-Based CUBE Media Proxy 571
 About Multiple Media Forking Using CUBE Media Proxy 571
 Secure Forking of Secure and Nonsecure Calls 572
 Deployment Scenarios for CUBE Media Proxy 572
 CUBE Media Proxy Using Unified CM Network-Based Recording 572
 SIPREC-Based CUBE Media Proxy 574
 Recording Metadata 575
 Session Identifier 577
 Session-ID Handling 577
 Recording State Notification 579
 SIP Info Messages from CUBE Media Proxy to Unified CM 579
 SIP Info Message Sent During the Initial Call 580
 SIP Info Message Sent During the Initial Call (All the Recorders as Optional) 580
 SIP Info Message Sent During the Initial Call (One Recorder as Mandatory and Remaining as
 Optional) 581
 How to Configure CUBE Media Proxy 582
 How to Configure CUBE Media Proxy for Network-Based Recording Solutions 582
 Configure Outbound Dial-Peers to the Recorders 582
 Configure CUBE Media Proxy 584
 Configure Inbound Dial-Peer from Unified CM 586
 How to Configure CUBE Media Proxy for SIPREC Solutions 587
 Verification of CUBE Media Proxy Configuration 587
 Supported Features 598
 Mid-Call Message Handling 598

Secure Recording of Secure Calls and Nonsecure Calls	598
Support for High Availability	599
Media Latch	599

PART X**SIP Header Manipulation 601****CHAPTER 44****Passing Headers Unsupported by CUBE 603**

Feature Information for Copying with SIP Profiles	603
Example: Passing a Header Not Supported by CUBE	603

CHAPTER 45**Copying SIP Headers 605**

Feature Information for Copying with SIP Profiles	605
How to Copy SIP Header Fields to Another	606
Copying From an Incoming Header and Modifying an Outgoing Header	606
Copying From One Outgoing Header to Another	608
Example: Copying the To Header into the SIP-Req-URI	609

CHAPTER 46**Manipulate SIP Status-Line Header of SIP Responses 611**

Feature Information for Manipulating SIP Responses	611
Copying Incoming SIP Response Status Line to Outgoing SIP Response	612
Modifying Status-Line Header of Outgoing SIP Response with User Defined Values	615

PART XI**Payload Type Interoperability 617****CHAPTER 47****Dynamic Payload Type Interworking for DTMF and Codec Packets for SIP-to-SIP Calls 619**

Feature Information for Dynamic Payload Type Interworking for DTMF and Codec Packets for SIP-to-SIP Calls	619
Restrictions for Dynamic Payload Type Interworking for DTMF and Codec Packets for SIP-to-SIP Calls	620
Symmetric and Asymmetric Calls	620
High Availability Checkpointing Support for Asymmetric Payload	621
How to Configure Dynamic Payload Type Passthrough for DTMF and Codec Packets for SIP-to-SIP Calls	622
Configuring Dynamic Payload Type Passthrough at the Global Level	622

Configuring Dynamic Payload Type Passthrough for a Dial Peer 623
 Verifying Dynamic Payload Interworking for DTMF and Codec Packets Support 624
 Troubleshooting Tips 624
 Configuration Examples for Assymmetric Payload Interworking 625
 Example: Asymmetric Payload Interworking—Passthrough Configuration 625
 Example: Asymmetric Payload Interworking—Interworking Configuration 626

PART XII

Protocol Interworking 627

CHAPTER 48

Delayed-Offer to Early-Offer 629

Feature Information for Delayed-Offer to Early-Offer 629
 Prerequisites for Delayed-Offer to Early-Offer 630
 Restrictions for Delayed-Offer to Early-Offer Media Flow-Around 630
 Delayed-Offer to Early-Offer in Media Flow-Around Calls 630
 Configuring Delayed Offer to Early Offer 631
 Configuring Delayed Offer to Early Offer for Video Calls 632
 Configuring Delayed Offer to Early Offer Medial Flow-Around 633
 MidCall Renegotiation Support for Delayed-Offer to Early-Offer Calls 634
 Restrictions for MidCall Renegotiation Support for DO-EO Calls 635
 Configuring Mid Call Renegotiation Support for Delayed-Offer to Early-Offer Calls 635
 High-Density Transcoding Calls in Delayed-Offer to Early-Offer 636
 Restrictions for High-Density Transcoding DO-EO Calls 637
 Configuring High-Density Transcoding 637

CHAPTER 49

H.323-to-SIP Interworking on CUBE 639

Prerequisites 639
 Restrictions 639
 H.323-to-SIP Basic Call Interworking 640
 H.323-to-SIP Supplementary Features Interworking 642
 H.323-to-SIP Codec Progress Indicator Interworking for Media Cut-Through 643
 Configuring H.323-to-SIP Interworking 643

CHAPTER 50

H.323-to-H.323 Interworking on CUBE 645

Feature Information for H.323-to-H.323 Interworking 645

Prerequisites	646
Restrictions	646
Slow Start to Fast-Start Interworking	646
Restrictions for Slow-Start and Fast-Start Interworking	647
Enabling Interworking between Slow Start and Fast Start	647
Call Failure Recovery (Rotary)	648
Enabling Call Failure Recovery (Rotary) without Identical Codec Configuration	648
Managing H.323 IP Group Call Capacities	649
Configuration Examples for Managing H.323 IP Group Call Capacities	651
Overlap Signaling	654
Configuring Overlap Signaling	654
Verifying H.323-to-H.323 Interworking	655
Troubleshooting H.323-to-H.323 Interworking	657

CHAPTER 51**SIP RFC 2782 Compliance with DNS SRV Queries 659**

Prerequisites SIP RFC 2782 Compliance with DNS SRV Queries	659
Information SIP RFC 2782 Compliance with DNS SRV Queries	659
How to Configure SIP-RFC 2782 Compliance with DNS SRV Queries	660
Configuring DNS Server Query Format RFC 2782 Compliance with DNS SRV Queries	660
Configuring DNS Server Lookups	661
Verifying	663
Feature Information for SIP RFC 2782 Compliance with DNS SRV Queries	663

PART XIII**Support for SRTP 665****CHAPTER 52****SRTP-SRTP Interworking 667**

Feature Information for SRTP-SRTP Interworking	667
Prerequisites for SRTP-SRTP Interworking	668
Restrictions for SRTP-SRTP Interworking	668
Information About SRTP-SRTP Interworking	668
Supplementary Services Support	669
How to Configure SRTP-SRTP Interworking	670
Configuring SRTP	670
Configuring Cipher Suite Preference (optional)	672

Applying Crypto Suite Selection Preference (optional)	673
Enabling SRTP Fallback	675
Configuration Examples	678
Example: Configuring SRTP-SRTP Interworking	678
Example: Changing the Cipher-Suite Preference	680

CHAPTER 53	SRTP-RTP Interworking	683
Feature Information for SRTP-RTP Interworking	683	
Prerequisites for SRTP-RTP Interworking	684	
Restrictions for SRTP-RTP Interworking	684	
Information About SRTP-RTP Interworking	684	
Support for SRTP-RTP Interworking	684	
Using SRTP-RTP Chain for Interworking Between AES_CM_128_HMAC_SHA1_32 and AES_CM_128_HMAC_SHA1_80 Crypto Suites	686	
Supplementary Services Support	687	
How to Configure Support for SRTP-RTP Interworking	688	
Configuring SRTP-RTP Interworking Support	688	
Configuring Crypto Authentication	690	
Enabling SRTP Fallback	692	
Troubleshooting Tips	694	
Verifying SRTP-RTP Supplementary Services Support	694	
Configuration Examples for SRTP-RTP Interworking	695	
Example: SRTP-RTP Interworking	695	
Example: Configuring Crypto Authentication	696	
Example: Configuring Crypto Authentication (Dial Peer Level)	696	
Example: Configuring Crypto Authentication (Global Level)	696	

CHAPTER 54	SRTP-SRTP Pass-Through	697
Feature Information for Support of SRTP-SRTP Pass-Through Calls	697	
Information About SRTP-SRTP Pass-Through	698	
Pass-Through of Unsupported Crypto Suites	698	
Configure Pass-Through of Unsupported Crypto Suites for a Specific Dial Peer	699	
Configure Pass-Through of Unsupported Crypto Suites Globally	701	
Configuration Examples for SRTP-SRTP Pass-Through	702	

PART XIV**High Availability 705**

CHAPTER 55**High Availability on Cisco 4000 Series ISR and Cisco Catalyst 8000 Series Edge Platforms 707**

About CUBE High Availability on Cisco 4000 Series ISR and Cisco Catalyst 8000 Series Edge Platforms **707**

Box-to-Box Redundancy **707**

Redundancy Group (RG) Infrastructure **708**

Network Topology **708**

Considerations and Restrictions **710**

 Considerations **710**

 Restrictions **711**

How to Configure CUBE High Availability on Cisco 4000 Series ISR and Cisco Catalyst 8000 Series Edge Platforms **712**

 Before You Begin **712**

 Configure High Availability **713**

 Configuration Examples **718**

 Example: Control Interface Protocol Configuration **718**

 Example: Redundancy Group Protocol Configuration **718**

 Example: Redundant Traffic Interface Configuration **718**

 Verify Your Configuration **718**

 Troubleshoot High Availability Issues **726**

CHAPTER 56**High Availability on Cisco ASR 1000 Series Aggregation Services Routers 729**

About CUBE High Availability on Cisco ASR 1000 Series Routers **729**

 Inbox Redundancy **730**

 Box-to-Box Redundancy **731**

 Redundancy Group (RG) Infrastructure **731**

 PROTECTED Mode **732**

 Network Topology **732**

 Considerations and Restrictions **734**

 Considerations **734**

 Restrictions **735**

How to Configure CUBE High Availability on Cisco ASR 1000 Series Router **736**

Before You Begin	736
Configure Inbox High Availability	737
Configure Box-to-Box High Availability	737
Configuration Examples	743
Verify Your Configuration	749
Verify Redundancy State on Active and Standby Routers	749
Verify Call State After Switchover	751
Verify SIP IP Address Bindings	754
Verify Current CPU Use	755
Force a Manual Failover for Testing	755
Troubleshoot High Availability Issues	756

CHAPTER 57**High Availability on Cisco CSR 1000V or C8000V Cloud Services Routers 759**

About vCUBE High Availability on CSR 1000V or C8000V Cloud Services Routers	759
Box-to-Box Redundancy	760
Redundancy Group (RG) Infrastructure	760
Network Topology	761
Considerations and Restrictions	763
Considerations	764
Restrictions	765
How to Configure vCUBE High Availability on Cisco CSR 1000v or C8000V	766
Before You Begin	766
Configure High Availability	766
Configuration Example	768
Troubleshoot High Availability Issues	769

CHAPTER 58**High Availability on Cisco Integrated Services Routers (ISR-G2) 771**

About CUBE High Availability on Cisco ISR-G2	771
Box-to-Box Redundancy	771
Hot Standby Router Protocol (HSRP)	772
Network Topology	772
Configure CUBE High Availability Using HSRP	773
Verify Redundancy State	784
Verify Call State After a Switchover	787

Considerations and Restrictions	790
Considerations	790
Restrictions	790
How to Configure CUBE High Availability on Cisco ISR-G2	791
Before You Begin	791
Configure High Availability	791
Configuration Examples	799
Example Configuration for Dual-Attached CUBE HSRP Redundancy	799
Example Configuration for Single-Attached CUBE HSRP Redundancy	802
Verify Your Configurations	804
Verify SIP IP Address Bindings	804
Verify Current CPU Use	804
Verify the Call Processing During a Switchover	805
Force a Manual Failover for Testing	805
Troubleshoot High Availability Issues	807

CHAPTER 59**DSP High Availability Support 811**

Feature Information for DSP High Availability Support on CUBE	811
Prerequisites for DSP High Availability	811
Features Supported with DSP High Availability	812
Restrictions for DSP High Availability	812
Troubleshooting DSP HA Support on CUBE	812
Configuration Examples for DSP HA	813

CHAPTER 60**Stateful Switchover Between Redundancy Paired Intra- or Inter-box Devices 815**

Feature Information for Stateful Switchover Between Redundancy Paired Intra- or Inter-box Devices	815
Prerequisites for Stateful Switchover Between Redundancy Paired Intra- or Inter-box Devices	816
Restrictions for Stateful Switchover Between Redundancy Paired Intra- or Inter-box Devices	817
Information About Stateful Switchover Between Redundancy Paired Intra- or Inter-box Devices	817
Call Escalation with Stateful Switchover	818
Call De-escalation with Stateful Switchover	818
Media Forking with High Availability	819
High Availability Protected Mode and Box-to-Box Redundancy for ASR	819
Support for Box-to-Box High Availability with Virtual IP Addresses	820

Monitoring Call Escalation and De-escalation with Stateful Switchover 820

Monitoring Media Forking with High Availability 822

Verifying the High Availability Protected Mode 824

Support for REFER and BYE/Also after Stateful Switch-Over 825

Troubleshooting Tips 826

Example: Configuring the Interfaces for ISR-G2 Devices 827

Example: Configuring the Interfaces for ASR Devices 827

Example: Configuring SIP Binding 827

CHAPTER 61

CVP Survivability TCL support with High Availability 829

Feature Information for CVP Survivability TCL support with High Availability 829

Prerequisites 830

Restrictions 830

Recommendations 830

CVP Survivability TCL support with High Availability 830

Configuring CVP Survivability TCL support with High Availability 830

PART XV

ICE-Lite Support on CUBE 831

CHAPTER 62

ICE-Lite Support on CUBE 833

Feature Information for ICE-Lite Support on CUBE 833

Restrictions for ICE-lite Support on CUBE 834

Information About ICE-Lite Support on CUBE 834

 Characteristics 834

 ICE Candidate 835

 ICE Lite 835

 High Availability Support with ICE 835

How to Configure ICE-Lite Support on CUBE 836

 Configuring ICE on the CUBE 836

 Verifying ICE-Lite on the CUBE (Success Flow Calls) 837

 ICE-Lite on CUBE (Error Flow Calls) 840

 Troubleshooting ICE-Lite Support on CUBE 845

Additional References 845

PART XVI**SIP Protocol Handling 847**

CHAPTER 63**Mid-call Signaling Consumption 849**

Feature Information for Mid-call Signaling 849

Prerequisites 850

Mid-call Signaling Passthrough - Media Change 850

Restrictions for Mid-Call Signaling Passthrough - Media Change 851

Behavior of Mid-call Re-INVITE Consumption 851

Configuring Passthrough of Mid-call Signalling 853

Example Configuring Passthrough SIP Messages at Dial Peer Level 854

Example Configuring Passthrough SIP Messages at the Global Level 854

Mid-call Signaling Block 854

Restrictions for Mid-Call Signaling Block 854

Blocking Mid-Call Signaling 855

Example Blocking SIP Messages at Dial Peer Level 856

Example: Blocking SIP Messages at the Global Level 856

Mid Call Codec Preservation 857

Configuring Mid Call Codec Preservation 857

Example: Configuring Mid Call Codec Preservation at the Dial Peer Level 858

Example: Configuring Mid Call Codec Preservation at the Global Level 858

CHAPTER 64**Early Dialog UPDATE Block 859**

Feature Information for Early Dialog UPDATE Block 859

Prerequisites 860

Restrictions 860

Information about Early Dialog UPDATE Block 860

Important Characteristics of Early Dialog UPDATE Block 860

Configuring Early Dialog UPDATE Block 861

Configuring Early Dialog UPDATE Block Renegotiate 862

Troubleshooting Tips 863

CHAPTER 65**Consumption of Forked 18x Responses with SDP During Early Dialog 865**

Feature Information for Consumption of Multiple Forked 18x Responses with SDP During Early Dialog 865

Prerequisites 866

Restrictions 866

Information About Consumption of Forked 18x Responses with SDP During Early Dialog 866

 Characteristics of Forked 18x Responses with SDP during Early Dialog 866

Configuring Consumption of Forked 18x Responses with SDP During Early Dialog 867

Configuring Consumption of Forked 18x Responses with SDP During Early Dialog Renegotiate 868

Troubleshooting Tips 870

CHAPTER 66

Support for Pass-Through of Unsupported Content Types in SIP INFO Messages 871

Feature Information 871

Configure SIP INFO Message with Unsupported Content Type 871

Information About Pass-Through of Unsupported Content Types in SIP INFO Messages 872

CHAPTER 67

Support for PAID PPID Privacy PCPID and PAURI Headers on the Cisco Unified Border Element 873

Feature Information for PAID PPID Privacy PCPID and PAURI Headers on the Cisco Unified Border Element 883

Prerequisites for Support for PAID PPID Privacy PCPID and PAURI Headers on the Cisco Unified Border Element 884

Restrictions for Support for PAID PPID Privacy PCPID and PAURI Headers on the Cisco Unified Border Element 885

Configuring P-Header and Random-Contact Support on the Cisco Unified Border Element 885

 Configuring P-Header Translation on a Cisco Unified Border Element 885

 Configuring P-Header Translation on an Individual Dial Peer 886

 Configuring P-Called-Party-Id Support on a Cisco Unified Border Element 887

 Configuring P-Called-Party-Id Support on an Individual Dial Peer 888

 Configuring Privacy Support on a Cisco Unified Border Element 889

 Configuring Privacy Support on an Individual Dial Peer 890

 Configuring Random-Contact Support on a Cisco Unified Border Element 891

 Configuring Random-Contact Support for an Individual Dial Peer 893

PART XVII

SIP Supplementary Services 895

CHAPTER 68	Dynamic Refer Handling	897
	Feature Information for Dynamic REFER Handling	897
	Prerequisites	898
	Restrictions	898
	Configuring REFER Passthrough with Unmodified Refer-to	898
	Configuring REFER Consumption	900
	Troubleshooting Tips	902

CHAPTER 69	Cause Code Mapping	903
	Feature Information for Cause Code Mapping	903
	Cause Code Mapping	904
	Configuring Cause Code Mapping	905
	Verifying Cause Code Mapping	906

PART XVIII	Hosted and Cloud Services	909
-------------------	----------------------------------	------------

CHAPTER 70	Hosted and Cloud Services Delivery with CUBE	911
-------------------	---	------------

CHAPTER 71	CUBE SIP Registration Proxy	913
	Registration Pass-Through Modes	913
	End-to-End Mode	913
	Peer-to-Peer Mode	914
	Registration in Different Registrar Modes	915
	Registration Overload Protection	916
	Registration Overload Protection--Call Flow	916
	Registration Rate-limiting	916
	Registration Rate-limiting Success--Call Flow	917
	Prerequisites for SIP Registration Proxy on Cisco UBE	917
	Restrictions	917
	Configuring CUBE SIP Registration Proxy	917
	Enabling Local SIP Registrar	917
	Configuring SIP Registration Proxy at the Global Level	919
	Configuring SIP Registration Proxy at the Tenant Level	920

Configuring SIP Registration Proxy at the Dial Peer Level	922
Configuring Registration Overload Protection Functionality	923
Configuring Cisco UBE to Route a Call to the Registrar Endpoint	924
Verifying the SIP Registration on Cisco UBE	925
Configuration Example—CUBE SIP Registration Proxy	926
Feature Information for CUBE SIP Registration Proxy	927

CHAPTER 72**Survivability for Hosted and Cloud Services 929**

Information About Survivability for Hosted and Cloud Services	929
Advantages of Using CUBE Survivability Feature	929
Local Fallback	929
Registration Synchronization	930
Registration Through Alias Mapping	930
CUBE when WAN is UP	931
CUBE Survivability When WAN Is Down	932
How to Configure Survivability for Hosted and Cloud Services	934
Configuring Local Fallback or Registration Synchronization Globally	934
Configuring Local Fallback or Registration Synchronization at the Tenant Level	935
Configuring Local Fallback or Registration Synchronization on a Dial Peer	936
Configuring Survivability for Phones Sending Single Register Request	937
Configuring OPTIONS Ping	938
Configuring Registration Timer	939
Configuring the REGISTER Message Throttling in CUBE	940
Configuring the Class of Restrictions (COR) List	941
Verifying Survivability for Hosted and Cloud Services	943
Configuration Examples—Survivability for Hosted and Cloud Services	945
Example: Configuring Local Fallback Globally	945
Example: Configuring Local Fallback at the Tenant Level	946
Example: Configuring Local Fallback on a Dial Peer	946
Example: Configuring Survivability for Phones Sending Single Register Request	946
Example: Configuring OPTIONS Ping	946
Example: Configuring the Registration Timer	946
Example: Configuring REGISTER Message Throttling	947
Example: Configuring the COR List	947

Feature Information for Survivability for Hosted and Cloud Services 947

CHAPTER 73

SUBSCRIBE-NOTIFY Passthrough 949

Restrictions for SUBSCRIBE-NOTIFY Passthrough 949

Information About SUBSCRIBE-NOTIFY Passthrough 950

SUBSCRIBE-NOTIFY Passthrough Request Routing 950

SUBSCRIBE-NOTIFY Passthrough Survivability Mode 951

Configure SUBSCRIBE-NOTIFY Passthrough 951

Configuring an Event List 951

Configuring SUBSCRIBE-NOTIFY Event Passthrough Globally 952

Configuring SUBSCRIBE-NOTIFY Event Passthrough at the Dial-Peer Level 953

Verifying SUBSCRIBE-NOTIFY Passthrough 954

Troubleshooting Tips 956

Configuration Examples for SUBSCRIBE-NOTIFY Passthrough 956

Example: Configuring an Event List 956

Example: Configuring SUBSCRIBE-NOTIFY Event Passthrough Globally 956

Example: Configuring SUBSCRIBE-NOTIFY Event Passthrough under a Dial Peer 957

Feature Information for SUBSCRIBE-NOTIFY Passthrough 957

PART XIX

Cisco Unified Communications Manager Line-Side Support 959

CHAPTER 74

Cisco Unified Communications Manager Line-Side Support 961

Feature Information for Cisco Unified Communications Manager Line-Side Support 961

Restrictions for Cisco Unified Communications Manager Line-Side Support 962

Information About Cisco Unified Communications Manager Line-Side Support 963

Cisco UBE Line-Side Deployment 963

Line-Side Deployment Scenarios 963

Line-Side Support for CUCM on CUBE 964

Configuring a PKI Trustpoint 965

Importing the CUCM and CAPF Key 966

Creating a CTL File 967

Configuring a Phone Proxy 968

Attaching a Phone Proxy to a Dial Peer 969

Verifying CUCM Lineside Support 971

Example: Configuring a PKI Trustpoint 973

Example: Importing the CUCM and CAPF Key 974

Example: Creating a CTL File 974

Example: Configuring a Phone Proxy 974

Example: Attaching a Phone Proxy to a Dial Peer 974

Example: Configuring CUCM Secure Line-Side 975

Example: Configuring CUCM Non-Secure Line-Side 977

PART XX

Security 981

CHAPTER 75

SIP TLS Support on CUBE 983

Feature Information for SIP TLS Support on CUBE 983

Restrictions 984

Information About SIP TLS Support on CUBE 985

Deployment 985

TLS Cipher Suite Category 985

How to Configure SIP TLS Support on CUBE 986

Configuring SIP TLS on CUBE 986

Verifying SIP TLS Configuration 994

SIP TLS Configuration Examples 995

Example: SIP TLS Configuration 995

PART XXI

Voice Quality in CUBE 1001

CHAPTER 76

CUBE Call Quality Statistics Enhancement 1003

Feature Information for Call Quality Statistics Enhancement 1003

Restrictions for Call Quality Statistics Enhancement 1004

Information About Call Quality Statistics Enhancement 1004

How to Configure Call Quality Parameters 1005

Configuring Call Quality Criteria Parameters 1005

Troubleshooting Call Quality Statistics 1006

Configuration Example for Call Quality Statistics 1007

CHAPTER 77

Voice Quality Monitoring 1009

Feature Information for Voice Quality Monitoring	1009
Prerequisites for Voice Quality Monitoring	1010
Restrictions for Voice Quality Monitoring and Voice Quality Statistics	1011
Information About Voice Quality Monitoring	1011
VQM Metrics	1012
How to Configure Voice Quality Monitoring	1012
Enabling Media Statistics Globally	1012
Verifying Voice Quality Monitoring	1013
Troubleshooting Tips	1015
Configuration Examples for Voice Quality Monitoring	1016
Example: Configuring Media Statistics Globally	1016
Example: CDR Enabled MOS Output	1016

PART XXII
Smart Licensing 1017

CHAPTER 78
CUBE Smart Licensing 1019

Smart License Operation	1019
Smart Software Licensing Task Flow for CUBE	1021
Obtain the Registration ID Token	1021
Configure Smart Licensing Transport Settings	1021
Associate the Host Platform with CSSM	1022
Configure CUBE Licensed Features	1023
Verify Smart Licensing Operation for CUBE	1023
CUBE High Availability Configurations	1027
Smart Licensing with CUBE Box-to-Box High Availability	1027
Verify Smart Licensing Operation for Box-to-Box High Availability	1028
Smart Licensing with CUBE Inbox High Availability	1030
Verify Smart Licensing Operation for Inbox High Availability	1031
Syslog Messages	1033

PART XXIII
Serviceability 1035

CHAPTER 79
VoIP Trace for CUBE 1037

VoIP Trace for CUBE	1037
---------------------	------

Prerequisites for Voip Trace	1038
Benefits of VoIP Trace	1038
Guide to using VoIP Trace Framework	1039
RTP Port Clear	1040
Feature Information for VoIP Trace	1041

CHAPTER 80
Support for Session Identifier 1043

Feature Information for Session Identifier Support	1043
Restrictions	1044
Information About Session Identifier	1044
Feature Behavior	1045
Configuring Support for Session Identifier	1045
Troubleshooting Tips	1045

PART XXIV
Security Compliance 1053

CHAPTER 81
Common Criteria (CC) and The Federal Information Processing Standards (FIPS) Compliance 1055

Feature Information for Common Criteria (CC) and the Federal Information Standards (FIPS) Compliance	1056
Supported Hardware and Software for Virtual CUBE	1056
Common Criteria Configuration on Cisco CSR 1000v	1056
Enable Common Criteria Mode	1056
SIP TLS Configuration	1057
SIP TLS Configuration Task Flow	1057
Generate RSA Public Key	1057
Configure Certificate Authority Server	1058
Configure CSR Trustpoint	1059
Configure Peer Trustpoint	1060
Add Client Verification Trustpoint	1061
Enforce Strict SRTP	1062
HTTPS TLS Configuration	1063
HTTPS TLS Configuration Task Flow	1063
Prepare Cisco CSR 1000v Router's HTTP Server to Run in CC Mode	1063
Create Certificate Map for HTTPS Peer Trustpoint	1064

Configure HTTPS TLS Version	1065
Configure Supported Cipher Suites	1066
Apply Certificate Map to HTTPS Peer Trustpoint	1066
NTP Configuration Restrictions in Common Criteria Mode	1067
FIPS Configuration on Cisco CSR 1000v	1068
Configuration Requirements for FIPS Compliance	1068

PART XXV**Appendixes 1069**

CHAPTER 82**Additional References 1071**

Related References	1071
Standards	1072
MIBs	1072
RFCs	1072
Technical Assistance	1074

CHAPTER 83**Glossary 1075**

Glossary	1075
----------	------





CHAPTER 1

Read Me First

Important Information



Note For CUBE feature support information in Cisco IOS XE Bengaluru 17.6.1a and later releases, see [Cisco Unified Border Element IOS-XE Configuration Guide](#).



Note The documentation set for this product strives to use bias-free language. For purposes of this documentation set, bias-free is defined as language that does not imply discrimination based on age, disability, gender, racial identity, ethnic identity, sexual orientation, socioeconomic status, and intersectionality. Exceptions may be present in the documentation due to language that is hardcoded in the user interfaces of the product software, language used based on RFP documentation, or language that is used by a referenced third-party product.

Feature Information

Use [Cisco Feature Navigator](#) to find information about feature support, platform support, and Cisco software image support. An account on Cisco.com is not required.

Related References

- [Cisco IOS Command References, All Releases](#)

Obtaining Documentation and Submitting a Service Request

- To receive timely, relevant information from Cisco, sign up at [Cisco Profile Manager](#).
- To get the business impact you're looking for with the technologies that matter, visit [Cisco Services](#).
- To submit a service request, visit [Cisco Support](#).
- To discover and browse secure, validated enterprise-class apps, products, solutions and services, visit [Cisco DevNet](#).
- To obtain general networking, training, and certification titles, visit [Cisco Press](#).
- To find warranty information for a specific product or product family, access [Cisco Warranty Finder](#).

- [Short Description, on page 2](#)

Short Description

Cisco and the Cisco logo are trademarks or registered trademarks of Cisco and/or its affiliates in the U.S. and other countries. To view a list of Cisco trademarks, go to this URL: <https://www.cisco.com/c/en/us/about/legal/trademarks.html>. Third-party trademarks mentioned are the property of their respective owners. The use of the word partner does not imply a partnership relationship between Cisco and any other company. (1721R)



CHAPTER 2

New and Changed Information

- [New and Changed Information](#), on page 3

New and Changed Information



Note

- For detailed information on CUBE features supported on Cisco IOS Releases, Cisco IOS XE 3S Releases, and Cisco IOS XE Denali 16.3.1 and later Releases, refer to [CUBE Cisco IOS Feature Roadmap](#), [CUBE Cisco IOS XE 3S Feature Roadmap](#), and [CUBE Cisco IOS XE Releases Feature Roadmap](#) respectively.
- For CUBE feature support information for Cisco IOS XE Bengaluru 17.6.1a and later releases, see [Cisco Unified Border Element IOS-XE Configuration Guide](#).
- H.323 protocol is no longer supported from Cisco IOS XE Bengaluru 17.6.1a onwards. Consider using SIP for multimedia applications.
- The documentation set for this product strives to use bias-free language. For purposes of this documentation set, bias-free is defined as language that does not imply discrimination based on age, disability, gender, racial identity, ethnic identity, sexual orientation, socioeconomic status, and intersectionality. Exceptions may be present in the documentation due to language that is hardcoded in the user interfaces of the product software, language used based on RFP documentation, or language that is used by a referenced third-party product.

Description	Documented at
Secure forking of nonsecure calls through Media Proxy	CUBE Media Proxy , on page 569
Support for Cisco 8200L Catalyst Edge Series Platforms	Supported Platforms , on page 5
Support for VoIP Trace Serviceability Framework	VoIP Trace for CUBE , on page 1037



CHAPTER 3

Supported Platforms



Note Cisco Cloud Services Router 1000V Series (CSR 1000V) is no longer supported from Cisco IOS XE Bengaluru 17.4.1a onwards. If you are using CSR 1000V, you have to upgrade to Cisco Catalyst 8000V Edge Software (Catalyst 8000V). For End-of-Life information on CSR 1000V, see [End-of-Sale and End-of-Life Announcement for the Select Cisco CSR 1000v Licenses](#).

Cisco Unified Border Element is supported on various platforms running on Cisco IOS Software Releases and Cisco IOS XE Software Releases.



Note For information on migrating from existing Cisco IOS XE 3S releases to the Cisco IOS XE Denali 16.3 release, see [Cisco IOS XE Denali 16.3 Migration Guide for Access and Edge Routers](#)

The following table provides information on Cisco router platform support for Cisco Unified Border Element:

Cisco Router Platforms	Cisco Router Models	Cisco IOS Software Releases
Cisco Integrated Services Generation 2 Routers (ISR G2)	Cisco 2900 Series Integrated Services Routers Cisco 3900 Series Integrated Services Routers	Cisco IOS 12 M and T Cisco IOS 15 M and T ¹
Cisco 4000 Series Integrated Services Routers (ISR G3)	Cisco 4321 Integrated Services Routers Cisco 4331 Integrated Services Routers Cisco 4351 Integrated Services Routers Cisco 4431 Integrated Services Routers Cisco 4451 Integrated Services Routers	Cisco IOS XE 3S Cisco IOS XE Denali 16.3.1 onwards ²
	Cisco 4461 Integrated Services Routers	Cisco IOS XE Amsterdam 17.2.1r onwards
Cisco 1000 Series Integrated Services Routers (ISR)	Cisco 1100 Integrated Services Router models ISR1100 4G/6G support CUBE features when running on IOS XE	Cisco IOS XE Gibraltar 16.12.1a onwards

Cisco Router Platforms	Cisco Router Models	Cisco IOS Software Releases
Cisco Aggregated Services Routers (ASR)	Cisco ASR1001-X Aggregated Services Routers Cisco ASR1002-X Aggregated Services Routers Cisco ASR1004 Aggregated Services Routers with RP2 Cisco ASR1006 Aggregated Services Routers with RP2 and ESP40	Cisco IOS XE 3S Cisco IOS XE Denali 16.3.1 onwards
	Cisco ASR1006-X Aggregated Services Routers with RP2 and ESP40	Cisco IOS XE Everest 16.6.1 onwards
	Cisco ASR1006-X Aggregated Services Routers with RP3 and ESP40/ESP100	Cisco IOS XE Everest 16.6.1 onwards
	Cisco ASR1006-X Aggregated Services Routers with RP3 and ESP100X	Cisco IOS XE Amsterdam 17.3.2 onwards
Cisco Cloud Services Routers (CSR)	Cisco Cloud Services Router 1000V series	Cisco IOS XE 3.15 onwards Cisco IOS XE Denali 16.3.1 onwards
Cisco Catalyst 8000V Edge Software (Catalyst 8000V)	Cisco Catalyst 8000V Edge Software (Catalyst 8000V)	Cisco IOS XE Bengaluru 17.4.1a onwards
Cisco 8300 Catalyst Edge Series Platforms	C8300-1N1S-6T C8300-1N1S-4T2X C8300-2N2S-6T C8300-2N2S-4T2X	Cisco IOS XE Amsterdam 17.3.2
Cisco 8200 Catalyst Edge Series Platform	C8200-1N-4T	Cisco IOS XE Bengaluru 17.4.1a
Cisco 8200L Catalyst Edge Series Platform	C8200L-1N-4T	Cisco IOS XE Bengaluru 17.5.1a

¹ Support for CUBE on Cisco 2900 Series Integrated Services Routers and Cisco 3900 Series Integrated Services Routers are only up to release 15.7 M.

² All CUBE features from release 11.5.0 (Cisco IOS XE Release 3.17) and features introduced in CUBE 11.5.1 on Cisco Integrated Services Generation 2 Routers (ISR G2) are included in CUBE release 11.5.2 for the Cisco IOS XE based platforms from Cisco IOS XE Denali 16.3.1 onwards.

• [Feature Comparison on Supported Platforms](#) , on page 7

Feature Comparison on Supported Platforms

The following table provides high level details of CUBE features supported on different platforms.



Note Collaboration feature support on Cisco ISR 4000 Series Routers is available from Cisco IOS XE Release 3.13.1S onwards. Cisco Cloud Services Routers 1000V Series support is available from Cisco IOS XE Release 3.15S onwards.

Table 1: Feature Comparisons for Supported Platforms

Features	Cisco ASR 1000 Series Routers	Cisco ISR G2 Series Routers	Cisco ISR 4000 Series Routers	Cisco ISR 1000 Series Routers
High Availability Implementation	Redundancy Group Infrastructure	Hot Standby Protocol (HSRP) Based	Redundancy Group Infrastructure	No
Media Forking	Yes (Cisco IOS XE Release 3.8S onwards)	Yes (Cisco IOS Release 15.2 (1) T onwards)	Yes (Cisco IOS XE Release 3.10S onwards)	No
DSP Card Type	SPA-DSP	PVDM2/PVDM3	PVDM4 SM-X-PVDM	No
Transcoder registered to CUCM	No	Yes (Exists via SCCP)	Yes (Exists via SCCP - Cisco IOS XE Release 3.11S onwards)	No
Transcoder—LTI	Yes	Yes	Yes	No
Cisco UC Gateway Services API	Yes (Cisco IOS XE Release 3.8S onwards)	Yes (Cisco IOS Release 15.2(2)T onwards)	Yes	Yes
Noise Reduction and ASP	Yes	Yes (Cisco IOS Release 15.2(3)T onwards)	Yes	No
Call Progress Analysis	Yes (Cisco IOS XE Release 3.9S onwards ; Recommended - Cisco IOS XE Release 3.15S)	Yes Cisco IOS Release 15.3(2)T onwards; Recommended -Cisco IOS Release 15.5(2)T onwards)	Yes Recommended - Cisco IOS XE Release 3.15S	No

Features	Cisco ASR 1000 Series Routers	Cisco ISR G2 Series Routers	Cisco ISR 4000 Series Routers	Cisco ISR 1000 Series Routers
SRTP-RTP Interworking	Yes - No DSP resources required (Cisco IOS XE Release 3.7S onwards)	Yes - DSP resources required (Cisco IOS Release 12.4(22)YB onwards)	Yes - No DSP resources required Cisco IOS XE Release 3.12S onwards	Yes - No DSP resources required
CUBE for SP Managed and Hosted Services	Yes	Yes	Yes	Yes
Unified SRST colocation with CUBE	Not supported	SCCP SRST is supported SIP SRST is not supported	Yes (Cisco IOS XE Fuji 16.7.1 Release onwards)	Yes. From Cisco IOS XE Bengaluru 17.5.1a
IPv6	Yes	Yes	Yes	Yes

Table 2: Feature Comparisons for Supported Platforms (Contd...)

Features	Cisco CSR 1000V Series Routers	Cisco 8000V Catalyst Series Edge Platforms	Cisco 8300 Catalyst Edge Series Platforms	Cisco 8200 Catalyst Edge Series Platforms	Cisco 8200L Catalyst Edge Series Platforms
HA Implementation	RG Infrastructure	RG Infrastructure	RG Infrastructure	RG Infrastructure	RG Infrastructure
Media Forking	Yes	Yes	Yes	Yes	Yes
DSP Card Type	No	No	NIM-PVDM SM-X-PVDM	NIM-PVDM SM-X-PVDM	NIM-PVDM SM-X-PVDM
Transcoder registered to CUCM	No	No	Yes (via SCCP)	Yes (via SCCP)	Yes (via SCCP)
Transcoder—LTI	No	No	Yes	Yes	Yes
Cisco UC Gateway Services API	Yes	Yes	Yes	Yes	Yes
Noise Reduction & ASP	No	No	Yes	Yes	Yes
Call Progress Analysis	No	No	Yes	Yes	Yes

Features	Cisco CSR 1000V Series Routers	Cisco 8000V Catalyst Series Edge Platforms	Cisco 8300 Catalyst Edge Series Platforms	Cisco 8200 Catalyst Edge Series Platforms	Cisco 8200L Catalyst Edge Series Platforms
SRTP-RTP Interworking	Yes - No DSP resources required (Cisco IOS XE Release 3.15S onwards)	Yes - No DSP resources required	Yes - No DSP resources required	Yes - No DSP resources required	Yes - No DSP resources required
CUBE for SP Managed and Hosted Services	Yes	Yes	Yes	Yes	Yes
Unified SRST colocation with CUBE	Not supported	No	Yes	Yes	Yes
IPv6	Yes	Yes	Yes	Yes	Yes



Note For more information on Unified SRST and Unified Border Element Co-location, see [Unified SRST and Unified Border Element Co-location](#).

Co-location of Cisco Unified Border Element - High Availability (HA) with Unified SRST is not supported.



PART I

CUBE Fundamentals and Basic Setup

- [Overview of Cisco Unified Border Element, on page 13](#)
- [Virtual CUBE, on page 25](#)
- [Dial-Peer Matching, on page 31](#)
- [DTMF Relay , on page 37](#)
- [Introduction to Codecs, on page 51](#)
- [Call Admission Control, on page 65](#)
- [Basic SIP Configuration, on page 83](#)
- [SIP Binding , on page 111](#)
- [Media Path, on page 127](#)
- [SIP Profiles, on page 135](#)
- [SIP Out-of-Dialog OPTIONS Ping Group, on page 163](#)
- [Configure TCL IVR Applications, on page 171](#)
- [VoIP for IPv6, on page 191](#)
- [Monitoring of Phantom Packets, on page 247](#)
- [Configurable SIP Parameters via DHCP, on page 253](#)



CHAPTER 4

Overview of Cisco Unified Border Element

Cisco Unified Border Element (CUBE) bridges voice and video connectivity between two separate VoIP networks. It is similar to a traditional voice gateway, except for the replacement of physical voice trunks with an IP connection. Traditional gateways connect VoIP networks to telephone companies using a circuit-switched connection, such as PRI. The CUBE connects VoIP networks to other VoIP networks and is often used to connect enterprise networks to Internet telephony service providers (ITSPs).

- [Information About Cisco Unified Border Element, on page 13](#)
- [How to Configure Basic CUBE Features, on page 18](#)

Information About Cisco Unified Border Element

Cisco Unified Border Element (CUBE) can terminate and originate signaling (H.323 and Session Initiation Protocol [SIP]) and media streams (Real-Time Transport Protocol [RTP] and RTP Control Protocol [RTCP]).

CUBE extends the functionality provided by conventional session border controllers (SBCs) in terms of protocol interworking, especially on the enterprise side. As shown in the chart below, the CUBE provides the following additional features:

Figure 1: Cisco Unified Border Element—More Than an SBC

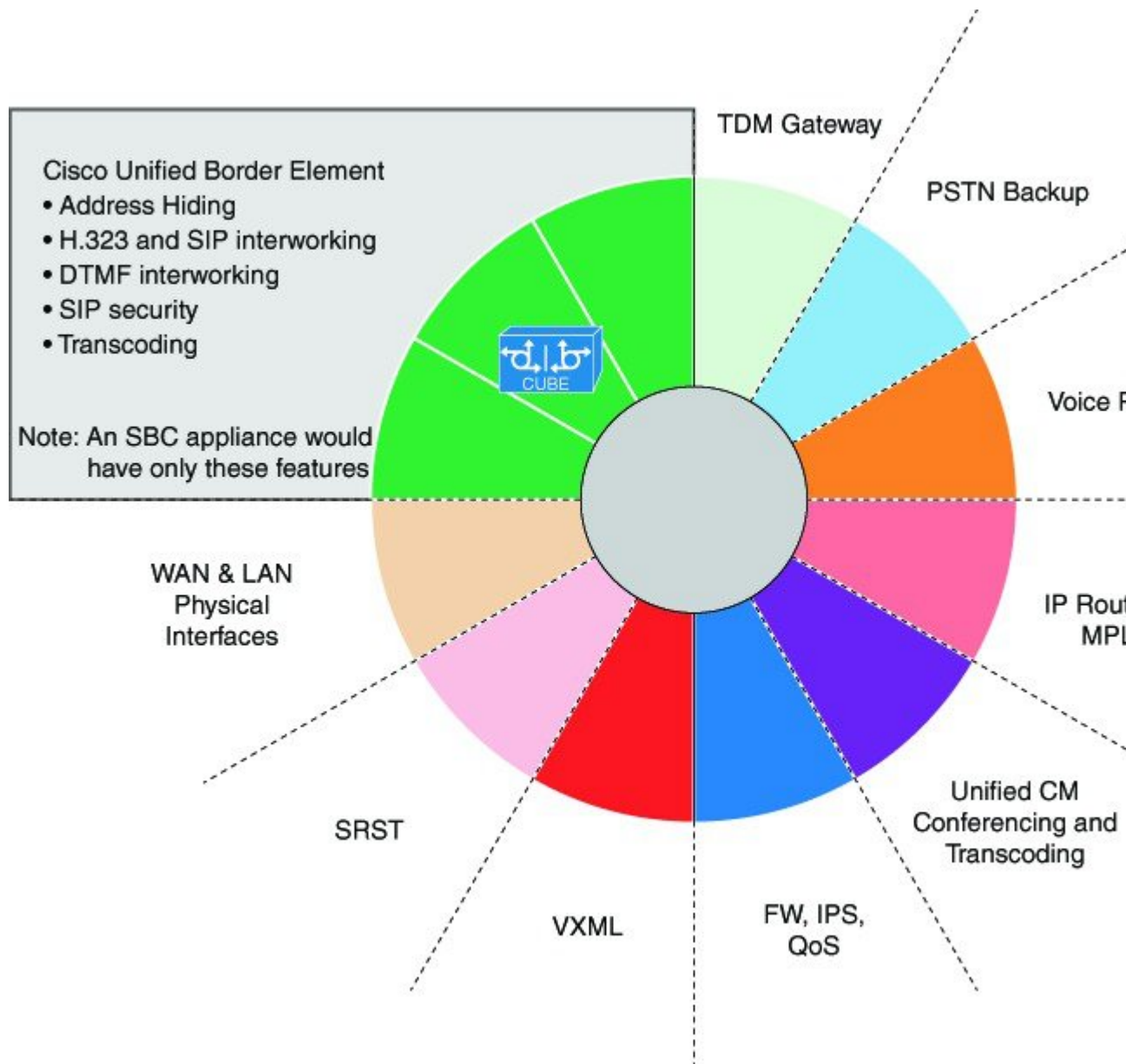

The CUBE provides a network-to-network interface point for:

- Signaling interworking—H.323 and SIP.
- Media interworking—dual-tone multifrequency (DTMF), fax, modem, and codec transcoding.
- Address and port translations—privacy and topology hiding.
- Billing and call detail record (CDR) normalization.
- Quality-of-service (QoS) and bandwidth management—QoS marking using differentiated services code point (DSCP) or type of service (ToS), bandwidth enforcement using Resource Reservation Protocol (RSVP), and codec filtering.

CUBE functionality is implemented on devices using a special IOS feature set, which allows CUBE to route a call from one VoIP dial peer to another.

Protocol interworking is possible for the following combinations:

- H.323-to-SIP interworking
- H.323-to-H.323 interworking
- SIP-to-SIP interworking

The CUBE provides a network-to-network demarcation interface for signaling interworking, media interworking, address and port translations, billing, security, quality of service, call admission control, and bandwidth management.

The CUBE is used by enterprise and small and medium-sized organizations to interconnect SIP PSTN access with SIP and H.323 enterprise unified communications networks.

A CUBE interoperates with several different network elements including voice gateways, IP phones, and call-control servers in many different application environments, from advanced enterprise voice and/or video services with Cisco Unified Communications Manager or Cisco Unified Communications Manager Express, as well as simpler toll bypass and voice over IP (VoIP) transport applications. The CUBE provides organizations with all the border controller functions integrated into the network layer to interconnect unified communications voice and video enterprise-to-service-provider architectures.

Figure 2: Why Does an Enterprise Need the CUBE?

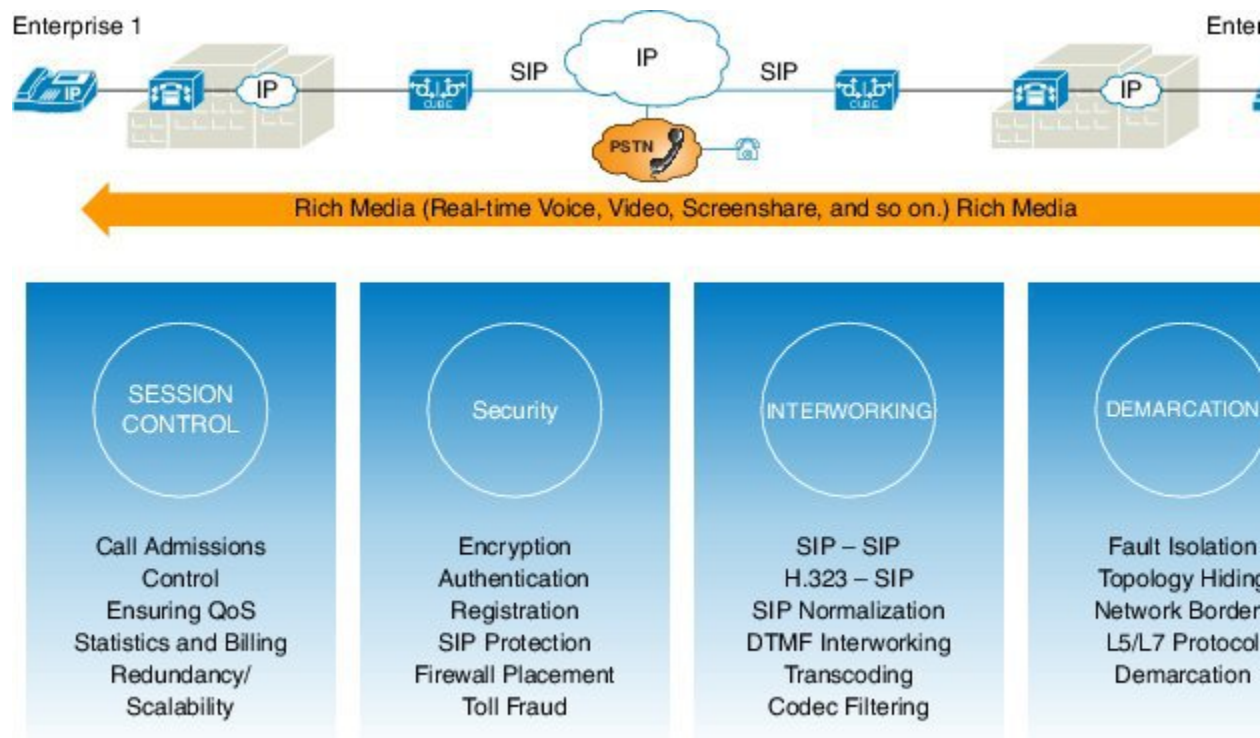

If an enterprise subscribes to VoIP services offered by an ITSP, connecting the enterprise CUCM through a CUBE provides network demarcation capabilities, such as security, topology hiding, transcoding, call admission control, protocol normalization and SIP registration, none of which is possible if CUCM connects directly to the ITSP. Another use case involves mergers or acquisitions in an enterprise and the need to integrate voice

equipment, such as CUCMs, IP PBXs, VM servers, and so on. If the networks in the two organizations have overlapping IP addresses, CUBE can be used to connect the two distinct networks until the acquired organization can be migrated into the enterprise addressing plan.

SIP/H.323 Trunking



Note H.323 protocol is no longer supported from Cisco IOS XE Bengaluru 17.6.1a onwards. Consider using SIP for multimedia applications.

The Session Initiation Protocol (SIP) is a signaling communications protocol, widely used for controlling multimedia communication sessions such as voice and video calls over IP networks. SIP (or H.323) trunking is the use of VoIP to facilitate the connection of PBX to other VoIP endpoints across the Internet. To use SIP trunking, an enterprise must have a PBX (internal VoIP system) that connects to all internal end users, an Internet telephony service provider (ITSP), and a gateway that serves as the interface between the PBX and the ITSP. One of the most significant advantages of SIP and H.323 trunking is the ability to combine data, voice, and video in a single line, eliminating the need for separate physical media for each mode.

Figure 3: SIP/H.323 Trunking

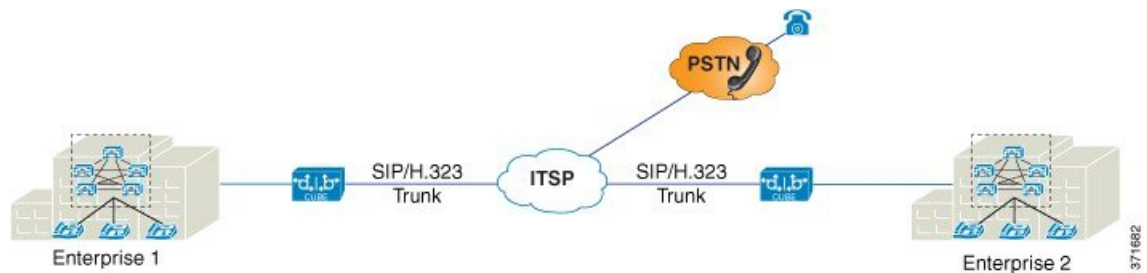

SIP trunking overcomes TDM barriers, in that it:

- Improves efficiency of interconnection between networks
- Simplifies PSTN interconnection with IP end-to-end
- Enables rich media services to employees, customers, and partners
- Carries converged voice, video, and data traffic

Figure 4: SIP Trunking Overcomes TDM Barriers



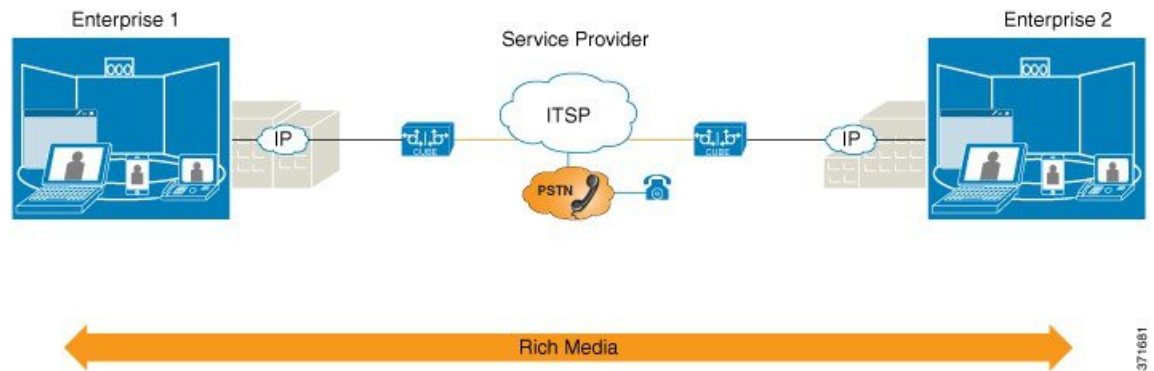

371681



Note For Cisco IOS XE Gibraltar 16.11.1a and later releases, the SIP processes are initiated only when either of the following CLIs is configured:

- Voice dial-peer with **session protocol** as SIP.
- **voice register global**
- **sip-ua**

In the releases before Cisco IOS XE Gibraltar 16.11.1a, the following commands initiated the SIP processes:

- **dial-peer voice** (*any*)
- **ephone-dn**
- **max-dn** under **call-manager-fallback**
- **ds0-group 0 timeslots 1 type e&m-wink-start**

Typical Deployment Scenarios for CUBE

CUBE in an enterprise environment serves two main purposes:

- **External Connections**—CUBE is the demarcation point within a unified communications network and provides interconnectivity with external networks. This includes H.323 and SIP voice and video connections.
- **Internal Connections**—When used within a VoIP network, CUBE increases flexibility and interoperability between devices.

Figure 5: Typical Deployment Scenarios

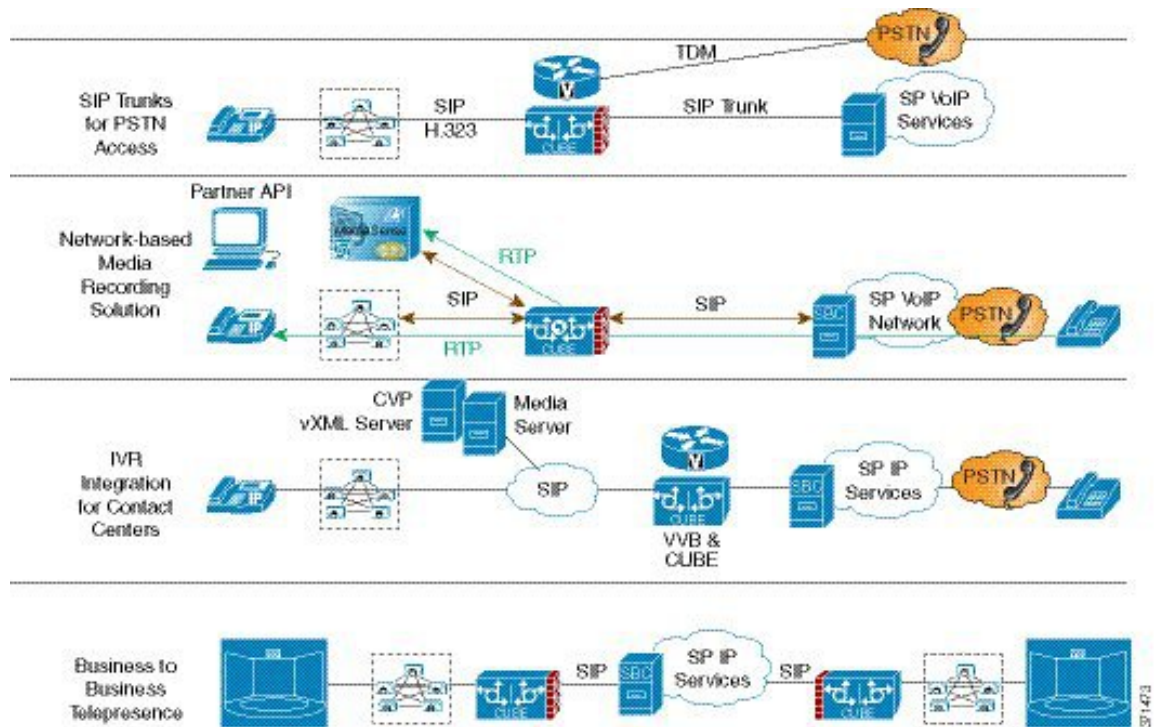

How to Configure Basic CUBE Features

Consider a scenario where XYZ corporation uses a VoIP network to provide phone services and uses a PRI connection for telecommunications services, and the PRI trunk is controlled by MGCP. Migration from MGCP PRI to SIP trunk is provided by ITSP telecommunications. CUCM sends the telephone number, as 10 digits, to CUBE. CUCM may send only the extension (4 digits) to the CUBE. When the call is diverted (using call-forward), the requirement of the ITSP is that they need the full 10-digit number in the SIP Diversion field.

Figure 6: CUBE Configuration Workflow

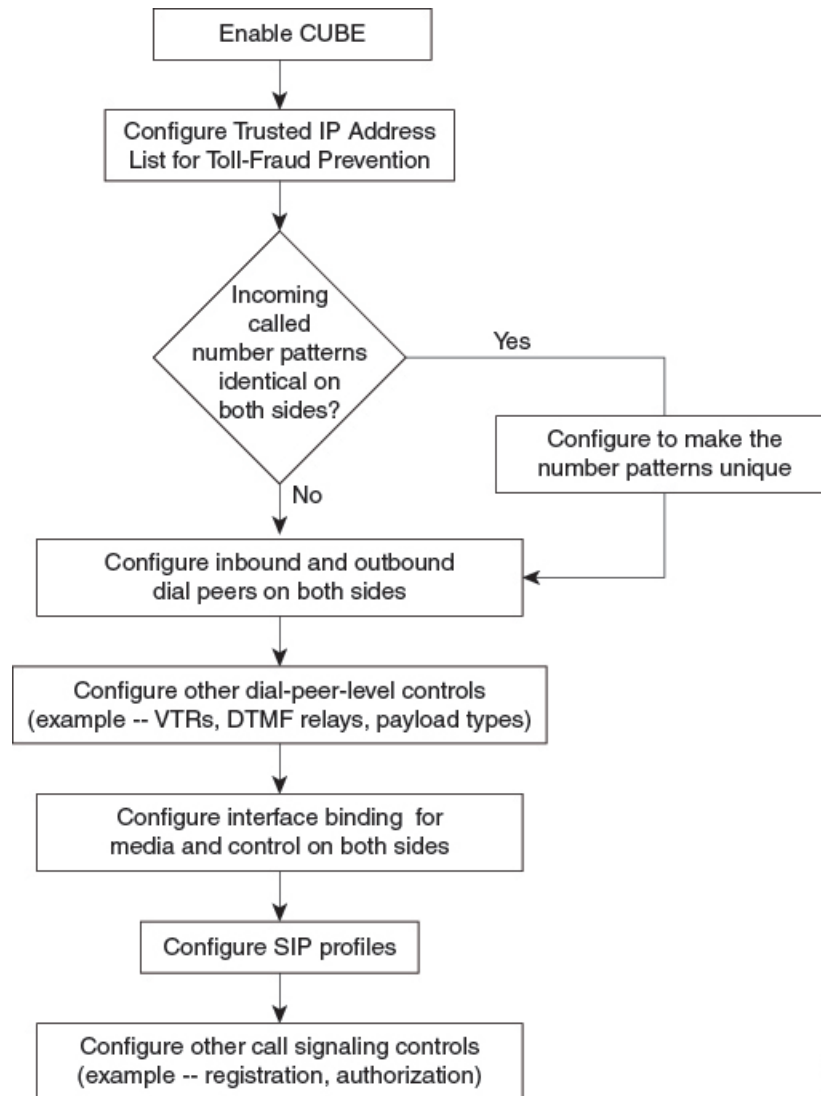

The following sections describe the basic setup of CUBE through the steps involved in migrating the XYZ corporation to CUBE using a SIP trunk.

Enabling the CUBE Application on a Device

SUMMARY STEPS

1. enable
2. configure terminal
3. voice service voip
4. mode border-element license [capacity *sessions* | periodicity {mins *value* | hours *value* | days *value*}]
5. allow-connections *from-type* to *to-type*
6. end

DETAILED STEPS

	Command or Action	Purpose
Step 1	enable Example: <pre>Device> enable</pre>	Enables privileged EXEC mode. Enter your password if prompted.
Step 2	configure terminal Example: <pre>Device# configure terminal</pre>	Enters global configuration mode.
Step 3	voice service voip Example: <pre>Device(config)# voice service voip</pre>	Enters global VoIP configuration mode.
Step 4	mode border-element license [capacity <i>sessions</i> periodicity {mins <i>value</i> hours <i>value</i> days <i>value</i>}] Example: <pre>Device(conf-voi-serv)# mode border-element license capacity 200</pre> <pre>Device(conf-voi-serv)# mode border-element license periodicity days 15</pre>	<p>Enables CUBE configuration and configures the number of licenses (capacity).</p> <ul style="list-style-type: none"> Effective from Cisco IOS XE Amsterdam 17.2.1r, the capacity keyword and <i>sessions</i> argument are deprecated. However, the keyword and argument are available in the Command Line Interface (CLI). If you try to configure license capacity using CLI, the following error message is displayed: <div data-bbox="906 1142 1492 1268" style="background-color: #f0f0f0; padding: 5px; margin: 5px 0;"> <pre>Error: CUBE SIP trunk licensing is now based on dynamic session counting. Static license capacity configuration has been deprecated.</pre> </div> Effective from Cisco IOS XE Amsterdam 17.2.1r, the periodicity keyword and [mins hours days] argument are introduced. The periodicity keyword configures periodicity interval for license entitlement requests for CUBE. If you do not configure license periodicity, the default license period of 7 days is enabled. <p>Note We recommend you to configure interval in days. Configuring interval in minutes or hours increases the frequency of entitlement requests and thereby increases the processing load on Cisco Smart Software Manager (CSSM). License periodicity configuration of minutes or hours is recommended to be used only with Cisco Smart Software Manager On-Prem (formerly known as Cisco Smart Software Manager satellite) mode.</p>

	Command or Action	Purpose
Step 5	allow-connections <i>from-type to to-type</i> Example: <pre>Device(conf-voi-serv)# allow-connections sip to sip</pre>	Allows connections between specific types of endpoints in a VoIP network. <ul style="list-style-type: none"> The two protocols (endpoints) refer to the VoIP protocols (SIP or H.323) on the two call legs.
Step 6	end Example: <pre>Device(conf-voi-serv)# end</pre>	Returns to privileged EXEC mode.

Verifying the CUBE Application on the Device

SUMMARY STEPS

1. **enable**
2. **show cube status**

DETAILED STEPS

Step 1 enable

Enables privileged EXEC mode.

Example:

```
Device> enable
```

Step 2 show cube status

Displays the CUBE status, the software version, the license capacity, the image version, and the platform name of the device. In releases before Cisco IOS XE Amsterdam 17.2.1r, CUBE status display is enabled only if **mode border-element** command is configured with call license capacity. Effective from Cisco IOS XE Amsterdam 17.2.1r, this dependency is removed and Licensed-Capacity information is excluded from output.

Example:

Before Cisco IOS XE Amsterdam 17.2.1r:

```
Device# show cube status

CUBE-Version : 12.5.0
SW-Version : 16.11.1, Platform CSR1000V
HA-Type : none
Licensed-Capacity : 10
Calls blocked (Smart Licensing Not Configured) : 0
Calls blocked (Smart Licensing Eval Expired) : 0
```

Effective from Cisco IOS XE Amsterdam 17.2.1r:

```
Device# show cube status

CUBE-Version : 12.8.0
```

SW-Version : 17.2.1, Platform CSR1000V
 HA-Type : none

Configuring a Trusted IP Address List for Toll-Fraud Prevention

SUMMARY STEPS

1. **enable**
2. **configure terminal**
3. **voice service voip**
4. **ip address trusted list**
5. **ipv4 *ipv4-address* [*network-mask*]**
6. **ipv6 *ipv6-address***
7. **end**

DETAILED STEPS

	Command or Action	Purpose
Step 1	enable Example: Device> enable	Enables privileged EXEC mode. • Enter your password if prompted.
Step 2	configure terminal Example: Device# configure terminal	Enters global configuration mode.
Step 3	voice service voip Example: Device(config)# voice service voip	Enters global VoIP configuration mode.
Step 4	ip address trusted list Example: Device(conf-voi-serv)# ip address trusted list	Enters IP address trusted list mode and enables the addition of valid IP addresses.
Step 5	ipv4 <i>ipv4-address</i> [<i>network-mask</i>] Example: Device(cfg-iptrust-list)# ipv4 192.0.2.1 255.255.255.0	Allows you to add up to 100 IPv4 addresses in the IP address trusted list. Duplicate IP addresses are not allowed. • The <i>network-mask</i> argument allows you to define a subnet IP address.
Step 6	ipv6 <i>ipv6-address</i> Example: Device(cfg-iptrust-list)# ipv6 2001:DB8:0:ABCD::1/48	Allows you to add IPv6 addresses to the trusted IP address list.

	Command or Action	Purpose
Step 7	end Example: Device(cfg-iptrust-list)# end	Returns to privileged EXEC mode.



CHAPTER 5

Virtual CUBE

The Cisco Unified Border Element (CUBE) feature set has traditionally been delivered with hardware router platforms, such as the Cisco Integrated Services Router (ISR) series. A subset of CUBE features (vCUBE) may be used in virtualized environments with the Cisco CSR 1000v Series Cloud Services Router or Cisco Catalyst 8000V Edge Software (Catalyst 8000V).



Note When upgrading to Catalyst 8000V software from a CSR1000V release, an existing throughput configuration will be reset to a maximum of 250 Mbps. Install an HSEC authorization code, which you can obtain from your Smart License account, before reconfiguring your required throughput level.

- [Feature Information for Virtual CUBE, on page 25](#)
- [Prerequisites for Virtual CUBE, on page 26](#)
- [Features Supported with Virtual CUBE, on page 27](#)
- [Restrictions, on page 27](#)
- [Information about Virtual CUBE, on page 27](#)
- [Install Virtual CUBE on ESXi, on page 28](#)
- [How to Enable Virtual CUBE, on page 29](#)
- [Troubleshooting Virtual CUBE, on page 29](#)

Feature Information for Virtual CUBE

The following table provides release information about the feature or features described in this module. This table lists only the software release that introduced support for a given feature in a given software release train. Unless noted otherwise, subsequent releases of that software release train also support that feature.

Use Cisco Feature Navigator to find information about platform support and Cisco software image support. To access Cisco Feature Navigator, go to <https://cfngng.cisco.com/>. An account on Cisco.com is not required.

Table 3: Feature Information for Virtual CUBE Support

Feature Name	Releases	Feature Information
Virtual CUBE in Cisco Catalyst 8000V Edge Software (Catalyst 8000V)	Cisco IOS XE Bengaluru 17.4.1a	Virtual CUBE introduced for Cisco Catalyst 8000V Edge Software (Catalyst 8000V) in VMware ESXi and AWS environments.

Feature Name	Releases	Feature Information
vCUBE in Amazon Web Services (AWS)	Cisco IOS XE Gibraltar 16.12.4a	vCUBE offer introduced in AWS for Cisco CSR 1000v Series Cloud Services Router.
Virtual CUBE	Cisco IOS XE 3.15S	Virtual CUBE introduced for Cisco CSR 1000v Series Cloud Services Router in VMware ESXi environments.

Prerequisites for Virtual CUBE

Hardware

- The vCUBE feature set is bundled as part of the Cisco virtual router software and is used when deployed in VMware ESXi virtualized environments. For more information on how to deploy Cisco virtualized routers in VMware ESXi environments, see [Installing the Cisco CSR 1000V in VMware ESXi Environments](#) and [Installing in VMware ESXi Environment](#).
- For information on the best practices for setting ESXi host BIOS parameters for performance, see [BIOS Settings](#).
- Virtual CUBE is supported on the CSR 1000V and C8000V platforms.
- Virtual CUBE is also supported in AWS. You must use the AWS Marketplace product listing for virtual CUBE.
- For more information about the Cisco CSR 1000V in AWS, see [Cisco CSR 1000V Series Cloud Services Router Deployment Guide for Amazon Web Services](#).



Note

- The CSR1000V and Catalyst 8000V product may be used in several different public and private cloud environments. However, vCUBE is only supported when deployed on VMware ESXi and AWS platforms currently.
- When you use a consolidated (.bin) image to upgrade a CSR 1000V medium configuration (2 vCPU, 4 GB RAM) to Catalyst 8000V, you must change the virtual machine vRAM allocation to at least 5 GB to ensure advertised performance. Alternatively and when deploying in AWS environments, boot the router using individual packages rather than a consolidated image without the need for additional memory. Refer to [Installing Subpackages from a Consolidated Package](#) for details.

Software

- Obtain the relevant license for the router platform. See [Virtual CUBE Licensing Requirements](#), on page 28 for more information.
- In AWS, only Bring Your Own License (BYOL) is supported for vCUBE. Pay as You Go (Subscription) versions of the CSR 1000V and C8000V are not supported. Make sure you choose the vCUBE AWS Marketplace product listing. Refer to [Cisco Virtual CUBE-BYOL](#).

- For more information about Cisco virtual routers, see [CSR 1000V Data Sheet](#) and [Catalyst 8000V Data Sheet](#).

Features Supported with Virtual CUBE

vCUBE supports most of the CUBE features available in IOS XE releases. vCUBE does not support the following:

- DSP-based features
 - Codec Transcoding, Transrating
 - Raw Inband to RTP-NTE DTMF Interworking
 - Call progress Analysis (CPA)
 - Noise Reduction (NR), Acoustic Shock Protection (ASP), and Audio Gain
- H.323 Interworking
- IOS-based Hardware Media Termination Point (MTP)



Note CUBE high availability is not currently supported on vCUBE when deployed in AWS.

Restrictions

- Software MTP is not supported.
- CSR1000V used as MTP/TRP for CUCM is not supported.



Note All caveats, restrictions, and limitations of Cisco ASR IOS-XE 3.15 and later releases are applicable to virtual CUBE.

Information about Virtual CUBE

Media

vCUBE media performance depends on the underlying host platform consistently providing packet switching latency of less than 5 milliseconds. The recommended hardware and virtual machine configurations ensure this performance when followed closely.

For more information on how to monitor media performance, see [Voice Quality Monitoring](#).

Virtual CUBE Licensing Requirements

For information about licensing of virtual CUBE with CSR1000V and C8000V, refer to [CUBE Smart Licensing](#).

Virtual CUBE with CSR1000V

vCUBE is enabled for the CSR1000V with the APPX and AX platform licenses. vCUBE processes and CLI commands are enabled when either of these licenses are enabled. Secure call features require the AX license. In common with all CUBE instances, L-CUBE Smart License options are required for each active session.

The following table details the license requirements for Virtual CUBE on the CSR1000V.

Virtual CUBE Session License	Platform License	Features	Throughput License
L-CUBE Smart License options	APPX	No TLS / SRTP support	Session count * (signaling + bidirectional media bandwidth)
	AX	All vCUBE features	

For detailed information about licensing, see [Cisco CSR 1000v Software Configuration Guide](#).

Virtual CUBE with Catalyst 8000V

vCUBE is enabled for the Catalyst 8000V with the DNA Network Essentials license.

Virtual CUBE Session License	DNA Subscription	Features	DNA Bandwidth License
L-CUBE Smart License options	Essentials or above	All vCUBE features	Session count * (signaling + bidirectional media bandwidth)/2

For detailed information on licensing, see [Licensing](#).

Install Virtual CUBE on ESXi

SUMMARY STEPS

1. Use the CSR1000V or the Catalyst 8000V OVA application file (available from software.cisco.com) to deploy a new virtual instance directly in VMware ESXi.

DETAILED STEPS

	Command or Action	Purpose
Step 1	Use the CSR1000V or the Catalyst 8000V OVA application file (available from software.cisco.com) to deploy a new virtual instance directly in VMware ESXi.	<p>Note Select the required instance size during the OVA deployment.</p> <p>For further details on how to perform the deployment, see Cisco CSR 1000V Series Cloud Services Router Software Configuration Guide or Cisco Catalyst 8000V Edge Software Installation And Configuration Guide.</p>

How to Enable Virtual CUBE

SUMMARY STEPS

1. Power on the virtual machine.
2. Enable platform and throughput licenses and register to a Cisco licensing server.
3. Enable virtual CUBE using the steps in [Enabling the CUBE Application on a Device](#).

DETAILED STEPS

	Command or Action	Purpose
Step 1	Power on the virtual machine.	Powers on the vCUBE.
Step 2	Enable platform and throughput licenses and register to a Cisco licensing server.	Enables platform and throughput licenses and registers that virtual CUBE to a licensing server.
Step 3	Enable virtual CUBE using the steps in Enabling the CUBE Application on a Device .	Enables vCUBE on a device.

Troubleshooting Virtual CUBE

To troubleshoot vCUBE, follow the same procedure for Cisco ASR routers. This procedure includes crash file decoding, decoding traceback, and so on. For more details, see [Troubleshoot Cisco ASR 1000 Series Aggregation Services Routers Crashes](#).

To troubleshoot virtual machine issues, see [Cisco CSR 1000V Series Cloud Services Router Software Configuration Guide](#) and [Cisco Catalyst 8000V Edge Software Configuration Guide](#).



CHAPTER 6

Dial-Peer Matching

CUBE allows VoIP-to-VoIP connection by routing calls from one VoIP dial peer to another. As VoIP dial peers can be handled by either SIP or H.323, CUBE can be used to interconnect VoIP networks of different signaling protocols. VoIP interworking is achieved by connecting an inbound dial peer with an outbound dial peer.



Note All CUBE Enterprise deployments must have signaling and media bind statements specified at the dial-peer or voice class tenant level. For voice call tenants, you must apply tenants to dial-peers used for CUBE call flows if these dial-peers do not have bind statements specified.

- [Dial Peers in CUBE, on page 31](#)
- [Configuring Inbound and Outbound Dial-Peer Matching for CUBE, on page 33](#)
- [Preference for Dial-Peer Matching, on page 34](#)

Dial Peers in CUBE

A dial peer is a static routing table, mapping phone numbers to interfaces or IP addresses.

A call leg is a logical connection between two routers or between a router and a VoIP endpoint. A dial peer is associated or matched to each call leg according to attributes that define a packet-switched network, such as the destination address.

Voice-network dial peers are matched to call legs based on configured parameters, after which an outbound dial peer is provisioned to an external component using the component's IP address. For more information, refer to the [Dial Peer Configuration Guide](#).

Dial-peer matching can also be done based on the VRF ID associated with a particular interface. For more information, see [Inbound Dial-Peer Matching Based on Multi-VRF, on page 359](#).

In CUBE, dial peers can also be classified as LAN dial peers and WAN dial peers based on the connecting entity from which CUBE sends or receives calls.

Figure 7: LAN and WAN Dial Peers

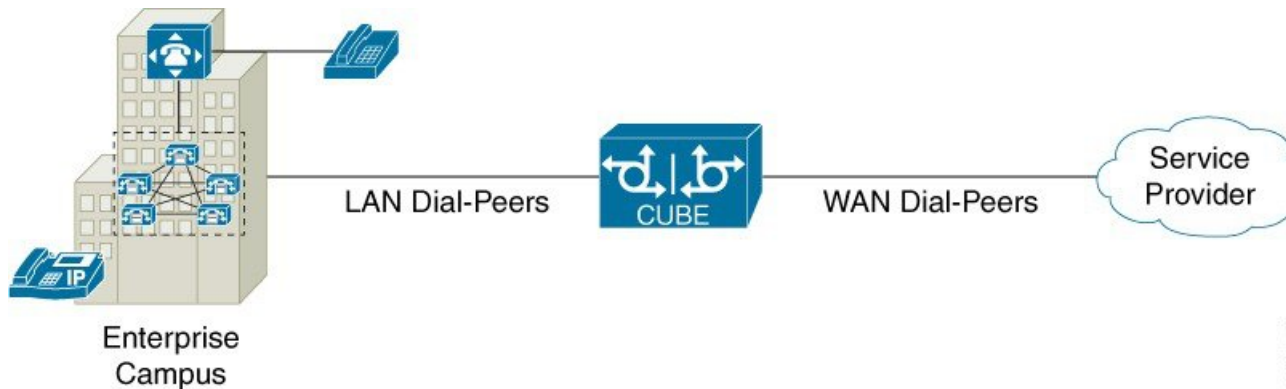

A LAN dial peer is used to send or receive calls between CUBE and the Private Branch Exchange (PBX)—a system of telephone extensions within an enterprise. Given below are examples of inbound and outbound LAN dial peers.

Figure 8: LAN Dial Peers

Inbound Dial-Peer for calls from CUCM to CUBE

```
dial-peer voice 100 voip
description *** Inbound LAN side dial-peer ***
incoming called-number 9T
session protocol sipv2
codec g711ulaw
dtmf-relay rtp-nte
```

CUCM sending 9
+ All digits dialed
(Outgoing calls)

Incoming call number
used to match the
inbound LAN dial peer

Outbound Dial-Peer for calls from CUBE to CUCM

```
dial-peer voice 200 voip
description *** Outbound LAN side dial-peer ***
destination-pattern [2-9].....
session protocol sipv2
session target ipv4:<CUCM_Address>
codec g711ulaw
dtmf-relay rtp-nte
```

SP will be sending
10 digits inbound
(Incoming Calls)

Destination pattern
used to match the
outbound LAN dial peer

A WAN dial peer is used to send or receive calls between CUBE and the SIP trunk provider. Given below are examples of inbound and outbound WAN dial peers.

Figure 9: WAN Dial Peers

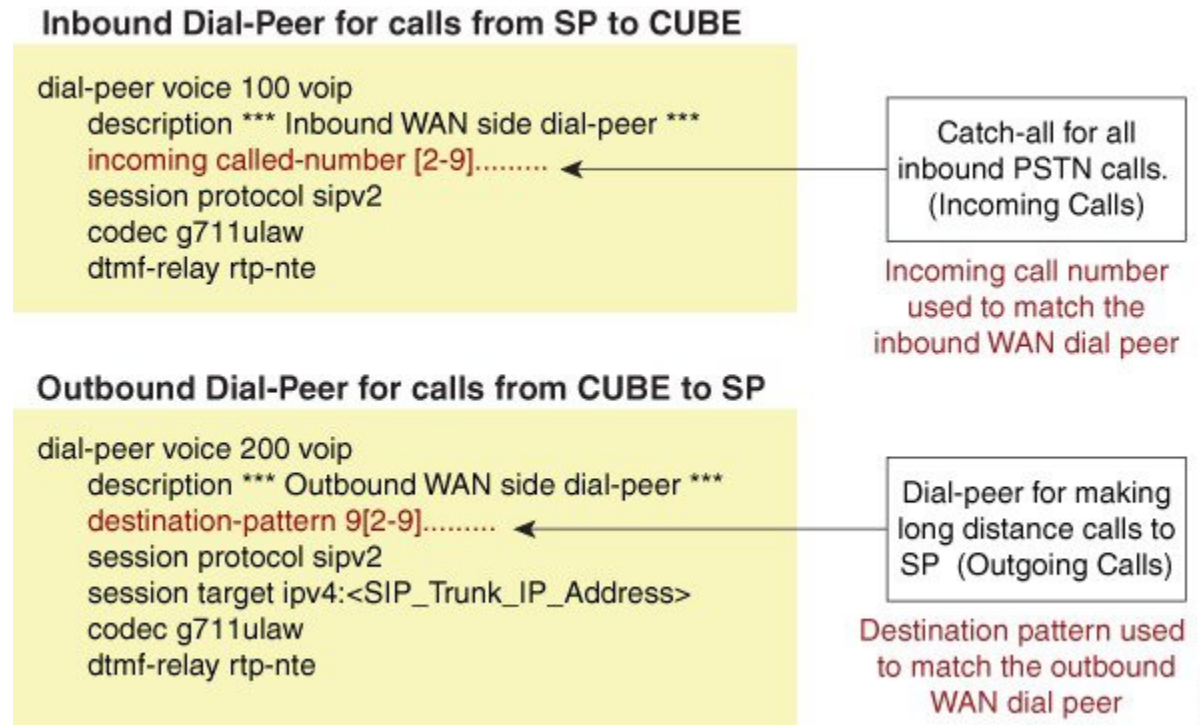

371526

Configuring Inbound and Outbound Dial-Peer Matching for CUBE

The following commands can be used for inbound and outbound dial peer matching in the CUBE:

Table 4: Incoming Dial-Peer Matching

Command in Dial-Peer Configuration	Description	Call Setup Element
incoming called-number <i>DNIS-string</i>	This command uses the destination number that was called to match the incoming call leg to an inbound dial peer. This number is called the dialed number identification service (DNIS) number.	DNIS number
answer-address <i>ANI-string</i>	This command uses the calling number to match the incoming call leg to an inbound dial peer. This number is called the originating calling number or automatic number identification (ANI) string.	ANI string
destination-pattern <i>ANI-string</i>	This command uses the inbound call leg to the inbound dial peer.	ANI string for inbound

Command in Dial-Peer Configuration	Description	Call Setup Element
{incoming called incoming calling} e164-pattern-map <i>pattern-map-group-id</i>	This command uses a group of incoming called (DNIS) or incoming calling (ANI) number patterns to match the inbound call leg to an inbound dial peer. The command calls a globally defined voice class identifier where the E.164 pattern groups are configured.	E.164 Patterns
voice class uri <i>URI-class-identifier</i> with incoming uri {from request to via} URI-class-identifier	This command uses the directory URI (Uniform Resource Identifier) number of an incoming INVITE from a SIP entity to match an inbound dial peer. This directory URI is part of the SIP address of a device. The command calls a globally defined voice class identifier where the directory URI is configured. It requires the configuration of session protocol sipv2	Directory URI
incoming uri {called calling} URI-class-identifier	This command uses the directory URI (Uniform Resource Identifier) number to match the outgoing H.323 call leg to an outgoing dial peer. The command calls a globally defined voice class identifier where the directory URI is configured.	Directory URI

Table 5: Outgoing Dial-Peer Matching

Dial-Peer Command	Description	Call Setup Element
destination-pattern <i>DNIS-string</i>	This command uses DNIS string to match the outbound call leg to the outbound dial peer.	DNIS string for outbound ANI string for inbound
destination <i>URI-class-identifier</i>	This command uses the directory URI (Uniform Resource Identifier) number to match the outgoing call leg to an outgoing dial peer. This directory URI is part of the SIP address of a device. The command actually refers to a globally defined voice class identifier where the directory URI is configured.	Directory URI
destination e164-pattern-map <i>pattern-map-group-id</i>	This command uses a group of destination number patterns to match the outbound call leg to an outbound dial peer. The command calls a globally defined voice class identifier where the E.164 pattern groups are configured.	E.164 patterns

Preference for Dial-Peer Matching

The following is the order in which inbound dial-peer is matched for SIP call-legs:

- **voice class uri** *URI-class-identifier* with **incoming uri** {*via*} *URI-class-identifier*
- **voice class uri** *URI-class-identifier* with **incoming uri** {*request*} *URI-class-identifier*
- **voice class uri** *URI-class-identifier* with **incoming uri** {*to*} *URI-class-identifier*
- **voice class uri** *URI-class-identifier* with **incoming uri** {*from*} *URI-class-identifier*
- **incoming called-number** *DNIS-string*
- **answer-address** *ANI-string*

The following is the order in which inbound dial-peer is matched for H.323 call-legs:

- **incoming uri** {*called*} *URI-class-identifier*
- **incoming uri** {*calling*} *URI-class-identifier*
- **incoming called-number** *DNIS-string*
- **answer-address** *ANI-string*

The following is the order in which outbound dial-peer is matched for SIP call-legs:

- **destination route-string**
- **destination** *URI-class-identifier* with **target carrier-id** *string*
- **destination-pattern** with **target carrier-id** *string*
- **destination** *URI-class-identifier*
- **destination-pattern**
- **target carrier-id** *string*



Note If CUBE with Cisco Unified Communications Manager Express (CUCME) is configured with the same DNs, then the ANI is given the preference. The system dial-peer for the DN is selected over the other dial-peers created.



CHAPTER 7

DTMF Relay

The DTMF Relay feature allows CUBE to send dual-tone multi-frequency (DTMF) digits over IP.

This chapter talks about DTMF tones, DTMF relay mechanisms, how to configure DTMF relays, and interoperability and priority with multiple relay methods.

- [Feature Information for DTMF Relay](#) , on page 37
- [Information About DTMF Relay](#) , on page 38
- [Verifying DTMF Relay](#) , on page 46

Feature Information for DTMF Relay

The following table provides release information about the feature or features described in this module. This table lists only the software release that introduced support for a given feature in a given software release train. Unless noted otherwise, subsequent releases of that software release train also support that feature.

Use Cisco Feature Navigator to find information about platform support and Cisco software image support. To access Cisco Feature Navigator, go to <https://cfng.cisco.com/>. An account on Cisco.com is not required.

Table 6: Feature Information for DTMF Relay

Feature Name	Releases	Feature Information
DTMF Relay	Cisco IOS Release 12.1(2)T Cisco IOS XE 2.1	The DTMF relay feature allows CUBE to send DTMF digits over IP. The dtmf-relay command was added.
Support for sip-info to rtp-nte DTMF relay mechanism for SIP-SIP calls	Cisco IOS XE Everest 16.6.1	This feature adds support for sip-info to rtp-nte DTMF relay mechanism for SIP-SIP calls.

Information About DTMF Relay

DTMF Tones

DTMF tones are used during a call to signal to a far-end device; these signals may be for navigating a menu system, entering data, or for other types of manipulation. They are processed differently from the DTMF tones that are sent during the call setup as part of the call control. TDM interfaces on Cisco devices support DTMF by default. Cisco VoIP dial-peers do not support the DTMF relay by default and to enable, requires DTMF relay capabilities.



Note DTMF tones that are sent by phones do not traverse the CUBE.

DTMF Relay

Dual-tone multifrequency (DTMF) relay is the mechanism for sending DTMF digits over IP. The VoIP dial peer can pass the DTMF digits either in the band or out of band.

In-band DTMF-Relay passes the DTMF digits using the RTP media stream. It uses a special payload type identifier in the RTP header to distinguish DTMF digits from actual voice communication. This method is more likely to work on lossless codecs, such as G.711.



Note The main advantage of DTMF relay is that in-band DTMF relay sends low-bandwidth codecs such as the G.729 and G.723 with greater fidelity. Without the use of DTMF relay, calls established with low-bandwidth codecs has trouble accessing automated DTMF-based systems. For example, voicemail, menu-based Automatic Call Distributor (ACD) systems, and automated banking systems.

Out-of-band DTMF-Relay passes DTMF digits using a signaling protocol (SIP or H.323) instead of using the RTP media stream.

The VoIP compressed code causes the loss of integrity of the DTMF digits. However, the DTMF relay prevents the loss of integrity of DTMF digits. The relayed DTMF regenerates transparently on the peer side.

Figure 10: DTMF Relay Mechanism

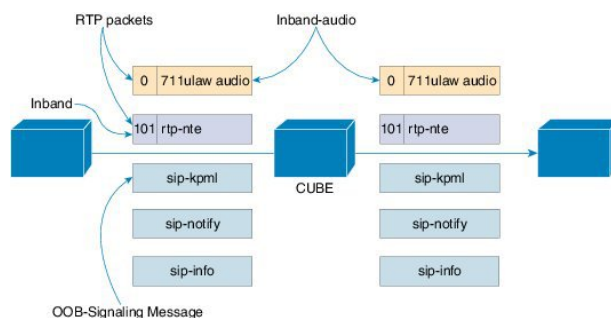

The following lists the DTMF relay mechanisms that support the VoIP dial-peers based on the configured keywords. The DTMF relay mechanism can be either out-of-band (H.323 or SIP) or in-band (RTP).

- **h245-alphanumeric and h245-signal**—These two methods are available only on H.323 dial peers. It is an out-of-band DTMF relay mechanism that transports the DTMF signals using H.245, which is the media control protocol of the H.323 protocol suite.

The H245-signal method carries more information about the DTMF event (such as its actual duration) than the H245-Alphanumeric method. It addresses a potential problem with the alphanumeric method when interworking with other vendors' systems.

- **sip-notify**—This method is available on the SIP dial peers only. It is a Cisco proprietary out-of-band DTMF relay mechanism that transports DTMF signals using SIP-Notify message. The SIP Call-Info header indicates the use of the SIP-Notify DTMF relay mechanism. Acknowledging the message with a 18x or 200 response message containing a similar SIP Call-Info header.

The Call-Info header for a NOTIFY-based out-of-band relay is as follows:

```
Call-Info: <sip: address>; method="NOTIFY;Event=telephone-event;Duration=msec"
```

DTMF relay digits are a 4 bytes in binary encoded format.

The mechanism is useful for communicating with SCCP IP phones that do not support in-band DTMF digits and analog phones that are attached to analog voice ports (FXS) on the router.

If multiple DTMF relay mechanisms enable and negotiate successfully on a SIP dial peer, NOTIFY-based out-of-band DTMF relay takes precedence.

- **sip-kpml**—This method is available only on SIP dial peers. The RFC 4730 defines the out-of-band DTMF relay mechanism to register the DTMF signals using the SIP-Subscribe messages. It transports the DTMF signals using the SIP-Notify messages containing an XML-encoded body. This method is called Key Press Markup Language.

If you configure KPML on the dial peer, the gateway sends INVITE messages with KPML in the Allow-Events header.

A registered SIP endpoint to Cisco Unified Communications Manager or Cisco Unified Communications Manager Express uses this method. This method is useful for non-conferencing calls and for interoperability between SIP products and SIP phones.

If you configure rtp-nte, sip-notify, and sip-kpml, the outgoing INVITE contains an SDP with a rtp-nte payload, a SIP Call-Info header, and an Allow-Events header with KPML.

The following SIP-Notify message displays after the subscription. The endpoints transmit digits using SIP-Notify messages with KPML events through XML. The following example transmits, the digit "1":

```
NOTIFY sip:192.168.105.25:5060 SIP/2.0
Event: kpml
<?xml version="1.0" encoding="UTF-8"?>
<kpml-response version="1.0" code="200" text="OK" digits="1" tag="dtmf"/>
```

- **sip-info**—The sip-info method is available only on SIP dial peers. It is an out-of-band DTMF relay mechanism that registers the DTMF signals using SIP-Info messages. The body of the SIP message consists of signaling information and uses the Content-Type application/dtmf-relay.

The method enables for SIP dial peers, and invokes on receiving a SIP INFO message with DTMF relay content.

The gateway receives the following sample SIP INFO message with specifics about the DTMF tone. The combination of the From, To, and Call-ID headers identifies the call leg. The signal and duration

headers specify the digit, in this case 1, and duration, 160 milliseconds in the example, for DTMF tone play.

```
INFO sip:2143302100@172.17.2.33 SIP/2.0
Via: SIP/2.0/UDP 172.80.2.100:5060
From: <sip:9724401003@172.80.2.100>;tag=43
To: <sip:2143302100@172.17.2.33>;tag=9753.0207
Call-ID: 984072_15401962@172.80.2.100
CSeq: 25634 INFO
Supported: 100rel
Supported: timer
Content-Length: 26
Content-Type: application/dtmf-relay
Signal= 1
Duration= 160
```

- **rtp-nte**—Real-Time Transport Protocol (RTP) Named Telephone Events (NTE). The RFC2833 defines the in-band DTMF relay mechanism. RFC2833 defines the formats of NTE-RTP packets to transport DTMF digits, hookflash, and other telephony events between two peer endpoints. Using the RTP stream, sends the DTMF tones as packet data after establishing call media. It is differentiated from the audio by the RTP payload type field, preventing compression of DTMF-based RTP packets. For example, sending the audio of a call on a session with an RTP payload type identifies it as G.711 data. Similarly sending the DTMF packets with an RTP payload type identifies them as NTEs. The consumer of the stream utilizes the G.711 packets and the NTE packets separately.

The SIP NTE DTMF relay feature provides a reliable digit relay between Cisco VoIP gateways on using a low-bandwidth codec.



Note By default, Cisco device uses Payload type 96 and 97 for fax. A third-party device may use Payload type 96 and 97 for DTMF. In such scenarios, we recommend you to perform one of the following:

- Change the Payload type for fax in both incoming and outgoing dial-peers using **rtp payload-type** command
- Use **assymmetric payload dtmf** command

For more information on configuring rtp payload-type and assymmetric payload DTMF, see [Dynamic Payload Type Interworking for DTMF and Codec Packets for SIP-to-SIP Calls](#).

Payload types and attributes of this method negotiate between the two ends at call setup. They use the Session Description Protocol (SDP) within the body section of the SIP message.



Note This method is not similar to the “Voice in-band audio/G711” transport. The latter is just the audible tones being passed as normal audio without any relay signaling method being “aware” or involved in the process. It is plain audio passing through end-to-end using the G711Ulaw/Alaw codec.

- **cisco-rtp**—It is an in-band DTMF relay mechanism that is Cisco proprietary, where the DTMF digits are encoded differently from the audio and are identified as Payload type 121. The DTMF digits are part

of the RTP data stream and distinguished from the audio by the RTP payload type field. Cisco Unified Communications Manager does not support this method.



Note The **cisco-rtp** operates only between two Cisco 2600 series or Cisco 3600 series devices. Otherwise, the DTMF relay feature does not function, and the gateway sends DTMF tones in-band.

- **G711 audio**—It is an in-band DTMF relay mechanism that is enabled by default and requires no configuration. Digits are transmitted within the audio of the phone conversation, that is, it is audible to the conversation partners; therefore, only uncompressed codecs like g711 Alaw or mu-law can carry in-band DTMF reliably. Female voices sometimes trigger the recognition of a DTMF tone.

The DTMF digits pass like the rest of your voice as normal audio tones with no special coding or markers. It uses the same codec as your voice, generated by your phone.

Configuring DTMF Relays

You can configure the DTMF relay using the **dtmf-relay method1** [...*[method6]*] command in the VoIP dial peer.

Perform DTMF negotiation based on the matching inbound dial-peer configuration.

Use any of the following variables *method*:

- **h245-alphanumeric**
- **h245-signal**
- **sip-notify**
- **sip-kpml**
- **sip-info**
- **rtp-nte [digit-drop]**
- **ciso-rtp**

Configure multiple DTMF methods on CUBE simultaneously in order to minimize MTP requirements. If you configure more than one out-of-band DTMF method, preference goes from highest to lowest in the order of configuration. If an endpoint does not support any of the configured DTMF relay mechanisms on CUBE, an MTP or transcoder is required.

The following table lists the supported DTMF relay types on a SIP and H.322 gateway.

Table 7: Supported H.323 and SIP DTMF Relay Methods

	H.323 Gateway	SIP Gateway
In-band	cisco-rtp, rtp-nte	rtp-nte
Out-of-band	h245-alphanumeric, h245-signal	sip-notify, sip-kpml, sip-info

Interoperability and Priority with Multiple DTMF Relay Methods

- CUBE negotiates both **rtp-nte** and **sip-kmpl** if both support and advertise in the incoming INVITE. However, If CUBE does not initiate **sip-kmpl**, CUBE relies on the **rtp-nte** DTMF method to receive digits and a SUBSCRIBE. CUBE still accepts SUBSCRIBES for KPML. It prevents double-digit reporting problems at CUBE.
- CUBE negotiates to one of the following:
 - **cisco-rtp**
 - **rtp-nte**
 - **rtp-nte** and **kpml**
 - **kpml**
 - **sip-notify**
- If you configure **rtp-nte**, **sip-notify**, and **sip-kpml**, the outgoing INVITE contains a SIP Call-Info header, an Allow-Events header with KPML, and an SDP with **rtp-nte** payload.
- If you configure more than one out-of-band DTMF method, preference goes from highest to lowest in the order of configuration.
- CUBE selects DTMF relay mechanisms using the following priority:
 - **sip-notify** or **sip-kpml** (highest priority)
 - **rtp-nte**
 - **None**—Send DTMF in-band

H.323 gateways select DTMF relay mechanisms using the following priority:

- **cisco-rtp**
- **h245-signal**
- **h245-alphanumeric**
- **rtp-nte**
- **None**—Send DTMF in-band

DTMF Interoperability Table

This table provides the DTMF interoperability information between various DTMF relay types in different call flow scenarios. For instance, refer table 3 if you must configure **sip-kpml** on an inbound dial peer and **h245-signal** on an outbound dial peer in an RTP-RTP Flow through configuration. The table shows that the combination supports (as image information is present) the required image IOS 12.4(15)T or IOS XE or above. The following are the call scenarios provided:

- RTP-RTP Flow-Through
- RTP-RTP with transcoder Flow-Through

- RTP-RTP Flow Around
- RTP-RTP with high-density transcoder Flow Through
- SRTP-RTP Flow Through

Table 8: RTP-RTP Flow-Through

	Outbound dial-peer protocol	H.323			SIP				In-band
Inbound dial-peer protocol	DTMF Relay Type	h245-alpha-numeric	h245-signal	Rtp-nte	Rtp-nte	Sip-kpml	Sip-notify	Sip-info	Voice in-band (G.711)
H.323	h245-alpha-numeric	Supported		Supported	Supported	Supported	Supported		
	h245-signal		Supported	Supported	Supported	Supported	Supported		
	rtp-nte	Supported	Supported	Supported	Supported		Supported		Supported*
SIP	rtp-nte	Supported	Supported	Supported	Supported	Supported	Supported		Supported*
	sip-kpml	Supported	Supported		Supported	Supported			
	sip-notify	Supported	Supported	Supported	Supported		Supported		
	sip-info				Supported ³				
In-band	Voice in-band (G.711)			Supported*	Supported*				Supported

³ Supported from Cisco IOS XE Everest 16.6.1 onwards for calls that do not involve DSP resources.

* Media resource is required (Transcoder) for Cisco IOS and IOS XE versions.

Table 9: RTP-RTP with DSP Involved Flow-Through Calls

	Outbound dial-peer protocol	H.323			SIP				In-band
Inbound dial-peer protocol	DTMF Relay Type	h245-alpha-numeric	h245-signal	Rtp-nte	Rtp-nte	Sip-kpml	Sip-notify	Sip-info	Voice in-band (G.711)
H.323	h245-alpha-numeric	Supported		Supported	Supported	Supported	Supported		
	h245-signal		Supported	Supported	Supported	Supported	Supported		
	rtp-nte	Supported	Supported	Supported	Supported				Supported

	Outbound dial-peer protocol	H.323			SIP				In-band
Inbound dial-peer protocol	DTMF Relay Type	h245-alpha-numeric	h245-signal	Rtp-nte	Rtp-nte	Sip-kpml	Sip-notify	Sip-info	Voice in-band (G.711)
SIP	rtp-nte	Supported	Supported	Supported	Supported				Supported
	sip-kpml	Supported	Supported			Supported			
	sip-notify	Supported	Supported	Supported			Supported		
	sip-info								
In-band	Voice in-band (G.711)			Supported	Supported				

Table 10: RTP-RTP Flow Around

	Outbound dial-peer protocol	H.323			SIP				In-band
Inbound dial-peer protocol	DTMF Relay Type	h245-alpha-numeric	h245-signal	Rtp-nte	Rtp-nte	Sip-kpml	Sip-notify	Sip-info	Voice in-band (G.711)
H.323	h245-alpha-numeric	Supported							
	h245-signal		Supported						
	rtp-nte			Supported					Supported*
SIP	rtp-nte				Supported				Supported*
	sip-kpml					Supported			
	sip-notify						Supported		
	sip-info								
In-band	Voice in-band (G.711)			Supported*	Supported*				Supported

* Media resource is required (Transcoder) for Cisco IOS and IOS XE versions. CUBE falls back to flow-through mode if the media resource is unavailable.

Table 11: RTP-RTP with High-Density Transcoder Flow Through

	Outbound dial-peer protocol	H.323			SIP				In-band
Inbound dial-peer protocol	DTMF Relay Type	h245-alpha-numeric	h245-signal	Rtp-nte	Rtp-nte	Sip-kpml	Sip-notify	Sip-info	Voice in-band (G.711)
H.323	h245-alpha-numeric	Supported				Supported	Supported		
	h245-signal		Supported			Supported	Supported		
	rtp-nte			Supported	Supported				Supported
SIP	rtp-nte			Supported	Supported	Supported			Supported
	sip-kpml	Supported	Supported			Supported			
	sip-notify	Supported	Supported				Supported		
	sip-info								
In-band	Voice in-band (G.711)			Supported	Supported				

Table 12: SRTP-RTP Flow Through

	Outbound dial-peer protocol	H.323			SIP				In-band
Inbound dial-peer protocol	DTMF Relay Type	h245-alpha-numeric	h245-signal	Rtp-nte	Rtp-nte	Sip-kpml	Sip-notify	Sip-info	Voice in-band (G.711)
H.323	h245-alpha-numeric								
	h245-signal								
	rtp-nte								
SIP	rtp-nte				Supported	Supported	Supported		Supported
	sip-kpml				Supported	Supported			
	sip-notify				Supported		Supported		
	sip-info								
In-band	Voice in-band (G.711)				Supported				Supported



Note For calls sent from an in-band (RTP-NTE) to an out-of band method, configure the **dtmf-relay rtp-nte digit-drop** command on the inbound dial-peer and the desired out-of-band method on the outgoing dial-peer. Otherwise, send the same digit in OOB and in-band, and gets interpreted as duplicate digits by the receiving end. On configuring the digit-drop option on the inbound leg, CUBE suppresses NTE packets and configures only relay digits using the OOB method on the outbound leg.

Verifying DTMF Relay

SUMMARY STEPS

1. **show sip-ua calls**
2. **show sip-ua calls dtmf-relay sip-info**
3. **show sip-ua history dtmf-relay kpml**
4. **show sip-ua history dtmf-relay sip-notify**

DETAILED STEPS

Step 1 show sip-ua calls

The following sample output shows that the DTMF method is SIP-KPML.

Example:

```
Device# show sip-ua calls

SIP UAC CALL INFO
Call 1
SIP Call ID           : 57633F68-2BE011D6-8013D46B-B4F9B5F6@172.18.193.251
  State of the call    : STATE_ACTIVE (7)
  Substate of the call : SUBSTATE_NONE (0)
  Calling Number       :
  Called Number        : 8888
  Bit Flags            : 0xD44018 0x100 0x0
  CC Call ID           : 6
  Source IP Address (Sig) : 192.0.2.1
  Destn SIP Req Addr:Port : 192.0.2.2:5060
  Destn SIP Resp Addr:Port : 192.0.2.3:5060
  Destination Name      : 192.0.2.4.250
  Number of Media Streams : 1
  Number of Active Streams : 1
  RTP Fork Object       : 0x0
  Media Mode            : flow-through
Media Stream 1
  State of the stream   : STREAM_ACTIVE
  Stream Call ID        : 6
  Stream Type           : voice-only (0)
  Negotiated Codec      : g711ulaw (160 bytes)
Codec Payload Type     : 0
  Negotiated Dtmf-relay : sip-kpml
  Dtmf-relay Payload Type : 0
  Media Source IP Addr:Port : 192.0.2.5:17576
  Media Dest IP Addr:Port  : 192.0.2.6:17468
```

```

    Orig Media Dest IP Addr:Port : 0.0.0.0:0
  Number of SIP User Agent Client(UAC) calls: 1
SIP UAS CALL INFO
  Number of SIP User Agent Server(UAS) calls: 0

```

Step 2 show sip-ua calls dtmf-relay sip-info

The following sample output displays active SIP calls with INFO DTMF Relay mode.

Example:

```

Device# show sip-ua calls dtmf-relay sip-info

Total SIP call legs:2, User Agent Client:1, User Agent Server:1
SIP UAC CALL INFO
Call 1
SIP Call ID           : 9598A547-5C1311E2-8008F709-2470C996@172.27.161.122
  State of the call    : STATE_ACTIVE (7)
  Calling Number       : sipp
  Called Number        : 3269011111
  CC Call ID          : 2
No.      Timestamp           Digit           Duration
=====
0      01/12/2013 17:23:25.615  2              250
1      01/12/2013 17:23:25.967  5              300
2      01/12/2013 17:23:26.367  6              300

Call 2
SIP Call ID           : 1-29452@172.25.208.177
  State of the call    : STATE_ACTIVE (7)
  Calling Number       : sipp
  Called Number        : 3269011111
  CC Call ID          : 1
No.      Timestamp           Digit           Duration
=====
0      01/12/2013 17:23:25.615  2              250
1      01/12/2013 17:23:25.967  5              300
2      01/12/2013 17:23:26.367  6              300

  Number of SIP User Agent Client(UAC) calls: 2

SIP UAS CALL INFO
Call 1
SIP Call ID           : 1-29452@172.25.208.177
  State of the call    : STATE_ACTIVE (7)
  Calling Number       : sipp
  Called Number        : 3269011111
  CC Call ID          : 1
No.      Timestamp           Digit           Duration
=====
0      01/12/2013 17:23:25.615  2              250
1      01/12/2013 17:23:25.967  5              300
2      01/12/2013 17:23:26.367  6              300

Call 2
SIP Call ID           : 9598A547-5C1311E2-8008F709-2470C996@172.27.161.122
  State of the call    : STATE_ACTIVE (7)
  Calling Number       : sipp
  Called Number        : 3269011111
  CC Call ID          : 2
No.      Timestamp           Digit           Duration
=====
0      01/12/2013 17:23:25.615  2              250
1      01/12/2013 17:23:25.967  5              300

```

Verifying DTMF Relay

```
2      01/12/2013 17:23:26.367  6                               300
```

```
Number of SIP User Agent Server(UAS) calls: 2
```

Step 3 show sip-ua history dtmf-relay kpml

The following sample output displays SIP call history with KMPL DTMF Relay mode.

Example:

```
Device# show sip-ua history dtmf-relay kpml
```

```
Total SIP call legs:2, User Agent Client:1, User Agent Server:1
```

```
SIP UAC CALL INFO
```

```
Call 1
```

```
SIP Call ID           : D0498774-F01311E3-82A0DE9F-78C438FF@10.86.176.119
State of the call     : STATE_ACTIVE (7)
Calling Number        : 2017
Called Number         : 1011
CC Call ID            : 257
```

```
No.      Timestamp      Digit      Duration
=====
```

```
Call 2
```

```
SIP Call ID           : 22BC36A5-F01411E3-81808A6A-5FE95113@10.86.176.142
State of the call     : STATE_ACTIVE (7)
Calling Number        : 2017
Called Number         : 1011
CC Call ID            : 256
```

```
No.      Timestamp      Digit      Duration
=====
```

```
Number of SIP User Agent Client(UAC) calls: 2
```

```
SIP UAS CALL INFO
```

```
Call 1
```

```
SIP Call ID           : 22BC36A5-F01411E3-81808A6A-5FE95113@10.86.176.142
State of the call     : STATE_ACTIVE (7)
Calling Number        : 2017
Called Number         : 1011
CC Call ID            : 256
```

```
No.      Timestamp      Digit      Duration
=====
```

```
Call 2
```

```
SIP Call ID           : D0498774-F01311E3-82A0DE9F-78C438FF@10.86.176.119
State of the call     : STATE_ACTIVE (7)
Calling Number        : 2017
Called Number         : 1011
CC Call ID            : 257
```

```
No.      Timestamp      Digit      Duration
=====
```

```
Number of SIP User Agent Server(UAS) calls: 2
```

Step 4 show sip-ua history dtmf-relay sip-notify

The following sample output displays SIP call history with SIP Notify DTMF Relay mode.

Example:

```
Device# show sip-ua history dtmf-relay sip-notify
```

```
Total SIP call legs:2, User Agent Client:1, User Agent Server:1
SIP UAC CALL INFO
Call 1
SIP Call ID           : 29BB98C-F01311E3-8297DE9F-78C438FF@10.86.176.119
  State of the call    : STATE_ACTIVE (7)
  Calling Number       : 2017
  Called Number        : 1011
  CC Call ID          : 252
No.      Timestamp      Digit      Duration
=====
```

```
Call 2
SIP Call ID           : 550E973B-F01311E3-817A8A6A-5FE95113@10.86.176.142
  State of the call    : STATE_ACTIVE (7)
  Calling Number       : 2017
  Called Number        : 1011
  CC Call ID          : 251
No.      Timestamp      Digit      Duration
=====
```

Number of SIP User Agent Client(UAC) calls: 2

```
SIP UAS CALL INFO
Call 1
SIP Call ID           : 550E973B-F01311E3-817A8A6A-5FE95113@10.86.176.142
  State of the call    : STATE_ACTIVE (7)
  Calling Number       : 2017
  Called Number        : 1011
  CC Call ID          : 251
No.      Timestamp      Digit      Duration
=====
```

```
Call 2
SIP Call ID           : 29BB98C-F01311E3-8297DE9F-78C438FF@10.86.176.119
  State of the call    : STATE_ACTIVE (7)
  Calling Number       : 2017
  Called Number        : 1011
  CC Call ID          : 252
No.      Timestamp      Digit      Duration
=====
```

Number of SIP User Agent Server(UAS) calls: 2



CHAPTER 8

Introduction to Codecs

A codec is a device or software capable of encoding or decoding a digital data stream or signal. Audio codecs can code or decode a digital data stream of audio. Video codecs enable compression or decompression of digital video.

CUBE uses codecs to compress digital voice samples to reduce bandwidth usage per call. This chapter describes the basics of encoding digital voice samples using codecs and how to configure them.

- [Why CUBE Needs Codecs, on page 51](#)
- [Voice Media Transmission, on page 52](#)
- [Voice Activity Detection, on page 53](#)
- [VoIP Bandwidth Requirements, on page 54](#)
- [Supported Audio and Video Codecs, on page 56](#)
- [How to Configure Codecs, on page 57](#)
- [Configuration Examples for Codecs, on page 62](#)

Why CUBE Needs Codecs

CUBE uses codecs to compress digital voice samples to reduce bandwidth usage per call. Refer to [Table 14: Codec and Bandwidth Information, on page 54](#) to see the relationship between codec and bandwidth utilization.

Configuring codecs on a device (configured as CUBE) allows the device to act as a demarcation point on a VoIP network and allows a dial peer to be established only if the desired codec criteria are satisfied. Additionally, preferences can be used to determine which codecs are selected over others.

If codec filtering is not required, CUBE also supports transparent codec negotiations. This enables negotiations between endpoints with CUBE leaving the codec information untouched.

The illustrations below show how codec negotiation is performed on CUBE. Two VoIP clouds need to be interconnected. In this scenario, both VoIP 1 and VoIP 2 networks have G.711 a-law configured as the preferred codec.

Figure 11: Codec Negotiation on CUBE

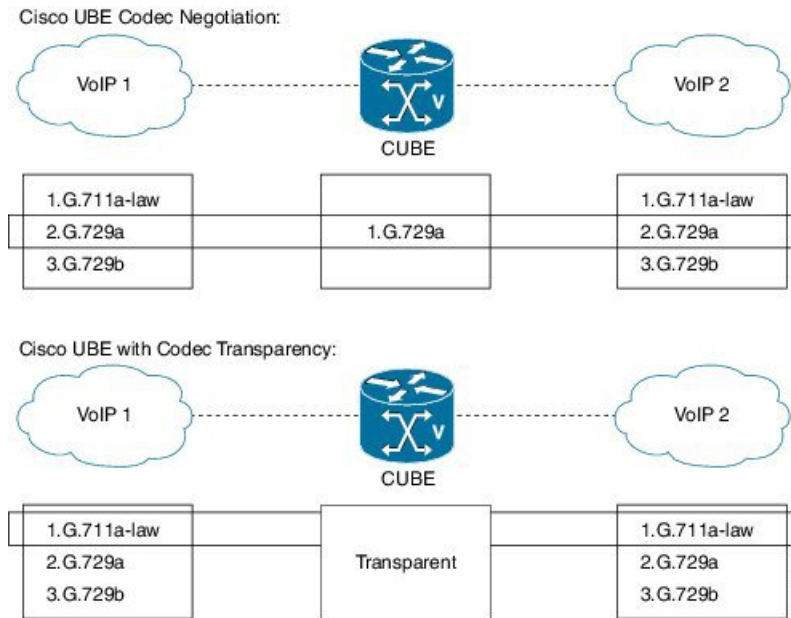

In the first example, the CUBE router is configured to use the G.729a codec. This can be done by using the appropriate codec command on both VoIP dial peers. When a call is set up, CUBE will accept only G.729a calls, thus influencing the codec negotiation.

In the second example, the CUBE dial peers are configured with a transparent codec and this leaves the codec information contained within the call signaling untouched. Because both VoIP 1 and VoIP 2 have G.711 a-law as their first choice, the resulting call will be a G.711 a-law call.

Restrictions for Voice-Class Codec Transparent

- While using the voice-class codec transparent, only the offer is passed transparently (without filtering). Codec filtering is done on the SDP present in answer and the first codec is passed to other side.
- CUBE does not support Early-Offer to Delayed-Offer (EO-DO) call flows.



Note You can use 'pass-thru content sdp', if you do not want to involve CUBE in the codec negotiation.

Voice Media Transmission

When a VoIP call is established, using the signaling protocols, the digitized voice samples need to be transmitted. These voice samples are often called the voice media. Voice media protocols found in a VoIP environment are the following:

- Real-Time Transport Protocol (RTP)—RTP is a Layer 4 protocol that is encapsulated inside UDP segments. RTP carries the actual digitized voice samples in a call.

- **Real-Time Control Protocol (RTCP)**—RTCP is a companion protocol to RTP. Both RTP and RTCP operate at Layer 4 and are encapsulated in UDP. RTP and RTCP typically use UDP ports 16384 to 32767, though these ranges may vary according to hardware platform. However, RTP uses the even port numbers in that range, whereas RTCP uses the odd port numbers. While RTP is responsible for carrying the voice stream, RTCP carries information about the RTP stream such as latency, jitter, packets, and octets sent and received.
- **Compressed RTP (cRTP)**—One of the challenges with RTP is its overhead. Specifically, the combined IP, UDP, and RTP headers are approximately 40 bytes in size, whereas a common voice payload size on a VoIP network is only 20 bytes, which includes 20 ms of voice by default. In that case, the header is twice the size of the payload. cRTP is used for RTP header compression and can reduce the 40-byte header to 2 or 4 bytes in size (depending on whether UDP checksums are in use), as shown in the figure below.

Figure 12: Compressed RTP

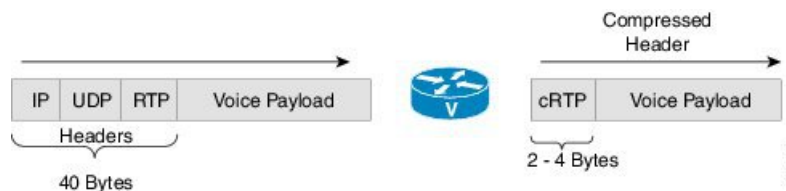

- **Secure RTP (sRTP)**—To help prevent an attacker from intercepting and decoding or possibly manipulating voice packets, sRTP supports encryption of RTP packets. In addition, sRTP provides message authentication, integrity checking, and protection against replay attacks.

VPN technology like IP Security (IPSec) may be used to protect traffic between sites. Encrypting sRTP traffic at the source of transmission results in encrypting already encrypted traffic, adding significant overhead and bandwidth needs. So it is recommended that sRTP is used for voice traffic, and that this traffic is excluded from IPSec encapsulation. sRTP uses lesser bandwidth, has the same level of security, and can be used by devices at any location because the payload is originated and terminated at the voice endpoint. Because endpoints can be mobile, the security follows the phone.

Voice Activity Detection

Voice Activity Detection (VAD) is a technology that works with the human nature of voice conversations, mainly that one person listens while the other talks. VAD classifies traffic as speech, unknown, and silence. Speech and unknown payloads are transported, but silence is dropped. This accounts for approximately 30 percent savings in bandwidth over time.

VAD can significantly reduce the amount of bandwidth required by a media stream. However, VAD has a few negative attributes that need to be considered. Because no packets are sent during silence, the listener can get the impression that the talker has been disconnected. Another characteristic is that it takes a moment for VAD to recognize the speech as having started again, and as a result, the first part of the sentence can be clipped. This can be annoying to the listening party. Music on Hold (MoH) and fax can also cause VAD to become ineffective because the media stream is constant.

VAD is enabled by default in CUBE dial peers as long as the codec selected supports it. VAD can be disabled at the VoIP dial peer using the **no vad** command. Some codecs, such as G.729b and G.729ab, support Comfort Noise Generation (CNG). When VAD is enabled, white noise is played to the listener during times when no packets are received. This leads the listener to believe that background noise is being heard. Cisco IP Phones and most gateways support CNG.

G.729 Annex-B and G.723.1 Annex-A include an integrated VAD function, but otherwise performs the same as G.729 and G.723.1, respectively.



Note VAD to NO-VAD calls are not supported by CUBE.

VoIP Bandwidth Requirements

The amount of bandwidth required varies by the codec and the transmission media. Two events require bandwidth. The media stream itself requires bandwidth between 17 to 106 kbps depending on codec, header compression, and Layer 2 and 3 headers. In addition, call signaling must be taken into account. While bandwidth required by call signaling is much smaller, it can cause problems on a network due to irregular requirements.

Table 13: Protocol Header Size Assumptions

Protocol	Header size
IP	20 bytes
UDP	8 bytes
RTP	12 bytes
cRTP	Reduces size of IP, UDP, RTP to 2 or 4 bytes

The table below gives calculations for the default voice payload sizes in Cisco CallManager or CUBE. For additional calculations, including different voice payload sizes and other protocols, use the [TAC Voice Bandwidth Codec Calculator](#) (registered customers only). For an explanation of each of the column headings, see the table below.

Table 14: Codec and Bandwidth Information

Codec & Bit Rate (kbps)	Codec Sample Size (Bytes)	Codec Sample Interval (ms)	Mean Opinion Score (MOS)	Voice Payload Size (Bytes)	Voice Payload Size (ms)	Payload Size (ms) Packets Per Second (PPS)	Bandwidth MP or FRF.12 (kbps)	Bandwidth w/cRTP MP or FRF.12 (kbps)	Bandwidth Ethernet (kbps)
G.711 (64 kbps)	80	10	4.1	160	20	50	82.8	67.6	87.2
G.729 (8 kbps)	10	10	3.92	20	20	50	26.8	11.6	31.2
G.723.1 (6.3 kbps)	24	30	3.9	24	30	33.3	18.9	8.8	21.9
G.723.1 (5.3 kbps)	20	30	3.8	20	30	33.3	17.9	7.7	20.8
G.726 (32 kbps)	20	5	3.85	80	20	50	50.8	35.6	55.2
G.726 (24 kbps)	15	5		60	20	50	42.8	27.6	47.2
G.728 (16 kbps)	10	5	3.61	60	30	33.3	28.5	18.4	31.5

Codec & Bit Rate (kbps)	Codec Sample Size (Bytes)	Codec Sample Interval (ms)	Mean Opinion Score (MOS)	Voice Payload Size (Bytes)	Voice Payload Size (ms)	Payload Size (ms) Packets Per Second (PPS)	Bandwidth MP or FRF.12 (kbps)	Bandwidth w/cRTP MP or FRF.12 (kbps)	Bandwidth Ethernet (kbps)
G722_64k(64 kbps)	80	10	4.13	160	20	50	82.8	67.6	87.2
ilbc_mode_20(15.2 kbps)	38	20	NA	38	20	50	34.0	18.8	38.4
ilbc_mode_30(13.33 kbps)	50	30	NA	50	30	33.3	25.867	15.73	28.8

Table 15: Explanation of Terms

Codec Bit Rate (kbps)	Based on the codec, this is the number of bits per second that need to be transmitted to deliver a voice call. (codec bit rate = codec sample size / codec sample interval).
Codec Sample Size (Bytes)	Size (Bytes) Based on the codec, this is the number of bytes captured by the digital signal processor (DSP) at each codec sample interval. For example, the G.729 coder operates on sample intervals of 10 ms, corresponding to 10 bytes (80 bits) per sample at a bit rate of 8 kbps. (codec bit rate = codec sample size / codec sample interval).
Codec Sample Interval (ms)	This is the sample interval at which the codec operates. For example, the G.729 coder operates on sample intervals of 10 ms, corresponding to 10 bytes (80 bits) per sample at a bit rate of 8 kbps. (codec bit rate = codec sample size / codec sample interval).
MOS	MOS is a system of grading the voice quality of telephone connections. With MOS, a wide range of listeners judge the quality of a voice sample on a scale of one (bad) to five (excellent). The scores are averaged to provide the MOS for the codec.
Voice Payload Size (Bytes)	The voice payload size represents the number of bytes (or bits) that are filled into a packet. The voice payload size must be a multiple of the codec sample size. For example, G.729 packets can use 10, 20, 30, 40, 50, or 60 bytes of voice payload size.
Voice Payload Size (ms)	Payload Size (ms) The voice payload size can also be represented in terms of the codec samples. For example, a G.729 voice payload size of 20 ms (two 10 ms codec samples) represents a voice payload of 20 bytes [(20 bytes * 8) / (20 ms) = 8 kbps]

PPS	PPS represents the number of packets that need to be transmitted every second in order to deliver the codec bit rate. For example, for a G.729 call with voice payload size per packet of 20 bytes (160 bits), 50 packets need to be transmitted every second [50 pps = (8 kbps) / (160 bits per packet)]
-----	--

Supported Audio and Video Codecs

CUBE is required to support the codec used between endpoints. g729r8 is supported by default. All other codecs have to be configured. The following codecs are supported:

Table 16: Audio Codecs Supported on CUBE

Codec Keyword	Codec
aacl	AACLD 90000 bps
clear-channel	Clear Channel 64000 bps (No voice capabilities: data transport only)
g711alaw	G.711 A Law 64000 bps
g711ulaw	G.711 u Law 64000 bps
g722-48	G722-48K 64000 bps - Only supported for H.320<->H.323 calls
g722-56	G722-56K 64000 bps - Only supported for H.320<->H.323 calls
g722-64	G722-64K 64000 bps
g723ar53	G.723.1 ANNEX-A 5300 bps (contains built-in VAD that cannot be disabled) Not supported on PVDM3.
g723ar63	G.723.1 ANNEX-A 6300 bps (contains built-in VAD that cannot be disabled) Not supported on PVDM3.
g723r53	G.723.1 5300 bps Not supported on PVDM3.
g723r63	G.723.1 6300 bps Not supported on PVDM3.
g726r16	G.726 16000 bps
g726r24	G.726 24000 bps
g726r32	G.726 32000 bps

Codec Keyword	Codec
g728	G.728 16000 bps
g729br8	G.729 ANNEX-B 8000 bps (contains built-in VAD that cannot be disabled)
g729r8	G.729 8000 bps
gsmamr-nb	GSM AMR-NB 4750 to 12200 bps (contains built-in VAD that cannot be disabled)
ilbc	iLBC 13330 or 15200 bps
isac	iSAC 10 to 32 kbps (variable bit-rate)
mp4a-latm	MP4A-LATM upto 128 kbps
transparent	Transparent; uses the endpoint codec
opus	Opus upto 510 kbps

Table 17: Video Codecs Supported on CUBE

Codec Keyword	Codec
h261	Video Codec H261
h263	Video Codec H263
h263+	Video Codec H263+
h264	Video Codec H264
mpeg4	Video Codec MPEG-4 ISO/IES 14496-2

How to Configure Codecs

Configuring Audio and Video Codecs at the Dial Peer Level

SUMMARY STEPS

1. **enable**
2. **configure terminal**
3. **dial-peer voice** *number* **voip**
4. Enter one of the following to configure an audio codec:
 - **codec** *codec* [**bytes** *payload-size* **fixed-bytes**]
 - **codec isac** [**mode** {**adaptive** | **independent**} [**bit-rate** *value* **framesize** { **30** | **60** } [**fixed**]]
 - **codec ilbc** [**mode** *frame-size* [**bytes** *payload-size*]]

- **codec mp4-latm** [**profile tag**]
 - **codec opus** [**profile tag**]
5. Do the following to configure a video codec:
- **video codec** *codec*
6. (Optional) Do one of the following to configure RTP payload type:
- **rtp payload-type cisco-codec-isac** *number*
 - **rtp payload-type cisco-codec-ilbc** *number*
 - **rtp payload-type cisco-codec-video-h263+** *number*
 - **rtp payload-type cisco-codec-video-h264** *number*
 - **rtp payload-type opus** *number*
7. end

DETAILED STEPS

	Command or Action	Purpose
Step 1	enable Example: Device> enable	Enables privileged EXEC mode. <ul style="list-style-type: none"> • Enter your password if prompted.
Step 2	configure terminal Example: Device> configure terminal	Enters global configuration mode.
Step 3	dial-peer voice <i>number</i> voip Example: Device(config)# dial-peer voice 1 voip	Enters dial peer configuration mode for the specified VoIP dial peer.
Step 4	Enter one of the following to configure an audio codec: <ul style="list-style-type: none"> • codec <i>codec</i> [bytes <i>payload-size</i> fixed-bytes] • codec isac [mode { adaptive independent } [bit-rate <i>value</i> framesize { 30 60 } [fixed]] • codec ilbc [mode <i>frame-size</i> [bytes <i>payload-size</i>]] • codec mp4-latm [profile tag] • codec opus [profile tag] Example: For g711alaw Codec Device(config-dial-peer)# codec g711alaw Example: For ISAC Codec Device(config-dial-peer)# codec isac mode independent	Configures an audio codec at the dial peer level. <ul style="list-style-type: none"> • g729r8, 20-byte payload is configured by default.

	Command or Action	Purpose
Step 5	Do the following to configure a video codec: <ul style="list-style-type: none"> • video codec <i>codec</i> Example: For Video Codec <pre>Device(config-dial-peer)# video codec h261</pre>	Configures a video codec at the dial peer level.
Step 6	(Optional) Do one of the following to configure RTP payload type: <ul style="list-style-type: none"> • rtp payload-type cisco-codec-isac <i>number</i> • rtp payload-type cisco-codec-ilbc <i>number</i> • rtp payload-type cisco-codec-video-h263+ <i>number</i> • rtp payload-type cisco-codec-video-h264 <i>number</i> • rtp payload-type opus <i>number</i> Example: <pre>Device(config-dial-peer)# rtp payload-type opus 114</pre>	Configures the RTP payload type.
Step 7	end Example: <pre>Device(config-dial-peer)# end</pre>	Returns to privileged EXEC mode.

Configuring Audio Codecs Using a Codec Voice Class and Preference Lists

Preferences can be used to determine which codecs will be selected over others.

A codec voice class is a construct within which a codec preference order can be defined. A codec voice class can then be applied to a dial peer, which then follows the preference order defined in the codec voice class.

SUMMARY STEPS

1. **enable**
2. **configure terminal**
3. **voice class codec** *tag*
4. Do the following for each audio codec you want to configure in the voice class:
 - **codec preference** *value codec-type*[**profile** *profile-tag*]
 - **codec preference** *value codec-type*[**bytes** *payload-size* **fixed-bytes**]
 - **codec preference** *value isac* [**mode** {**adaptive** | **independent**} [**bit-rate** *value* **framesize** { **30** | **60** } [**fixed**]]
 - **codec preference** *value ilbc* [**mode** *frame-size* [**bytes** *payload-size*]]
 - **codec preference** *value mp4-latm* [**profile** *tag*]
5. **exit**
6. **dial-peer voice** *number* **voip**
7. **voice-class** *codec tag* **offer-all**

8. end

DETAILED STEPS

	Command or Action	Purpose
Step 1	enable Example: Device> enable	Enables privileged EXEC mode. <ul style="list-style-type: none">• Enter your password if prompted.
Step 2	configure terminal Example: Device> configure terminal	Enters global configuration mode.
Step 3	voice class codec tag Example: Device(config)# voice class codec 10	Enters voice-class configuration mode for the specified codec voice class.
Step 4	Do the following for each audio codec you want to configure in the voice class: <ul style="list-style-type: none">• codec preference value codec-type[profile profile-tag]• codec preference value codec-type[bytes payload-size fixed-bytes]• codec preference value isac [mode {adaptive independent} [bit-rate value framesize { 30 60 } [fixed]]• codec preference value ilbc [mode frame-size [bytes payload-size]]• codec preference value mp4-latm [profile tag]	Configure a codec within the voice class and specifies a preference for the codec. This becomes part of a preference list
Step 5	exit Example: Device(config-class)# exit	Exits the current mode. <ul style="list-style-type: none">• Enter your password if prompted.
Step 6	dial-peer voice number voip Example: Device(config)# dial-peer voice 1 voip	Enters dial peer configuration mode for the specified VoIP dial peer.
Step 7	voice-class codec tag offer-all Example: Device(config-dial-peer)# voice-class codec 10	Applies the previously configured voice class and associated codecs to a dial peer. <ul style="list-style-type: none">• The offer-all keyword allows the device to offer all codecs configured in a codec voice class.
Step 8	end Example: Device(config-dial-peer)# end	Returns to privileged EXEC mode.

Configuring Video Codecs Using Codec Voice Class

SUMMARY STEPS

1. **enable**
2. **configure terminal**
3. **voice class codec tag**
4. **video codec codec**
5. **exit**
6. **dial-peer voice number voip**
7. **voice-class codec tag offer-all**
8. **end**

DETAILED STEPS

	Command or Action	Purpose
Step 1	enable Example: Device> enable	Enables privileged EXEC mode. <ul style="list-style-type: none">• Enter your password if prompted.
Step 2	configure terminal Example: Device> configure terminal	Enters global configuration mode.
Step 3	voice class codec tag Example: Device(config)# voice class codec 10	Enters voice-class configuration mode for the specified codec voice class.
Step 4	video codec codec Example: video codec h261	Configures a video codec within the voice class.
Step 5	exit Example: Device(config-class)# exit	Exits the current mode. <ul style="list-style-type: none">• Enter your password if prompted.
Step 6	dial-peer voice number voip Example: Device(config)# dial-peer voice 1 voip	Enters dial peer configuration mode for the specified VoIP dial peer.
Step 7	voice-class codec tag offer-all Example: Device(config-dial-peer)# voice-class codec 10	Applies the previously configured codec voice class and associated codecs to a dial peer. <ul style="list-style-type: none">• The offer-all keyword allows the device to offer all codecs configured in the codec voice class.

	Command or Action	Purpose
Step 8	end Example: Device(config-dial-peer)# end	Returns to privileged EXEC mode.

Verifying an Audio Call

SUMMARY STEPS

1. show call active voice [compact]

DETAILED STEPS

show call active voice [compact]

Displays a compact version of call information for voice calls in progress.

Example:

Device# **show call active voice compact**

```
<callID>  A/O FAX T<sec> Codec      type      Peer Address      IP R<ip>:<udp>
Total call-legs: 2
          23 ANS   T3      mp4a-latm  VOIP      Psipp              9.45.33.11:57210
          24 ORG   T3      mp4a-latm  VOIP      P123               9.45.33.11:57210
```

Example:

Device# **show call active voice compact**

```
<callID>  A/O FAX T<sec> Codec      type      Peer Address      IP R<ip>:<udp>
Total call-legs: 2
          58 ANS   T11     g711ulaw  VOIP      Psipp 2001:.....:230A:6080
          59 ORG   T11     g711ulaw  VOIP      P5000110011      10.13.37.150:6090
```

Configuration Examples for Codecs

Example: Configuring a Codec at Dial-Peer Level

```
Device(config)# dial-peer voice 5550199 voip
Device(config-dial-peer)# incoming called-number 5550199
Device(config-dial-peer)# codec g711ulaw
Device(config-dial-peer)# end
```

Example: Configuring a Codec Preference List and Applying it to a Dial Peer

```
Device(config)# voice class codec 100
Device(config-dial-peer)# codec preference 1 g711ulaw
Device(config-dial-peer)# exit
Device(config)# dial-peer voice 10 voip
Device(config-dial-peer)# voice-class codec 100
Device(config-dial-peer)# end
```

Example: Configuring a Codec Profile, Codec Preference List and Applying it to a Dial Peer for Opus Codec

```
router(config)#codec profile 79 opus
router(conf-codec-profile)#fmt "fmt:114 maxplaybackrate=16000; sprop-maxcapture=16000;
maxaveragebitrate=20000; stereo=1; sprop-stereo=0; useinbandfec=0; usedtx=0"
router(conf-codec-profile)#exit

router(config)#voice class codec 80
router(config-class)#codec preference 1 opus profile 79
router(config-class)#exit

router(config)#dial-peer voice 604 voip
router(config-dial-peer)#rtp payload-type opus 126
router(config-dial-peer)#voice-class codec 80 offer-all
router(config-dial-peer)#exit
```



CHAPTER 9

Call Admission Control

The call admission control feature enables you to control the audio quality and video quality of calls over a wide-area (IP WAN) link by limiting the number of calls that are allowed on that link at the same time. Audio and video quality can begin to degrade when too many active calls exist on a link and the amount of bandwidth is oversubscribed. Call admission control regulates audio and video quality by limiting the number of calls that can be active on a particular link at the same time.

The Call Admission Control feature controls number of calls based on resources and bandwidth, proactively reserve resources for good quality video calls, ensures that traffic adheres to QoS policies within each network.

CUBE provides different CAC mechanisms that are based on:

- Total Calls, CPU, or Memory
- Call Spike Detection
- Maximum Calls per Destination
- Dial-peer or Interface Bandwidth
- [Configuring CAC Based on Total Calls, CPU or Memory, on page 65](#)
- [Configuring CAC Based on Call Spike Detection, on page 67](#)
- [Configuring CAC Based on Maximum Calls per Destination, on page 68](#)
- [Bandwidth-Based Call Admission Control, on page 69](#)

Configuring CAC Based on Total Calls, CPU or Memory

The Call Admission Control (CAC) based on CPU Utilization feature permits the Cisco Voice Gateways to deny incoming calls exceeding a pre-configured threshold, permitting the selection of a system CPU load level value.

The ‘Call Threshold’ command allows you to configure two thresholds, high and low. The ‘Call Treatment’ is triggered when the current value of a resource goes beyond the configured high value. The ‘Call Treatment’ remains in effect until the current resource value falls below the configured low value.

SUMMARY STEPS

1. **enable**
2. **configure terminal**

3. **call threshold global [cpu-5sec | cpu-avg | io-mem | proc-mem | total-calls | total-mem] low *low-threshold* high *high-threshold***
4. **call treatment on**
5. **end**

DETAILED STEPS

	Command or Action	Purpose
Step 1	enable Example: Device> enable	Enables privileged EXEC mode. <ul style="list-style-type: none"> • Enter your password if prompted.
Step 2	configure terminal Example: Device# configure terminal	Enters global configuration mode.
Step 3	call threshold global [cpu-5sec cpu-avg io-mem proc-mem total-calls total-mem] low <i>low-threshold</i> high <i>high-threshold</i> Example: Device(config)# call threshold global total-calls low 1 high 1 or Device(config)# call threshold global cupu-avg low 75 high 85 or Device(config)# call threshold global toal-mem low 75 high 85	Configures the Call Admission Control feature based on the total calls, cpu, and memory usage at the interface level to reject SIP calls when the bandwidth that is required for the calls exceed the aggregate bandwidth threshold. Note By default, the system rejects incoming calls if the 5 second CPU utilization on the gateway exceeds 95%, and if the in-use process memory on the gateway exceeds 98%.
Step 4	call treatment on Example: Device(config)# call treatment on	Enables the call treatment feature.
Step 5	end Example: Device(config)# end	Exits global configuration mode and enters privileged EXEC mode.

Example: Internal Error Code (IEC) for Default Call Rejection Based on CPU Utilization and Memory

Following is the sample Internal Error Code (IEC) that explains default call rejection based on CPU utilization and memory:

```
%VOICE_IEC-3-GW: C SCRIPTS: Internal Error (Low memory): IEC=1.1.181.11.4.0 on callID
1GUID=00000000000000000000000000000000
%IVR-3-LOW_MEMORY_RESOURCE: IVR: System running low on memory (99/100 in use). Call (callID=1)
is rejected.

%VOICE_IEC-3-GW: C SCRIPTS: Internal Error (CPU high): IEC=1.1.181.11.3.0 on callID 2
%IVR-3-LOW_CPU_RESOURCE: IVR: System experiencing high cpu utilization (97/100). Call
(callID=2) is rejected.

%VOICE_IEC-3-GW: CCAPI: Internal Error (Call spike threshold): IEC=1.1.181.1.29.0 on callID
3
%SIP-3-MEMCAC: Call rejected due to CAC based on Memory usage, sent response 503
```

Configuring CAC Based on Call Spike Detection

The Call Admission Control (CAC) based on Call Spike Detection feature permits the Cisco Voice Gateways to monitor call arrival rate over a moving window of time. Calls exceeding the configured rate threshold are rejected. This feature helps in protecting against unexpected high call volumes, and INVITE-based DOS attacks.

You can configure this feature globally or on a per dial-peer level. An error code is sent when a call spike occurs, the error code is configurable globally or on a per dial-peer level.

SUMMARY STEPS

1. **enable**
2. **configure terminal**
3. **call spike threshold** *call number <1-2147483647>steps<3-10> size<100-250>*
4. **call treatment on**
5. **end**

DETAILED STEPS

	Command or Action	Purpose
Step 1	enable Example: Device> enable	Enables privileged EXEC mode. <ul style="list-style-type: none"> • Enter your password if prompted.
Step 2	configure terminal Example: Device# configure terminal	Enters global configuration mode.

	Command or Action	Purpose
Step 3	call spike threshold <i>call number</i> <i><1-2147483647>steps<3-10> size<100-250></i> Example: Device(config)# call spike 10 steps 3 size 100 Device(config)# call spike 12	Configures the Call Spike Call Admission Control feature at the device level to reject SIP calls when the call spike is detected as per the configuration (10 incoming call requests per 300 milliseconds)
Step 4	call treatment on Example: Device(config)# call treatment on	Enables the call treatment feature.
Step 5	end Example: Device(config)# end	Exits global configuration mode and enters privileged EXEC mode.

Configuring CAC Based on Maximum Calls per Destination

The Call Admission Control (CAC) based on Maximum Calls per Destination feature permits the Cisco Voice Gateways to restricting the number of concurrent calls that can be active on a VoIP dial peer. Maximum connections work on individual dial-peers and does not provide CAC for the entire gateway.

SUMMARY STEPS

1. **enable**
2. **configure terminal**
3. **dial-peer voice tag voip**
4. **session protocol sipv2**
5. **max-conn**
6. **end**

DETAILED STEPS

	Command or Action	Purpose
Step 1	enable Example: Device> enable	Enables privileged EXEC mode. <ul style="list-style-type: none"> • Enter your password if prompted.
Step 2	configure terminal Example: Device# configure terminal	Enters global configuration mode.

	Command or Action	Purpose
Step 3	dial-peer voice tag voip Example: Device(config)# dial-peer voice 10 voip	Enters dial peer voice configuration mode.
Step 4	session protocol sipv2 Example: Device(config-dial-peer)# session protocol sipv2	Configures SIP as the session protocol type.
Step 5	max-conn Example: Device(config)# max-conn <1-214748364>	Configures the Maximum Calls per Destination Call Admission Control feature at the device level to allow only 2 long-distance calls.
Step 6	end Example: Device# end	Exits global configuration mode and enters privileged EXEC mode.

Bandwidth-Based Call Admission Control

The Bandwidth-Based Call Admission Control (CAC) feature provides the functionality to reject SIP calls when the bandwidth accounted by the SIP signaling layer exceeds the aggregate bandwidth threshold for VoIP media traffic—voice, video, and fax. This functionality helps you prevent Quality of Service (QoS) degradation of VoIP media traffic for existing calls when the bandwidth allocated for VoIP traffic is fully utilized. The Bandwidth-Based Call Admission Control feature is supported on Session Initiation Protocol (SIP) trunks of the Time Division Multiplexing (TDM) SIP gateway and the Cisco Unified Border Element (Cisco UBE).

Midcall media renegotiation can also be rejected if the configured maximum bandwidth threshold for the VoIP media traffic is exceeded. The call continues as per the previously negotiated media codecs if midcall media renegotiation is rejected.

The excess subscription of the bandwidth allocated for VoIP traffic results in VoIP media packets being dropped or delayed, irrespective of the VoIP call to which they belong. Under such circumstances, it is better to deny new calls to prevent QoS deterioration for existing VoIP call traffic. The existing traffic congestion resolution mechanisms do not differentiate between media packets of existing calls (admitted) and new calls (oversubscribed). Similarly, existing call signaling is unaware of the media traffic congestion. The Bandwidth-Based Call Admission Control feature fills this gap by rejecting new SIP calls when the bandwidth allocated for VoIP traffic is fully utilized. The actual bandwidth usage is not measured and policed. The lower-level QoS policies control the traffic characteristics for the specified traffic class.



Note The Bandwidth-Based Call Admission Control feature is applicable only to VoIP traffic.

Restrictions for Bandwidth-Based Call Admission Control

- Cisco UBE, configured with the Bandwidth-Based Call Admission Control feature, will not reject the call if the bandwidth of the SDP answer is greater than the bandwidth of the SDP offer.
- Layer 2 overhead is not included in the bandwidth calculation.
- A midcall delayed-offer (DO) to DO call is disconnected if the bandwidth requested in an offer message (200 OK) exceeds the threshold bandwidth.
- Real Time Transport Control Protocol (RTCP) and RTP Named Telephone Event (RTP-NTE) bandwidth requirement is not computed.
- The Bandwidth-Based Call Admission Control feature does not support:
 - Cisco fax relay.
 - Filtering of codecs to accommodate calls within the available bandwidth.
 - Media flow-around, Session Description Protocol (SDP) pass-through, out-of-box low-density transcoding, high-density transcoding, video transcoding, and midcall consumption functionalities.
 - Non-SIP call legs.
 - SIP-to-H32X call flows (SIP-H320, H320-SIP, SIP-H324, H324-SIP).
 - Subinterfaces for bandwidth-based CAC on an interface.

Information About Bandwidth-Based Call Admission Control

Maximum Bandwidth Calculation

The bandwidth requirement for each SIP call leg is calculated using the codec information available in the SDP. Here, the actual media bandwidth used is not measured.

Bandwidth in Kbps (Kilo bits per second) = [codec bytes + RTP header (12) + UDP (8) + IP Header (20 or 40)] * Packets per seconds * 8/1000

Where, codec bytes = Codec payload size, in bytes, for a given packetization interval.

RTP header = Size of the RTP header, in bytes.

UDP = Size of the UDP header, in bytes.

IP Header = Size of the IP header, in bytes. The IPV4 header is 20 bytes and the IPV6 header is 40 bytes.

Packets per second = Number of RTP packets sent or received per second. This value is as per the negotiated packetization interval. The SDP media attribute "ptime" indicates the number of packets per second.

Bandwidth Tables

This section provides the sample maximum bandwidth calculation for audio and fax calls.

Table 18: Audio Bandwidth Table

Codec and Bit Rate (Kbps)	Codec Sample Size in Bytes	Voice Payload Size in Bytes	Voice Payload Size in Milliseconds	Packets Per Second	Bandwidth for IPv4 (excluding Layer 2) in Kbps	Bandwidth for IPv6 (excluding Layer 2) in Kbps
G.711 (64 Kbps)	80	160	20	50	80	88
G.729 (8 Kbps)	10	20	20	50	24	32
G.723.1 (6.3 Kbps)	24	24	30	33.3	17	22
G.723.1 (5.3 Kbps)	20	20	30	33.3	16	21
G.726 (32 Kbps)	20	80	20	50	48	56
G.726 (24 Kbps)	15	60	20	50	40	48
G.726 (16 Kbps)	10	40	20	50	32	40
G.728 (16 Kbps)	10	40	20	50	32	40
G722_64k (64 Kbps)	80	160	20	50	80	88
ilbc_mode_20 (15.2 Kbps)	38	38	20	50	31	39
ilbc_mode_30 (13.33 Kbps)	50	50	30	33.3	24	29
gsm (13 Kbps)	33	33	20	50	30	37
gsm (12 Kbps)	32	32	20	50	29	37
G.Clear (64 Kbps)	80	160	20	50	80	88
GSM AMR	—	—	—	—	15	15
ISAC (32 Kbps)	—	—	—	—	37	37

Aaclid (mpeg4)	—	—	—	—	Derived from the SDP bandwidth attribute (TIAS)	Derived from the SDP bandwidth attribute (TIAS)
-------------------	---	---	---	---	--	--

Table 19: Fax Bandwidth Table

T.38 Fax Bit Rate	Redundancy	Maximum Bandwidth in Kbps
2400	None	8
2400	Redundancy	17
9600 (default)	None	16
9600 (default)	Redundancy	46
14400	None	20
14400	Redundancy	65
33600	None	40
33600	Redundancy	142

How to Configure Bandwidth-Based Call Admission Control

Configuring Bandwidth-Based Call Admission Control at the Interface Level

You can configure the Bandwidth-Based Call Admission Control feature at the interface level to reject SIP calls when the bandwidth required for the call exceeds the aggregate bandwidth threshold.

You can configure the Bandwidth-Based Call Admission Control feature for the following interfaces:

- ATM
- Ethernet (Fast Ethernet, Gigabit Ethernet)
- Loopback
- Serial



Note Cisco recommends that you configure a bind media to associate a specific interface for SIP calls. Otherwise, the interface used for the calls will be determined based on the best local address that can access the remote media source address (for early offer calls) or the remote signaling source address (for delayed offer calls). When you use a Loopback interface to configure CAC, you must configure an additional bind-to-bind media with the Loopback interface at the global level or the dial peer level. Configure the **bind media source-interface loopback number** command in service SIP configuration mode to configure a bind media.

SUMMARY STEPS

1. **enable**
2. **configure terminal**
3. **call threshold interface** *type number int-bandwidth* {**class-map** *name* [**l2-overhead** *percentage*] | **low** *low-threshold* **high** *high-threshold*} [**midcall-exceed**]
4. **end**

DETAILED STEPS

	Command or Action	Purpose
Step 1	enable Example: Device> enable	Enables privileged EXEC mode. <ul style="list-style-type: none"> • Enter your password if prompted.
Step 2	configure terminal Example: Device# configure terminal	Enters global configuration mode.
Step 3	call threshold interface <i>type number int-bandwidth</i> { class-map <i>name</i> [l2-overhead <i>percentage</i>] low <i>low-threshold</i> high <i>high-threshold</i> } [midcall-exceed] Example: Device(config)# call threshold interface GigabitEthernet 0/0 int-bandwidth low 1000 high 20000 midcall-exceed or Device(config)# call threshold interface GigabitEthernet 0/0 int-bandwidth class-map voip-traffic l2-overhead 20 midcall-exceed	Configures the Bandwidth-Based Call Admission Control feature at the interface level to reject SIP calls when the bandwidth required for the calls exceed the aggregate bandwidth threshold. <ul style="list-style-type: none"> • You can configure the call threshold interface <i>type number</i> low <i>low-threshold</i> high <i>high-threshold</i> [midcall-exceed] command to apply call admission control to reject SIP calls once the accounted bandwidth reaches the <i>high-threshold</i> value and continues to be above the <i>low-threshold</i> value. • You can configure the call threshold interface <i>type number</i> int-bandwidth class-map <i>name</i> [l2-overhead <i>percentage</i>] [midcall-exceed] command to use the bandwidth value provisioned in the QoS policy under the interface for VoIP media traffic for CAC. See the Modular Quality of Service Command-Line Interface Overview document at http://www.cisco.com/en/US/

	Command or Action	Purpose
		docs/ios/12_2/qos/configuration/guide/qcfmdcli.html for information on the usage of the QoS policy with Call Admission Control. <ul style="list-style-type: none"> SIP calls are rejected when the calculated aggregate bandwidth of VoIP media traffic on the specified interface exceeds the configured bandwidth threshold.
Step 4	end Example: Device(config) # end	Exits global configuration mode and enters privileged EXEC mode.

Configuring Bandwidth-Based Call Admission Control at the Dial Peer Level

You can configure the Bandwidth-Based Call Admission Control feature at the dial peer level to reject SIP calls when the bandwidth required for the calls exceeds the aggregate bandwidth threshold.

SUMMARY STEPS

1. **enable**
2. **configure terminal**
3. **dial-peer voice tag voip**
4. **session protocol sipv2**
5. **max-bandwidth bandwidth-value [midcall-exceed]**
6. **end**

DETAILED STEPS

	Command or Action	Purpose
Step 1	enable Example: Device> enable	Enables privileged EXEC mode. <ul style="list-style-type: none"> Enter your password if prompted.
Step 2	configure terminal Example: Device# configure terminal	Enters global configuration mode.
Step 3	dial-peer voice tag voip Example: Device(config) # dial-peer voice 44 voip	Enters dial peer voice configuration mode.
Step 4	session protocol sipv2 Example:	Configures the Bandwidth-Based Call Admission Control feature for SIP dial peers only.

	Command or Action	Purpose
	Device(config-dial-peer)# session protocol sipv2	
Step 5	max-bandwidth <i>bandwidth-value</i> [midcall-exceed] Example: Device(config-dial-peer)# max-bandwidth 24 midcall-exceed	Configures the Bandwidth-Based Call Admission Control feature at the dial peer level to reject SIP calls when the bandwidth required for the calls exceed the aggregate bandwidth threshold. <ul style="list-style-type: none"> Configuring the midcall-exceed keyword allows exceeding the bandwidth threshold during mid-call media renegotiation. Media renegotiation exceeding the bandwidth threshold is rejected by default.
Step 6	end Example: Device(config-dial-peer)# end	Exits dial peer configuration mode and enters privileged EXEC mode.

Configuring the Bandwidth-Based Call Admission Control SIP Error Response Code Mapping

Mapping of the call rejection cause code to a specific SIP error response code is known as error response code mapping. The cause code for the call rejected because of the bandwidth-based CAC can be mapped to a SIP error response code between 400 to 600. The default SIP error response code is 488.

You can configure SIP error response codes for calls rejected by the Bandwidth-Based Call Admission Control feature at the global level, dial peer level, or both.

Configuring Bandwidth-Based Call Admission Control SIP Error Response Code Mapping at the Global Level

SUMMARY STEPS

- enable
- configure terminal
- voice service voip
- sip
- error-code-override cac-bandwidth failure *sip-status-code-number*
- end

DETAILED STEPS

	Command or Action	Purpose
Step 1	enable Example: Device> enable	Enables privileged EXEC mode. <ul style="list-style-type: none"> Enter your password if prompted.
Step 2	configure terminal Example:	Enters global configuration mode.

	Command or Action	Purpose
	Device# <code>configure terminal</code>	
Step 3	voice service voip Example: Device(config)# <code>voice service voip</code>	Enters voice-service configuration mode.
Step 4	sip Example: Device(conf-voi-serv)# <code>sip</code>	Enters service SIP configuration mode.
Step 5	error-code-override cac-bandwidth failure <i>sip-status-code-number</i> Example: Device(conf-serv-sip)# <code>error-code-override cac-bandwidth failure 500</code>	Configures bandwidth-based CAC SIP error response code mapping at the global level.
Step 6	end Example: Device(conf-serv-sip)# <code>end</code>	Exits service SIP configuration mode and enters privileged EXEC mode.

Configuring Bandwidth-Based Call Admission Control SIP Error Response Code Mapping at the Dial Peer Level

SUMMARY STEPS

1. `enable`
2. `configure terminal`
3. `dial-peer voice tag {pots | voatm | vofr | voip}`
4. `voice-class sip error-code-override cac-bandwidth failure {sip-status-code-number | system}`
5. `end`

DETAILED STEPS

	Command or Action	Purpose
Step 1	enable Example: Device> <code>enable</code>	Enables privileged EXEC mode. <ul style="list-style-type: none"> • Enter your password if prompted.
Step 2	configure terminal Example: Device# <code>configure terminal</code>	Enters global configuration mode.

	Command or Action	Purpose
Step 3	dial-peer voice <i>tag</i> { <i>pots</i> <i>voatm</i> <i>vofr</i> <i>voip</i> } Example: Device(config)# dial-peer voice 88 voip	Enters dial peer voice configuration mode.
Step 4	voice-class sip error-code-override cac-bandwidth failure { <i>sip-status-code-number</i> <i>system</i> } Example: Device(config-dial-peer)# voice-class sip error-code-override cac-bandwidth failure 500	Configures bandwidth-based CAC SIP error response code mapping at the dial peer level.
Step 5	end Example: Device(config-dial-peer)# end	Exits dial peer configuration mode and enters privileged EXEC mode.

Verifying Bandwidth-Based Call Admission Control

Perform this task to verify the configuration for the Bandwidth-Based Call Admission Control feature on Cisco UBE. The **show** commands need not be entered in any specific order.

SUMMARY STEPS

1. **enable**
2. **show call threshold config**
3. **show call threshold status**
4. **show call threshold stats**
5. **show dial-peer voice**

DETAILED STEPS

Step 1 enable

Example:

```
Device>enable
```

Enables privileged EXEC mode.

Step 2 show call threshold config

Example:

```
Device# show call threshold config
```

```
Some resource polling interval:
```

```
  CPU_AVG interval: 60
```

```
  Memory interval: 5
```

IF	Type	Value	Low	High	Enable
GigabitEthernet0/0	int-bandwidth	0	100	400	N/A

Displays the current call threshold configuration at the interface level for all resources.

Step 3 show call threshold status

Example:

```
Device# show call threshold status
```

Status	IF	Type	Value	Low	High	Enable
Avail	GigabitEthernet0/0	int-bandwidth	0	100	400	N/A

Displays the availability status of resources that are configured when the Bandwidth-Based Call Admission Control feature is enabled at an interface level.

Step 4 show call threshold stats

Example:

```
Device# show call threshold stats
```

```
Total resource check: 2
successful: 1
failed: 1
```

```
1: -----
   Failed resources: int-bandwidth,
   related interface: GigabitEthernet0/0; related option:N/A
   Recorded time: 04:49:39 UTC Wed Dec 8 2010
2: -----
Successful
   All resources are available for this check.
   Recorded time: 04:29:39 UTC Wed Dec 8 2010
```

Displays the statistics of resources that are configured when the Bandwidth-Based Call Admission Control feature is enabled at an interface level.

Step 5 show dial-peer voice

Example:

```
Device# show dial-peer voice
```

```
incoming called-number = `2000', connections/maximum = 0/unlimited,
bandwidth/maximum = 0/400,
.....
Successful Calls = 0, Failed Calls = 0, Incomplete Calls = 0
Accepted Calls = 3, Refused Calls = 0,
Bandwidth CAC Accepted Calls = 3, Bandwidth CAC Refused Calls = 0
```

Displays information for the voice dial peer.

Troubleshooting Tips

The following commands can help troubleshoot the Bandwidth-Based Call Admission Control feature:

- `debug ccsip all`
- `debug voice ccapi all`

Configuration Examples for Bandwidth-Based Call Admission Control

Example: Configuring Bandwidth-Based Call Admission Control at the Interface Level

The following example shows how to configure Cisco UBE to reject new SIP calls if the accounted VoIP media bandwidth on Gigabit Ethernet interface 0/0 exceeds 400 Kbps of bandwidth and continues to have a bandwidth above 100 Kbps:

```
Device> enable
Device# configure terminal
Device(config)# call threshold interface GigabitEthernet 0/0 int-bandwidth low 100 high 400
```

The following example shows how to configure Cisco UBE to reject new SIP calls if the VoIP media bandwidth on Gigabit Ethernet interface 0/0 exceeds the configured bandwidth for priority traffic in the “voip_traffic” class:

```
Device>enable
Device# configure terminal
Device(config)# class-map match-all voip-traffic

Device(config-cmap)# policy-map voip-policy
Device(config-pmap)# class voip-traffic
Device(config-pmap-c)# priority 440
Device(config-pmap-c)# end

Device# enaconfigure terminalble
Device(config)# call threshold interface GigabitEthernet 0/0 int-bandwidth class-map voip-traffic 12-overhead 10
```



Note Layer 2 overhead of 10 percent in the `call threshold` command indicates that the IP bandwidth, excluding Layer 2, is 90 percent of the configured priority bandwidth.

Example: Configuring Bandwidth-Based Call Admission Control at the Dial Peer Level

The following example shows how to configure Cisco UBE to reject calls once the accounted aggregate bandwidth of active calls exceeds 400 Kbps for a SIP dial peer:

```
Device> enable
Device# configure terminal
Device(config)# dial-peer voice 2000 voip
Device(config)# session protocol sipv2
Device(config-dial-peer)# max-bandwidth 400
```

Example: Configuring the Bandwidth-Based Call Admission Control SIP Error Response Code Mapping at the Global Level

The following example shows how to configure Cisco UBE for bandwidth-based CAC SIP error response code mapping at the global level:

```
Device> enable
Device# configure terminal
Device(config)# voice service voip
Device(conf-voi-serv)# sip
Device(conf-serv-sip)# error-code-override cac-bandwidth 500
```

Example: Configuring the Bandwidth-Based Call Admission Control SIP Error Response Code Mapping at the Dial Peer Level

The following example shows how to configure Cisco UBE for bandwidth-based CAC SIP error response code mapping at the dial peer level:

```
Device> enable
Device# configure terminal
Device(config)# dial-peer voice 88 voip
Device(config-dial-peer)# voice-class sip error-code-override cac-bandwidth failure 500
```

Feature Information for Bandwidth-Based Call Admission Control

The following table provides release information about the feature or features described in this module. This table lists only the software release that introduced support for a given feature in a given software release train. Unless noted otherwise, subsequent releases of that software release train also support that feature.

Use Cisco Feature Navigator to find information about platform support and Cisco software image support. To access Cisco Feature Navigator, go to <https://cfng.cisco.com/>. An account on Cisco.com is not required.

Table 20: Feature Information for Bandwidth-Based Call Admission Control

Feature Name	Releases	Feature Information
Bandwidth-Based Call Admission Control	15.2(2)T	<p>The Bandwidth-Based Call Admission Control feature provides the functionality to reject SIP calls when the bandwidth accounted by the SIP signaling layer exceeds the aggregate bandwidth threshold for VoIP media traffic—voice, video, and fax. This functionality helps prevent QoS degradation of VoIP media traffic for existing calls when the bandwidth allocated for VoIP traffic is fully utilized.</p> <p>The following commands were introduced or modified:</p> <p>call threshold interface, error-code-override, max-bandwidth, show call threshold, voice-class sip</p>
Bandwidth-Based Call Admission Control	Cisco IOS XE Release 3.7S	<p>The Bandwidth-Based Call Admission Control feature provides the functionality to reject SIP calls when the bandwidth accounted by the SIP signaling layer exceeds the aggregate bandwidth threshold for VoIP media traffic—voice, video, and fax. This functionality helps prevent QoS degradation of VoIP media traffic for existing calls when the bandwidth allocated for VoIP traffic is fully utilized.</p> <p>The following commands were introduced or modified:</p> <p>call threshold interface, error-code-override, max-bandwidth, show call threshold, voice-class sip</p>



CHAPTER 10

Basic SIP Configuration

This chapter provides basic configuration information for the following features:

- SIP Register Support
- SIP Redirect Processing Enhancement
- SIP 300 Multiple Choice Messages
- SIP implementation enhancements:
 - Interaction with Forking Proxies
 - SIP Intra-Gateway Hairpinning

Finding Support Information for Platforms and Cisco Software Images

Use Cisco Feature Navigator to find information about platform support and Cisco software image support. To access Cisco Feature Navigator, go to <http://www.cisco.com/go/cfn>. An account on Cisco.com is not required.

- [Prerequisites for Basic SIP Configuration, on page 83](#)
- [Restrictions for Basic SIP Configuration, on page 83](#)
- [Information About Basic SIP Configuration, on page 84](#)
- [How to Perform Basic SIP Configuration, on page 85](#)
- [Configuration Examples for Basic SIP Configuration, on page 101](#)
- [Toll Fraud Prevention, on page 108](#)

Prerequisites for Basic SIP Configuration

SIP Redirect Processing Enhancement Feature

- Ensure that your SIP gateway supports 300 or 302 Redirect messages.

Restrictions for Basic SIP Configuration

- If Hot Standby Router Protocol (HSRP) is configured on the Cisco IOS Gateway, IP-TDM calls are not supported.

Information About Basic SIP Configuration

SIP Register Support

With H.323, Cisco IOS gateways can register E.164 numbers of a POTS dial peer with a gatekeeper, which informs the gatekeeper of a user's contact information. Session Initiation Protocol (SIP) gateways allow the same functionality, but with the registration taking place with a SIP proxy or registrar. SIP gateways allow registration of E.164 numbers to a SIP proxy or registrar on behalf of analog telephone voice ports (FXS), IP phone virtual voice ports (EFXS), and local SCCP phones.

When registering dial peers with an external registrar, you can also register with a secondary SIP proxy or registrar to provide redundancy. The secondary registration can be used if the primary registrar fails.

SIP gateways allow registration of E.164 numbers to a SIP proxy or registrar server on behalf of analog telephone voice ports (FXS), IP phone virtual voice ports (EFXS), and local SCCP phones. By default, SIP gateways do not generate SIP Register messages. The following tasks set up the gateway to register E.164 telephone numbers with an external SIP registrar.



Note There are no commands that allow registration between the H.323 and SIP protocols.

SIP Redirect Processing Enhancement

SIP Redirect Processing allows flexibility in the handling of incoming redirect or 3xx class of responses. Redirect responses can be enabled or disabled through the command-line interface, providing a benefit to service providers who deploy Cisco SIP gateways. Redirect processing is active by default, which means that SIP gateways handle incoming 3xx messages in compliance with RFC 2543. RFC 2543 states that redirect response messages are used by SIP user agents to initiate a new Invite when a user agent learns that a user has moved from a previously known location.

In accordance with RFC 2543-bis-04, the processing of 3xx redirection is as follows:

- The uniform resource identifier (URI) of the redirected INVITE is updated to contain the new contact information provided by the 3xx redirect message.
- The transmitted CSeq number found in the CSeq header is increased by one. The new INVITE includes the updated CSeq.
- The To, From, and Call ID headers that identify the call leg remain the same. The same Call ID gives consistency when capturing billing history.
- The UAC retries the request at the new address given by the 3xx Contact header field.

Redirect handling can be disabled by using the **no redirection** command in SIP user-agent configuration mode. In this case, the user agent treats incoming 3xx responses as 4xx error class responses. The call is not redirected, and is instead released with the appropriate PSTN cause-code message. The table below shows the mapping of 3xx responses to 4xx responses.

Table 21: Mapping of 3xx Responses to 4xx Responses

Redirection (3xx) Response Message	Mapping to 4xx (Client Error) Response
300 Multiple choices	410 Gone
301 Moved Permanently	410 Gone
302 Moved Temporarily	480 Temporarily Unavailable
305 Use Proxy	410 Gone
380 Alternative Service	410 Gone
<any other 3xx response>	410 Gone

SIP Redirect Processing generates call history information with appropriate release cause codes that maybe used for accounting or statistics purposes. When a 3xx response is mapped to 4xx class of response, the cause code stored in call history is based on the mapped 4xx response code.

Call redirection must be enabled on the gateway for SIP call transfer involving redirect servers to be successful.

The Cisco IOS voice gateway can also use call redirection if an incoming VoIP call matches an outbound VoIP dial peer. The gateway sends a 300 or 302 Redirect message to the call originator, allowing the originator to reestablish the call. Two commands allow you to enable the redirect functionality, globally or on a specific inbound dial peer: **redirect ip2ip (dial-peer)** and **redirect ip2ip (voice service)**.

Sending SIP 300 Multiple Choice Messages

Originally, when a call was redirected, the SIP gateway would send a 302 Moved Temporarily message. The first longest match route on a gateway (dial-peer destination pattern) was used in the Contact header of the 302 message. Now, if multiple routes to a destination exist for a redirected number (multiple dial peers are matched), the SIP gateway sends a 300 Multiple Choice message, and the multiple routes in the Contact header are listed.

The **redirect contact order** command gives you the flexibility to choose the order in which routes appear in the Contact header.

How to Perform Basic SIP Configuration



Note For help with a procedure, see the verification and troubleshooting sections listed above.

Configuring SIP VoIP Services on a Cisco Gateway

Shut Down or Enable VoIP Service on Cisco Gateways

SUMMARY STEPS

1. `enable`
2. `configure terminal`
3. `voice service voip`
4. `[no] shutdown [forced]`
5. `exit`

DETAILED STEPS

	Command or Action	Purpose
Step 1	enable Example: Router> enable	Enters privileged EXEC mode or any other security level set by a system administrator. Enter your password if prompted.
Step 2	configure terminal Example: Router# configure terminal	Enters global configuration mode.
Step 3	voice service voip Example: Router(config)# voice service voip	Enters voice-service VoIP configuration mode.
Step 4	[no] shutdown [forced] Example: Router(config-voi-serv)# shutdown forced	Shuts down or enables VoIP call services.
Step 5	exit Example: Router(config-voi-serv)# exit	Exits the current mode.

Shut Down or Enable VoIP Submodes on Cisco Gateways

SUMMARY STEPS

1. `enable`
2. `configure terminal`
3. `voice service voip`

4. `sip`
5. `[no] call service stop [forced] [maintain-registration]`
6. `exit`

DETAILED STEPS

	Command or Action	Purpose
Step 1	enable Example: <pre>Router> enable</pre>	Enters privileged EXEC mode or any other security level set by a system administrator. Enter your password if prompted.
Step 2	configure terminal Example: <pre>Router# configure terminal</pre>	Enters global configuration mode.
Step 3	voice service voip Example: <pre>Router(config)# voice service voip</pre>	Enters voice-service VoIP configuration mode.
Step 4	sip Example: <pre>Router(config-voi-serv)# sip</pre>	Enters SIP configuration mode.
Step 5	[no] call service stop [forced] [maintain-registration] Example: <pre>Router(conf-serv-sip)# call service stop maintain-registration</pre>	Shuts down or enables VoIP call services for the selected submode.
Step 6	exit Example: <pre>Router(conf-serv-sip)# exit</pre>	Exits the current mode.

Configuring SIP Register Support

SUMMARY STEPS

1. `enable`
2. `configure terminal`
3. `sip-ua`
4. `registrar {dns: address | ipv4: destination-address} expires seconds [tcp] [secondary]`
5. `retry register number`

6. **timers register** *milliseconds*
7. **exit**

DETAILED STEPS

	Command or Action	Purpose
Step 1	enable Example: <pre>Router> enable</pre>	Enters privileged EXEC mode or any other security level set by a system administrator. Enter your password if prompted.
Step 2	configure terminal Example: <pre>Router# configure terminal</pre>	Enters global configuration mode.
Step 3	sip-ua Example: <pre>Router(config)# sip-ua</pre>	Enters SIP user-agent configuration mode.
Step 4	registrar {dns: address ipv4: destination-address} expires seconds [tcp] [secondary] Example: <pre>Router(config-sip-ua)# registrar ipv4:10.8.17.40 expires 3600 secondary</pre>	Registers E.164 numbers on behalf of analog telephone voice ports (FXS) and IP phone virtual voice ports (EFXS) with an external SIP proxy or SIP registrar server. Keywords and arguments are as follows: <ul style="list-style-type: none"> • dns: address --Domain-name server that resolves the name of the dial peer to receive calls. • ipv4: destination-address --IP address of the dial peer to receive calls. • expires seconds --Default registration time, in seconds. • tcp --Sets transport layer protocol to TCP. UDP is the default. • secondary --Specifies registration with a secondary SIP proxy or registrar for redundancy purposes. Optional.
Step 5	retry register number Example: <pre>Router(config-sip-ua)# retry register 6</pre>	Use this command to set the total number of SIP Register messages that the gateway should send. The argument is as follows: <ul style="list-style-type: none"> • number --Number of Register message retries. Range: 1 to 10. Default: 6.
Step 6	timers register milliseconds Example:	Use this command to set how long the SIP user agent waits before sending register requests. The argument is as follows:

	Command or Action	Purpose
	<code>Router(config-sip-ua)# timers register 500</code>	<ul style="list-style-type: none"> <i>milliseconds</i> --Waiting time, in ms. Range: 100 to 1000. Default: 500.
Step 7	exit Example: <code>Router(config-sip-ua)# exit</code>	Exits the current mode.

Configuring SIP Redirect Processing Enhancement

Configure Call-Redirect Processing Enhancement

Redirect processing using the **redirection** command is enabled by default. To disable and then reset redirect processing, perform the steps listed in this section:

IP-to-IP call redirection can be enabled globally or on a dial-peer basis. To configure, perform the steps listed in these sections:

Configuring Call-Redirect Processing Enhancement

SUMMARY STEPS

1. **enable**
2. **configure terminal**
3. **sip-ua**
4. **no redirection**
5. **redirection**
6. **exit**

DETAILED STEPS

	Command or Action	Purpose
Step 1	enable Example: <code>Router> enable</code>	Enters privileged EXEC mode or any other security level set by a system administrator. Enter your password if prompted.
Step 2	configure terminal Example: <code>Router# configure terminal</code>	Enters global configuration mode.
Step 3	sip-ua Example: <code>Router(config)# sip-ua</code>	Enters SIP user-agent configuration mode.

Configuring Call Redirect to Support Calls Globally

	Command or Action	Purpose
Step 4	no redirection Example: <pre>Router(config-sip-ua)# no redirection</pre>	Disables redirect handling--causes the gateway to treat incoming 3xx responses as 4xx error class responses.
Step 5	redirection Example: <pre>Router(config-sip-ua)# redirection</pre>	Resets call redirection to work as specified in RFC 2543. The command default redirection also resets call redirection to work as specified in RFC 2543.
Step 6	exit Example: <pre>Router(config-sip-ua)# exit</pre>	Exits the current mode.

Configuring Call Redirect to Support Calls Globally

To configure call redirect to support calls globally, perform the following steps.



Note To enable global IP-to-IP call redirection for all VoIP dial peers, use voice-service configuration mode. The default SIP application supports IP-to-IP redirection.

SUMMARY STEPS

1. **enable**
2. **configure terminal**
3. **voice service voip**
4. **redirect ip2ip**
5. **exit**

DETAILED STEPS

	Command or Action	Purpose
Step 1	enable Example: <pre>Router> enable</pre>	Enters privileged EXEC mode or any other security level set by a system administrator. Enter your password if prompted.
Step 2	configure terminal Example: <pre>Router# configure terminal</pre>	Enters global configuration mode.

	Command or Action	Purpose
Step 3	voice service voip Example: Router(config)# voice service voip	Enters voice-service VoIP configuration mode.
Step 4	redirect ip2ip Example: Router(conf-voi-serv)# redirect ip2ip	Redirect SIP phone calls to SIP phone calls globally on a gateway using the Cisco IOS voice gateway.
Step 5	exit Example: Router(conf-voi-serv)# exit	Exits the current mode.

Configuring Call Redirect to Support Calls on a Specific VoIP Dial Peer



Note To specify IP-to-IP call redirection for a specific VoIP dial peer, configure it on an inbound dial peer in dial-peer configuration mode. The default application on SIP SRST supports IP-to-IP redirection.

- When IP-to-IP redirection is configured in dial-peer configuration mode, the configuration on the specific inbound dial peer takes precedence over the global configuration entered under voice service configuration.

SUMMARY STEPS

1. **enable**
2. **configure terminal**
3. **dial-peer voice tag voip**
4. **application application-name**
5. **redirect ip2ip**
6. **exit**

DETAILED STEPS

	Command or Action	Purpose
Step 1	enable Example: Router> enable	Enters privileged EXEC mode or any other security level set by a system administrator. Enter your password if prompted.
Step 2	configure terminal Example: Router# configure terminal	Enters global configuration mode.

	Command or Action	Purpose
Step 3	dial-peer voice <i>tag</i> voip Example: <pre>Router(config)# dial-peer voice 29 voip</pre>	Use this command to enter dial-peer configuration mode. The argument is as follows: <ul style="list-style-type: none"> • <i>tag</i> --Digits that define a particular dial peer. Range: 1 to 2,147,483,647 (enter without commas).
Step 4	application <i>application-name</i> Example: <pre>Router(config-dial-peer)# application session</pre>	Enables a specific application on a dial peer. The argument is as follows: <ul style="list-style-type: none"> • <i>application-name</i> --Name of the predefined application you wish to enable on the dial peer. For SIP, the default Tcl application (from the Cisco IOS image) is session and can be applied to both VoIP and POTS dial peers. The application must support IP-to-IP redirection
Step 5	redirect ip2ip Example: <pre>Router(conf-dial-peer)# redirect ip2ip</pre>	Redirects SIP phone calls to SIP phone calls on a specific VoIP dial peer using the Cisco IOS voice gateway.
Step 6	exit Example: <pre>Router(conf-dial-peer)# exit</pre>	Exits the current mode.

Configuring SIP 300 Multiple Choice Messages

Configuring Sending of SIP 300 Multiple Choice Messages



Note If multiple routes to a destination exist for a redirected number (multiple dial peers are matched), the SIP gateway sends a 300 Multiple Choice message and the multiple routes in the Contact header are listed. This configuration allows users to choose the order in which the routes appear in the Contact header.

SUMMARY STEPS

1. **enable**
2. **configure terminal**
3. **voice service voip**
4. **sip**
5. **redirect contact order** [best-match | longest-match]
6. **exit**

DETAILED STEPS

	Command or Action	Purpose
Step 1	enable Example: <pre>Router> enable</pre>	Enters privileged EXEC mode or any other security level set by a system administrator. Enter your password if prompted.
Step 2	configure terminal Example: <pre>Router# configure terminal</pre>	Enters global configuration mode.
Step 3	voice service voip Example: <pre>Router(config)# voice service voip</pre>	Enters voice-service VoIP configuration mode.
Step 4	sip Example: <pre>Router(config-voi-serv)# sip</pre>	Enters SIP configuration mode.
Step 5	redirect contact order [best-match longest-match] Example: <pre>Router(conf-serv-sip)# redirect contact order best-match</pre>	Sets the order of contacts in the 300 Multiple Choice Message. Keywords are as follows: <ul style="list-style-type: none"> • best-match --Use the current system configuration to set the order of contacts. • longest-match --Set the contact order by using the destination pattern longest match first, and then the second longest match, the third longest match, and so on. This is the default.
Step 6	exit Example: <pre>Router(conf-serv-sip)# exit</pre>	Exits the current mode.

Configuring SIP Implementation Enhancements

Minor underlying or minimally configurable features are described in the following sections:

For additional information on SIP implementation enhancements, see “Achieving SIP RFC Compliance.”

Interaction with Forking Proxies

Call forking enables the terminating gateway to handle multiple requests and the originating gateway to handle multiple provisional responses for the same call. Call forking is required for the deployment of the *find me/follow me* type of services.

Support for call forking enables the terminating gateway to handle multiple requests and the originating gateway to handle multiple provisional responses for the same call. Interaction with forking proxies applies to gateways acting as a UAC, and takes place when a user is registered to several different locations. When the UAC sends an INVITE message to a proxy, the proxy forks the request and sends it to multiple user agents. The SIP gateway processes multiple 18X responses by treating them as independent transactions under the same call ID. When the relevant dial peers are configured for QoS, the gateway maintains state and initiates RSVP reservations for each of these independent transactions. When it receives an acknowledgment, such as a 200 OK, the gateway accepts the successful acknowledgment and destroys state for all other transactions.

The forking feature sets up RSVP for each transaction *only* if the dial peers are configured for QoS. If not, the calls proceed as best-effort.

Support for interaction with forking proxies applies only to gateways acting as UACs. It does not apply when the gateway acts as a UAS. In that case, the proxy forks multiple INVITES with the same call ID to the same gateway but with different request URLs.

Also, the forking feature sets up RSVP for each transaction *only* if the dial peers are configured for QoS. If not, the calls proceed as best-effort.

SIP Intra-Gateway Hairpinning

SIP hairpinning is a call routing capability in which an incoming call on a specific gateway is signaled through the IP network and back out the same gateway. This can be a PSTN call routed into the IP network and back out to the PSTN over the same gateway (see the figure below).

Figure 13: PSTN Hairpinning Example

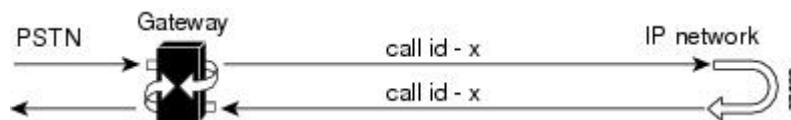

Similarly, SIP hairpinning can be a call signaled from a line (for example, a telephone line) to the IP network and back out to a line on the same access gateway (see the figure below).

Figure 14: Telephone Line Hairpinning Example

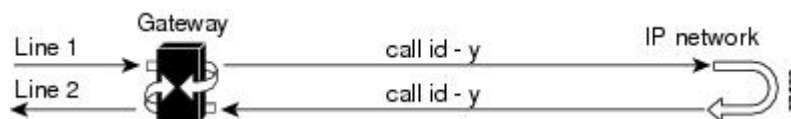

With SIP hairpinning, unique gateways for ingress and egress are unnecessary.

SIP supports plain old telephone service (POTS)-to-POTS hairpinning (which means that the call comes in one voice port and is routed out another voice port). It also supports POTS-to-IP call legs and IP-to-POTS call legs. However, it does not support IP-to-IP hairpinning. This means that the SIP gateway cannot take an inbound SIP call and reroute it back to another SIP device using the VoIP dial peers.

Only minimal configuration is required for this feature. To enable hairpinning on the SIP gateway, see the following configuration example for dial peers. Note that:

- The POTS dial peer must have preference 2 defined, and the VoIP dial peer must have preference 1 defined. This ensures that the call is sent out over IP, not Plain Old Telephone Service (POTS).
- The session target is the same gateway because the call is being redirected to it.

```
!  
dial-peer voice 53001 pots  
  preference 2  
  destination-pattern 5300001  
  prefix 5300001  
!  
dial-peer voice 53002 pots  
  preference 2  
  destination-pattern 5300002  
  prefix 5300002  
!  
dial-peer voice 530011 voip  
  preference 1  
  destination-pattern 5300001  
  session protocol sipv2  
  session target ipv4:10.1.1.41  
  playout-delay maximum 300  
  codec g711alaw  
!  
dial-peer voice 530022 voip  
  preference 1  
  destination-pattern 5300002  
  session protocol sipv2  
  session target ipv4:10.1.1.41  
  playout-delay maximum 300  
  codec g711alaw
```

Verifying SIP Gateway Status

To verify SIP gateway status and configuration, perform the following steps as appropriate (commands are listed in alphabetical order).

SUMMARY STEPS

1. `show sip service`
2. `show sip-ua register status`
3. `show sip-ua statistics`
4. `show sip-ua status`
5. `show sip-ua timers`

DETAILED STEPS

Step 1 `show sip service`

Use this command to display the status of SIP call service on a SIP gateway.

The following sample output shows that SIP call service is enabled:

Example:

```
Router# show sip service  
SIP Service is up
```

The following sample output shows that SIP call service was shut down with the **shutdown** command:

Example:

```
Router# show sip service
SIP service is shut globally
under 'voice service voip'
```

The following sample output shows that SIP call service was shut down with the **call service stop** command:

Example:

```
Router# show sip service
SIP service is shut
under 'voice service voip', 'sip' submode
```

The following sample output shows that SIP call service was shut down with the **shutdown forced** command:

Example:

```
Router# show sip service
SIP service is forced shut globally
under 'voice service voip'
```

The following sample output shows that SIP call service was shut down with the **call service stop forced** command:

Example:

```
Router# show sip service
SIP service is forced shut
under 'voice service voip', 'sip' submode
```

Step 2 show sip-ua register status

Use this command to display the status of E.164 numbers that a SIP gateway has registered with an external primary SIP registrar.

Example:

```
Router# show sip-ua register status
Line peer expires(sec) registered
4001 20001 596 no
4002 20002 596 no
5100 1 596 no
9998 2 596 no
```

Step 3 show sip-ua statistics

Use this command to display response, traffic, and retry SIP statistics, including whether call redirection is disabled.

The following sample shows that four registers were sent:

Example:

```
Router# show sip-ua statistics
SIP Response Statistics (Inbound/Outbound)
Informational:
  Trying 0/0, Ringing 0/0,
  Forwarded 0/0, Queued 0/0,
  SessionProgress 0/0
Success:
  OkInvite 0/0, OkBye 0/0,
  OkCancel 0/0, OkOptions 0/0,
  OkPrack 0/0, OkPreconditionMet 0/0,
  OkSubscribe 0/0, OkNOTIFY 0/0,
  OkInfo 0/0, 202Accepted 0/0
```

```

OkRegister 12/49
Redirection (Inbound only except for MovedTemp(Inbound/Outbound)) :
MultipleChoice 0, MovedPermanently 0,
MovedTemporarily 0/0, UseProxy 0,
AlternateService 0
Client Error:
BadRequest 0/0, Unauthorized 0/0,
PaymentRequired 0/0, Forbidden 0/0,
NotFound 0/0, MethodNotAllowed 0/0,
NotAcceptable 0/0, ProxyAuthReqd 0/0,
ReqTimeout 0/0, Conflict 0/0, Gone 0/0,
ReqEntityTooLarge 0/0, ReqURITooLarge 0/0,
UnsupportedMediaType 0/0, BadExtension 0/0,
TempNotAvailable 0/0, CallLegNonExistent 0/0,
LoopDetected 0/0, TooManyHops 0/0,
AddrIncomplete 0/0, Ambiguous 0/0,
BusyHere 0/0, RequestCancel 0/0,
NotAcceptableMedia 0/0, BadEvent 0/0,
SETooSmall 0/0
Server Error:
InternalError 0/0, NotImplemented 0/0,
BadGateway 0/0, ServiceUnavail 0/0,
GatewayTimeout 0/0, BadSipVer 0/0,
PreCondFailure 0/0
Global Failure:
BusyEverywhere 0/0, Decline 0/0,
NotExistAnywhere 0/0, NotAcceptable 0/0
Miscellaneous counters:
RedirectRspMappedToClientErr 0
SIP Total Traffic Statistics (Inbound/Outbound)
Invite 0/0, Ack 0/0, Bye 0/0,
Cancel 0/0, Options 0/0,
Prack 0/0, Comet 0/0,
Subscribe 0/0, NOTIFY 0/0,
Refer 0/0, Info 0/0
Register 49/16
Retry Statistics
Invite 0, Bye 0, Cancel 0, Response 0,
Prack 0, Comet 0, Reliable1xx 0, NOTIFY 0
Register 4
SDP application statistics:
Parses: 0, Builds 0
Invalid token order: 0, Invalid param: 0
Not SDP desc: 0, No resource: 0
Last time SIP Statistics were cleared: <never>

```

The following sample output shows the RedirectResponseMappedToClientError status message. An incremented number indicates that 3xx responses are to be treated as 4xx responses. When call redirection is enabled (default), the RedirectResponseMappedToClientError status message is not incremented.

Example:

```

Router# show sip-ua statistics
SIP Response Statistics (Inbound/Outbound)
Informational:
Trying 0/0, Ringing 0/0,
Forwarded 0/0, Queued 0/0,
SessionProgress 0/0
Success:
OkInvite 0/0, OkBye 0/0,
OkCancel 0/0, OkOptions 0/0,
OkPrack 0/0, OkPreconditionMet 0/0,
OKSubscribe 0/0, OkNotify 0/0,
202Accepted 0/0

```

```

Redirection (Inbound only):
  MultipleChoice 0, MovedPermanently 0,
  MovedTemporarily 0, UseProxy 0,
  AlternateService 0
Client Error:
  BadRequest 0/0, Unauthorized 0/0,
  PaymentRequired 0/0, Forbidden 0/0,
  NotFound 0/0, MethodNotAllowed 0/0,
  NotAcceptable 0/0, ProxyAuthReqd 0/0,
  ReqTimeout 0/0, Conflict 0/0, Gone 0/0,
  ReqEntityTooLarge 0/0, ReqURITooLarge 0/0,
  UnsupportedMediaType 0/0, BadExtension 0/0,
  TempNotAvailable 0/0, CallLegNonExistent 0/0,
  LoopDetected 0/0, TooManyHops 0/0,
  AddrIncomplete 0/0, Ambiguous 0/0,
  BusyHere 0/0, RequestCancel 0/0
  NotAcceptableMedia 0/0, BadEvent 0/0
Server Error:
  InternalError 0/0, NotImplemented 0/0,
  BadGateway 0/0, ServiceUnavail 0/0,
  GatewayTimeout 0/0, BadSipVer 0/0,
  PreCondFailure 0/0
Global Failure:
  BusyEverywhere 0/0, Decline 0/0,
  NotExistAnywhere 0/0, NotAcceptable 0/0
Miscellaneous counters:
  RedirectResponseMappedToClientError 1
SIP Total Traffic Statistics (Inbound/Outbound)
  Invite 0/0, Ack 0/0, Bye 0/0,
  Cancel 0/0, Options 0/0,
  Prack 0/0, Comet 0/0,
  Subscribe 0/0, Notify 0/0,
  Refer 0/0
Retry Statistics
  Invite 0, Bye 0, Cancel 0, Response 0,
  Prack 0, Comet 0, Reliable1xx 0, Notify 0
SDP application statistics:
  Parses: 0, Builds 0
  Invalid token order: 0, Invalid param: 0
  Not SDP desc: 0, No resource: 0

```

Step 4 **show sip-ua status**

Use this command to display status for the SIP user agent (UA), including whether call redirection is enabled or disabled.

Example:

```

Router# show sip-ua status
SIP User Agent Status
SIP User Agent for UDP : ENABLED
SIP User Agent for TCP : ENABLED
SIP User Agent bind status(signaling): DISABLED
SIP User Agent bind status(media): DISABLED
SIP max-forwards : 6
SIP DNS SRV version: 1 (rfc 2052)
Redirection (3xx) message handling: ENABLED

```

Step 5 **show sip-ua timers**

Use this command to display the current settings for the SIP user-agent (UA) timers.

The following sample output shows the waiting time before a register request is sent--that is, the value that is set with the **timers register** command:

Example:

```
Router# show sip-ua timers
SIP UA Timer Values (milliseconds)
trying 500, expires 180000, connect 500, disconnect 500
comet 500, prack 500, rellxx 500, notify 500
refer 500, register 500
```

General Troubleshooting Tips

For more information on troubleshooting, see the following references:

- "Cisco IOS Voice Troubleshooting and Monitoring Guide"
- Cisco Technical Support at <http://www.cisco.com/en/US/support/index.html>
- *Cisco IOS Debug Command Reference*
- *Cisco IOS Voice, Video, and Fax Configuration Guide*
- [Troubleshooting and Debugging VoIP Call Basics](#)
- [VoIP Debug Commands](#)



Note Commands are listed in alphabetical order.

- Make sure that VoIP is working.
- Make sure that you can make a voice call.
- Verify that SIP-supported codecs are used. Support for codecs varies on different platforms; use the **codec ?** command to determine the codecs available on a specific platform.
- Use the **debug aaa authentication** command to display high-level diagnostics related to AAA logins.
- Use the **debug asnl events** command to verify that the SIP subscription server is up. The output displays a pending message if, for example, the client is unsuccessful in communicating with the server.
- Use the debug call fallback family of commands to display details of VoIP call fallback.
- Use the **debug cch323** family of commands to provide debugging output for various components within an H.323 subsystem.
- Use the **debug ccsip** family of commands for general SIP debugging, including viewing direction-attribute settings and port and network address-translation traces. Use any of the following related commands:
 - **debug ccsip all**--Enables all SIP-related debugging
 - **debug ccsip calls**--Enables tracing of all SIP service-provider interface (SPI) calls
 - **debug ccsip error**--Enables tracing of SIP SPI errors.
 - **debug ccsip events**--Enables tracing of all SIP SPI events
 - **debug ccsip info**--Enables tracing of general SIP SPI information, including verification that call redirection is disabled

- **debug ccsip media**--Enables tracing of SIP media streams
 - **debug ccsip messages**--Enables all SIP SPI message tracing, such as those that are exchanged between the SIP user-agent client (UAC) and the access server
 - **debug ccsip preauth**--Enables diagnostic reporting of authentication, authorization, and accounting (AAA) preauthentication for SIP calls
 - **debug ccsip states**--Enables tracing of all SIP SPI state tracing
 - **debug ccsip transport**--Enables tracing of the SIP transport handler and the TCP or User Datagram Protocol (UDP) process
- Use the **debug isdn q931** command to display information about call setup and teardown of ISDN network connections (layer 3) between the local router (user side) and the network.
 - Use the **debug kpml** command to enable debug tracing of KeyPad Markup Language (KPML) parser and builder errors.
 - Use the **debug radius** command to enable debug tracing of RADIUS attributes.
 - Use the **debug rpms-proc preauth** command to enable debug tracing on the RPMS process for H.323 calls, SIP calls, or both H.323 and SIP calls.
 - Use the **debug rtr trace** command to trace the execution of an SAA operation.
 - Use the **debug voip** family of commands, including the following:
 - **debug voip ccapi protoheaders** --Displays messages sent between the originating and terminating gateways. If no headers are being received by the terminating gateway, verify that the **header-passing** command is enabled on the originating gateway.
 - **debug voip ivr script**--Displays any errors that might occur when the Tcl script is run
 - **debug voip rtp session named-event 101** --Displays information important to DTMF-relay debugging, if you are using codec types g726r16 or g726r24. Be sure to append the argument *101* to the command to prevent the console screen from flooding with messages and all calls from failing.

Sample output for some of these commands follows:

Sample Output for the debug ccsip events Command

- The example shows how the Proxy-Authorization header is broken down into a decoded username and password.

```
Router# debug ccsip events
CCSIP SPI: SIP Call Events tracing is enabled
21:03:21: sippmh_parse_proxy_auth: Challenge is 'Basic'.
21:03:21: sippmh_parse_proxy_auth: Base64 user-pass string is 'MTIzNDU2Nzg5MDEyMzQ1Njou'.
21:03:21: sip_process_proxy_auth: Decoded user-pass string is '1234567890123456:.'.
21:03:21: sip_process_proxy_auth: Username is '1234567890123456'.
21:03:21: sip_process_proxy_auth: Pass is '.'.
21:03:21: sipSPIAddBillingInfoToCcb: sipCallId for billing records =
10872472-173611CC-81E9C73D-F836C2B6@172.18.192.19421:03:21: ****Adding to UAS Request table
```

Sample Output for the debug ccsip info Command

This example shows only the portion of the debug output that shows that call redirection is disabled. When call redirection is enabled (default), there are no debug line changes.

```
Router# debug ccsip info
```

```
00:20:32: HandleUdpSocketReads :Msg enqueued for SPI with IPAddr: 172.18.207.10
:5060
00:20:32: CCSIP-SPI-CONTROL: act_sentinvite_new_message
00:20:32: CCSIP-SPI-CONTROL: sipSPICheckResponse
00:20:32: sip_stats_status_code
00:20:32: ccsip_get_code_class: !!Call Redirection feature is disabled on the GW
00:20:32: ccsip_map_call_redirect_responses: !!Mapping 302 response to 480
00:20:32: Roundtrip delay 4 milliseconds for method INVITE
```

Configuration Examples for Basic SIP Configuration

SIP Register Support Example

```
Current configuration : 3394 bytes
!
version 12.2
service timestamps debug uptime
service timestamps log uptime
no service password-encryption
service internal
!
memory-size iomem 15
ip subnet-zero
!
no ip domain lookup
!
voice service voip
  redirect ip2ip
sip
  redirect contact order best-match
ip dhcp pool vespa
  network 192.168.0.0 255.255.255.0
  option 150 ip 192.168.0.1
  default-router 192.168.0.1
!
voice call carrier capacity active
!
voice class codec 1
  codec preference 2 g711ulaw
!
no voice hpi capture buffer
no voice hpi capture destination
!
fax interface-type fax-mail
mta receive maximum-recipients 0
!
interface Ethernet0/0
  ip address 10.8.17.22 255.255.0.0
  half-duplex
!
interface FastEthernet0/0
  ip address 192.168.0.1 255.255.255.0
  speed auto
  no cdp enable
  h323-gateway voip interface
  h323-gateway voip id vespa2 ipaddr 10.8.15.4 1718
!
router rip
  network 10.0.0.0
```

```
network 192.168.0.0
!
ip default-gateway 10.8.0.1
ip classless
ip route 0.0.0.0 0.0.0.0 10.8.0.1
no ip http server
ip pim bidir-enable
!
tftp-server flash:SEPDEFAULT.cnf
tftp-server flash:P005B302.bin
call fallback active
!
call application global default.new
call rsvp-sync
!
voice-port 1/0
!
voice-port 1/1
!
mgcp profile default
!
dial-peer voice 1 pots
destination-pattern 5100
port 1/0
!
dial-peer voice 2 pots
destination-pattern 9998
port 1/1
!
dial-peer voice 123 voip
destination-pattern [12]...
session protocol sipv2
session target ipv4:10.8.17.42
dtmf-relay sip-notify
!
gateway
!
sip-ua
retry invite 3
retry register 3
timers register 150
registrar dns:myhost3.example.com expires 3600
registrar ipv4:10.8.17.40 expires 3600 secondary
!
telephony-service
max-dn 10
max-conferences 4
!
ephone-dn 1
number 4001
!
ephone-dn 2
number 4002
!
line con 0
exec-timeout 0 0
line aux 0
line vty 0 4
login
line vty 5 15
login
!
no scheduler allocate
end
```

SIP Redirect Processing Enhancement Examples

This section provides configuration examples to match the identified configuration tasks in the previous sections.



Note IP addresses and hostnames in examples are fictitious.

Call Redirection Disabled

This example shows that call redirection is disabled on the gateway.

```
Router# show running-config
Building configuration...
Current configuration : 2791 bytes
!
version 12.2
service config
no service single-slot-reload-enable
no service pad
service timestamps debug uptime
service timestamps log uptime
no service password-encryption
service internal
service udp-small-servers
!
interface FastEthernet2/0
ip address 172.18.200.24 255.255.255.0
duplex auto
no shut
speed 10
ip rsvp bandwidth 7500 7500
!
voice-port 1/1/1
no supervisory disconnect lcfo
!
dial-peer voice 1 pots
application session
destination-pattern 8183821111
port 1/1/1
!
dial-peer voice 3 voip
application session
destination-pattern 7173721111
session protocol sipv2
session target ipv4:172.18.200.36
codec g711ulaw
!
dial-peer voice 4 voip
application session
destination-pattern 6163621111
session protocol sipv2
session target ipv4:172.18.200.33
codec g711ulaw
!
gateway
!
sip-ua
no redirection
```

```

        retry invite 1
        retry bye 1
    !
    line con 0
    line aux 0
    line vty 0 4
    login
    !
end

```

Call Redirection Enabled

This example shows that call redirection is enabled on the gateway (the default). When call redirection is enabled, the output shows no redirection.

```

Router# show running-config
Building configuration...
Current configuration : 2791 bytes
!
version 12.2
service config
no service single-slot-reload-enable
no service pad
service timestamps debug uptime
service timestamps log uptime
no service password-encryption
service internal
service udp-small-servers
!
interface FastEthernet2/0
ip address 172.18.200.24 255.255.255.0
duplex auto
no shut
speed 10
ip rsvp bandwidth 7500 7500
!
voice-port 1/1/1
no supervisory disconnect lcfo
!
dial-peer voice 1 pots
application session
destination-pattern 8183821111
port 1/1/1
!
dial-peer voice 3 voip
application session
destination-pattern 7173721111
session protocol sipv2
session target ipv4:172.18.200.36
codec g711ulaw
!
dial-peer voice 4 voip
application session
destination-pattern 6163621111
session protocol sipv2
session target ipv4:172.18.200.33
codec g711ulaw
!
gateway
!
sip-ua
    retry invite 1
    retry bye 1

```

```

!
line con 0
line aux 0
line vty 0 4
login
!
end

```

Call Redirection Using IP-to-IP Redirection

This example shows that redirection was set globally on the router.

```

Current configuration : 3394 bytes
!
version 12.2
service timestamps debug uptime
service timestamps log uptime
no service password-encryption
service internal
!
memory-size iomem 15
ip subnet-zero
!
no ip domain lookup
!
voice service voip
  redirect ip2ip
sip
  redirect contact order best-match
ip dhcp pool vespa
  network 192.168.0.0 255.255.255.0
  option 150 ip 192.168.0.1
  default-router 192.168.0.1
!
voice call carrier capacity active
!
voice class codec 1
  codec preference 2 g711ulaw
!
!
no voice hpi capture buffer
no voice hpi capture destination
!
fax interface-type fax-mail
mta receive maximum-recipients 0
!
interface Ethernet0/0
  ip address 10.8.17.22 255.255.0.0
  half-duplex
!
interface FastEthernet0/0
  ip address 192.168.0.1 255.255.255.0
  speed auto
  no cdp enable
  h323-gateway voip interface
  h323-gateway voip id vespa2 ipaddr 10.8.15.4 1718
!
router rip
  network 10.0.0.0
  network 192.168.0.0
!
ip default-gateway 10.8.0.1
ip classless

```

```
ip route 0.0.0.0 0.0.0.0 10.8.0.1
no ip http server
ip pim bidir-enable
!
tftp-server flash:SEPDEFAULT.cnf
tftp-server flash:P005B302.bin
call fallback active
!
!
call application global default.new
call rsvp-sync
!
voice-port 1/0
!
voice-port 1/1
!
mgcp profile default
!
dial-peer voice 1 pots
 destination-pattern 5100
 port 1/0
!
dial-peer voice 2 pots
 destination-pattern 9998
 port 1/1
!
dial-peer voice 123 voip
 destination-pattern [12]...
 session protocol sipv2
 session target ipv4:10.8.17.42
 dtmf-relay sip-notify
!
gateway
!
sip-ua
 retry invite 3
 retry register 3
 timers register 150
 registrar dns:myhost3.example.com expires 3600
 registrar ipv4:10.8.17.40 expires 3600 secondary
!
!
telephony-service
 max-dn 10
 max-conferences 4
!
ephone-dn 1
 number 4001
!
ephone-dn 2
 number 4002
!
line con 0
 exec-timeout 0 0
line aux 0
line vty 0 4
 login
line vty 5 15
 login
!
no scheduler allocate
end
```

SIP 300 Multiple Choice Messages Example

This section provides a configuration example showing redirect contact order set to best match.

```
Current configuration : 3394 bytes
!
version 12.2
service timestamps debug uptime
service timestamps log uptime
no service password-encryption
service internal
!
memory-size iomem 15
ip subnet-zero
!
no ip domain lookup
!
voice service voip
  redirect ip2ip
sip
  redirect contact order best-match
ip dhcp pool vespa
  network 192.168.0.0 255.255.255.0
  option 150 ip 192.168.0.1
  default-router 192.168.0.1
!
voice call carrier capacity active
!
voice class codec 1
  codec preference 2 g711ulaw
!
no voice hpi capture buffer
no voice hpi capture destination
!
fax interface-type fax-mail
mta receive maximum-recipients 0
!
interface Ethernet0/0
  ip address 10.8.17.22 255.255.0.0
  half-duplex
!
interface FastEthernet0/0
  ip address 192.168.0.1 255.255.255.0
  speed auto
  no cdp enable
  h323-gateway voip interface
  h323-gateway voip id vespa2 ipaddr 10.8.15.4 1718
!
router rip
  network 10.0.0.0
  network 192.168.0.0
!
ip default-gateway 10.8.0.1
ip classless
ip route 0.0.0.0 0.0.0.0 10.8.0.1
no ip http server
ip pim bidir-enable
!
tftp-server flash:SEPDEFAULT.cnf
tftp-server flash:P005B302.bin
call fallback active
!
call application global default.new
```

```

call rsvp-sync
!
voice-port 1/0
!
voice-port 1/1
!
mgcp profile default
!
dial-peer voice 1 pots
 destination-pattern 5100
 port 1/0
!
dial-peer voice 2 pots
 destination-pattern 9998
 port 1/1
!
dial-peer voice 123 voip
 destination-pattern [12]...
 session protocol sipv2
 session target ipv4:10.8.17.42
 dtmf-relay sip-notify
!
gateway
!
sip-ua
 retry invite 3
 retry register 3
 timers register 150
 registrar dns:myhost3.example.com expires 3600
 registrar ipv4:10.8.17.40 expires 3600 secondary
!
telephony-service
 max-dn 10
 max-conferences 4
!
ephone-dn 1
 number 4001
!
ephone-dn 2
 number 4002
!
line con 0
 exec-timeout 0 0
line aux 0
line vty 0 4
 login
line vty 5 15
 login
!
no scheduler allocate
end

```

Toll Fraud Prevention

When a Cisco router platform is installed with a voice-capable Cisco IOS software image, appropriate features must be enabled on the platform to prevent potential toll fraud exploitation by unauthorized users. Deploy these features on all Cisco router Unified Communications applications that process voice calls, such as Cisco Unified Communications Manager Express (Cisco Unified CME), Cisco Survivable Remote Site Telephony (SRST), Cisco Unified Border Element (Cisco UBE), Cisco IOS-based router and standalone analog and

digital PBX and public-switched telephone network (PSTN) gateways, and Cisco contact-center VoiceXML gateways. These features include, but are not limited to, the following:

- **Disable secondary dial tone on voice ports**--By default, secondary dial tone is presented on voice ports on Cisco router gateways. Use private line automatic ringdown (PLAR) for foreign exchange office (FXO) ports and direct-inward-dial (DID) for T1/E1 ports to prevent secondary dial tone from being presented to inbound callers.
- **Cisco router access control lists (ACLs)**--Define ACLs to allow only explicitly valid sources of calls to the router or gateway, and therefore to prevent unauthorized SIP or H.323 calls from unknown parties to be processed and connected by the router or gateway.
- **Close unused SIP and H.323 ports**--If either the SIP or H.323 protocol is not used in your deployment, close the associated protocol ports. If a Cisco voice gateway has dial peers configured to route calls outbound to the PSTN using either time division multiplexing (TDM) trunks or IP, close the unused H.323 or SIP ports so that calls from unauthorized endpoints cannot connect calls. If the protocols are used and the ports must remain open, use ACLs to limit access to legitimate sources.
- **Change SIP port 5060**--If SIP is actively used, consider changing the port to something other than well-known port 5060.
- **SIP registration**--If SIP registration is available on SIP trunks, turn on this feature because it provides an extra level of authentication and validation that only legitimate sources can connect calls. If it is not available, ensure that the appropriate ACLs are in place.
- **SIP Digest Authentication**--If the SIP Digest Authentication feature is available for either registrations or invites, turn this feature on because it provides an extra level of authentication and validation that only legitimate sources can connect calls.
- **Explicit incoming and outgoing dial peers**--Use explicit dial peers to control the types and parameters of calls allowed by the router, especially in IP-to-IP connections on Cisco Unified CME, SRST, and Cisco UBE. Incoming dial peers offer additional control on the sources of calls, and outgoing dial peers on the destinations. Incoming dial peers are always used for calls. If a dial peer is not explicitly defined, the implicit dial peer 0 is used to allow all calls.
- **Explicit destination patterns**--Use dial peers with more granularity than .T for destination patterns to block disallowed off-net call destinations. Use class of restriction (COR) on dial peers with specific destination patterns to allow even more granular control of calls to different destinations on the PSTN.
- **Translation rules**--Use translation rules to manipulate dialed digits before calls connect to the PSTN to provide better control over who may dial PSTN destinations. Legitimate users dial an access code and an augmented number for PSTN for certain PSTN (for example, international) locations.
- **Tcl and VoiceXML scripts**--Attach a Tcl/VoiceXML script to dial peers to do database lookups or additional off-router authorization checks to allow or deny call flows based on origination or destination numbers. Tcl/VoiceXML scripts can also be used to add a prefix to inbound DID calls. If the prefix plus DID matches internal extensions, then the call is completed. Otherwise, a prompt can be played to the caller that an invalid number has been dialed.
- **Host name validation**--Use the “permit hostname” feature to validate initial SIP Invites that contain a fully qualified domain name (FQDN) host name in the Request Uniform Resource Identifier (Request URI) against a configured list of legitimate source hostnames.
- **Dynamic Domain Name Service (DNS)**--If you are using DNS as the “session target” on dial peers, the actual IP address destination of call connections can vary from one call to the next. Use voice source

groups and ACLs to restrict the valid address ranges expected in DNS responses (which are used subsequently for call setup destinations).

For more configuration guidance, see the “[Cisco IOS Unified Communications Manager Express Toll Fraud Prevention](#)” paper.



CHAPTER 11

SIP Binding

The SIP Binding feature enables you to configure a source IP address for signaling packets and media packets.

- [Feature Information for SIP Binding, on page 111](#)
- [Information About SIP Binding, on page 112](#)
- [Configuring SIP Binding, on page 118](#)
- [Verifying SIP Binding, on page 120](#)

Feature Information for SIP Binding

The following table provides release information about the feature or features described in this module. This table lists only the software release that introduced support for a given feature in a given software release train. Unless noted otherwise, subsequent releases of that software release train also support that feature.

Use Cisco Feature Navigator to find information about platform support and Cisco software image support. To access Cisco Feature Navigator, go to <https://cfnng.cisco.com/>. An account on Cisco.com is not required.

Table 22: Feature Information for SIP Binding

Feature Name	Releases	Feature Information
SIP Gateway Support for the bind Command	Cisco IOS 12.2(2)XB, 12.2(2)XB2, 12.2(8)T, 12.2(11)T, and 12.3(4)T Cisco IOS XE 3.1.0S	The SIP Gateway Support for the bind Command feature allows you to configure the source IP address of signaling packets and media packets. In 12.2(2)XB, this feature was introduced. In 12.3(4)T, this feature was expanded to provide the flexibility to specify different source interfaces for signaling and media, and allow network administrators a finer granularity of control on the network interfaces used for voice traffic. The following commands were introduced or modified: bind , show dial-peer voice , show ip sockets , show sip-ua connections , and show sip-ua status .

Feature Name	Releases	Feature Information
Support for Ability to Configure Source IP Address for Signaling and Media per SIP Trunk	15.1(2)T	This feature allows you to configure a separate source IP address per SIP trunk. This source IP address is embedded in all SIP signaling and media packets that traverse the SIP trunk. This feature enables service providers for better profiling and billing policies. It also enables greater security for enterprises by the use of distinct IP addresses within and outside the enterprise domain. The following command was introduced or modified: voice-class sip bind.
Support of Live Binding at dial-peers.	Cisco IOS XE Amsterdam 17.3.1a	This feature allows you to either change or add binding on a dial-peer that does not have any active calls, while other dial-peers with the same binding has active calls. The following command was introduced or modified: voice-class sip bind all.

Information About SIP Binding

When you configure SIP on a router, the ports on all its interfaces are open by default. This makes the router vulnerable to malicious attackers who can execute toll fraud across the gateway if the router has a public IP address and a public switched telephone network (PSTN) connection. To eliminate the threat, you should bind an interface to an IP address so that only those ports are open to the outside world. In addition, you should protect any public or untrusted interface by configuring a firewall or an access control list (ACL) to prevent unwanted traffic from traversing the router.



Note All CUBE Enterprise deployments must have signaling and media bind statements specified at the dial-peer or voice class tenant level. For voice call tenants, you must apply tenants to dial-peers used for CUBE call flows if these dial-peers do not have bind statements specified.

Benefits of SIP Binding

- SIP signaling and media paths can advertise the same source IP address on the gateway for certain applications, even if the paths used different addresses to reach the source. This eliminates confusion for firewall applications that may have taken action on source address packets before the use of binding.
- Firewalls filter messages based on variables such as the message source, the target address, and available ports. Normally a firewall opens only certain addresses or port combination to the outside world and those addresses can change dynamically. Because VoIP technology requires the use of more than one address or port combination, the **bind** command adds flexibility by assigning a gateway to a specific interface (and therefore the associated address) for the signaling or media application.
- You can obtain a predefined and separate interface for both signaling and media traffic. After a **bind** command is in effect, the interface it limits is bound solely to that purpose. Administrators can therefore

dictate the use of one network to transport the signaling and another network to transport the media. The benefits of administrator control are:

- Administrators know the traffic that runs on specific networks, thereby making debugging easier.
 - Administrators know the capacity of the network and the target traffic, thereby making engineering and planning easier.
 - Traffic is controlled, allowing Quality of Service (QoS) to be monitored.
- The **bind media** command relaxes the constraints imposed by the **bind control** and **bind all** commands, which cannot be set during an active call. The **bind media** command works with active calls.

Source Address

In early releases of Cisco IOS software with SIP functionality, the source address of a packet going out of the gateway was never deterministic. That is, the session protocols and VoIP layers always depended on the IP layer to give the *best local address*. The best local address was then used as the source address (the address showing where the SIP request came from) for signaling and media packets. Using this non-deterministic address occasionally caused confusion for firewall applications, because a firewall could not be configured with an exact address and would take action on several different source address packets.

However, the **bind** command enables you to configure the source IP address of signaling and media packets to a specific interface's IP address. Thus, the address that goes out on the packet is bound to the IP address of the interface specified with the **bind** command. Packets that are not destined to the bound address are discarded.

When you do not want to specify a bind address or if the interface is down, the IP layer still provides the best local address.

The Support Ability to Configure Source IP Address for Signaling and Media per SIP Trunk feature extends the global bind functionality to support the SIP signaling Transport Layer Socket (TLS) with UDP and TCP. The source address at the dial peer is the source address in all the signaling and media packets between the gateway and the remote SIP entity for calls using the dial-peer. Multiple SIP listen sockets with specific source address handle the incoming SIP traffic from each selected SIP entity. The order of preference for retrieving the SIP signalling and media source address for inbound and outbound calls is as follows:

- Bind configuration at dial peer level
- Bind configuration at global level
- Best local IP address to reach the destination

The table below describes the state of the system when the **bind** command is applied in the global or dial peer level:

Table 23: State of the System for the bind Address

Bind State	System Status
No global bind	The best local address is used in all outbound SIP messages. Only one SIP listen socket with a wildcard source address.
Global bind	Global bind address used in all outbound SIP messages. Only one SIP listen socket with global bind address.

Bind State	System Status
No global bind Dial peer bind	Dial peer bind address is used in outbound SIP messages of this dial peer. The remaining SIP messages use the best local address. One SIP listen socket with a wildcard source address. Additional SIP listen socket for each different dial peer bind listening on the specific dial peer bind address.
Global bind Dial peer bind	Dial peer bind address is used in outbound SIP messages of this dial peer. The remaining SIP messages use the global bind address. One SIP listen socket with global bind address. Additional SIP listen socket for each different dial peer bind command listening on the specific dial peer bind address.

The **bind** command performs different functions based on the state of the interface (see the table below).

Table 24: State of the Interface for the bind Command

Interface State	Result Using Bind Command
Shut down With or without active calls	TCP, TLS, and User Datagram Protocol (UDP) socket listeners are initially closed. (Socket listeners receive datagrams addressed to the socket.) Then the sockets are opened to listen to any IP address. If the outgoing gateway has the bind command enabled and has an active call, the call becomes a one-way call with media flowing from the outgoing gateway to the terminating gateway. The dial peer bind socket listeners of the interface are closed and the configuration turns inactive for all subsequent SIP messages.
No shut down No active calls	TCP, TLS, and UDP socket listeners are initially closed. (Socket listeners receive datagrams addressed to the socket.) Then the sockets are opened and bound to the IP address set by the bind command. The sockets accept packets destined for the bound address only. The dial peer bind socket listeners of the interface are reopened and the configuration turns active for all subsequent SIP messages.
No shut down Active calls	TCP, TLS, and UDP socket listeners are initially closed. Then the sockets are opened to listen to any IP address. The dial peer bind socket listeners of the interface are reopened and the configuration turns active for all subsequent SIP messages.

Interface State	Result Using Bind Command
Bound-interface IP address is removed.	<p>TCP, TLS, and UDP socket listeners are initially closed.</p> <p>Then the sockets are opened to listen to any address, because the IP address has been removed. This happens even when SIP was never bound to an IP address.</p> <p>A message stating that the IP address has been deleted from the SIP bound interface is printed.</p> <p>If the outgoing gateway has the bind command enabled and has an active call, the call becomes a one-way call with media flowing from the outgoing gateway to the terminating gateway.</p> <p>The dial peer bind socket listeners of the interface are closed and the configuration turns inactive for all subsequent SIP messages.</p>
The physical cable is pulled on the bound port or the interface layer is down.	<p>TCP, TLS, and UDP socket listeners are initially closed.</p> <p>Then the sockets are opened and bound to listen to any address.</p> <p>When the pulled cable is replaced, the result is as documented for no shutdown interfaces.</p> <p>The dial peer bind socket listeners of the interface are closed and the configuration turns inactive for all subsequent SIP messages.</p>
A bind interface is shut down or its IP address is changed or the physical cable is pulled while SIP calls are active.	<p>The call becomes a one-way call with media flowing in only one direction. It flows from the gateway where the change or shutdown took place, to the gateway where no change occurred. Thus, the gateway with the status change no longer receives media.</p> <p>The call is then disconnected, but the disconnected message is not understood by the gateway with the status change, and the call is still assumed to be active.</p> <p>If the bind interface is shutdown, the dial peer bind socket listeners of the interface are closed. If the IP address of the interface is changed, the socket listeners representing the bind command is opened with the available IP address of the interface and the configuration turns active for all subsequent SIP messages.</p>



Note If there are active calls, the **bind** command does not take effect if it is issued for the first time or if another **bind** command is in effect. A message reminds you that there are active calls and that the change cannot take effect.

The **bind** command applied at the dial peer level can be modified only in the following situations:

- Dial peer bind can be modified when the dial-peer do not have any active calls.
- Dial peer bind is disabled in the supported IOS configuration options.
- Dial peer bind is removed when the bound interface is removed.
- Dial peer bind is removed when the dial peer is removed.

Voice Media Stream Processing

The SIP Gateway Support Enhancements to the **bind** Command feature extends the capabilities of the **bind** command by supporting a deterministic network interface for the voice media stream. Before the voice media stream addition, the **bind** command supported a deterministic network interface for control (signaling) traffic or all traffic. With the SIP Gateway Support Enhancements to the **bind** Command feature, a finer granularity of control is achieved on the network interfaces used for voice traffic.

If multiple **bind** commands are issued in sequence—that is, if one **bind** command is configured and then another **bind** command is configured—a set interaction happens between the commands. The table below describes the expected command behavior.

Table 25: Interaction Between Previously Set and New bind Commands

Interface State	bind Command	Result Using bind Command
Without active calls	bind all	Generated bind control and bind media commands to override existing bind control and bind media commands.
	bind control	Overrides existing bind control command.
	bind media	Overrides existing bind media command.
With active calls	bind all or bind control or bind media	Global Configuration: Blocks the command, and the following error message appears: <ul style="list-style-type: none"> • Error: You cannot change the interface binding for a dial-peer that is processing live traffic.
	bind all or bind control or bind media	Dial-peer Configuration: You cannot apply bind or no bind command to a dial-peer that is processing active calls. Blocks the command, and the following error message appears: <ul style="list-style-type: none"> • Error: You cannot change the interface binding for a dial-peer that is processing live traffic.

Consider the following scenarios for attaching a tenant to a dial-peer that is processing active calls:

- You can attach a tenant to a dial-peer, when the the dial-peer has **bind** (**bind control** or **bind all**) command enabled.
- You cannot attach a tenant to a dial-peer, when the dial-peer has **no bind** or **bind media** command enabled and the tenant has **bind control** or **bind all** command enabled.

Consider the following scenarios for changing bind configuration on a tenant, when the tentant is attached to a dial-peer that is processing active calls:

- You can change the bind configuration on tenant, when the associated dial-peer has **bind** (**bind control** or **bind all**) command enabled. Because, the dial-peer bind configuration takes precedence over the tenant bind configuraiton.

- You cannot change the bind configuration on tenant, when the associated dial-peer has **no bind** or **bind media** command enabled and the tenant has **bind control** or **bind all** command enabled.

The **bind all** and **bind control** commands perform different functions based on the state of the interface.



Note The **bind all** command applies to global and dial peer. The table below applies to **bind media** only if the media interface is the same as the **bind control** interface. If the two interfaces are different, media behavior is independent of the interface state.

Table 26: bind all and bind control Functions, Based on Interface State

Interface State	Result Using bind all or bind control Commands
Shut down With or without active calls	TCP, TLS, and UDP socket listeners are initially closed. (Socket listeners receive datagrams addressed to the socket.) Then the sockets are opened to listen to any IP address. If the outgoing gateway has the bind command enabled and has an active call, the call becomes a one-way call with media flowing from the outgoing gateway to the terminating gateway. The dial peer bind socket listeners of the interface are closed and the configuration turns inactive for all subsequent SIP messages.
Not shut down Without active calls	TCP, TLS, and UDP socket listeners are initially closed. (Socket listeners receive datagrams addressed to the socket.) Then the sockets are opened and bound to the IP address set by the bind command. The sockets accept packets destined for the bound address only. The dial peer bind socket listeners of the interface are reopened and the configuration turns active for all subsequent SIP messages.
Not shut down With active calls	TCP, TLS, and UDP socket listeners are initially closed. Then the sockets are opened to listen to any IP address. The dial peer bind socket listeners of the interface are reopened and the configuration turns active for all subsequent SIP messages.

Interface State	Result Using bind all or bind control Commands
Bound interface's IP address is removed.	<p>TCP, TLS, and UDP socket listeners are initially closed.</p> <p>Then the sockets are opened to listen to any address because the IP address has been removed.</p> <p>A message is printed that states the IP address has been deleted from the bound SIP interface.</p> <p>If the outgoing gateway has the bind command enabled and has an active call, the call becomes a one-way call with media flowing from the outgoing gateway to the terminating gateway.</p> <p>The dial peer bind socket listeners of the interface are closed and the configuration turns inactive for all subsequent SIP messages.</p>
The physical cable is pulled on the bound port, or the interface layer goes down.	<p>TCP, TLS, and UDP socket listeners are initially closed.</p> <p>Then the sockets are opened and bound to listen to any address.</p> <p>When the pulled cable is replaced, the result is as documented for interfaces that are not shut down.</p> <p>The dial peer bind socket listeners of the interface are closed and the configuration turns inactive for all subsequent SIP messages.</p>
A bind interface is shut down, or its IP address is changed, or the physical cable is pulled while SIP calls are active.	<p>The call becomes a one-way call with media flowing in only one direction. The media flows from the gateway where the change or shutdown took place to the gateway where no change occurred. Thus, the gateway with the status change no longer receives media.</p> <p>The call is then disconnected, but the disconnected message is not understood by the gateway with the status change, and the call is still assumed to be active.</p> <p>If the bind interface is shutdown, the dial peer bind socket listeners of the interface are closed. If the IP address of the interface is changed, the socket listeners representing the bind command is opened with the available IP address of the interface and the configuration turns active for all subsequent SIP messages.</p>

Configuring SIP Binding

SUMMARY STEPS

1. **enable**
2. **configure terminal**
3. **interface** *type number*
4. **ip address** *ip-addressmask* [**secondary**]
5. **exit**
6. Use one of the following commands to configure SIP binding:
 - **bind** {**control** | **all**} **source-interface** *interface-id* [**ipv6-address** *ipv6-address*] in SIP configuration mode.

- **bind media** {**source-address ipv4** *ipv4-address* | **source-interface** *interface-id* [**ipv6-address** *ipv6-address*]} in SIP configuration mode.
- **voice-class sip bind media** {**source-address ipv4** *ipv4-address* | **source-interface** *interface-id* [**ipv6-address** *ipv6-address*]} in dial-peer configuration mode.

7. end

DETAILED STEPS

	Command or Action	Purpose
Step 1	<p>enable</p> <p>Example:</p> <pre>Router> enable</pre>	<p>Enables privileged EXEC mode.</p> <ul style="list-style-type: none"> • Enter your password if prompted.
Step 2	<p>configure terminal</p> <p>Example:</p> <pre>Router# configure terminal</pre>	<p>Enters global configuration mode.</p>
Step 3	<p>interface <i>type number</i></p> <p>Example:</p> <pre>Router(config)# interface fastethernet0/0</pre>	<p>Configures an interface type and enters the interface configuration mode.</p> <ul style="list-style-type: none"> • <i>type number</i> —Type of interface to be configured and the port, connector, or interface card number.
Step 4	<p>ip address <i>ip-addressmask</i> [secondary]</p> <p>Example:</p> <pre>Router(config-if)# ip address 192.168.200.33 255.255.255.0</pre>	<p>Configures a primary or secondary IP address for an interface.</p> <p>Note Secondary IP address on an interface with SIP binding is not supported for CUBE.</p>
Step 5	<p>exit</p> <p>Example:</p> <pre>Router(config-if)# exit</pre>	<p>Exits the current mode.</p>
Step 6	<p>Use one of the following commands to configure SIP binding:</p> <ul style="list-style-type: none"> • bind {control all} source-interface <i>interface-id</i> [ipv6-address <i>ipv6-address</i>] in SIP configuration mode. • bind media {source-address ipv4 <i>ipv4-address</i> source-interface <i>interface-id</i> [ipv6-address <i>ipv6-address</i>]} in SIP configuration mode. • voice-class sip bind media {source-address ipv4 <i>ipv4-address</i> source-interface <i>interface-id</i> [ipv6-address <i>ipv6-address</i>]} in dial-peer configuration mode. 	<p>Sets a source interface for signaling and media packets. The binding applies to the specified interfaces only. SIP must be configured globally or at a dial peer level.</p> <ul style="list-style-type: none"> • control —Binds signaling packets. • media —Binds media packets. • all —Binds signaling and media packets. • source-address—Binds media packets directly to an IP address. • ipv4 <i>ipv4-address</i>—Configures the IPv4 address.

	Command or Action	Purpose
	<p>Example: SIP binding in SIP configuration mode:</p> <pre>Device(config)# voice service voip Device(conf-voi-serv)# sip Device(conf-serv-sip)# bind control source-interface FastEthernet0/0 Device(conf-serv-sip)# exit</pre> <p>Device(config)# voice service voip Device(conf-voi-serv)# sip Device(conf-serv-sip)# bind media source-address ipv4 172.18.192.204 Device(conf-serv-sip)# exit</p> <p>Example: SIP binding in dial-peer configuration mode:</p> <pre>Device(config)# dial-peer voice 100 voip Device(config-dial-peer)# session protocol sipv2 Device(config-dial-peer)# voice-class sip bind control source-interface fastethernet0/0 Device(config-dial-peer)# exit</pre> <p>Device(config)# dial-peer voice 100 voip Device(config-dial-peer)# session protocol sipv2 Device(config-dial-peer)# voice-class sip bind media source-address ipv4 172.18.192.204 Device(config-dial-peer)# exit</p>	<ul style="list-style-type: none"> • source interface <i>interface-id</i>—Type of interface and its ID. • ipv6-address <i>ipv6-address</i>—Configures the IPv6 address. Ensure that the IPv6 address has been applied to an interface.
Step 7	end	Exits to privileged EXEC mode.

Verifying SIP Binding

SUMMARY STEPS

1. **show ip sockets**
2. **show sip-ua status**
3. **show sip-ua connections {tcp [tls] | udp} {brief | detail}**
4. **show dial-peer voice**
5. **show running-config**

DETAILED STEPS

Step 1 show ip sockets

Use this command to display IP socket information and indicate whether the bind address of the receiving gateway is set.

The following sample output indicates that the bind address of the receiving gateway is set:

Example:

```
Device# show ip sockets
```

```
Proto Remote Port Local Port In Out Stat TTY OutputIF
17 0.0.0.0 0--any-- 2517 0 0 9 0
17 --listen-- 172.18.192.204 1698 0 0 1 0
17 0.0.0.0 0 172.18.192.204 67 0 0 489 0
17 0.0.0.0 0 172.18.192.204 5060 0 0 A1 0
```

Example:

Step 2 show sip-ua status

Use this command to display SIP user-agent status and indicate whether bind is enabled.

The following sample output indicates that signaling is disabled and media on 172.18.192.204 is enabled:

Example:

```
Device# show sip-ua status
SIP User Agent Status
SIP User Agent for UDP : ENABLED
SIP User Agent for TCP : ENABLED
SIP User Agent for TLS over TCP : ENABLED
SIP User Agent bind status(signaling): DISABLED
SIP User Agent bind status(media): ENABLED 172.18.192.204
SIP early-media for 180 responses with SDP: ENABLED
SIP max-forwards : 70
SIP DNS SRV version: 2 (rfc 2782)
NAT Settings for the SIP-UA
Role in SDP: NONE
Check media source packets: DISABLED
Maximum duration for a telephone-event in NOTIFYs: 2000 ms
SIP support for ISDN SUSPEND/RESUME: ENABLED
Redirection (3xx) message handling: ENABLED
Reason Header will override Response/Request Codes: DISABLED
Out-of-dialog Refer: DISABLED
Presence support is DISABLED
protocol mode is ipv4
SDP application configuration:
  Version line (v=) required
Owner line (o=) required
Timespec line (t=) required
Media supported: audio video image
Network types supported: IN
Address types supported: IP4 IP6
Transport types supported: RTP/AVP udptl
```

Step 3 show sip-ua connections {tcp [tls] | udp} {brief | detail}

Use this command to display the connection details for the UDP transport protocol. The command output looks identical for TCP and TLS.

Example:

```
Device# show sip-ua connections udp detail

Total active connections      : 0
No. of send failures         : 0
No. of remote closures       : 0
No. of conn. failures        : 0
No. of inactive conn. ageouts : 10
```

```

-----Printing Detailed Connection Report-----
Note:
** Tuples with no matching socket entry
  - Do 'clear sip <tcp[tls]/udp> conn t ipv4:<addr>:<port>'
    to overcome this error condition
++ Tuples with mismatched address/port entry
  - Do 'clear sip <tcp[tls]/udp> conn t ipv4:<addr>:<port> id <connid>'
    to overcome this error condition
No Active Connections Found
----- SIP Transport Layer Listen Sockets -----
Conn-Id          Local-Address
=====
2                [9.42.28.29]:5060

```

Step 4 show dial-peer voice

Use this command, for each dial peer configured, to verify that the dial-peer configuration is correct. The following is sample output from this command for a VoIP dial peer:

Example:

```

Device# show dial-peer voice 101

VoiceOverIpPeer1234
  peer type = voice, system default peer = FALSE, information type = voice,
  description = '',
  tag = 1234, destination-pattern = '',
  voice reg type = 0, corresponding tag = 0,
  allow watch = FALSE
  answer-address = '', preference=0,
  CLID Restriction = None
  CLID Network Number = ''
  CLID Second Number sent
  CLID Override RDNIS = disabled,
  rtp-ssrc mux = system
  source carrier-id = '', target carrier-id = '',
  source trunk-group-label = '', target trunk-group-label = '',
  numbering Type = 'unknown'
  group = 1234, Admin state is up, Operation state is down,
  incoming called-number = '', connections/maximum = 0/unlimited,
  DTMF Relay = disabled,
  modem transport = system,
  URI classes:
    Incoming (Request) =
    Incoming (Via) =
    Incoming (To) =
    Incoming (From) =
    Destination =
  huntstop = disabled,
  in bound application associated: 'DEFAULT'
  out bound application associated: ''
  dnis-map =
  permission :both
  incoming COR list:maximum capability
  outgoing COR list:minimum requirement
  outgoing LPCOR:
  Translation profile (Incoming):
  Translation profile (Outgoing):
  incoming call blocking:
  translation-profile = ''
  disconnect-cause = 'no-service'
  advertise 0x40 capacity_update_timer 25 addrFamily 4 oldAddrFamily 4
  mailbox selection policy: none
  type = voip, session-target = ''

```



```

technology prefix:
settle-call = disabled
ip media DSCP = ef, ip media rsvp-pass DSCP = ef
ip media rsvp-fail DSCP = ef, ip signaling DSCP = af31,
ip video rsvp-none DSCP = af41, ip video rsvp-pass DSCP = af41
ip video rsvp-fail DSCP = af41,
ip defending Priority = 0, ip preemption priority = 0
ip policy locator voice:
ip policy locator video:
UDP checksum = disabled,
session-protocol = sipv2, session-transport = system,
req-qos = best-effort, acc-qos = best-effort,
req-qos video = best-effort, acc-qos video = best-effort,
req-qos audio def bandwidth = 64, req-qos audio max bandwidth = 0,
req-qos video def bandwidth = 384, req-qos video max bandwidth = 0,
RTP dynamic payload type values: NTE = 101
Cisco: NSE=100, fax=96, fax-ack=97, dtmf=121, fax-relay=122
CAS=123, TTY=119, ClearChan=125, PCM switch over u-law=0,
A-law=8, GSMAMR-NB=117 iLBC=116, AAC-ld=114, iSAC=124
lmr_tone=0, nte_tone=0
h263+=118, h264=119
G726r16 using static payload
G726r24 using static payload
RTP comfort noise payload type = 19
fax rate = voice, payload size = 20 bytes
fax protocol = system
fax-relay ecm enable
Fax Relay ans enabled
Fax Relay SG3-to-G3 Enabled (by system configuration)
fax NSF = 0xAD0051 (default)
codec = g729r8, payload size = 20 bytes,
video codec = None
voice class codec = `
voice class sip session refresh system
voice class sip rsvp-fail-policy voice post-alert mandatory keep-alive interval 30
voice class sip rsvp-fail-policy voice post-alert optional keep-alive interval 30
voice class sip rsvp-fail-policy video post-alert mandatory keep-alive interval 30
voice class sip rsvp-fail-policy video post-alert optional keep-alive interval 30
text relay = disabled
Media Setting = forking (disabled) flow-through (global)
Expect factor = 10, Icpif = 20,
Playout Mode is set to adaptive,
Initial 60 ms, Max 1000 ms
Playout-delay Minimum mode is set to default, value 40 ms
Fax nominal 300 ms
Max Redirects = 1, signaling-type = cas,
VAD = enabled, Poor QOV Trap = disabled,
Source Interface = NONE
voice class sip url = system,
voice class sip tel-config url = system,
voice class sip rellxx = system,
voice class sip anat = system,
voice class sip outbound-proxy = "system",
voice class sip associate registered-number =
    system,
voice class sip asserted-id system,
voice class sip privacy system
voice class sip e911 = system,
voice class sip history-info = system,
voice class sip reset timer expires 183 = system,
voice class sip pass-thru headers = system,
voice class sip pass-thru content unsupp = system,
voice class sip pass-thru content sdp = system,
voice class sip copy-list = system,

```

```

voice class sip g729 annexb-all = system,
voice class sip early-offer forced = system,
voice class sip negotiate cisco = system,
voice class sip block 180 = system,
voice class sip block 183 = system,
voice class sip block 181 = system,
voice class sip preloaded-route = system,
voice class sip random-contact = system,
voice class sip random-request-uri validate = system,
voice class sip call-route p-called-party-id = system,
voice class sip call-route history-info = system,
voice class sip privacy-policy send-always = system,
voice class sip privacy-policy passthru = system,
voice class sip privacy-policy strip history-info = system,
voice class sip privacy-policy strip diversion = system,
voice class sip map resp-code 181 = system,
voice class sip bind control = enabled, 9.42.28.29,
voice class sip bind media = enabled, 9.42.28.29,
voice class sip bandwidth audio = system,
voice class sip bandwidth video = system,
voice class sip encap clear-channel = system,
voice class sip error-code-override options-keepalive failure = system,
voice class sip calltype-video = false
voice class sip registration passthrough = System
voice class sip authenticate redirecting-number = system,
redirect ip2ip = disabled
local peer = false
probe disabled,
Secure RTP: system (use the global setting)
voice class perm tag = `
Time elapsed since last clearing of voice call statistics never
Connect Time = 0, Charged Units = 0,
Successful Calls = 0, Failed Calls = 0, Incomplete Calls = 0
Accepted Calls = 0, Refused Calls = 0,
Last Disconnect Cause is "",
Last Disconnect Text is "",
Last Setup Time = 0.
Last Disconnect Time = 0.

```

Note If the bind address is not configured at the dial-peer, the output of the **show dial-peer voice** command remains the same except for the values of the **voice class sip bind control** and **voice class sip bind media**, which display “system,” indicating that the bind is configured at the global level.

Step 5 show running-config

Although the bind all command is an accepted configuration, it does not appear in **show running-config** command output. Because the **bind all** command is equivalent to issuing the commands **bind control** and **bind media**, those are the commands that appear in the **show running-config** command output.

Example:

The following sample output shows that bind is enabled on router 172.18.192.204:

```

Building configuration...
Current configuration : 2791 bytes
!
version 12.2
service config
no service single-slot-reload-enable
no service pad
service timestamps debug uptime
service timestamps log uptime
no service password-encryption
service internal

```

```
service udp-small-servers
!
ip subnet-zero
ip ftp source-interface Ethernet0
!
voice service voip
  sip
    bind control source-interface FastEthernet0
  !
interface FastEthernet0
  ip address 172.18.192.204 255.255.255.0
  duplex auto
  speed auto
  fair-queue 64 256 1000
  ip rsvp bandwidth 75000 100
  !
voice-port 1/1/1
no supervisory disconnect lcfo
!
dial-peer voice 1 pots
  application session
  destination-pattern 5550111
  port 1/1/1
  !
dial-peer voice 29 voip
  application session
  destination-pattern 5550133
  session protocol sipv2
  session target ipv4:172.18.200.33
  codec g711ulaw
  !
gateway
!
line con 0
line aux 0
line vty 0 4
login
!
end
```



CHAPTER 12

Media Path

The Media Path feature allows you to configure the path taken by media after a call is established. You can configure media path in the following modes:

- Media flow-through
- Media flow-around
- Media anti-trombone
- [Feature Information for Media Path, on page 127](#)
- [Media Flow-Through, on page 128](#)
- [Media Flow-Around, on page 130](#)
- [Media Anti-Trombone, on page 131](#)

Feature Information for Media Path

The following table provides release information about the feature or features described in this module. This table lists only the software release that introduced support for a given feature in a given software release train. Unless noted otherwise, subsequent releases of that software release train also support that feature.

Use Cisco Feature Navigator to find information about platform support and Cisco software image support. To access Cisco Feature Navigator, go to <https://cfng.cisco.com/>. An account on Cisco.com is not required.

Table 27: Feature Information for Configuring Path of Media

Feature Name	Releases	Feature Information
Configuring Media Path	12.4(3), 12.4(24)T, 15.0(1)M	The Media Path feature allows you to configure the path taken by media after a call is established. The following commands were introduced by this feature: media-flow around, media flow-through, media anti-trombone.

Media Flow-Through

Media Flow-Through is a media path mode where media and signaling packets terminate and originate on CUBE. As CUBE is an active participant of the call, this mode is recommended when connected outside an enterprise (untrusted endpoints).

Figure 15: Media Flow-Through Mode

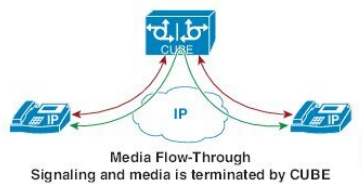

Restrictions for Media Flow-Through

- Media flow-through for Delayed-Offer to Early-Offer audio and video calls is not supported.



Note Cisco UBE supports Media-Flow Through video. However, Cisco UBE does not know the video SDP parameters that the various video end points support. Cisco UBE supports basic H264 SDP for Media-Flow Through video.

Cisco UBE supports the following video codecs:

- H261
- H263
- H263+
- H264
- MPEG-4



Note Cisco UBE supports the feature SDP pass-thru in Media-Flow Through. This feature allows Cisco UBE to support a video SDP parameter. The following example explains SDP pass-thru configuration.

```
Router#conf t
Router(config)#voice service voip
Router(config-voi-serv) sip
Router(config-voi-serv) pass-thru content sdp
```

Configure Media Flow-Through

SUMMARY STEPS

1. **enable**
2. **configure terminal**
3. Use one of the following commands to configure media flow-through:
 - **media flow-through** in dial-peer configuration mode
 - **media flow-through** in global VoIP configuration mode
4. **end**

DETAILED STEPS

	Command or Action	Purpose
Step 1	enable Example: Device> enable	Enables privileged EXEC mode. Enter your password if prompted.
Step 2	configure terminal Example: Device# configure terminal	Enters global configuration mode.
Step 3	Use one of the following commands to configure media flow-through: <ul style="list-style-type: none"> • media flow-through in dial-peer configuration mode • media flow-through in global VoIP configuration mode Example: In dial-peer configuration mode <pre>! Applying SIP profiles to one dial peer only Device (config) dial-peer voice 10 voip Device (config-dial-peer) media flow-through Device (config-dial-peer) end</pre> Example: In global VoIP SIP mode <pre>! Applying SIP profiles globally Device(config)# voice service voip Device(config-voi-serv)#media flow-through Device(config-voi-serv)#end</pre>	Enables media packets to pass through the endpoints, without the intervention of the CUBE.
Step 4	end	Exits to privileged EXEC mode.

Media Flow-Around

Media Flow-Around is a media path mode where signaling packets terminate and originate on CUBE. As media bypasses CUBE and flows directly between endpoints, this mode is recommended when connected within an enterprise (trusted endpoints). Media Flow-Around is supported for both audio and video calls.

Figure 16: Media Flow-Around

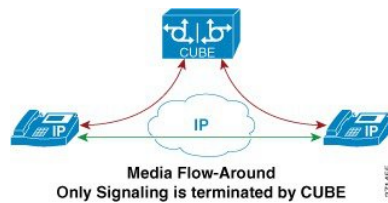

Configure Media Flow-Around

SUMMARY STEPS

1. **enable**
2. **configure terminal**
3. Use one of the following commands to configure media flow-around:
 - **media flow-around** in dial-peer configuration mode
 - **media flow-around** in global VoIP configuration mode
4. **end**

DETAILED STEPS

	Command or Action	Purpose
Step 1	enable Example: Device> enable	Enables privileged EXEC mode. Enter your password if prompted.
Step 2	configure terminal Example: Device# configure terminal	Enters global configuration mode.
Step 3	Use one of the following commands to configure media flow-around: <ul style="list-style-type: none"> • media flow-around in dial-peer configuration mode • media flow-around in global VoIP configuration mode Example:	Enables media packets to pass directly between the endpoints, without the intervention of the CUBE. The media packet is to flow around the gateway.

	Command or Action	Purpose
	<p>In dial-peer configuration mode</p> <pre>! Applying SIP profiles to one dial peer only Device (config)# dial-peer voice 10 voip Device (config-dial-peer)# media flow-around Device (config-dial-peer)# end</pre> <p>Example:</p> <p>In global VoIP SIP mode</p> <pre>! Applying SIP profiles globally Device (config)# voice service voip Device (config-voi-serv)#media flow-around Device (config-voi-serv)#end</pre>	
Step 4	end	Exits to privileged EXEC mode.

Media Anti-Trombone

Media Anti-Tromboning is a media path mode that allows CUBE to detect and avoid loops created by call transfers or call forwards. Loops are restricted to the SIP signaling path and removed from the RTP media path.

The user agent may initiate call forwards and call transfers that are sent towards CUBE as a new SIP INVITE dialog. CUBE considers the original call and the forwarded call as separate unrelated calls. Media anti-tromboning allows CUBE to detect the relation between the calls and resolve the media loop by sending SDP packets back to the sender.

The figure below illustrates how CUBE needlessly loops RTP packets towards the User Agent because it fails to detect the loop.

Figure 17: Tromboning - Needless looping of Media Packets

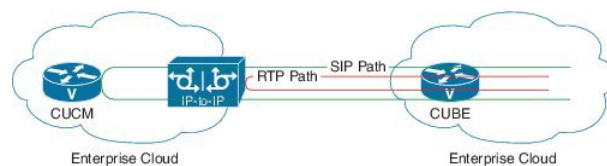

The figure below illustrates how CUBE detects and avoids the loop with the anti-tromboning feature.

Figure 18: Anti-Tromboning - Avoiding Media Loops



Prerequisites

Cisco Unified Border Element

- Cisco IOS Release 15.1(3)T or a later release must be installed and running on your Cisco Unified Border Element.

Cisco Unified Border Element (Enterprise)

- Cisco IOS XE Release 15.1(3)T or a later release must be installed and running on your Cisco ASR 1000 Series Router.

Restrictions for Media Anti-Tromboning

- When Media Anti-Tromboning media path mode is activated, CUBE does not perform supplementary services such as handling REFER-based call transfers or media services such as Secure Real-Time Transport Protocol (SRTP) and SNR.
- Anti-Tromboning does not work if one call leg is media flow-through and the other call leg is Media Flow-Around. Similarly, anti-tromboning does not work if one call leg is Session Description Protocol (SDP) passthrough and another call leg is SDP normal.
- H.323 is not supported.

Configuring Media Anti-Tromboning

Before you begin

Configure **mode border-element** command under **voice service voip**, global VoIP configuration mode.

SUMMARY STEPS

1. **enable**
2. **configure terminal**
3. Enter one of the following commands to configure media anti-tromboning:
 - **media anti-trombone** in dial-peer configuration mode
 - **media anti-trombone** in global VoIP configuration mode
4. **end**

DETAILED STEPS

	Command or Action	Purpose
Step 1	enable Example: Device> enable	Enables privileged EXEC mode. Enter your password if prompted.

	Command or Action	Purpose
Step 2	configure terminal Example: <pre>Device# configure terminal</pre>	Enters global configuration mode.
Step 3	Enter one of the following commands to configure media anti-tromboning: <ul style="list-style-type: none"> • media anti-trombone in dial-peer configuration mode • media anti-trombone in global VoIP configuration mode Example: In dial-peer configuration mode <pre>! Applying SIP profiles to one dial peer only Device (config)# dial-peer voice 10 voip Device (config-dial-peer)# media anti-trombone Device (config-dial-peer)# end</pre> Example: In global VoIP SIP mode <pre>! Applying SIP profiles globally Device (config)# voice service voip Device (config-voi-serv)# media anti-trombone Device (config-voi-serv)# end</pre>	Enables media anti-trombone for all calls.
Step 4	end	Exits to privileged EXEC mode.



CHAPTER 13

SIP Profiles

Session Initiation Protocol (SIP) profiles change SIP incoming or outgoing messages so that interoperability between incompatible devices can be ensured.

You can configure SIP profiles with rules to add, remove, copy, or modify the SIP, Session Description Protocol (SDP), and peer headers that enter or leave CUBE. The rules in a SIP profile configuration can be also tagged with a unique number. Tagging the rules allows you to insert or delete rules at any position of the existing SIP profile configuration without deleting and reconfiguring the entire voice-class sip profile.

Figure 19: Incoming and Outgoing Messages Where SIP Profiles Can Be Applied



You can use the following tool to test your SIP profile on an incoming message: <https://cway.cisco.com/tools/SipProfileTest/>.

- [Feature Information for SIP Profiles, on page 135](#)
- [Information About SIP Profiles, on page 136](#)
- [Restrictions for SIP Profiles, on page 139](#)
- [How to Configure SIP Profiles, on page 139](#)

Feature Information for SIP Profiles

The following table provides release information about the feature or features described in this module. This table lists only the software release that introduced support for a given feature in a given software release train. Unless noted otherwise, subsequent releases of that software release train also support that feature.

Use Cisco Feature Navigator to find information about platform support and Cisco software image support. To access Cisco Feature Navigator, go to www.cisco.com/go/cfn. An account on Cisco.com is not required.

Table 28: Feature Information for SIP Profiles

Feature Name	Releases	Feature Information
SIP Profiles (for inbound messages)	Cisco IOS 15.4(2)T Cisco IOS XE 3.12S	This feature extends support to inbound messages. This feature modifies the following commands: The inbound keyword was added to the sip-profiles and voice-class sip profiles commands.
Support for Rotary calls and Media Forking	Cisco IOS 15.3(1)T	With CSCty41575, this feature was enhanced to support forked and rotary calls.
Configuring SIP Profile (Add, Delete or Modify)	Cisco IOS 12.4(15)XZ Cisco IOS 12.4(20)T Cisco IOS XE 2.5	This feature allows users to change (add, delete, or modify) the standard SIP messages that are sent or received for better interworking with different SIP entities. This feature introduces the following commands: voice class sip-profiles , response , request .
Support for Non-Standard SIP Headers	Cisco IOS 15.5(2)T	This feature allows users to add, copy, delete, or modify non-standard (for example, X-Cisco-Recording-Participant) using SIP profiles. The word keyword was added to the sip-profiles command to allow the user to configure any non-standard SIP header.
Support for tagging rules in a SIP profile configuration	Cisco IOS 15.5(2)T Cisco IOS XE 3.15S	This feature allows users to tag the rules in a SIP profile configuration. Tagging the rules allows users to insert or delete rules at any position of the existing SIP profile configuration without deleting and reconfiguring the entire voice-class sip profile. The following command is introduced in voice class sip profiles configuration mode to tag and insert rules: rule This feature also allows users to upgrade or downgrade all the existing SIP profile configurations to rule-format and non-rule format. The following commands are introduced in global configuration mode: voice sip sip-profiles upgrade , voice sip sip-profiles downgrade
Support for Copying Unsupported SDP Headers	Cisco IOS 15.6(1)T Cisco IOS XE 3.17S	This feature allows for unsupported SDP headers to be copied into a SIP Profile and traverse through CUBE, for all m-lines. The feature introduces the following command: pass-thru content custom-sdp .

Information About SIP Profiles

Protocol translation and repair is a key Cisco Unified Border Element (CUBE) function. CUBE can be deployed between two devices that support the same VoIP protocol (For example. SIP), but do not interwork because

of differences in how the protocol is implemented or interpreted. CUBE can customize the SIP messaging on either side to what the devices in that segment of the network expects to see by normalizing the SIP messaging on the network border, or between two non-interoperable devices within the network.

Service providers may have policies for which SIP messaging fields should be present (or what constitutes valid values for the header fields) before a SIP call enters their network. Similarly, enterprises and small businesses may have policies for the information that can enter or exit their networks for policy or security reasons from a service provider SIP trunk.

Figure 20: SIP Profile

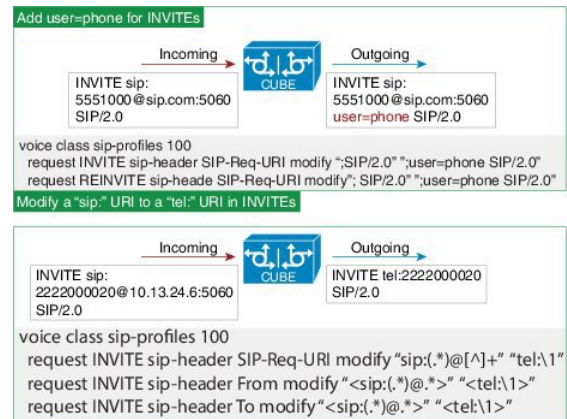

In order to customize SIP messaging in both directions, you can place and configure a CUBE with a SIP profile at the boundary of these networks.

In addition to network policy compliance, the CUBE SIP profiles can be used to resolve incompatibilities between SIP devices inside the enterprise network. These are the situations in which incompatibilities can arise:

- A device rejects an unknown header (value or parameter) instead of ignoring it
- A device sends incorrect data in a SIP message
- A device does not implement (or implements incorrectly) protocol procedures
- A device expects an optional header value or parameter, or an optional protocol procedure that can be implemented in multiple ways
- A device sends a value or parameter that must be changed or suppressed before it leaves or enters the network
- Variations in the SIP standards on how to achieve certain functions

The SIP profiles feature on CUBE provides a solution to these incompatibilities and customization issues.

SIP profiles can also be used to change a header name from the long form to the compact form. For example, From to f. This can be used as a way to reduce the length of a SIP message. By default, the device never sends the compact form of the SIP messages although it receives either the long or the short form.

Important Characteristics of SIP Profiles

The following are a few important notes for SIP Profiles:

- Copy Variables u01 to u99 are shared by inbound and outbound SIP Profiles.
- Session Initiation Protocol (SIP) and Session Description Protocol (SDP) headers are supported. SDP can be either a standalone body or part of a Multipurpose Internet Mail Extensions (MIME) message.
- The rules that are configured for an INVITE message are applied only to the first INVITE of a call. A special REINVITE keyword is used to manipulate subsequent INVITEs of a CALL.
- Manipulation of SIP headers by outbound SIP profiles occurs as the last step before the message leaves the CUBE device. That is, after destination dial-peer matching has taken place. Changes to the SIP messages are not remembered or acted on by the CUBE application. The Content-length field is recalculated after the SIP Profiles rules are applied to the outgoing message.
- If the **ANY** keyword is used in place of a header, it indicates that a rule must be applied to any message within the specified category.
- SIP header modification can be cryptic. It is easier to remove a header and add it back (with the new value), rather than modifying it.
- To include '?' (question-mark) character as part of match-pattern or replace-pattern, you must press "Ctrl+v" keys and then type "?". This operation is needed to treat '?' as an input character itself instead of the usual device help prompt.



Note Regex features like look-ahead, look-behind, OR operator, and non capturing group are not supported (for example, `?!`, `?:`, `?<=`, `|`, and so on).

- For header values used to add, modify or copy a header:
 - If a whitespace occurs, the entire value must be included between double quotes. For example, "User-Agent: CISCO CUBE"
 - If double quotes occur, a backslash must prefix the double quotes. For example, "User-Agent: \"CISCO\" CUBE"
 - Regular expressions are supported.
- If an incoming SIP message contains certain proprietary attributes, CUBE can copy these unsupported SDP attributes or lines from incoming leg to outgoing leg using a SIP profile rule.
- The copy variable can be used in outbound profile to add or modify the outgoing message.

Inbound SIP Profile:

- If the incoming message contains multiple instances of the same header, the header values are stored as a comma-separated list. Consider this fact while modifying it.
- Modification by an inbound SIP profile takes place before regular SIP call processing happens so that behavior of CUBE is as if it received the message directly without modification.

If inbound dial peer matching fails as required information could not be extracted from headers (like Request-URI, Via, From or To) due to issues in them, global dial peers are applied. An example is a request with invalid SIP-Req-URI.

- After modification by inbound SIP Profiles, the parameters in SIP message might change. This change might change the inbound dial-peer that is matched when an actual dial-peer lookup is done.
- In the register pass-through feature, there is only one dial-peer for register and response. So both register from phone and response from registrar go through the same inbound sip profile under the dial-peer if any.

Restrictions for SIP Profiles

- Removal or addition of mandatory headers is not supported. You can only modify mandatory headers. Mandatory SIP headers include To, From, Via, CSeq, Call-Id, and Max-Forwards. Mandatory SDP headers include v, o, s, t, c, and m.
- Addition or removal of entire Multipurpose Internet Mail Extensions (MIME) or (Session Description Protocol) SDP bodies from SIP messages is not supported.
- Syntax checking is not performed on SIP messages after SIP profile rules have been applied. Changes specified in the SIP profile should result in valid SIP protocol exchanges.
- The header length (including header name) after modification should not exceed 300 characters. Max header length for add value is approximately 220 characters. Max SDP length is 2048 characters. If any header length exceeds this maximum value after applying SIP profiles, then the profile is not applied.
- If a header-name is changed to its compact form, SIP profile rules cannot be applied on that header. Thus a SIP profile rule modifying a header name to its compact form must be the last rule on that header.
- We cannot modify the "image" m-line attributes (m=image 16850 udptl t38) using SIP profiles. SIP profiles can be applied only on audio and video m-lines in SDP.
- In a high-availability (HA) scenario, SIP profiles copy variable data is not check-pointed to standby.
- Existing limitations and restrictions of outbound SIP profiles apply to inbound SIP profiles as well.
- You cannot configure more than 99 variables for the SIP profiles copy option.
- Once a SIP profile is configured using rule tag, you cannot add rules without tags in the same profile and vice-versa.
- If a SIP profile is applied to modify the SDP content of a SIP message, CUBE does not increment the "o=" line version, which may cause ITSPs to disconnect the call. CUBE does not store the modified SDP after the application of the SIP profile.

Note that manipulation of SIP messages by outbound SIP profiles occurs as the final step before the outgoing message leaves the CUBE device, and occurs after destination dial-peer matching has taken place. Changes to SIP messages are not remembered or acted on by CUBE. The Content-length field is recalculated after SIP Profile rules are applied to outgoing messages.

How to Configure SIP Profiles

To configure SIP Profiles, you must first configure the SIP Profile globally, and apply it at either to all dial peers (globally) or to a single dial peer (dial-peer level). After a SIP profile is configured, it can be applied as an inbound or outbound profile.

Configuring a SIP Profile to Manipulate SIP Request or Response Headers

SUMMARY STEPS

1. **enable**
2. **configure terminal**
3. **voice class sip-profiles** *profile-id*
4. Enter one of the following to add, remove, modify SIP headers:
 - **request message** {**sip-header** | **sdp-header**} *header-to-add* **add** *header-value-to-add*
 - **request message** {**sip-header** | **sdp-header**} *header-to-remove* **remove**
 - **request message** {**sip-header** | **sdp-header**} *header-to-modify* **modify** *header-value-to-match* *header-value-to-replace*
5. Enter one of the following to add, remove, or modify SIP response headers:
 - **response message** [**method** *method-type*] {**sip-header** | **sdp-header**} *header-to-add* **add** *header-value-to-add*
 - **response message** [**method** *method-type*] {**sip-header** | **sdp-header**} *header-to-remove* **remove**
 - **response message** [**method** *method-type*] {**sip-header** | **sdp-header**} *header-to-modify* **modify** *header-value-to-match* *header-value-to-replace*
6. **end**

DETAILED STEPS

	Command or Action	Purpose
Step 1	enable	Enables privileged EXEC mode. <ul style="list-style-type: none"> • Enter your password if prompted.
Step 2	configure terminal	Enters global configuration mode.
Step 3	voice class sip-profiles <i>profile-id</i> Example: Device(config)# <code>voice class sip-profiles 10</code>	Creates a SIP Profiles and enters voice class configuration mode.
Step 4	Enter one of the following to add, remove, modify SIP headers: <ul style="list-style-type: none"> • request message {sip-header sdp-header} <i>header-to-add</i> add <i>header-value-to-add</i> • request message {sip-header sdp-header} <i>header-to-remove</i> remove • request message {sip-header sdp-header} <i>header-to-modify</i> modify <i>header-value-to-match</i> <i>header-value-to-replace</i> 	According to your choice, this step does one of the following: <ul style="list-style-type: none"> • Adds a SIP or SDP header to a SIP request. • Removes a SIP or SDP header to a SIP request. • Modifies a SIP or SDP header to a SIP request. • If ANY is used in place of a header, it indicates that a rule must be applied to any message within the specified category.

	Command or Action	Purpose
		<ul style="list-style-type: none"> For <i>header-value-to-add</i> used to add a header, <i>header-value-to-match</i> or <i>header-value-to-replace</i> used to modify a header: <ul style="list-style-type: none"> If a whitespace occurs, the entire value must be included between double quotes. For example, "User-Agent: CISCO CUBE" If double quotes occurs, a back slash must prefix the double quotes. For example, "\"CISCO\" CUBE" Regular expressions are supported.
Step 5	<p>Enter one of the following to add, remove, or modify SIP response headers:</p> <ul style="list-style-type: none"> response message [method <i>method-type</i>] {sip-header sdp-header} <i>header-to-add</i> add <i>header-value-to-add</i> response message [method <i>method-type</i>] {sip-header sdp-header} <i>header-to-remove</i> remove response message [method <i>method-type</i>] {sip-header sdp-header} <i>header-to-modify</i> modify <i>header-value-to-match</i> <i>header-value-to-replace</i> 	<p>According to your choice, this step does one of the following:</p> <ul style="list-style-type: none"> Adds a SIP or SDP header to a SIP response. Removes a SIP or SDP header to a SIP response. Modifies a SIP or SDP header to a SIP response. All notes from the previous step are applicable here.
Step 6	end	Exits to privileged EXEC mode

Configuring SIP Profiles for Copying Unsupported SDP Headers

CUBE can pass across SDP attributes by defining SIP profile rules. The following steps are involved:

1. Configure CUBE to pass-through custom SDP on in-leg.
2. Define rule to **Copy** relevant attributes from peer SDP on out-leg.
3. Define rule to **Add** or **Modify** attributes in outbound SDP with copied data.

SUMMARY STEPS

1. **enable**
2. **configure terminal**
3. To enable copying of unsupported SDP attribute from incoming leg to outbound leg, you need to enable one of the following commands:
 - In Global VoIP SIP configuration mode

```
pass-thru content custom-sdp
```
 - In dial-peer configuration mode (The configuration is applied on the incoming dial-peer)

```
voice-class sip pass-thru content custom-sdp
```

4. **voice class sip-profiles** *profile-id*
5. Enter one of the following to copy an unsupported SDP line or attribute from peer leg's SDP and add, modify, or remove in the outgoing SDP:
 - **request/response ANY peer-header sdp mline-index index COPY match-pattern copy-variable**
 - **request/response ANY sdp-header mline-index indexheader-name ADD copy-variable**
 - **request/response ANY sdp-header mline-index indexheader-name MODIFY copy-variable + replace-pattern**
 - **request/response ANY sdp-header mline-index indexheader-name REMOVE**
6. **end**

DETAILED STEPS

	Command or Action	Purpose
Step 1	enable Example: Device> enable	Enables privileged EXEC mode. <ul style="list-style-type: none"> • Enter your password if prompted.
Step 2	configure terminal Example: Device# configure terminal	Enters global configuration mode.
Step 3	To enable copying of unsupported SDP attribute from incoming leg to outbound leg, you need to enable one of the following commands: <ul style="list-style-type: none"> • In Global VoIP SIP configuration mode pass-thru content custom-sdp • In dial-peer configuration mode (The configuration is applied on the incoming dial-peer) voice-class sip pass-thru content custom-sdp Example: In Global VoIP SIP configuration mode: Device(config)# voice service voip Device(conf-voi-serv)# sip Device(conf-serv-sip)# pass-thru content custom-sdp Example: In Dial-peer configuration mode: Device(config)# dial-peer voice 2 voip Device(config-dial-peer)# voice-class sip pass-thru content custom-sdp	Enables copying of unsupported SDP attributes per m-line to the peer leg so that it can be used in outgoing SIP messages. Note Enabling this command does not enable the SDP Passthrough feature.
Step 4	voice class sip-profiles <i>profile-id</i> Example: Device(config)# voice class sip-profiles 10	Voice class sip-profile is configured on the outbound dial-peer or as a global configuration. Creates a SIP Profile and enters voice class configuration mode.

	Command or Action	Purpose
Step 5	<p>Enter one of the following to copy an unsupported SDP line or attribute from peer leg's SDP and add, modify, or remove in the outgoing SDP:</p> <ul style="list-style-type: none"> • request/response ANY peer-header sdp mline-index index COPY match-pattern copy-variable • request/response ANY sdp-header mline-index indexheader-name ADD copy-variable • request/response ANY sdp-header mline-index indexheader-name MODIFY copy-variable + replace-pattern • request/response ANY sdp-header mline-index indexheader-name REMOVE 	<p>M-line Index values:</p> <ul style="list-style-type: none"> • 0 - A value of zero represents the session level. • 1 to 6 - A value in the range of one to six represents the m-line number in SDP. <p>Copy: Enables copying of SDP line or attribute from peer leg SDP.</p> <p>Add: Enables adding the copied SDP line or attribute in the outgoing SDP.</p> <p>Modify: Enables modifying SDP line or attribute in the outgoing SDP.</p> <p>Remove: Enables removing SDP line or attribute in the outgoing SDP.</p>
Step 6	end	Exits to privileged EXEC mode.

Example: Configuring SIP Profile Rules (Attribute Passing)

```
response ANY peer-header sdp mline-index 4 copy "(a=ixmap:0.*)" u01
response ANY sdp-header mline-index 4 a=ixmap add "\u01"
```

Example: Configuring SIP Profile Rules (Parameter Passing)

```
response ANY peer-header sdp mline-index 2 copy "a=fmtp:126.*(max-fps=...)" u04
response ANY sdp-header mline-index 2 a=fmtp:126 modify ";" "; \u04;"
```

Example: Configuration to Remove an Attribute

```
response ANY sdp-header mline-index 4 a=test REMOVE
```

Configuring SIP Profile Using Rule Tag

Configure SIP profile rules using the rule tag, enables you to performing the following tasks:

- Add SIP profile request and response headers with a rule tag.
- Modify the existing SIP profile configurations by inserting a rule at any position of the SIP profile without deleting and reconfiguring the entire SIP profile.
- Remove a rule by specifying only rule tag.

Below are the rule tag behaviors that needs to be considered while using rule tag in SIP profile configurations:

- If a rule is added with the tag of an existing rule, then the existing rule is overwritten with the new rule.

- For inserting a rule at the desired position, the SIP profile configuration should be in rule format. In case the SIP profile is in non-rule format, upgrade the SIP profiles to rule format before inserting a rule.
- If a new rule is inserted, the new rule takes the position specified in **before tag**. The subsequent rules are incremented sequentially.
- Once the rule is removed, the tag belonging to the removed rule remains vacant. The tags associated with the subsequent rules remain unchanged.
- If a rule is added to a vacant tag, the new rule gets associated with the vacant tag and the subsequent rules remain unchanged.

SUMMARY STEPS

1. **enable**
2. **configure terminal**
3. **voice class sip-profiles** *profile-id*
4. Enter one of the following to add, copy, modify, or remove a SIP request or response headers to a SIP profile configuration:
 - **rule tag request** *method* **sdp-header** | **sip-header** *header-name* **add** | **copy** | **modify** | **remove** *string*
 - **rule tag response** *method* **sdp-header** | **sip-header** *header-name* **add** | **copy** | **modify** | **remove** *string*
5. Enter one of the following to insert a rule in between the existing set of rules to add, remove, or modify SIP request or response headers:
 - **rule before tag request** *method* **sdp-header** | **sip-header** *header-name* **add** | **copy** | **modify** | **remove** *string*
 - **rule before tag response** *method* **sdp-header** | **sip-header** *header-name* **add** | **copy** | **modify** | **remove** *string*
6. Enter the following to delete a rule:
 - **no rule tag**
7. **end**

DETAILED STEPS

	Command or Action	Purpose
Step 1	enable	Enables privileged EXEC mode. <ul style="list-style-type: none"> • Enter your password if prompted.
Step 2	configure terminal	Enters global configuration mode.
Step 3	voice class sip-profiles <i>profile-id</i> Example: Device(config)# voice class sip-profiles 10	Creates a SIP Profile and enters voice class configuration mode.

	Command or Action	Purpose
Step 4	<p>Enter one of the following to add, copy, modify, or remove a SIP request or response headers to a SIP profile configuration:</p> <ul style="list-style-type: none"> • rule tag request method sdp-header sip-header header-name add copy modify remove string • rule tag response method sdp-header sip-header header-name add copy modify remove string 	According to your choice, this step tags the SIP request or response header with a unique number.
Step 5	<p>Enter one of the following to insert a rule in between the existing set of rules to add, remove, or modify SIP request or response headers:</p> <ul style="list-style-type: none"> • rule before tag request method sdp-header sip-header header-name add copy modify remove string • rule before tag response method sdp-header sip-header header-name add copy modify remove string 	According to your choice this steps inserts the rule at the position specified in the before tag . The subsequent rules in the existing SIP profile configuration is incremented sequentially.
Step 6	<p>Enter the following to delete a rule:</p> <ul style="list-style-type: none"> • no rule tag 	According to your choice, this step tags the SIP request or response with a unique number.
Step 7	end	Exits voice class sip-profiles configuration mode.

Configuring a SIP Profile for Non-standard SIP Header

SUMMARY STEPS

1. **enable**
2. **configure terminal**
3. **voice class sip-profiles profile-id**
4. Enter one of the following to add, copy, remove, or modify non-standard SIP request headers:
 - **request message {sip-header} non-standard-header-to-add add non-standard-header-value-to-add**
 - **request message {sip-header} non-standard-header-to-copy copy non-standard-header-value-to-match copy-variable**
 - **request message {sip-header} non-standard-header-to-remove remove**
 - **request message {sip-header} non-standard-header-to-modify modify non-standard-header-value-to-match non-standard-header-value-to-replace**
5. Enter one of the following to add, copy, remove, or modify non-standard SIP response headers:
 - **response message [method method-type] {sip-header} non-standard-header-to-add add non-standard-header-value-to-add**
 - **response message [method method-type] {sip-header} non-standard-header-to-copy copy non-standard-header-value-to-match copy-variable**
 - **response message [method method-type] {sip-header} non-standard-header-to-remove remove**

- **response message** [**method method-type**] {**sip-header**} *non-standard-header-to-modify* **modify** *non-standard-header-value-to-match non-standard-header-value-to-replace*

6. end

DETAILED STEPS

	Command or Action	Purpose
Step 1	enable	Enables privileged EXEC mode. <ul style="list-style-type: none"> • Enter your password if prompted.
Step 2	configure terminal	Enters global configuration mode.
Step 3	voice class sip-profiles <i>profile-id</i> Example: Device(config)# voice class sip-profiles 10	Creates a SIP Profiles and enters voice class configuration mode.
Step 4	Enter one of the following to add, copy, remove, or modify non-standard SIP request headers: <ul style="list-style-type: none"> • request message {sip-header} <i>non-standard-header-to-add</i> add <i>non-standard-header-value-to-add</i> • request message {sip-header} <i>non-standard-header-to-copy</i> copy <i>non-standard-header-value-to-match copy-variable</i> • request message {sip-header} <i>non-standard-header-to-remove</i> remove • request message {sip-header} <i>non-standard-header-to-modify</i> modify <i>non-standard-header-value-to-match non-standard-header-value-to-replace</i> 	According to your choice, this step does one of the following: <ul style="list-style-type: none"> • Adds a non-standard SIP header to a SIP request. • Copies contents from a non-standard SIP header to a SIP request. • Removes a non-standard SIP header to a SIP request. • Modifies a non-standard SIP header to a SIP request. • If ANY is used in place of a header, it indicates that a rule must be applied to any message within the specified category. • For <i>non-standard-header-value-to-add</i> used to add a non-standard header, <i>non-standard-header-value-to-match</i> or <i>non-standard-header-value-to-replace</i> used to modify a non-standard header: <ul style="list-style-type: none"> • If a whitespace occurs, the entire value must be included between double quotes. For example, "User-Agent: CISCO CUBE" • If double quotes occurs, a back slash must prefix the double quotes. For example, "User-Agent: \"CISCO\" CUBE" • Regular expressions are supported.
Step 5	Enter one of the following to add, copy, remove, or modify non-standard SIP response headers: <ul style="list-style-type: none"> • response message [method method-type] {sip-header} <i>non-standard-header-to-add</i> add <i>non-standard-header-value-to-add</i> 	According to your choice, this step does one of the following: <ul style="list-style-type: none"> • Adds a non-standard SIP to a SIP response. • Copies contents from a non-standard SIP header to a SIP response.

	Command or Action	Purpose
	<ul style="list-style-type: none"> • response message [method <i>method-type</i>] {sip-header} <i>non-standard-header-to-copy</i> copy <i>non-standard-header-value-to-match</i> <i>copy-variable</i> • response message [method <i>method-type</i>] {sip-header} <i>non-standard-header-to-remove</i> remove • response message [method <i>method-type</i>] {sip-header} <i>non-standard-header-to-modify</i> modify <i>non-standard-header-value-to-match</i> <i>non-standard-header-value-to-replace</i> 	<ul style="list-style-type: none"> • Removes a non-standard header to a SIP response. • Modifies a non-standard SIP header to a SIP response. • All notes from the previous step are applicable here.
Step 6	end	Exits to privileged EXEC mode

Upgrading or Downgrading SIP Profile Configurations

You can upgrade or downgrade all the SIP Profile configurations to rule-format or non-rule format automatically.



Note We recommend that you downgrade the SIP profiles to non-rule format configuration before migrating to a version below Cisco IOS Release 15.5(2)T or Cisco IOS-XE Release 3.15S. If you migrate without downgrading the SIP profile configurations, then all the SIP profile configurations is lost after migration.

SUMMARY STEPS

1. **enable**
2. Enter the following to upgrade SIP profiles configurations to rule-format:
 - **voice sip sip-profiles upgrade**
3. Enter the following to downgrade SIP profiles configurations to non-rule format:
 - **voice sip sip-profiles downgrade**
4. **end**

DETAILED STEPS

	Command or Action	Purpose
Step 1	enable	Enables privileged EXEC mode. <ul style="list-style-type: none"> • Enter your password if prompted.
Step 2	Enter the following to upgrade SIP profiles configurations to rule-format: <ul style="list-style-type: none"> • voice sip sip-profiles upgrade Example: In EXEC(#) mode:	Upgrades all SIP Profiles to rule-format configurations.

	Command or Action	Purpose
	<code>Device#voice sip sip-profiles upgrade</code>	
Step 3	Enter the following to downgrade SIP profiles configurations to non-rule format: <ul style="list-style-type: none"> • voice sip sip-profiles downgrade Example: In EXEC(#) mode: <code>Device#voice sip sip-profiles downgrade</code>	Downgrades all SIP Profiles from rule-format configurations to non-rule format configurations.
Step 4	end	Exits privileged EXEC mode.

What to do next

Now apply the SIP Profile as an inbound or outbound SIP profile.

Configuring a SIP Profile as an Outbound Profile

SUMMARY STEPS

1. **enable**
2. **configure terminal**
3. Apply the SIP profile to a dial peer:
 - **voice-class sip profiles** *profile-id* in the dial-peer configuration mode.
 - **sip-profiles** *profile-id* in the global VoIP configuration mode
4. **end**

DETAILED STEPS

	Command or Action	Purpose
Step 1	enable	Enables privileged EXEC mode. <ul style="list-style-type: none"> • Enter your password if prompted.
Step 2	configure terminal	Enters global configuration mode.
Step 3	Apply the SIP profile to a dial peer: <ul style="list-style-type: none"> • voice-class sip profiles <i>profile-id</i> in the dial-peer configuration mode. • sip-profiles <i>profile-id</i> in the global VoIP configuration mode Example: In dial-peer configuration mode <code>!Applying SIP profiles to one dial peer only</code>	

	Command or Action	Purpose
	<pre>Device (config)# dial-peer voice 10 voip Device (config-dial-peer)# voice-class sip profiles 30 Device (config-dial-peer)# end</pre> <p>Example:</p> <p>In global VoIP SIP mode</p> <pre>! Applying SIP profiles globally Device(config)# voice service voip Device (config-voi-serv)# sip Device (config-voi-sip)# sip-profiles 20 Device (config-voi-sip)# end</pre>	
Step 4	end	Exits to privileged EXEC mode .

Configuring a SIP Profile as an Inbound Profile

You can configure a SIP profile as an inbound profile applied globally or to a single inbound dial peer. Inbound SIP profiles feature must be enabled before applying it to dial peers.

SUMMARY STEPS

1. **enable**
2. **configure terminal**
3. **voice service voip**
4. **sip**
5. **sip-profiles inbound**
6. Apply the SIP profile to a dial peer:
 - **voice-class sip profiles *profile-id* inbound** in the dial-peer configuration mode.
 - **sip-profiles *profile-id* inbound** in the global VoIP configuration mode
7. **end**

DETAILED STEPS

	Command or Action	Purpose
Step 1	enable	Enables privileged EXEC mode. <ul style="list-style-type: none"> • Enter your password if prompted.
Step 2	configure terminal	Enters global configuration mode.
Step 3	voice service voip Example: <pre>Device(config)# voice service voip</pre>	Enters global VoIP configuration mode.

	Command or Action	Purpose
Step 4	sip Example: <pre>Device(config-voi-serv)# sip</pre>	Enters global VoIP SIP configuration mode.
Step 5	sip-profiles inbound Example: <pre>Device(config-voi-sip)# sip-profiles inbound</pre>	Enables inbound SIP profiles feature.
Step 6	<p>Apply the SIP profile to a dial peer:</p> <ul style="list-style-type: none"> • voice-class sip profiles <i>profile-id</i> inbound in the dial-peer configuration mode. • sip-profiles <i>profile-id</i> inbound in the global VoIP configuration mode <p>Example: In dial-peer configuration mode</p> <pre>!Applying SIP profiles to one dial peer only Device (config)# dial-peer voice 10 voip Device (config-dial-peer)# voice-class sip profiles 30 inbound Device (config-dial-peer)# end</pre> <p>Example: In global VoIP SIP mode</p> <pre>! Applying SIP profiles globally Device(config)# voice service voip Device (config-voi-serv)# sip Device (config-voi-sip)# sip-profiles 20 inbound Device (config-voi-sip)# end</pre>	
Step 7	end	Exits to privileged EXEC mode

Verifying SIP Profiles

SUMMARY STEPS

1. **show dial-peer voice *id* | include profile**

DETAILED STEPS

show dial-peer voice *id* | include profile

Displays information related to SIP profiles configured on the specified dial peer.

Example:

```
Device# show dial-peer voice 10 | include profile

Translation profile (Incoming):
Translation profile (Outgoing):
translation-profile = ''
voice class sip profiles = 11
voice class sip profiles inbound = 10
```

Troubleshooting SIP Profiles

SUMMARY STEPS

1. debug ccsip all

DETAILED STEPS**debug ccsip all**

This command displays the applied SIP profiles.

Example:

Applied SIP profile is highlighted in the example below.

```
Device# debug ccsip all
...
Oct 12 06:51:53.619: //-1/735085DC8F3D/SIP/Info/sipSPIGetShrlPeer:
      Try match incoming dialpeer for Calling number:
      : sippOct 12 06:51:53.619:
      //-1/735085DC8F3D/SIP/Info/sipSPIGetCallConfig:
      Peer tag 2 matched for incoming call
Oct 12 06:51:53.619: //-1/xxxxxxxxxxxx/SIP/Info/sipSPIGetCallConfig:
      voice class SIP profiles tag is set : 1
Oct 12 06:51:53.619: //-1/735085DC8F3D/SIP/Info/sipSPIGetCallConfig:
      Not using Voice Class Codec
Oct 12 06:51:53.619: //-1/735085DC8F3D/SIP/Info/sipSPIGetCallConfig:
      xcoder high-density disabled
Oct 12 06:51:53.619: //-1/735085DC8F3D/SIP/Info/sipSPIGetCallConfig:
      Flow Mode set to FLOW_THROUGH
```

This command also displays the modifications performed by the SIP profile configuration, by preceding the modification information with the word sip_profiles, as highlighted in the example below.

Example:

```
Device# debug ccsip all
...
Oct 12 06:51:53.647: //-1/xxxxxxxxxxxx/SIP/Info/
      sip_profiles_application_change_sdp_line:
      New SDP header is added : b=AS: 1600
Oct 12 06:51:53.647: //-1/xxxxxxxxxxxx/SIP/Info/
      sip_profiles_update_content_length:
      Content length header before modification :
      Content-Length: 290
Oct 12 06:51:53.647: //-1/xxxxxxxxxxxx/SIP/Info/
```

```

sip_profiles_update_content_length:
Content length header after modification :
Content-Length: 279

```

Examples: Adding, Modifying, Removing SIP Profiles

Example: Adding a SIP, SDP, or Peer Header

Example: Adding "b=AS:4000" SDP header to the video-media Header of the INVITE SDP Request Messages

```

Device(config)# voice class sip-profiles 10
Device(config-class)# request INVITE sdp-header Video-Bandwidth-Info add "b=AS:4000"
Device(config-class)# end

```

Example: Adding "b=AS:4000" SDP header to the video-media Header of the INVITE SDP Request Messages in rule format

```

Device(config)# voice class sip-profiles 10
Device(config-class)# rule 1 request INVITE sdp-header Video-Bandwidth-Info add "b=AS:4000"
Device(config-class)# end

```

Example: Adding the Retry-After Header to the SIP 480 Response Messages

```

Device(config)# voice class sip-profiles 20
Device(config-class)# response 480 sip-header Retry-After add "Retry-After: 60"
Device(config-class)# end

```

Example: Adding the Retry-After Header to the SIP 480 Response Messages in rule format

```

Device(config)# voice class sip-profiles 20
Device(config-class)# rule 1 response 480 sip-header Retry-After add "Retry-After: 60"
Device(config-class)# end

```

Example: Adding "User-Agent: SIP-GW-UA" to the User-Agent Field of the 200 Response SIP Messages

```

Device(config)# voice class sip-profiles 40
Device(config-class)# response 200 sip-header User-Agent add "User-Agent: SIP-GW-UA"
Device(config-class)# end

```

Example: Adding "User-Agent: SIP-GW-UA" to the User-Agent Field of the 200 Response SIP Messages in rule format

```
Device(config)# voice class sip-profiles 40
Device(config-class)# rule 1 response 200 sip-header User-Agent add "User-Agent: SIP-GW-UA"
Device(config-class)# end
```

Example: Adding "a=ixmap:0 ping" in M-Line number 4 of the INVITE SDP Request Messages

```
Device(config)# voice class sip-profiles 10
Device(config-class)# request INVITE sdp-header mline-index 4 a=ixmap add "a=ixmap:0 ping"
Device(config-class)# end
```

Applying the SIP Profiles

```
! Applying SIP profiles globally
Device(config)#voice service voip
Device(config-voi-serv)#sip
Device(config-voi-sip)#sip-profiles 20
Device(config-voi-sip)#end

! Applying SIP profiles to one dial peer only
Device(config) dial-peer voice 10 voip
Device(config-dial-peer)#voice-class sip profiles 30
Device(config-dial-peer)#end
```

Example: Modifying a SIP, SDP, or Peer Header**Example: Modifying SIP-Req-URI of the Header of the INVITE and RE-INVITE SIP Request Messages to include "user=phone"**

```
Device(config)# voice class sip-profiles 30
Device(config-class)# request INVITE sip-header SIP-Req-URI modify "; SIP/2.0" ";user=phone SIP/2.0"
Device(config-class)# request RE-INVITE sip-header SIP-Req-URI modify "; SIP/2.0" ";user=phone SIP/2.0"
Device(config-class)# end
```

Example: Modifying SIP-Req-URI of the Header of the INVITE and RE-INVITE SIP Request Messages to include "user=phone" in rule format

```
Device(config)# voice class sip-profiles 30
Device(config-class)# rule 1 request INVITE sip-header SIP-Req-URI modify "; SIP/2.0" ";user=phone SIP/2.0"
Device(config-class)# rule 2 request RE-INVITE sip-header SIP-Req-URI modify "; SIP/2.0" ";user=phone SIP/2.0"
Device(config-class)# end
```

Modify the From Field of a SIP INVITE Request Messages to "gateway@gw-ip-address" Format

For example, modify 2222000020@10.13.24.7 to gateway@10.13.24.7

```
Device(config)# voice class sip-profiles 20
Device(config-class)# request INVITE sip-header From modify "<.*>(.*)@" "\1gateway@"
```

Modify the From Field of a SIP INVITE Request Messages to "gateway@gw-ip-address" Format in rule format

For example, modify 2222000020@10.13.24.7 to gateway@10.13.24.7

```
Device(config)# voice class sip-profiles 20
Device(config-class)# rule 1 request INVITE sip-header From modify "<.*>(.*)@" "\1gateway@"
```

Replace "CiscoSystems-SIP-GW-UserAgent" with "-" in the Originator Header of the SDP in INVITE Request Messages

```
Device(config)# voice class sip-profiles 10
Device(config-class)# request INVITE sdp-header Session-Owner modify
"CiscoSystems-SIP-GW-UserAgent" "-"
```

Replace "CiscoSystems-SIP-GW-UserAgent" with "-" in the Originator Header of the SDP in INVITE Request Messages in rule format

```
Device(config)# voice class sip-profiles 10
Device(config-class)# rule 1 request INVITE sdp-header Session-Owner modify
"CiscoSystems-SIP-GW-UserAgent" "-"
```

Convert "sip uri" to "tel uri" in Req-URI, From and To Headers of SIP INVITE Request Messages

For example, modify sip:2222000020@9.13.24.6:5060" to "tel:2222000020

```
Device(config)# voice class sip-profiles 40
Device(config-class)# request INVITE sip-header SIP-Req-URI modify "sip:(.*)@[^ ]+" "tel:\1"
Device(config-class)# request INVITE sip-header From modify "<sip:(.*)@.*>" "<tel:\1>"
Device(config-class)# request INVITE sip-header To modify "<sip:(.*)@.*>" "<tel:\1>"
```

Convert "sip uri" to "tel uri" in Req-URI, From and To Headers of SIP INVITE Request Messages in rule format

For example, modify sip:2222000020@9.13.24.6:5060" to "tel:2222000020

```
Device(config)# voice class sip-profiles 40
Device(config-class)# rule 1 request INVITE sip-header SIP-Req-URI modify "sip:(.*)@[^ ]+"
"tel:\1"
Device(config-class)# rule 2 request INVITE sip-header From modify "<sip:(.*)@.*>" "<tel:\1>"
Device(config-class)# rule 3 request INVITE sip-header To modify "<sip:(.*)@.*>" "<tel:\1>"
```

Example: Change the Audio Attribute Ptime:20 to Ptime:30

Inbound ptime:

```
a=ptime:20
```

Outbound ptime:

```
a=ptime:30
```

```
Device(config)# voice class sip-profiles 103
```

```
Device(config-class)# request ANY sdp-header Audio-Attribute modify "a=ptime:20" "a=ptime:30"
```

Example: Modify Audio direction "Audio-Attribute"

Some service providers or customer equipment reply to delay offer invites and or re-invites that contain a=inactive with a=inactive, a=recvonly, or a=sendonly. This can create an issue when trying to transfer or retrieve a call from hold. The result is normally one-way audio after hold or resume or transfer or moh is not heard. To resolve this issue changing the audio attribute to Sendrecv prevents the provider from replaying back with a=inactive, a=recvonly, or a=sendonly.

Case 1:

```
Inbound Audio-Attribute
```

```
a=inactive
```

```
Outbound Audio-Attribute
```

```
a=sendrecv
```

Case 2:

```
Inbound Audio-Attribute
```

```
a=recvonly
```

```
Outbound Audio-Attribute
```

```
a=sendrecv
```

Case 3

```
Inbound Audio-Attribute
```

```
a=sendonly
```

```
Outbound Audio-Attribute
```

```
a=sendrecv
```

```
Device(config)# voice class sip-profiles 104
```

```
Device(config-class)# request any sdp-header Audio-Attribute modify "a=inactive" "a=sendrecv"
```

```
Device(config-class)# request any sdp-header Audio-Attribute modify "a=recvonly" "a=sendrecv"
```

```
Device(config-class)# request any sdp-header Audio-Attribute modify "a=sendonly" "a=sendrecv"
```

```
Device(config-class)# response any sdp-header Audio-Attribute modify "a=inactive" "a=sendrecv"
```

```
Device(config-class)# response any sdp-header Audio-Attribute modify "a=recvonly" "a=sendrecv"
```

```
Device(config-class)# response any sdp-header Audio-Attribute modify "a=sendonly" "a=sendrecv"
```

Example: Modifying Packetization Mode in a=fmtp line of M-line number 2 of the INVITE SDP Request Messages

```
Device(config)# voice class sip-profiles 10
Device(config-class)# request INVITE sdp-header mline-index 2 a=fmtp modify
"packetization-mode=1" "packetization-mode=0"
Device(config-class)# end
```

Applying the SIP Profiles to Dial Peers

```
! Applying SIP Profiles globally
Device(config)# voice service voip
Device (config-voi-serv) sip-profiles 20
Device (config-voi-serv) sip-profiles 10
Device (config-voi-serv) sip-profiles 40
Device (config-voi-serv) sip-profiles 103
Device (config-voi-serv) sip-profiles 104
Device (config-voi-serv) exit

! Applying SIP Profiles to one dial peer only
Device (config) dial-peer voice 90 voip
Device (config-dial-peer) voice-class sip profiles 30
```

Example: Remove a SIP, SDP, or Peer Header

Remove Cisco-Guid SIP header from all Requests and Responses

```
Device(config)# voice class sip-profiles 20
Device(config-class)# request ANY sip-header Cisco-Guid remove
Device(config-class)# response ANY sip-header Cisco-Guid remove
Device(config-class)# end
```

Remove Server Header from 100 and 180 SIP Response Messages

```
Device(config)# voice class sip-profiles 20
Device(config-class)# response 100 sip-header Server remove
Device(config-class)# response 180 sip-header Server remove
Device(config-class)# end
```

Removing a SIP Profile rule in rule format configuration

SIP Profile configuration in rule format

```
Device(config)# voice class sip-profiles 10
Device(config-class)# rule 1 request any sdp-header Audio-Attribute modify "a=inactive"
"a=sendrecv"
```

```
Device(config-class)# rule 2 request any sdp-header Audio-Attribute modify "a=recvonly"
"a=sendrecv"
Device(config-class)# end
```

Removing the rule using rule tag

```
Device(config)# voice class sip-profiles 10
Device(config-class)# no rule 1
Device(config-class)# end
```

Once the rule is removed, the tag belonging to the removed rule remains vacant. The tags associated with the subsequent rules are unchanged.

The SIP Profile configuration after removing the rule

```
Device(config)# voice class sip-profiles 10
Device(config-class)# rule 2 request any sdp-header Audio-Attribute modify "a=recvonly"
"a=sendrecv"
Device(config-class)# end
```

Example: Removing "a=ixmap" in M-Line number 4 of the INVITE SDP Request Messages

```
Device(config)# voice class sip-profiles 10
Device(config-class)# response ANY sdp-header mline-index 4 a=ixmap REMOVE
Device(config-class)# end
```

Example: Inserting SIP Profile Rules

Example: Inserting a SIP Profile Rule

Inserting a SIP profile rule to a SIP Profile

```
Device(config)#voice class sip-profiles 1
Device(config-class)#rule 1 request INVITE sip-header Contact Modify "(.*)" "\1;temp=xyz"
Device(config-class)#rule 2 request INVITE sip-header Supported Add "Supported: "
Device(config-class)#rule before 2 request INVITE sip-header To Modify "(.*)" "\1;temp=abc"
```

The SIP Profile after inserting the new rule

```
Device(config)#voice class sip-profiles 1
Device(config-class)#rule 1 request INVITE sip-header Contact Modify "(.*)" "\1;temp=xyz"
Device(config-class)#rule 2 request INVITE sip-header To Modify "(.*)" "\1;temp=abc"
Device(config-class)#rule 3 request INVITE sip-header Supported Add "Supported: "
```

Example: Upgrading and Downgrading SIP Profiles automatically

Upgrading SIP Profiles to rule-format

The following is a snippet from `show running-config` command showing the SIP profiles in non-rule format:

```
Device#show running-config
!
request INVITE sip-header Contact Modify "(.*)" "\1;temp=xyz"
request INVITE sip-header Supported Add "Supported: "
!
```

Execute the following command in EXEC (#) mode to upgrade the SIP Profiles to rule-format:

```
Device#voice sip sip-profiles upgrade
```

The following is a snippet from **show running-config** command showing the SIP profiles after upgrading to rule-format:

```
Device#show running-config
!
rule 1 request INVITE sip-header Contact Modify "(.*)" "\1;temp=xyz"
rule 2 request INVITE sip-header Supported Add "Supported: "
!
```

Downgrading SIP Profiles to non-rule format

The following is a snippet from **show running-config** command showing SIP profiles in rule-format:

```
Device#show running-config
!
rule 1 request INVITE sip-header Contact Modify "(.*)" "\1;temp=xyz"
rule 2 request INVITE sip-header Supported Add "Supported: "
!
```

Execute the following command in EXEC(#) mode to downgrade SIP Profiles to non-rule format:

```
Device# voice sip sip-profiles downgrade
```

The following is a snippet from **show running-config** command showing SIP profiles after downgrading to non-rule format:

```
Device#show running-config
!
request INVITE sip-header Contact Modify "(.*)" "\1;temp=xyz"
request INVITE sip-header Supported Add "Supported: "
!
```

Example: Modifying Diversion Headers

Example: Modify Diversion Headers from Three-Digit Extensions to Ten Digits.

Most service providers require a ten digit diversion header. Prior to Call manager 8.6, Call manager would only send the extension in the diversion header. A SIP profile can be used to make the diversion header ten digits.

Call manager version 8.6 and above has the field "Redirecting Party Transformation CSS" which lets you expand the diversion header on the call manager.

The SIP profile will look for a diversion header containing "<sip:5...", where ... stands for the three-digit extension and then concatenates 9789365 with these three digits.

Original Diversion Header:

```
Diversion:<sip:5100@161.44.77.193>;privacy=off;reason=unconditional;counter=1;screen=no
```

Modified Diversion Header:

```
Diversion: <sip:9789365100@10.86.176.19>;privacy=off;reason=unconditional;counter=1;screen=no
```

```
Device(config)# voice class sip-profiles 101
Device(config-class)# request Invite sip-header Diversion modify "<sip:5(...)"
"<sip:9789365\1@"
Device(config-class)# end
```

Example: Create a Diversion header depending on the area code in the From field

Most service providers require a redirected call to have a diversion header that contains a full 10 digit number that is associated with a SIP trunk group. Sometimes, a SIP trunk may cover several different area codes, states, and geographic locations. In this scenario, the service provider may require a specific number to be placed in the diversion header depending on the calling party number.

In the below example, if the From field has an area code of 978 "<sip:978", the SIP profile leaves the From field as is and adds a diversion header.

```
Device(config)# voice class sip-profiles 102
Device(config-class)# request INVITE sip-header From modify "From: (.*)<sip:978(.*)@(.*)"
"From:\1<sip:978\2@\3\x0ADiversion:
<sip:9789365000@10.86.176.19:5060;privacy=off;reason=unconditional;counter=1;screen=no"
```

The below diversion header is added. There was no diversion header before this was added:

```
Diversion: <sip:9789365000@10.86.176.19:5060;transport=udp>"
```

Example: Sample SIP Profile Application on SIP Invite Message

The SIP profile configured is below:

```
voice class sip-profiles 1
  request INVITE sdp-header Audio-Bandwidth-Info add "b=AS:1600"
  request ANY sip-header Cisco-Guid remove
  request INVITE sdp-header Session-Owner modify "CiscoSystems-SIP-GW-UserAgent" "-"
```

The SIP INVITE message before the SIP profile has been applied is show below:

```
INVITE sip:2222000020@9.13.40.250:5060 SIP/2.0
Via: SIP/2.0/UDP 9.13.40.249:5060;branch=z9hG4bK1A203F
From: "sipp " <sip:1111000010@9.13.40.249>;tag=F11AE0-1D8D
To: <sip:2222000020@9.13.40.250>
Date: Mon, 29 Oct 2007 19:02:04 GMT
Call-ID: 4561B116-858811DC-804DEF2E-4CF2D71B@9.13.40.249
Cisco-Guid: 1163870326-2240287196-2152197934-1290983195
Content-Length: 290

v=0
o=CiscoSystemsSIP-GW-UserAgent 6906 8069 IN IP4 9.13.40.249
s=SIP Call
```

Example: Sample SIP Profile for Non-Standard SIP Headers

```
c=IN IP4 9.13.40.249
t=0 0
m=audio 17070 RTP/AVP 0
c=IN IP4 9.13.40.249
a=rtpmap:0 PCMU/8000
a=ptime:20
```

The SIP INVITE message after the SIP profile has been applied is shown below:

- The Cisco-Guid has been removed.
- CiscoSystemsSIP-GW-UserAgent has been replaced with -.
- The Audio-Bandwidth SDP header has been added with the value b=AS:1600.

```
INVITE sip:2222000020@9.13.40.250:5060 SIP/2.0
Via: SIP/2.0/UDP 9.13.40.249:5060;branch=z9hG4bK1A203F
From: "sipp " <sip:1111000010@9.13.40.249>;tag=F11AE0-1D8D
To: <sip:2222000020@9.13.40.250>
Date: Mon, 29 Oct 2007 19:02:04 GMT
Call-ID: 4561B116-858811DC-804DEF2E-4CF2D71B@9.13.40.249
Content-Length: 279
```

```
v=0
o=- 6906 8069 IN IP4 9.13.40.249
s=SIP Call
c=IN IP4 9.13.40.249
t=0 0
m=audio 17070 RTP/AVP 0
c=IN IP4 9.13.40.249
a=rtpmap:0 PCMU/8000
a=ptime:20
b=AS:1600
```

Example: Sample SIP Profile for Non-Standard SIP Headers

Before Cisco IOS Release 15.5(2)T, there was no method to add, copy, delete, or modify any non-standard SIP headers like 'X-Cisco-Recording-Participant' using SIP profiles. The SIP profile will look for the new option "WORD" that allows the user to change any non-standard SIP header.

```
voice class sip-profiles 1
request INVITE sip-header X-Cisco-Recording-Participant copy "sip:(.*)@" u01
request INVITE sip-header X-Cisco-Recording-Participant modify "sip:sipp@" "sip:1000@"
request INVITE sip-header My-Info add "My-Info: MF Call"
request INVITE sip-header My-Info remove
```

Example: Copy a User-to-User from REFER Message**Copy a User-to-User from a REFER message**

Apply the sip profile 1210 to the inbound dial-peer that receives the REFER. The sip profile 1211 need to be applied to the outbound dial-peer that is matched after the REFER is consumed.

```
voice class sip-profiles 1210
request REFER sip-header Refer-To copy "Refer-To:.User-to-User=(.)>" u03
request REFER sip-header x-user add "x-user: TEST2"
request REFER sip-header x-user modify "x-user: (.*)" "x-user: \u03"
```

The variable does not get copied properly between the call legs. Non-standard header to store the value and then modify it on the out leg. An ADD operation puts new header under the content-length header.

To store, remove and re-add the header:

```
voice class sip-profiles 1211
request INVITE sip-header x-user copy "x-user: (.)" u05
request INVITE sip-header User-to-User add "User-to-User: TEST1"
request INVITE sip-header User-to-User modify "User-to-User: (.)" "User-to-User: \u05"
request INVITE sip-header x-user remove
request INVITE sip-header Content-length copy "Content-Length: (.)" u06
request INVITE sip-header Content-length remove
request INVITE sip-header Content-length add "Content-Length: Test3"
request INVITE sip-header Content-length modify "Content-Length: (.)" "Content-Length: \u06"
```

Example: Copy a User-to-User from REFER Message



CHAPTER 14

SIP Out-of-Dialog OPTIONS Ping Group

This feature groups the monitoring of SIP dial-peers endpoints and servers by consolidating dial peers with the same SIP Out-of-Dialog (OOD) OPTIONS ping setup.

- [Information About SIP Out-Of-dialog OPTIONS Ping Group, on page 163](#)
- [How to Configure SIP Out-Of-dialog OPTIONS Ping Group, on page 164](#)
- [Configuration Examples For SIP Out-of-Dialog OPTIONS Ping Group , on page 166](#)
- [Additional References, on page 168](#)
- [Feature Information for SIP Out-of-dialog OPTIONS Ping Group , on page 169](#)

Information About SIP Out-Of-dialog OPTIONS Ping Group

SIP Out-of-Dialog OPTIONS Ping Group Overview

The SIP Out-Of-Dialog OPTIONS (OODO) Ping Group feature is an existing mechanism that is used by CUBE to monitor the status of a single SIP dial-peer destination (keepalive). A generic heartbeat mechanism allows you to monitor the status of SIP servers or endpoints and provide the option of marking a dial peer as inactive (busyout) upon total heartbeat failure.

You can now consolidate the sending of SIP OODO ping packets by grouping dial peers with the same SIP OODO ping setup. A keepalive profile is created and referenced by different SIP dial peers. An OODO Options ping heartbeat keepalive connection is set up for each dial-peer destination of a keepalive profile. If a heartbeat failure occurs for any of the dial peers of the profile, the status of the respective dial peer is changed to inactive (busyout) by CUBE.



Note Configuring the same OPTIONS KEEPALIVE profile on two or more dial-peers with different bind interfaces configured is not supported. This leads to a scenario wherein the OPTIONS SIP message is not sent from all bind interfaces except the first configured one. But the dial-peer is always marked as ACTIVE. Similarly, it is also not supported in multi VRF setup.

You can use the **shutdown** command to suspend monitoring of all dial peers associated with a keepalive profile.

The new command **voice-class sip options-keepalive profile tag** is used to monitor a group of SIP servers or endpoints and the existing **voice-class sip options-keepalive** command is used to monitor a single SIP endpoint or server.

You can configure a server group to be a part of a SIP OODO ping group. A SIP dial peer is updated to BUSY state only if all targets of its server group does not response to the OODO ping

How to Configure SIP Out-Of-dialog OPTIONS Ping Group

Configuring SIP Out-of-Dialog OPTIONS Ping Group

Before you begin

Configure SIP profiles and server groups.

SUMMARY STEPS

1. **enable**
2. **configure terminal**
3. **voice class sip-options-keepalive** *keepalive-group-profile-id*
4. **description** *text*
5. **transport** {tcp [tls] | udp | system}
6. **sip-profiles** *profile-number*
7. **down-interval** *down-interval*
8. **up-interval** *up-interval*
9. **retry** *retry-interval*
10. **exit**
11. **dial-peer voice** *dial-peer-id* **voip**
12. **session protocol sipv2**
13. **voice-class sip options-keepalive profile** *keepalive-group-profile-id*
14. **session server-group** *server-group-id*
15. **end**
16. **show voice class sip-options-keepalive** *keepalive-group-profile-id*

DETAILED STEPS

	Command or Action	Purpose
Step 1	enable Example: Device> enable	Enters privileged EXEC mode. <ul style="list-style-type: none"> • Enter your password if prompted.
Step 2	configure terminal Example:	Enters global configuration mode.

	Command or Action	Purpose
	Device# configure terminal	
Step 3	voice class sip-options-keepalive <i>keepalive-group-profile-id</i> Example: Device(config)# voice class sip-options-keepalive 171	Configures a keepalive profile and enters voice class configuration mode. <ul style="list-style-type: none"> You can use the shutdown command to suspend keepalive activity for all dial peers associated with the keepalive profile.
Step 4	description <i>text</i> Example: Device(config-class)# description Target Boston	Configures a textual description for the keepalive heartbeat connection.
Step 5	transport {tcp [tls] udp system} Example: Device(config-class)# transport tcp	Defines the transport protocol used for the keepalive heartbeat connection. <ul style="list-style-type: none"> The default value is system.
Step 6	sip-profiles <i>profile-number</i> Example: Device(config-class)# sip-profiles 100	Specifies the SIP profile that is to be used to send this message. <ul style="list-style-type: none"> To configure a SIP profile, refer to “Configuring SIP Parameter Modification”.
Step 7	down-interval <i>down-interval</i> Example: Device(config-class)# down-interval 35	Configures the time (in seconds) at which an SIP OODO ping is sent to the dial-peer endpoint when the heartbeat connection to the endpoint is in Down status. <ul style="list-style-type: none"> The default value is 30.
Step 8	up-interval <i>up-interval</i> Example: Device(config-class)# up-interval 65	Configures the time (in seconds) at which an SIP OODO ping is sent to the dial-peer endpoint when the heartbeat connection to the endpoint is in Up status. <ul style="list-style-type: none"> The default value is 60.
Step 9	retry <i>retry-interval</i> Example: Device(config-class)# retry 30	Configures the maximum number of OODO ping retrievals permitted for a dial-peer destination. After receiving failed responses for the configured number of OODO ping, the heartbeat connection status should be switched from Up to Down. <ul style="list-style-type: none"> The default value is 5. If a successful response is received for an OODO ping, the retry counter is set to zero.
Step 10	exit Example:	Exits voice class configuration mode and enters global configuration mode.

	Command or Action	Purpose
	Device(config-class)# exit	
Step 11	dial-peer voice <i>dial-peer-id</i> voip Example: Device(config)# dial-peer voice 123 voip	Defines a local dial peer and enters dial peer configuration mode.
Step 12	session protocol sipv2 Example: Device(config-dial-peer)# session protocol sipv2	Specifies SIP version 2 as the session protocol for calls between local and remote routers using the packet network.
Step 13	voice-class sip options-keepalive profile <i>keepalive-group-profile-id</i> Example: Device(config-dial-peer)# voice-class sip options-keepalive profile 171	Associates the dial peer with the specified keepalive group profile. The dial peer is monitored by CUBE according to the parameters defined by this profile.
Step 14	session server-group <i>server-group-id</i> Example: Device(config-dial-peer)# session server-group 151	Associates the dial peer with the specified keepalive group profile. The dial peer is monitored by the device according to the parameters defined by this profile.
Step 15	end Example: Device(config-dial-peer)# end	Exits dial peer configuration mode and enters privileged EXEC mode.
Step 16	show voice class sip-options-keepalive <i>keepalive-group-profile-id</i> Example: Device# show voice class sip-options-keepalive 171	Displays information about voice class server group.

Configuration Examples For SIP Out-of-Dialog OPTIONS Ping Group

Example: SIP Out-of-Dialog OPTIONS Ping for Group of SIP Endpoints

```
!Configuring the SIP profile
Device(config)# voice class sip-profiles 100
Device(config-class)# request INVITE sip-header SIP-Req-URI modify "; SIP/2.0" ";user=phone SIP/2.0"
```

```
!Configuring the SIP Keepalive Group
```

```

Device(config)# voice class sip-options-keepalive 171
Device(config-class)# transport tcp
Device(config-class)# sip-profile 100
Device(config-class)# down-interval 30
Device(config-class)# up-interval 60
Device(config-class)# retry 5
Device(config-class)# description Target New York
Device(config-class)# exit

!Configuring an outbound SIP Dial Peer
Device(config)# dial-peer voice 123 voip
Device(config-dial-peer)# session protocol sipv2
!Associating the Dial Peer with a keepalive profile group
Device(config-dial-peer)# voice-class sip options-keepalive profile 171
Device(config-dial-peer)# end

!Verifying the Keepalive group configurations
Device# show voice class sip-options-keepalive 171

Voice class sip-options-keepalive: 171                AdminStat: Up
Description: Target New York
Transport: system                Sip Profiles: 100
Interval(seconds) Up: 60         Down: 30
Retry: 5

  Peer Tag      Server Group      OOD SessID      OOD Stat      IfIndex
  -----      -
  123

```

Example: SIP Out-of-dialog OPTIONS Ping for Group of SIP Servers

```

!Configuring the Server Group
Device(config)# voice class server-group 151
Device(config-class)# ipv4 10.1.1.1 preference 1
Device(config-class)# ipv4 10.1.1.2 preference 2
Device(config-class)# ipv4 10.1.1.3 preference 3
Device(config-class)# hunt-scheme round-robin
Device(config-class)# description It has 3 entries
Device(config-class)# exit

!Configuring an E164 pattern map class
Device(config)# voice class e164-pattern-map 3000
Device(config-class)# e164 300

!Configuring an outbound SIP dial peer.
Device(config)# dial-peer voice 181 voip
!Associate a destination pattern map
Device(config-dial-peer)# destination e164-pattern-map 3000
Device(config-dial-peer)# session protocol sipv2
!Associate a server group with the dial peer
Device(config-dial-peer)# session server-group 151
!Associate the dial peer with a keepalive profile group
Device(config-dial-peer)# voice-class sip options-keepalive profile 171
Device(config-dial-peer)# end

!Verifying the Keepalive group configurations
Device# show voice class sip-options-keepalive 171

Voice class sip-options-keepalive: 171                AdminStat: Up
Description: Target New York

```

```

Transport: system                Sip Profiles: 100
Interval(seconds) Up: 60        Down: 30
Retry: 5

Peer Tag      Server Group  OOD SessID  OOD Stat  IfIndex
-----      -
123
181          151
                                Busy
                                106

Server Group: 151                OOD Stat: Busy
OOD SessID   OOD Stat
-----
1            Busy
2            Busy
3            Busy

OOD SessID: 1                    OOD Stat: Busy
Target: ipv4:10.1.1.1
Transport: system                Sip Profiles: 100

OOD SessID: 2                    OOD Stat: Busy
Target: ipv4:10.1.1.2
Transport: system                Sip Profiles: 100

OOD SessID: 3                    OOD Stat: Busy
Target: ipv4:10.5.0.1
Transport: system                Sip Profiles: 100
-----

```

Additional References

Related Documents

Related Topic	Document Title
Voice commands	Cisco IOS Voice Command Reference
Cisco IOS Commands	Cisco IOS Command List, All Releases
SIP Configuration Guide	
Configuring SIP profiles	
Configuring server groups	

Technical Assistance

Description	Link
<p>The Cisco Support website provides extensive online resources, including documentation and tools for troubleshooting and resolving technical issues with Cisco products and technologies.</p> <p>To receive security and technical information about your products, you can subscribe to various services, such as the Product Alert Tool (accessed from Field Notices), the Cisco Technical Services Newsletter, and Really Simple Syndication (RSS) Feeds.</p> <p>Access to most tools on the Cisco Support website requires a Cisco.com user ID and password.</p>	<p>http://www.cisco.com/support</p>

Feature Information for SIP Out-of-dialog OPTIONS Ping Group

The following table provides release information about the feature or features described in this module. This table lists only the software release that introduced support for a given feature in a given software release train. Unless noted otherwise, subsequent releases of that software release train also support that feature.

Use Cisco Feature Navigator to find information about platform support and Cisco software image support. To access Cisco Feature Navigator, go to <https://cfng.cisco.com/>. An account on Cisco.com is not required.

Table 29: Feature Information for SIP Out-of-dialog OPTIONS Ping Group

Feature Name	Releases	Feature Information
SIP Out-of-dialog OPTIONS Ping Group	Cisco IOS XE Release 3.11S 15.4(1)T	<p>This feature groups the monitoring of SIP dial peers endpoints and servers by consolidating SIP Out-Of-Dialog (OOD) Options of dial peers with the similar SIP OOD Options ping setup.</p> <p>The following commands were introduced or modified: voice class sip-options-keepalive, description, transport, sip-profiles, down-interval, up-interval, voice-class sip options-keepalive profile, retry, show voice class sip-options-keepalive.</p>



CHAPTER 15

Configure TCL IVR Applications

This chapter shows you how to configure Interactive Voice Response (IVR) using the Tool Command Language (TCL) scripts. The Cisco IOS Release 12.1(3)T release introduces TCL IVR Version 2.0 with several feature enhancements to the Cisco IVR functionality. This chapter contains the following sections:

To identify the hardware platform or software image information associated with a feature in this chapter, use the [Feature Navigator](#) on Cisco.com to search for information about the feature or refer to the software release notes for a specific release.

- [Tcl IVR Overview, on page 171](#)
- [Tcl IVR Enhancements, on page 172](#)
- [RTSP Client Implementation, on page 172](#)
- [TCL IVR Prompts Played on IP Call Legs, on page 173](#)
- [TCL Verbs, on page 174](#)
- [TCL IVR Prerequisite Tasks, on page 177](#)
- [TCL IVR Configuration Tasks List, on page 177](#)
- [Configuring the Call Application for the Dial Peer, on page 178](#)
- [Configuring TCL IVR on the Inbound POTS Dial Peer, on page 180](#)
- [Configuring TCL IVR on the Inbound VoIP Dial Peer, on page 182](#)
- [Verifying TCL IVR Configuration, on page 184](#)
- [TCL IVR Configuration Examples, on page 185](#)
- [TCL IVR for Gateway1 \(GW1\) Configuration Example, on page 185](#)
- [TCL IVR for GW2 Configuration Example, on page 188](#)

Tcl IVR Overview

IVR consists of simple voice prompting and digit collection to gather caller information for authenticating the user and identifying the destination. IVR applications can be assigned to specific ports or invoked on the basis of DNIS. An IP public switched telephone network gateway can have several IVR applications to accommodate many different gateway services, and you can customize the IVR applications to present different interfaces to the various callers.

IVR systems provide information in the form of recorded messages over telephone lines in response to user input in the form of spoken words, or more commonly dual tone multifrequency (DTMF) signalling. For example, when a user makes a call with a debit card, an IVR application is used to prompt the caller to enter a specific type of information, such as an account number. After playing the voice prompt, the IVR application collects the predetermined number of touch tones and then places the call to the destination phone or system.

IVR uses TCL scripts gather information and to process accounting and billing. For example, a TCL IVR script plays when a caller receives a voice-prompt instruction to enter a specific type of information, such as a personal identification number (PIN). After playing the voice prompt, the TCL IVR application collects the predetermined number of touch tones and sends the collected information to an external server for user authentication and authorization.



Note Audio playback is not supported when Secure Real-Time Transport Protocol (SRTP) is used with TCL IVR applications.

Tcl IVR Enhancements

Since the introduction of the Cisco IVR technology, the software has undergone several enhancements. TCL IVR Version 2.0 is made up of separate components that are described individually in the sections that follow. The enhancements are as follows:

- Real Time Streaming Protocol (RTSP) client implementation
- TCL IVR prompt playout and digit collection on IP call legs
- New TCL verbs to utilize RTSP scripting features

The enhancements add scalability and enable the TCL IVR scripting functionality on VoIP legs. In addition, support for RTSP enables VoIP gateways to play messages from RTSP-compliant announcement servers. The addition of these enhancements also reduces the CPU load and saves memory on the gateway because no packetization is involved. Larger prompts can be played, and the use of an external audio server is allowed.



Note TCL IVR 2.0 removed the signature locking mechanism requirement.

RTSP Client Implementation

RTSP is an application-level protocol used for control over the delivery of data that has real-time properties. Using RTSP also enables an external RTSP server to play announcements and interact with voice mail servers. It provides an extensive framework to enable control and to perform on-demand delivery of real-time data. For example, RTSP is used to control the delivery of audio streams from an audio server.

If you use an RTSP server in your network with VoIP gateways, a scripting application can run on the gateway and connect calls with audio streams from an external audio server. Using RTSP also has the following benefits:

- Reduces the CPU load
- Allows large prompts to be played that previously demanded high CPU usage from the gateway
- Saves memory on the gateway because no packetization is involved
- Allows use of an external audio server which removes the limitation on the number of prompts that can be played out and on the size of the prompt

TCL IVR Prompts Played on IP Call Legs

TCL IVR Version 2.0 scripts can be configured for incoming plain old telephone service (POTS) or VoIP call legs to play announcements to the user or collect user input (digits). With TCL IVR Version 2.0 the prompts can be triggered from both the PSTN side of the call leg and the IP side of the call leg. This feature enables the audio files (or prompts) to be played out over the IP network.

TCL IVR scripts played toward a VoIP call leg are subject to the following conditions:

- G.711 mu-law encoding must be used when prompts are played.
- G.711 mu-law encoding must also be used for the duration of these calls, even after prompt playout has completed.
- Digital signaling protocols (DSPs) can not be on the IP call leg so the script cannot initiate a tone.
- When an TCL IVR script is used to collect digits on a VoIP call leg, one of the following DTMF relay methods must be used.
 - For H.323 protocol configured on the call leg, use one of the following DTMF relay methods: Cisco proprietary RTP, H.245 Alphanumeric IE, or H.245 Signal IE
 - For SIP protocol configured on the call leg, use Cisco proprietary RTP



Note For additional information about the **dtmf-relay** command, refer to the [Cisco IOS Voice Command Reference - D through I](#).

IVR 2.0 enables the system to accept calls initiated from the IP side of the network using G.711, and terminate calls to the terminating gateway using the same codec. [Figure 21: IVR Control of Scripts on an IP Call Leg, on page 174](#) displays the TCL IVR application on the gateways controlling the scripts. IP phones can also originate a call to a gateway running an TCL IVR script.

Figure 21: IVR Control of Scripts on an IP Call Leg

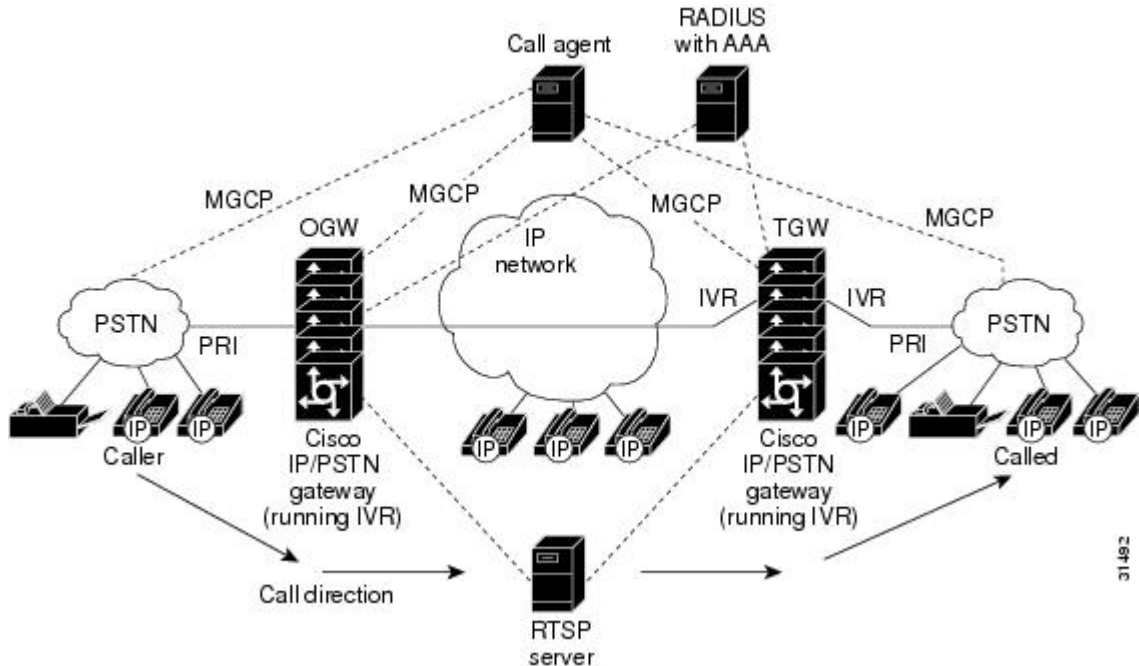

TCL Verbs

TCL IVR, Version 2.0, delivers a new set of TCL verbs and scripts that replace the previous TCL version. The new TCL verbs enable the user to:

- Utilize the RTSP audio servers
- Develop TCL scripts that interact with the IVR application
- Pass events to the Media Gateway Controller, which is a call agent

TCL IVR Version 2.0 is not backward compatible with the IVR 1.0 scripts.



Note For in-depth information about the TCL 2.0 verb set and how to develop scripts, refer to Cisco.com (Related Documentation index).

TCL IVR scripts use the TCL verbs to interact with the gateway during call processing in order to collect the required digits—for example, to request the PIN or account number for the caller. The TCL scripts are the default scripts for all Cisco voice features using IVR. TCL scripts are configured to control calls coming into or going out of the gateway.



Note Ensure that you have loaded the version of TCL scripts that support IVR Version 2.

The TCL IVR scripts shown below are listed as an example of the types of scripts available to be downloaded from the cisco.com Software Center. For a complete list of scripts, it is recommended that you check the Software Center.

Cisco provides the following IVR scripts:

- `fax_hop_on_1`—Collects digits from the redialer, such as account number and destination number. When a call is placed to an H.323 network, the set of fields (configured in the call information structure) are "entered", "destination", and "account".
- `clid_authen`—Authenticates the call with automatic number identification (ANI) and DNIS numbers, collects the destination data, and makes the call.
- `clid_authen_npw`—Performs as `clid_authen`, but uses a null password when authenticating, rather than DNIS numbers.
- `clid_authen_collect`—Authenticates the call with ANI and DNIS numbers and collects the destination data. If authentication fails, it collects the account and password.
- `clid_authen_col_npw`—Performs as `clid_authen_collect`, but uses a null password and does not use or collect DNIS numbers.
- `clid_col_npw_3`—Performs as `clid_authen_col_npw` except with that script, if authentication with the digits collected (account and PIN) fails, the `clid_authen_col_npw` script just plays a failure message (`auth_failed.au`) and then hangs up. The `clid_col_npw_3` script allows two failures, then plays the retry audio file (`auth_retry.au`) and collects the account and PIN again.
- The caller can interrupt the message by entering digits for the account number, triggering the prompt to tell the caller to enter the PIN. If authentication fails the third time, the script plays the audio file `auth_fail_final.au`, and hangs up.

[Table 30: `clid_col_npw_3` Script Prompt Audio Files, on page 175](#) lists the prompt audio files associated with the `clid_col_npw_3` script.

Table 30: `clid_col_npw_3` Script Prompt Audio Files

Audio Filename	Action
<code>flash:enter_account.au</code>	Asks the caller to enter an account number. Played as the first request.
<code>flash:auth_fail_retry.au</code>	Asks the caller to reenter the account number. Plays after two failures.
<code>flash:enter_pin.au</code>	Asks the caller to enter a PIN.
<code>flash:enter_destination.au</code>	Asks the caller to enter a destination phone number.
<code>flash:auth_fail_final.au</code>	Informs the caller that the account number authorization has failed three times.

[Table 31: Additional `clid_col_npw_3` Script Audio Files, on page 175](#) lists additional audio files associated with the `clid_col_npw_3` script.

Table 31: Additional `clid_col_npw_3` Script Audio Files

Audio Filename	Action
----------------	--------

auth_fail_retry.au	Informs the caller that authorization failed. Prompts the caller to reenter the account number followed by the pound sign (#).
auth_fail_final.au	Informs the caller, "I'm sorry, your account number cannot be verified. Please hang up and try again."

- `clid_col_npw_npw`—Tries to authenticate by using ANI, null as the user ID, user, and user password pair. If that fails, it collects an account number and authenticates with account and null. It allows three tries for the caller to enter the account number before ending the call with the authentication failed audio file. If authentication succeeds, it plays a prompt to enter the destination number.

[Table 32: clid_col_npw_npw Script Audio Files, on page 176](#) lists the audio files associated with the `clid_col_npw_npw` script.

Table 32: clid_col_npw_npw Script Audio Files

Audio Filename	Action
flash:enter_account.au	Asks the caller to enter the account number the first time.
flash:auth_fail_retry.au	Asks the caller to reenter the account number after first two failures.
flash:enter_destination.au	Asks the caller to enter the destination phone number.
flash:auth_fail_final.au	Informs the caller that the account number authorization has failed three times.

- `clid_col_dnis_3.tcl`—Authenticates the caller ID three times. First it authenticates the caller ID with DNIS. If that is not successful, it attempts to authenticate with the caller PIN up to three times.
- `clid_col_npw_3.tcl`—Authenticates with null. If authentication is not successful, it attempts to authenticate by using the caller PIN up to 3 times.
- `clid_4digits_npw_3.tcl`—Authenticates with null. If the authentication is not successful, it attempts to authenticate with the caller PIN up to 3 times using the 14-digit account number and password entered together.
- `clid_4digits_npw_3_cli.tcl`—Authenticates the account number and PIN respectively by using ANI and null. The number of digits allowed for the account number and password are configurable through the CLI. If the authentication fails, it allows the caller to retry. The retry number is also configured through the CLI.
- `clid_authen_col_npw_cli.tcl`—Authenticates the account number and PIN respectively using ANI and null. If the authentication fails, it allows the caller to retry. The retry number is configured through the CLI. The account number and PIN are collected separately.
- `clid_authen_collect_cli.tcl`—Authenticates the account number and PIN by using ANI and DNIS. If the authentication fails, it allows the caller to retry. The retry number is configured through the CLI. The account number and PIN are collected separately.
- `clid_col_npw_3_cli.tcl`—Authenticates by using ANI and null for account and PIN respectively. If the authentication fails, it allows the caller to retry. The retry number is configured through the CLI.

- `clid_col_npw_npw_cli.tcl`—Authenticates by using ANI and null for account and PIN respectively. If authentication fails, it allows the caller to retry. The retry number is configured through the CLI. The account number and PIN are collected together.



Note To display the contents of the TCL IVR script, use the `show call application voice` command.

TCL IVR Prerequisite Tasks

Before you configure your Cisco gateway to support TCL IVR, you must perform the following prerequisite tasks:

- Configure VoIP to support H.323-compliant gateways—meaning that in addition to the basic configuration tasks, such as configuring dial peers and voice ports, you must configure specific devices in your network to act as gateways.
- Configure a TFTP sever to perform storage and retrieval of the audio files, which are required by the Debit Card gateway or other features requiring TCL IVR scripts and audio files.
- Download the appropriate TCL IVR script from the Cisco.com. Use the **copy** command to copy your audio file (.au file) to your Flash memory, and the **audio-prompt load** command to read it into RAM. When you use TCL IVR applications, the gateway needs to know the URL where the TCL script can be found, as well as the URL of any audio file you want to use. Cisco IOS File System (IFS) is used to read the files, so any IFS-supported URLs can be used, which includes TFTP, FTP, or a pointer to a device on the router. During configuration of the application, you specify the URLs for the script and for the audio prompt. See the "Using URLs in IVR Scripts" chapter in the *TCL IVR API Version 2.0 Programmer's Guide* for more information.
- Make sure that your audio files are in the proper format. The TCL IVR prompts require audio file (.au) format of 8-bit, u-law, and 8-khz encoding. To encode your own audio files, we recommend that you use one of these two audio tools (or a tool of similar quality):
 - Cool Edit, manufactured by Syntrillium Software Corporation
 - AudioTool, manufactured by Sun Microsystems
- Make sure that your access platform has a minimum of 16 MB Flash and 128MB of DRAM memory.
- Install and configure the appropriate RADIUS security server in your network. The version of RADIUS that you are using must be able to support IETF-supported vendor specific attributes (VSAs), which are implemented by using IETF RADIUS attribute 26.

TCL IVR Configuration Tasks List

Before starting the software configuration tasks for the TCL IVR Version 2.0 features, complete the following preinstallation tasks:

- Download the TCL scripts and audio files to be used with this feature from the Cisco.com.

- Store the TCL scripts and audio files on a TFTP server configured to interact with your gateway access server.
- Create the TCL IVR application script to use with the **call application voice** command when configuring IVR using TCL scripts. You create this application first and store it on a server or location where it can be retrieved by the access server.
- Define the call flow and pass the defined parameter values to the application. Depending on the TCL script you select, these values can include the language of the audio file and the location of the audio file. [Table 30: clid_col_npw_3 Script Prompt Audio Files, on page 175](#) lists the TCL scripts and the parameter values they require.
- Associate the application to the incoming POTS or VoIP dial peer.



Note When an IVR script is used to detect a "long #" from a caller connected to the H.323 call leg, the DTMF method used must either be Cisco proprietary RTP or DTMF relay using H.245 signal IE. DTMF relay using H.245 alphanumeric IE does not report the actual duration of the digit, causing long pound (#) detection to fail.

Configuring the Call Application for the Dial Peer

Before you begin

You must configure the application that interacts with the dial peer before you configure the dial peer. The dial peer collects digits from the caller and uses the application you have created. Use the call application voice command as shown in the table that follows. Each command line is optional depending on the type of action desired or the digits to be collected.

To configure the application, enter the following commands in global configuration mode:

SUMMARY STEPS

1. **call application voice** *name url*
2. **call application voice** *name language digit language*
3. **call application voice** *name pin-length number*
4. **call application voice** *name retry-count number*
5. **call application voice** *name uid-length number*
6. **call application voice** *name set-location language category location*

DETAILED STEPS

	Command or Action	Purpose
Step 1	call application voice <i>name url</i> Example: Router(config)# call application voice <i>name url</i>	Defines the name of the application to be used with your TCL IVR script. The <i>url</i> argument specifies the location of the file and the access protocol. An example is as follows: flash:scripts/session.tcl

	Command or Action	Purpose
		<pre>tftp://dir/sarvi/scripts/session.tcl ftp://sarvi-ultra/scripts/session.tcl slot0:scripts/tcl/session..tcl</pre> <p>Note You can only configure a url if the application named <i>name</i> has <i>not</i> been configured.</p>
Step 2	<p>call application voice <i>name</i> language <i>digit</i> language</p> <p>Example:</p> <pre>Router(config)# call application voice name language digit language</pre>	<p>Specifies the language used by the audio files. An example is: <code>call application voice test language 1 en</code>. The arguments are as follows:</p> <ul style="list-style-type: none"> • <i>digit</i>—Specifies zero (0) through 9. • <i>language</i>—Specifies two characters that represent a language. For example, "en" for English, "sp" for Spanish, and "ch" for Mandarin. Enter aa to represent all.
Step 3	<p>call application voice <i>name</i> pin-length <i>number</i></p> <p>Example:</p> <pre>Router(config)# call application voice name pin-length number</pre>	<p>Defines the number of characters in the PIN for the designated application. Values are from 0 through 10.</p>
Step 4	<p>call application voice <i>name</i> retry-count <i>number</i></p> <p>Example:</p> <pre>Router(config)# call application voice name retry-count number</pre>	<p>Defines the number of times a caller is permitted to reenter the PIN for the designated application. Values are from 1 through 5.</p>
Step 5	<p>call application voice <i>name</i> uid-length <i>number</i></p> <p>Example:</p> <pre>Router(config)# call application voice name uid-length number</pre>	<p>Defines the number of characters allowed to be entered for the user ID for the designated application. Values are from 1 through 20.</p>
Step 6	<p>call application voice <i>name</i> set-location <i>language</i> <i>category</i> <i>location</i></p> <p>Example:</p> <pre>Router(config)# call application voicenameset-locationlanguage category location</pre>	<p>Defines the location, language, and category of the audio files for the designated application. An example is: set-location en 1 tftp://server dir/audio filename.</p>

What to do next

The following table lists TCL script names and the corresponding parameters that are required for each TCL scripts.

Table 33: TCL Scripts and Parameters

TCL Script Name	Description—Summary	Commands to Configure
clid_4digits_npw_3_cli.tcl	Authenticates the account number and PIN using ANI and null. The allowed length of digits is configurable through the CLI. If the authentication fails, it allows the caller to retry. The retry number is also configured through the CLI.	call application voice uid-len min = 1, max = 20, default = 10 call application voice pin-len min = 0, max = 10, default = 4 call application voice retry-count min = 1, max = 5, default = 3
clid_authen_col_npw_cli.tcl	Authenticates the account number and PIN using ANI and null. If the authentication fails, it allows the caller to retry. The retry number is configured through the CLI. The account number and PIN are collected separately.	call application voice retry-count min = 1, max = 5, default = 3
clid_authen_collect_cli.tcl	Authenticates the account number and PIN using ANI and DNIS. If the authentication fails, it allows the caller to retry. The retry number is configured through the CLI. The account number and PIN are collected separately.	call application voice retry-count min = 1, max = 5, default = 3
clid_col_npw_3_cli.tcl	Authenticates using ANI and null for account and PIN. If the authentication fails, it allows the caller to retry. The retry number is configured through the CLI.	call application voice retry-count min = 1, max = 5, default = 3
clid_col_npw_npw_cli.tcl	Authenticates using ANI and null for account and PIN. If authentication fails, it allows the caller to retry. The retry number is configured through the CLI. The account number and PIN are collected together.	call application voice retry-count min = 1, max = 5, default = 3

Configuring TCL IVR on the Inbound POTS Dial Peer

Before you begin

Configuring gw-accounting and AAA are not always required for POTS dial peer configuration. It is dependent upon the type of application that is being used with TCL IVR. For example, the Pre-Paid Calling Card feature requires accounting and the authentication caller ID application does not.

To configure the inbound POTS dial peer, use the following commands beginning in global configuration mode:

SUMMARY STEPS

1. **aaa new-model**
2. **gw-accounting h323**
3. **aaa authentication login h323 radius**
4. **aaa accounting connection h323 start-stop radius**
5. **radius-server host *ip-address* auth-port *number* acct-port *number***
6. **radius-server key *key***
7. **dial-peer voice *number* pots**
8. **application *name***
9. **destination-pattern *string***
10. **session target**

DETAILED STEPS

	Command or Action	Purpose
Step 1	aaa new-model Example: Router(config)# aaa new-model	(Optional) Enables AAA security and accounting services.
Step 2	gw-accounting h323 Example: Router(config)# gw-accounting h323	(Optional) Enables gateway-specific H.323 accounting.
Step 3	aaa authentication login h323 radius Example: Router(config)# aaa authentication login h323 radius	(Optional) Defines a method list called H.323 where RADIUS is defined as the only method of login authentication.
Step 4	aaa accounting connection h323 start-stop radius Example: Router(config)# aaa accounting connection h323 start-stop radius	(Optional) Defines a method list called H.323 where RADIUS is used to perform connection accounting, providing start-stop records.
Step 5	radius-server host <i>ip-address</i> auth-port <i>number</i> acct-port <i>number</i> Example: Router(config)# radius-server host <i>ip-address</i> auth-port <i>number</i> acct-port <i>number</i>	Identifies the RADIUS server and the ports that will be used for authentication and accounting services.
Step 6	radius-server key <i>key</i> Example: Router(config)# radius-server key <i>key</i>	Specifies the password used between the gateway and the RADIUS server.

	Command or Action	Purpose
Step 7	dial-peer voice <i>number pots</i> Example: Router(config)# dial-peer voice <i>number pots</i>	Enters dial-peer configuration mode to configure the incoming POTS dial peer. The <i>number</i> argument is a tag that uniquely identifies the dial peer.
Step 8	application <i>name</i> Example: Router(dial-peer)# application <i>name</i>	Associates the TCL IVR application with the incoming POTS dial peer. Enter the selected TCL IVR application name.
Step 9	destination-pattern <i>string</i> Example: Router(config-dial-peer)# destination-pattern <i>string</i>	Enters the telephone number associated with this dial peer. The <i>pattern</i> argument is a series of digits that specify the E.164 or private dialing plan telephone number. Valid entries are numbers from zero (0) through nine and letters from A through D. The following special characters can be entered in the string: <ul style="list-style-type: none"> • Plus sign (+)—(Optional) Indicates an E.164 standard number. The plus sign (+) is not supported on the Cisco MC3810 multiservice concentrator. • <i>string</i>—Specifies the E.164 or private dialing plan telephone number. Valid entries are the digits 0 through 9, the letters A through D, and the following special characters: <ul style="list-style-type: none"> • Asterisk (*) and pound sign (#) that appear on standard touch-tone dial pads. • Comma (,) inserts a pause between digits. • Period (.) matches any entered digit (this character is used as a wildcard). • T—(Optional) Indicates that the destination-pattern value is a variable length dial-string.
Step 10	session target Example: Router(config-dial-peer)# session target	Specifies the session target IP address.

Configuring TCL IVR on the Inbound VoIP Dial Peer

Before you begin

To configure the inbound VoIP dial peer, use the following commands beginning in global configuration mode:

SUMMARY STEPS

1. **dial-peer voice** *4401 voip*
2. **application** *application-name*
3. **destination-pattern** *pattern*
4. **session protocol** *sipv2*
5. **session target**
6. **dtmf-relay** *cisco-rtp*
7. **codec** *g711ulaw*

DETAILED STEPS

	Command or Action	Purpose
Step 1	dial-peer voice <i>4401 voip</i> Example: Router(config)# dial-peer voice <i>4401 voip</i>	Enters the dial-peer configuration mode and identifies the call leg.
Step 2	application <i>application-name</i> Example: Router(config-dial-peer)# application <i>application-name</i>	Specifies the name of the application and script to use.
Step 3	destination-pattern <i>pattern</i> Example: Router(config-dial-peer)# destination-pattern <i>pattern</i>	Enters the destination pattern.
Step 4	session protocol <i>sipv2</i> Example: Router(config-dial-peer)# session protocol <i>sipv2</i>	Specifies the session protocol. The default session protocol is H.323. The <i>sipv2</i> argument enables SIP.
Step 5	session target Example: Router(config-dial-peer)# session target	Specifies the session target IP address.
Step 6	dtmf-relay <i>cisco-rtp</i> Example: Router(config-dial-peer)# dtmf-relay <i>cisco-rtp</i>	Specifies the DTMF relay method. The keyword cisco-rtp specifies H.323 and SIP. Other keywords that are available only for H.323 are h245-alphanumeric and h245-signal . Note If digit collection from this VoIP call leg is required, the command dtmf-relay is required. The default is no dtmf-relay .
Step 7	codec <i>g711ulaw</i> Example: Router(config-dial-peer)# codec <i>g711ulaw</i>	Specifies the voice codec. Note If the configured application will be playing prompts to the VoIP call leg, the g711ulaw keyword is required.

Verifying TCL IVR Configuration

Before you begin

You can verify TCL IVR configuration by performing the following tasks:

- To verify TCL IVR configuration parameters, use the show running-config command.
- To display a list of all voice applications, use the show call application summary command.
- To display a list of all voice applications, use the show call application summary command.
- To show the contents of the script configured, use the show call application voice command.
- To verify that the operational status of the dial peer, use the show dial-peer voice command.

To verify the TCL IVR configuration, perform the following steps:

Step 1

Enter the show call application voice summary command to verify that the newly created applications are listed. The example output follows

```
Router# show call application voice summary
```

name	description
DEFAULT	NEW::Basic app to do DID, or supply dialtone.
fax_hop_on	Script to talk to a fax redialer
clid_authen	Authenticate with (ani, dnis)
clid_authen_collect	Authenticate with (ani, dnis), collect if that fails
clid_authen_npw	Authenticate with (ani, NULL)
clid_authen_col_npw	Authenticate with (ani, NULL), collect if that fails
clid_col_npw_3	Authenticate with (ani, NULL), and 3 tries collecting
clid_col_npw_npw	Authenticate with (ani, NULL) and 3 tries without pw
SESSION	Default system session application
hotwo	tftp://hostname/scripts/nb/nb_handoffTwoLegs.tcl
hoone	tftp://hostname/scripts/nb/nb_dohandoff.tcl
hodemst	tftp://hostname/scripts/nb/nb_handoff.tcl
clid	tftp://hostname/scripts/tcl_ivr/clid_authen_collect.tcl
db102	tftp://hostname/scripts/1.02/debitcard.tcl
*hw	tftp://171.69.184.xxx/tr_hello.tcl

name	description
*hw1	tftp://san*tr_db

```
tftp://171.69.184.235/tr_debitcard.answer.tcl
```

```
TCL Script Version 2.0 supported.
TCL Script Version 1.1 supported.
```

Note In the output shown, an asterisk (*) in an application indicates that this application was not loaded successfully. Use the **show call application voice** command with the *name* argument to view information for a particular application.

- Step 2** Enter the **show dial-peer voice** command with the *peer tag* argument and verify that the application associated with the dial peer is correct.
- Step 3** Enter the **show running-config** command to display the entire configuration.

TCL IVR Configuration Examples

Use the **show running-config** command to display the entire gateway configuration. [Figure 22: Example Configuration Topology, on page 185](#) shows the type of topology used in the configuration for the example.

In this example configuration, GW1 is running TCL IVR for phone A, and GW2 is running TCL IVR for phone B.

This section provides the following configuration examples:

Figure 22: Example Configuration Topology



TCL IVR for Gateway1 (GW1) Configuration Example

The following output is the result of using the **show running-config** command:

```

GW1
Router# show running-config

Building configuration...

Current configuration:

! Last configuration change at 08:39:29 PST Mon Jan 10 2000 by lab
!
version 12.2
service timestamps debug datetime msec
service timestamps log datetime msec
no service password-encryption

```

```

!
hostname GW1
!
logging buffered 100000 debugging
aaa new-model
aaa authentication login default local group radius
aaa authentication login h323 group radius
aaa authentication login con none
aaa authorization exec h323 group radius
aaa accounting connection h323 start-stop group radius
enable password xxx
!
username lab password 0 lab
!
resource-pool disable
!
clock timezone PST -8
ip subnet-zero
ip host baloo 1.14.124.xxx
ip host dirt 223.255.254.254
ip host rtspserver3 1.14.1xx.2
ip host rtspserver1 1.14.1xx.2
!
mgcp package-capability trunk-package
mgcp default-package trunk-package
isdn switch-type primary-net5
isdn voice-call-failure 0
!
tftp://dirt/hostname/WV/en_new/
call application voice debit_card tftp://dirt/Router/scripts.new/app_debitcard.tcl
call application voice debit_card uid-len 6
call application voice debit_card language 1 en
call application voice debit_card language 2 ch
call application voice debit_card set-location ch 0 tftp://dirt/hostname/WV/ch_new/
call application voice debit_card set-location en 0 tftp://dirt/hostname/WV/en_new/
call application voice debit_card_rtsp tftp://dirt/IVR 2.0/scripts.new/app_debitcard.tcl
call application voice debit_card_rtsp uid-len 6
call application voice debit_card_rtsp language 1 en
call application voice debit_card_rtsp language 2 ch
call application voice debit_card_rtsp set-location ch 0 rtsp://rtspserver1:554/
call application voice debit_card_rtsp set-location en 0 rtsp://rtspserver1:554/

mta receive maximum-recipients 0
!
controller E1 0
  clock source line primary
  pri-group timeslots 1-31
!
controller E1 1
!
controller E1 2
!
controller E1 3
!
gw-accounting h323
gw-accounting h323 vsa
gw-accounting voip
!
interface Ethernet0
  ip address 1.14.128.35 255.255.255.xxx
  no ip directed-broadcast
  h323-gateway voip interface
  h323-gateway voip id gk1 ipaddr 1.14.128.19 1xxx
  h323-gateway voip h323-id gw1@cisco.com

```



```
h323-gateway voip tech-prefix 5#
!
interface Serial0:15
  no ip address
  no ip directed-broadcast
  isdn switch-type primary-net5
  isdn incoming-voice modem
  fair-queue 64 256 0
  no cdp enable
!
interface FastEthernet0
  ip address 16.0.0.1 255.255.xxx.0
  no ip directed-broadcast
  duplex full
  speed auto
  no cdp enable
!
ip classless
ip route 0.0.0.0 0.0.0.0 1.14.128.33
ip route 1.14.xxx.0 255.xxx.255.xxx 16.0.0.2
ip route 1.14.xxx.16 255.xxx.255.240 1.14.xxx.33
no ip http server
!
radius-server host 1.14.132.2 auth-port 1645 acct-port 1646
radius-server key cisco
radius-server vsa send accounting
radius-server vsa send authentication
!
voice-port 0:D
  cptone DE
!
dial-peer voice 200 voip
  incoming called-number 53
  destination-pattern 34.....
  session target ipv4:16.0.0.2
  dtmf-relay h245-alphanumeric
  codec g711ulaw
!
dial-peer voice 102 pots
  application debit_card_rtsp
  incoming called-number 3450072
  shutdown
  destination-pattern 53.....
  port 0:D
!
dial-peer voice 202 voip
  shutdown
  destination-pattern 34.....
  session protocol sip2
  session target ipv4:16.0.0.2
  dtmf-relay cisco-rtp
  codec g711ulaw
!
dial-peer voice 101 pots
  application debit_card
  incoming called-number 3450070
  destination-pattern 53.....
  port 0:D
!
gateway
!
line con 0
  exec-timeout 0 0
  transport input none
```

```

line aux 0
line vty 0 4
  password xxx
!
ntp clock-period 17180740
ntp server 1.14.42.23
end

GW1#

```

TCL IVR for GW2 Configuration Example

The following output is the result of using the **show running-config** command:

```

GW2#
Router# show running-config

Building configuration...

Current configuration:
!
! Last configuration change at 08:41:12 PST Mon Jan 10 2000 by lab
!
version 12.2
service timestamps debug uptime
service timestamps log uptime
no service password-encryption
!
hostname GW2
!
logging buffered 100000 debugging
aaa new-model
aaa authentication login default local group radius
aaa authentication login h323 group radius
aaa authentication login con none
aaa authorization exec h323 group radius
aaa accounting connection h323 start-stop group radius
!
username lab password xxx
username 111119 password xxx
!
resource-pool disable
!
clock timezone PST -8
ip subnet-zero
ip host radiusserver2 1.14.132.2
ip host radiusserver1 1.14.138.11
ip host baloo 1.14.124.254
ip host rtspserver2 1.14.136.2
ip host dirt 223.255.254.254
ip host rtspserver3 1.14.126.2
!
mgcp package-capability trunk-package
mgcp default-package trunk-package
isdn switch-type primary-5ess
isdn voice-call-failure 0
!
call application voice clid_authen_sky
tftp://dirt/hostname/sky_scripts/clid_authen_collect_cli_sky.tcl

call application voice rtsp_demo tftp://dirt/hostname/sky_scripts/rtsp_demo.tcl

```

```

tftp://dirt/hostname/WV/en_new/
call application voice debit_card tftp://dirt/IVR 2.0/scripts.new/app_debitcard.tcl
call application voice debit_card uid-len 6
call application voice debit_card language 1 en
call application voice debit_card language 2 ch
call application voice debit_card set-location ch 0 tftp://dirt/hostname/WV/ch_new/
call application voice debit_card set-location en 0 tftp://dirt/hostname/WV/en_new/
call application voice clid_authen_rtsp tftp://dirt/IVR
2.0/scripts.new/app_clid_authen_collect_cli_rtsp.tcl

call application voice clid_authen_rtsp location rtsp://rtspserver2:554/
call application voice clid_authen1 tftp://dirt/IVR
2.0/scripts.new/app_clid_authen_collect_cli_rtsp.tcl
call application voice clid_authen1 location tftp://dirt/hostname/WV/en_new/
call application voice clid_authen1 uid-len 6
call application voice clid_authen1 retry-count 4
mta receive maximum-recipients 0
!
controller T1 0
 framing esf
 clock source line primary
 linecode b8zs
 pri-group timeslots 1-24
!
controller T1 1
 clock source line secondary 1
!
controller T1 2
!
controller T1 3
!
gw-accounting h323
gw-accounting h323 vsa
gw-accounting voip
!
interface Ethernet0
 ip address 1.14.xxx.4 255.255.xxx.240
 no ip directed-broadcast
 h323-gateway voip interface
 h323-gateway voip id gk2 ipaddr 1.14.xxx.18 1719
 h323-gateway voip h323-id gw2@cisco.com
 h323-gateway voip tech-prefix 3#
!
interface Serial0:23
 no ip address
 no ip directed-broadcast
 isdn switch-type primary-5ess
 isdn incoming-voice modem
 fair-queue 64 256 0
 no cdp enable
!
interface FastEthernet0
 ip address 16.0.0.2 255.xxx.255.0
 no ip directed-broadcast
 duplex full
 speed 10
 no cdp enable
!
ip classless
ip route 0.0.0.0 0.0.0.0 1.14.xxx.5
ip route 1.14.xxx.32 255.255.xxx.240 16.0.0.1
no ip http server
!
radius-server host 1.14.132.2 auth-port 1645 acct-port 1646

```

```
radius-server key cisco
radius-server vsa send accounting
radius-server vsa send authentication
!
voice-port 0:D
!
dial-peer voice 100 voip
  application debit_card
  incoming called-number 34
  shutdown
  destination-pattern 53.....
  session target ras
  dtmf-relay h245-alphanumeric
  codec g711ulaw
!
dial-peer voice 200 pots
  incoming called-number 30001
  destination-pattern 3450070
  port 0:D
  prefix 50070
!
dial-peer voice 101 voip
  application debit_card
  incoming called-number 34.....
  shutdown
  session protocol sipv2
  session target ipv4:16.0.0.1
  dtmf-relay cisco-rtp
  codec g711ulaw
!
dial-peer voice 102 voip
  incoming called-number 34.....
  destination-pattern 53.....
  session target ipv4:16.0.0.1
  dtmf-relay h245-alphanumeric
  codec g711ulaw
!
gateway
!
line con 0
  exec-timeout 0 0
  transport input none
line aux 0
line vty 0 4
  password xxx
!
ntp clock-period 17180933
ntp server 1.14.42.23
end

GW2#
```



CHAPTER 16

VoIP for IPv6

This document describes VoIP in IPv6 (VoIPv6), a feature that adds IPv6 capability to existing VoIP features. This feature adds dual-stack (IPv4 and IPv6) support on voice gateways and media termination points (MTPs), IPv6 support for Session Initiation Protocol (SIP) trunks, and support for Skinny Client Control Protocol (SCCP)-controlled analog voice gateways. In addition, the Session Border Controller (SBC) functionality of connecting a SIP IPv4 or H.323 IPv4 network to a SIP IPv6 network is implemented on a Cisco UBE to facilitate migration from VoIPv4 to VoIPv6.

- [Prerequisites for VoIP for IPv6, on page 191](#)
- [Restrictions for Implementing VoIP for IPv6, on page 191](#)
- [Information About VoIP for IPv6, on page 193](#)
- [How to Configure VoIP for IPv6, on page 199](#)
- [Configuration Examples for VoIP over IPv6, on page 222](#)
- [Troubleshooting Tips for VoIP for IPv6, on page 223](#)
- [Verifying and Troubleshooting Tips, on page 223](#)
- [Feature Information for VoIP for IPv6, on page 241](#)

Prerequisites for VoIP for IPv6

- Cisco Express Forwarding for IPv6 must be enabled.
- Virtual routing and forwarding (VRF) is not supported in IPv6 calls.
- One of the following releases is installed and running on your CUBE:
 - Cisco IOS Release 12.4(22)T or a later
 - Cisco IOS XE Release 3.3S or a later

Restrictions for Implementing VoIP for IPv6

The following are the restrictions for Cisco UBE features:

Media Flow-Through

- Video call flows with Alternative Network Address Types (ANAT) are not supported.

- Webex call flow with ANAT is not supported (Cisco UBE does not support ANAT on Video and Application media types).

SDP Pass-Through

- Supports only Early Offer (EO)–Early Offer (EO) and Delayed Offer (DO)–Delayed Offer (DO) call flows.
- Delayed Offer–Early Offer call flow falls back to Delayed Offer–Delayed Offer call flow.
- Supplementary services are not supported on SDP Pass-Through.
- Transcoding and DTMF interworking are not supported.



Note The above SDP Pass-Through restrictions are applicable for both IPv4 and IPv6.

- SDP Pass-Through does not support the dual-stack functionality.
- ANAT call flows do not support IPv4-to-IPv6 and IPv6-to-IPv4 Media interworking.

UDP Checksum

- CEF and process options are not supported on ASR1000 series routers.
- None option is partially supported on ISR-G2.

Media Anti-Trombone

- Media Anti-Trombone is not enabled if the initial call before tromboning is in Flow-Around (FA) mode.
- Media Anti-Trombone supports only symmetric media address type interworking (IPv4-IPv4 or IPv6-IPv6 media) with or without ANAT.
- Does not provide support for IPv4-IPv6 interworking cases with or without ANAT because Cisco UBE cannot operate in FA mode post tromboning.

IPv6 and IPv4 SRTP Interoperability

- IPv6 and IPv4 SRTP interoperability is not supported.
- When dual stack is configured with preference to IPv4, crypto keys appear only under IPv4. It does not appear under IPv6.

When dual stack is configured with preference to IPv6, crypto keys appear only under IPv6. It does not appear under IPv4.

Information About VoIP for IPv6

SIP Features Supported on IPv6

The Session Initiation Protocol (SIP) is an alternate protocol that is developed by the Internet Engineering Task Force (IETF) for multimedia conferencing over IP.

The Cisco SIP functionality enables Cisco access platforms to signal the setup of voice and multimedia calls over IP networks. SIP features also provide advantages in the following areas:

- Protocol extensibility
- System scalability
- Personal mobility services
- Interoperability with different vendors

A SIP User Agent (UA) operates in one of the following three modes:

- IPv4-only: Communication with only IPv6 UA is unavailable.
- IPv6-only: Communication with only IPv4 UA is unavailable.
- Dual-stack: Communication with only IPv4, only IPv6 and dual-stack UAs are available.

Dual-stack SIP UAs use Alternative Network Address Transport (ANAT) grouping semantics:

- Includes both IPv4 and IPv6 addresses in the Session Description Protocol (SDP).
- Is automatically disabled in dual-stack mode (can be enabled if necessary).
- Requires media to be bound to an interface that have both IPv4 and IPv6 addresses.
- Described in RFC 4091 and RFC 4092 (RFC 5888 describes general SDP grouping framework).

SIP UAs use “sdp-anat” option tag in the Required and Supported SIP header fields:

- Early Offer (EO) INVITE using ANAT semantics places “sdp-anat” in the Require header.
- Delayed Offer (DO) INVITE places “sdp-anat” in the Supported header.

SIP Signaling and Media Address Selection:

- Source address for SIP signaling is selected based on the destination signaling address type that is configured in the session-target of the outbound dial-peer:
 - If signaling bind is configured, source SIP signaling address is chosen from the bound interface.
 - If signaling bind is not configured, source SIP signaling address is chosen based on the best address in the UA to reach the destination signaling address.

SDP may or may not use ANAT semantics:

- When ANAT is used, media addresses in SDP are chosen from the interface media that is configured. When ANAT is not used, media addresses in SDP are chosen from the interface media that is configured OR based on the best address to reach the destination signaling address (when no media bind is configured).

SIP Voice Gateways in VoIPv6

Session Initiation Protocol (SIP) is a simple, ASCII-based protocol that uses requests and responses to establish communication among the various components in the network and to ultimately establish a conference between two or more endpoints.

In addition to the already existing features that are supported on IPv4 and IPv6, the SIP Voice Gateways support the following features:

- **History–Info:** The SIP History–info Header Support feature provides support for the history-info header in SIP INVITE messages only. The SIP gateway generates history information in the INVITE message for all forwarded and transferred calls. The history-info header records the call or dialog history. The receiving application uses the history-info header information to determine how and why the call has reached it.

For more information, refer to the “SIP History INFO” section in the [Cisco Unified Border Element \(Enterprise\) SIP Support Configuration Guide](#).

- **Handling 181/183 Responses with/without SDP:** The Handling 181/183 Responses with/without SDP feature provides support for SIP 181 (Call is Being Forwarded) and SIP 183 (Session Progress) messages either globally or on a specific dial-peer. Also, you can control when the specified SIP message is dropped based on either the absence or presence of SDP information.

For more information, refer to “SIP–Enhanced 180 Provisional Response Handling” section in the [Cisco Unified Border Element Configuration Guide](#).

- **Limiting the Rate of Incoming SIP Calls per Dial-Peer (Call Spike):** The call rate-limiting feature for incoming SIP calls starts working after a switch over in a SIP call. The rate-limiting is done for new calls received on the new Active. The IOS timers that track the call rate limits runs on active and standby mode and does not require any checkpoint. However, some statistics for calls rejected requires to be checked for the show commands to be consistent before and after the switchover.
- **PPI/PAI/Privacy and RPID Passing:** For incoming SIP requests or response messages, when the PAI or PPI privacy header is set, the SIP gateway builds the PAI or PPI header into the common SIP stack, thereby providing support to handle the call data present in the PAI or PPI header. For outgoing SIP requests or response messages, when the PAI or PPI privacy header is set, privacy information is sent using the PAI or PPI header.

For more information, refer to the “Support for PAID PPID Privacy PCPID and PAURI Headers on Cisco UBE” section in the [Cisco Unified Border Element SIP Support Configuration Guide](#).

- **SIP VMWI for FXS phones:** SIP provides visible message waiting indication (VMWI) on FXS phones. This feature provides users with the option to enable one message waiting indication (MWI): audible, visible, or both. The VMWI mechanism uses SIP Subscribe or Notify to get MWI updates from a virtual machine (VM) system, and then forwards updates to the FXS phone on the port.

For more information, refer to the “Configuring SIP MWI Features” section in the [SIP Configuration Guide](#).

- **SIP Session timer (RFC 4028):** This feature allows for a periodic refresh of SIP sessions through a re-INVITE or UPDATE request. The refresh allows both user agents and proxies to determine whether

the SIP session is still active. Two header fields can be defined: Session-Expires, which conveys the lifetime of the session, and Min-SE, which conveys the minimum allowed value for the session timer.

For more information, refer to the “SIP Session Timer Support” section in the [Cisco Unified Border Element SIP Support Configuration Guide](#).

- **SIP Media Inactivity Detection:** The SIP Media Inactivity Detection Timer feature enables Cisco gateways to monitor and disconnect VoIP calls if no Real-Time Control Protocol (RTCP) packets are received within a configurable time period.

For more information, refer to the [SIP Media Inactivity Timer](#) section.

The SIP Voice Gateways feature is supported for analog endpoints that are connected to Foreign Exchange Station (FXS) ports or a Cisco VG224 Analog Phone Gateway and controlled by a Cisco call-control system, such as a Cisco Unified Communications Manager (Cisco Unified CM) or a Cisco Unified Communications Manager Express (Cisco Unified CME).

For more information on SIP Gateway features and information about configuring the SIP voice gateway for VoIPv6, see the [Configuring VoIP for IPv6](#).

VoIPv6 Support on Cisco UBE

Cisco UBE in VoIPv6 adds IPv6 capability to VoIP features. This feature adds dual-stack support on voice gateways, IPv6 support for SIP trunks, support for SCCP-controlled analog voice gateways, support for real-time control protocol (RTCP) pass-through, and support for T.38 fax over IPv6.

For more information on these features, refer to the following:

- “Configuring Cisco IOS Gateways” section in the [Deploying IPv6 in Unified Communications Networks with Cisco Unified Communications Manager](#)
- “Trunks” section in [Deploying IPv6 in Unified Communications Networks with Cisco Unified Communications Manager](#)
- “SCCP-controlled analog voice gateways” section in the [SCCP Controlled Analog \(FXS\) Ports with Supplementary Features in Cisco IOS Gateways](#)
- “RTCP Pass-Through” section in [Cisco UBE RTCP Voice Pass-Through for IPv6](#)
- “T.38 fax over IPv6” section in [Fax, Modem, and Text Support over IP Configuration Guide](#)

Support has been added for audio calls in media Flow-Through (FT) and Flow-Around (FA) modes, High Density (HD) transcoding, Local Transcoding Interface (LTI), along with Voice Class Codec (VCC) support, support for Hold/Resume, REFER, re-INVITE, 302 based services, and support for media anti-trombone have been added to Cisco UBE.

Cisco UBE being a signaling proxy processes all signaling messages for setting up media channels. This enables Cisco UBE to affect the flow of media packets using the media flow-through and the media flow-around modes.

- Media FT and Media FA modes support the following call flows:
 - EO-to-EO
 - DO-to-DO
 - DO-to-EO

- **Media Flow-Through (FT):** In a media flow-through mode, between two endpoints, both signaling and media flows through the IP-to-IP Gateway (IPIP GW). The IPIP GW performs both signaling and media interworking between H.323/SIP IPv4 and SIP IPv6 networks.

Figure 23: H.323/SIP IPv4 – SIP IPv6 interworking in media flow-through mode

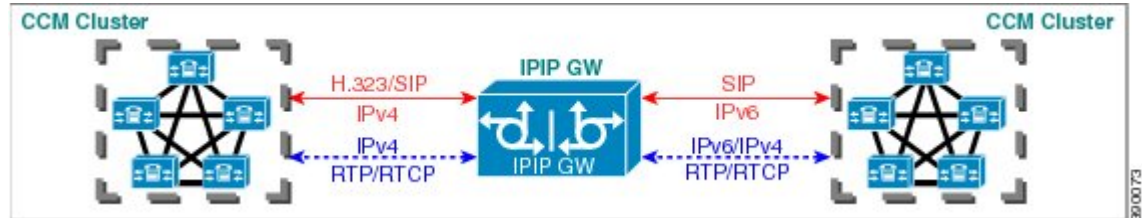

- **Media Flow-Around (FA):** Media flow-around provides the ability to have a SIP video call whereby signaling passes through Cisco UBE and media pass directly between endpoints bypassing the Cisco UBE.

Figure 24: H.323/SIP IPv4 - SIP IPv6 interworking in media flow-around mode

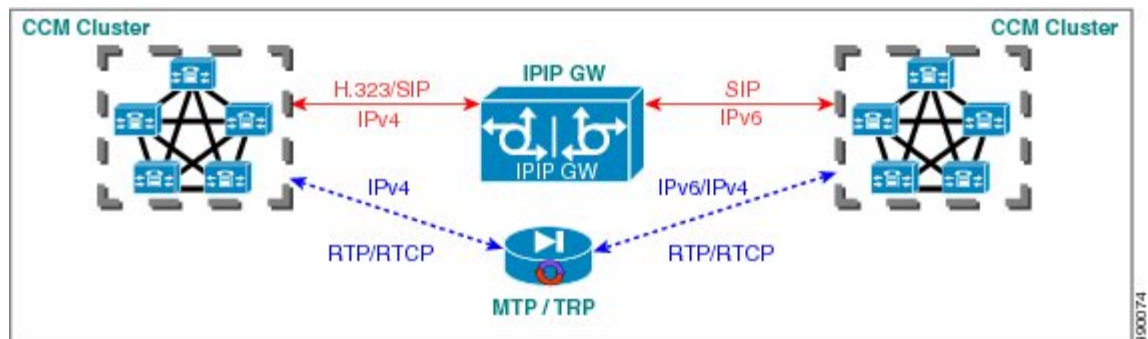

- **Assisted RTCP (RTCP Keepalive):** Assisted Real-time Transport Control Protocol (RTCP) enables Cisco UBE to generate RTCP keepalive reports on behalf of endpoints; however, endpoints, such as second generation Cisco IP phones (7940/7960) and Nortel Media Gateways (MG 1000T) do not generate any RTCP keepalive reports. Assisted RTCPs enable customers to use Cisco UBE to interoperate between endpoints and call control agents, such as Microsoft OCS/Lync so that RTCP reports are generated to indicate session liveness during periods of prolonged silence, such as call hold or call on mute.

The assisted RTCP feature helps Cisco UBE to generate standard RTCP keepalive reports on behalf of endpoints. RTCP reports determine the liveness of a media session during prolonged periods of silence, such as a call on hold or a call on mute.

- **SDP Pass-Through:** SDP is configured to pass through transparently at the Cisco UBE, so that both the remote ends can negotiate media independently of the Cisco UBE.

SDP pass-through is addressed in two modes:

- **Flow-through**—Cisco UBE plays no role in the media negotiation, it blindly terminates and re-originates the RTP packets irrespective of the content type negotiated by both the ends. This supports address hiding and NAT traversal.
- **Flow-around**—Cisco UBE neither plays a part in media negotiation, nor does it terminate and re-originate media. Media negotiation and media exchange is completely end-to-end.

For more information, refer to the “Configurable Pass-through of SIP INVITE Parameters” section in the [Cisco Unified Border Element SIP Support Configuration Guide](#) .

- **UDP Checksum for IPv6:** User Datagram Protocol (UDP) checksums provide data integrity for addressing different functions at the source and destination of the datagram, when a UDP packet originates from an IPv6 node.
- **IP Toll Fraud:** The IP Toll Fraud feature checks the source IP address of the call setup before routing the call. If the source IP address does not match an explicit entry in the configuration as a trusted VoIP source, the call is rejected.

For more information, refer to the “Configuring Toll Fraud Prevention” section in the [Cisco Unified Communications Manager Express System Administrator Guide](#) .

- **RTP Port Range:** Provides the capability where the port range is managed per IP address range. This feature solves the problem of limited number of RTP ports for more than 4000 calls. It enables combination of an IP address and a port as a unique identification for each call.
- **Hold/Resume:** Cisco UBE supports supplementary services such as Call Hold and Resume. An active call can be put in held state and later the call can be resumed.

For more information, refer to the “Configuring Call Hold/Resume for Shared Lines for Analog Ports” section in [Supplementary Services Features for FXS Ports on Cisco IOS Voice Gateways Configuration Guide](#) .

- **Call Transfer (re-INVITE, REFER):** Call transfer is used for conference calling, where calls can transition smoothly between multiple point-to-point links and IP level multicasting.

For more information, refer to the “Configurable Pass-through of SIP INVITE Parameters” section in the [Cisco Unified Border Element SIP Support Configuration Guide](#) .

- **Call Forward (302 based):** SIP provides a mechanism for forwarding or redirecting incoming calls. A Universal Access Servers (UAS) can redirect an incoming INVITE by responding with a 302 message (moved temporarily).
 - Consumption of 302 at stack level is supported for EO-EO, DO-DO and DO-EO calls for all combination of IPv4/IPv6/ANAT.
 - Consumption of 302 at stack level is supported for both FT and FA calls.

For more information, refer to the “Configuring Call Transfer and Forwarding” section in [Cisco Unified Communications Manager Express System Administrator Guide](#) .

- **Media Antitrombone:** Antitromboning is a media signaling service in SIP entity to overcome the media loops. Media Trombones are media loops in a SIP entity due to call transfer or call forward. Media loops in Cisco UBE are not detected because Cisco UBE looks at both call types as individual calls and not calls related to each other.

Antitrombone service has to be enabled only when no media interworking is required in both legs. Media antitrombone is supported only when the initial call is in IPv4 to IPv4 or IPv6 to IPv6 mode only.

For more information, refer to the “Configuring Media Antitrombone” section in the [Cisco Unified Border Element Protocol-Independent Features and Setup Configuration Guide](#) .

- **RE-INVITE Consumption:** The Re-INVITE/UPDATE consumption feature helps to avoid interoperability issues by consuming the mid-call Re-INVITES/UPDATEs from Cisco UBE. As Cisco

UBE blocks RE-INVITE / mid-call UPDATE, remote participant is not made aware of the SDP changes, such as Call Hold, Call Resume, and Call transfer.

For more information, refer to the “Cisco UBE Mid-call Re-INVITE/UPDATE Consumption” section in the [Cisco Unified Border Element Protocol-Independent Features and Setup Configuration Guide](#) .

- **Address Hiding:** The address hiding feature ensures that the Cisco UBE is the only point of signaling and media entry/exit in all scenarios. When you configure address-hiding, signaling and media peer addresses are also hidden from the endpoints, especially for supplementary services when the Cisco UBE passes REFER/3xx messages from one leg to the other.

For more information, refer to the “Configuring Address Hiding” section in the [SIP-to-SIP Connections on a Cisco Unified Border Element](#) .

- **Header Passing:** Header Pass through enables header passing for SIP INVITE, SUBSCRIBE and NOTIFY messages; disabling header passing affects only incoming INVITE messages. Enabling header passing results in a slight increase in memory and CPU utilization.

For more information, refer to the “SIP-to-SIP Connections on a Cisco Unified Border Element” section in the [SIP-to-SIPConnections on Cisco Unified Border Element](#) .

- **Refer-To Passing:** The Refer-to Passing feature is enabled when you configure refer-to-passing in Refer Pass through mode and the supplementary service SIP Refer is already configured. This enables the received refer-to header in Refer Pass through mode to move to the outbound leg without any modification. However, when refer-to-passing is configured in Refer Consumption mode without configuring the supplementary-service SIP Refer, the received Refer-to URI is used in the request-URI of the triggered invite.

For more information, refer to the “Configuring Support for Dynamic REFER Handling on Cisco UBE” section in the [Cisco Unified Border Element SIP Configuration Guide](#) .

- **Error Pass-through:** The SIP error message pass through feature allows a received error response from one SIP leg to pass transparently over to another SIP leg. This functionality will pass SIP error responses that are not yet supported on the Cisco UBE or will preserve the Q.850 cause code across two sip call-legs.

For more information, refer to the “Configuring SIP Error Message Passthrough” section in the [Cisco Unified Border Element SIP Support Configuration Guide](#) .

- **SIP UPDATE Interworking:** The SIP UPDATE feature allows a client to update parameters of a session (such as, a set of media streams and their codecs) but has no impact on the state of a dialog. UPDATE with SDP will support SDP Pass through, media flow around and media flow through. UPDATE with SDP support for SIP to SIP call flows is supported in the following scenarios:

- Early Dialog SIP to SIP media changes.
- Mid Dialog SIP to SIP media changes.

For more information, refer to the “SIP UPDATE Message per RFC 3311” section in the [Cisco Unified Border Element SIP Support Configuration Guide](#) .

- **SIP OPTIONS Ping:** The OPTIONS ping mechanism monitors the status of a remote Session Initiation Protocol (SIP) server, proxy or endpoints. Cisco UBE monitors these endpoints periodically.

For more information, refer to the “Cisco UBE Out-of-dialog OPTIONS Ping for Specified SIP Servers or Endpoints” section in the [Configuration of SIP Trunking for PSTN Access \(SIP-to-SIP\) Configuration Guide](#) .

- **Configurable Error Response Code in OPTIONS Ping:** Cisco UBE provides an option to configure the error response code when a dial peer is busied out because of an Out-of-Dialog OPTIONS ping failure.

For more information, refer to the “Configuring an Error Response Code upon an Out-of-Dialog OPTIONS Ping Failure” section in the [Cisco Unified Border Element SIP Support Configuration Guide](#).

- **SIP Profiles:** SIP profiles create a set of provisioning properties that you can apply to SIP trunk.
- **Dynamic Payload Type Interworking (DTMF and Codec Packets):** The Dynamic Payload Type Interworking for DTMF and Codec Packets for SIP-to-SIP Calls feature provides dynamic payload type interworking for dual tone multifrequency (DTMF) and codec packets for Session Initiation Protocol (SIP) to SIP calls. The Cisco UBE interworks between different dynamic payload type values across the call legs for the same codec. Also, Cisco UBE supports any payload type value for audio, video, named signaling events (NSEs), and named telephone events (NTEs) in the dynamic payload type range 96 to 127.

For more information, refer to the “Dynamic Payload Type Interworking for DTMF and Codec Packets for SIP-to-SIP Calls” section in the [Cisco Unified Border Element \(Enterprise\) Protocol-Independent Features and Setup Configuration Guide](#).

- **Audio Transcoding using Local Transcoding Interface (LTI):** Local Transcoding Interface (LTI) is an interface created to remove the requirement of SCCP client for Cisco UBE transcoding.

For information, refer to [Cisco Unified Border Element 9.0 Local Transcoding Interface \(LTI\)](#).

- **Voice Class Codec (VCC) with or without Transcoding:** The Voice Class Codec feature supports basic and all Re-Invite based supplementary services like call-hold/resume, call forward, call transfer, where if any mid-call codec changes, Cisco UBE inserts/removes/modifies the transcoder as needed.

Support for negotiation of an Audio Codec on each leg of a SIP-SIP call on the Cisco UBE feature supports negotiation of an audio codec using the Voice Class Codec (VCC) infrastructure on Cisco UBE.

VCC supports SIP-SIP calls on Cisco UBE and allows mid-call codec change for supplementary services.

How to Configure VoIP for IPv6

Configuring VoIP for IPv6

SIP is a simple, ASCII-based protocol that uses requests and responses to establish communication among the various components in the network and to ultimately establish a conference between two or more endpoints.

Users in a SIP network are identified by unique SIP addresses. A SIP address is similar to an e-mail address and is in the format of sip:userID@gateway.com. The user ID can be either a username or an E.164 address. The gateway can be either a domain (with or without a hostname) or a specific Internet IPv4 or IPv6 address.

A SIP trunk can operate in one of three modes: SIP trunk in IPv4-only mode, SIP trunk in IPv6-only mode, and SIP trunk in dual-stack mode, which supports both IPv4 and IPv6.

A SIP trunk uses the Alternative Network Address Transport (ANAT) mechanism to exchange multiple IPv4 and IPv6 media addresses for the endpoints in a session. ANAT is automatically disabled on SIP trunks in dual-stack mode. The ANAT Session Description Protocol (SDP) grouping framework allows user agents (UAs) to include both IPv4 and IPv6 addresses in their SDP session descriptions. The UA is then able to use any of its media addresses to establish a media session with a remote UA.

A Cisco Unified Border Element can interoperate between H.323/SIP IPv4 and SIP IPv6 networks in media flow-through mode. In media flow-through mode, both signaling and media flows through the Cisco Unified Border Element, and the Cisco Unified Border Element performs both signaling and media interoperation between H.323/SIP IPv4 and SIP IPv6 networks (see the figure below).

Figure 25: H.323/SIP IPv4--SIP IPv6 Interoperating in Media Flow-Through Mode

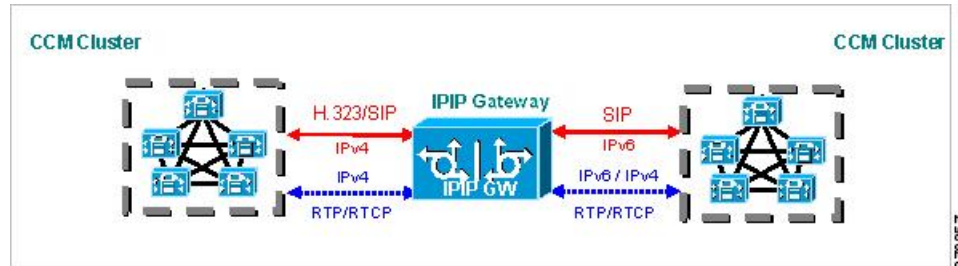

Shutting Down or Enabling VoIPv6 Service on Cisco Gateways

SUMMARY STEPS

1. `enable`
2. `configure terminal`
3. `voice service voip`
4. `shutdown [forced]`

DETAILED STEPS

	Command or Action	Purpose
Step 1	enable Example: Device> <code>enable</code>	Enables privileged EXEC mode. <ul style="list-style-type: none"> • Enter your password if prompted.
Step 2	configure terminal Example: Device# <code>configure terminal</code>	Enters global configuration mode.
Step 3	voice service voip Example: Device(config)# <code>voice service voip</code>	Enters voice service VoIP configuration mode.
Step 4	shutdown [forced] Example: Device(config-voi-serv)# <code>shutdown forced</code>	Shuts down or enables VoIP call services.

Shutting Down or Enabling VoIPv6 Submodes on Cisco Gateways

SUMMARY STEPS

1. `enable`
2. `configure terminal`
3. `voice service voip`
4. `sip`
5. `call service stop [forced]`

DETAILED STEPS

	Command or Action	Purpose
Step 1	enable Example: Device> <code>enable</code>	Enables privileged EXEC mode. <ul style="list-style-type: none"> • Enter your password if prompted.
Step 2	configure terminal Example: Device# <code>configure terminal</code>	Enters global configuration mode.
Step 3	voice service voip Example: Device(config)# <code>voice service voip</code>	Enters voice service VoIP configuration mode.
Step 4	sip Example: Device(config-voi-serv)# <code>sip</code>	Enters SIP configuration mode.
Step 5	call service stop [forced] Example: Device(config-serv-sip)# <code>call service stop</code>	Shuts down or enables VoIPv6 for the selected submode.

Configuring the Protocol Mode of the SIP Stack

Before you begin

SIP service should be shut down before configuring the protocol mode. After configuring the protocol mode as IPv6, IPv4, or dual-stack, SIP service should be reenabled.

SUMMARY STEPS

1. `enable`

2. `configure terminal`
3. `sip-ua`
4. `protocol mode ipv4 | ipv6 | dual-stack [preference {ipv4 | ipv6}]`

DETAILED STEPS

	Command or Action	Purpose
Step 1	enable Example: <pre>Device> enable</pre>	Enables privileged EXEC mode. <ul style="list-style-type: none"> • Enter your password if prompted.
Step 2	configure terminal Example: <pre>Device# configure terminal</pre>	Enters global configuration mode.
Step 3	sip-ua Example: <pre>Device(config)# sip-ua</pre>	Enters SIP user agent configuration mode.
Step 4	protocol mode ipv4 ipv6 dual-stack [preference {ipv4 ipv6}] Example: <pre>Device(config-sip-ua)# protocol mode dual-stack</pre>	Configures the Cisco IOS SIP stack in dual-stack mode.

Example: Configuring the SIP Trunk

This example shows how to configure the SIP trunk to use dual-stack mode, with IPv6 as the preferred mode. The SIP service must be shut down before any changes are made to protocol mode configuration.

```
Device(config)# sip-ua
Device(config-sip-ua)# protocol mode dual-stack preference ipv6
```

Enabling ANAT Mode

ANAT is automatically disabled on SIP trunks in dual-stack mode. Perform this task to enable ANAT in order to use a single-stack mode.

SUMMARY STEPS

1. `enable`
2. `configure terminal`
3. `voice service voip`
4. `sip`

5. anat

DETAILED STEPS

	Command or Action	Purpose
Step 1	enable Example: Device> enable	Enables privileged EXEC mode. <ul style="list-style-type: none"> • Enter your password if prompted.
Step 2	configure terminal Example: Device# configure terminal	Enters global configuration mode.
Step 3	voice service voip Example: Device(config)# voice service voip	Enters voice service VoIP configuration mode.
Step 4	sip Example: Device(config-voi-serv)# sip	Enters SIP configuration mode.
Step 5	anat Example: Device(conf-serv-sip)# anat	Enables ANAT on a SIP trunk.

Verifying SIP Gateway Status

Before you begin

To verify the status of SIP Gateway, use the following commands

SUMMARY STEPS

1. **show sip-ua calls**
2. **show sip-ua connections**
3. **show sip-ua status**

DETAILED STEPS

Step 1 **show sip-ua calls**

The **show sip-ua calls** command displays active user agent client (UAC) and user agent server (UAS) information on SIP calls:

Verifying SIP Gateway Status

```

Device# show sip-ua calls
SIP UAC CALL INFO
Call 1
SIP Call ID : 8368ED08-1C2A11DD-80078908-BA2972D0@2001::21B:D4FF:FED7:B000
State of the call      : STATE_ACTIVE (7)
Substate of the call   : SUBSTATE_NONE (0)
Calling Number         : 2000
Called Number          : 1000
Bit Flags              : 0xC04018 0x100 0x0
CC Call ID             : 2
Source IP Address (Sig) : 2001:DB8:0:ABCD::1
Destn SIP Req Addr:Port : 2001:DB8:0:0:FFFF:5060
Destn SIP Resp Addr:Port : 2001:DB8:0:1:FFFF:5060
Destination Name       : 2001::21B:D5FF:FE1D:6C00
Number of Media Streams : 1
Number of Active Streams : 1
RTP Fork Object        : 0x0
Media Mode              : flow-through
Media Stream 1
State of the stream    : STREAM_ACTIVE
Stream Call ID         : 2
Stream Type            : voice-only (0)
Stream Media Addr Type : 1709707780
Negotiated Codec       : (20 bytes)
Codec Payload Type     : 18
Negotiated Dtmf-relay  : inband-voice
Dtmf-relay Payload Type : 0
Media Source IP Addr:Port : [2001::21B:D4FF:FED7:B000]:16504
Media Dest IP Addr:Port  : [2001::21B:D5FF:FE1D:6C00]:19548
Options-Ping          ENABLED:NO    ACTIVE:NO
Number of SIP User Agent Client(UAC) calls: 1
SIP UAS CALL INFO
Number of SIP User Agent Server(UAS) calls: 0

```

Step 2 show sip-ua connections

Use the **show sip-ua connections** command to display SIP UA transport connection tables:

Example:

```

Device# show sip-ua connections udp brief
Total active connections      : 1
No. of send failures         : 0
No. of remote closures       : 0
No. of conn. failures        : 0
No. of inactive conn. ageouts : 0
Router# show sip-ua connections udp detail

Total active connections      : 1
No. of send failures         : 0
No. of remote closures       : 0
No. of conn. failures        : 0
No. of inactive conn. ageouts : 0
-----Printing Detailed Connection Report-----
Note:
** Tuples with no matching socket entry
- Do 'clear sip <tcp[tls]/udp> conn t ipv4:<addr>:<port>'
  to overcome this error condition
++ Tuples with mismatched address/port entry
- Do 'clear sip <tcp[tls]/udp> conn t ipv4:<addr>:<port> id <connid>'
  to overcome this error condition
Remote-Agent:2001::21B:D5FF:FE1D:6C00, Connections-Count:1
Remote-Port Conn-Id Conn-State WriteQ-Size

```

```

=====
5060      2 Established      0

```

Step 3 show sip-ua status

Use the **show sip-ua status** command to display the status of the SIP UA:

Example:

```

Device# show sip-ua status
SIP User Agent Status
SIP User Agent for UDP : ENABLED
SIP User Agent for TCP : ENABLED
SIP User Agent for TLS over TCP : ENABLED
SIP User Agent bind status(signaling): DISABLED
SIP User Agent bind status(media): DISABLED
SIP early-media for 180 responses with SDP: ENABLED
SIP max-forwards : 70
SIP DNS SRV version: 2 (rfc 2782)
NAT Settings for the SIP-UA
Role in SDP: NONE
Check media source packets: DISABLED
Maximum duration for a telephone-event in NOTIFYs: 2000 ms
SIP support for ISDN SUSPEND/RESUME: ENABLED
Redirection (3xx) message handling: ENABLED
Reason Header will override Response/Request Codes: DISABLED
Out-of-dialog Refer: DISABLED
Presence support is DISABLED
protocol mode is ipv6
SDP application configuration:
Version line (v=) required
Owner line (o=) required
Timespec line (t=) required
Media supported: audio video image
Network types supported: IN
Address types supported: IP4 IP6
Transport types supported: RTP/AVP udptl

```

RTCP Pass-Through

IPv4 and IPv6 addresses embedded within RTCP packets (for example, RTCP CNAME) are passed on to Cisco UBE without being masked. These addresses are masked on the Cisco UBE ASR 1000.

The Cisco UBE ASR 1000 does not support printing of RTCP debugs.



Note RTCP is passed through by default. No configuration is required for RTCP pass-through.

Configuring IPv6 Support for Cisco UBE

In Cisco UBE, IPv4-only and IPv6-only modes are not supported when endpoints are dual-stack. In this case, Cisco UBE must also be configured in dual-stack mode.

SUMMARY STEPS

1. enable
2. configure terminal
3. sip-ua
4. protocol mode {ipv4 | ipv6 | dual-stack {preference {ipv4 | ipv6}}}
5. end

DETAILED STEPS

	Command or Action	Purpose
Step 1	enable Example: Device> enable	Enables privileged EXEC mode. <ul style="list-style-type: none"> • Enter your password if prompted.
Step 2	configure terminal Example: Device# configure terminal	Enters global configuration mode.
Step 3	sip-ua Example: Device(config)# sip-ua	Enters SIP user-agent configuration mode.
Step 4	protocol mode {ipv4 ipv6 dual-stack {preference {ipv4 ipv6} ipv6}} Example: Device(config-sip-ua)# protocol mode ipv6	Configures the Cisco IOS SIP stack. <ul style="list-style-type: none"> • protocol mode dual-stack preference {ipv4 ipv6} —Sets the IP preference when the ANAT command is configured. • protocol mode {ipv4 ipv6} —Passes the IPv4 or IPv6 address in the SIP invite. • protocol mode dual-stack —Passes both the IPv4 addresses and the IPv6 addresses in the SIP invite and sets priority based on the far-end IP address.
Step 5	end Example: Device(conf-voi-serv)# end	Exits SIP user-agent configuration mode.

Verifying RTP Pass-Through

To enable RTCP packet-related debugging, use the following command

SUMMARY STEPS

1. debug voip rtcp packets

DETAILED STEPS

debug voip rtcp packets**Example:**

```
Device# debug voip rtcp packets
```

```
*Feb 14 06:24:58.799: //1/xxxxxxxxxxxx/RTP//Packet/voip_remote_rtcp_packet: Received RTCP packet
*Feb 14 06:24:58.799: (src ip=2001:DB8:C18:5:21B:D4FF:FEDD:35F0, src port=17699,
dst ip=2001:DB8:C18:5:21D:A2FF:FE72:4D00, dst port=17103)
*Feb 14 06:24:58.799: SR: ssrc=0x1F7A35F0 sr_ntp_h=0xD10346B4 sr_ntp_l=0x13173D8
F sr_timestamp=0x0 sr_npackets=381 sr_nbytes=62176
*Feb 14 06:24:58.799: RR: ssrc=0x1A1752F0 rr_loss=0x0 rr_ehsr=5748 rr_jitter=0 r
r_lsr=0x0 rr_dlsr=0x0
*Feb 14 06:24:58.799: SDES: ssrc=0x1F7A35F0 name=1 len=39 data=0.0.0@2001:DB8:C1
8:5:21B:D4FF:FEDD:35F0
*Feb 14 06:24:58.799: //2/xxxxxxxxxxxx/RTP//Packet/voip_remote_rtcp_packet: Send
ing RTCP packet
*Feb 14 06:24:58.799: (src ip=2001:DB8:C18:5:21D:A2FF:FE72:4D00, src port=23798,
dst ip=2001:DB8:C18:5:21B:D4FF:FED7:52F0, dst port=19416)
*Feb 14 06:24:58.799: SR: ssrc=0x0 sr_ntp_h=0xD10346B4 sr_ntp_l=0x13173D8F sr_ti
mestamp=0x0 sr_npackets=381 sr_nbytes=62176
*Feb 14 06:24:58.799: RR: ssrc=0x1A1752F0 rr_loss=0x0 rr_ehsr=5748 rr_jitter=0 r
r_lsr=0x0 rr_dlsr=0x0
*Feb 14 06:24:58.799: SDES: ssrc=0x1F7A35F0 name=1 len=39 data=0.0.0@2001:DB8:C1
8:5:21B:D4FF:FEDD:35F0
*Feb 14 06:24:58.919:
```

Configuring the Source IPv6 Address of Signaling and Media Packets

Users can configure the source IPv4 or IPv6 address of signaling and media packets to a specific interface's IPv4 or IPv6 address. Thus, the address that goes out on the packet is bound to the IPv4 or IPv6 address of the interface specified with the **bind** command.

The **bind** command also can be configured with one IPv6 address to force the gateway to use the configured address when the bind interface has multiple IPv6 addresses. The bind interface should have both IPv4 and IPv6 addresses to send out ANAT.

When you do not specify a bind address or if the interface is down, the IP layer still provides the best local address.

SUMMARY STEPS

1. **enable**
2. **configure terminal**
3. **voice service voip**
4. **sip**
5. **bind {control | media | all} source interface interface-id [ipv6-address ipv6-address]**

DETAILED STEPS

	Command or Action	Purpose
Step 1	enable Example: Device> enable	Enables privileged EXEC mode. <ul style="list-style-type: none"> • Enter your password if prompted.
Step 2	configure terminal Example: Device# configure terminal	Enters global configuration mode.
Step 3	voice service voip Example: Device(config)# voice service voip	Enters voice service VoIP configuration mode.
Step 4	sip Example: Device(config-voi-serv)# sip	Enters SIP configuration mode.
Step 5	bind {control media all} source interface <i>interface-id</i> [ipv6-address <i>ipv6-address</i>] Example: Device(config-serv-sip)# bind control source-interface FastEthernet 0/0	Binds the source address for signaling and media packets to the IPv6 address of a specific interface.

Example: Configuring the Source IPv6 Address of Signaling and Media Packets

```
Device(config)# voice service voip
Device(config-voi-serv)# sip
Device(config-serv-sip)# bind control source-interface fastEthernet 0/0
```

Configuring the SIP Server

SUMMARY STEPS

1. **enable**
2. **configure terminal**
3. **sip-ua**
4. **sip-server {dns: *host-name* | ipv4: *ipv4-address* | ipv6: [*ipv6-address*] [:*port-nums*]}**
5. **keepalive target {{ipv4 : *address* | ipv6 : *address*][: *port*] | dns : *hostname*} [tcp [tls] | udp] [secondary]**

DETAILED STEPS

	Command or Action	Purpose
Step 1	enable Example: Device> enable	Enables privileged EXEC mode. <ul style="list-style-type: none"> • Enter your password if prompted.
Step 2	configure terminal Example: Device# configure terminal	Enters global configuration mode.
Step 3	sip-ua Example: Device(config)# sip-ua	Enters SIP user agent configuration mode.
Step 4	sip-server {dns: host-name} ipv4: ipv4-address ipv6: [ipv6-address] :[port-nums]} Example: Device(config-sip-ua)# sip-server ipv6: 2001:DB8:0:0:8:800:200C:417A	Configures a network address for the SIP server interface.
Step 5	keepalive target {{ipv4 : address ipv6 : address}[:port] dns : hostname} [tcp [tls]] udp] [secondary] Example: Device(config-sip-ua)# keepalive target ipv6: 2001:DB8:0:0:8:800:200C:417A	Identifies SIP servers that will receive keepalive packets from the SIP gateway.

Example: Configuring the SIP Server

```
Device(config)# sip-ua
Device(config-sip-ua)# sip-server ipv6: 2001:DB8:0:0:8:800:200C:417A
```

Configuring the Session Target

SUMMARY STEPS

1. **enable**
2. **configure terminal**
3. **dial-peer voice tag {mmoip | pots | vofr | voip}**
4. **destination pattern [+ string T**

5. **session target** {**ipv4:** *destination-address* | **ipv6:** [*destination-address*] | **dns :** *\$s\$*. | *\$d\$*. | *\$e\$*. | *\$u\$*.] *host-name* | **enum:***table -num* | **loopback:***rtp* | **ras** | **sip-server**} [: *port*]

DETAILED STEPS

	Command or Action	Purpose
Step 1	enable Example: Device> enable	Enables privileged EXEC mode. • Enter your password if prompted.
Step 2	configure terminal Example: Device# configure terminal	Enters global configuration mode.
Step 3	dial-peer voice tag {mmoip pots vofr voip} Example: Device(config)# dial-peer voice 29 voip	Defines a particular dial peer, specifies the method of voice encapsulation, and enters dial peer configuration mode.
Step 4	destination pattern [+ string T] Example: Device(config-dial-peer)# destination-pattern 7777	Specifies either the prefix or the full E.164 telephone number to be used for a dial peer.
Step 5	session target {ipv4: destination-address ipv6: [destination-address] dns : \$s\$. \$d\$. \$e\$. \$u\$.] host-name enum:table -num loopback:rtp ras sip-server} [: port] Example: Device(config-dial-peer)# session target ipv6:2001:DB8:0:0:8:800:200C:417A	Designates a network-specific address to receive calls from a VoIP or VoIPv6 dial peer.

Example: Configuring the Session Target

```
Device(config)# dial-peer voice 29 voip
Device(config-dial-peer)# destination-pattern 7777
Device(config-dial-peer)# session target ipv6:2001:DB8:0:0:8:800:200C:417A
```

Configuring SIP Register Support

SUMMARY STEPS

1. **enable**

2. **configure terminal**
3. **sip-ua**
4. **registrar {dns: address | ipv4: destination-address [: port] | ipv6: destination-address : port} aor-domain expires seconds [tcp tls]] type [secondary] [scheme string]**
5. **retry register retries**
6. **timers register milliseconds**

DETAILED STEPS

	Command or Action	Purpose
Step 1	enable Example: Device> enable	Enables privileged EXEC mode. <ul style="list-style-type: none"> • Enter your password if prompted.
Step 2	configure terminal Example: Device# configure terminal	Enters global configuration mode.
Step 3	sip-ua Example: Device(config)# sip-ua	Enters SIP user agent configuration mode.
Step 4	registrar {dns: address ipv4: destination-address [: port] ipv6: destination-address : port} aor-domain expires seconds [tcp tls]] type [secondary] [scheme string] Example: Device(config-sip-ua)# registrar ipv6: 2001:DB8::1:20F:F7FF:FE0B:2972 expires 3600 secondary	Enables SIP gateways to register E.164 numbers on behalf of analog telephone voice ports, IP phone virtual voice ports, and SCCP phones with an external SIP proxy or SIP registrar.
Step 5	retry register retries Example: Device(config-sip-ua)# retry register 10	Configures the total number of SIP register messages that the gateway should send.
Step 6	timers register milliseconds Example: Device(config-sip-ua)# timers register 500	Configures how long the SIP UA waits before sending register requests.

Example: Configuring SIP Register Support

```
Device(config)# sip-ua
```

```
Device(config-sip-ua)# registrar ipv6: 2001:DB8:0:0:8:800:200C:417A expires 3600 secondary
Device(config-sip-ua)# retry register 10
Device((config-sip-ua)# timers register 500
```

Configuring Outbound Proxy Server Globally on a SIP Gateway

SUMMARY STEPS

1. enable
2. configure terminal
3. voice service voip
4. sip
5. outbound-proxy {ipv4: ipv4-address | ipv6: ipv6-address | dns: host : domain} [: port-number]

DETAILED STEPS

	Command or Action	Purpose
Step 1	enable Example: Device> enable	Enables privileged EXEC mode. <ul style="list-style-type: none"> • Enter your password if prompted.
Step 2	configure terminal Example: Device# configure terminal	Enters global configuration mode.
Step 3	voice service voip Example: Device(config)# voice service voip	Enters voice service VoIP configuration mode.
Step 4	sip Example: Device(config-voi-serv)# sip	Enters sip configuration mode.
Step 5	outbound-proxy {ipv4: ipv4-address ipv6: ipv6-address dns: host : domain} [: port-number] Example: Device(config-serv-sip)#outbound-proxy ipv6: 2001:DB8:0:0:8:800:200C:417A	Specifies the SIP outbound proxy globally for a Cisco IOS voice gateway using an IPv6 address.

Configuring UDP Checksum

SUMMARY STEPS

1. `enable`
2. `configure terminal`
3. `ipv6 udp checksum [process | cef | none]`
4. `exit`

DETAILED STEPS

	Command or Action	Purpose
Step 1	enable Example: <pre>Device> enable</pre>	Enables privileged EXEC mode. <ul style="list-style-type: none"> • Enter your password if prompted.
Step 2	configure terminal Example: <pre>Device# configure terminal</pre>	Enters global configuration mode.
Step 3	ipv6 udp checksum [process cef none] Example: <pre>Device(config)# ipv6 udp checksum process</pre>	Configures UDP checksum for Cisco UBE so that when you enable UDP checksum, it is computed and added for outgoing media packets. Similarly, disable the command to ignore the checksum calculation. Use the following keywords with the ipv6 udp checksum command: <ul style="list-style-type: none"> • process: Packets are punted to the process switching path for checksum validation. • cef: The UDP checksum validation is done in the CEF path. • none: UDP checksum validation is not done for received media packets in the CEF path and there is no UDP checksum computation for transmitted media packets.
Step 4	exit Example: <pre>Device(config)# exit</pre>	Exits global configuration mode and returns to privileged EXEC mode.

Configuring IP Toll Fraud

SUMMARY STEPS

1. **enable**
2. **configure terminal**
3. **voice service voip**
4. **ip address trusted list**
5. **ipv6 X:X:X:X::X**
6. **end**

DETAILED STEPS

	Command or Action	Purpose
Step 1	enable Example: Device> enable	Enables privileged EXEC mode. <ul style="list-style-type: none"> • Enter your password if prompted.
Step 2	configure terminal Example: Device# configure terminal	Enters global configuration mode.
Step 3	voice service voip Example: Device(config)# voice service voip	Enters voice service VoIP configuration mode.
Step 4	ip address trusted list Example: Device(config-voi-serv)# ip address trusted list	Enters IP address trusted list configuration mode. You can add unique and multiple IP addresses for incoming VoIP (H.323/SIP) calls to a list of trusted IP addresses.
Step 5	ipv6 X:X:X:X::X Example: Device(cfg-iptrust-list)# ipv6 2001:DB8::/48	Enters IPv6 addresses for toll fraud prevention.
Step 6	end Example: Device(cfg-iptrust-list)# end	Exits trusted list configuration mode and returns to global configuration mode.

Configuring the RTP Port Range for an Interface

SUMMARY STEPS

1. **enable**
2. **configure terminal**
3. **voice service voip**
4. **allow-connections sip to sip**
5. **media-address range** *range*
6. **rtp-port range** *range*
7. **exit**
8. **dial-peer voice tag voip**
9. **voice-class sip bind media source-interface** *interface*
10. **end**

DETAILED STEPS

	Command or Action	Purpose
Step 1	enable Example: Device> enable	Enables privileged EXEC mode. <ul style="list-style-type: none"> • Enter your password if prompted.
Step 2	configure terminal Example: Device# configure terminal	Enters global configuration mode.
Step 3	voice service voip Example: Device(config)# voice service voip	Enters voice service VoIP configuration mode.
Step 4	allow-connections sip to sip Example: Device(conf-voi-serv)# allow-connections sip to sip	Allows sip-to-sip connections under voice service voip configuration mode for Cisco UBE.
Step 5	media-address range <i>range</i> Example: Device(config-voi-serv)# media-address range 2001:DB8::/48	Configures the media-address range, which enables the media gateway to allocate the available free port for a given IP address within the address range.
Step 6	rtp-port range <i>range</i> Example:	Configures the RTP port range.

	Command or Action	Purpose
	<pre>Device(config-voi-serv)# rtp-port range 20000 30000</pre>	<p>Note</p> <ul style="list-style-type: none"> • Each Cisco UBE can configure ten unique IP address ranges. • The default global RTP port range is from 16384 to 32766.
Step 7	<p>exit</p> <p>Example:</p> <pre>Device(config-voi-ser)# exit</pre>	Exits voice service VoIP configuration mode.
Step 8	<p>dial-peer voice tag voip</p> <p>Example:</p> <pre>Device(config)# dial-peer voice 300 voip</pre>	Enters dial peer configuration mode.
Step 9	<p>voice-class sip bind media source-interface interface</p> <p>Example:</p> <pre>Device(config-dial-peer)# voice-class sip bind media source-interface GigabitEthernet 0</pre>	Matches the local SIP bind media IP address to the IP address range entries. Binds media packets to the IPv4 or IPv6 address of a specific interface and specifies an interface as the source address of SIP packets.
Step 10	<p>end</p> <p>Example:</p> <pre>Device(config-dial-peer)# end</pre>	Exits dial peer configuration mode and returns to global configuration mode.

Configuring Message Waiting Indicator Server Address

SUMMARY STEPS

1. enable
2. configure terminal
3. sip-ua
4. mwi-server {ipv4: destination-address | ipv6: destination-address | dns: host-name} peer-tag [output-dial-peer-tag]
5. end

DETAILED STEPS

	Command or Action	Purpose
Step 1	<p>enable</p> <p>Example:</p> <pre>Device> enable</pre>	<p>Enables privileged EXEC mode.</p> <ul style="list-style-type: none"> • Enter your password if prompted.

	Command or Action	Purpose
Step 2	configure terminal Example: Device# <code>configure terminal</code>	Enters global configuration mode.
Step 3	sip-ua Example: Device(config)# <code>sip-ua</code>	Enters SIP user-agent configuration mode.
Step 4	mwi-server {ipv4: destination-address ipv6: destination-address dns: host-name} peer-tag [output-dial-peer-tag] Example: Device(config-sip-ua)# <code>mwi-server ipv6 2001:DB8::/48 peer-tag 3</code>	Configures voice-mail server settings on a voice gateway or user agent. <ul style="list-style-type: none"> • <code>ipv4/ ipv6: destination-address</code>—IP address of the voice-mail server. • <code>dns: host-name</code>—Host device housing the domain name server that resolves the name of the voice-mail server. The argument should contain the complete hostname to be associated with the target address; for example, <code>dns:test.example.com</code>. • <code>peer-tag</code>—Attaches an existing dial peer to SIP MWI service.
Step 5	end Example: Device(config-sip-ua)# <code>end</code>	Exits SIP user-agent configuration mode and returns to global configuration mode.

Configuring Voice Ports

SUMMARY STEPS

1. `enable`
2. `configure terminal`
3. `voice-port port number`
4. `vmwi [fsk | dc-voltage]`
5. `end`

DETAILED STEPS

	Command or Action	Purpose
Step 1	enable Example: Device> <code>enable</code>	Enables privileged EXEC mode. <ul style="list-style-type: none"> • Enter your password if prompted.

	Command or Action	Purpose
Step 2	configure terminal Example: Device# configure terminal	Enters global configuration mode.
Step 3	voice-port <i>port number</i> Example: Device(config)# voice-port 3	Enters voiceport configuration mode.
Step 4	vmwi [fsk dc-voltage] Example: Device(config-voiceport)# vmwi fsk	Enables either Frequency–Shift Keying (FSK) visible message waiting indication (VMWI) or DC voltage on a Cisco VG224 onboard analog FXS voice port. VMWI is configured automatically when MWI is configured on the voice port. <ul style="list-style-type: none"> • If an FSK phone is connected to the voice port, use the fsk keyword. Similarly, if a DC voltage phone is connected to the voice port, use the dc-voltage keyword.
Step 5	end Example: Device(config-voiceport)# end	Exits voice-port configuration mode and returns to privileged EXEC mode.

Configuring Cisco UBE Mid-call Re-INVITE Consumption

Configuring Passthrough of Mid-call Signalling

Perform this task to configure passthrough of mid-call signaling (as Re-invites) only when bidirectional media is added.

SUMMARY STEPS

1. **enable**
2. **configure terminal**
3. Configure passthrough of mid-call signaling changes only when bidirectional media is added.
 - In Global VoIP SIP configuration mode
midcall-signaling passthru media-change
 - In dial-peer configuration mode
voice-class sip midcall-signaling passthru media-change
4. **end**

DETAILED STEPS

	Command or Action	Purpose
Step 1	enable Example: Device> enable	Enables privileged EXEC mode. <ul style="list-style-type: none"> • Enter your password if prompted.
Step 2	configure terminal Example: Device# configure terminal	Enters global configuration mode.
Step 3	Configure passthrough of mid-call signaling changes only when bidirectional media is added. <ul style="list-style-type: none"> • In Global VoIP SIP configuration mode midcall-signaling passthru media-change • In dial-peer configuration mode voice-class sip midcall-signaling passthru media-change Example: In Global VoIP SIP configuration mode: <pre>Device(config)# voice service voip Device(conf-voi-serv)# sip Device(conf-serv-sip)# midcall-signaling passthru media-change</pre> Example: In Dial-peer configuration mode: <pre>Device(config)# dial-peer voice 2 voip Device(config-dial-peer)# voice-class sip midcall-signaling passthru media-change</pre>	Re-Invites are passed through only when bidirectional media is added.
Step 4	end	Exits to privileged EXEC mode.

Configuring Passthrough SIP Messages at Dial Peer Level

Perform this task to configure passthrough SIP messages at the dial-peer level. You need to perform this task at the dial-peer level to consume all media-related mid-call Re-INVITES/UPDATES.



Note If the Cisco UBE Mid-call Re-INVITE/UPDATE consumption feature is configured on global and dial-peer level, dial-peer level takes precedence.

SUMMARY STEPS

1. **enable**
2. **configure terminal**
3. **dial-peer voice** *dial-peer tag* **voip**

4. `voice-class sip mid-call signaling passthru media-change`
5. `exit`

DETAILED STEPS

	Command or Action	Purpose
Step 1	enable Example: Device> <code>enable</code>	Enables privileged EXEC mode. <ul style="list-style-type: none"> • Enter your password if prompted.
Step 2	configure terminal Example: Device# <code>configure terminal</code>	Enters global configuration mode.
Step 3	dial-peer voice <i>dial-peer tag</i> voip Example: Device(config)# dial-peer voice 2 voip	Enters dial-peer voice configuration mode.
Step 4	voice-class sip mid-call signaling passthru media-change Example: Device(config-dial-peer)# <code>voice-class sip mid-call signaling passthru media-change</code>	Passes through SIP messages that involve media change.
Step 5	exit Example: Device(config-dial-peer)# <code>exit</code>	Exits dial-peer voice configuration mode and returns to global configuration mode.

Configuring H.323 IPv4-to-SIPv6 Connections in a Cisco UBE

An organization with an IPv4 network can deploy a Cisco UBE on the boundary to connect with the service provider's IPv6 network (see the figure below).

Figure 26: Cisco UBE Interoperating IPv4 Networks with IPv6 Service Provider

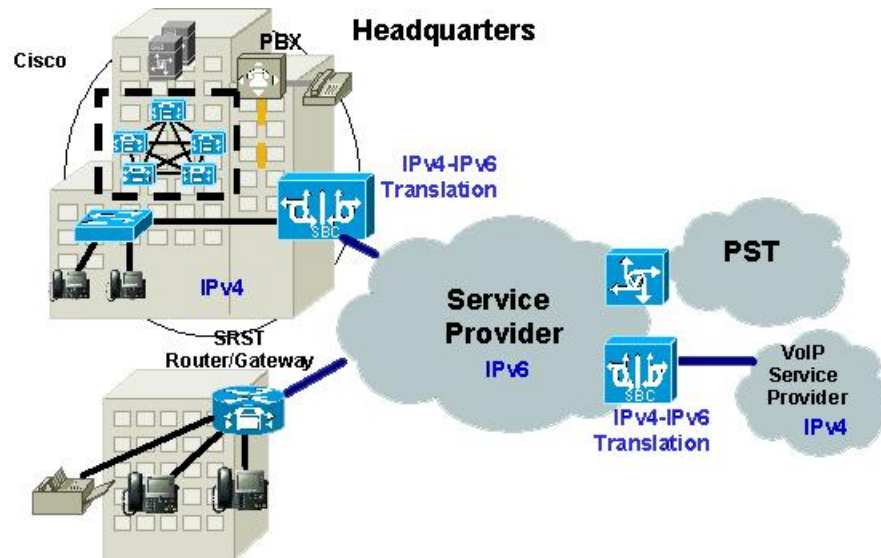

A Cisco UBE can interoperate between H.323/SIP IPv4 and SIP IPv6 networks in media flow-through mode. In media flow-through mode, both signaling and media flows through the Cisco UBE, and the Cisco UBE performs both signaling and media interoperation between H.323/SIP IPv4 and SIP IPv6 networks (see the figure below).

Figure 27: IPv4 to IPv6 Media Interoperating Through Cisco IOS MTP

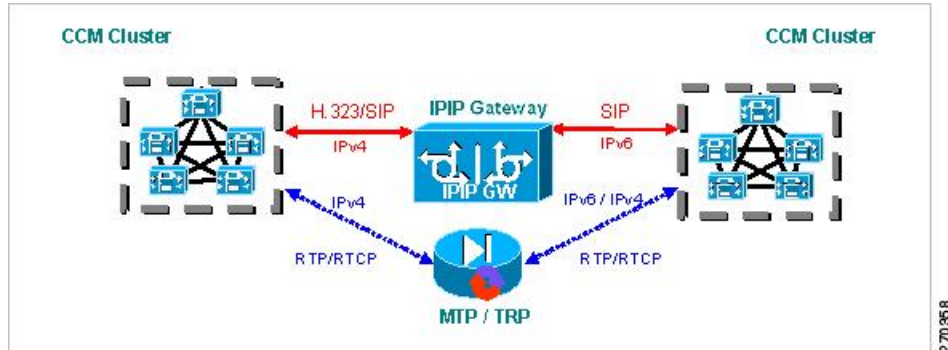

The Cisco UBE feature adds IPv6 capability to existing VoIP features. This feature adds dual-stack support on voice gateways and MTP, IPv6 support for SIP trunks, and SCCP-controlled analog voice gateways. In addition, the SBC functionality of connecting SIP IPv4 or H.323 IPv4 network to a SIP IPv6 network is implemented on a Cisco UBE to facilitate migration from VoIPv4 to VoIPv6.

Before you begin

Cisco UBE must be configured in IPv6-only or dual-stack mode to support IPv6 calls.



Note A Cisco UBE interoperates between H.323/SIP IPv4 and SIP IPv6 networks only in media flow-through mode.

SUMMARY STEPS

1. `enable`
2. `configure terminal`
3. `voice service voip`
4. `allow-connections` *from type to to type*

DETAILED STEPS

	Command or Action	Purpose
Step 1	enable Example: Device> <code>enable</code>	Enables privileged EXEC mode. <ul style="list-style-type: none"> • Enter your password if prompted.
Step 2	configure terminal Example: Device# <code>configure terminal</code>	Enters global configuration mode.
Step 3	voice service voip Example: Device(config)# <code>voice service voip</code>	Enters voice service VoIP configuration mode.
Step 4	allow-connections <i>from type to to type</i> Example: Device(config-voi-serv)# <code>allow-connections h323 to sip</code>	Allows connections between specific types of endpoints in a VoIPv6 network. Arguments are as follows: <ul style="list-style-type: none"> • <i>from-type</i> --Type of connection. Valid values: h323, sip. • <i>to-type</i> --Type of connection. Valid values: h323, sip.

Example: Configuring H.323 IPv4-to-SIPV6 Connections in a Cisco UBE

```
Device(config)# voice service voip
Device(config-voi-serv)# allow-connections h323 to sip
```

Configuration Examples for VoIP over IPv6

Example: Configuring the SIP Trunk

This example shows how to configure the SIP trunk to use dual-stack mode, with IPv6 as the preferred mode. The SIP service must be shut down before any changes are made to protocol mode configuration.

```
Device(config)# sip-ua
Device(config-sip-ua)# protocol mode dual-stack preference ipv6
```

Troubleshooting Tips for VoIP for IPv6

Media Flow-Through

To enable all Session Initiation Protocol (SIP)-related debugging, use the **debug ccsip all** command in privileged EXEC mode.

To trace the execution path through the call control application programming interface (CCAPI), use the **debug voip ccapi inout** command.

Media Flow-Around

To enable all Session Initiation Protocol (SIP)-related debugging, use the **debug ccsip all** command.

To trace the execution path through the call control application programming interface (CCAPI), use the **debug voip ccapi inout** command.

SDP Pass-Through

To enable all Session Initiation Protocol (SIP)-related debugging (when the call is active in Pass through mode), use the **debug ccsip all** command.

RTP Port Range

To enable all Session Initiation Protocol (SIP)-related debugging, use the **debug ccsip all** command.

To enable debugging for Real-Time Transport Protocol (RTP) named event packets, use the **debug voip rtp** command.

VMWI SIP

To collect debug information only for signaling events, use the **debug vpm signal** command.

To show all Session Initiation Protocol (SIP) Service Provider Interface (SPI) message tracing, use the **debug ccsip messages** command.

Verifying and Troubleshooting Tips

Verifying Cisco UBE ANAT Call Flows

To verify that media settings are enabled in the media flowthrough and media flow-around feature, use the following commands:

SUMMARY STEPS

1. **show call active voice brief**

2. show call active voice compact
3. show voip rtp connections

DETAILED STEPS

Step 1 show call active voice brief

Example:

```
Device# show call active voice brief
```

```
<ID>: <CallID> <start>ms.<index> (<start>) +<connect> pid:<peer_id> <dir> <addr> <state>
dur hh:mm:ss tx:<packets>/<bytes> rx:<packets>/<bytes> dscp:<packets violation> media:<packets
violation> audio tos:<audio tos value> video tos:<video tos value>
IP <ip>:<udp> rtt:<time>ms pl:<play>/<gap>ms lost:<lost>/<early>/<late>
delay:<last>/<min>/<max>ms <codec> <textrelay> <transcoded>

media inactive detected:<y/n> media cntrl rcvd:<y/n> timestamp:<time>

long duration call detected:<y/n> long duration call duration :<sec> timestamp:<time>
LostPacketRate:<%> OutOfOrderRate:<%>
MODEMPASS <method> buf:<fills>/<drains> loss <overall%> <multipkt>/<corrected>
last <buf event time>s dur:<Min>/<Max>s
FR <protocol> [int dlci cid] vad:<y/n> dtmf:<y/n> seq:<y/n>
<codec> (payload size)
ATM <protocol> [int vpi/vci cid] vad:<y/n> dtmf:<y/n> seq:<y/n>
<codec> (payload size)
Tele <int> (callID) [channel_id] tx:<tot>/<v>/<fax>ms <codec> noise:<l> acom:<l> i/o:<l>/<l> dBm
MODEMRELAY info:<rcvd>/<sent>/<resent> xid:<rcvd>/<sent> total:<rcvd>/<sent>/<drops>
speeds(bps): local <rx>/<tx> remote <rx>/<tx>
Proxy <ip>:<audio udp>,<video udp>,<tcp0>,<tcp1>,<tcp2>,<tcp3> endpt: <type>/<manf>
bw: <req>/<act> codec: <audio>/<video>
tx: <audio pkts>/<audio bytes>,<video pkts>/<video bytes>,<t120 pkts>/<t120 bytes>
rx: <audio pkts>/<audio bytes>,<video pkts>/<video bytes>,<t120 pkts>/<t120 bytes>

Telephony call-legs: 0
SIP call-legs: 2
H323 call-legs: 0
Call agent controlled call-legs: 0
SCCP call-legs: 0
Multicast call-legs: 0
Total call-legs: 2
0 : 987 361904110ms.1 (16:01:10.557 IST Tue May 14 2013) +530 pid:1 Answer 1005 connected
dur 00:00:56 tx:1082/173120 rx:1141/182560 dscp:0 media:0 audio tos:0xB8 video tos:0x0
IP 2001:1111:2222:3333:4444:5555:6666:1012:38356 SRTP: off rtt:0ms pl:0/0ms lost:0/0/0 delay:0/0/0ms
g711ulaw TextRelay: off Transcoded: No
media inactive detected:n media cntrl rcvd:n/a timestamp:n/a
long duration call detected:n long duration call duration:n/a timestamp:n/a
LostPacketRate:0.00 OutOfOrderRate:0.00

0 : 988 361904120ms.1 (16:01:10.567 IST Tue May 14 2013) +510 pid:2 Originate 2005 connected
dur 00:00:56 tx:1141/182560 rx:1082/173120 dscp:0 media:0 audio tos:0xB8 video tos:0x0
IP 2001:1111:2222:3333:4444:5555:6666:1012:26827 SRTP: off rtt:0ms pl:0/0ms lost:0/0/0 delay:0/0/0ms
g711ulaw TextRelay: off Transcoded: No
media inactive detected:n media cntrl rcvd:n/a timestamp:n/a
long duration call detected:n long duration call duration:n/a timestamp:n/a
LostPacketRate:0.00 OutOfOrderRate:0.00

Telephony call-legs: 0
SIP call-legs: 2
H323 call-legs: 0
Call agent controlled call-legs: 0
```

```

SCCP call-legs: 0
Multicast call-legs: 0
Total call-legs: 2

```

Step 2 show call active voice compact

Example:

```

Device# show call active voice compact

<callID>  A/O FAX T<sec> Codec      type      Peer Address      IP R<ip>:<udp>
Total call-legs: 2
          987 ANS   T61    g711ulaw  VOIP      P1005 2001:.....:1012:38356
          988 ORG   T61    g711ulaw  VOIP      P2005 2001:.....:1012:26827

```

Step 3 show voip rtp connections

Example:

```

Device# show voip rtp connections

VoIP RTP Port Usage Information:
Max Ports Available: 24273, Ports Reserved: 303, Ports in Use: 2
Port range not configured, Min: 16384, Max: 32767

Media-Address Range                               Ports Available  Ports Reserved  Ports In-use
Default Address-Range                             8091             101             0
2001::
2002::
9.0.0.0                               10.0.0.0         8091            101             1
Found 2 active RTP connections

```

Verifying and Troubleshooting Cisco UBE ANAT Flow-Through Call

To verify and troubleshoot **Cisco UBE ANAT Flow-Through** calls, use the following commands:

SUMMARY STEPS

1. debug ccsip message
2. show voip rtp connections

DETAILED STEPS

Step 1 debug ccsip message

Example:

```

Device# show logging

*Jun  7 09:17:41.135: //-1/xxxxxxxxxxxx/SIP/Msg/ccsipDisplayMsg:
Received:
INVITE sip:6000@[2001:DB8:C18:2:223:4FF:FEAC:4540]:5060 SIP/2.0

```

```

Via: SIP/2.0/UDP [2001:DB8:C18:2:219:2FFF:FE89:7928]:5060;branch=z9hG4bK1CA8CD
Remote-Party-ID: <sip:1001@[2001:DB8:C18:2:219:2FFF:FE89:7928]>;party=calling;screen=no;privacy=off
From: <sip:1001@[2001:DB8:C18:2:219:2FFF:FE89:7928]>;tag=6EDAC1D0-F25
To: <sip:6000@[2001:DB8:C18:2:223:4FF:FEAC:4540]>
Date: Thu, 07 Jun 2012 10:47:17 GMT
Call-ID: FC36AC29-AFC411E1-8725FA39-34B6D876@2001:DB8:C18:2:219:2FFF:FE89:7928
Supported: 100rel,timer,resource-priority,replaces
Require: sdp-anat
Min-SE: 1800
Cisco-Guid: 4231321369-2948862433-2168455193-0797538600
User-Agent: Cisco-SIPGateway/IOS-12.x
Allow: INVITE, OPTIONS, BYE, CANCEL, ACK, PRACK, UPDATE, REFER, SUBSCRIBE, NOTIFY, INFO, REGISTER
CSeq: 101 INVITE
Max-Forwards: 70
Timestamp: 1339066037
Contact: <sip:1001@[2001:DB8:C18:2:219:2FFF:FE89:7928]:5060>
Expires: 180
Allow-Events: telephone-event
Content-Type: application/sdp
Content-Disposition: session;handling=required
Content-Length: 441

```

```

v=0
o=CiscoSystemsSIP-GW-UserAgent 4604 5397 IN IP6 2001:DB8:C18:2:219:2FFF:FE89:7928
s=SIP Call
c=IN IP4 9.44.30.10
t=0 0
a=group:ANAT 1 2
m=audio 16970 RTP/AVP 18 19
c=IN IP4 9.44.30.10
a=mid:1
a=rtpmap:18 G729/8000
a=fmtp:18 annexb=no
a=rtpmap:19 CN/8000
a=ptime:20
m=audio 17066 RTP/AVP 18 19
c=IN IP6 2001:DB8:C18:2:219:2FFF:FE89:7928
a=mid:2
a=rtpmap:18 G729/8000
a=fmtp:18 annexb=no
a=rtpmap:19 CN/8000
a=ptime:20

```

```

*Jun 7 09:17:41.159: //31/FC34D7198140/SIP/Msg/ccsipDisplayMsg:
Sent:
SIP/2.0 100 Trying
Via: SIP/2.0/UDP [2001:DB8:C18:2:219:2FFF:FE89:7928]:5060;branch=z9hG4bK1CA8CD
From: <sip:1001@[2001:DB8:C18:2:219:2FFF:FE89:7928]>;tag=6EDAC1D0-F25
To: <sip:6000@[2001:DB8:C18:2:223:4FF:FEAC:4540]>
Date: Thu, 07 Jun 2012 09:17:41 GMT
Call-ID: FC36AC29-AFC411E1-8725FA39-34B6D876@2001:DB8:C18:2:219:2FFF:FE89:7928
Timestamp: 1339066037
CSeq: 101 INVITE
Allow-Events: telephone-event
Server: Cisco-SIPGateway/IOS-15.2.20120528.102328.
Content-Length: 0

```

```

*Jun 7 09:17:41.159: //32/FC34D7198140/SIP/Msg/ccsipDisplayMsg:
Sent:
INVITE sip:6000@9.44.30.11:5060 SIP/2.0
Via: SIP/2.0/UDP 9.44.30.14:5060;branch=z9hG4bK2688E
Remote-Party-ID: <sip:1001@9.44.30.14>;party=calling;screen=no;privacy=off
From: <sip:1001@9.44.30.14>;tag=6D0FC0-1428
To: <sip:6000@9.44.30.11>

```



```

Date: Thu, 07 Jun 2012 09:17:41 GMT
Call-ID: 7780227E-AFB811E1-8060F4DD-5665AA1B@9.44.30.14
Supported: timer,resource-priority,replaces
Require: sdp-anat
Min-SE: 1800
Cisco-Guid: 4231321369-2948862433-2168455193-0797538600
User-Agent: Cisco-SIPGateway/IOS-15.2.20120528.102328.
Allow: INVITE, OPTIONS, BYE, CANCEL, ACK, PRACK, UPDATE, REFER, SUBSCRIBE, NOTIFY, INFO, REGISTER
CSeq: 101 INVITE
Timestamp: 1339060661
Contact: <sip:1001@9.44.30.14:5060>
Expires: 180
Allow-Events: telephone-event
Max-Forwards: 69
Content-Type: application/sdp
Content-Disposition: session;handling=required   Phone is offhook
Content-Length: 437

```

```

v=0
o=CiscoSystemsSIP-GW-UserAgent 3184 51 IN IP4 9.44.30.14
s=SIP Call
c=IN IP6 2001:DB8:C18:2:223:4FF:FEAC:4540
t=0 0
a=group:ANAT 1 2
m=audio 16438 RTP/AVP 18 19
c=IN IP6 2001:DB8:C18:2:223:4FF:FEAC:4540
a=mid:1
a=rtpmap:18 G729/8000
a=fmtp:18 annexb=no
a=rtpmap:19 CN/8000
aptime:20
m=audio 16440 RTP/AVP 18 19
c=IN IP4 9.44.30.14
a=mid:2
a=rtpmap:18 G729/8000
a=fmtp:18 annexb=no
a=rtpmap:19 CN/8000
aptime:20

```

```

*Jun 7 09:17:41.179: //32/FC34D7198140/SIP/Msg/ccsipDisplayMsg:
Received:
SIP/2.0 100 Trying
Via: SIP/2.0/UDP 9.44.30.14:5060;branch=z9hG4bK2688E
From: <sip:1001@9.44.30.14>;tag=6D0FC0-1428
To: <sip:6000@9.44.30.11>
Date: Thu, 07 Jun 2012 10:40:14 GMT
Call-ID: 7780227E-AFB811E1-8060F4DD-5665AA1B@9.44.30.14
Timestamp: 1339060661
CSeq: 101 INVITE
Allow-Events: telephone-event
Server: Cisco-SIPGateway/IOS-15.2.2.5.T
Content-Length: 0

```

```

*Jun 7 09:17:41.203: //32/FC34D7198140/SIP/Msg/ccsipDisplayMsg:
Received:
SIP/2.0 180 Ringing
Via: SIP/2.0/UDP 9.44.30.14:5060;branch=z9hG4bK2688E
From: <sip:1001@9.44.30.14>;tag=6D0FC0-1428
To: <sip:6000@9.44.30.11>;tag=93D1F9D4-9E2
Date: Thu, 07 Jun 2012 10:40:14 GMT
Call-ID: 7780227E-AFB811E1-8060F4DD-5665AA1B@9.44.30.14
Timestamp: 1339060661
CSeq: 101 INVITE
Allow: INVITE, OPTIONS, BYE, CANCEL, ACK, PRACK, UPDATE, REFER, SUBSCRIBE, NOTIFY, INFO, REGISTER

```

```

Allow-Events: telephone-event
Remote-Party-ID: <sip:6000@9.44.30.11>;party=called;screen=no;privacy=off
Contact: <sip:6000@9.44.30.11:5060>
Server: Cisco-SIPGateway/IOS-15.2.2.5.T
Content-Length: 0

*Jun  7 09:17:41.207: //31/FC34D7198140/SIP/Msg/ccsipDisplayMsg:
Sent:
SIP/2.0 180 Ringing
Via: SIP/2.0/UDP [2001:DB8:C18:2:219:2FFF:FE89:7928]:5060;branch=z9hG4bK1CA8CD
From: <sip:1001@[2001:DB8:C18:2:219:2FFF:FE89:7928]>;tag=6EDAC1D0-F25
To: <sip:6000@[2001:DB8:C18:2:223:4FF:FEAC:4540]>;tag=6D0FF4-14D3
Date: Thu, 07 Jun 2012 09:17:41 GMT
Call-ID: FC36AC29-AFC411E1-8725FA39-34B6D876@2001:DB8:C18:2:219:2FFF:FE89:7928
Timestamp: 1339066037
CSeq: 101 INVITE
Allow: INVITE, OPTIONS, BYE, CANCEL, ACK, PRACK, UPDATE, REFER, SUBSCRIBE, NOTIFY, INFO, REGISTER
Allow-Events: telephone-event
Remote-Party-ID: <sip:6000@[2001:DB8:C18:2:223:4FF:FEAC:4540]>;party=called;screen=no;privacy=off
Contact: <sip:6000@[2001:DB8:C18:2:223:4FF:FEAC:4540]:5060>
Server: Cisco-SIPGateway/IOS-15.2.20120528.102328.
Content-Length: 0

*Jun  7 09:17:41.219: //32/FC34D7198140/SIP/Msg/ccsipDisplayMsg:
Received:
SIP/2.0 200 OK
Via: SIP/2.0/UDP 9.44.30.14:5060;branch=z9hG4bK2688E
From: <sip:1001@9.44.30.14>;tag=6D0FC0-1428
To: <sip:6000@9.44.30.11>;tag=93D1F9D4-9E2
Date: Thu, 07 Jun 2012 10:40:14 GMT
Call-ID: 7780227E-AFB811E1-8060F4DD-5665AA1B@9.44.30.14
Timestamp: 1339060661
CSeq: 101 INVITE
Allow: INVITE, OPTIONS, BYE, CANCEL, ACK, PRACK, UPDATE, REFER, SUBSCRIBE, NOTIFY, INFO, REGISTER
Allow-Events: telephone-event
Remote-Party-ID: <sip:6000@9.44.30.11>;party=called;screen=no;privacy=off
Contact: <sip:6000@9.44.30.11:5060>
Supported: replaces
Require: sdp-anat
Server: Cisco-SIPGateway/IOS-15.2.2.5.T
Supported: timer
Content-Type: application/sdp
Content-Disposition: session;handling=required
Content-Length: 435

v=0
o=CiscoSystemsSIP-GW-UserAgent 8213 2783 IN IP4 9.44.30.11
s=SIP Call
c=IN IP6 2001:DB8:C18:2:217:59FF:FEDE:8898
t=0 0
a=group:ANAT 1
m=audio 17200 RTP/AVP 18 19
c=IN IP6 2001:DB8:C18:2:217:59FF:FEDE:8898
a=mid:1
a=rtpmap:18 G729/8000
a=fmtp:18 annexb=no
a=rtpmap:19 CN/8000
aptime:20
m=audio 0 RTP/AVP 18 19
c=IN IP4 9.44.30.11
a=mid:2
a=rtpmap:18 G729/8000
a=fmtp:18 annexb=no

```

```
a=rtpmap:19 CN/8000
aptime:20
```

```
*Jun 7 09:17:41.227: //32/FC34D7198140/SIP/Msg/ccsipDisplayMsg:
```

```
Sent:
ACK sip:6000@9.44.30.11:5060 SIP/2.0
Via: SIP/2.0/UDP 9.44.30.14:5060;branch=z9hG4bK27145B
From: <sip:1001@9.44.30.14>;tag=6D0FC0-1428
To: <sip:6000@9.44.30.11>;tag=93D1F9D4-9E2
Date: Thu, 07 Jun 2012 09:17:41 GMT
Call-ID: 7780227E-AFB811E1-8060F4DD-5665AA1B@9.44.30.14
Max-Forwards: 70
CSeq: 101 ACK
Allow-Events: telephone-event
Content-Length: 0
```

```
*Jun 7 09:17:41.235: //31/FC34D7198140/SIP/Msg/ccsipDisplayMsg:
```

```
Sent:
SIP/2.0 200 OK
Via: SIP/2.0/UDP [2001:DB8:C18:2:219:2FFF:FE89:7928]:5060;branch=z9hG4bK1CA8CD
From: <sip:1001@[2001:DB8:C18:2:219:2FFF:FE89:7928]>;tag=6EDAC1D0-F25
To: <sip:6000@[2001:DB8:C18:2:223:4FF:FEAC:4540]>;tag=6D0FF4-14D3
Date: Thu, 07 Jun 2012 09:17:41 GMT
Call-ID: FC36AC29-AFC411E1-8725FA39-34B6D876@2001:DB8:C18:2:219:2FFF:FE89:7928
Timestamp: 1339066037
CSeq: 101 INVITE
Allow: INVITE, OPTIONS, BYE, CANCEL, ACK, PRACK, UPDATE, REFER, SUBSCRIBE, NOTIFY, INFO, REGISTER
Allow-Events: telephone-event
Remote-Party-ID: <sip:6000@[2001:DB8:C18:2:223:4FF:FEAC:4540]>;party=called;screen=no;privacy=off
Contact: <sip:6000@[2001:DB8:C18:2:223:4FF:FEAC:4540]:5060>
Supported: replaces
Require: sdp-anat
Server: Cisco-SIPGateway/IOS-15.2.20120528.102328.
Supported: timer
Content-Type: application/sdp
Content-Disposition: session;handling=required
Content-Length: 433
```

```
v=0
```

```
o=CiscoSystemsSIP-GW-UserAgent 8884 4606 IN IP6 2001:DB8:C18:2:223:4FF:FEAC:4540
s=SIP Call
c=IN IP4 9.44.30.14
t=0 0
a=group:ANAT 1
m=audio 16436 RTP/AVP 18 19
c=IN IP4 9.44.30.14
a=mid:1
a=rtpmap:18 G729/8000
a=fmtp:18 annexb=no
a=rtpmap:19 CN/8000
aptime:20
m=audio 0 RTP/AVP 18 19
c=IN IP6 2001:DB8:C18:2:223:4FF:FEAC:4540
a=mid:2
a=rtpmap:18 G729/8000
a=fmtp:18 annexb=no
a=rtpmap:19 CN/8000
aptime:20
```

```
*Jun 7 09:17:41.251: //-1/xxxxxxxxxxxx/SIP/Msg/ccsipDisplayMsg:
```

```
Received:
ACK sip:6000@[2001:DB8:C18:2:223:4FF:FEAC:4540]:5060 SIP/2.0
```

```
Via: SIP/2.0/UDP [2001:DB8:C18:2:219:2FFF:FE89:7928]:5060;branch=z9hG4bK1CB1E77
From: <sip:1001@[2001:DB8:C18:2:219:2FFF:FE89:7928]>;tag=6EDAC1D0-F25
To: <sip:6000@[2001:DB8:C18:2:223:4FF:FEAC:4540]>;tag=6D0FF4-14D3
Date: Thu, 07 Jun 2012 10:47:17 GMT
Call-ID: FC36AC29-AFC411E1-8725FA39-34B6D876@2001:DB8:C18:2:219:2FFF:FE89:7928
Max-Forwards: 70
CSeq: 101 ACK
Allow-Events: telephone-event
Content-Length: 0
```

Step 2 show voip rtp connections**Example:**

```
Device# show voip rtp connections
```

```
VoIP RTP Port Usage Information:
```

```
Max Ports Available: 8091, Ports Reserved: 101, Ports in Use: 3
Port range not configured, Min: 16384, Max: 32767
```

Media-Address Range	Ports Available	Ports Reserved	Ports In-use
Default Address-Range	8091	101	3

```
VoIP RTP active connections :
```

No.	CallId	dstCallId	LocalRTP	RmtRTP	LocalIP	RemoteIP
1	31	32	16436	16970	9.44.30.14	9.44.30.10
2	32	31	16438	17200	2001:DB8:C18:2:223:4FF:FEAC:4540	

```
2001:DB8:C18:2:217:59FF:FEDE:8898
Found 2 active RTP connections
```

Verifying Cisco UBE ANAT Flow-Around Calls

To verify Cisco UBE ANAT Flow-Around calls, use the **debug ccsip message** commands:

SUMMARY STEPS

1. **debug ccsip message**
2. **show voip rtp connections**

DETAILED STEPS**Step 1 debug ccsip message****Example:**

```
Device# Show logging
```

```
*Jun 7 17:26:30.681: //-1/xxxxxxxxxxxx/SIP/Msg/ccsipDisplayMsg:
Received:
INVITE sip:6000@[2001:DB8:C18:2:223:4FF:FEAC:4540]:5060 SIP/2.0
Via: SIP/2.0/UDP [2001:DB8:C18:2:223:33FF:FEB1:B440]:5060;branch=z9hG4bK14B25D
```

```

Remote-Party-ID: <sip:1001@[2001:DB8:C18:2:223:33FF:FEB1:B440]>;party=calling;screen=no;privacy=off
From: <sip:1001@[2001:DB8:C18:2:223:33FF:FEB1:B440]>;tag=5569ECC8-C79
To: <sip:6000@[2001:DB8:C18:2:223:4FF:FEAC:4540]>
Date: Thu, 07 Jun 2012 17:35:05 GMT
Call-ID: F44F5437-AFFD11E1-816CD9DB-F669887E@2001:DB8:C18:2:223:33FF:FEB1:B440
Supported: 100rel,timer,resource-priority,replaces
Require: sdp-anat
Min-SE: 1800
Cisco-Guid: 1170397766-2953384417-2170945561-0797538600
User-Agent: Cisco-SIPGateway/IOS-12.x
Allow: INVITE, OPTIONS, BYE, CANCEL, ACK, PRACK, UPDATE, REFER, SUBSCRIBE, NOTIFY, INFO, REGISTER
CSeq: 101 INVITE
Max-Forwards: 70
Timestamp: 1339090505
Contact: <sip:1001@[2001:DB8:C18:2:223:33FF:FEB1:B440]:5060>
Expires: 180
Allow-Events: telephone-event
Content-Type: application/sdp
Content-Disposition: session;handling=required
Content-Length: 465

```

```

v=0
o=CiscoSystemsSIP-GW-UserAgent 9103 1209 IN IP6 2001:DB8:C18:2:223:33FF:FEB1:B440
s=SIP Call
c=IN IP4 9.44.30.13
t=0 0
a=group:ANAT 1 2
m=audio 18706 RTP/AVP 18 0 19
c=IN IP4 9.44.30.13
a=mid:1
a=rtpmap:18 G729/8000
a=fmtp:18 annexb=no
a=rtpmap:0 PCMU/8000
a=rtpmap:19 CN/8000
m=audio 16384 RTP/AVP 18 0 19
c=IN IP6 2001:DB8:C18:2:223:33FF:FEB1:B440
a=mid:2
a=rtpmap:18 G729/8000
a=fmtp:18 annexb=no
a=rtpmap:0 PCMU/8000
a=rtpmap:19 CN/8000

```

```

*Jun 7 17:26:30.705: //106/45C2DA468166/SIP/Msg/ccsipDisplayMsg:
Sent:
SIP/2.0 100 Trying
Via: SIP/2.0/UDP [2001:DB8:C18:2:223:33FF:FEB1:B440]:5060;branch=z9hG4bK14B25D
From: <sip:1001@[2001:DB8:C18:2:223:33FF:FEB1:B440]>;tag=5569ECC8-C79
To: <sip:6000@[2001:DB8:C18:2:223:4FF:FEAC:4540]>
Date: Thu, 07 Jun 2012 17:26:30 GMT
Call-ID: F44F5437-AFFD11E1-816CD9DB-F669887E@2001:DB8:C18:2:223:33FF:FEB1:B440
Timestamp: 1339090505
CSeq: 101 INVITE
Allow-Events: telephone-event
Server: Cisco-SIPGateway/IOS-15.2.20120528.102328.
Content-Length: 0

```

```

*Jun 7 17:26:30.705: //107/45C2DA468166/SIP/Msg/ccsipDisplayMsg:
Sent:
INVITE sip:6000@9.44.30.11:5060 SIP/2.0
Via: SIP/2.0/UDP 9.44.30.14:5060;branch=z9hG4bK90BB
Remote-Party-ID: <sip:1001@9.44.30.14>;party=calling;screen=no;privacy=off
From: <sip:1001@9.44.30.14>;tag=22C984C-970

```

```

To: <sip:6000@9.44.30.11>
Date: Thu, 07 Jun 2012 17:26:30 GMT
Call-ID: C145AF07-AFFC11E1-813EF4DD-5665AA1B@9.44.30.14
Supported: timer,resource-priority,replaces
Require: sdp-anat
Min-SE: 1800
Cisco-Guid: 1170397766-2953384417-2170945561-0797538600
User-Agent: Cisco-SIPGateway/IOS-15.2.20120528.102328.
Allow: INVITE, OPTIONS, BYE, CANCEL, ACK, PRACK, UPDATE, REFER, SUBSCRIBE, NOTIFY, INFO, REGISTER
CSeq: 101 INVITE
Timestamp: 1339089990
Contact: <sip:1001@9.44.30.14:5060>
Expires: 180
Allow-Events: telephone-event
Max-Forwards: 69
Content-Type: application/sdp
Content-Disposition: session;handling=required
Content-Length: 418

```

```

v=0
o=CiscoSystemsSIP-GW-UserAgent 9582 2407 IN IP4 9.44.30.14
s=SIP Call
c=IN IP4 9.44.30.13
t=0 0
a=group:ANAT 1 2
m=audio 18706 RTP/AVP 18 19
c=IN IP4 9.44.30.13
a=mid:1
a=rtpmap:18 G729/8000
a=fmtp:18 annexb=no
a=rtpmap:19 CN/8000
a=ptime:20
m=audio 16384 RTP/AVP 18 19
c=IN IP6 2001:DB8:C18:2:223:33FF:FEB1:B440
a=mid:2
a=rtpmap:18 G729/8000
a=fmtp:18 annexb=no
a=rtpmap:19 CN/8000
a=ptime:20

```

```

*Jun 7 17:26:30.729: //107/45C2DA468166/SIP/Msg/ccsipDisplayMsg:
Received:
SIP/2.0 100 Trying
Via: SIP/2.0/UDP 9.44.30.14:5060;branch=z9hG4bK90BB
From: <sip:1001@9.44.30.14>;tag=22C984C-970
To: <sip:6000@9.44.30.11>
Date: Thu, 07 Jun 2012 18:49:04 GMT
Call-ID: C145AF07-AFFC11E1-813EF4DD-5665AA1B@9.44.30.14
Timestamp: 1339089990
CSeq: 101 INVITE
Allow-Events: telephone-event
Server: Cisco-SIPGateway/IOS-15.2.2.5.T
Content-Length: 0

```

```

*Jun 7 17:26:30.753: //107/45C2DA468166/SIP/Msg/ccsipDisplayMsg:
Received:
SIP/2.0 180 Ringing
Via: SIP/2.0/UDP 9.44.30.14:5060;branch=z9hG4bK90BB
From: <sip:1001@9.44.30.14>;tag=22C984C-970
To: <sip:6000@9.44.30.11>;tag=959183D0-2073
Date: Thu, 07 Jun 2012 18:49:04 GMT
Call-ID: C145AF07-AFFC11E1-813EF4DD-5665AA1B@9.44.30.14
Timestamp: 1339089990

```

```
CSeq: 101 INVITE
Allow: INVITE, OPTIONS, BYE, CANCEL, ACK, PRACK, UPDATE, REFER, SUBSCRIBE, NOTIFY, INFO, REGISTER
Allow-Events: telephone-event
Remote-Party-ID: <sip:6000@9.44.30.11>;party=called;screen=no;privacy=off
Contact: <sip:6000@9.44.30.11:5060>
Server: Cisco-SIPGateway/IOS-15.2.2.5.T
Content-Length: 0
```

```
*Jun 7 17:26:30.753: //106/45C2DA468166/SIP/Msg/ccsipDisplayMsg:
Sent:
SIP/2.0 180 Ringing
Via: SIP/2.0/UDP [2001:DB8:C18:2:223:33FF:FEB1:B440]:5060;branch=z9hG4bK14B25D
From: <sip:1001@[2001:DB8:C18:2:223:33FF:FEB1:B440]>;tag=5569ECC8-C79
To: <sip:6000@[2001:DB8:C18:2:223:4FF:FEAC:4540]>;tag=22C9880-150D
Date: Thu, 07 Jun 2012 17:26:30 GMT
Call-ID: F44F5437-AFFD11E1-816CD9DB-F669887E@2001:DB8:C18:2:223:33FF:FEB1:B440
Timestamp: 1339090505
CSeq: 101 INVITE
Allow: INVITE, OPTIONS, BYE, CANCEL, ACK, PRACK, UPDATE, REFER, SUBSCRIBE, NOTIFY, INFO, REGISTER
Allow-Events: telephone-event
Remote-Party-ID: <sip:6000@[2001:DB8:C18:2:223:4FF:FEAC:4540]>;party=called;screen=no;privacy=off
Contact: <sip:6000@[2001:DB8:C18:2:223:4FF:FEAC:4540]:5060>
Server: Cisco-SIPGateway/IOS-15.2.20120528.102328.
Content-Length: 0
```

```
*Jun 7 17:26:30.765: //107/45C2DA468166/SIP/Msg/ccsipDisplayMsg:
Received:
SIP/2.0 200 OK
Via: SIP/2.0/UDP 9.44.30.14:5060;branch=z9hG4bK90BB
From: <sip:1001@9.44.30.14>;tag=22C984C-970
To: <sip:6000@9.44.30.11>;tag=959183D0-2073
Date: Thu, 07 Jun 2012 18:49:04 GMT
Call-ID: C145AF07-AFFC11E1-813EF4DD-5665AA1B@9.44.30.14
Timestamp: 1339089990
CSeq: 101 INVITE
Allow: INVITE, OPTIONS, BYE, CANCEL, ACK, PRACK, UPDATE, REFER, SUBSCRIBE, NOTIFY, INFO, REGISTER
Allow-Events: telephone-event
Remote-Party-ID: <sip:6000@9.44.30.11>;party=called;screen=no;privacy=off
Contact: <sip:6000@9.44.30.11:5060>
Supported: replaces
Require: sdp-anat
Server: Cisco-SIPGateway/IOS-15.2.2.5.T
Supported: timer
Content-Type: application/sdp
Content-Disposition: session;handling=required
Content-Length: 412
```

```
v=0
o=CiscoSystemsSIP-GW-UserAgent 2764 5975 IN IP4 9.44.30.11
s=SIP Call
c=IN IP4 9.44.30.11
t=0 0
a=group:ANAT 1
m=audio 17278 RTP/AVP 18 19
c=IN IP4 9.44.30.11
a=mid:1
a=rtpmap:18 G729/8000
a=fmtp:18 annexb=no
a=rtpmap:19 CN/8000
aptime:20
m=audio 0 RTP/AVP 18 19
c=IN IP6 2001:DB8:C18:2:217:59FF:FEDE:8898
```

Verifying Cisco UBE ANAT Flow-Around Calls

```

a=mid:2
a=rtpmap:18 G729/8000
a=fmtp:18 annexb=no
a=rtpmap:19 CN/8000
a=ptime:20

```

```

*Jun  7 17:26:30.777: //107/45C2DA468166/SIP/Msg/ccsipDisplayMsg:
Sent:
ACK sip:6000@9.44.30.11:5060 SIP/2.0
Via: SIP/2.0/UDP 9.44.30.14:5060;branch=z9hG4bK91207D
From: <sip:1001@9.44.30.14>;tag=22C984C-970
To: <sip:6000@9.44.30.11>;tag=959183D0-2073
Date: Thu, 07 Jun 2012 17:26:30 GMT
Call-ID: C145AF07-AFFC11E1-813EF4DD-5665AA1B@9.44.30.14
Max-Forwards: 70
CSeq: 101 ACK
Allow-Events: telephone-event
Content-Length: 0

```

```

*Jun  7 17:26:30.785: //106/45C2DA468166/SIP/Msg/ccsipDisplayMsg:
Sent:
SIP/2.0 200 OK
Via: SIP/2.0/UDP [2001:DB8:C18:2:223:33FF:FEB1:B440]:5060;branch=z9hG4bK14B25D
From: <sip:1001@[2001:DB8:C18:2:223:33FF:FEB1:B440]>;tag=5569ECC8-C79
To: <sip:6000@[2001:DB8:C18:2:223:4FF:FEAC:4540]>;tag=22C9880-150D
Date: Thu, 07 Jun 2012 17:26:30 GMT
Call-ID: F44F5437-AFFD11E1-816CD9DB-F669887E@2001:DB8:C18:2:223:33FF:FEB1:B440
Timestamp: 1339090505
CSeq: 101 INVITE
Allow: INVITE, OPTIONS, BYE, CANCEL, ACK, PRACK, UPDATE, REFER, SUBSCRIBE, NOTIFY, INFO, REGISTER
Allow-Events: telephone-event
Remote-Party-ID: <sip:6000@[2001:DB8:C18:2:223:4FF:FEAC:4540]>;party=called;screen=no;privacy=off
Contact: <sip:6000@[2001:DB8:C18:2:223:4FF:FEAC:4540]:5060>
Supported: replaces
Require: sdp-anat
Server: Cisco-SIPGateway/IOS-15.2.20120528.102328.
Supported: timer
Content-Type: application/sdp
Content-Disposition: session;handling=required
Content-Length: 421

```

```

v=0
o=CiscoSystemsSIP-GW-UserAgent 9047 741 IN IP6 2001:DB8:C18:2:223:4FF:FEAC:4540
s=SIP Call
c=IN IP4 9.44.30.11
t=0 0
a=group:ANAT 1
m=audio 17278 RTP/AVP 18 19
c=IN IP4 9.44.30.11
a=mid:1
a=rtpmap:18 G729/8000
a=fmtp:18 annexb=no
a=rtpmap:19 CN/8000
a=ptime:20
m=audio 0 RTP/AVP 18 19
c=IN IP6 2001:DB8:C18:2:217:59FF:FEDE:8898
a=mid:2
a=rtpmap:18 G729/8000
a=fmtp:18 annexb=no
a=rtpmap:19 CN/8000

```



```
*Jun 7 17:26:30.793: //-1/xxxxxxxxxxxx/SIP/Msg/ccsipDisplayMsg:
Received:
ACK sip:6000@[2001:DB8:C18:2:223:4FF:FEAC:4540]:5060 SIP/2.0
Via: SIP/2.0/UDP [2001:DB8:C18:2:223:33FF:FEB1:B440]:5060;branch=z9hG4bK14C15A2
From: <sip:1001@[2001:DB8:C18:2:223:33FF:FEB1:B440]>;tag=5569ECC8-C79
To: <sip:6000@[2001:DB8:C18:2:223:4FF:FEAC:4540]>;tag=22C9880-150D
Date: Thu, 07 Jun 2012 17:35:05 GMT
Call-ID: F44F5437-AFFD11E1-816CD9DB-F669887E@2001:DB8:C18:2:223:33FF:FEB1:B440
Max-Forwards: 70
CSeq: 101 ACK
Allow-Events: telephone-event
Content-Length: 0
```

Step 2 show voip rtp connections

Example:

```
Device# show voip rtp connections
```

```
VoIP RTP Port Usage Information:
Max Ports Available: 8091, Ports Reserved: 101, Ports in Use: 0
Port range not configured, Min: 16384, Max: 32767
```

Media-Address Range	Ports Available	Ports Reserved	Ports In-use
Default Address-Range	8091	101	0

```
No active connections found
```

Verifying VMWI SIP

SUMMARY STEPS

1. show sip-ua mwi
2. debug vpm signal
3. debug ccsip messages

DETAILED STEPS

Step 1 show sip-ua mwi

Example:

```
Device# show sip-ua mwi
MWI type: 2
MWI server: 2001:10:12:1::2006 //IPv6 MWI Server Address//
MWI expires: 3600
MWI port: 5060
MWI dial peer tag: 0 //Shows the MWI-Server binding dial-peer tag. Tag "0" is default.//
MWI solicited //MWI type is solicited by default. Subscription of voice-port is required in this case only.//
MWI ipaddr cnt 1:
MWI ipaddr idx 0:
MWI server: 2001:10:12:1::2006, port 5060, transport 1 //IPv6 MWI Server Address//
MWI server dns lookup retry cnt: 0
```

Step 2 **debug vpm signal****Example:**

```
Device# debug vpm signal

Process vmwi. vmwi state: OFF
The phone is not on hook (1). Delay the vmwi processing. //Phone is offhook//
Process dc-voltage vmwi. State: OFF //VMWI state is off//
*Mar  2 02:33:34.841: [2/0] c2400_dc_volt_mwi: on=0
The phone is not onhook (1). Delay the vmwi processing. Process vmwi. vmwi state: ON //VMWI state
is on//
Voice port 0/2/1 subscribed MWI //Subscription of port for MWI (Solicited)//
```

Step 3 **debug ccsip messages****Example:**

```
Device# debug ccsip messages
```

Note The **debug ccsip messages** command shows the SIP Messages, such as Subscribe and Notify.

Verifying SDP Passthrough Configuration

SUMMARY STEPS

1. **debug ccsip all**
2. **show voip rtp connection**

DETAILED STEPS**Step 1** **debug ccsip all****Example:**

```
Device# show logging

Received:
INVITE sip:6000@[2001:DB8:C18:2:223:4FF:FEAC:4540]:5060 SIP/2.0
Via: SIP/2.0/UDP [2001:DB8:C18:2:223:33FF:FEB1:B440]:5060;branch=z9hG4bK20277F
Remote-Party-ID: <sip:1001@[2001:DB8:C18:2:223:33FF:FEB1:B440]>;party=calling;screen=no;privacy=off
From: <sip:1001@[2001:DB8:C18:2:223:33FF:FEB1:B440]>;tag=59283684-0
To: <sip:6000@[2001:DB8:C18:2:223:4FF:FEAC:4540]>
Date: Fri, 08 Jun 2012 11:01:48 GMT
Call-ID: 2D6EEC84-B09011E1-8235D9DB-F669887E@2001:DB8:C18:2:223:33FF:FEB1:B440
Supported: 100rel,timer,resource-priority,replaces
Require: sdp-anat
Min-SE: 1800
Cisco-Guid: 2131649325-2962952673-2175336473-0797538600
User-Agent: Cisco-SIPGateway/IOS-12.x
Allow: INVITE, OPTIONS, BYE, CANCEL, ACK, PRACK, UPDATE, REFER, SUBSCRIBE, NOTIFY, INFO, REGISTER
CSeq: 101 INVITE
Max-Forwards: 70
Timestamp: 1339153308
Contact: <sip:1001@[2001:DB8:C18:2:223:33FF:FEB1:B440]:5060>
Expires: 180
Allow-Events: telephone-event
```

```
Content-Type: application/sdp
Content-Disposition: session;handling=required
Content-Length: 488
```

```
v=0
o=CiscoSystemsSIP-GW-UserAgent 7132 4992 IN IP6 2001:DB8:C18:2:223:33FF:FEB1:B440
s=SIP Call
c=IN IP6 2001:DB8:C18:2:223:33FF:FEB1:B440
t=0 0
a=group:ANAT 1 2
m=audio 16406 RTP/AVP 18 0 19
c=IN IP6 2001:DB8:C18:2:223:33FF:FEB1:B440
a=mid:1
a=rtpmap:18 G729/8000
a=fmtp:18 annexb=no
a=rtpmap:0 PCMU/8000
a=rtpmap:19 CN/8000
m=audio 18024 RTP/AVP 18 0 19
c=IN IP4 9.44.30.13
a=mid:2
a=rtpmap:18 G729/8000
a=fmtp:18 annexb=no
a=rtpmap:0 PCMU/8000
a=rtpmap:19 CN/8000
```

```
Sent:
SIP/2.0 100 Trying
Via: SIP/2.0/UDP [2001:DB8:C18:2:223:33FF:FEB1:B440]:5060;branch=z9hG4bK20277F
From: <sip:1001@[2001:DB8:C18:2:223:33FF:FEB1:B440]>;tag=59283684-0
To: <sip:6000@[2001:DB8:C18:2:223:4FF:FEAC:4540]>
Date: Fri, 08 Jun 2012 10:53:14 GMT
Call-ID: 2D6EEC84-B09011E1-8235D9DB-F669887E@2001:DB8:C18:2:223:33FF:FEB1:B440
Timestamp: 1339153308
CSeq: 101 INVITE
Allow-Events: telephone-event
Server: Cisco-SIPGateway/IOS-15.2.20120528.102328.
Content-Length: 0
```

```
Sent:
INVITE sip:6000@[2001:DB8:C18:2:217:59FF:FEDE:8898]:5060 SIP/2.0
Via: SIP/2.0/UDP [2001:DB8:C18:2:223:4FF:FEAC:4540]:5060;branch=z9hG4bK15D1013
Remote-Party-ID: <sip:1001@[2001:DB8:C18:2:223:4FF:FEAC:4540]>;party=calling;screen=no;privacy=off
From: <sip:1001@[2001:DB8:C18:2:223:4FF:FEAC:4540]>;tag=5EAE624-253A
To: <sip:6000@[2001:DB8:C18:2:217:59FF:FEDE:8898]>
Date: Fri, 08 Jun 2012 10:53:14 GMT
Call-ID: FB05CC74-B08E11E1-82C1F4DD-5665AA1B@2001:DB8:C18:2:223:4FF:FEAC:4540
Supported: timer,resource-priority,replaces,sdp-anat
Min-SE: 1800
Cisco-Guid: 2131649325-2962952673-2175336473-0797538600
User-Agent: Cisco-SIPGateway/IOS-15.2.20120528.102328.
Allow: INVITE, OPTIONS, BYE, CANCEL, ACK, PRACK, UPDATE, REFER, SUBSCRIBE, NOTIFY, INFO, REGISTER
CSeq: 101 INVITE
Timestamp: 1339152794
Contact: <sip:1001@[2001:DB8:C18:2:223:4FF:FEAC:4540]:5060>
Expires: 180
Allow-Events: telephone-event
Max-Forwards: 69
Content-Type: application/sdp
Content-Disposition: session;handling=required
Content-Length: 443
```

```
v=0
o=CiscoSystemsSIP-GW-UserAgent 7132 4992 IN IP6 2001:DB8:C18:2:223:33FF:FEB1:B440
s=SIP Call
```

```
t=0 0
a=group:ANAT 1 2
m=audio 16712 RTP/AVP 18 0 19
c=IN IP6 2001:DB8:C18:2:223:4FF:FEAC:4540
a=mid:1
a=rtpmap:18 G729/8000
a=fmtp:18 annexb=no
a=rtpmap:0 PCMU/8000
a=rtpmap:19 CN/8000
m=audio 16714 RTP/AVP 18 0 19
c=IN IP4 9.44.30.14
a=mid:2
a=rtpmap:18 G729/8000
a=fmtp:18 annexb=no
a=rtpmap:0 PCMU/8000
a=rtpmap:19 CN/8000
```

```
*Jun 8 10:53:14.137: //243/7F0E632D81A9/SIP/Msg/ccsipDisplayMsg:
```

```
Received:
```

```
SIP/2.0 100 Trying
Via: SIP/2.0/UDP [2001:DB8:C18:2:223:4FF:FEAC:4540]:5060;branch=z9hG4bK15D1013
From: <sip:1001@[2001:DB8:C18:2:223:4FF:FEAC:4540]>;tag=5EAE624-253A
To: <sip:6000@[2001:DB8:C18:2:217:59FF:FEDE:8898]>
Date: Fri, 08 Jun 2012 12:15:49 GMT
Call-ID: FB05CC74-B08E11E1-82C1F4DD-5665AA1B@2001:DB8:C18:2:223:4FF:FEAC:4540
Timestamp: 1339152794
CSeq: 101 INVITE
Allow-Events: telephone-event
Server: Cisco-SIPGateway/IOS-15.2.2.5.T
Content-Length: 0
```

```
Received:
```

```
SIP/2.0 180 Ringing
Via: SIP/2.0/UDP [2001:DB8:C18:2:223:4FF:FEAC:4540]:5060;branch=z9hG4bK15D1013
From: <sip:1001@[2001:DB8:C18:2:223:4FF:FEAC:4540]>;tag=5EAE624-253A
To: <sip:6000@[2001:DB8:C18:2:217:59FF:FEDE:8898]>;tag=994FD4C0-90B
Date: Fri, 08 Jun 2012 12:15:49 GMT
Call-ID: FB05CC74-B08E11E1-82C1F4DD-5665AA1B@2001:DB8:C18:2:223:4FF:FEAC:4540
Timestamp: 1339152794
CSeq: 101 INVITE
Allow: INVITE, OPTIONS, BYE, CANCEL, ACK, PRACK, UPDATE, REFER, SUBSCRIBE, NOTIFY, INFO, REGISTER
Allow-Events: telephone-event
Remote-Party-ID: <sip:6000@[2001:DB8:C18:2:217:59FF:FEDE:8898]>;party=called;screen=no;privacy=off
Contact: <sip:6000@[2001:DB8:C18:2:217:59FF:FEDE:8898]:5060>
Server: Cisco-SIPGateway/IOS-15.2.2.5.T
Content-Length: 0
```

```
Sent:
```

```
SIP/2.0 180 Ringing
Via: SIP/2.0/UDP [2001:DB8:C18:2:223:33FF:FEB1:B440]:5060;branch=z9hG4bK20277F
From: <sip:1001@[2001:DB8:C18:2:223:33FF:FEB1:B440]>;tag=59283684-0
To: <sip:6000@[2001:DB8:C18:2:223:4FF:FEAC:4540]>;tag=5EAE658-2545
Date: Fri, 08 Jun 2012 10:53:14 GMT
Call-ID: 2D6EEC84-B09011E1-8235D9DB-F669887E@2001:DB8:C18:2:223:33FF:FEB1:B440
Timestamp: 1339153308
CSeq: 101 INVITE
Allow: INVITE, OPTIONS, BYE, CANCEL, ACK, PRACK, UPDATE, REFER, SUBSCRIBE, NOTIFY, INFO, REGISTER
Allow-Events: telephone-event
Remote-Party-ID: <sip:6000@[2001:DB8:C18:2:223:4FF:FEAC:4540]>;party=called;screen=no;privacy=off
Contact: <sip:6000@[2001:DB8:C18:2:223:4FF:FEAC:4540]:5060>
Server: Cisco-SIPGateway/IOS-15.2.20120528.102328.
Content-Length: 0
```

```
Received:
```

```
SIP/2.0 200 OK
Via: SIP/2.0/UDP [2001:DB8:C18:2:223:4FF:FEAC:4540]:5060;branch=z9hG4bK15D1013
From: <sip:1001@[2001:DB8:C18:2:223:4FF:FEAC:4540]>;tag=5EAE624-253A
To: <sip:6000@[2001:DB8:C18:2:217:59FF:FEDE:8898]>;tag=994FD4C0-90B
Date: Fri, 08 Jun 2012 12:15:49 GMT
Call-ID: FB05CC74-B08E11E1-82C1F4DD-5665AA1B@2001:DB8:C18:2:223:4FF:FEAC:4540
Timestamp: 1339152794
CSeq: 101 INVITE
Allow: INVITE, OPTIONS, BYE, CANCEL, ACK, PRACK, UPDATE, REFER, SUBSCRIBE, NOTIFY, INFO, REGISTER
Allow-Events: telephone-event
Remote-Party-ID: <sip:6000@[2001:DB8:C18:2:217:59FF:FEDE:8898]>;party=called;screen=no;privacy=off
Contact: <sip:6000@[2001:DB8:C18:2:217:59FF:FEDE:8898]:5060>
Supported: replaces
Require: sdp-anat
Server: Cisco-SIPGateway/IOS-15.2.2.5.T
Supported: timer
Content-Type: application/sdp
Content-Disposition: session;handling=required
Content-Length: 434
```

```
v=0
o=CiscoSystemsSIP-GW-UserAgent 5870 3683 IN IP6 2001:DB8:C18:2:217:59FF:FEDE:8898
s=SIP Call
c=IN IP6 2001:DB8:C18:2:217:59FF:FEDE:8898
t=0 0
a=group:ANAT 1
m=audio 17424 RTP/AVP 18 19
c=IN IP6 2001:DB8:C18:2:217:59FF:FEDE:8898
a=mid:1
a=rtpmap:18 G729/8000
a=fmtp:18 annexb=no
a=rtpmap:19 CN/8000
m=audio 0 RTP/AVP 18 19
c=IN IP4 9.44.30.11
a=mid:2
a=rtpmap:18 G729/8000
a=fmtp:18 annexb=no
a=rtpmap:19 CN/8000
```

```
Sent:
ACK sip:6000@[2001:DB8:C18:2:217:59FF:FEDE:8898]:5060 SIP/2.0
Via: SIP/2.0/UDP [2001:DB8:C18:2:223:4FF:FEAC:4540]:5060;branch=z9hG4bK15E99E
From: <sip:1001@[2001:DB8:C18:2:223:4FF:FEAC:4540]>;tag=5EAE624-253A
To: <sip:6000@[2001:DB8:C18:2:217:59FF:FEDE:8898]>;tag=994FD4C0-90B
Date: Fri, 08 Jun 2012 10:53:14 GMT
Call-ID: FB05CC74-B08E11E1-82C1F4DD-5665AA1B@2001:DB8:C18:2:223:4FF:FEAC:4540
Max-Forwards: 70
CSeq: 101 ACK
Allow-Events: telephone-event
Content-Length: 0
```

```
Sent:
SIP/2.0 200 OK
Via: SIP/2.0/UDP [2001:DB8:C18:2:223:33FF:FEB1:B440]:5060;branch=z9hG4bK20277F
From: <sip:1001@[2001:DB8:C18:2:223:33FF:FEB1:B440]>;tag=59283684-0
To: <sip:6000@[2001:DB8:C18:2:223:4FF:FEAC:4540]>;tag=5EAE658-2545
Date: Fri, 08 Jun 2012 10:53:14 GMT
Call-ID: 2D6EEC84-B09011E1-8235D9DB-F669887E@2001:DB8:C18:2:223:33FF:FEB1:B440
Timestamp: 1339153308
CSeq: 101 INVITE
Allow: INVITE, OPTIONS, BYE, CANCEL, ACK, PRACK, UPDATE, REFER, SUBSCRIBE, NOTIFY, INFO, REGISTER
Allow-Events: telephone-event
Remote-Party-ID: <sip:6000@[2001:DB8:C18:2:223:4FF:FEAC:4540]>;party=called;screen=no;privacy=off
Contact: <sip:6000@[2001:DB8:C18:2:223:4FF:FEAC:4540]:5060>
```

Verifying SDP Passthrough Configuration

```

Supported: replaces
Supported: sdp-anat
Server: Cisco-SIPGateway/IOS-15.2.20120528.102328.
Supported: timer
Content-Type: application/sdp
Content-Disposition: session;handling=required
Content-Length: 389

v=0
o=CiscoSystemsSIP-GW-UserAgent 5870 3683 IN IP6 2001:DB8:C18:2:217:59FF:FEDE:8898
s=SIP Call
t=0 0
a=group:ANAT 1
m=audio 16710 RTP/AVP 18 19
c=IN IP6 2001:DB8:C18:2:223:4FF:FEAC:4540
a=mid:1
a=rtpmap:18 G729/8000
a=fmtp:18 annexb=no
a=rtpmap:19 CN/8000
m=audio 0 RTP/AVP 18 19
c=IN IP4 9.44.30.14
a=mid:2
a=rtpmap:18 G729/8000
a=fmtp:18 annexb=no
a=rtpmap:19 CN/8000

Received:
ACK sip:6000@[2001:DB8:C18:2:223:4FF:FEAC:4540]:5060 SIP/2.0
Via: SIP/2.0/UDP [2001:DB8:C18:2:223:33FF:FEB1:B440]:5060;branch=z9hG4bK203700
From: <sip:1001@[2001:DB8:C18:2:223:33FF:FEB1:B440]>;tag=59283684-0
To: <sip:6000@[2001:DB8:C18:2:223:4FF:FEAC:4540]>;tag=5EAE658-2545
Date: Fri, 08 Jun 2012 11:01:48 GMT
Call-ID: 2D6EEC84-B09011E1-8235D9DB-F669887E@2001:DB8:C18:2:223:33FF:FEB1:B440
Max-Forwards: 70
CSeq: 101 ACK
Allow-Events: telephone-event
Content-Length: 0

```

Step 2 show voip rtp connection**Example:**

```
Device# show voip rtp connection
```

```
VoIP RTP Port Usage Information:
Max Ports Available: 8091, Ports Reserved: 101, Ports in Use: 2
Port range not configured, Min: 16384, Max: 32767
```

Media-Address Range	Ports Available	Ports Reserved	Ports In-use
Default Address-Range	8091	101	2

```
VoIP RTP active connections :
```

No.	CallId	dstCallId	LocalRTP	RmtRTP	LocalIP	RemoteIP
1	242	243	16710	16406	2001:DB8:C18:2:223:4FF:FEAC:4540	
					2001:DB8:C18:2:223:33FF:FEB1:B440	
2	243	242	16712	17424	2001:DB8:C18:2:223:4FF:FEAC:4540	
					2001:DB8:C18:2:217:59FF:FEDE:8898	

Found 2 active RTP connections

Feature Information for VoIP for IPv6

The following table provides release information about the feature or features described in this module. This table lists only the software release that introduced support for a given feature in a given software release train. Unless noted otherwise, subsequent releases of that software release train also support that feature.

Use Cisco Feature Navigator to find information about platform support and Cisco software image support. To access Cisco Feature Navigator, go to <https://cfng.cisco.com/>. An account on Cisco.com is not required.

Table 34: Feature Information for VoIP for IPv6

Feature Name	Releases	Feature Information
Cisco UBE support for IPv6	12.4(22)T	<p>Cisco Unified Border Element (Cisco UBE) support for SIP IPv4-IPv6 dual stack and IPv4 and IPv6 capability provides the following functionality:</p> <ul style="list-style-type: none"> • Translation of SIP IPv4 to IPv6 addresses • Administration and enforcement of policies for the IPv4/IPv6 mode of operation of each component. • Supports the following scenarios: H.323 IPv4 to SIP IPv6; SIP IPv4 to SIP IPv6, SIP IPv6 to SIP IPv6 • DTMF: Interworking capability on Cisco UBE (H.245 Signal, RFC 2833, SIP Notify, Key Press Markup Language, H.323 to SIP, RFC 2833 to G.711 Inband) • IPv6 topology hiding and demarcation • SIP Options-ping <p>The VoIP for IPv6 feature describes the Session Border Controller (SBC) functionality of connecting a SIP IPv4 or H.323 IPv4 network to a SIP IPv6 network that is implemented on a Cisco UBE to facilitate migration from VoIP4 to VoIPv6.</p>

Feature Name	Releases	Feature Information
Cisco UBE support for IPv6	15.3(2)T	

Feature Name	Releases	Feature Information
		<p>The following features are supported on Cisco UBE for 15.3(2)T:</p> <ul style="list-style-type: none"> • Assisted RTCP (RTCP Keepalive) • Audio Transcoding using Local Transcoding Interface (LTI) • Address Hiding • Call Transfer (re-INVITE, REFER) • Call Forward (302 based) • IP Toll Fraud • Hold/Resume • Media Flow-Through (FT) • Media Flow-Around (FA) • RE-INVITE Consumption • RTP Port Range • SDP Pass-Through • UDP Checksum • Media Anti-Trombone • Header Passing • Refer-To Passing • Error Pass-through • SIP UPDATE Interworking • SIP Session timer (RFC 4028) • SIP OPTIONS Ping • Configurable Error Response Code in OPTIONS Ping • Limiting the Rate of Incoming SIP Calls per Dial-Peer (aka Call Spike) • SIP Profiles • SIP Media Inactivity Detection

Feature Name	Releases	Feature Information
		<ul style="list-style-type: none"> • Dynamic Payload Type Interworking (DTMF and Codec Packets) • Voice Class Codec (VCC) with or without Transcoding • PPI/PAI/Privacy and RPID Passing
DSCP-Based QoS Support	12.4(22)T	IPv6 supports this feature.
IPv6 Dual Stack	12.4(22)T	<p>Adds IPv6 capability to existing VoIP features on the Cisco UBE. Additionally, the SBC functionality of connecting SIP IPv4 or H.323 IPv4 network to SIP IPv6 network is implemented on a Cisco UBE to facilitate migration from VoIPv4 to VoIPv6.</p> <p>The following commands were introduced or modified: None</p>
RTP/RTCP over IPv6	12.4(22)T	RTP stack supports the ability to create IPv6 connections using IPv6 unicast and multicast addresses as well as IPV4 connections.

Feature Name	Releases	Feature Information
TDM-SIP GW for IPv6	12.4(24)T 15.3(2)T	<p>IPv6 supports this feature.</p> <ul style="list-style-type: none"> • Session Initiation Protocol Features Supported on IPv6 • Cisco UBE features Supported on IPv6 • SIP Gateway Generic Features <p>Apart from the SIP Gateway features already supported on IPv4 and IPv6 for 12.4(24)T release, the following features are also supported on IPv6:</p> <ul style="list-style-type: none"> • SIP VMWI for FXS phones • History-Info • Handling 181/183 Responses with/without SDP • SIP Session Timer (4028) • SIP Media Inactivity Detection • PPI/PAI & Privacy (RFC3323/RFC3325) Headers



CHAPTER 17

Monitoring of Phantom Packets

The Monitoring of Phantom Packets feature allows you to configure port ranges specific to the VoIP Real-Time Transport Protocol (RTP) layer. This allows the VoIP RTP layer to safely drop packets without proper sessions (phantom packets) received on these ports of the Cisco Unified Border Element (CUBE) or Voice time-division multiplexing (TDM) gateways. Because the ports are configured specifically for the VoIP RTP layer, punting the packets to UDP process is not required. This helps in reducing the performance issues.

- [Restrictions of Monitoring of Phantom Packets, on page 247](#)
- [Information About Monitoring of Phantom Packets, on page 248](#)
- [How to Configure Monitoring of Phantom Packets, on page 248](#)
- [Configuration Examples For Monitoring of Phantom Packets, on page 250](#)
- [Additional References for Configurable Pass-Through of SIP INVITE Parameters, on page 250](#)
- [Feature Information for Monitoring of Phantom Packets, on page 251](#)

Restrictions of Monitoring of Phantom Packets

- The authentication, authorization, and accounting (AAA) default port range of 21645 to 21844 must not be configured.
- Up to ten port range entries can be defined under a single media-address range.
- The minimum port must be numerically lower than the maximum port.
- Port ranges should not overlap.
- Address ranges should not overlap.
- Address ranges and single addresses should not overlap.
- Where a range of addresses are defined in a single command, they will share any port ranges assigned. If there is a requirement to have different port ranges for different media addresses, then the addresses must be configured separately.
- If you are using the Transmission Control Protocol (TCP), the interface used for media and signaling should be different.
- For TCP, the media address and the signaling address should not be identical. If the media address and the signaling address are identical, and the Cisco IOS XE based router platform (Cisco ASR 1000 Series Aggregation Services Router, Cisco 4000 Series Integrated Services Routers, or Cisco Cloud Services Router 1000V Series) selects an ephemeral port to send out signaling packets, the port may overlap with

the port range of the media address. As a result, the signaling packets do not get punted up to the RP, and get dropped by the media packet filter. This may result in events such as incomplete TCP handshakes during the second leg of a call through CUBE or Voice Gateways.

Information About Monitoring of Phantom Packets

Monitoring of Phantom Packets

The Monitoring of Phantom Packets feature allows you to configure port ranges specific to the VoIP Real-Time Transport Protocol (RTP) layer. This configuration allows the VoIP RTP layer to safely drop packets without proper sessions (phantom packets) received on the ports of the Cisco Unified Border Element (CUBE) or Voice time-division multiplexing (TDM) gateways. Because the ports are configured specifically for the VoIP RTP layer, there is no need to punt the packets to the UDP process in case the packets were intended for some other application, thus reducing performance issues.

A phantom packet is a valid RTP packet meant for the CUBE or Voice TDM gateway without an existing session on the respective gateways. When a phantom packet is received by the VoIP RTP layers of the gateways, the packet is punted to the UDP process to check if it is required by any other applications causing performance issues, especially when a large number of such packets are received. A malicious attacker can also send a large number of phantom packets. The packet is punted to the UDP process because UDP port ranges are shared by many applications other than VoIP RTP and the VoIP RTP layer cannot drop the packet assuming the packet is for itself.

We recommend that you configure the IP address and port ranges specific to the media IP addresses, even if you are using a single virtual IP address for media. This feature allows you to configure port ranges specific to the VoIP RTP layer. If a phantom packet is received on the configured port, the VoIP RTP layer can safely drop the packet. If a phantom packet is received on any other port, the VoIP RTP layer punts the packet to the UDP process.

How to Configure Monitoring of Phantom Packets

Configuring Monitoring of Phantom Packets

SUMMARY STEPS

1. **enable**
2. **configure terminal**
3. **voice service voip**
4. **media-address range** *starting-ip-address ending-ip-address* **port range** *starting-port-number ending-port-number*
5. **port-range** *starting-port-number ending-port-number*
6. **end**

DETAILED STEPS

	Command or Action	Purpose
Step 1	enable Example: Device> enable	Enables privileged EXEC mode.
Step 2	configure terminal Example: Device# configure terminal	Enters global configuration mode.
Step 3	voice service voip Example: Device (config)# voice service voip	Specifies VoIP encapsulation and enters voice-service configuration mode.
Step 4	media-address range <i>starting-ip-address ending-ip-address</i> port range <i>starting-port-number ending-port-number</i> Example: Using IPv4 addresses: For single IP: Device (conf-voi-serv)# media-address range 10.1.1.1 10.1.1.1 For a range of IPs: Device (conf-voi-serv)# media-address range 10.1.1.1 10.1.1.254 Example: Using IPv6 addresses: For single IP: Device (conf-voi-serv)# media-address range 2001:DB8:1::1 2001:DB8:1::1 For a range of IPs: Device (conf-voi-serv)# media-address range 2001:DB8:1::1 2001:DB8:1::17 Example: Port range for media address. Device (cfg-media-addr-range)# port-range 8000 48198	Configures an IPv4 or IPv6 media address range. And, creates a port range for the configured media addresses. Note If you do not configure any port range, the default port range is applied. The default port range is 8000-48198 for ASR and ISR G3 platforms, and 16384-32766 for ISR G2 platforms.
Step 5	port-range <i>starting-port-number ending-port-number</i> Example: Device (cfg-media-addr-range)# port-range 8000 48198	Configures a port range. If you do not configure any port range nothing is applied. Note Ensure that the port range is not greater than the port range (if configured) specified in the media-address range command.

	Command or Action	Purpose
Step 6	end Example: Router (cfg-media-addr-range) # end	Exits voice-service configuration mode and returns to privileged EXEC mode.

Configuration Examples For Monitoring of Phantom Packets

```

Device(config)# voice service voip
Device(conf-voi-serv)# media-address range 10.1.1.1 10.1.1.254
Device(cfg-media-addr-range)# port-range 8000 21643
Device(cfg-media-addr-range)# port-range 21846 48000
Device(cfg-media-addr-range)# exit

Device(conf-voi-serv)# media-address range 2001:DB8:1::1 2001:DB8:1::17
Device(cfg-media-addr-range)# port-range 8000 21643
Device(cfg-media-addr-range)# port-range 21846 48000
Device(cfg-media-addr-range)# end

```



Note The ports from 21643 to 21845 are not used by the RTP layer. They might be used by applications such as AAA/Radius. These ports are allowed to be punted to the control plane if needed.

Additional References for Configurable Pass-Through of SIP INVITE Parameters

Related Documents

Related Topic	Document Title
Voice commands	Cisco IOS Voice Command Reference
Cisco IOS commands	Cisco IOS Command List, All Releases
SIP configuration tasks	SIP Configuration Guide, Cisco IOS Release 15M&T

Technical Assistance

Description	Link
<p>The Cisco Support website provides extensive online resources, including documentation and tools for troubleshooting and resolving technical issues with Cisco products and technologies.</p> <p>To receive security and technical information about your products, you can subscribe to various services, such as the Product Alert Tool (accessed from Field Notices), the Cisco Technical Services Newsletter, and Really Simple Syndication (RSS) Feeds.</p> <p>Access to most tools on the Cisco Support website requires a Cisco.com user ID and password.</p>	http://www.cisco.com/support

Feature Information for Monitoring of Phantom Packets

The following table provides release information about the feature or features described in this module. This table lists only the software release that introduced support for a given feature in a given software release train. Unless noted otherwise, subsequent releases of that software release train also support that feature.

Use Cisco Feature Navigator to find information about platform support and Cisco software image support. To access Cisco Feature Navigator, go to <https://cfng.cisco.com/>. An account on Cisco.com is not required.

Table 35: Feature Information for Monitoring of Phantom Packets

Feature Name	Releases	Feature Information
Monitoring of Phantom Packets	Cisco IOS XE Release 3.9S 15.4(1)T	<p>This feature allows you to configure port ranges specific to the VoIP Real-Time Transport Protocol (RTP) layer and drop phantom RTP packets (RTP packets that are configured in valid port range but for which there is no matching call or session).</p> <p>The following commands were introduced: port-range, media-address range.</p>



CHAPTER 18

Configurable SIP Parameters via DHCP

The Configurable SIP Parameters via DHCP feature allows a Dynamic Host Configuration Protocol (DHCP) server to provide Session Initiation Protocol (SIP) parameters via a DHCP client. These parameters are used for user registration and call routing.

The DHCP server returns the SIP Parameters via DHCP options 120 and 125. These options are used to specify the SIP user registration and call routing information. The SIP parameters returned are the SIP server address via Option 120, and vendor-specific information such as the pilot, contract or primary number, an additional range of secondary numbers, and the SIP domain name via Option 125.

In the event of changes to the SIP parameter values, this feature also allows a DHCP message called DHCPFORCERENEW to reset or apply a new set of values.

The SIP parameters provisioned by DHCP are stored, so that on reboot they can be reused.

- [Finding Feature Information, on page 253](#)
- [Prerequisites for Configurable SIP Parameters via DHCP, on page 253](#)
- [Restrictions for Configurable SIP Parameters via DHCP, on page 254](#)
- [Information About Configurable SIP Parameters via DHCP, on page 254](#)
- [How to Configure SIP Parameters via DHCP, on page 258](#)
- [Feature Information for Configurable SIP Parameters via DHCP, on page 265](#)

Finding Feature Information

Your software release may not support all the features documented in this module. For the latest caveats and feature information, see [Bug Search Tool](#) and the release notes for your platform and software release. To find information about the features documented in this module, and to see a list of the releases in which each feature is supported, see the feature information table.

Use Cisco Feature Navigator to find information about platform support and Cisco software image support. To access Cisco Feature Navigator, go to <https://cfng.cisco.com/>. An account on Cisco.com is not required.

Prerequisites for Configurable SIP Parameters via DHCP

- A DHCP interface has to be associated with SIP before configurable SIP parameters via DHCP can be enabled.

Cisco Unified Border Element

- Cisco IOS Release 12.4(22)YB or a later release must be installed and running on your Cisco Unified Border Element.

Cisco Unified Border Element (Enterprise)

- Cisco IOS XE Release 3.17S or a later release must be installed and running on your Cisco ASR 1000 Series Router.

Restrictions for Configurable SIP Parameters via DHCP

- DHCP Option 120 is the standard DHCP option (RFC3361) to get a SIP server address, and this can be used by any vendor DHCP server. Only one address is supported, which is in the IPv4 address format. Multiple IPv4 address entries are not supported. Also, there is no support for a DNS name in this or for any port number given behind the IPv4 address.
- DHCP Option 125 (RFC 3925) provides vendor-specific information and its interpretation is associated with the enterprise identity. The primary and secondary phone numbers and domain are obtained using Option 125, which is vendor-specific. As long as other customers use the same format as in the Next Generation Network (NGN) DHCP specification, they can use this feature.
- A primary or contract number is required in suboption 202 of DHCP Option 125. There can be only one instance of the primary number and not multiple instances.
- Multiple secondary or numbers in suboption 203 of DHCP Option 125 are supported. Up to five numbers are accepted and the rest ignored. Also, they have to follow the contract number in the DHCP packet data.
- Authentication is not supported for REGISTER and INVITE messages sent from a Cisco Unified Border Element that uses DHCP provisioning
- The DHCP provisioning of SIP Parameters is supported only over one DHCP interface.
- The DHCP option is available only to be configured for the primary registrar. It will not be available for a secondary registrar.

Information About Configurable SIP Parameters via DHCP

To perform basic Configurable SIP Parameters via DHCP configuration tasks, you should understand the following concepts:

Cisco Unified Border Element Support for Configurable SIP Parameters via DHCP

The Cisco Unified Border Element provides the support for the DHCP provisioning of the SIP parameters.

The NGN is modeled using SIP as a VoIP protocol. In order to connect to NGN, the User to Network Interface (UNI) specification is used. Cisco TelePresence Systems (CTS), consisting of an IP Phone, a codec, and Cisco Unified Communications Manager, are required to interconnect over the NGN for point-to-point and point-to-multipoint video calls. Because Cisco Unified Communications Manager does not provide a UNI

interface, there has to be an entity to provide the UNI interface. The Cisco Unified Border Element provides the UNI interface and has several advantages such as demarcation, delayed offer to early offer, and registration.

The figure below shows the Cisco Unified Border Element providing the UNI interface for the NGN.

Figure 28: Cisco NGN with Cisco Unified Border Element providing UNI interface



DHCP to Provision SIP Server, Domain Name, and Phone Number

NGN requires Cisco Unified Border Element to support DHCP (RFC 2131 and RFC 2132) to provision the following:

- IP address for Cisco Unified Border Element's UNI interface facing NGN
- SIP server address using option 120
- Option 125 vendor specific information to get:
 - Pilot number (also called primary or contract number), there is only one pilot number in DHCPACK, and REGISTER is done only for the pilot number
 - Additional numbers, or secondary numbers, are in DHCPACK; there is no REGISTER for additional numbers
 - SIP domain name
- DHCPFORCERENEW to reset or apply a new set of SIP parameters (RFC 3203)

DHCP-SIP Call Flow

The following scenario shows the DHCP messages involved in provisioning information such as the IP address for UNI interface, and SIP parameters including the SIP server address, phone number, and domain name, along with how SIP messages use the provisioned information.

The figure below shows the DHCP and SIP messages involved in obtaining the SIP parameters and using them for REGISTER and INVITE.

Figure 29: DHCP-SIP Call Flow

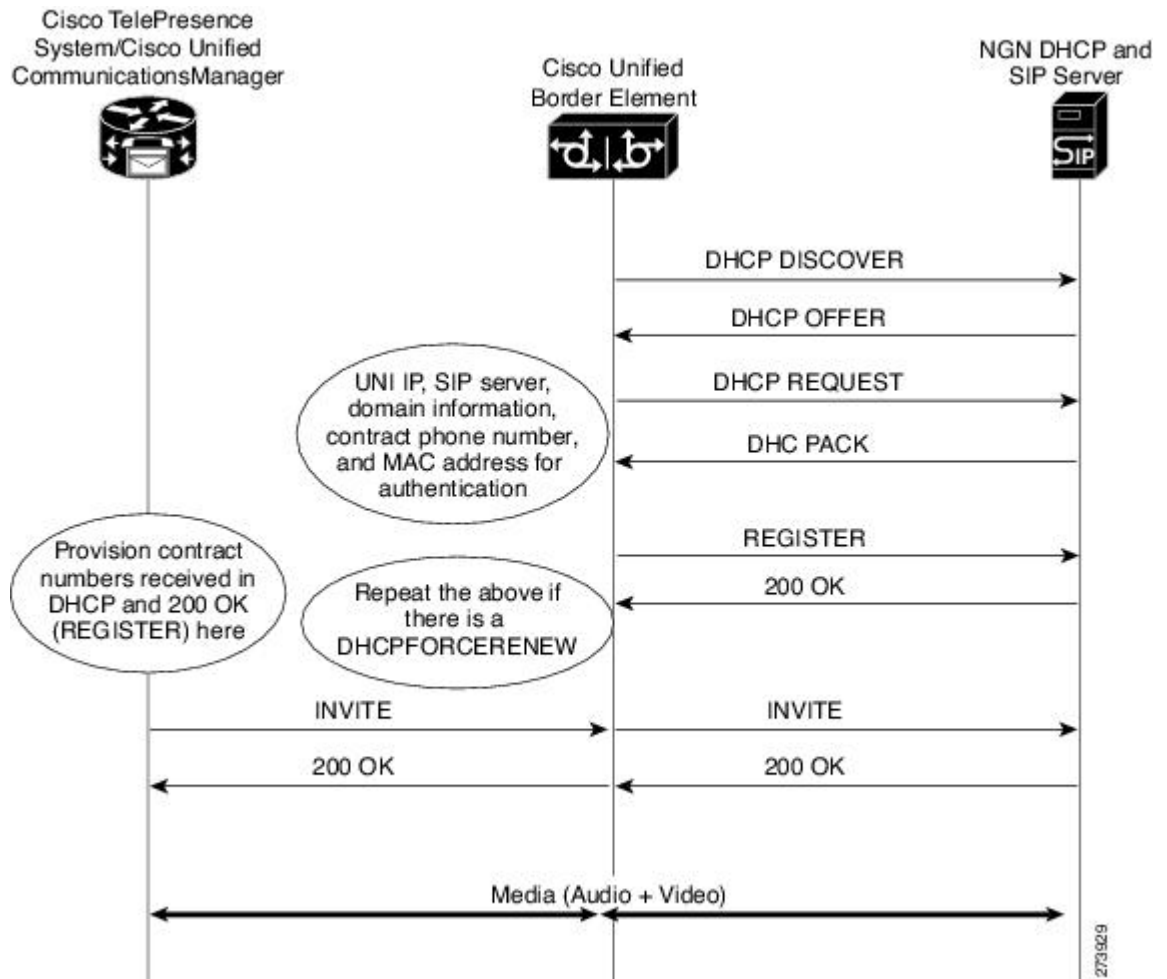

DHCP Message Details

The DHCP call flow involved in obtaining Cisco Unified Border Element provision information, including the IP address for UNI interface and SIP information such as phone number, domain, and SIP server, is shown in the figure below.

Figure 30: DHCP Message Details

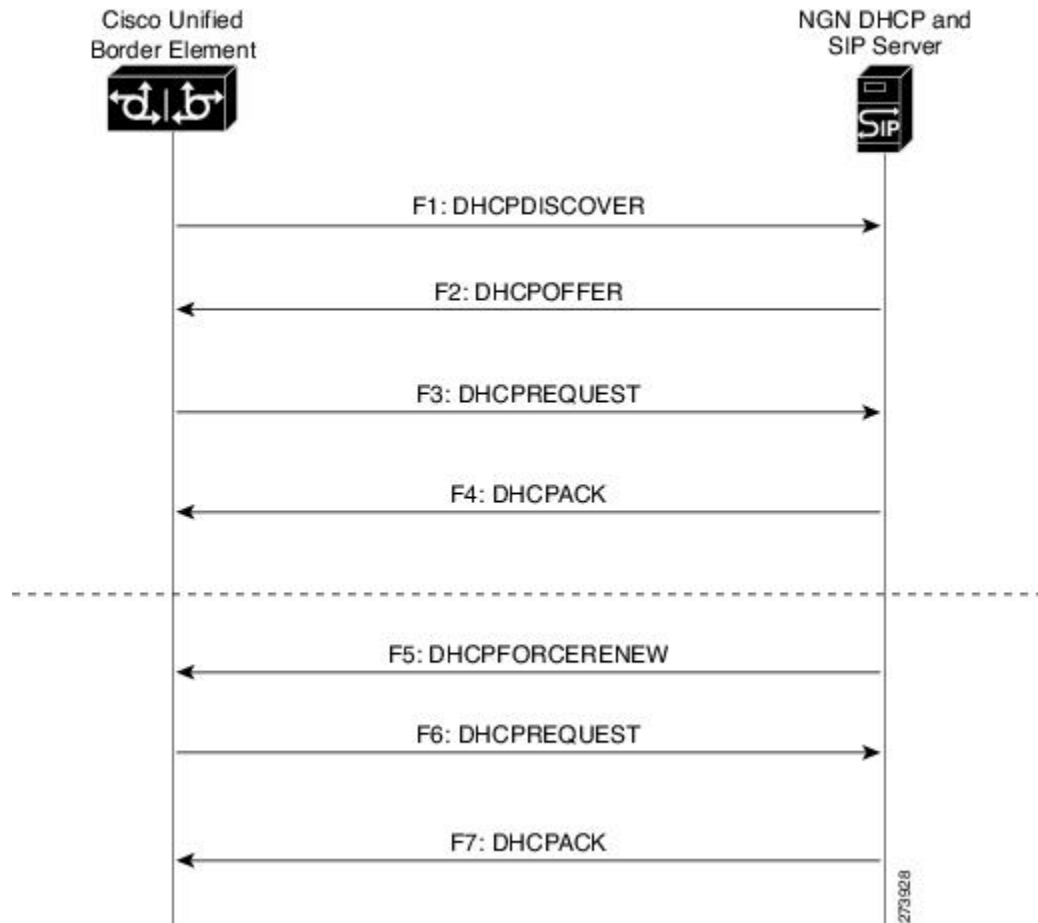

The DHCP messages involved in provisioning the SIP parameters are described in Steps 1 to 6.

1. F1: The Cisco Unified Border Element DHCP client sends a DHCPDISCOVER message to find the available NGN DHCP servers on the network and obtain a valid IPv4 address. The Cisco Unified Border Element DHCP client identity (computer name) and MAC address are included in this message.
2. F2: The Cisco Unified Border Element DHCP client receives a DHCPOFFER message from each available NGN DHCP server. The DHCPOFFER message includes the offered DHCP server's IPv4 address, the DHCP client's MAC address, and other configuration parameters.
3. F3: The Cisco Unified Border Element DHCP client selects an NGN DHCP server and its IPv4 address configuration from the DHCPOFFER messages it receives, and sends a DHCPREQUEST message requesting its usage. Note that this is where Cisco Unified Border Element requests SIP server information via DHCP Option 120 and vendor-identifying information via DHCP Option 125.
4. F4: The chosen NGN DHCP server assigns its IPv4 address configuration to the Cisco Unified Border Element DHCP client by sending a DHCPACK message to it. The Cisco Unified Border Element DHCP client receives the DHCPACK message. This is where the SIP server address, phone number and domain name information are received via DHCP options 120 and 125. The Cisco Unified Border Element will use the information for registering the phone number and routing INVITE messages to the given SIP server.

5. F5: When NGN has a change of information or additional information (such as changing SIP server address from 1.1.1.1 to 2.2.2.2) for assigning to Cisco Unified Border Element, the DHCP server initiates DHCPFORCERENEW to the Cisco Unified Border Element. If the authentication is successful, the Cisco Unified Border Element DHCP client accepts the DHCPFORCERENEW and moves to the next stage of sending DHCPREQUEST. Otherwise DHCPFORCERENEW is ignored and the current information is retained and used.
6. F6 and F7: In response to DHCPFORCERENEW, similar to steps F3 and F4, the Cisco Unified Border Element requests DHCP Options 120 and 125. Upon getting the response, SIP will apply these parameters if they are different by sending an UN-REGISTER message for the previous phone number and a REGISTER message for the new number. Similarly, a new domain and SIP server address will be used. If the returned information is the same as the current set, it is ignored and hence registration and call routing remains the same.

How to Configure SIP Parameters via DHCP

Configuring the DHCP Client

To receive the SIP configuration parameters the Cisco Unified Border Element has to act as a DHCP client. This is because in the NGN network, a DHCP server pushes the configuration to a DHCP client. Thus the Cisco Unified Border Element must be configured as a DHCP client.

Perform this task to configure the DHCP client.

Before you begin

You must configure the **ip dhcp client** commands before entering the **ip address dhcp** command on an interface to ensure that the DHCPDISCOVER messages that are generated contain the correct option values. The **ip dhcp client** commands are checked only when an IP address is acquired from DHCP. If any of the **ip dhcp client** commands are entered after an IP address has been acquired from DHCP, the DHCPDISCOVER messages' correct options will not be present or take effect until the next time the router acquires an IP address from DHCP. This means that the new configuration will only take effect after either the **ip address dhcp** command or the **release dhcp** and **renew dhcp** EXEC commands have been configured.

SUMMARY STEPS

1. **enable**
2. **configure terminal**
3. **interface type number**
4. **ip dhcp client request sip-server-address**
5. **ip dhcp client request vendor-identifying-specific**
6. **ip address dhcp**
7. **exit**

DETAILED STEPS

	Command or Action	Purpose
Step 1	enable	Enables privileged EXEC mode.

	Command or Action	Purpose
	Example: Router> enable	<ul style="list-style-type: none"> • Enter your password if prompted.
Step 2	configure terminal Example: Router# configure terminal	Enters global configuration mode.
Step 3	interface type number Example: Router(config)# interface gigabitethernet 0/0	Configures an interface type and enters interface configuration mode.
Step 4	ip dhcp client request sip-server-address Example: Router(config-if)# ip dhcp client request sip-server-address	Configures the DHCP client to request a SIP server address from a DHCP server.
Step 5	ip dhcp client request vendor-identifying-specific Example: Router(config-if)# ip dhcp client request vendor-identifying-specific	Configures the DHCP client to request vendor-specific information from a DHCP server.
Step 6	ip address dhcp Example: Router(config-if)# ip address dhcp	Acquires an IP address on the interface from the DHCP.
Step 7	exit Example: Router(config-if)# exit	Exits the current mode.

Configuring the DHCP Client Example

The following is an example of how to enable the DHCP client:

```
Router> enable
Router# configure terminal
Router(config)# interface gigabitethernet 1/1
Router(config-if)# ip dhcp client request sip-server-address
Router(config-if)# ip dhcp client request vendor-identifying-specific
Router(config-if)# ip address dhcp
Router(config-if)# exit
```

Enabling the SIP Configuration

Enabling the SIP configuration allows the Cisco Unified Border Element to use the SIP parameters received via DHCP for user registration and call routing. Perform this task to enable the SIP configuration.

Before you begin

The **dhcp interface** command has to be entered to declare the interface before the **registrar** and **credential** commands are entered.

SUMMARY STEPS

1. **enable**
2. **configure terminal**
3. **interface type number**
4. **sip-ua**
5. **dhcp interface type number**
6. **registrar dhcp expires seconds random-contact refresh-ratio seconds**
7. **credentials dhcp password [0|7] password realm domain-name**
8. **exit**

DETAILED STEPS

	Command or Action	Purpose
Step 1	enable Example: <pre>Router> enable</pre>	Enables privileged EXEC mode. <ul style="list-style-type: none"> • Enter your password if prompted.
Step 2	configure terminal Example: <pre>Router# configure terminal</pre>	Enters global configuration mode.
Step 3	interface type number Example: <pre>Router(config)# interface gigabitethernet 0/0</pre>	Configures an interface type and enters interface configuration mode.
Step 4	sip-ua Example: <pre>Router(config-if)# sip-ua</pre>	Enters SIP user-agent configuration mode.
Step 5	dhcp interface type number Example:	Assigns a specific interface for DHCP provisioning of SIP parameters.

	Command or Action	Purpose
	Router(sip-ua)# dhcp interface gigabitethernet 0/0	<ul style="list-style-type: none"> Multiple interfaces on the CUBE can be configured with DHCP--this command specifies the DHCP interface used with SIP.
Step 6	registrar dhcp expires seconds random-contact refresh-ratio seconds Example: Router(sip-ua)# registrar dhcp expires 100 random-contact refresh-ratio 90	Registers E.164 numbers on behalf of analog telephone voice ports (FXS) and IP phone virtual voice ports (EFXS) with an external SIP proxy or SIP registrar server. <ul style="list-style-type: none"> expires seconds --Specifies the default registration time, in seconds. Range is 60 to 65535. Default is 3600. refresh-ratio seconds --Specifies the refresh-ratio, in seconds. Range is 1 to 100 seconds. Default is 80.
Step 7	credentials dhcp password [0 7] password realm domain-name Example: Router(sip-ua)# credentials dhcp password cisco realm cisco.com	Sends a SIP registration message from a Cisco Unified Border Element in the UP state.
Step 8	exit Example: Router(sip-ua)# exit	Exits the current mode.

Enabling the SIP Configuration Example

The following is an example of how to enable the SIP configuration:

```
Router> enable
Router# configure terminal
Router(config)# interface gigabitethernet 1/0
Router(config-if)# sip-ua
Router(sip-ua)# dhcp interface gigabitethernet 1/0
Router(sip-ua)# registrar dhcp expires 90 random-contact refresh-ratio 90
Router(sip-ua)# credentials dhcp password cisco realm cisco.com
Router(sip-ua)# exit
```

Troubleshooting Tips

To display information on DHCP and SIP interaction when SIP parameters are provisioned by DHCP, use the **debug ccsip dhcp** command in privileged EXEC mode.

Configuring a SIP Outbound Proxy Server

An outbound-proxy configuration sets the Layer 3 address (IP address) for any outbound REGISTER and INVITE SIP messages. The SIP server can be configured as an outbound proxy server in voice service SIP configuration mode or dial peer configuration mode. When enabled in voice service SIP configuration mode, all the REGISTER and INVITE messages are forwarded to the configured outbound proxy server. When enabled in dial-peer configuration mode, only the messages hitting the defined dial-peer will be forwarded to the configured outbound proxy server.

The configuration tasks in each mode are presented in the following sections:

Perform either of these tasks to configure the SIP server as a SIP outbound proxy server.

Configuring a SIP Outbound Proxy Server in Voice Service VoIP Configuration Mode

Perform this task to configure the SIP server as a SIP outbound proxy server in voice service SIP configuration mode.

SUMMARY STEPS

1. **enable**
2. **configure terminal**
3. **voice service voip**
4. **sip**
5. **outbound-proxy dhcp**
6. **exit**

DETAILED STEPS

	Command or Action	Purpose
Step 1	enable Example: Router> enable	Enables privileged EXEC mode. <ul style="list-style-type: none"> • Enter your password if prompted.
Step 2	configure terminal Example: Router# configure terminal	Enters global configuration mode.
Step 3	voice service voip Example: Router(config)# voice service voip	Enters voice service VoIP configuration mode and specifies VoIP as the voice-encapsulation type.
Step 4	sip Example:	Enters voice service SIP configuration mode.

	Command or Action	Purpose
	<code>Router(config-voi-srv)# sip</code>	
Step 5	outbound-proxy dhcp Example: <code>Router(conf-serv-sip)# outbound-proxy dhcp</code>	Configures the DHCP client to request a SIP server address from a DHCP server.
Step 6	exit Example: <code>Router(config-serv-sip)# exit</code>	Exits the current mode.

Configuring a SIP Outbound Proxy Server in Voice Service VoIP Configuration Mode Example

The following is an example of how to configure a SIP outbound proxy in voice service SIP configuration mode:

```
Router> enable
Router# configure terminal

Router(config)# voice service voip
Router(config-voi-srv)# sip
Router(conf-serv-sip)# outbound-proxy dhcp
Router(config-serv-if)# exit
```

Configuring a SIP Outbound Proxy Server and Session Target in Dial Peer Configuration Mode

Perform this task to configure the SIP server as a SIP outbound proxy server in dial peer configuration mode.



Note SIP must be configured on the dial peer before DHCP is configured. Therefore the **session protocol sipv2** command must be executed before the **session target dhcp** command. DHCP is supported only with SIP configured on the dial peer.

>

SUMMARY STEPS

1. **enable**
2. **configure terminal**
3. **dial-peer voice number voip**
4. **session protocol sipv2**
5. **voice-class sip outbound-proxy dhcp**

6. session target dhcp
7. exit

DETAILED STEPS

	Command or Action	Purpose
Step 1	enable Example: Router> enable	Enables privileged EXEC mode. <ul style="list-style-type: none"> • Enter your password if prompted.
Step 2	configure terminal Example: Router# configure terminal	Enters global configuration mode.
Step 3	dial-peer voice number voip Example: Router(config)# dial-peer voice 10 voip	Defines a dial peer, specifies VoIP as the method of voice encapsulation, and enters dial peer configuration mode.
Step 4	session protocol sipv2 Example: Router(config-dial-peer)# session protocol sipv2	Enters the session protocol type as SIP.
Step 5	voice-class sip outbound-proxy dhcp Example: Router(config-dial-peer)# voice-class sip outbound-proxy dhcp	Configures the SIP server received from the DHCP server as a SIP outbound proxy server.
Step 6	session target dhcp Example: Router(config-dial-peer)# session target dhcp	Specifies that the DHCP protocol is used to determine the IP address of the session target.
Step 7	exit Example: Router(config-dial-peer)# exit	Exits the current mode.

Configuring a SIP Outbound Proxy Server in Dial Peer Configuration Mode Example

The following is an example of how to configure a SIP outbound proxy in dial peer configuration mode:

```

Router> enable
Router# configure terminal
Router(config)# dial-peer voice 11 voip
Router(config-dial-peer)# session protocol sipv2

Router(config-dial-peer)# voice-class sip outbound-proxy dhcp
Router(config-dial-peer)# session target dhcp
Router(config-dial-peer)# exit

```

Feature Information for Configurable SIP Parameters via DHCP

The following table provides release information about the feature or features described in this module. This table lists only the software release that introduced support for a given feature in a given software release train. Unless noted otherwise, subsequent releases of that software release train also support that feature.

Use Cisco Feature Navigator to find information about platform support and Cisco software image support. To access Cisco Feature Navigator, go to <https://cfng.cisco.com/>. An account on Cisco.com is not required.

Feature History Table for the ISR.

Table 36: Feature Information for Configurable SIP Parameters via DHCP

Feature Name	Releases	Feature Information
Configurable SIP Parameters via DHCP	12.4(22)YB 15.0(1)M	The Configurable SIP Parameters via DHCP feature introduces the configuring of SIP parameters via DHCP. The following commands were introduced or modified: credentials (sip-ua), debug ccsip dhcp, dhcp interface, ip dhcp-client forcerenew, outbound-proxy, registrar, session target (VoIP dial peer), show sip dhcp, voice-class sip outbound-proxy.

Feature History Table for the ASR.

Table 37: Feature Information for Configurable SIP Parameters via DHCP

Feature Name	Releases	Feature Information
Configurable SIP Parameters via DHCP	IOS XE Release 3.17S	The Configurable SIP Parameters via DHCP feature introduces the configuring of SIP parameters via DHCP. The following commands were introduced or modified: credentials (sip-ua), debug ccsip dhcp, dhcp interface, ip dhcp-client forcerenew, outbound-proxy, registrar, session target (VoIP dial peer), show sip dhcp, voice-class sip outbound-proxy.



PART II

Dial Peer Enhancements

- [Matching Inbound Dial Peers by URI, on page 269](#)
- [URI-Based Dialing Enhancements, on page 273](#)
- [Multiple Pattern Support on a Voice Dial Peer, on page 287](#)
- [Outbound Dial-Peer Group as an Inbound Dial-Peer Destination, on page 293](#)
- [Inbound Leg Headers for Outbound Dial-Peer Matching, on page 303](#)
- [Server Groups in Outbound Dial Peers, on page 313](#)
- [Domain-Based Routing Support on the Cisco UBE, on page 323](#)
- [ENUM Enhancement per Kaplan Draft RFC, on page 331](#)



CHAPTER 19

Matching Inbound Dial Peers by URI

The Matching Inbound Dial Peers by URI feature allows you to configure the selection of inbound dial peers by matching parts of the URI sent by a remote (neighboring) SIP entity. The match can be done on different parts of the URI like hostname, IP address, DNS name. This feature can be used to configure configuration policies, enforce specific call-treatment, security, and routing policies on each SIP trunk by originating SIP entity.

In a scenario where multiple SIP hops are involved in a call, there would be multiple via headers involved, and the topmost via header of an incoming SIP invite represents the last hop that forwarded the SIP request, and the bottom-most via header would represent the originator of the SIP request. This feature supports matching by the last hop that forwarded the request (neighboring SIP entity), which is the topmost via header.



Note For incoming dial-peer match based on URI, if there are multiple dial-peer matches, then the longest matching dial-peer is chosen (similar to multiple dial-peer match based on incoming called number). However for URI pattern match, there is no match length and hence this is the least preferred.

- [Configuring an Inbound Dial Peer to Match on URI, on page 269](#)
- [Examples for Configuring an Inbound Dial Peer to Match on a URI, on page 271](#)

Configuring an Inbound Dial Peer to Match on URI

SUMMARY STEPS

1. **enable**
2. **configure terminal**
3. **voice class uri** *voice-class-uri-tag*
4. Specify a URI field for the voice class:
 - **host** *hostname-pattern*
 - **host ipv4:** *ipv4-address*
 - **host ipv6:** *ipv6-address*
 - **host dns:** *dns-address*
 - **pattern** *uri-pattern*
 - **user-id** *username-pattern*

5. `exit`
6. `dial-peer voice tag voip`
7. `session protocol sipv2`
8. `incoming uri { from | request | to | via } voice-class-uri-tag`
9. `end`

DETAILED STEPS

	Command or Action	Purpose
Step 1	<p><code>enable</code></p> <p>Example:</p> <pre>Device> enable</pre>	<p>Enables privileged EXEC mode.</p> <ul style="list-style-type: none"> • Enter your password if prompted.
Step 2	<p><code>configure terminal</code></p> <p>Example:</p> <pre>Device> configure terminal</pre>	<p>Enters global configuration mode.</p>
Step 3	<p><code>voice class uri voice-class-uri-tag</code></p> <p>Example:</p> <pre>Device(config)# voice class uri 200</pre>	<p>Creates a voice class for matching SIP dial peers and enters voice URI class configuration mode.</p>
Step 4	<p>Specify a URI field for the voice class:</p> <ul style="list-style-type: none"> • <code>host hostname-pattern</code> • <code>host ipv4: ipv4-address</code> • <code>host ipv6: ipv6-address</code> • <code>host dns: dns-address</code> • <code>pattern uri-pattern</code> • <code>user-id username-pattern</code> <p>Example:</p> <pre>Device(config-voice-uri-class)# host server1</pre> <p>Example:</p> <pre>Device(config-voice-uri-class)# host ipv4:10.0.0.0</pre> <p>Example:</p> <pre>Device(config-voice-uri-class)# host dns:xxx.yyy.com</pre>	<ul style="list-style-type: none"> • You can specify up to ten instances of the host ipv4:, host ipv6:, and host dns: commands. • You can specify only one instance of the host hostname-pattern commands. • Length of <i>uri-pattern</i>, <i>username-pattern</i>, and <i>hostname-pattern</i> should be less than 32. • <i>username-pattern</i> is matched against the username field of the URI. • <i>hostname-pattern</i> is matched against the host field of the URI. • <i>uri-pattern</i> is matched against the entire URI. • Only one instance of the pattern and host commands are possible. <p>Note Patterns are case-sensitive.</p>
Step 5	<p><code>exit</code></p> <p>Example:</p> <pre>Device(config-voice-uri-class)# exit</pre>	<p>Enters global configuration mode.</p>

	Command or Action	Purpose
Step 6	dial-peer voice tag voip Example: Device(config)# dial-peer voice 6000 voip	Enters dial peer voice configuration mode.
Step 7	session protocol sipv2 Example: Device(config-dial-peer)# session protocol sipv2	Configures SIP as the session protocol type.
Step 8	incoming uri { from request to via } voice-class-uri-tag Example: Device(config-dial-peer)# incoming uri via 200	Configures the voice class with an inbound dial peer, so that it matches against configured URI fields.
Step 9	end Example: Device(config-dial-peer)# end	Exits dial peer voice configuration mode and enters privileged EXEC mode.

Examples for Configuring an Inbound Dial Peer to Match on a URI

Matching Against IPv4 Address and VIA

CUBE is configured to use incoming dial-peer 101 for incoming SIP calls from remote SIP endpoint having an IP address of 10.10.10.1

```
voice class uri 201 sip
host ipv4:10.10.10.1
```

```
dial-peer voice 101 voip
 session protocol sipv2
 incoming uri via 201
```

Incoming INVITE that can be matched against this dial peer.

```
INVITE sip:123@1.2.3.4:5060 SIP/2.0
Via: SIP/2.0/TCP 10.10.10.1:5093;branch=z9hG4bK-17716-1-0
Via: SIP/2.0/TCP 10.10.14.20:5093;branch=z9hG4bK-28280-1-0
```

Matching Against DNS Name and VIA

CUBE is configured to use incoming dial-peer 102 for incoming SIP calls from sample.com or an IP address that represents one of the resolved IP address of sample.com.

```
voice class uri 202 sip
host dns:sample.com
```

```
dial-peer voice 101 voip
  session protocol sipv2
  incoming uri via 202
```

Incoming INVITE that can be matched against this dial peer.

```
INVITE sip:123@1.2.3.4:5060 SIP/2.0
Via: SIP/2.0/TCP sample.com;branch=z9hG4bK-17716-1-0

INVITE sip:123@1.2.3.4:5060 SIP/2.0
Via: SIP/2.0/TCP 10.10.10.25:5093;branch=z9hG4bK-17716-1-0
```

10.10.10.25 is a resolved IP address of sample.com.

Matching Against Multiple Attributes and VIA

CUBE is configured to use incoming dial-peer 103 for incoming SIP calls from xxx.yyy.com, abc.def.com and IP addresses 10.10.10.10, 10.9.10.11 and 10.10.10.10.

```
voice class uri 203 sip
  host dns:xxx.yyy.com
  host dns:abc.def.com
  host ipv4:10.10.10.10
  host ipv4:10.9.10.11
  host ipv4:10.10.10.10
```

```
dial-peer voice 103 voip
  session protocol sipv2
  incoming uri via 203
```

Incoming INVITE that can be matched against this dial peer.

```
INVITE sip:123@1.2.3.4:5060 SIP/2.0
Via: SIP/2.0/TCP 10.10.10.10:5093;branch=z9hG4bK-17716-1-0
Via: SIP/2.0/TCP 10.10.14.20:5093;branch=z9hG4bK-28280-1-0
```

10.10.10.25 is a resolved IP address of sample.com.



CHAPTER 20

URI-Based Dialing Enhancements

The URI-Based Dialing Enhancements feature describes the enhancements made to Uniform Resource Identifier (URI)-based dialing on Cisco Unified Border Element (CUBE) for Session Initiation Protocol (SIP) calls. The URI-Based Dialing Enhancements feature includes support for call routing on Cisco UBE when the user part of the incoming Request-URI is non-E164 (for example, INVITE sip:user@abc.com).

- [Feature Information for URI-Based Dialing Enhancements, on page 273](#)
- [Information About URI-Based Dialing Enhancements, on page 274](#)
- [How to Configure URI-Based Dialing Enhancements, on page 277](#)
- [Configuration Examples for URI-Based Dialing Enhancements, on page 284](#)
- [Additional References for URI-Based Dialing Enhancements, on page 285](#)

Feature Information for URI-Based Dialing Enhancements

The following table provides release information about the feature or features described in this module. This table lists only the software release that introduced support for a given feature in a given software release train. Unless noted otherwise, subsequent releases of that software release train also support that feature.

Use Cisco Feature Navigator to find information about platform support and Cisco software image support. To access Cisco Feature Navigator, go to <https://cfng.cisco.com/>. An account on Cisco.com is not required.

Table 38: Feature Information for URI-Based Dialing Enhancements

Feature Name	Releases	Feature Information
URI-Based Dialing Enhancements		<p>The URI-Based Dialing Enhancements feature includes support for call routing on Cisco UBE when the user-part of the incoming Request-URI is non-E164 (for example, INVITE sip:user@abc.com).</p> <p>The following commands were introduced or modified: contact-passing, requi-passing, session target sip-uri and voice-class sip requi-passing</p>

Information About URI-Based Dialing Enhancements

Cisco Unified Communications Manager (CUCM) supports dialing using directory Uniform Resource Identifiers (URIs) for call addressing. Directory URIs follow the username@host format where the host portion is an IPv4 address or a fully qualified domain name. A directory URI is a string of characters that can be used to identify a directory number. If that directory number is assigned to a phone, CUCM can route calls to that phone using the directory URI. URI dialing is available for Session Initiation Protocol (SIP) and Signaling Connection Control Part (SCCP) endpoints that support directory URIs.



Note The minimum supported release of Cisco IOS required for URI based call routing on dial-peers is Cisco IOS XE Gibraltar Release 16.12. You must configure the 'call-route-uri' on the outgoing dial-peers to properly route the refer-to headers based on the URI matching.

The primary use of URI-based dialing is peer-to-peer calling between enterprises using complete URI addresses (that is, 'username@host'). The host part of the URI identifies the destination to which the call should be routed. In earlier Cisco Unified Border Element (Cisco UBE) URI routing, the URI was replaced in the SIP header with the destination server IP address. Then routing of calls was based on the following restrictions:

- The user part of the incoming Request-URI must be an E164 number.
- The outgoing Request-URI is always set to the session target information of the outbound dial peer.

The URI-Based Dialing Enhancements feature extends support for Cisco UBE URI-based routing of calls. With these enhancements Cisco UBE supports:

- URI-based routing when the user part of the incoming Request-URI is non-E164 (for example, INVITE sip:user@abc.com).
- URI-based routing when the user part is not present. The user part is an optional parameter in the URI (for example, INVITE sip:abc.com).
- Copying the outgoing Request-URI and To header from the inbound Request-URI and To header respectively.
- Deriving (optionally) the session target for the outbound dial peer from the host portion of the inbound URI.
- URI-based routing for 302, Refer, and Bye Also scenarios.
- Call hunting where the subsequent dial peer is selected based on URI.
- Pass through of 302, with the host part of Contact: unmodified.

Call Flows for URI-Based Dialing Enhancements

Case1: URI dialing with username being E164 or non-E164 number and Request-URI host copied from the inbound leg.

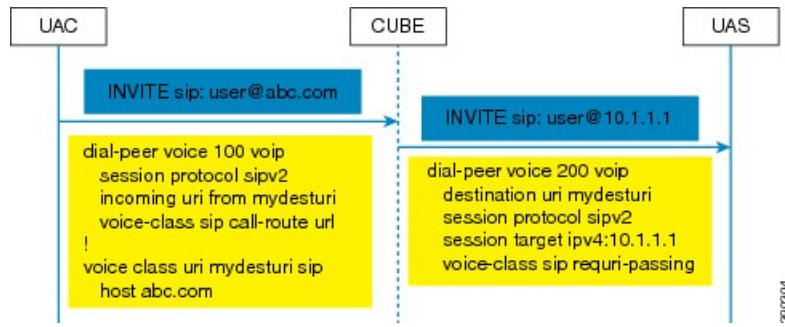

Case 2: Incoming Request-URI does not contain user part. The To: header information is also copied from the peer leg when the **requiri-passing** command is enabled.

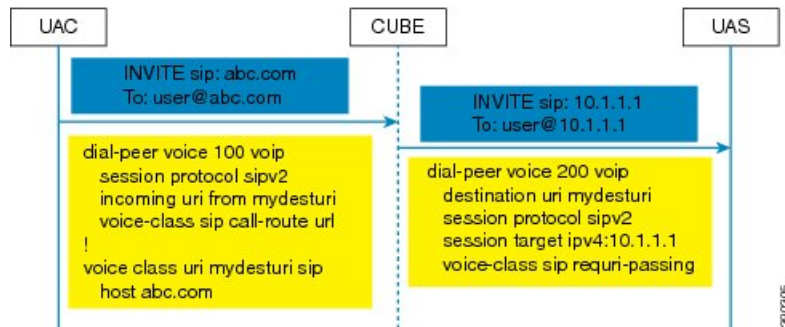

Case 3: The old behavior of setting the outbound Request-URI to session target is retained when the **requiri-passing** command is not enabled.

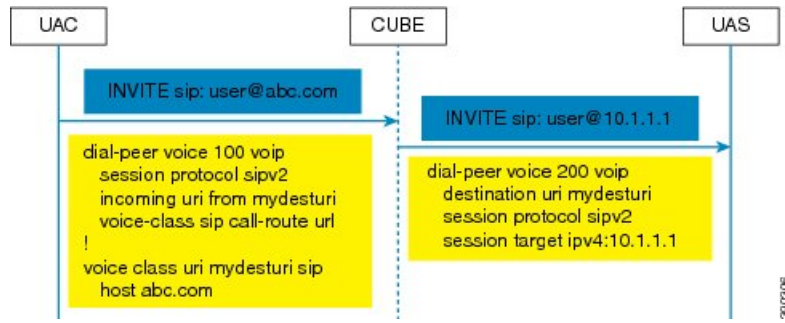

Case 4: The session target derived from the host part of the URI. The outgoing INVITE is sent to resolved IP address of the host part of the URI.

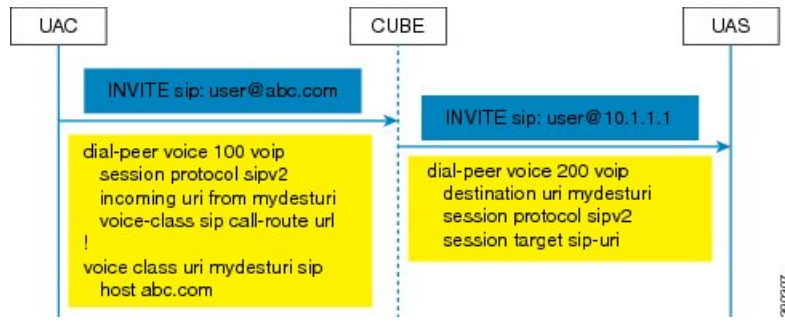

Case 5: Pass through of contact URI to request URI.

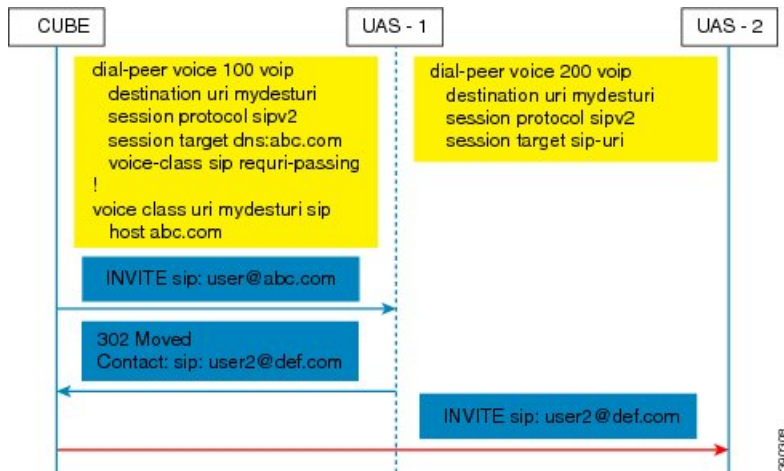

Case 6: In 302 pass-through, contact header can be passed through from one leg to another by using the **contact-passing** command.

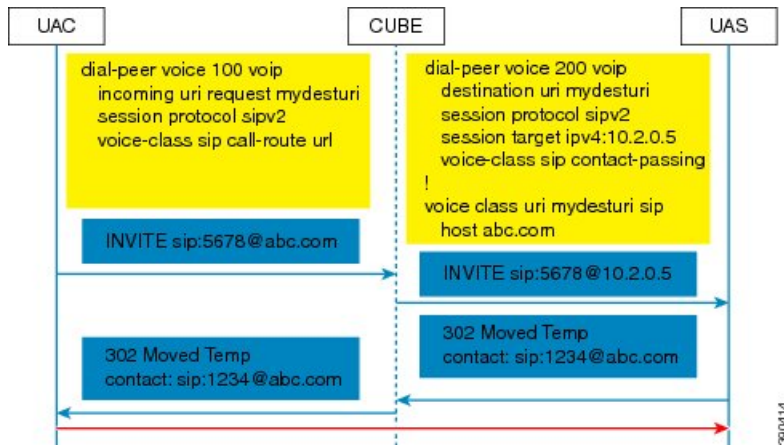

Case 7: Pass through of refer-to URI to request URI.

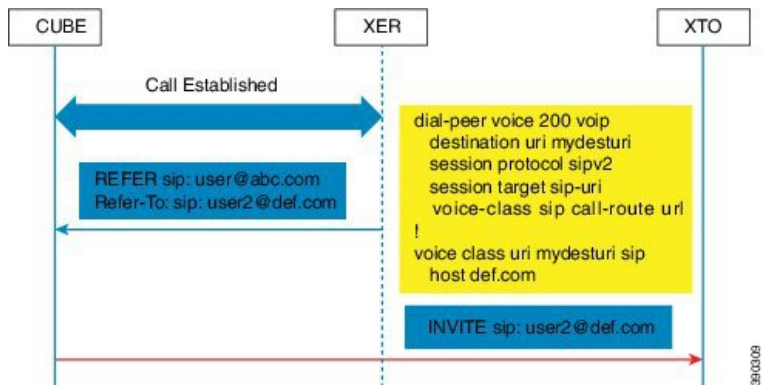

Case 8: URI routing based on BYE Also header.

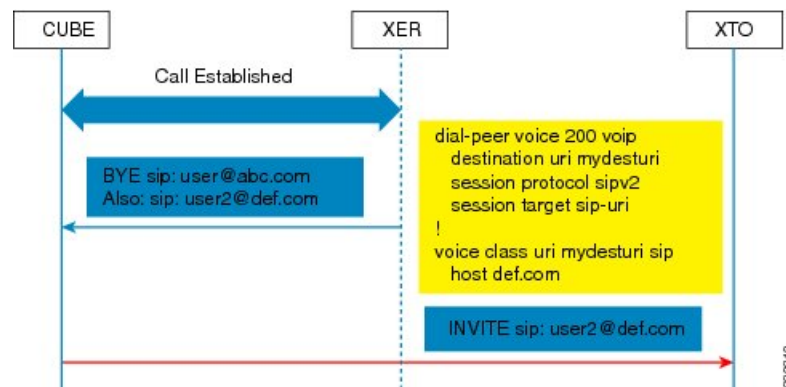

3810310

How to Configure URI-Based Dialing Enhancements

Configuring Pass Through of SIP URI Headers

Perform these tasks to configure the pass through of the host part of the Request-Uniform Resource Identifier (URI) and To Session Initiation Protocol (SIP) headers. By default, Cisco Unified Border Element (Cisco UBE) sets the host part of the URI to the value configured under the session target of the outbound dial peer. For more information, see Case 1 in the "Call Flows for URI-based Dialing Enhancements" section.

Configuring Pass Through of Request URI and To Header URI (Global Level)

SUMMARY STEPS

1. enable
2. configure terminal
3. voice service voip
4. sip
5. requri-passing
6. end

DETAILED STEPS

	Command or Action	Purpose
Step 1	enable Example: Device> enable	Enables privileged EXEC mode. <ul style="list-style-type: none"> • Enter your password if prompted.
Step 2	configure terminal Example: Device# configure terminal	Enters global configuration mode.
Step 3	voice service voip Example:	Specifies VoIP encapsulation and enters voice service configuration mode.

	Command or Action	Purpose
	Device(config)# voice service voip	
Step 4	sip Example: Device(conf-voi-serv)# sip	Enters the Session Initiation Protocol (SIP) configuration mode.
Step 5	requiri-passing Example: Router(conf-serv-sip)# requiri-passing	Enables pass through of the host part of the Request-URI and To SIP headers. By default, Cisco UBE sets the host part of the URI to the value configured under the session target of the outbound dial peer.
Step 6	end Example: Router(conf-serv-sip)# end	Ends the current configuration session and returns to privileged EXEC mode.

Configuring Pass Through of Request URI and To Header URI (Dial Peer Level)

SUMMARY STEPS

1. **enable**
2. **configure terminal**
3. **voice class uri tag sip**
4. **host hostname-pattern**
5. **exit**
6. **dial-peer voice tag voip**
7. **session protocol sipv2**
8. **destination uri tag**
9. **session target ipv4:ip-address**
10. **voice-class sip requiri-passing [system]**
11. **end**

DETAILED STEPS

	Command or Action	Purpose
Step 1	enable Example: Device> enable	Enables privileged EXEC mode. • Enter your password if prompted.
Step 2	configure terminal Example: Device# configure terminal	Enters global configuration mode.
Step 3	voice class uri tag sip Example: Device(config)# voice class uri mydesturi sip	Creates a voice class for matching dial peers to a Session Initiation Protocol (SIP) and enters voice URI class configuration mode.

	Command or Action	Purpose
Step 4	host <i>hostname-pattern</i> Example: Device(config-voice-uri-class)# host example.com	Matches a call based on the host field in a SIP Uniform Resource Identifier (URI).
Step 5	exit Example: Device(config-voice-uri-class)# exit	Exits voice URI class configuration mode.
Step 6	dial-peer voice <i>tag</i> voip Example: Device(config)# dial-peer voice 22 voip	Defines a VoIP dial peer and enters dial peer configuration mode.
Step 7	session protocol sipv2 Example: Device(config-dial-peer)# session protocol sipv2	Specifies a session protocol for calls between local and remote routers using the Internet Engineering Task Force (IETF) SIP.
Step 8	destination uri <i>tag</i> Example: Device(config)# destination uri mydesturi	Specifies the voice class used to match a dial peer to the destination URI of an outgoing call.
Step 9	session target ipv4:ip-address Example: Device(config-dial-peer)# session target ipv4:10.1.1.2	Designates a network-specific address to receive calls from a VoIP.
Step 10	voice-class sip requiri-passing [system] Example: Device(config-dial-peer)# voice-class sip requiri-passing system	Enables the pass through of SIP URI headers.
Step 11	end Example: Device(config-dial-peer)# end	Ends the current configuration session and returns to privileged EXEC mode.

Configuring Pass Through of 302 Contact Header

Configuring Pass Through of 302 Contact Header (Global Level)

SUMMARY STEPS

1. enable
2. configure terminal
3. voice service voip
4. sip

5. **contact-passing**
6. **end**

DETAILED STEPS

	Command or Action	Purpose
Step 1	enable Example: Device> enable	Enables privileged EXEC mode. <ul style="list-style-type: none">• Enter your password if prompted.
Step 2	configure terminal Example: Device# configure terminal	Enters global configuration mode.
Step 3	voice service voip Example: Device(config)# voice service voip	Specifies VoIP encapsulation and enters voice service configuration mode.
Step 4	sip Example: Device(conf-voi-serv)# sip	Enters voice service SIP configuration mode.
Step 5	contact-passing Example: Router(conf-serv-sip)# contact-passing	Enables pass through of the contact header from one leg to the other leg in 302 pass through scenario.
Step 6	end Example: Router(conf-serv-sip)# end	Ends the current configuration session and returns to privileged EXEC mode.

Configuring Pass Through of 302 Contact Header (Dial Peer Level)

SUMMARY STEPS

1. **enable**
2. **configure terminal**
3. **voice class uri *destination-tag* sip**
4. **user-id *id-tag***
5. **exit**
6. **voice service voip**
7. **allow-connections sip to sip**
8. **dial-peer voice *tag* voip**
9. **session protocol sipv2**
10. **destination uri *destination-tag***
11. **voice-class sip contact-passing**

12. end

DETAILED STEPS

	Command or Action	Purpose
Step 1	enable Example: Device> enable	Enables privileged EXEC mode. <ul style="list-style-type: none">• Enter your password if prompted.
Step 2	configure terminal Example: Device# configure terminal	Enters global configuration mode.
Step 3	voice class uri destination-tag sip Example: Device(config)# voice class uri mydesturi sip	Creates a voice class for matching dial peers to a Session Initiation Protocol (SIP) and enters voice URI class configuration mode.
Step 4	user-id id-tag Example: Device(config-voice-uri-class)# user-id 5678	Matches a call based on the User ID portion of the Uniform Resource Identifier (URI).
Step 5	exit Example: Device(config-voice-uri-class)# exit	Exits voice URI class configuration mode.
Step 6	voice service voip Example: Device(config)# voice service voip	Specifies Voice over IP (VoIP) as the voice encapsulation type and enters voice service configuration mode.
Step 7	allow-connections sip to sip Example: Device(conf-voi-serv)# allow-connections sip to sip	Allows connections between SIP endpoints in a VoIP network.
Step 8	dial-peer voice tag voip Example: Device(config)# dial-peer voice 200 voip	Defines a VoIP dial peer and enters dial peer configuration mode.
Step 9	session protocol sipv2 Example: Device(config-dial-peer)# session protocol sipv2	Specifies a session protocol for calls between local and remote routers using the Internet Engineering Task Force (IETF) SIP.
Step 10	destination uri destination-tag Example: Device(config-dial-peer)# destination uri mydesturi	Specifies the voice class used to match a dial peer to the destination URI of an outgoing call.

	Command or Action	Purpose
Step 11	voice-class sip contact-passing Example: Device(config-dial-peer)# voice-class sip contact-passing	Enables pass through of the contact header from one leg to the other leg in 302 pass through scenario.
Step 12	end Example: Device(config-dial-peer)# end	Ends the current configuration session and returns to privileged EXEC mode.

Deriving of Session Target from URI

Perform this task to derive the session target from the host part of the Uniform Resource Identifier (URI). The outgoing INVITE is sent to the resolved IP address of the host part of the URI. For more information, see Case 4 in the "Call Flows for URI-Based Dialing Enhancements" section.

SUMMARY STEPS

1. **enable**
2. **configure terminal**
3. **voice class uri destination-tag sip**
4. **host hostname-pattern**
5. **exit**
6. **dial-peer voice tag voip**
7. **session protocol sipv2**
8. **destination uri destination-tag**
9. **session target sip-uri**
10. **exit**
11. **voice class uri source-tag sip**
12. **host hostname-pattern**
13. **end**

DETAILED STEPS

	Command or Action	Purpose
Step 1	enable Example: Device> enable	Enables privileged EXEC mode. <ul style="list-style-type: none"> • Enter your password if prompted.
Step 2	configure terminal Example: Device# configure terminal	Enters global configuration mode.
Step 3	voice class uri destination-tag sip Example:	Creates or modifies a voice class for matching dial peers to a Session Initiation Protocol (SIP) or telephone (TEL)

	Command or Action	Purpose
	<code>Device(config)# voice class uri mydesturi sip</code>	Uniform Resource Identifier (URI) and enters voice URI class configuration mode.
Step 4	host <i>hostname-pattern</i> Example: <code>Device(config-voice-uri-class)# host destination.com</code>	Matches a call based on the host field in a SIP URI.
Step 5	exit Example: <code>Device(config-voice-uri-class)# exit</code>	Exits voice URI class configuration mode.
Step 6	dial-peer voice <i>tag voip</i> Example: <code>Device(config)# dial-peer voice 25 voip</code>	Defines a VoIP dial peer and enters dial peer configuration mode.
Step 7	session protocol <i>sipv2</i> Example: <code>Device(config-dial-peer)# session protocol sipv2</code>	Specifies a session protocol for calls between local and remote routers using the Internet Engineering Task Force (IETF) SIP.
Step 8	destination uri <i>destination-tag</i> Example: <code>Device(config-dial-peer)# destination uri mydesturi</code>	Specifies the voice class used to match a dial peer to the destination URI of an outgoing call.
Step 9	session target <i>sip-uri</i> Example: <code>Device(config-dial-peer)# session target sip-uri</code>	Derives session target from incoming URI.
Step 10	exit Example: <code>Device(config-dial-peer)# exit</code>	Exits dial peer voice configuration mode.
Step 11	voice class uri <i>source-tag sip</i> Example: <code>Device(config)# voice class uri mysourceuri sip</code>	Creates or modifies a voice class for matching dial peers to a SIP or TEL URI and enters voice URI class configuration mode.
Step 12	host <i>hostname-pattern</i> Example: <code>Device(config-voice-uri-class)# host abc.com</code>	Matches a call based on the host field in a SIP URI.
Step 13	end Example: <code>Device(config-voice-uri-class)# end</code>	Ends the current configuration session and returns to privileged EXEC mode.

Configuration Examples for URI-Based Dialing Enhancements

Example: Configuring Pass Through of Request URI and To Header URI

Example: Configuring Pass Through of Request URI and To Header URI (Global Level)

```
Device> enable
Device# configure terminal
Device(config)# voice service voip
Device(conf-voi-serv)# sip
Device(conf-serv-sip)# requiri-passing
Device(conf-serv-sip)# end
```

Example: Configuring Pass Through of Request URI and To Header URI (Dial Peer Level)

```
! Configuring URI voice class destination
Device(config)# voice class uri mydesturi sip
Device(config-voice-uri-class)# host xyz.com
Device(config-voice-uri-class)# exit

! Configuring outbound dial peer
Device(config)# dial-peer voice 13 voip
Device(config-dial-peer)# session protocol sipv2
Device(config-dial-peer)# destination uri mydesturi
Device(config-dial-peer)# session target ipv4:10.1.1.1
Device(config-dial-peer)# voice-class sip requiri-passing system
Device(config-dial-peer)# end
```

Example: Configuring Pass Through of 302 Contact Header

Example: Configuring Pass Through of 302 Contact Header (Global Level)

```
Device> enable
Device# configure terminal
Device(config)# voice service voip
Device(conf-voi-serv)# sip
Device(conf-serv-sip)# contact-passing
Device(conf-serv-sip)# end
```

Example: Configuring Pass Through of 302 Contact Header (Dial Peer Level)

```
! Configuring URI voice class destination
Device> enable
Device# configure terminal
Device(config)# voice class uri mydesturi sip
Device(config-voice-uri-class)# user-id 5678
Device(config-voice-uri-class)# exit

! Configuring outbound dial peer
Device(config)# voice service voip
```

```

Device(conf-voi-serv)# allow-connections sip to sip
Device(conf-voi-serv)# dial-peer voice 200 voip
Device(config-dial-peer)# session protocol sipv2
Device(config-dial-peer)# destination uri mydesturi
Device(config-dial-peer)# voice-class sip contact-passing
Device(config-dial-peer)# end

```

Example: Deriving Session Target from URI

```

Device> enable
Device# configure terminal
Device(config)# voice class uri mydesturi sip
Device(config-voice-uri-class)# host destination.com
Device(config-voice-uri-class)# exit
!
Device(config)# dial-peer voice 25 voip
Device(config-dial-peer)# session protocol sipv2
Device(config-dial-peer)# destination uri mydesturi
Device(config-dial-peer)# session target sip-uri
Device(config-dial-peer)# exit
!
Device(config)# voice class uri mysourceuri sip
Device(config-voice-uri-class)# host abc.com
Device(config-voice-uri-class)# end

```

Additional References for URI-Based Dialing Enhancements

Related Documents

Related Topic	Document Title
Voice commands	Cisco IOS Voice Command Reference
Cisco IOS commands	Cisco IOS Command List, All Releases
SIP configuration tasks	SIP Configuration Guide, Cisco IOS Release 15M&T

Technical Assistance

Description	Link
<p>The Cisco Support website provides extensive online resources, including documentation and tools for troubleshooting and resolving technical issues with Cisco products and technologies.</p> <p>To receive security and technical information about your products, you can subscribe to various services, such as the Product Alert Tool (accessed from Field Notices), the Cisco Technical Services Newsletter, and Really Simple Syndication (RSS) Feeds.</p> <p>Access to most tools on the Cisco Support website requires a Cisco.com user ID and password.</p>	http://www.cisco.com/support



CHAPTER 21

Multiple Pattern Support on a Voice Dial Peer

The Multiple Pattern Support on a Voice Dial Peer feature enables you to configure multiple patterns on a VoIP dial peer using an E.164 pattern map. A dial peer can be configured to match multiple patterns to an incoming calling or called number or an outgoing destination number.

- [Feature Information for Multiple Pattern Support on a Voice Dial Peer, on page 287](#)
- [Restrictions for Multiple Pattern Support on a Voice Dial Peer, on page 288](#)
- [Information About Multiple Pattern Support on a Voice Dial Peer, on page 288](#)
- [Configuring Multiple Pattern Support on a Voice Dial Peer, on page 288](#)
- [Verifying Multiple Pattern Support on a Voice Dial Peer, on page 290](#)
- [Configuration Examples for Multiple Pattern Support on a Voice Dial Peer, on page 292](#)

Feature Information for Multiple Pattern Support on a Voice Dial Peer

The following table provides release information about the feature or features described in this module. This table lists only the software release that introduced support for a given feature in a given software release train. Unless noted otherwise, subsequent releases of that software release train also support that feature.

Use Cisco Feature Navigator to find information about platform support and Cisco software image support. To access Cisco Feature Navigator, go to <https://cfng.cisco.com/>. An account on Cisco.com is not required.

Table 39: Feature Information for Multiple Pattern Support on a Voice Dial Peer

Feature Name	Releases	Feature Information
Configuring Multiple Pattern Support on a Voice Dial Peer (Inbound Calls)	Cisco IOS 15.4 (1)T Cisco IOS XE 3.11S	This feature was extended for inbound VoIP dial peers for incoming calling and called numbers. The following commands were introduced or modified: incoming called e164-pattern-map , incoming calling e164-pattern-map

Feature Name	Releases	Feature Information
Configuring Multiple Pattern Support on a Voice Dial Peer (Outbound Calls)	Cisco IOS 15.2(4)M Cisco IOS XE 3.7S	<p>This feature allows you to add more than one E.164 destination pattern inside a pattern map and configure that pattern map for one or more VoIP dial peers.</p> <p>This feature is supported for outbound peers only.</p> <p>The following commands were introduced or modified: destination e164-pattern-map, e164, show voice class e164-pattern-map, url, voice class e164-pattern-map load, voice class e164-pattern-map.</p>

Restrictions for Multiple Pattern Support on a Voice Dial Peer

- This feature is supported only on a VoIP dial peer.
- Duplicate patterns cannot be added to a pattern map.

Information About Multiple Pattern Support on a Voice Dial Peer

Matching an incoming or outgoing call using a pattern defined in a VoIP dial peer is an existing feature on the Cisco Unified Border Element (Enterprise) and Session Initiation Protocol (SIP) Gateway. You can now support multiple patterns on a VoIP dial peer using an E.164 pattern map. You can create a E.164 pattern map and then link it to one or more VoIP dial peers.

When a pattern is the only source to enable a dial peer, a valid E.164 pattern map enables the linked dial peers, whereas an invalid E.164 pattern map disables the linked dial peers. Additionally, whenever an E.164 pattern map is created or reloaded, one or more dial peers linked with an E.164 pattern map is enabled or disabled based on the validation of a pattern map.

You can match a pattern map to an incoming calling or called number or an outgoing destination number.

When a dial peer has multiple patterns, the pattern with the longest prefix is considered as the matching criteria.

Configuring Multiple Pattern Support on a Voice Dial Peer

SUMMARY STEPS

1. **enable**

2. **configure terminal**
3. **voice class e164-pattern-map** *pattern-map-id*
4. Do one of the following:
 - **e164** *pattern-map-tag*
 - **url** *url*
5. (Optional) **description** *string*
6. **exit**
7. **dial-peer voice** *dial-peer-id* **voip**
8. {**destination** | **incoming called** | **incoming calling**} **e164-pattern-map** *pattern-map-group-id*
9. **end**
10. (Optional) **voice class e164-pattern-map load** *pattern-map-group-id*
11. **show dial-peer voice** [**summary** | *dial-peer-id*]

DETAILED STEPS

	Command or Action	Purpose
Step 1	enable Example: Device> enable	Enters privileged EXEC mode. <ul style="list-style-type: none"> • Enter your password if prompted.
Step 2	configure terminal Example: Device# configure terminal	Enters global configuration mode.
Step 3	voice class e164-pattern-map <i>pattern-map-id</i> Example: Device (config)# voice class e164-pattern-map 1111	Creates a pattern map for configuring one or multiple E.164 patterns on a dial peer and enters voice class configuration mode.
Step 4	Do one of the following: <ul style="list-style-type: none"> • e164 <i>pattern-map-tag</i> • url <i>url</i> Example: Using URL text file: Device (voice-class)# url http://http-host/config-files/pattern-map.cfg Directly specifying match patterns: Device (voice-class)# e164 5557123	Configure one or more E.164 telephone number prefix match patterns for the pattern map. <ul style="list-style-type: none"> • Repeat this step for each pattern if you are using the e164 command. • You can specify a file URL containing the patterns for this dial peer using the url url command. You must then load the E.164 telephone prefixes using Step 10. The file can be internal (on the device) or external.

	Command or Action	Purpose
Step 5	(Optional) description <i>string</i> Example: Device (voice-class) # description It has 1 entry	Provides a description for the pattern map.
Step 6	exit Example: Device (voice-class) # exit	Exits voice class configuration mode and enters global configuration mode.
Step 7	dial-peer voice <i>dial-peer-id</i> voip Example: Device (config) # dial-peer voice 2222 voip	Defines a VoIP dial peer and enters dial peer configuration mode.
Step 8	{ destination incoming called incoming calling } e164-pattern-map <i>pattern-map-group-id</i> Example: Device (config-dial-peer) # incoming calling e164-pattern-map 1111	Links a pattern-map group with a dial peer. <ul style="list-style-type: none"> • Use the destination keyword for outbound dial peers. • Use the incoming called or incoming calling keywords for inbound dial peers using called or calling numbers.
Step 9	end Example: Device (config-dial-peer) # end	Exits dial peer configuration mode and enters privileged EXEC mode.
Step 10	(Optional) voice class e164-pattern-map load <i>pattern-map-group-id</i> Example: Device # voice class e164-pattern-map load 1111	Loads the specified pattern map with E.164 match patterns from a text file configured in the pattern map. <ul style="list-style-type: none"> • This step is required only if patterns have been defined for the specified pattern map using a file URL in Step 4.
Step 11	show dial-peer voice [summary <i>dial-peer-id</i>] Example: Device # show dial-peer voice 1111	Displays the status of a pattern map when the pattern map is associated with a dial peer.

Verifying Multiple Pattern Support on a Voice Dial Peer

SUMMARY STEPS

1. **show voice class e164-pattern-map** [**summary** | *pattern-map-id*]
2. **show dial-peer voice** [**summary** | *dial-peer-id*]

3. `show dialplan incall {sip | h323} {calling | called} e164-pattern`

DETAILED STEPS

Step 1 `show voice class e164-pattern-map [summary | pattern-map-id]`

Displays the status and contents of a specified pattern map or a status summary of all pattern maps.

Example:

```
Device# show voice class e164-pattern-map 200
```

```
e164-pattern-map 200
-----
  It has 1 entries
  It is not populated from a file.
  Map is valid.

E164 pattern
-----
200
```

Step 2 `show dial-peer voice [summary | dial-peer-id]`

Displays the status of pattern maps associated with all or a specified dial peer.

Example:

```
Device# show dial-peer voice | include e164-pattern-map
```

```
incoming calling e164-pattern-map tag = `200' status = valid,
destination e164-pattern-map tag = 3000 status = valid,
```

```
Device# show dial-peer voice 2222 | include e164-pattern-map
```

```
incoming calling e164-pattern-map tag = `200' status = valid,
```

Step 3 `show dialplan incall {sip | h323} {calling | called} e164-pattern`

Displays inbound dial peer details and associated pattern maps based on an incoming calling or called number.

Example:

```
Device# show dialplan incall voip calling 23456
```

```
VoiceOverIpPeer1234567
  peer type = voice, system default peer = FALSE, information type = voice,
  description = `',
  tag = 1234567, destination-pattern = `',
  destination e164-pattern-map tag = 200 status = valid,
  destination dpg tag = 200 status = valid,
  voice reg type = 0, corresponding tag = 0,
  allow watch = FALSE
  answer-address = `', preference=0,
  incoming calling e164-pattern-map tag = `200' status = valid,
  CLID Restriction = None
```

Configuration Examples for Multiple Pattern Support on a Voice Dial Peer

Example: Configuring Multiple Patterns for Outbound Dial Peers Using a File URL

```
Device# voice class e164-pattern-map 1111
Device(voice-class)# url http://http-host/config-files/pattern-map.cfg
Device(voice-class)# description For Outbound Dial Peer
Device(voice-class)# exit
Device(config)# dial-peer voice 2222 voip
Device(voice-dial-peer)# destination e164-pattern-map 1111
Device(voice-dial-peer)# exit
Device(config)# voice class e164-pattern-map load 1111
Device(config)# end
```

Example: Configuring Multiple Patterns for Outbound Dial Peers by Specifying Each E164 Pattern

```
Device# voice class e164-pattern-map 1112
Device(voice-class)# e164 5557456
Device(voice-class)# e164 5557455
Device(voice-class)# e164 5557454
Device(voice-class)# e164 5557453
Device(voice-class)# e164 5557452
Device(voice-class)# description For Outbound Dial Peer
Device(voice-class)# exit
Device(config)# dial-peer voice 2222 voip
Device(voice-dial-peer)# destination e164-pattern-map 1112
Device(voice-dial-peer)# end
!
```

Example: Configuring Multiple Patterns for Inbound Dial Peer

```
Device# voice class e164-pattern-map 1113
Device(voice-class)# url http://http-host/config-files/pattern-map.cfg
Device(voice-class)# description For Inbound Dial Peer
Device(voice-class)# exit
Device(config)# dial-peer voice 2222 voip
Device(voice-dial-peer)# incoming calling e164-pattern-map 1113
Device(voice-dial-peer)# exit
Device(config)# voice class e164-pattern-map load 1113
Device(config)# end
```



CHAPTER 22

Outbound Dial-Peer Group as an Inbound Dial-Peer Destination

This feature can group multiple outbound dial peers into a dial-peer group and configure this dial-peer group as the destination of an inbound dial peer.

- [Feature Information for Outbound Dial-Peer Group as an Inbound Dial-Peer Destination, on page 293](#)
- [Restrictions, on page 294](#)
- [Information About Outbound Dial-Peer Group as an Inbound Dial-Peer Destination, on page 294](#)
- [Configuring Outbound Dial-Peer Group as an Inbound Dial-Peer Destination, on page 295](#)
- [Verifying Outbound Dial-Peer Groups as an Inbound Dial-Peer Destination, on page 297](#)
- [Troubleshooting Tips, on page 298](#)
- [Configuration Examples for Outbound Dial Peer Group as an Inbound Dial-Peer Destination, on page 299](#)

Feature Information for Outbound Dial-Peer Group as an Inbound Dial-Peer Destination

The following table provides release information about the feature or features described in this module. This table lists only the software release that introduced support for a given feature in a given software release train. Unless noted otherwise, subsequent releases of that software release train also support that feature.

Use Cisco Feature Navigator to find information about platform support and Cisco software image support. To access Cisco Feature Navigator, go to <https://cfng.cisco.com/>. An account on Cisco.com is not required.

Table 40: Feature Information for Outbound Dial-Peer Group as an Inbound Dial-Peer Destination

Feature Name	Releases	Feature Information
Support for POTS dial-peer	Cisco IOS 15.5(1)T Cisco IOS XE 3.14S	An outgoing POTS dial peer can be part of a dial-peer group. An inbound POTS dial peer can have a dial-peer group as the destination.

Feature Name	Releases	Feature Information
Outbound Dial-Peer Group as an Inbound Dial-Peer Destination	Cisco IOS 15.4(1)T Cisco IOS XE 3.11S	This feature groups multiple outbound dial-peers into a dial-peer group and configures this dial-peer group as a destination of an inbound dial peer. The following commands were introduced or modified: voice class dpg , description , dial-peer preference , destination dpg , show voice class dpg .

Restrictions

- If a dial-peer group is in the shutdown state, regular dial-peer search occurs.
- If all dial-peers in an active dial-peer group are unavailable, call is disconnected.
- The number of matched digits is zero.
- The **destination-pattern** command is required on the outbound dial-peer even though matching is not done based on this command.
- The outgoing call setup is deferred until inter-digit timer expires or a terminator is entered.
- Dial-peer group works only with valid E.164 pattern.

For POTS dial-peers:

- Two-stage dialing is not supported.
- Overlapping dialing is not supported.
- TCL and VXML routing changes are not supported.
- Digit-stripping is not supported.

Information About Outbound Dial-Peer Group as an Inbound Dial-Peer Destination

You can group up to 20 outbound (H.323, SIP or POTS) dial peers into a dial-peer group and configure this dial-peer group as the destination of an inbound dial peer. Once an incoming call is matched by an inbound dial peer with an active destination dial-peer group, dial peers from this group are used to route the incoming call. No other outbound dial-peer provisioning to select outbound dial peers is used.

A preference can be defined for each dial peer in a dial-peer group. This preference is used to decide the order of selection of dial peers from the group for the setup of an outgoing call.

You can also specify various dial-peer hunt mechanism using the existing **dial-peer hunt** command.

Configuring Outbound Dial-Peer Group as an Inbound Dial-Peer Destination

Perform this task to configure a dial-peer group with multiple outbound peers and an inbound dial peer referencing this dial-peer group as a destination.

Before you begin

- Configure SIP, H.323 or POTS outbound dial peers to be associated with a dial-peer group.
- For an outbound POTS dial peer, ensure that **destination-pattern .T** and **no digit-strip** are configured to avoid unexpected dialed digit strip.

SUMMARY STEPS

1. **enable**
2. **configure terminal**
3. **dial-peer voice** *outbound-dial-peer-id* [**voip** | **pots**]
4. **destination-pattern** *pattern*
5. **no digit-strip** for POTS dial peers.
6. **exit**
7. (Optional) **dial-peer hunt** *hunt-order-number*
8. **voice class dpg** *dial-peer-group-id*
9. **dial-peer** *outbound-dial-peer-id* [**preference** *preference-order*]
10. (Optional) **description** *string*
11. **exit**
12. **dial-peer voice** *inbound-dial-peer-id* [**voip** | **pots**]
13. **destination dpg** *dial-peer-group-id*
14. **end**

DETAILED STEPS

	Command or Action	Purpose
Step 1	enable Example: Device> enable	Enters privileged EXEC mode. <ul style="list-style-type: none"> • Enter your password if prompted.
Step 2	configure terminal Example: Device# configure terminal	Enters global configuration mode.

	Command or Action	Purpose
Step 3	<p>dial-peer voice <i>outbound-dial-peer-id</i> [voip pots]</p> <p>Example: For VoIP dial peer:</p> <pre>Device(config)# dial-peer voice 123 voip</pre> <p>Example: For POTS dial peer:</p> <pre>Device(config)# dial-peer voice 345 pots</pre>	Defines a dial peer and enters dial peer configuration mode.
Step 4	<p>destination-pattern <i>pattern</i></p> <p>Example: For VoIP Dial Peers</p> <pre>Device(config-dial-peer)# destination-pattern 1004</pre> <p>Example: For POTS Dial Peers</p> <pre>Device(config-dial-peer)# destination-pattern .T</pre>	Configures a destination pattern. This step is required even though the value is not used for dial-peer matching.
Step 5	<p>no digit-strip for POTS dial peers.</p> <p>Example:</p> <pre>Device(config-dial-peer)# no digit-strip</pre>	Disable unexpected dialed digit strip.
Step 6	<p>exit</p> <p>Example:</p> <pre>Device(config-dial-peer)# exit</pre>	Exits to global configuration mode.
Step 7	<p>(Optional) dial-peer hunt <i>hunt-order-number</i></p> <p>Example:</p> <pre>Device(config)# dial-peer hunt 0</pre>	<p>Specifies a hunt selection mechanism for dial peers.</p> <ul style="list-style-type: none"> The default mechanism is random selection.
Step 8	<p>voice class dpg <i>dial-peer-group-id</i></p> <p>Example:</p> <pre>Device(config)# voice class dpg 181</pre>	<p>Creates a dial-peer group for grouping multiple outbound dial peers and enters voice class configuration mode.</p> <ul style="list-style-type: none"> You can use the shutdown command to resume regular outbound dial-peer provisioning in dial-peers with this dial-peer group as destination.
Step 9	<p>dial-peer <i>outbound-dial-peer-id</i> [preference <i>preference-order</i>]</p> <p>Example:</p>	Associates a configured outbound dial peer with this dial-peer group and configures a preference value.

	Command or Action	Purpose
	Device(config-class)# dial-peer 123 preference 1	<ul style="list-style-type: none"> Repeat this step for all outbound dial-peers that need to be added to this dial-peer group. If preference is not specified, the order of selection is random or as specified by the dial-peer hunt command.
Step 10	(Optional) description string Example: Device(config-class)# description Boston Destination	Provides a description for the dial-peer group.
Step 11	exit Example: Device(config-class)# exit	Exits voice class configuration mode and enters global configuration mode.
Step 12	dial-peer voice inbound-dial-peer-id [voip pots] Example: For VoIP dial peer: Device(config)# dial-peer voice 789 voip Example: For POTS dial peer: Device(config)# dial-peer voice 678 pots	Defines a dial peer and enters dial peer configuration mode.
Step 13	destination dpg dial-peer-group-id Example: Device(config-dial-peer)# destination dpg 181	Specifies a dial peer group from which an outbound dial peer can be chosen.
Step 14	end Example: Device(config-dial-peer)# end	Exits dial peer configuration mode and enters privileged EXEC mode.

Verifying Outbound Dial-Peer Groups as an Inbound Dial-Peer Destination

SUMMARY STEPS

1. **show voice class dpg dial-peer-group-id**
2. **show dial-peer voice inbound-dial-peer-id**

DETAILED STEPS

Step 1 `show voice class dpg dial-peer-group-id`

Displays the configuration of an outbound dial-peer group.

Example:

```
Device# show voice class dpg 200

Voice class dpg: 200      AdminStatus: Up
Description: Boston Destination
Total dial-peer entries: 4

Peer Tag      Pref
-----      -
1001          1
1002          2
1004          0
1003          1
-----
```

Step 2 `show dial-peer voice inbound-dial-peer-id`

Displays the referencing of destination dial-peer group from an inbound dial peer.

Example:

```
Device# show dial-peer voice 100 | include destination dpg

destination dpg tag = 200 status = valid,
```

Troubleshooting Tips

SUMMARY STEPS

1. Enter the following:
 - `debug voip dialpeer inout`
 - `debug voip ccapi inout`

DETAILED STEPS

Enter the following:

- `debug voip dialpeer inout`
- `debug voip ccapi inout`

Displays the configuration of an outbound dial-peer group.

Example:

```
*Jul 19 10:15:53.310 IST: //-1/ED647BD1B0F9/DPM/dpMatchCore:
  Dial String=4001, Expanded String=4001, Calling Number=
  Timeout=TRUE, Is Incoming=TRUE, Peer Info Type=DIALPEER_INFO_SPEECH
*Jul 19 10:15:53.310 IST: //-1/xxxxxxxxxxxx/DPM/vepm_match_pattern_map:
  DEPM 1000 use caching dialstring 4001 status 0
*Jul 19 10:15:53.310 IST: //-1/ED647BD1B0F9/DPM/MatchNextPeer:
```

Incoming dial peer is first matched:

```
Result=Success(0); Incoming Dial-peer=600 Is Matched
*Jul 19 10:15:53.310 IST: //-1/ED647BD1B0F9/DPM/dpMatchPeertype:exit@6602
*Jul 19 10:15:53.310 IST: //-1/ED647BD1B0F9/DPM/dpAssociateIncomingPeerCore:
  Result=Success(0) after DP_MATCH_INCOMING_DNIS; Incoming Dial-peer=600
*Jul 19 10:15:53.310 IST: //-1/ED647BD1B0F9/DPM/dpMatchSafModulePlugin:
  dialstring=NULL, saf_enabled=0, saf_dndb_lookup=0, dp_result=0
*Jul 19 10:15:53.310 IST: //-1/ED647BD1B0F9/DPM/dpAssociateIncomingPeerSPI:exit@7181
*Jul 19 10:15:53.311 IST: //-1/ED647BD1B0F9/DPM/dpMatchPeersCore:
  Calling Number=, Called Number=4001, Peer Info Type=DIALPEER_INFO_SPEECH
```

The dial-peer group associated with a dial peer is selected:

```
*Jul 19 10:15:53.311 IST: //-1/ED647BD1B0F9/DPM/dpMatchPeersCore:
  Outbound Destination DPG Group Request; Destination DPG=1
*Jul 19 10:15:53.311 IST: //-1/ED647BD1B0F9/DPM/dpMatchDestDPGGroup:
  Result=0
*Jul 19 10:15:53.311 IST: //-1/ED647BD1B0F9/DPM/dpMatchPeersCore:
  Result=SUCCESS(0) after DestDPGGroup
*Jul 19 10:15:53.311 IST: //-1/ED647BD1B0F9/DPM/dpMatchSafModulePlugin:
  dialstring=4001, saf_enabled=0, saf_dndb_lookup=1, dp_result=0
```

List of active Dial-peers configured within the DPG, sorted by preference:

```
*Jul 19 10:15:53.311 IST: //-1/ED647BD1B0F9/DPM/dpMatchPeersMoreArg:
  Result=SUCCESS(0)
List of Matched Outgoing Dial-peer(s):
  1: Dial-peer Tag=1004
  2: Dial-peer Tag=1001
  3: Dial-peer Tag=1003
  4: Dial-peer Tag=1002
```

Configuration Examples for Outbound Dial Peer Group as an Inbound Dial-Peer Destination

```
Device> enable
Device# configure terminal
! Configuring outbound dial peers that are to be grouped.
Device(config)# dial-peer voice 1001 voip
Device(config-dial-peer)# destination-pattern 1001
Device(config-dial-peer)# session protocol sipv2
Device(config-dial-peer)# session target ipv4:10.1.1.1
```

```

Device(config-dial-peer)# exit

Device(config)# dial-peer voice 1002 voip
Device(config-dial-peer)# destination-pattern 1002
Device(config-dial-peer)# session protocol sipv2
Device(config-dial-peer)# session target ipv4:10.1.1.2
Device(config-dial-peer)# exit

Device(config)# dial-peer voice 1003 voip
Device(config-dial-peer)# destination-pattern 1003
Device(config-dial-peer)# session protocol sipv2
Device(config-dial-peer)# session target ipv4:10.1.1.3
Device(config-dial-peer)# exit

Device(config)# dial-peer voice 1004 pots
Device(config-dial-peer)# destination-pattern 5...
Device(config-dial-peer)# no digit-strip
Device(config-dial-peer)# direct-inward-dial
Device(config-dial-peer)# port 1/0/0:23
Device(config-dial-peer)# forward-digits all
Device(config-dial-peer)# exit

!Grouping outbound dial peers and configuring preferences if needed.
Device(config)# voice class dpg 200
Device(config-class)# dial-peer 1001 preference 1
Device(config-class)# dial-peer 1002 preference 2
Device(config-class)# dial-peer 1003 preference 3
Device(config-class)# dial-peer 1004 preference 4
Device(config-class)# description Boston Destination
Device(config-class)# exit

!Associating outbound dial peer group with an inbound dial peer group.
Device(config)# dial-peer voice 100 voip
Device(config-dial-peer)# incoming called-number 13411
Device(config-dial-peer)# destination dpg 200
Device(config-dial-peer)# end

!Associating outbound dial peer group with an inbound POTS dial peer group.
Device(config)# dial-peer voice 600 pots
Device(config-dial-peer)# incoming called-number 4T
Device(config-dial-peer)# destination dpg 200
Device(config-dial-peer)# end

```

Verifying Outbound Dial-Peer Group Configuration

```

Device# show voice class dpg 200

Voice class dpg: 200      AdminStatus: Up
Description: Boston Destination
Total dial-peer entries: 4

Peer Tag      Pref
-----
1001          1
1002          2
1004          0
1003          1

```

Verifying Inbound Dial-Peer Referencing Outbound Dial-Peer Group

```
Device# show dial-peer voice 100 | include destination dpg
          destination dpg tag = 200 status = valid,
Device# show dial-peer voice 600 | include destination dpg
          destination dpg tag = 200 status = valid,
```



CHAPTER 23

Inbound Leg Headers for Outbound Dial-Peer Matching

The Inbound Leg Headers for Outbound Dial-Peer Matching feature allows you to match and provision an outbound dial peer for an outbound call leg using the headers from an inbound call leg. The following headers of an incoming call leg can be used for outbound dial-peer matching:

- VIA (SIP Header)
- FROM (SIP Header)
- TO (SIP Header)
- DIVERSION (SIP Header)
- REFERRED BY (SIP Header)
- Called Number
- Calling Number
- Carrier ID

- [Feature Information for Inbound Leg Headers for Outbound Dial-Peer Matching, on page 303](#)
- [Prerequisites for Inbound Leg Headers for Outbound Dial-Peer Matching, on page 304](#)
- [Restrictions for Inbound Leg Headers for Outbound Dial-Peer Matching, on page 304](#)
- [Information About Inbound Leg Headers for Outbound Dial-Peer Matching, on page 305](#)
- [Configuring Inbound Leg Headers for Outbound Dial-Peer Matching, on page 305](#)
- [Verifying Inbound Leg Headers for Outbound Dial-Peer Matching, on page 308](#)
- [Configuration Example: Inbound Leg Headers for Outbound Dial-Peer Matching, on page 310](#)

Feature Information for Inbound Leg Headers for Outbound Dial-Peer Matching

The following table provides release information about the feature or features described in this module. This table lists only the software release that introduced support for a given feature in a given software release train. Unless noted otherwise, subsequent releases of that software release train also support that feature.

Use Cisco Feature Navigator to find information about platform support and Cisco software image support. To access Cisco Feature Navigator, go to <https://cfng.cisco.com/>. An account on Cisco.com is not required.

Table 41: Feature Information for Inbound Leg Headers for Outbound Dial-Peer Matching

Feature Name	Releases	Feature Information
Inbound Leg Headers for Outbound Dial-Peer Matching	15.4(2)T, Cisco IOS XE Release 3.12S	<p>The Inbound Leg Headers for Outbound Dial-Peer Matching feature allows you to match and provision an outbound call leg using the headers of an inbound call leg.</p> <p>The following commands were introduced by this feature: destination provision-policy, destination uri-via, destination uri-to, destination uri-from, destination uri-diversion, destination uri-referred-by, show voice class dial-peer provision-policy</p> <p>The following commands were modified. show command incall, show dialplan dialpeer.</p>

Prerequisites for Inbound Leg Headers for Outbound Dial-Peer Matching

- CUBE or Voice Gateway must be configured.

Restrictions for Inbound Leg Headers for Outbound Dial-Peer Matching

- The existing **header-passing** command supports modification of SIP headers of INVITE message by the Tool Command Language (TCL) application. If the above SIP headers are modified by the TCL application, they cannot be used for outbound dial-peer provisioning.
- If multiple SIP via headers and diversion headers are found in an incoming INVITE or REFER message, only the top-most via header and top-most diversion header of an incoming INVITE or REFER message are used for outbound dial-peer provisioning.
- When an incoming call is matched to an inbound dial peer with an associated provision profile without rules, outbound dial-peer provisioning is disabled and the incoming call is disconnected by CUBE or voice gateway with cause code "unassigned number (1)".

Information About Inbound Leg Headers for Outbound Dial-Peer Matching

This feature allows you to match headers of an inbound call leg and provision an outbound dial peer for an outbound call leg. The following SIP headers of an incoming call leg can be used for outbound dial-peer matching

- VIA (SIP Header)
- FROM (SIP Header)
- TO (SIP Header)
- DIVERSION (SIP Header)
- REFERRED BY (SIP Header)
- Called Number
- Calling Number
- Carrier ID

The above headers are retrieved from an incoming INVITE or REFER message and used for outbound dial-peer provisioning.

SIP headers of an INVITE message are saved to an associated call leg. For example, an INVITE message is received for a new call leg A. Then, SIP headers are saved to call leg A itself for outbound dial-peer lookup.

On the other hand, SIP headers of a REFER message are saved to the peer call leg of the associated call leg. For example, call leg A and call leg B are connected in CUBE. The party at Call Leg B makes a blind transfer to the party at Call Leg C. A REFER message is received in CUBE for call leg B (transferor). But, SIP headers of the REFER message are saved under call leg A (transferee) for an outbound dial-peer lookup for Party C.

Configuring Inbound Leg Headers for Outbound Dial-Peer Matching

Before you begin

Necessary pattern maps have been configured.

SUMMARY STEPS

1. **enable**
2. **configure terminal**
3. **voice class dial-peer provision-policy tag**
4. (Optional) **description string**
5. **preference preference-order first-attribute second-attribute**
6. **exit**
7. **dial-peer voice inbound-dial-peer-tag voip**
8. **destination provision-policy tag**
9. **exit**
10. **dial-peer voice outbound-dial-peer-tag voip**

11. Configure a match command for an outbound dial peer according to the provision policy rule attribute configured.
12. **end**

DETAILED STEPS

	Command or Action	Purpose																				
Step 1	enable Example: Device> enable	Enters privileged EXEC mode. <ul style="list-style-type: none"> • Enter your password if prompted. 																				
Step 2	configure terminal Example: Device# configure terminal	Enters global configuration mode.																				
Step 3	voice class dial-peer provision-policy tag Example: Device(config)# voice class dial-peer provision-policy 200	Creates a provision policy profile in which a set of attributes for dial-peer matching can be defined. <ul style="list-style-type: none"> • You can use the shutdown command to deactivate the provision policy and allow normal outbound dial-peer provisioning. 																				
Step 4	(Optional) description string Example: Device(voice-class)# description match both calling and called	Provides a description for the provision policy profile.																				
Step 5	preference preference-order first-attribute second-attribute <table border="1" style="width: 100%; border-collapse: collapse;"> <thead> <tr> <th>First Attribute</th> <th>Second Attribute</th> </tr> </thead> <tbody> <tr> <td>diversion</td> <td>from, referred-by, to, uri, via</td> </tr> <tr> <td>from</td> <td>diversion, referred-by, to, uri, via</td> </tr> <tr> <td>referred-by</td> <td>diversion, from, to, uri, via</td> </tr> <tr> <td>to</td> <td>diversion, referred-by, from, uri, via</td> </tr> <tr> <td>uri</td> <td>diversion, referred-by, to, from, via, carrier-id</td> </tr> <tr> <td>via</td> <td>diversion, referred-by, to, uri, from</td> </tr> <tr> <td>called</td> <td>calling, carrier-id</td> </tr> <tr> <td>calling</td> <td>called</td> </tr> <tr> <td>carrier-id</td> <td>called, uri</td> </tr> </tbody> </table> Example:	First Attribute	Second Attribute	diversion	from, referred-by, to, uri, via	from	diversion, referred-by, to, uri, via	referred-by	diversion, from, to, uri, via	to	diversion, referred-by, from, uri, via	uri	diversion, referred-by, to, from, via, carrier-id	via	diversion, referred-by, to, uri, from	called	calling, carrier-id	calling	called	carrier-id	called, uri	Configures a provision policy rule. <ul style="list-style-type: none"> • You can configure up to two rules. This means up to four attributes can be configured for matching outbound dial peers. • If rules are not configured, outbound dial-peer provisioning is disabled, and an incoming call matched to an inbound dial peer associated with this profile is disconnected by CUBE or voice gateway with cause code "unassigned number (1)".
First Attribute	Second Attribute																					
diversion	from, referred-by, to, uri, via																					
from	diversion, referred-by, to, uri, via																					
referred-by	diversion, from, to, uri, via																					
to	diversion, referred-by, from, uri, via																					
uri	diversion, referred-by, to, from, via, carrier-id																					
via	diversion, referred-by, to, uri, from																					
called	calling, carrier-id																					
calling	called																					
carrier-id	called, uri																					

	Command or Action	Purpose																				
	Device(voice-class)# preference 2 calling called																					
Step 6	exit Example: Device(voice-class)# exit	Exits voice class configuration mode and enters global configuration mode.																				
Step 7	dial-peer voice inbound-dial-peer-tag voip	Enters dial peer configuration mode for an inbound dial peer.																				
Step 8	destination provision-policy tag Example: Device(config)# dial-peer voice 100 voip Device(config-dial-peer)# destination provision-policy 200 Device(config)# exit	Associates a provision policy profile with an inbound dial peer.																				
Step 9	exit	Exits dial peer configuration mode.																				
Step 10	dial-peer voice outbound-dial-peer-tag voip	Enters dial peer configuration mode for an outbound dial peer.																				
Step 11	Configure a match command for an outbound dial peer according to the provision policy rule attribute configured. <table border="1" data-bbox="284 1008 893 1816"> <thead> <tr> <th>Provision Policy Rule Attribute</th> <th>Dial-peer Match command</th> </tr> </thead> <tbody> <tr> <td>called</td> <td>destination-pattern pattern destination e164-pattern-map pattern-map-class-id</td> </tr> <tr> <td>calling</td> <td>destination calling e164-pattern-map pattern-map-class-id</td> </tr> <tr> <td>carrier-id</td> <td>carrier-id target</td> </tr> <tr> <td>uri</td> <td>destination uri uri-class-tag</td> </tr> <tr> <td>via</td> <td>destination uri-via uri-class-tag</td> </tr> <tr> <td>to</td> <td>destination uri-to uri-class-tag</td> </tr> <tr> <td>from</td> <td>destination uri-from uri-class-tag</td> </tr> <tr> <td>diversion</td> <td>destination uri-diversion uri-class-tag</td> </tr> <tr> <td>referred-by</td> <td>destination uri-referred-by uri-class-tag</td> </tr> </tbody> </table>	Provision Policy Rule Attribute	Dial-peer Match command	called	destination-pattern pattern destination e164-pattern-map pattern-map-class-id	calling	destination calling e164-pattern-map pattern-map-class-id	carrier-id	carrier-id target	uri	destination uri uri-class-tag	via	destination uri-via uri-class-tag	to	destination uri-to uri-class-tag	from	destination uri-from uri-class-tag	diversion	destination uri-diversion uri-class-tag	referred-by	destination uri-referred-by uri-class-tag	Configure a match command based on any of the four attributes defined in the provision policy rule.
Provision Policy Rule Attribute	Dial-peer Match command																					
called	destination-pattern pattern destination e164-pattern-map pattern-map-class-id																					
calling	destination calling e164-pattern-map pattern-map-class-id																					
carrier-id	carrier-id target																					
uri	destination uri uri-class-tag																					
via	destination uri-via uri-class-tag																					
to	destination uri-to uri-class-tag																					
from	destination uri-from uri-class-tag																					
diversion	destination uri-diversion uri-class-tag																					
referred-by	destination uri-referred-by uri-class-tag																					

	Command or Action	Purpose
	Example: Device(config)# dial-peer voice 300 voip Device(config-dial-peer)# destination uri-from 200 Device(config)# exit	
Step 12	end Example: Device(config-dial-peer)# end	Exits dial peer configuration mode and enters privileged EXEC mode.

Verifying Inbound Leg Headers for Outbound Dial-Peer Matching

SUMMARY STEPS

1. `show dialplan incall {sip | h323} {calling | called} e164-pattern | include voice`
2. `show dialplan dialpeer inbound-dial-peer-id number e164-pattern [timeout] | include Voice`
3. `show voice class dial-peer provision-policy`

DETAILED STEPS

Step 1 `show dialplan incall {sip | h323} {calling | called} e164-pattern | include voice`

Displays inbound dial peers based on an incoming calling or called number. Once you have the dial peer number, you can use it to search for the complete dial-peer details in the running-config.

Example:

```
Device# show dialplan incall sip calling 3333 | include Voice
```

```
VoiceOverIpPeer1
```

```
Device# show dialplan incall sip calling 4444 | include Voice
```

```
VoiceOverIpPeer1
```

```
Device# show running-config | section dial-peer voice 1 voip
```

```
dial-peer voice 1 voip
 destination dpg 10000
 incoming calling e164-pattern-map 100
 dtmf-relay rtp-nte
 codec g711ulaw
```

```
Device# show dialplan incall sip called 6000 timeout | include Voice
```

```
VoiceOverIpPeer100
```

```
Device# show running-config | section dial-peer voice 100 voip
```

```
dial-peer voice 100 voip
 incoming called e164-pattern-map 1
 incoming calling e164-pattern-map 1
```

```
dtmf-relay rtp-nte
codec g711ulaw
```

```
Device# show dialplan incall voip calling 23456
```

```
VoiceOverIpPeer1234567
  peer type = voice, system default peer = FALSE, information type = voice,
  description = `',
  tag = 1234567, destination-pattern = `',
  destination e164-pattern-map tag = 200 status = valid,
  destination dpg tag = 200 status = valid,
  voice reg type = 0, corresponding tag = 0,
  allow watch = FALSE
  answer-address = `', preference=0,
  incoming calling e164-pattern-map tag = `200' status = valid,
  CLID Restriction = None
```

Step 2 **show dialplan dialpeer inbound-dial-peer-id number e164-pattern [timeout] | include Voice**

Displays a list of outbound dial peers based on a specified inbound dial peer. This command line will be helpful find a list of outbound dial peer of a destination dial-peer group.

Example:

```
Device# show dialplan dialpeer 1 number 23457 timeout | include Voice
```

```
VoiceOverIpPeer100013
VoiceOverIpPeer100012
```

Example:

```
voice class dial-peer provision-policy 2000
  preference 2 diversion to
  !
  ...
  !
dial-peer voice 32555 voip
  session protocol sipv2
  session target ipv4:1.5.14.9
  destination uri-diversion 1
  destination uri-to test2
  !
dial-peer voice 32991 voip
  destination provision-policy 2000
  incoming called-number 1234
  !
```

```
Device# show dialplan dialpeer 32991 number 2234 timeout
```

```
Macro Exp.: 2234
Enter Diversion header:sip:1234@cisco.com
Enter To header:sip:2234@10.0.0.0
VoiceOverIpPeer32134
  peer type = voice, system default peer = FALSE, information type = voice,
  description = `',
```

Step 3 **show voice class dial-peer provision-policy**

Displays a list of configured provision policies and associated rules.

Example:

```
Device# show voice class dial-peer provision-policy
```

```
Voice class dial-peer provision-policy: 100 AdminStatus: Up
```

```

Description: match only called

Pref  Policy Rule
----  -
1     called

Voice class dial-peer provision-policy: 101  AdminStatus: Up
Description: match both calling and called

Pref  Policy Rule
----  -
1     called calling

Voice class dial-peer provision-policy: 102  AdminStatus: Up
Description: match calling first; if no match then match called

Pref  Policy Rule
----  -
1     calling
2     called

Voice class dial-peer provision-policy: 200  AdminStatus: Up
Description: match referred-by and via uri; if no match then match request- uri

Pref  Policy Rule
----  -
1     referred-by via
2     uri

voice class dial-peer provision-policy: 300  AdminStatus: Up
Description: match only request-uri

Pref  Policy Rule
----  -
1     uri

Voice class dial-peer provision-policy: 400  AdminStatus: Up
Description: match only request uri; if no match then match called

Pref  Policy Rule
----  -
1     uri
2     called

```

Configuration Example: Inbound Leg Headers for Outbound Dial-Peer Matching

Example: Configuring Inbound Called or Calling Numbers Used for Outbound Dial-Peer Matching

```

Device> enable
Device# configure terminal

Device(config)# voice class dial-peer provision-policy 200
Device(voice-class)# description match both calling and called
Device(voice-class)# preference 2 calling called

```

```
Device(voice-class)# exit

Device(config)# voice class e164-pattern-map 300
Device(voice-class)# description patterns
Device(voice-class)# e164 5557123
Device(voice-class)# e164 5558123
Device(voice-class)# e164 5559123
Device(voice-class)# exit

!Associating the Provision Policy with an Inbound Dial Peer
Device(config)# dial-peer voice 100 voip
Device(config-dial-peer)# destination provision-policy 200
Device(config-dial-peer)# end

!Associates a Pattern Map with an Outbound Dial Peer.
! The called number in the SIP headers of the inbound leg is matched to select the below
outbound dial peer.
Device(config)# dial-peer voice 200 voip
Device(config-dial-peer)# destination e164-pattern-map 300
Device(config-dial-peer)# end
```

Example: Configuring Inbound SIP Headers for Outbound Dial-Peer Matching

```
Device> enable
Device# configure terminal

Device(config)# voice class dial-peer provision-policy 200
Device(voice-class)# description match both calling and called
Device(voice-class)# preference 2 via from
Device(voice-class)# exit

!Associating the Provision Policy with an Inbound Dial Peer
Device(config)# dial-peer voice 100 voip
Device(config-dial-peer)# destination provision-policy 200
Device(config-dial-peer)# end

Device(config)# voice class uri 200 sip
Device(config-voice-uri-clas)# pattern 25054..

!Associates a Provision Policy with an Outbound Dial Peer.
The FROM SIP headers of the inbound leg is matched to select the below outbound dial peer.
Device(config)# dial-peer voice 200 voip
Device(config-dial-peer)# destination uri-from 200
Device(config-dial-peer)# end
```



CHAPTER 24

Server Groups in Outbound Dial Peers

This feature configures a server group (group of server addresses) that can be referenced from an outbound dial peer.

- [Feature Information for Configuring Server Groups in Outbound Dial Peers, on page 313](#)
- [Information About Server Groups in Outbound Dial Peers, on page 314](#)
- [How to Configure Server Groups in Outbound Dial Peers, on page 315](#)
- [Configuration Examples for Server Groups in Outbound Dial Peers, on page 319](#)

Feature Information for Configuring Server Groups in Outbound Dial Peers

The following table provides release information about the feature or features described in this module. This table lists only the software release that introduced support for a given feature in a given software release train. Unless noted otherwise, subsequent releases of that software release train also support that feature.

Use Cisco Feature Navigator to find information about platform support and Cisco software image support. To access Cisco Feature Navigator, go to <https://cfng.cisco.com/>. An account on Cisco.com is not required.

Table 42: Feature Information for Configuring Server Groups in Outbound Dial Peers

Feature Name	Releases	Feature Information
Server Groups in Outbound Dial Peers	Cisco IOS XE Release 3.11S 15.4(1)T	This feature configures server groups (groups of IPv4 and IPv6 addresses) which can be referenced from an outbound SIP dial peer. The following command is introduced under: voice class server-group, description, ipv4 port preference, ipv6 port preference, hunt-scheme, show voice class server-group, shutdown (Server Group).

Feature Name	Releases	Feature Information
Hunt Stop for Server Groups	Cisco IOS XE Bengaluru 17.4.1a	<p>This feature allows you to configure hunt-stop based on (configurable) response codes in the Server Group.</p> <p>The following command is introduced under voice class server-group. huntstop rule-tag resp-code from_resp_code to to_resp_code</p>

Information About Server Groups in Outbound Dial Peers

Server groups allow you to create simpler configurations by specifying a list of destination SIP servers for a single dial peer. When a call matches a dial peer that is configured with a server group, the destination is selected from the list of candidates based on a configured policy. If it is not possible to complete that call, the next candidate is selected. Alternatively, you can also choose to stop hunting through the group if a specified response code is received. If the call cannot be placed to any of the servers in the group, or hunting is stopped, call processing continues to the next preferred dial-peer.

You can configure server groups for SIP dial peers to include up to five IPv4 and IPv6 target server addresses listed in strict order of preference, or with equal weight for round robin or random selection.



Note Whenever destination server group is used, and multiple interfaces are involved, ensure that the server group must have the session targets, belonging to the same network as that of sip bind on the dial-peer, where the server-group is configured.

If there are session targets of different network, then different dial-peers must be created with appropriate grouping of the targets with respective binding of the interfaces.

If a server-group is in the shutdown mode, all dial-peers using this destination are out of service.



Note

- You can use Server Groups only with SIP dial-peers.
- If a destination IP on the server group responds with codes 404, 500, or 503, the server group hunts for the next destination. But if the server group receives codes 480, 486, or 600, hunting is not supported and hence the server group does not hunt to the next destination.



- Caution** Huntstop cannot be used with the following cause codes 401, 407, 415, 417, 422, 480, 485, 486, and 488.
- If you attempt to configure one of the listed cause codes specifically, the following CLI error message appears.
 Example, `huntstop 1 resp-code 401`
 Error: The specified response code cannot be used with Huntstop.
 - If you attempt to configure range of codes that includes one of those codes that are listed, the command is accepted with the following warning message.
 Example, `huntstop 1 resp-code 420-430`
 Warning: Range includes code(s) that will not stop hunting.

How to Configure Server Groups in Outbound Dial Peers

Configuring Server Groups in Outbound Dial Peers

SUMMARY STEPS

- enable**
- configure terminal**
- voice class server-group** *server-group-id*
- {ipv4 | ipv6}** *address* [**port** *port*] [**preference** *preference-order*]
- (Optional) **hunt-scheme round-robin**
- (Optional) **description** *string*
- (Optional) **huntstop** *rule-tag* **resp-code** *from_resp_code* to *to_resp_code*
- dial-peer voice** *dial-peer-id* **voip**
- session protocol sipv2**
- destination-pattern** [**+**] *string* [**T**]
- session server-group** *server-group-id*
- end**
- show voice class server-group** *server-group-id*

DETAILED STEPS

	Command or Action	Purpose
Step 1	enable Example: Device> enable	Enters privileged EXEC mode. <ul style="list-style-type: none"> Enter your password if prompted.

	Command or Action	Purpose
Step 2	configure terminal Example: Device# <code>configure terminal</code>	Enters global configuration mode.
Step 3	voice class server-group <i>server-group-id</i> Example: Device (config)# <code>voice class server-group 171</code>	Configures a voice class server group and enters voice class configuration mode. <ul style="list-style-type: none"> You can use the shutdown command to make the server group inactive.
Step 4	{ipv4 ipv6} <i>address</i> [port <i>port</i>] [preference <i>preference-order</i>] Example: Device (config-class)# <code>ipv4 10.1.1.1 preference 3</code>	Configures a server IP address as a part of this server group along with an optional port number and preference order. <ul style="list-style-type: none"> Repeat this step to add up to five servers to the server group. The servers are not selected by the preference value if round robin is configured in the next step. Default and highest value of preference is zero.
Step 5	(Optional) hunt-scheme round-robin Example: Device (config-class)# <code>hunt-scheme round-robin</code>	Defines a hunt method for the order of selection of target server IP addresses (from the IP addresses configured for this server group) for the setting up of outgoing calls. <ul style="list-style-type: none"> If a hunt scheme is not defined, an available IP address of highest preference value is selected. If neither a round-robin hunt scheme nor a preference value is configured, the selection of servers is random.
Step 6	(Optional) description <i>string</i> Example: Device (config-class)# <code>description It has 3 entries</code>	Provides a description for the server group.
Step 7	(Optional) huntstop <i>rule-tag</i> resp-code <i>from_resp_code</i> <i>to_resp_code</i> Example: You can configure hunting in 2 ways, providing the following cause codes - a. Range Device (config-class)# <code>huntstop 1 resp-code 400 to 410</code> b. Standalone	Stops hunting for servers in the Server Group based on configurable response codes. <ul style="list-style-type: none"> Huntstop rule identifier tags range: 1-1000. Configurable SIP error response codes range: 400 to 599. The range must be in between 400 and 599 and must be entered in minimum to maximum order (Example: 450 to 460). You can enter multiple ranges using additional instances of this command. Response codes do not need to be ordered between instances (Example: huntstop 1 500 to 510 and huntstop 2 400 to 450).

	Command or Action	Purpose
	<pre>Device(config-class)# huntstop 2 resp-code 414</pre>	<p>The following error message appears if there is an invalid input for SIP Response codes.</p> <pre>Error: Invalid SIP response code range configured for hunt-stop.</pre> <ul style="list-style-type: none"> Overlapping of SIP error response codes configuration is not permitted. For example, huntstop 1 resp-code 400 to 510. <p>The following error message appears if you try to configure the overlapping SIP error response codes.</p> <pre>Error: Overlap of response codes.</pre> <p>When one of the cause codes is in the configured range, the following warning message appears.</p> <p>Example, huntstop 1 resp-code 400 to 405</p> <pre>Warning: Range includes codes that will not stop hunting.</pre>
Step 8	<p>dial-peer voice <i>dial-peer-id</i> voip</p> <p>Example:</p> <pre>Device(config)# dial-peer voice 123 voip</pre>	Defines a VoIP dial peer and enters dial peer configuration mode.
Step 9	<p>session protocol sipv2</p> <p>Example:</p> <pre>Device(config-dial-peer)# session protocol sipv2</pre>	Specifies SIP version 2 as the session protocol for calls between local and remote routers using the packet network.
Step 10	<p>destination-pattern [+] <i>string</i> [T]</p> <p>Example:</p> <pre>Device(config-dial-peer)# destination-pattern +5550179</pre>	Specifies either the prefix or the full E.164 telephone number to be used for a dial peer.
Step 11	<p>session server-group <i>server-group-id</i></p> <p>Example:</p> <pre>Device(config-dial-peer)# session server-group 171</pre>	<p>Configures the specified server group as the destination of the dial peer.</p> <ul style="list-style-type: none"> This command is available for SIP dial peers only. If the specified server group is in shutdown mode, the dial peer is not selected to route outgoing calls.
Step 12	<p>end</p> <p>Example:</p> <pre>Device(config-dial-peer)# end</pre>	Exits dial peer configuration mode and enters privileged EXEC mode.
Step 13	<p>show voice class server-group <i>server-group-id</i></p> <p>Example:</p>	Displays information about the voice class server group.

	Command or Action	Purpose
	Device# <code>show voice class server-group 171</code>	

Verifying Server Groups in Outbound Dial Peers

SUMMARY STEPS

1. `show voice class server-group [server-group-id]`
2. `show running-config |section server-group`

DETAILED STEPS

Step 1 `show voice class server-group [server-group-id]`

The following example displays the configurations for all configured server groups or a specified server group.

Example:

```
Device# show voice class server-group 1

Voice class server-group: 1
AdminStatus: Up           OperStatus: Up
Hunt-Scheme: preference   Last returned server:
Description: It has 3 entries
Total server entries: 3

  Pref   Type   IP Address           IP Port
  ----   -
  1      ipv4   10.1.1.1             -----
  2      ipv4   10.1.1.2
  3      ipv4   10.1.1.3
-----

Total Huntstop tags: 2
Tag ID From Response code   To Response code
-----
  1      404           404
  2      410           599
-----
```

The following example displays the configurations for dial peers that are associated with server groups.

Example:

```
Device# show voice class server-group dialpeer 1

Voice class server-group: 1   AdminStatus: Up
Hunt-Scheme: preference
Total Remote Targets: 3

  Pref   Type   IP Address           IP Port
  ----   -
  1      ipv4   10.1.1.1             -----
  2      ipv4   10.1.1.2
  3      ipv4   10.1.1.3
```

Step 2 `show running-config |section server-group`

The following example displays the running configuration for server groups.

Example:

```
Device#show running-config | section server-group
voice class server-group 1
ipv4 10.1.1.1 preference 1
ipv4 10.1.1.2 preference 2
ipv4 10.1.1.3 preference 3
description It has 3 entries
huntstop 1 resp-code 404 to 404
huntstop 2 resp-code 410 to 599
voice class server-group 2
ipv4 10.1.1.1
ipv4 10.1.1.2
ipv4 10.1.1.3
description It has 3 entries
hunt-scheme round-robin
huntstop 1 resp-code 401 to 599
```

Configuration Examples for Server Groups in Outbound Dial Peers

Server Groups in Outbound Dial Peers (Preference-Based Selection)

```
! Configuring the Server Group
Device(config)# voice class server-group 1
Device(config-class)# ipv4 10.1.1.1 preference 1
Device(config-class)# ipv4 10.1.1.2 preference 2
Device(config-class)# ipv4 10.1.1.3 preference 3
Device(config-class)# description It has 3 entries
Device (config-class)# huntstop 1 resp-code 404
Device(config-class)# huntstop 2 resp-code 410 to 599
Device(config-class)# exit

! Configuring an outbound SIP dial peer.
Device(config)# dial-peer voice 1 voip
!Associate a destination pattern
Device(config-dial-peer)# destination-pattern 3001
Device(config-dial-peer)# session protocol sip2
!Associate a server group with the dial peer
Device(config-dial-peer)# session server-group 1
Device(config-dial-peer)# end

! Displays the configurations made for the outbound dial peer 181 associated with a server
group
Device# show voice class server-group dialpeer 1

Voice class server-group: 1      AdminStatus: Up
  Hunt-Scheme: preference
  Total Remote Targets: 3
```

```

Pref    Type    IP Address                                IP Port
----    -
1       ipv4     10.1.1.1                                -----
2       ipv4     10.1.1.2
3       ipv4     10.1.1.3

```

! Displays the configurations made for the server group.

Device# **show voice class server-group 1**

```

Voice class server-group: 1
AdminStatus: Up                OperStatus: Up
Hunt-Scheme: preference        Last returned server:
Description: It has 3 entries
Total server entries: 3

```

```

Pref    Type    IP Address                                IP Port
----    -
1       ipv4     10.1.1.1                                -----
2       ipv4     10.1.1.2
3       ipv4     10.1.1.3

```

```

-----
Total Huntstop tags: 2
Tag ID From Response code          To Response code
-----
1       404                               404
2       410                               599
-----

```

Server Groups in Outbound Dial Peers (Round-Robin-Based Selection)

```

! Configuring the Server Group
Device(config)# voice class server-group 2
Device(config-class)# ipv4 10.1.1.1
Device(config-class)# ipv4 10.1.1.2
Device(config-class)# ipv4 10.1.1.3
Device(config-class)# hunt-scheme round-robin
Device(config-class)# huntstop 1 resp-code 401 to 599
Device(config-class)# description It has 3 entries
Device(config-class)# exit

```

```

! Configuring an outbound SIP dial peer.
Device(config)# dial-peer voice 2 voip
! Associate a destination pattern
Device(config-dial-peer)# destination-pattern 3001
Device(config-dial-peer)# session protocol sipv2
! Associate a server group with the dial peer
Device(config-dial-peer)# session server-group 2
Device(config-dial-peer)# end

```

! Displays the configurations made for the outbound dial peer 181 associated with a server group

Device# **show voice class server-group dialpeer 2**

```

Voice class server-group: 2    AdminStatus: Up
Hunt-Scheme: round-robin
Total Remote Targets: 3

```

Pref	Type	IP Address	IP Port
----	----	-----	-----
0	ipv4	10.1.1.3	
0	ipv4	10.1.1.1	
0	ipv4	10.1.1.2	

! Displays the configurations made for the server group.

Device# **show voice class server-group 2**

```
Voice class server-group: 2
AdminStatus: Up           OperStatus: Up
Hunt-Scheme: round-robin  Last returned server: 10.1.1.2
Description: It has 3 entries
Total server entries: 3
```

Pref	Type	IP Address	IP Port
----	----	-----	-----
0	ipv4	10.1.1.1	
0	ipv4	10.1.1.2	
0	ipv4	10.1.1.3	

```
-----
Total Huntstop tags: 1
Tag ID From Response code    To Response code
-----
1      401                    599
-----
```



CHAPTER 25

Domain-Based Routing Support on the Cisco UBE

First Published: June 15, 2011

Last Updated: July 22, 2011

The Domain-based routing feature provides support for matching an outbound dial peer based on the domain name or IP address provided in the request URI of the incoming SIP message or an inbound dial peer.

Domain-based routing enables for calls to be routed on the outbound dialpeer based on the domain name or IP address provided in the request Uniform Resource Identifier (URI) of incoming Session IP message.

- [Feature Information for Domain-Based Routing Support on the Cisco UBE, on page 323](#)
- [Restrictions for Domain-Based Routing Support on the Cisco UBE, on page 324](#)
- [Information About Domain-Based Routing Support on the Cisco UBE, on page 324](#)
- [How to Configure Domain-Based Routing Support on the Cisco UBE, on page 325](#)
- [Configuration Examples for Domain-Based Routing Support on the Cisco UBE, on page 330](#)

Feature Information for Domain-Based Routing Support on the Cisco UBE

The following table provides release information about the feature or features described in this module. This table lists only the software release that introduced support for a given feature in a given software release train. Unless noted otherwise, subsequent releases of that software release train also support that feature.

Use Cisco Feature Navigator to find information about platform support and software image support. Cisco Feature Navigator enables you to determine which software images support a specific software release, feature set, or platform. To access Cisco Feature Navigator, go to <http://www.cisco.com/go/cfn>. An account on Cisco.com is not required.

Table 43: Feature Information for Domain-Based Routing Support on the Cisco UBE

Feature Name	Releases	Feature Information
Domain Based Routing Support on the Cisco UBE	15.2(1)T	The domain-based routing enables for calls to be routed on the outbound dial peer based on the domain name or IP address provided in the request URI (Uniform Resource Identifier) of incoming SIP message. The following commands were introduced or modified: call-route , voice-class sip call-route .
Domain Based Routing Support on the Cisco UBE	Cisco IOS XE Release 3.8S	The domain-based routing enables for calls to be routed on the outbound dial peer based on the domain name or IP address provided in the request URI (Uniform Resource Identifier) of incoming SIP message. The following commands were introduced or modified: call-route , voice-class sip call-route .

Any Internet Protocol (IP) addresses used in this document are not intended to be actual addresses. Any examples, command display output, and figures included in the document are shown for illustrative purposes only. Any use of actual IP addresses in illustrative content is unintentional and coincidental. © 2011 Cisco Systems, Inc. All rights reserved

Restrictions for Domain-Based Routing Support on the Cisco UBE

Domain-based routing support is available only for SIP-SIP call flows.

Information About Domain-Based Routing Support on the Cisco UBE

When a dial peer has an application configured as a session application, then only the user parameter of the request URI is used and is sent from the inbound SIP SPI to the application. The session application performs a match on an outbound dial peer based on the user parameter of the request URI sent from the inbound dial peer. In the figure below, 567 is the user portion of the request-URI that is passed from the inbound dial peer to the application and the matching outbound dial-peer found is 1000.

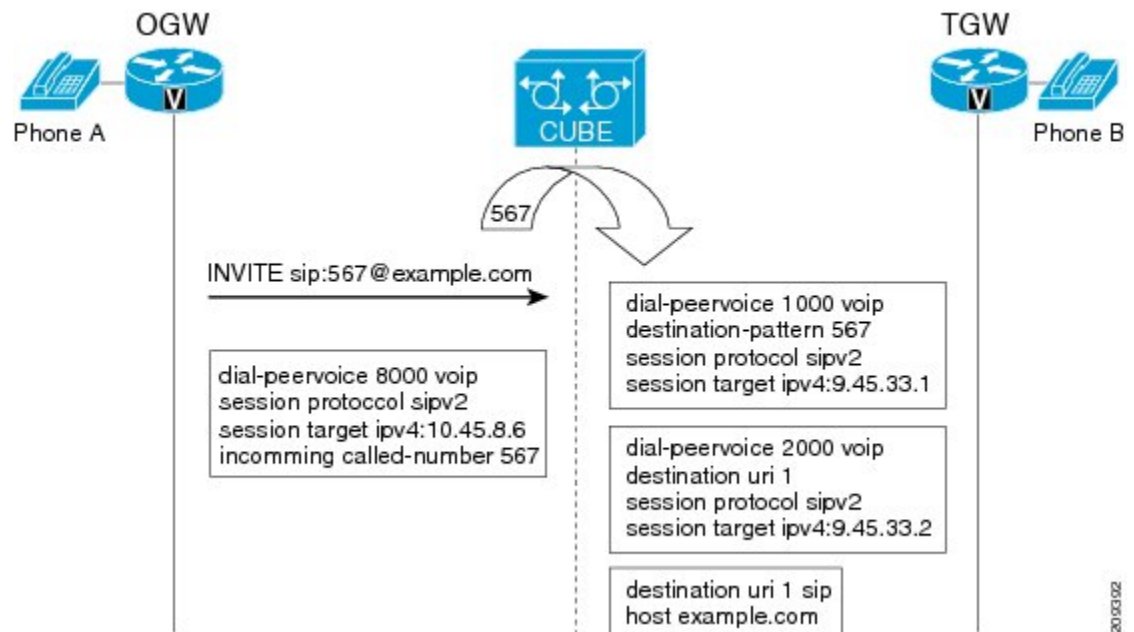

With the introduction of the domain-based routing feature, all parameters including the domain name of the request URI will be sent to the application and the outbound dial peer can be matched with any parameter. In Figure 1, when the domain name `example.com` is used to match an outbound dial peer the resulting dial peer is 2000. The `call route url` command is used for configuring domain-based routing.



Note Whenever using the `call route url` command, apply translation rule at outbound dial-peer not in to call-route url.

How to Configure Domain-Based Routing Support on the Cisco UBE

Configuring Domain-Based Routing at Global Level

SUMMARY STEPS

1. `enable`
2. `configure terminal`
3. `voice service voip`
4. `sip`
5. `call-route url`
6. `exit`

DETAILED STEPS

	Command or Action	Purpose
Step 1	enable Example: Device> enable	Enables privileged EXEC mode. <ul style="list-style-type: none"> • Enter your password if prompted.
Step 2	configure terminal Example: Device# configure terminal	Enters global configuration mode.
Step 3	voice service voip Example: Device(config)# voice service voip	Enters voice service configuration mode.
Step 4	sip Example: Device(conf-voi-serv)# sip	Enters voice service SIP configuration mode.
Step 5	call-route url Example: Device(conf-serv-sip)# call-route url Example:	Routes calls based on the URL.
Step 6	exit Example: Device(conf-serv-sip)# exit	Exits the current mode.

Configuring Domain-Based Routing at Dial Peer Level

SUMMARY STEPS

1. enable
2. configure terminal
3. dial-peer voice *dial-peer tag* voip
4. voice-class sip call-route url
5. exit

DETAILED STEPS

	Command or Action	Purpose
Step 1	enable Example: Device> enable	Enables privileged EXEC mode. <ul style="list-style-type: none"> • Enter your password if prompted.

```
s=SIP Call
c=IN IP6 2208:1:1:1:1:1:1:1:1116
t=0 0
m=image 17278 udptl t38
c=IN IP6 2208:1:1:1:1:1:1:1:1116
a=T38FaxVersion:0
a=T38MaxBitRate:14400
a=T38FaxFillBitRemoval:0
a=T38FaxTranscodingMMR:0
a=T38FaxTranscodingJBIG:0
a=T38FaxRateManagement:transferredTCF
a=T38FaxMaxBuffer:200
a=T38FaxMaxDatagram:320
a=T38FaxUdpEC:t38UDPRedundancy"
```

Step 3 debug voip dialpeer inout

The **debug ccsip all** and **debug voip dialpeer inout** commands can be entered in any order and any of the commands can be used for debugging depending on the requirement.

Example:

```
Displays information about the voice dial peers
Device# debug voip dialpeer inout
```

```
voip dialpeer inout debugging is on
```

The following event shows the calling and called numbers:

Example:

```
*May 1 19:32:11.731: //-1/6372E2598012/DPM/dpAssociateIncomingPeerCore:
  Calling Number=4085550111, Called Number=3600, Voice-Interface=0x0,
  Timeout=TRUE, Peer Encap Type=ENCAP_VOIP, Peer Search Type=PEER_TYPE_VOICE,
  Peer Info Type=DIALPEER_INFO_SPEECH
```

The following event shows the incoming dial peer:

Example:

```
*May 1 19:32:11.731: //-1/6372E2598012/DPM/dpAssociateIncomingPeerCore:
  Result=Success(0) after DP_MATCH_INCOMING_DNIS; Incoming Dial-peer=100
*May 1 19:32:11.731: //-1/6372E2598012/DPM/dpAssociateIncomingPeerCore:
  Calling Number=4085550111, Called Number=3600, Voice-Interface=0x0,
  Timeout=TRUE, Peer Encap Type=ENCAP_VOIP, Peer Search Type=PEER_TYPE_VOICE,
  Peer Info Type=DIALPEER_INFO_SPEECH
*May 1 19:32:11.731: //-1/6372E2598012/DPM/dpAssociateIncomingPeerCore:
  Result=Success(0) after DP_MATCH_INCOMING_DNIS; Incoming Dial-peer=100
*May 1 19:32:11.735: //-1/6372E2598012/DPM/dpMatchPeersCore:
  Calling Number=, Called Number=3600, Peer Info Type=DIALPEER_INFO_SPEECH
*May 1 19:32:11.735: //-1/6372E2598012/DPM/dpMatchPeersCore:
  Match Rule=DP_MATCH_DEST; Called Number=3600
*May 1 19:32:11.735: //-1/6372E2598012/DPM/dpMatchPeersCore:
  Result=Success(0) after DP_MATCH_DEST
*May 1 19:32:11.735: //-1/6372E2598012/DPM/dpMatchPeersMoreArg:
  Result=SUCCESS(0)
```

The following event shows the matched dial peers in the order of priority:

Example:

```
List of Matched Outgoing Dial-peer(s):
```

```
1: Dial-peer Tag=3600
2: Dial-peer Tag=36
```

Configuration Examples for Domain-Based Routing Support on the Cisco UBE

Example Configuring Domain-Based Routing Support on the Cisco UBE

The following example shows how to enable domain-based routing support on the Cisco UBE:

```
Device> enable
Device# configure terminal
Device(config)# voice service voip
Device(conf-voi-serv)# sip
Device(conf-serv-sip)# call-route url
Device(conf-serv-sip)# exit
Device(config)# dial-peer voice 2 voip
Device(config-dial-peer)# voice-class sip call-route url
Device(config-dial-peer)# exit
```



CHAPTER 26

ENUM Enhancement per Kaplan Draft RFC

The Cisco Unified Border Element (CUBE) facilitates the mapping of E.164 called numbers to Session Initiation Protocol (SIP) Uniform Resource Identifiers (URIs). The SIP ENUM technology allows the traditional telephony part of the network (using E.164 numbering to address destinations) to interwork with the SIP telephony part of the network, generally using SIP URIs. From the Public Switched Telephone Network (PSTN) network, if an end user dials an E.164 called party, the number can be translated by an ENUM gateway into the corresponding SIP URI. This SIP URI is then used to look up the Domain Name System (DNS) Naming Authority Pointer (NAPTR) Resource Records (RR). The NAPTR RR (as defined in RFC 2915) describes how the call should be forwarded or terminated and records information, such as email addresses, a fax number, a personal website, a VoIP number, mobile telephone numbers, voice mail systems, IP-telephony addresses, and web pages. Alternately, when the calling party is a VoIP endpoint and dials an E.164 number, then the originator's SIP user agent (UA) converts it into a SIP URI to be used to look up at the ENUM gateway DNS and fetch the NAPTR RR.

The ENUM enhancement per Kaplan draft RFC provides source-based routing, that is, SIP-to-SIP calls can be routed based on the source SIP requests. To provide source-based routing and to interact with the Policy Server, an EDNS0 OPT pseudo resource record with source URI, incoming SIP call ID, outbound SIP call ID, and Call Session Identification are added to the ENUM DNS query, according to **draft-kaplan-enum-sip-routing-04**. The incoming SIP call ID, outbound SIP call ID, and Call Session Identification are automatically included with an EDNS0 OPT pseudo resource record in the ENUM DNS query only if “source-uri no-cache” is enabled and XCC service is registered. This feature also provides the flexibility to disable route caching.

- [Feature Information for ENUM Enhancement per Kaplan Draft RFC, on page 331](#)
- [Restrictions for ENUM Enhancement per Kaplan Draft RFC, on page 332](#)
- [Information About ENUM Enhancement per Kaplan Draft RFC, on page 333](#)
- [How to Configure ENUM Enhancement per Kaplan Draft RFC, on page 333](#)
- [Troubleshooting Tips, on page 336](#)
- [Configuration Examples for ENUM Enhancement per Kaplan Draft RFC, on page 336](#)

Feature Information for ENUM Enhancement per Kaplan Draft RFC

The following table provides release information about the feature or features described in this module. This table lists only the software release that introduced support for a given feature in a given software release train. Unless noted otherwise, subsequent releases of that software release train also support that feature.

Use Cisco Feature Navigator to find information about platform support and Cisco software image support. To access Cisco Feature Navigator, go to <https://cfng.cisco.com/>. An account on Cisco.com is not required.

Table 44: Feature Information for ENUM Enhancement per Kaplan Draft RFC

Feature Name	Releases	Feature Information
ENUM Enhancement per Kaplan Draft RFC	Cisco IOS XE 3.14S Cisco IOS 15.5(1)T	The ENUM enhancement per Kaplan draft RFC provides source-based routing, that is, SIP-to-SIP calls can be routed based on the source SIP requests. To provide this source-based routing, an EDNS0 OPT pseudo resource record with source URI is added to the ENUM DNS query, according to draft-kaplan-enum-sip-routing-04 . This feature also provides the flexibility to disable route caching.
Support to include inbound call ID, outbound call ID and Call Session Identification to ENUM DNS query	Cisco IOS 15.5(2)T Cisco IOS XE 3.15S	This feature allows you to add incoming SIP call ID, outbound SIP call ID, and Call Session Identification to an EDNS0 OPT pseudo resource record in the ENUM DNS query.

Restrictions for ENUM Enhancement per Kaplan Draft RFC

- Supported only for SIP-to-SIP calls.
- The full command of **voice enum-match-table**, including the options, needs to be specified whenever being referenced by its subcommand. If not, the defaults, **no source-uri** and **no no-cached** (or **caching**) will take effect.
- As the maximum number of characters of the host shown in the **show host** command is 25, the source URI may not be displayed completely.
- The source URI is displayed in a separate line below, starting with “source-uri=”. Refer to the **show** command outputs in this chapter.
- If **no-cache** is configured in the **voice enum-match-table**, no cache table look-up would be made and hence an ENUM query would be made regardless of what is in the cache table.
- Both the target and source, where the source can be null/undefined or defined, need to be matched when looking up the cache table.
- The OPT RR will be added to the query for a SIP-to-SIP call only if the **source-uri** is configured for the outbound **enum-match-table**.
- The route will not be cached if the server does not support the OPT RR (it is recommended to remove the **source-uri** for this scenario if caching is preferred).
- The source URL can be prefixed with a host/target in the host name field in a double quote in the **show host host** command to display routes for the host specific with this source.
- A wild card, “*”, can be used to denote “all” hosts in the **show host** command. It can be by itself or any host matched with its prefix. The prefix can be a host name, partial or complete, or a domain name with partial or complete source URL.

Refer to the document titled *Unified Border Element ENUM Support Configuration Example* for a detailed message format.

Information About ENUM Enhancement per Kaplan Draft RFC

SIP-to-SIP calls can be routed based on the source SIP requests, using the ENUM enhancement feature. To provide source-based routing and to interact with Policy Server, an EDNS0 OPT pseudo resource record with source URI, incoming SIP call ID, outbound SIP call ID, and Call session Identification are added to the ENUM DNS query. The DNS server filters its response based on the source URI and call ID information and returns the appropriate NAPTR entries. To enable this feature, you must use the **source-uri** option in the **voice enum-match-table** *<table-number>* command. In addition, you can use the **no-cache** option to disable caching.

Refer to RFC 3761 and **draft-kaplan-enum-sip-routing-04** for more information about routing SIP requests with ENUM.

How to Configure ENUM Enhancement per Kaplan Draft RFC

Enabling Source-Based Routing

SUMMARY STEPS

1. **enable**
2. **configure terminal**
3. **voice enum-match-table** *match-table-index* [**source-uri**] [**no-cache**]
4. **end**

DETAILED STEPS

	Command or Action	Purpose
Step 1	enable Example: Device> enable	Enables privileged EXEC mode. • Enter your password if prompted.
Step 2	configure terminal Example: Device# configure terminal	Enters global configuration mode.
Step 3	voice enum-match-table <i>match-table-index</i> [source-uri] [no-cache] Example: Device(config)# voice enum-match-table 5 source-uri no-cache	Enables source URI filtering for the enum match table entry. You can use the no-cache option to disable the caching to the voice enum command.

	Command or Action	Purpose
Step 4	end Example: Device(config-enum)# end	Returns to privileged EXEC mode.

Testing the ENUM Request

To test the ENUM request, you can use the **source-url** option so that the source-based routing enum can be tested.

SUMMARY STEPS

1. **enable**
2. **test enum match-table-index input -pattern source-url source-url more parameter**
3. **end**

DETAILED STEPS

	Command or Action	Purpose
Step 1	enable Example: Device> enable	Enables privileged EXEC mode. <ul style="list-style-type: none"> • Enter your password if prompted.
Step 2	test enum match-table-index input -pattern source-url source-url more parameter Example: Device# test enum 1117777 source sip:1116666@10.1.50.16 more `ibcall-id=1-23735@10.1.50.16; obcall-id=7190DF-F1AA3CF1@10.1.110.222;sbc-id=1	Tests the source-based routing ENUM. <ul style="list-style-type: none"> • The source routing or no caching features depend on the voice enum-match-table command. If the source-uri command is not configured, the source-url source-url in the test command is ignored.
Step 3	end Example: Device# end	Returns to privileged EXEC mode.

Verifying the ENUM Request

The following **show** commands can be used to verify the operation of the test command. If the **no-cache** option is enabled, the **show host** command does not display the enum entry. Some sample outputs of the **show** command are shown below. The **show** commands can be entered in any order.

SUMMARY STEPS

1. **show host ***
2. **show host 1.0.9.3.e164-test***
3. **show host 1***

4. show host "1.0.9.3.e164-test sip*"

DETAILED STEPS

Step 1 show host *

Example:

```
Device# show host *
```

Host	Port	Flags	Age	Type	Address(es)
ns.e164-test	None	(temp, OK)	0	IP	127.0.0.1
1.0.9.3.e164-test sip:540 NA		(temp, OK)	0	NAPTR 0 0 U sip+E2U	/^.*\$/sip:3901@10.1.18.28/
Source-uri="sip:5403@1.4.65.5"					
1.1.9.3.e164-test sip:540 NA		(temp, OK)	0	NAPTR 0 0 U sip+E2U	/^.*\$/sip:3901@10.1.18.28/
Source-uri="sip:5403@1.4.65.5"					
1.0.9.3.e164-test sip:540 NA		(temp, OK)	0	NAPTR 0 0 U sip+E2U	/^.*\$/sip:3901@10.1.18.28/
Source-uri="sip:3401@1.4.65.5"					

Step 2 show host 1.0.9.3.e164-test*

Example:

```
Device# show host 1.0.9.3.e164-test*
```

Host	Port	Flags	Age	Type	Address(es)
1.0.9.3.e164-test sip:540 NA		(temp, OK)	0	NAPTR 0 0 U sip+E2U	/^.*\$/sip:3901@10.1.18.28/
Source-uri="sip:5403@1.4.65.5"					
1.0.9.3.e164-test sip:540 NA		(temp, OK)	0	NAPTR 0 0 U sip+E2U	/^.*\$/sip:3901@10.1.18.28/
Source-uri="sip:3401@1.4.65.5"					

Step 3 show host 1*

Example:

```
Device# show host 1*
```

Host	Port	Flags	Age	Type	Address(es)
1.0.9.3.e164-test sip:540 NA		(temp, OK)	0	NAPTR 0 0 U sip+E2U	/^.*\$/sip:3901@10.1.18.28/
Source-uri="sip:5403@1.4.65.5"					
1.1.9.3.e164-test sip:540 NA		(temp, OK)	0	NAPTR 0 0 U sip+E2U	/^.*\$/sip:3901@10.1.18.28/
Source-uri="sip:5403@1.4.65.5"					
1.0.9.3.e164-test sip:540 NA		(temp, OK)	0	NAPTR 0 0 U sip+E2U	/^.*\$/sip:3901@10.1.18.28/
Source-uri="sip:3401@1.4.65.5"					

Step 4 show host "1.0.9.3.e164-test sip*"

Example:

```
Device# show host "1.0.9.3.e164-test sip*"
```

Host	Port	Flags	Age	Type	Address(es)
ns.e164-test	None	(temp, OK)	0	IP	127.0.0.1
1.0.9.3.e164-test sip:540 NA		(temp, OK)	0	NAPTR 0 0 U sip+E2U	/^.*\$/sip:3901@10.1.18.28/
Source-uri="sip:5403@1.4.65.5"					
1.0.9.3.e164-test sip:540 NA		(temp, OK)	0	NAPTR 0 0 U sip+E2U	/^.*\$/sip:3901@10.1.18.28/
Source-uri="sip:3401@1.4.65.5"					

Troubleshooting Tips

Use the following commands for debugging information:

- **debug voip enum detail**
- **debug ip domain**
- **debug ccsip message**
- **debug voip ccapi inout**
- **clear voip fpi session correlator-id**—This command is used to clear the hung FPI sessions. After the hung session is identified using the existing **show** commands and its correlator is obtained, the **clear voip fpi session correlator-id** command can be used to clear the session.

Use the following **show** command that is helpful for debugging:

- **show host [all | * | host-name | partial -host -name*]**

Below is an extract of a sample ENUM DNS query containing the EDNS0 OPT pseudo resource record fields as per Kaplan Draft that is helpful in debugging. In the below query the values corresponding to ibcall-id, obcall-id, and sbc-id represent the incoming SIP call ID, outbound SIP call ID and Call Session Identification respectively.

```
7.7.7.7.1.1.1.e164.arpa sip:1116666@10.1.50.16enum_dns_query: name = 7.7.7.7.1.1.1.e164.arpa
sip:1116666@10.1.50.16 type = 35, ns_server = 0x0 no_cache 1 more_data
;ibcall-id=1-23735@10.1.50.16;
obcall-id=7190DF-39DD11E4-8008EDAD-F1AA3CF1@10.1.110.222;sbc-id=1
```

Configuration Examples for ENUM Enhancement per Kaplan Draft RFC

```
voice enum-match-table 1 source-uri //The source URI is sent to the DNS server to filter
the route.//
  description enable source-uri
  rule 2 1 /^\(.*\)$/ /\1/ e164.arpa

voice enum-match-table 2 source-uri no-cache
rule 1 1 /^\(.*\)$/ /\1/ e164-test

voice enum-match-table 3 no-cache //The cache table is not looked up and the route is not
cached.//
  rule 1 1 /^\(.*\)$/ /\1/ e164-test
```

The following is a sample configuration for the ENUM enhancement feature:

```
dial-peer voice 1 voip
  description ENUM Inbound dialpeer
  session protocol sipv2
  incoming called-number 1116666

dial-peer voice 2 voip
```

```
description ENUM Outbound dialpeer
destination-pattern 1117777
session protocol sipv2
session target enum:1 //Session target configured to look up ENUM table 1.//
```



PART **III**

Multi-Tenancy

- [Support for Multi-VRF, on page 341](#)
- [Configuring Multi-Tenants on SIP Trunks, on page 395](#)



CHAPTER 27

Support for Multi-VRF

The Virtual Routing and Forwarding (VRF) feature allows Cisco Unified Border Element (CUBE) to have multiple instances of routing and forwarding table to co-exist on the same device at the same time.

With Multi-VRF feature, each interface or subinterface can be associated with a unique VRF.



Note The information in this chapter is specific to Multi-VRF feature beginning in Cisco IOS Release 15.6(2)T. However, there is some information on Voice-VRF feature for the reference purpose only. For detailed information on the Voice-VRF feature, see http://www.cisco.com/c/en/us/td/docs/ios/12_4t/12_4t15/vrfawvgw.html.

- [Feature Information for VRF, on page 341](#)
- [Information About Voice-VRF, on page 343](#)
- [Information About Multi-VRF, on page 343](#)
- [VRF Preference Order , on page 344](#)
- [Restrictions, on page 344](#)
- [Recommendations, on page 345](#)
- [Configuring VRF, on page 346](#)
- [Configure VRF-Specific RTP Port Ranges, on page 351](#)
- [Directory Number \(DN\) Overlap across Multiple-VRFs , on page 354](#)
- [IP Overlap with VRF, on page 357](#)
- [Using Server Groups with VRF, on page 358](#)
- [Inbound Dial-Peer Matching Based on Multi-VRF, on page 359](#)
- [VRF Aware DNS for SIP Calls, on page 361](#)
- [High Availability with VRF, on page 362](#)
- [Configuration Examples, on page 362](#)
- [Troubleshooting Tips, on page 393](#)

Feature Information for VRF

The following table provides release information about the feature or features described in this module. This table lists only the software release that introduced support for a given feature in a given software release train. Unless noted otherwise, subsequent releases of that software release train also support that feature.

Use Cisco Feature Navigator to find information about platform support and Cisco software image support. To access Cisco Feature Navigator, go to <https://cfng.cisco.com/>. An account on Cisco.com is not required.

Table 45: Feature Information for VRF

Feature Name	Releases	Feature Information
Support for Voice-VRF (VRF-Aware)	Cisco IOS 12.4(11)XJ	This feature provides support to configure a VRF specific to voice traffic.
Support for Multi-VRF	Cisco IOS 15.6(2)T	This feature allows CUBE to have multiple instances of VRF to co-exist on the same device at the same time. The following commands are introduced: media-address voice-vrf name port-range min-max , show voice vrf
Enhancement to support up to 54 VRF instances	Cisco IOS 15.6(3)M Cisco IOS XE Denali 16.3.1	This feature enhancement provides support for up to 54 VRFs. Each of the VRFs supports up to 10 different RTP port ranges.
Support for Inbound Dial-peer Matching using VRF-ID	Cisco IOS 15.6(3)M Cisco IOS XE Denali 16.3.1	This feature supports inbound dial-peer matching using VRF ID.

Feature Name	Releases	Feature Information
Support for media flow-around using Multi-VRF	Cisco IOS XE Gibraltar 16.12.2	<p>This feature adds media flow-around support for the following intra-VRF call flows in standalone and high availability scenarios:</p> <ul style="list-style-type: none"> • Basic Audio Call • Call Hold and Resume • Re-INVITE based Call Transfer • 302 based Call Forward • Fax Pass Through Calls • T.38 Fax Calls <p>With media flow-around using Multi-VRF, only signalling is routed using VRFs and CUBE passes across the media IP and ports which it receives. For detailed information on media flow-around, see Media Path.</p>
Support up to 100 VRF instances	Cisco IOS XE Amsterdam 17.3.1a	This feature enhancement provides support up to 100 VRFs. Each of the VRFs supports up to 10 different RTP port ranges.

Information About Voice-VRF

Support for Voice-VRF (also known as VRF-Aware) was introduced in Cisco IOS Release 12.4(11)XJ to provide support for configuring a VRF specific to voice traffic. Voice-VRF can be configured using **voice vrf** *vrf-name* command. For more information on voice-VRF, see http://www.cisco.com/c/en/us/td/docs/ios/12_4/12_4t15/vrfawvgw.html.

Information About Multi-VRF

The Multi-VRF feature allows you to configure and maintain more than one instance of routing and forwarding tables within the same CUBE device and segregate voice traffic based on the VRF.

Multi-VRF uses input interfaces to distinguish calls for different VRFs and forms VRF tables by associating with one or more Layer 3 interfaces. Interface can be physical interface (such as FastEthernet ports, Gigabit Ethernet ports) or sub-interface. CUBE supports bridging calls on both intra-VRF and inter-VRF.



Note One physical interface or sub-interface can be associated with one VRF only. One VRF can be associated with multiple interfaces.

As per the Multi-VRF feature, the dial-peer configuration must include the use of the interface bind functionality. This is mandatory. It allows dial-peers to be mapped to a VRF via the interface bind.

The calls received on a dial-peer are processed based on the interface to which it is associated with. The interface is in turn associated with the VRF. So, the calls are processed based on the VRF table associated with that particular interface.

VRF Preference Order

Voice-VRF and Multi-VRF configurations can coexist. The following is the binding preference order for call processing:

Table 46: VRF Preference Order and Recommendations

Preference Order	Bind	Recommendations
1	Dial-peer Bind	—
2	Tenant Bind	Recommended for SIP trunk, especially when CUBE is collocated with Cisco Unified Survivability Remote Site Telephony. If Tenant bind is not configured, Voice-VRF is preferred for SIP trunk.
3	Global Bind	During device reboot, it is recommended to use global bind configuration to handle the early incoming traffic gracefully.
4	Voice-VRF	Recommended for hosted and cloud services configurations when CUBE is collocated with Cisco Unified Survivability Remote Site Telephony.

Restrictions

- Supports only SIP-SIP calls.
- Cisco Unified Communications Manager Express (Unified CME) and CUBE co-located with VRF is not supported.
- Cisco Unified Survivability Remote Site Telephony (Unified SRST) and CUBE co-location is not supported on releases before Cisco IOS XE Fuji 16.7.1.
- IPv6 on VRF is not supported.

- SDP pass-through is not supported on releases before Cisco IOS Release 15.6(3)M and Cisco IOS XE Denali 16.3.1.
- Calls are not supported when incoming dial-peer matched is default dial-peer (dial-peer 0).
- Media Anti-trombone is not supported with VRF.
- Cisco UC Services API with VRF is not supported.
- Multi-VRF is not supported on TDM-SIP gateway.
- VRF aware matching is applicable only for inbound dial-peer matching and not for outbound dial-peer matching.
- Invoking TCL scripts through a dial-peer is not supported with the Multi-VRF.
- Multi-VRF using global routing table or default routing table (VRF 0) with virtual interfaces is not supported on ISR-G2 (2900 and 3900 series) routers.
- SCCP-based media resources are not supported with VRF.
- Multi-VRF configured in media flow-around mode is supported only for intra-VRF calls. The following are not supported with Multi-VRF configured in media flow-around mode:
 - Supplementary services with REFER Consume, Mid-call (or Early Dialogue) block
 - Session Description Protocol (SDP) Passthrough
 - Media Recording
 - DSP flows (DTMF, transcode)

Recommendations

- For new deployments, we recommend a reboot of the router once all VRFs' are configured under interfaces.
- No VRF Route leaks are required on CUBE to bridge VoIP calls across different VRFs.
- High Availability(HA) with VRF is supported where VRF IDs are check-pointed in the event of fail-over. Ensure that same VRF configuration exists in both the HA boxes.
- Whenever destination server group is used with VRF, ensure that the server group should have the session targets, belonging to the same network as that of sip bind on the dial-peer, where the server-group is configured. This is because, dial-peer bind is mandatory with VRF and only one sip bind can be configured on any given dial-peer.
- If there are no VRF configuration changes at interface level, then reload of the router is not required.

Configuring VRF



Note We recommend you NOT to modify VRF settings on the interfaces in a live network as it requires CUBE reload to resume VRF functionality.

This section provides the generic configuration steps for creating a VRF. For detailed configuration steps specific to your network scenario (Multi-VRF and Multi-VRF with HA), refer to Configuration Examples section.



Note You can also use the latest configuration option, which allows creation of multiprotocol VRFs that support both IPv4 and IPv6. Entering the command **vrf definition** *vrf-name* creates the multiprotocol VRF. Under VRF definition submode, you can use the command **address-family** {*ipv4* / *ipv6*} to specify appropriate address family. To associate the VRF with an interface, use the command **vrf forwarding** *vrf-name* under the interface configuration submode.

For more information about the **vrf definition** and **vrf forwarding** commands, refer to the [Cisco IOS Easy Virtual Network Command Reference Guide](#).

Create a VRF

SUMMARY STEPS

1. **enable**
2. **configure terminal**
3. **ip vrf** *vrf-name*
4. **rd** *route-distinguisher*
5. **exit**

DETAILED STEPS

	Command or Action	Purpose
Step 1	enable Example: Device> enable	Enables privileged EXEC mode <ul style="list-style-type: none"> • Enter your password if prompted.
Step 2	configure terminal Example: Device# configure terminal	Enters global configuration mode.
Step 3	ip vrf <i>vrf-name</i> Example: Device(config)# ip vrf <i>VRF1</i>	Creates a VRF with the specified name. In the example, VRF name is VRF1. Note Space is not allowed in VRF name.

	Command or Action	Purpose
Step 4	rd <i>route-distinguisher</i> Example: Device(config)# rd 1:1	Creates a VRF table by specifying a route distinguisher. Enter either an AS number and an arbitrary number (xxx:y) or an IP address and arbitrary number (A.B.C.D:y)
Step 5	exit Example: Device(config)# exit	Exits present mode.

Assign Interface to VRF



Note If an IP address is already assigned to an interface, then associating a VRF with interface will disable the interface and remove the existing IP address. An error message (sample error message shown below) is displayed on the console. Assign the IP address to proceed further.

```
% Interface GigabitEthernet0/1 IPv4 disabled and address(es) removed due to enabling VRF VRF1
```

SUMMARY STEPS

1. **enable**
2. **configure terminal**
3. **interface***interface-name*
4. **ip vrf forwarding** *vrf-name*
5. **ip address** *ip address subnet mask*
6. **exit**

DETAILED STEPS

	Command or Action	Purpose
Step 1	enable Example: Device> enable	Enables privileged EXEC mode <ul style="list-style-type: none"> • Enter your password if prompted.
Step 2	configure terminal Example: Device# configure terminal	Enters global configuration mode.
Step 3	interface <i>interface-name</i> Example: Device(config)# interface <i>GigabitEthernet 0/1</i>	Enters the interface configuration mode.

	Command or Action	Purpose
Step 4	ip vrf forwarding <i>vrf-name</i> Example: Device(config-if)# ip vrf forwarding <i>VRP1</i>	Associates VRF with the interface. Note If there is an IP address associated with the interface, it will be cleared and you will be prompted to assign the IP address again.
Step 5	ip address <i>ip address subnet mask</i> Example: Device(config-if)# ip address <i>10.0.0.1 255.255.255.0</i>	IP address is assigned to the interface.
Step 6	exit Example: Device(config-if)# exit	Exits present mode.

Create Dial-peers

SUMMARY STEPS

1. **enable**
2. **configure terminal**
3. **dial-peer voice** *number voip*
4. **session protocol** *protocol*
5. Create dial-peer:
 - To create inbound dial-peer:
incoming called number *number*
 - To create outbound dial-peer:
destination pattern *number*
6. **codec** *codec-name*
7. **exit**

DETAILED STEPS

	Command or Action	Purpose
Step 1	enable Example: Device> enable	Enables privileged EXEC mode <ul style="list-style-type: none"> • Enter your password if prompted.
Step 2	configure terminal Example: Device# configure terminal	Enters global configuration mode.

	Command or Action	Purpose
Step 3	dial-peer voice <i>number</i> voip Example: Device(config)# dial-peer voice 1111 voip	Creates the dial-peer with the specified number.
Step 4	session protocol <i>protocol</i> Example: Device(config-dial-peer)# session protocol sipv2	Specifies the protocol associated with the dial-peer.
Step 5	Create dial-peer: <ul style="list-style-type: none"> To create inbound dial-peer: incoming called number <i>number</i> To create outbound dial-peer: destination pattern <i>number</i> Example: Inbound dial-peer: Device(config-dial-peer)# incoming called-number 1111 Outbound dial-peer: Device(config-dial-peer)# destination pattern 3333	Creates inbound and outbound dial-peer.
Step 6	codec <i>codec-name</i> Example: Device(config-dial-peer)# codec g711ulaw	Specifies the codec associated with this dial-peer.
Step 7	exit Example: Device(config-dial-peer)# exit	Exits present mode.

Bind Dial-peers

You can configure SIP binding at global level as well as at dial-peer level.

- Control and Media on a dial-peer have to bind with same VRF. Else, while configuring, the CLI parser will display an error

- Whenever global sip bind interface associated with a VRF is added, modified, or removed, you should restart the sip services under 'voice service voip > sip' mode so that the change in global sip bind comes into effect with associated VRF ID.

```
CUBE(config)# voice service voip
CUBE(conf-voi-serv)# sip
CUBE(conf-serv-sip)# call service stop
CUBE(conf-serv-sip)# no call service stop
CUBE(conf-serv-sip)# end
```

SUMMARY STEPS

1. enable
2. configure terminal
3. Bind control and media to the interface
 - At dial-peer level:

```
dial-peer voice number voip
voice-class sip bind control source-interface interface-name
voice-class sip bind media source-interface interface-name
```
 - At global configuration level

```
voice service voip
sip
bind control source-interface interface-name
bind media source-interface interface-name
```
4. exit

DETAILED STEPS

	Command or Action	Purpose
Step 1	enable Example: Device> enable	Enables privileged EXEC mode <ul style="list-style-type: none"> • Enter your password if prompted.
Step 2	configure terminal Example: Device# configure terminal	Enters global configuration mode.
Step 3	Bind control and media to the interface <ul style="list-style-type: none"> • At dial-peer level: <pre>dial-peer voice <i>number</i> voip voice-class sip bind control source-interface <i>interface-name</i></pre> 	Interface bind associates VRF to the specified dial-peer.

	Command or Action	Purpose
	<p>voice-class sip bind media source-interface <i>interface-name</i></p> <ul style="list-style-type: none"> At global configuration level <p>voice service voip</p> <p>sip</p> <p>bind control source-interface <i>interface-name</i></p> <p>bind media source-interface <i>interface-name</i></p> <p>Example: At dial-peer level:</p> <pre>Device(config)#dial-peer voice 1111 voip Device(config-dial-peer)# voice-class sip bind control source-interface GigabitEthernet0/1 Device(config-dial-peer)# voice-class sip bind media source-interface GigabitEthernet0/1</pre> <p>Example: At global configuration level:</p> <pre>Device(config)# voice service voip Device(conf-voi-serv)# sip Device(conf-voi-sip)# bind control source-interface GigabitEthernet0/1 Device(conf-voi-sip)# bind media source-interface GigabitEthernet0/1</pre>	
Step 4	<p>exit</p> <p>Example: Device(config-dial-peer)# exit</p>	Exits present mode.

Configure VRF-Specific RTP Port Ranges

You can configure each VRF to have its own set of RTP port range for VoIP RTP connections under **voice service voip**. A maximum of ten VRF port ranges are supported. Different VRFs can have overlapping RTP port range. VRF-based RTP port range limits (min, max port numbers) are same as global RTP port range. All three port ranges (global, media-address, VRF based) can coexist on CUBE and the preference order of RTP port allocation is as follows:

- VRF-based port range
- Media-address based port range
- Global RTP port range

SUMMARY STEPS

1. enable
2. configure terminal
3. voice service voip
4. media-address voice-vrf *vrf-name* port-range *min max*
5. exit

DETAILED STEPS

	Command or Action	Purpose
Step 1	enable Example: Device> enable	Enables privileged EXEC mode <ul style="list-style-type: none"> • Enter your password if prompted.
Step 2	configure terminal Example: Device# configure terminal	Enters global configuration mode.
Step 3	voice service voip Example: Device(config)# voice service voip	Enters voice service voip mode.
Step 4	media-address voice-vrf <i>vrf-name</i> port-range <i>min max</i> Example: conf-voi-serv)# media-address voice-vrf VRF1-Dec-15 cfg-media-addr-vrf)# port-range 9112 9118 The second line in this example is punt range. Punt range configuration helps to stop relaying media packets to control plane on the specified ports. If you need both punt range and port range, configure the port range inline with VRF and also in the second line. Example: Example 1 Device(conf-voi-serv)# media-address voice-vrf VRF1 port 16000 32000 The output: Device# show run section voice voice-card 0/3 dsp services dspfarm voice service voip no ip address trusted authenticate media-address voice-vrf VRF1 port 16000 32000 <i>*Here, the port-range is configured on the same line as the media address.</i>	Associates the RTP Port range with the VRF. If the RTP port range is not configured per each VRF, the default RTP port range is used across the VRFs used. You can configure up to ten port ranges per media address. The default port range is 8000-48198 for ASR and ISR G3 platforms, and 16384-32766 for Cisco ISR G2 platforms. Note <ul style="list-style-type: none"> • The port range must be configured on the same line as the media address. The port ranges configured using a second line on outgoing dial peer are not supported. • From Cisco IOS XE Amsterdam 17.3.1a onwards, you can configure 100 VRFs for up to 10 different RTP port ranges (that is, 10 different port ranges per each VRF).

	Command or Action	Purpose
	<p>Example:</p> <p>Example 2</p> <p>CUBE supports up to 100 VRFs. Hence, you can configure up to 100 media address instances, that is, one instance per voice-vrf. This configuration is subject to the maximum number of VRFs supported by the host platform.</p> <pre>Device(conf-voi-serv)# media-address voice-vrf VRF1 port-range 8000 48000 media-address voice-vrf VRF2 port-range 8000 48000 media-address voice-vrf VRF99 port-range 8000 48000 media-address voice-vrf VRF100 port-range 8000 48000</pre>	
Step 5	<p>exit</p> <p>Example:</p> <pre>Device(conf-voi-serv)# exit</pre>	Exits present mode.

Example: VRF with overlapping and non-overlapping RTP Port Range

Example 1 - Non-overlapping Port Range

The following is example shows two VRFs with non-overlapping RTP port range:

```
Device(conf)# voice service voip
Device(conf-voi-serv)# no ip address trusted authenticate
Device(conf-voi-serv)# media bulk-stats
Device(conf-voi-serv)# media-address voice-vrf vrf1 port-range 25000 28000
Device(conf-voi-serv)# media-address voice-vrf vrf2 port-range 29000 32000
Device(conf-voi-serv)# allow-connections sip to sip
Device(conf-voi-serv)# redundancy-group 1
Device(conf-voi-serv)# sip
```

The output for command **show voip rtp connections** shows as follows:

```
Device# show voip rtp connections

VoIP RTP Port Usage Information:
Max Ports Available: 23001, Ports Reserved: 101, Ports in Use: 2

Ports
Media-Address Range          Port Port Available Reserved In-use
-----
Global Media Pool            8000 48198 19999      101      0
VRF ID Based Media Pool
-----
vrf1                         25000 28000 1501           0         1
vrf2                         29000 32000 1501           0         1
-----

VoIP RTP active connections :
No. CallId  dstCallId  LocalRTP  RmtRTP  LocalIP          RemoteIP      MPSS  VRF
1    1001      1002      25000   16400   10.0.0.1        10.0.0.2     NO    vrf1
```

```

2      1002      1001      29000      16392      11.0.0.1      11.0.0.2      NO      vrf2

Found 2 active RTP connections

```

In the above output, you can observe that for both the VRF's having non-overlapping rtp port ranges, the local RTP port allocated for vrf1 and vrf2 are different.

Example 2 - Overlapping Port Range

The following is example shows two VRFs with overlapping RTP port range:

```

Device(conf)# voice service voip
Device(conf-voi-serv)# no ip address trusted authenticate
Device(conf-voi-serv)# media bulk-stats
Device(conf-voi-serv)# media-address voice-vrf vrf1 port-range 25000 28000
Device(conf-voi-serv)# media-address voice-vrf vrf2 port-range 25000 28000
Device(conf-voi-serv)# allow-connections sip to sip
Device(conf-voi-serv)# redundancy-group 1
Device(conf-voi-serv)# sip

```

The output for command **show voip rtp connections** shows as follows:

```

Device# show voip rtp connections

VoIP RTP Port Usage Information:
Max Ports Available: 23001, Ports Reserved: 101, Ports in Use: 2

Ports
Media-Address Range          Port  Port  Available Reserved  In-use
-----
Global Media Pool            8000  48198 19999      101      0
VRF ID Based Media Pool
-----
vrf1                         25000 28000 1501       0        1
vrf2                         25000 28000 1501       0        1
-----

VoIP RTP active connections :
No. CallId  dstCallId  LocalRTP  RmtRTP    LocalIP    RemoteIP    MPSS    VRF
-----
1      1001      1002      25000     16400     10.0.0.1    10.0.0.2    NO     vrf1
2      1002      1001      25000     16392     11.0.0.1    11.0.0.2    NO     vrf2

Found 2 active RTP connections

```

In the above output, you can observe that for both the VRF's having overlapping rtp port ranges, the local RTP port allocated for vrf1 and vrf2 is same.

Directory Number (DN) Overlap across Multiple-VRFs

CUBE has the capability to bridge calls across VRFs without the need for route leaks to be configured.

If multiple dial-peers on two different VRFs have the same destination-pattern and preference, CUBE will randomly choose a dial-peer and route the call using the session target of the selected dial-peer. Due to this, the call intended for one VRF may be routed to another VRF.

Dial-peer group feature allows you to route calls within the same VRF and not across VRFs. Configuring dial-peer group, routes the call to a specific VRF even if multiple dial-peers on two different VRFs have the same destination-pattern and preference.

To use dial-peer group feature, configure dial-peers such that there is a unique inbound dial-peer match for calls related to each VRF. Configuring dial-peer group, limits the outbound dial-peer search within the VRF.

Example: Associating Dial-peer Groups to Overcome DN Overlap

If a call is received on VRF1 and there are two dial-peers with same destination-pattern (one dial-peer bind to VRF1 and second dial-peer bind to VRF2), then by default, CUBE picks the VRF in random to route the call.

If you intended to route this call only to VRF1 dial-peer, then dial-peer group can be applied on inbound dial-peer which will restrict the CUBE to route the call only across the dial-peers within the dial-peer group and not pick a dial-peer bind to a different VRF.

Figure 31: Associating Dial-peer Group to overcome DN overlap

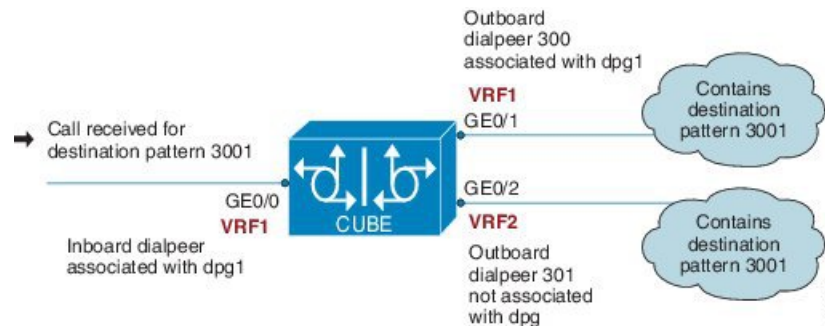

The following scenario is considered in the below example:

- VRF1 associated with Gigabitethernt Interface 0/0 and 0/1
- VRF 2 associated with Gigabitethernet Inetrface 0/2
- Dial-peer Group: dpg1
- VRF1 is associated with dial-peer group - dpg 1
- Outbound dial-peer 300 is selected as preference 1
- Inbound dial-peer 3000 associated with VRF 1 and dial-peer group 1 (dpg1)
- Outbound Dial-peer: 300 – destination pattern “3001” associated with VRF1
- Outbound dial-peer: 301 – destination pattern “3001” associated with VRF2

Configure a dial-peer group and set the outbound dial-peer preference.

```
Device# enable
Device# configure terminal
Device(config)# voice class dpg 1
Device(voice-class)# dial-peer 300 preference 1
```

Create inbound dial-peer and associated with dial-peer group 1 (dpg1)

```

Device(config)# dial-peer voice 3000 voip
Device(config-dial-peer)# video codec h264
Device(config-dial-peer)# session protocol sipv2
Device(config-dial-peer)# session transport udp

Device(config-dial-peer)# destination dpg 1
Device(config-dial-peer)# incoming called-number 3001
Device(config-dial-peer)# voice-class sip bind control source-interface GigabitEthernet0/1

Device(config-dial-peer)# voice-class sip bind media source-interface GigabitEthernet0/1
Device(config-dial-peer)# dtmf-relay sip-kpml
Device(config-dial-peer)# srtp fallback
Device(config-dial-peer)# codec g711ulaw

```

Creating outbound dial-peer with destination pattern '3001' associated with VRF1.

```

Device(config)# dial-peer voice 300 voip
Device(config-dial-peer)# destination-pattern 3001
Device(config-dial-peer)# video codec h264
Device(config-dial-peer)# session protocol sipv2
Device(config-dial-peer)# session target ipv4:10.0.0.1
Device(config-dial-peer)# voice-class sip bind control source-interface GigabitEthernet0/1
Device(config-dial-peer)# voice-class sip bind media source-interface GigabitEthernet0/1
Device(config-dial-peer)# dtmf-relay sip-kpml
Device(config-dial-peer)# codec g711ulaw

```

Creating outbound dial-peer with destination pattern '3001' associated with VRF2.

```

Device(config)# dial-peer voice 301 voip
Device(config-dial-peer)# destination-pattern 3001
Device(config-dial-peer)# video codec h264
Device(config-dial-peer)# session protocol sipv2
Device(config-dial-peer)# session target ipv4:11.0.0.1
Device(config-dial-peer)# voice-class sip bind control source-interface GigabitEthernet0/2
Device(config-dial-peer)# voice-class sip bind media source-interface GigabitEthernet0/2
Device(config-dial-peer)# dtmf-relay sip-kpml
Device(config-dial-peer)# codec g711ulaw

```

With above dial-peer group configuration, whenever dial-peer "3000" is matched as inbound dial-peer, CUBE will always route call using dial-peer "300" (VRF1). Without dial-peer group, CUBE would have picked dial-peers "300"(VRF1) and "301"(VRF2) in random to route the call.

```
Device# show vrf brief
```

Name	Default RD	Protocols	Interfaces
VRF1	1:1	ipv4	Gi0/0 Gi0/1
VRF2	2:2	ipv4	Gi0/2

```
Device# show dial-peer voice summary
```

```
dial-peer hunt 0
```

TAG	TYPE	MIN	AD	OPER	PREFIX	DEST-PATTERN	PRE	PASS	SESS-TARGET	OUT	
KEEPALIVE	VRF						FER	THRU		STAT	PORT
3000	voip	up	up				0	sys			
	VRF1										
300	voip	up	up		3001		0	sys	ipv4: 10.0.0.1		
	VRF1										
301	voip	up			3001		0	sys	ipv4: 11.0.0.1		
	VRF2										

IP Overlap with VRF

Generally, on a router, two interfaces cannot be configured with the same IP address. With the VRF feature, you can configure two or more interfaces with the same IP address because, each interface having the same IP address belongs to a unique VRF and hence belongs to a different routing domain. However, for successful call processing, you must ensure that appropriate call routing protocols are configured on the VRFs.

The following is a sample configuration:

Configure Gigabit Ethernet 0/0 that belongs to VRF1 with IP address 10.0.0.0.

```
Device# enable
Device# configure terminal
Device(config)# ip vrf VRF1
Device(config)# rd 1:1
Device(config)# exit
```

```
Device> enable
Device# configure terminal
Device(config)# interface GigabitEthernet0/0
Device(config-if)# ip vrf forwarding VRF1
Device(config-if)# ip address 10.0.0.0 255.255.255.0
Device(config-if)# speed auto
Device(config-if)# exit
```

Configure Gigabit Ethernet 0/1 that belongs to VRF2 with IP address 10.0.0.0.

```
Device# enable
Device# configure terminal
Device(config)# ip vrf VRF2
Device(config)# rd 1:1
Device(config)# exit
```

```
Device> enable
Device# configure terminal
Device(config)# interface GigabitEthernet0/1
Device(config-if)# ip vrf forwarding VRF2
Device(config-if)# ip address 10.0.0.0 255.255.255.0
Device(config-if)# speed auto
Device(config-if)# exit
```

For call routing on VRF1 and VRF2, ensure that appropriate routing entries are configured for both VRF1 and VRF2.



Note The above configurations are specific to VRF support only. For call routing, appropriate routing protocols must be configured in the network.

Even though Gigabit Ethernet 0/0 and Gigabit Ethernet 0/1 have an overlapping IP address, the call processing is not overlapped as they belong to different VRFs.

show ip interface brief command shows that GigabitEthernet 0/0 and GigabitEthernet 0/1 have an overlapping IP address:

```

Device# show ip interface brief
Interface                IP-Address      OK? Method Status      Protocol
Embedded-Service-Engine0/0 unassigned      YES NVRAM  administratively down down
GigabitEthernet0/0       10.0.0.0        YES NVRAM  up          up
GigabitEthernet0/1       10.0.0.0        YES NVRAM  up          up
GigabitEthernet0/1.1     unassigned      YES NVRAM  up          up
GigabitEthernet0/2       unassigned      YES NVRAM  up          up

```

show voip rtp connections command shows a video call that is established on CUBE across different interfaces belonging to different VRFs having Overlap IP address:

```

Device# show voip rtp connections
VoIP RTP Port Usage Information:
Max Ports Available: 11700, Ports Reserved: 303, Ports in Use: 4

Media-Address Range      Min   Max   Ports   Ports   Ports
                          Port  Port Available Reserved In-use
-----
Global Media Pool        20000 22000 900      101     0

VRF ID Based Media Pool
-----
POD2                      30002 32000 1000     0       0
POD1                      20000 30000 4900     101     2
POD3                      20000 30000 4900     101     2
-----

VoIP RTP active connections :
No. CallId  dstCallId  LocalRTP  RmtRTP   LocalIP   RemoteIP  MPSS  VRF
1          37         39        20000    18164    10.0.0.0  11.0.0.3 NO   VRF1
2          38         40        20002    18166    10.0.0.0  11.0.0.3 NO   VRF1
3          39         37        20002    16388    10.0.0.0  11.0.0.3 NO   VRF2
4          40         38        20000    16390    10.0.0.0  11.0.0.3 NO   VRF2
Found 4 active RTP connections

```

Using Server Groups with VRF

Whenever destination server group is used with VRF, ensure that the server group should have the session targets, belonging to the same network as that of sip bind on the dial-peer, where the server-group is configured. This is because the dial-peer bind is mandatory with VRF and only one sip bind can be configured on any given dial-peer.

The following scenario is considered in the below example:

Interfaces and associated IP address

- GigabitEthernet0/0/2 12.0.0.1
- GigabitEthernet0/0/1 11.0.0.1

```

Device# show ip interface brief
Interface                IP-Address      OK? Method Status      Protocol
GigabitEthernet0/0/0     10.0.0.1        YES NVRAM  up          up
GigabitEthernet0/0/1     11.0.0.1        YES NVRAM  up          up
GigabitEthernet0/0/2     12.0.0.1        YES NVRAM  up          up

```

- dial-peer 200 is bind to GigabitEthernet0/0/1
- server-group 1 (belonging to VRF1) is applied to dial-peer 200

```

Device(config)# dial-peer voice 200 voip
Device(config-dialpeer)# destination-pattern 4.....
Device(config-dialpeer)# session protocol sipv2
Device(config-dialpeer)# session transport udp
Device(config-dialpeer)# session server-group 1
Device(config-dialpeer)# voice-class sip bind control source-interface GigabitEthernet0/0/1
Device(config-dialpeer)# voice-class sip bind media source-interface GigabitEthernet0/0/1
Device(config-dialpeer)# codec g711ulaw

```

As dial-peer 200 is bind to GigabitEthernet0/0/1 , the session targets configured in the “server-group 1” should belong to the network which is reachable by the bind source interface GigabitEthernet0/0/1 as shown below:

```

Device(config)# voice class server-group 1
Device(config-class)# ipv4 11.0.0.22
Device(config-class)# ipv4 11.0.0.8 preference 2

```

Inbound Dial-Peer Matching Based on Multi-VRF

From Cisco IOS Release 15.6(3)M and Cisco IOS XE Denali 16.3.1 onwards, dial-peer matching is done based on the VRF ID associated with a particular interface.

Example: Inbound Dial-Peer Matching based on Multi-VRF

Prior to Cisco IOS 15.6(3)M and Cisco IOS XE Denali 16.3.1 releases, when an incoming out-of-dialog message such as INVITE, REGISTER, OPTIONS, NOTIFY, and so on are received on a particular VRF bound interface, inbound dial-peer matching was done using the complete set of inbound dial-peers regardless of the VRF association. The response would be sent based on this matched dial-peer. Since the inbound dial-peer selected could have a different VRF bound to it, the response was sent to the wrong VRF.

To overcome this issue, the inbound dial-peers are filtered based on the incoming VRF and then followed by the regular inbound dial-peer matching. Now, the response is sent to the same VRF on which the request was received.

Consider the following configuration example output to understand the inbound dial-peer matching criteria used in multi-VRF:

```

interface GigabitEthernet0/0
ip address 8.39.18.37 255.255.0.0
duplex auto
ip vrf forwarding VRF ID1
speed auto

interface GigabitEthernet0/1
ip address 9.39.18.55 255.255.0.0
duplex auto
ip vrf forwarding VRF ID2
speed auto

interface GigabitEthernet0/2
ip address 10.39.18.68 255.255.0.0
duplex auto
ip vrf forwarding VRF ID3
speed auto

```

```
dial-peer voice 1000 voip
description "Inbound dial-peer bound to VRF ID2"
session protocol sipv2
session target sip-server
session transport udp
incoming called-number 5678
voice-class sip bind control source-interface GigabitEthernet0/1
voice-class sip bind media source-interface GigabitEthernet0/1
codec g711ulaw
```

```
dial-peer voice 2000 voip
description "Inbound dial-peer bound to VRF ID1"
session protocol sipv2
session target sip-server
session transport udp
incoming called-number 5678
voice-class sip bind control source-interface GigabitEthernet0/0
voice-class sip bind media source-interface GigabitEthernet0/0
codec g711ulaw
```

```
dial-peer voice 3000 voip
description "Inbound dial-peer bound to VRF ID3"
session protocol sipv2
session target sip-server
session transport udp
incoming called-number 8000
voice-class sip bind control source-interface GigabitEthernet0/2
voice-class sip bind media source-interface GigabitEthernet0/2
codec g711ulaw
```

```
dial-peer voice 4000 voip
description "Inbound dial-peer bound to VRF ID1"
session protocol sipv2
session target sip-server
session transport udp
incoming called-number 2000
voice-class sip bind control source-interface GigabitEthernet0/0
voice-class sip bind media source-interface GigabitEthernet0/0
codec g711ulaw
```

Prior to Cisco IOS 15.6(3)M and Cisco IOS XE Denali 16.3.1 releases, when an incoming call is received for the dialed number 5678 on GigabitEthernet0/0 (VRF ID1), inbound dial-peer matching was done based on the called-number 5678. In this case, dial-peer 1000 which is bound to GigabitEthernet0/1 (VRF ID2) was considered to be the first matched dial-peer for this call. And, the response was sent incorrectly to VRF ID2 instead of VRF ID1.

With the introduction of VRF aware inbound dial-peer matching, the initial filtering is done based on the VRF ID and then based on the called-number. For the above example, a call with called-number of 5678 that is received on GigabitEthernet 0/0 with VRF ID 1 configured, the dial-peers will first be filtered to those that are bound to GigabitEthernet 0/0 before selection of the inbound dial-peer is performed. Now, the response is sent successfully on VRF ID1.



Note Whenever the VRF ID is added, modified, or removed under the interface, it is mandatory to execute the following command before making any calls: **clear interface** <interface>. If the **clear interface** <interface> command is not executed, the dial-peer is bound to the old VRF ID and not to the new VRF ID.



Note Inbound dial-peer matching based on VRF ID is selected in the following order of preference:

1. Dial-peer based configuration
 2. Tenant based configuration
 3. Global based configuration
-

Example: Tenant based Inbound Dial-Peer Matching

```
voice class tenant 1
  bind control source-interface GigabitEthernet0/0
  bind media source-interface GigabitEthernet0/0
  dial-peer voice 2000 voip
    description "Inbound dial-peer bound to VRF-ID 1"
    session protocol sipv2
    session target sip-server
    session transport udp
    incoming called-number 5678
  voice-class sip tenant 1
  codec g711ulaw
```

Example: Global based Inbound Dial-Peer Matching

```
voice service voip
  sip
  bind control source-interface GigabitEthernet0/0
  bind media source-interface GigabitEthernet0/0
```

VRF Aware DNS for SIP Calls

The VRF Aware DNS for SIP Calls feature enables you to specify the Virtual Routing and Forwarding (VRF) table so that the domain name system (DNS) can forward queries to name servers using the VRF table.

Because the same IP address can be associated with different DNS servers in different VRF domains, a separate list of name caches for each VRF is maintained. The DNS looks up the specific VRF name cache before sending a query to the VRF name server. All IP addresses obtained from a VRF-specific name cache are routed using the VRF table.

While processing a SIP call, if a hostname has to be resolved, only the VRF associated with the SIP call is used during DNS resolutions.



Note Ensure that the name-server is configured using **ip name-server vrf** command. For configuration details, see [Name Server Configuration](#).

High Availability with VRF

CUBE supports VRF in both HSRP and RG Infra high availability mode. VRF is supported on CUBE box-to-box and inbox high availability types.

For box-to-box high availability in Aggregation Services Routers 1000 Series and Integrated Services Routers 4000 Series, RG interface must not be associated with VRF where as the inbound and outbound interfaces (meant for handling VoIP traffic) can be associated with VRF's depending upon the deployment.

For box-to-box high availability in Integrated Services Routers Generation 2, HSRP interface must not be associated with VRF where as the inbound and outbound interfaces (meant for handling VoIP traffic) can be associated with VRFs depending upon the deployment

All the configurations including the VRF based RTP port range has to be identical on active and standby routers. VRF IDs will be check pointed before and after the switchover.

Configuration Examples



Note The steps in the following configuration example is for a new network and hence it is assumed that there is no existing configuration.

Example: Configuring Multi-VRF in Standalone Mode

The configuration in this scenario is as shown below where the GigabitEthernet 0/1 is assigned to VRF1 and GigabitEthernet 0/2 is assigned to VRF2.

Figure 32: Multi-VRF in Standalone Mode

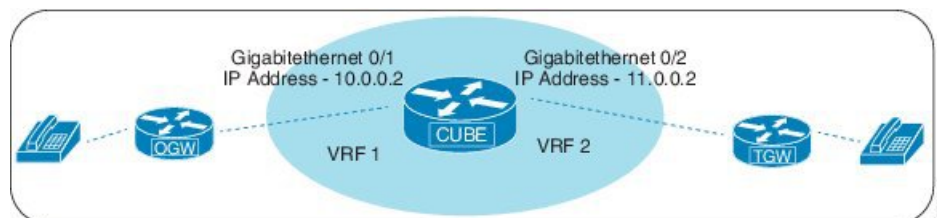

Configuring VRF

```
Device# enable
Device# configure terminal
Device(config)# ip vrf VRF1
Device(config)# rd 1:1
Device(config)# ip vrf VRF2
Device(config)# rd 2:2
Device(config)# exit
```

Associating interfaces with VRF

```
Device(config)# interface GigabitEthernet0/1
Device(config-if)# ip vrf forwarding VRF1
Device(config)# interface GigabitEthernet0/2
Device(config-if)# ip vrf forwarding VRF2
```



Note If an IP address is already assigned to an interface, then associating a VRF with interface will disable the interface and remove the existing IP address. An error message (sample error message shown below) is displayed on the console. Assign the IP address to proceed further.

```
% Interface GigabitEthernet0/1 IPv4 disabled and address(es) removed due to
enabling VRF VRF1
```

Configure Interface GigabitEthernet0/1

```
Device> enable
Device# configure terminal
Device(config)# interface GigabitEthernet0/1
Device(config-if)# ip address 10.0.0.2 255.255.255.0
Device(config-if)# speed auto
Device(config-if)# exit
```

Configure Interface GigabitEthernet0/2

```
Device(config)# interface GigabitEthernet0/2
Device(config-if)# ip address 11.0.0.2 255.255.255.0
Device(config-if)# speed auto
Device(config-if)# exit
```

Creating Dial-peer

Creating Inbound Dial-peer:

```
Device(config)# dial-peer voice 1111 voip
Device(config-dial-peer)# session protocol sipv2
Device(config-dial-peer)# incoming called-number 1111
Device(cofig-dial-peer)# codec g711ulaw
```

Creating Outbound Dial-peer:

```
Device(config)# dial-peer voice 2222 voip
Device(config-dial-peer)# destination pattern 1111
Device(config-dial-peer)# session protocol sipv2
```

Execute the following command to verify the dial-peer association with interface:

```
Device# show dial-peer voice summary
```

TAG	TYPE	MIN	OPER	AD PREFIX	DEST-PATTERN	PRE FER	PASS THRU	SESS-TARGET	STAT	OUT PORT	KEEPALIVE	VRF
1111	voip	up	up		-	0	syst	ipv4:10.0.0.2				
VRF1												
2222	voip	up	up		-	0	syst	ipv4:11.0.0.2				

VRF2

Configure Binding



Note

- Control and Media on a dial-peer have to bind with same VRF. Else, while configuring, the CLI parser will display an error.
- Whenever global sip bind interface associated with a VRF is added, modified, or removed, you should restart the sip services under voice service voip sip mode so that the change in global sip bind comes into effect with associated VRF ID.

```
Device(config)# voice service voip
Device(conf-voi-serv)# sip
Device(conf-serv-sip)# call service stop
Device(conf-serv-sip)# no call service stop
Device(conf-serv-sip)# end
```

```
Device(config)# dial-peer voice 1111 voip
Device(config-dial-peer)# voice-class sip bind control source-interface GigabitEthernet0/1
Device(config-dial-peer)# voice-class sip bind media source-interface GigabitEthernet0/1
```

```
Device(config)# dial-peer voice 2222 voip
Device(config-dial-peer)# voice-class sip bind control source-interface GigabitEthernet0/2
Device(config-dial-peer)# voice-class sip bind media source-interface GigabitEthernet0/2
```

Execute the following command to verify the interface association with VRF:

```
Device# show ip vrf brief
```

Name	Default	RD	Interfaces
Mgmt-intf	<not set>		Gi0
VRF1	1:1		Gi0/1
VRF2	2:2		Gi0/2

Execute the following command to verify a successful and active calls:

For a single call, you should be able to see two RTP connections as shown in the below example.

```
Device# show voip rtp connections
```

```
VoIP RTP Port Usage Information:
Max Ports Available: 23001, Ports Reserved: 101, Ports in Use: 2
```

Media-Address Range	Min Port	Max Port	Ports Available	Ports Reserved	Ports In-use
Global Media Pool	8000	48198	19999	101	0

```
-----
VoIP RTP active connections :
No. CallId dstCallId LocalRTP RmtRTP LocalIP RemoteIP MPSS VRF
1 1 2 25000 16390 10.0.0.1 10.0.0.2 NO VRF1
2 2 1 25002 16398 11.0.0.1 11.0.0.2 NO VRF2
```

```

Device# show call active voice brief -

Perf-AR1006#show call active voice brief
<ID>: <CallID> <start>ms.<index> (<start>) +<connect> pid:<peer_id> <dir> <addr> <state>
dur hh:mm:ss tx:<packets>/<bytes> rx:<packets>/<bytes> dscp:<packets violation>
media:<packets violation> audio tos:<audio tos value> video tos:<video tos value>
IP <ip>:<udp> rtt:<time>ms pl:<play>/<gap>ms lost:<lost>/<early>/<late>
delay:<last>/<min>/<max>ms <codec> <textrelay> <transcoded>

media inactive detected:<y/n> media cntrl rcvd:<y/n> timestamp:<time>

long duration call detected:<y/n> long duration call duration :<sec> timestamp:<time>
LostPacketRate:<%> OutOfOrderRate:<%>
VRF:<%>
MODEMPASS <method> buf:<fills>/<drains> loss <overall%> <multipkt>/<corrected>
last <buf event time>s dur:<Min>/<Max>s
FR <protocol> [int dlci cid] vad:<y/n> dtmf:<y/n> seq:<y/n>
<codec> (payload size)
ATM <protocol> [int vpi/vci cid] vad:<y/n> dtmf:<y/n> seq:<y/n>
<codec> (payload size)
Tele <int> (callID) [channel_id] tx:<tot>/<v>/<fax>ms <codec> noise:<l> acom:<l> i/o:<l>/<l>
dBm
MODEMRELAY info:<rcvd>/<sent>/<resent> xid:<rcvd>/<sent> total:<rcvd>/<sent>/<drops>
speeds(bps): local <rx>/<tx> remote <rx>/<tx>
Proxy <ip>:<audio udp>,<video udp>,<tcp0>,<tcp1>,<tcp2>,<tcp3> endpt: <type>/<manf>
bw: <req>/<act> codec: <audio>/<video>
tx: <audio pkts>/<audio bytes>,<video pkts>/<video bytes>,<t120 pkts>/<t120 bytes>
rx: <audio pkts>/<audio bytes>,<video pkts>/<video bytes>,<t120 pkts>/<t120 bytes>

Telephony call-legs: 0
SIP call-legs: 2
H323 call-legs: 0
Call agent controlled call-legs: 0
SCCP call-legs: 0
Multicast call-legs: 0
Total call-legs: 2
11FF : 8565722 511605450ms.1 (*16:21:53.676 IST Tue Aug 4 2015) +30 pid:400001
Answer 777412373 active
dur 00:00:22 tx:1110/66600 rx:1111/66660 dscp:0 media:0 audio tos:0xB8 video tos:0x0
IP 10.0.0.2:30804 SRTP: off rtt:0ms pl:0/0ms lost:0/0/0 delay:0/0/0ms g729r8 TextRelay:
off Transcoded: No ICE: Off
media inactive detected:n media cntrl rcvd:n/a timestamp:n/a
long duration call detected:n long duration call duration:n/a timestamp:n/a
LostPacketRate:0.00 OutOfOrderRate:0.00
VRF: VRF1
11FF : 8565723 511605470ms.1 (*16:21:53.696 IST Tue Aug 4 2015) +0 pid:400000 Originate
777512373 active
dur 00:00:22 tx:1111/66660 rx:1110/66600 dscp:0 media:0 audio tos:0xB8 video tos:0x0
IP 11.0.0.2:30804 SRTP: off rtt:0ms pl:0/0ms lost:0/0/0 delay:0/0/0ms g729r8 TextRelay:
off Transcoded: No ICE: Off
media inactive detected:n media cntrl rcvd:n/a timestamp:n/a
long duration call detected:n long duration call duration:n/a timestamp:n/a
LostPacketRate:0.00 OutOfOrderRate:0.00
VRF: VRF2

Telephony call-legs: 0
SIP call-legs: 2
H323 call-legs: 0
Call agent controlled call-legs: 0
SCCP call-legs: 0
Multicast call-legs: 0
Total call-legs: 2

```

```

Device# show sip-ua connections udp brief

Total active connections      : 2
No. of send failures         : 0
No. of remote closures       : 0
No. of conn. failures        : 0
No. of inactive conn. ageouts : 2

----- SIP Transport Layer Listen Sockets -----
Conn-Id      Local-Address
=====
2             [10.0.0.1]:5060:VRF1
3             [11.0.0.1]:5060:VRF2

Device# show call active voice compact

<callID> A/O FAX T<sec> Codec      type Peer Address IP R<ip>:<udp> VRF
Total call-legs: 2
8565722 ANS   T12   g711ulaw  VOIP  P777412373 10.0.0.2:30804 VRF1
8565723 ORG   T12   g711ulaw  VOIP  P777512373 11.0.0.2:30804 VRF2

Device# show call active video compact
MVRF-CUBE1#show call active video compact
<callID> A/O FAX T<sec> Codec type      Peer Address IP R<ip>:<udp> VRF
Total call-legs: 2
10193983 ANS   T30   H264   VOIP-VIDEO P2005    10.0.0.2:18078 VRF1
10193985 ORG   T30   H264   VOIP-VIDEO P3001    11.0.0.2:27042 VRF2

```

Example: Configuring RG Infra High Availability with VRF



Note Below configuration example is applicable for Cisco ASR 1000 Series Aggregated Services Routers (ASR) and Cisco 4000 Series Integrated Services Routers (ISR G3).



Note Do not configure VRF on the interface that is used for RG Infra. Traffic of VRF and RG Infra should be on different interfaces.

Figure 33: Multi-VRF in High Availability Mode (RG Infra)

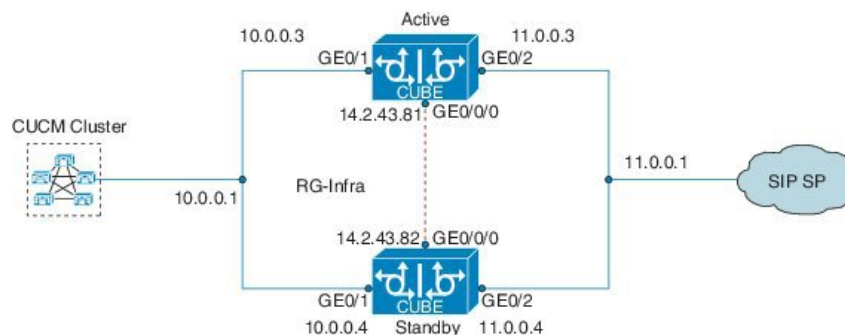

Configuration on Active Router



Note The configurations of Active Router and Stand By Router should be identical.

Configuring VRF

```
Device> enable
Device# configure terminal
Device(config)# ip vrf VRF1
Device(config)# rd 1:1
Device(config)# ip vrf VRF2
Device(config)# rd 2:2

Device(config)# voice service voip
Device(config)# no ip address trusted authenticate
Device(config)# media bulk-stats
Device(config)# allow-connections sip to sip
Device(config)# redundancy-group 1
Device(config)# sip

Device(config)# redundancy
Device(config)# mode none
Device(config)# application redundancy
Device(config)# group 1
Device(config)# name raf-b2b
Device(config)# priority 1
Device(config)# timers delay 30 reload 60
Device(config)# control GigabitEthernet0/0/0 protocol 1
Device(config)# data GigabitEthernet0/0/0
```

Associating interfaces with VRF

```
Device(config)# interface GigabitEthernet0/2
Device(config-if)# ip vrf forwarding vrf2
```



Note If an IP address is already assigned to an interface, then associating a VRF with interface will disable the interface and remove the existing IP address. An error message (sample error message shown below) is displayed on the console. Assign the IP address to proceed further.

```
% Interface GigabitEthernet0/1 IPv4 disabled and address(es) removed due to
enabling VRF VRF1
```

GigabitEthernet0/0/0 is used for configuring RG Infra and therefore do not configure any VRF with this interface.

```
Device(config)# interface GigabitEthernet0/0/0
Device(config-if)# ip address 14.2.43.81 255.255.0.0
Device(config-if)# negotiation auto
Device(config-if)# cdp enable
```

Inbound interface - GigabitEthernet0/1 is used for voice traffic configured with VRF1.

```

Device(config)# interface GigabitEthernet0/1
Device(config-if)# ip vrf forwarding VRF1
Device(config-if)# ip address 10.0.0.3 255.0.0.0
Device(config-if)# negotiation auto
Device(config-if)# cdp enable
Device(config-if)# redundancy rii 1
Device(config-if)# redundancy group 1 ip 10.0.0.1 exclusive

```

Outbound interface - GigabitEthernet0/2 is used for voice traffic configured with VRF2.

```

Device(config)# interface GigabitEthernet0/2
Device(config-if)# ip vrf forwarding VRF2
Device(config-if)# ip address 11.0.0.3 255.0.0.0
Device(config-if)# negotiation auto
Device(config-if)# cdp enable
Device(config-if)# redundancy rii 2
Device(config-if)# redundancy group 1 ip 11.0.0.1 exclusive

```

Creating Dial-peer

Creating Inbound Dial-peer:

```

Device(config)# dial-peer voice 1111 voip
Device(config-dial-peer)# destination pattern 1111
Device(config-dial-peer)# session protocol sipv2
Device(config-dial-peer)# session target ipv4:10.0.0.2
Device(config-dial-peer)# incoming called-number 1111

```

Creating Outbound Dial-peer:

```

Device(config)# dial-peer voice 3333 voip
Device(config)# destination-pattern 2222
Device(config-dial-peer)# session protocol sipv2
Device(config-dial-peer)# session target ipv4:11.0.0.2

```

Configuring Binding



Note Control and Media on a dial-peer have to bind with same VRF. Else, while configuring, the CLI parser will display an error.

```

Device(config)# dial-peer voice 1111 voip
Device(config-dial-peer)# voice-class sip bind control source-interface GigabitEthernet0/1
Device(config-dial-peer)# voice-class sip bind media source-interface GigabitEthernet0/1

Device(config)# dial-peer voice 3333 voip
Device(config-dial-peer)# voice-class sip bind control source-interface GigabitEthernet0/2
Device(config-dial-peer)# voice-class sip bind media source-interface GigabitEthernet0/2

```

Configuration on Standby Router



Note The configurations of Active and Stand By should be identical.

Configuring VRF

```
Device> enable
Device# configure terminal
Device(config)# ip vrf VRF1
Device(config)# rd 1:1
Device(config)# ip vrf VRF2
Device(config)# rd 2:2

Device(config)# voice service voip
Device(config)# no ip address trusted authenticate
Device(config)# media bulk-stats
Device(config)# allow-connections sip to sip
Device(config)# redundancy-group 1
Device(config)# sip

Device(config)# redundancy
Device(config)# mode none
Device(config)# application redundancy
Device(config)# group 1
Device(config)# name raf-b2b
Device(config)# priority 1
Device(config)# timers delay 30 reload 60
Device(config)# control GigabitEthernet0/0/0 protocol 1
Device(config)# data GigabitEthernet0/0/0
```

Associating interfaces with VRF

```
Device(config)# interface GigabitEthernet0/2
Device(config-if)# ip vrf forwarding VRF2
```



Note If an IP address is already assigned to an interface, then associating a VRF with interface will disable the interface and remove the existing IP address. An error message (sample error message shown below) is displayed on the console. Assign the IP address to proceed further.

```
% Interface GigabitEthernet0/1 IPv4 disabled and address(es) removed due to enabling
VRF VRF1
```

GigabitEthernet0/0/0 is used for configuring RG Infra and therefore do not configure any VRF with this interface.

```
Device(config)# interface GigabitEthernet0/0/0
Device(config-if)# ip address 14.2.43.81 255.255.0.0
Device(config-if)# negotiation auto
Device(config-if)# cdp enable
```

Inbound interface - GigabitEthernet0/1 is used for voice traffic configured with VRF1.

```

Device(config)# interface GigabitEthernet0/1
Device(config-if)# ip vrf forwarding VRF1
Device(config-if)# ip address 10.0.0.4 255.0.0.0
Device(config-if)# negotiation auto
Device(config-if)# cdp enable
Device(config-if)# redundancy rii 1
Device(config-if)# redundancy group 1 ip 10.0.0.1 exclusive

```

Outbound interface - GigabitEthernet0/2 is used for voice traffic configured with VRF2.

```

Device(config)# interface GigabitEthernet0/2
Device(config-if)# ip vrf forwarding VRF2
Device(config-if)# ip address 11.0.0.4 255.0.0.0
Device(config-if)# negotiation auto
Device(config-if)# cdp enable
Device(config-if)# redundancy rii 2
Device(config-if)# redundancy group 1 ip 11.0.0.1 exclusive

```

Creating Dial-peer

Creating Inbound Dial-peer:

```

Device(config)# dial-peer voice 1111 voip
Device(config-dial-peer)# destination pattern 1111
Device(config-dial-peer)# session protocol sipv2
Device(config-dial-peer)# session target ipv4:10.0.0.2
Device(config-dial-peer)# incoming called-number 1111

```

Creating Outbound Dial-peer:

```

Device(config)# dial-peer voice 3333 voip
Device(config)# destination-pattern 2222
Device(config-dial-peer)# session protocol sipv2
Device(config-dial-peer)# session target ipv4:11.0.0.2

```

Configuring Binding



Note Control and Media on a dial-peer have to bind with same VRF. Else, while configuring, the CLI parser will display an error.

```

Device(config)# dial-peer voice 1111 voip
Device(config-dial-peer)# voice-class sip bind control source-interface
GigabitEthernet0/1
Device(config)# voice-class sip bind media source-interface
GigabitEthernet0/1

Device(config)# dial-peer voice 3333 voip
Device(config)# voice-class sip bind control source-interface GigabitEthernet0/2
Device(config)# voice-class sip bind media source-interface GigabitEthernet0/2

```

Verification of Calls Before and After Switchover

RTP Connections on Active router:

```
Device# show voip rtp connections
```

```
VoIP RTP Port Usage Information:
```

```
Max Ports Available: 19999, Ports Reserved: 101, Ports in Use: 2
```

Media-Address Range	Min Port	Max Port	Ports Available	Ports Reserved	Ports In-use
Global Media Pool	8000	48198	19999	101	2

```
VoIP RTP active connections :
```

No.	CallId	dstCallId	LocalRTP	RmtRTP	LocalIP	RemoteIP	MPSS	VRF
1	5	6	8008	16388	10.0.0.1	10.0.0.2	NO	VRF1
2	6	5	8010	16388	11.0.0.1	11.0.0.2	NO	VRF2

```
Found 2 active RTP connections
```

RTP Connections on Standby Router after switchover

```
Device# show voip rtp connections
```

```
VoIP RTP Port Usage Information:
```

```
Max Ports Available: 19999, Ports Reserved: 101, Ports in Use: 2
```

Media-Address Range	Min Port	Max Port	Ports Available	Ports Reserved	Ports In-use
Global Media Pool	8000	48198	19999	101	2

```
VoIP RTP active connections :
```

No.	CallId	dstCallId	LocalRTP	RmtRTP	LocalIP	RemoteIP	MPSS	VRF
1	7	8	8012	16390	10.0.0.1	10.0.0.2	NO	VRF1
2	8	7	8014	16390	11.0.0.1	11.0.0.2	NO	VRF2

```
Found 2 active RTP connections
```

Active calls on Active Router

```
Device# show call active voice brief
```

```
11F3 : 5 243854170ms.1 (*11:48:43.972 UTC Mon May 25 2015) +6770 pid:0 Answer active
dur 00:00:14 tx:843/50551 rx:1028/61680 dscp:0 media:0 audio tos:0xB8 video tos:0x0
IP 10.0.0.2:16388 SRTP: off rtt:lms pl:0/0ms lost:0/0/0 delay:0/0/0ms g729r8 TextRelay:
off Transcoded: No ICE: Off
media inactive detected:n media contrl rcvd:n/a timestamp:n/a
long duration call detected:n long duration call duration:n/a timestamp:n/a
LostPacketRate:0.00 OutOfOrderRate:0.00

11F3 : 6 243854170ms.2 (*11:48:43.972 UTC Mon May 25 2015) +6770 pid:3333 Originate 2222
active
dur 00:00:14 tx:1028/61680 rx:843/50551 dscp:0 media:0 audio tos:0xB8 video tos:0x0
IP 11.0.0.2:16388 SRTP: off rtt:65522ms pl:0/0ms lost:0/0/0 delay:0/0/0ms g729r8 TextRelay:
off Transcoded: No ICE: Off
media inactive detected:n media contrl rcvd:n/a timestamp:n/a
long duration call detected:n long duration call duration:n/a timestamp:n/a
LostPacketRate:0.00 OutOfOrderRate:0.00
```

```

Telephony call-legs: 0
SIP call-legs: 2
H323 call-legs: 0
Call agent controlled call-legs: 0
SCCP call-legs: 0
Multicast call-legs: 0
Total call-legs: 2

```

```
Device#show sip-ua connections udp brief
```

```

Total active connections      : 2
No. of send failures         : 0
No. of remote closures       : 0
No. of conn. failures        : 0
No. of inactive conn. ageouts : 2

```

```

----- SIP Transport Layer Listen Sockets -----
Conn-Id      Local-Address
=====
2             [10.0.0.1]:5060:VRF1
3             [11.0.0.1]:5060:VRF2

```

Active calls on Standby router after switchover:

```
Device# show call active voice brief
```

```

11F9 : 8 245073830ms.1 (*12:16:18.094 UTC Mon May 25 2015) +26860 pid:3333 Originate 2222
connected
dur 00:03:37 tx:6757/405420 rx:6757/405420 dscp:0 media:0 audio tos:0x0 video tos:0x0
IP 11.0.0.2:16390 SRTP: off rtt:65531ms pl:0/0ms lost:0/0/0 delay:0/0/0ms g729r8 TextRelay:
off Transcoded: No ICE: Off
media inactive detected:n media contrl rcvd:n/a timestamp:n/a
long duration call detected:n long duration call duration:n/a timestamp:n/a
LostPacketRate:0.00 OutOfOrderRate:0.00

```

```

11F9 : 7 245073850ms.1 (*12:16:18.114 UTC Mon May 25 2015) +26840 pid:0 Answer connected
dur 00:03:37 tx:6757/405420 rx:6757/405420 dscp:0 media:0 audio tos:0x0 video tos:0x0
IP 10.0.0.2:16390 SRTP: off rtt:65523ms pl:0/0ms lost:0/0/0 delay:0/0/0ms g729r8 TextRelay:
off Transcoded: No ICE: Off
media inactive detected:n media contrl rcvd:n/a timestamp:n/a
long duration call detected:n long duration call duration:n/a timestamp:n/a
LostPacketRate:0.00 OutOfOrderRate:0.00

```

```

Telephony call-legs: 0
SIP call-legs: 2
H323 call-legs: 0
Call agent controlled call-legs: 0
SCCP call-legs: 0
Multicast call-legs: 0
Total call-legs: 2

```

Example: Configuring HSRP High Availability with VRF



Note Below configuration example is applicable for Cisco Integrated Services Routers Generation 2 (ISR G2) Platforms. [Cisco 2900 Series Integrated Services Routers and Cisco 3900 Series Integrated Services Routers]



Note Do not configure VRF on the interface that is used for HSRP. Traffic of VRF and HSRP should be on different interfaces.

Figure 34: Multi-VRF in High Availability Mode (HSRP)

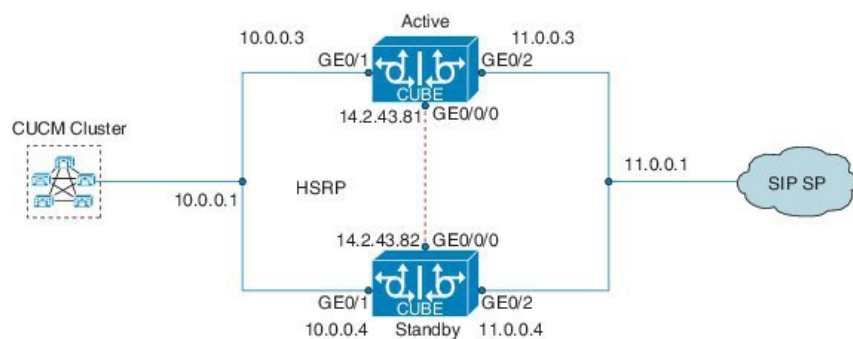

Configuration on Active Router



Note The configurations of Active Router and Stand By Router should be identical.

Configuring VRF

```
Device> enable
Device# configure terminal
Device(config)# ip vrf VRF1
Device(config)# rd 1:1
Device(config)# ip vrf VRF2
Device(config)# rd 2:2
```

Associating interfaces with VRF

```
Device(config)# interface GigabitEthernet0/1
Device(config-if)# ip vrf forwarding VRF1
```

```
Device(config)# interface GigabitEthernet0/2
Device(config-if)# ip vrf forwarding VRF2
```



Note If an IP address is already assigned to an interface, then associating a VRF with interface will disable the interface and remove the existing IP address. An error message (sample error message shown below) is displayed on the console. Assign the IP address to proceed further.

```
% Interface GigabitEthernet0/1 IPv4 disabled and address(es) removed due to
enabling VRF VRF1
```

The interface used for HSRP should not be configured with any VRF. In this example, GigabitEthernet0/0/0 is used for configuring HSRP and therefore no VRF is associated with this interface.

```
Device(config)# interface GigabitEthernet0/0/0
Device(config-if)# ip address 14.2.43.81 255.255.0.0
Device(config-if)# standby version 2
Device(config-if)# standby 93 ip 14.2.43.82
Device(config-if)# standby 93 priority 50
Device(config-if)# standby 93 preempt
Device(config-if)# standby 93 name cubeha
Device(config-if)# standby 93 track 1 decrement 5
Device(config-if)# standby 93 track 2 decrement 5
Device(config-if)# duplex auto
Device(config-if)# speed auto
```

Inbound interface - GigabitEthernet0/1 is used for voice traffic configured with VRF1.

```
Device(config)# interface GigabitEthernet0/1
Device(config-if)# ip vrf forwarding VRF1
Device(config-if)# ip address 10.0.0.3 255.0.0.0
Device(config-if)# standby version 2
Device(config-if)# standby 63 ip 10.0.0.4
Device(config-if)# standby 63 priority 50
Device(config-if)# standby 63 preempt
Device(config-if)# standby 63 track 1 decrement 5
Device(config-if)# duplex auto
Device(config-if)# speed auto
Device(config-if)#media-type rj45
```

Outbound interface - GigabitEthernet0/2 is used for voice traffic configured with VRF2.

```
Device(config)# interface GigabitEthernet0/2
Device(config-if)# ip vrf forwarding VRF2
Device(config-if)# ip address 11.0.0.3 255.0.0.0
Device(config-if)# standby version 2
Device(config-if)# standby 36 ip 11.0.0.4
Device(config-if)# standby 36 priority 50
Device(config-if)# standby 36 preempt
Device(config-if)# standby 36 track 1 decrement 5
Device(config-if)# duplex auto
Device(config-if)# speed auto
Device(config-if)#media-type rj45
```

```
Device(config)# ipc zone default
Device(config-ipczone)# association 1
```

```
Device(config-ipczone-assoc)# no shutdown
Device(config-ipczone-assoc)# protocol sctp
Device(config-ipc-protocol-sctp)# local port 5000
Device(config-ipc-local-sctp)# local-ip 14.2.43.81
Device(config-ipc-local-sctp)# exit
Device(config-ipc-protocol-sctp)# remote port 5000
Device(config-ipc-remote-sctp)# remote-ip 14.2.43.82
```

Creating Dial-peer

Creating Inbound Dial-peer:

```
Device(config)# dial-peer voice 1111 voip
Device(config-dial-peer)# destination pattern 1111
Device(config-dial-peer)# session protocol sipv2
Device(config-dial-peer)# session target ipv4:10.0.0.2
Device(config-dial-peer)# incoming called-number 1111
```

Creating Outbound Dial-peer:

```
Device(config)# dial-peer voice 3333 voip
Device(config)# destination-pattern 2222
Device(config-dial-peer)# session protocol sipv2
Device(config-dial-peer)# session target ipv4:11.0.0.2
```

Configuring Binding



Note Control and Media on a dial-peer have to bind with same VRF. Else, while configuring, the CLI parser will display an error.

```
Device(config)# dial-peer voice 1111 voip
Device(config-dial-peer)# voice-class sip bind control source-interface GigabitEthernet0/1
Device(config-dial-peer)# voice-class sip bind media source-interface GigabitEthernet0/1

Device(config)# dial-peer voice 3333 voip
Device(config-dial-peer)# voice-class sip bind control source-interface GigabitEthernet0/2
Device(config-dial-peer)# voice-class sip bind media source-interface GigabitEthernet0/2
```

Configuration on Standby Router



Note The configurations of Active and Stand By should be identical.

Configuring VRF

```
Device> enable
Device# configure terminal
Device(config)# ip vrf VRF1
Device(config)# rd 1:1
Device(config)# ip vrf VRF2
```

```
Device(config)# rd 2:2
```

Associating interfaces with VRF

```
Device(config)# interface GigabitEthernet0/1
Device(config-if)# ip vrf forwarding VRF1
```

```
Device(config)# interface GigabitEthernet0/2
Device(config-if)# ip vrf forwarding VRF2
```



Note If an IP address is already assigned to an interface, then associating a VRF with interface will disable the interface and remove the existing IP address. An error message (sample error message shown below) is displayed on the console. Assign the IP address to proceed further.

```
% Interface GigabitEthernet0/1 IPv4 disabled and address(es) removed due to
enabling VRF VRF1
```

The interface used for HSRP should not be configured with any VRF. In this example, GigabitEthernet0/0/0 is used for configuring HSRP and therefore no VRF is associated with this interface.

```
Device(config)# interface GigabitEthernet0/0/0
Device(config-if)# ip address 14.2.43.82 255.255.0.0
Device(config-if)# standby version 2
Device(config-if)# standby 93 ip 14.2.43.81
Device(config-if)# standby 93 priority 50
Device(config-if)# standby 93 preempt
Device(config-if)# standby 93 name cubeha
Device(config-if)# standby 93 track 1 decrement 5
Device(config-if)# standby 93 track 2 decrement 5
Device(config-if)# duplex auto
Device(config-if)# speed auto
```

Inbound interface - GigabitEthernet0/1 is used for voice traffic configured with VRF1.

```
Device(config)# interface GigabitEthernet0/1
Device(config-if)# ip vrf forwarding VRF1
Device(config-if)# ip address 10.0.0.4 255.0.0.0
Device(config-if)# standby version 2
Device(config-if)# standby 63 ip 10.0.0.3
Device(config-if)# standby 63 priority 50
Device(config-if)# standby 63 preempt
Device(config-if)# standby 63 track 1 decrement 5
Device(config-if)# duplex auto
Device(config-if)# speed auto
Device(config-if)#media-type rj45
```

Outbound interface - GigabitEthernet0/2 is used for voice traffic configured with VRF2.

```
Device(config)# interface GigabitEthernet0/2
Device(config-if)# ip vrf forwarding VRF2
Device(config-if)# ip address 11.0.0.4 255.0.0.0
Device(config-if)# standby version 2
```

```

Device(config-if)# standby 36 ip 11.0.0.3
Device(config-if)# standby 36 priority 50
Device(config-if)# standby 36 preempt
Device(config-if)# standby 36 track 1 decrement 5
Device(config-if)# duplex auto
Device(config-if)# speed auto
Device(config-if)#media-type rj45

Device(config)# ipc zone default
Device(config-ipczone)# association 1
Device(config-ipczone-assoc)# no shutdown
Device(config-ipczone-assoc)# protocol sctp
Device(config-ipc-protocol-sctp)# local port 5000
Device(config-ipc-local-sctp)# local-ip 14.2.43.82
Device(config-ipc-local-sctp)# exit
Device(config-ipc-protocol-sctp)# remote port 5000
Device(config-ipc-remote-sctp)# remote-ip 14.2.43.81

```

Creating Dial-peer

Creating Inbound Dial-peer:

```

Device(config)# dial-peer voice 1111 voip
Device(config-dial-peer)# destination pattern 1111
Device(config-dial-peer)# session protocol sipv2
Device(config-dial-peer)# session target ipv4:10.0.0.2
Device(config-dial-peer)# incoming called-number 1111

```

Creating Outbound Dial-peer:

```

Device(config)# dial-peer voice 3333 voip
Device(config)# destination-pattern 2222
Device(config-dial-peer)# session protocol sipv2
Device(config-dial-peer)# session target ipv4:11.0.0.2

```

Configuring Binding



Note Control and Media on a dial-peer have to bind with same VRF. Else, while configuring, the CLI parser will display an error.

```

Device(config)# dial-peer voice 1111 voip
Device(config-dial-peer)# voice-class sip bind control source-interface GigabitEthernet0/1
Device(config)# voice-class sip bind media source-interface GigabitEthernet0/1

Device(config)# dial-peer voice 3333 voip
Device(config)# voice-class sip bind control source-interface GigabitEthernet0/2
Device(config)# voice-class sip bind media source-interface GigabitEthernet0/2

```

Verification of redundancy States

On Active Router

```
Device(config)# show redundancy status

my state = 13 -ACTIVE
peer state = 8  -STANDBY HOT
Mode = Duplex
Unit ID = 0

Maintenance Mode = Disabled
Manual Swact = enabled
Communications = Up

client count = 17
client_notification_TMR = 120000 milliseconds
RF debug mask = 0x0
```

On Standby Router

```
Device(config)# show redundancy status

my state = 8 -STANDBY HOT
peer state = 13 ACTIVE
Mode = Duplex
Unit ID = 0

Maintenance Mode = Disabled
Manual Swact = enabled
Communications = Up

client count = 17
client_notification_TMR = 120000 milliseconds
RF debug mask = 0x0
```

Verification of Calls Before and After Switchover

RTP Connections on Active router:

```
Device# show voip rtp connections

VoIP RTP Port Usage Information:
Max Ports Available: 19999, Ports Reserved: 101, Ports in Use: 2

```

Media-Address Range	Min Port	Max Port	Ports Available	Ports Reserved	Ports In-use
Global Media Pool	8000	48198	19999	101	2

```

VoIP RTP active connections :
No. CallId      dstCallId      LocalRTP  RmtRTP      LocalIP      RemoteIP      MPSS  VRF
1      5              6          8008      16388      10.0.0.1      10.0.0.2      NO    VRF1
2      6              5          8010      16388      11.0.0.1      11.0.0.2      NO    VRF2
Found 2 active RTP connections
```

RTP Connections on Standby Router after switchover

```
Device# show voip rtp connections

VoIP RTP Port Usage Information:
Max Ports Available: 19999, Ports Reserved: 101, Ports in Use: 2

```

Media-Address Range	Min Port	Max Port	Ports Available	Ports Reserved	Ports In-use
Global Media Pool	8000	48198	19999	101	2

Media-Address Range	Port	Port	Available	Reserved	In-use
Global Media Pool	8000	48198	19999	101	2

VoIP RTP active connections :

No.	CallId	dstCallId	LocalRTP	RmtRTP	LocalIP	RemoteIP
1	7	8	8012	16390	10.0.0.1	10.0.0.2
2	8	7	8014	16390	11.0.0.1	11.0.0.2

Found 2 active RTP connections

Active calls on Active Router

Device# **show call active voice brief**

```
11F3 : 5 243854170ms.1 (*11:48:43.972 UTC Mon May 25 2015) +6770 pid:0 Answer active
dur 00:00:14 tx:843/50551 rx:1028/61680 dscp:0 media:0 audio tos:0xB8 video tos:0x0
IP 10.0.0.2:16388 SRTP: off rtt:1ms pl:0/0ms lost:0/0/0 delay:0/0/0ms g729r8 TextRelay:
off Transcoded: No ICE: Off
media inactive detected:n media contrl rcvd:n/a timestamp:n/a
long duration call detected:n long duration call duration:n/a timestamp:n/a
LostPacketRate:0.00 OutOfOrderRate:0.00

11F3 : 6 243854170ms.2 (*11:48:43.972 UTC Mon May 25 2015) +6770 pid:3333 Originate 2222
active
dur 00:00:14 tx:1028/61680 rx:843/50551 dscp:0 media:0 audio tos:0xB8 video tos:0x0
IP 11.0.0.2:16388 SRTP: off rtt:65522ms pl:0/0ms lost:0/0/0 delay:0/0/0ms g729r8 TextRelay:
off Transcoded: No ICE: Off
media inactive detected:n media contrl rcvd:n/a timestamp:n/a
long duration call detected:n long duration call duration:n/a timestamp:n/a
LostPacketRate:0.00 OutOfOrderRate:0.00
```

```
Telephony call-legs: 0
SIP call-legs: 2
H323 call-legs: 0
Call agent controlled call-legs: 0
SCCP call-legs: 0
Multicast call-legs: 0
Total call-legs: 2
```

Device#show sip-ua connections udp brief

```
Total active connections      : 2
No. of send failures          : 0
No. of remote closures        : 0
No. of conn. failures         : 0
No. of inactive conn. ageouts : 2
```

```
----- SIP Transport Layer Listen Sockets -----
Conn-Id      Local-Address
=====
2             [10.0.0.1]:5060:VRF1
3             [11.0.0.1]:5060:VRF2
```

Active calls on Standby router after switchover:

Example: Configuring Multi VRF where Media Flows Around the CUBE

```

Device# show call active voice brief

11F9 : 8 245073830ms.1 (*12:16:18.094 UTC Mon May 25 2015) +26860 pid:3333 Originate 2222
connected
dur 00:03:37 tx:6757/405420 rx:6757/405420 dscp:0 media:0 audio tos:0x0 video tos:0x0
IP 10.0.0.2:16390 SRTP: off rtt:65531ms pl:0/0ms lost:0/0/0 delay:0/0/0ms g729r8 TextRelay:
off Transcoded: No ICE: Off
media inactive detected:n media contrl rcvd:n/a timestamp:n/a
long duration call detected:n long duration call duration:n/a timestamp:n/a
LostPacketRate:0.00 OutOfOrderRate:0.00

11F9 : 7 245073850ms.1 (*12:16:18.114 UTC Mon May 25 2015) +26840 pid:0 Answer connected
dur 00:03:37 tx:6757/405420 rx:6757/405420 dscp:0 media:0 audio tos:0x0 video tos:0x0
IP 10.0.0.2:16390 SRTP: off rtt:65523ms pl:0/0ms lost:0/0/0 delay:0/0/0ms g729r8 TextRelay:
off Transcoded: No ICE: Off
media inactive detected:n media contrl rcvd:n/a timestamp:n/a
long duration call detected:n long duration call duration:n/a timestamp:n/a
LostPacketRate:0.00 OutOfOrderRate:0.00

Telephony call-legs: 0
SIP call-legs: 2
H323 call-legs: 0
Call agent controlled call-legs: 0
SCCP call-legs: 0
Multicast call-legs: 0
Total call-legs: 2

```

Example: Configuring Multi VRF where Media Flows Around the CUBE

The configuration in this scenario is as shown below where there is overlapping endpoint IP address across two customers and use CUBE for inter-enterprise calls. Here the media flows around the CUBE for the enterprises with Multi-VRF feature and both the enterprises have the same endpoint IP address.

Figure 35: Multi-VRF with Media Flow Around CUBE

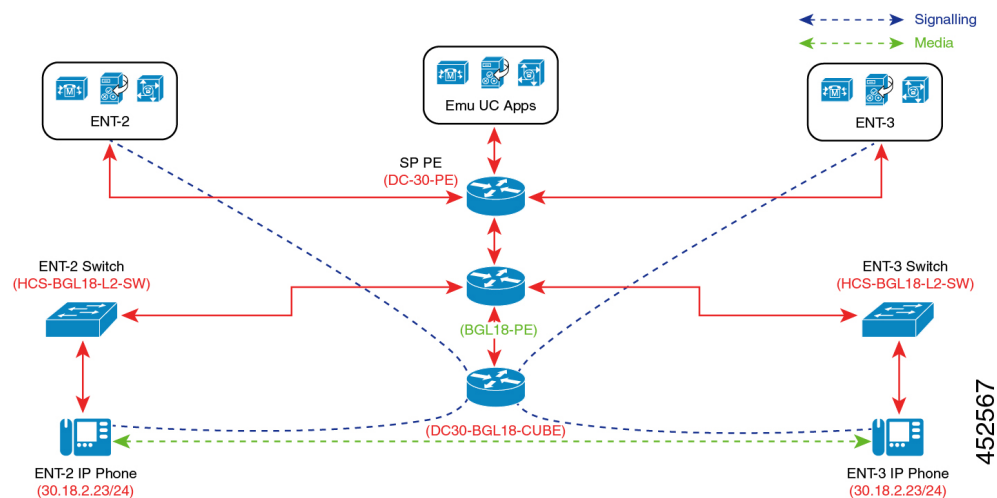

Set-up Information

- Two enterprises ENT2 and ENT3 have the same endpoint IP address.
- Provider Edge (PE) router acts as DHCP for both enterprises.
- PSTN call flow is simulated with the Emulation Call Manager.
- When a call is initiated from ENT2 to ENT3, the call is a flow around call and both the endpoints are connected directly.

Configuration Information

The table below details the configuration information required to configure Multi-VRF, where the media (call) flows around the CUBE.

Name	ENT2 Configuration	ENT3 Configuration
PE VRF Configuration	ENT2 PE VRF Configuration	ENT3 PE VRF Configuration
DHCP Configuration	<pre>ip dhcp pool DC30-ENT302 vrf Ent302 network 30.18.2.0 255.255.255.0 domain-name hcsent2.ciscolabs.com option 150 ip 200.1.1.10 default-router 30.18.2.1 dns-server 200.1.1.59</pre>	<pre>ip dhcp pool DC30-ENT303 vrf Ent303 network 30.18.2.0 255.255.255.0 domain-name hcsent3.ciscolabs.com option 150 ip 200.1.1.10 default-router 30.18.2.1 dns-server 200.1.1.59</pre>
CUBE VRF Configuration	ENT2 - CUBE VRF Configuration	ENT3 - CUBE VRF Configuration
CUBE Voice Class URI Configuration	<pre>! voice class uri 2112 sip pattern 200.1.1.10:8012 ! voice class uri 2114 sip pattern 172.16.30.62:8012 !</pre>	<pre>! voice class uri 3112 sip pattern 200.1.1.10:8013 ! voice class uri 3114 sip pattern 172.16.30.62:8013 !</pre>

Name	ENT2 Configuration	ENT3 Configuration
CUBE DPG Configuration	voice class dpg 2012 dial-peer 2012 ! voice class dpg 2014 dial-peer 2014 !	voice class dpg 3012 dial-peer 3012 ! voice class dpg 3014 dial-peer 3014 !
CUBE COR Member Configuration	dial-peer cor custom name Ent3102 name PGW-Ent3102	dial-peer cor custom name Ent3103 name PGW-Ent3103
CUBE COR List Configuration	dial-peer cor list From-Ent3102 member Ent3102 member PGW-Ent3102 ! dial-peer cor list To-Ent3102 member Ent3102 ! dial-peer cor list From-PGW-Ent3102 member Ent3102 ! dial-peer cor list To-PGW-Ent3102 member PGW-Ent3102 !	dial-peer cor list From-Ent3103 member Ent3103 member PGW-Ent3103 ! dial-peer cor list To-Ent3103 member Ent3103 ! dial-peer cor list From-PGW-Ent3103 member Ent3103 ! dial-peer cor list To-PGW-Ent3103 member PGW-Ent3103 !
Dial Peer Configuration	ENT2 - Dial Peer Configuration	ENT3 - Dial Peer Configuration

PE VRF Configuration - ENT2

```
BLR-PE-BGL18-NEW#sh run vrf Ent302
Building configuration...
Current configuration : 1072 bytes
ip vrf Ent302
  description Enterprise 3102 VRF
  rd 3102:1
  route-target export 3102:1
  route-target import 3102:1
  route-target import 110:1
!
interface GigabitEthernet0/0/0
  description Link to HCS-BGL18-CUBE (CUBE-ENT)
  ip address 192.168.18.9 255.255.255.252
  ip ospf network point-to-point
```

```

logging event link-status
load-interval 30
negotiation auto
mpls bgp forwarding
cdp enable
!
interface Port-channell
no ip address
no negotiation auto
!
interface Port-channell.302
encapsulation dot1Q 302
ip vrf forwarding Ent302
ip address 30.18.2.1 255.255.255.0
!
router bgp 65535
!
address-family ipv4 vrf Ent302
redistribute connected
exit-address-family
!
end

```

PE VRF Configuration - ENT3

```

BLR-PE-BGL18-NEW#sh run vrf Ent303
Building configuration...
Current configuration : 850 bytes
ip vrf Ent303
description Enterprise 3103 VRF
rd 3103:1
route-target export 3103:1
route-target import 3103:1
route-target import 110:1
!
interface GigabitEthernet0/0/0
description Link to HCS-BGL18-CUBE (CUBE-ENT)
ip address 192.168.18.9 255.255.255.252
ip ospf network point-to-point
logging event link-status
load-interval 30
negotiation auto
mpls bgp forwarding
cdp enable
!
interface Port-channell
no ip address
no negotiation auto
!
interface Port-channell.303
encapsulation dot1Q 303
ip vrf forwarding Ent303
ip address 30.18.2.1 255.255.255.0
!
router bgp 65535
!
address-family ipv4 vrf Ent303
redistribute connected
exit-address-family
!
end

```

CUBE VRF Configuration - ENT2

```

DC30-BGL18-CUBE#sh run vrf Ent302
Building configuration...
Current configuration : 616 bytes
ip vrf Ent302
  description Enterprise 3102 VRF
  rd 3102:1
  route-target export 3102:1
  route-target import 3102:1
!
interface GigabitEthernet0/0/0
  description Link to HCS-BGL18-PE1 from CUBE-VRF
  ip address 192.168.18.10 255.255.255.252
  ip ospf network point-to-point
  load-interval 30
  media-type rj45
  negotiation auto
!
interface GigabitEthernet0/0/0.302
  encapsulation dot1Q 302
  ip vrf forwarding Ent302
  ip address 172.131.2.21 255.255.255.252
  ip ospf network point-to-point
!
router ospf 302 vrf Ent302
  network 172.131.2.20 0.0.0.3 area 0.0.0.0
!
ip route vrf Ent302 0.0.0.0 0.0.0.0 172.131.2.22
end

```

CUBE VRF Configuration - ENT3

```

DC30-BGL18-CUBE#sh run vrf Ent303
Building configuration...
Current configuration : 616 bytes
ip vrf Ent303
  description Enterprise 3103 VRF
  rd 3103:1
  route-target export 3103:1
  route-target import 3103:1
!
interface GigabitEthernet0/0/0
  description Link to HCS-BGL18-PE1 from CUBE-VRF
  ip address 192.168.18.10 255.255.255.252
  ip ospf network point-to-point
  load-interval 30
  media-type rj45
  negotiation auto
!
interface GigabitEthernet0/0/0.303
  encapsulation dot1Q 303
  ip vrf forwarding Ent303
  ip address 172.131.3.21 255.255.255.252
  ip ospf network point-to-point
!
router ospf 303 vrf Ent303
  network 172.131.3.20 0.0.0.3 area 0.0.0.0
!
ip route vrf Ent303 0.0.0.0 0.0.0.0 172.131.3.22
end

```

Dial Peer Configuration - ENT2

```

dial-peer voice 2011 voip
corlist incoming From-Ent3102
description Inbound Trunk from BT-Ent302 CUCM

```

```

session protocol sipv2
destination dpg 2014
incoming uri via 2112
voice-class codec 1
voice-class sip profiles 1
voice-class sip options-keepalive
voice-class sip pass-thru content sdp
voice-class sip bind control source-interface
  GigabitEthernet0/0/0.302
voice-class sip bind media source-interface
  GigabitEthernet0/0/0.302
!
dial-peer voice 2012
  voipcorlist outgoing To-Ent3102
description *** Outbound Trunk to BT-Ent302 DN Routing ****
destination-pattern 8115
session protocol sipv2
session target ipv4:200.1.1.10:8012
session transport tcp
voice-class codec 1
voice-class sip profiles 1
voice-class sip options-keepalive
voice-class sip pass-thru content sdp
voice-class sip bind control source-interface
  GigabitEthernet0/0/0.302
voice-class sip bind media source-interface
  GigabitEthernet0/0/0.302
!
dial-peer voice 2013 voip
corlist incoming From-PGW-Ent3102
description Inbound Trunk from PGW-Ent3102
session protocol sipv2
session transport tcp
destination dpg 2012
incoming uri via 2114
voice-class codec 1
voice-class sip profiles 1
voice-class sip options-keepalive
voice-class sip pass-thru content sdp
voice-class sip bind control source-interface
  GigabitEthernet0/0/0.3030
voice-class sip bind media source-interface
  GigabitEthernet0/0/0.3030
!
dial-peer voice 2014 voip
corlist outgoing To-PGW-Ent3102
description Outbound Trunk to PGW-BT-Ent302
destination-pattern 8115
session protocol sipv2
session target ipv4:172.16.30.62:8012
session transport tcp
voice-class codec 1
voice-class sip profiles 1
voice-class sip options-keepalive
voice-class sip pass-thru content sdp
voice-class sip bind control source-interface
  GigabitEthernet0/0/0.3030
voice-class sip bind media source-interface
  GigabitEthernet0/0/0.3030
!

```

Dial Peer Configuration - ENT3

```

dial-peer voice 3011 voip
corlist incoming From-Ent3103

```

```

description Inbound Trunk from BT-Ent303 CUCM
session protocol sipv2
destination dpg 3014
incoming uri via 3112
voice-class codec 1
voice-class sip profiles 1
voice-class sip options-keepalive
voice-class sip pass-thru content sdp
voice-class sip bind control source-interface
GigabitEthernet0/0/0.303
voice-class sip bind media source-interface
GigabitEthernet0/0/0.303
!
dial-peer voice 3012
  voipcorlist outgoing To-Ent3103
description *** Outbound Trunk to BT-Ent303 DN Reouting ****
destination-pattern 8115
session protocol sipv2
session target ipv4:200.1.1.10:8013
session transport tcp
voice-class codec 1
voice-class sip profiles 1
voice-class sip options-keepalive
voice-class sip pass-thru content sdp
voice-class sip bind control source-interface
GigabitEthernet0/0/0.303
voice-class sip bind media source-interface
GigabitEthernet0/0/0.303
!
dial-peer voice 3013 voip
corlist incoming From-PGW-Ent3103
description Inbound Trunk from PGW-Ent3103
session protocol sipv2
session transport tcp
destination dpg 3012
incoming uri via 3114
voice-class codec 1
voice-class sip profiles 1
voice-class sip options-keepalive
voice-class sip pass-thru content sdp
voice-class sip bind control source-interface
GigabitEthernet0/0/0.3030
voice-class sip bind media source-interface
GigabitEthernet0/0/0.3030
!
dial-peer voice 3014 voip
corlist outgoing To-PGW-Ent3103
description Outbound Trunk to PGW-BT-Ent303
destination-pattern 8115
session protocol sipv2
session target ipv4:172.16.30.62:8013
session transport tcp
voice-class codec 1
voice-class sip profiles 1
voice-class sip options-keepalive
voice-class sip pass-thru content sdp
voice-class sip bind control source-interface
GigabitEthernet0/0/0.3030
voice-class sip bind media source-interface
GigabitEthernet0/0/0.3030
!

```

Debug Information



Note Execute `sh sip-ua calls called-number +14089135001`, to check the call behaviour.

Figure 36: Debug Information

```

Call 2
SIP Call ID      : 23D487BE-ED4111EA-90AE9E69-F6447A3E@172.131.2.21
State of the call : STATE_ACTIVE (7)
Substate of the call : SUBSTATE_NONE (0)
Calling Number    : +14089245001
Called Number     : +14089135001
Called URI        : sip:+14089135001@200.1.1.10:8012
Bit Flags         : 0xC04018 0x90000100 0x80080
CC Call ID       : 1199827
Local UUID        : 000020c200105000a00000505686a91d
Remote UUID       : 00002da600105000a000005056864727
Source IP Address (Sig) : 172.131.2.21
Destn SIP Req Addr:Port : [200.1.1.10]:8012
Destn SIP Resp Addr:Port : [200.1.1.10]:8012
Destination Name    : 200.1.1.10
Number of Media Streams : 3
Number of Active Streams : 0
RTP Fork Object     : 0x0
Media Mode          : flow-around
Media Stream 1
State of the stream : STREAM_DEAD
Stream Call ID      : 1199827
Stream Type         : voice-dtmf (1)
Stream Media Addr Type : 1
Negotiated Codec    : Passthrough (0 bytes)
Codec Payload Type  : 255 (None)
Negotiated Dtmf-relay : inband-voice
Dtmf-relay Payload Type : 0
QoS ID              : -1
Local QoS Strength  : BestEffort
Negotiated QoS Strength : BestEffort
Negotiated QoS Direction : None
Local QoS Status    : None
Media Source IP Addr:Port : [172.131.2.21]:0
Media Dest IP Addr:Port : [30.18.2.23]:0
Media Stream 2
State of the stream : STREAM_DEAD
Stream Call ID      : 1199848
Stream Type         : video (7)
Stream Media Addr Type : 1
Negotiated Codec    : Passthrough (0 bytes)
Codec Payload Type  : 255 (None)
Negotiated Dtmf-relay : inband-voice
Dtmf-relay Payload Type : 0
QoS ID              : -1
Local QoS Strength  : BestEffort
Negotiated QoS Strength : BestEffort
Negotiated QoS Direction : None
Local QoS Status    : None
Media Source IP Addr:Port : [172.131.2.21]:0
Media Dest IP Addr:Port : [30.18.2.23]:0
Media Stream 3
State of the stream : STREAM_DEAD
Stream Call ID      : 1199849
Stream Type         : application (10)
Stream Media Addr Type : 1
Negotiated Codec    : Passthrough (0 bytes)
Codec Payload Type  : 255 (None)
Negotiated Dtmf-relay : inband-voice
Dtmf-relay Payload Type : 0
QoS ID              : -1
Local QoS Strength  : BestEffort
Negotiated QoS Strength : BestEffort
Negotiated QoS Direction : None

```

Which indicates call is media flow around

Both Enterprises having same IP address

Both Enterprises having same IP address

452568

Example: Configuring Multi VRF where Media Flows Through the CUBE

The configuration in this scenario is as shown below where there is overlapping endpoint IP address across two customers and use CUBE for inter-enterprise calls. Here the media is flowing through the CUBE for the enterprises with Multi VRF feature and both the enterprises having same end-point IP address.

Figure 37: Multi-VRF with Media Flow Through CUBE

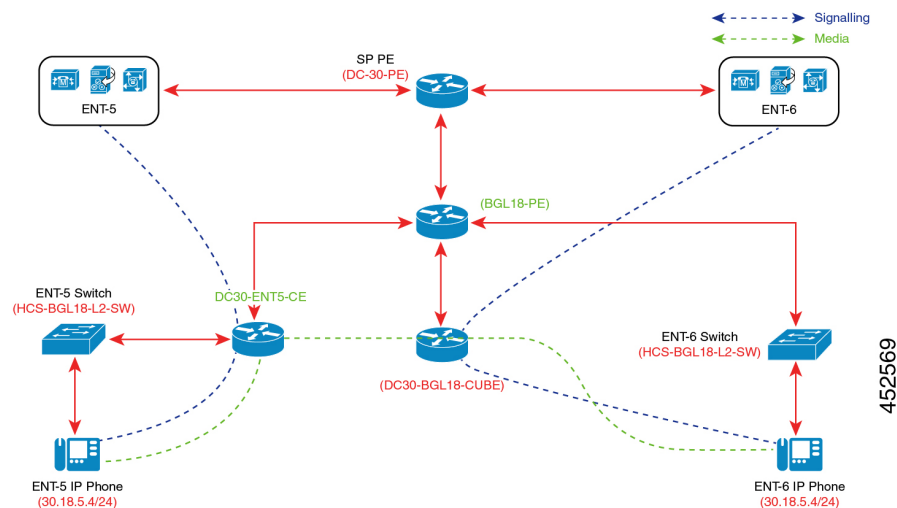

Set-up Information

- ENT5 and ENT6 have same endpoint IP addressing, and ENT5 act as PSTN customer.
- DC30-ENT5-CE and BGL-18-PE act as DHCP servers for ENT5 and ENT6 endpoints respectively.
- When a call is initiated from ENT5 to ENT6, the call is connected between two endpoints, and signalling and media flows through the CUBE.
- Customer Edge (CE) router will directly communicate with CUBE-Enterprises' Public IP address.

Configuration Information

The table below details the configuration information required to configure Multi-VRF, where the media (call) flows through the CUBE.

Table 47: Configuration Information

Name	CE CUBE Configuration	SP CUBE Configuration
DHCP Configuration	<pre>ip dhcp pool DC30-ENT305 network 30.18.5.0 255.255.255.0 domain-name hcsent5.ciscolabs.com option 150 ip 200.1.1.10 default-router 30.18.5.1 dns-server 200.1.1.59 !</pre>	<pre>ip dhcp pool DC30-ENT306 vrf Ent306 network 30.18.5.0 255.255.255.0 domain-name hcsent6.ciscolabs.com option 150 ip 200.1.1.10 default-router 30.18.5.1 dns-server 200.1.1.59 !</pre>
Voice Class URI Configuration	<pre>! voice class uri 5112 sip pattern 200.1.1.10:8015 ! voice class uri 5114 sip pattern 10.225.104.192 !</pre>	<pre>! voice class uri 102252 sip pattern 10.225.104.195:5060 ! voice class uri 102254 sip pattern 200.1.1.10:7016 !</pre>
DPG Configuration	<pre>! voice class dpg 5012 dial-peer 5012 ! voice class dpg 5014 dial-peer 5014 !</pre>	<pre>! voice class dpg 9992 dial-peer 1022502 ! voice class dpg 9994 dial-peer 1022504 !</pre>
COR Member Configuration	<pre>dial-peer cor custom name Ent3105 name PGW-Ent3105 !</pre>	<pre>dial-peer cor custom name BGL-Ent3105 name RCDN-Ent3106 !</pre>

Name	CE CUBE Configuration	SP CUBE Configuration
COR List Configuration	<pre> ! dial-peer cor list From-Ent3105 member Ent3105 member PGW-Ent3105 ! dial-peer cor list To-Ent3105 member Ent3105 ! dial-peer cor list From-PGW-Ent3105 member Ent3105 ! dial-peer cor list To-PGW-Ent3105 member PGW-Ent3105 ! </pre>	<pre> ! dial-peer cor list From-BGL-Ent3105 member BGL-Ent3105 member RCDN-Ent3106 ! dial-peer cor list To-BGL-Ent3105 member BGL-Ent3105 ! dial-peer cor list From-RCDN-Ent3106 member BGL-Ent3105 ! dial-peer cor list To-RCDN-Ent3106 member RCDN-Ent3106 ! </pre>
Dial-Peer Configuration	CE - Dial Peer Configuration	SP - Dial Peer Configuration
Interface Configuration	<pre> ! interface GigabitEthernet0/0/0 ip address 10.225.104.195 255.255.255.0 negotiation auto ! </pre>	<pre> ! interface GigabitEthernet0/0/1 ip address 10.225.104.192 255.255.255.0 negotiation auto ! </pre>

Dial Peer Configuration - CE

```

!
dial-peer voice 5011 voip
corlist incoming From-Ent3105
description Inbound Trunk from Ent3105 CUCM
session protocol sipv2
destination dpg 5014
incoming uri via 5112
voice-class codec 1
voice-class sip profiles 1
voice-class sip options-keepalive
voice-class sip pass-thru content sdp
voice-class sip bind control source-interface
  GigabitEthernet0/0/2
voice-class sip bind media source-interface
  GigabitEthernet0/0/2
!
dial-peer voice 5012 voip
corlist outgoing To-Ent3105

```

```

description *** Outbound Trunk to BT-Ent304 DN
  Reouting ****
destination-pattern 8115
session protocol sipv2
session target ipv4:200.1.1.10:8015
session transport tcp
voice-class codec 1
voice-class sip profiles 1
voice-class sip options-keepalive
voice-class sip pass-thru content sdp
voice-class sip bind control source-interface
  GigabitEthernet0/0/2
voice-class sip bind media source-interface
  GigabitEthernet0/0/2
!
dial-peer voice 5013 voip
corlist incoming From-PGW-Ent3105
description Inbound Trunk from PGW-Ent3105
session protocol sipv2
session transport tcp
destination dpg 5012
incoming uri via 5114
voice-class codec 1
voice-class sip profiles 1
voice-class sip options-keepalive
voice-class sip pass-thru content sdp
voice-class sip bind control source-interface
  GigabitEthernet0/0/0
voice-class sip bind media source-interface
  GigabitEthernet0/0/0
!
dial-peer voice 5014 voip
corlist outgoing To-PGW-Ent3105
description Outbound Trunk to PGW-Ent3105
destination-pattern 8115
session protocol sipv2
session target ipv4:10.225.104.192
session transport tcp
voice-class codec 1
voice-class sip profiles 1
voice-class sip options-keepalive
voice-class sip pass-thru content sdp
voice-class sip bind control source-interface
  GigabitEthernet0/0/0
voice-class sip bind media source-interface
  GigabitEthernet0/0/0
!

```

Dial Peer Configuration - SP

```

!
dial-peer voice 1022501 voip
corlist incoming From-BGL-Ent3105
description Inbound Trunk from Ent3105 CUCM
session protocol sipv2
destination dpg 9994
incoming uri via 102252
voice-class codec 1
voice-class sip profiles 1
voice-class sip options-keepalive
voice-class sip pass-thru content sdp
voice-class sip bind control source-interface
  GigabitEthernet0/0/1
voice-class sip bind media source-interface
  GigabitEthernet0/0/1

```

```

!
dial-peer voice 1022502 voip
corlist outgoing To-BGL-Ent3105
description *** Outbound Trunk to BT-Ent304 DN
  Reouting ****
destination-pattern 8115
session protocol sipv2
session target ipv4:10.225.104.195
session transport tcp
voice-class codec 1
voice-class sip profiles 1
voice-class sip options-keepalive
voice-class sip pass-thru content sdp
voice-class sip bind control source-interface
  GigabitEthernet0/0/1
voice-class sip bind media source-interface
  GigabitEthernet0/0/1
!
dial-peer voice 1022503 voip
corlist incoming From-RCDN-Ent3106
description Inbound Trunk from PGW-Ent3105
session protocol sipv2
session transport tcp
destination dpg 9992
incoming uri via 102254
voice-class codec 1
voice-class sip profiles 1
voice-class sip options-keepalive
voice-class sip pass-thru content sdp
voice-class sip bind control source-interface
  GigabitEthernet0/0/0.306
voice-class sip bind media source-interface
  GigabitEthernet0/0/0.306
!
dial-peer voice 1022504 voip
corlist outgoing To-RCDN-Ent3106
description Outbound Trunk to PGW-Ent3105
destination-pattern 8115
session protocol sipv2
session target ipv4:200.1.1.10:7016
session transport tcp
voice-class codec 1
voice-class sip profiles 1
voice-class sip options-keepalive
voice-class sip pass-thru content sdp
voice-class sip bind control source-interface
  GigabitEthernet0/0/0.306
voice-class sip bind media source-interface
  GigabitEthernet0/0/0.306
!

```

Debug Information



Note Execute **sh sip-ua calls called-number +16089185043**, to check the call behaviour.

Figure 38: Debug Information

```

DC30-BGL18-CUBE#sh sip-ua calls called-number +16089185043
Total SIP call legs:2, User Agent Client:1, User Agent Server:1
SIP UAC CALL INFO
Call 1
SIP Call ID           : F515C5F4-EACA11EA-B5AE9E69-F6447A3F
State of the call     : STATE_ACTIVE (7)
Substate of the call  : SUBSTATE_NONE (0)
Calling Number        : +16089175025
Called Number         : +16089185043
Called URI            : sip:+16089185043@200.1.1.10:7016
Bit Flags             : 0xC04018 0x90000100 0x80080
CC Call ID           : 947205
Local UUID            : 3833a59200105000a00000c1b1fd7f90
Remote UUID           : 24ecd4f600105000a00000c1b1fd7456
Source IP Address (Sig) : 172.131.6.21
Destn SIP Req Addr:Port : [200.1.1.10]:7016
Destn SIP Resp Addr:Port : [200.1.1.10]:7016
Destination Name       : 200.1.1.10
Number of Media Streams : 2
Number of Active Streams : 2
RTP Fork Object       : 0x0
Media Mode            : flow-through
Media Stream 1
State of the stream   : STREAM_ACTIVE
Stream Call ID        : 947205
Stream Type           : voice+dtmf (1)
Stream Media Addr Type : 1
Negotiated Codec      : Passthrough (0 bytes)
Codec Payload Type    : 255 (None)
Negotiated Dtmf-relay : inband-voice
Dtmf-relay Payload Type : 0
QoS ID                : -1

```

Which indicates call is media flow around

452570

Troubleshooting Tips

The following commands are helpful for troubleshooting:

- **show voip rtp connections**

The following is an example where media flow-around is configured. The output shows 0 connections since media does not flow through CUBE.

```

Device#show voip rtp connections
VoIP RTP Port Usage Information:
Max Ports Available: 19999, Ports Reserved: 101, Ports in Use: 0
Port range not configured

```

Media-Address Range	Min Port	Max Port	Ports Available	Ports Reserved	Ports In-use
Global Media Pool	8000	48198	19999	101	0

No active connections found

- **show call active voice compact**

```
Device#show call active voice compact
<callID> A/O FAX T<sec> Codec type Peer Address IP R<ip>:<udp> VRF
4021 ORG T45 g711ulaw VOIP P7474 8.41.17.71:27754 VRF1
4020 ANS T45 g711ulaw VOIP Psipp 8.41.17.71:17001 VRF1
```

- **debug ccsip verbose**

The output of **debug ccsip verbose** command is wordy and may cause issues when enabled on a busy network environment.



CHAPTER 28

Configuring Multi-Tenants on SIP Trunks

This feature allows specific global configurations for multiple tenants on SIP trunks that allow differentiated services for tenants. Configuring Multi-Tenants on SIP Trunks allows each tenant to have their own individual configurations. The configurations include timers, credentials, bind requests, and other parameters which are available under sip-ua and voice service voip/sip configurations. Multi-tenant functionality helps to create multiple configurations with ease and provides support for scalable and flexible mix of typical enterprise services.

- [Feature Information for Configuring Multi-Tenants on SIP Trunks, on page 395](#)
- [Information About Configuring Multi-tenants on SIP Trunks, on page 395](#)
- [How to Configure Multi-Tenants on SIP Trunks, on page 399](#)
- [Example: SIP Trunk Registration in Multi-Tenant Configuration, on page 401](#)

Feature Information for Configuring Multi-Tenants on SIP Trunks

The following table provides release information about the feature or features described in this module. This table lists only the software release that introduced support for a given feature in a given software release train. Unless noted otherwise, subsequent releases of that software release train also support that feature.

Use Cisco Feature Navigator to find information about platform support and Cisco software image support. To access Cisco Feature Navigator, go to <https://cfng.cisco.com/>. An account on Cisco.com is not required.

Feature Name	Releases	Feature Information
Support for Configuring Multi Tenants on SIP Trunks	Cisco IOS 15.6(2)T Cisco IOS XE Denali 16.3.1	This feature allows the provision to configure specific global configurations for multiple tenants on SIP trunks. The following commands were introduced: voice class tenant <tag> and voice-class sip tenant <tag>.

Information About Configuring Multi-tenants on SIP Trunks

With the introduction of multi-tenancy support on CUBE, the sip-specific attributes can be configured at per tenant basis in addition to the existing global or dial-peer levels.

The **voice class tenant** <tag> command allows sip-specific attributes to be configured at per tenant basis. The command **voice class tenant** <tag> can be then applied to individual dial-peers, thereby associating them to a particular tenant. See the following table "[Table 48: Multi-Tenant Configuration List](#)" for information on the complete list of configurations present under the **voice class tenant** <tag>.

If tenants are configured under dial-peer, then configurations are applied in the following order of preference.

- Dial-peer configuration
- Tenant configuration
- Global configuration

That is, if the value of the attribute under dial-peer configuration is system, then the value is taken from the tenant configuration. And, if the value under the tenant configuration is also system, then the global configuration is used.

If there are no tenants configured under dial-peer, then the configurations are applied using the default behavior in the following order:

- Dial-peer configuration
- Global configuration

The following table lists the various configurations present under **voice class tenant** <tag>. For more information on specific configurations, see the [Voice and Video](#) command reference guide lists.



Note Attributes that are not available under **voice class tenant** <tag> use the default behavior—With preference of dial-peer followed by the global configuration.

Table 48: Multi-Tenant Configuration List

Command	Description
aaa	SIP-UA AAA related configuration
anat	Allow alternative network address types IPv4 and IPv6
asserted-id	Configure SIP UA privacy identity settings
associate	Associate a RCB for outgoing calls
asymmetric	Configure global SIP asymmetric payload support
authentication	Digest Authentication Configuration
bandwidth	Allow SIP SDP bandwidth-related options
bind	SIP bind command
block	Block 18X response to INVITE
call-route	Configure call routing options

Command	Description
conn-reuse	Reuse the sip registration tcp connection for the end-point behind a Firewall
connection-reuse	Use listener port for sending requests over UDP
contact-passing	302 contact to be passed through for CFWD
content	Content carried as part of SIP message
copy-list	Configure list of entities to be sent to peer leg
credentials	User credentials for registration
disable-early-media	Disable early-media cut through
dns -a-override	Skip DNS A/AAAA query when SRV query timeout
dscp -profile	DSCP Profile global config
early-media	Configure method to handle early-media Update Request
early-offer	Configure sending Early-Offer
encap	Configure SDP encapsulation
error-code-override	Configure sip error code
error- passthru	SIP error response pass-thru functionality
exit	Exits from the voice class configuration mode
g729	G729 codec interoperability settings
handle-replaces	Handle INVITE with REPLACES header at SIP spi
header-passing	SIP Headers need to be passed to applications
help	Description of the interactive help system
history-info	History Info header support
host-registrar	Use sip-ua registrar value in Diversion and Contact header for 3xx messages
interop-handling	Enable interop-handling
localhost	Specify the DNS name for the localhost
map	Mapping options
max-forwards	Change number of max-forwards for SIP Methods
midcall -signaling	Configure method to handle mid-call signaling

nat	SIP nat global config
no	Negate a command or set its defaults
notify	SIP Signaling Notify Configuration
offer	Configure settings for Offers made from the Gateway
options-ping	Send OPTION pings to remote end
outbound-proxy	Configure an Outbound Proxy Server
pass-thru	SIP pass-through global config
permit	Permit hostname for this gateway
preloaded-route	Use pre-loaded route header for outgoing calls, if available
privacy	Configure SIP UA privacy settings
privacy-policy	Set privacy behavior for outgoing SIP messages
random-contact	Use Random Contact for outgoing calls, if available
random-request- uri	Configure options for Request-URI having random value
reason-header	Configure settings for supporting SIP Reason Header
redirection	Enable call redirection (3xx) handling
refer- ood	Configure maximum number of out-of-dialog refer made to the Gateway
referto -passing	Refer-To needs to be passed through for transfer
registrar	Configure SIP registrar VoIP Interface
registration	Enable registration options
rel1xx	Type of reliable provisional response support
remote-party-id	Enable Remote-Party-ID support in SIP User Agent
requi -passing	Request URI needs to be passed through
reset	SIP Reset Options
retry	Change default retries for each SIP Method
send	Configure outgoing message options
session	SIP Voice Protocol session config
sip-profiles	SIP Profiles global config

sip-server	Configure a SIP Server Interface
srtp	Allow SIP related SRTP options
srtp-auth	Allow to set preferred suites
tel-config	Tel format cfg for headers other than req -line in
timers	SIP Signaling Timers Configuration
update- callerid	Enable sending updates for callerid
url	Url configuration for request-line url in outgoing INVITE
video	Video related config for sip
warn-header	SIP Warning-Header global config
xfer	Transfer target configuration

How to Configure Multi-Tenants on SIP Trunks

Configuring Multi-Tenants on SIP Trunks

SUMMARY STEPS

1. **enable**
2. **configure terminal**
3. Use the following commands to configure multi-tenants:
 - **voice class tenant <tag>** in the global configuration mode

Once you configure the **voice class tenant <tag>** command in the global mode, the configuration will move to the **voice class tenant <tag>** submode. You can configure all the sip-specific attributes in this submode.

 - **voice-class sip tenant <tag>** in the dial-peer configuration mode
4. **end**

DETAILED STEPS

	Command or Action	Purpose
Step 1	enable Example: Device> enable	Enables privileged EXEC mode. <ul style="list-style-type: none"> • Enter your password if prompted.

	Command or Action	Purpose
Step 2	<p>configure terminal</p> <p>Example:</p> <pre>Device# configure terminal</pre>	Enters global configuration mode.
Step 3	<p>Use the following commands to configure multi-tenants:</p> <ul style="list-style-type: none"> • voice class tenant <tag> in the global configuration mode <p>Once you configure the voice class tenant <tag> command in the global mode, the configuration will move to the voice class tenant <tag> submode. You can configure all the sip-specific attributes in this submode.</p> <ul style="list-style-type: none"> • voice-class sip tenant <tag> in the dial-peer configuration mode <p>Example:</p> <p>In global configuration mode</p> <pre>! Configuring tenant 1 Device(config)# voice class tenant 1 Device (config-class)# ? aaa - sip-ua AAA related configuration anat - Allow alternative network address types IPV4 and IPV6 asserted-id - Configure SIP-UA privacy identity settings Video - video related function Warn-header - SIP related config for SIP. SIP warning-header global config. Device (config-voi-tenant)# end ----- ! Configuring tenant 2 Device(config)# voice class tenant 2 Device (config-class)# ? aaa - sip-ua AAA related configuration anat - Allow alternative network address types IPV4 and IPV6 asserted-id - Configure SIP-UA privacy identity settings outbound-proxy - Configure an Outbound Proxy Server pass-thru - SIP pass-through global config srtp - Allow SIP related SRTP options Warn-header - SIP related config for SIP. SIP warning-header global config. Device (config-voi-tenant)# end</pre> <p>Example:</p>	Use the voice-class sip tenant <tag> command in the global configuration mode to configure a tenant with sip-specific attributes. This command tag can then be applied to one or more dial-peers using the voice-class sip tenant <tag> command under the dial-peers.

	Command or Action	Purpose
	<p>In dial-peer configuration mode</p> <pre> !Configuring tenant 1 under dial-peer 10 Device (config)# dial-peer voice 10 voip Device (config-dial-peer)# voice-class sip tenant 1 Device (config-dial-peer)# end ----- !Configuring tenant 2 under dial-peer 20 Device (config)# dial-peer voice 20 voip Device (config-dial-peer)# voice-class sip tenant 2 Device (config-dial-peer)# end !An example for the use of the "no" form of command voice-class sip tenant Router(config)# dial-peer voice 3000 voip Router(config-dial-peer)# voice-class sip tenant 1 Router(config-dial-peer)# no voice-class sip tenant 1 </pre> <p>When the no form is configured, the dial-peer is no longer associated with the tenant tag configuration. The attributes are now applied using the default order of dial-peer followed by the global configuration.</p>	
Step 4	<p>end</p> <p>Example:</p> <pre> Device(config-dial-peer)# end </pre>	Returns to privileged EXEC mode.

Example: SIP Trunk Registration in Multi-Tenant Configuration

For SIP trunk registration, the **voice class tenant <tag>** command is not associated with any dial-peer configuration. All outgoing registrations are triggered to the Registrars when credentials are configured under **voice class tenant <tag>**.

```
Router# show run | sec tenant
```

```

Voice class tenant 1
registrar 1 ipv4:10.64.86.35:9051 expires 3600
credentials username aaaa password 7 06070E204D realm aaaa.com
outbound-proxy ipv4:10.64.86.35:9057
bind control source-interface GigabitEthernet0/0

```

```

Voice class tenant 2
registrar 1 ipv4:9.65.75.45:9052 expires 3600
credentials username bbbb password 7 110B1B0715 realm bbbb.com
outbound-proxy ipv4:10.64.86.40:9040
bind control source-interface GigabitEthernet0/1

```

For multi-tenancy support on Cisco Unified Border Element, you can configure voice class tenants with different credentials, but having the same registrar. In that scenario, it is recommended that you configure the

CLI commands **sip-server** and **registrar** under **voice class tenant** configuration. The following is a sample configuration:

```
voice class tenant 1
  credentials number 1111 username test password 7 071B245B5D1D realm ipvoice.jp
  authentication username test password 7 06120A3258
  registrar ipv4:1.1.1.1 expires 120
  sip-server ipv4:1.1.1.1
!
voice class tenant 2
  credentials number 2222 username test password 7 09584B1E0A11 realm ipvoice.jp
  authentication username test2 password 7 071B245F5A
  registrar ipv4:1.1.1.1 expires 120
  sip-server ipv4:1.1.1.1
```



PART **IV**

Codecs

- [Codec Support and Restrictions, on page 405](#)
- [Codec Preference Lists, on page 411](#)



CHAPTER 29

Codec Support and Restrictions

This chapter provides advanced information about the support of and restrictions for using certain codecs with CUBE. For basic information on how to configure codecs, refer to the [Introduction to Codecs](#) section.

- [Feature Information for Codec Support on CUBE, on page 405](#)
- [OPUS Codec Support on CUBE, on page 406](#)
- [ISAC Codec Support on CUBE, on page 408](#)
- [AAC-LD MP4A-LATM Codec Support on Cisco UBE, on page 408](#)

Feature Information for Codec Support on CUBE

The following table provides release information about the feature or features described in this module. This table lists only the software release that introduced support for a given feature in a given software release train. Unless noted otherwise, subsequent releases of that software release train also support that feature.

Use Cisco Feature Navigator to find information about platform support and Cisco software image support. To access Cisco Feature Navigator, go to www.cisco.com/go/cfn. An account on Cisco.com is not required.

Table 49: Feature Information for Codec Support on CUBE

Feature Name	Releases	Feature Information
Opus Codec Support	Cisco IOS XE Amsterdam 17.3.1a	Opus audio codec support on CUBE was introduced. The following commands were introduced or modified as part of Opus codec feature: <ul style="list-style-type: none">• <code>codec opus [profile tag]</code>• <code>codec profile tag profile</code>• <code>codec preference value codec-type [profile profile-tag]</code>• <code>rtp payload-type opus payload-type-number</code>

Feature Name	Releases	Feature Information
AAC-LD MP4A-LATM Codec Support	15.4(1)T Cisco IOS XE Release 3.12S	AAC-LD MP4A-LATM Codec Support on CUBE was introduced. The AAC-LD MP4A-LATM codec is a wideband audio codec that is used by video endpoints. MP4A-LATM is an MPEG4 audio coding standard, where LATM is Low-Overhead MPEG-4 Audio Transport Multiplex. The Cisco Unified Border Element (Cisco UBE) supports MP4A-LATM to enable call flows involving endpoints that use this codec, especially for media recording. The following commands were introduced or modified: codec mp4a-latm , codec preference tag mp4a-latm .
ISAC Codec Support	15.1(1)T	The ISAC Codec Support on CUBE was introduced. The following commands were introduced by this feature: codec isac , codec preference tag isac .

OPUS Codec Support on CUBE

The Opus interactive speech and audio codec is designed to handle a wide range of interactive audio applications. This includes VoIP, video conferencing, and in-game chat. The OPUS codec also supports live, distributed music performances. It scales from low bit rate narrowband speech at 6 kbps to high-quality stereo music at 510 kbps. Opus uses both Linear Prediction (LP) and Modified Discrete Cosine Transform (MDCT) algorithms to achieve good compression of both speech and music.



Note Opus codec is only supported for SIP-SIP call scenarios. It is not supported for TDM-SIP or Analog-SIP flows.

Design Recommendations for Opus Codec

The VoIP dial peer and voice class codec options are enhanced to offer Opus codec support on CUBE:

- **codec opus profile tag**—The CLI command under dial-peer configuration mode is enhanced:

```
router(config)#dial-peer voice 3002 voip
router(config-dial-peer)#codec opus profile 2
```

- **codec profile tag profile**—The CLI command configured under global configuration mode is enhanced to configure opus as a supported codec:

```
router(config)#codec profile 2 opus
router(conf-codec-profile)#fmtp "fmtp:114 maxplaybackrate=16000;
sprop-maxcapture=16000; maxaveragebitrate=20000; stereo=1; sprop-stereo=0;
useinbandfec=0; usedtx=0"
router(conf-codec-profile)#exit
```

- **codec preference value codec-type [profileprofile tag]**—The CLI command configured under voice class configuration mode is enhanced to configure opus as a preferred codec on the dial-peer:

```
router(config)#voice class codec 80
router(config-class)#codec preference 1 opus profile 79
router(config-class)#exit
```

- **rtp payload-type [opus number]**—The CLI command configured under dial-peer configuration mode is enhanced to configure opus as a supported payload type:

```
router(config)#dial-peer voice 604 voip
router(config-dial-peer)#rtp payload-type opus 126
```

- The default payload-type for **opus** is set to 114.
- The default payload-type for **cisco-codec-aacld** is set to 112.
- It is not mandatory that you configure a **codec profile** for Opus. For delayed offer to early offer flows, a codec profile must be used to configure an fmp value for the initial invite.
- The CLI command **show call active voice [brief | compact]** is modified to include details on Opus codec in the command output.
- The CLI command **show sip-ua calls** is modified to include details on Opus codec in the command output.
- Calls that require Opus codec transcoding as part of the Offer-Answer exchange are disconnected.
- Opus Codec is supported for both secure and non-secure calls (RTP-to-RTP, SRTP-to-SRTP, SRTP-to-RTP, and RTP-to-SRTP).
- Opus supports several clock rates. Only the highest clock rate of 48000 is advertised in the SDP. The following is a sample configuration of SDP for Opus codec:

```
m=audio 16000 RTP/AVP 114 a=rtpmap:114 opus/48000/2
```
- Opus codec defines the optional media format (fmp) parameters in a call. CUBE passes through the optional fmp parameters from one side to other if Opus codec is configured on both sides of the call.
- The following are the fmp parameters defined by Opus codec:
 - maxaveragebitrate
 - maxplaybackrate
 - stereo
 - useinbandfec
 - usedtx
 - sprop-maxcapture
 - sprop-stereo
- Dynamic payload interworking is enabled by default on CUBE. Configure **asymmetric payload [full]** if CUBE is not required to handle payload interworking. In this scenario, interworking is handled at the endpoints handling the media.

Restrictions for Opus Codec Support on CUBE

- Media recording is not supported with Extended Media Forking (XMF).

- CUBE does not support processing of multiple fmtp lines. If the received SDP has multiple fmtp lines, then only the first fmtp line is passed in the outbound INVITE.

ISAC Codec Support on CUBE

The iSAC codec is an adaptive VoIP codec specially designed to deliver wideband sound quality in both low- and high-bit rate applications. The iSAC codec automatically adjusts the bit-rate for the best quality or a fixed bit rate can be used if the network characteristics are known. This codec is designed for wideband VoIP communications. The iSAC codec offers better quality with reduced bandwidth for sideband applications.

Restrictions for ISAC Codec Support on CUBE

- Low complexity is not supported for the iSAC codec.

AAC-LD MP4A-LATM Codec Support on Cisco UBE

As part of this feature, Cisco UBE supports the following:

- Accept and send MP4A-LATM codec and corresponding FMTP profiles
- Configure MP4A-LATM under dial-peer or under voice-class codec as preferred codec
- Pass across real-time transport protocol (RTP) media for MP4A-LATM codec without any interworking
- Offer pre-configured FMTP profile for MP4A-LATM for DO-EO (Delayed-Offer to Early-Offer) calls
- Offer more than one FMTP profile (each with different payload type number) as mentioned by the offering endpoint, so that the answering endpoint can choose the best option.
- Offer only one instance of MP4A-LATM if media forking is applicable. The offered instance is the first one received in the offer.
- Calculate bandwidth for MP4A-LATM on the basis of either “b=TIAS” attribute or “bitrate” parameter in the FMTP attribute. If none of them are present in the session description protocol (SDP), the default maximum bandwidth, that is, 128 Kbps will be used for calculation.
- The following Cisco UBE features are supported with the MP4A-LATM codec:
 - Basic call (audio and video) flow-around and flow-through (FA and FT).
 - Voice Class Codec support in Cisco UBE with codec filtering
 - SRTP and SRCTP passthrough for SIP-to-SIP calls
 - Supplementary services
 - RSVP
 - Dynamic payload type interworking for DTMF and codec packets for SIP-to-SIP calls
 - Media Anti-Trombone with SIP signaling control on CUBE
 - Support for SIP UPDATE message per RFC 3311
 - RTP Media Loopback
 - Media forking for IP based calls using Zephyr recording server
 - Cisco UBE Mid-call Re-INVITE consumption
 - Signaling forking (Fastweb multile SIP Early Dialog Support, FA and FT)
 - Maximum bandwidth-based CAC
 - Media Policing
 - Box-to-Box High Availability (B2B HA)

- Inbox High Availability (Inbox HA)

Restrictions for AAC-LD MP4A-LATM Codec Support on Cisco UBE

Cisco UBE does not support the following:

- Codec transcoding between MP4A-LATM and other codecs
- Dual-tone Multifrequency (DTMF) interworking with MP4A-LATM codec
- Non-SIP-SIP, that is, SIP to other service provider interface (SPI) interworking with MP4A-LATM codec



CHAPTER 30

Codec Preference Lists

This chapter describes how to negotiate an audio codec from a list of codec associated with a preference. This chapter also describes how to disable codec filtering by configuring CUBE to send an outgoing offer with all configured audio codecs in the list assuming that the dspfarm supports all these codecs.

- [Feature Information for Negotiation of an Audio Codec from a List of Codecs, on page 411](#)
- [Codecs Configured Using Preference Lists, on page 412](#)
- [Prerequisites for Codec Preference Lists, on page 412](#)
- [Restrictions for Codecs Preference Lists, on page 413](#)
- [How to Configure Codec Preference Lists, on page 413](#)
- [Troubleshooting Negotiation of an Audio Codec from a List of Codecs, on page 416](#)
- [Verifying Negotiation of an Audio Codec from a List of Codecs, on page 417](#)

Feature Information for Negotiation of an Audio Codec from a List of Codecs

The following table provides release information about the feature or features described in this module. This table lists only the software release that introduced support for a given feature in a given software release train. Unless noted otherwise, subsequent releases of that software release train also support that feature.

Use Cisco Feature Navigator to find information about platform support and Cisco software image support. To access Cisco Feature Navigator, go to <https://cfng.cisco.com/>. An account on Cisco.com is not required.

Table 50: Feature Information for Negotiation of an Audio Codec from a List of Codecs on Each Leg of a SIP-to-SIP Call on the Cisco Unified Border Element

Feature Name	Releases	Feature Information
Negotiation of an Audio Codec from a List of Codecs on Each Leg of a SIP-to-SIP Call on the Cisco Unified Border Element	15.1(2)T	The Negotiation of an Audio Codec from a List of Codecs on Each Leg of a SIP-to-SIP Call on the Cisco Unified Border Element feature supports negotiation of an audio codec using the Voice Class Codec and Codec Transparent infrastructure on the Cisco UBE. The following command was introduced or modified: voice-class codec (dial peer).

Feature Name	Releases	Feature Information
Negotiation of an Audio Codec from a List of Codecs on Each Leg of a SIP-to-SIP Call on the Cisco Unified Border Element	Cisco IOS XE Release 3.8S	The Negotiation of an Audio Codec from a List of Codecs on Each Leg of a SIP-to-SIP Call on the Cisco Unified Border Element feature supports negotiation of an audio codec using the Voice Class Codec and Codec Transparent infrastructure on the Cisco UBE. The following command was introduced or modified: voice-class codec (dial peer).
Negotiation of an Audio Codec from a List of Codecs on Each Leg of a SIP-to-SIP Call on the Cisco Unified Border Element.	15.3(2)T	This feature provides high availability support for negotiation of an audio codec from a list of codecs on each leg of a SIP-to-SIP call on the Cisco Unified Border Element under the Voice Class Codec.

Codecs Configured Using Preference Lists

SIP-to-SIP calls configured using codecs using preference lists have the following features:

- Incoming and outgoing dial-peers can be configured with different preference lists.
- Both normal transcoding and high-density transcoding are supported with preference lists.
- Midcall codec changes for supplementary services are supported with preference lists. Transcoder resources are dynamically inserted or deleted when there is a codec or RTP-NTE to in-band DTMF interworking required.
- Reinvite-based supplementary services that are invoked from the Cisco Unified Communications Manager (CUCM), like call hold, call resume, Music On Hold (MOH), call transfer, and call forward are supported with preference lists.
- T.38 fax and fax passthrough switchover with preference lists are supported.
- Reinvite-based call hold and call resume for the Secure Real-Time Transfer protocol (SRTP) and Real-Time Transport Protocol (RTP) interworking on CUBE is supported with preference lists.
- High availability is supported for calls that use codecs with preference lists. But calls requiring the transcoder to be invoked are not checkpointed. During midcall renegotiation, if the call releases the transcoder, then the call is checkpointed.

Prerequisites for Codec Preference Lists

- Transcoding configuration on the CUBE.
- The digital signal processor (DSP) requirements to support the transcoding feature on the CUBE.

Restrictions for Codecs Preference Lists

For All Calls (SIP-to-SIP, H.323-to-H.323, SIP-to-H.323 calls)

- Video codecs are not supported with preference lists.
- Multiple audio streams are not supported.
- High-density transcoding is not supported when delayed offer to early offer is configured. Only low density transcoding is supported.
- Codec re-packetization feature is not supported when preference lists are configured.

For H.323-to-H.323 and SIP-to-H.323 Calls

The below restrictions do not exist for SIP-to-SIP calls from 15.1(2)T and Cisco IOS XE Release 3.8S onwards.

- You can configure dissimilar preference lists on the incoming and outgoing dial peers.
- Incoming and outgoing dial-peers cannot be configured with the different preference lists.
- Transcoding is not supported when preference lists are used.
- Mid-call codec changes and supplementary services (call-hold / resume, call forward) do not work when a preference list is configured.
- Mid-call insertion or deletion of transcoder is not supported with preference lists.
- Rotary dial peers are not supported when preference lists are used.
- Both incoming and outgoing dial-peers need to be configured with the same codec voice classes.
- The preference of codecs configured in a codec voice classes is not be applied to the outgoing call-leg. Basically codec filtering is applied first and only the filtered codecs will be sent out in the outgoing offer from CUBE.
- T.38 fax, fax-passthru and modem-passthru is not be supported with preference lists.
- SRTP<->RTP is not supported with preference lists.
- When a codec voice class is configured, call establishment is un-predictable when a transcoder is involved in the call. The call succeeds only if the end points choose the first codec in the list of offered codecs.



Note Codec preference in the voice class codec on the outgoing call leg is not followed when the same codecs are available in the respective incoming invite with SDP with different codec preference. Cube prioritizes and follows the incoming invite with SDP codec preference when compared to the voice class codec preference on the outgoing dial-peer leg.

How to Configure Codec Preference Lists

Configuring Audio Codecs Using a Codec Voice Class and Preference Lists

Preferences can be used to determine which codecs will be selected over others.

A codec voice class is a construct within which a codec preference order can be defined. A codec voice class can then be applied to a dial peer, which then follows the preference order defined in the codec voice class.

SUMMARY STEPS

1. **enable**
2. **configure terminal**
3. **voice class codec tag**
4. Do the following for each audio codec you want to configure in the voice class:
 - **codec preference value codec-type**[**profile profile-tag**]
 - **codec preference value codec-type**[**bytes payload-size fixed-bytes**]
 - **codec preference value isac** [**mode {adaptive | independent}**] [**bit-rate value framesize { 30 | 60 }**] [**fixed**]]
 - **codec preference value ilbc** [**mode frame-size** [**bytes payload-size**]]
 - **codec preference value mp4-latm** [**profile tag**]
5. **exit**
6. **dial-peer voice number voip**
7. **voice-class codec tag offer-all**
8. **end**

DETAILED STEPS

	Command or Action	Purpose
Step 1	enable Example: Device> enable	Enables privileged EXEC mode. • Enter your password if prompted.
Step 2	configure terminal Example: Device> configure terminal	Enters global configuration mode.
Step 3	voice class codec tag Example: Device(config)# voice class codec 10	Enters voice-class configuration mode for the specified codec voice class.
Step 4	Do the following for each audio codec you want to configure in the voice class: <ul style="list-style-type: none"> • codec preference value codec-type[profile profile-tag] • codec preference value codec-type[bytes payload-size fixed-bytes] • codec preference value isac [mode {adaptive independent}] [bit-rate value framesize { 30 60 }] [fixed]] • codec preference value ilbc [mode frame-size [bytes payload-size]] • codec preference value mp4-latm [profile tag] 	Configure a codec within the voice class and specifies a preference for the codec. This becomes part of a preference list
Step 5	exit	Exits the current mode.

	Command or Action	Purpose
	Example: Device(config-class)# exit	<ul style="list-style-type: none"> Enter your password if prompted.
Step 6	dial-peer voice <i>number</i> voip Example: Device(config)# dial-peer voice 1 voip	Enters dial peer configuration mode for the specified VoIP dial peer.
Step 7	voice-class codec <i>tag</i> offer-all Example: Device(config-dial-peer)# voice-class codec 10	Applies the previously configured voice class and associated codecs to a dial peer. <ul style="list-style-type: none"> The offer-all keyword allows the device to offer all codecs configured in a codec voice class.
Step 8	end Example: Device(config-dial-peer)# end	Returns to privileged EXEC mode.

Disabling Codec Filtering

Cisco UBE is configured to filter common codecs for the subsets, by default. The filtered codecs are sent in the outgoing offer. You can configure the Cisco UBE to offer all the codecs configured on an outbound leg instead of offering only the filtered codecs.



Note This configuration is applicable only for early offer calls from the Cisco UBE. For delayed offer calls, by default all codecs are offered irrespective of this configuration.

Perform this task to disable codec filtering and allow all the codecs configured on an outbound leg.

SUMMARY STEPS

1. **enable**
2. **configure terminal**
3. **dial-peer voice *tag* voip**
4. **voice-class codec *tag* offer-all**
5. **end**

DETAILED STEPS

	Command or Action	Purpose
Step 1	enable Example: Device> enable	Enables privileged EXEC mode. <ul style="list-style-type: none"> Enter your password if prompted.

	Command or Action	Purpose
Step 2	configure terminal Example: Device# configure terminal	Enters global configuration mode.
Step 3	dial-peer voice tag voip Example: Device(config)# dial-peer voice 10 voip	Enters dial peer voice configuration mode.
Step 4	voice-class codec tag offer-all Example: Device(config-dial-peer)# voice-class codec 10 offer-all	Adds all the configured voice class codec to the outgoing offer from the Cisco UBE.
Step 5	end Example: Device(config-dial-peer)# end	Exits the dial peer voice configuration mode.

Troubleshooting Negotiation of an Audio Codec from a List of Codecs

Use the following commands to debug any errors that you may encounter when you configure the Negotiation of an Audio Codec from a List of Codecs on Each Leg of a SIP-to-SIP Call on the Cisco Unified Border Element feature:

- **debug ccsip all**
- **debug voip ccapi input**
- **debug sccp messages**
- **debug voip rtp session**

For DSP-related debugs, use the following commands:

- **debug voip dsmp all**
- **debug voip dsmp rtp both payload all**
- **debug voip ipipgw**

Verifying Negotiation of an Audio Codec from a List of Codecs

Perform this task to display information to verify Negotiation of an Audio Codec from a List of Codecs on Each Leg of a SIP-to-SIP Call on the Cisco Unified Border Element configuration. These **show** commands need not be entered in any specific order.

SUMMARY STEPS

1. **enable**
2. **show call active voice brief**
3. **show voip rtp connections**
4. **show sccp connections**
5. **show dspfarm dsp active**

DETAILED STEPS

Step 1 enable

Enables privileged EXEC mode.

Step 2 show call active voice brief

Displays a truncated version of call information for voice calls in progress.

Example:

```
Device# show call active voice brief
<ID>: <CallID> <start>ms.<index> +<connect> pid:<peer_id> <dir> <addr> <state>
  dur hh:mm:ss tx:<packets>/<bytes> rx:<packets>/<bytes>
IP <ip>:<udp> rtt:<time>ms pl:<play>/<gap>ms lost:<lost>/<early>/<late>
  delay:<last>/<min>/<max>ms <codec>
media inactive detected:<y/n> media cntrl rcvd:<y/n> timestamp:<time>
long duration call detected:<y/n> long duration call duration :<sec> timestamp:<time>
MODEMPASS <method> buf:<fills>/<drains> loss <overall%> <multipkt>/<corrected>
  last <buf event time>s dur:<Min>/<Max>s
FR <protocol> [int dlci cid] vad:<y/n> dtmf:<y/n> seq:<y/n>
  <codec> (payload size)
ATM <protocol> [int vpi/vci cid] vad:<y/n> dtmf:<y/n> seq:<y/n>
  <codec> (payload size)
Tele <int> (callID) [channel_id] tx:<tot>/<v>/<fax>ms <codec> noise:<l> acom:<l> i/o:<l>/<l> dBm
  MODEMRELAY info:<rcvd>/<sent>/<resent> xid:<rcvd>/<sent> total:<rcvd>/<sent>/<drops>
  speeds(bps): local <rx>/<tx> remote <rx>/<tx>
Proxy <ip>:<audio udp>,<video udp>,<tcp0>,<tcp1>,<tcp2>,<tcp3> endpt: <type>/<manf>
bw: <req>/<act> codec: <audio>/<video>
  tx: <audio pkts>/<audio bytes>,<video pkts>/<video bytes>,<t120 pkts>/<t120 bytes>
  rx: <audio pkts>/<audio bytes>,<video pkts>/<video bytes>,<t120 pkts>/<t120 bytes>
Telephony call-legs: 0
SIP call-legs: 2
H323 call-legs: 0
Call agent controlled call-legs: 0
SCCP call-legs: 2
Multicast call-legs: 0
Total call-legs: 4
1243 : 11 971490ms.1 +-1 pid:1 Answer 1230000 connecting
  dur 00:00:00 tx:415/66400 rx:17/2561
  IP 192.0.2.1:19304 SRTP: off rtt:0ms pl:0/0ms lost:0/0/0 delay:0/0/0ms g711ulaw TextRelay: off
```

```

media inactive detected:n media contrl rcvd:n/a timestamp:n/a
long duration call detected:n long duration call duration:n/a timestamp:n/a
1243 : 12 971500ms.1 +-1 pid:2 Originate 3210000 connected
dur 00:00:00 tx:5/10 rx:4/8
IP 9.44.26.4:16512 SRTP: off rtt:0ms pl:0/0ms lost:0/0/0 delay:0/0/0ms g729br8 TextRelay: off
media inactive detected:n media contrl rcvd:n/a timestamp:n/a
long duration call detected:n long duration call duration:n/a timestamp:n/a
0 : 13 971560ms.1 +0 pid:0 Originate connecting
dur 00:00:08 tx:415/66400 rx:17/2561
IP 192.0.2.2:2000 SRTP: off rtt:0ms pl:0/0ms lost:0/0/0 delay:0/0/0ms g711ulaw TextRelay: off
media inactive detected:n media contrl rcvd:n/a timestamp:n/a
long duration call detected:n long duration call duration:n/a timestamp:n/a
0 : 15 971570ms.1 +0 pid:0 Originate connecting
dur 00:00:08 tx:5/10 rx:3/6
IP 192.0.2.3:2000 SRTP: off rtt:0ms pl:0/0ms lost:0/0/0 delay:0/0/0ms g729br8 TextRelay: off
media inactive detected:n media contrl rcvd:n/a timestamp:n/a
long duration call detected:n long duration call duration:n/a timestamp:n/a
Telephony call-legs: 0
SIP call-legs: 2
H323 call-legs: 0
Call agent controlled call-legs: 0
SCCP call-legs: 2
Multicast call-legs: 0
Total call-legs: 4

```

Step 3 show voip rtp connections

Displays Real-Time Transport Protocol (RTP) connections.

Example:

```

Device# show voip rtp connections
VoIP RTP active connections :
No. CallId      dstCallId  LocalRTP  RmtRTP     LocalIP           RemoteIP
1 11            12         16662     19304      192.0.2.1
192.0.2.2
2 12            11         17404     16512      192.0.2.2
192.0.2.3
3 13            14         18422     2000       192.0.2.4
9.44.26.3
4 15            14         16576     2000       192.0.2.6
192.0.2.5
Found 4 active RTP connections

```

Step 4 show sccp connections

Displays information about the connections controlled by the Skinny Client Control Protocol (SCCP) transcoding and conferencing applications.

Example:

```

Device# show sccp connections
sess_id  conn_id  stype mode   codec  sport rport ripaddr
5        5        xcode sendrcv g729b  16576 2000 192.0.2.3
5        6        xcode sendrcv g711u  18422 2000 192.0.2.4
Total number of active session(s) 1, and connection(s) 2

```

Step 5 show dspfarm dsp active

Displays active DSP information about the DSP farm service.

Example:

```
Device# show dspfarm dsp active
SLOT DSP VERSION STATUS CHNL USE TYPE RSC_ID BRIDGE_ID PKTS_TXED PKTS_RXED
0 1 27.0.201 UP 1 USED xcode 1 0x9 5 8
0 1 27.0.201 UP 1 USED xcode 1 0x8 2558 17
Total number of DSPFARM DSP channel(s) 1
```



PART **V**

DSP Services

- [Transcoding, on page 423](#)
- [Transrating, on page 441](#)
- [Call Progress Analysis Over IP-to-IP Media Session, on page 443](#)
- [Voice Packetization, on page 451](#)
- [Fax Detection for SIP Call and Transfer, on page 453](#)



CHAPTER 31

Transcoding

Transcoding is a process of converting one voice codec to another. For example, transcoding between iLBC and G.711 or iLBC and G.729.



Note In every transcoding operation, media flows through CUBE.

LTI based Transcoding

- Internal API is used to access Digital Signaling Processor (DSP) resources for transcoding.
- Transcoding resources (DSPFARM) and CUBE must be on the same platform.
- Only DSPFARM profile configuration is required. Skinny Client Control Protocol (SCCP) configuration is not required.
- No TCP socket is opened and no registration is used.
- DSPFARM profile is associated to a new application type CUBE.

```
Device(config)# dspfarm profile 1 transcode  
Device(config-dspfarm-profile)# associate application CUBE
```

- With LTI transcoding, higher performance is achieved since there is no need for extra SCCP legs and associated RTP streams. The performance is in line high-density mode that is offered with SCCP-based transcoding.
- **crypto pki trustpoint** configuration is not required for Secure Real-Time Transport Protocol (SRTP) to Real-Time Transport Protocol (RTP) calls.



Note The following support LTI-based transcoding:

- Cisco Aggregated Services Routers 1000 Series (ASR 1K)
- Cisco-Integrated Services Generation 2 Routers (Cisco ISR G2)
- Cisco 4000 Series-Integrated Services Routers (ISR G3)
- Cisco 8200 Catalyst Edge Series
- Cisco 8300 Catalyst Edge Series

SCCP based Transcoding

- Skinny Client Control Protocol (SCCP) protocol is used for controlling Digital Signaling Processor (DSP) resources used for transcoding.
- Transcoding resources (DSPFARM) and CUBE can be on different platforms.
- SCCP client (For example, **sccp ccm** configuration and SCCP server (telephony service) configuration is required apart from DSPFARM profile configuration.
- DSPFARM registers with Cisco Unified Border Element over TCP Socket, using SCCP.
- DSPFARM profile is associated to SCCP using the following commands:

```
Device(config)# dspfarm profile 1 transcode
Device(config-dspfarm-profile)# associate application SCCP
```

- High density transcoding needs to be enabled for higher performance. High density transcoding will flow-around through the transcoder.
- Secure Real-time Transport Protocol (SRTP) to Real-time Transport Protocol (RTP) using transcoder requires **crypto pki trustpoint** configuration to establish the Transport Layer Security (TLS) connection with SCCP server.



Note Integrated Services Routers Generation 1 series and Integrated Services Routers Generation 2 Series devices support SCCP-based Transcoding only.

- [Configure LTI-Based Transcoding, on page 424](#)
- [Configuration Examples for LTI Based Transcoding, on page 426](#)
- [Configuring SCCP-based Transcoding \(ISR-G2 devices only\), on page 428](#)
- [TLS for SCCP Connection for DSP Services, on page 430](#)
- [Configuring Secure Transcoding, on page 431](#)
- [Configuration Examples for SCCP Based Transcoding, on page 439](#)

Configure LTI-Based Transcoding



Note We recommend that you configure LTI-based Transcoding for Cisco Aggregated Services Routers (ASR), Cisco Integrated Services Generation 2 Routers (ISR G2), Cisco 4000 Series Integrated Services Routers (ISR G3), Cisco 8200 Catalyst Edge Series, and Cisco 8300 Catalyst Edge Series.

SUMMARY STEPS

1. **enable**
2. **configure terminal**
3. **voice-card** *voice-interface-slot-number*
4. **dsp services dspfarm**
5. **exit**

6. **dspfarm profile** *profile-identifier* **transcode**
7. **codec** *codec*
8. **maximum sessions** *sessions*
9. **associate application** **CUBE**
10. **no shutdown**

DETAILED STEPS

	Command or Action	Purpose
Step 1	enable Example: Device> enable	Enables privileged EXEC mode. <ul style="list-style-type: none">• Enter your password if prompted.
Step 2	configure terminal Example: Device> configure terminal	Enters global configuration mode.
Step 3	voice-card <i>voice-interface-slot-number</i> Example: Device(config)# voice-card 0/2	Configures a voice card and enters voice-card configuration mode.
Step 4	dsp services dspfarm	Enable voice-only DSP services on the Voice Card.
Step 5	exit	Exits the voice-card configuration mode.
Step 6	dspfarm profile <i>profile-identifier</i> transcode Example: Device(config)# dspfarm profile 2 transcode	Enters configuration mode for a DSP farm profile and defines a profile for DSP farm services. <ul style="list-style-type: none">• <i>profile-identifier</i>- Number that uniquely identifies a profile. Range: 1–65535.• transcode- Enables profile for transcoding.
Step 7	codec <i>codec</i> Example: Device(config-dspfarm-profile)# codec opus	Add a list of codecs that you wish to transcode.
Step 8	maximum sessions <i>sessions</i>	Configures maximum number of transcoding sessions.
Step 9	associate application CUBE Example: Device(config)# associate application CUBE	Configures an application to the profile for LTI-based transcoding.
Step 10	no shutdown	Brings the DSP farm in to service.

Configuration Examples for LTI Based Transcoding

LTI-based Transcoding

```

! Enabling dspfarm services under voice-card
Device(config)# voice-card 0/2
Device(config-voicecard)# dsp services dspfarm
Device(config-voicecard)# exit
! Configuring dspfarm profile
Device(config)# dspfarm profile 2 transcode
Device(config-dspfarm-profile)# codec g711ulaw
Device(config-dspfarm-profile)# codec g711alaw
Device(config-dspfarm-profile)# codec g729r8
Device(config-dspfarm-profile)# maximum sessions 10
Device(config-dspfarm-profile)# associate application CUBE
Device(config-dspfarm-profile)# no shutdown
! Starting Service Engine
Device(config)# interface ServiceEngine0/1/0
Device(config-if)# no shutdown
Device(config-if)# exit

```

Example: Secure LTI-based Transcoding

```

!Client trustpoints use HTTP to receive certificate from CA.
Device(config)#ip http server

```

```

!Generate an RSA Keypair.
!(This step generates Private and Public keys. In this example, CUBE is just a label. It
can be anything.)

```

```

crypto key generate rsa general-keys label CUBE modulus 1024
The name for the keys will be: CUBE
% The key modulus size is 1024 bits
% Generating 1024 bit RSA keys, keys will be non-exportable...
[OK] (elapsed time was 0 seconds)

```

```

!Configure IOS CA Server. In this example, CA Server is named cube-ca.

```

```

crypto pki server cube-ca
  database level complete
  no database archive
  grant auto
  lifetime certificate 1800

```

```

Secure-CUBE(cs-server)#no shut
%Some server settings cannot be changed after CA certificate generation.
% Please enter a passphrase to protect the private key
% or type Return to exit

```

```

Password:

```

```

Re-enter password:

```



```
% Generating 1024 bit RSA keys, keys will be non-exportable...
[OK] (elapsed time was 0 seconds)

% Certificate Server enabled.

!Create PKI trustpoints for cube for TLS communication.

crypto pki trustpoint CUBE-TLS
 enrollment url http://X.X.X.X:80
 serial-number none
 fqdn none
 ip-address none
 subject-name CN=Secure-CUBE
 revocation-check none
 rsakeypair CUBE

!Authenticate the trustpoint with CA server and accept certificate of CA

crypto pki authenticate CUBE-TLS
Certificate has the following attributes:
  Fingerprint MD5: BCEBB5A1 1AC882F7 24BE476D 06537711
  Fingerprint SHA1: CE2FEEA5 42515B33 3EF6A8F6 7E31D6DF 8E32BEB6

% Do you accept this certificate? [yes/no]: yes
Trustpoint CA certificate accepted.

!Enroll the trustpoint with CA server.
!In this step the CUBE receives a signed certificate from CA.

Secure-CUBE(config)#crypto pki enroll CUBE-TLS
%
% Start certificate enrollment ..
% Create a challenge password. You will need to verbally provide this
  password to the CA Administrator in order to revoke your certificate.
  For security reasons your password will not be saved in the configuration.
  Please make a note of it.

Password:
Re-enter password:

% The subject name in the certificate will include: CN=Secure-CUBE
% The fully-qualified domain name will not be included in the certificate
Request certificate from CA? [yes/no]: yes
% Certificate request sent to Certificate Authority
% The 'show crypto pki certificate verbose CUBE-TLS' command will show the
  fingerprint.

!Configure TCP TLS as transport protocol

voice service voip
 sip
 session transport tcp tls

!Assign trustpoint for sip-ua, this trustpoint is used for all SIP signaling between CUBE
and CUCM.

sip-ua
crypto signaling remote-addr <cucm pub ip address> 255.255.255.255 trustpoint CUBE-TLS
crypto signaling remote-addr <cucm sub ip address> 255.255.255.255 trustpoint CUBE-TLS
```

```

!or or default trustpoint can be configured for all SIP signaling from CUBE.

sip-ua
crypto signaling default trustpoint CUBE-TLS

!Enable SRTP.

Voice service voip
srtp fallback

!Configure secure transcoder is required.

dspfarm profile 1 transcode universal security
codec g711ulaw
codec g711alaw
codec g729ar8
codec g729abr8
maximum sessions 10
associate application CUBE

```

Configuring SCCP-based Transcoding (ISR-G2 devices only)

SUMMARY STEPS

1. **enable**
2. **configure terminal**
3. **voice-card** *voice-interface-slot-number*
4. **dspfarm**
5. **dsp service dspfarm**
6. **exit**
7. **telephony-service**
8. **sdspfarm units** *units*
9. **sdspfarm transcode sessions** *units*
10. **sdspfarm tag** *value Device-Name*
11. **max-ephones** *max-phones-to-be-supported*
12. **max-dn** *max-directorynumbers-to-be-supported*
13. **ip source-address** *CUBE-internal-ipv4-address* [**port** *port-number*]
14. **exit**
15. **sccp local** *interface-type number*
16. **sccp ccm** *CUBE-internal-ipv4-address* **identifier** *identifier-number* **version** *version-number*
17. **sccp**
18. **sccp ccm group** *group-id*
19. **associate ccm** *CCM-identifier* **priority** *priority*
20. **associate profile** *profile-identifier* **register** *Device-Name*
21. **exit**
22. **dspfarm profile** *profile-id* **transcode**
23. **codec** *codec*

- 24. **maximum sessions** *sessions*
- 25. **associate application** *sccp*
- 26. **exit**

DETAILED STEPS

	Command or Action	Purpose
Step 1	enable Example: Device> enable	Enables privileged EXEC mode. • Enter your password if prompted.
Step 2	configure terminal Example: Device> configure terminal	Enters global configuration mode.
Step 3	voice-card <i>voice-interface-slot-number</i> Example: Device(config)# voice-card 1	Configures a voice card and enters voice-card configuration mode.
Step 4	dspfarm	Enable voice card for DSP.
Step 5	dsp service dspfarm	Enable voice-only dspfarm services on the Voice Card.
Step 6	exit	Exits the voice-card configuration mode.
Step 7	telephony-service	Enters telephony-service configuration mode.
Step 8	sdspfarm units <i>units</i>	Define maximum number of dspfarm units.
Step 9	sdspfarm transcode sessions <i>units</i>	Define maximum number of dspfarm transcode session.
Step 10	sdspfarm tag <i>value Device-Name</i> Example: Device(config-telephony)# sdspfarm tag 1 CUBE-XCODE	Configures a name for the transcoder.
Step 11	max-ephones <i>max-phones-to-be-supported</i>	Configures the maximum number of phones that are to be supported.
Step 12	max-dn <i>max-directorynumbers-to-be-supported</i>	Configures the maximum number of directories to be supported.
Step 13	ip source-address <i>CUBE-internal-ipv4-address [port port-number]</i> Example: Device(config-telephony)# ip source-address 10.1.1.1 port 2000	Defines an IP address and port number for the telephony service.
Step 14	exit	Exits the telephony-service configuration mode.
Step 15	sccp local <i>interface-type number</i>	Configures the local gateway related parameters values.

	Command or Action	Purpose
Step 16	<code>sccp ccm CUBE-internal-ipv4-address identifier identifier-number version version-number</code>	Configures call manager related parameter values.
Step 17	<code>sccp</code>	Enable Skinny Client Control Protocol.
Step 18	<code>sccp ccm group group-id</code> Example: Device(config)#sccp ccm group 1	Configures Call Manager Group and enters SCCP CCM configuration mode.
Step 19	<code>associate ccm CCM-identifier priority priority</code> Example: Device(config-sccp-ccm)# associate ccm 1 priority 1	Configures Call Manager Group and enters SCCP CCM configuration mode.
Step 20	<code>associate profile profile-identifier register Device-Name</code> Example: Device(config-sccp-ccm)# associate profile 1 register CUBE-XCODE	Specifies the device name that needs to register.
Step 21	<code>exit</code>	Exits SCCP CCM configuration mode.
Step 22	<code>dspfarm profile profile-id transcode</code> Example: Device(config)# dspfarm profile 1 transcode	Configures a Transcoding profile and enters DSP profile configuration mode.
Step 23	<code>codec codec</code> Example: Device(config-dspfarm-profile)# codec ilbc	The codec rate to be attempted for SCCP-controlled connections.
Step 24	<code>maximum sessions sessions</code>	Configures maximum number of sessions.
Step 25	<code>associate application sccp</code> Example: Device(config-dspfarm-profile)# associate application sccp	Configures an application to the profile for SCCP-based transcoding.
Step 26	<code>exit</code>	Exits the telephony-service configuration mode.

TLS for SCCP Connection for DSP Services

The Cisco Unified Border Element supports Transport Layer Security (TLS) to be enabled or disabled between the Skinny Call Control Protocol (SCCP) server and the SCCP client. By default, TLS is enabled, which provides added protection at the transport level and ensures that SRTP keys are not easily accessible. Once TLS is disabled, the SRTP keys are not protected.

SRTP-RTP interworking is available with normal and universal transcoders. The transcoder on the Cisco Unified Border Element is invoked using SCCP messaging between the SCCP server and the SCCP client. SCCP messages carry the SRTP keys to the digital signal processor (DSP) farm at the SCCP client. The

transcoder can be within the same router or can be located in a separate router. TLS should be disabled only when the transcoder is located in the same router. To disable TLS, configure the **no** form of the **tls** command in DSPFARM profile configuration mode. Disabling TLS improves CPU performance.

Configuring Secure Transcoding

Configuring the Certificate Authority

Perform the steps described in this section to configure the certificate authority.

SUMMARY STEPS

1. **enable**
2. **configure terminal**
3. **ip http server**
4. **crypto pki server** *cs-label*
5. **database level** **complete**
6. **grant auto**
7. **no shutdown**
8. **exit**

DETAILED STEPS

	Command or Action	Purpose
Step 1	enable Example: Device> enable	Enables privileged EXEC mode. • Enter your password if prompted.
Step 2	configure terminal Example: Device# configure terminal	Enters global configuration mode.
Step 3	ip http server Example: Device(config)# ip http server	Enables the HTTP server on your IPv4 or IPv6 system, including the Cisco web browser user interface.
Step 4	crypto pki server <i>cs-label</i> Example: Device(config)# crypto pki server 3854-cube	Enables a Cisco IOS certificate server and enters certificate server configuration mode. • In the example, 3854-cube is specified as the name of the certificate server.

	Command or Action	Purpose
Step 5	database level complete Example: Device(cs-server)# database level complete	Controls what type of data is stored in the certificate enrollment database. <ul style="list-style-type: none"> • In the example, each issued certificate is written to the database.
Step 6	grant auto Example: Device(cs-server)# grant auto	Specifies automatic certificate enrollment.
Step 7	no shutdown Example: Device(cs-server)# no shutdown	Reenables the certificate server. <ul style="list-style-type: none"> • Create and enter a new password when prompted.
Step 8	exit Example: Device(cs-server)# exit	Exits certificate server configuration mode.

Configuring a Trustpoint for the Secure Universal Transcoder

Perform the task in this section to configure, authenticate, and enroll a trustpoint for the secure universal transcoder.

Before you begin

Before you configure a trustpoint for the secure universal transcoder, you should configure the certificate authority, as described in the [Configuring the Certificate Authority, on page 431](#).

SUMMARY STEPS

1. **enable**
2. **configure terminal**
3. **crypto pki trustpoint** *name*
4. **enrollment url** *url*
5. **serial-number**
6. **revocation-check** *method*
7. **rsakeypair** *key-label*
8. **end**
9. **crypto pki authenticate** *name*
10. **crypto pki enroll** *name*
11. **exit**

DETAILED STEPS

	Command or Action	Purpose
Step 1	enable Example: Device> enable	Enables privileged EXEC mode. <ul style="list-style-type: none"> • Enter your password if prompted.
Step 2	configure terminal Example: Device# configure terminal	Enters global configuration mode.
Step 3	crypto pki trustpoint <i>name</i> Example: Device(config)# crypto pki trustpoint secdsp	Declares the trustpoint that the router uses and enters ca-trustpoint configuration mode. <ul style="list-style-type: none"> • In the example, the trustpoint is named secdsp.
Step 4	enrollment url <i>url</i> Example: Device(ca-trustpoint)# enrollment url http://10.13.2.52:80	Specifies the enrollment parameters of a certification authority (CA). <ul style="list-style-type: none"> • In the example, the URL is defined as http://10.13.2.52:80.
Step 5	serial-number Example: Device(ca-trustpoint)# serial-number	Specifies whether the router serial number should be included in the certificate request.
Step 6	revocation-check <i>method</i> Example: Device(ca-trustpoint)# revocation-check crl	Checks the revocation status of a certificate. <ul style="list-style-type: none"> • In the example, the certificate revocation list checks the revocation status.
Step 7	rsa keypair <i>key-label</i> Example: Device(ca-trustpoint)# rsa keypair 3845-cube	Specifies which key pair to associate with the certificate. <ul style="list-style-type: none"> • In the example, the key pair 3845-cube generated during enrollment is associated with the certificate.
Step 8	end Example: Device(ca-trustpoint)# end	Exits ca-trustpoint configuration mode.
Step 9	crypto pki authenticate <i>name</i> Example: Device(config)# crypto pki authenticate secdsp	Authenticates the CA. <ul style="list-style-type: none"> • Accept the trustpoint CA certificate if prompted.

	Command or Action	Purpose
Step 10	crypto pki enroll <i>name</i> Example: Device(config)# crypto pki enroll secdsp	Obtains the certificate for the router from the CA. <ul style="list-style-type: none"> • Create and enter a new password if prompted. • Request a certificate from the CA if prompted.
Step 11	exit Example: Device(config)# exit	Exits global configuration mode.

Configuring DSPFARM Services

For configuration steps, see [Configure LTI-Based Transcoding](#).

Associating SCCP to the Secure DSPFARM Profile

Perform the task in this section to associate SCCP to the secure DSPFARM profile.

Before you begin

Before you associate SCCP to the secure DSPFARM profile, you should configure DSPFARM services, as described in the “Configuring DSPFARM Services”.

SUMMARY STEPS

1. **enable**
2. **configure terminal**
3. **sccp local** *interface-type interface-number*
4. **sccp ccm** *ip-address identifier identifier-number version version-number*
5. **sccp**
6. **associate ccm** *identifier-number priority priority-number*
7. **associate profile** *profile-identifier register device-name*
8. **dspfarm profile** *profile-identifier transcode universal security*
9. **trustpoint** *trustpoint-label*
10. **codec** *codec-type*
11. Repeat Step 10 to configure required codecs.
12. **maximum sessions** *number*
13. **associate application sccp**
14. **no shutdown**
15. **exit**

DETAILED STEPS

	Command or Action	Purpose
Step 1	enable	Enables privileged EXEC mode.

	Command or Action	Purpose
	<p>Example:</p> <pre>Device> enable</pre>	<ul style="list-style-type: none"> • Enter your password if prompted.
Step 2	<p>configure terminal</p> <p>Example:</p> <pre>Device# configure terminal</pre>	Enters global configuration mode.
Step 3	<p>sccp local <i>interface-type interface-number</i></p> <p>Example:</p> <pre>Device(config)# sccp local GigabitEthernet 0/0</pre>	<p>Selects the local interface that SCCP applications (transcoding and conferencing) use to register with Cisco CallManager.</p> <ul style="list-style-type: none"> • In the example, the following parameters are set: <ul style="list-style-type: none"> • GigabitEthernet is defined as the interface type that the SCCP application uses to register with Cisco CallManager. • The interface number that the SCCP application uses to register with Cisco CallManager is specified as 0/0.
Step 4	<p>sccp ccm <i>ip-address identifier identifier-number version version-number</i></p> <p>Example:</p> <pre>Device(config)# sccp ccm 10.13.2.52 identifier 1 version 5.0.1</pre>	<p>Adds a Cisco Unified Communications Manager server to the list of available servers.</p> <ul style="list-style-type: none"> • In the example, the following parameters are set: <ul style="list-style-type: none"> • 10.13.2.52 is configured as the IP address of the Cisco Unified Communications Manager server. • The number 1 identifies the Cisco Unified Communications Manager server. • The Cisco Unified Communications Manager version is identified as 5.0.1.
Step 5	<p>sccp</p> <p>Example:</p> <pre>Device(config)# sccp</pre>	Enables SCCP and related applications (transcoding and conferencing) and enters SCCP Cisco CallManager configuration mode.
Step 6	<p>associate ccm <i>identifier-number priority priority-number</i></p> <p>Example:</p> <pre>Device(config-sccp-ccm)# associate ccm 1 priority 1</pre>	<p>Associates a Cisco Unified CallManager with a Cisco CallManager group and establishes its priority within the group.</p> <ul style="list-style-type: none"> • In the example, the following parameters are set: <ul style="list-style-type: none"> • The number 1 identifies the Cisco Unified CallManager. • The Cisco Unified CallManager is configured with the highest priority within the Cisco CallManager group.

	Command or Action	Purpose
Step 7	<p>associate profile <i>profile-identifier</i> register <i>device-name</i></p> <p>Example:</p> <pre>Device(config-sccp-ccm)# associate profile 1 register sxcoder</pre>	<p>Associates a DSPFARM profile with a Cisco CallManager group.</p> <ul style="list-style-type: none"> In the example, the following parameters are set: <ul style="list-style-type: none"> The number 1 identifies the DSPFARM profile. Sxcoder is configured as the user-specified device name in Cisco Unified CallManager.
Step 8	<p>dspfarm profile <i>profile-identifier</i> transcode universal security</p> <p>Example:</p> <pre>Device(config-sccp-ccm)# dspfarm profile 1 transcode universal security</pre>	<p>Defines a profile for DSPFARM services and enters DSPFARM profile configuration mode.</p> <ul style="list-style-type: none"> In the example, the following parameters are set: <ul style="list-style-type: none"> Profile 1 is enabled for transcoding. Profile 1 is enabled for secure DSPFARM services.
Step 9	<p>trustpoint <i>trustpoint-label</i></p> <p>Example:</p> <pre>Device(config-dspfarm-profile)# trustpoint secdsp</pre>	<p>Associates a trustpoint with a DSPFARM profile.</p> <ul style="list-style-type: none"> In the example, the trustpoint to be associated with the DSPFARM profile is labeled secdsp.
Step 10	<p>codec <i>codec-type</i></p> <p>Example:</p> <pre>Device(config-dspfarm-profile)# codec g711ulaw</pre>	<p>Specifies the codecs that are supported by a DSPFARM profile.</p> <ul style="list-style-type: none"> In the example, the g711ulaw codec is specified.
Step 11	Repeat Step 10 to configure required codecs.	--
Step 12	<p>maximum sessions <i>number</i></p> <p>Example:</p> <pre>Device(config-dspfarm-profile)# maximum sessions 84</pre>	<p>Specifies the maximum number of sessions that are supported by the profile.</p> <ul style="list-style-type: none"> In the example, a maximum of 84 sessions are supported by the profile. The maximum number of sessions depends on the number of DSPs available for transcoding.
Step 13	<p>associate application sccp</p> <p>Example:</p> <pre>Device(config-dspfarm-profile)# associate application sccp</pre>	Associates SCCP to the DSPFARM profile.
Step 14	<p>no shutdown</p> <p>Example:</p> <pre>Device(config-dspfarm-profile)# no shutdown</pre>	Allocates DSPFARM resources and associates them with the application.

	Command or Action	Purpose
Step 15	<p>exit</p> <p>Example:</p> <pre>Device(config-dspfarm-profile)# exit</pre>	Exits DSPFARM profile configuration mode.

Registering the Secure Universal Transcoder to the CUBE

Perform the task in this section to register the secure universal transcoder to the Cisco Unified Border Element. The Cisco Unified Border Element Support for SRTP-RTP Interworking feature supports both secure transcoders and secure universal transcoders.

Before you begin

Before you register the secure universal transcoder to the Cisco Unified Border Element, you should associated SCCP to the secure DSPFARM profile, as described in the [Associating SCCP to the Secure DSPFARM Profile, on page 434](#).

SUMMARY STEPS

1. **enable**
2. **configure terminal**
3. **telephony-service**
4. **sdsfarm transcode sessions** *number*
5. **sdsfarm tag** *number device-name*
6. **em logout** *time1 time2 time3*
7. **max-ephones** *max-ephones*
8. **max-dn** *max-directory-numbers*
9. **ip source-address** *ip-address*
10. **secure-signaling trustpoint** *label*
11. **tftp-server-credentials trustpoint** *label*
12. **create cnf-files**
13. **no sccp**
14. **sccp**
15. **end**

DETAILED STEPS

	Command or Action	Purpose
Step 1	<p>enable</p> <p>Example:</p> <pre>Device> enable</pre>	<p>Enables privileged EXEC mode.</p> <ul style="list-style-type: none"> • Enter your password if prompted.
Step 2	<p>configure terminal</p> <p>Example:</p>	Enters global configuration mode.

	Command or Action	Purpose
	Device> configure terminal	
Step 3	telephony-service Example: Device(config)# telephony-service	Enters telephony-service configuration mode.
Step 4	sdspfarm transcode sessions <i>number</i> Example: Device(config-telephony)# sdspfarm transcode sessions 84	Specifies the maximum number of transcoding sessions allowed per Cisco CallManager Express router. <ul style="list-style-type: none"> • In the example, a maximum of 84 DSPFARM sessions are specified.
Step 5	sdspfarm tag <i>number device-name</i> Example: Device(config-telephony)# sdspfarm tag 1 sxcoder	Permits a DSPFARM to be registered to Cisco Unified CallManager Express and associates it with an SCCP client interface's MAC address. <ul style="list-style-type: none"> • In the example, DSPFARM 1 is associated with the sxcoder device.
Step 6	em logout <i>time1 time2 time3</i> Example: Device(config-telephony)# em logout 0:0 0:0 0:0	Configures three time-of-day-based timers for automatically logging out all Extension Mobility feature users. <ul style="list-style-type: none"> • In the example, all users are logged out from Extension Mobility after 00:00.
Step 7	max-ephones <i>max-ephones</i> Example: Device(config-telephony)# max-ephones 4	Sets the maximum number of Cisco IP phones to be supported by a Cisco CallManager Express router. <ul style="list-style-type: none"> • In the example, a maximum of four phones are supported by the Cisco CallManager Express router.
Step 8	max-dn <i>max-directory-numbers</i> Example: Device(config-telephony)# max-dn 4	Sets the maximum number of extensions (ephone-dns) to be supported by a Cisco Unified CallManager Express router. <ul style="list-style-type: none"> • In the example, a maximum of four extensions is allowed.
Step 9	ip source-address <i>ip-address</i> Example: Device(config-telephony)# ip source-address 10.13.2.52	Identifies the IP address and port through which IP phones communicate with a Cisco Unified CallManager Express router. <ul style="list-style-type: none"> • In the example, 10.13.2.52 is configured as the router IP address.

	Command or Action	Purpose
Step 10	<p>secure-signaling trustpoint <i>label</i></p> <p>Example:</p> <pre>Device(config-telephony)# secure-signaling trustpoint secdsp</pre>	<p>Specifies the name of the Public Key Infrastructure (PKI) trustpoint with the certificate to be used for TLS handshakes with IP phones on TCP port 2443.</p> <ul style="list-style-type: none"> In the example, PKI trustpoint secdsp is configured.
Step 11	<p>tftp-server-credentials trustpoint <i>label</i></p> <p>Example:</p> <pre>Device(config-telephony)# tftp-server-credentials trustpoint scme</pre>	<p>Specifies the PKI trustpoint that signs the phone configuration files.</p> <ul style="list-style-type: none"> In the example, PKI trustpoint scme is configured.
Step 12	<p>create cnf-files</p> <p>Example:</p> <pre>Device(config-telephony)# create cnf-files</pre>	<p>Builds the XML configuration files that are required for IP phones in Cisco Unified CallManager Express.</p>
Step 13	<p>no sccp</p> <p>Example:</p> <pre>Device(config-telephony)# no sccp</pre>	<p>Disables SCCP and its related applications (transcoding and conferencing) and exits telephony-service configuration mode.</p>
Step 14	<p>sccp</p> <p>Example:</p> <pre>Device(config)# sccp</pre>	<p>Enables SCCP and related applications (transcoding and conferencing).</p>
Step 15	<p>end</p> <p>Example:</p> <pre>Device(config)# end</pre>	<p>Exits global configuration mode.</p>

Configuration Examples for SCCP Based Transcoding

Example: SCCP-based Transcoding

```
! Enabling dspfarm services under voice-card
Device(config)# voice-card 1

Device(config-voicecard)# dspfarm
Device(config-voicecard)# dsp services dspfarm
Device(config-voicecard)# exit

! Configuring Telephony Service
Device(config)# telephony-service
Device(config-telephony)# sdspfarm units 1
```

```
Device(config-telephony)# sdspfarm transcode sessions 128
Device(config-telephony)# sdspfarm tag 1 CUBE-XCODE
Device(config-telephony)# max-ephones 10
Device(config-telephony)# max-dn 10
Device(config-telephony)# ip source-address 10.1.1.1 port 2000
Device(config-telephony)# exit

! Configuring SCCP
Device(config)# no sccp
Device(config)# sccp local GigabitEthernet0/0
Device(config)# sccp ccm 10.1.1.1 identifier 1 version 4.0
Device(config)# sccp
Device(config)# sccp ccm group 1
Device(config-sccp-ccm)# associate ccm 1 priority 1
Device(config-sccp-ccm)# associate profile 1 register CUBE-XCODE
Device(config-sccp-ccm)# exit

! Configuring dspfarm profile
Device(config)# dspfarm profile 1 transcode
Device(config-dspfarm-profile)# codec g711ulaw
Device(config-dspfarm-profile)# codec g711alaw
Device(config-dspfarm-profile)# codec g729r8
Device(config-dspfarm-profile)# maximum sessions 10

Device(config-dspfarm-profile)# associate application SCCP
Device(config-dspfarm-profile)# exit
```



CHAPTER 32

Transrating

Transrating is a process of configuring a different packetization for a voice codec. For example, transrating G.729 20ms to G.729 30ms.

- [Configuring Transrating for a Codec, on page 441](#)

Configuring Transrating for a Codec

SUMMARY STEPS

1. **enable**
2. **configure terminal**
3. **dial-peer voice *number* voip**
4. **codec *codec-name* bytes *voice-payload-size* [fixed-bytes]**
5. **end**

DETAILED STEPS

	Command or Action	Purpose
Step 1	enable Example: Device> enable	Enables privileged EXEC mode. <ul style="list-style-type: none">• Enter your password if prompted.
Step 2	configure terminal Example: Device> configure terminal	Enters global configuration mode.
Step 3	dial-peer voice <i>number</i> voip Example: Device(config)# dial-peer voice 1 voip	Enters dial peer configuration mode for the specified VoIP dial peer.
Step 4	codec <i>codec-name</i> bytes <i>voice-payload-size</i> [fixed-bytes] Example: Device(config-dial-peer)# codec g729r8 bytes 30 fixed-byte	Configures a different packetizations for a voice codec.

	Command or Action	Purpose
Step 5	end Example: Device(config-dial-peer) # end	Exits to privileged EXEC mode.



CHAPTER 33

Call Progress Analysis Over IP-to-IP Media Session

The Call Progress Analysis Over IP-IP Media Session feature enables the detection of automated answering systems and live human voices on outbound calls and communicates the detected information to the external application. Typically, call progress analysis (CPA) is extensively used in contact center deployments in conjunction with the outbound Session Initiation Protocol (SIP) dialer, where CPA is enabled on the Cisco Unified Border Element (Cisco UBE), and digital signal processors (DSP) perform the CPA functionality.

- [Feature Information for Call Progress Analysis Over IP-IP Media Session, on page 443](#)
- [Restrictions for Call Progress Analysis Over IP-to-IP Media Session, on page 444](#)
- [Information About Call Progress Analysis Over IP-IP Media Session, on page 445](#)
- [How to Configure Call Progress Analysis Over IP-to-IP Media Session, on page 446](#)
- [Configuration Examples for the Call Progress Analysis Over IP-to-IP Media Session, on page 449](#)

Feature Information for Call Progress Analysis Over IP-IP Media Session

The following table provides release information about the feature or features described in this module. This table lists only the software release that introduced support for a given feature in a given software release train. Unless noted otherwise, subsequent releases of that software release train also support that feature.

Use Cisco Feature Navigator to find information about platform support and Cisco software image support. To access Cisco Feature Navigator, go to <https://cfng.cisco.com/>. An account on Cisco.com is not required.

Table 51: Feature Information for Call Progress Analysis Over IP-IP Media Session

Feature Name	Releases	Feature Information
Call Progress Analysis Over IP-to-IP Media Session	15.3(2)T	The Call Progress Analysis Over IP-to-IP Media Session feature enables detection of automated answering systems and live human voices on outbound calls and communicates the detected information to an external application. The following command was introduced: call-progress-analysis.
Call Progress Analysis Over IP-to-IP Media Session	Cisco IOS XE Release 3.9S	The Call Progress Analysis Over IP-to-IP Media Session feature enables detection of automated answering systems and live human voices on outbound calls and communicates the detected information to an external application. The following command was introduced: call-progress-analysis.
Support for additional call flows	15.5(2)T Cisco IOS XE Release 3.15S	Call Progress Analysis feature is enhanced to support the following call-flows: <ul style="list-style-type: none"> • 180 SIP response received without SDP • Direct call connect (without 18x from Service Provider) • Multiple 18x response to INVITE • Early dialog UPDATE • Dialer-CUBE CPA call record

Restrictions for Call Progress Analysis Over IP-to-IP Media Session

- Only SIP-to-SIP Early Offer (EO-to-EO) call flows are supported.
- Session Description Protocol (SDP) passthrough and flow-around media calls are not supported.
- Only the G711 flavor of codec is supported.
- High Availability (HA) is not supported.
- Skinny Client Control Protocol (SCCP)-based digital signal processor (DSP) farm is not supported.
- CPA cannot not be detected if Dialer uses Inband as DTMF relay mechanism, that is, Inband to RTP-NTE DTMF inter-working is not supported with CPA.
- CPA call record is not supported for "180 without SDP" and "Direct Call Connect (without 18x)" call flows from Service Provider.

- With VCC codec configured on the dial-peer, the list of codecs in the VCC should match with the list of codec provisioned in DSP transcoder profile when CPA is enabled.

Information About Call Progress Analysis Over IP-IP Media Session

Call Progress Analysis

Call progress analysis (CPA) is a DSP algorithm that analyzes the Real-Time Transport Protocol (RTP) voice stream to look for special information tones (SIT), fax or modem tones, human speech, and answering machine tones. CPA also passes the voice information to Cisco IOS or Cisco Unified Border Element (Cisco UBE).

CPA is initiated on receiving a new SIP INVITE with x-cisco-cpa content. While a call is in progress, the DSP or the Xcoder analyzes the incoming voice or media stream. The DSP identifies the type of voice stream based on statistical voice patterns or specific tone frequencies and provides the information to the Cisco UBE. The Cisco UBE notifies the dialer with a SIP UPDATE with x-cisco-cpa content along with the detected event. Based on the report, the caller (dialer) can decide to either transfer the call or terminate the call.

To use the CPA functionality, you must enable CPA and configure CPA timing and threshold parameters.

Table 52: X-cisco-cpa content meaning

SIP Message	Direction of Message	Meaning
18x or 200	Cisco IOS to dialer	Cisco UBE informs the dialer if CPA is enabled for a call or not.
New INVITE	Dialer to Cisco IOS	Dialer requests Cisco IOS or the Cisco UBE to activate the CPA algorithm for this session.
UPDATE	Cisco IOS to dialer	Cisco IOS or the Cisco UBE notifies the dialer about the detected event.

CPA Events

Table 53: CPA Event Detection List

CPA Event	Definition
Asm	Answer machine
AsmT	Answer machine terminate tone
CpaS	Start of the Call Progress Analysis
FT	Fax/Modem tone

CPA Event	Definition
LS	Live human speech
LV	Low volume or dead air call
SitIC	Special information tone IC -- Intercept -- Vacant number or Automatic Identification System (AIS)
SitNC	SIT tone NC—No Circuit (NC), Emergency, or Trunk Blockage
SitVC	SIT tone VC—Vacant Code
SitRO	SIT tone RO—Reorder Announcement
SitMT	Miscellaneous SIT Tone

How to Configure Call Progress Analysis Over IP-to-IP Media Session

Enabling CPA and Setting the CPA Parameters

Perform the following task to enable CPA and set the CPA timing and threshold parameters:

SUMMARY STEPS

1. **enable**
2. **configure terminal**
3. **dspfarm profile *profile-identifier* transcode**
4. **call-progress-analysis**
5. **exit**
6. **voice service voip**
7. **cpa timing live-person *max-duration***
8. **cpa timing term-tone *max-duration***
9. **cpa threshold active-signal *signal-threshold***
10. **end**

DETAILED STEPS

	Command or Action	Purpose
Step 1	enable Example: Device> enable	Enables privileged EXEC mode. <ul style="list-style-type: none"> • Enter your password if prompted.

	Command or Action	Purpose
Step 2	<p>configure terminal</p> <p>Example: Device# configure terminal</p>	Enters global configuration mode.
Step 3	<p>dspfarm profile <i>profile-identifier</i> transcode</p> <p>Example: Device(config)# dspfarm profile 15 transcode</p>	Enters DSP farm profile configuration mode, defines a profile for DSP farm services, and enables the profile for transcoding.
Step 4	<p>call-progress-analysis</p> <p>Example: Device(config-dspfarm-profile)# call-progress-analysis</p>	<p>Enables call progress analysis (CPA) on Cisco UBE.</p> <ul style="list-style-type: none"> You must configure this command to activate the CPA feature and set CPA parameters.
Step 5	<p>exit</p> <p>Example: Device(config-dspfarm-profile)# exit</p>	Exits DSP farm profile configuration mode and enters global configuration mode.
Step 6	<p>voice service voip</p> <p>Example: Device(config)# voice service voip</p>	Enters voice service configuration mode.
Step 7	<p>cpa timing live-person <i>max-duration</i></p> <p>Example: Device(conf-voi-serv)# cpa timing live-person 2501</p>	(Optional) Sets the maximum waiting time (in milliseconds) that the CPA algorithm uses to determine if a call is answered by a live human.
Step 8	<p>cpa timing term-tone <i>max-duration</i></p> <p>Example: Device(conf-voi-serv)# cpa timing term-tone 15500</p>	(Optional) Sets the maximum waiting time (in milliseconds) that the CPA algorithm uses to wait for the answering machine termination tone after the answering machine is detected.
Step 9	<p>cpa threshold active-signal <i>signal-threshold</i></p> <p>Example: Device(conf-voi-serv)# cpa threshold active-signal 18db</p>	<p>(Optional) Sets the threshold (in decibels) of an active signal that is related to the measured noise floor level.</p> <ul style="list-style-type: none"> If a signal threshold configured by this command is greater than the measured noise floor level, then the signal is considered as active. The active signal thresholds that you can configure are 9, 12, 15, 18, and 21 decibels.

	Command or Action	Purpose
Step 10	end Example: Device(conf-voi-serv)# end	Exits voice service configuration mode and returns to privileged EXEC mode.

Verifying the Call Progress Analysis Over IP-to-IP Media Session

Perform this task to verify that call progress analysis has been configured for a digital signal processor (DSP) farm profile.

SUMMARY STEPS

1. **enable**
2. **show dspfarm profile *profile-identifier***

DETAILED STEPS

Step 1 **enable**

Enables privileged EXEC mode.

Example:

```
Device> enable
```

Step 2 **show dspfarm profile *profile-identifier***

Displays the configured DSP farm profile information for a selected Cisco Call Manager group. In the following sample output, the Call Progress Analysis field shows that CPA is enabled.

Example:

```
Device# show dspfarm profile 3

Profile ID = 3, Service =Universal TRANSCODING, Resource ID = 3
Profile Description :
Profile Service Mode : Non Secure
Profile Admin State : UP
Profile Operation State : ACTIVE
Application : CUBE Status : ASSOCIATED
Resource Provider : FLEX_DSFRM Status : UP
Number of Resource Configured : 4
Number of Resources Out of Service : 0
Number of Resources Active : 0
Codec Configuration: num_of_codecs:4
Codec : g711ulaw, Maximum Packetization Period : 30
Codec : g711alaw, Maximum Packetization Period : 30
Codec : g729ar8, Maximum Packetization Period : 60
Codec : g729abr8, Maximum Packetization Period : 60
Noise Reduction : ENABLED
Call Progress Analysis : ENABLED
```

Troubleshooting Tips

Use the following commands to troubleshoot the call progress analysis for SIP-to-SIP calls:

- `debug ccsip all`
- `debug voip ccapi inout`
- `debug voip hpi all`
- `debug voip ipipgw`
- `debug voip media resource provisioning all`

Configuration Examples for the Call Progress Analysis Over IP-to-IP Media Session

Example: Enabling CPA and Setting the CPA Parameters

The following example shows how to enable CPA and set a few timing and threshold parameters. Depending on your requirements, you can configure more timing and threshold parameters.

```
Device> enable
Device# configure terminal
Device(config)# dspfarm profile 15 transcode
Device(config-dspfarm-profile)# call-progress-analysis
Device(config-dspfarm-profile)# exit
Device(config)# voice service voip
Device(conf-voi-serv)# cpa timing live-person 2501
Device(conf-voi-serv)# cpa timing term-tone 15500
Device(conf-voi-serv)# cpa threshold active-signal 18db
Device(conf-voi-serv)# end
```



CHAPTER 34

Voice Packetization

After the voice wavelength is digitized, the DSP collects the digitized data for an amount of time until there is enough data to fill the payload of a single packet.

With G.711, either 20 ms or 30 ms worth of voice is transmitted in a single packet. 20 ms worth of voice corresponds to 160 samples per packet. With 20 ms worth of voice per packet, 50 packets are created per second: $1 \text{ sec} / 20 \text{ ms} = 50$.

The packetization rate has a direct effect on the total amount of bandwidth needed. More packets require more headers, and each header adds 40 bytes to the packet. The [Table 14: Codec and Bandwidth Information, on page 54](#) table shows the effect of packetization rates on bandwidth utilization.

Codecs such as G.729 also compress the digitized output. G.729 creates a codeword for every 10 ms of voice. This “codeword” is a predefined representation of a 10-ms sample of human voice. Two codewords are contained in each packet at 50 packets per second or three codewords at 33.3 packets per second. Because the codewords need fewer bits, the overall bandwidth required is reduced.

Table 54: Packetization for different Codecs

Supported Codecs	Packetization (ms)
G.711 a-law 64 Kbps	10, 20, 30
G.711 law 64 Kbps	10, 20, 30
G.723 5.3/6/3 Kbps	30, 60
G.729, G.729A, G.729B, G.729AB 8 Kbps	10, 20, 30, 40, 50, 60
G.722—64 Kbps	10, 20, 30

- [Configuring Transrating for a Codec, on page 451](#)

Configuring Transrating for a Codec

SUMMARY STEPS

1. **enable**
2. **configure terminal**
3. **dial-peer voice *number* voip**

4. `codec codec-name bytes voice-payload-size [fixed-bytes]`
5. `end`

DETAILED STEPS

	Command or Action	Purpose
Step 1	enable Example: Device> enable	Enables privileged EXEC mode. <ul style="list-style-type: none"> • Enter your password if prompted.
Step 2	configure terminal Example: Device> configure terminal	Enters global configuration mode.
Step 3	dial-peer voice number voip Example: Device(config)# dial-peer voice 1 voip	Enters dial peer configuration mode for the specified VoIP dial peer.
Step 4	codec codec-name bytes voice-payload-size [fixed-bytes] Example: Device(config-dial-peer)# codec g729r8 bytes 30 fixed-byte	Configures a different packetizations for a voice codec.
Step 5	end Example: Device(config-dial-peer)# end	Exits to privileged EXEC mode.



CHAPTER 35

Fax Detection for SIP Call and Transfer

The fax detection feature detects whether an inbound call is from a fax machine. If the inbound call is from a fax machine, the call is rerouted appropriately.

- [Restrictions for Fax Detection for SIP Call and Transfer On Cisco IOS XE, on page 453](#)
- [Information About Fax Detection for SIP Call and Transfer, on page 453](#)
- [Fax Detection with Cisco IOS XE High Availability, on page 456](#)
- [How to Configure Fax Detection for SIP Calls, on page 456](#)
- [Configuration Examples for Fax Detection for SIP Calls, on page 460](#)
- [Feature Information for Fax Detection for SIP Call and Transfer, on page 461](#)

Restrictions for Fax Detection for SIP Call and Transfer On Cisco IOS XE

- The Fax Detect feature is only supported with routers fitted with DSP modules.
- Only the g711ulaw and g711alaw codecs can be used for detecting fax CNG tone.
- Each destination number can be of a maximum length of 32 characters.
- Fax Detection is only supported with LTI-based transcoding.

Information About Fax Detection for SIP Call and Transfer

Fax detection is typically used if you need to have a single phone number for both voice and fax services. Incoming calls are initially answered by an auto attendant or interactive voice response (IVR) service. At this point, the media stream is monitored for fax tones. Calls identified as coming from a fax machine are then rerouted to a new destination, such as a fax server.

For Fax detection to work, the **cng-fax-detect** command under DSP farm and the **detect-fax** command must be configured in the inbound dial-peer. The fax detection feature may be configured to redirect calls to a local voice port or a remote application.



Note Fax detection on CUBE is also supported through a TCL script. The script answers an incoming call, plays a prompt and makes an outgoing voice or fax call. You can download the TCL script from the [CiscoDevNet Github](#).

Local Redirect Mode

Local redirect may be used to transfer a fax call to either a local port or remote destination. Multiple destinations may be used if required, allowing the CUBE to hunt for the first available resource. The configured hunt list can include any number of destination ports.

Figure 39: Local Redirect Call Flow

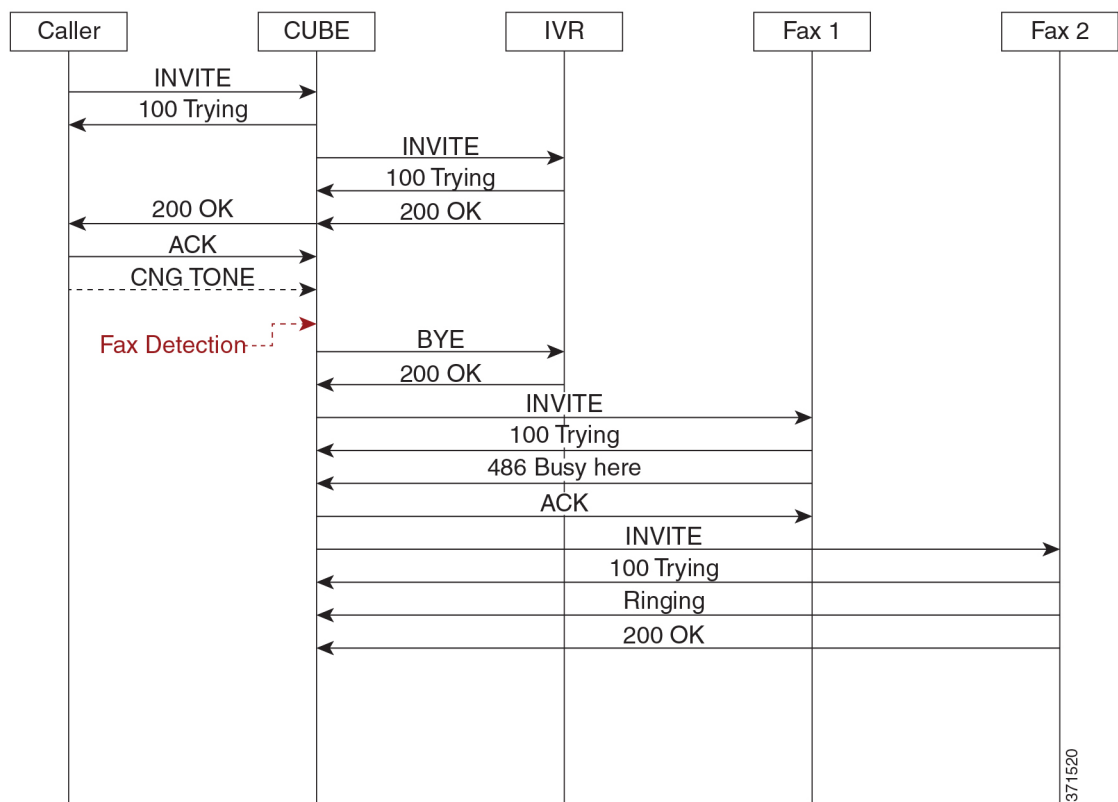

An initial connection is made as a voice call through CUBE to the IVR. On detection of fax tones in the media path, CUBE closes the connection to the IVR, then hunts through a list of numbers to establish a connection to a fax machine or fax server, allowing the originating fax machine to complete its transmission. In a scenario where T.38 is not supported by CUBE, it will fallback to passthrough.

For each call, a digital signal processor (DSP) channel is allocated to detect the fax CNG tone. This DSP remains allocated until the original call leg clears at the end of the call. In the call flow example above, the first fax machine is busy, so the CUBE establishes the call with the second fax machine.



Note For Local Redirect, new calls legs are negotiated as voice, not as fax session.

Refer Redirect Mode

In this mode, calls are redirected to a fax service by the original calling party. The redirect is based on information provided by CUBE in a SIP Refer message (similar to a blind transfer).

In this mode, only one redirection target can be configured.

Figure 40: Refer Redirect Call Flow

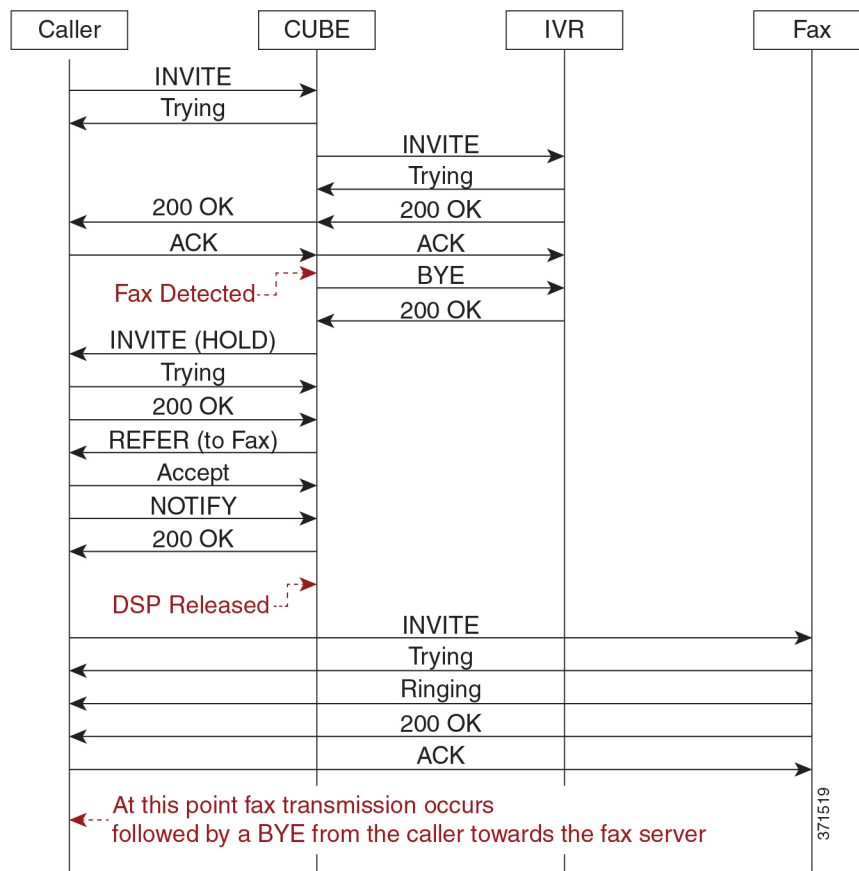

An initial connection is made as a voice call through CUBE to the IVR. On detection of fax tones in the media path, CUBE closes the connection to the IVR. To transfer the call, CUBE first sends a re-invite to put the original call leg on hold, then sends a SIP REFER with details of the remote fax server. From this point, CUBE is no longer involved in the call flow as the originating fax communicates directly with the destination server.

For each call, a DSP channel or resource is allocated to detect the CNG tone. This resource is released once the call transfer has been initiated.

Transcoder Behavior for Cisco IOS XE

For the fax tone detection support offered for Cisco IOS XE, the DSP resource behavior for local and refer redirect is as follows:

- For local redirect, CUBE doesn't release the transcoder until the fax call disconnects.
- For refer redirect, CUBE releases the transcoder when the REFER message is sent to the peer leg.

Fax Detection with Cisco IOS XE High Availability

Fax detection and transfer are supported with CUBE High Availability (HA) deployments. In this mode, two CUBE routers are configured to run in Active-Standby mode.

The following behaviors specific to this feature must be noted:

- Failover after initial call has been established, but fax hasn't been detected—The call is preserved, but tone detection is not available for the remainder of that call. The originating fax machine terminates the call after CNG time-out.
- Failover after fax detection, but before the transferred call leg is established—The initial call is preserved and the transfer fails. The originating fax machine terminates the call after CNG time-out.

How to Configure Fax Detection for SIP Calls

Configure DSP Resource to Detect Fax Tone

SUMMARY STEPS

1. **enable**
2. **configure terminal**
3. **dspfarm profile *tag* transcode universal**
4. **cng-fax-detect**
5. **maximum sessions *sessions***
6. **associate application CUBE**
7. **end**

DETAILED STEPS

	Command or Action	Purpose
Step 1	enable Example: Device> enable	Enables privileged EXEC mode. <ul style="list-style-type: none"> • Enter your password if prompted.

	Command or Action	Purpose
Step 2	configure terminal Example: <pre>Device# configure terminal</pre>	Enters global configuration mode.
Step 3	dspfarm profile tag transcode universal Example: <pre>Device(config)# dspfarm profile 5 transcode universal</pre>	Enters DSP farm profile configuration mode and enables the profile for transcoding.
Step 4	cng-fax-detect Example: <pre>Device(config-dspfarm-profile)# cng-fax-detect</pre>	Enables CNG tone detection.
Step 5	maximum sessions sessions Example: <pre>Device(config-dspfarm-profile)# maximum sessions 6</pre>	Configures maximum number of sessions.
Step 6	associate application CUBE Example: <pre>Device(config-dspfarm-profile)# associate application CUBE</pre>	Configures an application to the profile for LTI-based transcoding.
Step 7	end Example: <pre>Device(config-dspfarm-profile)# end</pre>	Returns to privileged EXEC mode.

Dial-peer Configuration to Redirect Fax Call

SUMMARY STEPS

1. **enable**
2. **configure terminal**
3. **dial-peer voice number voip**
4. **description tag**
5. **session protocol sipv2**
6. **incoming called number number**
7. **voice-class codec tag**
8. **no vad**
9. **detect-fax [mode { refernumber| localnumber}]**

10. end

DETAILED STEPS

	Command or Action	Purpose
Step 1	enable Example: Device> enable	Enables privileged EXEC mode. <ul style="list-style-type: none">• Enter your password if prompted.
Step 2	configure terminal Example: Device# configure terminal	Enters global configuration mode.
Step 3	dial-peer voice <i>number</i> voip Example: Device(config)# dial-peer voice 401 voip	Enters dial peer configuration mode for the specified VoIP dial peer.
Step 4	description <i>tag</i> Example: Device(config-dial-peer)# description Incoming dial-peer for Fax	Provides a description for the incoming dial-peer for Fax.
Step 5	session protocol sipv2 Example: Device(config-dial-peer)# session protocol sipv2	Configures SIP as the session protocol type.
Step 6	incoming called number <i>number</i> Example: Device(config-dial-peer)# incoming called-number 903309	Creates inbound dial-peer.
Step 7	voice-class codec <i>tag</i> Example: Device(config-dial-peer)# voice-class codec 111	Applies the previously configured voice class and associated codecs to a dial peer. The voice class codec can only include g711ulaw and g711alaw.
Step 8	no vad Example: Device(config-dial-peer)# no vad	Disables voice activity detection (VAD) for the calls using the dial peer being configured.
Step 9	detect-fax [<i>mode</i> { <i>refernumber</i> <i>localnumber</i> }] Example:	Defines fax detection as local or refer mode and refers to the directory number of the fax machine.

	Command or Action	Purpose
	Device(config-dial-peer)# detect-fax refer 12101	If local mode is configured, then a list of numbers, separated by a space may be entered. Refer mode only allows a destination number to be configured.
Step 10	end Example: Device(config-dial-peer)# end	Returns to privileged EXEC mode.

Verifying Fax Detection for SIP Calls

SUMMARY STEPS

1. enable
2. show call active voice compact
3. show dspfarm dsp active

DETAILED STEPS

Step 1 **enable**

Example:

```
Device> enable
```

Enables privileged EXEC mode.

Step 2 **show call active voice compact**

Example:

This is a sample output of call setup when the call is connected:

```
Device# show call active voice compact
```

```

<callID>  A/O FAX T<sec> Codec      type      Peer Address      IP R<ip>:<udp>
Total call-legs: 3
      9   ANS  T4      g711ulaw  VOIP      P808808      9.42.25.145:17940
     10   ORG  T4      g711ulaw  VOIP      P309903      9.42.25.149:16396
     11   ANS  T4      g711ulaw  VOIP      P808808      9.42.25.149:16394
    
```

Step 3 **show dspfarm dsp active**

Example:

This is a sample output of the DSP channel reserved to detect CNG tone after the call is set up.

```
Device# show dspfarm dsp active
```

```

SLOT    DSP VERSION  STATUS CHNL USE  TYPE    RSC_ID BRIDGE_ID  PKTS_TXED  PKTS_RXED
  0      2    36.1.0    UP     1  USED   xcode     1         9         228         119
    
```

```

0      2    36.1.0  UP    1  USED  xcode  1    10    113    251
Total number of DSPFARM DSP channel(s) 1

```

Troubleshooting Fax Detection for SIP Calls

You can enable the logs of the following **debug** or **show** commands, which are helpful in debugging fax detection for SIP calls:

- **debug voip ipipgw all**
- **debug ccsip verbose**
- **debug voip ccapi all**
- **debug voip dsmp all**
- **debug voip hpi all**
- **debug media resource provisioning all**
- **show call active voice compact**
- **show dspfarm dsp active**
- **show voip rtp connections**

Configuration Examples for Fax Detection for SIP Calls

Example: Configuring Local Redirect

The following is a sample configuration in local redirect mode for fax detection. In this example, the dial-peer has to be configured for the FAX directory numbers 9033010 and 9033011.

```

dspfarm profile 10 transcode universal
codec g729abr8
codec g729ar8
codec g711alaw
codec g711ulaw
codec g729r8
codec ilbc
codec g722-64
cng-fax-detect
maximum sessions 6
associate application CUBE
!
dial-peer voice 401 voip
description "Incoming dial-peer to ASR"
session protocol sipv2
incoming called-number 903309
voice-class codec 111
dtmf-relay rtp-nte
no vad

```

```
detect-fax mode local 9033010 9033011

dial-peer voice 406 voip
description "Outbound dialpeer for ..."
destination-pattern 9033010
session protocol sipv2
session target ipv4:9.41.36.11:14762
voice-class codec 111
dtmf-relay rtp-nte
fax protocol pass-through g711ulaw
no vad

dial-peer voice 406 voip
description "Outbound dialpeer for ..."
destination-pattern 9033011
session protocol sipv2
session target ipv4:9.41.36.11:14765
voice-class codec 111
dtmf-relay rtp-nte
fax protocol pass-through g711ulaw
no vad
```

Example: Configuring Refer Redirect

In Refer mode, only one fax number can be configured.

```
dial-peer voice 401 voip
description "Incoming dial-peer to ASR"
session protocol sipv2
incoming called-number 903309
voice-class codec 111
dtmf-relay rtp-nte
no vad
detect-fax mode refer 9033010

dial-peer voice 406 voip
description "Outbound dialpeer for ..."
destination-pattern 9033010
session protocol sipv2
session target ipv4:9.41.36.11:14762
voice-class codec 111
dtmf-relay rtp-nte
fax protocol pass-through g711ulaw
no vad
```

Feature Information for Fax Detection for SIP Call and Transfer

The following table provides release information about the feature or features described in this module. This table lists only the software release that introduced support for a given feature in a given software release train. Unless noted otherwise, subsequent releases of that software release train also support that feature.

Use Cisco Feature Navigator to find information about platform support and Cisco software image support. To access Cisco Feature Navigator, go to <https://cfng.cisco.com/>. An account on Cisco.com is not required.

Table 55: Feature Information for Fax Detection for SIP Call and Transfer

Feature Name	Releases	Feature Information
Fax Detection for SIP Call and Transfer	Cisco IOS 15.4(2)T	<p>Fax detection is the capability to detect automatically whether an incoming call is voice or fax. For calls coming from an IP trunk to CUBE, the Fax Detection for SIP Call and Transfer feature is used to detect CNG tones (calling tones) so that the fax server can handle the actual fax transmission or redirect the fax call to a configured fax number.</p> <p>The following commands were introduced: cng-fax-detect and detect-fax mode.</p>
Fax Detection for SIP Call and Transfer on Cisco IOS XE Platforms	Cisco IOS XE Amsterdam 17.2.1r	Support was introduced for SIP call and transfer for IP-to-IP calls on Cisco IOS XE platforms for Cisco Unified Border Element.



PART VI

Video

- [Video Suppression, on page 465](#)



CHAPTER 36

Video Suppression

The video suppression feature allows pass-through of only audio and image (for T.38 Fax) media types in SDP and drops all other media capabilities.

- [Feature Information for Video Suppression, on page 465](#)
- [Restrictions, on page 465](#)
- [Information About Video Suppression, on page 466](#)
- [Configuring Video Suppression, on page 466](#)
- [Troubleshooting Tips, on page 467](#)

Feature Information for Video Suppression

The following table provides release information about the feature or features described in this module. This table lists only the software release that introduced support for a given feature in a given software release train. Unless noted otherwise, subsequent releases of that software release train also support that feature.

Use Cisco Feature Navigator to find information about platform support and Cisco software image support. To access Cisco Feature Navigator, go to www.cisco.com/go/cfn. An account on Cisco.com is not required.

Table 56: Feature Information for Video Suppression

Feature Name	Releases	Feature Information
Support for Video Suppression	Cisco IOS 15.6(2)T Cisco IOS XE Denali 16.3.1	This feature allows pass-through of only audio and application (for T.38 Fax) media types and drops all other media types in SDP. The following commands are introduced: audio forced , voice-class sip audio forced

Restrictions

- Supports only SIP-SIP calls.

- Video suppression is not supported in SDP pass-through mode.
- Video suppression feature removes both video and application m-lines in the incoming SDP. It is not possible to remove application m-line alone and pass across video m-line parameters.

Information About Video Suppression

Video suppression feature enables CUBE to interwork with the networks that support only audio and image media types in SDP and the networks that support video and application media types in addition to audio and image media types.

By default video suppression feature is disabled on CUBE and hence the video capabilities are passed through in SDP. Passing across the video capabilities could cause interoperability issues if one of the networks do not support video capabilities.

By enabling video suppression feature, you can configure CUBE to pass-through audio and image only, and drop all other capabilities such as video and application m-lines. This helps enterprises to interwork with audio capable networks and video capable networks smoothly.

You can enable video suppression at dial-peer level and at global configuration level.

Feature Behavior

- If video suppression is enabled on any of the dial-peers (inbound or outbound), video capabilities are not offered for that particular call.
- Configuring **voice-class sip audio forced [system]** command at a dial-peer level makes use of global configuration level settings for allowing only audio and image media.
- Video suppression feature will work as expected even when codec transparent feature is configured.

Configuring Video Suppression

SUMMARY STEPS

1. **enable**
2. **configure terminal**
3. Enter one of the following commands:
 - In the dial-peer configuration mode
voice-class sip audio forced
 - In the global VoIP SIP configuration mode
audio forced
4. **end**

DETAILED STEPS

	Command or Action	Purpose
Step 1	enable	Enables privileged EXEC mode. <ul style="list-style-type: none"> • Enter your password if prompted.
Step 2	configure terminal	Enters global configuration mode.
Step 3	<p>Enter one of the following commands:</p> <ul style="list-style-type: none"> • In the dial-peer configuration mode voice-class sip audio forced • In the global VoIP SIP configuration mode audio forced <p>Example: In dial-peer configuration mode</p> <pre>!Applying audio-forced to one dial peer only Device (config)# dial-peer voice 10 voip Device (config-dial-peer)# voice-class sip audio forced Device (config-dial-peer)# end</pre> <p>Example: In global VoIP SIP configuration mode</p> <pre>! Applying audio forced globally Device(config)# voice service voip Device (config-voi-serv)# sip Device (config-voi-sip)# audio forced Device (config-voi-sip)# end</pre>	Enables pass-through of only audio and image media types in SDP.
Step 4	end	Exits present configuration mode and enters privileged EXEC mode.

Troubleshooting Tips

The following commands are useful for debugging:

- show voip rtp connections
- show call active voice brief
- show call active video brief
- debug voip dialpeer
- debug ccsip all
- debug voip ccapi inout



PART **VII**

Media Services

- [Configuring RTCP Report Generation, on page 471](#)



CHAPTER 37

Configuring RTCP Report Generation

The assisted Real-time Transport Control Protocol (RTCP) feature adds the ability for Cisco Unified Border Element (Cisco UBE) to generate standard RTCP keepalive reports on behalf of endpoints. RTCP reports determine the liveliness of a media session during prolonged periods of silence, such as call hold or mute. Therefore, it is important for the Cisco UBE to generate RTCP reports irrespective of whether the endpoints send or receive media.

Cisco UBE generates RTCP report only when inbound and outbound call legs are SIP, or SIP to H.323, or H.323 to SIP.

- [Prerequisites, on page 471](#)
- [Restrictions, on page 471](#)
- [Configuring RTCP Report Generation on Cisco UBE, on page 472](#)
- [Troubleshooting Tips, on page 473](#)
- [Feature Information for Configuring RTCP Report Generation, on page 474](#)

Prerequisites

Cisco Unified Border Element

- Cisco IOS Release 15.1(2)T or a later release must be installed and running on your Cisco Unified Border Element.

Cisco Unified Border Element (Enterprise)

- Cisco IOS XE Release 3.17S or a later release must be installed and running on your Cisco ASR 1000 Series Router and Cisco ISR 4000 Series Router.

Restrictions

- RTCP report generation over IPv6 is not supported.
- RTCP report generation is not supported for Secure Real-time Transport Protocol (SRTP) or SRT Control Protocol (SRTCP) pass-through as Cisco UBE is not aware of the media encryption or decryption keys.
- RTCP report generation is not supported for loopback calls, T.38 fax, and modem relay calls.

- RTCP or SRTCP report generation is not supported when Cisco UBE inserts a Digital Signal Processor (DSP) for RTP-SRTP interworking on RTP and SRTP call legs.
- RTCP report generation is not supported when there is a call hold with an invalid media address such as 0.0.0.0 in Session Description Protocol (SDP) or Open Logical Channel (OLC).
- RTCP report generation is not supported for RTCP multiplexed with RTP on the same address and port.
- RTCP report generation is not supported on enterprise aggregation services routers (ASRs) and 4000 series integrated services routers (ISRs) when Media Termination Points are collocated with the Cisco Unified Border Element. It affects RFC2833 and RFC4733 DTMF generation when MTP is used for DTMF conversion from Out-of-Band (OOB) to RFC2833 or RFC4733.
- RTCP packet generation is not supported on the SIP leg when the H.323 leg puts the SIP leg on hold in a Slow Start to Delayed-Offer call.

Configuring RTCP Report Generation on Cisco UBE

RTCP keepalive packets indicate session liveliness. When configured on Cisco UBE, RTCP keepalive packets are sent on both inbound and outbound SIP or H.323 call legs.

Perform this task to configure RTCP report generation on Cisco UBE.

SUMMARY STEPS

1. **enable**
2. **configure terminal**
3. **voice service voip**
4. **allow-connections** *from-type* **to** *to-type*
5. **rtcp keepalive**
6. **end**

DETAILED STEPS

	Command or Action	Purpose
Step 1	enable Example: Router> enable	Enables privileged EXEC mode. <ul style="list-style-type: none"> • Enter your password if prompted.
Step 2	configure terminal Example: Router# configure terminal	Enters global configuration mode.
Step 3	voice service voip Example: Router(config)# voice service voip	Enters voice service configuration mode.

	Command or Action	Purpose
Step 4	allow-connections <i>from-type</i> to <i>to-type</i> Example: <pre>Router(conf-voi-serv)# allow-connections sip to sip</pre>	Allows connections between SIP endpoints in a VoIP network.
Step 5	rtcp keepalive Example: <pre>Router(conf-voi-serv)# rtcp keepalive</pre>	Configures RTCP keepalive report generation.
Step 6	end Example: <pre>Router(conf-voi-serv)# end</pre>	Exits voice service configuration mode and returns to privileged EXEC mode.

Troubleshooting Tips

Use the following debug commands for debugging related to RTCP keepalive packets:

- **debug voip rtcp packet** --Shows details related to RTCP keepalive packets such as RTCP sending and receiving paths, Call ID, Globally Unique Identifier (GUID), packet header, and so on.

```
Router# debug voip rtcp packet
01:06:27.450: //6/xxxxxxxxxxxx/RTP//Event/voip_rtp_send_rtcp_keepalive: Generate RTCP
Keepalive
*Mar 17 01:06:27.450: rtcp_send_report: Attributes
      (src ip=192.168.30.3, src port=17101, dst ip=192.168.30.4, dst port=18619
      bye=0, initial=1, ssrc=0x07111E02, keepalive=1)
*Mar 17 01:06:27.450: rtcp_construct_keepalive_report: Constructed Report
      (rtcp=0x2E5AF214, ssrc=0x07111E02, source->ssrc=0x00001E03, total_len=36)
2E5AF210:      80C90001 07111E02 81CA0006      .I.....J..
2E5AF220: 07111E02 010F302E 302E3040 392E3435      .....0.0.0@9.45
2E5AF230: 2E33302E 33000000 00      .30.3....
```



Caution Under moderate traffic loads, the **debug voip rtp packet** command produces a high volume of output and the command should be enabled only when the call volume is very low.

- **debug voip rtp packet** --Shows details about VoIP RTP packet debugging trace.

```
Router# debug voip rtp packet
VOIP RTP All Packets debugging is on
```

- **debug voip rtp session** --Shows all RTP session debug information.

```
Router# debug voip rtp session
VOIP RTP All Events debugging is on
```

- **debug voip rtp error** --Shows details about debugging trace for RTP packet error cases.

```
Router# debug voip rtp error
VOIP RTP Errors debugging is on
```

- **debug ip rtp protocol** --Shows details about RTP protocol debugging trace.

```
Router# debug ip rtp protocol
RTP protocol debugging is on
```

- **debug voip rtp session** --Shows all RTCP session debug information.

```
Router# debug voip rtcp session
VOIP RTCP Events debugging is on
```

- **debug voip rtcp error** -- Shows details about debugging trace for RTCP packet error cases.

```
Router# debug voip rtcp error
VOIP RTCP Errors debugging is on
```

Feature Information for Configuring RTCP Report Generation

The following table provides release information about the feature or features described in this module. This table lists only the software release that introduced support for a given feature in a given software release train. Unless noted otherwise, subsequent releases of that software release train also support that feature.

Use Cisco Feature Navigator to find information about platform support and Cisco software image support. To access Cisco Feature Navigator, go to <https://cfng.cisco.com/>. An account on Cisco.com is not required.

Feature History Table entry for the Cisco Unified Border Element. .

Table 57: Feature Information for Configuring RTCP Report Generation

Feature Name	Releases	Feature Information
Assisted RTCP	15.1(2)T	This feature adds the ability for Cisco UBE to generate standard RTCP keepalive reports on behalf of endpoints and ensures the liveliness of a media session during prolonged periods of silence, such as call hold. The following commands were introduced or modified in this release: rtcp keepalive , debug voip rtcp , debug voip rtp , debug ip rtp protocol , and ip rtcp report interval .

Feature History Table entry for the Cisco Unified Border Element (Enterprise) .

Table 58: Feature Information for Configuring RTCP Report Generation

Feature Name	Releases	Feature Information
Assisted RTCP	IOS XE Release 3.17S	<p>This feature adds the ability for Cisco UBE to generate standard RTCP keepalive reports on behalf of endpoints and ensures the liveliness of a media session during prolonged periods of silence, such as call hold.</p> <p>The following commands were introduced or modified in this release: rtcp keepalive, debug voip rtp, debug voip rtp, debug ip rtp protocol, and ip rtp report interval.</p>



PART **VIII**

Media Recording

- [Network-Based Recording, on page 479](#)
- [SIPREC \(SIP Recording\), on page 507](#)
- [Video Recording - Additional Configurations, on page 537](#)
- [Third-Party GUID Capture for Correlation Between Calls and SIP-based Recording, on page 543](#)
- [Cisco Unified Communications Gateway Services--Extended Media Forking, on page 551](#)



CHAPTER 38

Network-Based Recording

The Network-Based Recording feature supports software-based forking for Real-time Transport Protocol (RTP) streams. Media forking provides the ability to create midcall multiple streams (or branches) of audio and video associated with a single call and then send the streams of data to different destinations. To enable network-based recording using Cisco Unified Border Element (CUBE), you can configure specific commands or use a call agent. CUBE acts as a recording client and MediaSense Session Initiation Protocol (SIP) recorder acts a recording server.

- [Feature Information for Network-Based Recording, on page 479](#)
- [Restrictions for Network-Based Recording, on page 480](#)
- [Information About Network-Based Recording Using CUBE, on page 481](#)
- [How to Configure Network-Based Recording, on page 485](#)
- [Additional References for Network-Based Recording, on page 505](#)

Feature Information for Network-Based Recording

The following table provides release information about the feature or features described in this module. This table lists only the software release that introduced support for a given feature in a given software release train. Unless noted otherwise, subsequent releases of that software release train also support that feature.

Use Cisco Feature Navigator to find information about platform support and software image support. Cisco Feature Navigator enables you to determine which software images support a specific software release, feature set, or platform. To access Cisco Feature Navigator, go to <http://www.cisco.com/go/cfn>. An account on Cisco.com is not required.

Table 59: Feature Information for Network-Based Recording

Feature Name	Releases	Feature Information
Security Readiness Criteria (SRC)—Modified the command show sip-ua calls .	Cisco IOS XE Gibraltar Release 16.11.1a	Command show sip-ua calls is modified to display local crypto key and remote crypto key.
Audio-only Stream Forking of Video Call	Cisco IOS 15.4(3)M Cisco IOS XE 3.13S	The Audio-only Stream Forking of Video Call feature supports CUBE-based forking and recording of only audio calls in a call that includes both audio and video. The following commands were introduced: media-type audio .

Feature Name	Releases	Feature Information
Network-Based Recording of Video Calls Using CUBE	Cisco IOS 15.3(3)M Cisco IOS XE 3.10S	The Network-Based Recording of Video Calls using CUBE feature supports forking and recording of video calls.
Network-Based Recording of Audio Calls Using CUBE	Cisco IOS 15.2(1)T Cisco IOS XE 3.8S	The Network-Based Recording of Audio Calls using CUBE feature supports forking for RTP streams. The following commands were introduced or modified: media class , media profile recorder , media-recording , recorder parameter , recorder profile , show voip recmsp session .

Restrictions for Network-Based Recording

- Network-based recording is not supported for the following calls:
 - Calls that do not use Session Initiation Protocol (SIP). Must be a SIP-to-SIP call flow
 - Flow-around calls
 - Session Description Protocol (SDP) pass-through calls
 - Real-time Transport Protocol (RTP) loopback calls
 - High-density transcoder calls
 - IPv6-to-IPv6 calls
 - IPv6-to-IPv4 calls with IPv4 endpoint.
 - Secure Real-time Transport Protocol (SRTP) passthrough calls
 - SRTP-RTP calls with forking for SRTP leg (forking is supported for the RTP leg)
 - Resource Reservation Protocol (RSVP)
 - Multicast music on hold (MOH)



Note Mid-call gateway recording session stops when the call is on hold. For the use case demonstrating the Hold function on the IP phone, see [Call Recording Examples for Network-Based and Phone-Based Recording](#).

- Any media service parameter change via Re-INVITE or UPDATE from Recording server is not supported. Midcall renegotiation and supplementary services can be done through the primary call only.
- Media service parameter change via Re-INVITE or UPDATE message from the recording server is not supported
- Recording is not supported if CUBE is running a TCL IVR application with the exception of `survivability.tcl`, which is supported with network based recording.

- Media mixing on forked streams is not supported
- Digital Signal Processing (DSP) resources are not supported on forked legs
- RecordTone insertion is not supported with SRTP calls.
- Forking does not stop when RTP stream changes mid call to RTP stream. This is for backward compatibility.
- MediaForkingReason tag is to notify midcall stream events. Notification for codec change is not supported.
- Server Groups in outbound dial-peers towards recorders is not supported.
- Forking a single call on a CUBE using both dial-peer based recording and SIPREC is not supported.

Restrictions for Video Recording

- If the main call has multiple video streams (m-lines), the video streams other than the first video m-line are not forked.
- Application media streams of the primary call are not forked to the recording server.
- Forking is not supported if the anchor leg or recording server is on IPv6.
- High availability is not supported on forked video calls.

Information About Network-Based Recording Using CUBE

Deployment Scenarios for CUBE-based Recording

CUBE as a recording client has the following functions:

- Acts as a SIP user agent and sets up a recording session (SIP dialog) with the recording server.
- Acts as the source of the recorded media and forwards the recorded media to the recording server.
- Sends information to a server that helps the recording server associate the call with media streams and identifies the participants of the call. This information sent to the recording server is called metadata.



Note CUBE simply forwards the RTP streams it receives to the SIP recorder. It does not support omitting any pre-agent VRU activity from the recording.

If you want to omit the VRU segment from a recording, you must use the Unified CVP to route the agent segment of the call back through CUBE. To do this, you need to separate ingress and media forking function from one another, which means you must either route the call through the ingress router a second time, or route it through a second router.

Given below is a typical deployment scenario of a CUBE-based recording solution. The information flow is described below:

Figure 41: Deployment Scenario for CUBE-based Recording Solution

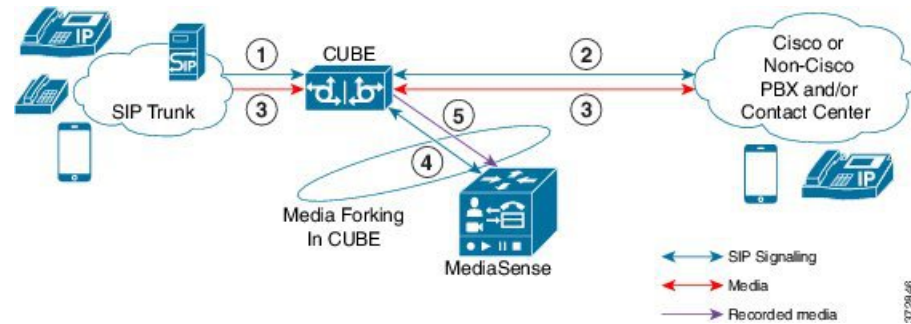

1. Incoming call from SIP trunk.
2. Outbound call to a Contact Centre
3. Media between endpoints flowthrough CUBE
4. CUBE sets up a new SIP session with MediaSense based on policy.
5. CUBE forks RTP media to MediaSense. For an audio call, audio is forked. For a video call, both audio and video are forked. For an audio-only configuration in a audio-video call, only audio is forked. There will be two or four m-lines to the recording server, based on the type of recording

The metadata carried in the SIP session between the recording client and the recording server is to:

- Carry the communication session data that describes the call.
- Send the metadata to the recording server. The recording server uses the metadata to associate communication sessions involving two or more participants with media streams.

The call leg that is created between the recording client and the recording server is known as the recording session.

Open Recording Architecture

The Open Recording Architecture (ORA) comprises of elements, such as application management server and SIP bridge, to support IP-based recording. The ORA IP enables recording by solving topology issues, which accelerates the adoption of Cisco unified communication solutions.

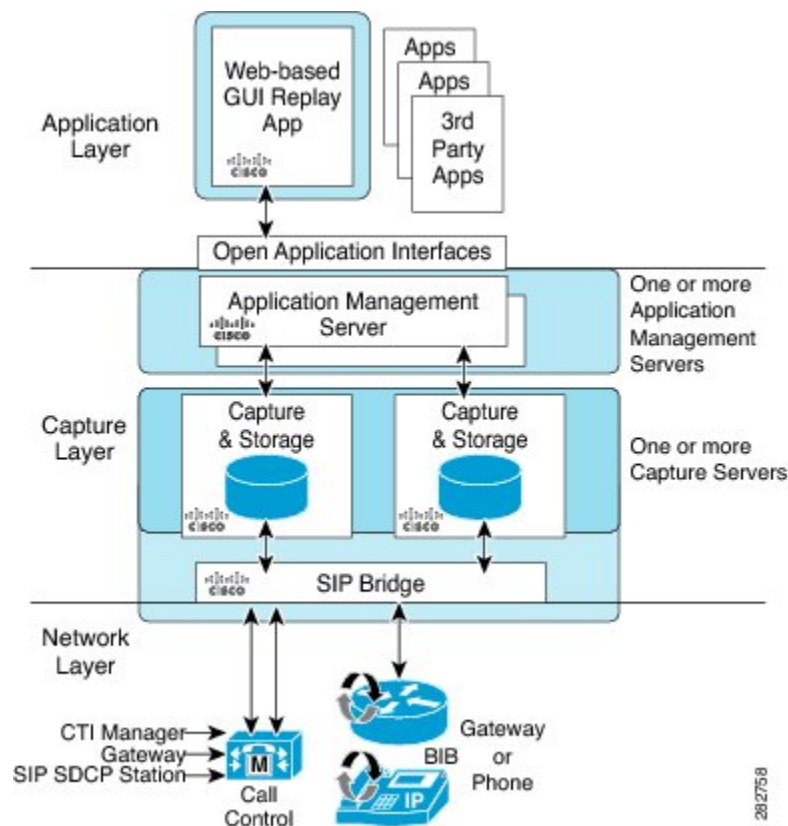

Following are the three layers of the ORA architecture:

Network Layer

The ORA network layer is comprised of call control systems, media sources, and IP foundation components, such as routers and switches.

Capture and Media Processing Layer

The ORA capture and media processing layer includes core functions of ORA—terminating media streams, storage of media and metadata, and speech analytics that can provide real-time events for applications.

Application Layer

The ORA application layer supports in-call and post-call applications through open programming interfaces.

In-call applications include applications that make real-time business decisions (for example, whether to record a particular call or not), control pause and resume from Interactive Voice Response (IVR) or agent desktop systems, and perform metadata tagging and encryption key exchange at the call setup.

Post-call applications include the following:

- Traditional compliance search, replay, and quality monitoring.
- Advanced capabilities, such as speech analytics, transcription, and phonetic search.
- Custom enterprise integration.

- Enterprise-wide policy management.

Media Forking Topologies

The following topologies support media forking:

Media Forking with Cisco UCM

The figure below illustrates media forking with Cisco Unified CallManager (Cisco UCM) topology. This topology supports replication of media packets to allow recording by the caller agent. It also enables CUBE to establish full-duplex communication with the recording server. In this topology, SIP recording trunk is enhanced to have additional call metadata.

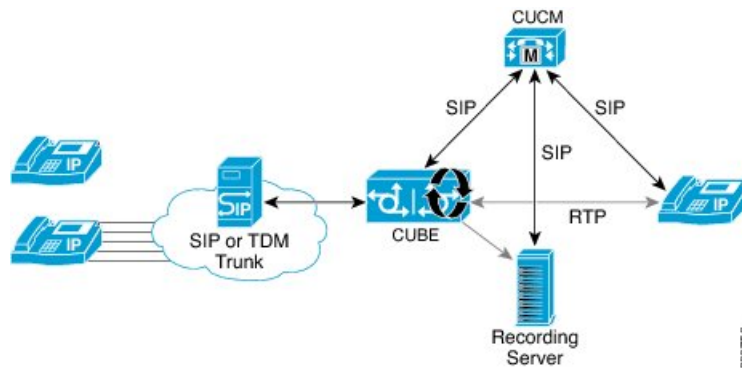

Media Forking without Cisco UCM

The topology below shows media forking without the Cisco UCM topology. This topology supports static configuration on CUBE and the replication of media packets to allow recording caller-agent and full-duplex interactions at an IP call recording server.

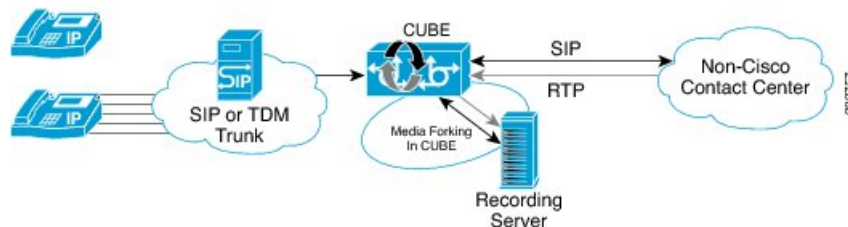

SIP Recorder Interface

SIP is used as a protocol between CUBE and the MediaSense SIP server. Extensions are made to SIP to carry the recording session information needed for the recording server. This information carried in SIP sessions between the recording client and the recording server is called metadata.

Metadata

Metadata is the information that is passed by the recording client to the recording server in a SIP session. Metadata describes the communication session and its media streams.

Metadata is used by the recording server to:

- Identify participants of the call.
- Associate media streams with the participant information. Each participant can have one or more media streams, such as audio and video.
- Identify the participant change due to transfers during the call.

The recording server uses the metadata information along with other SIP message information, such as dialog ID and time and date header, to derive a unique key. The recording server uses this key to store media streams and associate the participant information with the media streams.

How to Configure Network-Based Recording

Configuring Network-Based Recording (with Media Profile Recorder)

SUMMARY STEPS

1. **enable**
2. **configure terminal**
3. **media profile recorder** *profile-tag*
4. (Optional) **media-type audio**
5. **media-recording** *dial-peer-tag* [*dial-peer-tag2...dial-peer-tag5*]
6. **exit**
7. **media class** *tag*
8. **recorder profile** *tag*
9. **exit**
10. **dial-peer voice** *dummy-recorder-dial-peer-tag* **voip**
11. **media-class** *tag*
12. **destination-pattern** **[+]** *string* **[T]**
13. **session protocol sipv2**
14. **session target ipv4:***[recording-server-destination-address | recording-server-dns]*
15. **session transport tcp**
16. **end**

DETAILED STEPS

	Command or Action	Purpose
Step 1	enable Example: Device> enable	Enables privileged EXEC mode. <ul style="list-style-type: none"> • Enter your password if prompted.
Step 2	configure terminal Example:	Enters global configuration mode.

	Command or Action	Purpose
	Device# configure terminal	
Step 3	media profile recorder <i>profile-tag</i> Example: Device(config)# media profile recorder 100	Configures the media profile recorder and enters media profile configuration mode.
Step 4	(Optional) media-type audio Example: Device(cfg-mediaprofile)# media-type audio	Configures recording of audio only in a call with both audio and video. If this configuration is not done, both audio and video are recorded.
Step 5	media-recording <i>dial-peer-tag</i> [<i>dial-peer-tag2...dial-peer-tag5</i>] Example: Device(cfg-mediaprofile)# media-recording 8000 8001 8002	Configures the dial-peers that need to be configured. Note You can specify a maximum of five dial-peer tags.
Step 6	exit Example: Device(cfg-mediaprofile)# exit	Exits media profile configuration mode.
Step 7	media class <i>tag</i> Example: Device(config)# media class 100	Configures a media class and enters media class configuration mode.
Step 8	recorder profile <i>tag</i> Example: Device(cfg-mediaclass)# recorder profile 100	Configures the media profile recorder.
Step 9	exit Example: Device(cfg-mediaclass)# exit	Exits media class configuration mode.
Step 10	dial-peer voice <i>dummy-recorder-dial-peer-tag</i> voip Example: Device(config)# dial-peer voice 8000 voip	Configures a recorder dial peer and enters dial peer voice configuration mode.
Step 11	media-class <i>tag</i> Example:	Configures media class on a dial peer.

	Command or Action	Purpose
	Device(config-dial-peer)# media-class 100	
Step 12	<p>destination-pattern [+] <i>string</i> [T]</p> <p>Example:</p> <pre>Device(config-dial-peer)# destination-pattern 595959</pre>	<p>Specifies either the prefix or the full E.164 telephone number (depending on your dial plan) to be used for a dial peer.</p> <p>Note The predefined valid entries for <i>string</i> are the digits 0 to 9, the letters A to F and, the following special characters:</p> <ul style="list-style-type: none"> • The asterisk (*) and pound sign (#) that appear on standard touch-tone dial pads. • Plus sign (+), which indicates that the preceding digit occurred one or more times. • Backslash symbol (\), which is followed by a single character, and matches that character. <p>Media Forking functionality does not work with the wildcard entries other than the predefined set.</p>
Step 13	<p>session protocol sipv2</p> <p>Example:</p> <pre>Device(config-dial-peer)# session protocol sipv2</pre>	Configures the VoIP dial peer to use Session Initiation Protocol (SIP).
Step 14	<p>session target</p> <p>ipv4:[<i>recording-server-destination-address</i> <i>recording-server-dns</i>]</p> <p>Example:</p> <pre>Device(config-dial-peer)# session target ipv4:10.42.29.7</pre>	<p>Specifies a network-specific address for a dial peer. Keyword and argument are as follows:</p> <ul style="list-style-type: none"> • ipv4: <i>destination address</i> --IP address of the dial peer, in this format: <i>xxx.xxx.xxx.xxx</i>
Step 15	<p>session transport tcp</p> <p>Example:</p> <pre>Device(config-dial-peer)# session transport tcp</pre>	Configures a VoIP dial peer to use Transmission Control Protocol (TCP).
Step 16	<p>end</p> <p>Example:</p> <pre>Device(config-dial-peer)# end</pre>	Returns to privileged EXEC mode.

Configuring Network-Based Recording (without Media Profile Recorder)

SUMMARY STEPS

1. **enable**
2. **configure terminal**
3. **media class tag**
4. **recorder parameter**
5. (Optional) **media-type audio**
6. **media-recording dial-peer-tag**
7. **exit**
8. **exit**
9. **dial-peer voice dummy-recorder-dial-peer-tag voip**
10. **media-class tag**
11. **destination-pattern** [+] *string* [T]
12. **session protocol sipv2**
13. **session target ipv4:**[*recording-server-destination-address* | *recording-server-dns*]
14. **session transport tcp**
15. **end**

DETAILED STEPS

	Command or Action	Purpose
Step 1	enable Example: Device> enable	Enables privileged EXEC mode. <ul style="list-style-type: none"> • Enter your password if prompted.
Step 2	configure terminal Example: Device# configure terminal	Enters global configuration mode.
Step 3	media class tag Example: Device(config)# media class 100	Configures the media class and enters media class configuration mode.
Step 4	recorder parameter Example: Device(cfg-mediaclass)# recorder parameter	Enters media class recorder parameter configuration mode to enable you to configure recorder-specific parameters.
Step 5	(Optional) media-type audio Example:	Configures recording of audio only in a call with both audio and video.

	Command or Action	Purpose
	Device(cfg-mediaprofile)# media-type audio	Note If this configuration is not done, both audio and video are recorded.
Step 6	media-recording dial-peer-tag Example: Device(cfg-mediaclass-recorder)# media-recording 8000, 8001, 8002	Configures voice-class recording parameters. Note You can specify a maximum of five dial-peer tags.
Step 7	exit Example: Device(cfg-mediaclass-recorder)# exit	Exits media class recorder parameter configuration mode.
Step 8	exit Example: Device(cfg-mediaclass)# exit	Exits media class configuration mode.
Step 9	dial-peer voice dummy-recorder-dial-peer-tag voip Example: Device(config)# dial-peer voice 8000 voip	Configures a recorder dial peer and enters dial peer voice configuration mode.
Step 10	media-class tag Example: Device(config-dial-peer)# media-class 100	Configures media class on a dial peer.
Step 11	destination-pattern [+] <i>string</i> [T] Example: Device(config-dial-peer)# destination-pattern 595959	Specifies either the prefix or the full E.164 telephone number (depending on your dial plan) to be used for a dial peer. Note The predefined valid entries for <i>string</i> are the digits 0 to 9, the letters A to F and, the following special characters: <ul style="list-style-type: none"> • The asterisk (*) and pound sign (#) that appear on standard touch-tone dial pads. • Plus sign (+), which indicates that the preceding digit occurred one or more times. • Backslash symbol (\), which is followed by a single character, and matches that character. Media Forking functionality does not work with the wildcard entries other than the predefined set.

	Command or Action	Purpose
Step 12	session protocol sipv2 Example: <pre>Device(config-dial-peer)# session protocol sipv2</pre>	Configures the VoIP dial peer to use Session Initiation Protocol (SIP).
Step 13	session target ipv4:[<i>recording-server-destination-address</i> <i>recording-server-dns</i>] Example: <pre>Device(config-dial-peer)# session target ipv4:10.42.29.7</pre>	Specifies a network-specific address for a dial peer. Keyword and argument are as follows: <ul style="list-style-type: none"> • ipv4: <i>destination address</i> --IP address of the dial peer, in this format: <i>xxx.xxx.xxx.xxx</i>
Step 14	session transport tcp Example: <pre>Device(config-dial-peer)# session transport tcp</pre>	Configures a VoIP dial peer to use Transmission Control Protocol (TCP).
Step 15	end Example: <pre>Device(config-dial-peer)# end</pre>	Returns to privileged EXEC mode.

Verifying the Network-Based Recording Using CUBE

Perform this task to verify the configuration of the Network-Based Recording Using CUBE. The **show** and **debug** commands can be entered in any order.

SUMMARY STEPS

1. **enable**
2. **show voip rtp connections**
3. **show voip recmsp session**
4. **show voip recmsp session detail call-id** *call-id*
5. **show voip rtp forking**
6. **show call active voice compact**
7. **show call active video compact**
8. **show sip-ua calls**
9. **show call active video brief**
10. **debug ccsip messages** (for audio calls)
11. **debug ccsip messages** (for video calls)
12. **debug ccsip messages** (for audio-only recording in a call with both audio and video)
13. Enter one of the following:
 - **debug ccsip all**
 - **debug voip recmsp all**
 - **debug voip ccapi all**

- **debug voip fpi all** (for ASR devices only)

DETAILED STEPS

Step 1

enable

Enables privileged EXEC mode.

Example:

```
Device> enable
```

Step 2

show voip rtp connections

Displays Real-Time Transport Protocol (RTP) connections. Two extra connections are displayed for forked legs.

Example:

```
Device# show voip rtp connections
```

```
VoIP RTP Port Usage Information:
```

```
Max Ports Available: 8091, Ports Reserved: 101, Ports in Use: 8
```

```
Port range not configured, Min: 16384, Max: 32767
```

Media-Address Range	Ports Available	Ports Reserved	Ports In-use
Default Address-Range	8091	101	8

```
VoIP RTP active connections :
```

No.	CallId	dstCallId	LocalRTP	RmtRTP	LocalIP	RemoteIP
1	1	2	16384	20918	10.104.45.191	10.104.8.94
2	2	1	16386	17412	10.104.45.191	10.104.8.98
3	3	4	16388	29652	10.104.45.191	10.104.8.98
4	4	3	16390	20036	10.104.45.191	10.104.8.94
5	6	5	16392	58368	10.104.45.191	10.104.105.232
6	7	5	16394	53828	10.104.45.191	10.104.105.232
7	8	5	16396	39318	10.104.45.191	10.104.105.232
8	9	5	16398	41114	10.104.45.191	10.104.105.232

```
Found 8 active RTP connections
```

Step 3

show voip recmsp session

Displays active recording Media Service Provider (MSP) session information internal to CUBE.

Example:

```
Device# show voip recmsp session
```

```
REC MSP active sessions:
```

MSP Call-ID	AnchorLeg Call-ID	ForkedLeg Call-ID
-------------	-------------------	-------------------

```

143                               141                               145
Found 1 active sessions

```

Step 4 `show voip recmsp session detail call-id call-id`

Displays detailed information about the recording MSP Call ID.

Example:

```

Device# show voip recmsp session detail call-id 145
RECMSP active sessions:
Detailed Information
=====
Recording MSP Leg Details:
Call ID: 143
GUID : 7C5946D38ECD

AnchorLeg Details:
Call ID: 141
Forking Stream type: voice-nearend
Participant: 708090

Non-anchor Leg Details:
Call ID: 140
Forking Stream type: voice-farend
Participant: 10000

Forked Leg Details:
Call ID: 145
Near End Stream CallID 145
Stream State ACTIVE
Far End stream CallID 146
Stream State ACTIVE
Found 1 active sessions

Device# show voip recmsp session detail call-id 5

RECMSP active sessions:
Detailed Information
=====
Recording MSP Leg Details:
Call ID: 5
GUID : 1E01B6000000

AnchorLeg Details:
Call ID: 1
Forking Stream type: voice-nearend
Forking Stream type: video-nearend
Participant: 1777

Non-anchor Leg Details:
Call ID: 2
Forking Stream type: voice-farend
Forking Stream type: video-farend
Participant: 1888

Forked Leg Details:
Call ID: 6
Voice Near End Stream CallID 6
Stream State ACTIVE
Voice Far End stream CallID 7
Stream State ACTIVE
Video Near End stream CallID 8
Stream State ACTIVE

```

```
Video Far End stream CallID 9
Stream State ACTIVE
Found 1 active sessions
```

Output Field	Description
Stream State	Displays the state of the call. This can be ACTIVE or HOLD.
Msp Call-Id	Displays an internal Media service provider call ID and forking related statistics for an active forked call.
Anchor Leg Call-id	Displays an internal anchor leg ID, which is the dial peer where forking enabled. The output displays the participant number and stream type. Stream type voice-near end indicates the called party side.
Non-Anchor Call-id	Displays an internal non-anchor leg ID, which is the dial peer where forking is not enabled. The output displays the participant number and stream type. Stream type voice-near end indicates the called party side.
Forked Call-id	This forking leg call-id will show near-end and far-end stream call-id details with state of the Stream . Displays an internal foked leg ID. The output displays near-end and far-end details of a stream.

Step 5 show voip rtp forking

Displays RTP media-forking connections.

Example:

```
Device# show voip rtp forking
VoIP RTP active forks :
Fork 1
  stream type voice-only (0): count 0
  stream type voice+dtmf (1): count 0
  stream type dtmf-only (2): count 0
  stream type voice-nearend (3): count 1
    remote ip 10.42.29.7, remote port 38526, local port 18648
    codec g711ulaw, logical ssrc 0x53
    packets sent 29687, packets received 0
  stream type voice+dtmf-nearend (4): count 0
  stream type voice-farend (5): count 1
    remote ip 10.42.29.7, remote port 50482, local port 17780
    codec g711ulaw, logical ssrc 0x55
    packets sent 29686, packets received 0
  stream type voice+dtmf-farend (6): count 0
  stream type video (7): count
```

Output Field	Description
remote ip 10.42.29.7, remote port 38526, local port 18648	Recording server IP, recording server port, and local CUBE device port where data for stream 1 was first sent from.
remote ip 10.42.29.7, remote port 50482, local port 17780	Recording server IP, recording server port, and local CUBE device port where data for stream 2 was first sent from.
packets sent 29686	Number of packets sent to the recorder

Output Field	Description
codec g711ulaw	Codec negotiated for the recording leg.

Step 6 **show call active voice compact**

Displays a compact version of voice calls in progress. An additional call leg is displayed for media forking.

Example:

```
Device# show call active voice compact
<callID> A/O FAX T<sec> Codec      type      Peer Address      IP R<ip>:<udp>
Total call-legs: 3
      140 ANS      T644   g711ulaw   VOIP      P10000           10.42.30.32:18638
      141 ORG      T644   g711ulaw   VOIP      P708090          10.42.30.189:26184
      145 ORG      T643   g711ulaw   VOIP      P595959          10.42.29.7:38526
```

Step 7 **show call active video compact**

Displays a compact version of video calls in progress.

Example:

```
Device# show call active video compact
<callID> A/O FAX T<sec> Codec      type      Peer Address      IP R<ip>:<udp>
Total call-legs: 3
      1 ANS      T14    H264       VOIP-VIDEO P1777           10.104.8.94:20036
      2 ORG      T14    H264       VOIP-VIDEO P1888           10.104.8.98:29652
      6 ORG      T13    H264       VOIP-VIDEO P1234          10.104.105.232:39318
```

Step 8 **show sip-ua calls**

Displays active user agent client (UAC) and user agent server (UAS) information on SIP calls.

Example:

```
Device# show sip-ua calls
Total SIP call legs:2, User Agent Client:1, User Agent Server:1
SIP UAC CALL INFO
Call 1
SIP Call ID      : C9A3AA00-B49A11E8-8018A74B-CD0B0450@10.0.0.1
  State of the call      : STATE_ACTIVE (7)
  Substate of the call   : SUBSTATE_NONE (0)
  Calling Number         : 1234
  Called Number          : 9876
  Called URI             : sip:9876@10.0.0.2:9800
  Bit Flags              : 0xC04018 0x90000100 0x80
  CC Call ID            : 13
  Local UUID             : 7d14e2d622ec504f9aaa4ba029ddd136
  Remote UUID            : 2522eaa82f505c868037da95438fc49b
  Source IP Address (Sig) : 10.0.0.1
  Destn SIP Req Addr:Port : [10.0.0.2]:9800
  Destn SIP Resp Addr:Port : [10.0.0.2]:9800
  Destination Name       : 10.0.0.2
  Number of Media Streams : 2
  Number of Active Streams: 2
  RTP Fork Object        : 0x0
  Media Mode             : flow-through
Media Stream 1
  State of the stream    : STREAM_ACTIVE
  Stream Call ID         : 13
  Stream Type            : voice-only (0)
```

```

Stream Media Addr Type      : 1
Negotiated Codec           : g711ulaw (160 bytes)
Codec Payload Type         : 0
Negotiated Dtmf-relay      : inband-voice
Dtmf-relay Payload Type    : 0
QoS ID                     : -1
Local QoS Strength         : BestEffort
Negotiated QoS Strength    : BestEffort
Negotiated QoS Direction   : None
Local QoS Status           : None
Media Source IP Addr:Port  : [10.0.0.1]:8022
Media Dest IP Addr:Port    : [10.0.0.2]:6008
Local Crypto Suite         : AES_CM_128_HMAC_SHA1_80 (
                           AEAD_AES_256_GCM
                           AEAD_AES_128_GCM
                           AES_CM_128_HMAC_SHA1_80
                           AES_CM_128_HMAC_SHA1_32 )
Remote Crypto Suite        : AES_CM_128_HMAC_SHA1_80
Local Crypto Key           : bTQqZXbgFJddAlhE9wJGV3aKxo5vPV+Z1234tVb2
Remote Crypto Key          : bTQqZXbgFJddAlhE9wJGV3aKxo5vPV+Z9876tVb2
Media Stream 2
State of the stream        : STREAM_ACTIVE
Stream Call ID             : 14
Stream Type                 : video (7)
Stream Media Addr Type     : 1
Negotiated Codec           : h264 (0 bytes)
Codec Payload Type         : 97
Negotiated Dtmf-relay      : inband-voice
Dtmf-relay Payload Type    : 0
QoS ID                     : -1
Local QoS Strength         : BestEffort
Negotiated QoS Strength    : BestEffort
Negotiated QoS Direction   : None
Local QoS Status           : None
Media Source IP Addr:Port  : [10.0.0.1]:8020
Media Dest IP Addr:Port    : [10.0.0.2]:9802
Local Crypto Suite         : AES_CM_128_HMAC_SHA1_80 (
                           AEAD_AES_256_GCM
                           AEAD_AES_128_GCM
                           AES_CM_128_HMAC_SHA1_80
                           AES_CM_128_HMAC_SHA1_32 )
Remote Crypto Suite        : AES_CM_128_HMAC_SHA1_80
Local Crypto Key           : bTQqZXbgFJddAlhE9wJGV3aKxo5vPV+Z2345tVb2
Remote Crypto Key          : bTQqZXbgFJddAlhE9wJGV3aKxo5vPV+Z8765tVb2
Mid-Call Re-Association Count: 0
SRTP-RTP Re-Association DSP Query Count: 0

```

```

Options-Ping      ENABLED:NO      ACTIVE:NO
Number of SIP User Agent Client(UAC) calls: 1

```

SIP UAS CALL INFO

Call 1

```

SIP Call ID           : 1-12049@10.0.0.2
State of the call     : STATE_ACTIVE (7)
Substate of the call  : SUBSTATE_NONE (0)
Calling Number        : 1234
Called Number         : 9876
Called URI            : sip:9876@10.0.0.1:5060
Bit Flags             : 0xC0401C 0x10000100 0x4
CC Call ID           : 11
Local UUID            : 2522eaa82f505c868037da95438fc49b
Remote UUID          : 7d14e2d622ec504f9aaa4ba029ddd136
Source IP Address (Sig) : 10.0.0.1

```

```

Destn SIP Req Addr:Port : [10.0.0.2]:5060
Destn SIP Resp Addr:Port: [10.0.0.2]:5060
Destination Name       : 10.0.0.2
Number of Media Streams : 2
Number of Active Streams: 2
RTP Fork Object       : 0x0
Media Mode            : flow-through

Media Stream 1
  State of the stream   : STREAM_ACTIVE
  Stream Call ID       : 11
  Stream Type          : voice-only (0)
  Stream Media Addr Type : 1
  Negotiated Codec     : g711ulaw (160 bytes)
  Codec Payload Type   : 0
  Negotiated Dtmf-relay : inband-voice
  Dtmf-relay Payload Type : 0
  QoS ID               : -1
  Local QoS Strength   : BestEffort
  Negotiated QoS Strength : BestEffort
  Negotiated QoS Direction : None
  Local QoS Status     : None
  Media Source IP Addr:Port: [10.0.0.1]:8016
  Media Dest IP Addr:Port : [10.0.0.2]:6009
  Local Crypto Suite   : AES_CM_128_HMAC_SHA1_80
  Remote Crypto Suite  : AES_CM_128_HMAC_SHA1_80
  Local Crypto Key     : bTQqZXbgFJddA1hE9wJGV3aKxo5vPV+Z9876tVb2
  Remote Crypto Key    : bTQqZXbgFJddA1hE9wJGV3aKxo5vPV+Z1234tVb2

Media Stream 2
  State of the stream   : STREAM_ACTIVE
  Stream Call ID       : 12
  Stream Type          : video (7)
  Stream Media Addr Type : 1
  Negotiated Codec     : h264 (0 bytes)
  Codec Payload Type   : 97
  Negotiated Dtmf-relay : inband-voice
  Dtmf-relay Payload Type : 0
  QoS ID               : -1
  Local QoS Strength   : BestEffort
  Negotiated QoS Strength : BestEffort
  Negotiated QoS Direction : None
  Local QoS Status     : None
  Media Source IP Addr:Port: [10.0.0.1]:8018
  Media Dest IP Addr:Port : [10.0.0.2]:5062
  Local Crypto Suite   : AES_CM_128_HMAC_SHA1_80
  Remote Crypto Suite  : AES_CM_128_HMAC_SHA1_80
  Local Crypto Key     : bTQqZXbgFJddA1hE9wJGV3aKxo5vPV+Z8765tVb2
  Remote Crypto Key    : bTQqZXbgFJddA1hE9wJGV3aKxo5vPV+Z2345tVb2

Mid-Call Re-Association Count: 0
SRTP-RTP Re-Association DSP Query Count: 0

```

```

Options-Ping   ENABLED:NO   ACTIVE:NO
Number of SIP User Agent Server (UAS) calls: 1

```

Step 9 show call active video brief

Displays a truncated version of video calls in progress.

Example:

```
Device# show call active video brief
```

```

Telephony call-legs: 0
SIP call-legs: 3
H323 call-legs: 0

```

```

Call agent controlled call-legs: 0
SCCP call-legs: 0
Multicast call-legs: 0
Total call-legs: 3

0 : 1 87424920ms.1 (*12:23:53.573 IST Wed Jul 17 2013) +1050 pid:1 Answer 1777 active
dur 00:00:46 tx:5250/1857831 rx:5293/1930598 dscp:0 media:0 audio tos:0xB8 video tos:0x88
IP 10.104.8.94:20036 SRTP: off rtt:0ms pl:0/0ms lost:0/0/0 delay:0/0/0ms H264 TextRelay: off
Transcoded: No
...
0 : 2 87424930ms.1 (*12:23:53.583 IST Wed Jul 17 2013) +1040 pid:2 Originate 1888 active
dur 00:00:46 tx:5293/1930598 rx:5250/1857831 dscp:0 media:0 audio tos:0xB8 video tos:0x88
IP 10.104.8.98:29652 SRTP: off rtt:0ms pl:0/0ms lost:0/0/0 delay:0/0/0ms H264 TextRelay: off
Transcoded: No
...
0 : 6 87425990ms.1 (*12:23:54.643 IST Wed Jul 17 2013) +680 pid:1234 Originate 1234 active
dur 00:00:46 tx:10398/3732871 rx:0/0 dscp:0 media:0 audio tos:0xB8 video tos:0x0
IP 10.104.105.232:39318 SRTP: off rtt:0ms pl:0/0ms lost:0/0/0 delay:0/0/0ms H264 TextRelay: off
Transcoded: No
...

```

Step 10 debug ccsip messages (for audio calls)

```

Sent:
INVITE sip:22222@10.42.29.7:5060 SIP/2.0
Via: SIP/2.0/TCP 10.42.30.10:5060;branch=z9hG4bKB622CF
X-Cisco-Recording-Participant: sip:708090@10.42.30.5;media-index="0"
X-Cisco-Recording-Participant: sip:10000@10.42.30.32;media-index="1"
From: <sip:10.42.30.10>;tag=5096700-1E1A
To: <sip:595959@10.42.29.7>
Date: Fri, 18 Mar 2011 07:01:50 GMT
Call-ID: 6E6CF813-506411E0-80EAE01B-4C27AA62@10.42.30.10
Supported: 100rel,timer,resource-priority,replaces,sdp-anat
Min-SE: 1800
Cisco-Guid: 1334370502-1348997600-2396699092-3395863316
User-Agent: Cisco-SIPGateway/IOS-15.2(0.0.2)PIA16
Allow: INVITE, OPTIONS, BYE, CANCEL, ACK, PRACK, UPDATE, REFER, SUBSCRIBE, NOTIFY, INFO, REGISTER
CSeq: 101 INVITE
Max-Forwards: 70
Timestamp: 1300431710
Contact: <sip:10.42.30.10:5060;transport=tcp>
Expires: 180
Allow-Events: telephone-event
Content-Type: application/sdp
Content-Disposition: session;handling=required
Content-Length: 449
v=0
o=CiscoSystemsSIP-GW-UserAgent 3021 3526 IN IP4 10.42.30.10
s=SIP Call
c=IN IP4 10.42.30.10
t=0 0
m=audio 24544 RTP/AVP 0 101 19
c=IN IP4 10.42.30.10
a=rtpmap:0 PCMU/8000
a=rtpmap:101 telephone-event/8000
a=fmtp:101 0-16
a=rtpmap:19 CN/8000
a=ptime:20
a=sendonly
m=audio 31166 RTP/AVP 0 101 19
c=IN IP4 10.42.30.10
a=rtpmap:0 PCMU/8000
a=rtpmap:101 telephone-event/8000

```

```

a=fmtp:101 0-16
a=rtpmap:19 CN/8000
aptime:20
a=sendonly
Received:
SIP/2.0 200 Ok
Via: SIP/2.0/TCP 10.104.46.198:5060;branch=z9hG4bK13262B
To: <sip:23232323@10.104.46.201>;tag=ds457251f
From: <sip:10.104.46.198>;tag=110B66-1CBC
Call-ID: 7142FB-9A5011E0-801EF71A-59B4D258@10.104.46.198
CSeq: 101 INVITE
Content-Length: 206
Contact: <sip:23232323@10.104.46.201:5060;transport=tcp>
Content-Type: application/sdp
Allow: INVITE, BYE, CANCEL, ACK, NOTIFY, INFO, UPDATE
Server: Cisco-ORA/8.5
v=0
o=CiscoORA 2187 1 IN IP4 10.104.46.201
s=SIP Call
c=IN IP4 10.104.46.201
t=0 0
m=audio 54100 RTP/AVP 0
a=rtpmap:0 PCMU/8000
a=recvonly
m=audio 39674 RTP/AVP 0
a=rtpmap:0 PCMU/8000
a=recvonly

Sent:
ACK sip:23232323@10.104.46.201:5060;transport=tcp SIP/2.0
Via: SIP/2.0/TCP 10.104.46.198:5060;branch=z9hG4bK141B87
From: <sip:10.104.46.198>;tag=110B66-1CBC
To: <sip:23232323@10.104.46.201>;tag=ds457251f
Date: Mon, 20 Jun 2011 08:42:01 GMT
Call-ID: 7142FB-9A5011E0-801EF71A-59B4D258@10.104.46.198
Max-Forwards: 70
CSeq: 101 ACK
Allow-Events: telephone-event
Content-Length: 0

```

Output Field	Description
INVITE sip:22222@10.42.29.7:5060 SIP/2.0	22222 is the destination pattern or the number of recording server and is configured under the recorder dial peer.
X-Cisco-Recording-Participant: sip:708090@10.42.30.5;media-index="0"	Cisco proprietary header with originating and terminating participant number and IP address used to communicate to the recording server
Cisco-Guid: 1334370502-1348997600-2396699092-3395863316	GUID is the same for the primary call and forked call .
m=audio 24544 RTP/AVP 0 101 19	First m-line of participant with payload type and codec information .
m=audio 31166 RTP/AVP 0 101 19	Second m- line of another participant with codec info and payload type.

Output Field	Description
a=sendonly	CUBE is always in send only mode towards Recording server.
a=recvonly	Recording server is in receive mode only.

Step 11 **debug ccsip messages** (for video calls)

```

Sent: INVITE sip:575757@9.45.38.39:7686 SIP/2.0
.
.
Via: SIP/2.0/UDP 9.41.36.41:5060;branch=z9hG4bK2CC2408
X-Cisco-Recording-Participant: sip:1777@10.104.45.207;media-
index="0 2"
X-Cisco-Recording-Participant: sip:1888@10.104.45.207;media-   index="1 3"
.
.
Cisco-Guid: 0884935168-0000065536-0000000401-3475859466
.
.
v=0
.
.
m=audio 17232 RTP/AVP 0 19
.
.
a=sendonly
m=audio 17234 RTP/AVP 0 19
.
.
a=sendonly

m=video 17236 RTP/AVP 126
.
.
.

a=fmtp:126 profile-level-id=42801E;packetization-mode=1
a=sendonly
m=video 17238 RTP/AVP 126
.
.

.
a=fmtp:126 profile-level-id=42801E;packetization-mode=1
a=sendonly

```

Output Field	Description
Sent: INVITE sip:575757@9.45.38.39:7686 SIP/2.0	22222 is the destination pattern or the number of recording server and is configured under the recorder dial peer.

Output Field	Description
X-Cisco-Recording-Participant: sip:1777@10.104.45.207;media-index="0 2" X-Cisco-Recording-Participant: sip:1888@10.104.45.207;media-index="1 3"	Cisco proprietary header with originating and terminating participant number and IP address used to communicate to the recording server
Cisco-Guid: 0884935168-0000065536-0000000401-3475859466	GUID is the same for the primary call and forked call .
m=audio 17232 RTP/AVP 0 19	First m-line of participant with payload type and audio codec.
m=audio 17234 RTP/AVP 0 19	Second m-line of another participant with payload type and audio codec.
m=video 17236 RTP/AVP 126	Third m-line of participant with video payload type and codec info .
m=video 17238 RTP/AVP 126	Fourth m-line of another participant with video payload type and codec info .
a=sendonly	CUBE is always in send only mode towards Recording server.

```

Receive:
SIP/2.0 200 OK
.
.
.

v=0
.
.
m=audio 1592 RTP/AVP 0
.
.
a=recvonly
m=audio 1594 RTP/AVP 0
.
.
a=recvonly
m=video 1596 RTP/AVP 126
.
.
a=fmtp:97 profile-level-id=420015
a=recvonly
m=video 1598 RTP/AVP 126
.
.
a=fmtp:126 profile-level-id=420015
a=recvonly
Sent:
ACK sip:9.45.38.39:7686;transport=UDP SIP/2.0

Via: SIP/2.0/UDP 9.41.36.41:5060;branch=z9hG4bK2CD7

From: <sip:9.41.36.41>;tag=1ECFD128-24DF

To: <sip:575757@9.45.38.39>;tag=16104SIPpTag011

Date: Tue, 19 Mar 2013 11:40:01 GMT

```

Call-ID: FFFFFFFF91E00FE6-FFFFFFF8FC011E2-FFFFFFF824DF469-FFFFFFFB6661C06@9.41.36.41

Max-Forwards: 70

CSeq: 101 ACK

Allow-Events: telephone-event

Content-Length: 0

Output Field	Description
m=audio 1592 RTP/AVP 0	First m-line of recording server after it started listening.
m=audio 1594 RTP/AVP 0	Second m-line of recording server after it started listening.
m=video 1596 RTP/AVP 126	Third m-line of recording server after it started listening.
m=video 1598 RTP/AVP 126	Fourth m-line of recording server after it started listening.
a=recvonly	Recording server in receive only mode.

Step 12 debug ccsip messages (for audio-only recording in a call with both audio and video)

Displays offer sent to MediaSense having only audio m-lines, when the **media-type audio** command is configured.

```
Sent:
INVITE sip:54321@9.45.38.39:36212 SIP/2.0
Via: SIP/2.0/UDP 9.41.36.15:5060;branch=z9hG4bK2216B
X-Cisco-Recording-Participant: sip:4321@9.45.38.39;media-index="0"
X-Cisco-Recording-Participant: sip:1111000010@9.45.38.39;media-index="1"
From: <sip:9.41.36.15>;tag=A2C74-5D9
To: <sip:54321@9.45.38.39>.....
Content-Type: application/sdp
Content-Disposition: session;handling=required
Content-Length: 337

v=0
o=CiscoSystemsSIP-GW-UserAgent 9849 5909 IN IP4 9.41.36.15
s=SIP Call
c=IN IP4 9.41.36.15
t=0 0
m=audio 16392 RTP/AVP 0 19
c=IN IP4 9.41.36.15
a=rtpmap:0 PCMU/8000
a=rtpmap:19 CN/8000
a=ptime:20
a=sendonly
m=audio 16394 RTP/AVP 0 19
c=IN IP4 9.41.36.15
a=rtpmap:0 PCMU/8000
a=rtpmap:19 CN/8000
a=ptime:20
a=sendonly
```

Response from CUBE has inactive video m-lines.

```
Received:
SIP/2.0 200 OK
Via: SIP/2.0/UDP 9.41.36.15:5060;branch=z9hG4bK2216B
```

```

...
v=0
...
m=audio 36600 RTP/AVP 0
c=IN IP4 9.45.38.39
a=rtpmap:0 PCMU/8000
a=ptime:20
a=recvonly
m=audio 36602 RTP/AVP 0
c=IN IP4 9.45.38.39
a=rtpmap:0 PCMU/8000
a=ptime:20
a=recvonly
m=video 0 RTP/AVP 98
c=IN IP4 9.45.38.39
b=TIAS:1500000
a=rtpmap:98 H264/90000
a=fmtp:98 profile-level-id=420015
a=inactive
m=video 0 RTP/AVP 98
c=IN IP4 9.45.38.39
b=TIAS:1500000
a=rtpmap:98 H264/90000
a=fmtp:98 profile-level-id=420015
a=inactive

```

Step 13 Enter one of the following:

- **debug ccsip all**
- **debug voip recmsp all**
- **debug voip ccapi all**
- **debug voip fpi all** (for ASR devices only)

Displays detailed debug messages.

For Audio:

Media forking initialized:

```

*Jun 15 10:37:55.404: //103/3E7E90AE8006/SIP/Info/ccsip_trigger_media_forking: MF: Recv Ack..
*Jun 15 10:37:55.404: //103/3E7E90AE8006/SIP/Info/ccsip_trigger_media_forking: MF: Recv Ack & it's
Anchor leg. Start MF.
*Jun 15 10:37:55.404: //103/3E7E90AE8006/SIP/Info/ccsip_ipip_media_forking_preprocess_event: MF:
initial-call. State = 1 & posting the event E_IPIP_MEDIA_FORKING_CALLSETUP_IND

```

Media forking started:

```

*Jun 15 10:37:55.404: //103/3E7E90AE8006/SIP/Info/ccsip_ipip_media_service_get_event_data: Event
id = 30
*Jun 15 10:37:55.404: //103/3E7E90AE8006/SIP/Function/sipSPIUisValidCcb:
*Jun 15 10:37:55.404: //103/3E7E90AE8006/SIP/Function/ccsip_is_valid_ccb:
*Jun 15 10:37:55.404: //103/3E7E90AE8006/SIP/Info/ccsip_ipip_media_forking: MF: Current State = 1,
event =30
*Jun 15 10:37:55.404: //103/3E7E90AE8006/SIP/Info/ccsip_ipip_media_forking: MF: State & Event
combination is cracked..
*Jun 15 10:37:55.404: //103/3E7E90AE8006/SIP/Function/sipSPIGetMainStream:
*Jun 15 10:37:55.404: //103/3E7E90AE8006/SIP/Function/sipSPIGetMainStream:
*Jun 15 10:37:55.404: //103/3E7E90AE8006/SIP/Info/ccsip_ipip_media_forking_precondition: MF: Can
be started with current config.
*Jun 15 10:37:55.404: //103/3E7E90AE8006/SIP/Info/ccsip_ipip_media_forking_BuildMediaRecParticipant:
MF: Populate rec parti header from this leg.

```

Forking header populated:

```
*Jun 15 10:37:55.404: //103/3E7E90AE8006/SIP/Info/ccsip_get_recording_participant_header: MF: X-Cisco
header is RPID..
```

Media forking setup record session is successful:

```
*Jun 15 10:37:55.404: //103/3E7E90AE8006/SIP/Info/ccsip_get_recording_participant_header: MF:
Building SIP URL..
*Jun 15 10:37:55.404: //103/3E7E90AE8006/SIP/Info/ccsip_get_recording_participant_header: MF: Sipuser
= 98459845
*Jun 15 10:37:55.404: //103/3E7E90AE8006/SIP/Info/ccsip_get_recording_participant_header: MF: Host
= 9.42.30.34
*Jun 15 10:37:55.404: //103/3E7E90AE8006/SIP/Function/sipSPIGetFirstStream:
*Jun 15 10:37:55.404: //103/3E7E90AE8006/SIP/Function/voip_media_dir_to_cc_media_dir:
*Jun 15 10:37:55.404: //103/3E7E90AE8006/SIP/Info/ccsip_ipip_media_forking_BuildMediaRecStream: MF:
direction type =3 3
*Jun 15 10:37:55.404: //103/3E7E90AE8006/SIP/Info/ccsip_ipip_media_forking_BuildMediaRecStream: MF:
callid 103 set to nearend..
*Jun 15 10:37:55.404: //103/3E7E90AE8006/SIP/Info/ccsip_ipip_media_forking_BuildMediaRecStream: MF:
dtmf is inband
*Jun 15 10:37:55.404: //103/3E7E90AE8006/SIP/Info/ccsip_ipip_media_forking_BuildMediaRecStream: MF:
First element..
*Jun 15 10:37:55.404: //103/3E7E90AE8006/SIP/Info/ccsip_ipip_media_forking_BuildMediaRecParticipant:
MF: First element..
*Jun 15 10:37:55.404: //103/3E7E90AE8006/SIP/Info/ccsip_ipip_media_forking_BuildMediaRecParticipant:
MF: Populate rec parti header from peer leg.
*Jun 15 10:37:55.404: //104/3E7E90AE8006/SIP/Info/ccsip_get_recording_participant_header: MF: X-Cisco
header is RPID..
*Jun 15 10:37:55.404: //103/3E7E90AE8006/SIP/Info/ccsip_ipip_media_forking_write_to_TDContainer:
MF: Data written to TD Container..
*Jun 15 10:37:55.404: //-1/xxxxxxxxxxxx/Event/recmsp_api_setup_session: Event: E_REC_SETUP_REQ
anchor call ID:103, msp call ID:105 infunction recmsp_api_setup_session
*Jun 15 10:37:55.404: //-1/xxxxxxxxxxxx/Inout/recmsp_api_setup_session: Exit with Success
*Jun 15 10:37:55.404: //103/3E7E90AE8006/SIP/Info/act_sip_mf_idle_callsetup_ind: MF:
setup_record_session is success..
```

Media forking forked stream started:

```
*Jun 15 10:37:55.404: //103/3E7E90AE8006/SIP/Info/sipSPIMFChangeState: MF: Prev state = 1 & New
state = 2
*Jun 15 10:37:55.404: //103/3E7E90AE8006/SIP/Info/ccsip_gen_service_process_event: MF: 30 event
handled.
*Jun 15 10:37:55.406: //106/000000000000/SIP/Info/ccsip_call_setup_request: Set Protocol information
*Jun 15 10:37:55.406: //106/xxxxxxxxxxxx/CCAPI/cc_set_post_tagdata:
*Jun 15 10:37:55.406: //106/000000000000/SIP/Info/ccsip_ipip_media_forking_read_from_TDContainer:
MF: Data read from TD container..
*Jun 15 10:37:55.406: //106/000000000000/SIP/Info/ccsip_ipip_media_forking_forked_leg_config: MF:
MSP callid = 105
*Jun 15 10:37:55.406: //106/000000000000/SIP/Info/ccsip_ipip_media_forking_forked_leg_config: MF:
Overwriting the GUID with the value got from MSP.
*Jun 15 10:37:55.406: //106/000000000000/SIP/Info/ccsip_iwf_handle_peer_event:
*Jun 15 10:37:55.406: //106/000000000000/SIP/Info/ccsip_iwf_map_ccapi_event_to_iwf_event: Event
Category: 1, Event Id: 179
*Jun 15 10:37:55.406: //106/000000000000/SIP/Info/ccsip_iwf_process_event:
*Jun 15 10:37:55.406: //106/000000000000/SIP/Function/sipSPIUisValidCcb:
*Jun 15 10:37:55.406: //106/3E7E90AE8006/SIP/Info/ccsip_ipip_media_forking_add_forking_stream: MF:
Forked stream added..
*Jun 15 10:37:55.406: //106/3E7E90AE8006/SIP/Info/ccsip_ipip_media_forking_read_from_TDContainer:
MF: Data read from TD container..
*Jun 15 10:37:55.406: //106/3E7E90AE8006/SIP/Function/sipSPIGetFirstStream:
*Jun 15 10:37:55.406: //106/3E7E90AE8006/SIP/Info/ccsip_ipip_media_forking_Display_TDContainerData:
** DISPLAY REC PART ***
*Jun 15 10:37:55.406: //106/3E7E90AE8006/SIP/Info/ccsip_ipip_media_forking_Display_TDContainerData:
recorder tag = 5
```

For Video:

Media Forking Initialized:

```
*Mar 19 16:40:01.784 IST: //522/34BF0A000000/SIP/Info/notify/32768/ccsip_trigger_media_forking: MF:
  Recv Ack & it's Anchor leg. Start MF.
*Mar 19 16:40:01.784 IST:
//522/34BF0A000000/SIP/Info/info/32768/ccsip_ipip_media_forking_preprocess_event: MF: initial-call.
  State = 1 & posting the event E_IPIP_MEDIA_FORKING_CALLSETUP_IND
```

Media forking started:

```
*Mar 19 16:40:01.784 IST: //522/34BF0A000000/SIP/Info/info/36864/ccsip_ipip_media_forking: MF:
Current State = 1, event =31
*Mar 19 16:40:01.784 IST: //522/34BF0A000000/SIP/Info/info/36864/ccsip_ipip_media_forking: MF: State
  & Event combination is cracked..
*Mar 19 16:40:01.784 IST: //522/34BF0A000000/SIP/Function/sipSPIGetMainStream:
*Mar 19 16:40:01.784 IST: //522/34BF0A000000/SIP/Function/sipSPIGetMainStream:
*Mar 19 16:40:01.787 IST:
//522/34BF0A000000/SIP/Info/info/34816/ccsip_ipip_media_forking_precondition: MF: Can be started
with current config.
*Mar 19 16:40:01.787 IST: //-1/xxxxxxxxxxxx/Event/recmsp_api_create_session: Event:
E_REC_CREATE_SESSION anchor call ID:522, msp call ID:526
*Mar 19 16:40:01.787 IST: //-1/xxxxxxxxxxxx/Inout/recmsp_api_create_session: Exit with Success
```

Recording participant for anchor leg:

```
//522/34BF0A000000/SIP/Info/verbose/32768/ccsip_ipip_media_forking_BuildMediaRecParticipant: MF:
Populate rec parti header from this leg.
*Mar 19 16:40:01.788 IST:
//522/34BF0A000000/SIP/Info/info/33792/ccsip_get_recording_participant_header: MF: X-Cisco header
is PAI..
```

Adding an audio stream:

```
*Mar 19 16:40:01.788 IST: //522/34BF0A000000/SIP/Function/sipSPIGetFirstStream:
*Mar 19 16:40:01.788 IST:
//522/34BF0A000000/SIP/Info/verbose/32768/ccsip_ipip_media_forking_BuildMediaRecStream: MF: Adding
a Audio stream..
*Mar 19 16:40:01.789 IST: //522/34BF0A000000/SIP/Function/voip_media_dir_to_cc_media_dir:
*Mar 19 16:40:01.789 IST:
//522/34BF0A000000/SIP/Info/info/32768/ccsip_ipip_media_forking_BuildAudioRecStream: MF: direction
type =3 3
*Mar 19 16:40:01.789 IST:
//522/34BF0A000000/SIP/Info/info/32768/ccsip_ipip_media_forking_BuildAudioRecStream: MF: callid 522
set to nearend..
*Mar 19 16:40:01.789 IST:
//522/34BF0A000000/SIP/Info/info/32768/ccsip_ipip_media_forking_BuildAudioRecStream: MF: This
rcstream has 522 callid
*Mar 19 16:40:01.789 IST:
//522/34BF0A000000/SIP/Info/verbose/32768/ccsip_ipip_media_forking_BuildAudioRecStream: MF: Setting
data for audio stream..
*Mar 19 16:40:01.789 IST:
//522/34BF0A000000/SIP/Info/info/32800/ccsip_ipip_media_forking_BuildAudioRecStream: MF: dtmf is
inband
.
```

Video forking:

```
*Mar 19 16:40:01.789 IST: //522/34BF0A000000/SIP/Function/sipSPIGetVideoStream:
*Mar 19 16:40:01.789 IST:
//522/34BF0A000000/SIP/Info/verbose/32772/ccsip_ipip_media_forking_BuildMediaRecStream: MF:
video_codec present,Continue with Video Forking..
```

For Video

Additional References for Network-Based Recording

Related Documents

MediaSense Installation and Administration Guide	Cisco MediaSense Installation and Administration Guide
--	--

Standards and RFCs

RFCs	Title
RFC 3984	<i>RTP Payload Format for H.264 Video</i>
RFC 5104	<i>Codec Control Messages in the RTP Audio-Visual Profile with Feedback (AVPF)</i>
RFC 5168	<i>XML Schema for Media Control</i>



CHAPTER 39

SIPREC (SIP Recording)

The SIPREC (SIP Recording) feature supports media recording for Real-time Transport Protocol (RTP) streams in compliance with section 3.1.1. of RFC 7245, with CUBE acting as the Session Recording Client. SIP is used as a protocol between CUBE and the recording server. Recording of a media session is done by sending a copy of a media stream to the recording server. Metadata is the information that is passed by the recording client to the recording server in a SIP session. The recording metadata describes the communication session and its media streams, and also identifies the participants of the call. CUBE acts as the recording client and any third party recorder acts as the recording server.

- [Feature Information for SIPREC-based Recording, on page 507](#)
- [Prerequisites for SIPREC Recording, on page 508](#)
- [Restrictions for SIPREC Recording, on page 508](#)
- [Information About SIPREC Recording Using CUBE, on page 509](#)
- [How to Configure SIPREC-Based Recording, on page 510](#)
- [Configuration Examples for SIPREC-based Recording, on page 515](#)
- [Configuration Example for Metadata Variations with Different Mid-call Flows, on page 521](#)
- [Configuration Example for Metadata Variations with Different Transfer Flows, on page 534](#)
- [Configuration Examples for Metadata Variations with Caller-ID UPDATE Flow, on page 535](#)
- [Configuration Example for Metadata Variations with Call Disconnect, on page 536](#)

Feature Information for SIPREC-based Recording

The following table provides release information about the feature or features described in this module. This table lists only the software release that introduced support for a given feature in a given software release train. Unless noted otherwise, subsequent releases of that software release train also support that feature.

Use Cisco Feature Navigator to find information about platform support and Cisco software image support. To access Cisco Feature Navigator, go to <https://cfngn.cisco.com/>. An account on Cisco.com is not required.

Feature Name	Releases	Feature Information
SIPREC (SIP Recording)	Cisco IOS 15.6(1)T Cisco IOS XE 3.17S	The SIPREC Recording feature supports recording of audio and video calls. Only audio and video media lines are forked. The following commands were modified: recorder parameter and recorder profile .

Prerequisites for SIPREC Recording

Make sure that:

- Recorders must be reachable from CUBE
- SIPREC should be configured; else, CUBE will fall back to the existing Network-Based Recording implementation. For more information, see *Network-Based Recording* section.
- CUBE supports the SIP Recording Metadata model format requirements specified in [draft-ietf-siprec-metadata-17](#). Recorders must support metadata format of ver17 at a minimum
- CUBE should be in compliance with the Session Recording Protocols defined in [draft-ietf-siprec-protocol-16](#). CUBE supports only the “siprec Option” Tag and the “src feature” tag among the various other extensions defined in the protocols draft; CUBE does not support the SDP extensions.

Restrictions for SIPREC Recording

SIPREC-based recording is not supported for the following calls:

- Any media service parameter change via Re-INVITE or UPDATE from recording server is not supported. For example, hold-resume or any codec changes
- IPv6-to-IPv6 call recording
- IPv6-to-IPv4 call recording if the recording server is configured on the IPv6 call leg
- Calls that do not use Session Initiation Protocol (SIP). Must be a SIP-to-SIP call flow
- Flow-around calls
- Session Description Protocol (SDP) pass-through calls
- Real-time Transport Protocol (RTP) loopback calls
- High-density transcoder calls
- Secure Real-time Transport Protocol (SRTP) passthrough calls
- SRTP-RTP calls with forking for SRTP leg (forking is supported for the RTP leg)
- Multicast music on hold (MOH)
- Mid-call renegotiation and supplementary services like Hold/Resume, control pause, and so on are not supported on the recorder call leg
- Recording is not supported if CUBE is running a TCL IVR application with the exception of `survivability.tcl`, which is supported with SIPREC based recording
- Media mixing on forked streams is not supported
- Digital Signal Processing (DSP) resources are not supported on forked legs
- Server Groups in outbound dial-peers towards recorders is not supported.

- Forking a single call on a CUBE using both dial-peer based recording and SIPREC is not supported.

Restrictions for Video Recording

- If the main call has multiple video streams (m-lines), the video streams other than the first video m-line are not forked
- Application media streams of the primary call are not forked to the recording server
- Forking is not supported if the anchor leg or recording server is on IPv6

Information About SIPREC Recording Using CUBE

Deployment

You need to have:

- Participants — SIP UAs involved in the Communication Session. The UA can be any SIP element.
- Communication Session (CS) — Session established between the endpoints.
- Session Recording Client (SRC) — CUBE acts as the session recording client that triggers the recording session.
- Session Recording Server (SRS) — A SIP User Agent (UA) which is a specialized media server and that acts as a sink for the recorded media and metadata.
- Recording Session (RS) — SIP dialog established between CUBE (recording client) and the recording server.
- Recording Metadata — Information on the CS and the associated media stream data sent from CUBE to RS.

The following figure illustrates a third party recorder deployment with CUBE.

Figure 42: Deployment Scenario for SIPREC Recording Solution

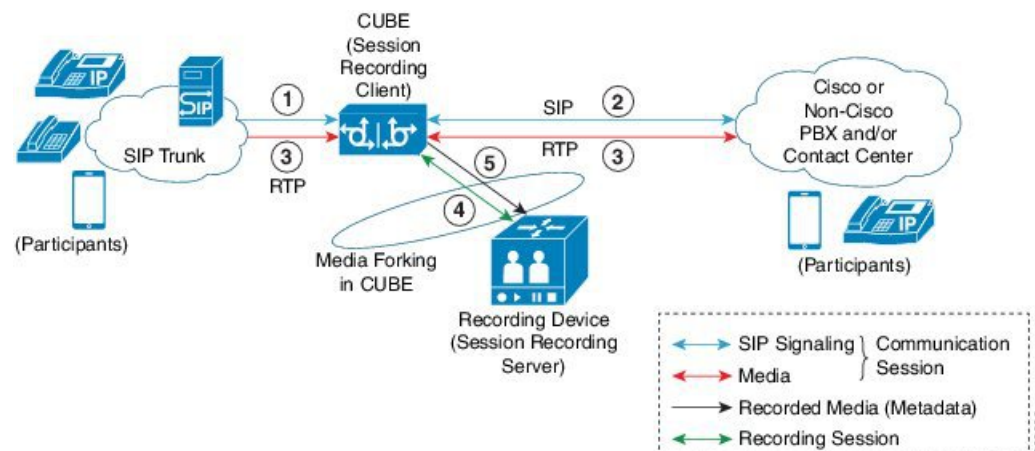

Information flow is described below:

1. Incoming call from SIP trunk
2. Outbound call to Contact Center
3. Media between endpoints flowthrough CUBE
4. CUBE sets up a new SIP session with the recording device (SRS)
5. CUBE forks RTP media to SRS

In the preceding illustration, the Real Time Protocol (RTP) carries voice data and media streams between the user agents and CUBE. The RTP unidirectional stream represent the communication session forked from CUBE to the recording server to indicate forked media. The Session Initiation protocol (SIP) carries call signaling information along with the metadata information. Media streams from CUBE to recording server are unidirectional because only CUBE sends recorded data to recording server; the recording server does not send any media to CUBE.

Metadata has the following functions:

- Carry the communication session data (audio and video calls) that describes the call to the recording server.
- Identifies the participants list.
- Identifies the session and media association time.

If there are any changes in the call sessions, for example, hold-resume, transfer and so on, these sessions are notified to the recording server through metadata.

SIPREC High Availability Support

High availability is supported for SIPREC recording using CUBE. All metadata elements will be checkpointed in a forked call when high-availability is configured. In the event of SSO, all the forked calls and media contexts are preserved on failover.

How to Configure SIPREC-Based Recording

Configuring SIPREC-Based Recording (with Media Profile Recorder)

SUMMARY STEPS

1. **enable**
2. **configure terminal**
3. **media profile recorder** *profile-tag*
4. (Optional) **media-type audio**
5. **media-recording** *dial-peer-tag* [*dial-peer-tag2...dial-peer-tag5*]
6. **exit**
7. **media class** *tag*
8. **recorder profile** *profile-tag siprec*
9. **exit**

10. **dial-peer voice** *dp-tag voip*
11. **session protocol sipv2**
12. **media-class** *tag*
13. **dial-peer voice** *dial-peer-tag voip*
14. **destination-pattern** *[+] string [T]*
15. **session protocol sipv2**
16. **session target ipv4:***[recording-server-destination-address | recording-server-dns]*
17. **session transport tcp**
18. **end**

DETAILED STEPS

	Command or Action	Purpose
Step 1	enable Example: <pre>Device> enable</pre>	Enables privileged EXEC mode. <ul style="list-style-type: none"> • Enter your password if prompted.
Step 2	configure terminal Example: <pre>Device# configure terminal</pre>	Enters global configuration mode.
Step 3	media profile recorder <i>profile-tag</i> Example: <pre>Device(config)# media profile recorder 100</pre>	Configures the media profile recorder and enters media profile configuration mode.
Step 4	(Optional) media-type audio Example: <pre>Device(cfg-mediaprofile)# media-type audio</pre>	Configures recording of audio only in a call with both audio and video. If this configuration is not done, both audio and video are recorded.
Step 5	media-recording <i>dial-peer-tag</i> <i>[dial-peer-tag2...dial-peer-tag5]</i> Example: <pre>Device(cfg-mediaprofile)# media-recording 8000 8001 8002</pre>	Configures the dial-peers that need to be configured Note You can specify a maximum of five dial-peer tags.
Step 6	exit Example: <pre>Device(cfg-mediaprofile)# exit</pre>	Exits media profile configuration mode.
Step 7	media class <i>tag</i> Example:	Configures a media class and enters media class configuration mode.

	Command or Action	Purpose
	Device(config)# media class 100	
Step 8	recorder profile <i>profile-tag</i> siprec Example: Device(cfg-mediaclass)# recorder profile 100 siprec	Configures the media profile SIPREC recorder.
Step 9	exit Example: Device(cfg-mediaclass)# exit	Exits media class configuration mode.
Step 10	dial-peer voice <i>dp-tag</i> voip Example: Device(config)# dial-peer voice 1 voip	Dial peer that needs to be forked.
Step 11	session protocol sipv2 Example: Device(config-dial-peer)# session protocol sipv2	Configures the VoIP dial peer to use Session Initiation Protocol (SIP).
Step 12	media-class <i>tag</i> Example: Device(config-dial-peer)# media-class 100	Configures media class on a dial peer.
Step 13	dial-peer voice <i>dial-peer-tag</i> voip Example: Device(config)# dial-peer voice 8000 voip	Configures a recorder dial peer and enters dial peer voice configuration mode.
Step 14	destination-pattern [+] <i>string</i> [T] Example: Device(config-dial-peer)# destination-pattern 595959	Specifies either the prefix or the full E.164 telephone number (depending on your dial plan) to be used for a dial peer.
Step 15	session protocol sipv2 Example: Device(config-dial-peer)# session protocol sipv2	Configures the VoIP dial peer to use Session Initiation Protocol (SIP).
Step 16	session target ipv4: <i>[recording-server-destination-address recording-server-dns]</i>	Specifies a network-specific address for a dial peer. Keyword and argument are as follows:

	Command or Action	Purpose
	Example: Device(config-dial-peer)# session target ipv4:10.42.29.7	<ul style="list-style-type: none"> • ipv4: <i>destination address</i> --IP address of the dial peer, in this format: <i>xxx.xxx.xxx.xxx</i>
Step 17	session transport tcp Example: Device(config-dial-peer)# session transport tcp	Configures a VoIP dial peer to use Transmission Control Protocol (TCP).
Step 18	end Example: Device(config-dial-peer)# end	Returns to privileged EXEC mode.

Configuring SIPREC-Based Recording (without Media Profile Recorder)

SUMMARY STEPS

1. **enable**
2. **configure terminal**
3. **media class tag**
4. **recorder parametersiprec**
5. (Optional) **media-type audio**
6. **media-recording dial-peer-tag**
7. **exit**
8. **exit**
9. **dial-peer voice dp-tag voip**
10. **session protocol sipv2**
11. **media-class tag**
12. **dial-peer voice dial-peer-tag voip**
13. **destination-pattern [+]** *string* [T]
14. **session protocol sipv2**
15. **session target ipv4:***[recording-server-destination-address | recording-server-dns]*
16. **session transport tcp**
17. **end**

DETAILED STEPS

	Command or Action	Purpose
Step 1	enable Example: Device> enable	Enables privileged EXEC mode. <ul style="list-style-type: none"> • Enter your password if prompted.

	Command or Action	Purpose
Step 2	configure terminal Example: Device# configure terminal	Enters global configuration mode.
Step 3	media class tag Example: Device(config)# media class 100	Configures the media class and enters media class configuration mode.
Step 4	recorder parametersiprec Example: Device(cfg-mediaclass)# recorder parameter siprec	Enables SIPREC recording.
Step 5	(Optional) media-type audio Example: Device(cfg-mediaprofile)# media-type audio	Configures recording of audio only in a call with both audio and video. Note If this configuration is not done, both audio and video are recorded.
Step 6	media-recording dial-peer-tag Example: Device(cfg-mediaclass-recorder)# media-recording 8000, 8001, 8002	Configures voice-class recording parameters. Note You can specify a maximum of five dial-peer tags.
Step 7	exit Example: Device(cfg-mediaclass-recorder)# exit	Exits media class recorder parameter configuration mode.
Step 8	exit Example: Device(cfg-mediaclass)# exit	Exits media class configuration mode.
Step 9	dial-peer voice dp-tag voip Example: Device(config)# dial-peer voice 1 voip	Dial peer that needs to be forked.
Step 10	session protocol sipv2 Example: Device(config-dial-peer)# session protocol sipv2	Configures the VoIP dial peer to use Session Initiation Protocol (SIP).

	Command or Action	Purpose
Step 11	media-class <i>tag</i> Example: Device(config-dial-peer)# media-class 100	Configures media class on a dial peer.
Step 12	dial-peer voice <i>dial-peer-tag</i> voip Example: Device(config)# dial-peer voice 8000 voip	Configures a recorder dial peer and enters dial peer voice configuration mode.
Step 13	destination-pattern [+] <i> string</i> [T] Example: Device(config-dial-peer)# destination-pattern 595959	Specifies either the prefix or the full E.164 telephone number (depending on your dial plan) to be used for a dial peer.
Step 14	session protocol sipv2 Example: Device(config-dial-peer)# session protocol sipv2	Configures the VoIP dial peer to use Session Initiation Protocol (SIP).
Step 15	session target ipv4: <i>[recording-server-destination-address recording-server-dns]</i> Example: Device(config-dial-peer)# session target ipv4:10.42.29.7	Specifies a network-specific address for a dial peer. Keyword and argument are as follows: <ul style="list-style-type: none"> • ipv4: <i>destination address</i> --IP address of the dial peer, in this format: <i>xxx.xxx.xxx.xxx</i>
Step 16	session transport tcp Example: Device(config-dial-peer)# session transport tcp	Configures a VoIP dial peer to use Transmission Control Protocol (TCP).
Step 17	end Example: Device(config-dial-peer)# end	Returns to privileged EXEC mode.

Configuration Examples for SIPREC-based Recording

Example: Configuring SIPREC-based Recording with Media Profile Recorder

```
Router> enable
Router# configure terminal
```

```
Router(config)# media class 101
Router(cfg-mediaclass)# recorder profile 201 siprec
```

Example: Configuring SIPREC-based Recording without Media Profile Recorder

```
Router> enable
Router# configure terminal
Router(config)# media class 101
Router(cfg-mediaclass)# recorder parameter siprec
Router(cfg-mediaclass-recorder)# media-recording 403
```

Validate SIPREC Functionality

Use the command **show voip rtp connections** to verify that media forking configuration is correct:

```
CUBE#show voip rtp connections
VoIP RTP active connections :
No. CallId dstCallId LocalRTP RmtRTP LocalIP RemoteIP
1 36 37 18358 19362 209.165.201.5 209.165.201.10
2 37 36 17294 17690 10.0.0.5 10.0.0.20
3 39 38 19812 42196 172.16.0.10 10.0.0.10
4 40 38 24230 60234 172.16.0.10 10.0.0.10
Found 4 active RTP connections
```

In this example, the call between the 2 phones has resulted into 2 RTP streams (1 and 2). The 2 RTP streams (3 and 4) are the recorded streams that are sent to the Recording Server (10.0.0.10 in this example). The call Recording Server receives a duplicated RTP stream that represents the recorded call. Use the command **show voip recmsp session** to verify:

```
CUBE#sh voip recmsp session
RECMSP active sessions:
MSP Call-ID AnchorLeg Call-ID ForkedLeg Call-ID
143 141 145
Found 1 active sessions
```

To get more details of the streams run the command **show voip recmsp session detail call-id <the value specified in the above op>**:

```
CUBE#show voip recmsp session detail call-id <the value specified in the above o/p>
CUBE#show voip recmsp session detail call-id 143
RECMSP active sessions:
Detailed Information
=====
Recording MSP Leg Details:
Call ID: 143
GUID : 7C5946D38ECD
AnchorLeg Details:
Call ID: 141
Forking Stream type: voice-nearend
Participant: 2001
Non-anchor Leg Details:
Call ID: 140
Forking Stream type: voice-farend
Participant: 1001
Forked Leg Details:
Call ID: 145
Near End Stream CallID 145
Stream State ACTIVE
Far End stream CallID 146
```

```
Stream State ACTIVE
Found 1 active sessions
```

Where:

- **Stream State:** This state shows the state of the call – can be either in ACTIVE or HOLD state.
- **Anchor Leg Call-id:** This ID is the call-id of the anchor leg (Dial-peer where forking is enabled) which is also internal to the system. The output in brief describes the participant number and stream type as voice near-end, which is called party side.
- **Non-Anchor Call-id:** This ID is the call-id of nonanchor leg (Dial-peer where forking is not enabled).
- **Forked Call-id:** This forking leg call-id shows near-end and far-end stream call-id details with state of the Stream.

If you want to know the remote IPs and ports for the near-end and far-end legs, use the **show voip rtp forking** command:

```
CUBE#show voip rtp forking
VoIP RTP active forks:
Fork 1
  stream type voice-only (0): count 0
  stream type voice+dtmf (1): count 0
  stream type dtmf-only (2): count 0
  stream type voice-nearend (3): count 1
  remote ip 10.0.0.10, remote port 38526, local port 18648
  codec g711ulaw, logical ssrc 0x53
  packets sent 29687, packets received 0
  stream type voice+dtmf-nearend (4): count 0
  stream type voice-farend (5): count 1
  remote ip 10.0.0.10, remote port 50482, local port 17780
  codec g711ulaw, logical ssrc 0x55
  packets sent 29686, packets received 0
  stream type voice+dtmf-farend (6): count 0
  stream type video (7): count
```

Remote IP/ Port is the recording server ip and port address. Codec indicates which codec is negotiated to record the call leg. Packets that are sent indicate the number of packets that are sent to Recording Server from each stream.

Troubleshoot

The following is a sample SIPREC configuration on IOS/IOS-XE voice routers.

```
media class 777
recorder parameter siprec
media-recording 777
!
dial-peer voice 11 voip
description CUCM
session protocol sipv2
session target ipv4:10.0.0.15
destination e164-pattern-map 164
media-class 777
codec g711ulaw
!
dial-peer voice 777 voip
destination-pattern AAAA
session protocol sipv2
session target ipv4:10.0.0.10
codec g711ulaw
```

Working Scenario

After the call is connected, the inbound/outbound CCS SIP info legs helps to understand that a recording call has been initiated. In the following example, the outbound call leg 4536 posts a media forking start indication to its peer inbound leg 4535. This inbound leg ignores this event because it is not the anchor leg (in this example, media-class command is configured on the outgoing dial peer (Peer ID 4536)).

```
017895: May 13 15:32:45.273:
//4536/2FD863BAA01F/SIP/Info/info/32768/ccsip_trigger_media_forking: MF: EO leg. set the
pending
flag. wait for peer leg to indicate start
017896: May 13 15:32:45.273:
//4536/2FD863BAA01F/SIP/Info/info/32768/ccsip_trigger_media_forking: MF: posting
CC_EV_H245_MEDIA_FORKING_START_IND.
017901: May 13 15:32:45.273: //4535/2FD863BAA01F/SIP/Info/notify/32768/ccsip_event_handler:
CC_EV_H245_MEDIA_FORKING_START_IND: peer ID 4536, event = 217 type = 1
017902: May 13 15:32:45.273: //4535/2FD863BAA01F/SIP/Info/verbose/32768/ccsip_event_handler:
Ignoring the event on non-anchor leg
```

Similarly, the outbound call leg 4536 posts a media forking start indication to the inbound call leg 5435.

```
018221: May 13 15:32:45.290: //4536/2FD863BAA01F/SIP/Info/notify/32768/ccsip_event_handler:
CC_EV_H245_MEDIA_FORKING_START_IND: peer ID 4535, event = 217 type = 1
```

Outbound leg processes the event and triggers the recording session.

```
018222: May 13 15:32:45.290: //4536/2FD863BAA01F/SIP/Info/verbose/32768/ccsip_event_handler:
Peer leg has indicated start. Trigger Media Forking.
018229: May 13 15:32:45.290: //-1/xxxxxxxxxxxx/Event/recmsp_api_create_session: Event:
E_REC_CREATE_SESSION anchor call ID:4536, msp call ID:4537
018230: May 13 15:32:45.290: //-1/xxxxxxxxxxxx/Inout/recmsp_api_create_session: Exit with
Success
```

Recording dial-peer lookup.

```
018320: May 13 15:32:45.293: //4537/2FD863BAA01F/RECMSP/Inout/recmsp_get_dp_tag_list: REC
DP: =
777
018390: May 13 15:32:45.296: //-
1/xxxxxxxxxxxx/SIP/Info/verbose/5120/sipSPIGetOutboundHostAndDestHostPrivate: CCSIP:
target_host
: 10.0.0.10 target_port : 5060
```

Create XML metadata.

```
018513: May 13 15:32:45.301:
//4538/2FD863BAA01F/SIP/Info/info/32768/ccsip_ipip_mf_create_xml_metadata: MF: XML metadata
Len:
[1763]
<?xml version="1.0" encoding="UTF-8"?>
<recording xmlns="urn:ietf:params:xml:ns:recording:1">
<datamode>complete</datamode>
<session session_id="MIgZ2nTLEemWfQilvyb4Q==">
<sipSessionID>a0b9b2a1e4db51f082e777c0df9015e5;remote=6bea155500105000a0002c31246a214b</sipSessi
onID>
<start-time>2019-05-13T15:32:45.293Z</start-time>
</session>
<participant participant_id="MIhBMXTLEemWfQilvyb4Q==">
<nameID aor="sip:1234@10.0.0.15">
</nameID>
</participant>
<participantsses**MSG 00003 TRUNCATED**
**MSG 00003 CONTINUATION #01**sionassoc participant_id="MIhBMXTLEemWfQilvyb4Q=="
session_id="MIgZ2nTLEemWfQilvyb4Q==">
<associate-time>2019-05-13T15:32:45.293Z</associate-time>
```

```

</participantsessionassoc>
<stream stream_id="MIlSKnTLEemWG6Qilvyb4Q==" session_id="MIgZ2nTLEemWFaQilvyb4Q==">
<label>1</label>
</stream>
<participant participant_id="MIhBMXTLEemWF6Qilvyb4Q==">
<nameID aor="sip:911@209.165.201.1">
<name xml:lang="en">Emergency</name>
</nameID>
</participant>
<participantsessionassoc participant_id="MIhBMXTLEemWF6Qilvyb4Q=="
session_id="MIgZ2nTLEemWFaQilvyb4Q==">
<asso**MSG 00003 TRUNCATED**
**MSG 00003 CONTINUATION #02**ciate-time>2019-05-13T15:32:45.293Z</associate-time>
</participantsessionassoc>
<stream stream_id="MIlSKnTLEemWHKQilvyb4Q==" session_id="MIgZ2nTLEemWFaQilvyb4Q==">
<label>2</label>
</stream>
<participantstreamassoc participant_id="MIhBMXTLEemWFqQilvyb4Q==">
<send>MIlSKnTLEemWG6Qilvyb4Q==</send>
<recv>MIlSKnTLEemWHKQilvyb4Q==</recv>
</participantstreamassoc>
<participantstreamassoc participant_id="MIhBMXTLEemWF6Qilvyb4Q==">
<send>MIlSKnTLEemWHKQilvyb4Q==</send>
<recv>MIlSKnTLEemWG6Qilvyb4Q==</recv>
</participantstreamassoc>
</recording>

```

INVITE is sent to recorder with metadata in XML format where:

- The **nameID** attribute represents the name and SIP/SIPS/tel URI (also called the address of record) of each participant.
- The **participant_id** attribute indicates the unique ID assigned to each participant in the recording session.
- The **stream_id** attribute indicates the unique ID assigned to each media stream in the recording session.
- The **session_id** attribute is used to reference the communication session to which a given media stream belongs.
- The label metadata attribute provides the value of **a=label** attribute assigned to this media stream in the SDP of the SIP request and responses of the recording session. It plays a key role in associating a media stream with its metadata information.

```

018628: May 13 15:32:45.306: //4538/2FD863BAA01F/SIP/Msg/ccsipDisplayMsg:
Sent:
INVITE sip:AAAA@10.0.0.10:5060 SIP/2.0
Via: SIP/2.0/UDP y.y.y.y:5060;branch=z9hG4bK11BD2CA
From: <sip:y.y.y.y>;tag=F75AD7F-2065
To: <sip:AAAA@10.0.0.10>
Date: Mon, 13 May 2019 15:32:45 GMT
Call-ID: 3089C795-74CB11E9-961DA422-D6FC9BE1@y.y.y.y
Supported: 100rel,timer,resource-priority,replaces,sdp-anat
Require: siprec
Min-SE: 1800
Cisco-Guid: 0802710458-1959465449-2686421522-1015028268
User-Agent: Cisco-SIPGateway/IOS-16.10.2
Allow: INVITE, OPTIONS, BYE, CANCEL, ACK, PRACK, UPDATE, REFER, SUBSCRIBE, NOTIFY, INFO,
REGISTER
CSeq: 101 INVITE
Max-Forwards: 70
Timestamp: 1557761565
Contact: <sip:y.y.y.y:5060>;+sip.src
Expires: 180

```

```

Allow-Events: telephone-event
Session-ID: a62dd6d8be0059c38d142bae9b46880b;remote=00000000000000000000000000000000
Session-Expires: 1800
Content-Type: multipart/mixed;boundary=uniqueBoundary
Mime-Version: 1.0
Content-Length: 2470
--uniqueBoundary
Content-Type: application/sdp
Content-Disposition: session;handling=required
v=0
o=CiscoSystemsSIP-GW-UserAgent 5511 2889 IN IP4 y.y.y.y
s=SIP Call
c=IN IP4 y.y.y.y
t=0 0
m=audio 8086 RTP/AVP 0 101 19
c=IN IP4 y.y.y.y
a=rtpmap:0 PCMU/8000
a=rtpmap:101 telephone-event/8000
a=fmtp:101 0-16
a=rtpmap:19 CN/8000
aptime:20
a=sendonly
a=label:1
m=audio 8088 RTP/AVP 0 101 19
c=IN IP4 y.y.y.y
a=rtpmap:0 PCMU/8000
a=rtpmap:101 telephone-event/8000
a=fmtp:101 0-16
a=rtpmap:19 CN/8000
aptime:20
a=sendonly
a=label:2
--uniqueBoundary
Content-Type: application/rs-metadata+xml
Content-Disposition: recording-session
<?xml version="1.0" encoding="UTF-8"?>
<recording xmlns="urn:ietf:params:xml:ns:recording:1">
  <datamode>complete</datamode>
  <session session_id="MIgZ2nTLEemWfQilvyb4Q==">
<sipSessionID>a0b9b2a1e4db51f082e777c0df9015e5;remote=6bea155500105000a0002c31246a214b</sipSessi
onID>
  <start-time>2019-05-13T15:32:45.293Z</start-time> </session>
  <participant participant_id="MIhBMXTLEemWFqQilvyb4Q==">
    <nameID aor="sip:1234@10.0.0.15">
</nameID>
  </participant>
  <participantsessionassoc participant_id="MIhBMXTLEemWFqQilvyb4Q=="
    session_id="MIgZ2nTLEemWfQilvyb4Q==">
    <associate-time>2019-05-13T15:32:45.293Z</associate-time>
  </participantsessionassoc>
  <stream stream_id="MILSKnTLEemWG6Qilvyb4Q==" session_id="MIgZ2nTLEemWfQilvyb4Q==">
    <label>1</label>
  </stream>
  <participant participant_id="MIhBMXTLEemWF6Qilvyb4Q==">
    <nameID aor="sip:911@209.165.201.1">
    <name xml:lang="en">Emergency</name>
    </nameID>
  </participant>
  <participantsessionassoc participant_id="MIhBMXTLEemWF6Qilvyb4Q=="
    session_id="MIgZ2nTLEemWfQilvyb4Q==">
    <associate-time>2019-05-13T15:32:45.293Z</associate-time>
  </participantsessionassoc>

```

```

<stream stream_id="MIlSKnTLEemWHKQilvyb4Q==" session_id="MIgZ2nTLEemWFAQilvyb4Q==">
  <label>2</label>
</stream>
<participantstreamassoc participant_id="MIhBMXTLEemWFqQilvyb4Q==">
  <send>MIlSKnTLEemWG6Qilvyb4Q==</send>
  <recv>MIlSKnTLEemWHKQilvyb4Q==</recv>
</participantstreamassoc>
<participantstreamassoc participant_id="MIhBMXTLEemWF6Qilvyb4Q==">
  <send>MIlSKnTLEemWHKQilvyb4Q==</send>
  <recv>MIlSKnTLEemWG6Qilvyb4Q==</recv>
</participantstreamassoc>
</recording>
--uniqueBoundary--

```

In 200 OK recorder sends media **a=recvonly** and media forking is started.

```

018638: May 13 15:32:45.307: //4538/2FD863BAA01F/SIP/Msg/ccsipDisplayMsg:
Received:
SIP/2.0 200 OK
Via: SIP/2.0/UDP y.y.y.y:5060;branch=z9hG4bK11BD2CA
From: <sip:y.y.y.y>;tag=F75AD7F-2065
To: <sip:AAAA@10.0.0.10>;tag=7
Call-ID: 3089C795-74CB11E9-961DA422-D6FC9BE1@y.y.y.y
CSeq: 101 INVITE
Contact: <sip:10.0.0.10:5060;transport=UDP>
Content-Type: application/sdp
Content-Length: 207
v=0
o=user1 53655765 2353687637 IN IP4 10.0.0.10
s=-
c=IN IP4 10.0.0.10
t=0 0
m=audio 6000 RTP/AVP 0
a=rtpmap:0 PCMU/8000
a=recvonly
m=audio 8002 RTP/AVP 0
a=rtpmap:0 PCMU/8000
a=recvonly
018809: May 13 15:32:45.313: //4537/2FD863BAA01F/REC MSP/Event/recmsp_api_connect: Event:
E_REC_CC_CONNECTmsp call ID:4537 in recmsp_api_connect

```

Configuration Example for Metadata Variations with Different Mid-call Flows

Example: Complete SIP Recording Metadata Information Sent in INVITE or Re-INVITE

The following example provides all the elements involved in Recording Metadata XML body.

```

--uniqueBoundary
Content-Type: application/sdp
Content-Disposition: session;handling=required
v=0
o=CiscoSystemsSIP-GW-UserAgent 509 7422 IN IP4 9.42.25.149
s=SIP Call
c=IN IP4 9.42.25.149
t=0 0
m=audio 16552 RTP/AVP 8 101

```

Example: Complete SIP Recording Metadata Information Sent in INVITE or Re-INVITE

```

c=IN IP4 9.42.25.149
a=rtpmap:8 PCMA/8000
a=rtpmap:101 telephone-event/8000
a=fmtp:101 0-16
aptime:20
a=sendonly
a=label:1
m=audio 16554 RTP/AVP 8 101
c=IN IP4 9.42.25.149
a=rtpmap:8 PCMA/8000
a=rtpmap:101 telephone-event/8000
a=fmtp:101 0-16
aptime:20
a=sendonly
a=label:2
m=video 16556 RTP/AVP 119
c=IN IP4 9.42.25.149
b=TIAS:1000000
a=rtpmap:119 H264/90000
a=fmtp:119 profile-level-id=42801E;packetization-mode=0
a=sendonly
a=label:3
m=video 16558 RTP/AVP 97
c=IN IP4 9.42.25.149
b=TIAS:1000000
a=rtpmap:97 H264/90000
a=fmtp:97 profile-level-id=42801E;packetization-mode=0
a=sendonly
a=label:4
--uniqueBoundary
Content-Type: application/rs-metadata+xml
Content-Disposition: recording-session

<?xml version="1.0" encoding="UTF-8"?>
<recording xmlns="urn:ietf:params:xml:ns:recording:1">
  <datamode>complete</datamode>
  <session session_id="JaPQePlCEeSA66sYHx7YVg==">
    <sipSessionID>276ac102a3c05270a4375d99512ea1a1;remote=110b0c0f50775078b13d60be0044db11
    </sipSessionID>
    <start-time>2015-05-19T09:42:06.911Z</start-time>
  </session>
  <participant participant_id="JaPQePlCEeSA76sYHx7YVg==">
    <nameID aor="sip:808808@9.0.0.174">
      <name xml:lang="en">808808</name>
    </nameID>
  </participant>
  <participantsessionassoc participant_id="JaPQePlCEeSA76sYHx7YVg=="
  session_id="JaPQePlCEeSA66sYHx7YVg==">
    <associate-time>2015-05-19T09:42:06.911Z</associate-time>
  </participantsessionassoc>
  <stream stream_id="JaPQePlCEeSA8KsYHx7YVg==" session_id="JaPQePlCEeSA66sYHx7YVg==">
    <label>1</label>
  </stream>
  <stream stream_id="JaPQePlCEeSA8asYHx7YVg==" session_id="JaPQePlCEeSA66sYHx7YVg==">
    <label>3</label>
  </stream>
  <participant participant_id="JaPQePlCEeSA8qsYHx7YVg==">
    <nameID aor="sip:909909@9.0.0.174">
      <name xml:lang="en">909909</name>
    </nameID>
  </participant>
  <participantsessionassoc participant_id="JaPQePlCEeSA8qsYHx7YVg=="
  session_id="JaPQePlCEeSA66sYHx7YVg==">
    <associate-time>2015-05-19T09:42:06.911Z</associate-time>

```



```

</participantsessionassoc>
<stream stream_id="JaPQeP1CEeSA86sYHx7YVg==" session_id="JaPQeP1CEeSA66sYHx7YVg==">
  <label>2</label>
</stream>
<stream stream_id="JaPQeP1CEeSA9KsYHx7YVg==" session_id="JaPQeP1CEeSA66sYHx7YVg==">
  <label>4</label>
</stream>
<participantstreamassoc participant_id="JaPQeP1CEeSA76sYHx7YVg==">
  <send>JaPQeP1CEeSA8KsYHx7YVg==</send>
  <recv>JaPQeP1CEeSA86sYHx7YVg==</recv>
  <send>JaPQeP1CEeSA8asYHx7YVg==</send>
  <recv>JaPQeP1CEeSA9KsYHx7YVg==</recv>
</participantstreamassoc>
<participantstreamassoc participant_id="JaPQeP1CEeSA8qsYHx7YVg==">
  <send>JaPQeP1CEeSA86sYHx7YVg==</send>
  <recv>JaPQeP1CEeSA8KsYHx7YVg==</recv>
  <send>JaPQeP1CEeSA9KsYHx7YVg==</send>
  <recv>JaPQeP1CEeSA8asYHx7YVg==</recv>
</participantstreamassoc>
</recording>
-uniqueBoundary-

```

Output Field	Description
urn:ietf:params:xml:ns:recording:1	Defines the namespace URI for the elements—Uniform Resource Namespace (URN).
datamode>complete</datamode	<dataMode> is a recording element that indicates whether the XML document is a complete document or a partial update. If no <dataMode> element is present then the default value is "complete".
session session_id="JaPQeP1CEeSA66sYHx7YVg=="	Session ID which remains constant for the complete call leg.
sipSessionID 276ac102a3c05270a4375d99512ea1a1; remote=110b0c0f50775078b13d60be0044db11	This attribute carries a SIP Session-ID of the original call between the participants.
<participant participant_id="JaPQeP1CEeSA76sYHx7YVg=="> <nameID aor="sip:808808@9.0.0.174">	Name and participant ID of the first participant. The first participant will always be the anchor leg of the call. Each participant has a unique 'participant_id' attribute. For example, nameID is sip:808808 .
a=label:1; <stream stream_id="JaPQeP1CEeSA86sYHx7YVg==" session_id="JaPQeP1CEeSA66sYHx7YVg=="> <label>1</label> </stream>	The <stream> element represents a Media Stream object. Stream element indicates the SDP media lines associated with the session and participants. The <label> element within the <stream> element references an SDP "a=label" attribute that identifies an m-line within the RS SDP. This m-line carries the media stream from the SRC to the SRS.

Output Field	Description
<pre> participantsessionassoc participant_id="JaPQeP1CEeSA76sYHx7YVg==" session_id="JaPQeP1CEeSA66sYHx7YVg=="> </pre>	<p>Participant CS Association class describes the association of the first participant to a CS for a period of time. A participant can associate and dissociate from a CS several times.</p> <p>ParticipantCS association class has the following attributes:</p> <ul style="list-style-type: none"> • Associate-time—Time when the participant is associated to CS. • Disassociate-time—Time when the participant is dissociated from a CS. <p>Each CS object is represented by one session element. Each session element has a unique 'session_id' attribute which helps to identify unique CS sessions.</p>
<pre> participantsessionassoc participant_id="JaPQeP1CEeSA8qsYHx7YVg==" session_id="JaPQeP1CEeSA66sYHx7YVg=="> </pre>	<p>Participant CS Association class describes the association of the second participant to a CS for a period of time. A participant can associate and dissociate from a CS several times.</p> <p>The 'session_id' attribute helps to identify unique CS session of the second participant.</p>
<pre> participantstreamassoc participant_id="JaPQeP1CEeSA76sYHx7YVg==">; participantstreamassoc participant_id="JaPQeP1CEeSA8qsYHx7YVg==">; </pre>	<p>Participant stream association class describes the association of either participant 1 or 2 to a media stream for a period of time, as a sender or as a receiver, or both. These streams can be either audio or video or both.</p> <p>ParticipantStream association class has the following attributes:</p> <ul style="list-style-type: none"> • Associate-time—Time when the participant starts contributing for a media stream. • Disassociate-time—Time when the participant stops receiving a media stream.

Example: Hold with Send-only / Recv-only Attribute in SDP

When a participant puts the audio call on hold with send-only attribute, the stream is sent only in one direction.

Here, in a normal recording session, both participants sent audio and video streams.

```

--uniqueBoundary
Content-Type: application/sdp
Content-Disposition: session;handling=required

v=0
o=CiscoSystemsSIP-GW-UserAgent 2973 4879 IN IP4 9.42.25.149
s=SIP Call
c=IN IP4 9.42.25.149

```

```

t=0 0
m=audio 16464 RTP/AVP 0 101
c=IN IP4 9.42.25.149
a=rtpmap:0 PCMU/8000
a=rtpmap:101 telephone-event/8000
a=fmtp:101 0-16
a=ptime:20
a=sendonly
a=label:1
m=audio 16466 RTP/AVP 0 101
c=IN IP4 9.42.25.149
a=rtpmap:0 PCMU/8000
a=rtpmap:101 telephone-event/8000
a=fmtp:101 0-16
a=ptime:20
a=sendonly
a=label:2
m=video 16468 RTP/AVP 97
c=IN IP4 9.42.25.149
b=TIAS:1000000
a=rtpmap:97 H264/90000
a=fmtp:97 profile-level-id=42801E;packetization-mode=0
a=sendonly
a=label:3
m=video 16470 RTP/AVP 97
c=IN IP4 9.42.25.149
b=TIAS:1000000
a=rtpmap:97 H264/90000
a=fmtp:97 profile-level-id=42801E;packetization-mode=0
a=sendonly
a=label:4

--uniqueBoundary
Content-Type: application/rs-metadata+xml
Content-Disposition: recording-session

<?xml version="1.0" encoding="UTF-8"?>
<recording xmlns="urn:ietf:params:xml:ns:recording:1">
...
  <stream stream_id="jIBTUf1BEeSAdKsYHx7YVg==" session_id="jH+2kf1BEeSAb6sYHx7YVg==">
    <label>1</label>
  </stream>
  <stream stream_id="jIBTUf1BEeSAdasYHx7YVg==" session_id="jH+2kf1BEeSAb6sYHx7YVg==">
    <label>3</label>
  </stream>
...
  <stream stream_id="jIBTUf1BEeSAd6sYHx7YVg==" session_id="jH+2kf1BEeSAb6sYHx7YVg==">
    <label>2</label>
  </stream>
  <stream stream_id="jIBTUf1BEeSAeKsYHx7YVg==" session_id="jH+2kf1BEeSAb6sYHx7YVg==">
    <label>4</label>
  </stream>
  <participantstreamassoc participant_id="jIBTUf1BEeSAd6sYHx7YVg==">
    <send>jIBTUf1BEeSAdKsYHx7YVg==</send>
    <recv>jIBTUf1BEeSAd6sYHx7YVg==</recv>
    <send>jIBTUf1BEeSAdasYHx7YVg==</send>
    <recv>jIBTUf1BEeSAeKsYHx7YVg==</recv>
  </participantstreamassoc>
  <participantstreamassoc participant_id="jIBTUf1BEeSAdqsYHx7YVg==">
    <send>jIBTUf1BEeSAd6sYHx7YVg==</send>
    <recv>jIBTUf1BEeSAdKsYHx7YVg==</recv>
    <send>jIBTUf1BEeSAeKsYHx7YVg==</send>
    <recv>jIBTUf1BEeSAdasYHx7YVg==</recv>
  </participantstreamassoc>

```

```
</recording>
```

```
--uniqueBoundary--
```

In this scenario, the second participant puts the call on hold using `sendonly` and the first participant will respond using `recvonly`. You can see from the **participantStream association** element that the second participant only sends audio and video streams and the first participant just receives the media streams.

The output after the second participant puts the call on hold with `sendonly` attribute:

```
--uniqueBoundary
```

```
Content-Type: application/sdp
```

```
v=0
```

```
o=CiscoSystemsSIP-GW-UserAgent 2973 4880 IN IP4 9.42.25.149
```

```
s=SIP Call
```

```
c=IN IP4 9.42.25.149
```

```
t=0 0
```

```
m=audio 16464 RTP/AVP 0 101
```

```
c=IN IP4 9.42.25.149
```

```
a=rtpmap:0 PCMU/8000
```

```
a=rtpmap:101 telephone-event/8000
```

```
a=fmtp:101 0-16
```

```
aptime:20
```

```
a=inactive
```

```
a=label:1
```

```
m=audio 16466 RTP/AVP 0 101
```

```
c=IN IP4 9.42.25.149
```

```
a=rtpmap:0 PCMU/8000
```

```
a=rtpmap:101 telephone-event/8000
```

```
a=fmtp:101 0-16
```

```
aptime:20
```

```
a=sendonly
```

```
a=label:2
```

```
m=video 16468 RTP/AVP 97
```

```
c=IN IP4 9.42.25.149
```

```
b=TIAS:1000000
```

```
a=rtpmap:97 H264/90000
```

```
a=fmtp:97 profile-level-id=42801E;packetization-mode=0
```

```
a=inactive
```

```
a=label:3
```

```
m=video 16470 RTP/AVP 97
```

```
c=IN IP4 9.42.25.149
```

```
b=TIAS:1000000
```

```
a=rtpmap:97 H264/90000
```

```
a=fmtp:97 profile-level-id=42801E;packetization-mode=0
```

```
a=sendonly
```

```
a=label:4
```

```
--uniqueBoundary
```

```
Content-Type: application/rs-metadata+xml
```

```
Content-Disposition: recording-session
```

```
<?xml version="1.0" encoding="UTF-8"?>
```

```
<recording xmlns="urn:ietf:params:xml:ns:recording:1">
```

```
...
```

```
<stream stream_id="jIBTUf1BEeSAdKsYHx7YVg==" session_id="jH+2kf1BEeSAb6sYHx7YVg==">
  <label>1</label>
```

```
</stream>
```

```
<stream stream_id="jIBTUf1BEeSAdasYHx7YVg==" session_id="jH+2kf1BEeSAb6sYHx7YVg==">
  <label>3</label>
```

```
</stream>
```

```
...
```

```
<stream stream_id="jIBTUf1BEeSAd6sYHx7YVg==" session_id="jH+2kf1BEeSAb6sYHx7YVg==">
```

```

        <label>2</label>
    </stream>
    <stream stream_id="jIBTUf1BEeSAeKsYHx7YVg==" session_id="jH+2kf1BEeSAb6sYHx7YVg==">
        <label>4</label>
    </stream>
    <participantstreamassoc participant_id="jIBTUf1BEeSAd6sYHx7YVg==">
        <recv>jIBTUf1BEeSAd6sYHx7YVg==</recv>
        <recv>jIBTUf1BEeSAeKsYHx7YVg==</recv>
    </participantstreamassoc>
    <participantstreamassoc participant_id="jIBTUf1BEeSAdqsYHx7YVg==">
        <send>jIBTUf1BEeSAd6sYHx7YVg==</send>
        <send>jIBTUf1BEeSAeKsYHx7YVg==</send>
    </participantstreamassoc>
</recording>

--uniqueBoundary--

```

Example: Hold with Inactive Attribute in SDP

Here, you can see that video call is sent in the initial INVITE to recorder where both the participants send and receive audio and video streams. There are 2 audio and 2 video streams from both the participants each in the **participantStream association** element.

```

--uniqueBoundary
Content-Type: application/sdp
Content-Disposition: session;handling=required

v=0
o=CiscoSystemsSIP-GW-UserAgent 7476 1347 IN IP4 9.42.25.149
s=SIP Call
c=IN IP4 9.42.25.149
t=0 0
m=audio 16496 RTP/AVP 0 101
c=IN IP4 9.42.25.149
a=rtpmap:0 PCMU/8000
a=rtpmap:101 telephone-event/8000
a=fmtp:101 0-16
a=ptime:20
a=sendonly
a=label:1
m=audio 16498 RTP/AVP 0 101
c=IN IP4 9.42.25.149
a=rtpmap:0 PCMU/8000
a=rtpmap:101 telephone-event/8000
a=fmtp:101 0-16
a=ptime:20
a=sendonly
a=label:2
m=video 16500 RTP/AVP 97
c=IN IP4 9.42.25.149
b=TIAS:1000000
a=rtpmap:97 H264/90000
a=fmtp:97 profile-level-id=42801E;packetization-mode=0
a=sendonly
a=label:3
m=video 16502 RTP/AVP 97
c=IN IP4 9.42.25.149
b=TIAS:1000000
a=rtpmap:97 H264/90000
a=fmtp:97 profile-level-id=42801E;packetization-mode=0
a=sendonly
a=label:4

```

Example: Hold with Inactive Attribute in SDP

```

--uniqueBoundary
Content-Type: application/rs-metadata+xml
Content-Disposition: recording-session

<?xml version="1.0" encoding="UTF-8"?>
<recording xmlns="urn:ietf:params:xml:ns:recording:1">
...
  <stream stream_id="uV/B4f1BEeSAmKsYHx7YVg==" session_id="uV/B4f1BEeSAk6sYHx7YVg==">
    <label>1</label>
  </stream>
  <stream stream_id="uV/B4f1BEeSAmasYHx7YVg==" session_id="uV/B4f1BEeSAk6sYHx7YVg==">
    <label>3</label>
  </stream>
...
  <stream stream_id="uV/B4f1BEeSAm6sYHx7YVg==" session_id="uV/B4f1BEeSAk6sYHx7YVg==">
    <label>2</label>
  </stream>
  <stream stream_id="uV/B4f1BEeSAnKsYHx7YVg==" session_id="uV/B4f1BEeSAk6sYHx7YVg==">
    <label>4</label>
  </stream>
  <participantstreamassoc participant_id="uV/B4f1BEeSA16sYHx7YVg==">
    <send>uV/B4f1BEeSAmKsYHx7YVg==</send>
    <recv>uV/B4f1BEeSAm6sYHx7YVg==</recv>
    <send>uV/B4f1BEeSAmasYHx7YVg==</send>
    <recv>uV/B4f1BEeSAnKsYHx7YVg==</recv>
  </participantstreamassoc>
  <participantstreamassoc participant_id="uV/B4f1BEeSAmqsYHx7YVg==">
    <send>uV/B4f1BEeSAm6sYHx7YVg==</send>
    <recv>uV/B4f1BEeSAmKsYHx7YVg==</recv>
    <send>uV/B4f1BEeSAnKsYHx7YVg==</send>
    <recv>uV/B4f1BEeSAmasYHx7YVg==</recv>
  </participantstreamassoc>
</recording>

--uniqueBoundary--

```

When the first participant puts the call on hold with inactive SDP attribute, there will be not any active streams in the metadata.

```

--uniqueBoundary
Content-Type: application/sdp

v=0
o=CiscoSystemsSIP-GW-UserAgent 7476 1348 IN IP4 9.42.25.149
s=SIP Call
c=IN IP4 9.42.25.149
t=0 0
m=audio 16496 RTP/AVP 0 101
c=IN IP4 9.42.25.149
a=rtpmap:0 PCMU/8000
a=rtpmap:101 telephone-event/8000
a=fmtp:101 0-16
a=ptime:20
a=inactive
a=label:1
m=audio 16498 RTP/AVP 0 101
c=IN IP4 9.42.25.149
a=rtpmap:0 PCMU/8000
a=rtpmap:101 telephone-event/8000
a=fmtp:101 0-16
a=ptime:20
a=inactive
a=label:2
m=video 16500 RTP/AVP 97

```

```

c=IN IP4 9.42.25.149
b=TIAS:1000000
a=rtpmap:97 H264/90000
a=fmtp:97 profile-level-id=42801E;packetization-mode=0
a=inactive
a=label:3
m=video 16502 RTP/AVP 97
c=IN IP4 9.42.25.149
b=TIAS:1000000
a=rtpmap:97 H264/90000
a=fmtp:97 profile-level-id=42801E;packetization-mode=0
a=inactive
a=label:4

--uniqueBoundary
Content-Type: application/rs-metadata+xml
Content-Disposition: recording-session

<?xml version="1.0" encoding="UTF-8"?>
<recording xmlns="urn:ietf:params:xml:ns:recording:1">
...
  <stream stream_id="uV/B4f1BEeSAmKsYHx7YVg==" session_id="uV/B4f1BEeSAk6sYHx7YVg==">
    <label>1</label>
  </stream>
  <stream stream_id="uV/B4f1BEeSAmAsYHx7YVg==" session_id="uV/B4f1BEeSAk6sYHx7YVg==">
    <label>3</label>
  </stream>
...
  <stream stream_id="uV/B4f1BEeSAm6sYHx7YVg==" session_id="uV/B4f1BEeSAk6sYHx7YVg==">
    <label>2</label>
  </stream>
  <stream stream_id="uV/B4f1BEeSAnKsYHx7YVg==" session_id="uV/B4f1BEeSAk6sYHx7YVg==">
    <label>4</label>
  </stream>
  <participantstreamassoc participant_id="uV/B4f1BEeSA16sYHx7YVg==">
  </participantstreamassoc>
  <participantstreamassoc participant_id="uV/B4f1BEeSAmqsYHx7YVg==">
  </participantstreamassoc>
</recording>

--uniqueBoundary--

```

Example: Escalation

During escalation, video streams will be added to the Re-INVITE meta-data sent to the recorder.

In the below example, you can see the metadata representation of an original audio call sent in the initial INVITE to the recorder where both the participants send and receive audio streams.

```

--uniqueBoundary
Content-Type: application/sdp
Content-Disposition: session;handling=required

v=0
o=CiscoSystemsSIP-GW-UserAgent 6360 4788 IN IP4 9.42.25.149
s=SIP Call
c=IN IP4 9.42.25.149
t=0 0
m=audio 16628 RTP/AVP 8 101
c=IN IP4 9.42.25.149
a=rtpmap:8 PCMA/8000
a=rtpmap:101 telephone-event/8000
a=fmtp:101 0-16

```

```

a=ptime:20
a=sendonly
a=label:1
m=audio 16630 RTP/AVP 8 101
c=IN IP4 9.42.25.149
a=rtpmap:8 PCMA/8000
a=rtpmap:101 telephone-event/8000
a=fmtp:101 0-16
a=ptime:20
a=sendonly
a=label:2

--uniqueBoundary
Content-Type: application/rs-metadata+xml
Content-Disposition: recording-session

<?xml version="1.0" encoding="UTF-8"?>
<recording xmlns="urn:ietf:params:xml:ns:recording:1">
...
  <stream stream_id="evyS5/1CEeSBOKsYHx7YVg==" session_id="evv2v/1CEeSBM6sYHx7YVg==">
    <label>1</label>
  </stream>
...
  <stream stream_id="evyS5/1CEeSBOqsYHx7YVg==" session_id="evv2v/1CEeSBM6sYHx7YVg==">
    <label>2</label>
  </stream>
  <participantstreamassoc participant_id="evyS5/1CEeSBN6sYHx7YVg==">
    <send>evyS5/1CEeSBOKsYHx7YVg==</send>
    <recv>evyS5/1CEeSBOqsYHx7YVg==</recv>
  </participantstreamassoc>
  <participantstreamassoc participant_id="evyS5/1CEeSBOasYHx7YVg==">
    <send>evyS5/1CEeSBOqsYHx7YVg==</send>
    <recv>evyS5/1CEeSBOKsYHx7YVg==</recv>
  </participantstreamassoc>
</recording>

--uniqueBoundary--

```

After escalation, video streams get added into the **participantStream association** element in metadata for both the participants. There will be 4 streams in total.

```

--uniqueBoundary
Content-Type: application/sdp

v=0
o=CiscoSystemsSIP-GW-UserAgent 6360 4789 IN IP4 9.42.25.149
s=SIP Call
c=IN IP4 9.42.25.149
t=0 0
m=audio 16628 RTP/AVP 18 101
c=IN IP4 9.42.25.149
a=rtpmap:18 G729/8000
a=fmtp:18 annexb=no
a=rtpmap:101 telephone-event/8000
a=fmtp:101 0-16
a=ptime:20
a=sendonly
a=label:1
m=audio 16630 RTP/AVP 18 101
c=IN IP4 9.42.25.149
a=rtpmap:18 G729/8000
a=fmtp:18 annexb=no
a=rtpmap:101 telephone-event/8000
a=fmtp:101 0-16
a=ptime:20

```



```

a=sendonly
a=label:2
m=video 16636 RTP/AVP 97
c=IN IP4 9.42.25.149
b=TIAS:1000000
a=rtpmap:97 H264/90000
a=fmtp:97 profile-level-id=42801E;packetization-mode=0
a=sendonly
a=label:3
m=video 16638 RTP/AVP 97
c=IN IP4 9.42.25.149
b=TIAS:1000000
a=rtpmap:97 H264/90000
a=fmtp:97 profile-level-id=42801E;packetization-mode=0
a=sendonly
a=label:4

--uniqueBoundary
Content-Type: application/rs-metadata+xml
Content-Disposition: recording-session

<?xml version="1.0" encoding="UTF-8"?>
<recording xmlns="urn:ietf:params:xml:ns:recording:1">
...
  <stream stream_id="evyS5/1CEeSBOKsYHx7YVg==" session_id="evv2v/1CEeSBM6sYHx7YVg==">
    <label>1</label>
  </stream>
  <stream stream_id="e5Zhtv1CEeSBPKsYHx7YVg==" session_id="evv2v/1CEeSBM6sYHx7YVg==">
    <label>3</label>
  </stream>
...
  <stream stream_id="e5Zhtv1CEeSBPasYHx7YVg==" session_id="evv2v/1CEeSBM6sYHx7YVg==">
    <label>4</label>
  </stream>
  <participantstreamassoc participant_id="evyS5/1CEeSBN6sYHx7YVg==">
    <send>evyS5/1CEeSBOKsYHx7YVg==</send>
    <recv>evyS5/1CEeSBOqsYHx7YVg==</recv>
    <send>e5Zhtv1CEeSBPKsYHx7YVg==</send>
    <recv>e5Zhtv1CEeSBPasYHx7YVg==</recv>
  </participantstreamassoc>
  <participantstreamassoc participant_id="evyS5/1CEeSBOasYHx7YVg==">
    <send>evyS5/1CEeSBOqsYHx7YVg==</send>
    <recv>evyS5/1CEeSBOKsYHx7YVg==</recv>
    <send>e5Zhtv1CEeSBPasYHx7YVg==</send>
    <recv>e5Zhtv1CEeSBPKsYHx7YVg==</recv>
  </participantstreamassoc>
</recording>

--uniqueBoundary--

```

Example: De-escalation

During de-escalation, video streams will be truncated in the Re-INVITE metadata sent to the recorder.

In the below example, you can see two streams each for the audio and video calls in the metadata.

```

--uniqueBoundary
Content-Type: application/sdp
Content-Disposition: session;handling=required

v=0
o=CiscoSystemsSIP-GW-UserAgent 7616 8308 IN IP4 9.42.25.149
s=SIP Call

```

Example: De-escalation

```

c=IN IP4 9.42.25.149
t=0 0
m=audio 16648 RTP/AVP 116 101
c=IN IP4 9.42.25.149
a=rtpmap:116 iLBC/8000
a=fmtp:116 mode=20
a=rtpmap:101 telephone-event/8000
a=fmtp:101 0-16
aptime:20
a=maxptime:20
a=sendonly
a=label:1
m=audio 16650 RTP/AVP 116 101
c=IN IP4 9.42.25.149
a=rtpmap:116 iLBC/8000
a=fmtp:116 mode=20
a=rtpmap:101 telephone-event/8000
a=fmtp:101 0-16
aptime:20
a=maxptime:20
a=sendonly
a=label:2
m=video 16652 RTP/AVP 97
c=IN IP4 9.42.25.149
b=TIAS:1000000
a=rtpmap:97 H264/90000
a=fmtp:97 profile-level-id=42801E;packetization-mode=0
a=sendonly
a=label:3
m=video 16654 RTP/AVP 97
c=IN IP4 9.42.25.149
b=TIAS:1000000
a=rtpmap:97 H264/90000
a=fmtp:97 profile-level-id=42801E;packetization-mode=0
a=sendonly
a=label:4

--uniqueBoundary
Content-Type: application/rs-metadata+xml
Content-Disposition: recording-session

<?xml version="1.0" encoding="UTF-8"?>
<recording xmlns="urn:ietf:params:xml:ns:recording:1">
...
  <stream stream_id="j50QdP1CEeSBSqsYHx7YVg==" session_id="j5L0TP1CEeSBRasYHx7YVg==">
    <label>1</label>
  </stream>
  <stream stream_id="j50QdP1CEeSBS6sYHx7YVg==" session_id="j5L0TP1CEeSBRasYHx7YVg==">
    <label>3</label>
  </stream>
...
  <stream stream_id="j50QdP1CEeSBTasYHx7YVg==" session_id="j5L0TP1CEeSBRasYHx7YVg==">
    <label>2</label>
  </stream>
  <stream stream_id="j50QdP1CEeSBTqsYHx7YVg==" session_id="j5L0TP1CEeSBRasYHx7YVg==">
    <label>4</label>
  </stream>
  <participantstreamassoc participant_id="j50QdP1CEeSBSasYHx7YVg==">
    <send>j50QdP1CEeSBSqsYHx7YVg==</send>
    <recv>j50QdP1CEeSBTasYHx7YVg==</recv>
    <send>j50QdP1CEeSBS6sYHx7YVg==</send>
    <recv>j50QdP1CEeSBTqsYHx7YVg==</recv>
  </participantstreamassoc>
  <participantstreamassoc participant_id="j50QdP1CEeSBTKsYHx7YVg==">

```

```

        <send>j50QdP1CEeSBTasYHx7YVg==</send>
        <recv>j50QdP1CEeSBSqsYHx7YVg==</recv>
        <send>j50QdP1CEeSBTqsYHx7YVg==</send>
        <recv>j50QdP1CEeSBS6sYHx7YVg==</recv>
    </participantstreamassoc>
</recording>

```

```
--uniqueBoundary--
```

After de-escalation, video streams are removed from the metadata and only audio calls will be present in the **participantStream association** element.

```

--uniqueBoundary
Content-Type: application/sdp

v=0
o=CiscoSystemsSIP-GW-UserAgent 7616 8309 IN IP4 9.42.25.149
s=SIP Call
c=IN IP4 9.42.25.149
t=0 0
m=audio 16648 RTP/AVP 0 101
c=IN IP4 9.42.25.149
a=rtpmap:0 PCMU/8000
a=rtpmap:101 telephone-event/8000
a=fmtp:101 0-16
a=ptime:20
a=sendonly
a=label:1
m=audio 16650 RTP/AVP 0 101
c=IN IP4 9.42.25.149
a=rtpmap:0 PCMU/8000
a=rtpmap:101 telephone-event/8000
a=fmtp:101 0-16
a=ptime:20
a=sendonly
a=label:2
m=video 0 RTP/AVP 97
c=IN IP4 9.42.25.149
b=TIAS:1000000
a=rtpmap:97 H264/90000
a=fmtp:97 profile-level-id=42801E;packetization-mode=0
a=sendonly
a=label:3
m=video 0 RTP/AVP 97
c=IN IP4 9.42.25.149
b=TIAS:1000000
a=rtpmap:97 H264/90000
a=fmtp:97 profile-level-id=42801E;packetization-mode=0
a=sendonly
a=label:4

--uniqueBoundary
Content-Type: application/rs-metadata+xml
Content-Disposition: recording-session

<?xml version="1.0" encoding="UTF-8"?>
<recording xmlns="urn:ietf:params:xml:ns:recording:1">
...
    <stream stream_id="j50QdP1CEeSBSqsYHx7YVg==" session_id="j5L0TP1CEeSBRasYHx7YVg==">
        <label>1</label>
    </stream>
...
    <stream stream_id="j50QdP1CEeSBTasYHx7YVg==" session_id="j5L0TP1CEeSBRasYHx7YVg==">
        <label>2</label>
    </stream>

```

```

    <participantstreamassoc participant_id="j50QdP1CEeSBSasYHx7YVg==">
      <send>j50QdP1CEeSBSqsYHx7YVg==</send>
      <recv>j50QdP1CEeSBTasYHx7YVg==</recv>
    </participantstreamassoc>
    <participantstreamassoc participant_id="j50QdP1CEeSBTKsYHx7YVg==">
      <send>j50QdP1CEeSBTasYHx7YVg==</send>
      <recv>j50QdP1CEeSBSqsYHx7YVg==</recv>
    </participantstreamassoc>
  </recording>

--uniqueBoundary--

```

Configuration Example for Metadata Variations with Different Transfer Flows

Example: Transfer of Re-INVITE/REFER Consume Scenario

In the case of Re-INVITE or REFER Consume transfer scenarios, CUBE receives re-INVITE with caller-id change. This re-INVITE will have the remote-party-ID details.

After transfer, participant A is disassociated from the call and participant C joins the call. This information is provided in the metadata sent to the recording server. Here, **7774442214** associates and **7774442212** disassociates from the call.

```

INVITE sip:7774442216@10.64.86.102:5060;transport=tcp SIP/2.0
From: <sip:7774442212@10.104.54.52>;tag=498652~97a89a01
To: <sip:7774442216@10.64.86.102>;tag=7C798-1441
...
...
Remote-Party-ID: <sip:7774442214@10.104.54.52>;party=calling;screen=yes;privacy=off
Contact: <sip:7774442214@10.104.54.52:5060;transport=tcp>
...
  <participant participant_id="vm+z2xM6EeWAIN4iOrLrag==">
    <nameID aor="sip:7774442214@10.104.54.52">
      </nameID>
    </participant>
    <participantsessionassoc participant_id="vm+z2xM6EeWAIN4iOrLrag=="
session_id="vACJ+xM6EeWAF94iOrLrag==">
      <associate-time>2015-06-16T08:44:32.869Z</associate-time>
    </participantsessionassoc>
    ...
  <participant participant_id="vACJ+xM6EeWAGN4iOrLrag==">
    <nameID aor="sip:7774442212@10.104.54.52">
      </nameID>
    </participant>
    <participantsessionassoc participant_id="vACJ+xM6EeWAGN4iOrLrag=="
session_id="vACJ+xM6EeWAGN4iOrLrag==">
      <disassociate-time>2015-06-16T08:44:32.869Z</disassociate-time>
    </participantsessionassoc>
    ...

```

Configuration Examples for Metadata Variations with Caller-ID UPDATE Flow

Example: Caller-ID UPDATE Request and Response Scenario

In case of Re-INVITE based transfer, any UPDATE request will contain caller-id changes. These changes are forwarded to the remote party and once CUBE receives a 200OK message, the remote-party-ID details are transferred.

The response of UPDATE request contains the associated caller-id changes. The CUBE forwards the response UPDATE information to the remote party with caller-id changes after the UPDATE request. From the metadata, you can see that the participants A and C disassociate from the call and participants B and D joins (associates) the call. Here, **7774442212** and **7774442216** disassociates from the call and **7774442214** and **7774442218** joins the call after the caller-id update.

```
UPDATE sip:7774442216@10.64.86.102:5060;transport=tcp SIP/2.0
From: <sip:7774442212@10.104.54.52>;tag=498652~97a89a01
To: <sip:7774442216@10.64.86.102>;tag=7C798-1441
...
...
Remote-Party-ID: <sip:7774442214@10.104.54.52>;party=calling;screen=yes;privacy=off
Contact: <sip:7774442214@10.104.54.52:5060;transport=tcp>
```

Response of UPDATE contains caller-id changes

```
...
SIP/2.0 200 OK
From: <sip:7774442212@10.64.86.102>;tag=7C78C-1E7C
To: <sip:7774442216@10.104.54.52>;tag=498653~97a89a01
...
Remote-Party-ID: <sip:7774442218@10.104.54.52>;party=called;screen=yes;privacy=off
Contact: <sip:7774442218@10.104.54.52:5060>
Content-Length: 0
```

```
...
<participant participant_id="vm+z2xM6EeWAIN4iOrLrag==">
  <nameID aor="sip:7774442214@10.104.54.52">
    </nameID>
  </participant>
  <participantsessionassoc participant_id="vm+z2xM6EeWAIN4iOrLrag=="
session_id="vACJ+xM6EeWAF94iOrLrag==">
    <associate-time>2015-06-16T08:44:32.869Z</associate-time>
  </participantsessionassoc>
  <participant participant_id="vm+z2xM6EeWAIN4iOrLrag==">
    <nameID aor="sip:7774442218@10.104.54.52">
      </nameID>
    </participant>
    <participantsessionassoc participant_id="vm+z2xM6EeWAIN4iOrLrag=="
session_id="vACJ+xM6EeWAF94iOrLrag==">
      <associate-time>2015-06-16T08:44:32.869Z</associate-time>
    </participantsessionassoc>
    <participant participant_id="vACJ+xM6EeWAGN4iOrLrag==">
      <nameID aor="sip:7774442212@10.104.54.52">
        </nameID>
      </participant>
      <participantsessionassoc participant_id="vACJ+xM6EeWAGN4iOrLrag=="
session_id="vACJ+xM6EeWAGN4iOrLrag==">
        <disassociate-time>2015-06-16T08:44:32.869Z</disassociate-time>
```

```

</participantsessionassoc>
<participant participant_id="vACJ+xM6EeWAGN4iOrLrag==">
  <nameID aor="sip:7774442216@10.104.54.52">
    </nameID>
  </participant>
<participantsessionassoc participant_id="vACJ+xM6EeWAGN4iOrLrag=="
session_id="vACJ+xM6EeWAGN4iOrLrag==">
  <disassociate-time>2015-06-16T08:44:32.869Z</disassociate-time>
</participantsessionassoc>
...

```

Configuration Example for Metadata Variations with Call Disconnect

Example: Disconnect while Sending Metadata with BYE

When the original call disconnects without any reason, CUBE initiates a BYE session with the recording server along with the metadata.

In this case, the metadata contains the end time of the session along with the disassociation time of all the active participants from the call.

```

BYE sip:55555555@8.41.17.71:13961;transport=UDP SIP/2.0
...
Reason: Q.850;cause=16
Content-Type: application/rs-metadata+xml
Content-Disposition: recording-session
Content-Length: 984

<?xml version="1.0" encoding="UTF-8"?>
<recording xmlns="urn:ietf:params:xml:ns:recording:1">
  <datamode>complete</datamode>
  <session session_id="t5nW8RM6EeWACN4iOrLrag==">
    <end-time>2015-06-16T08:44:36.661Z</end-time>
  </session>
  <participant participant_id="t5nW8RM6EeWACT4iOrLrag==">
    <nameID aor="sip:7774442212@10.104.54.52">
      </nameID>
    </participant>
  <participantsessionassoc participant_id="t5nW8RM6EeWACT4iOrLrag=="
session_id="t5nW8RM6EeWACT4iOrLrag==">
    <disassociate-time>2015-06-16T08:44:36.657Z</disassociate-time>
  </participantsessionassoc>
  <participant participant_id="t5nW8RM6EeWACd4iOrLrag==">
    <nameID aor="sip:7774442214@10.104.54.52">
      </nameID>
    </participant>
  <participantsessionassoc participant_id="t5nW8RM6EeWACd4iOrLrag=="
session_id="t5nW8RM6EeWACd4iOrLrag==">
    <disassociate-time>2015-06-16T08:44:36.657Z</disassociate-time>
  </participantsessionassoc>
</recording>

```



CHAPTER 40

Video Recording - Additional Configurations

This module describes the following additional configurations that can be done for Video Recording:

- Request a Full-Intra Frame using RTCP or SIP INFO methods.
- Configure an H.264 Packetization mode.
- Monitor Intra-Frames and Reference Frames
- [Feature Information for Video Recording - Additional Configurations, on page 537](#)
- [Information About Additional Configurations for Video Recording, on page 538](#)
- [How to Configure Additional Configurations for Video Recording, on page 538](#)
- [Verifying Additional Configurations for Video Recording, on page 541](#)

Feature Information for Video Recording - Additional Configurations

The following table provides release information about the feature or features described in this module. This table lists only the software release that introduced support for a given feature in a given software release train. Unless noted otherwise, subsequent releases of that software release train also support that feature.

Use Cisco Feature Navigator to find information about platform support and Cisco software image support. To access Cisco Feature Navigator, go to <https://cfng.cisco.com/>. An account on Cisco.com is not required.

Table 60: Feature Information for Network-Based Recording of Video Calls Using Cisco Unified Border Element

Feature Name	Releases	Feature Information
Network-Based Recording of Video Calls Using Cisco Unified Border Element	15.3(3)M Cisco IOS XE Release 3.10S	The Network-Based Recording of Video Calls Using Cisco Unified Border Element feature supports software-based forking and recording of video calls. The following commands were introduced or modified: media profile video , ref-frame-req rtcp , ref-frame-req sip-info , video profile , h264-packetization-mode , monitor-ref-frames .

Information About Additional Configurations for Video Recording

Full Intra-Frame Request

Full Intra-Frame Request is a request sent for an I-frame. An I-frame is an entire key or reference frame that is compressed without considering preceding or succeeding video frames. Succeeding video frames are differences to the original I-frame (what has moved) instead of entire video frame information.

The call between Cisco Unified Border Element and the Cisco MediaSense server is established after the call between the endpoints is established. As a result, the Real-Time Transport Protocol (RTP) channel between the endpoints gets established first and the RTP channel with the recording server gets established later. The impact of this delay is more on video recording because the initial I-frame from the endpoint may not get forked, and frames that follow cannot get decoded. To mitigate the impact of the lost RTP video packets, Cisco Unified Border Element generates Full Intra-Frame Request (FIR) using either Real-Time Transport Control Protocol (RTCP) or SIP INFO, or both, requesting the endpoint to send a fully encoded video frame in the subsequent RTP packet.

The following types of FIR are supported on network-based recording of video calls using Cisco Unified Border Element:

- RTCP FIR (based on [RFC 5104](#)).
- SIP INFO FIR (based on [RFC 5168](#)).
- Both RTCP FIR and SIP INFO FIR (Cisco Unified Border Element can be configured to send both RTCP FIR and SIP INFO requests at the same time).

How to Configure Additional Configurations for Video Recording

Enabling FIR for Video Calls (Using RTCP or SIP INFO)

Perform this task to enable Full Intra-Frame Request (FIR) during the network-based recording of a video call using Real-Time Transport Control Protocol (RTCP) or using the Session Initiation Protocol (SIP) INFO method.

SUMMARY STEPS

1. **enable**
2. **configure terminal**
3. **media profile video** *media-profile-tag*
4. Do one of the following:
 - **ref-frame-req rtcp retransmit-count** *retransmit-number*
 - **ref-frame-req sip-info**
5. **end**

DETAILED STEPS

	Command or Action	Purpose
Step 1	enable Example: Device> enable	Enables privileged EXEC mode.
Step 2	configure terminal Example: Device# configure terminal	Enters global configuration mode.
Step 3	media profile video <i>media-profile-tag</i> Example: Device(config)# media profile video 1	Configures a video media profile and enters media profile configuration mode.
Step 4	Do one of the following: <ul style="list-style-type: none"> • ref-frame-req rtcp retransmit-count <i>retransmit-number</i> • ref-frame-req sip-info Example: Device(cfg-mediaprofile)# ref-frame-req rtcp retransmit-count 4 Example: Device(cfg-mediaprofile)# ref-frame-req sip-info	Enables FIR using the RTCP or SIP INFO method.
Step 5	end Example: Device(cfg-mediaprofile)# end	Exits media profile configuration mode.

Configuring H.264 Packetization Mode

When a device configured as CUBE is offered more than one H.264 packetization mode on an inbound video call leg, the device offers all received modes to the outbound call leg, allowing dynamic change of mode during a call. However when a call is forked, the MediaSense recording server is not able to support this dynamic change of the packetization mode.

This feature restricts the device and allows it to offer only the configured packetization mode to the outbound call leg when media forking is configured.

SUMMARY STEPS

1. **enable**
2. **configure terminal**
3. **media profile video *media-profile-tag***
4. **h264-packetization-mode *packetization mode***
5. **end**

DETAILED STEPS

	Command or Action	Purpose
Step 1	enable Example: Device> enable	Enables privileged EXEC mode.
Step 2	configure terminal Example: Device# configure terminal	Enters global configuration mode.
Step 3	media profile video <i>media-profile-tag</i> Example: Device(config)# media profile video 1	Configures a video media profile and enters media profile configuration mode.
Step 4	h264-packetization-mode <i>packetization mode</i> Example: Device(cfg-mediaprofile)# h264-packetization-mode 2	Configures the H.264 packetization mode offered by a device on the outbound call leg of a forked call when multiple H.264 packetization modes are present in the offer received by the device on the inbound call leg.
Step 5	end Example: Device(cfg-mediaprofile)# end	Exits media profile configuration mode.

Monitoring Reference files or Intra Frames

Perform this task to configure device to perform deep packet inspection (DPI) of RTP packets received from an endpoint and keep track of how many instantaneous decoder refresh (IDR) frames have been received and the timestamp of the IDRs.

SUMMARY STEPS

1. **enable**
2. **configure terminal**
3. **media profile video** *media-profile-tag*
4. **monitor-ref-frames**
5. **end**

DETAILED STEPS

	Command or Action	Purpose
Step 1	enable Example: Device> enable	Enables privileged EXEC mode.

	Command or Action	Purpose
Step 2	configure terminal Example: Device# configure terminal	Enters global configuration mode.
Step 3	media profile video media-profile-tag Example: Device(config)# media profile video 1	Configures a video media profile and enters media profile configuration mode.
Step 4	monitor-ref-frames Example: Device(cfg-mediaprofile)# monitor-ref-frames	Monitors reference frames or intra-frames.
Step 5	end Example: Device(cfg-mediaprofile)# end	Exits media profile configuration mode.

Verifying Additional Configurations for Video Recording

Perform this task to verify the additional configurations of the video recording. The **show** commands can be entered in any order.

SUMMARY STEPS

1. **enable**
2. **show call active video called-number number | include VideoRtcpIntraFrameRequestCount**
3. **show call active video called-number number | include VideoSipInfoIntraFrameRequestCount**
4. **show call active video | include VideoTimeOfLastReferenceFrame**
5. **show call active video | include VideoReferenceFrameCount**

DETAILED STEPS

Step 1 enable

Enables privileged EXEC mode.

Example:

```
Device> enable
```

Step 2 show call active video called-number number | include VideoRtcpIntraFrameRequestCount

Displays the number of RTCP FIR requests sent on each leg.

Example:

```
Device# show call active video called-number 990057 | include VideoRtcpIntraFrameRequestCount

! Main call legs
```

```
VideoRtcpIntraFrameRequestCount=1
VideoRtcpIntraFrameRequestCount=1

!CUBE does not generate FIR request on forked leg
VideoRtcpIntraFrameRequestCount=0
```

Step 3 **show call active video called-number *number* | include VideoSipInfoIntraFrameRequestCount**

Displays the number of SIP INFO FIR requests sent on each leg.

Example:

```
Device# show call active video called-number 990062 | include VideoSipInfoIntraFrameRequestCount

! Main call legs
VideoSipInfoIntraFrameRequestCount=1
VideoSipInfoIntraFrameRequestCount=1

!CUBE does not generate FIR request on forked leg
VideoSipInfoIntraFrameRequestCount=0
```

Step 4 **show call active video | include VideoTimeOfLastReferenceFrame**

Displays the timestamp of latest IDR frame.

Step 5 **show call active video | include VideoReferenceFrameCount**

Displays the number of IDR frames received on that call leg.



CHAPTER 41

Third-Party GUID Capture for Correlation Between Calls and SIP-based Recording

The Third-Party GUID Capture for Correlation Between Calls and SIP-based Recording feature provides support for the transmission of globally unique identifiers (GUIDs) received from a third-party private branch exchange (PBX) to the recording server using an established Session Initiation Protocol (SIP) session, making CUBE recording more interoperable with third-party vendors.

- [Feature Information for Third-Party GUID Capture for Correlation Between Calls and SIP-based Recording, on page 543](#)
- [Restrictions for Third-Party GUID Capture for Correlation Between Calls and SIP-based Recording, on page 544](#)
- [Information About Third-Party GUID Capture for Correlation Between Calls and SIP-based recording, on page 544](#)
- [How to Capture Third-Party GUID for Correlation Between Calls and SIP-based Recording, on page 544](#)
- [Verifying Third-Party GUID Capture for Correlation Between Calls and SIP-based Recording, on page 547](#)
- [Configuration Examples for Third-Party GUID Capture for Correlation Between Calls and SIP-based Recording, on page 548](#)

Feature Information for Third-Party GUID Capture for Correlation Between Calls and SIP-based Recording

The following table provides release information about the feature or features described in this module. This table lists only the software release that introduced support for a given feature in a given software release train. Unless noted otherwise, subsequent releases of that software release train also support that feature.

Use Cisco Feature Navigator to find information about platform support and Cisco software image support. To access Cisco Feature Navigator, go to <https://cfng.cisco.com/>. An account on Cisco.com is not required.

Table 61: Feature Information for Third-Party GUID Capture for Correlation Between Calls and SIP-based Recording

Feature Name	Releases	Feature Information
Third-Party GUID Capture for Correlation Between Calls and SIP-based Recording	Cisco IOS 15.4(3)M Cisco IOS XE 3.13S	The Third-Party GUID Capture for Correlation Between Calls and SIP-based Recording feature provides support for the transmission of globally unique identifiers (GUIDs) received from a third-party private branch exchange (PBX) to the recording server via an established SIP session, making CUBE recording more interoperable with third-party vendors.

Restrictions for Third-Party GUID Capture for Correlation Between Calls and SIP-based Recording

- The third-party GUID must be received through an INVITE message or a 200 OK message (depending on whether the third-party PBX is initiating the call [caller] or receiving the call [callee]). No other request type, including re-invites, is supported.
- The third-party GUID can be received only through the primary inbound call leg or the primary outbound call leg.

Information About Third-Party GUID Capture for Correlation Between Calls and SIP-based recording

Enterprise call control systems such as the Cisco Unified Communications Manager (CUCM) use globally unique identifiers (GUIDs) to correlate the multiple call legs of a single call. The call can then be forwarded or transferred, creating additional call legs associated with the same GUID. When recording is configured, CUBE initiates a SIP session with a recorder server and forks the media packets it receives or transmits, along with participant information like called number, calling number, Remote Party ID (RPID), and P-Asserted-Identity (PAI).

While the Cisco-Guid header (used by CUCM) is transmitted to the recording server, third-party GUIDs are not. Third-party GUIDs can be received through an INVITE message or a 200 OK message, depending on whether the third-party PBX is initiating the call [caller] or receiving the call [callee].

Forwarding the GUID to the recording server enables correlation between call records of the PBX and the recording server.

How to Capture Third-Party GUID for Correlation Between Calls and SIP-based Recording

To capture the third-party GUID and forward it to the recording server, you need to copy a third-party GUID header that CUBE receives, configure a SIP copylist for that header, and apply it to the primary inbound and

outbound call leg dial peers. A SIP profile is configured to copy this incoming header to a user-defined variable and apply it to an outgoing header on the recording leg dial peer.

SUMMARY STEPS

1. **enable**
2. **configure terminal**
3. **voice class sip-copylist tag**
4. **sip-header *ThirdParty-GUID-headername***
5. **exit**
6. **dial-peer voice *inbound-dialpeer-tag* voip**
7. **voice class sip-copylist tag**
8. **exit**
9. **dial-peer voice *outbound-dialpeer-tag* voip**
10. **voice class sip-copylist tag**
11. **exit**
12. **voice class sip-profiles *profile-id***
13. **request INVITE peer-header sip *GUID-header-to-copy* copy *header-value-to-match* copy-variable**
14. **request INVITE sip-header *header-to-add* add *header-value-to-add***
15. **request INVITE sip-header *GUID-header-to-modify* modify *header-value-to-match* *header-value-to-replace***
16. **exit**
17. **dial-peer voice *recorder-dial-peer-tag* voip**
18. **voice-class sip profiles *profile-tag***
19. **end**

DETAILED STEPS

	Command or Action	Purpose
Step 1	enable Example: Device> enable	Enables privileged EXEC mode. <ul style="list-style-type: none">• Enter your password if prompted.
Step 2	configure terminal Example: Device# configure terminal	Enters global configuration mode.
Step 3	voice class sip-copylist tag Example: Device(config)# voice class sip-copylist 100	Configures a list of entities to be sent to a peer call leg and enters voice class configuration mode.
Step 4	sip-header <i>ThirdParty-GUID-headername</i> Example: Device(config-class)# sip-header ThirdParty-GUID	Specifies that the third-party GUID header must be copied from the inbound dial-peer leg to the outbound dial-peer call leg.

	Command or Action	Purpose
Step 5	exit Example: Device(config-class)# exit	Exits voice class configuration mode.
Step 6	dial-peer voice <i>inbound-dialpeer-tag</i> voip Example: Device(config)# dial-peer voice 2 voip	Enters inbound dial-peer configuration mode.
Step 7	voice class sip-copylist <i>tag</i> Example: Device(config-dial-peer)# voice class sip-copylist 100	Applies the copy list to the dial peer.
Step 8	exit Example: Device(config-dial-peer)# exit	Exits to global configuration mode.
Step 9	dial-peer voice <i>outbound-dialpeer-tag</i> voip Example: Device(config)# dial-peer voice 3 voip	Enters outbound dial-peer configuration mode.
Step 10	voice class sip-copylist <i>tag</i> Example: Device(config-dial-peer)# voice class sip-copylist 100	Applies the copy list to the dial peer.
Step 11	exit Example: Device(config-dial-peer)# exit	Exits to global configuration mode.
Step 12	voice class sip-profiles <i>profile-id</i> Example: Device(config)# voice class sip-profiles 10	Creates a SIP profile and enters voice class configuration mode.
Step 13	request INVITE peer-header sip <i>GUID-header-to-copy</i> <i>copy header-value-to-match copy-variable</i> Example: Device(config-class)# request INVITE peer-header sip Third-Party-GUID copy "(.*) " u01	Copies headers from the INVITE message of the incoming dial peer into a copy variable.
Step 14	request INVITE sip-header <i>header-to-add</i> add <i>header-value-to-add</i>	Adds a SIP header to a SIP request.

	Command or Action	Purpose
	Example: <pre>Device(config-class)# request INVITE sip-header Unsupported add "Unsupported: Dummy Header"</pre>	
Step 15	request INVITE sip-header <i>GUID-header-to-modify</i> modify <i>header-value-to-match header-value-to-replace</i> Example: <pre>Device(config-class)# request INVITE sip-header Unsupported modify ".*" "Third-Party-GUID: \u01"</pre>	Modifies the outgoing header using the copy variable defined in the previous step.
Step 16	exit Example: <pre>Device(config-class)# exit</pre>	Exits to global configuration mode.
Step 17	dial-peer voice <i>recorder-dial-peer-tag</i> voip Example: <pre>Device(config)# dial-peer voice 2 voip</pre>	Enters the dial peer configuration mode for the specified outbound recorder dial peer.
Step 18	voice-class sip profiles <i>profile-tag</i> Example: <pre>Device(config-dial-peer)# voice-class sip profiles 30</pre>	Applies the SIP profile to the recording dial peer.
Step 19	end Example: <pre>Device(config-dial-peer)# end</pre>	Exits to privileged EXEC mode.

Verifying Third-Party GUID Capture for Correlation Between Calls and SIP-based Recording

SUMMARY STEPS

1. **debug ccsip messages** for an INVITE message
2. **debug ccsip messages** for a 200 OK message

DETAILED STEPS

Step 1 **debug ccsip messages** for an INVITE message

Displays all Session Initiation Protocol (SIP) Service Provider Interface (SPI) messages for an INVITE message.

Example:

```

Received:
SIP/2.0 200 OK
Via: SIP/2.0/UDP 9.44.29.32:5060;branch=z9hG4bK121F62
From: "sipp " <sip:1111000010@9.44.29.32>;tag=906F9C-21B9
To: "sut" <sip:4321@9.0.0.120>;tag=30050SIPpTag0111
Call-ID: 67B65D26-473711E3-8029B214-265DCDFE@9.44.29.32
CSeq: 101 INVITE
Contact: <sip:9.0.0.120:6019;transport=UDP>
Cisco-Guid: passthru
Content-Type: application/sdp
Content-Length: 108

```

Step 2 debug ccsip messages for a 200 OK message

Displays all Session Initiation Protocol (SIP) Service Provider Interface (SPI) messages for a 200 OK message.

Example:

```

Received:
SIP/2.0 200 OK
Via: SIP/2.0/UDP 9.44.29.32:5060;branch=z9hG4bK121F62
From: "sipp " <sip:1111000010@9.44.29.32>;tag=906F9C-21B9
To: "sut" <sip:4321@9.0.0.120>;tag=30050SIPpTag0111
Call-ID: 67B65D26-473711E3-8029B214-265DCDFE@9.44.29.32
CSeq: 101 INVITE
Contact: <sip:9.0.0.120:6019;transport=UDP>
Cisco-Guid: passthru
Content-Type: application/sdp
Content-Length: 108

```

Configuration Examples for Third-Party GUID Capture for Correlation Between Calls and SIP-based Recording

```

! Create a copylist
Device(config)# voice class sip-copylist 100
! GUID for third party PBX
Device(config-class)# sip-header Third-Party-GUID
!GUID for CUCM
Device(config-class)# sip-header Cisco-Guid
Device(config-class)# exit

! Apply copylist to inbound dial peer so that headers specified in copylist are copied
Device(config)# dialpeer voice 2 voip
Device(config-dial-peer)# voice class sip-copylist 100
Device(config-dial-peer)# exit

! SIP profile copies incoming third-party GUID to a variable from a peer header. This
variable
! is then used modify outgoing headers
Device(config)# voice class sip-profiles 10
Device(config-class)# request INVITE peer-header sip Third-Party-GUID copy "(*)" u01
Device(config-class)# request INVITE sip-header Unsupported add "Unsupported: Dummy Header"
Device(config-class)# request INVITE sip-header Unsupported modify ".*" "Third-Party-GUID:
\u01"

```

```
Device(config-class)# exit

! Apply SIP profile to outbound dial peer
Device(config)# dial-peer voice 2 voip
Device(config-dial-peer)# voice-class sip profiles 30
```



CHAPTER 42

Cisco Unified Communications Gateway Services--Extended Media Forking

The Cisco Unified Communications (UC) Services API provides a unified web service interface for the different services in IOS gateway thereby facilitating rapid service development at application servers and managed application service providers.

This chapter explains the Extended Media Forking (XMF) provider that allows applications to monitor calls and trigger media forking on Real-time Transport Protocol (RTP) and Secure RTP calls.

- [Feature Information for Cisco Unified Communications Gateway Services—Extended Media Forking, on page 551](#)
- [Restrictions for Extended Media Forking, on page 552](#)
- [Information About Cisco Unified Communications Gateway Services, on page 552](#)
- [How to Configure UC Gateway Services, on page 558](#)
- [Configuration Examples for UC Gateway Services, on page 565](#)

Feature Information for Cisco Unified Communications Gateway Services—Extended Media Forking

The following table provides release information about the feature or features described in this module. This table lists only the software release that introduced support for a given feature in a given software release train. Unless noted otherwise, subsequent releases of that software release train also support that feature.

Use Cisco Feature Navigator to find information about platform support and Cisco software image support. To access Cisco Feature Navigator, go to <https://cfng.cisco.com/>. An account on Cisco.com is not required.

Feature Name	Releases	Feature Information
Cisco Unified Communications Gateway Services	Cisco IOS 15.3(3)M Cisco IOS XE 3.10S	The Cisco Unified Communications (UC) Services API provides a unified web service interface for the different services in IOS gateway thereby facilitating rapid service development at application servers and managed application service providers.

Feature Name	Releases	Feature Information
Cisco UC Gateway Services API support for Secure RTP Forking	Cisco IOS 15.4(3)M Cisco IOS XE 3.13S	This feature provides support for Extended Media Forking (XMF) provider to monitor calls and trigger media forking on RTP and SRTP calls.
Support for Cisco UC Services API Media Forking with Survivability TCL	Cisco IOS 15.6(1)T Cisco IOS XE 3.17S	This feature allows media forking for the calls controlled by CVP Survivability TCL script with Cisco Unified Communication Services API.

Restrictions for Extended Media Forking

The Extended Media Forking does not support the following:

- Media renegotiation.
- Media mixing on forked media streams.
- recordTone insertion with SRTP calls.
- mediaForkingReason tag is only to Notify midcall stream events; notification for events such as codec change.
- Supplementary services such as hold/resume, call forward, Call Transfer, and so on.
- High Availability.
- Virtual Routing and Forwarding (VRF) or Multi-VRF.
- Hair-pinning calls from CUBE to Cisco Unified Customer Voice Portal (CVP) and back to the same CUBE for Extended Media Forking (XMF) Gateway recording.
- Forking of calls on a TDM leg.



Note

- Supports only voice media stream.

Information About Cisco Unified Communications Gateway Services

Extended Media Forking (XMF) Provider and XMF Connection

The XMF provider allows applications to monitor calls and trigger media forking on the calls and has the capability to service up to 32 applications. The XMF provider can invoke a call-based or a connection-based media forking using the Unified Communications (UC) API. After the media forking is invoked, it can preserve the media forking initiated by the web application if the WAN connection to the application is lost. The XMF provider also provides the recording tone to the parties involved in the call.

The XMF connection describes the relationship between an XMF call and the endpoint (or trunk) involved in the call. A connection abstraction maintained in the gateway has the following connection states:

- **IDLE:** This state is the initial state for all new connections. Such connections are not actively part of a telephone call, yet their references to the Call and Address objects are valid. Connections typically do not stay in the IDLE state for long and quickly transition to other states. The application may choose to be notified at this state using the event filters and if done, call/connection at the gateway provider will use the `NotifyXmfConnectionData(CREATED)` message to notify the application listener that a new connection is created.
- **ADDRESS_COLLECT:** In this state the initial information package is collected from the originating party and is examined according to the “dialing plan” to determine the end of collection of addressing information. In this state, the call in the gateway collects digits from the endpoint. No notification is provided.
- **CALL_DELIVERY:** On the originating side, this state involves selecting of the route as well as sending an indication of the desire to set up a call to the specified called party. On the terminating side, this state involves checking the busy/idle status of the terminating access and also informing the terminating message of an incoming call. The application may choose to be notified at this state using the event filters and if done, the call or connection at the gateway provider will use the `NotifyXmfConnectionData(CALL_DELIVERY)` message to notify the application listener.
- **ALERTING:** This state implies that the Address is being notified of an incoming call. The application may choose to be notified at this state using the event filters and if done, the call or connection at the gateway provider will use the `NotifyXmfConnectionData(ALERTING)` message to notify the application listener.
- **CONNECTED:** This state implies that a connection and its Address is actively part of a telephone call. In common terms, two parties talking to one another are represented by two connections in the CONNECTED state. The application may choose to be notified at this state using the event filters and if done, the call or connection at the gateway provider will use the `NotifyXmfConnectionData(CONNECTED)` message to notify the application listener.
- **DISCONNECTED:** This state implies it is no longer part of the telephone call. A Connection in this state is interpreted as once previously belonging to this telephone call. The application may choose to be notified at this state using the event filters and if done, the call or connection at the gateway provider will use the `NotifyXmfConnectionData(DISCONNECTED)` message to notify the application listener.

XMF Call-Based Media Forking

In call-based media forking of the gateway, the stream from the calling party is termed as a near-end stream and the stream from the called party is termed as a far-end stream.

The XMF provider actively handles single media forking request per session. Any new media forking request from the external application overrides or stops the current forking instance and initiates a new forking instance (to the appropriate target IP address or ports).

After accepting the media forking request, the XMF provider returns a response message and starts to fork media streams of a connection to the target forked streams. The application receives a `NotifyXmfCallData` message notification for the updated media forking status, that is, `FORK-FAILED`, `FORK_STARTED`, or `FORK_DONE`.

XMF Connection-Based Media Forking

In connection-based media forking of the gateway, the incoming stream to the connection is termed as near-end stream and the outgoing stream of the connection is termed as far-end stream.

The XMF provider actively handles single media forking request per session. Any new media forking request from the external application will override or stop the current forking instance and would start a new forking instance (to the appropriate target IP address or ports).

After the media forking request is accepted, the XMF provider returns a response message and starts to fork media streams of a connection to the target forked streams.

Figure 43: XMF Connection-Based Media Forking

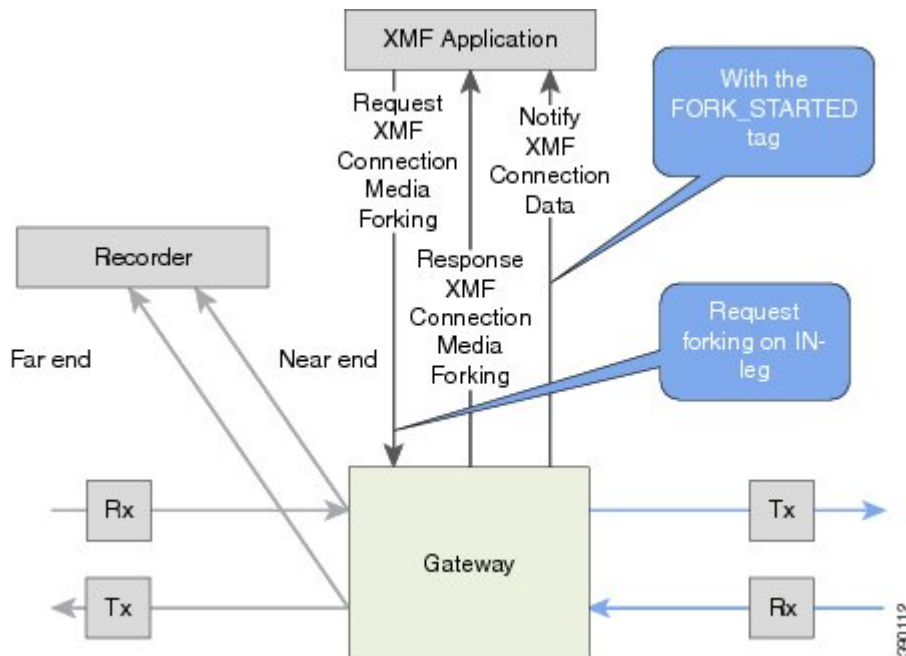

A NotifyXmfConnectionData message will be notified to the application for the updated media forking status:

- **FORK_FAILED**—Media forking is setup failure. No forked RTP connections can be established to target RTP addresses.
- **FORK_STARTED**—Media forking is set up successfully. Both Tx (transmit) and Rx (receive) forked RTP connections are established and connected to target (farEnd and nearEnd) RTP addresses.
- **FORK_DONE**—Media forking is completed. Both Tx and Rx forked RTP connections are released.

Extended Media Forking API with Survivability TCL

Cisco Unified Border Element (CUBE) supports Survivability TCL Script to co-exist with Cisco Unified Communication (UC) Services API.

Cisco UC Services API XMF interface supports media forking for all the calls controlled by survivability TCL script including the survivability re-attempted calls. Thus, all the calls controlled by survivability TCL script can be recorded when requested by Cisco UC Services XMF API.

Cisco Unified Communications Manager controlled Gateway recording utilizes XMF to trigger media forking on CUBE or SIP based PSTN gateways in the supported call flows.



Note Media forking is allowed only for survivability TCL script supported by Cisco Unified Customer Voice Portal (CVP). CVP survivability TCL script is not supported in High Availability mode.

The following call scenarios are supported:

- Basic comprehensive call
- Calls with Refer Consume
- Calls with Mid-call failure
- Calls with alternative route with initial call failure

There are no configuration changes required for enabling CVP survivability TCL support with Cisco UC Gateway Services API.

Media Forking for SRTP Calls

- SRTP forking is supported in XMF application service providers and the supported APIs are RequestCallMediaForking, RequestCallMediaSetAttributes, and RequestConnectionMediaForking.
- SRTP forking is supported for SRTP-to-SRTP, SRTP-to-RTP, and RTP-to-SRTP calls.
 - For SRTP-to-SRTP calls, media forking on either leg would result in SRTP streams being forked.
 - For SRTP fallback calls, after the initial offer, CUBE will fall back to RTP. Media forking either call legs would result in RTP streams being forked.
 - RTP-to-SRTP call flow does not involve transcoding.
- SRTP Crypto keys are notified over the API.
- Supports automatic stopping of media forking when stream changes from SRTP or to SRTP.
 - The optional mediaForkingReason tag in XMF Notify messages indicates that the forking has been stopped internally.
 - mediaForkingReason tag is only present when the connection changes state, such as mid-call re-INVITE. SRTP stream can change to RTP or SRTP stream can change keys mid-call.
 - mediaForkingReason tag is always accompanied by FORK_DONE.

Crypto Tag

For SRTP forking, the optional Crypto tag in NotifyXmfConnectionData or NotifyXmfCallData message indicates the context of an actively forked SRTP connection.



Note The Crypto tag is only present in the notification message where FORK_STARTED tag is present.

The optional Crypto tag specifies the following:

- The Crypto suite used for encryption and authentication algorithm.
- The base64 encoded primary key and salt used for encryption.

Crypto suite can be one of the two suites supported in IOS:

- AES_CM_128_HMAC_SHA1_32
- AES_CM_128_HMAC_SHA1_80

Example of SDP Data sent in an SRTP Call

Original SIP SDP Crypto Offer	SIP SDP Crypto Answer
v=0	v=0
o=CiscoSystemsSIP-GW-UserAgent 7826 3751 IN IP4 172.18.193.98	o=CiscoSystemsSIP-GW-UserAgent 7826 3751 IN IP4 172.18.193.98
s=SIP Call	s=SIP Call
c=IN IP4 172.18.193.98	c=IN IP4 172.18.193.98
t= 0 0	t=0 0
m=audio 51372 RTP/SAVP 0	m=audio 49170 RTP/SAVP 0
a=rtpmap:0 PCMU/8000	a=crypto:1 AES_CM_128_HMAW_SHA1_32
a=crypto:1 AES_CM_128_HMAC_SHA1_32	inline:NzB4d1BINUAwLEw6UzF3WSI+PSdFcGdUShpX1Zj
inline:0RmdmcmVCspEc3QGZiNWpVLEJhQXldHAWJSoj	



Note The application is notified of the content in Crypto and inline SDP lines.

Multiple XMF Applications and Recording Tone

Multiple XMF allows multiple (maximum 32) web applications to register with the XMF provider as separate XMF applications and provide redundancy for the voice calls recording. Recording tone provides recording tone capability to the recording sessions. Recording tone is supported for IP to IP, IP to TDM, and TDM to TDM trunks.

An example topology is as shown below where 4 CUCM applications are deployed. CUCM triggers media forking request to Cisco UBE. Recording tone is played to the parties involved in the call based on the recordTone parameter set in the media forking request.

Figure 44: Multiple XMF Applications and Recording Tone

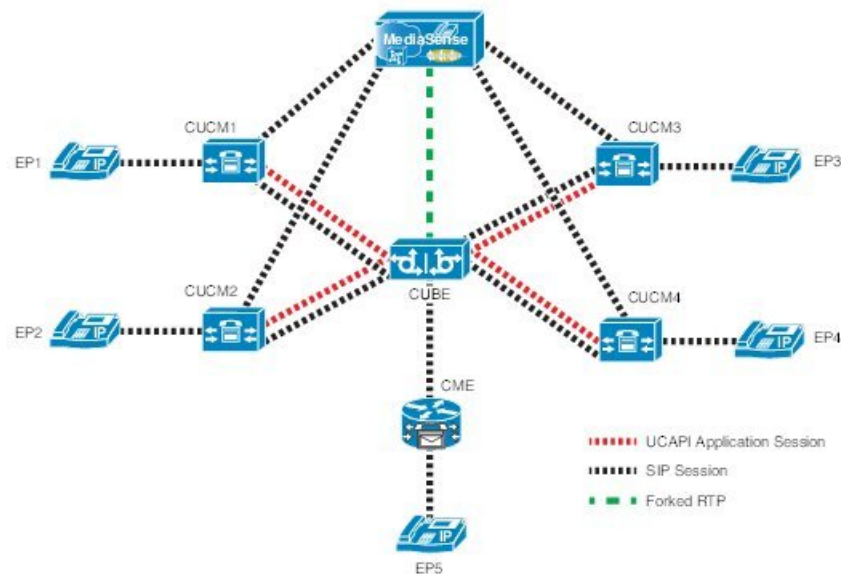

Media forking can be invoked using any of the following APIs:

- RequestXmfConnectionMediaForking
- RequestXmfCallMediaForking
- RequestXmfCallMediaSetAttributes

The “recordTone” parameter can be enabled in any of the above requests and recording tone will be played for the parties involved in the call. The “recordTone” parameter in the API request can have the following values:

- COUNTRY_US
- COUNTRY_AUSTRALIA
- COUNTRY_GERMANY
- COUNTRY_RUSSIA
- COUNTRY_SPAIN
- COUNTRY_SWITZERLAND

There is no difference in the recording tone beep when any country value is chosen. Recording tone beep is played at an interval of every 15 seconds. Digital signal processors and other resources are not utilized for playing recording tone even for transcoded calls. No specific configuration is required to enable or disable recording tone. By default, no recording tone is enabled.

If “recordTone” parameter is enabled only on the farEndAddr, then this tone is played only on the outgoing leg. Likewise, if enabled only on the nearEndAddr, then the tone is played only on the incoming leg. When enabled in both the far and near end, then recording tone is played on both the legs.

The RequestXmfConnectionMediaForking API allows insertion of recording tone on a per connection basis. There could be scenarios where one leg receives two recordTone insertion requests. When a leg receives recordTone insertion request, the nearEnd request always takes precedence over the farEnd request.

Forking Preservation

After media forking is initiated by the web application, the forking can be preserved to continue the recording, even if the WAN connection to the application is lost or if the application is unregistered.

Figure 45: Forking Preservation

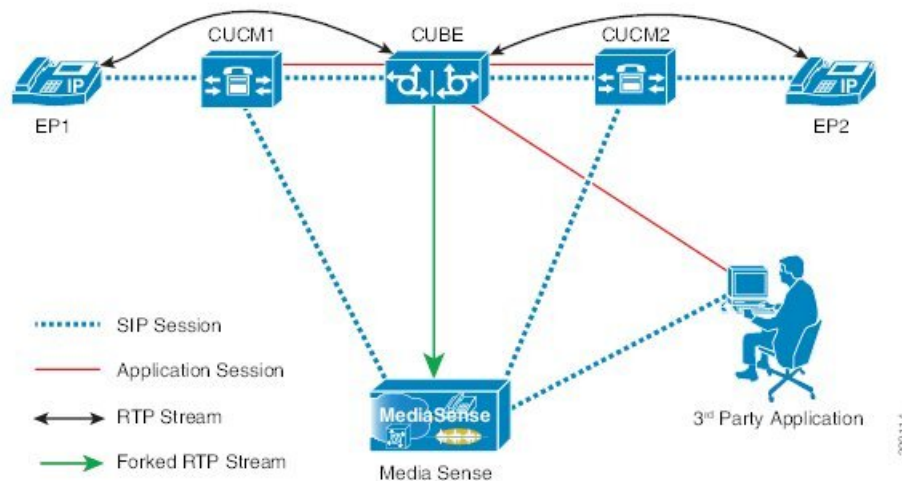

The “preserve” parameter value can be set to TRUE or FALSE in any of the 3 forking requests (RequestXmfConnectionMediaForking, RequestXmfCallMediaForking, or RequestXmfCallMediaSetAttributes) from the application to Cisco UBE.

- If the “preserve” parameter received is TRUE, then forking will continue the recording, even if the WAN connection to application is lost or application is unregistered.
- If the “preserve” parameter received is FALSE, then forking will not continue the recording.
- If the “preserve” parameter is not received in the media forking request, then forking will not continue the recording.

How to Configure UC Gateway Services

Configuring Cisco Unified Communication IOS Services on the Device

SUMMARY STEPS

1. **enable**
2. **configure terminal**
3. **ip http server**

4. **ip http max-connections** *value*
5. **ip http timeout-policy idle** *seconds* **life** *seconds* **requests** *value*
6. **http client connection idle timeout** *seconds*
7. **uc wsapi**
8. **message-exchange max-failures** *number*
9. **probing max-failures** *number*
10. **probing interval keepalive** *seconds*
11. **probing interval negative** *seconds*
12. **source-address** *ip-address*
13. **end**

DETAILED STEPS

	Command or Action	Purpose
Step 1	enable Example: Device> enable	Enables privileged EXEC mode. <ul style="list-style-type: none"> • Enter your password if prompted.
Step 2	configure terminal Example: Device# configure terminal	Enters global configuration mode.
Step 3	ip http server Example: Device(config)# ip http server	Enables the HTTP server (web server) on the system.
Step 4	ip http max-connections <i>value</i> Example: Device(config)# ip http max-connection 100	Sets the maximum number of concurrent connections to the HTTP sever that will be allowed. The default value is 5.
Step 5	ip http timeout-policy idle <i>seconds</i> life <i>seconds</i> requests <i>value</i> Example: Device(config)# ip http timeout-policy idle 600 life 86400 requests 86400	Sets the characteristics that determine how long a connection to the HTTP server should remain open. The characteristics are: <ul style="list-style-type: none"> • idle—The maximum number of seconds the connection will be kept open if no data is received or response data can not be sent out on the connection. Note that a new value may not take effect on any already existing connections. If the server is too busy or the limit on the life time or the number of requests is reached, the connection may be closed sooner. The default value is 180 seconds (3 minutes). • life—The maximum number of seconds the connection will be kept open, from the time the

	Command or Action	Purpose
		<p>connection is established. Note that the new value may not take effect on any already existing connections. If the server is too busy or the limit on the idle time or the number of requests is reached, it may close the connection sooner. Also, since the server will not close the connection while actively processing a request, the connection may remain open longer than the specified life time if processing is occurring when the life maximum is reached. In this case, the connection will be closed when processing finishes. The default value is 180 seconds (3 minutes). The maximum value is 86400 seconds (24 hours).</p> <ul style="list-style-type: none"> • requests—The maximum limit on the number of requests processed on a persistent connection before it is closed. Note that the new value may not take effect on any already existing connections. If the server is too busy or the limit on the idle time or the life time is reached, the connection may be closed before the maximum number of requests are processed. The default value is 1. The maximum value is 86400.
Step 6	<p>http client connection idle timeout <i>seconds</i></p> <p>Example:</p> <pre>Device(config)# http client connection idle timeout 600</pre>	Sets the number of seconds that the client waits in the idle state until it closes the connection.
Step 7	<p>uc wsapi</p> <p>Example:</p> <pre>Device(config)# uc wsapi</pre>	Enters Cisco Unified Communication IOS Service configuration mode.
Step 8	<p>message-exchange max-failures <i>number</i></p> <p>Example:</p> <pre>Device(config-uc-wsapi)# message-exchange max-failures 2</pre>	Configures the maximum number of failed message exchanges between the application and the provider before the provider stops sending messages to the application. Range is 1 to 3. Default is 1.
Step 9	<p>probing max-failures <i>number</i></p> <p>Example:</p> <pre>Device(config-uc-wsapi)# probing max-failures 5</pre>	Configures the maximum number of failed probing messages before the router unregisters the application. Range is 1 to 5. Default is 3.

	Command or Action	Purpose
Step 10	<p>probing interval keepalive <i>seconds</i></p> <p>Example:</p> <pre>Device(config-uc-wsapi)# probing interval keepalive 255</pre>	<p>Configures the time interval between probing messages when the session is in a keepalive state. Range is from 1 to 255 seconds. Default is 5 seconds.</p> <p>Note The keepalive timer restarts when a valid HTTP message is received from the UC services API. The following are valid HTTP messages that can restart the timer:</p> <ul style="list-style-type: none"> • RESPONSE_XMF_REGISTER • RESPONSE_XMF_CONN_MEDIA_FORKING • SOLICIT_XMF_PROBING • NOTIFY_XMF_CONNECTION_DATA
Step 11	<p>probing interval negative <i>seconds</i></p> <p>Example:</p> <pre>Device(config-uc-wsapi)# probing interval negative 10</pre>	<p>Configures the interval between negative probing messages, in seconds.</p>
Step 12	<p>source-address <i>ip-address</i></p> <p>Example:</p> <pre>Device(config-uc-wsapi)# source-address 192.1.12.14</pre>	<p>Configures the IP address (hostname) as the source IP address for the UC IOS service.</p> <p>Note The source IP address is used by the provider in the NotifyProviderStatus messages.</p>
Step 13	<p>end</p> <p>Example:</p> <pre>Device(config-uc-wsapi)# end</pre>	<p>Returns to privileged EXEC mode.</p>

Configuring the XMF Provider

SUMMARY STEPS

1. **enable**
2. **configure terminal**
3. **uc wsapi**
4. **source-address** *ip address*
5. **provider xmf**
6. **no shutdown**
7. **remote-url** *index url*
8. **end**

DETAILED STEPS

	Command or Action	Purpose
Step 1	enable Example: Device> enable	Enables privileged EXEC mode. <ul style="list-style-type: none"> • Enter your password if prompted.
Step 2	configure terminal Example: Device# configure terminal	Enters global configuration mode.
Step 3	uc wsapi Example: Device(config)# uc wsapi	Enters Cisco Unified Communication IOS Service configuration mode.
Step 4	source-address <i>ip address</i> Example: Device(config)# source-address 172.156.19.38	Configures the source ip address.
Step 5	provider xmf Example: Device(config-uc-wsapi)# provider xmf	Enters XMF provider configuration mode.
Step 6	no shutdown Example: Device(config-uc-wsapi)# no shutdown	Activates XMF provider.
Step 7	remote-url <i>index url</i> Example: Device(config-uc-wsapi)# remote-url 1 http://test.com:8090/ucm_xmf	Specifies the URL (IP address and port number) that the application uses to communicate with XMF provider. The XMF provider uses the IP address and port to authenticate incoming requests.
Step 8	end Example: Device(config-uc-wsapi)# end	Returns to privileged EXEC mode.

Verifying the UC Gateway Services

The **show** commands can be entered in any order.

SUMMARY STEPS

1. **enable**
2. **show wsapi registration all**
3. **show wsapi registration xmf** *remote-url-index*
4. **show call media-forking**

DETAILED STEPS

Step 1 enable

Enables privileged EXEC mode.

Example:

```
Device> enable
```

Step 2 show wsapi registration all

Displays the details of applications registered. Each registered application is identified by a different ID.

Example:

```
Device# show wsapi registration all
```

```
Provider XMF
=====
registration index: 11
  id: 2E7C3034:XMF:myapp:26
  appUrl:http://pascal-lnx.cisco.com:8094/xmf
  appName: myapp
  provUrl: http://9.45.46.16:8090/cisco_xmf
  prober state: STEADY
  connEventsFilter:
CREATED|REDIRECTED|ALERTING|CONNECTED|TRANSFERRED|CALL_DELIVERY|DISCONNECTED|HANDOFF_JOIN|HANDOFF_LEAVE

  mediaEventsFilter: DTMF|MEDIA_ACTIVITY|MODE_CHANGE|TONE_DIAL|TONE_OUT_OF_SERVICE|TONE_SECOND_DIAL

registration index: 1
  id: 2E7C304A:XMF:myapp:27
  appUrl:http://pascal-lnx.cisco.com:8092/xmf
  appName: myapp
  provUrl: http://9.45.46.16:8090/cisco_xmf
  prober state: STEADY
  connEventsFilter:
CREATED|REDIRECTED|ALERTING|CONNECTED|TRANSFERRED|CALL_DELIVERY|DISCONNECTED|HANDOFF_JOIN|HANDOFF_LEAVE

  mediaEventsFilter: DTMF|MEDIA_ACTIVITY|MODE_CHANGE|TONE_DIAL|TONE_OUT_OF_SERVICE|TONE_SECOND_DIAL

registration index: 21
  id: 2E7C6423:XMF:myapp:28
  appUrl:http://pascal-lnx.cisco.com:8096/xmf
  appName: myapp
  provUrl: http://9.45.46.16:8090/cisco_xmf
  prober state: STEADY
  connEventsFilter:
CREATED|REDIRECTED|ALERTING|CONNECTED|TRANSFERRED|CALL_DELIVERY|DISCONNECTED|HANDOFF_JOIN|HANDOFF_LEAVE

  mediaEventsFilter: DTMF|MEDIA_ACTIVITY|MODE_CHANGE|TONE_DIAL|TONE_OUT_OF_SERVICE|TONE_SECOND_DIAL

registration index: 31
```

```

id: 2E7C69E8:XMf:myapp:29
appUrl:http://pascal-lnx.cisco.com:8098/xmf
appName: myapp
provUrl: http://9.45.46.16:8090/cisco_xmf
prober state: STEADY
connEventsFilter:
CREATED|REDIRECTED|ALERTING|CONNECTED|TRANSFERRED|CALL_DELIVERY|DISCONNECTED|HANDOFF_JOIN|HANDOFF_LEAVE

mediaEventsFilter: DTMF|MEDIA_ACTIVITY|MODE_CHANGE|TONE_DIAL|TONE_OUT_OF_SERVICE|TONE_SECOND_DIAL

```

Step 3 **show wsapi registration xmf remote-url-index**

Displays the details of only a particular XMF registered application with any ID ranging from 1 to 32.

Example:

```

Device# show wsapi registration xmf 1

Provider XMF
=====
registration index: 1
  id: 2E7C6423:XMf:myapp:28
  appUrl:http://pascal-lnx.cisco.com:8096/xmf
  appName: myapp
  provUrl: http://9.45.46.16:8090/cisco_xmf
  prober state: STEADY
  connEventsFilter:
CREATED|REDIRECTED|ALERTING|CONNECTED|TRANSFERRED|CALL_DELIVERY|DISCONNECTED|HANDOFF_JOIN|HANDOFF_LEAVE

mediaEventsFilter: DTMF|MEDIA_ACTIVITY|MODE_CHANGE|TONE_DIAL|TONE_OUT_OF_SERVICE|TONE_SECOND_DIAL

```

Step 4 **show call media-forking**

Displays the forked stream information.

Example:

```

Device# show call media-forking

Warning: Output may be truncated if sessions are added/removed concurrently!

Session      Call      n/f  Destination (port address)
187          BA        near 45864 10.104.105.232
188          BA        far  54922 10.104.105.232
189          B9        near 45864 10.104.105.232
190          B9        far  54922 10.104.105.232

FORK_DONE Notifications

//WSAPI/INFRA/wsapi_send_outbound_message_by_provider_info:
*Dec 21 10:31:21.016 IST: //WSAPI/INFRA/0/9/546CF8:25:tx_contextp 15898C1C tx_id 19 context1 (0 0)
context2 (9 9):
out_url http://gauss-lnx.cisco.com:8081/xmf*Dec 21 10:31:21.020 IST:
wsapi_send_outbound_message_by_provider_info:
<?xml version="1.0" encoding="UTF-8"?><SOAP:Envelope
xmlns:SOAP="http://www.w3.org/2003/05/soap-envelope"><SOAP:Body>
<NotifyXmfConnectionData xmlns="http://www.cisco.com/schema/cisco_xmf/v1_0"><msgHeader><transactionID>
546CF8:25</transactionID><registrationID>4CA5E4:XMf:myapp:4</registrationID></msgHeader><callData><callID>25</callID><state>
ACTIVE</state></callData><connData><connID>132</connID><state>ALERTING</state></connData><event><mediaForking>
<mediaForkingState>FORK_DONE</mediaForkingState></mediaForking></event></NotifyXmfConnectionData></SOAP:Body></SOAP:Envelope>

FORK_FAILED Notification

//WSAPI/INFRA/wsapi_send_outbound_message_by_provider_info:
*Dec 21 10:31:21.016 IST: //WSAPI/INFRA/0/9/546CF8:25:tx_contextp 15898C1C tx_id 19 context1 (0 0)

```

```
context2 (9 9):
out_url http://gauss-lnx.cisco.com:8081/xmf*Dec 21 10:31:21.020 IST:
wsapi_send_outbound_message_by_provider_info:
<?xml version="1.0" encoding="UTF-8"?><SOAP:Envelope
xmlns:SOAP="http://www.w3.org/2003/05/soap-envelope"><SOAP:Body>
<NotifyXmfConnectionData xmlns="http://www.cisco.com/schema/cisco_xmf/v1_0"><msgHeader><transactionID>
546CF8:25</transactionID><registrationID>4CA5E4:XMF:myapp:4</registrationID></msgHeader><callData><callID>25</callID><state>
ACTIVE</state></callData><connData><connID>132</connID><state>ALERTING</state></connData><event><mediaForking>
<mediaForkingState>FORK_FAILED</mediaForkingState></mediaForking></event></NotifyXmfConnectionData></SOAP:Body>
</SOAP:Envelope>
```

Troubleshooting Tips

Use the following **debug** commands to troubleshoot the UC Gateway Services configurations.

- **debug wsapi infrastructure all**
- **debug wsapi xmf all**
- **debug wsapi xmf messages**
- **debug wsapi infrastructure detail**
- **debug voip application**
- **debug voip application media forking**

Configuration Examples for UC Gateway Services

Example: Configuring Cisco Unified Communication IOS Services

The following example shows how to configure the device for Cisco Unified Communication IOS Services and enable the HTTP server:

```
Device> enable
Device# configure terminal
Device(config)# ip http server
Device(config)# ip http max-connection 100
Device(config)# ip http timeout-policy idle 600 life 86400 requests 86400
Device(config)# http client connection idle timeout 600
Device(config)# uc wsapi
Device(config-uc-wsapi)# message-exchange max-failures 2
Device(config-uc-wsapi)# probing max-failures 5
Device(config-uc-wsapi)# probing interval keepalive 255
Device(config-uc-wsapi)# probing interval negative 10
Device(config-uc-wsapi)# source-address 192.1.12.14
Device(config-uc-wsapi)# end
```

Example: Configuring the XMF Provider

The following example shows how to enable the XMF providers. The configuration specifies the address and port that the application uses to communicate with the XMF provider:

```
Device> enable
Device# configure terminal
Device(config)# uc wsapi
Device(config-uc-wsapi)# provider xmf
Device(config-uc-wsapi)# no shutdown
Device(config-uc-wsapi)# remote-url 1 http://test.com:8090/ucm_xmf
Device(config-uc-wsapi)# end
```

Example: Configuring UC Gateway Services

```
uc wsapi
message-exchange max-failures 5
response-timeout 10
source-address 192.1.12.14
probing interval negative 20
probing interval keepalive 250
!
provider xmf
remote-url 1 http://pascal-lnx.cisco.com:8050/ucm_xmf
```



PART **IX**

CUBE Media Proxy

- [CUBE Media Proxy, on page 569](#)



CHAPTER 43

CUBE Media Proxy

CUBE Media Proxy is a solution that provides multiple forking function, and is built on CUBE architecture. Multiple forks are required for recorder redundancy and advanced media processing needs. The CUBE Media Proxy solution supports mandatory and optional recorders.

CUBE Media Proxy supports Unified CM Network-Based Recording (NBR) and SIP-Based Media Recording (SIPREC), to enable forking and recording of Real-Time Transport Protocol (RTP) streams.

- [Feature Information for CUBE Media Proxy, on page 569](#)
- [Supported Platforms, on page 570](#)
- [Restrictions for CUBE Media Proxy, on page 570](#)
- [CUBE Media Proxy Using Unified CM Network-Based Recording, on page 571](#)
- [SIPREC-Based CUBE Media Proxy, on page 571](#)
- [About Multiple Media Forking Using CUBE Media Proxy, on page 571](#)
- [Secure Forking of Secure and Nonsecure Calls, on page 572](#)
- [Deployment Scenarios for CUBE Media Proxy, on page 572](#)
- [Recording Metadata, on page 575](#)
- [Session Identifier, on page 577](#)
- [Recording State Notification, on page 579](#)
- [How to Configure CUBE Media Proxy, on page 582](#)
- [Verification of CUBE Media Proxy Configuration, on page 587](#)
- [Supported Features, on page 598](#)

Feature Information for CUBE Media Proxy

The following table provides release information about the feature or features that are described in this module. This table lists only the software release that introduced support for a given feature in a given software release train. Unless noted otherwise, subsequent releases of that software release train also support that feature.

Use Cisco Feature Navigator to find information about platform support and software image support. Cisco Feature Navigator enables you to determine which software images support a specific software release, feature set, or platform. To access Cisco Feature Navigator, go to <http://www.cisco.com/go/cfn>. You do not require an account on Cisco.com.

Table 62: Feature Information for Recording Proxy

Feature Name	Releases	Feature Information
Secure forking of nonsecure calls	Cisco IOS XE Bengaluru 17.5.1a	CUBE Media Proxy supports both secure and nonsecure forking of nonsecure calls.
SIPREC-Based CUBE Media Proxy	Cisco IOS XE Amsterdam 17.3.1a	The SIPREC-based CUBE Media Proxy solution supports forking to multiple recorders.
CUBE Media Proxy	IOS XE Gibraltar Release 16.10.1a	The CUBE Media Proxy solution provides multiple forking functions for redundancy and advanced media processing.

Supported Platforms

CUBE Media Proxy is supported on the following Cisco router platforms running on Cisco IOS XE Software Releases:

- Cisco 4000 Series Integrated Services Routers (ISR4321, ISR4331, ISR4351, ISR4431, ISR4451, and ISR4461)
- Cisco Aggregated Services Routers (ASR - ASR1001-X, ASR1002-X, ASR1004 with RP2, ASR1006 with RP2, Cisco ASR1006-X Aggregated Services Routers with RP2 and ESP40, ASR 1006-X with RP3 and ESP40/ESP100)
- Cisco Cloud Services Routers (CSR1000V series)
- Cisco Catalyst 8000V Edge Software (Catalyst 8000V) series
- Cisco 8300 Catalyst Edge Series Platforms
- Cisco 8200 Catalyst Edge Series Platform (C8200-1N-4T)
- Cisco 8200L Catalyst Edge Series Platform (C8200L-1N-4T)



Note When upgrading to C8000V software from a CSR1000V release, an existing throughput configuration will be reset to a maximum of 250Mbps. Install an HSEC authorization code, which you can obtain from your Smart License account, before reconfiguring your required throughput level.

Restrictions for CUBE Media Proxy

CUBE Media Proxy using Unified CM NBR, and SIPREC-Based CUBE Media Proxy do not support the following:

- Forking of video sessions
- Recording of calls from endpoints that are registered with the Cloud. For example, Cisco Webex Calling.
- SRTP fallback

- Midcall block
- Concurrent use with CUBE B2BUA SBC features.
- Server Groups in outbound dial-peers toward recorders.
- Midcall updates from the recorders such as pause or resume recording, RE-INVITE with SDP changes, INVITE that replaces header that is sent by recorders when they switch from active to standby CUBE Media Proxy.



Note Midcall update "BYE" from the recorders is supported.

- Unified CM NBR and SIPREC for the same call flow.

The following restriction applies when using CUBE Media Proxy with Unified CM NBR:

- If the primary recorder sends a=inactive in the response SDP, the same is forwarded to Unified CM. Forking is not triggered to any of the recorders.

CUBE Media Proxy Using Unified CM Network-Based Recording

CUBE Media Proxy using Unified CM Network-Based Recording (NBR), is Unified CM dependent and requires you to configure inbound dial-peers from Unified CM. After receiving a media forking request from Unified CM, the CUBE Media Proxy establishes media forks to the configured targets.

SIPREC-Based CUBE Media Proxy

The SIPREC (SIP Media Recording) feature supports media recording for Real-Time Transport Protocol (RTP) streams in compliance with section 3.1.1. of RFC 7245, with CUBE Media Proxy acting as the Session Recording Client (SRC). SIP is used to establish a Recording Session between the CUBE Media Proxy and recorders (or any other media application).

For SIPREC solutions, CUBE Media Proxy accepts an inbound RTP fork from a CUBE SBC and replicates this RTP fork to multiple SIPREC targets based on its inbound configuration.

About Multiple Media Forking Using CUBE Media Proxy

Unified CM Network-Based CUBE Media Proxy and SIPREC-Based CUBE Media Proxy support the following functions:

- Media forking for up to five destinations per call
- Destination redundancy by hunting algorithm
- Media fork policy control
- Load balancing during initial call setup
- High Availability

- TLS, TCP, and UDP transport protocols
- Secure forking of nonsecure calls
- Secure forking of secure calls

Secure Forking of Secure and Nonsecure Calls

From Cisco IOS XE Bengaluru 17.5.1a onwards, you can configure a combination of secure and nonsecure forks for a nonsecure call.

[CUBE Media Proxy Using Unified CM Network-Based Recording, on page 571](#) supports secure forking of secure and nonsecure calls.



Note You cannot use the **mandatory policy** command with secure forking configurations.

For SRTP pass through to work in secure media forking, the Command Line Interface **srtp pass-thru** should be configured at global or dial-peer level.

Deployment Scenarios for CUBE Media Proxy



Note From Cisco IOS XE Bengaluru 17.5.1a onwards, you can deploy a combination of secure and nonsecure destinations.

CUBE Media Proxy Using Unified CM Network-Based Recording

In Network Based Recording (NBR) deployments, Cisco Unified Communications Manager establishes an initial forked media leg with CUBE Media Proxy. This may either be from a phone using its built-in bridge ([Deployment Scenario for CUBE Media Proxy Using Unified CM NBR for Internal Call](#)), or from a CUBE SBC using the eXtended Media Forking (XMF) API ([Deployment Scenario for CUBE Media Proxy Using Unified CM NBR for External Call](#)).

Figure 46: Deployment Scenario for CUBE Media Proxy Using Unified CM NBR for Internal Call

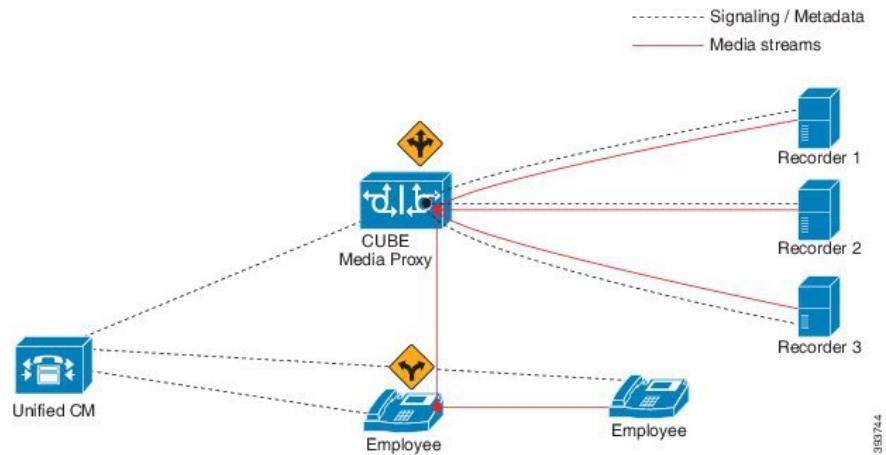
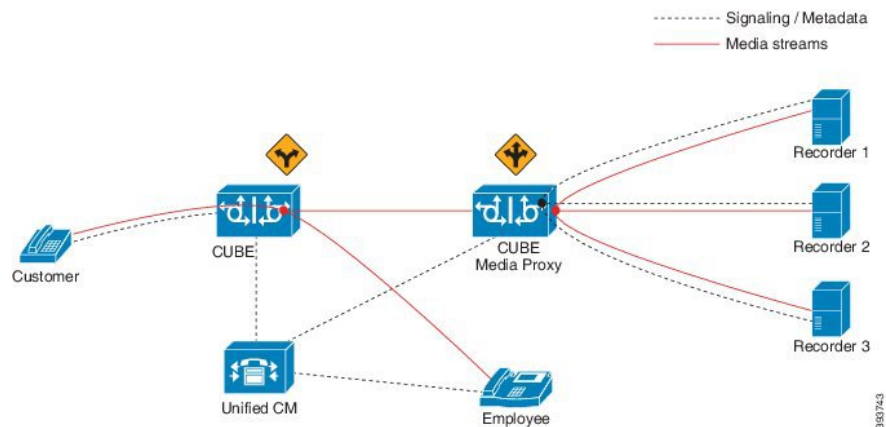

Figure 47: Deployment Scenario for CUBE Media Proxy Using Unified CM NBR for External Call



The information flow is as follows:

1. External or internal call is set up between the endpoints.
2. CUBE Media Proxy receives the media forking request from UCM.
3. CUBE Media Proxy sets up sessions with the recorders based on the proxy policy.
 - Mandatory recorder: Proxy policy is configured to set a recorder as mandatory. CUBE Media Proxy tries to establish connection with the mandatory recorder. Forking to the remaining recorders happen only if the connection with the mandatory recorder is successful.
 - Optional recorders: When the proxy policy is not configured, all the recorders are set as optional. CUBE Media Proxy tries to establish a connection with the remaining recorders even if any of the recorders fail.

**Note**

- If the CUBE Media Proxy receives a '486' response from the initial recorder, CUBE Media Proxy does not fork the INVITE to other recorders. To perform alternate routing, configure the **voice hunt user-busy** command in global configuration mode.

Example: **Router(config)# voice hunt user-busy**

- Secure recorders: When secure recorders are configured, mandatory proxy policy configuration does not apply. CUBE Media Proxy tries to establish a connection with the first secure recorder from the list of configured dial-peers. Forking to the remaining recorders happens after establishing a connection with the first secure recorder.

4. If required, Cisco Unified SIP Proxy may be used to route or load balance a media fork for a group of recorders.

**Note**

The CUBE Media Proxy solution supports Unified CM Release 12.5.1 and Cisco Unified SIP Proxy Release 9.1.8.

SIPREC-Based CUBE Media Proxy

CUBE Media Proxy may be configured to fork media autonomously using SIPREC, as shown in the following scenario.

Figure 48: Deployment Scenario for SIPREC-Based CUBE Media Proxy

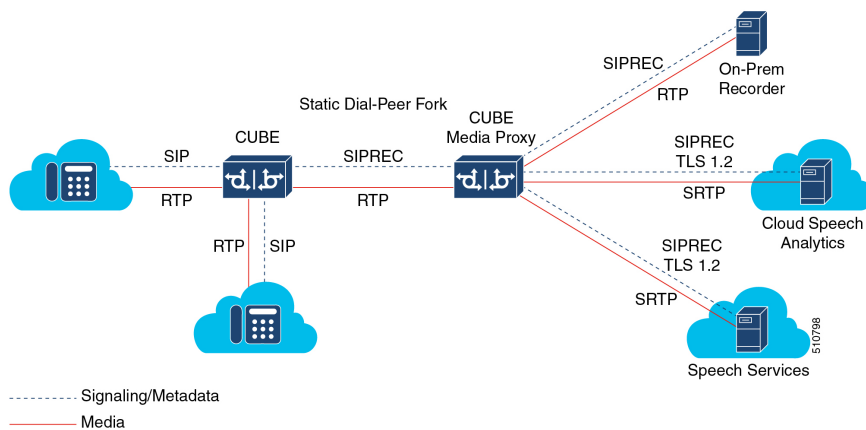

The information flow in this scenario is as follows:

1. CUBE SBC receives a call from a SIP trunk and routed to the intended destination.
2. CUBE SBC uses SIPREC to establish a media fork of the call with CUBE Media Proxy.
3. CUBE Media Proxy uses SIPREC to establish secure or nonsecure media forks with up to five destinations.



Note On receiving BYE from the primary secure recorder, Media Proxy disconnects all secure and nonsecure recording sessions. BYE received from any other recorder, secure or nonsecure, will not impact other active recording sessions.

Recording Metadata

Metadata is the information that a Recording Server (RS) receives from a Recording Client (RC) in a SIP session. Metadata has the following functions:

- Carries the communication session data that describes the call to the Recording Server.
- Identifies the participants list.
- Identifies the session and media association time.

Recording Metadata in CUBE Media Proxy Using Unified CM NBR

Unified CM passes information about the forked call to CUBE Media Proxy in up to 16 metadata parameters that are included in the **From** header of the SIP Invite. CUBE Media Proxy includes a copy of this metadata in the Invite it sends to the configured destinations. The following is an example of a **From** header with metadata.



Note The **From** header, including all metadata must not exceed 583 bytes.

Following is a sample SIP header of a recording request:

```
From: "abcd" <sip:198101@10.200.25.137;
x-nearend;x-refci=27298698;x-nearendclusterid=NY-NJ-Labcluster;
x-nearenddevice=SEP2834A28318CE;
x-nearendaddr=198101;x-farendrefci=27298699;
x-farendclusterid=NY-NJ-Labcluster;x-farenddevice=AFIFIM-VI1;x-farendaddr=172001;
x-sessionid=696dd5d3f7755c6abdc438e93d01febF>;
tag=14087~b35a5915-3167-4d6a-871d-c121221602bf-27298703
```

Recording Metadata in SIPREC-Based CUBE Media Proxy

The initial SIPREC Invite from CUBE to CUBE Media Proxy, and the SIPREC Invite from CUBE Media Proxy to the recorders, includes recording metadata in a SIPREC XML body.

Following is a sample SIPREC INVITE:

```
INVITE sip:9876@8.43.33.203:5060 SIP/2.0
Via: SIP/2.0/UDP 8.43.33.209:5060;branch=z9hG4bK20959B
From: <sip:8.43.33.209>;tag=678813-6AC
To: <sip:9876@8.43.33.203>
Date: Thu, 13 Feb 2020 03:35:19 GMT
Call-ID: B0FA2851-4D4811EA-82E5D263-E98F8024@8.43.33.209
```

```

Supported: 100rel,timer,resource-priority,replaces,sdp-anat
Require: siprec
Min-SE: 1800
Cisco-Guid: 2967454021-1296568810-2195116643-3918495780
User-Agent: Cisco-SIPGateway/IOS-17.3.20200207.160928
Allow: INVITE, OPTIONS, BYE, CANCEL, ACK, PRACK, UPDATE, REFER, SUBSCRIBE, NOTIFY, INFO,
REGISTER
CSeq: 101 INVITE
Max-Forwards: 70
Timestamp: 1581564919
Contact: <sip:8.43.33.209:5060>;+sip.src
Expires: 180
Allow-Events: telephone-event
Session-ID: 812eae44f57c50b38e897d75d8e12809;remote=00000000000000000000000000000000
Content-Type: multipart/mixed;boundary=uniqueBoundary
Mime-Version: 1.0
Content-Length: 2250

--uniqueBoundary
Content-Type: application/sdp
Content-Disposition: session;handling=required

v=0
o=CiscoSystemsSIP-GW-UserAgent 5146 1045 IN IP4 8.43.33.209
s=SIP Call
c=IN IP4 8.43.33.209
t=0 0
m=audio 8278 RTP/AVP 0
c=IN IP4 8.43.33.209
a=rtpmap:0 PCMU/8000
a=ptime:20
a=sendonly
a=label:1
m=audio 8280 RTP/AVP 0
c=IN IP4 8.43.33.209
a=rtpmap:0 PCMU/8000
a=ptime:20
a=sendonly
a=label:2

--uniqueBoundary
Content-Type: application/rs-metadata+xml
Content-Disposition: recording-session

<?xml version="1.0" encoding="UTF-8"?>
<recording xmlns="urn:ietf:params:xml:ns:recording:1">
  <datamode>complete</datamode>
  <session session_id="sPVtz01IEeqC3dJj6Y+AJA==">
    <sipSessionID>0e0960d88013509f86e7ad2d78da208a;remote=4d0de1325c205fa08f77d8d31c1b3a6f</sipSessionID>
    <start-time>2020-02-13T03:35:19.008Z</start-time>
  </session>
  <participant participant_id="sPVtz01IEeqC3tJj6Y+AJA==">
    <nameID aor="sip:3478@8.41.17.71">
    </nameID>
  </participant>
  <participantsessionassoc participant_id="sPVtz01IEeqC3tJj6Y+AJA=="
session_id="sPVtz01IEeqC3dJj6Y+AJA==">
    <associate-time>2020-02-13T03:35:19.008Z</associate-time>
  </participantsessionassoc>
  <stream stream_id="sPgFxxklIEeqC49Jj6Y+AJA==" session_id="sPVtz01IEeqC3dJj6Y+AJA==">
    <label>1</label>
  </stream>

```

```

    <participant participant_id="sPVtz01IEeqC39Jj6Y+AJA==">
      <nameID aor="sip:98765@8.41.17.71">
        </nameID>
      </participant>
      <participantsessionassoc participant_id="sPVtz01IEeqC39Jj6Y+AJA=="
session_id="sPVtz01IEeqC3dJj6Y+AJA==">
        <associate-time>2020-02-13T03:35:19.008Z</associate-time>
</participantsessionassoc>
      <stream stream_id="sPgFxxk1IEeqC5NJj6Y+AJA==" session_id="sPVtz01IEeqC3dJj6Y+AJA==">
        <label>2</label>
      </stream>
      <participantstreamassoc participant_id="sPVtz01IEeqC3tJj6Y+AJA==">
        <send>sPgFxxk1IEeqC49Jj6Y+AJA==</send>
        <recv>sPgFxxk1IEeqC5NJj6Y+AJA==</recv>
      </participantstreamassoc>
      <participantstreamassoc participant_id="sPVtz01IEeqC39Jj6Y+AJA==">
        <send>sPgFxxk1IEeqC5NJj6Y+AJA==</send>
        <recv>sPgFxxk1IEeqC49Jj6Y+AJA==</recv>
      </participantstreamassoc>
</recording>

--uniqueBoundary--

```

For a SIPREC call, the Require header in the SIP Invite (from Cisco UBE to CUBE Media Proxy, and from CUBE Media Proxy to the recorders) must have a "siprec" extension. The Require header must also have metadata in the XML body, else the call is dropped. The Contact header in a SIP invite has a "+sip.src" extension.

Session Identifier

In both NBR and SIPREC modes, CUBE Media Proxy uses the Session-ID header in request and response messages to exchange session identifiers for tracking a recording session between peers.

The Session-ID comprises of the following two Universally Unique Identifiers (UUIDs) corresponding to the initiator and recipient of the recording request respectively:

- Local UUID corresponds to UUID of the User Agent that sends a recording request to the participants of a recording session.
- Remote UUID corresponds to UUID of the User Agent that receives the recording request in a recording session.

Session-ID Handling

CUBE Media Proxy generates a unique UUID locally, and this UUID is passed as local UUID value in the Session-ID header of the following SIP request and response:

- Request to primary and optional recorders.
- Response to Unified CM (Network-Based Recording) or CUBE (SIPREC-Based).

The following events are involved in the Session-ID handling by CUBE Media Proxy:

1. The initial Invite received by CUBE Media Proxy includes a local UUID generated by the originating platform and a null remote UUID as shown in the following example.

```
Session-ID: db248b6cbdc547bbc6c6fdb6916eeb;remote=00000000000000000000000000000000
```

2. When sending an Invite to the primary recorder, CUBE Media Proxy generates a new UUID to use for the local Session Identifier. The remote UUID remains null.

```
Session-ID: 8dfb2f2e1d4c518db6122080fb8b1d83;remote=00000000000000000000000000000000
```

3. The subsequent 200 OK response from the primary recorder includes a local session identifier that it generated and the UUID provided by CUBE Media Proxy in the Invite as the remote session identifier.

```
Session-ID: 4fd24d9121935531a7f8d750ad16e19;remote=8dfb2f2e1d4c518db6122080fb8b1d83
```

4. When sending a 200 OK to the originating platform, CUBE Media Proxy uses the UUID it generated as the local session identifier and the UUID it received initially as the remote session identifier.

```
Session-ID: 8dfb2f2e1d4c518db6122080fb8b1d83;remote=db248b6cbdc547bbc6c6fdb6916eeb
```

5. CUBE Media Proxy sends a forking request to the remaining four recorders with Session-ID header containing the same locally generated UUID as the local UUID and a "NULL" value for the remote UUID.

```
Session-ID: 8dfb2f2e1d4c518db6122080fb8b1d83;remote=00000000000000000000000000000000
```

6. CUBE Media Proxy receives 200OK response from the remaining four recorders. The Session-ID header of the response message from each recorder contains UUID of the recorder as the local UUID and the locally generated UUID by the CUBE Media Proxy as the remote UUID.

```
Session-ID: 4fd24d9121935531a7f8d750ad17f20;remote=8dfb2f2e1d4c518db6122080fb8b1d83
```

7. In NBR mode, CUBE Media Proxy sends a SIP Info Message to Unified CM. For more information on SIP Info Message, see [SIP Info Messages from CUBE Media Proxy to Unified CM, on page 579](#). The Session-ID header of the SIP Info Message contains locally generated UUID by CUBE Media Proxy as local UUID and the UUID of Unified CM as the remote UUID.

```
Session-ID: 8dfb2f2e1d4c518db6122080fb8b1d83;remote=db248b6cbdc547bbc6c6fdb6916eeb
```

Recording State Notification

SIP Info Messages from CUBE Media Proxy to Unified CM

After trying or establishing an NBR session with the recorders, the CUBE Media Proxy sends SIP Info message to Unified CM to provide the consolidated status of all the recorders.

A SIP Info message is sent during the following stages of a recording session:

1. **Initial Call:** After receiving a response from all the configured recorders during the initial call, a SIP Info message with status of each recorder is sent to the initiator of the recording session.
2. **Mid-Call:** When the status of any of the recorders changes during a call, another SIP Info message with status of each recorder is sent to the initiator of the recording session. A change in status may result from any of the recorders sending a "BYE" or rejecting a midcall RE-INIVITE.



Note The examples in the following sections illustrate CUBE Media Proxy forking to two of the maximum five destinations.

XML Format of a SIP Info Message

The Content-Type header present in the SIP Info message is:

```
Content-Type:application/x-cisco-proxy-recording-status+xml
```

The following is the XML format of a SIP info message.

```
<recorderList>
  <recorder>
    <uri>recorder1</uri>
    <recordertype>Mandatory</recordertype>
    <status>Success</status>
    <errormessage>null</errormessage>
  </recorder>
  <recorder>
    <uri>recorder2</uri>
    <recordertype>Mandatory</recordertype>
    <status>Failed</status>
    <errormessage>SIP error code received from Recorder</errormessage>
  </recorder>
</recorderList>
```

Table 63: Details of XML Tag and Data Type

XML Tag	Data Type
uri (Mandatory)	String
recordertype (Mandatory)	Enum (Mandatory, Optional)
status (Mandatory)	Enum (Success, Failed)
errormessage (Optional)	String



Note The primary recorder in a secure forking scenario functions the same way as a mandatory recorder functions in a nonsecure forking scenario except that the `recorderType` tag is shown as optional. The following is the XML format of a SIP INFO message in a combination of secure and nonsecure forking scenario:

```
<recorderList>
  <recorder>
    <recorderType>Optional</recorderType>
    <status>Success</status>
  </recorder>
  <recorder>
    <recorderType>Optional</recorderType>
    <status>Success</status>
  </recorder>
  <recorder>
    <recorderType>Optional</recorderType>
    <status>Success</status>
  </recorder>
  <recorder>
    <recorderType>Optional</recorderType>
    <status>Success</status>
  </recorder>
  <recorder>
    <recorderType>Optional</recorderType>
    <status>Success</status>
  </recorder>
</recorderList>
```

SIP Info Message Sent During the Initial Call

SIP Info Message Sent During the Initial Call (All the Recorders as Optional)

For information on how to configure the recorders as Optional, see Step 3 and Step 4 of [Configure CUBE Media Proxy, on page 584](#).

The SIP Info Message that is sent during a recording session depends on the scenarios that are given in the following table:

Table 64: Call Scenarios and Recorder Status During the Initial Call with All Recorders as Optional

Scenario	<status> of <i>recorder-1</i> in a SIP Info Message	<status> of <i>recorder-2</i> in a SIP Info Message
Call to the primary recorder <i>recorder-1</i> is established and forking to <i>recorder-2</i> is triggered successfully.	<success>	<success>
Call to the primary recorder <i>recorder-1</i> is established and forking to <i>recorder-2</i> is rejected with 503 Service Unavailable.	<success>	<failure>

Scenario	<status> of <i>recorder-1</i> in a SIP Info Message	<status> of <i>recorder-2</i> in a SIP Info Message
Call to the primary recorder <i>recorder-1</i> is established and there is no response from <i>recorder-2</i> to the forking request.	<success>	<failure>
Call to the recorder <i>recorder-1</i> and <i>recorder-2</i> is rejected with 503 Service Unavailable.	<failure>	<failure>
There is no response from <i>recorder-1</i> or <i>recorder-2</i> are down.	<failure>	<failure>
<i>recorder-1</i> and <i>recorder-2</i> responds to the call with a 488 Not Acceptable Here response.	<failure>	<failure>
<i>recorder-1</i> and <i>recorder-2</i> reponds to the call with a 600 Busy Everywhere response.	<failure>	<failure>

**Note**

- After a SIP Info Message is sent, a 200 OK response is received from the initiator of the recording session.
- In all failure scenarios, an error code is sent in the <errormessage>.

SIP Info Message Sent During the Initial Call (One Recorder as Mandatory and Remaining as Optional)

For information on how to configure the recorders as Mandatory, see Step 3, Step 4 and, Step 5 of [Configure CUBE Media Proxy, on page 584](#).

The SIP Info Message that is sent during a recording session depends on the scenarios that are given in the following table.

Table 65: Call Scenarios and Recorder Status During the Initial Call with a Mandatory Recorder

Scenario	<status> of <i>recorder-1</i> in a SIP Info Message	<status> Of <i>recorder-2</i> in a SIP Info Message
Call to the mandatory recorder <i>recorder-1</i> is established and forking to the optional recorder <i>recorder-2</i> is triggered successfully.	<success>	<success>

Scenario	<status> of <i>recorder-1</i> in a SIP Info Message	<status> Of <i>recorder-2</i> in a SIP Info Message
Call to the mandatory recorder <i>recorder-1</i> is rejected with a failure message and hence the optional recorder <i>recorder-2</i> is not tried.	<failure>	<failure>
Call to the mandatory recorder <i>recorder-1</i> is established and when the optional recorder <i>recorder-2</i> is tried, the mandatory recorder disconnects with a BYE.	<failure> Note BYE is sent in the <errormessage>.	<cancelled> Note The connection to the optional recorder is cancelled as the primary recorder disconnects.
After the call is established with a mandatory recorder <i>recorder-1</i> and the optional recorder <i>recorder-2</i> , the mandatory recorder disconnects with a BYE.	<failure> Note BYE is sent in the <errormessage>.	<disconnected> Note The optional recorder is disconnected.

**Note**

- After a SIP Info Message is sent, a 200 OK response is received from the initiator of the recording session. Unified CM sends a 415 Unsupported Media Type message if the INFO sent from CUBE Media Proxy has a malformed XML body.
- For all failure scenarios, an error code is sent in the <errormessage>.

How to Configure CUBE Media Proxy

How to Configure CUBE Media Proxy for Network-Based Recording Solutions

Following are the steps to configure CUBE Media Proxy for Network-Based Recording solutions:

Configure Outbound Dial-Peers to the Recorders

SUMMARY STEPS

1. **enable**
2. **configure terminal**
3. **dial-peer voice *recorder-dial-peer-tag* voip**
4. **destination-pattern [+]** *string*
5. **session protocol sipv2**
6. **session target ipv4:***[recording-server-destination-address | recording-server-dns]*
7. **session transport [udp|tcp|tls]**
8. (Optional) **voice-class sip srtp crypto <crypto-tag> OR srtp pass-thru**

9. end

DETAILED STEPS

	Command or Action	Purpose
Step 1	enable Example: <pre>Device> enable</pre>	Enables privileged EXEC mode. <ul style="list-style-type: none"> • Enter your password if prompted.
Step 2	configure terminal Example: <pre>Device# configure terminal</pre>	Enters global configuration mode.
Step 3	dial-peer voice recorder-dial-peer-tag voip Example: <pre>Device(config)# dial-peer voice 8000 voip</pre>	Configures a recorder dial peer and enters dial peer voice configuration mode.
Step 4	destination-pattern [+] <i>string</i> Example: <pre>Device(config-dial-peer)# destination-pattern 595959</pre>	Specifies either the prefix or full E.164 number required to reach the recorder. A destination pattern must not include regular expressions in this case. Note Alternatively, "destination uri" may be used.
Step 5	session protocol sipv2 Example: <pre>Device(config-dial-peer)# session protocol sipv2</pre>	Configures the VoIP dial peer to use Session Initiation Protocol (SIP).
Step 6	session target ipv4: [<i>recording-server-destination-address</i> <i>recording-server-dns</i>] Example: <pre>Device(config-dial-peer)# session target ipv4:198.51.100.1</pre>	Specifies the target network address for the recorder. Keyword and argument are as follows: <ul style="list-style-type: none"> • ipv4: <i>destination address</i> --IP address of the media target. Note Cisco Unified SIP Proxy may be used to route or load balance forked sessions between a group of recorders. In this case, the Unified SIP Proxy IPv4 address should be configured as the session target.
Step 7	session transport [udp tcp tls] Example: <pre>Device(config-dial-peer)# session transport tcp</pre>	Configures a VoIP dial peer to use TCP. Using the session transport command, you can also configure UDP and TLS protocols.
Step 8	(Optional) voice-class sip srtp crypto <crypto-tag> OR srtp pass-thru	Configures SRTP crypto profile on the dial-peer. OR

	Command or Action	Purpose
	<p>Example:</p> <pre>Device(config-dial-peer)#voice-class sip srtp crypto 20</pre> <p>OR</p> <pre>Device(config-dial-peer)#srtp pass-thru</pre>	<p>Configure the SRTP pass through on the outbound dial-peer for incoming INVITE.</p> <p>Note</p> <ul style="list-style-type: none"> • This step is optional and is required only for secure media forking. • The voice-class sip srtp crypto <crypto-tag> is configured for RTP-SRTP Interworking. • The srtp pass-thru is configured for SRTP-SRTP pass through.
Step 9	<p>end</p> <p>Example:</p> <pre>Device(config-dial-peer)# end</pre>	Returns to privileged EXEC mode.

Configure CUBE Media Proxy

Before you begin

For secure forking, outbound dial peers must be configured for TLS or SRTP. For further information, refer to [Configuring CUBE for SIP TLS](#).

SUMMARY STEPS

1. **enable**
2. **configure terminal**
3. **media profile recorder** *profile-tag*
4. **media-recording proxy** [*dial-peer-tag1 dial-peer-tag2 dial-peer-tag3 dial-peer-tag4 dial-peer-tag5*]
5. **media-recording proxy secure** [*dial-peer-tag1 dial-peer-tag2 dial-peer-tag3 dial-peer-tag4 dial-peer-tag5*]
6. **proxy policy mandatory** *dial-peer-tag*
7. **exit**
8. **media class** *tag*
9. **recorder profile** *tag*
10. **exit**

DETAILED STEPS

	Command or Action	Purpose
Step 1	<p>enable</p> <p>Example:</p> <pre>Device> enable</pre>	<p>Enables privileged EXEC mode.</p> <ul style="list-style-type: none"> • Enter your password if prompted.

	Command or Action	Purpose
Step 2	<p>configure terminal</p> <p>Example:</p> <pre>Device# configure terminal</pre>	Enters global configuration mode.
Step 3	<p>media profile recorder <i>profile-tag</i></p> <p>Example:</p> <pre>Device(config)# media profile recorder 100</pre>	Configures the media profile recorder and enters media profile configuration mode.
Step 4	<p>media-recording proxy [<i>dial-peer-tag1 dial-peer-tag2 dial-peer-tag3 dial-peer-tag4 dial-peer-tag5</i>]</p> <p>Example:</p> <pre>Device(cfg-mediaprofile)# media-recording proxy 8000 8001 8002</pre>	<p>Configures the dial-peers for forking. The proxy configures the first dial-peer of the sequence for establishing a back-to-back (B2B) call, and the remaining dial-peers for media forking.</p> <p>Note You can specify maximum of five dial-peer tags.</p>
Step 5	<p>media-recording proxy secure [<i>dial-peer-tag1 dial-peer-tag2 dial-peer-tag3 dial-peer-tag4 dial-peer-tag5</i>]</p> <p>Example:</p> <pre>Device(cfg-mediaprofile)# media-recording proxy secure 9000 9001 9002</pre>	<p>From Cisco IOS XE Bengaluru 17.5.1a onwards, CUBE Media Proxy supports both secure and nonsecure forking. You can configure the dial-peers for both secure and nonsecure forking. The permitted number of configured secure and nonsecure dial peers for forking is five. The behaviour in Cisco IOS XE Bengaluru 17.4.1a and earlier releases is unchanged if there are no secure dial peers configured.</p> <p>Note</p> <ul style="list-style-type: none"> All secure dial peers must use the same voice class srtp-crypto profile.
Step 6	<p>proxy policy mandatory <i>dial-peer-tag</i></p> <p>Example:</p> <pre>Device(cfg-mediaprofile)# proxy policy mandatory 8001</pre>	<p>(Optional)</p> <p>Specifies the dial peer that must be connected before other forks are attempted.</p> <p>Note</p> <ul style="list-style-type: none"> The proxy policy mandatory command cannot be used when dial peers are configured using media recording proxy secure command. Only one mandatory dial peer may be configured for each profile. The mandatory dial peer must be one of those configured with the media-recording proxy command.
Step 7	<p>exit</p> <p>Example:</p> <pre>Device(cfg-mediaprofile)# exit</pre>	Exits media profile configuration mode.

	Command or Action	Purpose
Step 8	media class tag Example: Device(config)# media class 100	Configures a media class and enters media class configuration mode.
Step 9	recorder profile tag Example: Device(cfg-mediaclass)# recorder profile 100	Configures the media profile recorder.
Step 10	exit Example: Device(cfg-mediaclass)# exit	Exits media class configuration mode.

Configure Inbound Dial-Peer from Unified CM

SUMMARY STEPS

1. **enable**
2. **configure terminal**
3. **dial-peer voice call-manager-dial-peer-tag voip**
4. **incoming uri {from | request | to | via } tag**
5. **media-class tag**
6. (Optional) **srtp pass-thru**
7. **exit**

DETAILED STEPS

	Command or Action	Purpose
Step 1	enable Example: Device> enable	Enables privileged EXEC mode. <ul style="list-style-type: none"> • Enter your password if prompted.
Step 2	configure terminal Example: Device# configure terminal	Enters global configuration mode.
Step 3	dial-peer voice call-manager-dial-peer-tag voip Example: Device(config)# dial-peer voice 1000 voip	Configures an inbound dial peer and enters the dial peer voice configuration mode.

	Command or Action	Purpose
Step 4	incoming uri {from request to via } tag Example: <pre>Device(config-dial-peer)# incoming uri via 101</pre>	Configures the voice class to match the VoIP dial-peer to the URI of an incoming call from Unified CM using the header in an incoming SIP INVITE message. Note For more information on incoming uri command, see incoming uri .
Step 5	media-class tag Example: <pre>Device(config-dial-peer)# media-class 100</pre>	Configures media class on the inbound dial peer from Unified CM.
Step 6	(Optional) srtp pass-thru Example: <pre>Device(config-dial-peer)#srtp pass-thru</pre>	Configure the SRTP pass through on the inbound dial peer for incoming INVITE. Note This step is optional and is required only for secure media forking. The srtp pass-thru is configured for SRTP-SRTP pass through.
Step 7	exit Example: <pre>Device(cfg-mediaclass)# exit</pre>	Exits media class configuration mode.

How to Configure CUBE Media Proxy for SIPREC Solutions

Following are the steps to configure SIPREC-based CUBE Media Proxy:

1. [Configure Outbound Dial-Peers to the Recorders, on page 582.](#)
2. [Configure CUBE Media Proxy, on page 584.](#)
3. Configure SIPREC on CUBE. For more information, see [SIPREC \(SIP Recording\)](#).

Verification of CUBE Media Proxy Configuration

You can verify the configuration of CUBE Media Proxy using Unified CM NBR and SIPREC-Based CUBE Media Proxy using the following **show** and **debug** commands.

- **debug voip fpi all** (for ASR devices only)
- **debug voip ccapi all**
- **debug voip recmsp all**
- **debug ccsip all**
- **debug ccsip messages**(for audio calls)

The CUBE Media Proxy sends INVITES to the recorders with a single stream, which successfully forks the primary call to the recorders. INVITES to recorders have a single m-line with a send-only attribute.

- **show voip rtp connections**

Displays Real-Time Transport Protocol (RTP) connections.

Example:

For CUBE Media Proxy with Unified CM NBR, recording sessions consist of two sets of RTP streams that are set up independently for near-end and far-end streams. The following example shows RTP connections from 198.51.100.1 is forked to three recorders 8.41.17.71 to 73.

This example shows NBR with 3 recorders. Two inbound INVITES (one each for near-end or far-end).

```
Device# show voip rtp connections
VoIP RTP Port Usage Information:
Max Ports Available: 19999, Ports Reserved: 101, Ports in Use:8
Port range not configured
Min  Max  Ports  Ports  Ports

Media-Address Range          Port  Port  Available  Reserved  In-use
Global Media Pool            8000  48198  19999      101        8
VoIP RTP active connections :
```

No.	CallId	dstCallId	LocalRTP	RmtRTP	LocalIP	RemoteIP	MPSS
1	100	101	8218	8372	198.51.100.1	192.0.2.1	NO
2	101	100	8220	9000	8.43.21.69	8.41.17.71	NO
3	104	103	8222	9238	8.43.21.69	8.41.17.72	NO
4	107	106	8224	9250	8.43.21.69	8.41.17.73	NO
5	108	109	8226	8374	198.51.100.1	192.0.2.1	NO
6	109	108	8228	9002	8.43.21.69	8.41.17.71	NO
7	112	111	8230	9240	8.43.21.69	8.41.17.72	NO
8	115	114	8232	9252	8.43.21.69	8.41.17.73	NO

Found 8 active RTP connections

For CUBE Media Proxy using SIPREC, both near-end and far-end streams are established with the same inbound INVITE, which includes the detail in 2 m-lines. The following example shows how the inbound RTP connections are established before creating the RTP connections for five forks.

This example shows SIPREC with 5 recorders. One inbound INVITE (both near-end or far-end streams).

```
Device# show voip rtp connections
VoIP RTP Port Usage Information:
Max Ports Available: 19999, Ports Reserved: 101, Ports in Use: 12
Port range not configured
Min  Max  Ports  Ports  Ports

Media-Address Range          Port  Port  Available  Reserved  In-use
Global Media Pool            8000  48198  19999      101       12
VoIP RTP active connections :
```

No.	CallId	dstCallId	LocalRTP	RmtRTP	LocalIP	RemoteIP	MPSS	VRF
1	200	202	8108	6012	198.51.100.1	192.0.2.1	NO	NA
2	201	203	8110	6014	198.51.100.1	192.0.2.1	NO	NA
3	202	200	8112	6004	8.43.21.69	8.41.17.71	NO	NA

4	203	201	8114	8882	8.43.21.69	8.41.17.71	NO	NA
5	208	204	8116	6000	8.43.21.69	8.41.17.72	NO	NA
6	209	204	8118	8886	8.43.21.69	8.41.17.72	NO	NA
7	212	205	8120	6008	8.43.21.69	8.41.17.73	NO	NA
8	213	205	8122	9990	8.43.21.69	8.41.17.73	NO	NA
9	216	206	8124	6024	8.43.21.69	8.41.17.74	NO	NA
10	217	206	8126	9978	8.43.21.69	8.41.17.74	NO	NA
11	220	207	8128	6016	8.43.21.69	8.41.17.75	NO	NA
12	221	207	8130	9968	8.43.21.69	8.41.17.75	NO	NA

Found 12 active RTP connections

- **show voip recmsp session**

Displays active recording Media Service Provider (MSP) session information internal to CUBE Media Proxy.

Following is the sample output for CUBE Media Proxy using Unified CM NBR or SIPREC-Based CUBE Media Proxy:

```
Device# show voip recmsp session

RECMSP active sessions:
MSP Call-ID           AnchorLeg Call-ID       ForkedLeg Call-ID
103                   99                      107
104                   99                      111
105                   99                      115
106                   99                      119
Found 4 active sessions
```

- **show voip recmsp session detail call-id *call-id***

Displays detailed information about the recording MSP Call ID.

Example:

Following is the sample output for CUBE Media Proxy using Unified CM NBR:

```
Device# show voip recmsp session detail call-id 104
RECMSP active sessions:
Detailed Information
=====
Recording MSP Leg Details:
Call ID: 103
GUID : 7C5946D38ECD

AnchorLeg Details:
Call ID: 100
Forking Stream type: voice-nearend
Participant: 10000

Non-anchor Leg Details:
Call ID: 101
Forking Stream type: voice-farend
Participant: 708090

Forked Leg Details:
Call ID: 104
Voice Near End Stream CallID 104
Stream State ACTIVE
Found 1 active sessions
```

In SIPREC-based CUBE Media Proxy, there are two voice near-end streams for the forked call leg. Following is the sample output:

```

Device# show voip recmsp session detail call-id 208
RECMSMP active sessions:
Detailed Information
=====
Recording MSP Leg Details:
Call ID: 204
GUID : C710812A808A

AnchorLeg Details:
Call ID: 200
Forking Stream type: voice-nearend
Participant: sipp

Non-anchor Leg Details:
Call ID: 202
Forking Stream type: voice-farend
Participant: 9876

Forked Leg Details:
Call ID: 208
Voice Near End Stream CallID 208
Stream State ACTIVE
Voice Near End Stream CallID 209
Stream State ACTIVE
Found 1 active sessions

```

- **show voip rtp forking**

Displays RTP media-forking connections.

Example:

Following is the sample output for CUBE Media Proxy using Unified CM NBR:

```

Device# show voip rtp forking
VoIP RTP active forks :
Fork 1
  stream type voice-only (0): count 0
  stream type voice+dtmf (1): count 0
  stream type dtmf-only (2): count 0
  stream type voice-nearend (3): count 1
    remote ip 8.41.17.72, remote port 9238, local port 8222
    codec g711ulaw, logical ssrc 0x53
    packets sent 29687, packets received 0
  stream type voice+dtmf-nearend (4): count 0
  stream type voice+dtmf-farend (6): count 0
  stream type video (7): count 0
  stream type video-nearend (8): count 0
  stream type video-farend (9): count 0
  stream type application (10): count 0
Fork 2
  stream type voice-only (0): count 0
  stream type voice+dtmf (1): count 0
  stream type dtmf-only (2): count 0
  stream type voice-nearend (3): count 1
    remote ip 8.41.17.73, remote port 9250, local port 8224
    codec g711ulaw, logical ssrc 0x53
    packets sent 29687, packets received 0
  stream type voice+dtmf-nearend (4): count 0
  stream type voice+dtmf-farend (6): count 0
  stream type video (7): count 0
  stream type video-nearend (8): count 0
  stream type video-farend (9): count 0
  stream type application (10): count 0
Fork 3

```

```

stream type voice-only (0): count 0
stream type voice+dtmf (1): count 0
stream type dtmf-only (2): count 0
stream type voice-nearend (3): count 1
    remote ip 8.41.17.72, remote port 9240, local port 8230
        codec g711ulaw, logical ssrc 0x58
        packets sent 2980, packets received 0
stream type voice+dtmf-nearend (4): count 0
stream type voice+dtmf-farend (6): count 0
stream type video (7): count 0
stream type video-nearend (8): count 0
stream type video-farend (9): count 0
stream type application (10): count 0
Fork 4
stream type voice-only (0): count 0
stream type voice+dtmf (1): count 0
stream type dtmf-only (2): count 0
stream type voice-nearend (3): count 1
    remote ip 8.41.17.73, remote port 9252, local port 8232
        codec g711ulaw, logical ssrc 0x58
        packets sent 2980, packets received 0
stream type voice+dtmf-nearend (4): count 0
stream type voice+dtmf-farend (6): count 0
stream type video (7): count 0
stream type video-nearend (8): count 0
stream type video-farend (9): count 0
stream type application (10): count 0

```

Following is the sample output for SIPREC-Based CUBE Media Proxy:

```

Device# show voip rtp forking
VoIP RTP active forks :
Fork 1
stream type voice-only (0): count 0
stream type voice+dtmf (1): count 0
stream type dtmf-only (2): count 0
stream type voice-nearend (3): count 2
    remote ip 8.41.17.72, remote port 6000, local port 8116
        codec g711ulaw, logical ssrc 0x53
        packets sent 29687, packets received 0
    remote ip 8.41.17.72, remote port 8886, local port 8118
        codec g711ulaw, logical ssrc 0x53
        packets sent 1296, packets received 0
stream type voice+dtmf-nearend (4): count 0
stream type voice+dtmf-farend (6): count 0
stream type video (7): count 0
stream type video-nearend (8): count 0
stream type video-farend (9): count 0
stream type application (10): count 0
Fork 2
stream type voice-only (0): count 0
stream type voice+dtmf (1): count 0
stream type dtmf-only (2): count 0
stream type voice-nearend (3): count 2
    remote ip 8.41.17.73, remote port 6008, local port 8120
        codec g711ulaw, logical ssrc 0x53
        packets sent 29687, packets received 0
    remote ip 8.41.17.73, remote port 9990, local port 8122
        codec g711ulaw, logical ssrc 0x53
        packets sent 1296, packets received 0
stream type voice+dtmf-nearend (4): count 0
stream type voice+dtmf-farend (6): count 0
stream type video (7): count 0
stream type video-nearend (8): count 0

```

```

stream type video-farend (9): count 0
stream type application (10): count 0
Fork 3
stream type voice-only (0): count 0
stream type voice+dtmf (1): count 0
stream type dtmf-only (2): count 0
stream type voice-nearend (3): count 2
  remote ip 8.41.17.74, remote port 6024, local port 8124
  codec g711ulaw, logical ssrc 0x53
  packets sent 29687, packets received 0
  remote ip 8.41.17.74, remote port 9978, local port 8126
  codec g711ulaw, logical ssrc 0x53
  packets sent 1296, packets received 0
stream type voice+dtmf-nearend (4): count 0
stream type voice+dtmf-farend (6): count 0
stream type video (7): count 0
stream type video-nearend (8): count 0
stream type video-farend (9): count 0
stream type application (10): count 0
Fork 4
stream type voice-only (0): count 0
stream type voice+dtmf (1): count 0
stream type dtmf-only (2): count 0
stream type voice-nearend (3): count 2
  remote ip 8.41.17.75, remote port 6016, local port 8128
  codec g711ulaw, logical ssrc 0x53
  packets sent 29687, packets received 0
  remote ip 8.41.17.75, remote port 9968, local port 8130
  codec g711ulaw, logical ssrc 0x53
  packets sent 1296, packets received 0
stream type voice+dtmf-nearend (4): count 0
stream type voice+dtmf-farend (6): count 0
stream type video (7): count 0
stream type video-nearend (8): count 0
stream type video-farend (9): count 0
stream type application (10): count 0

```

• show call active voice compact

Displays a compact version of voice CallsInProgress. An extra call leg is displayed for media forking.

Example:

Following is a sample using NBR:

```

Device# show call active voice compact
<callID> A/O/FAX T<sec> Codec      type      Peer Address      IP R<ip>:<udp>
Total call-legs: 8
 100  ANS      T644    g711ulaw  VOIP      P10000           192.0.2.1:8372
 101  ORG      T644    g711ulaw  VOIP      P708090           8.41.17.71:9000
 104  ORG      T643    g711ulaw  VOIP      P708090           8.41.17.72:9238
 107  ORG      T643    g711ulaw  VOIP      P708090           8.41.17.73:9250
 108  ANS      T642    g711ulaw  VOIP      P10000           192.0.2.1:8374
 109  ORG      T642    g711ulaw  VOIP      P708090           8.41.17.71:9002
 112  ORG      T641    g711ulaw  VOIP      P708090           8.41.17.72:5240
 115  ORG      T641    g711ulaw  VOIP      P708090           8.41.17.72:9252

```

Following is a sample output using SIPREC:

```

Device# show call active voice compact
<callID> A/O FAX T<sec> Codec      type      Peer Address      IP R<ip>:<udp>
Total call-legs: 6
 200  ANS      T644    g711ulaw  VOIP      P10000           192.0.2.1:8108
 202  ORG      T644    g711ulaw  VOIP      P708090           8.41.17.71:8112

```

208	ORG	T643	g711ulaw	VOIP	P708090	8.41.17.72:8116
212	ORG	T643	g711ulaw	VOIP	P708090	8.41.17.73:8120
216	ORG	T643	g711ulaw	VOIP	P708090	8.41.17.74:8124
220	ORG	T643	g711ulaw	VOIP	P708090	8.41.17.75:8128

- **show sip-ua calls**

Displays active user agent client (UAC) and user agent server (UAS) information on SIP calls.

Example:

Following is the sample output for CUBE Media Proxy using Unified CM NBR:

```
Device# show sip-ua calls
Total SIP call legs:3, User Agent Client:2, User Agent Server:1
SIP UAC CALL INFO
Call 1
SIP Call ID           : 4091A49B-308911E8-8008EC4C-8D01D66C@192.0.2.1
State of the call     : STATE_ACTIVE (7)
Substate of the call  : SUBSTATE_NONE (0)
Calling Number        : 808808
Called Number         : 8453
Called URI            :
Bit Flags             : 0xC04018 0x80000100 0x80
CC Call ID            : 2
Local UUID            : c7351800dd135daba19758eac6b1dd70
Remote UUID           : ab9f4823802156aaaa8d62e04aaa2b96
Source IP Address (Sig) : 192.0.2.1
Destn SIP Req Addr:Port : [192.0.2.2]:9312
Destn SIP Resp Addr:Port : [192.0.2.2]:9312
Destination Name      :
Number of Media Streams : 1
Number of Active Streams : 1
RTP Fork Object       : 0x0
Media Mode             : flow-through
Media Stream 1
State of the stream   : STREAM_ACTIVE
Stream Call ID        : 2
Stream Type           : voice-only (0)
Stream Media Addr Type : 1
Negotiated Codec      : g711ulaw (160 bytes)
Codec Payload Type    : 0
Negotiated Dtmf-relay : inband-voice
Dtmf-relay Payload Type : 0
QoS ID                : -1
Local QoS Strength    : BestEffort
Negotiated QoS Strength : BestEffort
Negotiated QoS Direction : None
Local QoS Status      : None
Media Source IP Addr:Port : [192.0.2.1]:8002
Media Dest IP Addr:Port  : [192.0.2.2]:9000
Mid-Call Re-Association Count: 0
SRTP-RTP Re-Association DSP Query Count: 0

Options-Ping    ENABLED:NO    ACTIVE:NO
```

Following is the sample output for SIPREC-based CUBE Media Proxy:

```
Device# show sip-ua calls
Total SIP call legs:6, User Agent Client:5, User Agent Server:1
SIP UAC CALL INFO
Call 1
SIP Call ID           : C711BA13-7E9B11EA-8090D6ED-255EEFA0@8.43.21.69
```

```

State of the call      : STATE_ACTIVE (7)
Substate of the call  : SUBSTATE_NONE (0)
Calling Number        : sipp
Called Number         : 9876
Called URI            : sip:9876@8.41.17.71:8881
Bit Flags             : 0xC04018 0x90000100 0x80
CC Call ID           : 101
Local UUID            : eeabf35db3d25ca4b8276616cdcf5d15
Remote UUID           : 8afa5ed7b8a052e29235bade4affcf9e
Source IP Address (Sig) : 8.43.21.69
Destn SIP Req Addr:Port : [8.41.17.71]:8881
Destn SIP Resp Addr:Port : [8.41.17.71]:8881
Destination Name      : 8.41.17.71
Number of Media Streams : 2
Number of Active Streams: 2
RTP Fork Object       : 0x0
Media Mode            : flow-through

Media Stream 1
  State of the stream  : STREAM_ACTIVE
  Stream Call ID       : 101
  Stream Type          : voice+dtmf (1)
  Stream Media Addr Type : 1
  Negotiated Codec     : g711ulaw (160 bytes)
  Codec Payload Type   : 0
  Negotiated Dtmf-relay : rtp-nte
  Dtmf-relay Payload Type : 101
  QoS ID               : -1
  Local QoS Strength   : BestEffort
  Negotiated QoS Strength : BestEffort
  Negotiated QoS Direction : None
  Local QoS Status     : None
  Media Source IP Addr:Port : [8.43.21.69]:8112
  Media Dest IP Addr:Port  : [8.41.17.71]:6005

Media Stream 2
  State of the stream  : STREAM_ACTIVE
  Stream Call ID       : 102
  Stream Type          : voice+dtmf (1)
  Stream Media Addr Type : 1
  Negotiated Codec     : g711ulaw (160 bytes)
  Codec Payload Type   : 0
  Negotiated Dtmf-relay : rtp-nte
  Dtmf-relay Payload Type : 101
  QoS ID               : -1
  Local QoS Strength   : BestEffort
  Negotiated QoS Strength : BestEffort
  Negotiated QoS Direction : None
  Local QoS Status     : None
  Media Source IP Addr:Port : [8.43.21.69]:8114
  Media Dest IP Addr:Port  : [8.41.17.71]:8883
Mid-Call Re-Association Count: 0
SRTP-RTP Re-Association DSP Query Count: 0

```

```
Options-Ping    ENABLED:NO    ACTIVE:NO
```

• show voip fpi calls

Displays the call (both inbound and outbound leg) information at the application level.

Example:

Following is the sample output for CUBE Media Proxy using Unified CM NBR:

```
Device#show voip fpi calls
Number of Calls : 1
```



```
-----
confID    correlator  AcallID    BcallID    state      event
-----
1005      1           1019       1020       ALLOCATED  DETAIL_STAT_RSP
-----
```

As there are 2-m lines in the incoming invite to SIPREC-based CUBE Media Proxy, two FPI sessions are created. Following is the sample output:

```
Device#show voip fpi calls
Number of Calls : 2
```

```
-----
confID    correlator  AcallID    BcallID    state      event
-----
42        13         102        100        ALLOCATED  DETAIL_STAT_RSP
41        14         99         101        ALLOCATED  DETAIL_STAT_RSP
-----
```

• **show media-proxy sessions**

Displays the inbound and forked Call-ID, Session-ID, and dial peer tag details of the active recording sessions. The "Secure" field in the command output is tagged Y if the recording session is secure and N if the recording session is nonsecure. The "SIPREC" field in the command output is tagged Y for SIPREC-based recording session and N for Unified CM-based recording session.

Example:

```
Device# show media-proxy sessions
```

```

No.      Call-ID          Session-ID          Dialpeer    Secure
SIPREC   Inbound/Forked  LocalUuid;RemoteUuid  Tag         (Y/N)
(Y/N)
=====
1        36770/-         a234a20672ce596d969c59ee9767f127;  3          N
Y
          aaaaaaaaaaaaaaaaaaaaaaaaaaaaaaaaaaaaaa

```

• **show media-proxy sessions summary**

Displays the active recording session details such as the dial peer tag, IP address, port number, number of failed recording sessions, and total number of recording sessions.

Example:

NBR:

```
Device# show media-proxy sessions summary
```

```

No      Inbound/Forked    Dialpeer-Tag      IP:Port          Total/Failed
Sessions
-----
1       Forked            100               ipv4:8.41.17.71:5060  2/0
2       Forked            200               ipv4:8.41.17.72:5060  2/0
3       Forked            300               ipv4:8.41.17.73:5060  2/0
4       Inbound           5678

```

SIPREC:

```
Device# show media-proxy sessions summary
```

```

No      Inbound/Forked    Dialpeer-Tag      IP:Port          Total/Failed
Sessions
-----
1       Forked            100               ipv4:8.41.17.71:5060  1/0

```

2	Forked	200	ipv4:8.41.17.72:5060	1/0
3	Forked	300	ipv4:8.41.17.73:5060	1/0
4	Forked	400	ipv4:8.41.17.74:5060	1/0
5	Forked	500	ipv4:8.41.17.75:5060	1/0
6	Inbound	5678		1/0

- **show media-proxy sessions call-id** *call-id*

Displays the details of the inbound leg and all the forked legs that are associated with the specified SIP leg call-ID. MSP call-ID is not a valid call-ID for this command. Specify the CCAPI call identifier of the SIP leg.

Example:

```
Device# show media-proxy sessions call-id 101
CC Call-ID: 100 Inbound-leg
Dur: 00:00:15 tx: 0/0 rx: 1484/296800 lost: 0/0/0 delay: 0/0/0ms
Remote-Addr: 192.0.2.1:8372 Local-Addr: 192.0.2.1:8218 rtt:0ms pl:0/0ms
Dialpeer-Tag: 5678 Negotiated-Codec: g711ulaw
SRTP-Status: off SRTP-Cipher: NA
LocalUUID: 6bde661e9767590b930f3427ad6e94e9 RemoteUUID: ab9f4823802156aaaa8d62e04aaa2b96

CC Call-ID: 101 Forked-leg (Primary)
Dur: 00:00:15 tx: 1484/296800 rx: 0/0 lost: 0/0/0 delay: 0/0/0ms
Remote-Addr: 8.41.17.71:9000 Local-Addr: 8.43.21.69:8220 rtt:0ms pl:0/0ms
Dialpeer-Tag: 100 Negotiated-Codec: g711ulaw
SRTP-Status: off SRTP-Cipher: NA
LocalUUID: ab9f4823802156aaaa8d62e04aaa2b96 RemoteUUID: 6bde661e9767590b930f3427ad6e94e9

CC Call-ID: 104 Forked-leg
Dur: 00:00:15 tx: 1480/296000 rx: 0/0 lost: 0/0/0 delay: 0/0/0ms
Remote-Addr: 8.41.17.72:9238 Local-Addr: 8.43.21.69:8222 rtt:0ms pl:0/0ms
Dialpeer-Tag: 200 Negotiated-Codec: g711ulaw
SRTP-Status: off SRTP-Cipher: NA
LocalUUID: 6bde661e9767590b930f3427ad6e94e9 RemoteUUID: dcdf882f0876890b930f3427be7fa5f6

CC Call-ID: 107 Forked-leg
Dur: 00:00:15 tx: 1479/295800 rx: 0/0 lost: 0/0/0 delay: 0/0/0ms
Remote-Addr: 8.41.17.73:9250 Local-Addr: 8.43.21.69:8224 rtt:0ms pl:0/0ms
Dialpeer-Tag: 300 Negotiated-Codec: g711ulaw
SRTP-Status: off SRTP-Cipher: NA
LocalUUID: 6bde661e9767590b930f3427ad6e94e9 RemoteUUID: 8df0863a6434263f60e50124dae649e6
```

- **show media-proxy sessions session-id** *WORD*

Displays the details of the Media Proxy recording sessions that are associated with the specified session-ID. To display the details of a specific call-leg, specify the complete session ID string as, *local-uuid;remote=remote-uuid*. Tokens that are allowed for *WORD* are '*', [0-9], [a-f], and [A-F].

Example:

```
Device# show media-proxy sessions session-id 6bde661e9767590b930f3427ad6e94e9
CC Call-ID: 100 Inbound-leg
Dur: 00:00:15 tx: 0/0 rx: 1484/296800 lost: 0/0/0 delay: 0/0/0ms
Remote-Addr: 192.0.2.1:8372 Local-Addr: 192.0.2.1:8218 rtt:0ms pl:0/0ms
Dialpeer-Tag: 5678 Negotiated-Codec: g711ulaw
SRTP-Status: off SRTP-Cipher: NA
LocalUUID: 6bde661e9767590b930f3427ad6e94e9 RemoteUUID: ab9f4823802156aaaa8d62e04aaa2b96

CC Call-ID: 101 Forked-leg (Primary)
Dur: 00:00:15 tx: 1484/296800 rx: 0/0 lost: 0/0/0 delay: 0/0/0ms
Remote-Addr: 8.41.17.71:9000 Local-Addr: 8.43.21.69:8220 rtt:0ms pl:0/0ms
```

```

Dialpeer-Tag: 100 Negotiated-Codec: g711ulaw
SRTP-Status: off SRTP-Cipher: NA
LocalUUID: ab9f4823802156aaaa8d62e04aaa2b96 RemoteUUID: 6bde661e9767590b930f3427ad6e94e9

CC Call-ID: 104 Forked-leg
Dur: 00:00:15 tx: 1480/296000 rx: 0/0 lost: 0/0/0 delay: 0/0/0ms
Remote-Addr: 8.41.17.72:9238 Local-Addr: 8.43.21.69:8222 rtt:0ms pl:0/0ms
Dialpeer-Tag: 200 Negotiated-Codec: g711ulaw
SRTP-Status: off SRTP-Cipher: NA
LocalUUID: 6bde661e9767590b930f3427ad6e94e9 RemoteUUID: dcdcf882f0876890b930f3427be7fa5f6

CC Call-ID: 107 Forked-leg
Dur: 00:00:15 tx: 1479/295800 rx: 0/0 lost: 0/0/0 delay: 0/0/0ms
Remote-Addr: 8.41.17.73:9250 Local-Addr: 8.43.21.69:8224 rtt:0ms pl:0/0ms
Dialpeer-Tag: 300 Negotiated-Codec: g711ulaw
SRTP-Status: off SRTP-Cipher: NA
LocalUUID: 6bde661e9767590b930f3427ad6e94e9 RemoteUUID: 8df0863a6434263f60e50124dae649e6

```

- **show media-proxy sessions metadata-session-id *x-session-id***

Displays the details of the Media Proxy recording sessions based on the *x-session-id* present in the "From" header of the INVITE from Cisco Unified Communications Manager.

Example:

```

Device# show media-proxy sessions metadata-session-id 696dd5d3f7755c6abdc438e93d01febf

CC Call-ID: 108 Inbound-leg
Dur: 00:00:46 tx: 0/0 rx: 3105/578880 lost: 0/0/0 delay: 0/0/0ms
Remote-Addr: 192.0.2.1:8374 Local-Addr: 198.51.100.1:8226 rtt: 0ms pl: 0/0ms
Dialpeer-Tag: 1 Negotiated-Codec: g711ulaw
SRTP-Status: off SRTP-Cipher: NA
LocalUUID: 528b282b804c5fd098eaba3696c00de2 RemoteUUID: 4fd8036613424366fe00521d46ea16e3

CC Call-ID: 108 Forked-leg (Primary)
Dur: 00:00:46 tx: 3105/578880 rx: 0/0 lost: 0/0/0 delay: 0/0/0ms
Remote-Addr: 8.41.17.71:9002 Local-Addr: 8.43.21.69:8228 rtt: 0ms pl: 0/0ms
Dialpeer-Tag: 2 Negotiated-Codec: g711ulaw
SRTP-Status: off SRTP-Cipher: NA
LocalUUID: 4fd8036613424366fe00521d46ea16e3 RemoteUUID: 528b282b804c5fd098eaba3696c00de2

CC Call-ID: 112 Forked-leg
Dur: 00:00:46 tx: 3100/577880 rx: 0/0 lost: 0/0/0 delay: 0/0/0ms
Remote-Addr: 8.41.17.72:9240 Local-Addr: 8.43.21.69:8230 rtt: 0ms pl: 0/0ms
Dialpeer-Tag: 3 Negotiated-Codec: g711ulaw
SRTP-Status: off SRTP-Cipher: NA
LocalUUID: 528b282b804c5fd098eaba3696c00de2 RemoteUUID: 74ad4a4da25e71f2ba0cdc58b8e22f04

CC Call-ID: 115 Forked-leg
Dur: 00:00:46 tx: 3101/578080 rx: 0/0 lost: 0/0/0 delay: 0/0/0ms
Remote-Addr: 8.41.17.73:9252 Local-Addr: 8.43.21.69:8232 rtt: 0ms pl: 0/0ms
Dialpeer-Tag: 4 Negotiated-Codec: g711ulaw
SRTP-Status: off SRTP-Cipher: NA
LocalUUID: 528b282b804c5fd098eaba3696c00de2 RemoteUUID: 96c06c6fc4809314dc2efe7ada030ed6

```

Supported Features

Mid-Call Message Handling

CUBE Media Proxy using Unified CM NBR or SIPREC support midcall signaling events that involve RE-INVITES from the initiator of the recording session (Unified CM or Cisco UBE) to the recorders. CUBE Media Proxy handles the RE-INVITES that request a session refresh, change in SDP for media address, direction or codec, or change SRTP crypto suite/key.

For NBR solutions, CUBE Media Proxy sends status updates of a midcall event to Unified CM using SIP Info messages.

When CUBE Media Proxy establishes a new set of forked sessions, the first is referred to as the primary. Where a destination is configured as mandatory, the destination is always the primary. Where all destinations are optional, the first successfully created session is the primary.

Perform the following steps to handle midcall messages:

1. On receipt of a RE-INVITE, CUBE Media Proxy sends the RE-INVITE to the primary recorder.
2. If the primary destination responds to the RE-INVITE with a BYE, then:
 - If the primary is mandatory, the call and all forks are stopped by sending BYE to the destinations and originator.
 - If the primary is optional, the BYE is acknowledged, but not passed back to the originator. The primary session is maintained in a dormant state and further midcall updates are blocked for the remainder of the call.
3. For other responses, the message from the primary is sent to the originator (Unified CM or CUBE).
4. Where the RE-INVITE requests a change in SDP or SRTP and only if this is successfully acknowledged (200 OK) by the primary, the RE-INVITE is sent to the other destinations.
5. If any of the other destinations respond to the RE-INVITE with a failure, CUBE Media Proxy clears that fork by sending a BYE to that destination. The status of this failed session is provided to Unified CM in an INFO message in NBR configurations.

Secure Recording of Secure Calls and Nonsecure Calls

Secure Recording of Secure Calls

With CUBE Media Proxy using Unified CM NBR, it is possible to extend encrypted calls to forked destinations. In this scenario, call signaling is secured using TLS for each connection between CUBE Media Proxy and Unified CM and recorders. As SRTP passthrough is used for media flows, the cipher suite and encryption key negotiated between Unified CM and the primary destination is used for all forks.

Refer to [Configuring SIP TLS](#) to secure signaling on Unified CM and forked legs. SRTP configuration is only required for the Unified CM.

Secure Recording of Nonsecure Calls

From Cisco IOS XE Bengaluru 17.5.1a, CUBE Media Proxy used in NBR or SIPREC mode may be configured to secure specific forked sessions when the original call is not encrypted. In this case, the primary destination must be secured and is treated in the same way as a mandatory destination as described in the message handling section above. Refer to [SIP TLS and SRTP-RTP internetworking](#)

Support for High Availability

CUBE Media Proxy may be run on a high availability pair of platforms to ensure that calls and media forks are maintained if hardware failure. Call and forked session state is continuously synchronized between the platforms, ensuring that the standby can seamlessly take over media forwarding and call control if necessary.

High availability is available for Cisco Media Proxy configured for Unified CM NBR or SIPREC using either box-to-box or inbox redundancy options.

The following conditions apply when using CUBE Media Proxy high availability:

- Both Active and Standby platforms must have a common hardware and software configuration.
- Calls are synchronized by establishing a checkpoint with the standby on completion of each INVITE, REINVITE, UPDATE, or BYE message transaction.
- Connections that are not successfully established at the point of switchover are not maintained (as there is no checkpoint for the incomplete message transaction).
- In Unified CM NBR mode, checkpoint information includes call metadata, SRTP context and common session ID for all forked sessions. Checkpoints are created after message flows between a recorder and Unified CM are complete. For example, when an optional recorder sends a BYE, the checkpoint is created after CUBE Media Proxy receives the 200 OK response from Unified CM for the INFO message it sends.
- In SIPREC mode, checkpoint information includes common session ID, but not metadata.

You can use the following **show** commands to monitor the recording sessions on the Active and the Standby instances of CUBE Media Proxy:

- **show call active voice compact**
- **show voip rtp connections**
- **show voip recmsp session**
- **show media-proxy sessions**
- **show media-proxy sessions summary**
- **show sip-ua calls**

Media Latch

By default, CUBE Media Proxy using Unified CM NBR uses source address validation to check if the IP address and port details that are received in the UDP header of the RTP or SRTP packets match with the details in the SDP sent by the SIP User Agent. Packets without matching IP address and port are dropped.

In a typical SCCP-based BiB recording using Unified CM NBR CUBE Media Proxy, Unified CM first sends an SDP with the IP address and a dummy port to the CUBE Media Proxy to get the capabilities of CUBE Media Proxy. Unified CM then sends this SDP to the SCCP phone. The CUBE Media Proxy does not know

the BiB IP address and port details of the SCCP phone. In these call flows, the IP address and port details in the media packets that are sent from BiB of the SCCP phone to SCCP phone, are different from the IP address and port details in the packets that are sent from Unified CM to the CUBE Media Proxy.

Media Latching is enabled on Unified CM NBR CUBE Media Proxy by default so that the CUBE Media Proxy learns the remote IP address and port details from the UDP transport header of the first RTP or SRTP packet. Media latching is turned on for every call that flows through the CUBE Media Proxy, and works for initial and midcall scenarios. Media Latching is enabled on the inbound leg (Unified CM leg), such that the media packets are accepted even if they are sent from a source IP address and port that is different from the IP address that is advertised in the SDP.



PART **X**

SIP Header Manipulation

- [Passing Headers Unsupported by CUBE, on page 603](#)
- [Copying SIP Headers, on page 605](#)
- [Manipulate SIP Status-Line Header of SIP Responses, on page 611](#)



CHAPTER 44

Passing Headers Unsupported by CUBE

This feature is used to pass parameters that are unsupported by CUBE, but mandatory to the service provider from one leg to another. When a SIP message is received, a check is done for the header, and if it is available, it is copied into a copy list and passed on to the outbound dial peer leg.

- [Feature Information for Copying with SIP Profiles, on page 603](#)
- [Example: Passing a Header Not Supported by CUBE, on page 603](#)

Feature Information for Copying with SIP Profiles

The following table provides release information about the feature or features described in this module. This table lists only the software release that introduced support for a given feature in a given software release train. Unless noted otherwise, subsequent releases of that software release train also support that feature.

Use Cisco Feature Navigator to find information about platform support and Cisco software image support. To access Cisco Feature Navigator, go to <https://cfngn.cisco.com/>. An account on Cisco.com is not required.

Table 66: Feature Information for Copying with SIP Profiles

Feature Name	Releases	Feature Information
Support for conditional header manipulation of SIP headers	15.1(3)T Cisco IOS XE Release 3.6S	This feature allows users to copy content from one header to the another. This is done by copying the content of messages into variables which can then be used to modify other SIP headers. This feature modifies the following commands: voice class sip-profiles , response , request , voice-class sip copy-list , sip-header

Example: Passing a Header Not Supported by CUBE

CUBE does not pass “x-cisco-tip”. However, certain TelePresence equipments require “TIP”.

The SIP profile below will look for "x-cisco-tip" in the inbound contact header then pass it in the outbound contact header.

Inbound Contact Header

```
Contact: <sip:89016442998@161.44.77.193;transport=udp>;x-cisco-tip
```

Outbound Contact Header

```
Contact: <sip:89016442998@10.86.176.19:5060>;x-cisco-tip
```

Create a copylist to pass the Contact Header from the incoming message to the outgoing message. The “x-cisco-tip” is not copied in this step as it is unsupported by CUBE.

```
!Create a copyList
Device(config)# voice class sip-copylist 1
Device(config-class)# sip-header Contact
Device(config-class)# exit

!Apply the copylist to incoming dial peer.
Device(config)# dial-peer voice 1 voip
Device(config-dial-peer)# description incoming SIP Trunk
Device(config-dial-peer)# incoming called-number
Device(config-dial-peer)# voice-class sip copy-list 1
```

Create a SIP profile that copies “x-cisco-tip” into a variable, and use that variable to modify the outgoing Contact header. Apply the SIP profile to an outbound dial peer.

```
Device# voice class sip-profiles 3001

!Copy the Contact header from the incoming dial peer into variable u01
Device(config-class)# request INVITE peer-header sip Contact copy "(:x-cisco-tip)" u01

!Modify the outgoing SIP Invite with this variable.
Device(config-class)# request INVITE sip-header Contact modify "$" "\u01"

!Apply the SIP Profile to the outgoing dial peer.
Device(config)# dial-peer voice 5000 voip
Device(config-dial-peer)# description outbound SIP
Device(config-dial-peer)# destination-pattern 5...$
Device(config-dial-peer)# voice-class sip profiles 3001
```



CHAPTER 45

Copying SIP Headers

This feature shows you how outgoing SIP headers can be manipulated using information from incoming and other outgoing SIP headers.

- [Feature Information for Copying with SIP Profiles](#), on page 605
- [How to Copy SIP Header Fields to Another](#), on page 606
- [Example: Copying the To Header into the SIP-Req-URI](#), on page 609

Feature Information for Copying with SIP Profiles

The following table provides release information about the feature or features described in this module. This table lists only the software release that introduced support for a given feature in a given software release train. Unless noted otherwise, subsequent releases of that software release train also support that feature.

Use Cisco Feature Navigator to find information about platform support and Cisco software image support. To access Cisco Feature Navigator, go to <https://cfng.cisco.com/>. An account on Cisco.com is not required.

Table 67: Feature Information for Copying with SIP Profiles

Feature Name	Releases	Feature Information
Support for conditional header manipulation of SIP headers	15.1(3)T Cisco IOS XE Release 3.6S	This feature allows users to copy content from one header to the another. This is done by copying the content of messages into variables which can then be used to modify other SIP headers. This feature modifies the following commands: voice class sip-profiles , response , request , voice-class sip copy-list , sip-header

How to Copy SIP Header Fields to Another

Copying From an Incoming Header and Modifying an Outgoing Header

To copy content from an incoming header that a device receives to an outgoing header, configure a SIP copylist for that header and apply it to an incoming dial peer. Configure a SIP profile to copy the incoming header to a user-defined variable and apply it to an outgoing header.

SUMMARY STEPS

1. **enable**
2. **configure terminal**
3. **voice class sip-copylist** *tag*
4. Do one of the following:
 - **sip-header** *header-name*
 - **sip-header SIP-Req-URI**
5. **exit**
6. **dial-peer voice** *inbound-dial-peer-tag* **voip**
7. **voice-class sip-copylist** *tag*
8. **exit**
9. **voice class sip-profiles** *profile-id*
10. **{request | response} message peer-header sip** *header-to-copy* **copy** *header-value-to-match* *copy-variable*
11. **{request | response} message {sip-header | sdp-header}** *header-to-modify* **modify** *header-value-to-match* *header-value-to-replace*
12. **exit**
13. **dial-peer voice** *outbound-dial-peer-tag* **voip**
14. **voice-class sip-profiles** *profile-id*
15. **exit**

DETAILED STEPS

	Command or Action	Purpose
Step 1	enable	Enables privileged EXEC mode. <ul style="list-style-type: none"> • Enter your password if prompted.
Step 2	configure terminal	Enters global configuration mode.
Step 3	voice class sip-copylist <i>tag</i> Example: Device(config)# voice class sip-copylist 100	Configures a list of entities to be sent to a peer call leg and enters voice class configuration mode.

	Command or Action	Purpose
Step 4	Do one of the following: <ul style="list-style-type: none"> • sip-header <i>header-name</i> • sip-header SIP-Req-URI Example: <pre>Device(config-class)# sip-header To</pre>	Specifies the SIP header to be copied to the peer call leg. <ul style="list-style-type: none"> • sip-req-uri—Configures Cisco Unified Border Element (UBE) to send a SIP request Uniform Resource Identifier (URI) to the peer call leg. • header-name—Configures Cisco Unified Border Element (UBE) to send the header name specified to the peer call leg.
Step 5	exit	Exits voice class configuration mode.
Step 6	dial-peer voice <i>inbound-dial-peer-tag</i> voip Example: <pre>Device(config)# dial-peer voice 2 voip</pre>	Enters the dial peer configuration mode for the specified inbound dial peer.
Step 7	voice-class sip-copylist <i>tag</i> Example: <pre>Device(config-dial-peer)# voice-class sip-copylist 100</pre>	Applies the copy list to the dial-peer.
Step 8	exit	Exits to global configuration mode.
Step 9	voice class sip-profiles <i>profile-id</i> Example: <pre>Device(config)# voice class sip-profiles 10</pre>	Create a SIP Profile and enters voice class configuration mode.
Step 10	{request response} message peer-header sip <i>header-to-copy copy header-value-to-match copy-variable</i> Example: <pre>Device(config-class)# request INVITE peer-header sip TO copy "sip:(.*)@" u01</pre>	Copies headers from the corresponding incoming dial peer into a copy variable.
Step 11	{request response} message {sip-header sdp-header} <i>header-to-modify modify header-value-to-match header-value-to-replace</i> Example: <pre>Device(config-class)# request INVITE sip-header SIP-Req-URI modify ".*@(.*)" "INVITE sip:\u01@1"</pre>	Modifies an outgoing SIP or SDP header using the copy variable defined in the previous step.
Step 12	exit	Exits to global configuration mode.
Step 13	dial-peer voice <i>outbound-dial-peer-tag</i> voip Example: <pre>Device(config)# dial-peer voice 2 voip</pre>	Enters the dial peer configuration mode for the specified outbound dial peer.

	Command or Action	Purpose
Step 14	voice-class sip-profiles <i>profile-id</i> Example: Device(config-dial-peer)# voice-class sip-profiles 10	SIP Profile is applied to the dial-peer.
Step 15	exit	Exits to global configuration mode.

Copying From One Outgoing Header to Another

SUMMARY STEPS

1. **enable**
2. **configure terminal**
3. **voice class sip-profiles** *profile-id*
4. **{request | response} message {sip-header | sdp-header} header-to-copy copy header-value-to-match copy-variable**
5. **{request | response} message {sip-header | sdp-header} header-to-modify modify header-value-to-match header-value-to-replace**
6. **end**

DETAILED STEPS

	Command or Action	Purpose
Step 1	enable	Enables privileged EXEC mode. <ul style="list-style-type: none"> • Enter your password if prompted.
Step 2	configure terminal	Enters global configuration mode.
Step 3	voice class sip-profiles <i>profile-id</i> Example: Device(config)# voice class sip-profiles 10	Creates a SIP profile and enters voice class configuration mode.
Step 4	{request response} message {sip-header sdp-header} header-to-copy copy header-value-to-match copy-variable Example: Device(config-class)# request INVITE sip-header TO copy "sip:(.*)@" u01	Copies the contents of the specified header from an outbound message into a copy variable.
Step 5	{request response} message {sip-header sdp-header} header-to-modify modify header-value-to-match header-value-to-replace Example:	Modifies an outgoing SIP or SDP header using the copy variable defined in the previous step.

	Command or Action	Purpose
	Device(config-class)# request INVITE sip-header SIP-Req-URI modify ".*@(.*)" "INVITE sip:\u01@1"	
Step 6	end Example: Device(config-class)# end	Exits voice class configuration mode and enters privileged EXEC mode.

What to do next

Apply the SIP Profile to an outbound dial peer.

Example: Copying the To Header into the SIP-Req-URI

Copying Contents from One Header to Another

Given below is a scenario in an organization, where the provider has sent only a global reference number in the SIP-Req-URI header of the INVITE message, and has placed the actual phone destination number only in the To: SIP header. The CUCM typically routes on the SIP-Req-URI.



Given below is the original SIP message, where the INVITE has a non-routable value of 43565432A5. The actual phone destination number is 2555552 and is present in the To: SIP header.

Figure 49: Incoming SIP Message

```
INVITE sip:43565432A5@192.168.1.100:5060 SIP/2.0
From: <sip:027784200@A.eu;user=phone>;
To: <sip:2555552@A.eu>
...
```

Given below is the SIP message that is required. Note that 43565432A5 has changed to 2555552 in the SIP INVITE.

Figure 50: Modified SIP Message

```
INVITE sip:2555552@192.168.1.100:5060 SIP/2.0
From: <sip:027784200@A.eu;user=phone>;
To: <sip:2555552@A.eu>
...
```

Because CUBE is a back-to-back user agent, the incoming dial peer is matched to the outgoing dial peer. The SIP Profile configured below copies the value from the incoming dial peer

Example: Copying the To Header into the SIP-Req-URI

```

Device# voice class sip-profiles 1

!Copy the To header from the incoming dial peer into variable u01
Device(config-class)# request INVITE peer-header sip TO copy "sip:(.*)@" u01

!Modify the outgoing SIP Invite with this variable.
Device(config-class)# request INVITE sip-header SIP-Req-URI modify ".*@(.)" "INVITE
sip:\u01@\1"

```

Apply the SIP profile to the incoming dial peer.

```

Device(config)# dial-peer voice 99 voip
Device(config-dial-peer)# outgoing to CUCM
Device(config-dial-peer)# destination-pattern 02555555.
Device(config-dial-peer)# session protocol sipv2
Device(config-dial-peer)# session target ipv4:10.1.2.3

!Applying SIP profile to the dial peer
Device(config-dial-peer)# voice-class sip profiles 1
Device(config-dial-peer)# voice-class code 1
Device(config-dial-peer)# dtmf-relay rtp-nte
Device(config-dial-peer)# no vad

```

Additionally, if you would like to copy the To: Header from the inbound dial peer to the outbound dial peer, use a copy list.

```

!Create a copy List
Device(config)# voice class sip-copylist 1
Device(config-class)# sip-header TO
Device(config-class)# exit

!Apply the copy list to incoming dial peer.
Device(config)# dial-peer voice 1 voip
Device(config-dial-peer)# description incoming SIP Trunk
Device(config-dial-peer)# session protocol sipv2
Device(config-dial-peer)# session target sip-server
Device(config-dial-peer)# incoming uri to TRUNK
Device(config-dial-peer)# voice-class code 1
Device(config-dial-peer)# voice-class sip copy-list 1

Device(config)# voice class uri TRUNK sip
Device(config-class)# user-id 2555555.
Device(config-class)# end

```



CHAPTER 46

Manipulate SIP Status-Line Header of SIP Responses

The SIP status line is a SIP response header, and it can be modified like any other SIP headers of a message. It can either be modified with a user-defined value, or the status line from an incoming response can be copied to an outgoing SIP response. The SIP header keyword used for the response status line is **SIP-StatusLine**.

- [Feature Information for Manipulating SIP Responses, on page 611](#)
- [Copying Incoming SIP Response Status Line to Outgoing SIP Response, on page 612](#)
- [Modifying Status-Line Header of Outgoing SIP Response with User Defined Values, on page 615](#)

Feature Information for Manipulating SIP Responses

The following table provides release information about the feature or features described in this module. This table lists only the software release that introduced support for a given feature in a given software release train. Unless noted otherwise, subsequent releases of that software release train also support that feature.

Use Cisco Feature Navigator to find information about platform support and Cisco software image support. To access Cisco Feature Navigator, go to <https://cfng.cisco.com/>. An account on Cisco.com is not required.

Table 68: Feature Information for Manipulating SIP Responses

Feature Name	Releases	Feature Information
SIP Profile Enhancements for SIP responses and error codes	15.4(1)T Cisco IOS XE Release 3.12S	This feature extends SIP profiles to allow the following: <ul style="list-style-type: none">• Modification of the outgoing SIP response status line. Previously, only modification of outgoing SIP requests and responses was possible.• Copying of the incoming SIP response status-line. The information from the peer-leg status-line can then be copied to user-variables and applied to the outbound response status-line. This option can be used to pass-thru the error-code and error phrase from peer-leg. Previously, only copying of SIP headers were possible.• Before applying a SIP profile to a response from CUBE, the response can be mapped to its corresponding request.

Feature Name	Releases	Feature Information
Support for conditional header manipulation of SIP headers	15.1(3)T Cisco IOS XE Release 3.6S	This feature allows users to copy content from one header to the another. This is done by copying the content of messages into variables which can then be used to modify other SIP headers. This feature modifies the following commands: voice class sip-profiles , response , request , voice-class sip copy-list , sip-header

Copying Incoming SIP Response Status Line to Outgoing SIP Response

To copy content from the status line of an incoming SIP response that a device receives to an outgoing response, configure a SIP copylist for SIP status line and apply it to an incoming dial peer. A SIP profile must be configured to copy the status line of an incoming SIP response to a user-defined variable and apply it to an outgoing SIP response.

Figure 51: Call Flow for Copying the Status Line from the Incoming SIP Response to the Outgoing SIP Response

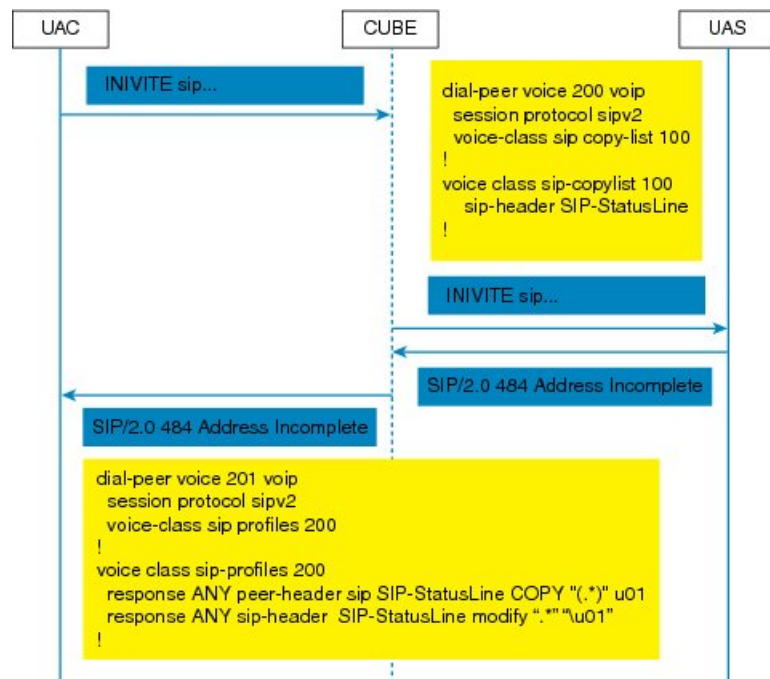

SUMMARY STEPS

1. **enable**
2. **configure terminal**
3. **voice class sip-copylist tag**
4. **sip-header SIP-StatusLine**

5. **exit**
6. **dial-peer voice** *inbound-dial-peer-id* **voip**
7. **voice-class sip copy-list** *list-id*
8. **exit**
9. **voice class sip-profiles** *tag*
10. **response** *response-code* **peer-header sip SIP-StatusLine copy** *match-pattern* *copy-variable*
11. **response** *response-code* **sip-header SIP-StatusLine modify** *match-pattern* *copy-variable*
12. **exit**

DETAILED STEPS

	Command or Action	Purpose
Step 1	enable Example: Device> enable	Enables privileged EXEC mode. • Enter your password if prompted.
Step 2	configure terminal Example: Device# configure terminal	Enters global configuration mode.
Step 3	voice class sip-copylist <i>tag</i> Example: Device(config)# voice class sip-copylist 1	Configures a list of entities to be sent to the peer call leg and enters voice class configuration mode.
Step 4	sip-header SIP-StatusLine Example: Device(config-class)# sip-header SIP-StatusLine	Specifies that the Session Initiation Protocol (SIP) status line header must be sent to the peer call leg.
Step 5	exit Example: Device(config-class)# exit	Exits voice class configuration mode and returns to global configuration mode.
Step 6	dial-peer voice <i>inbound-dial-peer-id</i> voip Example: Device(config)# dial-peer voice 99 voip	Specifies an inbound dial peer and enters dial peer configuration mode.
Step 7	voice-class sip copy-list <i>list-id</i> Example: Device(config-dial-peer)# voice-class sip copy-list 1	Associates the SIP copy list with the inbound dial peer.
Step 8	exit Example: Device(config-dial-peer)# exit	Exits dial peer configuration mode and returns to global configuration mode.

	Command or Action	Purpose
Step 9	voice class sip-profiles tag Example: Device(config)# voice class sip-profiles 10	Enables dial peer-based VoIP SIP profile configurations and enters voice class configuration mode.
Step 10	response response-code peer-header sip SIP-StatusLine copy match-pattern copy-variable Example: Device(config-class)# response ANY peer-header sip SIP-StatusLine copy "(.*)" u01	Copies responses from the corresponding incoming call leg into a copy variable.
Step 11	response response-code sip-header SIP-StatusLine modify match-pattern copy-variable Example: Device(config-class)# response ANY sip-header SIP-StatusLine modify ".*" "\u01"	Modifies an outgoing response using the copy variable defined in the previous step.
Step 12	exit Example: Device(config-class)# exit	Exits voice class configuration mode and returns to global configuration mode.

What to do next

Apply the SIP profile to the outbound dial peer to copy the SIP response to the outbound leg.

Modifying Status-Line Header of Outgoing SIP Response with User Defined Values

Figure 52: Call Flow Configuring a New Status Line for an Outgoing SIP Response Based on an Incoming SIP Request

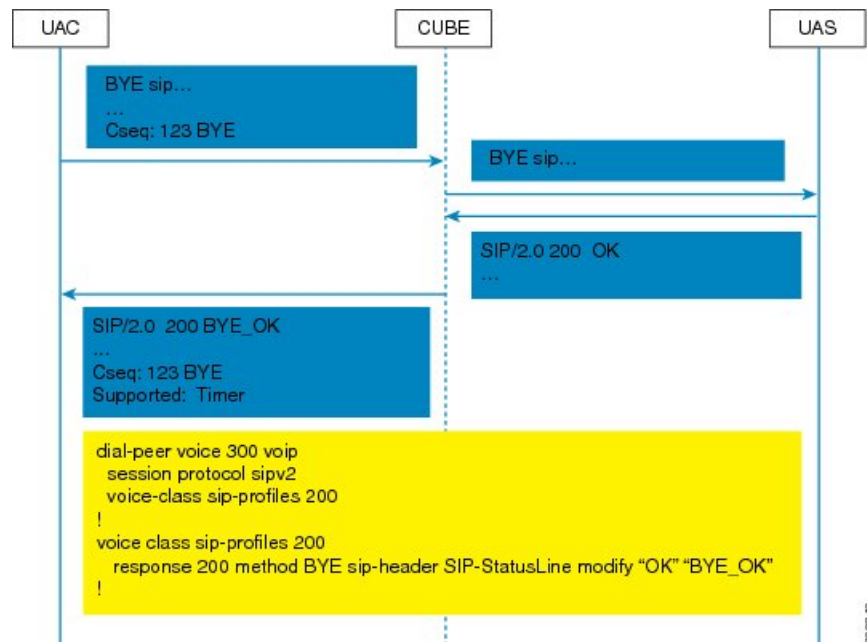

SUMMARY STEPS

1. **enable**
2. **configure terminal**
3. **voice class sip-profiles tag**
4. **response response-code [method method-type] sip-header SIP-StatusLine modify match-pattern replacement-pattern**
5. **exit**

DETAILED STEPS

	Command or Action	Purpose
Step 1	enable Example: Device> enable	Enables privileged EXEC mode. <ul style="list-style-type: none"> • Enter your password if prompted.
Step 2	configure terminal Example: Device# configure terminal	Enters global configuration mode.

	Command or Action	Purpose
Step 3	voice class sip-profiles <i>tag</i> Example: Device(config)# voice class sip-profiles 10	Enables dial peer-based VoIP SIP profile configurations and enters voice class configuration mode.
Step 4	response <i>response-code</i> [method <i>method-type</i>] sip-header SIP-StatusLine modify <i>match-pattern</i> <i>replacement-pattern</i> Example: Modifying status line of a SIP header to a user-defined response type: Device(config-class)# response 404 sip-header SIP-StatusLine modify "404 Not Found" "404 MyError"	Modifies SIP status line of a SIP response with user-defined values.
Step 5	exit Example: Device(config-class)# exit	Exits voice class configuration mode.

What to do next

Associate the SIP profile with an outbound dial peer.



PART **XI**

Payload Type Interoperability

- [Dynamic Payload Type Interworking for DTMF and Codec Packets for SIP-to-SIP Calls, on page 619](#)



CHAPTER 47

Dynamic Payload Type Interworking for DTMF and Codec Packets for SIP-to-SIP Calls

The Dynamic Payload Type Interworking for DTMF and Codec Packets for SIP-to-SIP Calls feature provides dynamic payload type interworking for dual tone multifrequency (DTMF) and codec packets for Session Initiation Protocol (SIP) to SIP calls.

Based on this feature, the Cisco Unified Border Element (Cisco UBE) interworks between different dynamic payload type values across the call legs for the same codec. Also, Cisco UBE supports any payload type value for audio, video, named signaling events (NSEs), and named telephone events (NTEs) in the dynamic payload type range 96 to 127.

- [Feature Information for Dynamic Payload Type Interworking for DTMF and Codec Packets for SIP-to-SIP Calls](#), on page 619
- [Restrictions for Dynamic Payload Type Interworking for DTMF and Codec Packets for SIP-to-SIP Calls](#), on page 620
- [Symmetric and Asymmetric Calls](#), on page 620
- [High Availability Checkpointing Support for Asymmetric Payload](#), on page 621
- [How to Configure Dynamic Payload Type Passthrough for DTMF and Codec Packets for SIP-to-SIP Calls](#), on page 622
- [Configuration Examples for Assymetric Payload Interworking](#), on page 625

Feature Information for Dynamic Payload Type Interworking for DTMF and Codec Packets for SIP-to-SIP Calls

The following table provides release information about the feature or features described in this module. This table lists only the software release that introduced support for a given feature in a given software release train. Unless noted otherwise, subsequent releases of that software release train also support that feature.

Use Cisco Feature Navigator to find information about platform support and Cisco software image support. To access Cisco Feature Navigator, go to <https://cfngn.cisco.com/>. An account on Cisco.com is not required.

Table 69: Feature Information for Dynamic Payload Interworking for DTMF and Codec Packets Support

Feature Name	Releases	Feature Information
Dynamic Payload Type Interworking for DTMF and Codec Packets for SIP-to-SIP Calls	15.0(1)XA 15.1(1)T	The Dynamic Payload Type Interworking for DTMF and Codec Packets for SIP-to-SIP Calls feature provides dynamic payload type interworking for DTMF and codec packets for SIP-to-SIP calls. The following commands were introduced or modified: asymmetric payload and voice-class sip asymmetric payload .
Dynamic Payload Type Interworking for DTMF and Codec Packets for SIP-to-SIP Calls	Cisco IOS Release XE 3.1S	The Dynamic Payload Type Interworking for DTMF and Codec Packets for SIP-to-SIP Calls feature provides dynamic payload type interworking for DTMF and codec packets for SIP-to-SIP calls. The following commands were introduced or modified: asymmetric payload and voice-class sip asymmetric payload .

Restrictions for Dynamic Payload Type Interworking for DTMF and Codec Packets for SIP-to-SIP Calls

The Dynamic Payload Type Interworking for DTMF and Codec Packets for SIP-to-SIP Calls feature is not supported for the following:

- H323-to-H323 and H323-to-SIP calls.
- All transcoded calls.
- Secure Real-Time Protocol (SRTP) pass-through calls.
- Flow-around calls.
- Asymmetric payload types are not supported on early-offer (EO) call legs in a delayed-offer to early-offer (DO-EO) scenario.
- Cisco fax relay.
- Multiple m lines with the same dynamic payload types, where m is:

$m = \text{audio } \langle \text{media-port1} \rangle \text{ RTP/AVP XXX } m = \text{video } \langle \text{media-port2} \rangle \text{ RTP/AVP XXX}$

Symmetric and Asymmetric Calls

Cisco UBE supports dynamic payload type negotiation and interworking for all symmetric and asymmetric payload type combinations. A call leg on Cisco UBE is considered as symmetric or asymmetric based on the payload type value exchanged during the offer and answer with the endpoint:

- A symmetric endpoint accepts and sends the same payload type.
- An asymmetric endpoint can accept and send different payload types.

The Dynamic Payload Type Interworking for DTMF and Codec Packets for SIP-to-SIP Calls feature is enabled by default for a symmetric call. An offer is sent with a payload type based on the dial-peer configuration. The answer is sent with the same payload type as was received in the incoming offer. When the payload type values negotiated during the signaling are different, the Cisco UBE changes the Real-Time Transport Protocol (RTP) payload value in the VoIP to RTP media path.

To support asymmetric call legs, you must enable The Dynamic Payload Type Interworking for DTMF and Codec Packets for SIP-to-SIP Calls feature. The dynamic payload type value is passed across the call legs, and the RTP payload type interworking is not required. The RTP payload type handling is dependent on the endpoint receiving them.

High Availability Checkpointing Support for Asymmetric Payload

High availability for a call involving asymmetric payloads is supported. In case of fail-over from active to stand-by, the asymmetric payload interworking will be continued as new active CUBE passes across the payload type values according to the negotiation and call establishment.

Figure 53: Sample High-Availability Topology

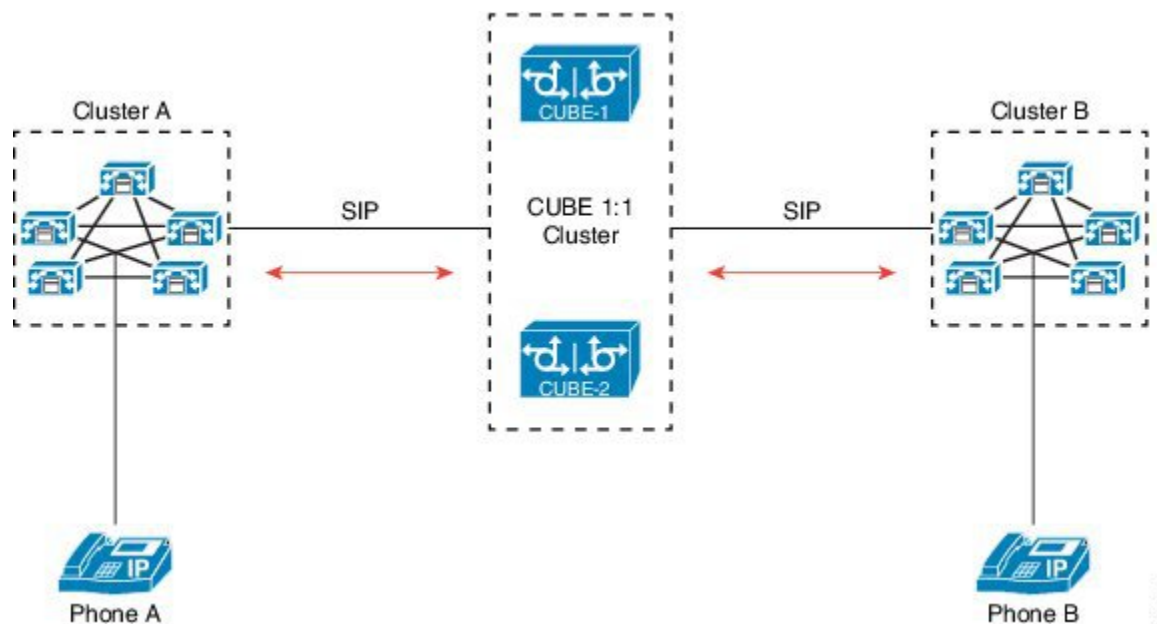

How to Configure Dynamic Payload Type Passthrough for DTMF and Codec Packets for SIP-to-SIP Calls

Configuring Dynamic Payload Type Passthrough at the Global Level

Perform this task to configure the pass through of DTMF or codec payload to the other call leg (instead of performing dynamic payload type interworking) feature at the global level.

SUMMARY STEPS

1. `enable`
2. `configure terminal`
3. `voice service voip`
4. `sip`
5. `asymmetric payload {dtmf | dynamic-codecs | full | system}`
6. `end`

DETAILED STEPS

	Command or Action	Purpose
Step 1	enable Example: <pre>Device> enable</pre> Example:	Enables privileged EXEC mode. <ul style="list-style-type: none"> • Enter your password if prompted.
Step 2	configure terminal Example: <pre>Device# configure terminal</pre>	Enters global configuration mode.
Step 3	voice service voip Example: <pre>Device(config)# voice service voip</pre>	Enters voice service configuration mode.
Step 4	sip Example: <pre>Device(conf-voi-serv)# sip</pre>	Enters voice service SIP configuration mode.
Step 5	asymmetric payload {dtmf dynamic-codecs full system}	Configures global SIP asymmetric payload support.

	Command or Action	Purpose
	Example: <pre>Device(conf-serv-sip)# asymmetric payload full</pre>	Note The dtmf and dynamic-codecs keywords are internally mapped to the full keyword to provide asymmetric payload type support for audio and video codecs, DTMF, and NSEs.
Step 6	end Example: <pre>Device(conf-serv-sip)# end</pre>	Exits voice service SIP configuration mode and enters privileged EXEC mode.

Configuring Dynamic Payload Type Passthrough for a Dial Peer

Perform this task to configure the pass through of DTMF or codec payload to the other call leg (instead of performing dynamic payload type interworking) feature at the dial-peer level.

SUMMARY STEPS

1. **enable**
2. **configure terminal**
3. **dial-peer voice tag voip**
4. **voice-class sip asymmetric payload {dtmf | dynamic-codecs | full | system}**
5. **end**

DETAILED STEPS

	Command or Action	Purpose
Step 1	enable Example: <pre>Device> enable</pre>	Enables privileged EXEC mode. <ul style="list-style-type: none"> • Enter your password if prompted.
Step 2	configure terminal Example: <pre>Device# configure terminal</pre>	Enters global configuration mode.
Step 3	dial-peer voice tag voip Example: <pre>Device(config)# dial-peer voice 77 voip</pre>	Enters dial peer voice configuration mode.
Step 4	voice-class sip asymmetric payload {dtmf dynamic-codecs full system} Example:	Configures the dynamic SIP asymmetric payload support. Note The dtmf and dynamic-codecs keywords are internally mapped to the full keyword to provide asymmetric payload type support for audio and video codecs, DTMF, and NSEs.

	Command or Action	Purpose
	Device(config-dial-peer)# voice-class sip asymmetric payload full	
Step 5	end Example: Device(config-dial-peer)# end	(Optional) Exits dial peer voice configuration mode and enters privileged EXEC mode.

Verifying Dynamic Payload Interworking for DTMF and Codec Packets Support

This task shows how to display information to verify Dynamic Payload Type Interworking for DTMF and Codec Packets for SIP-to-SIP Calls configuration feature. These **show** commands need not be entered in any specific order.

SUMMARY STEPS

1. **enable**
2. **show call active voice compact**
3. **show call active voice**

DETAILED STEPS

	Command or Action	Purpose
Step 1	enable Example: Device> enable	Enables privileged EXEC mode. <ul style="list-style-type: none"> • Enter your password if prompted.
Step 2	show call active voice compact Example: Device# show call active voice compact	(Optional) Displays a compact version of call information.
Step 3	show call active voice Example: Device# show call active voice	(Optional) Displays call information for voice calls in progress.

Troubleshooting Tips

Use the following commands to debug any errors that you may encounter when you configure the Dynamic Payload Type Interworking for DTMF and Codec Packets for SIP-to-SIP Calls feature:

- **debug ccsip all**
- **debug voip ccapi inout**

- **debug voip rtp**

Use the following debug commands to troubleshoot HA Checkpointing for Asymmetric Payload:

- **debug voip ccapi all**
- **debug voice high-availability all**
- **debug voip rtp error**
- **debug voip rtp inout**
- **debug voip rtp packet**
- **debug voip rtp high-availability**
- **debug voip rtp function**
- **debug ccsp all**

Use the following **show** commands to troubleshoot HA Checkpointing for Asymmetric Payload:

- **show redundancy state**
- **show redundancy inter-device**
- **show standby brief**
- **show voice high-availability summary**
- **show voip rtp stats**
- **show voip rtp high-availability stats**
- **show voip rtp connection detail**
- **show call active voice brief**
- **show call active voice [summary]**
- **show call active video brief**
- **show call active video [summary]**
- **show align**
- **show memory debug leak**

Configuration Examples for Asymmetric Payload Interworking

Example: Asymmetric Payload Interworking—Passthrough Configuration

```
!  
voice service voip  
  allow-connections sip to sip  
  sip  
    rel1xx disable  
    asymmetric payload full  
    midcall-signaling passthru  
!  
dial-peer voice 1 voip  
  voice-class sip asymmetric payload full  
  session protocol sipv2  
  rtp payload-type cisco-codec-fax-ind 110  
  rtp payload-type cisco-codec-video-h264 112  
  session target ipv4:9.13.8.23  
!
```

In the above example, it is assumed that 110 and 112 are not used for any other payload.

Example: Asymmetric Payload Interworking—Interworking Configuration

```
!  
voice service voip  
  allow-connections sip to sip  
!  
dial-peer voice 1 voip  
  session protocol sipv2  
  rtp payload-type cisco-codec-fax-ind 110  
  rtp payload-type cisco-codec-video-h264 112  
  session target ipv4:9.13.8.23  
!
```

In the above example, it is assumed that 110 and 112 are not used for any other payload.



PART **XII**

Protocol Interworking

- [Delayed-Offer to Early-Offer, on page 629](#)
- [H.323-to-SIP Interworking on CUBE, on page 639](#)
- [H.323-to-H.323 Interworking on CUBE, on page 645](#)
- [SIP RFC 2782 Compliance with DNS SRV Queries, on page 659](#)



CHAPTER 48

Delayed-Offer to Early-Offer

The Delayed-Offer to Early-Offer (DO-EO) feature allows CUBE to convert a delayed offer that it receives into an early offer. This feature is supported in the Media Flow-Around mode.

This feature also supports high-density transcoding calls, where transcoding IP addresses and port numbers are exchanged between the sender and receiver. This feature also supports midcall renegotiation of codecs required if an exchange of parameters that is not end-to-end causes an inefficient media flow.

- [Feature Information for Delayed-Offer to Early-Offer, on page 629](#)
- [Prerequisites for Delayed-Offer to Early-Offer, on page 630](#)
- [Restrictions for Delayed-Offer to Early-Offer Media Flow-Around, on page 630](#)
- [Delayed-Offer to Early-Offer in Media Flow-Around Calls, on page 630](#)
- [MidCall Renegotiation Support for Delayed-Offer to Early-Offer Calls, on page 634](#)
- [High-Density Transcoding Calls in Delayed-Offer to Early-Offer, on page 636](#)

Feature Information for Delayed-Offer to Early-Offer

The following table provides release information about the feature or features described in this module. This table lists only the software release that introduced support for a given feature in a given software release train. Unless noted otherwise, subsequent releases of that software release train also support that feature.

Use Cisco Feature Navigator to find information about platform support and Cisco software image support. To access Cisco Feature Navigator, go to <https://cfngn.cisco.com/>. An account on Cisco.com is not required.

Table 70: Feature Information for Delayed-Offer to Early-Offer

Feature Name	Releases	Feature Information
Delayed-Offer to Early-Offer	Cisco IOS 12.4(3) Cisco IOS 12.4(24)T Cisco IOS 15.0(1)M	The Delayed-Offer to Early-Offer feature allows CUBE to convert a delayed offer it receives into an early offer. The following commands were introduced by this feature: voice-class sip early-offer forced , early-offer forced and media transcoder high-density .
Delayed-Offer to Early-Offer Support for Video Calls	Cisco IOS 12.4(22)T	The Delayed-Offer to Early-Offer support was extended for video calls. The following command was introduced: codec-profile

Feature Name	Releases	Feature Information
Media Flow- Around with SIP Signaling control on CUBE	Cisco IOS 15.1(3)T	Support for Media Flow-Around for Delayed-Offer to Early-Offer audio calls on CUBE was introduced. No new commands were introduced or modified.
Midcall Renegotiation Support for DO-EO Calls	Cisco IOS 15.4(2)T Cisco IOS XE 3.12S	The Midcall renegotiation of codecs feature configures the midcall renegotiation of codecs, if an exchange of parameters that is not end-to-end causes an inefficient media flow. The following commands were modified by this feature: voice-class sip early-offer forced renegotiate [always], early-offer forced renegotiate [always].

Prerequisites for Delayed-Offer to Early-Offer

Configure delayed-offer to early-offer in media flow-around mode.

Restrictions for Delayed-Offer to Early-Offer Media Flow-Around

- CUBE does not support change in IP address or port number in the locally triggered RE-INVITE response.
- CUBE does not support DE-EO Media Flow-Around for video calls.

Delayed-Offer to Early-Offer in Media Flow-Around Calls

Delayed-Offer to Early-Offer (DO-EO) allows CUBE to convert a delayed offer (DO) into an early offer (EO) in the media flow-around mode.

CUBE sends its local IP address in the initial EO INVITE Session Description Protocol (SDP) message. In the image, this is illustrated by INVITE (SDP1, CUIP1). Later, an additional RE-INVITE is locally generated by CUBE to communicate the SDP message details from the sender. This is illustrated by RE-INVITE (SDP5, IP2) in the below image. The RE-INVITE response is consumed by CUBE and not communicated to the sender.

Figure 54: Delayed Offer to Early Offer in Media Flow-Around Calls

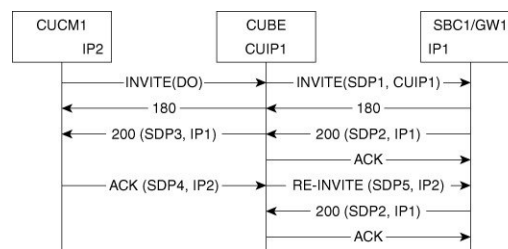

CUBE supports delayed offer to early offer for SIP-to-SIP video calls. CUBE generates an outgoing Early Offer INVITE with the configured codec list, for an incoming Delayed Offer INVITE.

DO-EO video call is supported if both audio and video codecs are configured under a dial peer. **codec profile** command defines the codec attributes for Video (H263, H264) and Audio (AACLD) codecs. The codec attributes configured under codec-profile is used to generate the a=fmtp attribute line in the Early Offer SDP.

Configuring Delayed Offer to Early Offer

SUMMARY STEPS

1. **enable**
2. **configure terminal**
3. Configure conversion of a delayed offer to an early offer:
 - In dial-peer configuration mode
 - voice-class sip early-offer forced**
 - In global VoIP SIP configuration mode
 - early-offer forced**
4. **end**

DETAILED STEPS

	Command or Action	Purpose
Step 1	enable Example: Device> enable	Enables privileged EXEC mode. Enter your password if prompted.
Step 2	configure terminal Example: Device# configure terminal	Enters global configuration mode.
Step 3	Configure conversion of a delayed offer to an early offer: <ul style="list-style-type: none"> • In dial-peer configuration mode <ul style="list-style-type: none"> voice-class sip early-offer forced • In global VoIP SIP configuration mode <ul style="list-style-type: none"> early-offer forced Example: In dial-peer configuration mode: Device (config) dial-peer voice 10 voip Device (config-dial-peer) voice-class sip early-offer forced Device (config-dial-peer) end	

	Command or Action	Purpose
	In global VoIP SIP mode: Device(config)# voice service voip Device (config-voi-serv) sip Device (config-voi-sip) early-offer forced Device (config-voi-sip) end	
Step 4	end	Exits to privileged EXEC mode.

Configuring Delayed Offer to Early Offer for Video Calls

SUMMARY STEPS

1. **enable**
2. **configure terminal**
3. **codec profile** *tag profile*
4. **dial-peer voice number** *number voip*
5. **codec** *codec profile*
6. **video codec** *codec profile*
7. **voice-class sip early-offer forced**
8. **end**

DETAILED STEPS

	Command or Action	Purpose
Step 1	enable Example: Device> enable	Enables privileged EXEC mode. Enter your password if prompted.
Step 2	configure terminal Example: Device# configure terminal	Enters global configuration mode.
Step 3	codec profile <i>tag profile</i> Example: codec profile 1 aacl codec profile 2 H264	Configures the audio and video codec profiles.
Step 4	dial-peer voice number <i>number voip</i> Example: Device(config)# dial-peer voice 1 voip	Enters dial peer configuration mode for the specified VoIP dial peer.

	Command or Action	Purpose
Step 5	codec <i>codec profile</i> Example: Device(config-dial-peer)# profile 1 aacld	Audio codec profile is applied on the dial peer.
Step 6	video codec <i>codec profile</i> Example: Device(config-dial-peer)# video codec h264 profile 2	Video codec profile is applied on the dial peer.
Step 7	voice-class sip early-offer forced Example: Device (config-dial-peer)# voice-class sip early-offer forced	
Step 8	end	Exits to privileged EXEC mode.

Configuring Delayed Offer to Early Offer Medial Flow-Around

SUMMARY STEPS

1. **enable**
2. **configure terminal**
3. **medial flow-around**
4. Configure conversion of a delayed offer to an early offer:
 - In dial-peer configuration mode
voice-class sip early-offer forced
 - In global VoIP SIP configuration mode
early-offer forced
5. **end**

DETAILED STEPS

	Command or Action	Purpose
Step 1	enable Example: Device> enable	Enables privileged EXEC mode. Enter your password if prompted.
Step 2	configure terminal Example:	Enters global configuration mode.

	Command or Action	Purpose
	Device# configure terminal	
Step 3	medial flow-around Example: Device(config-voi-serv)# media flow-around	Enables media flow-around.
Step 4	Configure conversion of a delayed offer to an early offer: <ul style="list-style-type: none"> • In dial-peer configuration mode voice-class sip early-offer forced • In global VoIP SIP configuration mode early-offer forced Example: In dial-peer configuration mode: <pre>Device (config) dial-peer voice 10 voip Device (config-dial-peer) voice-class sip early-offer forced Device (config-dial-peer) end</pre> Example: In global VoIP SIP mode: <pre>Device(config)# voice service voip Device (config-voi-serv) sip Device (config-voi-sip) early-offer forced Device (config-voi-sip) end</pre>	
Step 5	end	Exits to privileged EXEC mode.

MidCall Renegotiation Support for Delayed-Offer to Early-Offer Calls

When CUBE converts a delayed offer into an early offer, an incomplete exchange of Format specific parameters (FMTP) occurs during call establishment, resulting in either the noninitiation of media transmission or media transmission in a quality that may not be the best. This is especially a problem in video calls.

To overcome this situation, midcall renegotiation of capabilities can be configured.

The **early-offer forced renegotiate [always]** command is used to configure this in global VoIP configuration mode (config-voi-serv) and the **voice-class sip early-offer forced renegotiate** command is dial-peer configuration mode (config-dial-peer) and voice-class configuration mode (config-class).

Figure 55: MidCall Renegotiation of Capabilities

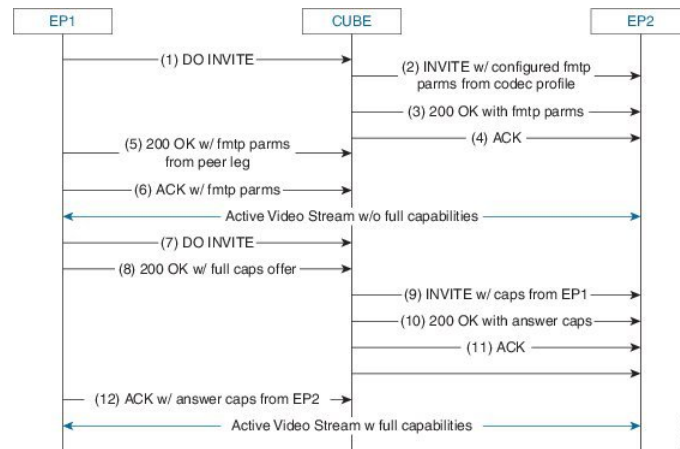

The **early-offer forced renegotiate** command triggers a delayed-offer RE-INVITE if the negotiated codecs are one of the following:

- aac1d—Audio codec AACLD 90000 bps
- h263—Video codec H263
- h263+—Video codec H263+
- h264—Video codec H264
- mp4a—Wideband audio codec

The **early-offer forced renegotiate always** command always triggers a delayed-offer RE-INVITE. This option can be used to support all other codecs.

Restrictions for MidCall Renegotiation Support for DO-EO Calls

- If **midcall-signaling block** or **midcall-signaling passthru media-change** commands have been configured, the feature does not work because a midcall RE-INVITE is not triggered by CUBE.
- if initial call is transcoded, then midcall re-invite is not triggered by CUBE.



Note For EO to EO calls, the Delayed-Offer midcall RE-INVITE is not triggered by the CUBE, if either **midcall-signaling block** or **midcall-signaling passthru media-change** command is configured.

Configuring Mid Call Renegotiation Support for Delayed-Offer to Early-Offer Calls

SUMMARY STEPS

1. **enable**
2. **configure terminal**
3. **dial-peer voice *id* voip**
4. **media transcoder high-density**

5. end

DETAILED STEPS

	Command or Action	Purpose
Step 1	enable Example: Device> enable	Enables privileged EXEC mode. Enter your password if prompted.
Step 2	configure terminal Example: Device# configure terminal	Enters global configuration mode.
Step 3	dial-peer voice <i>id</i> voip	Enters dial-peer configuration mode and configures the selected dial peer.
Step 4	media transcoder high-density Example: Device (config) dial-peer voice 10 voip Device (config-dial-peer) media transcoder high-density Device (config-dial-peer) end	
Step 5	end	Exits to privileged EXEC mode.

High-Density Transcoding Calls in Delayed-Offer to Early-Offer

High-Density Transcoding Calls in the media flow-around DO-to-EO mode is a feature where the transcoding IP address and port number are exchanged between the originating and terminating user agents. For high-density transcoding calls, CUBE is in the media flow-through mode even if media flow-around is configured.

In the figure below, XIP1 is passed to CUCM1 when a 200 OK is received from SBC1. ACK from CUCM1 triggers new RE-INVITE with transcoding IP address and port number (XIP2) and this RE-INVITE has to be locally handled in CUBE.

Figure 56: High-Density Transcoding Calls in DO-to-EO

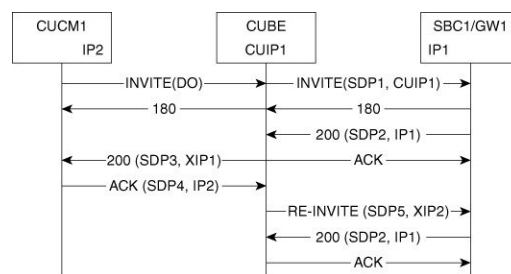

The **media transcoder high-density** command is used to configure this feature in dial-peer configuration mode (config-dial-peer). Refer to “Modes for Configuring Dial Peers” section to enter these modes and configure this feature.

For high-density transcoding calls with a common codec, CUBE should be in Media Flow-Through mode even though media flow-around is configured.

Figure 57: High-Density Transcoding Calls for Common Codecs in DO-to-EO

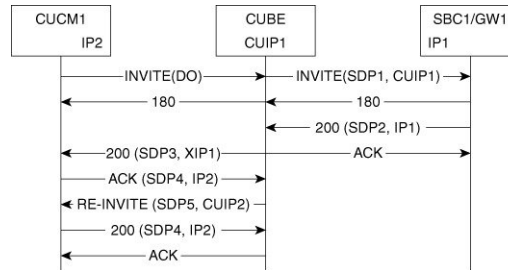

Restrictions for High-Density Transcoding DO-EO Calls

For high-density transcoding calls with a common codec, CUBE will be in Media Flow-through mode even though Media Flow-Around is configured.

Configuring High-Density Transcoding

To configure High-Density Transcoding delayed offer to early offer calls in media flow-around mode, perform the following steps:

SUMMARY STEPS

1. enable
2. configure terminal
3. voice service voip
4. media transcoder high-density
5. sip
6. early offer-forced
7. end

DETAILED STEPS

	Command or Action	Purpose
Step 1	enable Example: Device> enable	Enables privileged EXEC mode. Enter your password if prompted.
Step 2	configure terminal Example:	Enters global configuration mode.

	Command or Action	Purpose
	Device# configure terminal	
Step 3	voice service voip Example: Device(config)# voice service voip	Enters voice service configuration mode.
Step 4	media transcoder high-density Example: Device(config-voi-serv)# media transcoder high-density	Enables media transcoder high-density for transcoding high-density media calls.
Step 5	sip Example: Device(config-voi-serv)# sip	Enters SIP configuration mode.
Step 6	early offer-forced Example: Device(config-voi-sip)# early offer-forced	Forcefully sends SIP EO invites on the Out-Leg.
Step 7	end Example: Device(config-voi-sip)# end	Exits the present configuration mode.



CHAPTER 49

H.323-to-SIP Interworking on CUBE

This chapter describes how to configure H.323-to-SIP interworking in CUBE and lists the various features supported in this interworking model.



Note H.323 protocol is no longer supported from Cisco IOS XE Bengaluru 17.6.1a onwards. Consider using SIP for multimedia applications.

- [Prerequisites, on page 639](#)
- [Restrictions, on page 639](#)
- [H.323-to-SIP Basic Call Interworking, on page 640](#)
- [H.323-to-SIP Supplementary Features Interworking, on page 642](#)
- [H.323-to-SIP Codec Progress Indicator Interworking for Media Cut-Through , on page 643](#)
- [Configuring H.323-to-SIP Interworking , on page 643](#)

Prerequisites

- [Enable CUBE on the device](#)
- Perform basic H.323 gateway configuration. See [Configuring H.323 Gateway \(Optional\)](#)
- Perform basic H.323 gatekeeper configuration. See [Configuring H.323 Gatekeeper \(Optional\)](#)

Restrictions

- Changing codecs during rotary dial peer selection is not supported.
- Voice class codec is not supported.
- Configure extended capabilities on dial peers for fast start-to-early media scenarios.
- Delayed Offer to Slow-Start is not supported for SRTP-to-SRTP H.323-to-SIP calls.
- During a triggered INVITE scenario the Cisco UBE always generates a delayed offer INVITE.
- Fast-start to delayed-media signal interworking is not supported.

- Fast Start to Early Offer Supplementary Service will not work without extended capabilities configured under dial-peer.
- GSMFR and GSMEFR codecs are not supported.
- Media flow-around is not supported.
- Passing multiple diversion headers or multiple contact header in 302 to the H.323 leg is not supported.
- RSVP for supplementary scenarios is not supported.
- Session refresh is not supported.
- SIP-to-H.323 Supplementary Services based on H.450 is not supported.
- Slow-start to early media signal interworking is not supported.
- Supplementary services are Empty Capability Set (ECS) based supplementary services from the H.323 perspective, not H.450 supplementary services.
- LTI based transcoding is not supported.
- Transcoding for supplementary calls is not supported.
- SCCP based codec transcoding is not support with an exception of Delayed-Offer to Slow-Start with static codec.
- DTMF interworking rtp-nte to inband is supported only with non-high-density transcoding in a delayed-offer to slow-start call.

H.323-to-SIP Basic Call Interworking

This feature enables the IP-to-IP gateway to bridge calls between networks that support different VoIP call-signaling protocols (SIP and H.323). The SIP-to-H.323 protocol interworking capabilities of the CUBE support the following:

Feature	Supported Release	Additional Description
Basic voice calls (G.711 and G.729 codecs)	12.4(11)T	
UDP and TCP transport	12.3(11)T	SIP (UDP)↔H.323 (TCP) SIP (TCP)↔H.323 (TCP) SIP (UDP)↔H.323 (UDP) SIP (TCP)↔H.323 (UDP) Default SIP protocol is UDP. Default H.323 protocol is TCP.

Feature	Supported Release	Additional Description
Interworking between <ul style="list-style-type: none"> • H.323 Fast-Start and SIP early-media signaling • H.323 Slow-Start and SIP delayed-media signaling 	12.3(11)T	<ul style="list-style-type: none"> • H.323 Fast Start<—>SIP Early Media • H.323 Slow Start <—>SIP Delay Media <p>Note No other combinations are supported. For example, H.323 Slow Start <—>SIP Early Media is not supported and results in call failure.</p>
H.323-to-SIP RSVP Support	12.3(11)T	The following cases are supported (acc-qos and reg_qos): <ul style="list-style-type: none"> • H.323 to H.323 with only one leg having RSVP • H.323 to H.323 with both legs having RSVP • H.323 to SIP with only one leg having RSVP • H.323 to SIP with both legs having RSVP
DTMF relay interworking:	12.3(11)T 12.4(6)XE	<ul style="list-style-type: none"> • H.245 alpha/signal<—>SIP Notify • H.245 alpha/signal <—>SIP RFC 2833 • H.245 alpha/signal <—> SIP KPML • G.711 Inband DTMF<—>RFC 2833
Voice call transcoding support	12.3(11)T	<ul style="list-style-type: none"> • Only voice and DTMF are supported. (G.711-G.729) • Codec transparent and codec filtering is not supported • Cisco Fax Relay and T.38 Fax are not supported

Feature	Supported Release	Additional Description
Calling/called name and number	12.3(11)T	<ul style="list-style-type: none"> • H.323 IOS FXS/SCCP – IPIPGW – SIP IOS FXS • H.323 IOS FXS/SCCP – IPIPGW – SIP CCME Skinny Phone • H.323 IOS FXS/SCCP – IPIPGW – SIP IP Phone • CCM Phone – IPIPGW – SIP CCME Skinny Phone • CCM Phone – IPIPGW – SIP IP Phone • SIP IOS FXS – IPIPGW – H.323 IOS FXS • SIP IOS FXS – IPIPGW – H.323 CCME Skinny Phone
RADIUS call-accounting records	12.3(11)T	H.323<—>SIP Radius call accounting
TCL IVR 2.0 for SIP, including media playout and digit collection (RFC 2833 DTMF relay)	12.3(11)T 12.4(11)T	12.3(11)T—TCL IVR 2.0 for SIP, including media playout and digit collection (RFC 2833 DTMF relay) 12.4(11)T —TCL IVR support with SIP NOTIFY DTMF
SRTP Passthrough	12.4(15)XY	
Supplementary Services (ECS based).	12.4(11)XJ2	
Codec Transparent	12.4(11)T	
Extended codec support and codec filtering	12.4(11)T	

H.323-to-SIP Supplementary Features Interworking

This interworking provides enhanced termination and re-origination of signaling and media between VoIP and Video Networks in conformance with RFC3261.

Feature	Release
Support H.323-to-SIP Supplementary services for CUCM with MTP on the H.323 Trunk.	12.3(11)T

Feature	Release
ILBC Codec Support	12.3(11)T
Interworking between G.711 inband DTMF to RFC2833	12.3(11)T
VXML 3.x support	12.3(11)T
SIP CDRs and H.323 CDRs Mapping	12.3(11)T
Conference ID can be used to correlate H.323 and SIP Radius records. Conference ID is unique on both H.323 and SIP legs	12.3(11)T
VXML support with SIP Notify	12.4(11)T
Mapping ECS to ReINVITE and ECS to REFER on the Cisco CUBE	12.4(20)T

H.323-to-SIP Codec Progress Indicator Interworking for Media Cut-Through

OGW is the originating gateway and TGW is the terminating gateway.

Table 71: SIP(OGW)→IPIGW→H.323(TGW) calls

SIP at In Leg	H.323 at Out Leg	Comments
183 Session Progress	Progress/Alert PI = 8	Analog phone at TGW
180 Ring	Alert with PI = 0	SCCP phone at TGW

Table 72: H.323(OGW)→IPIGW→SIP(TGW) calls

H.323 at In Leg	SIP at Out Leg	Comments
Progress/Alert PI = 8	183 Session Progress	Analog phone at TGW
Alert with PI = 0	180 Ring	SIP/SCCP phone at TGW

Configuring H.323-to-SIP Interworking

SUMMARY STEPS

1. **enable**
2. **configure terminal**
3. **voice service voip**
4. **allow-connections h.323 to sip**
5. **allow-connections sip to h.323**

6. end

DETAILED STEPS

	Command or Action	Purpose
Step 1	enable Example: Router> enable	Enables privileged EXEC mode. • Enter your password if prompted.
Step 2	configure terminal Example: Router# configure terminal	Enters global configuration mode.
Step 3	voice service voip Example: Router(config)# voice service voip	Enters Global VoIP configuration mode.
Step 4	allow-connections h.323 to sip Example:	Allows connections from a h.323 endpoint to a SIP endpoint.
Step 5	allow-connections sip to h.323 Example:	Allows connections from a SIP endpoint to a H.323 endpoint.
Step 6	end Example: Router(conf-voi-serv)# end	Exits to privileged EXEC mode.



CHAPTER 50

H.323-to-H.323 Interworking on CUBE

This chapter describes how to configure and enable features for H.323-to-H.323 connections on CUBE.



Note H.323 protocol is no longer supported from 17.6.1 onwards. Consider using SIP for multimedia applications.

Configuring H.323-to-H.323 connections on a CUBE open all ports by default. If CUBE has a public IP address and a PSTN connection, CUBE becomes vulnerable to malicious attackers who can execute toll fraud across the gateway. To eliminate this threat, you can bind an interface to a private IP address that is inaccessible to untrusted hosts. In addition, you can protect any public or untrusted interface by configuring a firewall or an access control list (ACL) to prevent unwanted traffic from traversing the router.

- [Feature Information for H.323-to-H.323 Interworking, on page 645](#)
- [Prerequisites, on page 646](#)
- [Restrictions, on page 646](#)
- [Slow Start to Fast-Start Interworking, on page 646](#)
- [Call Failure Recovery \(Rotary\), on page 648](#)
- [Managing H.323 IP Group Call Capacities, on page 649](#)
- [Overlap Signaling, on page 654](#)
- [Verifying H.323-to-H.323 Interworking, on page 655](#)
- [Troubleshooting H.323-to-H.323 Interworking, on page 657](#)

Feature Information for H.323-to-H.323 Interworking

The following table provides release information about the feature or features described in this module. This table lists only the software release that introduced support for a given feature in a given software release train. Unless noted otherwise, subsequent releases of that software release train also support that feature.

Table 73: Feature Information for H.323-to-H.323 Interworking

Feature Name	Releases	Feature Information
H.323-to-H.323 Connections on a Cisco Unified Border Element	12.3(1)	H.323-to-H.323 Gateway configuration provides a network-to-network demarcation point between independent VoIP and video networks by for billing, security, call-admission control, QoS, and signaling interworking.

Feature Name	Releases	Feature Information
Managing H.323 IP Group Call Capacities	12.2(13)T	Creates a maximum capacity for the IP group providing extra control for load and resource balancing.
Overlap Signaling for H.323-to-H.323 Connections on a Cisco Unified Border Element	12.3(11)T	The terminating gateway is responsible for collecting all the called number digits. Overlap signaling is implemented by matching destination patterns on the dial peers.
Rotary Support	12.3(11)T 12.4(6)T	12.3(11)T—H.323-to-H.323 Call Failure Recovery (Rotary) on a Cisco Unified Border Element. Eliminates codec restrictions and enables the Cisco UBE to restart codec negotiation with the originating endpoint based on the codec capabilities of the next dial peer in the rotary group for H.323-to-H.323 interconnections. 12.4(6)T—Secure RTP with IPSEC for Signaling.
Signal Interworking	12.3(11)T	H.323-to-H.323 Interworking Between Fast Start and Slow Start. This feature enables the Cisco UBE to bridge calls between VoIP endpoints that support only H.323 FastStart procedures and endpoints that support only normal H.245 signaling (SlowStart).

Prerequisites

- [Enable CUBE application on a device](#)
- Perform basic H.323 gateway configuration. See [Configuring H.323 Gateway](#)
- Perform basic H.323 gatekeeper configuration. See [Configuring H.323 Gatekeeper](#)

Restrictions

- Voice class codec is not supported.
- LTI-based transcoding is not supported.
- Supplementary services with transcoding is not supported.
- DTMF Interworking rtp-nte to out of band is not supported when high density transcoder is enabled. Use normal transcoding for rtp-nte to out of band DTMF interworking.
- SCCP based codec transcoding is not supported. An exception to this restriction is slow start to slow start with a static codec.

Slow Start to Fast-Start Interworking

The slow-start to fast-start interworking feature allows two endpoints configured for slow start and fast start respectively to connect with each other through CUBE without dropping the call.

Restrictions for Slow-Start and Fast-Start Interworking

- Slow-start to fast-start interworking is supported only for H.323-to-H.323 calls.
- Transcoding in slow-start to fast-start interworking is not supported.

Enabling Interworking between Slow Start and Fast Start

Configure interworking between slow start and fast start on both inbound and outbound call legs.



Note This task should not be used in situations where fast-start to fast-start or slow-start to slow-start calls are possible.

Before you begin

Ensure that a codec is configured on incoming and outgoing call legs.

SUMMARY STEPS

1. **enable**
2. **configure terminal**
3. Use one of the following commands to configure interworking between slow start and fast start.
 - **call start interwork** in global VoIP configuration mode
 - **call start interwork** in voice class configuration and applied to inbound and outbound dial peers.
4. **end**

DETAILED STEPS

	Command or Action	Purpose
Step 1	enable Example: Router> enable	Enables privileged EXEC mode. <ul style="list-style-type: none"> • Enter your password if prompted.
Step 2	configure terminal Example: Router# configure terminal	Enters global configuration mode.
Step 3	Use one of the following commands to configure interworking between slow start and fast start. <ul style="list-style-type: none"> • call start interwork in global VoIP configuration mode • call start interwork in voice class configuration and applied to inbound and outbound dial peers. Example:	Enables interworking between slow start and fast start.

	Command or Action	Purpose
	<p>In global VoIP configuration mode</p> <pre>Device(config)# voice service voip Device(conf-voi-serv)# h323 Device(conf-serv-h323)# call start interwork</pre> <p>Example:</p> <p>In voice class configuration mode</p> <pre>!Configuring a Voice class with Fast Start and Slow Start Interworking Device(config)# voice class h323 10 Device(config-class)# call start interwork</pre> <p>!Applying the voice class to a dial peer.</p> <pre>Device(config)# dial-peer voice 20 voip Device(config-dial-peer)# voice-class h323 10</pre>	
Step 4	end	Exits to privileged EXEC mode.

Call Failure Recovery (Rotary)

Call failure recovery (Rotary) is a feature that provides the flexibility to route a call to a destination with multiple paths based on the policy of a service provider. If one path disconnects the call for any reason (like unreachableDestination, destinationReject, noPermission etc), the call can be routed by choosing another dial peer to the same destination based on configured preference.

Rotary is implemented using the dial peer hunt feature (see [Configuring Hunt Groups](#)), and the search for a successful dial peer continues until a **huntstop** command is encountered.

The feature described in this chapter is an enhancement that removes a restriction on codec configuration, that requires for identical codec capabilities configured on all dial peers in a rotary group. This is done by supporting an Empty Capability set (TCS=0) when rotary is configured.

The feature allows the CUBE to restart the codec negotiation process with the originating endpoint based on the codec capabilities of the next dial peer in the rotary group.

Enabling Call Failure Recovery (Rotary) without Identical Codec Configuration

Before you begin

Configure Call Failure Recovery (Rotary) using dial-peer hunt groups. See [Configuring Dial-Peer Hunt Groups](#).

SUMMARY STEPS

1. **enable**
2. **configure terminal**
3. **voice service voip**
4. **h323**

5. `emptycapability`
6. `exit`

DETAILED STEPS

	Command or Action	Purpose
Step 1	enable Example: Device> <code>enable</code>	Enables privileged EXEC mode. <ul style="list-style-type: none"> • Enter your password if prompted.
Step 2	configure terminal Example: Device# <code>configure terminal</code>	Enters global configuration mode.
Step 3	voice service voip Example: Device(config)# <code>voice service voip</code>	Enters VoIP voice-service configuration mode.
Step 4	h323 Example: Device(conf-voi-serv)# <code>h323</code>	Enters H.323 voice-service configuration mode.
Step 5	emptycapability Example: Device(conf-serv-h323)# <code>emptycapability</code>	Enables call failure recovery (TCS=0) without the need for identical codec configuration.
Step 6	exit Example: Router(conf-serv-h323)# <code>exit</code>	Exits the current mode.

Managing H.323 IP Group Call Capacities

Managing maximum capacity for an IP group is done with carrier IDs created on an IP trunk group. If you do not configure specific carrier IDs, you can use the **ip circuit default only** command to create a single carrier. However, if you want to use carrier ID-based routing, or if you need extra control for load and resource balancing, you must configure carrier IDs in conjunction with the **voice source-group** command.

CUBE works with the **voice source-group** command to provide matching criteria for incoming calls. The **voice source-group** command assigns a name to a set of source IP group characteristics. The terminating gateway uses these characteristics to identify and translate the incoming VoIP call. If there is no voice source group match, the default carrier ID is used, any source carrier ID on the incoming message is transmitted

without change, and no destination carrier is available. Call-capacity information is reported to the gatekeeper, but carrier routing information is not.

If the voice source group matches, the matched source carrier ID is used and the target carrier ID defined in the voice source group is used for the destination carrier ID.



Note You can use this task only when there are no active calls are active.

>

SUMMARY STEPS

1. **enable**
2. **configure terminal**
3. **voice service voip**
4. **h323**
5. ip circuit max-calls *maximum-calls*
6. ip circuit carrier-id *carrier-name* [reserved-calls *reserved*]
7. **ip circuit default only**
8. **exit**

DETAILED STEPS

	Command or Action	Purpose
Step 1	enable Example: Router> enable	Enables privileged EXEC mode. <ul style="list-style-type: none"> • Enter your password if prompted.
Step 2	configure terminal Example: Router# configure terminal	Enters global configuration mode.
Step 3	voice service voip Example: Router(config)# voice service voip	Enters VoIP voice-service configuration mode.
Step 4	h323 Example: Router(conf-voi-serv)# h323	Enters H.323 voice-service configuration mode.

	Command or Action	Purpose
Step 5	<p><code>ip circuit max-calls <i>maximum-calls</i></code></p> <p>Example:</p> <pre>Router(config-serv-h323)# ip circuit max-calls 1500</pre>	<p>(Required only if reserved calls are to exceed 1000) Sets the maximum number of aggregate H.323 IP circuit carrier call legs.</p> <p>If you do not configure this value, the default maximum value is 1000 reserved call legs. You may need to configure a lower value to obtain overload behavior. You can also configure a higher value.</p> <p>Note After you set a maximum number of call legs for defined circuits, any aggregate capacity left over is available for default circuits. For example, if you specify 1000 as the maximum number of call legs and then reserve 200 call legs for defined circuits, 800 call legs are available for use by default circuits.</p> <p>Note CUBE prevents you from allocating all of the capacity to specified carriers; at least one available circuit is required, which can be the default.</p>
Step 6	<p><code>ip circuit carrier-id <i>carrier-name</i> [reserved-calls <i>reserved</i>]</code></p> <p>Example:</p> <pre>Router(config-serv-h323)# ip circuit carrier-id AA reserved-calls 500</pre>	<p>(Optional) Defines an IP circuit using the specified name as the circuit ID.</p> <p>Note The reserved keyword for this command is optional. Using this keyword creates a specified maximum number of calls for that circuit ID. The default value is 200 call legs.</p>
Step 7	<p>ip circuit default only</p> <p>Example:</p> <pre>Router(config-serv-h323)# ip circuit default only</pre>	<p>(Optional) Creates a single carrier to use all of the call capacity available to CUBE.</p> <p>Note If you use the ip circuit default only command, you cannot use the ip circuit carrier-id command to configure more circuits. Using the ip circuit default only command creates a single carrier using the default carrier name.</p>
Step 8	<p>exit</p> <p>Example:</p> <pre>Router(conf-serv-h323)# exit</pre>	<p>Exits the current mode.</p>

Configuration Examples for Managing H.323 IP Group Call Capacities

The following examples show a default carrier with no voice source group configured:

Example: Default Carrier with No Voice Source Group

```
voice service voip
  allow-connections h323 to h323
```

```
h323
ip circuit max-calls 1000
ip circuit default only
```

If there is no incoming source carrier ID:

- Capacity only is reported to the gatekeeper using the default circuit (two call legs).
- No source or destination carrier information is reported.

If there is an incoming source carrier ID:

- Two call legs are counted against the default circuit and reported to the GK.
- The source carrier ID is passed through the gateway to the terminating leg.

The following examples show a configuration with more reserved calls than the default value for the **max-calls** argument (1000):

Example: Configuration with Default Calls in Excess of 1000

This example assigns 1100 calls to other carriers, leaving 400 calls available to the default carrier:

```
voice service voip
allow-connections h323 to h323
h323
ip circuit max-calls 1000
ip circuit carrier-id AA reserved-calls 500
ip circuit carrier-id bb reserved-calls 500
ip circuit carrier-id cc reserved-calls 100
```

The following examples show the default carrier configured with an incoming source carrier but no voice source group configured.



Note In this example, 800 call legs are implicitly reserved for the default circuit.

Example: Default Carrier and Incoming Source Carrier with No Voice Source Group



Note A gatekeeper is required with carrier-id routing.

```
voice service voip
allow-connections h323 to h323
h323
ip circuit max-calls 1000
ip circuit carrier-id AA reserved-calls 200
```

If there is no incoming source carrier ID:

- Capacity only is reported to the GK using the default circuit (two call legs).
- No source or destination carrier information is reported.

If there is an incoming source carrier ID called “AA”:

- One call leg is counted against circuit “AA”.
- One call leg (outbound) is counted against the default circuit.

- The source carrier ID is passed through the gateway to the terminating leg.

If there is an incoming source carrier ID called “BB” (for example) or anything other than “AA”:

- Two call legs are counted against the default circuit.
- The source carrier ID “BB” is passed through the gateway to the terminating leg.

The following examples show the first voice source-group match case:

Example: Voice Source-Group Match Case 1

```
voice service voip
  allow-connections h323 to h323
  h323
    ip circuit max-calls 1000
    ip circuit carrier-id AA reserved-calls 200
!
voice source-group 1
  carrier-id source AA
  carrier-id target AA
```

If there is no incoming source carrier ID, the default circuit is used because there is no match in the voice source group.

If there is an incoming source carrier ID called “AA,” the following are in effect:

- The voice source group matches.
- Both call legs are counted against circuit “AA”.
- The source carrier ID is passed through the gateway to the terminating leg.
- The destination carrier ID is “AA”.

The following examples show the second voice source group match case:

Example: Voice Source-Group Match Case 2

```
voice service voip
  allow-connections h323 to h323
  h323
    ip circuit max-calls 1000
    ip circuit carrier-id AA reserved-calls 200
    ip circuit carrier-id BB reserved-calls 200
!
voice source-group 1
  carrier-id source AA
  carrier-id target BB
```

If there is no incoming source carrier ID, the default circuit is used because there is no match in the voice source group.

If there is an incoming source carrier ID called “AA”:

- The voice source-group matches.
- One leg is counted against circuit “AA”.
- One leg is counted against circuit “BB”.
- The source carrier ID is passed through the gateway to the terminating leg.
- The destination carrier ID is “BB”.

The following examples show the third voice source-group match case:

Example: Voice Source-Group Match Case 3

```
voice service voip
  allow-connections h323 to h323
  h323
    ip circuit max-calls 1000
    ip circuit carrier-id AA reserved-calls 200
    ip circuit carrier-id BB reserved-calls 200
  !
voice source-group 1
  access-list 1
  carrier-id source BB
```

If the access-list matches, the following apply:

- One leg is counted against circuit “BB”.
- One leg is counted against the default circuit (for the destination circuit).
- The source carrier ID is synthesized to “BB” and used to report to the gatekeeper. It is also used on the outgoing setup.

If a source carrier ID is received on the incoming setup, it is overridden with the synthesized carrier ID

Overlap Signaling

Overlap signaling requires that called digits be sent one-by-one as they are received from the calling device. The first digit is sent in a call setup message and subsequent digits are sent in information messages. This technique is used when a receiving gateway is able to recognize variable-length phone numbers, and requires that the originating gateway signal the end of the call setup process.

Overlap signaling is implemented by matching destination patterns on the dial peers. When H.225 signal overlap is configured on the originating gateway, it sends the SETUP to the terminating gateway once a dial-peer match is found. The originating gateway sends all further digits received from the user to the terminating gateway using INFO messages until it receives a sending complete message from the user. The terminating gateway receives the digits in SETUP and subsequent INFO messages and does a dial-peer match. If a match is found, it sends a SETUP with the collected digits to the PSTN. All subsequent digits are sent to the PSTN using INFO messages to complete the call.

Configuring Overlap Signaling

SUMMARY STEPS

1. **enable**
2. **configure terminal**
3. **voice service voip**
4. **h323**
5. **h225 signal overlap**
6. **h225 timeout t302 seconds**
7. **exit**

DETAILED STEPS

	Command or Action	Purpose
Step 1	enable Example: <pre>Router> enable</pre>	Enables privileged EXEC mode. <ul style="list-style-type: none"> • Enter your password if prompted.
Step 2	configure terminal Example: <pre>Router# configure terminal</pre>	Enters global configuration mode.
Step 3	voice service voip Example: <pre>Router(config)# voice service voip</pre>	Enters VoIP voice-service configuration mode.
Step 4	h323 Example: <pre>Router(conf-voi-serv)# h323</pre>	Enters H.323 voice-service configuration mode.
Step 5	h225 signal overlap Example: <pre>Router(conf-serv-h323)# h225 signal overlap</pre>	Activates overlap signaling to the destination gateway.
Step 6	h225 timeout t302 <i>seconds</i> Example: <pre>Router(conf-serv-h323)# h225 timeout t302 15</pre>	Sets the t302 timer timeout value. The argument is as follows: <ul style="list-style-type: none"> • <i>seconds</i>— Number of seconds for timeouts. Range: 1 to 30.
Step 7	exit Example: <pre>Router(conf-serv-h323)# exit</pre>	Exits the current mode.

Verifying H.323-to-H.323 Interworking

To verify Cisco Unified Border Element feature configuration and operation, perform the following steps (listed alphabetically) as appropriate.



Note The word “calls” refers to call legs in some commands and output.

SUMMARY STEPS

1. **show call active video**
2. **show call active voice**
3. **show call active fax**
4. **show call history video**
5. **show call history voice**
6. **show call history fax**
7. **show crm**
8. **show dial-peer voice**
9. **show running-config**
10. **show voip rtp connections**

DETAILED STEPS

Step 1 **show call active video**

Use this command to display the active video H.323 call legs.

Step 2 **show call active voice**

Use this command to display call information for voice calls that are in progress.

Step 3 **show call active fax**

Use this command to display the fax transmissions that are in progress.

Step 4 **show call history video**

Use this command to display the history of video H.323 call legs.

Step 5 **show call history voice**

Use this command to display the history of voice call legs.

Step 6 **show call history fax**

Use this command to display the call history table for fax transmissions that are in progress.

Step 7 **show crm**

Use this command to display the carrier ID list or IP circuit utilization.

Step 8 **show dial-peer voice**

Use this command to display information about voice dial peers.

Step 9 **show running-config**

Use this command to verify which H.323-to-H.323, H.323-to-SIP, or SIP-to-SIP connection types are supported.

Step 10 **show voip rtp connections**

Use this command to display active Real-Time Transport Protocol (RTP) connections.

Troubleshooting H.323-to-H.323 Interworking



Caution Under moderate traffic loads, these **debug** commands produce a high volume of output.

- **debug cch323 all**
 - **debug h225 asn1**
 - **debug h225 events**
 - **debug h225 q931**
 - **debug h245 asn1**
 - **debug h245 events**
 - **debug voip ipipgw**
 - **debug voip ccapi inout**
-



CHAPTER 51

SIP RFC 2782 Compliance with DNS SRV Queries

Effective with Cisco IOS XE Release 2.5, the Domain Name System Server (DNS SRV) query used to determine the IP address of the user endpoint is modified in compliance with RFC 2782 (which supersedes RFC 2052). The DNS SRV query prepends the protocol label with an underscore "_" character to reduce the risk of duplicate names being used for unrelated purposes. The form compliant with RFC 2782 is the default style.

- [Prerequisites SIP RFC 2782 Compliance with DNS SRV Queries, on page 659](#)
- [Information SIP RFC 2782 Compliance with DNS SRV Queries, on page 659](#)
- [How to Configure SIP-RFC 2782 Compliance with DNS SRV Queries, on page 660](#)
- [Configuring DNS Server Lookups , on page 661](#)
- [Verifying, on page 663](#)
- [Feature Information for SIP RFC 2782 Compliance with DNS SRV Queries, on page 663](#)

Prerequisites SIP RFC 2782 Compliance with DNS SRV Queries

Cisco Unified Border Element

- Cisco IOS Release 12.2(8)T or a later release must be installed and running on your Cisco Unified Border Element.

Cisco Unified Border Element (Enterprise)

- Cisco IOS XE Release 2.5 or a later release must be installed and running on your Cisco ASR 1000 Series Router.

Information SIP RFC 2782 Compliance with DNS SRV Queries

Session Initiation Protocol (SIP) on Cisco VoIP gateways uses the DNS SRV query to determine the IP address of the user endpoint. The query string has a prefix in the form of "protocol.transport." and is attached to the fully qualified domain name (FQDN) of the next hop SIP server. This prefix style originated in RFC 2052. Beginning with Cisco IOS XE Release 2.5, a second style, in compliance with RFC 2782, prepends the protocol label with an underscore "_"; for example, "_protocol._transport." The addition of the underscore reduces the risk of the same name being used for unrelated purposes. The form compliant with RFC 2782 is the default style.



Note The DNS SRV lookup is always attempted first for a Fully Qualified Domain Name (FQDN). If the DNS SRV lookup fails CUBE falls back to A-AAAA lookup. If you manually add a port number to a FQDN, the CUBE performs an A-AAAA lookup instead of SRV lookup.

Example:

'session target dns:cisco.com' would perform an SRV lookup and 'session target dns:cisco.com:5060' would perform an A-AAAA lookup.

How to Configure SIP-RFC 2782 Compliance with DNS SRV Queries

Configuring DNS Server Query Format RFC 2782 Compliance with DNS SRV Queries

Compliance with RFC 2782 changes the DNS SVR protocol label style. RFC 2782 updates RFC 2052 by prepending the protocol label with an underscore character. The prefix format compliant with RFC 2782 is the default format. However, backward compatibility is available, allowing newer versions of Cisco IOS software to work with older networks that support only RFC 2052 DNS SVR prefix style.

To configure the format of DNS SRV queries to comply with RFC 2782, complete this task.



Note You do not have to perform this task if you want to use the default RFC 2782 format.

SUMMARY STEPS

1. **enable**
2. **configure terminal**
3. **interface** *type number*
4. **sip-ua**
5. **srv version** {1 | 2}
6. **exit**

DETAILED STEPS

	Command or Action	Purpose
Step 1	enable Example: Router> enable	Enables privileged EXEC mode. <ul style="list-style-type: none"> • Enter your password if prompted.

	Command or Action	Purpose
Step 2	configure terminal Example: <pre>Router# configure terminal</pre>	Enters global configuration mode.
Step 3	interface type number Example: <pre>Router(config)# interface gigabitethernet 0/0/0</pre>	Configures an interface type and enters interface configuration mode
Step 4	sip-ua Example: <pre>Router(config-if)# sip-ua</pre>	Enters SIP UA configuration mode.
Step 5	srv version {1 2} Example: <pre>Router(config-sip-ua)# srv version 2</pre>	Generates DNS SRV queries in either RFC 2782 or RFC 2052 format. <ul style="list-style-type: none"> • 1 --The query is set to the domain name prefix of protocol.transport. (RFC 2052 style). • 2 --The query is set to the domain name prefix of _protocol._transport. (RFC 2782 style). This is the default.
Step 6	exit Example: <pre>Router(config-sip-ua)# exit</pre>	Exits the current configuration mode.

Configuring DNS Server Lookups

Following is the example to configure '_sip_udp.'

```
!
dial-peer voice 1 voip
  session protocol sipv2
  session transport udp
  session target dns:cisco.com
!
```

Following are the examples to configure '_sip_tcp.'

```
!
dial-peer voice 1 voip
  session protocol sipv2
  session transport tcp
  session target dns:cisco.com
!
!
dial-peer voice 1 voip
```

```

session protocol sipv2
session transport tcp tls
session target dns:cisco.com
!

```

Following is the example to configure '_sips._tcp!'.

```

!
dial-peer voice 1 voip
 session protocol sipv2
 session transport tcp tls
 session target dns:cisco.com
 voice-class sip url sips
!

```

From Cisco IOS XE Gibraltar Release 16.12.3 onwards, CUBE sends '_sips._tcp.' query when the transport is TLS. The '_sips._tcp.' query is independent of the URI scheme—sip or sips. Following is the example to configure '_sips._tcp!'.

```

!
dial-peer voice 1 voip
 session protocol sipv2
 session transport tcp tls
 session target dns:cisco.com
!

```

Following is the sample configuration for a local DNS SRV.

```

!
ip name-server 172.18.110.64
!
ip domain lookup
!
ip host 1.cisco.com 10.10.10.1
ip host 2.cisco.com 10.10.10.2
ip host 3.cisco.com 10.10.10.3
!
ip host _sip._tcp.cisco.com srv 1 50 5061 1.cisco.com
ip host _sip._tcp.cisco.com srv 1 50 5061 2.cisco.com
ip host _sip._tcp.cisco.com srv 1 50 5061 3.cisco.com
!
ip host _sips._tcp.cisco.com srv 1 50 5061 1.cisco.com
ip host _sips._tcp.cisco.com srv 1 50 5061 2.cisco.com
ip host _sips._tcp.cisco.com srv 1 50 5061 3.cisco.com
!
ip host _sip._udp.cisco.com srv 1 50 5060 1.cisco.com
ip host _sip._udp.cisco.com srv 1 50 5060 2.cisco.com
ip host _sip._udp.cisco.com srv 1 50 5060 3.cisco.com
!
ip host _sip._tcp.cisco.com srv 1 50 5060 1.cisco.com
ip host _sip._tcp.cisco.com srv 1 50 5060 2.cisco.com
ip host _sip._tcp.cisco.com srv 1 50 5060 3.cisco.com
!

```



Note Locally hosted DNS SRV entries are not supported until IOS-XE release 3.17S.

Troubleshooting Tips

You can use the following commands to troubleshoot the DNS SRV issues.

debug ip dns view

```

debug ip domain
debug ccip info
debug ccip messages

```

Verifying

The following example shows sample is output from the **show sip-ua status** command used to verify the style of DNS server queries:

```

Router# show sip-ua status
SIP User Agent Status
SIP User Agent for UDP : ENABLED
SIP User Agent for TCP : ENABLED
SIP User Agent bind status(signaling): DISABLED
SIP User Agent bind status(media): DISABLED
SIP max-forwards : 6
SIP DNS SRV version: 1 (rfc 2052)

```

Feature Information for SIP RFC 2782 Compliance with DNS SRV Queries

The following table provides release information about the feature or features described in this module. This table lists only the software release that introduced support for a given feature in a given software release train. Unless noted otherwise, subsequent releases of that software release train also support that feature.

Use Cisco Feature Navigator to find information about platform support and Cisco software image support. To access Cisco Feature Navigator, go to <https://cfng.cisco.com/>. An account on Cisco.com is not required.

ISR feature history table entry

Table 74: Feature Information for SIP: RFC 2782 Compliance with DNS SRV Queries

Feature Name	Releases	Feature Information
SIP: RFC 2782 Compliance of DNS SRV Queries	12.2(8)T, 12.2(11)T, 12.2(15)T	Effective with Cisco IOS XE Release 2.5, the DNS SRV query used to determine the IP address of the user endpoint is modified in compliance with RFC 2782 (which supersedes RFC 2052). The DNS SRV query prepends the protocol label with an underscore "_" character to reduce the risk of duplicate names being used for unrelated purposes. The form compliant with RFC 2782 is the default style. The following command was introduced or modified: srv version .

ASR feature history table entry

Table 75: Feature Information for SIP: RFC 2782 Compliance with DNS SRV Queries

Feature Name	Releases	Feature Information
SIP: RFC 2782 Compliance of DNS SRV Queries	Cisco IOS XE Release 2.5	Effective with Cisco IOS XE Release 2.5, the DNS SRV query used to determine the IP address of the user endpoint is modified in compliance with RFC 2782 (which supersedes RFC 2052). The DNS SRV query prepends the protocol label with an underscore "_" character to reduce the risk of duplicate names being used for unrelated purposes. The form compliant with RFC 2782 is the default style. The following command was introduced or modified: srv version .



PART **XIII**

Support for SRTP

- [SRTP-SRTP Interworking, on page 667](#)
- [SRTP-RTP Interworking, on page 683](#)
- [SRTP-SRTP Pass-Through, on page 697](#)



CHAPTER 52

SRTP-SRTP Interworking

Cisco Unified Border Element (CUBE) supports secure calls between two networks having different cipher suites. SRTP-SRTP interworking is supported for audio and video calls.

- [Feature Information for SRTP-SRTP Interworking, on page 667](#)
- [Prerequisites for SRTP-SRTP Interworking, on page 668](#)
- [Restrictions for SRTP-SRTP Interworking, on page 668](#)
- [Information About SRTP-SRTP Interworking, on page 668](#)
- [How to Configure SRTP-SRTP Interworking, on page 670](#)
- [Configuration Examples, on page 678](#)

Feature Information for SRTP-SRTP Interworking

The following table provides release information about the feature or features described in this module. This table lists only the software release that introduced support for a given feature in a given software release train. Unless noted otherwise, subsequent releases of that software release train also support that feature.

Use Cisco Feature Navigator to find information about platform support and Cisco software image support. To access Cisco Feature Navigator, go to <https://cfng.cisco.com/>. An account on Cisco.com is not required.

Table 76: Feature Information for SRTP-SRTP Interworking

Feature Name	Releases	Feature Information
Security Readiness Criteria (SRC)—Modified the command show sip-ua calls .	Cisco IOS XE Gibraltar Release 16.11.1a	Command show sip-ua calls is modified to display local crypto key and remote crypto key.
Support for SRTP-SRTP interworking	Cisco IOS XE Everest 16.5.1b	This feature allows secure calls between two enterprises using different cipher suites. Supported cipher suites are as follows: <ul style="list-style-type: none"> • AEAD_AES_256_GCM • AEAD_AES_128_GCM • AES_CM_128_HMAC_SHA1_80 • AES_CM_128_HMAC_SHA1_32

Prerequisites for SRTP-SRTP Interworking

- Cisco IOS XE Everest Release 16.5.1b or later



Note SRTP-SRTP Interworking feature is not supported on Cisco ISR G2 Series Routers.

Restrictions for SRTP-SRTP Interworking

- Asymmetric SRTP fallback configuration is not supported
- Call Progress Analysis (CPA) is not supported
- Transcoding calls are not supported
- SRTCP-RTCP interworking is not supported
- More than one audio and video m-line is not supported
- Unified CME and Unified SRST flows and SIP-TDM flows are not supported
- GCM ciphers with extension header are not supported

Information About SRTP-SRTP Interworking

From Cisco IOS XE Everest Release 16.5.1b onwards, when SRTP is enabled, by default Cisco Unified Border Element supports secure calls between networks using different cipher suites. The cipher suites that are supported for SRTP-SRTP interworking with default preference order are as follows:

- AEAD_AES_256_GCM
- AEAD_AES_128_GCM
- AES_CM_128_HMAC_SHA1_80
- AES_CM_128_HMAC_SHA1_32

Figure 58: SRTP-SRTP Interworking

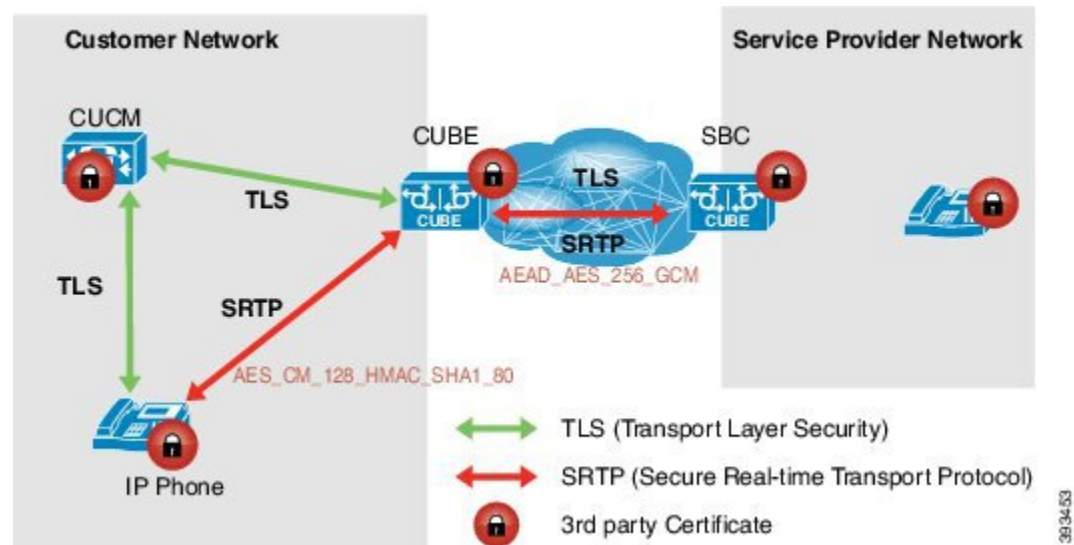

CUBE allows you to change the list of preference order of the cipher-suites. Cipher-suite preference can be configured globally (under **voice service voip >> sip**), on a voice class tenant, or on a dial peer.

The preference range is 1–4, where 1 represents highest preference. CUBE offers SRTP cipher-suites in SDP offer based on the preference configured. For SDP answer, the highest configured preference cipher suite that matches the offer from peer is selected.

Supplementary Services Support

The following supplementary services are supported:

- Midcall codec change with voice class codec configuration
- Reinvite-based call hold and resume.
- Music on hold (MoH) invoked from the Cisco Unified Communications Manager (Cisco UCM), where the call leg changes between SRTP and RTP for an MoH source.
- Reinvite-based call forward and call transfer.
- Call transfer based on a REFER message, with local consumption or pass-through of the REFER message on the CUBE
- Call forward based on a 302 message, with local consumption or pass-through of the 302 message on the CUBE.
- T.38 fax switchover
- Fax pass-through switchover

For call transfers involving REFER and 302 messages (messages that are locally consumed on CUBE), end-to-end media renegotiation is initiated from CUBE only when you configure the **supplementary-service media-renegotiate** command in voice service VoIP configuration mode.



Note Any call-flow wherein there is a switchover from RTP to SRTP on the same SIP call-leg requires the **supplementary-service media-renegotiate** command that is enabled in global or voice service VoIP configuration mode to ensure that there is 2-way audio.

Example call-flows:

- RTP-RTP flow switching to SRTP-RTP.
- Nonsecure MOH being played during secure call hold or resume.
- RTP-SRTP flow switching to SRTP- SRTP.

When supplementary services are invoked from the endpoints, the call can switch between SRTP and RTP during the call duration. Hence, Cisco recommends that you configure such SIP trunks for SRTP fallback. For information on configuring SRTP fallback, refer [Enabling SRTP Fallback, on page 675](#).

How to Configure SRTP-SRTP Interworking

Configuring SRTP

SUMMARY STEPS

1. **enable**
2. **configure terminal**
3. **dial-peer voice tag voip**
4. **destination-pattern string**
5. **session protocol sipv2**
6. **session target ipv4:destination-address**
7. **incoming called-number string**
8. **srtp**
9. **codec codec**
10. **end**
11. **dial-peer voice tag voip**
12. Repeat Steps 4, 5, 6, and 7 to configure a second dial peer.
13. **srtp**
14. **codec codec**
15. **exit**

DETAILED STEPS

	Command or Action	Purpose
Step 1	enable Example:	Enables privileged EXEC mode. <ul style="list-style-type: none"> • Enter your password if prompted.

	Command or Action	Purpose
	Device> enable	
Step 2	configure terminal Example: Device# configure terminal	Enters global configuration mode.
Step 3	dial-peer voice tag voip Example: Device(config)# dial-peer voice 201 voip	Defines a particular dial peer, to specify the method of voice encapsulation, and enters dial peer voice configuration mode. <ul style="list-style-type: none"> • In the example, the following parameters are set: <ul style="list-style-type: none"> • Dial peer 201 is defined. • VoIP is shown as the method of encapsulation.
Step 4	destination-pattern string Example: Device(config-dial-peer)# destination-pattern 5550111	Specifies either the prefix or the full E.164 telephone number to be used for a dial peer string. <ul style="list-style-type: none"> • In the example, 5550111 is specified as the pattern for the telephone number.
Step 5	session protocol sipv2 Example: Device(config-dial-peer)# session protocol sipv2	Specifies a session protocol for calls between local and remote routers using the packet network. <ul style="list-style-type: none"> • In the example, the sipv2 keyword is configured so that the dial peer uses the SIP protocol.
Step 6	session target ipv4:destination-address Example: Device(config-dial-peer)# session target ipv4:10.13.25.102	Designates an IP address where calls will be sent. <ul style="list-style-type: none"> • In the example, calls matching this outbound dial-peer will be sent to 10.13.25.102.
Step 7	incoming called-number string Example: Device(config-dial-peer)# incoming called-number 5550111	Specifies a digit string that can be matched by an incoming call to associate the call with a dial peer. <ul style="list-style-type: none"> • In the example, 5550111 is specified as the pattern for the E.164 or private dialing plan telephone number.
Step 8	srtp Example: Device(config-dial-peer)# srtp	Specifies that SRTP is used to enable secure calls for the dial peer.
Step 9	codec codec Example:	Specifies the voice coder rate of speech for the dial peer.

	Command or Action	Purpose
	Device(config-dial-peer)# codec g711ulaw	<ul style="list-style-type: none"> In the example, G.711 mu-law at 64,000 bps, is specified as the voice coder rate for speech.
Step 10	end Example: Device(config-dial-peer)# end	Exits dial peer voice configuration mode.
Step 11	dial-peer voice tag voip Example: Device(config)# dial-peer voice 200 voip	Defines a particular dial peer, to specify the method of voice encapsulation, and enters dial peer voice configuration mode. <ul style="list-style-type: none"> In the example, the following parameters are set: <ul style="list-style-type: none"> Dial peer 200 is defined. VoIP is shown as the method of encapsulation.
Step 12	Repeat Steps 4, 5, 6, and 7 to configure a second dial peer.	--
Step 13	srtp Example: Device(config-dial-peer)# srtp	Specifies that SRTP is used to enable secure calls for the dial peer.
Step 14	codec codec Example: Device(config-dial-peer)# codec g711ulaw	Specifies the voice coder rate of speech for the dial peer. <ul style="list-style-type: none"> In the example, G.711 mu-law at 64,000 bps, is specified as the voice coder rate for speech.
Step 15	exit Example: Device(config-dial-peer)# exit	Exits dial peer voice configuration mode.

Configuring Cipher Suite Preference (optional)



Note No additional configurations are required if you want to configure the default preference order. Use the following procedure for changing the default preference.

SUMMARY STEPS

1. **enable**
2. **configure terminal**
3. **voice class srtp-crypto tag**

4. `crypto preference cipher-suite`
5. `exit`

DETAILED STEPS

	Command or Action	Purpose
Step 1	enable Example: Device> <code>enable</code>	Enables privileged EXEC mode. <ul style="list-style-type: none"> • Enter your password if prompted.
Step 2	configure terminal Example: Device# <code>configure terminal</code>	Enters global configuration mode.
Step 3	voice class srtp-crypto tag Example: Device(config)# <code>voice class srtp-crypto 100</code>	Enters voice class configuration mode and assign an identification tag for a srtp-crypto voice class.
Step 4	<code>crypto preference cipher-suite</code> Example: Device(config-class)# <code>crypto 1 AEAD_AES_256_GCM</code>	Specifies the preference for an SRTP cipher-suite that will be offered by Cisco Unified Border Element (CUBE) in the SDP in offer and answer. You can configure a maximum of four preferences.
Step 5	exit Example: Device(config-class)# <code>exit</code>	Exits the present configuration mode.

Example

What to do next

Assign SRTP Crypto voice class globally, or on a voice-class tenant, or on a dial-peer. For more information, see [Applying Crypto Suite Selection Preference \(optional\)](#), on page 673.

Applying Crypto Suite Selection Preference (optional)

Before you begin

- Ensure that an srtp voice-class is created using the `voice class srtp-crypto crypto-tag` command

SUMMARY STEPS

1. `enable`
2. `configure terminal`
3. Apply crypto suite selection preference

- In global configuration mode:
 - **voice service voice**
 - **sip**
 - **srtp-crpto** *crypto-tag*
- In voice class tenant configuration mode:
 - **voice class tenant** *tag*
 - **srtp-crypto** *crypto-tag*
- In dial-peer configuration mode:
 - **dial-peer voice** *tag voip*
 - **voice-class sip srtp-crypto** *crypto-tag*

4. end

DETAILED STEPS

	Command or Action	Purpose
Step 1	enable Example: Device> enable	Enables privileged EXEC mode. <ul style="list-style-type: none"> • Enter your password if prompted.
Step 2	configure terminal Example: Device# configure terminal	Enters global configuration mode.
Step 3	Apply crypto suite selection preference <ul style="list-style-type: none"> • In global configuration mode: <ul style="list-style-type: none"> • voice service voice • sip • srtp-crpto <i>crypto-tag</i> • In voice class tenant configuration mode: <ul style="list-style-type: none"> • voice class tenant <i>tag</i> • srtp-crypto <i>crypto-tag</i> • In dial-peer configuration mode: <ul style="list-style-type: none"> • dial-peer voice <i>tag voip</i> • voice-class sip srtp-crypto <i>crypto-tag</i> 	Assigns previously configured crypto-suite selection preference. The <i>cryptp-tag</i> maps to the tag created using the voice class srtp-crypto command available in global configuration mode.

	Command or Action	Purpose
	<p>Example:</p> <p>In global configuration mode:</p> <pre>Device> enable Device# configure terminal Device(config)# voice service voice Device(conf-voi-serv)# sip Device(conf-serv-sip)# srtp-crypto 102</pre> <p>In voice class tenant configuration mode:</p> <pre>Device> enable Device# configure terminal Device(config)# voice class tenant 100 Device(conf-serv-sip)# srtp-crypto 102</pre> <p>In dial-peer configuration mode:</p> <pre>Device> enable Device# configure terminal Device(config)# dial-peer voice 300 voip Device(config-dial-peer)# voice-class sip srtp-crypto 102</pre>	
Step 4	<p>end</p> <p>Example:</p> <pre>Device(config-dial-peer)# exit</pre>	Exits the present configuration mode.

Enabling SRTP Fallback

You can configure SRTP with the fallback option so that a call can fall back to RTP if SRTP is not supported by the other call end. Enabling SRTP fallback is required for supporting nonsecure supplementary services such as MoH, call forward, and call transfer.

SUMMARY STEPS

- enable**
- configure terminal**
- Enter one of the following commands:
 - In dial-peer configuration mode

```
dial-peer
voice
tag
voip

srtp
fallback (for interworking with devices other than Cisco Unified Communications Manager)
```

or

voice-class sip srtp

negotiate cisco (Enable this CLI along with **srtp fallback** command to support SRTP fallback with Cisco Unified Communications Manager)

- In global VoIP SIP configuration mode

voice service voip

sip

srtp

fallback(for interworking with devices other than Cisco Unified Communications Manager)

or

srtp

negotiate cisco (Enable this CLI along with **srtp fallback** command to support SRTP fallback with Cisco Unified Communications Manager)

4. exit

DETAILED STEPS

	Command or Action	Purpose
Step 1	<p>enable</p> <p>Example:</p> <pre>Device> enable</pre>	<p>Enables privileged EXEC mode.</p> <ul style="list-style-type: none"> • Enter your password if prompted.
Step 2	<p>configure terminal</p> <p>Example:</p> <pre>Device# configure terminal</pre>	<p>Enters global configuration mode.</p>
Step 3	<p>Enter one of the following commands:</p> <ul style="list-style-type: none"> • In dial-peer configuration mode <p>dial-peer</p> <p>voice</p> <p><i>tag</i></p> <p>voip</p> <p>srtp</p> <p>fallback (for interworking with devices other than Cisco Unified Communications Manager)</p> <p>or</p> <p>voice-class sip srtp</p> <p>negotiate cisco (Enable this CLI along with srtp</p>	<p>Enables call fallback to nonsecure mode.</p>

	Command or Action	Purpose
	<p>fallback command to support SRTP fallback with Cisco Unified Communications Manager)</p> <ul style="list-style-type: none"> In global VoIP SIP configuration mode <pre>voice service voip sip srtp fallback(for interworking with devices other than Cisco Unified Communications Manager) or srtp negotiate cisco (Enable this CLI along with srtp fallback command to support SRTP fallback with Cisco Unified Communications Manager)</pre> <p>Example:</p> <pre>Device(config)# dial-peer voice 10 voip Device(config-dial-peer)# srtp fallback</pre> <p>Example:</p> <pre>Device(config)# dial-peer voice 10 voip Device(config-dial-peer)# voice-class sip srtp negotiate Cisco</pre> <p>Example:</p> <pre>Device(config)# voice service voip Device(config)# sip Device(conf-voi-serv)# srtp fallback</pre> <p>Example:</p> <pre>Device(config)# voice service voip Device(config)# sip Device(conf-voi-serv)# srtp negotiate cisco</pre>	
Step 4	<p>exit</p> <p>Example:</p> <pre>Device(conf-voi-serv)# exit</pre>	Exits present configuration mode and enters privileged EXEC mode.

Configuration Examples

Example: Configuring SRTP-SRTP Interworking

The following example shows how to configure support for SRTP-SRTP interworking. In this example, the incoming call leg preference is set to AEAD_AES_256_GCM crypto-suite and the outgoing call leg preference is set to AES_CM_128_HMAC_SHA1_80 crypto-suite.

Configure SRTP:

```
Device> enable
Device# configure terminal
Device(config)# dial-peer voice 300 voip
Device(config-dial-peer)# description "inbound dialpeer for 81560"
Device(config-dial-peer)# session protocol sipv2
Device(config-dial-peer)# incoming called-number 81560
Device(config-dial-peer)# srtp
Device(config-dial-peer)# codec g711ulaw
Device(config-dial-peer)# end

Device(config)# dial-peer voice 400 voip
Device(config-dial-peer)# destination-pattern 81560
Device(config-dial-peer)# description "outbound dialpeer for 81560"
Device(config-dial-peer)# session protocol sipv2
Device(config-dial-peer)# session target ipv4:10.13.25.102
Device(config-dial-peer)# srtp
Device(config-dial-peer)# codec g711ulaw
```

Create a voice class srtp-crypto 100 and assign AEAD_AES_256_GCM crypto-suite with highest preference:

```
Device(config)# voice class srtp-crypto 100
Device(config-class)# crypto 1 AEAD_AES_256_GCM
```

Assign srtp-crypto 100 on incoming dial-peer:

```
Device(config)# dial-peer voice 300 voip
Device(config-dial-peer)# voice-class sip srtp-crypto 100
Device(config-dial-peer)# codec g711ulaw
Device(config-dial-peer)# srtp
```

Create a voice class srtp-crypto 103 and assign AES_CM_128_HMAC_SHA1_80 crypto-suite with highest preference:

```
Device> enable
Device# configure terminal
Device(config)# voice class srtp-crypto 103
Device(config-class)# crypto 1 AES_CM_128_HMAC_SHA1_80
```

Assign srtp-crypto 103 on outgoing dial-peer:

```
Device(config)# dial-peer voice 400 voip
```

```

Device(config-dial-peer)# voice-class sip srtp-crypto 103
Device(config-dial-peer)# codec g711ulaw
Device(config-dial-peer)# srtp

Device# show sip-ua calls
Total SIP call legs:2, User Agent Client:1, User Agent Server:1
SIP UAC CALL INFO
Call 1
SIP Call ID          : 706E9625-C4FB11E6-8008AFC8-C0129831@10.25.15.63
  State of the call   : STATE_ACTIVE (7)
  Substate of the call : SUBSTATE_NONE (0)
  Calling Number      : 61230
  Called Number       : 81560
  Called URI          :
  Bit Flags           : 0xC04018 0x80000100 0x80
  CC Call ID          : 2
  Local UUID          : d5173c8551b25b06820edc687e50ab90
  Remote UUID         : 2e9094e33b815992a519f82abfae09d2
  Source IP Address (Sig) : 10.25.16.63
  Destn SIP Req Addr:Port : [10.13.25.102]:14560
  Destn SIP Resp Addr:Port : [10.13.25.102]:14560
  Destination Name    :
  Number of Media Streams : 1
  Number of Active Streams: 1
  RTP Fork Object     : 0x0
  Media Mode          : flow-through
Media Stream 1
  State of the stream   : STREAM_ACTIVE
  Stream Call ID       : 2
  Stream Type          : voice+dtmf (1)
  Stream Media Addr Type : 1
  Negotiated Codec     : g711ulaw (80 bytes)
  Codec Payload Type   : 0
  Negotiated Dtmf-relay : rtp-nte
  Dtmf-relay Payload Type : 101
  QoS ID               : -1
  Local QoS Strength   : BestEffort
  Negotiated QoS Strength : BestEffort
  Negotiated QoS Direction : None
  Local QoS Status     : None
  Media Source IP Addr:Port : [10.25.15.63]:8002
  Media Dest IP Addr:Port  : [10.13.25.102]:14240
  Local Crypto Suite    : AES_CM_128_HMAC_SHA1_80
  Remote Crypto Suite   : AES_CM_128_HMAC_SHA1_80
  Local Crypto Key      : bTQqZXbgFJddA1hE9wJGV3aKxo5vPV+Z1234tVb2
  Remote Crypto Key     : bTQqZXbgFJddA1hE9wJGV3aKxo5vPV+Z9876tVb2
  Mid-Call Re-Association Count: 0
  SRTP-RTP Re-Association DSP Query Count: 0

```

```

Options-Ping    ENABLED:NO    ACTIVE:NO
Number of SIP User Agent Client(UAC) calls: 1

```

```

SIP UAS CALL INFO
Call 1
SIP Call ID          : 1-8614@10.41.50.13
  State of the call   : STATE_ACTIVE (7)
  Substate of the call : SUBSTATE_NONE (0)
  Calling Number      : 61230
  Called Number       : 81560
  Called URI          : sip:81560@10.13.25.102:5060
  Bit Flags           : 0xC0401C 0x10000100 0x4
  CC Call ID          : 1

```

```

Local UUID           : 2e9094e33b815992a519f82abfae09d2
Remote UUID          : d5173c8551b25b06820edc687e50ab90
Source IP Address (Sig) : 10.25.15.63
Destn SIP Req Addr:Port : [10.41.50.13]:14450
Destn SIP Resp Addr:Port: [10.41.50.13]:14450
Destination Name      : 10.41.50.13
Number of Media Streams : 1
Number of Active Streams: 1
RTP Fork Object       : 0x0
Media Mode            : flow-through
Media Stream 1
  State of the stream   : STREAM_ACTIVE
  Stream Call ID        : 1
  Stream Type           : voice+dtmf (0)
  Stream Media Addr Type : 1
  Negotiated Codec      : g711ulaw (80 bytes)
  Codec Payload Type    : 0
  Negotiated Dtmf-relay : rtp-nte
  Dtmf-relay Payload Type : 101
  QoS ID                : -1
  Local QoS Strength    : BestEffort
  Negotiated QoS Strength : BestEffort
  Negotiated QoS Direction : None
  Local QoS Status      : None
  Media Source IP Addr:Port: [10.25.15.63]:8000
  Media Dest IP Addr:Port : [10.41.50.13]:14670
  Local Crypto Suite    : AEAD_AES_256_GCM
  Remote Crypto Suite   : AEAD_AES_256_GCM (
                        AEAD_AES_256_GCM
                        AEAD_AES_128_GCM )
  Local Crypto Key      : bTQqZXbgFJddAlhE9wJGV3aKxo5vPV+Z8765tVb2
  Remote Crypto Key     : bTQqZXbgFJddAlhE9wJGV3aKxo5vPV+Z2345tVb2
Mid-Call Re-Association Count: 0
SRTP-RTP Re-Association DSP Query Count: 0

```

```

Options-Ping    ENABLED:NO    ACTIVE:NO
Number of SIP User Agent Server(UAS) calls: 1

```

Example: Changing the Cipher-Suite Preference

Specify SRTP cipher-suite preference:

```

Device> enable
Device# configure terminal
Device(config)# voice class srtp-crypto 100
Device(config-class)# crypto 1 AEAD_AES_256_GCM
Device(config-class)# crypto 2 AEAD_AES_128_GCM
Device(config-class)# crypto 4 AES_CM_128_HMAC_SHA1_32

```

The following is the snippet of **show running-config** command output showing the cipher-suite preference:

```

Device# show running-config
voice class srtp-crypto 100
crypto 1 AEAD_AES_256_GCM
crypto 2 AEAD_AES_128_GCM
crypto 4 AES_CM_128_HMAC_SHA1_32

```

If you want to change the preference 4 to `AES_CM_128_HMAC_SHA1_80`, execute the following command:

```
Device(config-class)# crypto 4 AES_CM_128_HMAC_SHA1_80
```

The following is the snippet of **show running-config** command output showing the change in cipher-suite:

```
Device# show running-config  
voice class srtp-crypto 100  
crypto 1 AEAD_AES_256_GCM  
crypto 2 AEAD_AES_128_GCM  
crypto 4 AES_CM_128_HMAC_SHA1_80
```

If you want to change the preference of AES_CM_128_HMAC_SHA1_80 to 3, execute the following commands:

```
Device(config-class)# no crypto 4  
Device(config-class)# crypto 3 AES_CM_128_HMAC_SHA1_80
```

The following is the snippet of **show running-config** command output showing the cipher-suite preference overwritten:

```
Device# show running-config  
voice class srtp-crypto 100  
crypto 1 AEAD_AES_256_GCM  
crypto 2 AEAD_AES_128_GCM  
crypto 3 AES_CM_128_HMAC_SHA1_80
```



CHAPTER 53

SRTP-RTP Interworking

The Cisco Unified Border Element (CUBE) Support for SRTP-RTP Interworking feature allows secure network to non-secure network calls and provides operational enhancements for Session Initiation Protocol (SIP) trunks from Cisco Unified Call Manager and Cisco Unified Call Manager Express. Support for Secure Real-Time Transport Protocol (SRTP) to Real-Time Transport Protocol (RTP) interworking in a network is enabled for SIP-SIP audio calls.

- [Feature Information for SRTP-RTP Interworking, on page 683](#)
- [Prerequisites for SRTP-RTP Interworking, on page 684](#)
- [Restrictions for SRTP-RTP Interworking, on page 684](#)
- [Information About SRTP-RTP Interworking, on page 684](#)
- [How to Configure Support for SRTP-RTP Interworking, on page 688](#)
- [Configuration Examples for SRTP-RTP Interworking, on page 695](#)

Feature Information for SRTP-RTP Interworking

The following table provides release information about the feature or features described in this module. This table lists only the software release that introduced support for a given feature in a given software release train. Unless noted otherwise, subsequent releases of that software release train also support that feature.

Use Cisco Feature Navigator to find information about platform support and Cisco software image support. To access Cisco Feature Navigator, go to <https://cfng.cisco.com/>. An account on Cisco.com is not required.

Table 77: Feature Information for SRTP-RTP Interworking

Feature Name	Releases	Feature Information
Cisco Unified Border Element Support for SRTP-RTP Interworking	12.4(22)YB , 15.0(1)M Cisco IOS XE 3.1S	This feature allows secure to non-secure enterprise calls. Support for SRTP-RTP interworking between one or multiple Cisco Unified Border Elements is enabled for SIP-SIP audio calls.
Supplementary Services Support on CUBE for SRTP-RTP Calls	Cisco IOS 15.2(1)T Cisco IOS XE 3.7S	The SRTP-RTP Interworking feature was enhanced to support supplementary services for SRTP-RTP calls.

Feature Name	Releases	Feature Information
Support for AEAD_AES_GCM_256 and AEAD_AES_GCM_128 crypto-suites	Cisco IOS XE Everest 16.5.1b	AEAD_AES_GCM_256 and AEAD_AES_GCM_128 crypto suites were added to support SRTP-RTP interworking.

Prerequisites for SRTP-RTP Interworking

- SRTP-RTP interworking is supported with Cisco Unified CallManager 7.0 and later releases.
- DSP resources are required for platforms running on Cisco IOS Releases. For more information on configuring DSP resources, see [Transcoding](#)
- Platforms running on Cisco IOS XE Releases do not require DSP resources.

Restrictions for SRTP-RTP Interworking

- Asymmetric SRTP fallback configuration is not supported on the Cisco Integrated Services Router Generation 2 platform.
- Dial peer hunting to H323 or TDM is not supported.
- Video calls are not supported on platforms running on Cisco IOS Releases.
- More than one video m-line is not supported.
- DTMF interworking is not supported on ISR G2 (2900, 3900) series routers. It is supported only on platforms running on Cisco IOS XE Releases.
- GCM ciphers with extension header are not supported.

Information About SRTP-RTP Interworking

To configure support for SRTP-RTP interworking, you should understand the following concepts:

Support for SRTP-RTP Interworking

The Cisco Unified Border Element Support for SRTP-RTP Interworking feature connects SRTP Cisco Unified Call Manager domains with the following:

- RTP Cisco Unified Call Manager domains. Domains that do not support SRTP or have not been configured for SRTP, as shown in the figure below.
- RTP Cisco applications or servers. For example, Cisco Unified MeetingPlace, Cisco WebEx, or Cisco Unity, which do not support SRTP, or have not been configured for SRTP, or are resident in a secure data center, as shown in the figure below.

- RTP to third-party equipment. For example, IP trunks to PBXs or virtual machines, which do not support SRTP.

Figure 59: SRTP Domain Connections

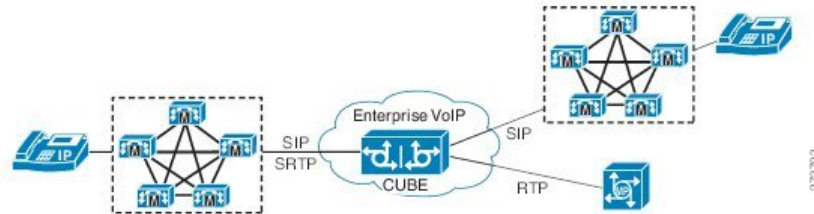

The Cisco Unified Border Element Support for SRTP-RTP Interworking feature connects SRTP enterprise domains to RTP SIP provider SIP trunks. SRTP-RTP interworking connects RTP enterprise networks with SRTP over an external network between businesses. This provides flexible secure business-to-business communications without the need for static IPsec tunnels or the need to deploy SRTP within the enterprise, as shown in the figure below.

Figure 60: Secure Business-to-Business Communications

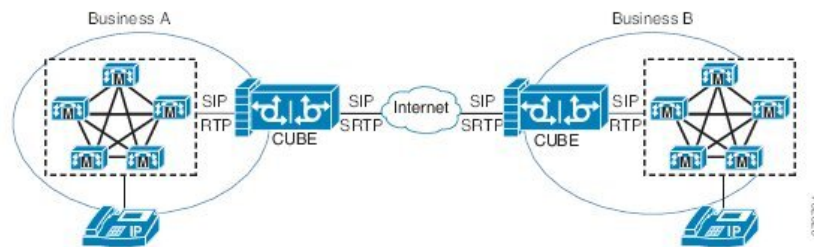

SRTP-RTP interworking also connects SRTP enterprise networks with static IPsec over external networks, as shown in the figure below.

Figure 61: SRTP Enterprise Network Connections

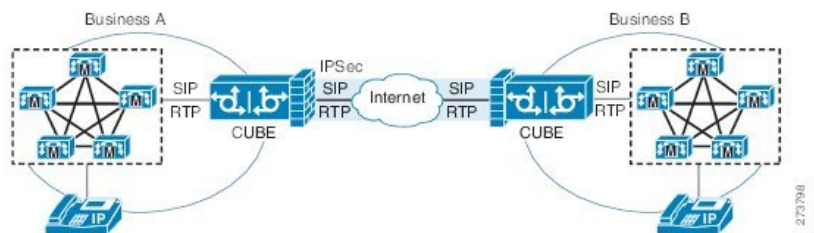

SRTP-RTP interworking on the CUBE in a network topology uses single-pair key generation. Existing audio and dual-tone multifrequency (DTMF) transcoding is used to support voice calls. SRTP-RTP interworking support is provided in both flow-through and high-density mode. There is no impact on SRTP-SRTP pass-through calls.

SRTP is configured on one dial peer using the `srtp` and `srtp fallback` commands. RTP is configured on the other dial peer. The dial peer configuration takes precedence over the global configuration on the CUBE.

Fallback handling occurs if one of the call endpoints does not support SRTP. The call can fall back to RTP-RTP, or the call can fail, depending on the configuration. Fallback takes place only if the `srtp fallback` command is configured on the respective dial peer.

Using SRTP-RTP Chain for Interworking Between AES_CM_128_HMAC_SHA1_32 and AES_CM_128_HMAC_SHA1_80 Crypto Suites

A single Cisco Unified Call Manager (CUCM) device cannot terminate a Secure Real-time Transport Protocol (SRTP) connection with an IP Phone using the AES_CM_128_HMAC_SHA1_32 crypto suite and initiate an SRTP connection with an external CUBE device with the AES_CM_128_HMAC_SHA1_80 crypto suite at the same time.

For Cisco Unified Call Manager (Unified Communications Manager) and IP Phone devices that support only AES_CM_128_HMAC_SHA1_32 crypto suite, the interim SRTP-RTP interworking solution that is described below can be implemented.

- CUCM or IP Phone side:
 - An SRTP connection using the AES_CM_128_HMAC_SHA1_32 crypto suite exists between the IP Phone and CUBE1.
 - An RTP connection exists between CUBE1 and CUBE2.
- SIP trunk side—An SRTP connection using the AES_CM_128_HMAC_SHA1_80 crypto suite is initiated by CUBE2 here. In the image below, CUBE2 is the border element on the Customer Network and SBC is the border element on the Service Provider Network.

Figure 62: SRTP-RTP Interworking Supporting AES_CM_128_HMAC_SHA1_32 crypto suite

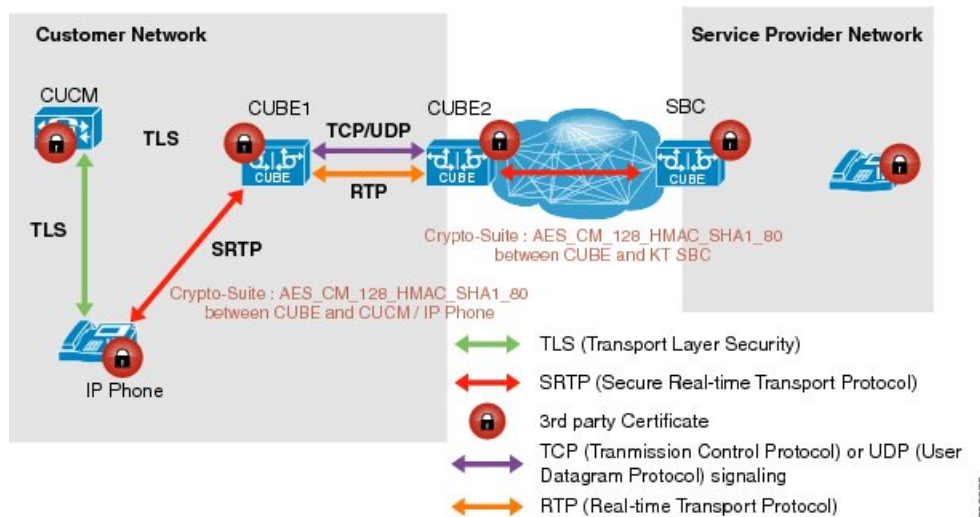

Note

- AES_CM_128_HMAC_SHA1_32 to AES_CM_128_HMAC_SHA1_80 interworking is not supported upto Cisco IOS 15.5(3)M Release and Cisco IOS XE Everest 16.4.1 Release.
- From Cisco IOS XE Everest 16.5.1b Release onwards, SRTP-SRTP interworking is supported and therefore SRTP-RTP chain is not required.

Supplementary Services Support

The following supplementary services are supported:

- Midcall codec change with voice class codec configuration
- Reinvite-based call hold and resume.
- Music on hold (MoH) invoked from the Cisco Unified Communications Manager (Cisco UCM), where the call leg changes between SRTP and RTP for an MoH source.
- Reinvite-based call forward and call transfer.
- Call transfer based on a REFER message, with local consumption or pass-through of the REFER message on the CUBE
- Call forward based on a 302 message, with local consumption or pass-through of the 302 message on the CUBE.
- T.38 fax switchover
- Fax pass-through switchover

For call transfers involving REFER and 302 messages (messages that are locally consumed on CUBE), end-to-end media renegotiation is initiated from CUBE only when you configure the **supplementary-service media-renegotiate** command in voice service VoIP configuration mode.



Note Any call-flow wherein there is a switchover from RTP to SRTP on the same SIP call-leg requires the **supplementary-service media-renegotiate** command that is enabled in global or voice service VoIP configuration mode to ensure that there is 2-way audio.

Example call-flows:

- RTP-RTP flow switching to SRTP-RTP.
- Nonsecure MOH being played during secure call hold or resume.
- RTP-SRTP flow switching to SRTP- SRTP.

When supplementary services are invoked from the endpoints, the call can switch between SRTP and RTP during the call duration. Hence, Cisco recommends that you configure such SIP trunks for SRTP fallback. For information on configuring SRTP fallback, refer [Enabling SRTP Fallback, on page 675](#).

How to Configure Support for SRTP-RTP Interworking

Configuring SRTP-RTP Interworking Support



Note From Cisco IOS XE Everest Release 16.5.1b onwards, the following crypto suites are enabled by default on the SRTP leg:

- AEAD_AES_256_GCM
- AEAD_AES_128_GCM
- AES_CM_128_HMAC_SHA1_80
- AES_CM_128_HMAC_SHA1_32

Use the following procedure for changing the default preference list.

Perform the task in this section to enable SRTP-RTP interworking support between one or multiple Cisco Unified Border Elements for SIP-SIP audio calls. In this task, RTP is configured on the incoming call leg and SRTP is configured on the outgoing call leg.



Note This feature is available only on Cisco IOS images with security package.

SUMMARY STEPS

1. **enable**
2. **configure terminal**
3. **dial-peer voice tag voip**
4. **destination-pattern string**
5. **session protocol sipv2**
6. **session target ipv4: destination-address**
7. **incoming called-number string**
8. **codec codec**
9. **end**
10. **dial-peer voice tag voip**
11. Repeat Steps 4, 5, 6, and 7 to configure a second dial peer.
12. **srtp**
13. **codec codec**
14. **exit**

DETAILED STEPS

	Command or Action	Purpose
Step 1	enable Example: Device> enable	Enables privileged EXEC mode. <ul style="list-style-type: none"> • Enter your password if prompted.
Step 2	configure terminal Example: Device# configure terminal	Enters global configuration mode.
Step 3	dial-peer voice tag voip Example: Device(config)# dial-peer voice 201 voip	Defines a particular dial peer, to specify the method of voice encapsulation, and enters dial peer voice configuration mode. <ul style="list-style-type: none"> • In the example, the following parameters are set: <ul style="list-style-type: none"> • Dial peer 201 is defined. • VoIP is shown as the method of encapsulation.
Step 4	destination-pattern string Example: Device(config-dial-peer)# destination-pattern 5550111	Specifies either the prefix or the full E.164 telephone number to be used for a dial peer string. <ul style="list-style-type: none"> • In the example, 5550111 is specified as the pattern for the telephone number.
Step 5	session protocol sipv2 Example: Device(config-dial-peer)# session protocol sipv2	Specifies a session protocol for calls between local and remote routers using the packet network. <ul style="list-style-type: none"> • In the example, the sipv2 keyword is configured so that the dial peer uses the SIP protocol.
Step 6	session target ipv4: destination-address Example: Device(config-dial-peer)# session target ipv4:10.13.25.102.	Designates an IPv4 destination address where calls will be sent. <ul style="list-style-type: none"> • In the example, calls matching this outbound dial-peer will be sent to 10.13.25.102.
Step 7	incoming called-number string Example: Device(config-dial-peer)# incoming called-number 5550111	Specifies a digit string that can be matched by an incoming call to associate the call with a dial peer. <ul style="list-style-type: none"> • In the example, 5550111 is specified as the pattern for the E.164 or private dialing plan telephone number.
Step 8	codec codec Example:	Specifies the voice coder rate of speech for the dial peer. <ul style="list-style-type: none"> • In the example, G.711 mu-law at 64,000 bps, is specified as the voice coder rate for speech.

	Command or Action	Purpose
	Device(config-dial-peer)# codec g711ulaw	
Step 9	end Example: Device(config-dial-peer)# end	Exits dial peer voice configuration mode.
Step 10	dial-peer voice tag voip Example: Device(config)# dial-peer voice 200 voip	Defines a particular dial peer, to specify the method of voice encapsulation, and enters dial peer voice configuration mode. <ul style="list-style-type: none"> • In the example, the following parameters are set: <ul style="list-style-type: none"> • Dial peer 200 is defined. • VoIP is shown as the method of encapsulation.
Step 11	Repeat Steps 4, 5, 6, and 7 to configure a second dial peer.	--
Step 12	srtp Example: Device(config-dial-peer)# srtp	Specifies that SRTP is used to enable secure calls for the dial peer.
Step 13	codec codec Example: Device(config-dial-peer)# codec g711ulaw	Specifies the voice coder rate of speech for the dial peer. <ul style="list-style-type: none"> • In the example, G.711 mu-law at 64,000 bps, is specified as the voice coder rate for speech.
Step 14	exit Example: Device(config-dial-peer)# exit	Exits dial peer voice configuration mode.

Configuring Crypto Authentication



Note Effective Cisco IOS XE Everest Releases 16.5.1b, **srtp-auth** command is deprecated. Although this command is still available in Cisco IOS XE Everest software, executing this command does not cause any configuration changes. Use **voice class srtp-crypto** command to configure the preferred cipher-suites for the SRTP call leg (connection). For more information, see SRTP-SRTP Interworking.

SUMMARY STEPS

1. **enable**
2. **configure terminal**

3. Execute the commands based on your configuration mode

- In dial-peer configuration mode:

```
dial-peer voice tag voip
```

```
voice-class sip srtp-auth {sha1-32 | sha1-80 | system}
```

- In global VoIP SIP configuration mode:

```
voice service voip
```

```
sip
```

```
srtp-auth {sha1-32 | sha1-80}
```

4. end

DETAILED STEPS

	Command or Action	Purpose
Step 1	enable Example: Device> enable	Enables privileged EXEC mode. <ul style="list-style-type: none"> • Enter your password if prompted.
Step 2	configure terminal Example: Device# configure terminal	Enters global configuration mode.
Step 3	Execute the commands based on your configuration mode <ul style="list-style-type: none"> • In dial-peer configuration mode: <pre>dial-peer voice tag voip</pre> <pre>voice-class sip srtp-auth {sha1-32 sha1-80 system}</pre> • In global VoIP SIP configuration mode: <pre>voice service voip</pre> <pre>sip</pre> <pre>srtp-auth {sha1-32 sha1-80}</pre> Example: <pre>Device(config)# dial-peer voice 15 voip</pre> <pre>Device(config-dial-peer)# voice-class sip srtp-auth</pre> <pre>sha1-80</pre> Example: <pre>Device(config)# voice service voip</pre> <pre>Device(conf-voi-serv)# sip</pre> <pre>Device(conf-serv-sip)# srtp-auth sha1-80</pre>	Configures an SRTP connection on CUBE using the preferred crypto suite. <ul style="list-style-type: none"> • The default value is sha1-32.

	Command or Action	Purpose
Step 4	end Example: Device(conf-serv-sip)# end	Ends the current configuration session and returns to privileged EXEC mode.

Enabling SRTP Fallback

You can configure SRTP with the fallback option so that a call can fall back to RTP if SRTP is not supported by the other call end. Enabling SRTP fallback is required for supporting nonsecure supplementary services such as MoH, call forward, and call transfer.

SUMMARY STEPS

- enable**
- configure terminal**
- Enter one of the following commands:
 - In dial-peer configuration mode

```
dial-peer
voice
tag
voip

srtp
fallback (for interworking with devices other than Cisco Unified Communications Manager)

or

voice-class sip srtp
negotiate cisco (Enable this CLI along with srtp fallback command to support SRTP fallback with Cisco Unified Communications Manager )
```
 - In global VoIP SIP configuration mode

```
voice service voip

sip

srtp
fallback(for interworking with devices other than Cisco Unified Communications Manager)

or

srtp
negotiate cisco (Enable this CLI along with srtp fallback command to support SRTP fallback with Cisco Unified Communications Manager )
```
- exit**

DETAILED STEPS

	Command or Action	Purpose
Step 1	enable Example: Device> enable	Enables privileged EXEC mode. <ul style="list-style-type: none"> • Enter your password if prompted.
Step 2	configure terminal Example: Device# configure terminal	Enters global configuration mode.
Step 3	Enter one of the following commands: <ul style="list-style-type: none"> • In dial-peer configuration mode <pre>dial-peer voice tag voip srtp fallback (for interworking with devices other than Cisco Unified Communications Manager) or voice-class sip srtp negotiate cisco (Enable this CLI along with srtp fallback command to support SRTP fallback with Cisco Unified Communications Manager)</pre> • In global VoIP SIP configuration mode <pre>voice service voip sip srtp fallback(for interworking with devices other than Cisco Unified Communications Manager) or srtp negotiate cisco (Enable this CLI along with srtp fallback command to support SRTP fallback with Cisco Unified Communications Manager)</pre> Example: Device(config)# dial-peer voice 10 voip Device(config-dial-peer)# srtp fallback	Enables call fallback to nonsecure mode.

	Command or Action	Purpose
	<p>Example:</p> <pre>Device(config)# dial-peer voice 10 voip Device(config-dial-peer)# voice-class sip srtp negotiate Cisco</pre> <p>Example:</p> <pre>Device(config)# voice service voip Device(config)# sip Device(conf-voi-serv)# srtp fallback</pre> <p>Example:</p> <pre>Device(config)# voice service voip Device(config)# sip Device(conf-voi-serv)# srtp negotiate cisco</pre>	
Step 4	<p>exit</p> <p>Example:</p> <pre>Device(conf-voi-serv)# exit</pre>	Exits present configuration mode and enters privileged EXEC mode.

Troubleshooting Tips

The following commands help in troubleshooting SRTP-RTP supplementary services support:

- `debug ccsip all`
- `debug voip ccapi inout`

Verifying SRTP-RTP Supplementary Services Support

Perform this task to verify the configuration for SRTP-RTP supplementary services support.

SUMMARY STEPS

1. `enable`
2. `show call active voice brief`

DETAILED STEPS

-
- Step 1** **enable**
- Enables privileged EXEC mode.
- Example:**

```
Device> enable
```

Step 2 show call active voice brief

Displays call information for voice calls in progress.

Example:

```
Device# show call active voice brief
Telephony call-legs: 0
SIP call-legs: 2
H323 call-legs: 0
Call agent controlled call-legs: 0
SCCP call-legs: 2
ulticast call-legs: 0
Total call-legs: 4
0    : 1 12:49:45.256 IST Fri Jun 3 2011.1 +29060 pid:1 Answer 10008001 connected
dur 00:01:19 tx:1653/271092 rx:2831/464284 dscp:0 media:0
IP 10.45.40.40:7892 SRTP: on rtt:0ms pl:0/0ms lost:0/0/0 delay:0/0/0ms g711ulaw TextRelay: off
media inactive detected:n media contrl rcvd:n/a timestamp:n/a
long duration call detected:n long duration call duration:n/a timestamp:n/a

0    : 2 12:49:45.256 IST Fri Jun 3 2011.2 +29060 pid:22 Originate 20009001 connected
dur 00:01:19 tx:2831/452960 rx:1653/264480 dscp:0 media:0
IP 10.45.40.40:7893 SRTP: off rtt:0ms pl:0/0ms lost:0/0/0 delay:0/0/0ms g711ulaw TextRelay: off
media inactive detected:n media contrl rcvd:n/a timestamp:n/a
long duration call detected:n long duration call duration:n/a timestamp:n/a

0    : 3 12:50:14.326 IST Fri Jun 3 2011.1 +0 pid:0 Originate connecting
dur 00:01:19 tx:2831/452960 rx:1653/264480 dscp:0 media:0
IP 10.45.34.252:2000 SRTP: off rtt:0ms pl:0/0ms lost:0/0/0 delay:0/0/0ms g711ulaw TextRelay: off
media inactive detected:n media contrl rcvd:n/a timestamp:n/a
long duration call detected:n long duration call duration:n/a timestamp:n/a

0    : 5 12:50:14.326 IST Fri Jun 3 2011.2 +0 pid:0 Originate connecting
dur 00:01:19 tx:1653/271092 rx:2831/464284 dscp:0 media:0
IP 10.45.34.252:2000 SRTP: on rtt:0ms pl:0/0ms lost:0/0/0 delay:0/0/0ms g711ulaw TextRelay: off
media inactive detected:n media contrl rcvd:n/a timestamp:n/a
long duration call detected:n long duration call duration:n/a timestamp:n/a
```

Configuration Examples for SRTP-RTP Interworking

Example: SRTP-RTP Interworking

The following example shows how to configure support for SRTP-RTP interworking. In this example, the incoming call leg is RTP and the outgoing call leg is SRTP.

```
%SYS-5-CONFIG_I: Configured from console by console
dial-peer voice 201 voip
 destination-pattern 5550111
 session protocol sipv2
 session target ipv4:10.13.25.102
 incoming called-number 5550112
 codec g711ulaw
```

```

!
dial-peer voice 200 voip
destination-pattern 5550112
session protocol sipv2
session target ipv4:10.13.2.51
incoming called-number 5550111
srtp
codec g711ulaw

```

Example: Configuring Crypto Authentication



Note Effective Cisco IOS XE Everest Releases 16.5.1b, **srtp-auth** command is deprecated. Although this command is still available in Cisco IOS XE Everest software, executing this command does not cause any configuration changes. Use **voice class srtp-crypto** command to configure the preferred cipher-suites for the SRTP call leg (connection). For more information, see SRTP-SRTP Interworking.

Example: Configuring Crypto Authentication (Dial Peer Level)

The following example shows how to configure Cisco UBE to support an SRTP connection using the AES_CM_128_HMAC_SHA1_80 crypto suite at the dial peer level:

```

Device> enable
Device# configure terminal
Device(config)# dial-peer voice 15 voip
Device(config-dial-peer)# voice-class sip srtp-auth sha1-80
Device(config-dial-peer)# end

```

Example: Configuring Crypto Authentication (Global Level)

The following example shows how to configure Cisco UBE to support an SRTP connection using the AES_CM_128_HMAC_SHA1_80 crypto suite at the global level:

```

Device> enable
Device# configure terminal
Device(config)# voice service voip
Device(conf-voi-serv)# sip
Device(conf-serv-sip)# srtp-auth sha1-80
Device(conf-serv-sip)# end

```



CHAPTER 54

SRTP-SRTP Pass-Through

SRTP-SRTP pass-through feature allows pass-through of encrypted media from one call-leg to the other.

- [Feature Information for Support of SRTP-SRTP Pass-Through Calls, on page 697](#)
- [Information About SRTP-SRTP Pass-Through, on page 698](#)
- [Configure Pass-Through of Unsupported Crypto Suites for a Specific Dial Peer, on page 699](#)
- [Configure Pass-Through of Unsupported Crypto Suites Globally, on page 701](#)
- [Configuration Examples for SRTP-SRTP Pass-Through, on page 702](#)

Feature Information for Support of SRTP-SRTP Pass-Through Calls

The following table provides release information about the feature or features described in this module. This table lists only the software release that introduced support for a given feature in a given software release train. Unless noted otherwise, subsequent releases of that software release train also support that feature.

Use Cisco Feature Navigator to find information about platform support and Cisco software image support. To access Cisco Feature Navigator, go to <https://cfng.cisco.com/>. An account on Cisco.com is not required.

Table 78: Feature Information for SRTP-SRTP Pass-Through

Feature Name	Releases	Feature Information
Support for SRTP-SRTP Basic calls	12.4.15XZ	This feature introduced support for basic SRTP-SRTP pass-through calls.
Support for AES_CM_128_HMAC_SHA1_80 crypto suite	Cisco IOS 15.4(1)T Cisco IOS XE 3.11S	Support AES_CM_128_HMAC_SHA1_80 crypto suite on the Session Initiation Protocol (SIP) Trunk interface was introduced. The following commands were introduced or modified: show sip-ua srtp , srtp-auth and voice-class sip srtp-auth .

Feature Name	Releases	Feature Information
Enhanced Support for SRTP-SRTP Pass-Through	Cisco IOS 15.6(1)T Cisco IOS XE 3.17S	Introduced support for pass-through of the following unsupported crypto suites: <ul style="list-style-type: none"> • AEAD_AES_128_GCM • AEAD_AES_256_GCM • AEAD_AES_128_CCM • AEAD_AES_256_CCM The srtp command was modified to add pass-thru keyword.

Information About SRTP-SRTP Pass-Through

Cisco Unified Border Element supports SIP calls between endpoints using Transport Layer Security (TLS) for SIP signaling encryption and Secure Real-Time Protocol (SRTP) to provide RTP media encryption. However, these two encryption mechanisms may not be deployed simultaneously, depending on the required call flow invoked on the associated configuration.

The following are conditions of the SRTP Passthrough feature:

- SRTP Passthrough must be configured on both legs of the call. If the target adjacency does not support SRTP Passthrough, then the call is rejected by error message 415 (Unsupported Media Type).
- "m= .. RTP/SAVP .." and a="crypto:..." fields coming in on an Invite from one adjacency are passed on in an Invite to the target adjacency.
- "m= ...RTP/SAVP..." is a required field in the Invite to trigger SRTP Passthrough behavior in the SBC.

Pass-Through of Unsupported Crypto Suites



Note Effective from Cisco IOS XE Everest Release 16.5.1b, CUBE supports AEAD_AES_128_GCM and AEAD_AES_256_GCM crypto-suites. For more information, see [SRTP-SRTP Interworking](#).

CUBE supports transparent passthrough of all (supported and unsupported) crypto suites.

Until Cisco IOS Release 15.6(1)T and Cisco IOS XE Release 3.17S, CUBE and DSP supported SRTP pass-through only for AES_CM_128_HMAC_SHA1_80 crypto suite.

From Cisco IOS Release 15.6(1)T and Cisco IOS XE Release 3.17S onwards, CUBE supports pass-through of the following unsupported crypto suites:

- AEAD_AES_128_GCM
- AEAD_AES_256_GCM
- AEAD_AES_128_CCM

- AEAD_AES_256_CCM

CUBE has the ability to pass across crypto attributes (containing any unsupported crypto suites) as well as media packets (encrypted with unsupported crypto suites).

If SRTP pass-thru feature is enabled, media interworking will not be supported. Ensure that you have symmetric configuration on both the incoming and outgoing dial-peers to avoid media-related issues.

Configure Pass-Through of Unsupported Crypto Suites for a Specific Dial Peer

SUMMARY STEPS

1. **enable**
2. **configure terminal**
3. **dial-peer voice tag voip**
4. **destination-pattern string**
5. **session protocol sipv2**
6. **sessiontarget ipv4: destination-address**
7. **incoming called-number string**
8. **srtp pass-thru**
9. **codec codec**
10. **end**
11. **dial-peer voice tag voip**
12. Repeat Steps 4, 5, 6, and 7 to configure a second dial peer.
13. **srtp pass-thru**
14. **codec codec**
15. **exit**

DETAILED STEPS

	Command or Action	Purpose
Step 1	enable Example: Device> enable	Enables privileged EXEC mode. <ul style="list-style-type: none"> • Enter your password if prompted.
Step 2	configure terminal Example: Device# configure terminal	Enters global configuration mode.

	Command or Action	Purpose
Step 3	dial-peer voice tag voip Example: <pre>Device(config)# dial-peer voice 201 voip</pre>	Defines a particular dial peer, to specify the method of voice encapsulation, and enters dial peer voice configuration mode. <ul style="list-style-type: none"> In the example, the following parameters are set: <ul style="list-style-type: none"> Dial peer 201 is defined. VoIP is shown as the method of encapsulation.
Step 4	destination-pattern string Example: <pre>Device(config-dial-peer)# destination-pattern 5550111</pre>	Specifies either the prefix or the full E.164 telephone number to be used for a dial peer string. <ul style="list-style-type: none"> In the example, 5550111 is specified as the pattern for the telephone number.
Step 5	session protocol sipv2 Example: <pre>Device(config-dial-peer)# session protocol sipv2</pre>	Specifies a session protocol for calls between local and remote routers using the packet network. <ul style="list-style-type: none"> In the example, the sipv2 keyword is configured so that the dial peer uses the IETF SIP.
Step 6	sessiontarget ipv4: destination-address Example: <pre>Device(config-dial-peer)# session target ipv4:10.13.25.102</pre>	Designates a network-specific address to receive calls from a VoIP or VoIPv6 dial peer. <ul style="list-style-type: none"> In the example, the IP address of the dial peer to receive calls is configured as 10.13.25.102.
Step 7	incoming called-number string Example: <pre>Device(config-dial-peer)# incoming called-number 5550111</pre>	Specifies a digit string that can be matched by an incoming call to associate the call with a dial peer. <ul style="list-style-type: none"> In the example, 5550111 is specified as the pattern for the E.164 or private dialing plan telephone number.
Step 8	srtp pass-thru Example: <pre>Device(config-dial-peer)# srtp pass-thru</pre>	Enables transparent passthrough of all crypto suites for a specific dial peer.
Step 9	codec codec Example: <pre>Device(config-dial-peer)# codec g711ulaw</pre>	Specifies the voice coder rate of speech for the dial peer. <ul style="list-style-type: none"> In the example, G.711 mu-law at 64,000 bps, is specified as the voice coder rate for speech.
Step 10	end Example: <pre>Device(config-dial-peer)#end</pre>	Exits dial peer voice configuration mode.

	Command or Action	Purpose
Step 11	dial-peer voice tag voip Example: Device(config)# dial-peer voice 200 voip	Defines a particular dial peer, to specify the method of voice encapsulation, and enters dial peer voice configuration mode. <ul style="list-style-type: none"> • In the example, the following parameters are set: <ul style="list-style-type: none"> • Dial peer 200 is defined. • VoIP is shown as the method of encapsulation.
Step 12	Repeat Steps 4, 5, 6, and 7 to configure a second dial peer.	--
Step 13	srtp pass-thru Example: Device(config-dial-peer)# srtp pass-thru	Enables transparent passthrough of all crypto suites for a specific dial peer.
Step 14	codec codec Example: Device(config-dial-peer)# codec g711ulaw	Specifies the voice coder rate of speech for the dial peer. <ul style="list-style-type: none"> • In the example, G.711 mu-law at 64,000 bps, is specified as the voice coder rate for speech.
Step 15	exit Example: Device(config-dial-peer)# exit	Exits dial peer voice configuration mode.

Configure Pass-Through of Unsupported Crypto Suites Globally

SUMMARY STEPS

1. **enable**
2. **configure terminal**
3. **voice service voip**
4. **srtp pass-thru**
5. **end**

DETAILED STEPS

	Command or Action	Purpose
Step 1	enable Example: Device> enable	Enables privileged EXEC mode. <ul style="list-style-type: none"> • Enter your password if prompted.

	Command or Action	Purpose
Step 2	configure terminal Example: Device# configure terminal	Enters global configuration mode.
Step 3	voice service voip Example: Device(config)# voice service voip	Enters VoIP voice-service configuration mode.
Step 4	srtp pass-thru Example: Device(config-dial-peer)# srtp pass-thru	Enables transparent passthrough of all crypto suites globally.
Step 5	end Example: Device(config-dial-peer)# end	Exits dial peer voice configuration mode.

Configuration Examples for SRTP-SRTP Pass-Through

Example for SRTP=SRTP Pass-Through

```
enable
configure terminal
dial-peer voice 201 voip
destination-pattern 5550111
session protocol sipv2
session target ipv4:10.13.25.102
incoming called-number 5550111
srtp
codec g711ulaw
end

dial-peer voice 200 voip
destination-pattern 5550111
session protocol sipv2
session target ipv4:10.13.25.101
incoming called-number 5550111
srtp
codec g711ulaw
end
```

Example for Pass-Through of Unsupported Crypto Suites for a specific dial peer

```
enable
configure terminal
```

```
dial-peer voice 201 voip
destination-pattern 5550111
session protocol sipv2
session target ipv4:10.13.25.102
incoming called-number 5550111
srtp pass-thru
codec g711ulaw
end
```

```
dial-peer voice 200 voip
destination-pattern 5550111
session protocol sipv2
session target ipv4:10.13.25.101
incoming called-number 5550111
srtp pass-thru
codec g711ulaw
end
```

Example for Pass-Through of Unsupported Crypto Suites Globally

```
enable
configure terminal
voice service voip
srtp pass-thru
end
```



PART **XIV**

High Availability

- [High Availability on Cisco 4000 Series ISR and Cisco Catalyst 8000 Series Edge Platforms, on page 707](#)
- [High Availability on Cisco ASR 1000 Series Aggregation Services Routers, on page 729](#)
- [High Availability on Cisco CSR 1000V or C8000V Cloud Services Routers, on page 759](#)
- [High Availability on Cisco Integrated Services Routers \(ISR-G2\), on page 771](#)
- [DSP High Availability Support , on page 811](#)
- [Stateful Switchover Between Redundancy Paired Intra- or Inter-box Devices, on page 815](#)
- [CVP Survivability TCL support with High Availability, on page 829](#)



CHAPTER 55

High Availability on Cisco 4000 Series ISR and Cisco Catalyst 8000 Series Edge Platforms

The High Availability (HA) feature allows you to benefit from the failover capability of Cisco Unified Border Element (CUBE) on two routers, one active and one standby. When the active router goes down for any reason, the standby router takes over seamlessly, preserving and processing your calls.

Figure 63: Cisco CUBE High Availability

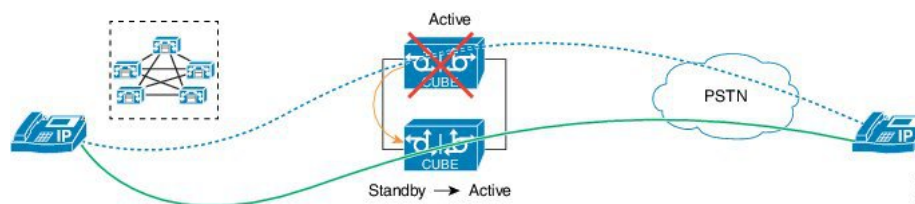

- [About CUBE High Availability on Cisco 4000 Series ISR and Cisco Catalyst 8000 Series Edge Platforms, on page 707](#)
- [How to Configure CUBE High Availability on Cisco 4000 Series ISR and Cisco Catalyst 8000 Series Edge Platforms, on page 712](#)
- [Verify Your Configuration, on page 718](#)
- [Troubleshoot High Availability Issues, on page 726](#)

About CUBE High Availability on Cisco 4000 Series ISR and Cisco Catalyst 8000 Series Edge Platforms

CUBE supports Box-to-box redundancy on Cisco 4000 Series Integrated Services Router (Cisco 4000 Series ISR), Cisco Catalyst 8300, 8200, and 8200-L Series Edge Platforms, and uses Redundancy Group Infrastructure to provide High Availability.

Box-to-Box Redundancy

Box-to-box redundancy enables configuring a pair of routers to act as back up for each other. In the router pair, the active router is determined based on the failover conditions. The router pair continuously exchange status messages. CUBE session information is checkpointed across the active and standby router. This enables

the standby router to immediately take over all CUBE call processing responsibilities when the active router becomes unavailable.

Redundancy Group (RG) Infrastructure

A group of redundant interfaces form a Redundancy Group. The active and standby routers are connected by a configurable control link and data synchronization link. The control link is used to communicate the redundancy state for each router. The data synchronization link is used to transfer stateful information to synchronize the stateful database for the calls and media flows. Each pair of redundant interfaces is configured with the same unique ID number, also known as the Redundancy Interface Identifier (RII).

A Virtual IP address (VIP) is configured on interfaces that connect to the external network. All signaling and media is sourced from and sent to the Virtual IP address. External devices such as Cisco Unified Communication Manager, uses VIP as the destination IP address for the calls traversing through Cisco UBE.

The following figure shows the redundancy group configured for a pair of routers with a single outgoing interface.

Figure 64: Redundancy Group Configuration

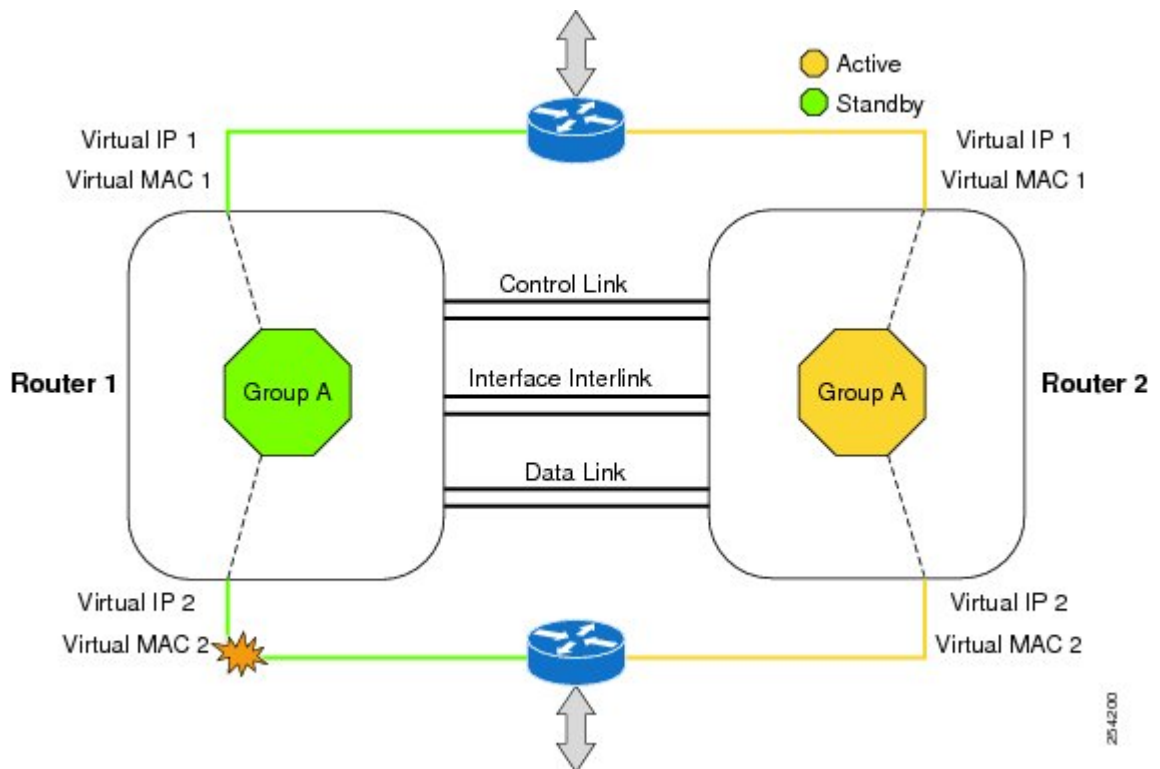

Network Topology

This section describes how to configure the following network topology. PSTN access uses an Active and Standby pair of routers in a SIP trunk deployment between a Cisco Unified Communications Manager (Unified CM) and a service provider SIP trunk.

Figure 65: Network Topology with switch between active and standby routers

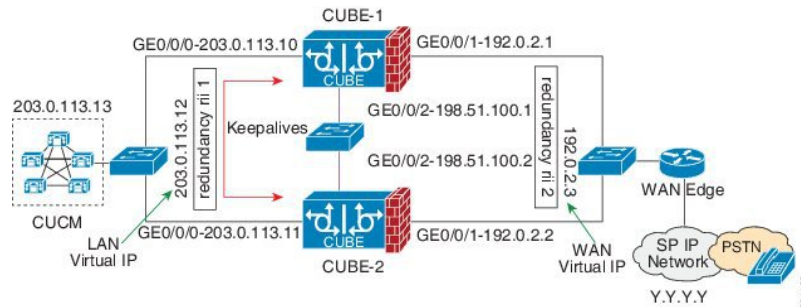
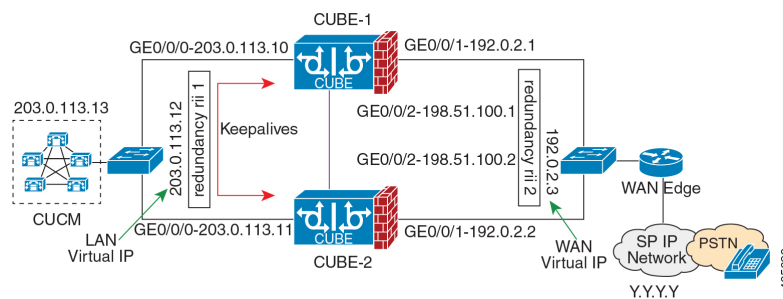

Figure 66: Network Topology with crossover cable between active and standby routers



In this topology, both Active and Standby routers have the same configuration and connects through a physical switch across same interfaces. The topology is mandatory for the CUBE High Availability (HA) to work. For example, the CUBE-1 and CUBE-2 interface toward WAN must terminate on the same switch. Use Multiple interfaces or subinterfaces on either LAN or WAN side. Also, one CUBE has a lower IP address across all three interfaces on the same CUBE platform.

We recommend that you keep the following in mind when configuring this topology:

- Connect the redundancy group control and data interfaces in the CUBE HA pair to the same physical switch to avoid any latency in the network.
- The RG control and data interfaces of the CUBE HA pair can be connected through a back-to-back cable or using a switch as shown in figures **Network Topology with switch between active and standby routers** and **Network Topology with crossover cable between active and standby routers**. However, it is recommended to use Portchannel for the RG control and data interfaces for redundancy. A single connection using back-to-back cable or switch presents a single point of failure due to a faulty cable, port, or switch, resulting in error state where both routers are Active.
- If the RG ID is the same for the two different CUBE HA pairs, keepalive interface for check-pointing the RG control and data, and traffic must be in a different subnet or VLAN.



Note This recommendation is applicable only if you connect using a switch, not by back-to-back cables.

- You can configure a maximum of two redundancy groups. Hence, there can be only two Active and Standby pairs within the same network.



Note This recommendation is applicable only if you connect using a switch, not by back-to-back cables.

- Source all signaling and media from and to the virtual IP address.
- Always save the running configuration to avoid losing it due to router reload during a failover.
- Virtual Routing and Forwarding
 - Define Virtual Router Forwarding (VRF) in the same order on both Active and Standby routers for an accurate synchronization of data.
 - You can configure VRFs only on the traffic interface (SIP and RTP). Do not configure VRF on redundancy group control and data interface.
 - VRF configurations on both the Active and Standby router must be identical. VRF IDs checkpoints for the calls before and after switchover (includes VRF-based RTP port range).
- Manually copy the configurations from one router to the other.
- Replicating the configuration on the Standby router does not commit to the startup configuration; it is the running configuration. You must run the **write memory** command to commit the changes that are synchronized from the Active router on the Standby router.

Considerations and Restrictions

The following is a list of further considerations and restrictions you should know before configuring this topology:

Considerations

- Only active calls are checkpointed (Calls that are connected with 200 OK or ACK transaction completed).
- When you apply and save the configuration for the first time, the platform must be reloaded.
- For H.323, and TCP-based calls, media preservation is supported after the failover, but session signaling is not preserved.
- If you have Cisco Unified Customer Voice Portal (CVP) in your network, we recommend that you configure TCP session transport for the SIP trunk between CVP and CUBE.
- Upon failover, the previously active CUBE reloads by design.
- CUBE uses the virtual IP address to communicate Smart Licensing information.
- For SIP-SIP TLS calls, configure both the active and standby CUBE as trust points to a common external CA Server.
- TCP sessions are not preserved during the failover. Remote user agents are expected to reestablish TCP sessions (using port 5060) before sending subsequent messages.
- Call Admission Control (CAC) state is maintained through switchover. After Stateful Switchover, no calls are allowed if the CAC limit is reached before the switchover.

- Up to six multimedia lines in the SDP are checkpointed for CUBE high availability. From Cisco IOS XE Release 3.17 onwards, SDP Passthru (up to two m-lines) calls are also checkpointed.
- Survivability.tcl preservation is supported from Cisco IOS XE Release 3.17 onwards for Unified Customer Voice Portal (CVP) deployments.
- SRTP-RTP, SRTP-SRTP, and SRTP Passthru are supported.



Note Redundancy control traffic that is exchanged between CUBE-1 and CUBE-2 is not secured natively and displays SRTP encryption keys in cleartext. If SRTP is used, you must secure this traffic by configuring a transport IPsec tunnel between the two interfaces that are used as the redundancy control link.

- Port channel is supported for both RG control data and traffic interfaces only from Cisco IOS XE 16.3.1 onwards.

Figure 67: Additional Supported Options for CUBE HA

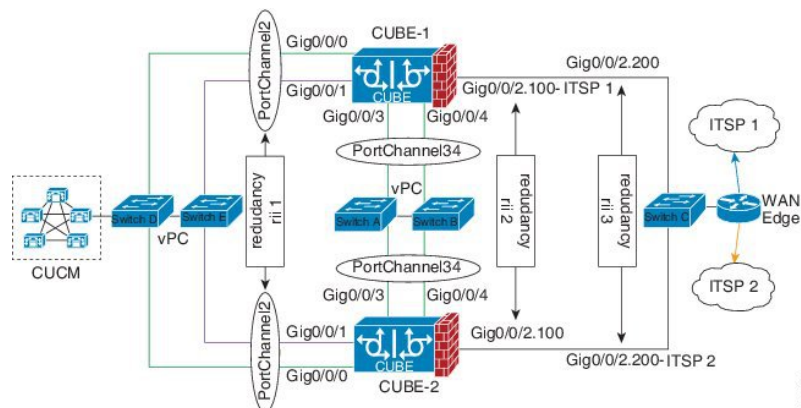

- LTI-based transcoder call flow preservation is supported from Cisco IOS XE Release 3.15 onwards and requires the same DSP module capacity on both active and standby in the same slot or subslot.
- While deploying High Availability pair with Application Centric Infrastructure (ACI), perform one of the following:
 - Disable IP data plane learning on the ACI VRF.
Refer to [IP Data-plane Learning](#) for details.
 - Use an intermediate Layer 3 switch between the High Availability pair and the ACI deployment. This Layer 3 switch prevents the ACI from directly learning the CUBE IP address and its associated MAC addresses.

Restrictions

- IPv6 is not supported.
- All SCCP-based media resources (Conference bridge, Transcoding, Hardware MTP, and Software MTP) are not supported.

- Cisco Unified Survivable Remote Site Telephony (Cisco Unified SRST) or TDM Gateway colocation on CUBE HA is not supported.
- Routers connected through Metropolitan Area Network (MAN) Ethernet regardless of latency are not supported.
- Out-of-band DTMF (Notify or KPML) is not supported post switchover. Only rtp-nte to rtp-nte and voice-inband to voice-inband DTMF works after the switchover.
- Media-flow around and UC Services API (Cisco Unified Communications Manager Network-Based Recording) are not supported.
- You cannot terminate Wide Area Network (WAN) on CUBE directly or Data HA on either side. Both active and standby routers must be in the same Data Center and connected to the same physical switch.
- The Courtesy Callback (CCB) feature is not supported if a callback was registered with Cisco Unified Customer Voice Portal (CVP) and then a switchover was done on CUBE.
- You cannot configure a secondary IP address for the interfaces.
- If the redundancy group ID is same for the two different CUBE HA pairs, then the keepalive interface that is used for checkpointing RG control and data traffic must be in a different subnet or VLAN.
- Call Progress Analysis (CPA) calls (before transferred to the agent), SCCP-based media resources, Noise Reduction, Acoustic Shock Protection (ASP), and transrating calls are not supported.
- The failover time for a Box-to-box application is higher than the Inbox application.
- One CUBE must have lower IPs across all the three interfaces on the same CUBE platform. For instance, CUBE-1 must have lower IP addresses in Gig0/0/0 interface compared with CUBE-2 Gig0/0/0 interface.
- CUBE box-to-box high availability requires same priority and threshold to be configured on both CUBE-1 and CUBE-2.

How to Configure CUBE High Availability on Cisco 4000 Series ISR and Cisco Catalyst 8000 Series Edge Platforms

Before You Begin

- Use Cisco IOS-XE Release 3.11 and or later on both active and standby routers.
- Ensure that you have the required licenses for configuring high availability. For detailed information, see [Cisco Unified Border Element Data Sheet](#).
- Connect the active and the standby router through a layer 2 connection for the control path.
- Configure the Network Time Protocol (NTP) or set the clock to be identical on both active and standby routers, to allow timestamps and call timers to match.
- The latency times must be minimal on all control and data links to prevent timeouts.
- Physically redundant links, such as Gigabit EtherChannel, must be used for the control and data paths.

Configure High Availability

SUMMARY STEPS

1. Configure the Redundancy Group (RG).
2. Configure interface tracking.
3. Configure the interfaces.
4. Configure SIP Binding.
5. (Optional) If H.323 calls are involved, enable H.323 binding.
6. Configure the Punt Policing feature.
7. Configure the RG group under **voice service voip**. This enables Box-to-box CUBE HA.
8. Configure the Media Inactivity timer.
9. Reload the router.
10. Configure the peer router.
11. Point the attached devices to the CUBE Virtual IP (VIP) address.

DETAILED STEPS

Step 1 Configure the Redundancy Group (RG).

- a) Enter application redundancy mode.

Example:

```
Router>enable
Router#configure terminal
Router(config)#redundancy
Router(config-r)#mode none
Router(config-red)#application redundancy
Router(config-red-app)#group 1
```

- b) Configure a name for the redundancy group.

Example:

```
Router(config-red-app-grp)#name cube-ha
```

where *cube-ha* is the name of the redundancy group.

- c) Specify the initial priority and failover threshold for a redundancy group.

Example:

```
Router(config-red-app-grp)#priority 100 failover threshold 75
```

where 100 is the priority value and 75 is the threshold value. Both routers should have the same priority and threshold values.

- d) Configure the timers for delay and reload.

Example:

```
Router(config-red-app-grp)#timers delay 30 reload 60
```

Delay timer which is the amount of time to delay the RG group's initialization and role negotiation after the interface comes up.

Default: 30 seconds. Range is 0-10000 seconds.

Reload timer is the amount of time to delay RG group initialization and role-negotiation after a reload.

Default: 60 seconds. Range is 0-10000 seconds.

- e) Configure the interface used to exchange keepalive and hello messages between the router pair.

Example:

```
Router(config-red-app-grp)#control GigabitEthernet0/0/2 protocol 1
```

where GigabitEthernet0/0/2 is the interface and protocol 1 is the protocol instance that is attached to the interface.

- f) Configure the interface that is used for checkpointing of data traffic.

Example:

```
Router(config-red-app-grp)#data GigabitEthernet0/0/2
```

- g) Configure RG group tracking.

Example:

```
Router(config-red-app-grp)#track 1 shutdown
Router(config-red-app-grp)#track 2 shutdown
```

- h) Specify the protocol instance that will be attached to a control interface and enters redundancy application protocol configuration mode.

Example:

```
Router(config-red-app-grp)#protocol 1
```

- i) Configure the two timers for hellotime and holdtime.

Example:

```
Router(config-red-app-grp)#timers hellotime 3 holdtime 10
```

hellotime—Interval between successive hello messages.

Default is 3 seconds. Range is 250 milliseconds-254 seconds.

holdtime—The interval between the receipt of a hello message and the presumption that the sending router has failed. This duration has to be greater than the hellotime.

Default is 10 seconds. Range is 750 milliseconds-255 seconds.

We recommend that you configure the holdtime timer that is configured to be at least 3 times the value of the hellotime timer.

Step 2 Configure interface tracking.

The **track** command is used in RG to track the voice traffic interface state so that the active router initiates switchover after the traffic interface is down.

Configure the following commands at the global level to track the status of the interface.

Example:

```
Router(config)#track 1 interface GigabitEthernet0/0/0 line-protocol
Router(config)#track 2 interface GigabitEthernet0/0/1 line-protocol
```

Step 3 Configure the interfaces.

- a) Configure the redundancy interface identifier for the redundancy group.

Required for generating a Virtual MAC (VMAC) address. You must use the same rii ID value on the interface of each router (active and standby) that has the same Virtual IP address.

If there is more than one Box-to-box HA pair on the same LAN, each pair **MUST** have unique rii IDs on their respective interfaces (to prevent collision). **show redundancy application group all** must indicate the correct local and peer information.

Example:

```
Router(config)#interface GigabitEthernet0/0/0
Router(config-if)#ip address 203.0.113.10 255.255.0.0
Router(config-if)#negotiation auto
Router(config-if)#redundancy rii 1

Router(config)#interface GigabitEthernet0/0/1
Router(config-if)#ip address 192.0.2.1 255.255.255.0
Router(config-if)#negotiation auto
Router(config-if)#redundancy rii 2
```

- b) Associate the interface with the redundancy group created.

Example:

```
Router(config-if)#redundancy group 1 ip 203.0.113.12 exclusive
Router(config-if)#redundancy group 1 ip 192.0.2.3 exclusive
```

- c) Configure interface for RG control and data.

Example:

```
Router(config)#interface GigabitEthernet0/0/2
Router(config-if)#ip address 198.51.100.1 255.255.255.0
Router(config-if)#media-type rj45
Router(config-if)#negotiation auto
```

Step 4

Configure SIP Binding.

Configure CUBE to bind SIP messages to the interface that is configured with a Virtual IP address (VIP) for the RG group employed.

Example:

```
Router(config)#dial-peer voice 1 voip
Router(config-dial-peer)#session protocol sipv2
Router(config-dial-peer)#incoming called-number 2000
Router(config-dial-peer)#voice-class sip bind control source-interface GigabitEthernet0/0/0
Router(config-dial-peer)#voice-class sip bind media source-interface GigabitEthernet0/0/0
Router(config-dial-peer)#codec g711ulaw
Router(config-dial-peer)#!

Router(config)#dial-peer voice 2 voip
Router(config-dial-peer)#destination-pattern 2000
Router(config-dial-peer)#session protocol sipv2
Router(config-dial-peer)#session target ipv4:203.0.113.13
Router(config-dial-peer)#voice-class sip bind control source-interface GigabitEthernet0/0/1
Router(config-dial-peer)#voice-class sip bind media source-interface GigabitEthernet0/0/1
Router(config-dial-peer)#codec g711ulaw
```

Step 5

(Optional) If H.323 calls are involved, enable H.323 binding.

Under the interface used by H.323, configure `voip-bind` with its source address equal to the interface's VIP for the RG group employed.

Example:

```
Router#voice service voip
Router(conf-voi-serv)#h323
Router(conf-serv-h323)#call preserve limit-media-detection
Router(conf-serv-h323)#no h225 timeout keepalive

Router(config)#interface GigabitEthernet0/0/0
Router(config-if)#ip address 203.0.113.10 255.255.0.0
Router(config-if)#media-type rj45
Router(config-if)#negotiation auto
Router(config-if)#redundancy rii 1
Router(config-if)#redundancy group 1 ip 9.13.25.123 exclusive
Router(config-if)#h323-gateway voip interface
Router(config-if)#h323-gateway voip bind srcaddr 203.0.113.12

Router(config)#interface GigabitEthernet0/0/1
Router(config-if)#ip address 192.0.2.1 255.255.255.0
Router(config-if)#media-type rj45
Router(config-if)#negotiation auto
Router(config-if)#redundancy rii 2
Router(config-if)#redundancy group 1 ip 192.0.2.3 exclusive
Router(config-if)#h323-gateway voip interface
Router(config-if)#h323-gateway voip bind srcaddr 192.0.2.3
```

Step 6

Configure the Punt Policing feature.

SIP packets towards the virtual IP address and physical IP address match different punt-cause codes. The punt-rate of the virtual IP address with a punt-cause of 60, is lower than the punt-rate of the physical IP address.

To ensure that the behaviour of the SIP packets towards virtual and physical IP address remains the same, you must increase the punt-rate of the virtual IP address by using the **platform punt-policer** command in global configuration mode.

Note For Cisco IOS XE Releases 16.6.7, 16.9.4, 16.11.1, 16.12.1, 17.1.1 and later releases, you do not need to increase the punt-rate.

Example:

```
Router(config)#platform punt-policer 60 40000
```

In the preceding example, the punt-rate of the virtual IP address (punt-cause 60) is increased from the default value of 2000–40000.

The following table provides details of the fields of the CLI.

Keyword	Description
platform punt-policer	Configures the Punt Policing feature.
<i>60</i>	<i>punt-cause</i> —Punt cause. Range is 1–107. Punt cause of the virtual interface is 60.
<i>40000</i>	<i>punt-rate</i> —Rate limit in packets per second. Range is 10–146484.

Note The default punt rate value of the virtual IP address and the physical IP address varies with the router platform.

Note The default and maximum setting are platform-specific. Default value is optimal for most deployments. Change the rate only when suggested by Cisco Support.

Step 7 Configure the RG group under **voice service voip**. This enables Box-to-box CUBE HA.

Example:

```
Router#voice service voip
Router(conf-voi-serv)#redundancy-group 1
```

Step 8 Configure the Media Inactivity timer.

The Media Inactivity Timer enables the active and standby router pair to monitor and disconnect calls if no Real-Time Protocol (RTP) packets are received within a configurable time period.

For the SIP calls, the switched over calls are cleared with signaling (as signaling information is preserved for switched calls).

The Media Inactivity Timer releases TCP-based and H.323-based calls. This is used to guard against any hung sessions resulting from the failover when a normal call disconnect does not clear the call.

You must configure the same duration for the Media Inactivity Timer on both routers. The default value is 30 seconds for SIP and H.323 calls. The sample configuration is as follows:

Example:

```
Router(config)#ip rtcp report interval 9000
Router(config)#gateway
Router(config-gateway)#media-inactivity-criteria all
Router(config-gateway)#timer receive-rtp 1200
Router(config-gateway)#timer receive-rtcp 5
```

SIP and H.323 call legs are cleared once the RTCP timer expires.

Step 9 Reload the router.

Once all the preceding configurations are completed, you must save the configurations, and reload the router.

Example:

```
Router>enable
Router#relaod
```

Step 10 Configure the peer router.

Follow the preceding steps to configure the standby router. Make sure that you use the correct IP addresses.

Step 11 Point the attached devices to the CUBE Virtual IP (VIP) address.

The IP-PBX, Unified SIP Proxy, or service provider must route the calls to CUBE's Virtual IP address.

HA configuration does not handle SIP and H.323 messages to the CUBE's physical IP addresses.

For H.323 calls, you must disable the keepalive messages in Unified CM configuration.

- a. Go to **System** menu, and choose **Service Parameters**. At the bottom of the Service Parameters, enable **Advanced**.
- b. Set the **Allow TCP KeepAlives for H323** to False.

- c. After this setting is saved, restart the CallManager Services.

Configuration Examples

Example: Control Interface Protocol Configuration

```
Router#configure terminal
Router(config)#redundancy
Router(config-red)#mode none
Router(config-red)#application redundancy
Router(config-red-app)#protocol 4
Router(config-red-app-prot)#name rgl
Router(config-red-app-prot)#timers hellotime 3 holdtime 10
Router(config-red-app-prot)#authentication text password
```

Example: Redundancy Group Protocol Configuration

```
Router#configure terminal
Router(config)#redundancy
Router(red)#application redundancy
Router(config-red-app)#protocol 1
Router(config-red-app-prtcl)#name RG1
Router(config-red-app-prtcl)#timers hellotime 1 holdtime 3
Router(config-red-app-prtcl)#end
Router#configure terminal
Router(config)#redundancy
Router(red)#application redundancy
Router(config-red-app)#protocol 2
Router(config-red-app-prtcl)#name RG1
Router(config-red-app-prtcl)#end
```

Example: Redundant Traffic Interface Configuration

```
Router#configure terminal
Router(config)#interface GigabitEthernet 0/0/2
Router(config-if)#ip address 198.51.100.1 255.0.0.0
Router(config-if)#ip nat outside
Router(config-if)#ip virtual-reassembly
Router(config-if)#negotiation auto
Router(config-if)#redundancy rii 200
Router(config-if)#redundancy group 1 ip 198.51.100.50 exclusive decrement 10
```

Verify Your Configuration

All configuration commands in this task are optional. You can use the **show** commands in any order.

SUMMARY STEPS

1. **show redundancy application group** [*group-id* | **all**]
2. **show redundancy application transport** {**clients** | **group** [*group-id*]}

3. **show redundancy application protocol** *{protocol-id | group [group-id]}*
4. **show redundancy application faults group** *[group-id]*
5. **show redundancy application if-mgr** *group [group-id]*
6. **show redundancy application control-interface** *group [group-id]*
7. **show redundancy application data-interface** *group [group-id]*

DETAILED STEPS

Step 1 **show redundancy application group** *[group-id | all]*

Example:

```
Router#show redundancy application group
Group ID      Group Name                State
-----
1             Generic-Redundancy-1     STANDBY
2             Generic-Redundancy2     ACTIVE
```

The following example shows the details of redundancy application group 1:

```
Router#show redundancy application group 1
Group ID:1
Group Name:Generic-Redundancy-1

Administrative State: No Shutdown
Aggregate operational state : Up
My Role: STANDBY
Peer Role: ACTIVE
Peer Presence: Yes
Peer Comm: Yes
Peer Progression Started: Yes

RF Domain: btob-one
RF state: STANDBY HOT
Peer RF state: ACTIVE
```

The following example shows the details of redundancy application group 2:

```
Router#show redundancy application group 2
Group ID:2
Group Name:Generic-Redundancy2

Administrative State: No Shutdown
Aggregate operational state : Up
My Role: ACTIVE
Peer Role: STANDBY
Peer Presence: Yes
Peer Comm: Yes
Peer Progression Started: Yes

RF Domain: btob-two
RF state: ACTIVE
Peer RF state: STANDBY HOT
```

Step 2 **show redundancy application transport** *{clients | group [group-id]}*

Example:

```
Router#show redundancy application transport client
```

Client	Conn#	Priority	Interface	L3	L4
(0)RF	0	1	CTRL	IPV4	SCTP
(1)MCP_HA	1	1	DATA	IPV4	UDP_REL
(4)AR	0	1	ASYM	IPV4	UDP
(5)CF	0	1	DATA	IPV4	SCTP

The following example shows configuration details for the redundancy application transport group:

```
Router#show redundancy application transport group
```

```
Transport Information for RG (1)
Client = RF
TI  conn_id my_ip          my_port peer_ip      peer_por intf  L3    L4
0   0        1.1.1.1          59000   1.1.1.2     59000  CTRL  IPV4  SCTP
Client = MCP_HA
TI  conn_id my_ip          my_port peer_ip      peer_por intf  L3    L4
1   1        9.9.9.2           53000   9.9.9.1     53000  DATA IPV4  UDP_REL
Client = AR
TI  conn_id my_ip          my_port peer_ip      peer_por intf  L3    L4
2   0        0.0.0.0           0       0.0.0.0     0      NONE_IN NONE_L3 NONE_L4
Client = CF
TI  conn_id my_ip          my_port peer_ip      peer_por intf  L3    L4
3   0        9.9.9.2           59001   9.9.9.1     59001  DATA IPV4  SCTP
Transport Information for RG (2)
Client = RF
TI  conn_id my_ip          my_port peer_ip      peer_por intf  L3    L4
8   0        1.1.1.1          59004   1.1.1.2     59004  CTRL  IPV4  SCTP
Client = MCP_HA
TI  conn_id my_ip          my_port peer_ip      peer_por intf  L3    L4
9   1        9.9.9.2           53002   9.9.9.1     53002  DATA IPV4  UDP_REL
Client = AR
TI  conn_id my_ip          my_port peer_ip      peer_por intf  L3    L4
10  0        0.0.0.0           0       0.0.0.0     0      NONE_IN NONE_L3 NONE_L4
Client = CF
TI  conn_id my_ip          my_port peer_ip      peer_por intf  L3    L4
11  0        9.9.9.2           59005   9.9.9.1     59005  DATA IPV4  SCTP
```

The following example shows the configuration details of redundancy application transport group 1:

```
Router#show redundancy application transport group 1
```

```
Transport Information for RG (1)
Client = RF
TI  conn_id my_ip          my_port peer_ip      peer_por intf  L3    L4
0   0        1.1.1.1          59000   1.1.1.2     59000  CTRL  IPV4  SCTP
Client = MCP_HA
TI  conn_id my_ip          my_port peer_ip      peer_por intf  L3    L4
1   1        9.9.9.2           53000   9.9.9.1     53000  DATA IPV4  UDP_REL
Client = AR
TI  conn_id my_ip          my_port peer_ip      peer_por intf  L3    L4
2   0        0.0.0.0           0       0.0.0.0     0      NONE_IN NONE_L3 NONE_L4
Client = CF
TI  conn_id my_ip          my_port peer_ip      peer_por intf  L3    L4
3   0        9.9.9.2           59001   9.9.9.1     59001  DATA IPV4  SCTP
```

The following example shows configuration details of redundancy application transport group 2:

```

Router#show redundancy application transport group 2
Transport Information for RG (2)
Client = RF
TI   conn_id my_ip           my_port peer_ip           peer_por intf    L3    L4
8    0       1.1.1.1         59004  1.1.1.2         59004  CTRL  IPV4  SCTP
Client = MCP_HA
TI   conn_id my_ip           my_port peer_ip           peer_por intf    L3    L4
9    1       9.9.9.2         53002  9.9.9.1         53002  DATA  IPV4  UDP_REL
Client = AR
TI   conn_id my_ip           my_port peer_ip           peer_por intf    L3    L4
10   0       0.0.0.0         0      0.0.0.0         0      NONE_IN NONE_L3 NONE_L4
Client = CF
TI   conn_id my_ip           my_port peer_ip           peer_por intf    L3    L4
11   0       9.9.9.2         59005  9.9.9.1         59005  DATA  IPV4  SCTP

```

Step 3 **show redundancy application protocol** {*protocol-id* | **group** [*group-id*]}

Example:

```

Router#show redundancy application protocol group

RG Protocol RG 1
-----
Role: Standby
Negotiation: Enabled
Priority: 50
Protocol state: Standby-hot
Ctrl Intf(s) state: Up
Active Peer: address 1.1.1.2, priority 150, intf Gi0/0/0
Standby Peer: Local
Log counters:
role change to active: 0
role change to standby: 1
disable events: rg down state 1, rg shut 0
ctrl intf events: up 2, down 1, admin_down 1
reload events: local request 0, peer request 0

RG Media Context for RG 1
-----
Ctx State: Standby
Protocol ID: 1
Media type: Default
Control Interface: GigabitEthernet0/0/0
Current Hello timer: 3000
Configured Hello timer: 3000, Hold timer: 10000
Peer Hello timer: 3000, Peer Hold timer: 10000
Stats:
Pkts 117, Bytes 7254, HA Seq 0, Seq Number 117, Pkt Loss 0
Authentication not configured
Authentication Failure: 0
Reload Peer: TX 0, RX 0
Resign: TX 0, RX 0
Active Peer: Present. Hold Timer: 10000
Pkts 115, Bytes 3910, HA Seq 0, Seq Number 1453975, Pkt Loss 0

RG Protocol RG 2
-----
Role: Active
Negotiation: Enabled
Priority: 135
Protocol state: Active
Ctrl Intf(s) state: Up

```

```

Active Peer: Local
Standby Peer: address 1.1.1.2, priority 130, intf Gi0/0/0
Log counters:
role change to active: 1
role change to standby: 1
disable events: rg down state 1, rg shut 0
ctrl intf events: up 2, down 1, admin_down 1
reload events: local request 0, peer request 0

RG Media Context for RG 2
-----
Ctx State: Active
Protocol ID: 2
Media type: Default
Control Interface: GigabitEthernet0/0/0
Current Hello timer: 3000
Configured Hello timer: 3000, Hold timer: 10000
Peer Hello timer: 3000, Peer Hold timer: 10000
Stats:
Pkts 118, Bytes 7316, HA Seq 0, Seq Number 118, Pkt Loss 0
Authentication not configured
Authentication Failure: 0
Reload Peer: TX 0, RX 0
Resign: TX 0, RX 1
Standby Peer: Present. Hold Timer: 10000
Pkts 102, Bytes 3468, HA Seq 0, Seq Number 1453977, Pkt Loss 0

```

The following example shows configuration details for the redundancy application protocol group 1:

```

Router#show redundancy application protocol group 1

RG Protocol RG 1
-----
Role: Standby
Negotiation: Enabled
Priority: 50
Protocol state: Standby-hot
Ctrl Intf(s) state: Up
Active Peer: address 1.1.1.2, priority 150, intf Gi0/0/0
Standby Peer: Local
Log counters:
role change to active: 0
role change to standby: 1
disable events: rg down state 1, rg shut 0
ctrl intf events: up 2, down 1, admin_down 1
reload events: local request 0, peer request 0

RG Media Context for RG 1
-----
Ctx State: Standby
Protocol ID: 1
Media type: Default
Control Interface: GigabitEthernet0/0/0
Current Hello timer: 3000
Configured Hello timer: 3000, Hold timer: 10000
Peer Hello timer: 3000, Peer Hold timer: 10000
Stats:
Pkts 120, Bytes 7440, HA Seq 0, Seq Number 120, Pkt Loss 0
Authentication not configured
Authentication Failure: 0
Reload Peer: TX 0, RX 0
Resign: TX 0, RX 0
Active Peer: Present. Hold Timer: 10000

```

Pkts 118, Bytes 4012, HA Seq 0, Seq Number 1453978, Pkt Loss 0

The following example shows configuration details for the redundancy application protocol group 2:

```
Router# show redundancy application protocol group 2

RG Protocol RG 2
-----
Role: Active
Negotiation: Enabled
Priority: 135
Protocol state: Active
Ctrl Intf(s) state: Up
Active Peer: Local
Standby Peer: address 1.1.1.2, priority 130, intf Gi0/0/0
Log counters:
role change to active: 1
role change to standby: 1
disable events: rg down state 1, rg shut 0
ctrl intf events: up 2, down 1, admin_down 1
reload events: local request 0, peer request 0

RG Media Context for RG 2
-----
Ctx State: Active
Protocol ID: 2
Media type: Default
Control Interface: GigabitEthernet0/0/0
Current Hello timer: 3000
Configured Hello timer: 3000, Hold timer: 10000
Peer Hello timer: 3000, Peer Hold timer: 10000
Stats:
Pkts 123, Bytes 7626, HA Seq 0, Seq Number 123, Pkt Loss 0
Authentication not configured
Authentication Failure: 0
Reload Peer: TX 0, RX 0
Resign: TX 0, RX 1
Standby Peer: Present. Hold Timer: 10000
Pkts 107, Bytes 3638, HA Seq 0, Seq Number 1453982, Pkt Loss 0
```

The following example shows configuration details for the redundancy application protocol 1:

```
Router#show redundancy application protocol 1

Protocol id: 1, name: rg-protocol-1
Hello timer in msec: 3000
Hold timer in msec: 10000
OVL1-1#show redundancy application protocol 2
Protocol id: 2, name: rg-protocol-2
Hello timer in msec: 3000
Hold timer in msec: 10000
```

Step 4 show redundancy application faults group [group-id]

Example:

```
Router#show redundancy application faults group

Faults states Group 1 info:
Runtime priority: [50]
RG Faults RG State: Up.
Total # of switchovers due to faults: 0
Total # of down/up state changes due to faults: 2
```

```

Faults states Group 2 info:
Runtime priority: [135]
RG Faults RG State: Up.
Total # of switchovers due to faults: 0
Total # of down/up state changes due to faults: 2

```

The following example shows configuration details specific to redundancy application faults group 1:

```

Router#show redundancy application faults group 1

Faults states Group 1 info:
Runtime priority: [50]
RG Faults RG State: Up.
Total # of switchovers due to faults: 0
Total # of down/up state changes due to faults: 2

```

The following example shows configuration details specific to redundancy application faults group 2:

```

Router#show redundancy application faults group 2

Faults states Group 2 info:
Runtime priority: [135]
RG Faults RG State: Up.
Total # of switchovers due to faults: 0
Total # of down/up state changes due to faults: 2

```

Step 5 `show redundancy application if-mgr group [group-id]`

Example:

```
Router#show redundancy application if-mgr group
```

```

RG ID: 1
=====

interface      GigabitEthernet0/0/3.152
-----
VMAC           0007.b421.4e21
VIP            55.1.1.255
Shut           shut
Decrement      10

interface      GigabitEthernet0/0/2.152
-----
VMAC           0007.b421.5209
VIP            45.1.1.255
Shut           shut
Decrement      10

RG ID: 2
=====

interface      GigabitEthernet0/0/3.166
-----
VMAC           0007.b422.14d6
VIP            4.1.255.254
Shut           no shut
Decrement      10

interface      GigabitEthernet0/0/2.166
-----
VMAC           0007.b422.0d06
VIP            3.1.255.254

```

```
Shut          no shut
Decrement     10
```

The following examples shows configuration details for redundancy application interface manager group 1 and group 2:

```
Router#show redundancy application if-mgr group 1
```

```
RG ID: 1
=====

interface     GigabitEthernet0/0/3.152
-----
VMAC          0007.b421.4e21
VIP           55.1.1.255
Shut          shut
Decrement     10

interface     GigabitEthernet0/0/2.152
-----
VMAC          0007.b421.5209
VIP           45.1.1.255
Shut          shut
Decrement     10
```

```
Router#show redundancy application if-mgr group 2
```

```
RG ID: 2
=====

interface     GigabitEthernet0/0/3.166
-----
VMAC          0007.b422.14d6
VIP           4.1.255.254
Shut          no shut
Decrement     10

interface     GigabitEthernet0/0/2.166
-----
VMAC          0007.b422.0d06
VIP           3.1.255.254
Shut          no shut
Decrement     10
```

Step 6 **show redundancy application control-interface group [group-id]**

Example:

```
Router#show redundancy application control-interface group
```

```
The control interface for rg[1] is GigabitEthernet0/0/0
Interface is Control interface associated with the following protocols: 2 1
Interface Neighbors:
Peer: 1.1.1.2 Active RGs: 1 Standby RGs: 2
```

```
The control interface for rg[2] is GigabitEthernet0/0/0
Interface is Control interface associated with the following protocols: 2 1
Interface Neighbors:
Peer: 1.1.1.2 Active RGs: 1 Standby RGs: 2
```

The following example shows configuration details of the redundancy application control-interface group 1:

```
Router#show redundancy application control-interface group 1
```

```
The control interface for rg[1] is GigabitEthernet0/0/0
Interface is Control interface associated with the following protocols: 2 1
Interface Neighbors:
Peer: 1.1.1.2 Active RGs: 1 Standby RGs: 2
```

The following example shows configuration details of the redundancy application control-interface group 2:

```
Router#show redundancy application control-interface group 2

The control interface for rg[2] is GigabitEthernet0/0/0
Interface is Control interface associated with the following protocols: 2 1
Interface Neighbors:
Peer: 1.1.1.2 Active RGs: 1 Standby RGs: 2
```

Step 7 **show redundancy application data-interface group [group-id]**

Example:

```
Router#show redundancy application data-interface group

The data interface for rg[1] is GigabitEthernet0/0/1
The data interface for rg[2] is GigabitEthernet0/0/1
```

The following examples show configuration details specific to redundancy application data-interface group 1 and group 2:

```
Router#show redundancy application data-interface group 1
The data interface for rg[1] is GigabitEthernet0/0/1

Router#show redundancy application data-interface group 2
The data interface for rg[2] is GigabitEthernet0/0/1
```

Troubleshoot High Availability Issues

Use the following show and debug commands to troubleshoot any issues:

- **show redundancy application group all**
- **show redundancy application transport clients**
- **show redundancy client domain all | inc VOIP RG**
- **show voice high-availability summary**
- **show voip fpi stats**
- **debug voip rtp session**
- **debug voice high-availability all**
- **debug voip fpi all**
- **debug redundancy application group {config | faults | media | protocol | rii transport | vp}**



Note Do not turn on a large number of debugs on a system carrying high volume of active call traffic.



CHAPTER 56

High Availability on Cisco ASR 1000 Series Aggregation Services Routers

The High Availability (HA) feature allows you to benefit from the failover capability of Cisco Unified Border Element (CUBE) on two routers, one active and one standby. When the active router goes down for any reason, the standby router takes over seamlessly, preserving and processing your calls.

Figure 68: Cisco CUBE High Availability

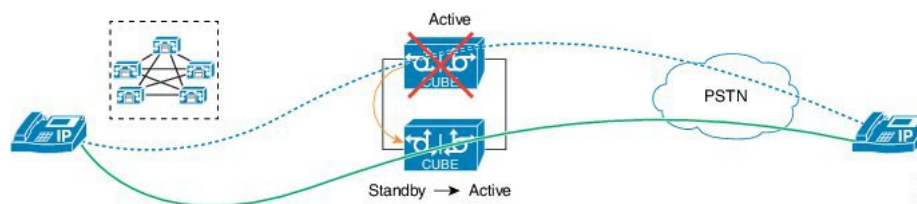

- [About CUBE High Availability on Cisco ASR 1000 Series Routers, on page 729](#)
- [How to Configure CUBE High Availability on Cisco ASR 1000 Series Router, on page 736](#)
- [Verify Your Configuration, on page 749](#)
- [Troubleshoot High Availability Issues, on page 756](#)

About CUBE High Availability on Cisco ASR 1000 Series Routers

CUBE supports two HA options on the Cisco ASR 1000 Series Aggregation Services Router:

- Box-to-box Redundancy
- Inbox Redundancy

The following table describes the Cisco ASR 1000 Series Router models supported for each redundancy type:

Table 79: Redundancy Type, Supported Models, and Supported Cisco IOS XE Release

Redundancy Type	Router Models	Supported Cisco IOS-XE Release
Box-to-box	<ul style="list-style-type: none"> • Cisco ASR 1001-X Router • Cisco ASR 1002-X Router • Cisco ASR 1004 Router • Cisco ASR 1006 Router (with a single RP and an ESP) • Cisco ASR 1006-X Router (with a single RP and an ESP) 	Cisco IOS XE Release 3.11 onwards
Inbox	Cisco ASR 1006 Router	Cisco IOS XE Release 3.11 onwards



Note Cisco ASR 1006 supports both Box-to-box and Inbox redundancy. You cannot switch between these two modes dynamically.

The following table provides details on the type of information that is preserved in different call types:

Table 80: Call Preservation for Various Call Types

Call Type	Transport Layer	Call Preservation After Switchover
SIP-SIP	UDP	Both media and session signaling are preserved.
SIP-SIP	TCP/TLS	Both media and session signaling are preserved using port 5060.
SIP-H.323	TCP or UDP	Only media is preserved. Session signaling is not preserved.
H.323-H.323	TCP	

Inbox Redundancy

Inbox redundancy with Stateful Switchover (SSO) mechanism provides redundancy within the same device. Cisco ASR1006 supports the stateful failover from an active Enhanced Services Processor (ESP) to a standby and from an active Route Processor to a standby on the same box.

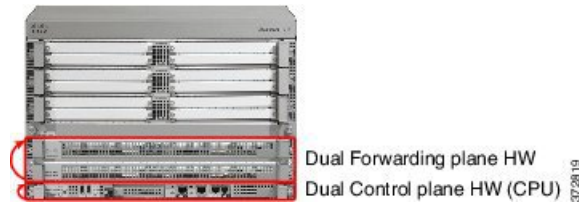
Figure 69: Inbox Redundancy

Box-to-Box Redundancy

Box-to-box redundancy enables configuring a pair of routers to act as back up for each other. In the router pair, the active router is determined based on the failover conditions. The router pair continuously exchange status messages. CUBE session information is checkpointed across the active and standby router. This enables the standby router to immediately take over all CUBE call processing responsibilities when the active router becomes unavailable.

Redundancy Group (RG) Infrastructure

A group of redundant interfaces form a Redundancy Group. The active and standby routers are connected by a configurable control link and data synchronization link. The control link is used to communicate the redundancy state for each router. The data synchronization link is used to transfer stateful information to synchronize the stateful database for the calls and media flows. Each pair of redundant interfaces is configured with the same unique ID number, also known as the Redundancy Interface Identifier (RII).

A Virtual IP address (VIP) is configured on interfaces that connect to the external network. All signaling and media is sourced from and sent to the Virtual IP address. External devices such as Cisco Unified Communication Manager, uses VIP as the destination IP address for the calls traversing through Cisco UBE.

The following figure shows the redundancy group configured for a pair of routers with a single outgoing interface.

Figure 70: Redundancy Group Configuration

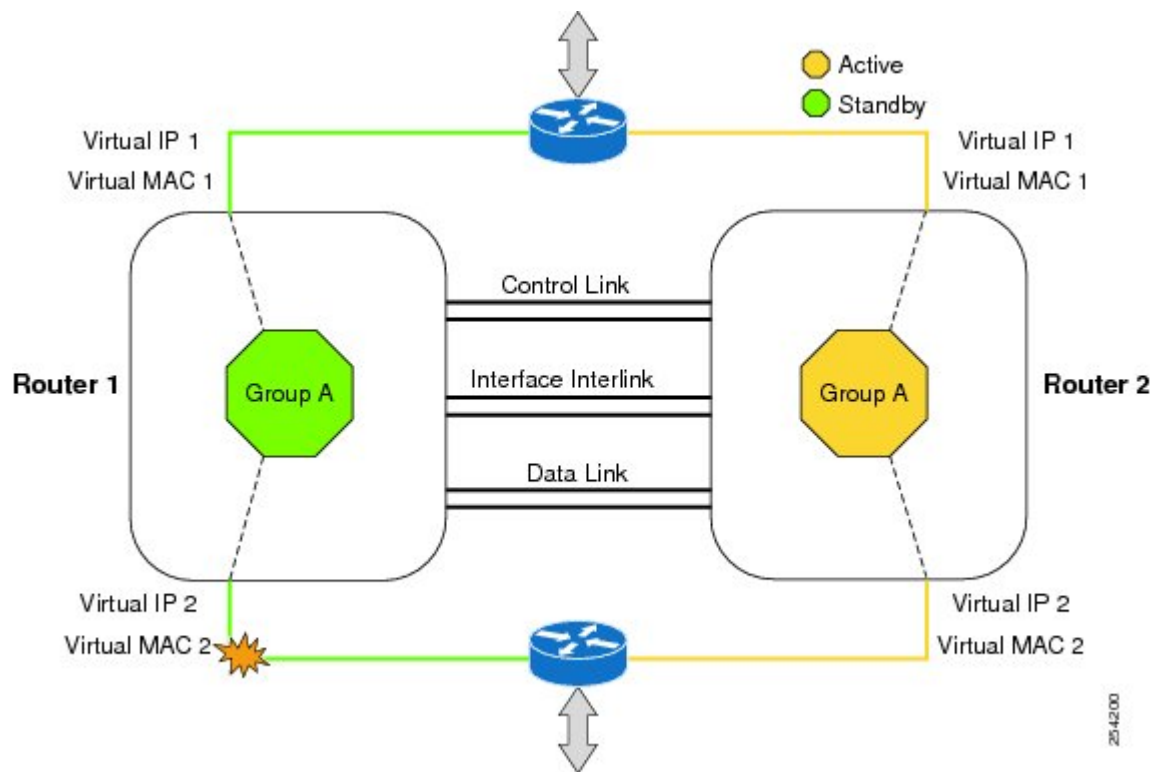

PROTECTED Mode

The default failover redundancy behavior in a box-to-box HA pair is to reload the affected router to avoid out-of-sync conditions or Split brain. From release IOS XE 3.11 onwards, you can configure a Cisco ASR 1000 Series Router to transition into PROTECTED mode, which has the following features:

- Bulk sync request, Call checkpointing, and incoming call processing are disabled.
- You must manually reload a router in PROTECTED mode to come out of this state.

To enable the PROTECTED mode, use the **no redundancy-reload** command under **voice service voip**.

Network Topology

This section describes how to configure the following network topology. PSTN access uses an Active and Standby pair of routers in a SIP trunk deployment between a Cisco Unified Communications Manager (Unified CM) and a service provider SIP trunk.

Figure 71: Network Topology with switch between active and standby routers

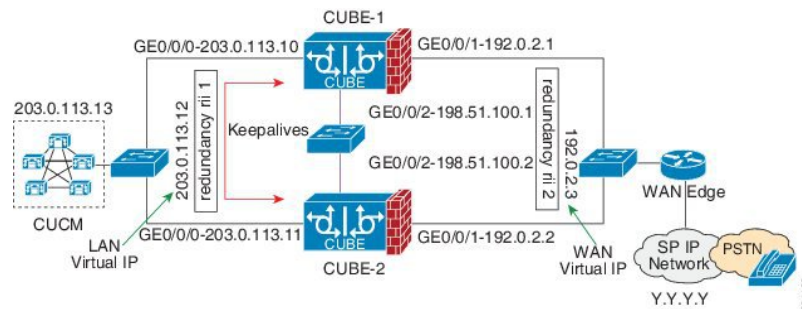
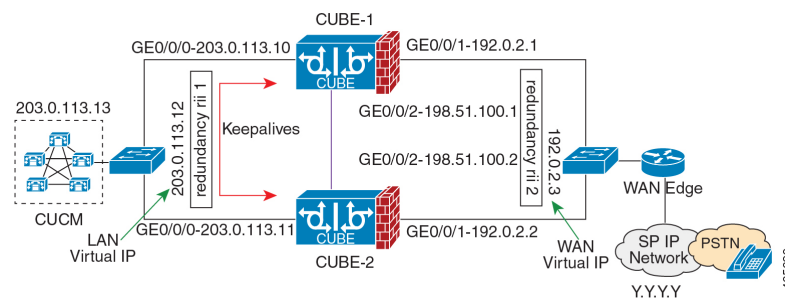

Figure 72: Network Topology with crossover cable between active and standby routers



In this topology, both Active and Standby routers have the same configuration and connects through a physical switch across same interfaces. The topology is mandatory for the CUBE High Availability (HA) to work. For example, the CUBE-1 and CUBE-2 interface toward WAN must terminate on the same switch. Use Multiple interfaces or subinterfaces on either LAN or WAN side. Also, one CUBE has a lower IP address across all three interfaces on the same CUBE platform.

We recommend that you keep the following in mind when configuring this topology:

- Connect the redundancy group control and data interfaces in the CUBE HA pair to the same physical switch to avoid any latency in the network.
- The RG control and data interfaces of the CUBE HA pair can be connected through a back-to-back cable or using a switch as shown in figures **Network Topology with switch between active and standby routers** and **Network Topology with crossover cable between active and standby routers**. However, it is recommended to use Portchannel for the RG control and data interfaces for redundancy. A single connection using back-to-back cable or switch presents a single point of failure due to a faulty cable, port, or switch, resulting in error state where both routers are Active.
- If the RG ID is the same for the two different CUBE HA pairs, keepalive interface for check-pointing the RG control and data, and traffic must be in a different subnet or VLAN.



Note This recommendation is applicable only if you connect using a switch, not by back-to-back cables.

- You can configure a maximum of two redundancy groups. Hence, there can be only two Active and Standby pairs within the same network.



Note This recommendation is applicable only if you connect using a switch, not by back-to-back cables.

- Source all signaling and media from and to the virtual IP address.
- Always save the running configuration to avoid losing it due to router reload during a failover.
- Virtual Routing and Forwarding
 - Define Virtual Router Forwarding (VRF) in the same order on both Active and Standby routers for an accurate synchronization of data.
 - You can configure VRFs only on the traffic interface (SIP and RTP). Do not configure VRF on redundancy group control and data interface.
 - VRF configurations on both the Active and Standby router must be identical. VRF IDs checkpoints for the calls before and after switchover (includes VRF-based RTP port range).
- Manually copy the configurations from one router to the other.
- Replicating the configuration on the Standby router does not commit to the startup configuration; it is the running configuration. You must run the **write memory** command to commit the changes that are synchronized from the Active router on the Standby router.

Considerations and Restrictions

The following is a list of further considerations and restrictions you should know before configuring this topology:

Considerations

- Only active calls are checkpointed (Calls that are connected with 200 OK or ACK transaction completed).
- When you apply and save the configuration for the first time, the platform must be reloaded.
- For H.323, and TCP-based calls, media preservation is supported after the failover, but session signaling is not preserved.
- If you have Cisco Unified Customer Voice Portal (CVP) in your network, we recommend that you configure TCP session transport for the SIP trunk between CVP and CUBE.
- Upon failover, the previously active CUBE reloads by design.
- CUBE uses the virtual IP address to communicate Smart Licensing information.
- For SIP-SIP TLS calls, configure both the active and standby CUBE as trust points to a common external CA Server.
- TCP sessions are not preserved during the failover. Remote user agents are expected to reestablish TCP sessions (using port 5060) before sending subsequent messages.
- Call Admission Control (CAC) state is maintained through switchover. After Stateful Switchover, no calls are allowed if the CAC limit is reached before the switchover.

- All SCCP-based media resources (Conference bridge, Transcoding, Hardware MTP, and Software MTP) are not supported.
- Cisco Unified Survivable Remote Site Telephony (Cisco Unified SRST) or TDM Gateway colocation on CUBE HA is not supported.
- Routers connected through Metropolitan Area Network (MAN) Ethernet regardless of latency are not supported.
- Out-of-band DTMF (Notify or KPML) is not supported post switchover. Only rtp-nte to rtp-nte and voice-inband to voice-inband DTMF works after the switchover.
- Media-flow around and UC Services API (Cisco Unified Communications Manager Network-Based Recording) are not supported.
- You cannot terminate Wide Area Network (WAN) on CUBE directly or Data HA on either side. Both active and standby routers must be in the same Data Center and connected to the same physical switch.
- The Courtesy Callback (CCB) feature is not supported if a callback was registered with Cisco Unified Customer Voice Portal (CVP) and then a switchover was done on CUBE.
- You cannot configure a secondary IP address for the interfaces.
- If the redundancy group ID is same for the two different CUBE HA pairs, then the keepalive interface that is used for checkpointing RG control and data traffic must be in a different subnet or VLAN.
- One CUBE must have lower IPs across all the three interfaces on the same CUBE platform. For instance, CUBE-1 must have lower IP addresses in Gig0/0/0 interface compared with CUBE-2 Gig0/0/0 interface.
- CUBE box-to-box high availability requires same priority and threshold to be configured on both CUBE-1 and CUBE-2.

How to Configure CUBE High Availability on Cisco ASR 1000 Series Router

Before You Begin

- Use the same hardware platform, including the cards and their positioning.
- Place both Active and Standby routers physically in the same location, which is connected to the same Ethernet LAN.
- If there are currently dual RPs or ESPs in the Cisco ASR 1006 Router, remove the extra RP or ESP and reload the router before configuring the redundancy mode.
- Use Cisco IOS-XE Release 3.11 and or later on both active and standby routers.
- Ensure that you have the required licenses for using CUBE in High Availability mode. For detailed information, see [Cisco Unified Border Element Data Sheet](#). In addition to an ASR1000 platform license (Advanced IP or Advanced Enterprise) and CUBE session licenses, a Firewall/NAT Stateful Inter-Chassis Redundancy License (Part number: FLSASR1-FWNAT-R) is also required for Box-to-Box High Availability configurations.

Configure Inbox High Availability

Enable inbox redundancy.

Example:

```
Router>enable
Router#configure terminal
Router(config)#redundancy
Router(config-r)#mode sso
Router(config-r)#end
Router(config)#copy run start /* This is to save the configuration */
```

Configure Box-to-Box High Availability

SUMMARY STEPS

1. Disable inbox and software redundancy.
2. Configure the Redundancy Group (RG).
3. Configure interface tracking.
4. Configure the interfaces.
5. Configure SIP Binding.
6. (Optional) If H.323 calls are involved, enable H.323 binding.
7. Configure the Punt Policing feature.
8. Configure the RG group under **voice service voip**. This enables Box-to-box CUBE HA.
9. Configure the Media Inactivity timer.
10. Reload the router.
11. Configure the peer router.
12. Point the attached devices to the CUBE Virtual IP (VIP) address.

DETAILED STEPS

Step 1 Disable inbox and software redundancy.

- a) Disable software redundancy.

Example:

Disable software redundancy:

```
Router>enable
Router#configure terminal
Router(config)#redundancy
Router(config-r)#mode none
```

Example:

Disable the inbox redundancy if you are using ASR1006 router:

```
Router>enable
Router#configure terminal
Router(config)#redundancy
Router(config-r)#mode rpr
```

- b) Save the running configuration to a text file in the bootflash.

Example:

```
Router>enable
Router#copy running-configuration bootflash:<filename>
```

In the preceding command, provide a name of your preference for *<filename>*.

- c) Force the router to go into ROMMON mode upon next reload and erase the existing configuration from the NVRAM:

Example:

```
Router>enable
Router#configure terminal
Router(config)#config-register 0x0
Router(config)#write erase
```

- d) Reload the router.

Example:

```
Router>enable
Router#reload
```

- e) At ROMMON prompt, reset the `IOSXE_Dual_IOS` variable to disable the software redundancy.

Example:

```
rommon1>IOSXE_DUAL_IOS=0
rommon2>sync
```

- f) Boot the image from the bootflash or harddisk, or from the network.

Example:

```
rommon1>boot bootflash:isr4400-universalk9.03.13.02.S.154-3.S2-ext.SPA.bin
```

- g) When the router is up, reapply the old configuration by copying the configuration file to the running-configuration.

Example:

```
Router>enable
Router#copy bootflash:sampleconfig running-configuration
```

- h) Change the config register back to a nonzero value.

Example:

```
Router>enable
Router#Config-register 0x2102
```

Step 2

Configure the Redundancy Group (RG).

- a) Enter application redundancy mode.

Example:

```
Router>enable
Router#configure terminal
Router(config)#redundancy
Router(config-r)#mode none
Router(config-red)#application redundancy
Router(config-red-app)#group 1
```

- b) Configure a name for the redundancy group.

Example:

```
Router(config-red-app-grp)#name cube-ha
```

where *cube-ha* is the name of the redundancy group.

- c) Specify the initial priority and failover threshold for a redundancy group.

Example:

```
Router(config-red-app-grp)#priority 100 failover threshold 75
```

where 100 is the priority value and 75 is the threshold value. Both routers should have the same priority and threshold values.

- d) Configure the timers for delay and reload.

Example:

```
Router(config-red-app-grp)#timers delay 30 reload 60
```

Delay timer which is the amount of time to delay the RG group's initialization and role negotiation after the interface comes up.

Default: 30 seconds. Range is 0-10000 seconds.

Reload timer is the amount of time to delay RG group initialization and role-negotiation after a reload.

Default: 60 seconds. Range is 0-10000 seconds.

- e) Configure the interface used to exchange keepalive and hello messages between the router pair.

Example:

```
Router(config-red-app-grp)#control GigabitEthernet0/0/2 protocol 1
```

where GigabitEthernet0/0/2 is the interface and protocol 1 is the protocol instance that is attached to the interface.

- f) Configure the interface that is used for checkpointing of data traffic.

Example:

```
Router(config-red-app-grp)#data GigabitEthernet0/0/2
```

- g) Configure RG group tracking.

Example:

```
Router(config-red-app-grp)#track 1 shutdown
Router(config-red-app-grp)#track 2 shutdown
```

If you want protected mode, enter the following command:

```
Router(config-red-app-grp)#track 3 shutdown
```

- h) Specify the protocol instance that will be attached to a control interface and enters redundancy application protocol configuration mode.

Example:

```
Router(config-red-app-grp)#protocol 1
```

- i) Configure the two timers for hellotime and holdtime.

Example:

```
Router(config-red-app-grp)#timers hellotime 3 holdtime 10
```

hellotime—Interval between successive hello messages.

Default is 3 seconds. Range is 250 milliseconds-254 seconds.

holdtime—The interval between the receipt of a hello message and the presumption that the sending router has failed. This duration has to be greater than the hellotime.

Default is 10 seconds. Range is 750 milliseconds-255 seconds.

We recommend that you configure the holdtime timer that is configured to be at least 3 times the value of the hellotime timer.

Step 3

Configure interface tracking.

The **track** command is used in RG to track the voice traffic interface state so that the active router initiates switchover after the traffic interface is down.

Configure the following commands at the global level to track the status of the interface.

```
Router(config)#track 1 interface GigabitEthernet0/0/0 line-protocol
Router(config)#track 2 interface GigabitEthernet0/0/1 line-protocol
```

If you want protected mode, enter the following command:

```
Router(config)#track 3 interface GigabitEthernet0/0/2 line-protocol
```

Step 4

Configure the interfaces.

- a) Configure the redundancy interface identifier for the redundancy group.

Required for generating a Virtual MAC (VMAC) address. You must use the same rii ID value on the interface of each router (active and standby) that has the same Virtual IP address.

If there is more than one Box-to-box HA pair on the same LAN, each pair **MUST** have unique rii IDs on their respective interfaces (to prevent collision). **show redundancy application group all** must indicate the correct local and peer information.

Example:

```
Router(config)#interface GigabitEthernet0/0/0
Router(config-if)#ip address 203.0.113.10 255.255.0.0
Router(config-if)#negotiation auto
Router(config-if)#redundancy rii 1
```

```
Router(config)#interface GigabitEthernet0/0/1
Router(config-if)#ip address 192.0.2.1 255.255.255.0
Router(config-if)#negotiation auto
Router(config-if)#redundancy rii 2
```

- b) Associate the interface with the redundancy group created.

Example:

```
Router(config-if)#redundancy group 1 ip 203.0.113.12 exclusive
Router(config-if)#redundancy group 1 ip 192.0.2.3 exclusive
```

- c) Configure interface for RG control and data.

Example:

```
Router(config)#interface GigabitEthernet0/0/2
Router(config-if)#ip address 198.51.100.1 255.255.255.0
Router(config-if)#media-type rj45
Router(config-if)#negotiation auto
```

Step 5

Configure SIP Binding.

Configure CUBE to bind SIP messages to the interface that is configured with a Virtual IP address (VIP) for the RG group employed.

Example:

```
Router(config)#dial-peer voice 1 voip
Router(config-dial-peer)#session protocol sipv2
Router(config-dial-peer)#incoming called-number 2000
Router(config-dial-peer)#voice-class sip bind control source-interface GigabitEthernet0/0/0
Router(config-dial-peer)#voice-class sip bind media source-interface GigabitEthernet0/0/0
Router(config-dial-peer)#codec g711ulaw
Router(config-dial-peer)#!
```

```
Router(config)#dial-peer voice 2 voip
Router(config-dial-peer)#destination-pattern 2000
Router(config-dial-peer)#session protocol sipv2
Router(config-dial-peer)#session target ipv4:203.0.113.13
Router(config-dial-peer)#voice-class sip bind control source-interface GigabitEthernet0/0/1
Router(config-dial-peer)#voice-class sip bind media source-interface GigabitEthernet0/0/1
Router(config-dial-peer)#codec g711ulaw
```

Step 6

(Optional) If H.323 calls are involved, enable H.323 binding.

Under the interface used by H.323, configure voip-bind with its source address equal to the interface's VIP for the RG group employed.

Example:

```
Router#voice service voip
Router(conf-voi-serv)#h323
Router(conf-serv-h323)#call preserve limit-media-detection
Router(conf-serv-h323)#no h225 timeout keepalive

Router(config)#interface GigabitEthernet0/0/0
Router(config-if)#ip address 203.0.113.10 255.255.0.0
Router(config-if)#media-type rj45
Router(config-if)#negotiation auto
Router(config-if)#redundancy rii 1
Router(config-if)#redundancy group 1 ip 9.13.25.123 exclusive
Router(config-if)#h323-gateway voip interface
Router(config-if)#h323-gateway voip bind srcaddr 203.0.113.12

Router(config)#interface GigabitEthernet0/0/1
Router(config-if)#ip address 192.0.2.1 255.255.255.0
Router(config-if)#media-type rj45
Router(config-if)#negotiation auto
```

```
Router(config-if)#redundancy rii 2
Router(config-if)#redundancy group 1 ip 192.0.2.3 exclusive
Router(config-if)#h323-gateway voip interface
Router(config-if)#h323-gateway voip bind srcaddr 192.0.2.3
```

Step 7 Configure the Punt Policing feature.

SIP packets towards the virtual IP address and physical IP address match different punt-cause codes. The punt-rate of the virtual IP address with a punt-cause of 60, is lower than the punt-rate of the physical IP address.

To ensure that the behaviour of the SIP packets towards virtual and physical IP address remains the same, you must increase the punt-rate of the virtual IP address by using the **platform punt-policer** command in global configuration mode.

Note For Cisco IOS XE Releases 16.6.7, 16.9.4, 16.11.1, 16.12.1, 17.1.1 and later releases, you do not need to increase the punt-rate.

Example:

```
Router(config)#platform punt-policer 60 40000
```

In the preceding example, the punt-rate of the virtual IP address (punt-cause 60) is increased from the default value of 2000–40000.

The following table provides details of the fields of the CLI.

Keyword	Description
platform punt-policer	Configures the Punt Policing feature.
<i>60</i>	<i>punt-cause</i> —Punt cause. Range is 1–107. Punt cause of the virtual interface is 60.
<i>40000</i>	<i>punt-rate</i> —Rate limit in packets per second. Range is 10–146484.

Note The default punt rate value of the virtual IP address and the physical IP address varies with the router platform.

Note The default and maximum setting are platform-specific. Default value is optimal for most deployments. Change the rate only when suggested by Cisco Support.

Step 8 Configure the RG group under **voice service voip**. This enables Box-to-box CUBE HA.

Example:

```
Router#voice service voip
Router(conf-voi-serv)#redundancy-group 1
```

For enabling protected mode:

```
Router#voice service voip
Router(conf-voi-serv)#no redundancy-reload
```

Step 9 Configure the Media Inactivity timer.

The Media Inactivity Timer enables the active and standby router pair to monitor and disconnect calls if no Real-Time Protocol (RTP) packets are received within a configurable time period.

For the SIP calls, the switched over calls are cleared with signaling (as signaling information is preserved for switched calls).

The Media Inactivity Timer releases TCP-based and H.323-based calls. This is used to guard against any hung sessions resulting from the failover when a normal call disconnect does not clear the call.

You must configure the same duration for the Media Inactivity Timer on both routers. The default value is 30 seconds for SIP and H.323 calls. The sample configuration is as follows:

Example:

```
Router(config)#ip rtcp report interval 9000
Router(config)#gateway
Router(config-gateway)#media-inactivity-criteria all
Router(config-gateway)#timer receive-rtp 1200
Router(config-gateway)#timer receive-rtcp 5
```

SIP and H.323 call legs are cleared once the RTCP timer expires.

Step 10 Reload the router.

Once all the preceding configurations are completed, you must save the configurations, and reload the router.

Example:

```
Router>enable
Router#relaod
```

Step 11 Configure the peer router.

Follow the preceding steps to configure the standby router. Make sure that you use the correct IP addresses.

Step 12 Point the attached devices to the CUBE Virtual IP (VIP) address.

The IP-PBX, Unified SIP Proxy, or service provider must route the calls to CUBE's Virtual IP address.

HA configuration does not handle SIP and H.323 messages to the CUBE's physical IP addresses.

For H.323 calls, you must disable the keepalive messages in Unified CM configuration.

- a. Go to **System** menu, and choose **Service Parameters**. At the bottom of the Service Parameters, enable **Advanced**.
- b. Set the **Allow TCP KeepAlives for H323** to False.
- c. After this setting is saved, restart the CallManager Services.

Configuration Examples

The following sample configuration assumes interfaces Gig0/0/0 is used for incoming calls, and Gig0/0/1 is used for outgoing calls, and Gig0/0/2 is used for redundancy.

Active Router Configurations

```
Router1# show run
```

```
Building configuration...
Current configuration : 3082 bytes
!
```

```

! Last configuration change at 21:33:13 UTC Sun Sep 19 2010
!
version 15.1
service timestamps debug datetime msec
service timestamps log datetime msec
!
hostname b2bred2
!
boot-start-marker
boot system flash bootflash:asr1000rp2-adventerprisek9.BLD_MCP_DEV_LATEST_201008
24_091509.bin
boot-end-marker
!
!
vrf definition Mgmt-intf
!
  address-family ipv4
  exit-address-family
  !
  address-family ipv6
  exit-address-family
  !
logging buffered 77777777
no logging console
enable secret 5 $1$kan3$QsGBuVkgGDZgRlg4lSrsWl
!
no aaa new-model
!
!
!
ip source-route
!
!
multilink bundle-name authenticated
!
!
voice service voip
  media bulk-stats
  allow-connections h323 to h323
  allow-connections h323 to sip
  allow-connections sip to h323
  allow-connections sip to sip
  redundancy-group 1
  h323
  emptycapability
  call preserve limit-media-detection
  no h225 timeout keepalive
  h245 passthru tcsnonstd-passthru
  sip
  early-offer forced
  midcall-signaling passthru
!
!
voice iec syslog
!
!
track 1 interface GigabitEthernet0/0/0 line-protocol
track 2 interface GigabitEthernet0/0/1 line-protocol
!
!
redundancy
  mode none
  application redundancy
  group 1

```

```
    name voice-b2bha
    priority 100 failover threshold 75
    timers delay 30 reload 60
    control GigabitEthernet0/0/2 protocol 1
    data GigabitEthernet0/0/2
    track 1 shutdown
    track 2 shutdown
protocol 1
    timers hellotime 3 holdtime 10
!
!
!
ip ftp username bhks
ip ftp password bhks
!
!
interface GigabitEthernet0/0/0
    ip address 203.0.113.10 255.255.255.0
    media-type rj45
    negotiation auto
    no mop enabled
    redundancy rii 1
    redundancy group 1 ip 203.0.113.12 exclusive
    h323-gateway voip interface
    h323-gateway voip bind srcaddr 203.0.113.12
!
interface GigabitEthernet0/0/1
    ip address 192.0.2.1 255.255.255.0
    media-type rj45
    negotiation auto
    redundancy rii 2
    redundancy group 1 ip 192.0.2.3 exclusive
    h323-gateway voip interface
    h323-gateway voip bind srcaddr 192.0.2.3

interface GigabitEthernet0/0/2
    ip address 198.51.100.1 255.255.255.0
    media-type rj45
    negotiation auto
!
interface GigabitEthernet0
    vrf forwarding Mgmt-intf
    no ip address
    negotiation auto
!
!
no ip http server
no ip http secure-server
ip rtcp report interval 9000
ip route 0.0.0.0 0.0.0.0 9.44.0.1
!
logging esm config
dialer-list 1 protocol ip permit
dialer-list 1 protocol ipx permit
!
!
!
control-plane
!
!
!
dial-peer voice 10 voip
    destination-pattern 140854.....
    session protocol sipv2
```

```

session target ipv4:y.y.y.y
voice-class sip bind control source-interface GigabitEthernet0/0/1
voice-class sip bind media source-interface GigabitEthernet0/0/1
codec g711ulaw
no vad
!
dial-peer voice 20 voip
session protocol sipv2
session target ipv4:203.0.113.13
incoming called-number 140854.....
voice-class sip bind control source-interface GigabitEthernet0/0/0
voice-class sip bind media source-interface GigabitEthernet0/0/0
codec g711ulaw
no vad
!
!
gateway
media-inactivity-criteria all
timer receive-rtcp 5
timer receive-rtp 1200
!
!
line con 0
exec-timeout 0 0
stopbits 1
line vty 0 4
no login
!
exception data-corruption buffer truncate
end

```

Standby Router Configurations

```

Router2#sh run
Building configuration...
Current configuration : 2606 bytes
!
! Last configuration change at 21:34:07 UTC Sun Sep 19 2010
!
version 15.1
service timestamps debug datetime msec
service timestamps log datetime msec
!
hostname b2bred1
!
boot-start-marker
boot system flash bootflash:asr1000rp2-adventerprisek9.BLD_MCP_DEV_LATEST_201008
24_091509.bin
boot-end-marker
!
!
vrf definition Mgmt-intf
!
address-family ipv4
exit-address-family
!
address-family ipv6
exit-address-family
!
logging buffered 77777777
no logging console
!
no aaa new-model
!
!

```



```

ip source-route
!
!!
multilink bundle-name authenticated
!
!
!
voice service voip
media bulk-stats
allow-connections h323 to h323
allow-connections h323 to sip
allow-connections sip to h323
allow-connections sip to sip
redundancy-group 1
h323
emptycapability
call preserve limit-media-detection
no h225 timeout keepalive
h245 passthru tcsnonstd-passthru
sip
early-offer forced
midcall-signaling passthru
!
!
voice iec syslog
!
!
!
track 1 interface GigabitEthernet0/0/0 line-protocol
track 2 interface GigabitEthernet0/0/1 line-protocol
!
!
!
redundancy
mode none
application redundancy
group 1
name voice-b2bha
priority 100 failover threshold 75
timers delay 30 reload 60
control GigabitEthernet0/0/2 protocol 1
data GigabitEthernet0/0/2
track 1 shutdown
track 2 shutdown
protocol 1
timers hellotime 3 holdtime 10
!
!
ip ftp username bhks
ip ftp password bhks
!
!
interface GigabitEthernet0/0/0
ip address 203.0.113.11 255.255.255.0
media-type rj45
negotiation auto
redundancy rii 1
redundancy group 1 ip 203.0.113.12 exclusive
h323-gateway voip interface
h323-gateway voip bind srcaddr 203.0.113.12
!
interface GigabitEthernet0/0/1
ip address 192.0.2.2 255.255.255.0
media-type rj45

```

```

negotiation auto
redundancy rii 2
redundancy group 1 ip 192.0.2.3 exclusive
h323-gateway voip interface
h323-gateway voip bind srcaddr 192.0.2.3
interface GigabitEthernet0/0/2
ip address 198.51.100.2 255.255.255.0
media-type rj45
negotiation auto
!
interface GigabitEthernet0
vrf forwarding Mgmt-intf
no ip address
shutdown
negotiation auto
!
!
no ip http server
no ip http secure-server
ip rtcp report interval 9000
ip route 0.0.0.0 0.0.0.0 9.44.0.1
!
logging esm config
!
!
control-plane
!
!
dial-peer voice 10 voip
destination-pattern 140854.....
session protocol sipv2
session target ipv4:y.y.y.y
voice-class sip bind control source-interface GigabitEthernet0/0/1
voice-class sip bind media source-interface GigabitEthernet0/0/1
codec g711ulaw
no vad
!
dial-peer voice 20 voip
session protocol sipv2
session target ipv4:203.0.113.13
incoming called-number 140854.....
voice-class sip bind control source-interface GigabitEthernet0/0/0
voice-class sip bind media source-interface GigabitEthernet0/0/0
codec g711ulaw
no vad
!
!
gateway
media-inactivity-criteria all
timer receive-rtcp 5
timer receive-rtp 1200
!
!
line con 0
exec-timeout 0 0
stopbits 1
line vty 0 4
no login
!
exception data-corruption buffer truncate
end

```

Verify Your Configuration

Verify Redundancy State on Active and Standby Routers

Use the `show redundancy application group all` command to display the redundancy inter-device states.

Step 1 Active Router:

Example:

```
Router#show redundancy application group all

Faults states Group 1 info:
  Runtime priority: [100]
  RG Faults RG State: Up.
    Total # of switchovers due to faults: 0
    Total # of down/up state changes due to faults: 2
  Group ID:1
  Group Name:voice-b2bha

Administrative State: No Shutdown
Aggregate operational state : Up
My Role: ACTIVE
Peer Role: STANDBY
Peer Presence: Yes
Peer Comm: Yes
Peer Progression Started: Yes

RF Domain: btob-one
  RF state: ACTIVE
  Peer RF state: STANDBY HOT

RG Protocol RG 1
-----
  Role: Active
  Negotiation: Enabled
  Priority: 100
  Protocol state: Active
  Ctrl Intf(s) state: Up
  Active Peer: Local
  Standby Peer: address 203.0.113.11, priority 100, intf Gi0/0/2
  Log counters:
    role change to active: 1
    role change to standby: 0
    disable events: rg down state 1, rg shut 0
    ctrl intf events: up 1, down 2, admin_down 1
    reload events: local request 0, peer request 0

RG Media Context for RG 1
-----
  Ctx State: Active
  Protocol ID: 1
  Media type: Default
  Control Interface: GigabitEthernet0/0/2
  Current Hello timer: 3000
  Configured Hello timer: 3000, Hold timer: 10000
  Peer Hello timer: 3000, Peer Hold timer: 10000
  Stats:
  Pkts 27719, Bytes 1718578, HA Seq 0, Seq Number 27719, Pkt Loss
```

```

0
  Authentication not configured
  Authentication Failure: 0
  Reload Peer: TX 0, RX 0
  Resign: TX 0, RX 0
  Standby Peer: Present. Hold Timer: 10000
  Pkts 27700, Bytes 941800, HA Seq 0, Seq Number 27708, Pkt Loss 0

```

Step 2 Standby Router:

Example:

```

Router#show redundancy application group all

Faults states Group 1 info:
  Runtime priority: [100]
  RG Faults RG State: Up.
  Total # of switchovers due to faults: 0
  Total # of down/up state changes due to faults: 2
  Group ID:1
  Group Name:voice-b2bha

Administrative State: No Shutdown
Aggregate operational state : Up
My Role: STANDBY
Peer Role: ACTIVE
Peer Presence: Yes
Peer Comm: Yes
Peer Progression Started: Yes

RF Domain: btob-one
  RF state: STANDBY HOT
  Peer RF state: ACTIVE

RG Protocol RG 1
-----
  Role: Standby
  Negotiation: Enabled
  Priority: 100
  Protocol state: Standby-hot
  Ctrl Intf(s) state: Up
  Active Peer: address 203.0.113.10, priority 100, intf Gi0/0/2
  Standby Peer: Local
  Log counters:
    role change to active: 0
    role change to standby: 1
    disable events: rg down state 1, rg shut 0
    ctrl intf events: up 1, down 2, admin_down 1
    reload events: local request 0, peer request 0

RG Media Context for RG 1
-----
  Ctx State: Standby
  Protocol ID: 1
  Media type: Default
  Control Interface: GigabitEthernet0/0/2
  Current Hello timer: 3000
  Configured Hello timer: 3000, Hold timer: 10000
  Peer Hello timer: 3000, Peer Hold timer: 10000
  Stats:
    Pkts 27832, Bytes 1725584, HA Seq 0, Seq Number 27832, Pkt Loss
0
  Authentication not configured
  Authentication Failure: 0

```

```

Reload Peer: TX 0, RX 0
Resign: TX 0, RX 0
Active Peer: Present. Hold Timer: 10000
Pkts 27830, Bytes 946220, HA Seq 0, Seq Number 27843, Pkt Loss 0

```

Verify Call State After Switchover

Use the **show voice high-availability summary** command to verify the following:

- The checkpointing of calls on the standby router after a switchover
- The media-inactivity count on the active router when the calls are over
- Native and non-native (preserved) calls when both call types are present
- Presence of leaked RTP, HA, SPI sessions

Active Router

```
Router#show voice high-availability summary
```

```

===== HA Message Sizes =====
SCCPAPP Data Size:412
SIPSPI Data Size:4260
H323SPI Data Size:2164
RTSPI Data Size:861
CCAPI Data Size:188
VOIPRTP Data Size:158
HA Data Size:68
Total Data Size:4842

===== Voice HA DB INFO =====
Number of calls in HA DB: 0
Number of calls in HA sync pending DB: 0
Number of current SWMTP calls with HA: 0
-----
First a few entries in HA DB:
-----
-----
First a few entries in Sync Pending DB:
-----
-----

===== Voice HA Process INFO =====
Active process current tick: 92663
Active process number of tick events pending: 0
Active process number of tick events processed: 0
===== Voice HA RF INFO =====
FUNCTIONING RF DOMAIN: 0x2
-----
RF Domain: 0x0
Voice HA Client Name: VOIP RF CLIENT
Voice HA RF Client ID: 1345
Voice HA RF Client SEQ: 128
My current RF state ACTIVE (13)
Peer current RF state DISABLED (1)
Current VOIP HA state [LOCAL / PEER] :

```

```

[ACTIVE (13) / UNKNOWN (0)]
-----
RF Domain: 0x2 [RG: 1]
Voice HA Client Name: VOIP RG CLIENT
Voice HA RF Client ID: 4054
Voice HA RF Client SEQ: 418
My current RF state ACTIVE (13)
Peer current RF state STANDBY HOT (8)
Current VOIP HA state [LOCAL / PEER] :
[ACTIVE (13) / STANDBY HOT (8)]
-----
Voice HA Active and Standby are in sync.
System has experienced switchover.

===== Voice HA CF INFO =====
Voice HA CF for RG(1):
  local ip = 9.13.25.190; remote ip = 9.13.25.191
  local port = 4026; remote port = 4025
  CF setup done: TRUE
  Role is Active. Client side stats:
    Received checkpointing requests: 0
    Wrote to sockets: 0
    Checkpoint buffer in use: 0
    Pending transmit events: 0

===== Voice HA COUNTERS =====
Total number of checkpoint requests sent (Active): 0
Total APP DATA sent on Active: 0
Total CREATE sent on Active: 0
Total MODIFY sent on Active: 0
Total DELETE sent on Active: 0
Total number of checkpoint requested received (Standby): 0
Total APP DATA received on Standby: 0
Total CREATE received on Standby: 0
Total MODIFY received on Standby: 0
Total DELETE received on Standby: 0
Media Inactivity event count: 0
Max Media Up time since Call Create: 0 msec
Queue Failed for MEDIA EVENT - move entry 2 sync pending db: 0
Queue Failed for CREATE - move entry to sync pending db: 0
Queue Failed for MODIFY - move entry to sync pending db: 0
Queue Failed for DELETE - move entry to sync pending db: 0
No Entry Found when processing Tick Queue Event: 0
Entry Deleted - never checkpointed :0
Added Element to Multi Delete List: 0
Standby received Delete as part of Multi-Delete Message: 0
Active Sent Multi Delete Message to Standby: 0
Standby Callback Invoked by CF: 0
Standby Callback Invoked by CF - Negotiation Message: 0
Standby Callback Invoked by CF - No Msg Header: 0
Standby Callback Invoked by CF - ISSU Xform Fail: 0
Standby Callback Invoked by CF - malloc VOIP Buffer fail: 0
Standby Callback Invoked by CF - enqueue to voip ha fail: 0
0 0 0 0 0 0 0 0 0 0 0 0 0 0 0 0 0 0 0 0 0 0 0 0 0 0 0 0 0 0 0 0
0 0 0 0 0 0 0 0 0 0 0 0 0 0 0 0 0 0 0 0 0 0 0 0 0 0 0 0 0 0 0 0
0 0 0 0 0 0 0 0 0 0 0 0 0 0 0 0 0 0 0 0 0 0 0 0 0 0 0 0 0 0 0 0
0 0 0 0 0 0 0 0 0 0 0 0 0 0 0 0 0 0 0 0 0 0 0 0 0 0 0 0 0 0 0 0
0 0 0 0 0 0 0 0 0 0 0 0 0 0 0 0 0 0 0 0 0 0 0 0 0 0 0 0 0 0 0 0
Checkpoint overflow: 0
HA DB elememnt pool overrun count: 0
HA DB aux element pool overrun count: 0
HA DB insertion failure count: 0
HA DB deletion failure count: 0
Tick event pool overrun count: 0

```

```

Tick event queue overrun count: 0
Checkpoint send failure count - ISSU Transform Failure: 0
Checkpoint send failure count - CF failed: 0
Checkpoint get buffer failure count: 0
Checkpoint Received IPC Flow ON from CF: 0
Checkpoint Received IPC Flow OFF from CF: 0

```

Standby Router

```
Router#show voice high-availability summary
```

```

===== HA Message Sizes =====
SCCPAPP Data Size:412
SIPSPI Data Size:4260
H323SPI Data Size:2164
RTSPI Data Size:861
CCAPI Data Size:188
VOIP RTP Data Size:158
HA Data Size:68
Total Data Size:4842

===== Voice HA DB INFO =====
Number of calls in HA DB: 0
Number of calls in HA sync pending DB: 0
Number of current SWMTP calls with HA: 0
-----
First a few entries in HA DB:
-----
-----
First a few entries in Sync Pending DB:
-----
-----

===== Voice HA Process INFO =====
Active process current tick: 46846
Active process number of tick events pending: 0
Active process number of tick events processed: 0
===== Voice HA RF INFO =====
FUNCTIONING RF DOMAIN: 0x2
-----
RF Domain: 0x0
Voice HA Client Name: VOIP RF CLIENT
Voice HA RF Client ID: 1345
Voice HA RF Client SEQ: 128
My current RF state ACTIVE (13)
Peer current RF state DISABLED (1)
Current VOIP HA state [LOCAL / PEER] :
[ACTIVE (13) / UNKNOWN (0)]
-----
RF Domain: 0x2 [RG: 1]
Voice HA Client Name: VOIP RG CLIENT
Voice HA RF Client ID: 4054
Voice HA RF Client SEQ: 418
My current RF state STANDBY HOT (8)
Peer current RF state ACTIVE (13)
Current VOIP HA state [LOCAL / PEER] :
[STANDBY HOT (8) / ACTIVE (13)]
-----
Voice HA Standby is not available.
System has not experienced switchover.

===== Voice HA CF INFO =====
Voice HA CF for RG(1):
  local ip = 203.0.113.10; remote ip = 203.0.113.11
  local port = 4025; remote port = 4026

```

```

CF setup done: TRUE
Role is Standby. Server side stats:
  Received raw message: 0
  Received checkpointing requests: 0
  Invalid header counter: 0

===== Voice HA COUNTERS =====
Total number of checkpoint requests sent (Active): 0
Total APP DATA sent on Active: 0
Total CREATE sent on Active: 0
Total MODIFY sent on Active: 0
Total DELETE sent on Active: 0
Total number of checkpoint requested received (Standby): 0
Total APP DATA received on Standby: 0
Total CREATE received on Standby: 0
Total MODIFY received on Standby: 0
Total DELETE received on Standby: 0
Media Inactivity event count: 0
Max Media Up time since Call Create: 0 msec
Queue Failed for MEDIA EVENT - move entry 2 sync pending db: 0
Queue Failed for CREATE - move entry to sync pending db: 0
Queue Failed for MODIFY - move entry to sync pending db: 0
Queue Failed for DELETE - move entry to sync pending db: 0
No Entry Found when processing Tick Queue Event: 0
Entry Deleted - never checkpointed :0
Added Element to Multi Delete List: 0
Standby received Delete as part of Multi-Delete Message: 0
Active Sent Multi Delete Message to Standby: 0
Standby Callback Invoked by CF: 0
Standby Callback Invoked by CF - Negotiation Message: 0
Standby Callback Invoked by CF - No Msg Header: 0
Standby Callback Invoked by CF - ISSU Xform Fail: 0
Standby Callback Invoked by CF - malloc VOIP Buffer fail: 0
Standby Callback Invoked by CF - enqueue to voip ha fail: 0
0 0 0 0 0 0 0 0 0 0 0 0 0 0 0 0 0 0 0 0 0 0 0 0 0 0 0 0 0 0 0 0
0 0 0 0 0 0 0 0 0 0 0 0 0 0 0 0 0 0 0 0 0 0 0 0 0 0 0 0 0 0 0 0
0 0 0 0 0 0 0 0 0 0 0 0 0 0 0 0 0 0 0 0 0 0 0 0 0 0 0 0 0 0 0 0
0 0 0 0 0 0 0 0 0 0 0 0 0 0 0 0 0 0 0 0 0 0 0 0 0 0 0 0 0 0 0 0
0 0 0 0 0 0 0 0 0 0 0 0 0 0 0 0 0 0 0 0 0 0 0 0 0 0 0 0 0 0 0 0
Checkpoint overflow: 0
HA DB elememnt pool overrun count: 0
HA DB aux element pool overrun count: 0
HA DB insertion failure count: 0
HA DB deletion failure count: 0
Tick event pool overrun count: 0
Tick event queue overrun count: 0
Checkpoint send failure count - ISSU Transform Failure: 0
Checkpoint send failure count - CF failed: 0
Checkpoint get buffer failure count: 0
Checkpoint Received IPC Flow ON from CF: 0
Checkpoint Received IPC Flow OFF from CF: 0

```

Verify SIP IP Address Bindings

Use the **show sip-ua status** command to verify SIP IP address bindings.

```
Router#show sip-ua status
```

```

SIP User Agent Status
SIP User Agent for UDP : ENABLED
SIP User Agent for TCP : ENABLED
SIP User Agent for TLS over TCP : ENABLED
SIP User Agent bind status(signaling): DISABLED

```



```
SIP User Agent bind status(media): DISABLED
Snapshot of SIP listen sockets : 2

=====
Local Address Listen Port Secure Listen Port
=====
203.0.113.13          5060          5061
203.0.113.13          5060          5061
SIP early-media for 180 responses with SDP: ENABLED
SIP max-forwards : 70
```

Verify Current CPU Use

Use the **show process cpu history** to verify the CPU utilization percentage at regular intervals.

Check CPU utilization before performing a switchover and proceed with a forced failover only when the CPU utilization is less than 70%. You can also use **show process cpu sorted** command repeatedly to know the CPU utilization for a particular process.

Force a Manual Failover for Testing

Box-to-box redundancy on the Cisco ASR 1000 Series Router platform supports full stateful switchover of calls. This means the media (RTP) and signaling information of the calls is preserved.

You can expect that switchovers occurring in real environments, where there is a constant mixture of calls in transient (call setup or being modified) and established state, result in some dropped calls during a failover.

To check that your configuration is correct, you can force a manual switchover.



Note A switchover involves the active router reloading, while the standby router takes over and becomes the new active router, processing incoming calls and maintaining the media streams and signaling information for calls until they are complete. The new active router continues to act as such until another switchover occurs. There is no pre-emption mechanism on Box-to-box redundancy.

Before you begin

Before you start a manual switchover, take note of the following:

- Monitor the CPU utilization % on the active and standby router pair. The active router has the higher CPU utilization as it is actively handling the calls, while the standby router shows little CPU utilization.
- Ensure that you perform a manual switchover when the CPU utilization of the active router is not more than 70%.
- Use the **show voip rtp connection** command to make sure that existing calls across the active and standby router pair are in sync.

You can achieve manual switchovers in various ways:

Procedure

- Initiate the manual switchover by using the CLI **redundancy application reload group *RG ID* self** on the active router.
- Reload of the active router

- Power cycle the active router
- Pull out any RG configured interface of the active router
- Shutdown any RG configured interface of the active router

Troubleshoot High Availability Issues

Use the following show and debug commands to troubleshoot High Availability issues:

- **show redundancy application group all**
- **show redundancy application transport clients**
- **show redundancy client domain all | inc VOIP RG**
- **show voice high-availability summary**
- **show voip fpi stats**
- **debug voip rtp session**
- **debug voice high-availability all**
- **debug voip fpi all**
- **debug redundancy application group {config | faults | media | protocol | rri transport | vp}**



Note On every switchover after reload, you must enable the debugs on the new standby router.



Note Do not turn on many debugs on a system carrying high volume of active call traffic.

Troubleshooting Tips

- Check for proper HA states on both the active and standby router in the output of the show commands, like **show redundancy application group**.
- Perform incoming and outgoing ping tests with the VIPs employed.
- In the presence of active calls, look for the use of any physical interface's IP address in the output of **show voip rtp connections** on both the active and standby routers. VIP must be used in both the show outputs and the debugs.
- In the output of **show voip rtp connection | inc Found** and **show call active voice compact | inc Total** on both the active and standby routers, check for any large number of mismatched calls.
- To debug problems, enable the corresponding debug options:
 - VoIP RTP
 - VoIP FPI
 - VoIP HA

- SIPs (SIP, H.323, SCCPAPP)



CHAPTER 57

High Availability on Cisco CSR 1000V or C8000V Cloud Services Routers



Note Cisco Cloud Services Router 1000V Series (CSR 1000V) is no longer supported from Cisco IOS XE Bengaluru 17.4.1a onwards. If you are using CSR 1000V, you have to upgrade to Cisco Catalyst 8000V Edge Software (Catalyst 8000V). For End-of-Life information on CSR 1000V, see [End-of-Sale and End-of-Life Announcement for the Select Cisco CSR 1000v Licenses](#).

The High Availability (HA) feature allows you to benefit from the failover capability of Cisco Unified Border Element (CUBE) on two routers, one active and one standby. When the active router goes down for any reason, the standby router takes over seamlessly, preserving and processing your calls.

Figure 74: Cisco CUBE High Availability

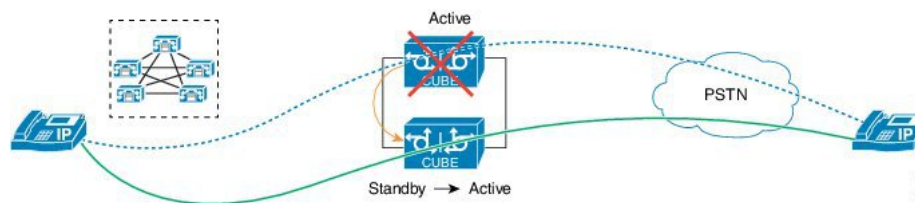

- [About vCUBE High Availability on CSR 1000V or C8000V Cloud Services Routers](#), on page 759
- [How to Configure vCUBE High Availability on Cisco CSR 1000v or C8000V](#), on page 766
- [Troubleshoot High Availability Issues](#), on page 769

About vCUBE High Availability on CSR 1000V or C8000V Cloud Services Routers

Cisco Unified Border Element running on Cisco CSR 1000v Series Cloud Services Router and C8000V is called Virtual CUBE (vCUBE). vCUBE leverages Redundancy Group (RG) Infrastructure to provide high availability. HA is configured between two vCUBE Cisco CSR 1000v or C8000V instances running on either the same host or across different hosts that are connected through the same switch.

You can configure vCUBE on Cisco CSR 1000v or C8000V running on virtualized hosts listed in the [Cisco Unified Border Element Data Sheet](#).

Box-to-Box Redundancy

Box-to-box redundancy enables configuring a pair of routers to act as back up for each other. In the router pair, the active router is determined based on the failover conditions. The router pair continuously exchange status messages. CUBE session information is checkpointed across the active and standby router. This enables the standby router to immediately take over all CUBE call processing responsibilities when the active router becomes unavailable.

Redundancy Group (RG) Infrastructure

A group of redundant interfaces form a Redundancy Group. The active and standby routers are connected by a configurable control link and data synchronization link. The control link is used to communicate the redundancy state for each router. The data synchronization link is used to transfer stateful information to synchronize the stateful database for the calls and media flows. Each pair of redundant interfaces is configured with the same unique ID number, also known as the Redundancy Interface Identifier (RII).

A Virtual IP address (VIP) is configured on interfaces that connect to the external network. All signaling and media is sourced from and sent to the Virtual IP address. External devices such as Cisco Unified Communication Manager, uses VIP as the destination IP address for the calls traversing through Cisco UBE.

The following figure shows the redundancy group configured for a pair of routers with a single outgoing interface.

Figure 75: Redundancy Group Configuration

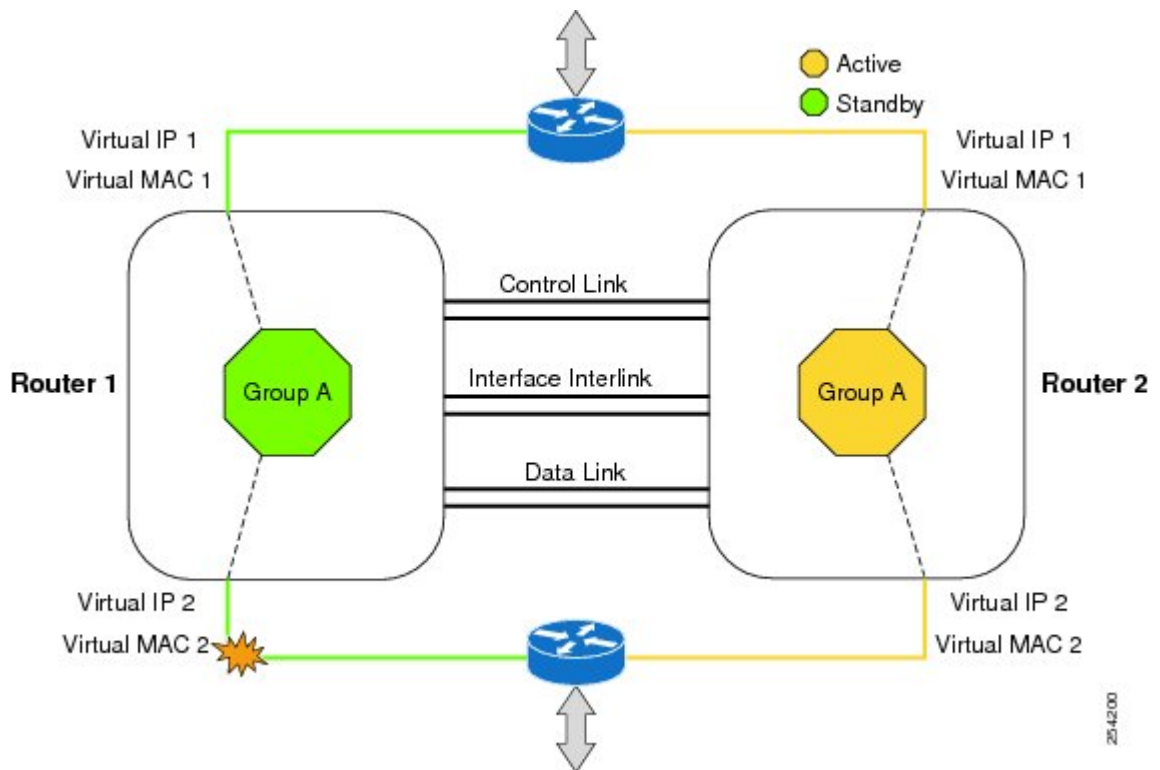

Network Topology

Figure 76: Virtual CUBE High Availability

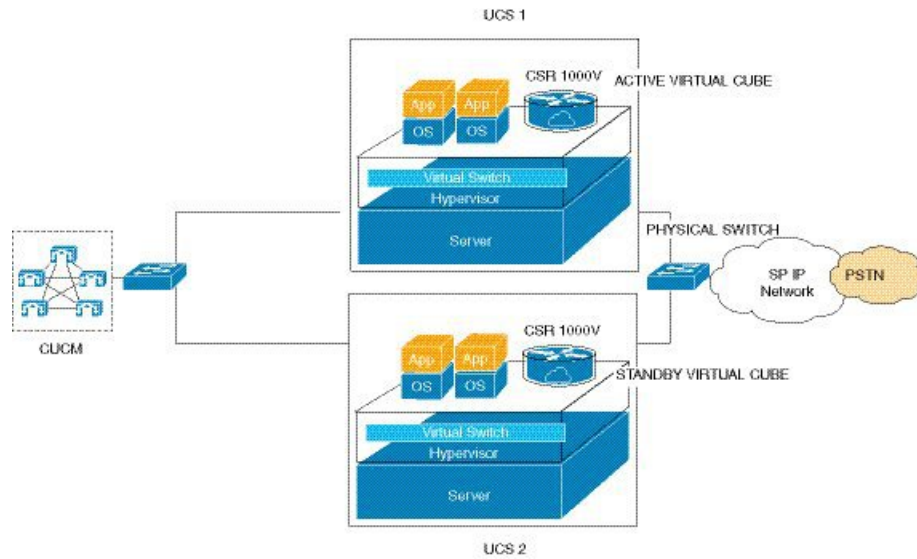
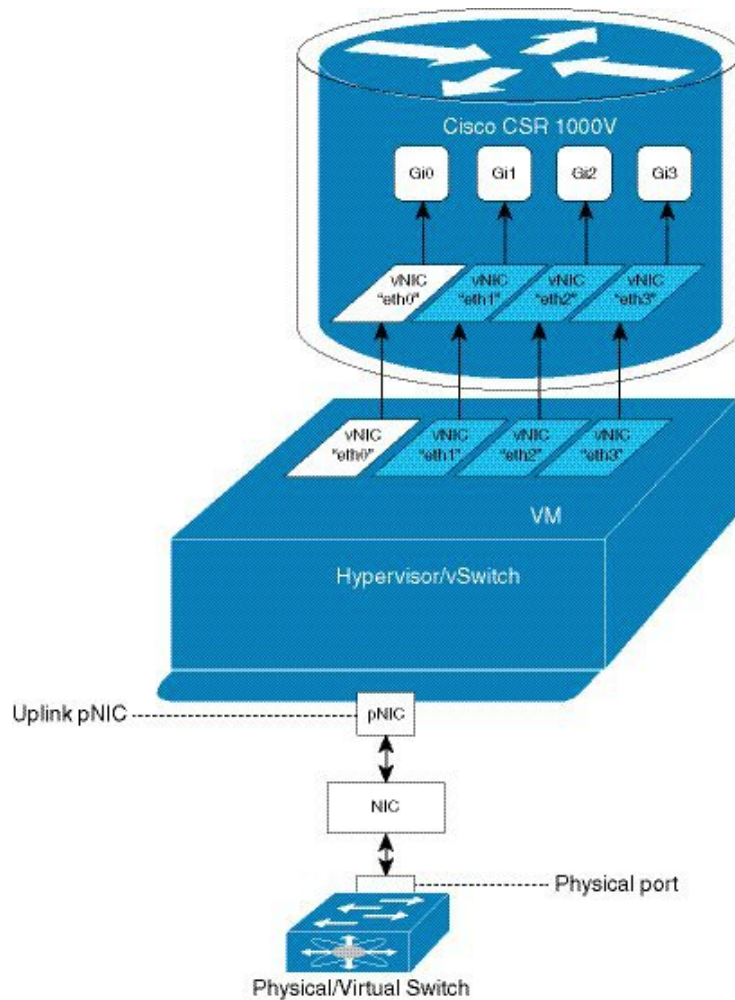

Figure 77: vNICs Mapped to Cisco CSR 1000V Router Interfaces



We recommend that you keep the following in mind when enabling this topology:

- Connect the Cisco CSR 1000v or C8000V running on the server to the virtual switch within the virtualized host. Then connect the virtual switches to external switches using the physical host interfaces. The virtual switch routes the traffic internally between the virtual machines and also connects the external networks.
- Configure high-availability connectivity using redundancy on virtual switch to avoid checkpointing failures.

In a scenario where the physical switch is down and there is no redundancy configured on virtual switch, the active router continues to process calls as it tracks only the status of virtual switch (which is up). At the same time, the standby router assumes the role of active router as it does not receive keepalive messages from the active router through the physical switch. Hence checkpointing fails. To avoid such scenarios, we recommend you to configure high availability connectivity using redundancy on virtual switch.

- Do not track the switches that are used to connect non-networking end devices or LAN, to determine uplink failures.

- Connect the redundancy group control and data interfaces in the CUBE HA pair to the same physical switch to avoid any latency in the network.
- The RG control and data interfaces of the CUBE HA pair can be connected through a back-to-back cable or using a switch. However, it is recommended to use Portchannel for the RG control and data interfaces for redundancy. A single connection using back-to-back cable or switch presents a single point of failure due to a faulty cable, port, or switch, resulting in error state where both routers are Active.
- If the RG ID is the same for the two different CUBE HA pairs, keepalive interface for check-pointing the RG control and data, and traffic must be in a different subnet or VLAN.



Note This recommendation is applicable only if you connect using a switch, not by back-to-back cables.

- You can configure a maximum of two redundancy groups. Hence, there can be only two Active and Standby pairs within the same network.



Note This recommendation is applicable only if you connect using a switch, not by back-to-back cables.

- Source all signaling and media from and to the virtual IP address.
- Always save the running configuration to avoid losing it due to router reload during a failover.
- Virtual Routing and Forwarding
 - Define Virtual Router Forwarding (VRF) in the same order on both Active and Standby routers for an accurate synchronization of data.
 - You can configure VRFs only on the traffic interface (SIP and RTP). Do not configure VRF on redundancy group control and data interface.
 - VRF configurations on both the Active and Standby router must be identical. VRF IDs checkpoints for the calls before and after switchover (includes VRF-based RTP port range).
- Manually copy the configurations from one router to the other.
- Replicating the configuration on the Standby router does not commit to the startup configuration; it is the running configuration. You must run the **write memory** command to commit the changes that are synchronized from the Active router on the Standby router.

Considerations and Restrictions

The following is a list of further considerations and restrictions you should know before configuring this topology:

Considerations

Before you configure High Availability feature on Cisco UBE, understand its behavior, and also know the Cisco IOS XE Software version that is required for supporting the call processing features to work seamlessly after switchover.

- Only active calls are checkpointed (Calls that are connected with 200 OK or ACK transaction completed).
- When you apply and save the configuration for the first time, the platform must be reloaded.
- For H.323, and TCP-based calls, media preservation is supported after the failover, but session signaling is not preserved.
- If you have Cisco Unified Customer Voice Portal (CVP) in your network, we recommend that you configure TCP session transport for the SIP trunk between CVP and CUBE.
- Upon failover, the previously active CUBE reloads by design.
- CUBE uses the virtual IP address to communicate Smart Licensing information.
- For SIP-SIP TLS calls, configure both the active and standby CUBE as trust points to a common external CA Server.
- TCP sessions are not preserved during the failover. Remote user agents are expected to reestablish TCP sessions (using port 5060) before sending subsequent messages.
- Call Admission Control (CAC) state is maintained through switchover. After Stateful Switchover, no calls are allowed if the CAC limit is reached before the switchover.
- Up to six multimedia lines in the SDP are checkpointed for CUBE high availability. From Cisco IOS XE Release 3.17 onwards, SDP Passthru (up to two m-lines) calls are also checkpointed.
- Survivability.tcl preservation is supported from Cisco IOS XE Release 3.17 onwards for Unified Customer Voice Portal (CVP) deployments.
- SRTP-RTP, SRTP-SRTP, and SRTP Passthru are supported.



Note Redundancy control traffic that is exchanged between CUBE-1 and CUBE-2 is not secured natively and displays SRTP encryption keys in cleartext. If SRTP is used, you must secure this traffic by configuring a transport IPsec tunnel between the two interfaces that are used as the redundancy control link.

- Port channel is supported for both RG control data and traffic interfaces only from Cisco IOS XE 16.3.1 onwards.

Figure 78: Additional Supported Options for CUBE HA

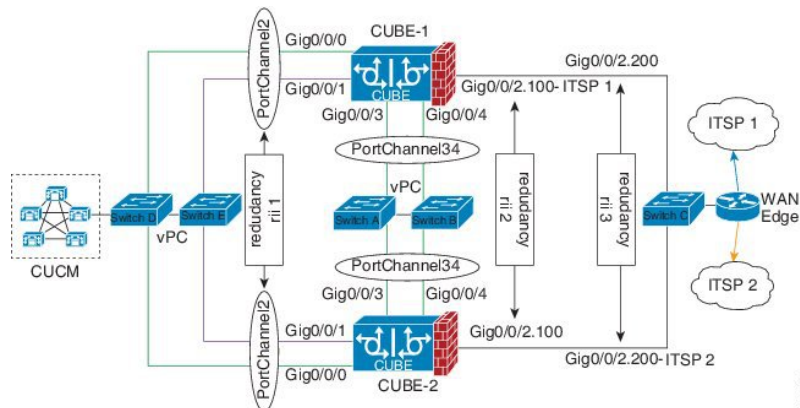

- While deploying High Availability pair with Application Centric Infrastructure (ACI), perform one of the following:
 - Disable IP data plane learning on the VRF.
Refer to [IP Data-plane Learning](#) for details.
 - Use an intermediate Layer 3 switch between the High Availability pair and the ACI deployment. This Layer 3 switch prevents the ACI from directly learning the CUBE IP address and its associated MAC addresses.

Restrictions

- Geographic stateful switchover is not supported.
- Calls in the transient state at the time of switchover are not preserved.
- IPv6 is not supported.
- All SCCP-based media resources (Conference bridge, Transcoding, Hardware MTP, and Software MTP) are not supported.
- Cisco Unified Survivable Remote Site Telephony (Cisco Unified SRST) or TDM Gateway colocation on CUBE HA is not supported.
- Routers connected through Metropolitan Area Network (MAN) Ethernet regardless of latency are not supported.
- Out-of-band DTMF (Notify or KPML) is not supported post switchover. Only rtp-nte to rtp-nte and voice-inband to voice-inband DTMF works after the switchover.
- Media-flow around and UC Services API (Cisco Unified Communications Manager Network-Based Recording) are not supported.
- You cannot terminate Wide Area Network (WAN) on CUBE directly or Data HA on either side. Both active and standby routers must be in the same Data Center and connected to the same physical switch.
- The Courtesy Callback (CCB) feature is not supported if a callback was registered with Cisco Unified Customer Voice Portal (CVP) and then a switchover was done on CUBE.

- You cannot configure a secondary IP address for the interfaces.
- If the redundancy group ID is same for the two different CUBE HA pairs, then the keepalive interface that is used for checkpointing RG control and data traffic must be in a different subnet or VLAN.

How to Configure vCUBE High Availability on Cisco CSR 1000v or C8000V

Before You Begin

- Use Cisco IOS-XE Release 3.11 and or later on both active and standby routers.
- Ensure that you have the required licenses for configuring high availability. For detailed information, see [Cisco Unified Border Element Data Sheet](#).

Configure High Availability

Procedure

	Command or Action	Purpose
Step 1	Configure the Redundancy Group.	
Step 2	Configure the interfaces.	
Step 3	Configure SIP Binding. Example: <pre> Router(config)#dial-peer voice 1 voip Router(config-dial-peer)#session protocol sipv2 Router(config-dial-peer)#incoming called-number 2000 Router(config-dial-peer)#voice-class sip bind control source-interface GigabitEthernet0/0/0 Router(config-dial-peer)#voice-class sip bind media source-interface GigabitEthernet0/0/0 Router(config-dial-peer)#codec g711ulaw Router(config-dial-peer)#! Router(config)#dial-peer voice 2 voip Router(config-dial-peer)#destination-pattern 2000 Router(config-dial-peer)#session protocol sipv2 Router(config-dial-peer)#session target ipv4:203.0.113.13 Router(config-dial-peer)#voice-class sip bind control source-interface GigabitEthernet0/0/1 Router(config-dial-peer)#voice-class sip bind media source-interface GigabitEthernet0/0/1 Router(config-dial-peer)#codec g711ulaw </pre>	Configure CUBE to bind SIP messages to the interface that is configured with a virtual IP address (VIP) for the Redundancy Group employed.

	Command or Action	Purpose								
Step 4	<p>Configure the Punt Policing feature.</p> <p>Example:</p> <pre>Router(config)#platform punt-policer 60 40000</pre> <p>In the preceding example, the punt-rate of the virtual IP address (punt-cause 60) is increased from the default value of 2000–40000.</p>	<p>SIP packets toward the virtual IP address and physical IP address match different punt-cause codes. The punt-rate of the virtual IP address with a punt-cause of 60, is lower than the punt-rate of the physical IP address.</p> <p>To ensure that the behaviour of the SIP packets toward virtual and physical IP address remains the same, you must increase the punt-rate of the virtual IP address by using the platform punt-policer command in global configuration mode.</p> <p>Note For Cisco IOS XE Releases 16.6.7, 16.9.4, 16.11.1, 16.12.1, 17.1.1 and later releases, you do not need to increase the punt-rate.</p> <p>The following table provides details of the fields of the CLI.</p> <table border="1"> <thead> <tr> <th>Keyword</th> <th>Description</th> </tr> </thead> <tbody> <tr> <td>platform punt-policer</td> <td>Configures the Punt Policing feature.</td> </tr> <tr> <td><i>60</i></td> <td><i>punt-cause</i>—Punt cause. Range is 1–107. Punt cause of the virtual interface is 60.</td> </tr> <tr> <td><i>40000</i></td> <td><i>punt-rate</i>—Rate limit in packets per second. Range is 10–146484.</td> </tr> </tbody> </table> <p>Note The default punt rate value of the virtual IP address and the physical IP address varies with the router platform.</p> <p>Note The default and maximum setting are platform-specific. Default value is optimal for most deployments. Change the rate only when suggested by Cisco Support.</p>	Keyword	Description	platform punt-policer	Configures the Punt Policing feature.	<i>60</i>	<i>punt-cause</i> —Punt cause. Range is 1–107. Punt cause of the virtual interface is 60.	<i>40000</i>	<i>punt-rate</i> —Rate limit in packets per second. Range is 10–146484.
Keyword	Description									
platform punt-policer	Configures the Punt Policing feature.									
<i>60</i>	<i>punt-cause</i> —Punt cause. Range is 1–107. Punt cause of the virtual interface is 60.									
<i>40000</i>	<i>punt-rate</i> —Rate limit in packets per second. Range is 10–146484.									
Step 5	<p>Configure the Redundancy Group under voice service voip. This Redundancy Group creation enables Box-to-Box CUBE high availability.</p> <p>Example:</p> <pre>Router#voice service voip Router(conf-voi-serv)#redundancy-group 1</pre>	<p>For enabling protected mode:</p> <pre>Router#voice service voip Router(conf-voi-serv)#no redundancy-reload</pre>								
Step 6	<p>Configure the Media Inactivity timer.</p> <p>Example:</p>	<p>The Media Inactivity Timer enables the Active and Standby router pair to monitor and disconnect calls if no Real-Time Protocol (RTP) packets are received within a configurable time period.</p>								

	Command or Action	Purpose
	<pre>Router(config)#ip rtcp report interval 9000 Router(config)#gateway Router(config-gateway)#media-inactivity-criteria all Router(config-gateway)#timer receive-rtp 1200 Router(config-gateway)#timer receive-rtcp 5</pre>	<p>For the SIP calls, the switched over calls are cleared with signaling (as signaling information is preserved for switched calls).</p> <p>The Media Inactivity Timer releases TCP-based calls. This is used to guard against any hung sessions resulting from the failover when a normal call disconnect does not clear the call.</p> <p>You must configure the same duration for the Media Inactivity Timer on both routers. The default value is 30 seconds for SIP calls. The sample configuration is as follows:</p> <p>SIP call legs are cleared once the RTCP timer expires.</p>
Step 7	<p>Reload the router.</p> <p>Example:</p> <pre>Router>enable Router#relaod</pre>	<p>Once all the preceding configurations are completed, you must save the configurations, and reload the router.</p>
Step 8	<p>Configure the peer router.</p>	<p>Follow the preceding steps to configure the standby router. Make sure that you use the correct IP addresses.</p>
Step 9	<p>Point the attached devices to the CUBE Virtual IP (VIP) address.</p>	<p>The IP-PBX, Unified SIP Proxy, or service provider must route the calls to CUBE's virtual IP address.</p> <p>High availability configuration does not handle SIP messages to the CUBE's physical IP addresses.</p>

Configuration Example

Active Router:

```
voice service voip
no ip address trusted authenticate
allow-connections sip to sip
redundancy-group 1
sip
bind control source-interface GigabitEthernet1
bind media source-interface GigabitEthernet1
!
redundancy
application redundancy
group 1
name cube_b2b_ha_1
priority 125 failover threshold 75
timers delay 30 reload 60
control GigabitEthernet2 protocol 1
data GigabitEthernet2
track 1 shutdown
protocol 1
name cube_b2b_ha_1
authentication text sol_ha1
!
```

```
track 1 interface GigabitEthernet1 line-protocol
!
interface GigabitEthernet1
 ip address 192.0.2.1 255.255.255.0
 negotiation auto
 no mop enabled
 no mop sysid
 redundancy rii 102
 redundancy group 1 ip 192.0.2.3 exclusive
!
interface GigabitEthernet2
 ip address 198.51.100.1 255.255.255.0
 negotiation auto
 no mop enabled
 no mop sysid
```

Standby Router:

```
voice service voip
 no ip address trusted authenticate
 allow-connections sip to sip
 redundancy-group 2
sip
 bind control source-interface GigabitEthernet1
 bind media source-interface GigabitEthernet1
!
redundancy
 application redundancy
 group 2
  name cube_b2b_ha_1
  priority 100 failover threshold 75
  timers delay 30 reload 60
  control GigabitEthernet2 protocol 1
  data GigabitEthernet2
  track 1 shutdown
 protocol 1
  name cube_b2b_ha_1
  authentication text sol_ha1
!
track 1 interface GigabitEthernet1 line-protocol
!
interface GigabitEthernet1
 ip address 192.0.2.2 255.255.255.0
 negotiation auto
 no mop enabled
 no mop sysid
 redundancy rii 102
 redundancy group 2 ip 192.0.2.3 exclusive
!
interface GigabitEthernet2
 ip address 198.51.100.2 255.255.255.0
 negotiation auto
 no mop enabled
 no mop sysid
```

Troubleshoot High Availability Issues

Use the following show and debug commands to troubleshoot High Availability issues:

- **show redundancy application group all**
- **show redundancy application transport clients**

- **show redundancy client domain all | inc VOIP RG**
- **show voice high-availability summary**
- **show voip fpi stats**
- **debug voip rtp session**
- **debug voice high-availability all**
- **debug voip fpi all**
- **debug redundancy application group {config | faults | media | protocol | rii transport | vp}**



Note Do not turn on a large number of debugs on a system carrying high volume of active call traffic.



CHAPTER 58

High Availability on Cisco Integrated Services Routers (ISR-G2)

The High Availability (HA) feature allows you to benefit from the failover capability of Cisco Unified Border Element (CUBE) on two routers, one active and one standby. When the active router goes down for any reason, the standby router takes over seamlessly, preserving and processing your calls.

Figure 79: Cisco CUBE High Availability

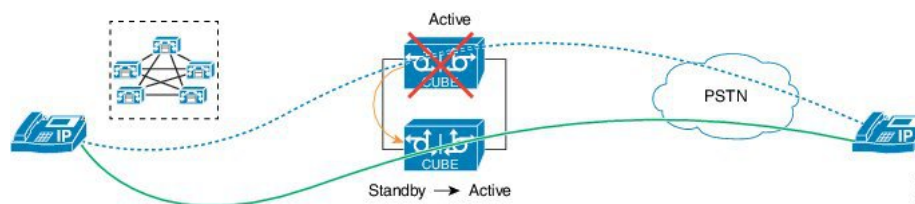

- [About CUBE High Availability on Cisco ISR-G2](#), on page 771
- [How to Configure CUBE High Availability on Cisco ISR-G2](#), on page 791
- [Verify Your Configurations](#), on page 804
- [Troubleshoot High Availability Issues](#), on page 807

About CUBE High Availability on Cisco ISR-G2

CUBE supports Box-to-box redundancy on Cisco Integrated Services Router Generation 2 Router (ISR-G2) and uses Hot Standby Routing Protocol (HSRP) technology to provide High Availability.

Box-to-Box Redundancy

Box-to-box redundancy enables configuring a pair of routers to act as back up for each other. In the router pair, active router is determined based on the failover conditions. The router pair continuously exchange status messages. Cisco CUBE session information is checkpointed across the active and standby router. This enables the standby router to immediately take over all Cisco CUBE call processing responsibilities when the active router becomes unavailable.

Hot Standby Router Protocol (HSRP)

Hot Standby Router Protocol (HSRP) technology provides high network availability by not relying on any single router for routing IP traffic from hosts on the network.

By sharing an IP address and a MAC (Layer 2) address, two or more routers consist a virtual router group that is called a Standby group or HSRP group. This HSRP group acts as a single virtual router to hosts on the LAN. HSRP is used to select an active router and a standby router in an HSRP group. The active router forwards packets that the host sends to the virtual router group. Active and standby routers continually exchange periodic HSRP messages once the protocol has completed the router selection process.

HSRP monitors both the inside and outside interfaces. If any of the interfaces go down, the whole router is considered down and the standby router takes over the responsibilities of the active router.

The RTP streams of established calls are checkpointed between the active and standby routers through the HSRP protocol. Therefore the media streams of established calls are preserved over the HSRP failover from the active to the standby routers. Calls in the transient state (calls that are not established yet, or are in the process of being modified with transfer or hold function) at the time of failover are disconnected.



Note For redundant solutions that use HSRP, CDRs are only generated by the active router.

HSRP Features

- Preemption—The HSRP preemption feature enables the router with the highest priority to immediately become the active router. Priority is determined as follows.
 1. Priority value that you configure.
 2. IP address.

In each case, higher value is of a greater priority.

- Preempt Delay—The preempt delay feature allows you to delay the preemption for a configurable time period. Preempt delay allows the router to populate its routing table before becoming the active router.
- Interface Tracking—Allows you to specify details of another interface on the router of the HSRP group. Interface tracking helps to monitor the change in the HSRP priority of a given HSRP group.

Network Topology

This section describes how to configure the following dual-attached and single-attached network topology. The dual-attached network topology is the most common configuration, in which an active and standby pair of routers is used in a SIP trunk deployment between a Cisco Unified Communications Manager (Unified CM) and a service provider (SP) SIP trunk for PSTN access. It is also possible to configure CUBE HSRP Box-to-box redundancy with a single-attached network topology.

Figure 80: Dual-Attached Network Topology

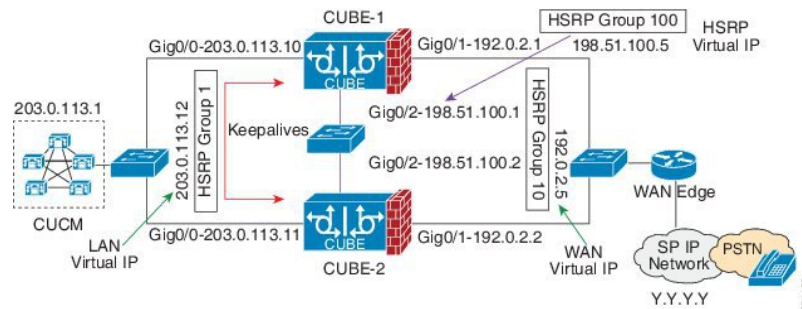
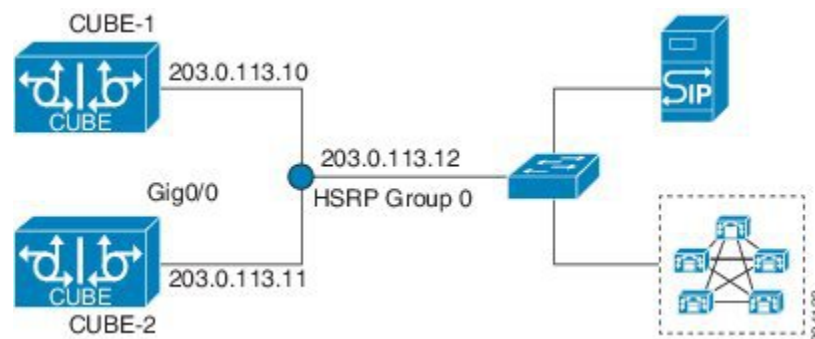

Figure 81: Single-Attached Network Topology



In these topologies, both active and standby routers have the same configuration and both platforms are connected through a physical switch across similar interfaces. This is required for Cisco UBE HA to work. For example, the CUBE-1 and CUBE-2 interface towards WAN must terminate on the same switch. Multiple interfaces or sub-interfaces can be used on either LAN or WAN side. Also, one Cisco UBE has a lower IP address across all three interfaces on the same Cisco UBE platform. This criteria decides the HSRP active state.

We recommend that you keep the following in mind when configuring these topologies:

- Configure all interfaces of an HSRP group with the same priority.
- The active and standby router pair, and interface combination on a particular LAN must have a unique HSRP group number.

Configure CUBE High Availability Using HSRP

Before you begin

It is recommended that you have the knowledge of the following topics:

- How to configure and use Cisco IOS® Voice.
- How to configure and use CUBE.
- How HSRP high availability works on general router platforms.

Components used:

- Minimum software release of CUBE 8.5 (Cisco IOS Release 15.1.2T), implemented on a Cisco 2900 or 3900 Series Integrated Service Router Generation 2 (ISR G2).
- Two identical ISR G2s equipped with the UC Technology Package license (SL-29-UC-K9 or SL-39-UC-K9) installed, 1G DRAM memory, and Cisco IOS Software Release 15.1.2T or later.
- Both routers must be physically located on the same Ethernet LAN.
- The CUBE configuration of both routers is identical and must be manually copied from one router to the other.
- SIP-SIP call flows.

SUMMARY STEPS

1. Enable CUBE and CUBE Redundancy.
2. Enable HSRP.
3. Configure HSRP Communication Transport.
4. Configure HSRP on Interfaces.
5. Configure HSRP Timers.
6. **Configure Media Inactivity Timer.**
7. **Configure SIP Binding to HSRP Address**
8. Reload Routers.
9. **Point Attached Softswitches to CUBE HSRP Virtual Address**

DETAILED STEPS

	Command or Action	Purpose
Step 1	Enable CUBE and CUBE Redundancy. Example: <pre>voice service voip mode border-element allow-connections sip to sip</pre> Example: <pre>voice service voip redundancy</pre>	Enables CUBE on both routers. Also, enables CUBE redundancy and call check pointing on both routers.
Step 2	Enable HSRP. Example: <pre>redundancy inter-device scheme standby SB</pre>	Enables router redundancy schemes on both routers, where: <ul style="list-style-type: none"> • Scheme — redundancy state tracking scheme. • Standby — enable standby (HSRP) state tracking scheme. • SB — the HSRP standby group name.
Step 3	Configure HSRP Communication Transport. Example: Active Configuration:	Enables the HSRP Inter-Device Communication Transport. <ul style="list-style-type: none"> • ipc zone default — Configures the Inter-Device Communication Protocol (IPC) and enters IPC zone configuration mode. Use this command to initiate the

	Command or Action	Purpose
	<pre> ipc zone default association 1 no shutdown protocol sctp local-port 5000 local-ip 10.10.24.14 remote-port 5000 remote-ip 10.10.24.13 Standby Configuration: ipc zone default association 1 no shutdown protocol sctp local-port 5000 local-ip 10.10.24.13 remote-port 5000 remote-ip 10.10.24.14 Note Exit from the local-sctp prompts to configure the remote Stream Control Transmission Protocol (SCTP) parameters as follows: XFR-2(config)#ipc zone default XFR-2(config-ipczone)#association 1 XFR-2(config-ipczone-assoc)#no shutdown XFR-2(config-ipczone-assoc)# protocol sctp Pod4-3925(config-ipc-protocol-sctp)#local-port 5000 XFR-2(config-ipc-local-sctp)#local-ip 10.10.24.13 XFR-2(config-ipc-local-sctp)#exit XFR-2(config-ipc-protocol-sctp)#remote-port 5000 XFR-2(config-ipc-remote-sctp)#remote-ip 10.10.24.14 XFR-2(config-ipc-remote-sctp)#end </pre>	<p>communication link between the Active and Standby devices.</p> <ul style="list-style-type: none"> • association 1 — Configures an association between the two devices and enters the IPC association configuration mode. Under this, configure the details of the association such as transport protocol, local port, local IP address, remote port and remote IP address. Valid association IDs range from 1 to 255. There are no default association IDs. • no shutdown — Restarts a disabled association and its associated transport protocol. For any changes to the transport protocol parameters, this association must be shut down. • protocol sctp — Configures SCTP as the transport protocol for this association and enables SCTP protocol configuration mode. • local-port port_num — Defines the local SCTP port number to use in order to communicate with the redundant peer. • local-ip ip_addr — Defines the local router's IP address to use in order to communicate with the redundant peer. The local IP address must match the remote IP address on the redundant router. • remote-port port_num — Defines the remote SCTP port number to use in order to communicate with the redundant peer. • remote-ip ip_addr — Defines the remote IP address of the peer router used to communicate with the local device. All remote IP addresses must point to the same device. <p>Note The local-port and the remote-port must be set to 5000 on the Active and Standby routers.</p>
<p>Step 4</p>	<p>Configure HSRP on Interfaces.</p> <p>Example:</p> <p>Active Configuration:</p> <pre> interface GigabitEthernet0/0 ip address 10.10.25.14 255.255.255.0 duplex auto keepalive speed auto standby delay minimum 30 reload 60 standby version 2 standby 0 ip 10.10.25.1 standby 0 preempt </pre>	<p>Configures the HSRP Inter-Device Communication Transport.</p> <ul style="list-style-type: none"> • 0 / 6—Defines the Standby Group Number. • keepalive—Enables keepalive for HSRP in order to monitor up/down events. • standby delay—Delays HSRP initialization until the physical interface is up. <ul style="list-style-type: none"> • minimum—Defines the minimum time in seconds to delay HSRP group initialization after

	Command or Action	Purpose
	<pre>standby 0 priority 50 standby 0 track 2 decrement 10 standby 0 name SB ! interface GigabitEthernet0/1 ip address 10.10.24.14 255.255.255.0 duplex auto speed auto media-type rj45 standby delay minimum 30 reload 60 standby version 2 standby 6 ip 10.10.24.1 standby 6 priority 50 standby 6 track 1 decrement 10 Standby Configuration: interface GigabitEthernet0/0 ip address 10.10.25.13 255.255.255.0 duplex auto speed auto keepalive standby delay minimum 30 reload 60 standby version 2 standby 0 ip 10.10.25.1 standby 0 preempt standby 0 priority 50 standby 0 name SB standby 0 track 2 decrement 10 ! interface GigabitEthernet0/1 ip address 10.10.24.13 255.255.255.0 duplex auto speed auto media-type rj45 standby delay minimum 30 reload 60 standby version 2 standby 6 ip 10.10.24.1 standby 6 priority 50 standby 6 preempt standby 6 track 1 decrement 10</pre>	<p>an interface comes up. This minimum delay period applies to all subsequent interface events.</p> <ul style="list-style-type: none"> • reload—Defines the time period to delay after the router is reloaded. • standby x ip—Defines the virtual IPv4 IP address shared between the Active and Standby devices. This command enables the HSRP on the interface. • standby x preempt—Allows the router to become the active router when the priority is higher than all other HSRP-configured routers in the hot standby group. If you do not use the standby preempt command in the configuration for a router, that router does not become the active router, even if the priority is higher than all other routers. • standby x priority—Defines the Hot Standby priority used in order to choose the active router. It ranges from 1 to 255 where 1 denotes the lowest priority and 255 the highest priority. In cases where the standby priority is the same, the device with the higher IP address assumes the role of the Active router. • standby x name—Defines the name of the standby group which matches the scheme defined in Step 2 (SB). For multiple HSRP groups, the same standby name is used as only one standby scheme is allowed in the configurations. • standby 6 track 1 decrement 10—Defines priority tracking. <p>In order to avoid race conditions when a router boots up and an interface comes up to establish contact (Hello) between the Active and Standby routers, it is recommended to configure this:</p> <pre>interface GigabitEthernet0/0 standby delay minimum 30 reload 60</pre>
Step 5	Configure HSRP Timers.	<p>There are two important HSRP timers:</p> <ul style="list-style-type: none"> • Hello Timer: The interval between successive HSRP Hello messages from a given router. This timer can be configured in seconds or milliseconds under the HSRP interface. The default value is 3 seconds. • Hold Timer: The interval between the receipt of a Hello message and the presumption that the sending router has failed. This time can be configured in

	Command or Action	Purpose
		<p>seconds or milliseconds under the HSRP interface. The default value is 8 seconds.</p> <p>The HSRP Hello and Hold Timers are set to their default values. Therefore, they do not show up explicitly in the configurations. The recommended values for the Hello/Hold Timers are the default values.</p> <p>Note If you should use non-default values, you must configure each router to use the same Hello time and Hold timer values.</p> <p>The Hello and Hold timers can be configured under the HSRP interface with this CLI:</p> <pre>Router(config-if)#standby 0 timers ? <1-254> Hello interval in seconds msec Specify hello interval in milliseconds Router (config-if)#standby 0 timers 2 ? <3-255> Hold time in seconds msec Specify hold interval in milliseconds Router(config-if)#standby 0 timers 2 msec 40</pre> <p>In the previous configuration, the Hello timer is set to 2 seconds and the Hold timer to 40 milliseconds.</p> <p>Note You can lower the timer settings to speed up failover or preemption. However, in order to avoid increased CPU use and unnecessary standby state flapping, it is recommended not to set the Hello timer at less than 1 second, and the Hold timer at less than 4 seconds.</p>
Step 6	Configure Media Inactivity Timer.	<p>The Media Inactivity Timer enables the Active/Standby router pair to monitor and disconnect calls if no Real-Time Protocol (RTP) packets are received within a configurable time period.</p> <p>When RTP packets for a call are not received by the Active/Standby router, the SIP Media Inactivity Timer releases the session. This is used to guard against any hung sessions that might have resulted from the failover in the event that a normal call disconnect does not clear the call.</p> <p>The same duration for the Media Inactivity Timer must be configured on both routers. The default value is 28 seconds. This timer is configured as follows:</p> <pre>ip rtcp report interval 3000 gateway media-inactivity-criteria all</pre>

	Command or Action	Purpose
		<pre>timer receive-rtp 86400 timer receive-rtcp 5</pre> <p>Note The media inactivity detection timer is defined with two CLI commands. One command configures the Real-time Transport Control Protocol (RTCP) report interval, and another defines the multiplying factor M (this also identifies the mode of detection with Cisco IOS Release 12.4(4)T). The controlling mechanism is accomplished through the configuration of application CLI.</p> <p>Media inactive timer = M * ip rtcp report interval</p> <p>The inactivity detection is supported in two modes based on which timer multiplying factor configuration (M factor) is used:</p> <p>timer receive-rtcp: Beginning from Cisco IOS Release 12.3(4)T, this mode detects inactivity with the use of no DSP statistics (either an RTP or RTCP packet received is considered active). No explicit enabling is needed. This timer is the default. When this timer is used, the call is disconnected when a silent call is detected. This behavior is not DSP-based, but is the default behavior when no application CLI is configured.</p> <p>timer media-inactive: This mode is available in Cisco IOS Release 12.4(4)T, where detection is based on DSP statistics (it uses RTP-only mechanism; packets sent or received are considered active). If both directions are absent, it is considered inactive. This timer is enabled or disabled with the use of application CLI, which can also be used in order to control notification.</p>
Step 7	Configure SIP Binding to HSRP Address	<p>Configures the CUBE SIP messaging in order to use the HSRP virtual address in SIP messaging:</p> <pre>dial-peer voice 100 voip description to-SIP voice-class sip bind control source-interface GigabitEthernet0/0 voice-class sip bind media source-interface GigabitEthernet0/0 ! dial-peer voice 200 voip description to-CUCM voice-class sip bind control source-interface GigabitEthernet0/1 voice-class sip bind media source-interface GigabitEthernet0/1</pre> <p>Once HSRP is configured under the physical interface and the bind command has been issued, calls to the physical IP</p>

	Command or Action	Purpose
		address will fail. This is because the SIP listening socket is now bound to the virtual IP address but the signaling packets use the physical IP address, and therefore cannot be handled.
Step 8	Reload Routers.	<p>Once all the above configurations have been completed, the redundancy show output is as follows:</p> <pre>XFR-2#show redundancy inter-device Redundancy inter-device state: RF_INTERDEV_STATE_INIT Pending Scheme: Standby (Will not take effect until next reload) Pending Groupname: b2bha Scheme: <NOT CONFIGURED> Peer present: UNKNOWN Security: Not configured</pre> <p>When you reload the router, the HSRP configuration is enabled as follows:</p> <p>Active Router Configuration:</p> <pre>XFR-2#show redundancy inter-device Redundancy inter-device state: RF_INTERDEV_STATE_ACT Scheme: Standby Groupname: b2bha Group State: Active Peer present: RF_INTERDEV_PEER_COMM Security: Not configured</pre> <p>Standby Router Configuration:</p> <pre>CUBE_XFR#show redundancy inter-device Redundancy inter-device state: RF_INTERDEV_STATE_STDBY Scheme: Standby Groupname: b2bha Group State: Standby Peer present: RF_INTERDEV_PEER_COMM Security: Not configured</pre>
Step 9	Point Attached Softswitches to CUBE HSRP Virtual Address	The CUCM, IP-PBX, SIP proxy or SP SBCs or SP softswitches that route calls to CUBE must use the HSRP virtual address in their SIP messaging. SIP messages to the CUBE physical IP addresses are not handled with an HSRP configuration.

Example

Sample Configurations for Dual-Attached CUBE HSRP Redundancy

In these configurations, the HSRP Hello and Hold timers use their default values of 3 and 8 seconds respectively, and are not shown explicitly in the CLI output.

Active Configuration:

```
ipc zone default
  association 1
  no shutdown
  protocol sctp
```

```

        local-port 5000
        local-ip 10.10.24.14
        remote-port 5000
        remote-ip 10.10.24.13
    !
voice service voip
    mode border-element
    allow-connections sip to sip
    redundancy
    !
redundancy inter-device
    scheme standby SB
    !
redundancy
    !
interface GigabitEthernet0/0
    ip address 10.10.25.14 255.255.255.0
    duplex auto
    keepalive
    speed auto
    standby delay minimum 30 reload 60
    standby version 2
    standby 0 ip 10.10.25.1
    standby 0 preempt
    standby 0 priority 50
    standby 0 track 2 decrement 10
    standby 0 name SB

    !
interface GigabitEthernet0/1
    ip address 10.10.24.14 255.255.255.0
    duplex auto
    speed auto
    media-type rj45
    standby delay minimum 30 reload 60
    standby version 2
    standby 6 ip 10.10.24.1
    standby 6 priority 50
    standby 6 track 1 decrement 10

    !
ip rtcp report interval 3000
    !
track 1 interface GigabitEthernet0/0 line-protocol
    !
track 2 interface GigabitEthernet0/1 line-protocol
    !
dial-peer voice 100 voip
    description to-SIP
    destination-pattern 9T
    session protocol sipv2
    session target ipv4:x.x.x.x
    voice-class sip bind control source-interface GigabitEthernet0/0
    voice-class sip bind media source-interface GigabitEthernet0/0
    !
dial-peer voice 200 voip
    description to-CUCM
    destination-pattern 555....
    session protocol sipv2
    session target ipv4:y.y.y.y
    voice-class sip bind control source-interface GigabitEthernet0/1
    voice-class sip bind media source-interface GigabitEthernet0/1
    !
gateway

```

```

media-inactivity-criteria all
timer receive-rtcp 5
timer receive-rtp 1200

```

Standby Configuration:

```

ipc zone default
  association 1
  no shutdown
  protocol sctp
  local-port 5000
  local-ip 10.10.24.13
  remote-port 5000
  remote-ip 10.10.24.14
!
voice service voip
  mode border-element
  allow-connections sip to sip
  redundancy
!
redundancy inter-device
  scheme standby SB
!
redundancy
!
interface GigabitEthernet0/0
  ip address 10.10.25.13 255.255.255.0
  duplex auto
  keepalive
  speed auto
  standby delay minimum 30 reload 60
  standby version 2
  standby 0 ip 10.10.25.1
  standby 0 preempt
  standby 0 priority 50
  standby 0 name SB
  standby 0 track 2 decrement 10
!
interface GigabitEthernet0/1
  ip address 10.10.24.13 255.255.255.0
  duplex auto
  speed auto
  media-type rj45
  standby delay minimum 30 reload 60
  standby version 2
  standby 6 ip 10.10.24.1
  standby 6 priority 50
  standby 6 preempt
  standby 6 track 1 decrement 10
!
ip rtcp report interval 3000
!
track 1 interface GigabitEthernet0/0 line-protocol
!
track 2 interface GigabitEthernet0/1 line-protocol
!
dial-peer voice 100 voip
  description to-SIP
  destination-pattern 9T
  session protocol sipv2
  session target ipv4:x.x.x.x
  voice-class sip bind control source-interface GigabitEthernet0/0
  voice-class sip bind media source-interface GigabitEthernet0/0

```

```

!
dial-peer voice 200 voip
  description to-CUCM
  destination-pattern 555....
  session protocol sipv2
  session target ipv4:y.y.y.y
  voice-class sip bind control source-interface GigabitEthernet0/1
  voice-class sip bind media source-interface GigabitEthernet0/1
!
gateway
  media-inactivity-criteria all
  timer receive-rtcp 5
  timer receive-rtp 1200

```

Sample Configuration for Single-Attached CUBE HSRP Redundancy

While a dual-attached CUBE is the most common configuration, especially for SP SIP trunk connections, it is also possible to configure CUBE HSRP box-to-box redundancy with a single-attached CUBE deployment as given in this section.

Active Router Configuration:

```

ipc zone default
  association 1
  no shutdown
  protocol sctp
    local-port 5000
    local-ip 1.2.175.8
    remote-port 5000
    remote-ip 1.2.175.12
!
voice service voip
  mode border-element
  allow-connections sip to sip
  redundancy
  sip
    bind control source-interface GigabitEthernet0/0
    bind media source-interface GigabitEthernet0/0
!
redundancy inter-device
  scheme standby SB
!
redundancy
!
interface GigabitEthernet0/0
  ip address 1.2.175.8 255.255.0.0
  duplex auto
  speed auto
  keepalive
  standby delay minimum 30 reload 60
  standby version 2
  standby 0 ip 1.2.175.100
  standby 0 preempt
  standby 0 priority 50
  standby 0 name SB
  standby 0 track 1 decrement 10

!
ip rtcp report interval 3000
!
dial-peer voice 5 voip
  description to-SIP-application
  destination-pattern 9T
  session protocol sipv2

```

```

    session target ipv4:x.x.x.x
  !
dial-peer voice 9 voip
  description to-CUCM
  destination-pattern 555....
  session protocol sipv2
  session target ipv4:y.y.y.y
  !
gateway
media-inactivity-criteria all
timer receive-rtcp 5
timer receive-rtp 1200

```

Standby Router Configuration:

```

ipc zone default
  association 1
  no shutdown
  protocol sctp
  local-port 5000
  local-ip 1.2.175.12
  remote-port 5000
  remote-ip 1.2.175.8
  !
voice service voip
  mode border-element
  allow-connections sip to sip
  redundancy
  sip
    bind control source-interface GigabitEthernet0/0
    bind media source-interface GigabitEthernet0/0
  !
redundancy inter-device
  scheme standby SB
  !
redundancy
  !
interface GigabitEthernet0/0
  ip address 1.2.175.12 255.255.0.0
  duplex auto
  speed auto
  standby delay minimum 30 reload 60
  standby version 2
  standby 0 ip 1.2.175.100
  standby 0 priority 50
  standby 0 preempt
  standby 0 name SB
  standby 0 track 1 decrement 10

  !
ip rtcp report interval 3000
  !
dial-peer voice 5 voip
  description to-SIP-application
  destination-pattern 9T
  session protocol sipv2
  session target ipv4:x.x.x.x
  !
dial-peer voice 9 voip
  description to-CUCM
  destination-pattern 555....
  session protocol sipv2
  session target ipv4:y.y.y.y
  !
gateway

```

```
media-inactivity-criteria all
timer receive-rtcp 5
timer receive-rtp 1200
```

Verify Redundancy State

SUMMARY STEPS

1. Use the **show redundancy inter-Router** and **show redundancy state** commands to verify the redundancy state.

DETAILED STEPS

	Command or Action	Purpose
Step 1	Use the show redundancy inter-Router and show redundancy state commands to verify the redundancy state.	<p>The following are sample outputs for the commands show redundancy inter-Router and show redundancy state before inter-router configuration:</p> <pre>XFR-2#show redundancy inter-Router Redundancy inter-Router state: RF_INTERDEV_STATE_PNC_NO_HSRP Scheme: Standby Groupname: b2bha Group State: Init Protocol: <NOT CONFIGURED></pre> <pre>XFR-2#show redundancy states my state = 3 -NEGOTIATION peer state = 1 -DISABLED Mode = Simplex Unit ID = 0 Maintenance Mode = Disabled Manual Swact = disabled (system is simplex (no peer unit)) Communications = Down Reason: Simplex mode client count = 14 client_notification_TMR = 30000 milliseconds RF debug mask = 0x0</pre> <p>The following is a sample output for the command show redundancy inter-Router after the inter-router configuration and before router reload:</p> <pre>XFR-2#show redundancy inter-Router Redundancy inter-Router state: RF_INTERDEV_STATE_INIT Pending Scheme: Standby (Will not take effect until next reload) Pending Groupname: b2bha Scheme: <NOT CONFIGURED> Peer present: UNKNOWN Security: Not configured</pre>

	Command or Action	Purpose
		<p>The following are sample outputs for the commands show redundancy inter-Router and show redundancy state after the router reload:</p> <pre>CUBE_XFR#show redundancy inter-Router Redundancy inter-Router state: RF_INTERDEV_STATE_PNC_NO_HSRP Scheme: Standby Groupname: b2bha Group State: Init Peer present: UNKNOWN Security: Not configured CUBE_XFR#show redundancy states my state = 3 -NEGOTIATION peer state = 13 -ACTIVE Mode = Duplex Unit ID = 0 Maintenance Mode = Disabled Manual Swact = disabled (this unit is still initializing) Communications = Up client count = 14 client_notification_TMR = 30000 milliseconds RF debug mask = 0x0</pre> <p>The following are sample outputs for the commands show redundancy inter-Router and show redundancy state during a switchover:</p> <pre>CUBE_XFR#show redundancy inter-Router Redundancy inter-Router state: RF_INTERDEV_STATE_ACT Scheme: Standby Groupname: b2bha Group State: Active Peer present: RF_INTERDEV_PEER_NO_COMM Security: Not configured XFR-2#show redundancy states my state = 13 -ACTIVE peer state = 1 -DISABLED Mode = Simplex Unit ID = 0 Maintenance Mode = Disabled Manual Swact = disabled (system is simplex (no peer unit)) Communications = Up client count = 14 client_notification_TMR = 30000 milliseconds RF debug mask = 0x0</pre> <p>The following are sample outputs for the commands show redundancy inter-Router and show redundancy state</p>

	Command or Action	Purpose
		<p>after a switch over, but before the routers exchange Hello status messages:</p> <pre>CUBE_XFR#show redundancy inter-Router Redundancy inter-Router state: RF_INTERDEV_STATE_ACT Scheme: Standby Groupname: b2bha Group State: Active Peer present: RF_INTERDEV_PEER_NO_COMM Security: Not configured XFR-2#show redundancy inter-Router Redundancy inter-Router state: RF_INTERDEV_STATE_HSRP_STDBY_PNC Scheme: Standby Groupname: b2bha Group State: Standby Peer present: RF_INTERDEV_PEER_NO_COMM Security: Not configured</pre> <p>The following are sample outputs for the commands show redundancy inter-Router and show redundancy state after the exchange of Hello status messages:</p> <pre>XFR-2#show redundancy inter-Router Redundancy inter-Router state: RF_INTERDEV_STATE_ACT Scheme: Standby Groupname: b2bha Group State: Active Peer present: RF_INTERDEV_PEER_COMM Security: Not configured XFR-2#show redundancy states my state = 13 -ACTIVE peer state = 8 -STANDBY HOT Mode = Duplex Unit ID = 0 Maintenance Mode = Disabled Manual Swact = disabled (peer unit not yet in terminal standby state) Communications = Up client count = 14 client_notification_TMR = 30000 milliseconds RF debug mask = 0x0 CUBE_XFR#show redundancy inter-Router Redundancy inter-Router state: RF_INTERDEV_STATE_STDBY Scheme: Standby Groupname: b2bha Group State: Standby Peer present: RF_INTERDEV_PEER_COMM Security: Not configured CUBE_XFR#show redundancy states my state = 8 -STANDBY HOT peer state = 13 -ACTIVE</pre>

	Command or Action	Purpose
		Mode = Duplex Unit ID = 0 Maintenance Mode = Disabled Manual Swact = cannot be initiated from this the standby unit Communications = Up client count = 14 client_notification_TMR = 30000 milliseconds RF debug mask = 0x0

Verify Call State After a Switchover

Use the **show voice high-availability summary** command to verify the following:

- The checkpointing of calls on the standby router after a switchover
- The media-inactivity count on the active router when the calls are over
- To check for native and nonnative (for example, preserved) calls when both types of calls are present
- To identify the presence of leaked RTP, HA, SPI sessions

Verify checkpointing of calls on the standby router after a switchover

In this example, 800 calls were checkpointed from active to standby after the switchover.

```
Router#show voice high-availability summary
```

```

===== Voice HA DB INFO =====
Number of calls in HA DB: 0
Number of calls in HA sync pending DB: 0
Number of calls in HA preserved session DB: 0

-----
First a few entries in HA DB:
-----

-----
First a few entries in Sync Pending DB:
-----

-----

===== Voice HA Process INFO =====
Active process current tick: 3100
Active process number of tick events pending: 0
Active process number of tick events processed: 0
voice service voip is configured to have redundancy

===== Voice HA RF INFO =====
Voice HA RF Client Name: VOIP RF CLIENT
Voice HA RF Client ID: 1345
My current rf state STANDBY HOT
Peer current rf state ACTIVE
Voice HA Standby is not available.
System has not experienced switchover.

```

```

===== Voice HA CF INFO =====
Voice HA CF Client Name: CHKPT VOIP SYMPHONY
Voice HA CF Client ID: 252
Voice HA CF Client Status: Peer NOT READY; TP flow ON.

===== Voice HA COUNTERS =====
Total number of checkpoint requests sent (Active): 0
Total number of checkpoint requested received (Standby): 971
Total CREATE received on Standby: 800
Total MODIFY received on Standby: 0
Total DELETE received on Standby: 800
Media Inactivity event count: 0

Checkpoint CREATE overflow: 0
Checkpoint MODIFY overflow: 0
Checkpoint DELETE overflow: 0
HA DB elememnt pool overrun count: 0
HA DB aux element pool overrun count: 0
HA DB insertion failure count: 0
HA DB deletion failure count: 0
Tick event pool overrun count: 0
Tick event queue overrun count: 0
Checkpoint send failure count: 0
Checkpoint get buffer failure count: 0

```

Verify the media-inactivity count on the active router when the calls are over

In this example, 800 calls are cleared by the media-inactivity timer.

```
Router#show voice high-availability summary
```

```

===== Voice HA DB INFO =====
Number of calls in HA DB: 0
Number of calls in HA sync pending DB: 0
Number of calls in HA preserved session DB: 0

-----
First a few entries in HA DB:
-----

-----
First a few entries in Sync Pending DB:
-----

-----

===== Voice HA Process INFO =====
Active process current tick: 4213
Active process number of tick events pending: 0
Active process number of tick events processed: 0
voice service voip is configured to have redundancy

===== Voice HA RF INFO =====
Voice HA RF Client Name: VOIP RF CLIENT
Voice HA RF Client ID: 1345
My current rf state ACTIVE
Peer current rf state STANDBY HOT
Voice HA Active and Standby are in sync.
System has experienced switchover.

===== Voice HA CF INFO =====
Voice HA CF Client Name: CHKPT VOIP SYMPHONY
Voice HA CF Client ID: 252
Voice HA CF Client Status: Peer READY; TP flow ON.

```

```

===== Voice HA COUNTERS =====
Total number of checkpoint requests sent (Active): 971
Total number of checkpoint requested received (Standby): 800
Total CREATE received on Standby: 800
Total MODIFY received on Standby: 0
Total DELETE received on Standby: 0
Media Inactivity event count: 800

Checkpoint CREATE overflow: 0
Checkpoint MODIFY overflow: 0
Checkpoint DELETE overflow: 0
HA DB elememnt pool overrun count: 0
HA DB aux element pool overrun count: 0
HA DB insertion failure count: 0
HA DB deletion failure count: 0
Tick event pool overrun count: 0
Tick event queue overrun count: 0
Checkpoint send failure count: 0
  Checkpoint get buffer failure count: 0

```

Verify native and non-native (preserved) calls when both are present

The numbers of calls on the system are shown as follows:

- Total number of calls = "Number of calls in HA DB" + "Number of calls in HA sync pending DB". This is $100 + 50 = 150$ in the example output below.
- Total number of preserved (nonnative) calls = "Number of calls in HA preserved session DB". This is 70 in the example output below.
- Total number of native calls (calls set up since the failover and therefore not preserved over the failover) is the difference in the previous two numbers. In this example, it is $150 - 70 = 80$.

```
Router#show voice high-availability summary
```

```

===== Voice HA DB INFO =====
Number of calls in HA DB: 100
Number of calls in HA sync pending DB: 50
Number of calls in HA preserved session DB: 70

```

Identify the presence of leaked RTP, HA, SPI Sessions

The total number of preserved (non-native) calls cleared by Media Inactivity is equal to the total CREATE received on standby router minus total DELETE received on standby router. Compare this number with the Media Inactivity event count and the number of media down events, as shown in the output of the **show voip fpi stats** command.

```
Router# show voice high-availability summary
```

```

===== Voice HA DB INFO =====
Number of calls in HA DB: 0
Number of calls in HA sync pending DB: 0
Number of calls in HA preserved session DB: 0

===== Voice HA COUNTERS =====
Total number of checkpoint requests sent (Active): 971
Total number of checkpoint requested received (Standby): 800
Total CREATE received on Standby: 800
Total MODIFY received on Standby: 0
Total DELETE received on Standby: 0
Media Inactivity event count: 800

```

- Box-to-box redundancy configuration supports multiple HSRP groups per router, but only a single HSRP group per physical interface.
- Loopback addresses with HSRP are not supported, the SIP bind command must use the HSRP virtual IP address.
- No support for media-flow around or UC Services API (Cisco Unified Communications Manager - Network-Based Recording).
- WANs cannot terminate directly on the CUBE or on data HSRP on either sides.
- Call Progress Analysis (CPA) calls (before to being transferred to the agent), SCCP-based media resources, Noise Reduction, Acoustic Shock Protection (ASP), and transrating calls are not checkpointed.
- Courtesy Callback (CCB) feature is not supported if a callback was registered with Cisco Unified Customer Voice Portal (CVP) and then a switchover was done on CUBE.

How to Configure CUBE High Availability on Cisco ISR-G2

Before You Begin

- Two identical ISR-G2s equipped with the UC Technology Package license (SL-29-UC-K9 or SL-39-UC-K9) installed, 1G DRAM memory, and Cisco IOS Software release 15.1.2T or later.
- Ensure that you have the required licenses for configuring High Availability. For detailed information, see [Cisco Unified Border Element Data Sheet](#).

Configure High Availability

SUMMARY STEPS

1. Define the redundancy scheme.
2. Enable CUBE and CUBE redundancy.
3. Configure Inter-process Communication (IPC) protocol at the HSRP interface.
4. (Optional) Configure Virtual Route Forwarding (VRF) on the platform.
5. Configure HSRP on the interfaces.
6. Configure Interface Tracking.
7. Bind traffic to the respective interfaces.
8. Configure Media Inactivity feature.
9. Reload the routers.
10. Point the attached devices to the CUBE HSRP Virtual IP (VIP) address.

DETAILED STEPS

Step 1 Define the redundancy scheme.

Example:

```
Router(config)#redundancy inter-device
Router(config-red-interdevice)#scheme standby SB
```

The following table provides details of the CLIs used in the configuration.

Keyword	Description
scheme	Redundancy state tracking scheme
standby	Enables standby (HSRP) state tracking scheme
SB	HSRP standby group name

The router enters the interdevice configuration mode and names the redundancy scheme that is used between the two routers. The CLIs listed in the preceding example create interdependency between the CUBE redundancy and HSRP.

Step 2

Enable CUBE and CUBE redundancy.

Example:

Enable CUBE on both routers

```
Router(config)#voice service voip
Router(config-voi-serv)#mode border-element
Router(config-voi-serv)#allow-connections sip to sip
```

Enables CUBE on the router and allows connections between the specific type of endpoints in a VoIP network.

Example:

Enable the CUBE redundancy and call checkpointing on both routers

```
Router(config)#voice service voip
Router(config-voi-serv)#redundancy
```

Step 3

Configure Inter-process Communication (IPC) protocol at the HSRP interface.

Example:

Active CUBE configuration

```
CUBE-1(config)#ipc zone default
CUBE-1(config-ipzone)#association 1
CUBE-1(config-ipczone-assoc)#no shutdown
CUBE-1(config-ipczone-assoc)#protocol sctp
CUBE-1(config-ipc-protocol-sctp)#local-port 5000
CUBE-1(config-ipc-local-sctp)#local-ip 203.0.113.10
CUBE-1(config-ipc-local-sctp)#remote-port 5000
CUBE-1(config-ipc-remote-sctp)#remote-ip 203.0.113.11
```

Example:

Standby CUBE configuration

```
CUBE-2(config)#ipc zone default
CUBE-2(config-ipzone)#association 1
CUBE-2(config-ipczone-assoc)#no shutdown
CUBE-2(config-ipczone-assoc)#protocol sctp
CUBE-2(config-ipc-protocol-sctp)#local-port 5000
CUBE-2(config-ipc-local-sctp)#local-ip 203.0.113.11
```

```
CUBE-2(config-ipc-local-sctp)#remote-port 5000
CUBE-2(config-ipc-remote-sctp#remote-ip 203.0.113.10
```

The following table provides details of the CLIs used in the configuration.

Option	Description
ipc zone default	Configures the Inter-process Communication Protocol (IPC) and enters IPC zone configuration mode. Use this command to initiate the communication link between the active and standby routers.
association 1	Configures an association between the two routers and enters the IPC association configuration mode. Under this, configure the details of the association such as the transport protocol, local port, local IP address, remote port, and remote IP address. Valid association IDs range 1–255. There are no default association IDs.
no shutdown	Restarts a disabled association and the associated transport protocol. For any changes to the transport protocol parameters, you must shut down the association.
protocol sctp	Configures Stream Control Transmission Protocol (SCTP) as the transport protocol for the association and enables SCTP protocol configuration mode.
local-port <i>port_num</i>	Defines the local SCTP port number for communication with the redundant peer.
local-ip <i>ip_addr</i>	Defines the local router's IP address for communication with the redundant peer. The local IP address must match the remote IP address on the redundant router.
remote-port <i>port_num</i>	Defines the remote SCTP port number for communication with the redundant peer.
remote-ip <i>ip_addr</i>	Defines the remote IP address for communication with the redundant peer. All remote IP addresses must point to the same router.

Allows the active CUBE to communicate with the standby CUBE about the state of the calls. Configuration must be applied on the LAN side.

Note The local-port and the remote-port must be set to 5000 on the active and standby routers.

Step 4 (Optional) Configure Virtual Route Forwarding (VRF) on the platform.

Example:

VRF configuration on active and standby CUBE

```
Router(config)#ip vrf LAN-VRF
Router(config)#rd 1:1
Router(config)#ip vrf WAN-VRF
Router(config)#rd 1:1
```

The following table provides details of the CLIs used in the configuration.

Option	Description
ip vrf <i>vrf-name</i>	Creates a VRF with the specified name. Note Space is not allowed in the VRF name.
rd <i>route-distinguisher</i>	Creates a VRF table by specifying a route distinguisher. Enter either an AS number and an arbitrary number (xxx:y) or an IP address and arbitrary number (A.B.C.D:y).

CUBE High Availability with HSRP supports VRF. Traffic interfaces (SIP/RTP) can have VRFs configured. VRF IDs are checkpointed for the calls before and after the switchover. VRF configurations including VRF-based RTP port range, must be identical on both active and standby routers.

Step 5

Configure HSRP on the interfaces.

a) Configure the inside interface.

Example:

Active CUBE configuration

```
CUBE-1(config)#interface GigabitEthernet0/0
CUBE-1(config-if)#description "Enterprise LAN"
CUBE-1(config-if)#ip vrf forwarding LAN-VRF
CUBE-1(config-if)#ip address 203.0.113.10 255.255.255.0
CUBE-1(config-if)#standby version 2
CUBE-1(config-if)#standby 1 ip 203.0.113.12
CUBE-1(config-if)#standby delay minimum 30 reload 60
CUBE-1(config-if)#standby 1 preempt
CUBE-1(config-if)#standby 1 track 2 decrement 10
CUBE-1(config-if)#standby 1 track 3 decrement 10
CUBE-1(config-if)#standby 1 priority 50
```

Example:

Standby CUBE configuration

```
CUBE-2(config)#interface GigabitEthernet0/0
CUBE-2(config-if)#description "Enterprise LAN"
CUBE-2(config-if)#ip vrf forwarding LAN-VRF
CUBE-2(config-if)#ip address 203.0.113.11 255.255.255.0
CUBE-2(config-if)#standby version 2
CUBE-2(config-if)#standby 1 ip 203.0.113.12
CUBE-2(config-if)#standby delay minimum 30 reload 60
CUBE-2(config-if)#standby 1 preempt
CUBE-2(config-if)#standby 1 track 2 decrement 10
CUBE-2(config-if)#standby 1 track 3 decrement 10
CUBE-2(config-if)#standby 1 priority 50
```

b) Configure the outside interface.

Example:

Active CUBE configuration

```
CUBE-1(config)#interface GigabitEthernet0/1
CUBE-1(config-if)#description "Enterprise WAN"
CUBE-1(config-if)#ip vrf forwarding WAN-VRF
CUBE-1(config-if)#ip address 192.0.2.1 255.255.255.0
CUBE-1(config-if)#standby version 2
CUBE-1(config-if)#standby 10 ip 192.0.2.5
CUBE-1(config-if)#standby delay minimum 30 reload 60
CUBE-1(config-if)#standby 10 preempt
CUBE-1(config-if)#standby 10 track 2 decrement 10
CUBE-1(config-if)#standby 10 track 3 decrement 10
CUBE-1(config-if)#standby 10 priority 50
```

Example:

Standby CUBE configuration

```
CUBE-2(config)#interface GigabitEthernet0/1
CUBE-2(config-if)#description "Enterprise WAN"
CUBE-2(config-if)#ip vrf forwarding WAN-VRF
CUBE-2(config-if)#ip address 192.0.2.2 255.255.255.0
CUBE-2(config-if)#standby version 2
CUBE-2(config-if)#standby 10 ip 192.0.2.5
CUBE-2(config-if)#standby delay minimum 30 reload 60
CUBE-2(config-if)#standby 10 preempt
CUBE-2(config-if)#standby 10 track 2 decrement 10
CUBE-2(config-if)#standby 10 track 3 decrement 10
CUBE-2(config-if)#standby 10 priority 50
```

- c) Configure the HSRP interface (between the active and standby CUBE).

Example:

Active CUBE configuration

```
CUBE-1(config)#interface GigabitEthernet0/2
CUBE-1(config-if)#description "HSRP Interface"
CUBE-1(config-if)#ip address 198.51.100.1 255.255.255.0
CUBE-1(config-if)#standby version 2
CUBE-1(config-if)#standby 100 ip 198.51.100.5
CUBE-1(config-if)#standby delay minimum 30 reload 60
CUBE-1(config-if)#standby 100 preempt
CUBE-1(config-if)#standby 100 name SB
CUBE-1(config-if)#standby 100 track 2 decrement 10
CUBE-1(config-if)#standby 100 track 3 decrement 10
CUBE-1(config-if)#standby 100 priority 50
```

Example:

Standby CUBE configuration

```
CUBE-2(config)#interface GigabitEthernet0/2
CUBE-2(config-if)#description "HSRP Interface"
CUBE-2(config-if)#ip address 198.51.100.2 255.255.255.0
CUBE-2(config-if)#standby version 2
CUBE-2(config-if)#standby 100 ip 198.51.100.5
CUBE-2(config-if)#standby delay minimum 30 reload 60
CUBE-2(config-if)#standby 100 preempt
CUBE-2(config-if)#standby 100 name SB
CUBE-2(config-if)#standby 100 track 2 decrement 10
CUBE-2(config-if)#standby 100 track 3 decrement 10
CUBE-2(config-if)#standby 100 priority 50
```

Note `ip vrf forwarding vrf-name` is applicable only if you have configured VRF.

The HSRP interface cannot have VRFs associated with it. For a CUBE deployment that has VRFs configured for SIP/RTP interfaces, you must have minimum of three interfaces. Otherwise, you can use any of the LAN interfaces as an HSRP interface.

The following table provides details of the CLIs used in the configuration.

Option	Description
<code>interface type number</code>	Configures an interface type and enters the interface configuration mode.
<code>ip address ip_address subnet_mask</code>	Configures an IP address for an interface.
<code>standby version {1/2}</code>	Changes the HSRP version.
<code>standby [group-number] ip [ip_address]</code>	<p>Activates HSRP.</p> <ul style="list-style-type: none"> If you do not configure a group number, the default group number is 0. The group number range is 0–255 for HSRP version 1 and 0–4095 for HSRP version 2. The value for the <code>ip_address</code> argument is the virtual IP address of the virtual device. For HSRP to elect a designated device, you must configure the virtual IP address for at least one of the devices in the group; it can be learned on the other devices in the group.
<code>standby delay minimum min-seconds reload reload-seconds</code>	<p>Configures the delay period before the initialization of HSRP group.</p> <ul style="list-style-type: none"> The <code>min-seconds</code> value is the minimum time (in seconds) to delay the HSRP group initialization after an interface comes up. This minimum delay period applies to all subsequent interface events. The <code>reload-seconds</code> value is the time period to delay after the device has reloaded. This delay period applies only to the first interface-up event after the device has reloaded. <p>Note The recommended <code>min-seconds</code> value is 30 and the recommended <code>reload-seconds</code> value is 60.</p>
<code>standby group-number preempt</code>	Allows the router to become the active router when the priority is higher than all other HSRP-configured routers in the HSRP group. If you do not use the <code>standby preempt</code> command in the configuration for a router, that router does not become the active router, even if the priority is higher than all other routers.

Option	Description
standby <i>group-number</i> track <i>track-process-number</i> decrement <i>value</i>	Configures HSRP to track a device and change the HSRP priority on the basis of the state of the device. Decrement value specifies the value by which the HSRP priority of the tracked device is decremented (or incremented) when the device goes down (or becomes available).
standby <i>x</i> priority	Defines the Hot Standby priority that is used in choosing the active router. The range is 1–255, where 1 denotes the lowest priority and 255 the highest priority. Note In cases where the standby priority is the same, the device with the higher IP address assumes the role of the active router.
ip vrf forwarding <i>vrf-name</i>	Associates the specified VRF with the interface.

Step 6 Configure Interface Tracking.**Example:**

Active and standby CUBE configuration

```
Router(config)#track 1 interface Gig0/0 line-protocol
Router(config)#track 2 interface Gig0/1 line-protocol
Router(config)#track 3 interface Gig0/2 line-protocol
```

Create a tracking list to track the line-protocol state of an interface.

The following table provides details of the CLIs used in the configuration.

Option	Description
track <i>object-number</i> interface <i>interface-id</i> line-protocol	Enters tracking configuration mode. <ul style="list-style-type: none"> • The <i>object-number</i> identifies the tracked object and the range is 1–500. • The <i>interface-id</i> represents the interface that is tracked.

Step 7 Bind traffic to the respective interfaces.

- a) Bind traffic that is destined to the outside (Service Provider (SP) SIP trunk) to the outside physical interface.

Example:

Active and standby CUBE configuration

```
Router(config)#dial-peer voice 100 voip
Router(config-dial-peer)#description TO SERVICE PROVIDER
Router(config-dial-peer)#destination-pattern 9T
Router(config-dial-peer)#session protocol sipv2
Router(config-dial-peer)#session target ipv4:y.y.y.y
Router(config-dial-peer)#voice-class sip bind control source-interface GigabitEthernet0/1
Router(config-dial-peer)#voice-class sip bind media source-interface GigabitEthernet0/1
```

- b) Bind traffic that is destined to the inside (Unified CM or IP PBX) to the inside physical interface.

Example:

Active and standby CUBE configuration

```
CUBE(config)#dial-peer voice 200 voip
CUBE(config-dial-peer)#description TO CUCM
CUBE(config-dial-peer)#destination-pattern 555...
CUBE(config-dial-peer)#session protocol sipv2
CUBE(config-dial-peer)#session target ipv4:203.0.113.1
CUBE(config-dial-peer)#voice-class sip bind control source-interface GigabitEthernet0/0
CUBE(config-dial-peer)#voice-class sip bind media source-interface GigabitEthernet0/0
```

Binding the traffic to the respective interfaces ensures that all RTP and SIP packets are created with the virtual IP associated with the respective physical interface.

The following table provides details of the CLIs used in the configuration.

Option	Description
dial-peer voice <i>number voip</i>	Defines a local dial peer. <ul style="list-style-type: none"> The <i>number</i> argument identifies the dial peer. Valid entries are 1–2147483647.
description <i>string</i>	Provides a description for the dial-peer group.
destination-pattern <i>string</i>	Defines the phone number that identifies the destination pattern that is associated with the dial-peer.
session-protocol sipv2	Configures SIP as the session protocol type.
session target <i>ip-address</i>	Configures the network address of the remote router to which you want to send a call once a local voice-network dial peer is matched.
voice-class sip bind control source-interface <i>interface-id</i> voice-class sip bind media source-interface <i>interface-id</i>	Sets a source interface for signaling and media packets. The binding applies to the specified interfaces only. <ul style="list-style-type: none"> control—Binds signaling packets. binds—Binds media packets. source-interface <i>interface-id</i>—Type of interface and its ID.

Step 8

Configure Media Inactivity feature.

Example:

Active and standby CUBE configuration

```
CUBE(config)#ip rtcp report interval 3000
!
CUBE(config)#gateway
CUBE(config-gateway)#media-inactivity-criteria all
```

```
timer receive-rtcp 5
timer receive-rtp 86400
```

the following table provides details of the CLIs used in the configuration.

Option	Description
ip rtcp report interval <i>time in milliseconds</i>	Configures the average reporting interval between subsequent RTCP report transmissions.
gateway	Enters the gateway configuration mode.
media-inactivity-criteria all	Specifies the use of both RTCP and RTP for detecting the silence on a voice call.
timer receive-rtcp <i>timer</i>	Enable the Real-Time Control Protocol (RTCP) timer and configures a multiplication factor for the RTCP timer interval for Session Initiation Protocol (SIP) or H.323. <ul style="list-style-type: none"> <i>timer</i>—Multiples of the RTCP report transmission interval. Range is 0–1000. Default value is 0. Recommended value is 5.

The Media Inactivity Timer enables the active/standby router pair to monitor and disconnect calls, if the router pair does not receive Real-Time Protocol (RTP) packets within a configurable time period.

When the active or the standby router does not receive RTP packets for a call, the SIP Media Inactivity Timer releases the session. The Media Inactivity Timer guards against any hung sessions resulting from the failover when a normal call disconnect does not clear the call.

You must configure the same duration for the Media Inactivity Timer on both routers.

Step 9

Reload the routers.

After completing all the preceding configuration steps, save and reload both the active and standby router.

Step 10

Point the attached devices to the CUBE HSRP Virtual IP (VIP) address.

The IP-PBX, Cisco Unified SIP Proxy, or service provider must route the calls to CUBE's virtual IP address. This HA configuration does not handle SIP/H.323 messages to CUBE's physical IP addresses.

Configuration Examples

Example Configuration for Dual-Attached CUBE HSRP Redundancy

This section provides sample configurations for both the active and standby CUBE routers. In these configurations, the HSRP Hello and Hold timers use their default values of 3 and 8 seconds respectively, and are not shown explicitly in the CLI output.

Active Router Configuration

```
ipc zone default
  association 1
  no shutdown
```

```

    protocol sctp
      local-port 5000
      local-ip 203.0.113.10
      remote-port 5000
      remote-ip 203.0.113.11
  !
voice service voip
  mode border-element
  allow-connections sip to sip
  redundancy
  !
redundancy inter-device
  scheme standby SB
  !
redundancy
  !
interface GigabitEthernet0/0
  ip address 203.0.113.10 255.255.255.0
  standby version 2
  standby 1 ip 203.0.113.12
  standby delay minimum 30 reload 60
  standby 1 preempt
  standby 1 track 2 decrement 10
  standby 1 track 3 decrement 10
  standby 1 priority 50

  !
interface GigabitEthernet0/1
  ip address 192.0.2.1 255.255.255.0
  standby version 2
  standby 10 ip 192.0.2.5
  standby delay minimum 30 reload 60
  standby 10 preempt
  standby 10 track 2 decrement 10
  standby 10 track 3 decrement 10
  standby 10 priority 50

  !
interface GigabitEthernet0/2
  ip address 198.51.100.1 255.255.255.0
  standby version 2
  standby 100 ip 198.51.100.5
  standby delay minimum 30 reload 60
  standby 100 preempt
  standby 100 name SB
  standby 100 track 2 decrement 10
  standby 100 track 3 decrement 10
  standby 100 priority 50

  !
track 1 interface Gig0/0 line-protocol
track 2 interface Gig0/1 line-protocol
track 3 interface Gig0/2 line-protocol
  !
dial-peer voice 100 voip
  description TO SERVICE PROVIDER
  destination-pattern 9T
  session protocol sipv2
  session target ipv4:y.y.y
  voice-class sip bind control source-interface GigabitEthernet0/1
  voice-class sip bind media source-interface GigabitEthernet0/1
  !
dial-peer voice 200 voip
  description TO CUCM

```

```

destination-pattern 555....
session protocol sipv2
session target ipv4:203.0.113.1
voice-class sip bind control source-interface GigabitEthernet0/0
voice-class sip bind media source-interface GigabitEthernet0/0
!
ip rtcp report interval 3000
!
gateway
media-inactivity-criteria all
timer receive-rtcp 5
timer receive-rtp 86400

```

Standby Router Configuration

```

ipc zone default
association 1
no shutdown
protocol sctp
local-port 5000
local-ip 203.0.113.11
remote-port 5000
remote-ip 203.0.113.10
!
voice service voip
mode border-element
allow-connections sip to sip
redundancy
!
redundancy inter-device
scheme standby SB
!
redundancy
!interface GigabitEthernet0/0
ip address 203.0.113.11 255.255.255.0
standby version 2
standby 1 ip 203.0.113.12
standby delay minimum 30 reload 60
standby 1 preempt
standby 1 track 2 decrement 10
standby 1 track 3 decrement 10
standby 1 priority 50
!
interface GigabitEthernet0/1
ip address 192.0.2.2 255.255.255.0
standby version 2
standby 10 ip 192.0.2.5
standby delay minimum 30 reload 60
standby 10 preempt
standby 10 track 2 decrement 10
standby 10 track 3 decrement 10
standby 10 priority 50
!
interface GigabitEthernet0/2
ip address 198.51.100.2 255.255.255.0
standby version 2
standby 100 ip 198.51.100.5
standby delay minimum 30 reload 60
standby 100 preempt
standby 100 name SB
standby 100 track 2 decrement 10
standby 100 track 3 decrement 10

```

```

standby 100 priority 50

!
track 1 interface Gig0/0 line-protocol
track 2 interface Gig0/1 line-protocol
track 3 interface Gig0/2 line-protocol
!
dial-peer voice 100 voip
description TO SERVICE PROVIDER
destination-pattern 9T
session protocol sipv2
session target ipv4:y.y.y.y
voice-class sip bind control source-interface GigabitEthernet0/1
voice-class sip bind media source-interface GigabitEthernet0/1
!
dial-peer voice 200 voip
description TO CUCM
destination-pattern 555....
session protocol sipv2
session target ipv4:203.0.113.1
voice-class sip bind control source-interface GigabitEthernet0/0
voice-class sip bind media source-interface GigabitEthernet0/0
!
ip rtcp report interval 3000
!
gateway
media-inactivity-criteria all
timer receive-rtcp 5
timer receive-rtp 86400

```

Example Configuration for Single-Attached CUBE HSRP Redundancy

Although a dual-attached CUBE is the most common configuration, especially for SP SIP trunk connections, it is also possible to configure CUBE HSRP box-to-box redundancy with a single-attached CUBE deployment. The sample configurations for both the active and standby CUBE routers are as follows:

Active Router Configuration

```

ipc zone default
association 1
no shutdown
protocol sctp
local-port 5000
local-ip 203.0.113.10
remote-port 5000
remote-ip 203.0.113.11
!
voice service voip
mode border-element
allow-connections sip to sip
redundancy
sip
bind control source-interface GigabitEthernet0/0
bind media source-interface GigabitEthernet0/0
!
redundancy inter-device
scheme standby SB
!
redundancy
!
interface GigabitEthernet0/0
ip address 203.0.113.10 255.255.0.0
duplex auto

```



```

speed auto
keepalive
standby delay minimum 30 reload 60
standby version 2
standby 0 ip 203.0.113.12
standby 0 preempt
standby 0 priority 50
standby 0 name SB
standby 0 track 1 decrement 10

!
ip rtcp report interval 3000
!
dial-peer voice 5 voip
description to-SIP-application
destination-pattern 9T
session protocol sipv2
session target ipv4:x.x.x.x
!
dial-peer voice 9 voip
description to-CUCM
destination-pattern 555....
session protocol sipv2
session target ipv4:y.y.y.y
!
gateway
media-inactivity-criteria all
timer receive-rtcp 5
timer receive-rtp 86400

```

Standby Router Configuration

```

ipc zone default
association 1
no shutdown
protocol sctp
local-port 5000
local-ip 203.0.113.11
remote-port 5000
remote-ip 203.0.113.10
!
voice service voip
mode border-element
allow-connections sip to sip
redundancy
sip
bind control source-interface GigabitEthernet0/0
bind media source-interface GigabitEthernet0/0
!
redundancy inter-device
scheme standby SB
!
redundancy
!
interface GigabitEthernet0/0
ip address 203.0.113.11 255.255.0.0
duplex auto
speed auto
standby delay minimum 30 reload 60
standby version 2
standby 0 ip 203.0.113.12
standby 0 priority 50
standby 0 preempt
standby 0 name SB

```

```

standby 0 track 1 decrement 10

!
ip rtcp report interval 3000
!
dial-peer voice 5 voip
  description to-SIP-application
  destination-pattern 9T
  session protocol sipv2
  session target ipv4:x.x.x.x
!
dial-peer voice 9 voip
  description to-CUCM
  destination-pattern 555....
  session protocol sipv2
  session target ipv4:y.y.y.y
!
gateway
  media-inactivity-criteria all
  timer receive-rtcp 5
  timer receive-rtp 86400

```

Verify Your Configurations

Verify SIP IP Address Bindings

Use the **show sip-ua status** command to verify the SIP binding status.

```

Router#show sip-ua status

SIP User Agent Status
SIP User Agent for UDP : ENABLED
SIP User Agent for TCP : ENABLED

SIP User Agent for TLS over TCP : ENABLED
SIP User Agent bind status(signaling): DISABLED
SIP User Agent bind status(media): DISABLED
Snapshot of SIP listen sockets : 2
  Local Address      Listen Port      Secure Listen Port
  =====
  192.0.2.1          5060             5061
  192.0.2.1          5060             5061
SIP early-media for 180 responses with SDP: ENABLED
SIP max-forwards : 70

```

Verify Current CPU Use

Use the **show process cpu history** command to verify the CPU utilization percentage at regular intervals.

Check CPU utilization before performing a switchover and proceed with a forced failover only when the CPU utilization is less than 70%. The **show process cpu sorted** command can also be used repeatedly to understand the CPU utilization for a particular process.

Verify the Call Processing During a Switchover

Use the **show sip-ua statistics** command to verify the call drops during the switchover by checking the number of BYE messages. Calls in progress during the switchover are dropped. Only established calls are preserved.

Use the **show interface accounting** command to verify the media path confirmation during a switchover.

```
Router#show interfaces g0/0 accounting
```

```
GigabitEthernet0/0
Protocol Pkts In Chars In Pkts Out      Chars Out
Other          1          58          6          360
IP             406       178841     201       16394
ARP            569       34292      0          0
CDP            116       31672     22         7304
```



Note Check IP **Pkts In** and **Pkts Out** counters. These counters must be increasing at reasonable rate. For example, if you are using G.711 20ms packetization and no VAD, you must see the packet counters increase by around 50 every second.

Force a Manual Failover for Testing

Box-to-box redundancy using HSRP supports the stateful switchover of calls which means both media (RTP) and call signaling are preserved. Therefore, during the switchover, only calls in the active state (media path in "sendrecv" connection mode) are preserved while calls in the transient state (non-active state, media path not in "sendrecv" connection mode) are not.

You can expect that switchovers occurring in real environments, where there is a constant mixture of calls in transient (call setup or being modified) and established state, result in some dropped calls during a failover. You can estimate the number of dropped calls by using the following formula: $(0.3 + \text{HSRP hold-timer}) * \text{CPS}$.

To check that your configuration is correct, you can force a manual switchover.

You can achieve manual switchovers in various ways:

- Initiate the manual switchover by using the **redundancy switch-activity force** command on the active router.
- Reload of the active router
- Hard restart of the active router
- Pull out the HSRP interface or power cable of the active router.
- Shut down the HSRP interface of the active router.
- Change in any parameter of the HSRP interface of the active/standby router without shutting down the association under IPC mode leads to a router reload. Therefore, you must shut down the interface before you make any changes, unless you are using this as a trigger to force a switchover.

The **show voip rtp connections** command shows the number of active connections on both the active and standby routers after a switchover.

The **show call active voice brief** command does not show any output on the standby router after a switchover because the signaling information is not checkpointed.

Before you begin

Before you start a manual switchover, take note of the following:

- Monitor the CPU utilization % on the active and standby pair. The active router has a higher CPU utilization as it is actively handling the calls, while the standby router shows 0 CPU utilization as it is idle until a switchover occurs.
- Ensure that you perform a manual switchover when the CPU utilization of the active router is no more than 70%. All switchovers lead to a spike in CPU utilization.
- Use the **show voip rtp connection** and **show voice high-availability summary** commands to make sure that the existing calls across the active and standby router pair are in sync.

Perform the following steps to configure and verify a single switch over:

SUMMARY STEPS

1. Configure HSRP Box-to-box redundancy as explained in the Configuration section.
2. Reload and keep both routers in rommon.
3. Boot up one router. After the router comes up, execute the **show redundancy state** command and make sure it displays **my state** as active and peer state as Disabled. This can take a while after boot up.
4. Boot up the second router. After the router comes up, execute the **show redundancy state** command and make sure it displays **my state** as standby-Hot and **peer state** as active.
5. Start one or more calls across the system. Execute the **show voice high-availability summary** and **show voip rtp connection** commands on both the active and standby routers to make sure that the calls are up and checkpointed.
6. Test switchover by reloading the active router. If you are using a phone to make calls, you can listen to the phone to make sure that the media path is preserved. If you are using test equipment, you can use the packet displays to determine if media for the calls are flowing.
7. Test Media Inactivity: Stop the call. Repeat **show voip rtp connection** . After the media-inactivity timer expiry, there must be no more active RTP connections. You can also check this using the **show voice high-availability summary** command.

DETAILED STEPS

Step 1 Configure HSRP Box-to-box redundancy as explained in the Configuration section.

Step 2 Reload and keep both routers in rommon.

Step 3 Boot up one router. After the router comes up, execute the **show redundancy state** command and make sure it displays **my state** as active and peer state as Disabled. This can take a while after boot up.

Example:

```
Router#show redundancy states
```

```
my state = 13 -ACTIVE
peer state = 1 -DISABLED
```

Step 4 Boot up the second router. After the router comes up, execute the **show redundancy state** command and make sure it displays **my state** as standby-Hot and **peer state** as active.

Example:

```
Router#show redundancy states

my state = 8 -STANDBY HOT
peer state = 13 -ACTIVE
```

Step 5 Start one or more calls across the system. Execute the **show voice high-availability summary** and **show voip rtp connection** commands on both the active and standby routers to make sure that the calls are up and checkpointed.

Step 6 Test switchover by reloading the active router. If you are using a phone to make calls, you can listen to the phone to make sure that the media path is preserved. If you are using test equipment, you can use the packet displays to determine if media for the calls are flowing.

Example:

```
Router#show interfaces g0/0 accounting

GigabitEthernet0/0
Protocol Pkts In Chars In Pkts Out Chars Out
Other          1          58          6          360
IP            406       178841       201       16394
ARP           569       34292         0         0
CDP           116       31672         22        7304
```

Step 7 Test Media Inactivity: Stop the call. Repeat **show voip rtp connection** . After the media-inactivity timer expiry, there must be no more active RTP connections. You can also check this using the **show voice high-availability summary** command.

Example:

```
Router#show voice high-availability summary | include media

Media Inactivity event count: 1
```

Troubleshoot High Availability Issues

Use the following show and debug commands to troubleshoot any issues:

- **show redundancy state**
- **show redundancy inter-device**
- **show standby brief**
- **show standby internal**
- **show sip-ua status**
- **show sip-ua statistics**
- **show voice high-availability summary**
- **show voip rtp connection | include connection**
- **show arp**
- **debug voip ccapi all**

- **debug voip ccapi error**
- **debug voip rtp session**
- **debug voip rtcp session**
- **debug voip rtp error**
- **debug voip rtcp error**
- **debug voice high-availability all**
- **debug voice high-availability error**
- **debug ccsip info**
- **debug ccsip messages**
- **debug ccsip media**
- **debug ccsip error**
- **debug standby terse**



Note Do not turn on a large number of debugs on a system carrying high volume of active call traffic.



Note On every switchover, after router reload, you must re-enable the debugs on the new standby router.

Each router in an HSRP group participates in the protocol by implementing a simple state machine. All routers begin in the Initial state.

The following table illustrates the different router states.

States	Description
Initial	This is the starting state and indicates that HSRP is not running. This state is entered through configuration change or when an Interface first comes up.
Learn	The router has not determined the virtual IP address, and not yet seen an authenticated Hello message from the active router. In this state, the router is still waiting to hear from the active router.
Listen	The router knows the virtual IP address, but is not the active or standby router. It listens for Hello messages from those routers.

States	Description
Speak	The router sends periodic Hello messages and is actively participating in the election of the active and standby router. A router cannot enter the Speak state unless it has the virtual IP address.
Standby	The router is a candidate to become the next active router and sends periodic Hello messages. Excluding transient conditions, there MUST be at most one router in the group in Standby state.
Active	The router is currently forwarding packets that are sent to the group's virtual MAC/IP address. The router sends periodic Hello messages. Besides transient conditions, there MUST be at most one router in Active state in the group.

Troubleshooting Tip - Why Are There Two Active Routers?

This scenario occurs when both routers fail to see the HSRP Hellos from each other.

- Check if each router can ping the other's IP interface address. If not, then communication between the routers is down.
- Use the **debug standby** command to see if the routers are sending and receiving HSRP Hello packets. If the peer is sending Hellos, but they are not being received then check **show interface** or **show controller** commands to see if the interface is listening to the HSRP multicast address.



CHAPTER 59

DSP High Availability Support

Cisco Unified Border Element (CUBE) DSP High Availability support for SIP-to-SIP calls is added for Box-to-Box and Inbox configurations. Earlier, calls that required DSP resources were not checkpointed. As a result, both the media and signaling sessions were not preserved after switchover resulting in call failure.



Note DSP HA is supported only for SIP-to-SIP calls.

- [Feature Information for DSP High Availability Support on CUBE, on page 811](#)
- [Prerequisites for DSP High Availability, on page 811](#)
- [Features Supported with DSP High Availability, on page 812](#)
- [Restrictions for DSP High Availability, on page 812](#)
- [Troubleshooting DSP HA Support on CUBE, on page 812](#)
- [Configuration Examples for DSP HA, on page 813](#)

Feature Information for DSP High Availability Support on CUBE

The following table provides release information about the feature or features described in this module. This table lists only the software release that introduced support for a given feature in a given software release train. Unless noted otherwise, subsequent releases of that software release train also support that feature.

Use Cisco Feature Navigator to find information about platform support and Cisco software image support. To access Cisco Feature Navigator, go to <https://cfng.cisco.com/>. An account on Cisco.com is not required.

Table 81: Feature Information for DSP HA Support on CUBE

Feature Name	Releases	Feature Information
DSP HA Support on CUBE	Cisco IOS 15.5(2)T Cisco IOS XE 3.15S	Provides DSP High availability support for SIP-to-SIP calls on Box-to-Box and Inbox redundancies.

Prerequisites for DSP High Availability

- LTI Transcoding

- DSP HA is supported only on the following routers and its corresponding modules:
 - Cisco ISR G2 series (PVDM3)
 - Cisco ASR 1000 series (SPA-DSP)
 - Cisco ISR 4000 series (PVDM4)
 - Cisco Catalyst 8200 Edge series
 - Cisco Catalyst 8300 Edge series
- The same type and capacity DSP modules must be used in the Active and Standby CUBE devices (box-to-box)
- The DSP modules must be installed in the same slot and subslot in the Active and Standby CUBE devices (box-to-box)
- The Active and Standby CUBE devices must have the same DSPFARM configurations (box-to-box)

Features Supported with DSP High Availability

- Transcoding with Supplementary Services
- Voice Class Codec
- G.711 in-band -> RFC2833 (RTP-NTE) DTMF interworking variant
- SRTP-RTP Interworking (ISR-G2 only)
- Fax calls with transcoder invoked for codec mis-match

Restrictions for DSP High Availability

- Media flow-around calls are not supported.
- SDP passthrough calls are not supported.
- Audio Transrating is not supported.
- Call Progress Analysis is not supported.
- Dolby Noise Reduction (NR) and Acoustic Shock Protection (ASP) are not supported.
- All SCCP-based media resources (Conference bridge, Transcoding, HW MTP, and SW MTP) are not supported with Cisco Unified Border Element High Availability.

Troubleshooting DSP HA Support on CUBE

You can use the following debug commands to troubleshoot DSP HA:

- debug voip dsmp all

- debug voip dsm all
- debug ccsip message
- debug voip ipipgw
- debug voip ipipgw high-availability
- debug voip high-availability all
- debug media resource provisioning all
- debug dsp-resource-manager flex dspfarm
- debug dsp-resource-manager flex function
- debug dsp-resource-manager flex error

Configuration Examples for DSP HA

Active Configuration

```

-----
voice-card 0
 dsp services dspfarm

dspfarm profile 2 transcode universal
 codec g711ulaw
 codec g711alaw
 codec g729ar8
 codec g729abr8
 maximum sessions 100
 associate application CUBE

```

Standby Configuration

```

-----
voice-card 0
 dsp services dspfarm

dspfarm profile 2 transcode universal
 codec g711ulaw
 codec g711alaw
 codec g729ar8
 codec g729abr8
 maximum sessions 100
 associate application CUBE

```

The following example shows the DSP HA output for the active and standby configurations:

On Active:

```

Mang-Active#show dspfarm dsp active
SLOT   DSP VERSION   STATUS CHNL USE   TYPE   RSC_ID BRIDGE_ID PKTS_TXED PKTS_RXED
0           13   39.0.0           UP     1     USED  xcode     1         16558
          3005   3007

```

```

0          13    39.0.0          UP          1    USED  xcode    1          16559
          3004    3005

```

Total number of DSPFARM DSP channel(s) 1

On Standby:

Mang-Standby#show dspfarm dsp active

SLOT	DSP	VERSION	STATUS	CHNL	USE	TYPE	RSC_ID	BRIDGE_ID	PKTS_TXED	PKTS_RXED	
0		13	39.0.0		UP		1	USED	xcode	1	16558
	0		0								
0		13	39.0.0		UP		1	USED	xcode	1	16559
	0		0								

Total number of DSPFARM DSP channel(s) 1



CHAPTER 60

Stateful Switchover Between Redundancy Paired Intra- or Inter-box Devices

Stateful switchover provides protection for network edge devices with dual Route Processors (RPs) that represent a single point of failure in the network design, and where an outage might result in loss of service for customers.

- [Feature Information for Stateful Switchover Between Redundancy Paired Intra- or Inter-box Devices, on page 815](#)
- [Prerequisites for Stateful Switchover Between Redundancy Paired Intra- or Inter-box Devices, on page 816](#)
- [Restrictions for Stateful Switchover Between Redundancy Paired Intra- or Inter-box Devices, on page 817](#)
- [Information About Stateful Switchover Between Redundancy Paired Intra- or Inter-box Devices, on page 817](#)

Feature Information for Stateful Switchover Between Redundancy Paired Intra- or Inter-box Devices

Feature Name	Releases	Feature Information
Stateful Switchover Between Redundancy Paired Intra or Inter-box Devices	Cisco IOS XE Release 3.2S	Provides protection for network edge devices with dual Route Processors (RPs) that represent a single point of failure in the network design, and where an outage might result in loss of service for customers.
Stateful Switchover Between Redundancy Paired Intra or Inter-box Devices	Cisco IOS Release 15.2(3)T	Provides protection for network edge devices with dual Route Processors (RPs) that represent a single point of failure in the network design, and where an outage might result in loss of service for customers.
Stateful Switchover Between Redundancy Paired Intra or Inter-box Devices (Call Escalation and De-escalation with Stateful Switchover)	Cisco IOS XE Release 3.8S 15.3(1)T	Provides support for call escalation and de-escalation with stateful switchover.

Feature Name	Releases	Feature Information
Stateful Switchover Between Redundancy Paired Intra or Inter-box Devices (Media Forking with High Availability)	Cisco IOS XE Release 3.8S 15.3(1)T	Provides support for media forking with high availability mechanism.
High Availability Protected Mode and Box-to-Box HA Support	Cisco IOS XE Release 3.11S	Provides support for enabling the PROTECTED mode on a Voice HA-enabled ASR.
OPTIONS PING Support under HA Configuration	15.4(3)M Cisco IOS XE Release 3.13S	The OPTIONS ping with CUBE high availability feature adds the ability to match the incoming dial-peer in the context of the OPTIONS message, allowing response with the virtual IP address shared between the active and standby CUBEs. Box-to-box high availability is supported using virtual IP addresses for the signaling and media, by enhancing the CUBE response to an inbound OPTIONS ping message. This is possible because dial-peer matching of a request URI that does not have a user part is supported. For configuration examples, see the Examples section about configuring interfaces (ISR and ASR) and configuring SIP binding.
Support for REFER and BYE/Also after Software Switch-Over	Cisco IOS 15.5(2)T Cisco IOS XE Release 3.15S	REFER based supplementary services with high availability is supported on Cisco Unified Border Element (Cisco UBE) after stateful switchover. Support is also provided for SIP-to-SIP BYE/Also calls.

Prerequisites for Stateful Switchover Between Redundancy Paired Intra- or Inter-box Devices

Cisco Unified Border Element (Enterprise)

- Cisco IOS XE Release 3.2 or a later release must be installed and running on your Cisco ASR 1000 Series Router.

Cisco Unified Border Element

- Cisco IOS Release 15.2(3)T or a later release must be installed and running on your Cisco Unified Border Element.

Restrictions for Stateful Switchover Between Redundancy Paired Intra- or Inter-box Devices

- Call escalation and de-escalation are not supported in REFER consumption mode.
- Session Description Protocol (SDP) passthru calls are not supported.
- Resource Reservation Protocol (RSVP) is not supported.
- Alternative Network Address Types (ANAT) for IPv4 or IPv6 interworking is not supported.
- SDP passthrough calls are not supported for media forking.
- Media flow-around fork calls are not checkpointed.
- For high availability PROTECTED mode, redundancy group (RG) is not supported on cross-over cable. However, if cross-over cable is used and the connection flaps or if the RG link is connected using a switch and the switch resets, or if there is a switchover, then both the devices will go into PROTECTED mode resulting in no VoIP functionality.

Information About Stateful Switchover Between Redundancy Paired Intra- or Inter-box Devices

In specific Cisco networking devices that support dual RPs, stateful switchover takes advantage of Route Processor redundancy to increase network availability. When two route processors (RPs) are installed, one RP acts as the active RP, and the other acts as a backup, or standby RP. Following an initial synchronization between the two processors if the active RP fails, or is manually taken down for maintenance or removed, the standby RP detects the failure and initiates a switchover. During a switchover, the standby RP assumes control of the router, connects with the network interfaces, and activates the local network management interface and system console. Stateful switchover dynamically maintains Route Processor state information between them.

The following conditions and restrictions apply to the current implementation of SSO:

- Calls that are handled by nondefault session application (TCL/VXML) will not be checkpointed prebridge.
- Flow-through calls whose state has not been accurately checkpointed will be cleared with media inactivity-based clean up. This condition could occur if active failure happens when:
 - Some check point data has not yet been sent to the standby.
 - The call leg was in the middle of a transaction.
 - Flow around calls whose state has not been accurately checkpointed (due to either of the reasons mentioned above) can be cleared with the **clear call voice causecode** command.

For more information about the Stateful Switchover feature and for detailed procedures for enabling this feature, see the "Configuring Stateful Switchover" chapter of the *Cisco IOS High Availability Configuration Guide, Release 12.2SR*.

Call Escalation with Stateful Switchover

The call escalation workflow is as follows:

1. The call starts as an audio call between Phone A (video-capable) and Phone B (only audio-capable) registered to two different Cisco Unified Communications Manager (CUCM) clusters connected using Cisco Unified Border Element (Cisco UBE).
2. The call is then transferred to Phone C, which is a video-capable phone.
3. The media parameters within the reinvite are renegotiated end-to-end.
4. The call is escalated to a video call.



Note If the Cisco UBE switchover happens at any instance, then audio calls will be preserved before escalation and video calls will be preserved after escalation.

Figure 83: Call Escalation

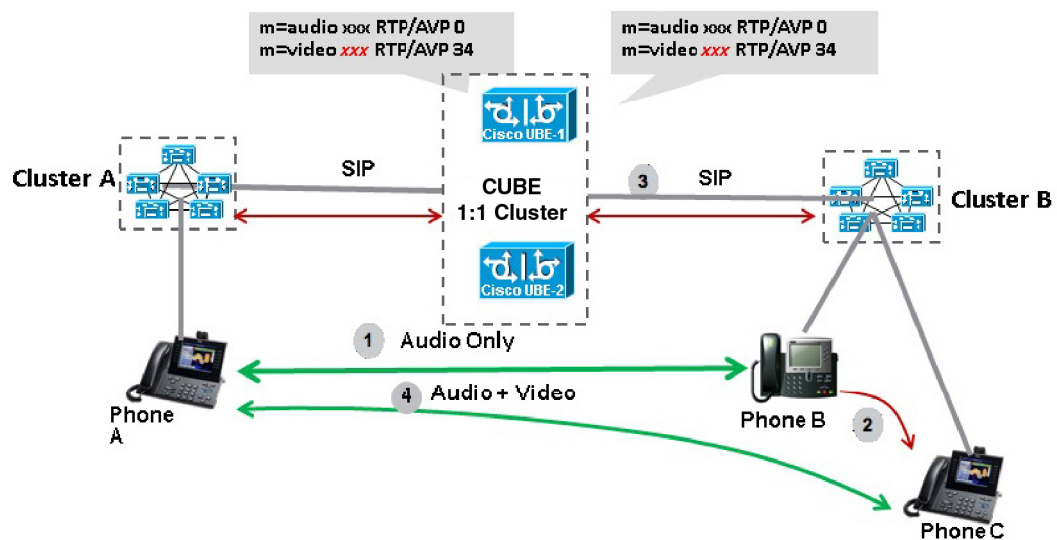

336002

Call De-escalation with Stateful Switchover

The call de-escalation workflow is as follows:

1. The call starts as a video call between Phone A and Phone B registered to two different Cisco Unified Communications Manager (CUCM) clusters connected using Cisco Unified Border Element (Cisco UBE).
2. The call is then transferred to Phone C, which is an audio-only phone.
3. The media parameters within the reinvite are renegotiated end-to-end.
4. The call is de-escalated to an audio-only call.



Note If the Cisco UBE switchover happens at any instance, then video calls will be preserved before de-escalation and audio calls will be preserved after de-escalation.

Figure 84: Call De-escalation

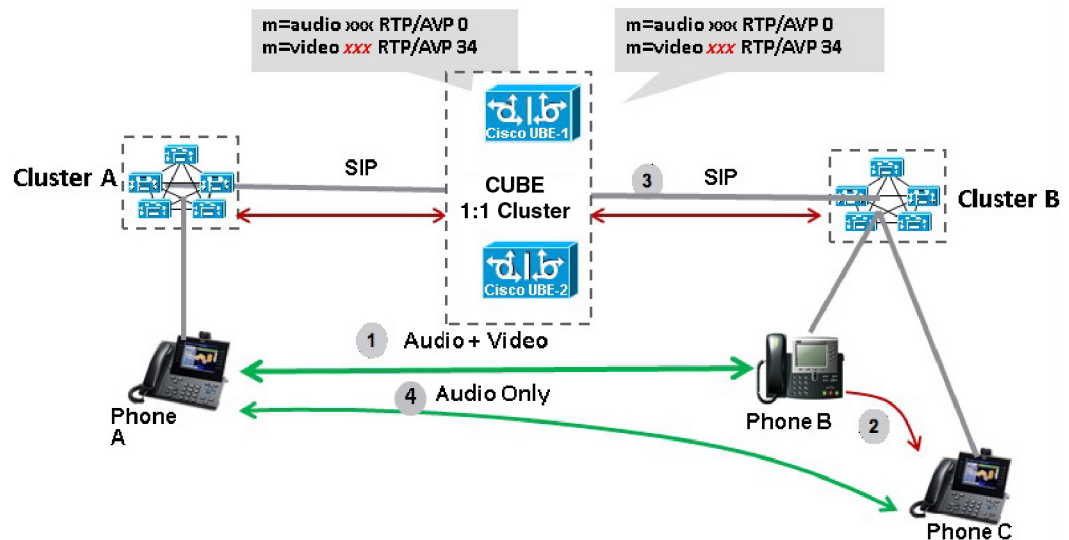

336003

Media Forking with High Availability

Media forking with high availability is supported on ISR G2, ISR G3 and ASR platforms. When a primary call is connected and a forked call-leg is established on an active Cisco UBE device, both the primary and the forked call-leg will be checkpointed in the standby Cisco UBE device. If the active device goes down, the standby device ensures that the forking call is active and is able to exchange further transactions with the recording server with preserved calls such as hold/resume, transfer, conference, and so on. A recording server is a Session Initiation Protocol (SIP) user agent that archives media for extended durations, providing search and retrieval of the archived media. The recording server is a storage place of the recorded session metadata.

The active and standby devices must have the same configurations for checkpointing to happen correctly. The recorder can be configured both ways with a media profile and directly on a media class. The media profile can be associated under media class, and the media class can be applied to the incoming or outgoing dial-peer to start recording.

For more information, see the “Network-based Recording Using Cisco UBE” module in the *Cisco Unified Border Element Protocol-Independent Features and Setup Configuration Guide*.

High Availability Protected Mode and Box-to-Box Redundancy for ASR

To configure box-to-box high availability (HA) support for ASRs, use the **mode rpr** command (rpr is route processor redundancy) in **redundancy** configuration mode.

**Note**

- Use the same hardware for both the ASR boxes in the active or standby pair to ensure compatibility before and after failover.
- A separate physical interface must be used for checkpointing calls between the active and standby devices.

Self-reload in a voice HA-enabled device helps to recover the box-to-box HA pair from out-of-sync conditions. Instead of self-reload, you can configure the device to transition into protected mode. In protected mode:

- Bulk sync request, call checkpointing, and incoming call processing are disabled.
- The device in protected mode needs to be manually reloaded to come out of this state.
- In a high availability scenario, if CUBE in standby redundancy group (RG) state is already in VoIP HA protected mode and a switchover occurs, causing the standby CUBE to become active on RG level, VoIP functionality is disabled. This is because incoming call processing is disabled in VoIP HA protected mode, so even when the standby CUBE assumes the active role on RG level, call processing remains impaired. The only way to restore call processing is to manually reboot the affected CUBE instance to exit protected mode.

To enable the protected mode, use the **no redundancy-reload** command under “voice service voip” configuration mode. The default is **redundancy-reload**, which reloads control when the redundancy group (RG) fails.

Support for Box-to-Box High Availability with Virtual IP Addresses

The OPTIONS ping with CUBE high availability feature adds the ability to match the incoming dial-peer in the context of the OPTIONS message, allowing response with the virtual IP address shared between the active and standby CUBEs. Box-to-box high availability is supported using virtual IP addresses for the signaling and media, by enhancing the CUBE response to an inbound OPTIONS ping message. This is possible because dial-peer matching of a request URI that does not have a user part is supported.

**Important**

When OPTIONS Ping SIP Trunk (from CUCM) is configured to CUBE that is running in HA mode, the SIP Trunk goes down whenever the active interface goes down. The SIP Trunk comes back in service, when the OPTIONS Ping next retry happens to CUBE HA node. The default retry time is 60 seconds.

**Note**

For configuration examples, see the Examples section about configuring interfaces (ISR and ASR) and configuring SIP binding.

Monitoring Call Escalation and De-escalation with Stateful Switchover

Perform this task to monitor calls before and after escalation or de-escalation and before and after stateful switchover on active and standby Cisco UBE devices. The **show** commands can be entered in any order.

SUMMARY STEPS

1. **enable**
2. **show call active voice compact**
3. **show call active video compact**
4. **show call active voice stats**
5. **show call active video stats**

DETAILED STEPS**Step 1 enable**

Enables privileged EXEC mode.

Example:

```
Device> enable
```

Step 2 show call active voice compact

Displays a compact version of call information for the voice calls in progress.

Example:

```
Device# show call active voice compact
```

```
<callID>  A/O FAX T<sec> Codec      type      Peer Address      IP R<ip>:<udp>
Total call-legs: 2
          512 ANS   T1      g711ulaw   VOIP      Psipp             9.45.38.39:6016
          513 ORG   T1      g711ulaw   VOIP      P123             10.104.46.222:6000
```

Step 3 show call active video compact

Displays a compact version of call information for the video calls in progress.

Example:

```
Device# show call active video compact
```

```
<callID>  A/O FAX T<sec> Codec      type      Peer Address      IP R<ip>:<udp>
Total call-legs: 2
          512 ANS   T19     H263       VOIP-VIDEO Psipp             9.45.38.39:1699
          513 ORG   T19     H263       VOIP-VIDEO P123             10.104.46.222:1697
```

Step 4 show call active voice stats

Displays information about digital signal processing (DSP) voice quality metrics.

Example:

```
Device# show call active voice stats
```

```
dur 00:00:16 tx:2238/85044 rx:1618/61484 dscp:0 media:0 audio tos:0xB8 video tos:0x0
IP 9.45.25.33:58300 SRTP: off rtt:0ms pl:0/0ms lost:0/0/0 delay:0/0/0ms g711ulaw TextRelay: off
Transcoded: No
dur 00:00:16 tx:1618/61484 rx:2238/85044 dscp:0 media:0 audio tos:0xB8 video tos:0x0
IP 9.45.25.33:58400 SRTP: off rtt:0ms pl:0/0ms lost:0/0/0 delay:0/0/0ms g711ulaw TextRelay: off
Transcoded: No
```

Step 5 show call active video stats

Displays information about digital signal processing (DSP) video quality metrics.

Example:

```
Device# show call active video stats

dur 00:00:00 tx:27352/1039376 rx:36487/1386506 dscp:0 media:0 audio tos:0xB8 video tos:0x88
IP 9.45.25.33:1697 SRTP: off rtt:0ms pl:0/0ms lost:0/0/0 delay:0/0/0ms H264 TextRelay: off Transcoded:
No
dur 00:00:00 tx:36487/1386506 rx:27352/1039376 dscp:0 media:0 audio tos:0xB8 video tos:0x88
IP 9.45.25.33:1699 SRTP: off rtt:0ms pl:0/0ms lost:0/0/0 delay:0/0/0ms H264 TextRelay: off Transcoded:
No
```

Monitoring Media Forking with High Availability

Perform this task to monitor media forking calls with high availability on active and standby Cisco UBE devices. The **show** commands can be entered in any order.

SUMMARY STEPS

1. **enable**
2. **show call active voice compact**
3. **show voip rtp connections**
4. **show voip recmsp session**
5. **show voip rtp forking**
6. **show voip rtp forking**

DETAILED STEPS

Step 1 enable

Enables privileged EXEC mode.

Example:

```
Device> enable
```

Step 2 show call active voice compact

Displays a compact version of call information for the voice calls in progress. In the output shown, the first and second connections are for the basic call and the third connection is for the forked leg.

Example:

```
Device# show call active voice compact

<callID>  A/O FAX T<sec> Codec      type      Peer Address      IP R<ip>:<udp>
Total call-legs: 3
  4423 ANS   T28   g711ulaw  VOIP      P9538390040      173.39.67.102:22792
  4424 ORG   T28   g711ulaw  VOIP      P708090           9.42.30.189:26300
  4426 ORG   T27   g711ulaw  VOIP      P9876            10.104.46.201:56356
```

Step 3 show voip rtp connections

Displays real-time transport protocol (RTP) named event packets. In the output shown, two additional call legs are shown on the Cisco UBE device. Both the active and standby devices will have the same number of connections.

Example:

```
Device# show voip rtp connections
```

```
VoIP RTP active connections :
No. CallId      dstCallId LocalRTP RmtRTP   LocalIP           RemoteIP
1    4439        4440      16646   19022   10.104.46.251    173.39.67.102
2    4440        4439      16648   22950   9.42.30.213      9.42.30.189
3    4442        4441      16650   36840   10.104.46.251    10.104.46.201
4    4443        4441      16652   54754   10.104.46.251    10.104.46.201
Found 4 active RTP connections
```

Step 4 show voip recmsp session

Displays active recording Media Service Provider (MSP) session information. In the output shown, the fork leg details and the number of forking calls are displayed. Both the active and standby devices will have the same call information.

Example:

```
Device# show voip recmsp session
```

```
REC MSP active sessions:
MSP Call-ID          AnchorLeg Call-ID      ForkedLeg Call-ID
4441                  4440                    4442
Found 1 active sessions
```

Step 5 show voip rtp forking

Displays the RTP media-forking connections. In the output shown, on the active device, packets will be sent.

Example:

```
Device# show voip rtp forking
```

```
VoIP RTP active forks :
Fork 1
  stream type voice-only (0): count 0
  stream type voice+dtmf (1): count 0
  stream type dtmf-only (2): count 0
  stream type voice-nearend (3): count 1
    remote ip 10.104.46.201, remote port 36840, local port 16650
    codec g711ulaw, logical ssrc 0x53
    packets sent 30788, packets received 0
  stream type voice+dtmf-nearend (4): count 0
  stream type voice-farend (5): count 1
    remote ip 10.104.46.201, remote port 54754, local port 16652
    codec g711ulaw, logical ssrc 0x55
    packets sent 30663, packets received 0
  stream type voice+dtmf-farend (6): count 0
  stream type video (7): count 0
  stream type application (8): count 0
```

Step 6 show voip rtp forking

Displays the RTP media-forking connections. In the output shown, on the standby device, packets will not be sent. After the switchover happens, packets will be sent from the new active device.

Example:

```
Device# show voip rtp forking
```

```
VoIP RTP active forks :
Fork 1
```

```

stream type voice-only (0): count 0
stream type voice+dtmf (1): count 0
stream type dtmf-only (2): count 0
stream type voice-nearend (3): count 1
  remote ip 10.104.46.201, remote port 36840, local port 16650
  codec g711ulaw, logical ssrc 0x53
  packets sent 0, packets received 0
stream type voice+dtmf-nearend (4): count 0
stream type voice-farend (5): count 1
  remote ip 10.104.46.201, remote port 54754, local port 16652
  codec g711ulaw, logical ssrc 0x55
  packets sent 0, packets received 0
stream type voice+dtmf-farend (6): count 0
stream type video (7): count 0
stream type application (8): count 0

```

Verifying the High Availability Protected Mode

Perform this task to verify the configuration for high availability protected mode, assuming the local device is ACTIVE and the peer device went into PROTECTED mode.

SUMMARY STEPS

1. **enable**
2. **show voice high-availability rf-client** (active device)
3. **show voice high-availability rf-client** (standby device)

DETAILED STEPS

Step 1 enable

Example:

```
Router> enable
```

Enables privileged EXEC mode.

Step 2 show voice high-availability rf-client (active device)

Example:

```
Device# show voice high-availability rf-client
```

```
FUNCTIONING RF DOMAIN: 0x2
```

```
-----
```

```
RF Domain: 0x0
Voice HA Client Name: VOIP RF CLIENT
Voice HA RF Client ID: 1345
Voice HA RF Client SEQ: 128
My current RF state ACTIVE (13)
Peer current RF state DISABLED (1)
```

```
Current VOIP HA state [LOCAL / PEER] :
[(ACTIVE (13) / UNKNOWN (0)]
```

```

-----
RF Domain: 0x2 [RG: 1]
Voice HA Client Name: VOIP RG CLIENT
Voice HA RF Client ID: 4054
Voice HA RF Client SEQ: 448
My current RF state ACTIVE (13)
Peer current RF state STANDBY HOT (8)

Current VOIP HA state [LOCAL / PEER] :
      [(ACTIVE (13) / PROTECTED (7))]

```

Step 3 **show voice high-availability rf-client** (standby device)

Example:

```
Device# show voice high-availability rf-client
```

```

RF Domain: 0x0
Voice HA Client Name: VOIP RF CLIENT
Voice HA RF Client ID: 1345
Voice HA RF Client SEQ: 128
My current RF state ACTIVE (13)
Peer current RF state DISABLED (1)

Current VOIP HA state [LOCAL / PEER] :
      [(ACTIVE (13) / PROTECTED (0))]

```

```

-----
RF Domain: 0x2 [RG: 1]
Voice HA Client Name: VOIP RG CLIENT
Voice HA RF Client ID: 4054
Voice HA RF Client SEQ: 448
My current RF state STANDBY HOT (8)
Peer current RF state ACTIVE (13)

Current VOIP HA state [LOCAL / PEER] :
      [PROTECTED (7) / ACTIVE (13)]

```

Support for REFER and BYE/Also after Stateful Switch-Over

REFER based supplementary services with high availability is supported post-stateful switchover on CUBE. Support is also provided for SIP-to-SIP BYE/Also calls.

Use the **show sip-ua handoff stats** command to display the call handoff statistics for calls handed off successfully after switchover. Following are the statistics displayed:

- Total number of calls handed off
- Total number of successful calls handoffs
- Total numbers of unsuccessful call handoffs

The following sample output displays the call handoff statistics:

```

2951-CUBE#show sip-ua handoff stats
Total Calls Handed Off      = 1

```

```
Successful Call Hand offs    = 1
Un-Successful Call Hand offs = 0
2951-CUBE#
```

Troubleshooting Tips

Use the following commands to troubleshoot call escalation and de-escalation with stateful switchover:

- **debug voip ccapi all**
- **debug voip ccapi service**
- **debug voice high-availability all**
- **debug voip rtp error**
- **debug voip rtp inout**
- **debug voip rtp high-availability**
- **debug voip rtp function**
- **debug ccsip all**

Use the following commands to troubleshoot media forking support on high availability:

- **debug ccsip all**
- **debug voip high-availability all**
- **debug voip ccapi inout**
- **debug voip recmsp all**

Use the following commands to troubleshoot PROTECTED mode on high availability:

- **debug voice high-availability rf**
- **debug voice high-availability inout**
- **debug redundancy progression**
- **debug redundancy application group faults all**
- **debug redundancy application group protocol all**
- **debug voip ccapi inout**
- **debug cch323 session**
- **debug cch323 function**
- **debug cch323 error**
- **debug ccsip all**

Use the following debug commands to troubleshoot issues related to handling of REFER based supplementary services:

- **debug ccsip verbose**

- debug voip application all
- debug voip ccapi all
- debug voice high-availability all

Example: Configuring the Interfaces for ISR-G2 Devices

ISR-G2 (HSRP-based)

```
interface GigabitEthernet0/0/0
 ip address 10.10.25.14 255.255.255.0
 duplex auto
 keepalive
 speed auto
 standby delay minimum 30 reload 60
 standby version 2
 standby 0 ip 10.10.25.1
   standby 0 preempt
 standby 0 priority 50
 standby 0 track 2 decrement 10
 standby 0 name SB
```

Example: Configuring the Interfaces for ASR Devices

ASR (RG Infra-based)

```
interface GigabitEthernet0/0/0
 ip address 10.13.25.190 255.255.0.0
 negotiation auto
 redundancy rii 1
 redundancy group 1 ip 10.13.25.123 exclusive
```

Example: Configuring SIP Binding

```
dial-peer voice inbound-dial-peer-tag voip
 session protocol sipv2
 incoming uri from mydesturi
 voice-class sip call-route url
 voice-class sip bind control source-interface GigabitEthernet 0/0/0
 !
 voice class uri mydesturi
   host abc.com
```



CHAPTER 61

CVP Survivability TCL support with High Availability

Call survivability features are supported in Cisco Unified Border Element (CUBE) high availability mode for all active calls handled by Cisco Voice Portal (CVP).

- [Feature Information for CVP Survivability TCL support with High Availability, on page 829](#)
- [Prerequisites, on page 830](#)
- [Restrictions, on page 830](#)
- [Recommendations, on page 830](#)
- [CVP Survivability TCL support with High Availability, on page 830](#)
- [Configuring CVP Survivability TCL support with High Availability, on page 830](#)

Feature Information for CVP Survivability TCL support with High Availability

The following table provides release information about the feature or features described in this module. This table lists only the software release that introduced support for a given feature in a given software release train. Unless noted otherwise, subsequent releases of that software release train also support that feature.

Use Cisco Feature Navigator to find information about platform support and Cisco software image support. To access Cisco Feature Navigator, go to <https://cfngn.cisco.com/>. An account on Cisco.com is not required.

Table 82: Feature Information for CVP Survivability TCL support with High Availability

Feature Name	Releases	Feature Information
CVP Survivability TCL support with High Availability	Cisco IOS 15.6(2)T Cisco IOS XE Denali 16.3.1	This feature enables CUBE support call survivability features in CUBE high availability mode for all active calls handled by CVP.

Prerequisites

- CVP survivability TCL application is configured on incoming dial-peer

Restrictions

- If there is a courtesy callback (CCB) registered with CVP, then post switchover, CCB is not supported.
- Only call survivability TCL script is supported with CUBE high availability. Other TCL based services are not supported.
- Only the active calls will be check pointed. (Calls which are connected - 200OK / ACK transaction completed). Calls in transition state will not be check pointed.

Recommendations

- Configure TCP session transport for the SIP trunk between CUBE and CVP.

CVP Survivability TCL support with High Availability

Contact Center Deployments use call survivability TCL script on CUBE to provide basic Call survivability services when downstream CVP nodes are not reachable. From Cisco IOS Release 15.6(2)T onwards, call survivability features are supported in CUBE High Availability mode. Post switchover, all events received on the calls handled by CVP are posted to Call Survivability TCL application for further processing. Thus, call survivability features are supported in CUBE high availability mode for all active calls handled by CVP.

For more information on CVP Call Survivability TCL, refer to http://www.cisco.com/c/dam/en/us/td/docs/voice_ip_comm/cust_contact/contact_center/customer_voice_portal/cvp9_0/configuration/guide/cvp-configuration-and-administration-guide.pdf

Configuring CVP Survivability TCL support with High Availability

Existing configuration of applying the survivability TCL application on incoming dial-peer is sufficient. No additional configuration required.



PART **XV**

ICE-Lite Support on CUBE

- [ICE-Lite Support on CUBE, on page 833](#)



CHAPTER 62

ICE-Lite Support on CUBE

Interactive Connectivity Establishment (ICE) is a protocol for Network Address Translator (NAT) traversal for UDP-based multimedia sessions established with the offer-answer model. ICE makes use of the Session Traversal Utilities for NAT (STUN) protocol and its extension, Traversal Using Relay NAT (TURN), and can be used by any protocol utilizing the offer-answer model, such as the Session Initiation Protocol (SIP).

The ICE-Lite Support on CUBE feature enables the remote peers of CUBE (that may be behind a NAT and doing ICE) to use the ICE semantics in the session description protocol (SDP) and perform an offer-answer exchange of SDP messages. The CUBE can also interwork with endpoints that support or do not support ICE. ICE agents (devices) that are always attached to the public Internet have a special type of implementation called Lite. CUBE will be in ICE-lite mode only. CUBE supports the ICE-lite feature from Cisco IOS Release 15.5(2)S.

- [Feature Information for ICE-Lite Support on CUBE, on page 833](#)
- [Restrictions for ICE-lite Support on CUBE, on page 834](#)
- [Information About ICE-Lite Support on CUBE, on page 834](#)
- [How to Configure ICE-Lite Support on CUBE, on page 836](#)
- [Additional References, on page 845](#)

Feature Information for ICE-Lite Support on CUBE

The following table provides release information about the feature or features described in this module. This table lists only the software release that introduced support for a given feature in a given software release train. Unless noted otherwise, subsequent releases of that software release train also support that feature.

Use Cisco Feature Navigator to find information about platform support and Cisco software image support. To access Cisco Feature Navigator, go to <https://cfngn.cisco.com/>. An account on Cisco.com is not required.

Table 83: Feature Information for ICE-Lite Support on CUBE

Feature Name	Releases	Feature Information
ICE-Lite Support on CUBE	Cisco IOS 15.5(3)M Cisco IOS XE 3.16S	The ICE-Lite Support on CUBE feature enables the remote peers of CUBE (that may be behind a NAT and doing ICE) to use the ICE semantics in the session description protocol (SDP) and perform an offer-answer exchange of SDP messages. The CUBE can also interwork with endpoints that support or do not support ICE. ICE agents (devices) that are always attached to the public Internet have a special type of implementation called Lite. CUBE will be in ICE-lite mode only. The following commands were introduced or modified: debug voip icelib , show voip ice global-stats , show voip ice instance call-id call-id , show voip ice summary , and stun usage ice

Restrictions for ICE-lite Support on CUBE

The following features are not supported with ICE:

- IPv6
- Alternative Network Address Types (ANAT)
- ANAT-ICE interworking
- Media anti-trombone
- High availability support for video calls
- Codec Transparent
- SDP passthrough
- Media flow-around
- Resource Reservation Protocol (RSVP)
- SIP-to-TDM gateway support
- Media Termination Point (MTP)
- VXML and TCL Scripts

Information About ICE-Lite Support on CUBE

Characteristics

The following are some of the key characteristics of ICE-lite.

- A CLI configured for ICE-lite.

- Support for ICE-lite in the contact header with a media-tag option of REGISTER message (as per RFC 5768).
- ICE-lite feature is in compliance with section 4.2 of RFC 7584, with CUBE acting as ICE termination Back-to-Back UA.
- CUBE accepts Full ICE Offer and responds in ICE-lite mode.
- CUBE responds to mid call updates or early dialog updates with changes to SDP parameters, and which requires ICE to restart.
- For outbound offer from CUBE, a Session Description Protocol (SDP) with ICE-lite semantics is sent.
- ICE protocol verifies all types of media streams (audio, video, application media lines) and components (RTP, RTCP), wherever applicable.

ICE Candidate

To execute ICE, an agent has to identify all of its address candidates. A candidate is a transport address—a combination of IP address and port for a transport protocol, such as UDP. A candidate can be derived from physical or logical network interfaces, or discoverable using STUN and TURN. A viable candidate is a transport address obtained directly from a local interface; such a candidate is called a host candidate. The local interface could be ethernet or WiFi, or it could be one that is obtained through a tunnel mechanism, such as a Virtual Private Network (VPN) or Mobile IP (MIP). In all cases, such a network interface appears to the agent as a local interface from which ports (and thus candidates) can be allocated.



Note Refer to RFC 5245 for more information about ICE candidates.

ICE Lite

ICE agents (devices) that are always attached to the public Internet have a special type of implementation called Lite. For ICE to be used in a call, both the endpoints (agents) must support it. An ICE agent that supports Lite neither gathers ICE candidates nor triggers ICE connectivity checks; however, the agent responds to connectivity checks and includes only host candidates for any media stream. An ICE agent that supports the lite mode is called an ICE-lite endpoint.



Note Refer to RFC 5245 for more information about ICE-lite implementation and connectivity checks.

High Availability Support with ICE

High availability (HA) is supported only for audio calls that use ICE. For video calls, as the size of SDP is larger, HA will not work. Some of the design considerations are the following:

- No new checkpoint module for ICE instance.
- ICE instance will be re-created on the standby device from SIP HA re-creation path by using source SDP, destination SDP, and configuration profile.

- As no information related to ICE is checkpointed, in the standby device, the ICE valid list (created after connectivity checks are done) is populated from currently used media address.

How to Configure ICE-Lite Support on CUBE

Configuring ICE on the CUBE

ICE lite can be configured under STUN, and the decision to use ICE for a session is based on the offer/answer. This configuration is used for outbound dial-peers of CUBE to decide whether to offer ICE in SDP or not. For an incoming offer, the decision to do ICE is based on what the remote end offers in SDP.

SUMMARY STEPS

1. **enable**
2. **configure terminal**
3. **voice class stun-usage tag**
4. **stun usage ice lite**
5. **end**

DETAILED STEPS

	Command or Action	Purpose
Step 1	enable Example: Device> enable	Enables privileged EXEC mode. • Enter your password if prompted.
Step 2	configure terminal Example: Device# configure terminal	Enters global configuration mode.
Step 3	voice class stun-usage tag Example: Device(config)# voice class stun-usage 5	Sets STUN usage global parameters, and enters voice class configuration mode.
Step 4	stun usage ice lite Example: Device(config-class)# stun usage ice lite	Configures ICE in ICE-Lite mode.
Step 5	end Example: Device(config-class)# end	Returns to privileged EXEC mode.

Verifying ICE-Lite on the CUBE (Success Flow Calls)

The following **show** commands can be used to verify ICE for success flow calls. The **show** commands can be entered in any order.

SUMMARY STEPS

1. **show call active video compact**
2. **show voip rtp connections**
3. **show voip ice instance call-id** *call-id-1*
4. **show voip ice instance call-id** *call-id-2*
5. **show voip ice summary**
6. **show voip ice global-stats**

DETAILED STEPS

Step 1 show call active video compact

Example:

```
Device# show call active video compact

<callID>  A/O FAX T<sec> Codec      type      Peer Address      IP R<ip>:<udp>
Total call-legs: 4
          25 ANS   T189  H264      VOIP-VIDEO P8181      72.163.212.137:2328
          30 ORG   T189  H264      VOIP-VIDEO P9191      9.45.46.16:8028
          35 ANS   T189  H264      VOIP-VIDEO P8181      9.45.46.16:8008
          36 ORG   T189  H264      VOIP-VIDEO P9191      72.163.212.163:2328
```

Step 2 show voip rtp connections

The following sample output displays the VoIP RTP usage information and RTP active connections.

Example:

```
Device# show voip rtp connections

VoIP RTP Port Usage Information:
Max Ports Available: 19999, Ports Reserved: 101, Ports in Use: 20

Media-Address Range      Min Max   Ports   Ports   Ports
                          Port Port   Available Reserved In-use
-----
Global Media Pool        8000 48198 19999   101     20
-----

VoIP RTP active connections :
No. CallId dstCallLocalRTP RmtRTP   LocalIP      RemoteIP      MPSS
1   25     30     8000     2326     10.104.45.107 72.163.212.137 NO
2   26     31     8002     2328     10.104.45.107 72.163.212.137 NO
3   27     32     8036     2454     10.104.45.107 72.163.212.137 NO
4   28     33     8004     2330     10.104.45.107 72.163.212.137 NO
5   29     34     8038     2332     10.104.45.107 72.163.212.137 NO
6   30     25     8006     8016     9.45.46.16     9.45.46.16   NO
7   31     26     8008     8028     9.45.46.16     9.45.46.16   NO
8   32     27     8010     8030     9.45.46.16     9.45.46.16   NO
9   33     28     8012     8032     9.45.46.16     9.45.46.16   NO
10  34     29     8014     8034     9.45.46.16     9.45.46.16   NO
11  35     36     8016     8006     9.45.46.16     9.45.46.16   NO
```

```

12 36 35 8018 2326 10.104.45.107 72.163.212.163 NO
13 37 41 8020 2328 10.104.45.107 72.163.212.163 NO
14 38 42 8022 2454 10.104.45.107 72.163.212.163 NO
15 39 43 8024 2330 10.104.45.107 72.163.212.163 NO
16 40 44 8026 2332 10.104.45.107 72.163.212.163 NO
17 41 37 8028 8008 9.45.46.16 9.45.46.16 NO
18 42 38 8030 8010 9.45.46.16 9.45.46.16 NO
19 43 39 8032 8012 9.45.46.16 9.45.46.16 NO
20 44 40 8034 8014 9.45.46.16 9.45.46.16 NO
Found 20 active RTP connections

```

Step 3 show voip ice instance call-id *call-id-1*

The following sample output displays the active ICE sessions on the ICE-full and the ICE-lite legs where there are ICE negotiations.

Example:

```
Device# show voip ice instance call-id 25
```

```

Interactive Connectivity Check(ICE) Instance details:
Call-ID is 25
Instance is 0x7FC617FC0508
Overall ICE-State is COMPLETED
LocalAgent's mode is ICE-CONTROLLED
RemoteAgent's mode is ICE-CONTROLLING
m-line:1
-----
ICE-State: ACTIVE
NominatedPairs:
LocalIP 10.104.45.107 port 8000 type host RemoteIP 72.163.212.137 port 2326 type host

m-line:2
-----
ICE-State: ACTIVE
NominatedPairs:
LocalIP 10.104.45.107 port 8002 type host RemoteIP 72.163.212.137 port 2328 type host
LocalIP 10.104.45.107 port 8003 type host RemoteIP 72.163.212.137 port 2329 type host

m-line:3
-----
ICE-State: ACTIVE
NominatedPairs:
LocalIP 10.104.45.107 port 8036 type host RemoteIP 72.163.212.137 port 2454 type host

m-line:4
-----
ICE-State: ACTIVE
NominatedPairs:
LocalIP 10.104.45.107 port 8004 type host RemoteIP 72.163.212.137 port 2330 type host
LocalIP 10.104.45.107 port 8005 type host RemoteIP 72.163.212.137 port 2331 type host

m-line:5
-----
ICE-State: ACTIVE
NominatedPairs:
LocalIP 10.104.45.107 port 8038 type host RemoteIP 72.163.212.137 port 2332 type host

Total Rx STUN Bind Req 22
Total Tx STUN Bind Succ Resp 22
Total Tx STUN Bind failure resp 0

```

Step 4 show voip ice instance call-id *call-id-2*

The following sample output displays the idle ICE sessions on the ICE-lite and the ICE-lite legs where there are no ICE negotiations.

Example:

```
Device# show voip ice instance call-id 30

Interactive Connectivity Check(ICE) Instance details:
Call-ID is 30
Instance is 0x7FC617FC03F8
Overall ICE-State is RUNNING
LocalAgent's mode is ICE-CONTROLLED
RemoteAgent's mode is ICE-CONTROLLING
m-line:1
-----
ICE-State: IDLE
No candidate has been nominated

m-line:2
-----
ICE-State: IDLE
No candidate has been nominated

m-line:3
-----
ICE-State: IDLE
No candidate has been nominated

m-line:4
-----
ICE-State: IDLE
No candidate has been nominated

m-line:5
-----
ICE-State: IDLE
No candidate has been nominated

Total Rx STUN Bind Req 0
Total Tx STUN Bind Succ Resp 0
Total Tx STUN Bind failure resp 0
```

Step 5 show voip ice summary

The following sample output displays a summary of active ICE sessions.

Example:

```
Device# show voip ice summary

CALL-ID          ICE-STATE
-----
25                COMPLETED
30                RUNNING
35                RUNNING
36                COMPLETED
```

Step 6 show voip ice global-stats

The following sample output displays the global ICE statistics.

Example:

```
Device# show voip ice global-stats
```

```
Interactive Connectivity Establishment(ICE) global stats:
Total Rx Stun BindingRequests      : 43
Total Tx Stun BindingSuccessResponses: 43
Total Tx Stun BindingErrorResponses : 0
```

ICE-Lite on CUBE (Error Flow Calls)

The following are the **show** command sample outputs followed by the system logs for error flow calls. The **show** commands can be entered in any order.

SUMMARY STEPS

1. **show call active voice compact**
2. **show voip rtp connections**
3. **show voip ice instance call-id *call-id***
4. **show voip ice instance call-id *call-id***
5. **show voip ice summary**
6. **show voip ice global-stats**

DETAILED STEPS

Step 1 show call active voice compact

Example:

```
Device# show call active video compact
```

```
<callID> A/O FAX T<sec> Codec      type      Peer Address      IP R<ip>:<udp>
Total call-legs: 2
      57 ANS      T4      g711ulaw  VOIP      Padithyam      173.39.64.79:7078
      58 ORG      T4      g711ulaw  VOIP      P9191          72.163.212.163:2336
```

Step 2 show voip rtp connections

The following sample output displays the VoIP RTP usage information and RTP active connections.

Example:

```
Device# show voip rtp connections
```

```
VoIP RTP Port Usage Information:
Max Ports Available: 19999, Ports Reserved: 101, Ports in Use: 2

Media-Address Range      Min   Max   Ports   Ports   Ports
                          Port  Port Available Reserved In-use
-----
Global Media Pool        8000 48198 19999   101     2
-----

VoIP RTP active connections :
No. CallId dstCallLocalRTP RmtRTP   LocalIP      RemoteIP      MPSS
1  57      58      8040      7078      10.104.45.107 173.39.64.79  NO
```

```

2 58 57 8042 2336 10.104.45.107 72.163.212.163 NO
Found 2 active RTP connections

```

Step 3 **show voip ice instance call-id** *call-id*

The following sample output displays the ICE sessions.

Example:

```

Device# show voip ice instance call-id 57

Interactive Connectivity Check(ICE) Instance details:
Call-ID is 57
Instance is 0x7FC617FC03F8
Overall ICE-State is RUNNING
LocalAgent's mode is ICE-CONTROLLED
RemoteAgent's mode is ICE-CONTROLLING
m-line:1
-----
ICE-State: IDLE
No candidate has been nominated

Total Rx STUN Bind Req 2
Total Tx STUN Bind Succ Resp 0
Total Tx STUN Bind failure resp 2

```

Step 4 **show voip ice instance call-id** *call-id*

The following sample output displays the ICE sessions.

Example:

```

Device# show voip ice instance call-id 58

Interactive Connectivity Check(ICE) Instance details:
Call-ID is 58
Instance is 0x7FC617FC0508
Overall ICE-State is RUNNING
LocalAgent's mode is ICE-CONTROLLED
RemoteAgent's mode is ICE-CONTROLLING
m-line:1
-----
ICE-State: IDLE
No candidate has been nominated

Total Rx STUN Bind Req 2
Total Tx STUN Bind Succ Resp 0
Total Tx STUN Bind failure resp 2

```

Step 5 **show voip ice summary**

The following sample output displays a summary of active ICE sessions.

Example:

```

Device# show voip ice summary

CALL-ID          ICE-STATE
-----
57                RUNNING
58                RUNNING
Total number of sessions: 2

```

Step 6 show voip ice global-stats

The following sample output displays the global ICE statistics.

Example:

```
Device# show voip ice global-stats

Interactive Connectivity Establishment(ICE) global stats:
Total Rx Stun BindingRequests      : 47
Total Tx Stun BindingSuccessResponses: 43
Total Tx Stun BindingErrorResponses : 4
```

The following are the sys logs for invalid message integrity and for sending ICE-controlled parameter.

Sys Log for invalid message integrity:

```
004012: *Aug  8 14:25:30.876 IST: %CISCO_STUN-4-INVALID_MESSAGE_INTEGRITY: Invalid Message-Integrity
attribute in the received STUN message on UDP IP address 10.104.45.107 port 8040###STUN Message
structure start###
Message Type           : STUN_MSG_TYPE_BINDING_REQ
Magic Cookie           : 2112A442
Transaction ID        : 01CD61B24C077331EDC27A5B
Mapped Address        : Not Set/Present
User Name             : Not Set/Present
Error code not present
Alternate Server      : Not Set/Present
Realm                 : Not Set/Present
nonce                 : Not Set/Present
Xormapped Address    : Not Set/Present
Server                : Not Set/Present
ICE Priority          : Not Set/Present
ICE Controlled        : Not Set/Present
ICE Controlling      : Not Set/Present
Cisco-flowdata       :
cisco-flowdata is not present
Message Integrity     : Not Set/Present
Finger Print         : Not Set/Present
###STUN Message structure End###

004013: *Aug  8 14:25:30.876 IST: //-1/xxxxxxxxxxxxx/STUN/Inout/cisco_stun_process_event: Exit
004014: *Aug  8 14:25:30.876 IST: //57/91300134802E/STUN/Inout/cisco_stun_process_event: Entry with
Eventtype:7
004015: *Aug  8 14:25:30.876 IST: //57/91300134802E/STUN/Inout/cisco_stun_process_send_msg_event:
Entry
004016: *Aug  8 14:25:30.876 IST: //-1/xxxxxxxxxxxxx/STUN/Inout/stunSendMsg: Entry
004017: *Aug  8 14:25:30.876 IST: //-1/xxxxxxxxxxxxx/STUN/Inout/stunGetMsgClass: Entry
004018: *Aug  8 14:25:30.876 IST: //-1/xxxxxxxxxxxxx/STUN/Detail/stunGetMsgClass: en_StunResp
004019: *Aug  8 14:25:30.876 IST: //-1/xxxxxxxxxxxxx/STUN/Detail/stunSendMsg: dMsgClass:3
004020: *Aug  8 14:25:30.876 IST: //-1/xxxxxxxxxxxxx/STUN/Inout/stunEncodeMsg: Entry
004021: *Aug  8 14:25:30.876 IST: //-1/xxxxxxxxxxxxx/STUN/Detail/stunCalculateSize:      Length of
ERROR-CODE = 20
004022: *Aug  8 14:25:30.876 IST: //-1/xxxxxxxxxxxxx/STUN/Detail/stunCalculateSize:      Length of
MESSAGE-INTEGRITY = 24
004023: *Aug  8 14:25:30.876 IST: //-1/xxxxxxxxxxxxx/STUN/Detail/stunEncodeMsg: STUN Message Length
= 64
004024: *Aug  8 14:25:30.876 IST: //-1/xxxxxxxxxxxxx/STUN/Inout/stunEncodeHdr: Entry
004025: *Aug  8 14:25:30.876 IST: //-1/xxxxxxxxxxxxx/STUN/Inout/stunEncodeHdr: Exit
004026: *Aug  8 14:25:30.876 IST: //-1/xxxxxxxxxxxxx/STUN/Inout/stunEncodeAttr: Entry
004027: *Aug  8 14:25:30.876 IST: //-1/xxxxxxxxxxxxx/STUN/Inout/stunEncodeAttr: Exit
004028: *Aug  8 14:25:30.876 IST: //-1/xxxxxxxxxxxxx/STUN/Detail/stunEncodeMsgIntegrity: Original
STUN Message Length = 44
004029: *Aug  8 14:25:30.876 IST: //-1/xxxxxxxxxxxxx/STUN/Detail/stunEncodeMsgIntegrity: Adjusted
```



```

STUN Message Length = 44
004030: *Aug 8 14:25:30.876 IST: //-1/xxxxxxxxxxxxx/STUN/Detail/stunEncodeMsgIntegrity: Successfully
Encoded MI attribute. Exit
004031: *Aug 8 14:25:30.876 IST: //-1/xxxxxxxxxxxxx/STUN/Inout/stunSetMsgIntegrityToStunMessage:
Entry
004032: *Aug 8 14:25:30.876 IST: //-1/xxxxxxxxxxxxx/STUN/Inout/stunSetMsgIntegrityToStunMessage: Exit
with success
004033: *Aug 8 14:25:30.876 IST: //-1/xxxxxxxxxxxxx/STUN/Detail/stunEncodeMsg: Total length:64
004034: *Aug 8 14:25:30.876 IST: //-1/xxxxxxxxxxxxx/STUN/Inout/stunEncodeMsg: Exit
004035: *Aug 8 14:25:30.876 IST: //57/91300134802E/STUN/Inout/stunSendMsgToNetwork: Entry
004036: *Aug 8 14:25:30.876 IST: //57/91300134802E/STUN/Detail/stunSendMsgToNetwork: Message sending
from, 10.104.45.107:8040, to 173.39.64.79:7078
004037: *Aug 8 14:25:30.876 IST: //57/91300134802E/STUN/Detail/stunSendMsgToNetwork: Stun Message:

0111002C2112A44201CD61B24C077331EDC27A5B0009000F0000040042616420526571756573740000080014D0E2E828944BF3D07CC5C06D026D8909B85EF3E9
004038: *Aug 8 14:25:30.876 IST: //57/91300134802E/STUN/Inout/stunSendMsgToNetwork: Exit
004039: *Aug 8 14:25:30.876 IST: //-1/xxxxxxxxxxxxx/STUN/Detail/stunSendMsg:
** Sent Stun Packet to Network **
###STUN Message structure start###
Message Type : STUN_MSG_TYPE_BINDING_ERR_RESP
Magic Cookie : 2112A442
Transaction ID : 01CD61B24C077331EDC27A5B
Mapped Address : Not Set/Present
User Name : Not Set/Present
Error Code : Number = 400 ,Reason = Bad Request
Alternate Server : Not Set/Present
Realm : Not Set/Present
nonce : Not Set/Present
Xormapped Address : Not Set/Present
Server : Not Set/Present
ICE Priority : Not Set/Present
ICE Controlled : Not Set/Present
ICE Controlling : Not Set/Present
Cisco-flowdata :
cisco-flowdata is not present
Message Integrity : D0E2E828944BF3D07CC5C06D026D8909B85EF3E9
004040: *Aug 8 14:25:30.876 IST: Finger Print : Not Set/Present
###STUN Message structure End###

004041: *Aug 8 14:25:30.876 IST: //-1/xxxxxxxxxxxxx/STUN/Detail/stunSendMsg: Sent Bind Response, Free
the transaction
004042: *Aug 8 14:25:30.876 IST: //57/91300134802E/STUN/Detail/cisco_stun_process_send_msg_event:
STUN message Sent

```

Sys Log for sending ICE-controlled parameter instead of ICE-controlling parameter:

```

004130: *Aug 8 14:25:30.912 IST: //-1/xxxxxxxxxxxxx/STUN/Inout/stunGetMsgClass: Entry
004131: *Aug 8 14:25:30.912 IST: //-1/xxxxxxxxxxxxx/STUN/Detail/stunGetMsgClass: en_StunReq
004132: *Aug 8 14:25:30.912 IST: %CISCO_STUN-4-ICE_ROLE_CONFLICT: Ice Role Conflcit detected in the
received STUN message on UDP IP address 10.104.45.107 port 8042
004133: *Aug 8 14:25:30.912 IST: //-1/xxxxxxxxxxxxx/STUN/Inout/stunSetErrorCodeToStunMessage: Entry
004134: *Aug 8 14:25:30.912 IST: //-1/xxxxxxxxxxxxx/STUN/Detail/stunSetErrorCodeToStunMessage:
reason:Role Conflcit, code:487
004135: *Aug 8 14:25:30.912 IST: //-1/xxxxxxxxxxxxx/STUN/Inout/stunSetErrorCodeToStunMessage: Exit
with success
004136: *Aug 8 14:25:30.912 IST: //-1/xxxxxxxxxxxxx/STUN/Inout/stun_process_send_bind_response: Exit
004137: *Aug 8 14:25:30.912 IST: //-1/xxxxxxxxxxxxx/STUN/Detail/stun_post_bind_request_ind_to_app:
Post Message to Application
004138: *Aug 8 14:25:30.912 IST: //-1/xxxxxxxxxxxxx/STUN/Detail/cisco_stun_process_stun_pak_rcvd_event:
Received New STUN message###STUN Message structure start###
Message Type : STUN_MSG_TYPE_BINDING_REQ
Message Length : 80
Magic Cookie : 2112A442
Transaction ID : F1CF84958CE76D15C83059D9

```

```

Mapped Address           : Not Set/Present
User Name                : GAah:4wWY
Error code not present
Alternate Server         : Not Set/Present
Realm                    : Not Set/Present
nonce                    : Not Set/Present
Xormapped Address       : Not Set/Present
Server                   : Cisco
ICE Priority              : 1862270975
ICE Controlled         : 11920035603547232620
ICE Controlling      : Not Set/Present
Cisco-flowdata          :
cisco-flowdata is not present
Message Integrity        : 0AF4B8C2378CB90AB0B0A3806507D766BF5CD1DD
004139: *Aug 8 14:25:30.912 IST: Finger Print           : 4235512547
###STUN Message structure End###

004140: *Aug 8 14:25:30.912 IST: //-1/xxxxxxxxxxxxx/STUN/Inout/cisco_stun_process_event: Exit
004141: *Aug 8 14:25:30.912 IST: //58/91300134802E/STUN/Inout/cisco_stun_process_event: Entry with
      EventType:7
004142: *Aug 8 14:25:30.912 IST: //58/91300134802E/STUN/Inout/cisco_stun_process_send_msg_event:
      Entry
004143: *Aug 8 14:25:30.912 IST: //-1/xxxxxxxxxxxxx/STUN/Inout/stunSendMsg: Entry
004144: *Aug 8 14:25:30.912 IST: //-1/xxxxxxxxxxxxx/STUN/Inout/stunGetMsgClass: Entry
004145: *Aug 8 14:25:30.912 IST: //-1/xxxxxxxxxxxxx/STUN/Detail/stunGetMsgClass: en_StunResp
004146: *Aug 8 14:25:30.912 IST: //-1/xxxxxxxxxxxxx/STUN/Detail/stunSendMsg: dMsgClass:3
004147: *Aug 8 14:25:30.912 IST: //-1/xxxxxxxxxxxxx/STUN/Inout/stunEncodeMsg: Entry
004148: *Aug 8 14:25:30.912 IST: //-1/xxxxxxxxxxxxx/STUN/Detail/stunCalculateSize:      Length of
      ERROR-CODE = 24
004149: *Aug 8 14:25:30.912 IST: //-1/xxxxxxxxxxxxx/STUN/Detail/stunCalculateSize:      Length of
      MESSAGE-INTEGRITY = 24
004150: *Aug 8 14:25:30.912 IST: //-1/xxxxxxxxxxxxx/STUN/Detail/stunEncodeMsg: STUN Message Length
      = 68
004151: *Aug 8 14:25:30.912 IST: //-1/xxxxxxxxxxxxx/STUN/Inout/stunEncodeHdr: Entry
004152: *Aug 8 14:25:30.912 IST: //-1/xxxxxxxxxxxxx/STUN/Inout/stunEncodeHdr: Exit
004153: *Aug 8 14:25:30.912 IST: //-1/xxxxxxxxxxxxx/STUN/Inout/stunEncodeAttr: Entry
004154: *Aug 8 14:25:30.912 IST: //-1/xxxxxxxxxxxxx/STUN/Inout/stunEncodeAttr: Exit
004155: *Aug 8 14:25:30.912 IST: //-1/xxxxxxxxxxxxx/STUN/Detail/stunEncodeMsgIntegrity: Original
      STUN Message Length = 48
004156: *Aug 8 14:25:30.912 IST: //-1/xxxxxxxxxxxxx/STUN/Detail/stunEncodeMsgIntegrity: Adjusted
      STUN Message Length = 48
004157: *Aug 8 14:25:30.912 IST: //-1/xxxxxxxxxxxxx/STUN/Detail/stunEncodeMsgIntegrity: Successfully
      Encoded MI attribute. Exit
004158: *Aug 8 14:25:30.912 IST: //-1/xxxxxxxxxxxxx/STUN/Inout/stunSetMsgIntegrityToStunMessage:
      Entry
004159: *Aug 8 14:25:30.912 IST: //-1/xxxxxxxxxxxxx/STUN/Inout/stunSetMsgIntegrityToStunMessage: Exit
      with success
004160: *Aug 8 14:25:30.912 IST: //-1/xxxxxxxxxxxxx/STUN/Detail/stunEncodeMsg: Total length:68
004161: *Aug 8 14:25:30.912 IST: //-1/xxxxxxxxxxxxx/STUN/Inout/stunEncodeMsg: Exit
004162: *Aug 8 14:25:30.912 IST: //58/91300134802E/STUN/Inout/stunSendMsgToNetwork: Entry
004163: *Aug 8 14:25:30.912 IST: //58/91300134802E/STUN/Detail/stunSendMsgToNetwork: Message sending
      from, 10.104.45.107:8042, to 72.163.212.163:2336
004164: *Aug 8 14:25:30.912 IST: //58/91300134802E/STUN/Detail/stunSendMsgToNetwork: Stun Message:

011100302112A442F1CF84958CE76D15C83059D90009001100000457526F6C6520436F6E666C636974000000008001413402FC99C6029653902605739773476578806E
004165: *Aug 8 14:25:30.913 IST: //58/91300134802E/STUN/Inout/stunSendMsgToNetwork: Exit
004166: *Aug 8 14:25:30.913 IST: //-1/xxxxxxxxxxxxx/STUN/Detail/stunSendMsg:
** Sent Stun Packet to Network **
###STUN Message structure start###
Message Type         : STUN_MSG_TYPE_BINDING_ERR_RESP
Magic Cookie             : 2112A442
Transaction ID           : F1CF84958CE76D15C83059D9
Mapped Address           : Not Set/Present
User Name                : Not Set/Present

```

```

Error Code                : Number = 487 ,Reason = Role Conflcit
Alternate Server          : Not Set/Present
Realm                    : Not Set/Present
nonce                    : Not Set/Present
Xormapped Address        : Not Set/Present
Server                   : Not Set/Present
ICE Priority              : Not Set/Present
ICE Controlled           : Not Set/Present
ICE Controlling          : Not Set/Present
Cisco-flowdata           :
cisco-flowdata is not present
Message Integrity        : 13402FC99C60296539026305739773476578806E
004167: *Aug  8 14:25:30.913 IST: Finger Print                : Not Set/Present
###STUN Message structure End###

004168: *Aug  8 14:25:30.913 IST: //-1/xxxxxxxxxxxxx/STUN/Detail/stunSendMsg: Sent Bind Response, Free
the transaction
004169: *Aug  8 14:25:30.913 IST: //58/91300134802E/STUN/Detail/cisco_stun_process_send_msg_event:
STUN message Sent

```

Troubleshooting ICE-Lite Support on CUBE

You can use the following **debug** commands to troubleshoot the ICE-lite support on CUBE feature. Use these commands to enable ICE debugs for each call.

- **debug voip icelib all**
- **debug voip icelib default**
- **debug voip icelib detail**
- **debug voip icelib error**
- **debug voip icelib event**
- **debug voip icelib inout**
- **debug voip stun all**
- **debug voip stun default**
- **debug voip stun detail**
- **debug voip stun error**
- **debug voip stun event**
- **debug voip stun inout**
- **debug voip stun message**
- **debug voip stun packet**

Additional References

Standards and RFCs

Standard/RFC	Title
RFC 5389	<i>Session Traversal Utilities for NAT (STUN)</i>
RFC 5245	<i>Interactive Connectivity Establishment (ICE): A Protocol for Network Address Translator (NAT) Traversal for Offer/Answer Protocols</i>

Standard/RFC	Title
RFC 5766	<i>Traversal Using Relays around NAT (TURN): Relay Extensions to Session Traversal Utilities for NAT (STUN)</i>
RFC 5768	<i>Indicating Support for Interactive Connectivity Establishment (ICE) in the Session Initiation Protocol (SIP)</i>
RFC 3840	<i>Indicating User Agent Capabilities in the Session Initiation Protocol (SIP)</i>
RFC 7584	<i>Session Traversal Utilities for NAT (STUN) Message Handling for SIP Back-to-Back User Agents (B2BUAs)</i>

Technical Assistance

Description	Link
<p>The Cisco Support website provides extensive online resources, including documentation and tools for troubleshooting and resolving technical issues with Cisco products and technologies.</p> <p>To receive security and technical information about your products, you can subscribe to various services, such as the Product Alert Tool (accessed from Field Notices), the Cisco Technical Services Newsletter, and Really Simple Syndication (RSS) Feeds.</p> <p>Access to most tools on the Cisco Support website requires a Cisco.com user ID and password.</p>	http://www.cisco.com/support



PART **XVI**

SIP Protocol Handling

- [Mid-call Signaling Consumption, on page 849](#)
- [Early Dialog UPDATE Block, on page 859](#)
- [Consumption of Forked 18x Responses with SDP During Early Dialog, on page 865](#)
- [Support for Pass-Through of Unsupported Content Types in SIP INFO Messages, on page 871](#)
- [Support for PAID PPID Privacy PCPID and PAURI Headers on the Cisco Unified Border Element, on page 873](#)



CHAPTER 63

Mid-call Signaling Consumption

The Cisco Unified Border Element BE Mid-call Signaling support aims to reduce the interoperability issues that arise due to consuming mid-call RE-INVITES/UPDATES.

Mid-call Re-INVITES/UPDATES can be consumed in the following ways:

- Mid-call Signaling Passthrough - Media Change
- Mid-call Signaling Block
- Mid-call Signaling Codec Preservation



Note This feature should be used as a last resort only when there is no other option in CUBE. This is because configuring this feature can break video-related features. For Delay-offer Re-INVITE, the configured codec will be passed as an offer in 200 message to change the codec, the transcoder is added in the answer.

- [Feature Information for Mid-call Signaling, on page 849](#)
- [Prerequisites, on page 850](#)
- [Mid-call Signaling Passthrough - Media Change, on page 850](#)
- [Mid-call Signaling Block, on page 854](#)
- [Mid Call Codec Preservation, on page 857](#)

Feature Information for Mid-call Signaling

The following table provides release information about the feature or features described in this module. This table lists only the software release that introduced support for a given feature in a given software release train. Unless noted otherwise, subsequent releases of that software release train also support that feature.

Use Cisco Feature Navigator to find information about platform support and Cisco software image support. To access Cisco Feature Navigator, go to <https://cfng.cisco.com/>. An account on Cisco.com is not required.

Table 84: Feature Information for Mid-call Signaling

Feature Name	Releases	Feature Information
Mid-call Re-INVITE Consumption	Cisco IOS 15.2(1)T Cisco IOS XE 3.6S	The Mid-call Re-INVITE consumption feature consumes mid-call Re-INVITEs from CUBE and helps to avoid interoperability issues because of these re-invites The following commands were introduced or modified: midcall-signaling .
Mid-call Codec Preservation	Cisco IOS 15.3(2)T Cisco IOS XE 3.9S	The Mid-call Codec Preservation feature helps to disables codec negotiation in the middle of a call and preserves the codec negotiated before the call. The following commands were introduced or modified: midcall-signaling preserve-codec , voice-class sip midcall-signaling preserve-codec .
Mid-call Re-INVITE Consumption Enhancements	Cisco IOS 15.5(3)M Cisco IOS XE 3.16S	Mid-call signaling Re-INVITE consumption is enhanced to support: <ul style="list-style-type: none"> • Re-INVITE based call transfer • Call transfer with REFER Consume • Normalization of call hold in a call set-up

Prerequisites

- [Enable CUBE application on a device](#)

Mid-call Signaling Passthrough - Media Change

Passthrough media change method optimizes or consumes mid-call, media-related signaling within the call. Mid-call signaling changes will be passed through only when bidirectional media like T.38 or video is added.

The command **midcall-signaling passthru media-change** needs to be configured to enable passthrough media change.

Restrictions for Mid-Call Signaling Passthrough - Media Change

- SIP-H.323 calls are not supported.
- TDM Gateways are not supported.
- Session Description Protocol (SDP) -passthrough is not supported.
- When **codec T** is configured, the offer from CUBE has only audio codecs, and so the video codecs are not consumed.
- Re-invites are not consumed if media flow-around is configured.
- Re-invites are not consumed if media anti-tromboning is configured.
- De-escalation re-invites are consumed. So, one call leg might be de-escalated to audio only while the other call leg continues to support audio and video.
- Re-invites with media direction changes are consumed.
- Video transcoding is not supported.
- Multicast Music On Hold (MMOH) is not supported.
- When the **midcall-signaling passthru media-change** command is configured and high-density transcoder is enabled, there might be some impact on Digital Signal Processing (DSP) resources as the transcoder might be used for all the calls.
- Session timer is handled leg by leg whenever this feature is configured and it includes session timer negotiation for initial INVITE/200 OK transaction as well.
- More than two m-lines in the SDP is not supported.
- Alternative Network Address Types (ANAT) is not supported.
- Video calls and Application streams are not supported when mid-call signaling block is configured.
- In the SRTP-RTP scenario, re-invites are not consumed.

Behavior of Mid-call Re-INVITE Consumption

- If mid-call signaling block is enabled on either of call-legs, video parameters and application streams are not negotiated, and are rejected in the answer.
- When flow around and offer-all is configured, CUBE performs codec renegotiation even if mid-call signaling block is configured globally.
- The following behavior is for refer consume scenario:
 - REFER consume is supported for blind, alert and consult call transfers.
 - Existing codecs or DTMF is used for local bridging of new call legs. No Re-INVITE or UPDATE is sent for media re-negotiation after REFER.

- Call gets dropped when DSP is required but not available.
 - A call can be escalated to video only if transferee and transfer-to dial-peers do not have mid-call signaling block configured.
 - Video calls are de-escalated if mid-call signaling block configuration on transfer-to dial-peer.
 - For Re-INVITE based call-transfer involving Cisco Unified Communications Manager, all Re-INVITE are locally answered and transcoder is invoked if negotiated codecs are different than the codecs before call-transfer.
- The following behavior is for INVITE with REPLACES Header consume scenario:
 - CUBE consumes INVITE with REPLACES Header only when the **handle-replaces** CLI is configured (under **sip-ua** or **voice-class tenant**). In this case, CUBE consumes the INVITE and handles it locally. It triggers an outbound INVITE without replaces header and call gets connected with agent.
 - If the **handle-replaces** CLI is enabled, the 'transfer-to' party must have the same codec that is used for the original call setup. If there is a different codec offer, CUBE rejects the INVITE with 488 error.
 - If the **handle-replaces** CLI is not configured, CUBE does not consume the INVITE with REPLACES Header and the outgoing INVITE holds same replace header which CUBE is received.
 - INVITE with REPLACES Header consumption does not support the following configurations:
 - Delayed Offer INVITE
 - Codec, DTMF attribute changes, and RSVP
 - Mid-call Signaling block
 - IPv6
 - The following table provides the details of the behavior when the initial call is establish without 'sendrecv' parameter, that means, the initial call is established with 'sendonly', 'recvonly' or 'inactive'.

Scenario	Behavior
If an Offer is received with 'sendonly' and mid-call block is configured on any or both call legs	Offer is sent with 'sendrecv'.
If an Answer is received with 'sendonly' and the peer leg supports mid-call signaling	Answer is sent with 'sendonly'. Resume transaction is end-to-end.
If an Answer is received with 'sendonly' and the peer leg does not supports mid-call signaling	Answer is sent with 'sendrecv'. Resume transaction is consumed.
If Offer as well as Answer is received with 'sendonly' and Offering leg does not support mid-call signaling	Answer is sent with 'recvonly'. Resume from Offering leg is end-to-end. Resume from answering leg is consumed.
If Offer as well as Answer is received with 'sendonly' and Answering leg does not support mid-call signaling	Answer is sent with 'inactive'. Resume from Offering leg is consumed. Resume from answering leg is end-to-end.

Scenario	Behavior
If Offer as well as Answer is received with 'sendonly' and both legs do not support mid-call signaling	Answer is sent with 'recvonly'. Resume transaction is consumed.

Configuring Passthrough of Mid-call Signalling

Perform this task to configure passthrough of mid-call signaling (as Re-invites) only when bidirectional media is added.

SUMMARY STEPS

1. **enable**
2. **configure terminal**
3. Configure passthrough of mid-call signaling changes only when bidirectional media is added.
 - In Global VoIP SIP configuration mode

```
midcall-signaling passthru media-change
```
 - In dial-peer configuration mode

```
voice-class sip midcall-signaling passthru media-change
```
4. **end**

DETAILED STEPS

	Command or Action	Purpose
Step 1	enable Example: Device> enable	Enables privileged EXEC mode. <ul style="list-style-type: none"> • Enter your password if prompted.
Step 2	configure terminal Example: Device# configure terminal	Enters global configuration mode.
Step 3	Configure passthrough of mid-call signaling changes only when bidirectional media is added. <ul style="list-style-type: none"> • In Global VoIP SIP configuration mode <pre>midcall-signaling passthru media-change</pre> • In dial-peer configuration mode <pre>voice-class sip midcall-signaling passthru media-change</pre> Example: In Global VoIP SIP configuration mode:	Re-Invites are passed through only when bidirectional media is added.

	Command or Action	Purpose
	<pre>Device(config)# voice service voip Device(conf-voi-serv)# sip Device(conf-serv-sip)# midcall-signaling passthru media-change</pre> <p>Example:</p> <p>In Dial-peer configuration mode:</p> <pre>Device(config)# dial-peer voice 2 voip Device(config-dial-peer)# voice-class sip midcall-signaling passthru media-change</pre>	
Step 4	end	Exits to privileged EXEC mode.

Example Configuring Passthrough SIP Messages at Dial Peer Level

The following example shows how to passthrough SIP messages at the dial peer Level:

```
dial-peer voice 600 voip
 destination-pattern 222222222
 session protocol sipv2
 session target ipv4:9.45.38.39:9001
 voice-class sip midcall-signaling passthru media-change
 incoming called-number 1111111111
 voice-class codec 2 offer-all
dial-peer voice 400 voip
 destination-pattern 1111111111
 session protocol sipv2
 session target ipv4:9.45.38.39:9000
 incoming called-number 222222222
 voice-class codec 1 offer-all
```

Example Configuring Passthrough SIP Messages at the Global Level

The following example shows how to passthrough SIP messages at the global level:

```
Device(config)# voice service voip
Device(conf-voi-serv)# no ip address trusted authenticate
Device(conf-voi-serv)# allow-connections sip to sip
Device(conf-voi-serv)# sip
Device(conf-serv-sip)# midcall-signaling passthru media-change
```

Mid-call Signaling Block

The Block method blocks all mid-call media-related signaling to the specific SIP trunk. The command **midcall-signaling block** needs to be configured to enable this behavior. Video escalation and T.38 call flow are rejected when the **midcall-signaling block** command is configured. This command should be configured only when basic call is the focus and mid-call can be consumed.

Restrictions for Mid-Call Signaling Block

- SIP-H.323 calls are not supported.

- TDM Gateways are not supported.
- Session Description Protocol (SDP) -passthrough is not supported
- Video calls and Application streams are not supported.
- When media flow-around is configured, Mid-call INVITE is rejected with 488 error message.
- Re-invites are not consumed if media anti-tromboning is configured.
- Multicast Music On Hold (MMOH) is not supported.
- When the **midcall-signaling passthru media-change** command is configured and high-density transcoder is enabled, there might be some impact on Digital Signal Processing (DSP) resources as the transcoder might be used for all the calls.
- Session timer is handled leg by leg whenever this feature is configured.
- More than two m-lines in the SDP is not supported.
- Alternative Network Address Types (ANAT) is not supported.
- When mid-call signaling block is configured, you can either configure REFER consume or enable TCL script. Mid-call signaling block is not supported if both REFER consume and TCL script are enabled. We also recommend not to configure **supplementary-service media-renegotiate** command.
- In the SRTP-RTP scenario, re-invites are not consumed.

Blocking Mid-Call Signaling

Perform this task to block mid-call signaling:

SUMMARY STEPS

1. **enable**
2. **configure terminal**
3. Configure blocking of mid-call signaling changes:
 - In Global VoIP SIP configuration mode
midcall-signaling block
 - In dial-peer configuration mode
voice-class sip midcall-signaling block
4. **end**

DETAILED STEPS

	Command or Action	Purpose
Step 1	enable Example: Device> enable	Enables privileged EXEC mode. <ul style="list-style-type: none"> • Enter your password if prompted.

	Command or Action	Purpose
Step 2	configure terminal Example: Device# configure terminal	Enters global configuration mode.
Step 3	Configure blocking of mid-call signaling changes: <ul style="list-style-type: none"> • In Global VoIP SIP configuration mode midcall-signaling block • In dial-peer configuration mode voice-class sip midcall-signaling block Example: In Global VoIP SIP configuration mode: Device(config)# voice service voip Device(conf-voi-serv)# sip Device(conf-serv-sip)# midcall-signaling block Example: In Dial-peer configuration mode: Device(config)# dial-peer voice 2 voip Device(config-dial-peer)# voice-class sip midcall-signaling block	Mid-call signaling is always blocked.
Step 4	end	Exits to privileged EXEC mode.

Example Blocking SIP Messages at Dial Peer Level

```
dial-peer voice 107 voip
 destination-pattern 74000
 session protocol sipv2
 session target ipv4:9.45.36.9
 incoming called-number 84000
 voice-class codec 1 offer-all
!
dial-peer voice 110 voip
 destination-pattern 84000
 session protocol sipv2
 session target ipv4:9.45.35.2
 incoming called-number 74000
 voice-class codec 1 offer-all
 voice-class sip midcall-signaling block
!
```

Example: Blocking SIP Messages at the Global Level

The following example shows how to block SIP messages at the global Level

```
Device(config)#voice service voip
Device(config-voi-serv)#no ip address trusted authenticate
Device(config-voi-serv)#allow-connections sip to sip
Device(config-voi-serv)#sip
Device(config-serv-sip)#midcall-signaling block
```

Mid Call Codec Preservation

Mid call codec preservation defines whether a codec can be negotiated after a call has been initiated. You can enable or disable codec negotiation in the middle of a call.



Note In the SRTP-RTP scenario, re-invites are not consumed.

Configuring Mid Call Codec Preservation

This task disables codec negotiation in the middle of a call and preserves the codec negotiated before the call.

SUMMARY STEPS

1. **enable**
2. **configure terminal**
3. Enter one of the following to disable midcall codec renegotiation:
 - In Global VoIP SIP configuration mode
 - midcall-signaling preserve-codec**
 - In dial-peer configuration mode
 - voice-class sip midcall-signaling preserve-codec**
4. **end**

DETAILED STEPS

	Command or Action	Purpose
Step 1	enable Example: Device> enable	Enables privileged EXEC mode. <ul style="list-style-type: none"> • Enter your password if prompted.
Step 2	configure terminal Example: Device# configure terminal	Enters global configuration mode.
Step 3	Enter one of the following to disable midcall codec renegotiation: <ul style="list-style-type: none"> • In Global VoIP SIP configuration mode <ul style="list-style-type: none"> midcall-signaling preserve-codec • In dial-peer configuration mode <ul style="list-style-type: none"> voice-class sip midcall-signaling preserve-codec Example:	Disables codec negotiation in the middle of a call and preserves the codec negotiated before the call.

Example: Configuring Mid Call Codec Preservation at the Dial Peer Level

	Command or Action	Purpose
	<pre>Device(config)# voice service voip Device(conf-voi-serv)# sip Device(conf-serv-sip)# midcall-signaling preserve-codec Example: Device(config)# dial-peer voice 10 voip Device(conf-dial-peer)# voice-class sip midcall-signaling preserve-codec</pre>	
Step 4	<pre>end Example: Device(conf-serv-sip)# end</pre>	Exits to privileged EXEC mode.

Example: Configuring Mid Call Codec Preservation at the Dial Peer Level

Example: Configuring Mid Call Codec Preservation at the Dial Peer Level

```
dial-peer voice 107 voip
 destination-pattern 74000
 session protocol sipv2
 session target ipv4:9.45.36.9
 incoming called-number 84000
 voice-class codec 1 offer-all
!
dial-peer voice 110 voip
 destination-pattern 84000
 session protocol sipv2
 session target ipv4:9.45.35.2
 incoming called-number 74000
 voice-class codec 1 offer-all
 voice-class sip midcall-signaling preserve-codec
!
```

Example: Configuring Mid Call Codec Preservation at the Global Level

Example: Configuring Mid Call Codec Preservation at the Global Level

```
Device(config)# voice service voip
Device(conf-voi-serv)# no ip address trusted authenticate
Device(conf-voi-serv)# allow-connections sip to sip
Device(conf-voi-serv)# sip
Device(conf-serv-sip)# midcall-signaling preserve-codec
```



CHAPTER 64

Early Dialog UPDATE Block

This feature enables CUBE to consume UPDATE requests with SDP, received during an early dialog. UPDATE requests are blocked at CUBE and are not passed through from one leg to the other leg.

If the UPDATE request contains changes in caller-ID, transcoder insertion or deletion, or video escalation or de-escalation, then, CUBE can renegotiate the capabilities by sending a DO invite after the call is established.

- [Feature Information for Early Dialog UPDATE Block, on page 859](#)
- [Prerequisites, on page 860](#)
- [Restrictions, on page 860](#)
- [Information about Early Dialog UPDATE Block, on page 860](#)
- [Configuring Early Dialog UPDATE Block, on page 861](#)
- [Configuring Early Dialog UPDATE Block Renegotiate, on page 862](#)
- [Troubleshooting Tips, on page 863](#)

Feature Information for Early Dialog UPDATE Block

The following table provides release information about the feature or features described in this module. This table lists only the software release that introduced support for a given feature in a given software release train. Unless noted otherwise, subsequent releases of that software release train also support that feature.

Use Cisco Feature Navigator to find information about platform support and Cisco software image support. To access Cisco Feature Navigator, go to <https://cfng.cisco.com/>. An account on Cisco.com is not required.

Table 85: Feature Information for Mid-call Signaling

Feature Name	Releases	Feature Information
Early Dialog UPDATE Block	Cisco IOS 15.5(3)M Cisco IOS XE 3.16S	This feature allows CUBE to consume the UPDATE requests with SDP received during an early dialog. The following command is introduced: early-media update block .

Prerequisites

- **rel1xx require "100rel"** command needs to be configured in global voice service voip sip configuration mode.

Restrictions

- Switch over to fax calls are not supported.
- Session Description Protocol (SDP) passthrough is not supported.
- Alternative Network Address Types (ANAT) is not supported.

Information about Early Dialog UPDATE Block

UPDATE request with SDP received during an early dialog is consumed by CUBE and hence is not passed from one leg to the other leg. This feature can be configured only for the UPDATE requests with SDP.

To pass through the information in UPDATE requests containing changes in caller-ID, transcoder insertion or deletion, or video escalation or de-escalation, CUBE can renegotiate the capabilities by sending a DO invite after the call is established. Thus both the user agents are synchronized and this helps in effective utilization of resources.

Renegotiation can be configured only for the UPDATE requests containing the following changes:

- Caller ID
- Transcoder insertion or deletion
- Video escalation or de-escalation

'Early Dialog UPDATE Block' and 'Early Dialog UPDATE Block Renegotiate' can be configured at dial peer level and also at global voice service voip sip configuration level.

Important Characteristics of Early Dialog UPDATE Block

The following are a few important characteristics of Early Dialog UPDATE block:

- If vcc codec is offered by the user agent through an UPDATE, first codec common between received and configured in in-leg at dial-peer is sent in 200OK.
- UPDATE request is consumed, if an UPDATE request with SDP is received after CUBE sends out 200 OK for an INVITE and before ACK is received.
- A 200 Ok is sent for an UPDATE even if there is no transcoder available ONLY for DTMF (rtp-nte to inband). CUBE falls back to inband.
- If Transcoder is unavailable, only the first codec received in the UPDATE request is sent in 200OK.
- CUBE sends 488 message if transcoder is required but unavailable for codec changes, SRTP-RTP inter-working, and transrating,

- When a video escalation is received via UPDATE, CUBE sends 200 OK with video port as ZERO. No Video RTP or DP sessions are created.
- When a video de-escalation is received via UPDATE, CUBE sends 200 ok with video port as ZERO. RTP or DP sessions for video are made as INACTIVE instead of deleting. So, effectively there will be four RTP connections or 2 DP connections present with remote video port as ZERO.
- Early-media UPDATE renegotiation takes precedence over DO-EO renegotiation.
- If an early dialog UPDATE is received from one leg to change the caller-ID and the other leg supports UPDATE method, CUBE sends across the caller-id UPDATE to other side and there wont be any renegotiation.
- If Re-Invite is received before triggering DO invite, then DO is not triggered.
- If **no update-callerid** command is enabled and UPDATE request contains only caller-ID changes, then re-negotiation does not happen for any early dialog caller-ID changes. If UPDATE request contains transcoder changes or video escalation or de-escalation, re-negotiation happens even if **no update-callerid** command is enabled.
- If mid-call signaling block is configured, DO invite is not triggered.

Configuring Early Dialog UPDATE Block

Configuring early dialog UPDATE Block enables CUBE to block all early dialog UPDATE requests from passing through to the user agents.

SUMMARY STEPS

1. **enable**
2. **configure terminal**
3. Enter one of the following commands to block early dialog UPDATE requests:
 - In the dial-peer configuration mode
voice-class sip early-media update block
 - In the global VoIP SIP configuration mode
early media update block
4. **end**

DETAILED STEPS

	Command or Action	Purpose
Step 1	enable	Enables privileged EXEC mode. <ul style="list-style-type: none"> • Enter your password if prompted.
Step 2	configure terminal	Enters global configuration mode.
Step 3	Enter one of the following commands to block early dialog UPDATE requests:	

	Command or Action	Purpose
	<ul style="list-style-type: none"> In the dial-peer configuration mode voice-class sip early-media update block In the global VoIP SIP configuration mode early media update block <p>Example: In dial-peer configuration mode</p> <pre>!Applying Early Dialog UPDATE block to one dial peer only Device (config)# dial-peer voice 10 voip Device (config-dial-peer)# voice-class sip early-media update block Device (config-dial-peer)# end</pre> <p>Example: In global VoIP SIP configuration mode</p> <pre>! Applying Early Dialog UPDATE block globally Device(config)# voice service voip Device (config-voi-serv)# sip Device (config-voi-sip)# early media update block Device (config-voi-sip)# end</pre>	
Step 4	end	Exits VoIP SIP configuration mode and enters privileged EXEC mode.

Configuring Early Dialog UPDATE Block Renegotiate

Configuring Early Dialog UPDATE Block Renegotiate enables CUBE to renegotiate the call if UPDATE request with SDP contains changes caller-ID, transcoder insertion or deletion, or video escalation or deletion. CUBE renegotiates by sending a DO invite after the call is established.

SUMMARY STEPS

- enable**
- configure terminal**
- Enter one of the following commands:
 - In the dial-peer configuration mode
voice-class sip early-media update block re-negotiate
 - In the global VoIP configuration mode
early media update block re-negotiate
- end**

DETAILED STEPS

	Command or Action	Purpose
Step 1	enable	Enables privileged EXEC mode. <ul style="list-style-type: none"> • Enter your password if prompted.
Step 2	configure terminal	Enters global configuration mode.
Step 3	<p>Enter one of the following commands:</p> <ul style="list-style-type: none"> • In the dial-peer configuration mode voice-class sip early-media update block re-negotiate • In the global VoIP configuration mode early media update block re-negotiate <p>Example: In dial-peer configuration mode</p> <pre>!Applying Early Dialog UPDATE block re-negotiate to one dial peer only Device (config)# dial-peer voice 10 voip Device (config-dial-peer)# voice-class sip early-media update block re-negotiate Device (config-dial-peer)# end</pre> <p>Example: In global VoIP SIP configuration mode</p> <pre>! Applying Early Dialog UPDATE block re-negotiate globally Device(config)# voice service voip Device (config-voi-serv)# sip Device (config-voi-sip)# early media update block re-negotiate Device (config-voi-sip)# end</pre>	Renegotiates the call if the UPDATE request contains changes in caller ID, transcoder addition or deletion, or video escalation or de-escalation.
Step 4	end	Exits VoIP SIP configuration mode and enters privileged EXEC mode.

Troubleshooting Tips

Use the following command for debugging information:

- **debug ccsip all**
- **debug voip ccapi inout**
- **show voip rtp connections**



CHAPTER 65

Consumption of Forked 18x Responses with SDP During Early Dialog

The Cisco Unified Border Element supports consumption of forked 18x responses with SDP, under certain conditions during an early dialog, to reduce the interoperability issues that arise due to signaling forking.

When CUBE receives forked 18x responses with SDP, the media negotiation by default is end-to-end. This means that CUBE has to send an UPDATE with SDP on the inbound leg to renegotiate the new media offer. Under certain conditions, the inbound leg may not be able to support sending UPDATE messages with SDP for media renegotiation. This results in CUBE consuming the forked 18x responses with SDP and may result in DSP resources being used for media interworking. Media parameters such as direction change, and call escalation or de-escalation is not propagated end-to-end. If required, these media changes can be renegotiated end-to-end, after the calls are connected, using a DO re-INVITE.

- [Feature Information for Consumption of Multiple Forked 18x Responses with SDP During Early Dialog, on page 865](#)
- [Prerequisites, on page 866](#)
- [Restrictions, on page 866](#)
- [Information About Consumption of Forked 18x Responses with SDP During Early Dialog, on page 866](#)
- [Configuring Consumption of Forked 18x Responses with SDP During Early Dialog, on page 867](#)
- [Configuring Consumption of Forked 18x Responses with SDP During Early Dialog Renegotiate, on page 868](#)
- [Troubleshooting Tips, on page 870](#)

Feature Information for Consumption of Multiple Forked 18x Responses with SDP During Early Dialog

The following table provides release information about the feature or features described in this module. This table lists only the software release that introduced support for a given feature in a given software release train. Unless noted otherwise, subsequent releases of that software release train also support that feature.

Use Cisco Feature Navigator to find information about platform support and Cisco software image support. To access Cisco Feature Navigator, go to <https://cfng.cisco.com/>. An account on Cisco.com is not required.

Table 86: Feature Information for Consumption of Multiple Forked 18x Responses with SDP During Early Dialog

Feature Name	Releases	Feature Information
Support for Forked 18x Responses with SDP during Early Dialog	Cisco IOS 15.6(3)M Cisco IOS XE Denali 16.3.1	This feature allows CUBE to consume multiple forked 18x responses with SDP received during an early dialog.

Prerequisites

- Re-negotiation is triggered only if the renegotiate **early media update block re-negotiate** CLI is enabled

Restrictions

The following features or call-flows are not supported:

- SIP Delayed-Offer to Delayed-Offer call flows
- Session Description Protocol (SDP) passthrough mode
- Secure Real-Time Transport Protocol (SRTP) passthrough calls
- Alternative Network Address Types (ANAT)
- Media flow-around
- Media anti-trombone
- Early-dialog UPDATE block

Information About Consumption of Forked 18x Responses with SDP During Early Dialog

Forked 18x responses for INVITE requests with SDP during early dialog will be consumed by CUBE to reduce interoperability issues between user agents.

Characteristics of Forked 18x Responses with SDP during Early Dialog

- If PRACK or UPDATE is not supported on the inbound leg, by default, CUBE consumes the forked 18x responses
- If PRACK or UPDATE is not supported and CUBE has to initiate renegotiation after call connect, then the **early media update block re-negotiate** CLI must be enabled
- When PRACK and UPDATE are supported on the inbound leg and CUBE has to consume the forked 18x responses, the **early media update block** CLI must be enabled

- If PRACK and UPDATE are supported and CUBE has to consume the forked 18x responses and initiate renegotiation after call connect, then the **early media update block renegotiate** CLI must be enabled
- If mid-call signaling block or mid-call signaling passthrough media changes are configured, DO invite is not triggered



Note CUBE utilizes the EARLY UPDATE BLOCK functionality to configure the forked 18x responses with SDP during early dialog. The **early media update block** command is used to consume the forked 18x responses and the **early media update block renegotiate** command is used to renegotiate the forked 18x responses after the call connect.

Renegotiation (when enabled via configuration) is triggered for the forked 18x responses containing the following changes:

- DSP Transcoder insertion
- Video escalation or de-escalation
- Media directional changes



Note It is recommended to configure the **early media update block re-negotiate** command whenever there are transcoding, DTMF interworking, or video changes.

Configuring Consumption of Forked 18x Responses with SDP During Early Dialog

Perform the following procedure to enable CUBE to block all early dialog forked 18x requests from passing through to the user agents.

SUMMARY STEPS

1. **enable**
2. **configure terminal**
3. Enter one of the following commands to block the forked 18x responses with SDP during early dialog:
 - In the dial-peer configuration mode
voice-class sip early-media update block
 - In the global VoIP SIP configuration mode
early media update block
4. **end**

DETAILED STEPS

	Command or Action	Purpose
Step 1	enable	Enables privileged EXEC mode. <ul style="list-style-type: none"> • Enter your password if prompted.
Step 2	configure terminal	Enters global configuration mode.
Step 3	<p>Enter one of the following commands to block the forked 18x responses with SDP during early dialog:</p> <ul style="list-style-type: none"> • In the dial-peer configuration mode voice-class sip early-media update block • In the global VoIP SIP configuration mode early media update block <p>Example: In dial-peer configuration mode</p> <pre>!Applying Early Dialog UPDATE block to one dial peer only Device (config)# dial-peer voice 10 voip Device (config-dial-peer)# voice-class sip early-media update block Device (config-dial-peer)# end</pre> <p>Example: In global VoIP SIP configuration mode</p> <pre>! Applying Early Dialog UPDATE block globally Device(config)# voice service voip Device (config-voi-serv)# sip Device (config-voi-sip)# early media update block Device (config-voi-sip)# end</pre>	
Step 4	end	Exits VoIP SIP configuration mode and enters privileged EXEC mode.

Configuring Consumption of Forked 18x Responses with SDP During Early Dialog Renegotiate

Perform the following procedure to enable CUBE to renegotiate forked 18x calls with SDP during early dialog after consumption of these forked 18x responses. CUBE renegotiates by sending a DO invite after the call is established.

SUMMARY STEPS

1. **enable**

2. **configure terminal**
3. Enter one of the following commands:
 - In the dial-peer configuration mode
 - voice-class sip early-media update block re-negotiate**
 - In the global VoIP configuration mode
 - early media update block re-negotiate**
4. **end**

DETAILED STEPS

	Command or Action	Purpose
Step 1	enable	Enables privileged EXEC mode. <ul style="list-style-type: none"> • Enter your password if prompted.
Step 2	configure terminal	Enters global configuration mode.
Step 3	<p>Enter one of the following commands:</p> <ul style="list-style-type: none"> • In the dial-peer configuration mode <ul style="list-style-type: none"> voice-class sip early-media update block re-negotiate • In the global VoIP configuration mode <ul style="list-style-type: none"> early media update block re-negotiate <p>Example: In dial-peer configuration mode</p> <pre>!Applying Early Dialog UPDATE block re-negotiate to one dial peer only Device (config)# dial-peer voice 10 voip Device (config-dial-peer)# voice-class sip early-media update block re-negotiate Device (config-dial-peer)# end</pre> <p>Example: In global VoIP SIP configuration mode</p> <pre>! Applying Early Dialog UPDATE block re-negotiate globally Device(config)# voice service voip Device (config-voi-serv)# sip Device (config-voi-sip)# early media update block re-negotiate Device (config-voi-sip)# end</pre>	Renegotiates the call if the forked 18x responses with SDP during early dialog contains changes in transcoder addition, or video escalation or de-escalation.
Step 4	end	Exits VoIP SIP configuration mode and enters privileged EXEC mode.

Troubleshooting Tips

Use the following command for debugging information:

- debug ccsip verbose
- show voip rtp connections detail
- show call active voice brief
- show dspfarm dsp active
- show voice dsmp stream brief
- show platform hardware qfp active feature sbc global

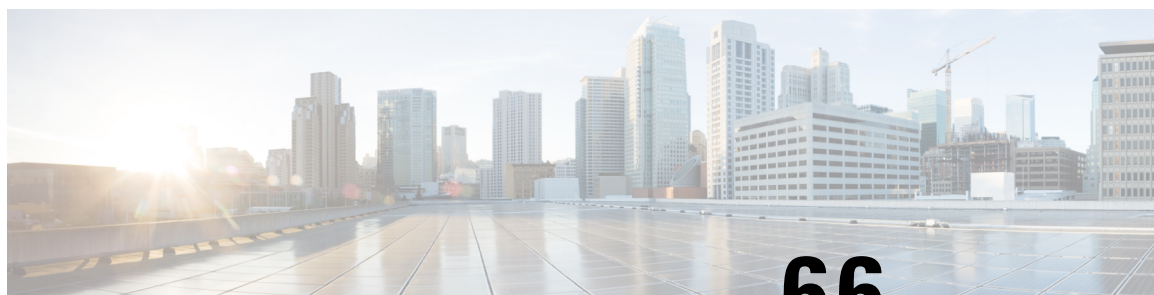

CHAPTER 66

Support for Pass-Through of Unsupported Content Types in SIP INFO Messages

This feature allows the CUBE to pass-through all unsupported content types in a SIP INFO message.

- [Feature Information, on page 871](#)
- [Configure SIP INFO Message with Unsupported Content Type, on page 871](#)
- [Information About Pass-Through of Unsupported Content Types in SIP INFO Messages, on page 872](#)

Feature Information

The following table provides release information about the feature or features described in this module. This table lists only the software release that introduced support for a given feature in a given software release train. Unless noted otherwise, subsequent releases of that software release train also support that feature.

Use Cisco Feature Navigator to find information about platform support and Cisco software image support. To access Cisco Feature Navigator, go to <https://cfng.cisco.com/>. An account on Cisco.com is not required.

Feature Name	Releases	Feature Information
Support for pass-through of unsupported content types in SIP INFO messages	Cisco IOS 15.5(3)M Cisco IOS XE 3.16S	This feature allows CUBE to pass-through SIP INFO methods or request message types with unsupported content types. Media negotiation and media exchange is completely end-to-end.

Configure SIP INFO Message with Unsupported Content Type

You must enable the **pass-thru content unsupp** command to pass-through all unsupported content types in a SIP INFO message. There is no additional configuration task required for this feature.

Information About Pass-Through of Unsupported Content Types in SIP INFO Messages

The Support for Pass-Through of Unsupported Content Types in SIP INFO Messages feature allows the CUBE to pass-through all unsupported content types in a SIP INFO message.

Upon receipt of a SIP INFO message with unsupported content type, CUBE triggers a SIP INFO message on the outgoing peer call leg. The response received for this SIP INFO message is triggered on the incoming peer call leg and information flows end-to-end. Prior to releases 15.5(3)M and 3.16S, on reception of SIP INFO message with unsupported content type, CUBE will respond with the “415 Unsupported Media Type” error response.

Supported content types include the following:

- application/sdp
- application/qsig
- application/media-control+xml
- application/x-q931
- application/gtd
- application/simple-message-summary
- application/kpml-response+xml
- application/dtmf-relay
- application/broadsoft
- message/sipfrag
- audio/telephone-event
- multipart/mixed
- application/x-cisco-record+json



CHAPTER 67

Support for PAID PPID Privacy PCPID and PAURI Headers on the Cisco Unified Border Element

The figure below shows a typical network topology where the Cisco Unified Border Element is configured to route messages between a call manager system (such as the Cisco Unified Call Manager) and a Next Generation Network (NGN).

Figure 85: Cisco Unified Border Element and Next Generation Topology

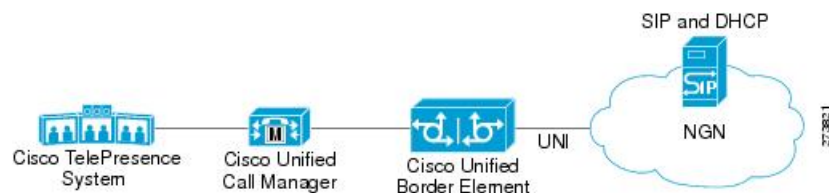

Devices that connect to an NGN must comply with the User-Network Interface (UNI) specification. The Cisco Unified Border Element supports the NGN UNI specification and can be configured to interconnect NGN with other call manager systems, such as the Cisco Unified Call Manager.

The Cisco Unified Border Element supports the following:

- the use of P-Preferred Identity (PPID), P-Asserted Identity (PAID), Privacy, P-Called Party Identity (PCPID), in INVITE messages
- the translation of PAID headers to PPID headers and vice versa
- the translation of RPID headers to PAID or PPID headers and vice versa
- the configuration and/or pass through of privacy header values
- the use of the PCPID header to route INVITE messages
- the use of multiple PAURI headers in the response messages (200 OK) it receives to REGISTER messages

P-Preferred Identity and P-Asserted Identity Headers

NGN servers use the PPID header to identify the preferred number that the caller wants to use. The PPID is part of INVITE messages sent to the NGN. When the NGN receives the PPID, it authorizes the value, generates a PAID based on the preferred number, and inserts it into the outgoing INVITE message towards the called party.

However, some call manager systems, such as Cisco Unified Call Manager 5.0, use the Remote-Party Identity (RPID) value to send calling party information. Therefore, the Cisco Unified Border Element must support building the PPID value for an outgoing INVITE message to the NGN, using the RPID value or the From: value received in the incoming INVITE message. Similarly, CUBE supports building the RPID and/or From: header values for an outgoing INVITE message to the call manager, using the PAID value received in the incoming INVITE message from the NGN.

In non-NGN systems, the Cisco Unified Border Element can be configured to translate between PPID and PAID values, and between From: or RPID values and PAID/PPID values, at global and dial-peer levels.

In configurations where all relevant servers support the PPID or PAID headers, the Cisco Unified Border Element can be configured to transparently pass the header.



Note If the NGN sets the From: value to anonymous, the PAID is the only value that identifies the caller.

The table below describes the types of INVITE message header translations supported by the Cisco Unified Border Element. It also includes information on the configuration commands to use to configure P-header translations.

The table below shows the P-header translation configuration settings only. In addition to configuring these settings, you must configure other system settings (such as the session protocol).

Table 87: P-header Configuration Settings

Incoming Header	Outgoing Header	Configuration Notes
From:	RPID	To enable the translation to RPID headers in the outgoing header, use the remote-party-id command in SIP user-agent configuration mode. For example: Router(config-sip-ua)# remote-party-id This is the default system behavior. Note If both, remote-party-id and asserted-id commands are configured, then the asserted-id command takes precedence over the remote-part-id command.
PPID	PAID	To enable the translation to PAID privacy headers in the outgoing header at a global level, use the asserted-id pai command in voice service VoIP SIP configuration mode. For example: Router(conf-serv-sip)# asserted-id pai To enable the translation to PAID privacy headers in the outgoing header on a specific dial peer, use the voice-class sip asserted-id pai command in dial peer voice configuration mode. For example: Router(config-dial-peer)# voice-class sip asserted-id pai
PPID	RPID	To enable the translation to RPID headers in the outgoing header, use the remote-party-id command in SIP user-agent configuration mode. For example: Router(config-sip-ua)# remote-party-id This is the default system behavior.

Incoming Header	Outgoing Header	Configuration Notes
PAID	PPID	<p>To enable the translation to PPID privacy headers in the outgoing header at a global level, use the asserted-id ppi command in voice service VoIP SIP configuration mode. For example: Router(conf-serv-sip)# asserted-id ppi</p> <p>To enable the translation to PPID privacy headers in the outgoing header on a specific dial peer, use the voice-class sip asserted-id ppi command in dial peer voice configuration mode. For example: Router(config-dial-peer)# voice-class sip asserted-id ppi</p>
PAID	RPID	<p>To enable the translation to RPID headers in the outgoing header, use the remote-party-id command in SIP user-agent configuration mode. For example: Router(config-sip-ua)# remote-party-id</p> <p>This is the default system behavior.</p>
RPID	PPID	<p>To enable the translation to PPID privacy headers in the outgoing header at a global level, use the asserted-id ppi command in voice service VoIP SIP configuration mode. For example: Router(conf-serv-sip)# asserted-id ppi</p> <p>To enable the translation to PPID privacy headers in the outgoing header on a specific dial peer, use the voice-class sip asserted-id ppi command in dial peer voice configuration mode. For example: Router(config-dial-peer)# voice-class sip asserted-id ppi</p>
RPID	PAID	<p>To enable the translation to PAID privacy headers in the outgoing header at a global level, use the asserted-id pai command in voice service VoIP SIP configuration mode. For example: Router(conf-serv-sip)# asserted-id pai</p> <p>To enable the translation to PAID privacy headers in the outgoing header on a specific dial peer, use the voice-class sip asserted-id pai command in dial peer voice configuration mode. For example: Router(config-dial-peer)# voice-class sip asserted-id pai</p>
RPID	From:	<p>By default, the translation to RPID headers is enabled and the system translates PPID headers in incoming messages to RPID headers in the outgoing messages. To disable the default behavior and enable the translation from PPID to From: headers, use the no remote-party-id command in SIP user-agent configuration mode. For example: Router(config-sip-ua)# no remote-party-id</p>



Note Privacy functions are not initialized on Unified Border Element without configuring **asserted-id pai** or **asserted-id ppi**. Ensure that you configure **asserted-id pai** or **asserted-id ppi** to support privacy functions on Unified Border Element.

The CUBE can be configured to transparently pass the PAID and PPID headers in the incoming and outgoing Session Initiation Protocol (SIP) requests or response messages from end-to-end.

- Requests include: INVITEs and UPDATEs
- Responses include: 18x and 200OK



Note The priority of P-headers are in the following order: PAID, PPID, and RPID.

Table 88: PAID and PPID header configuration settings for mid-call requests and responses

Incoming Header	Outgoing Header	Configuration Notes
PAID	PPID	<p>To enable the translation to PPID headers in the outgoing header at a global level, use the asserted-id ppi command in voice service VoIP SIP configuration mode. For example: Router(conf-serv-sip)# asserted-id ppi</p> <p>To enable the translation to PPID headers in the outgoing header on a specific dial peer, use the voice-class sip asserted-id ppi command in dial peer voice configuration mode. For example: Router(config-dial-peer)# voice-class sip asserted-id ppi</p>
RPID	PPID	<p>To enable the translation to PPID headers in the outgoing header at a global level, use the asserted-id ppi command in voice service VoIP SIP configuration mode. For example: Router(conf-serv-sip)# asserted-id ppi</p> <p>To enable the translation to PPID headers in the outgoing header on a specific dial peer, use the voice-class sip asserted-id ppi command in dial peer voice configuration mode. For example: Router(config-dial-peer)# voice-class sip asserted-id ppi</p>

Incoming Header	Outgoing Header	Configuration Notes
PPID	PPID	<p>To enable the translation to PPID headers in the outgoing header at a global level, use the asserted-id ppi command in voice service VoIP SIP configuration mode.</p> <p>To enable the translation to PPID headers in the outgoing header on a specific dial peer, use the voice-class sip asserted-id ppi command in dial peer voice configuration mode. For example: Router(config-dial-peer)# voice-class sip asserted-id ppi</p>
PAID	PAID	<p>To enable the translation to PAID headers in the outgoing header at a global level, use the asserted-id pai command in voice service VoIP SIP configuration mode.</p> <p>To enable the translation to PAID headers in the outgoing header on a specific dial peer, use the voice-class sip asserted-id pai command in dial peer voice configuration mode. For example: Router(config-dial-peer)# voice-class sip asserted-id pai</p>
RPID	PAID	<p>To enable the translation to PAID headers in the outgoing header at a global level, use the asserted-id pai command in voice service VoIP SIP configuration mode.</p> <p>To enable the translation to PAID headers in the outgoing header on a specific dial peer, use the voice-class sip asserted-id pai command in dial peer voice configuration mode.</p>

Incoming Header	Outgoing Header	Configuration Notes
PPID	PAID	<p>To enable the translation to PAID headers in the outgoing header at a global level, use the asserted-id pai command in voice service VoIP SIP configuration mode.</p> <p>To enable the translation to PAID headers in the outgoing header on a specific dial peer, use the voice-class sip asserted-id pai command in dial peer voice configuration mode.</p>
PAID	RPID	<p>To enable the translation to RPID headers in the outgoing header, use the remote-party-id command in SIP user-agent configuration mode. For example:</p> <pre>Router(config-sip-ua)# remote-party-id.</pre> <p>Note PAID and PPID headers are not configured in this case.</p>
RPID	RPID	<p>To enable the translation to RPID headers in the outgoing header, use the remote-party-id command in SIP user-agent configuration mode. For example:</p> <pre>Router(config-sip-ua)# remote-party-id.</pre> <p>Note PAID and PPID headers are not configured in this case.</p>
PPID	RPID	<p>To enable the translation to RPID headers in the outgoing header, use the remote-party-id command in SIP user-agent configuration mode. For example:</p> <pre>Router(config-sip-ua)# remote-party-id</pre>
FROM	FROM	No configuration required except for the remote-party-id header.

Incoming Header	Outgoing Header	Configuration Notes
FROM	RPID	To enable the translation to RPID headers in the outgoing header, use the remote-party-id command in SIP user-agent configuration mode. For example: Router(config-sip-ua)# remote-party-id
PAID	PAID	Enables PPID headers on the incoming dial-peer and PAID headers on the outgoing dial-peer.
RPID	PAID	Enables PPID headers on incoming dial-peer and PAID headers on outgoing dial-peer.
PPID	PAID	Enables PPID headers on incoming dial-peer and PAID headers on outgoing dial-peer.
PAID	PAID	Enables RPID headers on incoming dial-peer and PAID headers on outgoing dial-peer.
RPID	PAID	Enables RPID headers on incoming dial-peer and PAID headers on outgoing dial-peer.
PPID	PAID	Enables RPID headers on incoming dial-peer and PAID headers on outgoing dial-peer.
PAID	PPID	Enables PAID headers on incoming dial-peer and PPID headers on outgoing dial-peer.
RPID	PPID	Enables PAID headers on incoming dial-peer and PPID headers on outgoing dial-peer.
PPID	PPID	Enables PAID headers on incoming dial-peer and PPID on outgoing dial-peer.
PAID	PPID	Enables RPID headers on incoming dial-peer and PPID headers on outgoing dial-peer.
RPID	PPID	Enables RPID headers on incoming dial-peer and PPID headers on outgoing dial-peer.

Incoming Header	Outgoing Header	Configuration Notes
PPID	RPID	Enables RPID headers on incoming dial-peer and PPID headers on outgoing dial-peer.
PAID	RPID	Enables PPID headers on incoming dial-peer and RPID headers on outgoing dial-peer. Note PAID headers will be given priority and RPID headers will be created using the PAID header information.
RPID	RPID	Enables PPID headers on incoming dial-peer and RPID headers on outgoing dial-peer.
PPID	RPID	Enables PPID headers on incoming dial-peer and RPID headers on outgoing dial-peer. Note PPID headers will be given priority and RPID headers will be created using the PPID header information.
PAID	RPID	Enables PAID headers on incoming dial-peer and RPID headers on outgoing dial-peer. Note PAID headers will be given priority and RPID headers will be created using the PAID header information.
RPID	RPID	Enables PAID headers on incoming dial-peer and RPID headers on outgoing dial-peer.
PPID	RPID	Enables PAID headers on incoming dial-peer and RPID headers on outgoing dial-peer. Note PPID headers will be given priority and RPID headers will be created using the PPID header information.

Privacy

If the user is subscribed to a privacy service, the Cisco Unified Border Element can support privacy using one of the following methods:

- Using prefixes

The NGN dial plan can specify prefixes to enable privacy settings. For example, the dial plan may specify that if the caller dials a prefix of 184, the calling number is not sent to the called party.

The dial plan may also specify that the caller can choose to send the calling number to the called party by dialing a prefix of 186. Here, the Cisco Unified Border Element transparently passes the prefix as part of the called number in the INVITE message.

The actual prefixes for the network are specified in the dial plan for the NGN, and can vary from one NGN to another.

- Using the Privacy header

If the Privacy header is set to None, the calling number is delivered to the called party. If the Privacy header is set to a Privacy:id value, the calling number is not delivered to the called party.

- Using Privacy values from the peer call leg

If the incoming INVITE has a Privacy header or a RPID with privacy on, the outgoing INVITE can be set to Privacy: id. This behavior is enabled by configuring **privacy pstn** command globally or **voice-class sip privacy pstn** command on the selected dial-peer.

Incoming INVITE can have multiple privacy header values, id, user, session, and so on. Configure the **privacy-policy passthru** command globally or **voice-class sip privacy-policy passthru** command to transparently pass across these multiple privacy header values.

Some NGN servers require a Privacy header to be sent even though privacy is not required. In this case the Privacy header must be set to none. The Cisco Unified Border Element can add a privacy header with the value None while forwarding the outgoing INVITE to NGN. Configure the **privacy-policy send-always** globally or **voice-class sip privacy-policy send-always** command in dial-peer to enable this behavior.

If the user is not subscribed to a privacy service, the Cisco Unified Border Element can be configured with no Privacy settings.



Note For the Privacy functions to work as intended, the command **asserted-id {pai|ppi}** must be configured.

P-Called Party Identity

The Cisco Unified Border Element can be configured to use the PCPID header in an incoming INVITE message to route the call, and to use the PCPID value to set the To: value of outgoing INVITE messages.

The PCPID header is part of the INVITE messages sent by the NGN, and is used by Third Generation Partnership Project (3GPP) networks. The Cisco Unified Border Element uses the PCPID from incoming INVITE messages (from the NGN) to route calls to the Cisco Unified Call Manager.



Note The PCPID header supports the use of E.164 numbers only.

P-Associated URI

The Cisco Unified Border Element supports the use of PAURI headers sent as part of the registration process. After the Cisco Unified Border Element sends REGISTER messages using the configured E.164 number, it receives a 200 OK message with one or more PAURIs. The number in the first PAURI (if present) must match the contract number. The Cisco Unified Border Element supports a maximum of six PAURIs for each registration.



Note The Cisco Unified Border Element performs the validation process only when a PAURI is present in the 200 OK response.

The registration validation process works as follows:

- The Cisco Unified Border Element receives a REGISTER response message that includes PAURI headers that include the contract number and up to five secondary numbers.
- The Cisco Unified Border Element validates the contract number against the E.164 number that it is registering:
 - If the values match, the Cisco Unified Border Element completes the registration process and stores the PAURI value. This allows administration tools to view or retrieve the PAURI if needed.
 - If the values do not match, the Cisco Unified Border Element unregisters and then reregisters the contract number. The Cisco Unified Border Element performs this step until the values match.

Random Contact Support

The Cisco Unified Border Element can use random-contact information in REGISTER and INVITE messages so that user information is not revealed in the contact header.

To provide random contact support, the Cisco Unified Border Element performs SIP registration based on the random-contact value. The Cisco Unified Border Element then populates outgoing INVITE requests with the random-contact value and validates the association between the called number and the random value in the Request-URI of the incoming INVITE. The Cisco Unified Border Element routes calls based on the PCPID, instead of the Request-URI which contains the random value used in contact header of the REGISTER message.

The default contact header in REGISTER messages is the calling number. The Cisco Unified Border Element can generate a string of 32 random alphanumeric characters to replace the calling number in the REGISTER contact header. A different random character string is generated for each pilot or contract number being registered. All subsequent registration requests will use the same random character string.

The Cisco Unified Border Element uses the random character string in the contact header for INVITE messages that it forwards to the NGN. The NGN sends INVITE messages to the Cisco Unified Border Element with random-contact information in the Request URI. For example: INVITE sip:FefhH3ziHe9i8ImcGjDD1PEc5XfFy51G@10.12.1.46:5060.

The Cisco Unified Border Element will not use the To: value of the incoming INVITE message to route the call because it might not identify the correct user agent if supplementary services are invoked. Therefore, the Cisco Unified Border Element must use the PCPID to route the call to the Cisco Unified Call Manager. You can configure routing based on the PCPID at global and dial-peer levels.

- [Feature Information for PAID PPID Privacy PCPID and PAURI Headers on the Cisco Unified Border Element, on page 883](#)

- Prerequisites for Support for PAID PPID Privacy PCPID and PAURI Headers on the Cisco Unified Border Element, on page 884
- Restrictions for Support for PAID PPID Privacy PCPID and PAURI Headers on the Cisco Unified Border Element, on page 885
- Configuring P-Header and Random-Contact Support on the Cisco Unified Border Element, on page 885

Feature Information for PAID PPID Privacy PCPID and PAURI Headers on the Cisco Unified Border Element

The following table provides release information about the feature or features described in this module. This table lists only the software release that introduced support for a given feature in a given software release train. Unless noted otherwise, subsequent releases of that software release train also support that feature.

Use Cisco Feature Navigator to find information about platform support and Cisco software image support. To access Cisco Feature Navigator, go to <https://cfng.cisco.com/>. An account on Cisco.com is not required.

Table 89: Feature Information for PAID and PPID Headers on Cisco Unified Border Element (CUBE)

Feature Name	Releases	Feature Information
PAID and PPID Headers in mid-call re-INVITE and UPDATE request and responses on Cisco Unified Border Element	Cisco IOS 15.5(3)M Cisco IOS XE 3.16S	This feature enables CUBE platforms to support: <ul style="list-style-type: none"> • P-Preferred Identity (PPID) and P-Asserted Identity (PAID) in mid-call re-INVITE messages and responses from end-to-end. • P-Preferred Identity (PPID) and P-Asserted Identity (PAID) in mid-call UPDATE messages and responses from end-to-end. • Configuration and/or pass through of PAID and PPID header values.

Feature History Table entry for the Cisco Unified Border Element and Cisco Unified Border Element (Enterprise).

Table 90: Feature Information for PAID, PPID, Privacy, PCPID, and PAURI Headers on CUBE

Feature Name	Releases	Feature Information
PAID, PPID, Privacy, PCPID, and PAURI Headers on the Cisco Unified Border Element	12.4(22)YB 15.0(1)M Cisco IOS XE Release 3.1S	<p>This feature enables CUBE platforms to support:</p> <ul style="list-style-type: none"> • P-Preferred Identity (PPID), P-Asserted Identity (PAID), Privacy, P-Called Party Identity (PCPID), in INVITE messages • Translation of PAID headers to PPID headers and vice versa • Translation of From: or RPID headers to PAID or PPID headers and vice versa • Configuration and/or pass through of privacy header values • PCPID header to route INVITE messages • Multiple PAURI headers in the response messages (200 OK) it receives to REGISTER messages • P-Preferred Identity and P-Asserted Identity Headers <p>The following commands were introduced: call-route p-called-party-id, privacy-policy, random-contact, random-request-uri validate, voice-class sip call-route p-called-party-id, voice-class sip privacy-policy, voice-class sip random-contact, and voice-class sip random-request-uri validate.</p>

Prerequisites for Support for PAID PPID Privacy PCPID and PAURI Headers on the Cisco Unified Border Element

Cisco Unified Border Element

- Cisco IOS Release 12.4(22)YB or a later release must be installed and running on your Cisco Unified Border Element.

Cisco Unified Border Element (Enterprise)

- Cisco IOS XE Release 3.1S or a later release must be installed and running on your Cisco ASR 1000 Series Router.

Restrictions for Support for PAID PPID Privacy PCPID and PAURI Headers on the Cisco Unified Border Element

- To enable random-contact support, you must configure the Cisco Unified Border Element to support SIP registration with random-contact information. In addition, you must configure random-contact support in VoIP voice-service configuration mode or on the dial peer.
- If random-contact support is configured for SIP registration only, the system generates the random-contact information, includes it in the SIP REGISTER message, but does not include it in the SIP INVITE message.
- If random-contact support is configured in VoIP voice-service configuration mode or on the dial peer only, no random contact is sent in either the SIP REGISTER or INVITE message.
- Passing of "+" is not supported with PAID PPID Privacy PCPID and PAURI Headers.

Configuring P-Header and Random-Contact Support on the Cisco Unified Border Element

To enable random contact support you must configure the Cisco Unified Border Element to support Session Initiation Protocol (SIP) registration with random-contact information, as described in this section.

To enable the Cisco Unified Border Element to use the PCPID header in an incoming INVITE message to route the call, and to use the PCPID value to set the To: value of outgoing INVITE messages, you must configure P-Header support as described in this section.

Configuring P-Header Translation on a Cisco Unified Border Element

To configure P-Header translations on a Cisco Unified Border Element, perform the steps in this section.

SUMMARY STEPS

1. **enable**
2. **configure terminal**
3. **voice service voip**
4. **sip**
5. **asserted-id *header-type***
6. **exit**

DETAILED STEPS

	Command or Action	Purpose
Step 1	enable Example:	Enables privileged EXEC mode. <ul style="list-style-type: none"> • Enter your password if prompted.

	Command or Action	Purpose
	Router> enable	
Step 2	configure terminal Example: Router# configure terminal	Enters global configuration mode.
Step 3	voice service voip Example: Router(config)# voice service voip	Enters VoIP voice-service configuration mode.
Step 4	sip Example: Router(conf-voi-serv)# sip	Enters voice service VoIP SIP configuration mode.
Step 5	asserted-id <i>header-type</i> Example: Router(conf-serv-sip)# asserted-id ppi	Specifies the type of privacy header in the outgoing SIP requests and response messages.
Step 6	exit Example: Router(conf-serv-sip)# exit	Exits the current mode.

Configuring P-Header Translation on an Individual Dial Peer

To configure P-Header translation on an individual dial peer, perform the steps in this section.

SUMMARY STEPS

1. enable
2. configure terminal
3. dial-peer voice *tag* voip
4. voice-class sip asserted-id *header-type*
5. exit

DETAILED STEPS

	Command or Action	Purpose
Step 1	enable Example:	Enables privileged EXEC mode. <ul style="list-style-type: none"> • Enter your password if prompted.

	Command or Action	Purpose
	<code>Router> enable</code>	
Step 2	configure terminal Example: <code>Router# configure terminal</code>	Enters global configuration mode.
Step 3	dial-peer voice tag voip Example: <code>Router(config)# dial-peer voice 2611 voip</code>	Defines the dial peer, specifies the method of voice encapsulation, and enters dial peer voice configuration mode.
Step 4	voice-class sip asserted-id header-type Example: <code>Router(config-dial-peer)# voice-class sip asserted-id ppi</code>	Specifies the type of privacy header in the outgoing SIP requests and response messages, on this dial peer.
Step 5	exit Example: <code>Router(config-dial-peer)# exit</code>	Exits the current mode.

Configuring P-Called-Party-Id Support on a Cisco Unified Border Element

To configure P-Called-Party-Id support on a Cisco Unified Border Element, perform the steps in this section.

SUMMARY STEPS

1. `enable`
2. `configure terminal`
3. `voice service voip`
4. `sip`
5. `call-route p-called-party-id`
6. `random-request-uri validate`
7. `exit`

DETAILED STEPS

	Command or Action	Purpose
Step 1	enable Example: <code>Router> enable</code>	Enables privileged EXEC mode. <ul style="list-style-type: none"> • Enter your password if prompted.

	Command or Action	Purpose
Step 2	configure terminal Example: Router# configure terminal	Enters global configuration mode.
Step 3	voice service voip Example: Router(config)# voice service voip	Enters VoIP voice-service configuration mode.
Step 4	sip Example: Router(conf-voi-serv)# sip	Enters voice service VoIP SIP configuration mode.
Step 5	call-route p-called-party-id Example: Router(conf-serv-sip)# call-route p-called-party-id	Enables the routing of calls based on the PCPID header.
Step 6	random-request-uri validate Example: Router(conf-serv-sip)# random-request-uri validate	Enables the validation of the random string in the Request URI of the incoming INVITE message.
Step 7	exit Example: Router(conf-serv-sip)# exit	Exits the current mode.

Configuring P-Called-Party-Id Support on an Individual Dial Peer

To configure P-Called-Party-Id support on an individual dial peer, perform the steps in this section.

SUMMARY STEPS

1. enable
2. configure terminal
3. dial-peer voice *tag* voip
4. voice-class sip call-route p-called-party-id
5. voice-class sip random-request-uri validate
6. exit

DETAILED STEPS

	Command or Action	Purpose
Step 1	enable Example: Router> enable	Enables privileged EXEC mode. • Enter your password if prompted.
Step 2	configure terminal Example: Router# configure terminal	Enters global configuration mode.
Step 3	dial-peer voice tag voip Example: Router(config)# dial-peer voice 2611 voip	Defines the dial peer, specifies the method of voice encapsulation, and enters dial peer voice configuration mode.
Step 4	voice-class sip call-route p-called-party-id Example: Router(config-dial-peer)# voice-class sip call-route p-called-party-id	Enables the routing of calls based on the PCPID header on this dial peer.
Step 5	voice-class sip random-request-uri validate Example: Router(config-dial-peer)# voice-class sip random-request-uri validate	Enables the validation of the random string in the Request URI of the incoming INVITE message on this dial peer.
Step 6	exit Example: Router(config-dial-peer)# exit	Exits the current mode.

Configuring Privacy Support on a Cisco Unified Border Element

To configure privacy support on a Cisco Unified Border Element, perform the steps in this section.

SUMMARY STEPS

1. **enable**
2. **configure terminal**
3. **voice service voip**
4. **sip**
5. **privacy *privacy-option***
6. **privacy-policy *privacy-policy-option***
7. **exit**

DETAILED STEPS

	Command or Action	Purpose
Step 1	enable Example: Router> enable	Enables privileged EXEC mode. <ul style="list-style-type: none"> • Enter your password if prompted.
Step 2	configure terminal Example: Router# configure terminal	Enters global configuration mode.
Step 3	voice service voip Example: Router(config)# voice service voip	Enters VoIP voice-service configuration mode.
Step 4	sip Example: Router(conf-voi-serv)# sip	Enters voice service VoIP SIP configuration mode.
Step 5	privacy <i>privacy-option</i> Example: Router(conf-serv-sip)# privacy id	Enables the privacy settings for the header.
Step 6	privacy-policy <i>privacy-policy-option</i> Example: Router(conf-serv-sip)# privacy-policy passthru	Specifies the privacy policy to use when passing the privacy header from one SIP leg to the next.
Step 7	exit Example: Router(conf-serv-sip)# exit	Exits the current mode.

Configuring Privacy Support on an Individual Dial Peer

To configure privacy support on an individual dial peer, perform the steps in this section.

SUMMARY STEPS

1. **enable**
2. **configure terminal**
3. **dial-peer voice *tag* voip**
4. **voice-class sip privacy *privacy-option***

5. **voice-class sip privacy-policy** *privacy-policy-option*
6. **exit**

DETAILED STEPS

	Command or Action	Purpose
Step 1	enable Example: Router> enable	Enables privileged EXEC mode. <ul style="list-style-type: none"> • Enter your password if prompted.
Step 2	configure terminal Example: Router# configure terminal	Enters global configuration mode.
Step 3	dial-peer voice tag voip Example: Router(config)# dial-peer voice 2611 voip	Defines the dial peer, specifies the method of voice encapsulation, and enters dial peer voice configuration mode.
Step 4	voice-class sip privacy privacy-option Example: Router(config-dial-peer)# voice-class sip privacy id	Enables the privacy settings for the header on this dial peer.
Step 5	voice-class sip privacy-policy privacy-policy-option Example: Router(config-dial-peer)# voice-class sip privacy-policy passthru	Specifies the privacy policy to use when passing the privacy header from one SIP leg to the next, on this dial peer.
Step 6	exit Example: Router(config-dial-peer)# exit	Exits the current mode.

Configuring Random-Contact Support on a Cisco Unified Border Element

To configure random-contact support on a Cisco Unified Border Element, perform the steps in this section.

SUMMARY STEPS

1. **enable**
2. **configure terminal**
3. **sip-ua**
4. **credentials username username password password realm domain-name**

5. **registrar ipv4:** *destination-address* **random-contact expires** *expiry*
6. **exit**
7. **voice service voip**
8. **sip**
9. **random-contact**
10. **exit**

DETAILED STEPS

	Command or Action	Purpose
Step 1	enable Example: <pre>Router> enable</pre>	Enables privileged EXEC mode. <ul style="list-style-type: none"> • Enter your password if prompted.
Step 2	configure terminal Example: <pre>Router# configure terminal</pre>	Enters global configuration mode.
Step 3	sip-ua Example: <pre>Router(config)# sip-ua</pre>	Enters SIP user-agent configuration mode.
Step 4	credentials username <i>username</i> password <i>password</i> realm <i>domain-name</i> Example: <pre>Router(config-sip-ua)# credentials username 123456 password cisco realm cisco</pre>	Sends a SIP registration message from the Cisco Unified Border Element.
Step 5	registrar ipv4: <i>destination-address</i> random-contact expires <i>expiry</i> Example: <pre>Router(config-sip-ua)# registrar ipv4:10.1.2.2 random-contact expires 200</pre>	Enables the SIP gateways to register E.164 numbers on behalf of analog telephone voice ports (FXS), IP phone virtual voice ports (EFXS), and Skinny Client Control Protocol (SCCP) phones with an external SIP proxy or SIP registrar. <ul style="list-style-type: none"> • The random-contact keyword configures the Cisco Unified Border Element to send the random string from the REGISTER message to the registrar.
Step 6	exit Example: <pre>Router(config-sip-ua)# exit</pre>	Exits the current mode.
Step 7	voice service voip Example:	Enters VoIP voice-service configuration mode.

	Command or Action	Purpose
	<code>Router(config)# voice service voip</code>	
Step 8	sip Example: <code>Router(conf-voi-serv)# sip</code>	Enters voice service VoIP SIP configuration mode.
Step 9	random-contact Example: <code>Router(conf-serv-sip)# random-contact</code>	Enables random-contact support on a Cisco Unified Border Element.
Step 10	exit Example: <code>Router(conf-serv-sip)# exit</code>	Exits the current mode.

Configuring Random-Contact Support for an Individual Dial Peer

To configure random-contact support for an individual dial peer, perform the steps in this section.

SUMMARY STEPS

1. **enable**
2. **configure terminal**
3. **sip-ua**
4. **credentials username *username* password *password* realm *domain-name***
5. **registrar ipv4: *destination-address* random-contact expires *expiry***
6. **exit**
7. **dial-peer voice *tag* voip**
8. **voice-class sip random-contact**
9. **exit**

DETAILED STEPS

	Command or Action	Purpose
Step 1	enable Example: <code>Router> enable</code>	Enables privileged EXEC mode. • Enter your password if prompted.
Step 2	configure terminal Example: <code>Router# configure terminal</code>	Enters global configuration mode.

	Command or Action	Purpose
Step 3	sip-ua Example: <pre>Router(config)# sip-ua</pre>	Enters SIP user-agent configuration mode.
Step 4	credentials username <i>username</i> password <i>password</i> realm <i>domain-name</i> Example: <pre>Router(config-sip-ua)# credentials username 123456 password cisco realm cisco</pre>	Sends a SIP registration message from the Cisco Unified Border Element.
Step 5	registrar ipv4: <i>destination-address</i> random-contact expires <i>expiry</i> Example: <pre>Router(config-sip-ua)# registrar ipv4:10.1.2.2 random-contact expires 200</pre>	Enables the SIP gateways to register E.164 numbers on behalf of FXS, EFXS, and SCCP phones with an external SIP proxy or SIP registrar. <ul style="list-style-type: none"> The random-contact keyword configures the Cisco Unified Border Element to send the random string from the REGISTER message to the registrar.
Step 6	exit Example: <pre>Router(config-sip-ua)# exit</pre>	Exits the current mode.
Step 7	dial-peer voice <i>tag</i> voip Example: <pre>Router(config)# dial-peer voice 2611 voip</pre>	Defines the dial peer, specifies the method of voice encapsulation, and enters dial peer voice configuration mode.
Step 8	voice-class sip random-contact Example: <pre>Router(config-dial-peer)# voice-class sip random-contact</pre>	Enables random-contact support on this dial peer.
Step 9	exit Example: <pre>Router(config-dial-peer)# exit</pre>	Exits the current mode.



PART **XVII**

SIP Supplementary Services

- [Dynamic Refer Handling, on page 897](#)
- [Cause Code Mapping, on page 903](#)



CHAPTER 68

Dynamic Refer Handling

When a dial-peer match occurs, CUBE passes the REFER message from an in leg to an out leg. Also, the host part of the Refer-to header is modified with the IP address.

The Dynamic REFER handling feature provides configurations to pass across or consume the REFER message. When an endpoint invokes a supplementary service such as a call transfer, the endpoint generates and sends an in-dialog REFER request towards the Cisco UBE. If the REFER message is consumed, an INVITE is sent towards refer-to dial-peer

- [Feature Information for Dynamic REFER Handling, on page 897](#)
- [Prerequisites, on page 898](#)
- [Restrictions, on page 898](#)
- [Configuring REFER Passthrough with Unmodified Refer-to , on page 898](#)
- [Configuring REFER Consumption, on page 900](#)
- [Troubleshooting Tips, on page 902](#)

Feature Information for Dynamic REFER Handling

The following table provides release information about the feature or features described in this module. This table lists only the software release that introduced support for a given feature in a given software release train. Unless noted otherwise, subsequent releases of that software release train also support that feature.

Use Cisco Feature Navigator to find information about platform support and Cisco software image support. To access Cisco Feature Navigator, go to <https://cfng.cisco.com/>. An account on Cisco.com is not required.

Table 91: Feature Information for Dynamic REFER Handling

Feature Name	Releases	Feature Information
REFER Consume (Enhancements)	IOS 15.5(1)T IOS XE 3.14.0 S	REFER Consume (Enhancements) provides additional configurations to conditionally forward the REFER message. The following commands were introduced: refer consume .

Feature Name	Releases	Feature Information
Dynamic REFER Handling	IOS 15.2(1)T IOS XE Release 3.7S	The Dynamic REFER handling feature provides configurations to pass across or consume the REFER message The following commands were introduced: referto-passing , voice-class sip referto-passing .

Prerequisites

- Transcoding configuration is required on the CUBE for midcall transcoder insertion, deletion, or modification during call transfers.

Restrictions

- Only Session Initiation Protocol (SIP)-to-SIP call transfers are supported.
- Call escalation and de-escalation are not supported.
- Video transcoding is not supported.
- Session Description Protocol (SDP) pass-through is not supported.
- In REFER consume scenario, if TCL script is enabled, then **supplementary-service media-renegotiate** command should not be configured.

Configuring REFER Passthrough with Unmodified Refer-to

This task configures the passthrough of REFER message from the in leg to the out leg on a dial-peer match. A REFER is sent towards inbound dial peer. This task also ensures that the host part of the Refer-to header is unmodified and not changed to the IP address during passthrough.

supplementary service refer	Results
yes	REFER is passed through from the in leg to the out leg
no	INVITE is sent towards refer-to dial-peer



Note This configurations in this task can be overridden by the **refer consume** command. Refer to the *Configuring REFER Consumption* task for more information.

SUMMARY STEPS

1. **enable**
2. **configure terminal**
3. Configure REFER passthrough:
 - **supplementary-service sip refer** in global VoIP configuration mode.
 - **supplementary-service sip refer** in dial-peer configuration mode.
4. (Optional) Configure unmodified Refer-to:
 - **referto-passing** in Global VoIP SIP configuration mode.
 - **voice-class sip referto-passing [system]** in dial-peer configuration mode.
5. **end**

DETAILED STEPS

	Command or Action	Purpose
Step 1	enable Example: Device> enable	Enables privileged EXEC mode. <ul style="list-style-type: none"> • Enter your password if prompted.
Step 2	configure terminal Example: Device# configure terminal	Enters global configuration mode.
Step 3	Configure REFER passthrough: <ul style="list-style-type: none"> • supplementary-service sip refer in global VoIP configuration mode. • supplementary-service sip refer in dial-peer configuration mode. Example: In Global VoIP configuration mode: Device(config)# voice service voip Device(conf-voi-serv)# supplementary-service sip refer Example: In dial-peer configuration mode: Device(config)# dial-peer voice 22 voip Device(config-dial-peer)# supplementary-service sip refer	Configures REFER passthrough. A REFER is sent towards the inbound dial peer
Step 4	(Optional) Configure unmodified Refer-to: <ul style="list-style-type: none"> • referto-passing in Global VoIP SIP configuration mode. 	Ensures that the refer-to header is unmodified and not changed to the IP address during passthrough

	Command or Action	Purpose
	<ul style="list-style-type: none"> • voice-class sip refer-to-passing [system] in dial-peer configuration mode. <p>Example:</p> <p>In Global VoIP configuration mode:</p> <pre>Device(config)# voice service voip Device(conf-voi-serv)# sip Device(conf-serv-sip)# refer-to-passing</pre> <p>Example:</p> <p>In dial-peer configuration mode:</p> <pre>Device(config)# dial-peer voice 22 voip Device(config-dial-peer)# voice-class sip refer-to-passing</pre>	
Step 5	end	Exits to privileged EXEC mode.

Configuring REFER Consumption

This task configures the consumption of REFER message on a dial-peer match. An INVITE is sent towards the Refer-to dial peer.

Table 92: Configurations for REFER Consumption

supplementary service refer	refer consume	Results
yes	no	REFER is sent towards inbound dial-peer
yes	yes	INVITE is sent towards refer-to dial-peer
no	no	INVITE is sent towards refer-to dial-peer
no	yes	INVITE is sent towards refer-to dial-peer

SUMMARY STEPS

1. **enable**
2. **configure terminal**
3. Enter one of the following:
 - **no supplementary-service sip refer** in global VoIP configuration mode.
 - **no supplementary-service sip refer** in dial-peer configuration mode.
4. **refer consume** in global VoIP configuration mode.
5. (Optional) **supplementary-service media-renegotiate** in global VoIP configuration mode.
6. (Optional) Enter one of the following:
 - **xfer target** in global VoIP configuration mode.
 - **xfer target** in voice class tenant configuration mode.

7. end

DETAILED STEPS

	Command or Action	Purpose
Step 1	<p>enable</p> <p>Example:</p> <pre>Device> enable</pre>	<p>Enables privileged EXEC mode.</p> <ul style="list-style-type: none"> • Enter your password if prompted.
Step 2	<p>configure terminal</p> <p>Example:</p> <pre>Device# configure terminal</pre>	<p>Enters global configuration mode.</p>
Step 3	<p>Enter one of the following:</p> <ul style="list-style-type: none"> • no supplementary-service sip refer in global VoIP configuration mode. • no supplementary-service sip refer in dial-peer configuration mode. <p>Example:</p> <p>In global VoIP configuration mode:</p> <pre>Device(config)# voice service voip Device(conf-voi-serv)# no supplementary-service sip refer</pre> <p>Example:</p> <p>In dial-peer configuration mode:</p> <pre>Device(config)# dial-peer voice 22 voip Device(config-dial-peer)# no supplementary-service sip refer</pre>	<p>Configures REFER consumption. An INVITE is sent towards the Refer-to dial peer.</p>
Step 4	<p>refer consume in global VoIP configuration mode.</p> <p>Example:</p> <p>In dial-peer configuration mode:</p> <pre>Device(config)# dial-peer voice 22 voip Device(config-dial-peer)# refer consume</pre>	<p>Configures REFER consumption.</p>
Step 5	<p>(Optional) supplementary-service media-renegotiate in global VoIP configuration mode.</p> <p>Example:</p> <p>In global VoIP configuration mode:</p> <pre>Device(config)# voice service voip Device(conf-voi-serv)# supplementary-service media-renegotiate</pre>	<p>Enables end-to-end media renegotiation during the call transfer in REFER consumption mode.</p>

	Command or Action	Purpose
Step 6	<p>(Optional) Enter one of the following:</p> <ul style="list-style-type: none"> • xfer target in global VoIP configuration mode. • xfer target in voice class tenant configuration mode. <p>Example:</p> <p>In global VoIP configuration mode:</p> <pre>router(config)#sip-ua router(config-sip-ua)#xfer target refer-to</pre> <p>Example:</p> <p>In voice class tenant configuration mode:</p> <pre>Router(config)#voice class tenant 1 Router(config-class)#xfer target refer-to</pre>	To route the INVITE to refer-to host address.
Step 7	end	Exits to privileged EXEC mode.

Troubleshooting Tips

Use any of the following debug commands:

- **debug ccsip all**
- **debug voip ccapi inout**
- **debug sccp messages**
- **debug voip application supplementary-service**
- **debug voip application state**
- **debug voip application media negotiation**



CHAPTER 69

Cause Code Mapping

With the Cause Code Mapping feature, the NOTIFY message sent by CUBE to a Customer Voice Portal (CVP) contains a proper reason for failure of call transfer based on the information received by CUBE from the caller instead of a 503 Service Unavailable message for all scenarios.

- [Feature Information for Cause Code Mapping, on page 903](#)
- [Cause Code Mapping, on page 904](#)
- [Configuring Cause Code Mapping, on page 905](#)
- [Verifying Cause Code Mapping, on page 906](#)

Feature Information for Cause Code Mapping

The following table provides release information about the feature or features described in this module. This table lists only the software release that introduced support for a given feature in a given software release train. Unless noted otherwise, subsequent releases of that software release train also support that feature.

Use Cisco Feature Navigator to find information about platform support and Cisco software image support. To access Cisco Feature Navigator, go to <https://cfng.cisco.com/>. An account on Cisco.com is not required.

Table 93: Feature Information for Cause Code Mapping

Feature Name	Releases	Feature Information
Cause Code Mapping	Cisco IOS 15.5(1)T Cisco IOS XE 3.14S Cisco IOS 15.5(1)T3 Cisco IOS 15.5(1)S3 Cisco IOS 15.5(2)T1 Cisco IOS 15.5(2)S1 Cisco IOS 15.4(3)M4 Cisco IOS 15.4(3)S4	With the Cause Code Mapping feature, the NOTIFY message sent by CUBE to a Customer Voice Portal (CVP) contains a proper reason for failure of call transfer based on the information received by CUBE from the caller. Following are the cause codes supported: <ul style="list-style-type: none"> • 17—486 Busy Here • 19—503 Service Unavailable • 21—403 Forbidden • 31—480 Temporarily Unavailable • 102—504 Server Time-out

Feature Name	Releases	Feature Information
Cause Code Mapping (Enhancement)	Cisco IOS 15.6(1)T	<p>With the Cause Code Mapping (Enhancement) feature, additional NOTIFY messages are introduced to inform CVP the proper reason for call failures based on the information received by CUBE from the caller instead of a 503 Service Unavailable message for all scenarios.</p> <p>The following cause codes were introduced:</p> <ul style="list-style-type: none"> • 1—404 Not Found • 20—480 Temporarily Unavailable • 27—502 Bad Gateway • 28—484 Address Incomplete • 38—503 Service Unavailable

Cause Code Mapping

If CUBE is configured to consume REFERs that it receives, the following actions occur:

1. CUBE consumes the REFER that it receives from a Customer Voice Portal (CVP).
2. CUBE sends an INVITE (instead of a REFER) to the outbound leg (towards the caller).
3. CUBE receives a status from the caller.
4. CUBE sends a NOTIFY message to the CVP.

Figure 86: Refer Consume in CUBE

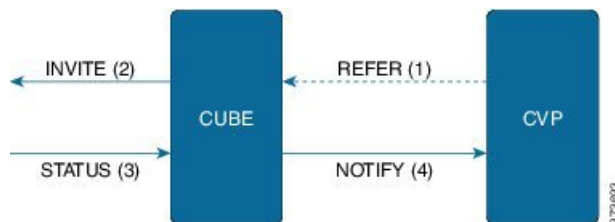

Previously, the NOTIFY message sent in step 4 included a 503 Service Unavailable message irrespective of the reason for failure of call transfer in step 3.

With the Cause Code Mapping feature, the NOTIFY message contains proper reason for failure of call transfer so that the CVP can take an appropriate action.

Table 94: Cause Code Mappings

Status Message received by CUBE (Step 3)	Cause Code	Notify message sent to CVP (Step 4)
486	17	486 Busy Here

Status Message received by CUBE (Step 3)	Cause Code	Notify message sent to CVP (Step 4)
480	31	480 Temporarily Unavailable
403	21	403 Forbidden
480	19	503 Service Unavailable
504	102	504 Server Time-out
404	1	404 Not Found
480	20	480 Temporarily Unavailable
484	28	484 Address Incomplete
502	27	502 Bad Gateway
503	38	503 Service Unavailable



Note Cause code mappings for cause code 19 and 21 require configurations mentioned in [Configuring Cause Code Mapping, on page 905](#).



Note This mapping is only for the REFER consume scenario and not for REFER passthrough.

Configuring Cause Code Mapping

SUMMARY STEPS

1. enable
2. configure terminal
3. sip-ua
4. reason-header override
5. end

DETAILED STEPS

	Command or Action	Purpose
Step 1	enable Example: Device> enable	Enters privileged EXEC mode. <ul style="list-style-type: none"> • Enter your password if prompted.

	Command or Action	Purpose
Step 2	configure terminal Example: Device# <code>configure terminal</code>	Enters global configuration mode.
Step 3	sip-ua Example: Device(config)# <code>sip-ua</code>	Enters the SIP user agent configuration mode.
Step 4	reason-header override Example: Device(config-sip-ua)# <code>reason-header override</code>	Configures the sending of a proper reason for failure of call transfer in the NOTIFY message so that the Customer Voice Portal (CVP) can take an appropriate action.
Step 5	end Example: Device(config-sip-ua)# <code>end</code>	Exits to privileged EXEC mode.

Verifying Cause Code Mapping

SUMMARY STEPS

1. Enter the following:
 - `debug ccsip function`
 - `debug ccsip message`
 - `debug voip application state`
 - `debug voip application core`
 - `debug voip ccapi inout`

DETAILED STEPS

Enter the following:

- `debug ccsip function`
- `debug ccsip message`
- `debug voip application state`
- `debug voip application core`
- `debug voip ccapi inout`

Example:

486 Received by CUBE:

Received:
SIP/2.0 486 Busy Here
Via: SIP/2.0/UDP 9.40.3.231:5060;branch=z9hG4bK1C15625F7
From: <sip:2222@9.40.3.231>;tag=49B0964D-213C
To: <sip:3333@9.0.0.174>;tag=1
Call-ID: 7D7073E4-3F3B11E4-917BF9A9-A90B2232@9.40.3.231
CSeq: 101 INVITE
Allow-Events: telephone-event
Content-Length: 0
Reason: Q.850;cause=17

486 Busy here response sent in NOTIFY by CUBE

Sent:
NOTIFY sip:1111@9.0.0.174:9000 SIP/2.0
Via: SIP/2.0/UDP 9.40.3.231:5060;branch=z9hG4bK1C1571767
From: <sip:2222@9.40.3.231:5060>;tag=49B08E64-1374
To: <sip:1111@9.0.0.174>;tag=1
Call-ID: 1-25970@9.0.0.174
CSeq: 102 NOTIFY
Max-Forwards: 70
Date: Fri, 19 Sep 2014 13:55:46 GMT
User-Agent: Cisco-SIPGateway/IOS-15.5.20140712.124355.
Event: refer
Subscription-State: terminated;reason=noresource
Contact: <sip:2222@9.40.3.231:5060>
Content-Type: message/sipfrag
Content-Length: 25

SIP/2.0 486 Busy here



PART XVIII

Hosted and Cloud Services

- [Hosted and Cloud Services Delivery with CUBE, on page 911](#)
- [CUBE SIP Registration Proxy, on page 913](#)
- [Survivability for Hosted and Cloud Services, on page 929](#)
- [SUBSCRIBE-NOTIFY Passthrough, on page 949](#)



CHAPTER 70

Hosted and Cloud Services Delivery with CUBE

Cisco Unified Border Element (CUBE) delivers hosted and cloud based communication services at customer sites by managing registration traffic and ensuring uninterrupted service, when the remote call control platform becomes unreachable.

Figure 87: Cisco UBE in Hosted and Cloud Services

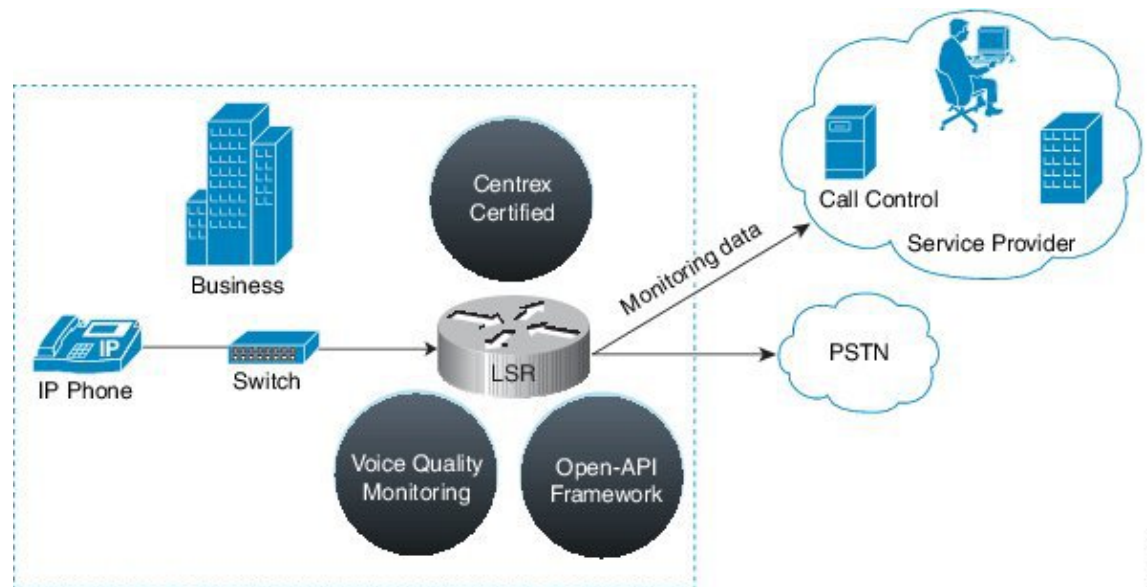

384137



CHAPTER 71

CUBE SIP Registration Proxy

The CUBE SIP Registration Proxy feature allows service providers to control the flow of registration messages between a customer's private network and their hosted communications platform.

By controlling routine registration traffic at the customer site, service providers can ensure service availability to local endpoints, while protecting core services from high message loads

- [Registration Pass-Through Modes, on page 913](#)
- [Registration Overload Protection, on page 916](#)
- [Registration Rate-limiting, on page 916](#)
- [Prerequisites for SIP Registration Proxy on Cisco UBE, on page 917](#)
- [Restrictions, on page 917](#)
- [Configuring CUBE SIP Registration Proxy, on page 917](#)
- [Configuration Example—CUBE SIP Registration Proxy, on page 926](#)
- [Feature Information for CUBE SIP Registration Proxy, on page 927](#)

Registration Pass-Through Modes

Cisco UBE uses the following two modes for registration pass-through:

End-to-End Mode

In the end-to-end mode, Cisco UBE collects the registrar details from the Uniform Resource Identifier (URI) and passes the registration messages to the registrar. The registration information contains the expiry time for rate-limiting, the challenge information from the registrar, and the challenge response from the user.

Cisco UBE also passes the challenge to the user if the register request is challenged by the registrar. The registrar sends the 401 or 407 message to the user requesting for user credentials. This process is known as challenge.

Cisco UBE ignores the local registrar and authentication configuration in the end-to-end mode. It passes the authorization headers to the registrar without the header configuration.

End-to-End Mode--Call Flows

This section explains the following end-to-end pass-through mode call flows:

Register Success Scenario

The register success scenario for the end-to-end registration pass-through mode is as follows:

1. The user sends the register request to Cisco UBE.
2. Cisco UBE matches the request with a dial peer and forwards the request to the registrar.
3. Cisco UBE receives a success response message (200 OK message) from the registrar and forwards the message to the endpoint (user).
4. The registrar details and expiry value are passed to the user.

Registrar Challenging the Register Request Scenario

The following scenario explains how the registrar challenges the register request:

1. The user sends the register request to Cisco UBE.
2. Cisco UBE matches the register request with a dial peer and forwards it to the registrar.
3. The registrar challenges the register request.
4. Cisco UBE passes the registrar response and the challenge request, only if the registrar challenges the request to the user.
5. The user sends the register request and the challenge response to the Cisco UBE.
6. Cisco UBE forwards the response to the registrar.
7. Cisco UBE receives success message (200 OK message) from the registrar and forwards it to the user.

Peer-to-Peer Mode

In the peer-to-peer registration pass-through mode, the outgoing register request uses the registrar details from the local Cisco UBE configuration. Cisco UBE answers the challenges received from the registrar using the configurable authentication information. Cisco UBE can also challenge the incoming register requests and authenticate the requests before forwarding them to the network.

In this mode, Cisco UBE sends a register request to the registrar and also handles register request challenges. That is, if the registration request is challenged by the registrar (registrar sends 401 or 407 message), Cisco UBE forwards the challenge to the user and then passes the challenge response sent by the user to the registrar. In the peer-to-peer mode, Cisco UBE can use the **authentication** command to calculate the authorization header and then challenge the user depending on the configuration.



Note The **registrar** command must be configured in peer-to-peer mode. Otherwise, the register request is rejected with the 503 response message.

Peer-to-Peer Mode--Call Flows

This section explains the following peer-to-peer pass-through mode call flows:

Register Success Scenario

The register success scenario for a peer-to-peer registration pass-through mode is as follows:

1. The user sends the register request to Cisco UBE.
2. Cisco UBE matches the register request with a dial peer and forwards the register request to the registrar.
3. Cisco UBE receives a success message (200 OK message) from the registrar and forwards it to the endpoint (user). The following functions are performed:
 - Cisco UBE picks up the details about the registrar from the configuration.
 - Cisco UBE passes the registrar details and expiry value to the user.

Registrar Challenging the Register Request Scenario

The following scenario explains how the registrar challenges the register request:

1. The user sends the register request to Cisco UBE.
2. Cisco UBE matches the register request with a dial peer and forwards the register request to the registrar.
3. The user responds to the challenge request.
4. Cisco UBE validates the challenge response and forwards the register request to the registrar.
5. Cisco UBE receives a success message from the registrar and forwards it to the endpoint (user).

Registration in Different Registrar Modes

This section explains SIP registration pass-through in the following registrar modes:

Primary-Secondary Mode

In the primary-secondary mode the register message is sent to both the primary and the secondary registrar servers simultaneously.

The register message is processed as follows:

- The first successful response is passed to the phone as a SUCCESS message.
- All challenges to the request are handled by Cisco UBE.
- If the final response received from the primary and the secondary servers is an error response, the error response that arrives later from the primary or the secondary server is passed to the phone.
- If only one registrar is configured, a direct mapping is performed between the primary and the secondary server.
- If no registrar is configured, or if there is a Domain Name System (DNS) failure, the "503 service not available" message is sent to the phone.

DHCP Mode

In the DHCP mode the register message is sent to the registrar server using DHCP.

Multiple Register Mode

In the multiple register mode, you can configure a dial peer to select and enable the indexed registrars. Register messages must be sent only to the specified index registrars.

The response from the registrar is mapped the same way as in the primary-secondary mode.

Registration Overload Protection

The registration overload protection functionality enables Cisco UBE to reject the registration requests that exceed the configured threshold value.

To support the registration overload protection functionality, Cisco UBE maintains a global counter to count all the pending outgoing registrations and prevents the overload of the registration requests as follows:

- The registration count is decremented if the registration transaction is terminated.
- The outgoing registrations are rejected if the count goes beyond a configured threshold.
- The incoming register request is rejected with the 503 response if the outgoing registration is activated by the incoming register request.
- A retry timer set for a random value is used for attempting the registration again if the registrations are originated from Cisco UBE or a gateway.

The registration overload protection functionality protects the network from the following:

- Avalanche Restart--All the devices in the network restart at the same time.
- Component Failures--Sudden burst of load is routed through the device due to a device failure.

Registration Overload Protection--Call Flow

The following steps explain the register overload protection scenario:

1. The user sends a register request to Cisco UBE.
2. Cisco UBE matches the request with a dial peer and forwards the register request to the registrar.
3. The registration is rejected with a random retry value when the registration threshold value is reached.



Note The call flow for the DNS query on the Out Leg is the same for the end-to-end and peer-to-peer mode.

Registration Rate-limiting

The registration rate-limiting functionality enables you to configure different SIP registration pass-through rate-limiting options. The rate-limiting options include setting the expiry time and the fail count value for a Cisco UBE. You can configure the expiry time to reduce the load on the registrar and the network. Cisco UBE limits the reregistration rate by maintaining two different timers--in-registration timer and out-registration timer.

The initial registration is triggered based on the incoming register request. The expiry value for the outgoing register is selected based on the Cisco UBE configuration. On receiving the 200 OK message (response to the BYE message) from the registrar, a timer is started using the expiry value available in the 200 OK message. The timer value in the 200 OK message is called the out-registration timer. The success response is forwarded to the user. The expiry value is taken from the register request and the timer is started accordingly. This timer is called the in-registration timer. There must be a significant difference between the in-registration timer and the out-registration timer values for effective rate-limiting.

Registration Rate-limiting Success--Call Flow

The following steps explain a scenario where the rate-limiting functionality is successful:

1. The user sends the register request to Cisco UBE.
2. Cisco UBE matches the registration request with a dial peer and forwards it to the registrar. The outgoing register request contains the maximum expiry value if the rate-limiting functionality is configured.
3. The registrar accepts the registration.
4. Cisco UBE forwards the success response with the proposed expiry timer value.
5. The user sends the reregistration requests based on the negotiated value. Cisco UBE resends the register requests until the out-leg expiry timer value is sent.
6. Cisco UBE forwards the subsequent register request to the registrar, if the reregister request is received after the out-leg timer is reached.

Prerequisites for SIP Registration Proxy on Cisco UBE

- You must enable the local SIP registrar. See [Enabling Local SIP Registrar, on page 917](#).
- You must configure dial peers manually for call routing and pattern matching

Restrictions

- IPv6 support is not provided.

Configuring CUBE SIP Registration Proxy

Enabling Local SIP Registrar

Perform this task to enable the local SIP registrar.

SUMMARY STEPS

1. **enable**
2. **configure terminal**

3. `voice service voip`
4. `sip`
5. `registrar server [expires [max value] [min value]]`
6. `end`

DETAILED STEPS

	Command or Action	Purpose
Step 1	enable Example: Device> enable	Enables privileged EXEC mode. <ul style="list-style-type: none"> • Enter your password if prompted.
Step 2	configure terminal Example: Device# configure terminal	Enters global configuration mode.
Step 3	voice service voip Example: Device(config)# voice service voip	Enters voice-service configuration mode.
Step 4	sip Example: Device(conf-voi-serv)# sip	Enters service SIP configuration mode.
Step 5	registrar server [expires [max value] [min value]] Example: Device(conf-serv-sip)# registrar server	Enables the local SIP registrar. <ul style="list-style-type: none"> • Optionally you can configure the expiry time of the registrar using the following keywords: <ul style="list-style-type: none"> • expires--Configures the registration expiry time. • max--Configures the maximum registration expiry time. • min--Configures the minimum registration expiry time. <p>Note The registrar command must be configured in peer-to-peer mode. Otherwise, the register request is rejected with the 503 response message.</p>
Step 6	end Example: Device(conf-serv-sip)# end	Exits service SIP configuration mode and returns to privileged EXEC mode.

Configuring SIP Registration Proxy at the Global Level

Perform this task to configure SIP registration proxy at the global level.

SUMMARY STEPS

1. **enable**
2. **configure terminal**
3. **voice service voip**
4. **sip**
5. **registration passthrough** [**system** | [**static** | **dynamic** [**local-fallback** *value*]]] [**rate-limit** [**expires** *value*] [**fail-count** *value*]] [**reg-sync** *value*] [**registrar-index** *index*]]
6. **end**

DETAILED STEPS

	Command or Action	Purpose
Step 1	enable Example: Device> enable	Enables privileged EXEC mode. <ul style="list-style-type: none"> • Enter your password if prompted.
Step 2	configure terminal Example: Device# configure terminal	Enters global configuration mode.
Step 3	voice service voip Example: Device(config)# voice service voip	Enters voice-service configuration mode.
Step 4	sip Example: Device(conf-voi-serv)# sip	Enters service SIP configuration mode.
Step 5	registration passthrough [system [static dynamic [local-fallback <i>value</i>]]] [rate-limit [expires <i>value</i>] [fail-count <i>value</i>]] [reg-sync <i>value</i>] [registrar-index <i>index</i>]] Example: Device(conf-serv-sip)# registration passthrough	Configures the SIP registration pass-through options. <ul style="list-style-type: none"> • You can specify different SIP registration pass-through options using the following keywords: <ul style="list-style-type: none"> • dynamic—SIP Registration uses the dynamic registrar details (default). • local-fallback—Configures Local Fallback - (e2e). • rate-limit—Enables rate-limiting.

	Command or Action	Purpose
		<ul style="list-style-type: none"> • reg-sync—Sends REGISTER messages when registrar up (p2p). • registrar-index—Configures a list of registrars to be used for registration. For detailed information, see Configuring Multiple Registrars on SIP Trunks. • static—SIP Registration Use static Registrar Details. • system—Use system registration passthrough configuration.
Step 6	end Example: <pre>Device(conf-serv-sip)# end</pre>	Exits service SIP configuration mode and returns to privileged EXEC mode.

Configuring SIP Registration Proxy at the Tenant Level

SUMMARY STEPS

1. **enable**
2. **configure terminal**
3. **voice class tenant tag**
4. **registrar { dhcp | [registrar index] registrar-server-address [:port] | expires value }**
5. **registration passthrough [system | [static | dynamic [local-fallback value]] [rate-limit [expires value] [fail-count value]] [reg-sync value] [registrar-index index]]**
6. **exit**
7. **dial-peer voice tag voip**
8. **voice-class sip tenant tag**
9. **exit**

DETAILED STEPS

	Command or Action	Purpose
Step 1	enable Example: <pre>Device> enable</pre>	Enables privileged EXEC mode. <ul style="list-style-type: none"> • Enter your password if prompted.
Step 2	configure terminal Example: <pre>Device# configure terminal</pre>	Enters global configuration mode.

	Command or Action	Purpose
Step 3	<p>voice class tenant <i>tag</i></p> <p>Example:</p> <pre>Device(config)# voice class tenant 1</pre>	Enters the tenant configuration mode.
Step 4	<p>registrar { dhcp [<i>registrar index</i>] } <i>registrar-server-address</i> [:<i>port</i>] expires <i>value</i>}</p> <p>Example:</p> <pre>Device(config-class)# registrar ipv4:10.65.75.45:9052 expires 3600</pre>	Configures the registrar server.
Step 5	<p>registration passthrough [system [static dynamic [local-fallback <i>value</i>]]] [rate-limit [expires <i>value</i>]] [fail-count <i>value</i>]] [reg-sync <i>value</i>]] [registrar-index <i>index</i>]</p> <p>Example:</p> <pre>Device(config-class)# registration passthrough static</pre>	<p>Configures SIP registration pass-through options on a dial peer on a dial peer.</p> <ul style="list-style-type: none"> You can specify different SIP registration pass-through options using the following keywords: <ul style="list-style-type: none"> dynamic—SIP Registration uses the dynamic registrar details (default). local-fallback—Configures Local Fallback - (e2e). rate-limit—Enables rate-limiting. reg-sync—Sends REGISTER messages when registrar up (p2p). registrar-index—Configures a list of registrars to be used for registration. For detailed information, see Configuring Multiple Registrars on SIP Trunks. static—SIP Registration Use static Registrar Details. system—Use system registration passthrough configuration.
Step 6	<p>exit</p> <p>Example:</p> <pre>Device(config-class)# exit</pre>	Exits tenant configuration mode and returns to global configuration mode.
Step 7	<p>dial-peer voice <i>tag</i> voip</p> <p>Example:</p> <pre>Device(config)# dial-peer voice 444 voip</pre>	Enters dial peer voice configuration mode.

	Command or Action	Purpose
Step 8	voice-class sip tenant <i>tag</i> Example: <pre>Device(config-dial-peer)# voice-class sip tenant 1</pre>	Associates the dial-peer with the tenant.
Step 9	exit Example: <pre>Device(config-class)# exit</pre>	Exits dial-peer configuration mode and returns to global configuration mode.

Configuring SIP Registration Proxy at the Dial Peer Level

Perform this task to configure SIP registration proxy at the dial peer level.

SUMMARY STEPS

1. **enable**
2. **configure terminal**
3. **dial-peer voice** *tag* **voip**
4. **voice-class sip registration passthrough** [**system** | [**static** | **dynamic** [**local-fallback** *value*]] [**rate-limit** [**expires** *value*] [**fail-count** *value*]] [**reg-sync** *value*] [**registrar-index** *index*]]
5. **exit**

DETAILED STEPS

	Command or Action	Purpose
Step 1	enable Example: <pre>Device> enable</pre>	Enables privileged EXEC mode. <ul style="list-style-type: none"> • Enter your password if prompted.
Step 2	configure terminal Example: <pre>Device# configure terminal</pre>	Enters global configuration mode.
Step 3	dial-peer voice <i>tag</i> voip Example: <pre>Device(config)# dial-peer voice 444 voip</pre>	Enters dial peer voice configuration mode.
Step 4	voice-class sip registration passthrough [system [static dynamic [local-fallback <i>value</i>]] [rate-limit [expires <i>value</i>] [fail-count <i>value</i>]] [reg-sync <i>value</i>] [registrar-index <i>index</i>]]	Configures SIP registration pass-through options on a dial peer on a dial peer. <ul style="list-style-type: none"> • You can specify different SIP registration pass-through options using the following keywords:

	Command or Action	Purpose
	<p>Example:</p> <pre>Device(config-dial-peer)# voice-class sip registration passthrough static</pre>	<ul style="list-style-type: none"> • dynamic—SIP Registration uses the dynamic registrar details (default). • local-fallback—Configures Local Fallback - (e2e). • rate-limit—Enables rate-limiting. • reg-sync—Sends REGISTER messages when registrar up (p2p). • registrar-index—Configures a list of registrars to be used for registration. For detailed information, see Configuring Multiple Registrars on SIP Trunks. • static—SIP Registration Use static Registrar Details. • system—Use system registration passthrough configuration.
Step 5	<p>exit</p> <p>Example:</p> <pre>Device(config-dial-peer)# exit</pre>	Exits dial peer voice configuration mode and returns to global configuration mode.

Configuring Registration Overload Protection Functionality

Perform this task to configure registration overload protection functionality on Cisco UBE.

SUMMARY STEPS

1. **enable**
2. **configure terminal**
3. **sip-ua**
4. **registration spike** *max-number*
5. **end**

DETAILED STEPS

	Command or Action	Purpose
Step 1	<p>enable</p> <p>Example:</p> <pre>Device> enable</pre>	<p>Enables privileged EXEC mode.</p> <ul style="list-style-type: none"> • Enter your password if prompted.

	Command or Action	Purpose
Step 2	configure terminal Example: Device# configure terminal	Enters global configuration mode.
Step 3	sip-ua Example: Device(config)# sip-ua	Enters SIP user-agent configuration mode.
Step 4	registration spike max-number Example: Device(config-sip-ua)# registration spike 100	Configures registration overload protection functionality on Cisco UBE.
Step 5	end Example: Device(config-sip-ua)# end	Exits SIP user-agent configuration mode and returns to privileged EXEC mode.

Configuring Cisco UBE to Route a Call to the Registrar Endpoint

Perform this task to configure Cisco UBE to route a call to the registrar endpoint.



Note You must perform this configuration on a dial peer that is pointing towards the endpoint.

SUMMARY STEPS

1. enable
2. configure terminal
3. dial-peer voice tag {pots | voatm | vofr | voip}
4. session target registrar
5. exit

DETAILED STEPS

	Command or Action	Purpose
Step 1	enable Example: Device> enable	Enables privileged EXEC mode. <ul style="list-style-type: none"> • Enter your password if prompted.

	Command or Action	Purpose
Step 2	configure terminal Example: Device# <code>configure terminal</code>	Enters global configuration mode.
Step 3	dial-peer voice tag {pots voatm vofr voip} Example: Device(config)# <code>dial-peer voice 444 voip</code>	Enters dial peer voice configuration mode.
Step 4	session target registrar Example: Device(config-dial-peer)# <code>session target registrar</code>	Configures Cisco UBE to route the call to the registrar endpoint.
Step 5	exit Example: Device(config-dial-peer)# <code>exit</code>	Exits dial peer voice configuration mode and returns to global configuration mode.

Verifying the SIP Registration on Cisco UBE

Perform this task to verify the configuration for SIP registration on Cisco UBE. The **show** commands need not be entered in any specific order.

SUMMARY STEPS

1. **enable**
2. **show sip-ua registration passthrough status**
3. **show sip-ua registration passthrough status detail**

DETAILED STEPS

Step 1 enable

Enables privileged EXEC mode.

Example:

```
Device> enable
```

Step 2 show sip-ua registration passthrough status

Displays the SIP user agent (UA) registration pass-through status information.

Example:

```
Device# show sip-ua registration passthrough status
```

```

CallId      Line      peer      mode In-Exp      reg-I Out-Exp
=====
771         5500550055  1         p2p  64          1     64
=====

```

Step 3 show sip-ua registration passthrough status detail

Displays the SIP UA registration pass-through status information in detail.

Example:

```

Device# show sip-ua registration passthrough status detail
=====
Configured Reg Spike Value: 0
Number of Pending Registrations: 0
=====
Call-Id: 763
Registering Number: 5500550055
Dial-peer tag: 601
Pass-through Mode: p2p
Negotiated In-Expires: 64 Seconds
Next In-Register Due in: 59 Seconds
In-Register Contact: 9.45.36.5
-----
Registrar Index: 1
Registrar URL: ipv4:9.45.36.4
Negotiated Out-Expires: 64 Seconds
Next Out-Register After: 0 Seconds
=====

```

The following section will be added to the "Examples" section of the SIP to SIP chapter.

Configuration Example—CUBE SIP Registration Proxy

```

!
!
voice service voip
sip
    registrar server expires max 121 min 61
    registration passthrough static rate-limit expires 9000 fail-count 5 registrar-index 1 3
    5
!
dial-peer voice 1111 voip
destination-pattern 1234
voice-class sip pass-thru content unsupp
session protocol sipv2
session target registrar
!
dial-peer voice 1111 voip
destination-pattern 1234
voice-class sip pass-thru content unsupp
voice-class sip registration passthrough static rate-limit expires 9000 fail-count 5
registrar-index 1 3 5
authentication username 1234 password 7 075E731F1A realm cisco.com
session protocol sipv2
session target registrar
!

```

```

sip-ua
  registration spike 1000
!
!

```

Feature Information for CUBE SIP Registration Proxy

Table 95: Feature Information for Support for SIP Registration Proxy on CUBE

Feature Name	Releases	Feature Information
Support for CUBE SIP Registration Proxy	Cisco IOS XE Fuji 16.9.1	<p>CUBE SIP Registration Proxy supports sending outbound registrations from CUBE based on incoming registrations. This feature enables direct registration of SIP endpoints with the SIP registrar in hosted Unified Communications deployments. This feature also provides various benefits for handling CUBE deployments with no IPPBX support.</p> <p>The following commands were introduced or modified: authentication (dial peer), registrar server, registration passthrough, registration spike, show sip-ua registration passthrough status, voice-class sip registration passthrough static rate-limit.</p>



CHAPTER 72

Survivability for Hosted and Cloud Services

The Survivability for Hosted and Cloud Services on the CUBE is used to:

- Monitor the WAN status periodically from the CUBE.
- Route calls and handle line-side subscriptions locally when the WAN link is down.
- Synchronize the registrations with the server when the WAN link is up.
- [Information About Survivability for Hosted and Cloud Services, on page 929](#)
- [How to Configure Survivability for Hosted and Cloud Services, on page 934](#)
- [Configuration Examples—Survivability for Hosted and Cloud Services, on page 945](#)
- [Feature Information for Survivability for Hosted and Cloud Services, on page 947](#)

Information About Survivability for Hosted and Cloud Services

Advantages of Using CUBE Survivability Feature

The survivability feature on CUBE addresses the following issues by providing local fallback or registration synchronization:

1. When a WAN link or registrar server comes up, it waits until each SIP phone sends the REGISTER message to the server, so that outside phones can reach that phone.
2. If the phone register timer setting is too large, the outside phone waits that much time to reach that phone, after a link flap.
3. If the phone register timer setting is too small, it floods the WAN link.
4. When the WAN link or registrar server is down, you cannot make any local calls.

Local Fallback

- CUBE does not need to configure credentials, as the phones trigger registration. Although CUBE receives REGISTER messages for each phone every 5 minutes; for example, it throttles and sends REGISTER messages every 1 hour to the registrar server, avoiding high WAN bandwidth usage. This addresses the issues 1, 2, and 3.

- In normal operation when the WAN link or registrar server is up, the phone's primary server URL is the registrar server (E2E) registration.
- "OPTIONS ping" is used to monitor the registrar server link status. When the detected link is down, CUBE replies with a 500 message and when the phone receives this message, it sends the REGISTER message to CUBE, which is the secondary server (P2P registration). CUBE replies with a 200 OK message to P2P registration when the link is down. The dial-peer keeps the dynamic registrar session target and the local call does not fail. This addresses issue 4.

Registration Synchronization

- If you configure the phones to send REGISTER messages every 1 hour (to help alleviate the WAN link), the CUBE uses the credentials that were configured to respond to registrar server authentication challenge. This addresses issue 3.
- When the WAN link or registration server is down (detected by OPTIONS ping), the CUBE keeps the registration database of the SIP phones that were previously registered successfully, and it does not send REGISTER messages out; CUBE replies with a 200 OK message and dial-peer keeps the dynamic registrar session target. The local call does not fail, addressing issue 4.
- When the registrar link is up after a link flap, the CUBE sends REGISTER message for each phone that was earlier successfully registered to the registrar server. This is throttled to avoid bulk REGISTER messages flooding WAN link and the registrar. This addresses issues 1 and 2.

Registration Through Alias Mapping

The following illustration shows how a phone (with alias mapping) registers to the service provider through CUBE.

Figure 88: SIP Phone Registration

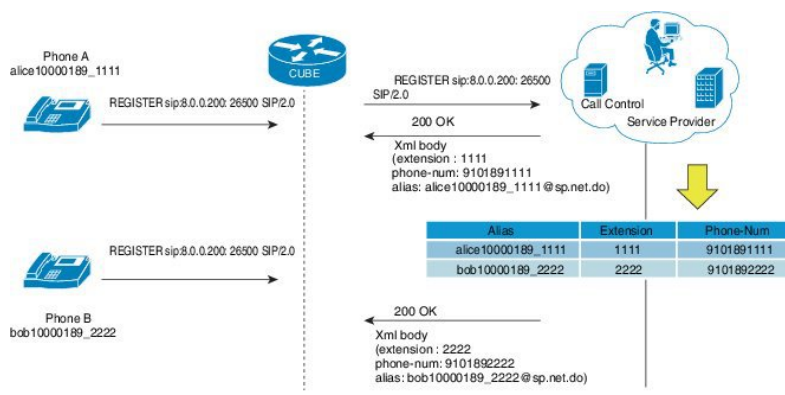

The addresses-of-record (AOR) sent in the REGISTER is an alias which is mapped to an extension and (or) phone number by the service provider. The service provider returns the mapping details in the 200 OK response sent to the REGISTER. CUBE has the ability to cache the alias mapping details in its call routing database. When a call is made from the phone, the Request-URI of the INVITE contains the dialed number (short extension or phone number).

If WAN is up, CUBE always routes the INVITE sent from the phone to the service provider without looking up at the alias mapping cache.

If WAN or the service provider is down, that is, in survivability mode, CUBE routes the INVITE locally by looking up at the alias mapping cache.

Alias Mapping—Supported Methods

1. When the service provider returns the mapping details in the 200 OK message of the REGISTER in the following predefined format:

Alias	Extension	Phone
alice10000189_1111	1111	10000189

2. The short extension or phone number is embedded in the AOR of the REGISTER. For example, AOR is **alice10000189_1111** and the short extension is **1111**.

An inbound sip profile can be applied to the REGISTER which extracts the extension part from the AOR and adds an X-CISCO-EXTENSION header.

CUBE when WAN is UP

The following illustration provides an example as to how a typical phone makes a call to another local phone registered in the same server when WAN or the registrar server is up in a typical hosted deployment. The circled numbers in the image indicate the numerical order in which the sequence occurs.

Figure 89: WAN Link is UP - CUBE Deployment

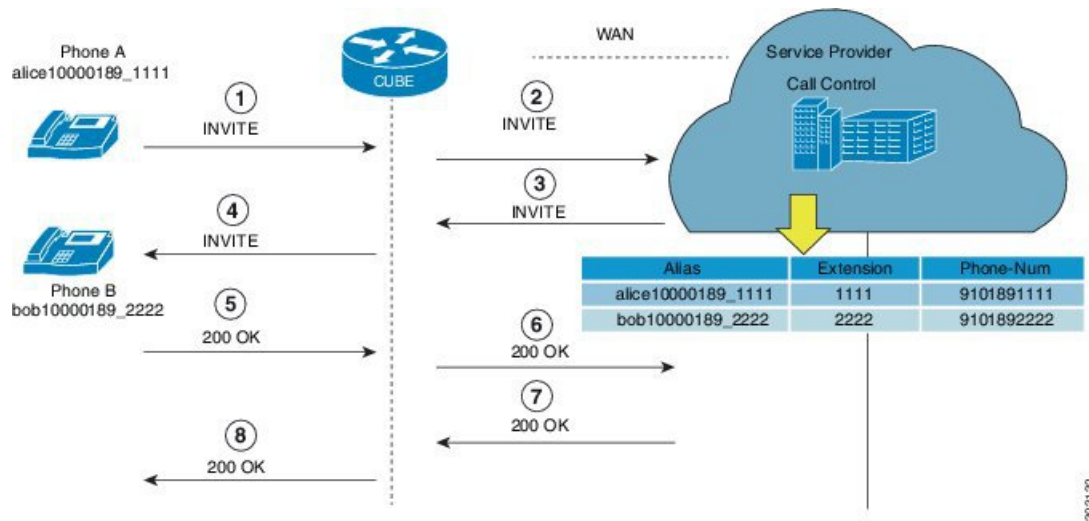

The call flow scenario is as follows: Phone A initiates a call to the Phone B registered to the same server.

1. Phone A sends an initial INVITE request to Phone B to participate in a call session through CUBE.
2. CUBE sends this INVITE to the service provider.
3. The service provider in turn sends the INVITE to CUBE. Since the WAN link is up, the service provider maps details of the user from the register server and provides details of the user, for example, alias of the user, short extension number, and phone number.
4. CUBE sends INVITE with all the above mentioned information to Phone B.

Example: Normal Mode (WAN is Up in P2P Mode)

5. Phone B sends a 200 OK response to CUBE for the received INVITE.
6. CUBE sends a 200 OK answer to the service provider.
7. The service provider responds to CUBE with a 200 OK answer.
8. A final 200 OK response is sent to Phone A by CUBE and the call is established between Phone A and Phone B.

Example: Normal Mode (WAN is Up in P2P Mode)

```
CUBE# show sip-ua registration passthrough status
```

CallId	DirectoryNum	peer	mode	In-Exp	reg-I	Out-Exp	survival
21	NCPPhone1006	1	p2p	135 /144	1	144	normal

Example: Normal Mode (WAN is Up in E2E Mode)

```
CUBE# show sip-ua registration passthrough status
```

CallId	DirectoryNum	peer	mode	In-Exp	reg-I	Out-Exp	survival
14574	NCPPhone1006	301	e2e	117 /120	--	120	normal

CUBE Survivability When WAN Is Down

In survivability mode, CUBE provides end-to end telephony services when access to the centralized servers is interrupted because of a WAN outage or other factors, like the server being down.

The following illustration shows how a call is established between two endpoints when WAN link is down during survivability by directly dialing into an extension.

Figure 90: CUBE Survivability When WAN Is Down

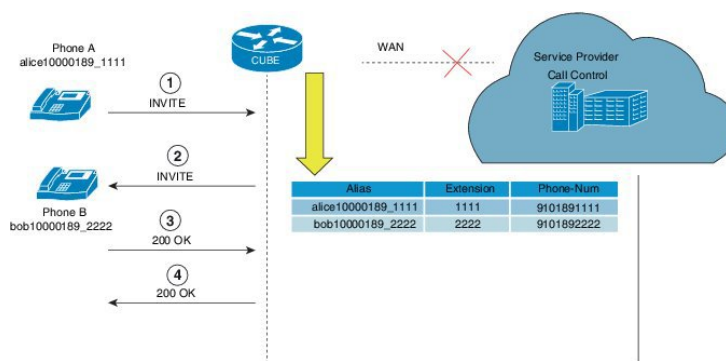

Earlier, when WAN was down, User A could only contact User B using either the alias or the user-id of User B, and not using their extensions or phone numbers.

Now, in the event the WAN link or registration server is down, when a local call is made, INVITE is sent to CUBE. CUBE maps the details of the user like the extension number and phone-number stored during registration. Local phones can now be reached on their short extensions or phone numbers by similar phones that are subscribed to the server through the same CUBE.

It is possible to register multiple contacts for a single AOR; however, if multiple contacts are registered for a single subscriber, the CUBE uses only the topmost registered contact to deliver the call to that subscriber. For this reason, multiple contacts are not supported.

A few phone models, such as, Cisco IP Phone 7800 Series with Multiplatform Firmware and Cisco IP Phone 8800 Series with Multiplatform Firmware, sends register request to primary registrar only and do not send secondary REGISTER request to the secondary registrar (CUBE) in E2E mode when primary registrar could not be reached. In such scenarios, phone service goes down after it receives 500 response from CUBE for REGISTER request toward primary registrar.

To avoid phones getting into such error condition, CUBE checks for the response from the primary registrar side. When CUBE receives request timeout on WAN side or responses other than 200, 4XX, and 3XX from primary registrar, survivability will be enabled.

To enable survivability on such phones, refer [Configuring Survivability for Phones Sending Single Register Request](#), on page 937.

Survivability Support for Public Switched Telephone Network Access When WAN Is Down

If WAN link going down or registrar service unavailable, you can access the phones in the Public Switched Telephone Network (PSTN) through FXO or PRI cards that are configured on Cisco Unified Border Element.



Note Survivability support for Public Switched Telephone Network (PSTN) access is supported only for CUBE running on Cisco 4000 Series Integrated Services Router.

Figure 91: Survivability Support for PSTN Access When WAN Is Down

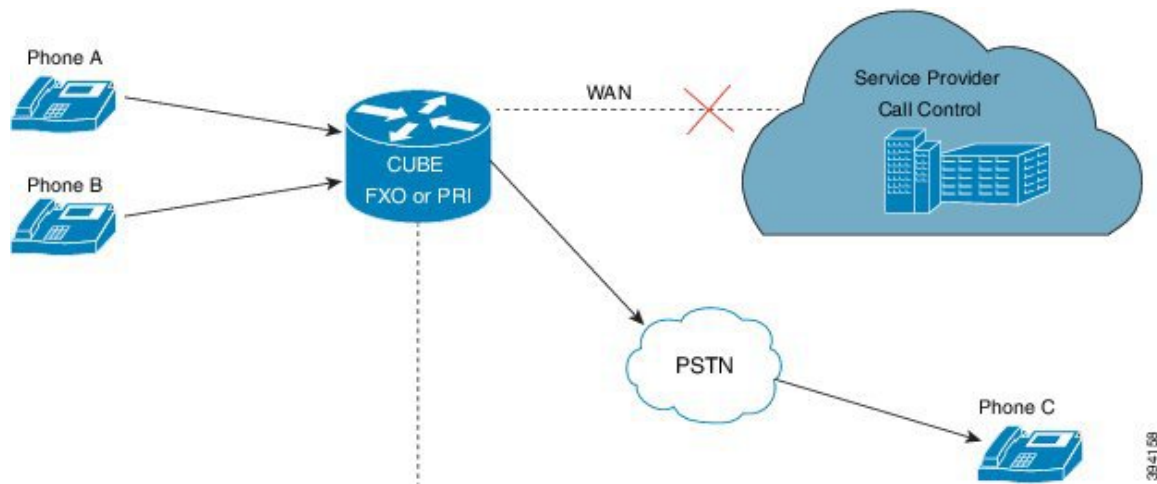

394158

Example: Survivability Mode in P2P (regsync mode) when WAN is Down

```
CUBE# show sip-ua registration passthrough status
```

CallId	DirectoryNum	peer	mode	In-Exp	reg-I	Out-Exp	survival
38	NCPhone1008	1	p2p	3595 /3600	1	3600	regsync

Example: Survivability Mode in E2E (local fallback mode) when WAN is Down

```
CUBE# show sip-ua registration passthrough status
```

```
CallId    DirectoryNum    peer    mode    In-Exp    reg-I    Out-Exp    survival
=====    =====
70        NCPPhone1006    1       e2e     35 /70    --       0          locfall
=====
```

```
CallId    DirectoryNum    peer    mode    In-Exp    reg-I    Out-Exp    survival
=====    =====
513       NCPPhone1008    1       e2e     40 /70    --       0          locfall
=====
```

How to Configure Survivability for Hosted and Cloud Services

Configuring Local Fallback or Registration Synchronization Globally

SUMMARY STEPS

1. **enable**
2. **configure terminal**
3. **voice service voip**
4. **sip**
5. **registration passthrough local-fallback tag**
6. **end**

DETAILED STEPS

	Command or Action	Purpose
Step 1	enable Example: Device> enable	Enables privileged EXEC mode. • Enter your password if prompted.
Step 2	configure terminal Example: Device# configure terminal	Enters global configuration mode.
Step 3	voice service voip Example: Device(config)# voice service voip	Enters voice service VoIP configuration mode.
Step 4	sip Example:	Enters voice service SIP configuration mode.

	Command or Action	Purpose
	Device(conf-voi-serv)# sip	
Step 5	registration passthrough local-fallback tag Example: Device(conf-serv-sip)# registration passthrough local-fallback 10	Configures SIP registration passthrough for local fallback mode; this will locally respond to REGISTER in p2p mode when WAN is down. The <i>tag</i> is the WAN link or registrar server dial-peer tag. <ul style="list-style-type: none"> To configure the registration sync mode, you can use the registration passthrough reg-sync tag command. Use the static keyword to set the phone URL to p2p registration.
Step 6	end Example: Device(conf-serv-sip)# end	Returns to privileged EXEC mode.

Configuring Local Fallback or Registration Synchronization at the Tenant Level

SUMMARY STEPS

1. **enable**
2. **configure terminal**
3. **voice class tenant tag**
4. **registration passthrough local-fallback tag**
5. **exit**
6. **dial-peer voice tag voip**
7. **voice-class sip tenant tag**
8. **exit**

DETAILED STEPS

	Command or Action	Purpose
Step 1	enable Example: Device> enable	Enables privileged EXEC mode. <ul style="list-style-type: none"> Enter your password if prompted.
Step 2	configure terminal Example: Device# configure terminal	Enters global configuration mode.
Step 3	voice class tenant tag Example:	Enters voice class tenant configuration mode.

	Command or Action	Purpose
	Device(config)# voice class tenant 1	
Step 4	registration passthrough local-fallback tag Example: Device(config-class)# registration passthrough local-fallback 10	Configures SIP registration passthrough for local fallback mode; this locally responds to REGISTER in p2p mode when WAN is down. The <i>tag</i> is the WAN link or registrar server dial-peer tag. <ul style="list-style-type: none"> To configure the registration sync mode, you can use the registration passthrough reg-sync tag command. Use the static keyword to set the phone URL to p2p registration.
Step 5	exit Example: Device(config-class)# exit	Exits tenant configuration mode and returns to global configuration mode.
Step 6	dial-peer voice tag voip Example: Device(config)# dial-peer voice 444 voip	Enters dial peer voice configuration mode.
Step 7	voice-class sip tenant tag Example: Device(config-dial-peer)# voice-class sip tenant 1	Associates the dial-peer with the tenant.
Step 8	exit Example: Device(config-class)# exit	Exits dial-peer configuration mode and returns to global configuration mode.

Configuring Local Fallback or Registration Synchronization on a Dial Peer

SUMMARY STEPS

1. enable
2. configure terminal
3. dial-peer voice tag voip
4. voice-class sip registration passthrough local-fallback tag
5. end

DETAILED STEPS

	Command or Action	Purpose
Step 1	enable Example: <pre>Device> enable</pre>	Enables privileged EXEC mode. <ul style="list-style-type: none"> • Enter your password if prompted.
Step 2	configure terminal Example: <pre>Device# configure terminal</pre>	Enters global configuration mode.
Step 3	dial-peer voice tag voip Example: <pre>Device(config)# dial-peer voice 4 voip</pre>	Enters dial peer VoIP configuration mode.
Step 4	voice-class sip registration passthrough local-fallback tag Example: <pre>Device(config-dial-peer)# voice-class sip registration passthrough local-fallback 10</pre>	Configures SIP registration passthrough for local fallback mode; this will locally respond to REGISTER in p2p mode when WAN is down. The <i>tag</i> is the WAN link or registrar server dial-peer tag. <ul style="list-style-type: none"> • To configure the registration sync mode, you can use the voice-class sip registration passthrough reg-sync tag command.
Step 5	end Example: <pre>Device(conf-serv-sip)# end</pre>	Returns to privileged EXEC mode.

Configuring Survivability for Phones Sending Single Register Request

The following configuration enables CUBE to always check for the response from remote side. Request timeout on WAN side or response other than 200, 4XX, and 3XX received by CUBE from SBC enables the survivability.

SUMMARY STEPS

1. **enable**
2. **configure terminal**
3. **voice service voip**
4. **sip**
5. **survivability single-register**
6. **end**

DETAILED STEPS

	Command or Action	Purpose
Step 1	enable Example: <pre>Device> enable</pre>	Enables privileged EXEC mode. <ul style="list-style-type: none"> • Enter your password if prompted.
Step 2	configure terminal Example: <pre>Device# configure terminal</pre>	Enters global configuration mode.
Step 3	voice service voip Example: <pre>Device(config)# voice service voip</pre>	Enters voice service VoIP configuration mode.
Step 4	sip Example: <pre>Device(conf-voi-serv)# sip</pre>	Enters voice service SIP configuration mode.
Step 5	survivability single-register Example: <pre>Device(conf-serv-sip)# survivability single-register</pre>	Enables CUBE to always check for the response from the remote side. Request timeout on WAN side or response other than 200, 4XX, and 3XX received by CUBE from SBC enables the survivability.
Step 6	end Example: <pre>Device(conf-serv-sip)# end</pre>	Returns to privileged EXEC mode.

Configuring OPTIONS Ping

SUMMARY STEPS

1. **enable**
2. **configure terminal**
3. **dial-peer voice tag voip**
4. **voice-class sip options-keepalive up-interval value down-interval value**
5. **end**

DETAILED STEPS

	Command or Action	Purpose
Step 1	enable Example: <pre>Device> enable</pre>	Enables privileged EXEC mode. <ul style="list-style-type: none"> • Enter your password if prompted.
Step 2	configure terminal Example: <pre>Device# configure terminal</pre>	Enters global configuration mode.
Step 3	dial-peer voice tag voip Example: <pre>Device(config)# dial-peer voice 3 voip</pre>	Enters dial peer configuration mode.
Step 4	voice-class sip options-keepalive up-interval value down-interval value Example: <pre>Device(config-dial-peer)# voice-class sip options-keepalive up-interval 120 down-interval 120</pre>	Configures OPTIONS keepalive timer interval for DOWN and UP endpoints.
Step 5	end Example: <pre>Device(config-dial-peer)# end</pre>	Returns to privileged EXEC mode.

Configuring Registration Timer

Perform the following task to configure the registration timer in the CUBE rather than on all SIP phones.

SUMMARY STEPS

1. **enable**
2. **configure terminal**
3. **voice service voip**
4. **sip**
5. **registrar server expires max value min value**
6. **end**

DETAILED STEPS

	Command or Action	Purpose
Step 1	enable Example: <pre>Device> enable</pre>	Enables privileged EXEC mode. <ul style="list-style-type: none"> • Enter your password if prompted.
Step 2	configure terminal Example: <pre>Device# configure terminal</pre>	Enters global configuration mode.
Step 3	voice service voip Example: <pre>Device(config)# voice service voip</pre>	Enters voice service VoIP configuration mode.
Step 4	sip Example: <pre>Device(conf-voi-serv)# sip</pre>	Enters voice service SIP configuration mode.
Step 5	registrar server expires max <i>value</i> min <i>value</i> Example: <pre>Device(conf-serv-sip)# registrar server expires max 300 min 200</pre>	Configures the maximum and minimum time (in seconds) for the registration expiry in CUBE. <ul style="list-style-type: none"> • If the phone sends expiry time as 600 seconds, then the CUBE will reply with 200 OK message and expiry time 300 seconds, and the phone will resend with expiry 300.
Step 6	end Example: <pre>Device(conf-serv-sip)# end</pre>	Returns to privileged EXEC mode.

Configuring the REGISTER Message Throttling in CUBE

Perform the following task to throttle the REGISTER message in CUBE.

SUMMARY STEPS

1. **enable**
2. **configure terminal**
3. **voice service voip**
4. **sip**
5. **registration passthrough rate-limit expires *value* local-fallback *tag***

6. end

DETAILED STEPS

	Command or Action	Purpose
Step 1	enable Example: <pre>Device> enable</pre>	Enables privileged EXEC mode. <ul style="list-style-type: none"> • Enter your password if prompted.
Step 2	configure terminal Example: <pre>Device# configure terminal</pre>	Enters global configuration mode.
Step 3	voice service voip Example: <pre>Device(config)# voice service voip</pre>	Enters voice service VoIP configuration mode.
Step 4	sip Example: <pre>Device(conf-voi-serv)# sip</pre>	Enters voice service SIP configuration mode.
Step 5	registration passthrough rate-limit expires value local-fallback tag Example: <pre>Device(conf-serv-sip)# registration passthrough rate-limit expires 3600 local-fallback 3</pre>	Configures the SIP registration passthrough rate-limit expiry value for local-fallback (e2e). Although CUBE receives the REGISTER message every 5 minutes (300 seconds), it will send only one register message every one hour. <ul style="list-style-type: none"> • Under dial peer configuration mode, you can use the voice-class sip registration passthrough rate-limit expires value reg-sync dial-peer-tag command.
Step 6	end Example: <pre>Device(conf-serv-sip)# end</pre>	Returns to privileged EXEC mode.

Configuring the Class of Restrictions (COR) List

Class of Restrictions (COR) provides the ability to deny certain call attempts based on the incoming and outgoing class of restrictions that are provisioned on the dial peers.

COR specifies which incoming dial peer can use which outgoing dial peer to make a call. You can provision each dial peer with an incoming and an outgoing COR list. The incoming COR list indicates the capability of the dial peer to initiate certain classes of calls. The outgoing COR list indicates the capability that is required for an incoming dial peer to deliver a call through this outgoing dial peer.

Before you begin

You must configure COR Groups. For more information, see [Dial Peer Configuration Guide](#).

SUMMARY STEPS

1. **enable**
2. **configure terminal**
3. **dial-peer voice *tag* voip**
4. **corlist incoming *dial-peer***
5. **corlist outgoing *dial-peer***
6. **description *string***
7. **destination-pattern *number***
8. **session protocol sipv2**
9. **session target registrar**
10. **voice-class sip registration passthrough local-fallback *tag***
11. **end**

DETAILED STEPS

	Command or Action	Purpose
Step 1	enable Example: <pre>Device> enable</pre>	Enables privileged EXEC mode. <ul style="list-style-type: none"> • Enter your password if prompted.
Step 2	configure terminal Example: <pre>Device# configure terminal</pre>	Enters global configuration mode.
Step 3	dial-peer voice <i>tag</i> voip Example: <pre>Device(config)# dial-peer voice 3 voip</pre>	Enters dial peer configuration mode.
Step 4	corlist incoming <i>dial-peer</i> Example: <pre>Device(config-dial-peer)# corlist incoming FromPhone</pre>	Specifies the COR to be applied on an incoming dial peer (for incoming calls).
Step 5	corlist outgoing <i>dial-peer</i> Example: <pre>Device(config-dial-peer)# corlist outgoing FromSP</pre>	Specifies the COR to be applied for outgoing dial peer (for outgoing calls).

	Command or Action	Purpose
Step 6	description <i>string</i> Example: Device(config-dial-peer)# description registration	Adds a description to a dial peer.
Step 7	destination-pattern <i>number</i> Example: Device(config-dial-peer)# destination-pattern 1111	Specifies either the prefix or the full E.164 phone number to be used for the dial peer.
Step 8	session protocol sipv2 Example: Device(config-dial-peer)# session protocol sipv2	Specifies the session protocol for SIP calls between local and remote devices using the packet network.
Step 9	session target registrar Example: Device(config-dial-peer)# session target registrar	Specifies to route the call to the registrar endpoint for SIP dial peers.
Step 10	voice-class sip registration passthrough local-fallback <i>tag</i> Example: Device(config-dial-peer)# voice-class sip registration passthrough local-fallback 5	Configures SIP registration passthrough for local fallback mode.
Step 11	end Example: Device(config-dial-peer)# end	Returns to privileged EXEC mode.

Verifying Survivability for Hosted and Cloud Services

The **show** commands can be entered in any order.

SUMMARY STEPS

1. **enable**
2. **show dial-peer voice summary**
3. **show sip-ua registration passthrough status**
4. **show sip-ua register status**
5. **show voip rtp connections**
6. **show call active voice compact**

DETAILED STEPS

Step 1 enable

Enables privileged EXEC mode.

Example:

```
Device> enable
```

Step 2 show dial-peer voice summary

Displays the summary information for each voice dial peer.

Example:

```
Device# show dial-peer voice summary
```

```
dial-peer hunt 0
          AD
TAG      TYPE  MIN  OPER  PREFIX  DEST-PATTERN  PRE  PASS  OUT
1        voip  up   up     1111...  1111...       0   syst  registrar
2        voip  up   down  1.....  1.....       0   syst  ipv4:10.104.45.253      busyout
1000     voip  down down  9900...  9900...       0   syst  ipv4:9.0.0.174:30601
101     voip  down down  1.....  1.....       0   syst  ipv4:10.104.45.31
102     voip  down down  11.....  11.....       0   syst  ipv4:10.104.45.253
300     voip  down down  .T       .T           0   syst
400     voip  down down  11110...  11110...     0   syst  registrar
```

Step 3 show sip-ua registration passthrough status

Displays information about the SIP user agent registration passthrough status. In the sample output shown below, the parameter In-Exp shows the remaining expiry time and the survival field parameters can be regsync, locfall, or normal.

Example:

```
Device# show sip-ua registration passthrough status
```

```
CallId      Line      peer      mode In-Exp      reg-I Out-Exp survival
=====
5300        1111008  1         e2e  1041 /1200  ----- 1200  normal *
5305        1111002  1         e2e  2847 /3000  ----- 3000  normal *
5311        1111020  1         e2e  1070 /1200  ----- 1200  normal *
=====
```

Step 4 show sip-ua register status

Displays information about the SIP user agent register status.

Example:

```
Device# show sip-ua register status
```

```
Line      peer  expires(sec)  reg survival P-Associ-URI
=====
11123    23    59            yes regsync
```

Step 5 show voip rtp connections

Displays Real-Time Transport Protocol (RTP) named event packets.

Example:

```
Device# show voip rtp connections
```

```
VoIP RTP Port Usage Information:
Max Ports Available: 8091, Ports Reserved: 101, Ports in Use: 2
Port range not configured, Min: 16384, Max: 32767
```

Ports	Ports	Ports
Media-Address Range	Reserved	In-use
		Available

Default Address-Range	8091
101	2

```
VoIP RTP active connections :
```

No.	CallId	dstCallId	LocalRTP	RmtRTP	LocalIP	RemoteIP
1	5324	5325	16410	16464	9.40.1.168	9.40.1.173
2	5325	5324	16412	16528	9.40.1.168	9.40.1.174

Found 2 active RTP connections

Step 6 show call active voice compact

Displays the compact version of the call information for voice calls in progress.

Example:

```
Device# show call active voice compact
```

```
<callID> A/O FAX T<sec> Codec type Peer Address IP R<ip>:<udp>
Total call-legs: 2
      5324 ANS T9 g711ulaw VOIP P1111008 9.40.1.173:16464
      5325 ORG T9 g711ulaw VOIP P1111020 9.40.1.174:16528
```

Configuration Examples—Survivability for Hosted and Cloud Services

Example: Configuring Local Fallback Globally

In the following example, local fallback is configured at global level:

```
Device> enable
Device# configure terminal
Device(config)# voice service voip
Device(conf-voi-serv)# sip
Device(conf-serv-sip)# registration passthrough local-fallback 10
Device(config-serv-sip)# end
```

Example: Configuring Local Fallback at the Tenant Level

In the following example, local fallback is configured for tenant 1 and is applied for dial-peer 444:

```
Device>enable
Device#configure terminal
Device(config)#voice class tenant 1
Device(config-class)#registration passthrough local-fallback 10
Device(config-class)#exit
Device(config)#dial-peer voice 444 voip
Device(config-dial-peer)#voice-class sip tenant 1
Device(config-class)# exit
```

Example: Configuring Local Fallback on a Dial Peer

In the following example, local fallback is configured on dial-peer 2.

```
Device> enable
Device# configure terminal
Device(config)# dial-peer voice 2 voip
Device(config-dial-peer)# voice-class sip registration passthrough local-fallback 10
Device(config-dial-peer)# end
```

Example: Configuring Survivability for Phones Sending Single Register Request

In the following example, survivability is configured for phones sending single register request:

```
Device> enable
Device# configure terminal
Device(config)# voice service voip
Device(conf-voi-serv)# sip
Device(conf-serv-sip)# survivability single-register
Device(config-serv-sip)# end
```

Example: Configuring OPTIONS Ping

In the following example, OPTIONS Ping is configured on dial-peer 3:

```
Device> enable
Device# configure terminal
Device(config)# dial-peer voice 3 voip
Device(config-dial-peer)# voice-class sip options-keepalive up-interval 120 down-interval
120
Device(config-dial-peer)# end
```

Example: Configuring the Registration Timer

In the following example, registration timer is configured with a expiration value of minimum 200 and maximum 300 seconds.

```

Device> enable
Device# configure terminal
Device(config)# voice service voip
Device(conf-voi-serv)# sip
Device(conf-serv-sip)# registrar server expires max 300 min 200
Device(conf-serv-sip)# end

```

Example: Configuring REGISTER Message Throttling

In the following example, REGISTER message throttling is configured:

```

Device>enable
Device#configure terminal
Device(config)#voice service voip
Device(conf-voi-serv)#sip
Device(conf-serv-sip)#registration passthrough rate-limit expires 3600 local-fallback 3
Device(conf-serv-sip)#end

```

Example: Configuring the COR List

In the following example, "FromPhone" and "FromSP" COR groups are configured and applied to dial-peer 2:

```

Device>enable
Device# configure terminal
Device(config)#dial-peer cor list FromPhone
Device(config-dp-corlist)#member 911
Device(config-dp-corlist)#member 1800
Device(config)#dial-peer cor list FromSP
Device(config-dp-corlist)#member 911
Device(config-dp-corlist)#member 1800
Device(config-dp-corlist)#exit
Device(config)# dial-peer voice 2 voip
Device(config-dial-peer)# corlist incoming FromPhone
Device(config-dial-peer)# corlist outgoing FromSP
Device(config-dial-peer)# description registration
Device(config-dial-peer)# destination-pattern 1111
Device(config-dial-peer)# session protocol sipv2
Device(config-dial-peer)# session target registrar
Device(config-dial-peer)# voice-class sip registration passthrough local-fallback 5
Device(config-dial-peer)# end

```

Feature Information for Survivability for Hosted and Cloud Services

The following table provides release information about the feature or features described in this module. This table lists only the software release that introduced support for a given feature in a given software release train. Unless noted otherwise, subsequent releases of that software release train also support that feature.

Use Cisco Feature Navigator to find information about platform support and Cisco software image support. To access Cisco Feature Navigator, go to <https://cfng.cisco.com/>. An account on Cisco.com is not required.

Table 96: Feature Information for Survivability for Hosted and Cloud Services

Feature Name	Releases	Feature Information
Survivability for Hosted and Cloud Services	Cisco IOS XE Fuji 16.9.1	Supports survivability for Hosted and Cloud Services.



CHAPTER 73

SUBSCRIBE-NOTIFY Passthrough

The SUBSCRIBE-NOTIFY mechanism is used for implementation of features such as Message Waiting Indication (MWI), Shared Call Appearance, Multiple Caller Appearance, Busy Lamp Field, and so on.

In CUBE, the SUBSCRIBE-NOTIFY framework on Unified Communications (UC) products supports the following:

- Configurable and Selective Passthrough of SUBSCRIBE and NOTIFY transactions from phones with the normalization that is required for address or topology hiding and dialog content updates for “dialog” event subscription.
- Survivability mode handling of incoming SUBSCRIBE request for critical events.
- [Restrictions for SUBSCRIBE-NOTIFY Passthrough, on page 949](#)
- [Information About SUBSCRIBE-NOTIFY Passthrough, on page 950](#)
- [Configure SUBSCRIBE-NOTIFY Passthrough, on page 951](#)
- [Configuration Examples for SUBSCRIBE-NOTIFY Passthrough, on page 956](#)
- [Feature Information for SUBSCRIBE-NOTIFY Passthrough, on page 957](#)

Restrictions for SUBSCRIBE-NOTIFY Passthrough

- The SUBSCRIBE-NOTIFY passthrough framework can only pass through events when there is a one-to-one association between the incoming request and the outgoing location to which the request has been sent out. This means that either:
 - There should be an outbound dial-peer identified for the request received.
 - or
 - The outbound target for the request could be only a single registrar.
- The following use cases are not supported:
 - SUBSCRIBE-NOTIFY passthrough with hunting of outbound dial-peers to which the subscribe or notify requests need to be sent.
 - SUBSCRIBE-NOTIFY passthrough where an inbound dial-peer has peer-to-peer mode of registration passthrough enabled with more than one registrar (there will be no forking of Subscribe-Notify Requests)

- Local subscribe handling of unsupported events when the remote registrar is unavailable. Local subscribe handling is only applicable to cases where the inbound dial-peer matching the subscribe has registration passthrough enabled with “local-fallback.”

Information About SUBSCRIBE-NOTIFY Passthrough

The key attributes of the SUBSCRIBE-NOTIFY Passthrough feature are as follows:

- Message Passthrough Application (MPA)—The SIP MPA handles SUBSCRIBE-NOTIFY passthrough. This application maintains subscribe dialogs, and references the dial-peer database and registration passthrough configurations to route the initial SUBSCRIBE and unsolicited NOTIFY requests.
- Header Passthrough—All the non-mandatory headers in SUBSCRIBE-NOTIFY requests and responses are passed through from one endpoint to the other.
- Content Passthrough—The content bodies in SUBSCRIBE-NOTIFY requests are passed through transparently from one endpoint to the other.
- “Dialog” Event Content Manipulation—The content in the NOTIFY body for a dialog event is updated before passthrough when the dialog is maintained by the CUBE.
- Passthrough Configuration and Filtering—SUBSCRIBE-NOTIFY passthrough is configurable globally as well as under dial-peer, and can be configured for selected events using the configuration of an event list.
- Error Passthrough for SUBSCRIBE-NOTIFY Requests—When an error is received for a SUBSCRIBE-NOTIFY request, the error is passed through to the peer with the relevant headers.
- Backward Compatibility—The SIP MPA has the highest priority when SUBSCRIBE-NOTIFY passthrough is enabled. If passthrough is not enabled (either for all events or for a specific event), the current applications will control the incoming requests and responses.
- 401/407 Error Message Passthrough—SIP message 401/407 is sent by the user-agent server (UAS) or end device to challenge messages like INVITE/REFER/SUBSCRIBE and request for endpoint credentials information. CUBE does not store endpoint credential information to act on behalf of phone or endpoint. To enable the passthrough of 401/407, you can enable the **error passthru** command at the global level. The messages 401/407 are in passthru mode for INVITE/REFER/SUBSCRIBE.

SUBSCRIBE-NOTIFY Passthrough Request Routing

The first step of request or response routing is for CUBE to determine whether or not the request has to be passed through. When a new SUBSCRIBE or unsolicited NOTIFY request arrives, its headers are used to match an incoming dial-peer. If the incoming dial-peer has SUBSCRIBE-NOTIFY Passthrough (SNPT) enabled or if there is no incoming dial-peer and global SNPT is enabled for that event, then the request is handed off to be passed through. For solicited subscriptions, the passthrough check is applicable only to the initial SUBSCRIBE request; subsequent requests or responses are not checked and will be routed based on updated dialog parameters.

The second step is to determine the outbound destination of the SUBSCRIBE or unsolicited NOTIFY request.

- **First Pass: Outbound dial-peer match**—An outbound VoIP dial-peer is first matched based on the request headers (From, To, and Via), the Subscriber Number (userid in the To header), and the incoming dial-peer Class of Restrictions (CoR) if any. If there is a match, the request is routed to the session target.
- **Second Pass: Configured registrar for registration passthrough in peer-to-peer mode**—If no outbound dial-peer is found and the incoming dial-peer has registration passthrough enabled in static (peer-to-peer) mode with a single registrar configured, then the request is routed to the registrar address.
- **Third Pass: Configured registrar for registration passthrough in end-to-end mode**—If no outbound dial-peer is found and the incoming dial-peer has registration passthrough enabled in dynamic (end-to-end) mode:
 - If the request Uniform Resource Identifier (URI) has the CUBE IP address, the request is routed to the configured registrar if only a single registrar is configured.
 - If the request URI has a non-CUBE IP address, then the request is routed to that IP address.
- **Fourth Pass: Request URI-based routing**—If no outbound dial-peer is found and no registration passthrough is configured, the request URI is used to route the request if it does not point to the CUBE's IP address.

SUBSCRIBE-NOTIFY Passthrough Survivability Mode

In survivability mode, the CUBE could encounter the following scenarios:

- When the CUBE receives a line-seize (event) subscribe in survivability mode, it checks the line-seize queue to see if another phone has already seized the same line; if not, CUBE accepts the subscription, sends a NOTIFY response with State = Active, and starts the timer for expiration. In survivability mode, SUBSCRIBE received for any event other than line-seize is rejected.
- If another phone has already subscribed for the line, CUBE sends a 200 OK (request successful) response for the new subscribe, but a final NOTIFY to indicate that the subscription has been terminated.
- If the subscription timer expires without re-subscription from the phone, CUBE sends a final NOTIFY to remove the subscription.
- If a subscription is created in active mode, but re-subscriptions or unsubscriptions are received in survivability mode, then CUBE returns an error for this subscription.

Configure SUBSCRIBE-NOTIFY Passthrough

Configuring an Event List

SUMMARY STEPS

1. **enable**
2. **configure terminal**
3. **voice class sip-event** *number*
4. **event** *name*
5. **end**

DETAILED STEPS

	Command or Action	Purpose
Step 1	enable Example: <pre>Device> enable</pre>	Enables privileged EXEC mode. <ul style="list-style-type: none"> • Enter your password if prompted.
Step 2	configure terminal Example: <pre>Device# configure terminal</pre>	Enters global configuration mode.
Step 3	voice class sip-event <i>number</i> Example: <pre>Device(config)# voice class sip-event 1</pre>	Enters voice class configuration mode and configures the list of events to be passed through.
Step 4	event <i>name</i> Example: <pre>Device(config-class)# event message-summary</pre>	Adds the name of the event to be added to the event list.
Step 5	end Example: <pre>Device(config-class)# end</pre>	Returns to privileged EXEC mode.

Configuring SUBSCRIBE-NOTIFY Event Passthrough Globally

SUMMARY STEPS

1. enable
2. configure terminal
3. voice service voip
4. sip
5. pass-thru subscribe-notify-events *tag*
6. end

DETAILED STEPS

	Command or Action	Purpose
Step 1	enable Example:	Enables privileged EXEC mode. <ul style="list-style-type: none"> • Enter your password if prompted.

	Command or Action	Purpose
	Device> enable	
Step 2	configure terminal Example: Device# configure terminal	Enters global configuration mode.
Step 3	voice service voip Example: Device(config)# voice class voip	Enters voice service VoIP configuration mode.
Step 4	sip Example: Device(conf-voi-serv)# sip	Enters voice service SIP configuration mode.
Step 5	pass-thru subscribe-notify-events tag Example: Device(conf-serv-sip)# pass-thru subscribe-notify-events 1	Configures SUBSCRIBE-NOTIFY passthrough event with the SIP event list tag number to be linked globally. <ul style="list-style-type: none"> You can use the pass-thru subscribe-notify-events all command to configure passthrough for all SUBSCRIBE-NOTIFY events.
Step 6	end Example: Device(conf-serv-sip)# end	Returns to privileged EXEC mode.

Configuring SUBSCRIBE-NOTIFY Event Passthrough at the Dial-Peer Level

SUMMARY STEPS

1. enable
2. configure terminal
3. dial-peer voice tag voip
4. voice-class sip pass-thru subscribe-notify-events tag
5. end

DETAILED STEPS

	Command or Action	Purpose
Step 1	enable Example:	Enables privileged EXEC mode. <ul style="list-style-type: none"> Enter your password if prompted.

	Command or Action	Purpose
	Device> enable	
Step 2	configure terminal Example: Device# configure terminal	Enters global configuration mode.
Step 3	dial-peer voice tag voip Example: Device(config)# dial-peer voice 123 voip	Enters dial peer voice configuration mode.
Step 4	voice-class sip pass-thru subscribe-notify-events tag Example: Device(config-dial-peer)# voice-class sip pass-thru subscribe-notify-events 1	Configures SUBSCRIBE-NOTIFY passthrough event with the SIP event list tag number to be linked globally. <ul style="list-style-type: none"> You can use the voice-class sip pass-thru subscribe-notify-events all command to configure passthrough for all SUBSCRIBE-NOTIFY events.
Step 5	end Example: Device(conf-serv-sip)# end	Returns to privileged EXEC mode.

Verifying SUBSCRIBE-NOTIFY Passthrough

Perform this task to verify the configuration for SUBSCRIBE-NOTIFY Passthrough and to verify the subscriptions created. The **show** commands can be entered in any order.

SUMMARY STEPS

1. enable
2. show dial-peer voice *number* | inc pass
3. show subscription asnl session active
4. show subscription sip

DETAILED STEPS

-
- Step 1** **enable**
- Enables privileged EXEC mode.
- Example:**
- ```
Device> enable
```



**Step 2** `show dial-peer voice number | inc pass`

Displays the information for voice dial peers. The following sample output shows the configured SUBSCRIBE-NOTIFY passthrough event for a particular dial peer.

**Example:**

```
Device# show dial-peer voice 123 | inc pass

ip media DSCP = ef, ip media rsvp-pass DSCP = ef
ip video rsvp-none DSCP = af41, ip video rsvp-pass DSCP = af41
voice class sip pass-thru headers = system,
voice class sip pass-thru subscribe-notify-events = system,
voice class sip pass-thru content unsupp = system,
voice class sip pass-thru content sdp = system,
voice class sip privacy-policy passthru = system,
voice class sip registration passthrough = System
voice class sip referto-passing = system
```

**Step 3** `show subscription asnl session active`

Displays information about Application Subscribe/Notify Layer (ASNL)-based and non-ASNL-based SIP subscriptions.

**Example:**

```
Device# show subscription asnl session active
```

```
ASNL Active Subscription Records Details:
=====
Number of active subscriptions: 1
URL: sip:user@10.7.104.88
 Event Name : stress
 Session ID : 8
 Expiration Time : 50 seconds
 Subscription Duration : 5 seconds
 Protocol : ASNL_PROTO_SIP
 Remote IP address : 10.7.104.88
 Port : 5060
 Call ID : 5
 Total Subscriptions Sent : 1
 Total Subscriptions Received: 0
 Total Notifications Sent : 0
 Total Notifications Received : 2
 Last response code : ASNL_NOTIFY_RCVD
 Last error code : ASNL_NONE
 First Subscription Time : 10:55:12 UTC Apr 9 2000
 Last Subscription Time : 10:55:12 UTC Apr 9 2000
 First Notify Time : 10:55:12 UTC Apr 9 2000
 Last Notify Time : 10:55:17 UTC Apr 9 2000
 Application that subscribed : stress
 Application receiving notification: stress
```

**Step 4** `show subscription sip`

Displays information about ASNL-based and non-ASNL-based SIP subscriptions.

**Example:**

```
Device# show subscription sip
```

```
ASNL Active Subscription Records Summary:
=====
```

Number of active subscriptions: 2

| SubId | CallId | Proto          | URL                            | Event      |
|-------|--------|----------------|--------------------------------|------------|
| 1     | N/A    | ASNL_PROTO_SIP | "Plutus" <sip:1111003@primary> | all        |
| 2     | N/A    | ASNL_PROTO_SIP | sip:1111003@primaryappserver1  | as-feature |

| Client  | EXPIRES(sec) | EVENT            |
|---------|--------------|------------------|
| 1111003 | 0            | as-feature-event |
| 1234    | 0            | message-summary  |

## Troubleshooting Tips

Use the following commands to troubleshoot SUBSCRIBE-NOTIFY Passthrough:

- **debug mpa events**
- **debug mpa error**
- **debug ccsip messages**
- **debug asnl events**
- **debug asnl error**
- **debug ccsip all**

## Configuration Examples for SUBSCRIBE-NOTIFY Passthrough

### Example: Configuring an Event List

The following example shows how to configure an event list and add an event to the list of events that have to be passed through.

```
Device> enable
Device# configure terminal
Device(config)# voice class sip-event-list 1
Device(config-class)# event 1 message-summary
Device(config-class)# end
```

### Example: Configuring SUBSCRIBE-NOTIFY Event Passthrough Globally

The following example shows how to configure the SUBSCRIBE-NOTIFY passthrough event and link the SIP event list tag number globally.

```
Device> enable
Device# configure terminal
Device(config)# voice service voip
Device(conf-voi-serv)# sip
Device(conf-serv-sip)# pass-thru subscribe-notify-events 1
Device(conf-serv-sip)# end
```

## Example: Configuring SUBSCRIBE-NOTIFY Event Passthrough under a Dial Peer

The following example shows how to configure the SUBSCRIBE-NOTIFY passthrough event and link the SIP event list tag number under a dial peer.

```
Device> enable
Device# configure terminal
Device(config)# dial-peer voice 123 voip
Device(config-dial-peer)# voice-class sip pass-thru subscribe-notify-events 1
Device(config-dial-peer)# end
```

## Feature Information for SUBSCRIBE-NOTIFY Passthrough

The following table provides release information about the feature or features described in this module. This table lists only the software release that introduced support for a given feature in a given software release train. Unless noted otherwise, subsequent releases of that software release train also support that feature.

Use Cisco Feature Navigator to find information about platform support and Cisco software image support. To access Cisco Feature Navigator, go to <https://cfng.cisco.com/>. An account on Cisco.com is not required.

Table 97: Feature Information for SUBSCRIBE-NOTIFY Passthrough

| Feature Name                        | Releases                 | Feature Information                                                                                                                                                                                                                                                                                                                                                                                                                                                                                                                                                                                                                                                                    |
|-------------------------------------|--------------------------|----------------------------------------------------------------------------------------------------------------------------------------------------------------------------------------------------------------------------------------------------------------------------------------------------------------------------------------------------------------------------------------------------------------------------------------------------------------------------------------------------------------------------------------------------------------------------------------------------------------------------------------------------------------------------------------|
| CUBE (SUBSCRIBE-NOTIFY Passthrough) | Cisco IOS XE Fuji 16.9.1 | <p>The SUBSCRIBE-NOTIFY mechanism is used for implementation of features such as Message Waiting Indication (MWI), Shared Call Appearance, Multiple Caller Appearance, Busy Lamp Field, and so on.</p> <p>In CUBE, the SUBSCRIBE-NOTIFY framework on Unified Communications (UC) products supports the following:</p> <ul style="list-style-type: none"> <li>• Configurable and Selective Passthrough of SUBSCRIBE and NOTIFY transactions from phones with the normalization required for address or topology hiding and dialog content updates for “dialog” event subscription.</li> <li>• Survivability mode handling of incoming SUBSCRIBE request for critical events.</li> </ul> |



## PART **XIX**

# **Cisco Unified Communications Manager Line-Side Support**

- [Cisco Unified Communications Manager Line-Side Support](#) , on page 961





## CHAPTER 74

# Cisco Unified Communications Manager Line-Side Support

---



**Note** The Cisco Unified Communications Manager (Unified Communications Manager) Lineside feature is no longer supported. The feature is deprecated for Cisco Unified Border Element on Cisco IOS 15.5(2)T Release and later releases. To support this feature, you must configure Cisco Unified Border Element on Cisco IOS 15.4(2)T or prior releases.

---

Cisco Unified Communications Manager is an enterprise-class IP communications processing system. It extends enterprise telephony features and capabilities to IP phones, media processing devices, VoIP gateways, mobile devices, and multimedia applications. Cisco Unified Border Element (Cisco UBE) provides line-side support for Cisco Unified Communications Manager. This support enables communication between devices (such as phones) used by remote users on different logical networks, in both cloud-based and premise-based deployments.

- [Feature Information for Cisco Unified Communications Manager Line-Side Support, on page 961](#)
- [Restrictions for Cisco Unified Communications Manager Line-Side Support, on page 962](#)
- [Information About Cisco Unified Communications Manager Line-Side Support, on page 963](#)

## Feature Information for Cisco Unified Communications Manager Line-Side Support

The following table provides release information about the feature or features described in this module. This table lists only the software release that introduced support for a given feature in a given software release train. Unless noted otherwise, subsequent releases of that software release train also support that feature.

Use Cisco Feature Navigator to find information about platform support and Cisco software image support. To access Cisco Feature Navigator, go to <https://cfng.cisco.com/>. An account on Cisco.com is not required.

Table 98: Feature Information for Cisco Unified Communications Manager Line-Side Support

| Feature Name                                           | Releases                               | Feature Information                                                                                                                                                                                                                                                                                                                                                                                                                                                                                                                                                                                                                                                                                                                                                                                                                                                                                                         |
|--------------------------------------------------------|----------------------------------------|-----------------------------------------------------------------------------------------------------------------------------------------------------------------------------------------------------------------------------------------------------------------------------------------------------------------------------------------------------------------------------------------------------------------------------------------------------------------------------------------------------------------------------------------------------------------------------------------------------------------------------------------------------------------------------------------------------------------------------------------------------------------------------------------------------------------------------------------------------------------------------------------------------------------------------|
| Cisco Unified Communications Manager Line-Side Support | 15.5(2)T                               | The Cisco Unified Communications Manager (CUCM) Line-Side Support feature was supported until the release 15.4(2)T. This feature has been deprecated from 15.5(2)T release onwards.                                                                                                                                                                                                                                                                                                                                                                                                                                                                                                                                                                                                                                                                                                                                         |
| Simplified Line-Side Support of CUCM on CUBE           | 15.4(2)T<br>Cisco IOS XE Release 3.12S | The Simplified Line-Side Support of CUCM on CUBE feature simplifies the complex CUBE configurations required for registering IP Phones on a CUCM through CUBE using a single CLI that automatically applies all the necessary configurations.<br><br>The following commands were modified by this feature: <b>extension cucm</b> and <b>voice-class sip extension cucm</b> .                                                                                                                                                                                                                                                                                                                                                                                                                                                                                                                                                |
| Cisco Unified Communications Manager Line-Side Support | 15.3(3)M<br>Cisco IOS XE Release 3.10S | The Cisco Unified Communications Manager Line-Side Support feature provides line-side support for Cisco Unified Communications Manager and IP phones deployed on different logical networks, in both cloud-based and premise-based deployments.<br><br>The following commands were introduced or modified: <b>access-secure</b> , <b>capf-address</b> , <b>clear voice phone-proxy all-sessions</b> , <b>complete (ctl file)</b> , <b>ctl-file (phone proxy)</b> , <b>debug voice phone-proxy</b> , <b>description (ctl file)</b> , <b>description (phone proxy)</b> , <b>disable service-settings</b> , <b>max-concurrent-sessions</b> , <b>phone-proxy (dial peer)</b> , <b>port-range</b> , <b>record-entry</b> , <b>show voice class ctl-file</b> , <b>show voice class phone-proxy</b> , <b>service-map</b> , <b>session-timeout</b> , <b>tftp-server address</b> , <b>voice-ctl-file</b> , <b>voice-phone-proxy</b> . |

## Restrictions for Cisco Unified Communications Manager Line-Side Support

- In Cisco Unified Communications Manager Line-Side Support deployments, Cisco Unified Border Element does not support TFTP encrypted configuration files.



# Information About Cisco Unified Communications Manager Line-Side Support

## Cisco UBE Line-Side Deployment

In a typical deployment Cisco Unified Border Element (Cisco UBE) is placed between the Cisco Unified Communications Manager and the endpoint. Before invoking a service the phone contacts the CUBE Trivial File Transfer Protocol (TFTP) server to get configuration information such as the Certificate Trust List (CTL) file and phone-specific configuration settings. The phone then registers with Cisco Unified Communications Manager. In the deployment shown below, Cisco Unified Communications Manager and the phone configuration operate in unsecured mode (TCP to Real-Time Transport Protocol). The phone configuration can be changed to operate in a secure mode (Transport Layer Security Secure to Real-Time Transport Protocol) if needed. When the phone registration is completed the phone can invoke all normal call services.

**Figure 92: Cisco UBE Line-Side Deployment**

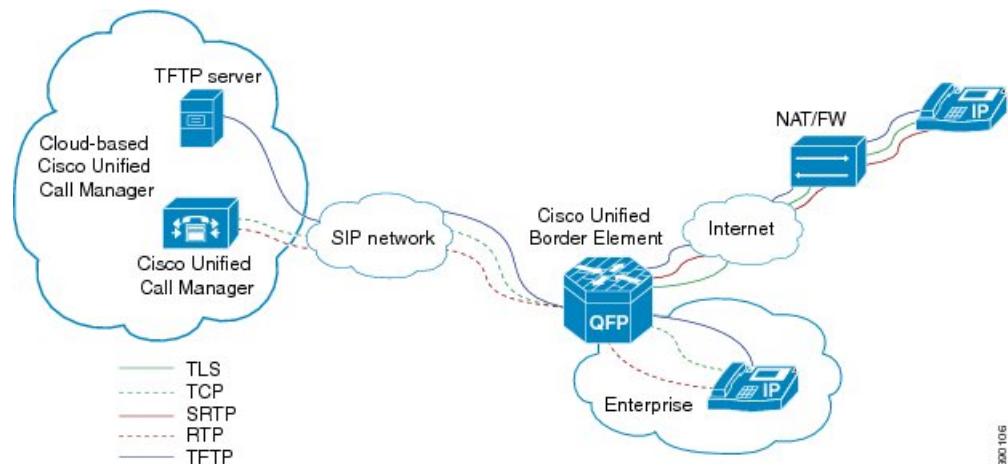

## Line-Side Deployment Scenarios

Cisco Unified Call Manager Line-Side support can be deployed in the following ways:

- Line-Side Secure Deployment -

CUCM line-side secure deployment, provides secure access between phone and CUBE. CUBE terminates the TLS connection from phone and initiates a TCP connection to CUCM to perform TLS-TCP inter-working. Refer to 'Example: Configuring CUCM Secure Line-Side' section for the steps involved in configuring secure deployment.

- Line-Side Non-Secure Deployment -

CUCM line-side non-secure deployment, provides a non-secure connection between phone and CUBE. Refer to 'Example: Configuring CUCM Non-Secure Line-Side' section for the steps involved in configuring non-secure deployment.

## Line-Side Support for CUCM on CUBE

For an IP phone to register on a CUCM through CUBE, CUBE must be configured to do the following requirements.

- TCP must be used for registration.
- The MAC address of the device (device ID) and the device name, present in the CONTACT header of the REGISTER message, need to be copied to the outgoing messages and passed to the CUCM intact.

**Table 99: Command for Line-Side Support for CUCM on CUBE**

| Dial-Peer Configuration Mode (config-dial-peer) | Global VoIP Configuration mode (config-voi-serv) |
|-------------------------------------------------|--------------------------------------------------|
| voice-class sip extension cucm                  | sip<br>extension cucm                            |

When Line Side Support for CUCM on CUBE feature is configured, the following supported, nonmandatory headers are passed through automatically without the need for further configuration:

- Call-Info
- Content-ID
- Allow-Events
- Supported
- Remote-Party-ID
- Require
- Referred-By

**Figure 93: Predefined Supported NonMandatory Headers**

```
!-- predefined hidden supported non-mandatory header pass-through list
!-- the list number 20001 is out of user configuration range

voice class sip-hdr-passthru list 20001
passthru-hdr Call-Info
passthru-hdr Content-ID
passthru-hdr Allow-Events
passthru-hdr Supported
passthru-hdr Remote-Party-ID
passthru-hdr Require
passthru-hdr Referred-By
```

371467

When Line Side Support for CUCM on CUBE is configured, predefined SIP profiles automatically remove the Cisco-Guide header from the outgoing INVITE.

**Figure 94: Predefined SIP Profile**

```
!-- predefined hidden sip profile
!-- the profile number 20001 is out of user configuration range

voice class sip-profiles 20001
request INVITE sip-header Cisco-Guid remove
```

371468



**Note** If a user explicitly configures the above configurations, ensure that the configurations are merged with the above automatic configurations.

# Configuring a PKI Trustpoint

## SUMMARY STEPS

1. **crypto key generate rsa** [*label key-label*] [*modulus modulus-size*] **general-keys**
2. **crypto pki trustpoint** *name*
3. **enrollment selfsigned**
4. **subject-name** [*x.500-name*]
5. **subject-alt-name** *sip-security-profile-name*
6. **revocation-check** *method1*[*method2* [*method3*]]
7. **rsakeypair** *key-label*

## DETAILED STEPS

|        | Command or Action                                                                                                                                                                                                                               | Purpose                                                                                                                                                                                                                                                                                                                              |
|--------|-------------------------------------------------------------------------------------------------------------------------------------------------------------------------------------------------------------------------------------------------|--------------------------------------------------------------------------------------------------------------------------------------------------------------------------------------------------------------------------------------------------------------------------------------------------------------------------------------|
| Step 1 | <p><b>crypto key generate rsa</b> [<i>label key-label</i>] [<i>modulus modulus-size</i>] <b>general-keys</b></p> <p><b>Example:</b></p> <pre>Device(config)# crypto key generate rsa label pp_rsa modulus 1024 general-keys</pre>               | <p>Generates a RSA key pair.</p> <p><b>Note</b> A self-signed key can only support a <i>modulus-size</i> value of 1024 bits.</p>                                                                                                                                                                                                     |
| Step 2 | <p><b>crypto pki trustpoint</b> <i>name</i></p> <p><b>Example:</b></p> <pre>Device(config)# crypto pki trustpoint callmg23</pre>                                                                                                                | <p>Declares the trustpoint that the device should use and enters ca-trustpoint configuration mode.</p>                                                                                                                                                                                                                               |
| Step 3 | <p><b>enrollment selfsigned</b></p> <p><b>Example:</b></p> <pre>Device(config-ca-trustpoint)# enrollment selfsigned</pre>                                                                                                                       | <p>Specifies self-signed enrollment for a trustpoint.</p>                                                                                                                                                                                                                                                                            |
| Step 4 | <p><b>subject-name</b> [<i>x.500-name</i>]</p> <p><b>Example:</b></p> <pre>Device(config-ca-trustpoint)# subject-name CN=ASR1006-CCN-4</pre>                                                                                                    | <p>Specifies the subject name in the certificate request.</p>                                                                                                                                                                                                                                                                        |
| Step 5 | <p><b>subject-alt-name</b> <i>sip-security-profile-name</i></p> <p><b>Example:</b></p> <pre>Device(config-ca-trustpoint)# subject-alt-name 6961_SEC.cisco.com 8941_SEC.cisco.com 8945_SEC.cisco.com 7975_SEC.cisco.com 7970_SEC.cisco.com</pre> | <p>Specifies the alternative subject name in the certificate request.</p> <ul style="list-style-type: none"> <li>• Use the <b>subject-alt-name</b> command only when Cisco UBE is interacting with CUCM in secure mode.</li> <li>• The value of <b>subject-alt-name</b> must be the SIP security profile name under CUCM.</li> </ul> |

|               | Command or Action                                                                                                                                               | Purpose                                                        |
|---------------|-----------------------------------------------------------------------------------------------------------------------------------------------------------------|----------------------------------------------------------------|
| <b>Step 6</b> | <b>revocation-check</b> <i>method1</i> [ <i>method2</i> [ <i>method3</i> ]]<br><b>Example:</b><br><pre>Device(config-ca-trustpoint)# revocation-check crl</pre> | Checks the revocation status of a certificate.                 |
| <b>Step 7</b> | <b>rsakeypair</b> <i>key-label</i><br><b>Example:</b><br><pre>Device(config-ca-trustpoint)# rsakeypair ppl</pre>                                                | Specifies which RSA keypair to associate with the certificate. |

**What to do next**

Import the CUCM and CAPF key.

## Importing the CUCM and CAPF Key

**Before you begin**

Download the CUCM key (the CallManager.pem file) from the Cisco Unified Communications Manager Operating System Administration web page.

Login to Cisco Unified OS Administration and Security and Certificate Management, download the CUCM key (the CallManager.pem file), and copy and paste the CUCM key to CUBE

**SUMMARY STEPS**

1. **crypto pki trustpoint** *name*
2. **revocation-check** *method1*[*method2* [*method3*]]
3. **enrollment terminal**
4. **crypto pki authenticate** *name*

**DETAILED STEPS**

|               | Command or Action                                                                                                                                                | Purpose                                                                            |
|---------------|------------------------------------------------------------------------------------------------------------------------------------------------------------------|------------------------------------------------------------------------------------|
| <b>Step 1</b> | <b>crypto pki trustpoint</b> <i>name</i><br><b>Example:</b><br><pre>Device(config)# crypto pki trustpoint cucm_trustpoint</pre>                                  | Creates a trustpoint for the CUCM key and enters ca-trustpoint configuration mode. |
| <b>Step 2</b> | <b>revocation-check</b> <i>method1</i> [ <i>method2</i> [ <i>method3</i> ]]<br><b>Example:</b><br><pre>Device(config-ca-trustpoint)# revocation-check none</pre> | Checks the revocation status of a certificate.                                     |

|               | Command or Action                                                                                                                                 | Purpose                                                                                                                                                                                                                                                                                                                       |
|---------------|---------------------------------------------------------------------------------------------------------------------------------------------------|-------------------------------------------------------------------------------------------------------------------------------------------------------------------------------------------------------------------------------------------------------------------------------------------------------------------------------|
| <b>Step 3</b> | <b>enrollment terminal</b><br><b>Example:</b><br><pre>Device(config-ca-trustpoint)# enrollment terminal</pre>                                     | Specifies manual cut-and-paste certificate enrollment.                                                                                                                                                                                                                                                                        |
| <b>Step 4</b> | <b>crypto pki authenticate <i>name</i></b><br><b>Example:</b><br><pre>Device(config-ca-trustpoint)# crypto pki authenticate cucm_trustpoint</pre> | Authenticates the trustpoint. At the prompt to enter the certificate, copy the contents of the CallManager.pem file that you downloaded above and paste it at the prompt. At the prompt to accept the file, enter “yes”.<br><br><b>Note</b> When you copy the certificate, ensure that you also copy the BEGIN and END lines. |

#### What to do next

Repeat the above steps for the CAPF key (the CAPF.pem file).

## Creating a CTL File

### SUMMARY STEPS

1. **voice-ctl-file *ctl-filename***
2. **record-entry selfsigned trustpoint *trustpoint-name***
3. **record-entry capf trustpoint *trustpoint-name***
4. **record-entry cucm-tftp trustpoint *trustpoint-name***
5. **complete**

### DETAILED STEPS

|               | Command or Action                                                                                                                                                              | Purpose                                                          |
|---------------|--------------------------------------------------------------------------------------------------------------------------------------------------------------------------------|------------------------------------------------------------------|
| <b>Step 1</b> | <b>voice-ctl-file <i>ctl-filename</i></b><br><b>Example:</b><br><pre>Device(config)#voice-ctl-file ctl</pre>                                                                   | Creates a CTL file and enters CTL file configuration mode.       |
| <b>Step 2</b> | <b>record-entry selfsigned trustpoint <i>trustpoint-name</i></b><br><b>Example:</b><br><pre>Device(config-ctl-file)#record-entry selfsigned trustpoint self-trustpoint6s</pre> | Configures the trustpoints to be used for creating the CTL file. |

|               | Command or Action                                                                                                                                                  | Purpose                                                                                                                                        |
|---------------|--------------------------------------------------------------------------------------------------------------------------------------------------------------------|------------------------------------------------------------------------------------------------------------------------------------------------|
| <b>Step 3</b> | <b>record-entry capf trustpoint</b> <i>trustpoint-name</i><br><b>Example:</b><br>Device(config-ctl-file)#record-entry capf<br>trustpoint capf-trustpoint6s         | Specifies that the trustpoint is created using the CAPF certificate imported from Cisco Unified Communications Manager to the device.          |
| <b>Step 4</b> | <b>record-entry cucm-tftp trustpoint</b> <i>trustpoint-name</i><br><b>Example:</b><br>Device(config-ctl-file)#record-entry cucm-tftp<br>trustpoint cucm-trustpoint | Specifies that the trustpoint is created using the specified TFTP and Cisco Unified Communications Manager certificate imported to the device. |
| <b>Step 5</b> | <b>complete</b><br><b>Example:</b><br>Device(config-ctl-file)# complete                                                                                            | Completes the CTL-file creation.                                                                                                               |

## Configuring a Phone Proxy

### SUMMARY STEPS

1. **voice-phone-proxy** *phone-proxy-name*
2. **voice-phone-proxy file-buffer** *size*
3. **tftp-server-address** [**ipv4** *server-ip-address* | *domain-name*]
4. **ctl-file** *ctl-filename*
5. **access-secure**
6. **complete**

### DETAILED STEPS

|               | Command or Action                                                                                                       | Purpose                                                             |
|---------------|-------------------------------------------------------------------------------------------------------------------------|---------------------------------------------------------------------|
| <b>Step 1</b> | <b>voice-phone-proxy</b> <i>phone-proxy-name</i><br><b>Example:</b><br>Device(config)# voice-phone-proxy pp             | Configures a phone proxy and enters phone-proxy configuration mode. |
| <b>Step 2</b> | <b>voice-phone-proxy file-buffer</b> <i>size</i><br><b>Example:</b><br>Device(config)# voice-phone-proxy file-buffer 30 | Configures the phone-proxy file buffering parameter, in MB.         |
| <b>Step 3</b> | <b>tftp-server-address</b> [ <b>ipv4</b> <i>server-ip-address</i>   <i>domain-name</i> ]<br><b>Example:</b>             | Configures the TFTP server address.                                 |

|               | Command or Action                                                                                  | Purpose                                                              |
|---------------|----------------------------------------------------------------------------------------------------|----------------------------------------------------------------------|
|               | Device(config-phone-proxy)# tftp-server-address<br>ipv4 172.110.36.2                               |                                                                      |
| <b>Step 4</b> | <b>ctl-file</b> <i>ctl-filename</i><br><b>Example:</b><br>Device(config-phone-proxy)# ctl-file ct1 | Configures the CTL filename.                                         |
| <b>Step 5</b> | <b>access-secure</b><br><b>Example:</b><br>Device(config-phone-proxy)# access-secure               | Specifies that the secure (encrypted) mode is to be used for access. |
| <b>Step 6</b> | <b>complete</b><br><b>Example:</b><br>Device(config-phone-proxy)# complete                         | Completes the phone-proxy configuration.                             |

## Attaching a Phone Proxy to a Dial Peer

### SUMMARY STEPS

1. **dial-peer voice** *tag* **voip**
2. **phone-proxy** *phone-proxy-name* **signal-addr ipv4** *ipv4-address* **cucm ipv4** *ipv4-address*
3. **session protocol sipv2**
4. **session target registrar**
5. **session transport** {**udp** | **tcp** [**tls**]}
6. **incoming uri** {**from** | **request** | **to** | **via**} *tag*
7. **destination uri** *tag*
8. **voice-class sip call-route url**
9. **voice-class sip profiles** *number*
10. **voice-class sip registration passthrough** [**registrar-index** *index*]
11. **voice-class sip pass-thru headers**
12. **voice-class sip copy-list** {*tag* | **system**}
13. **codec transparent**

### DETAILED STEPS

|               | Command or Action                                                                                           | Purpose                                                                                                               |
|---------------|-------------------------------------------------------------------------------------------------------------|-----------------------------------------------------------------------------------------------------------------------|
| <b>Step 1</b> | <b>dial-peer voice</b> <i>tag</i> <b>voip</b><br><b>Example:</b><br>Device(config)# dial-peer voice 10 voip | Defines a particular dial peer, specifies the method of voice encapsulation, and enters dial peer configuration mode. |

|               | Command or Action                                                                                                                                                                                                                                                             | Purpose                                                                                                                                                                               |
|---------------|-------------------------------------------------------------------------------------------------------------------------------------------------------------------------------------------------------------------------------------------------------------------------------|---------------------------------------------------------------------------------------------------------------------------------------------------------------------------------------|
| <b>Step 2</b> | <p><b>phone-proxy</b> <i>phone-proxy-name</i> <b>signal-addr</b> <b>ipv4</b> <i>ipv4-address</i> <b>cucm</b> <b>ipv4</b> <i>ipv4-address</i></p> <p><b>Example:</b></p> <pre>Device(config-dial-peer)# phone-proxy pp1 signal-addr ipv4 10.0.0.8 cucm ipv4 198.51.100.1</pre> | Configures the phone proxy for the related dial peer.                                                                                                                                 |
| <b>Step 3</b> | <p><b>session protocol</b> <b>sipv2</b></p> <p><b>Example:</b></p> <pre>Device(config-dial-peer)# session protocol sipv2</pre>                                                                                                                                                | Specifies a session protocol (SIPv2) for calls between local and remote devices.                                                                                                      |
| <b>Step 4</b> | <p><b>session target</b> <b>registrar</b></p> <p><b>Example:</b></p> <pre>Device(config-dial-peer)# session target registrar</pre>                                                                                                                                            | Specifies that a call from a VoIP dial peer is routed to the registrar end point.                                                                                                     |
| <b>Step 5</b> | <p><b>session transport</b> {<b>udp</b>   <b>tcp</b> [<b>tls</b>]}</p> <p><b>Example:</b></p> <pre>Device(config-dial-peer)# session transport tcp tls</pre>                                                                                                                  | Configures the underlying transport layer protocol for SIP messages to transport layer security over TCP (TLS over TCP).                                                              |
| <b>Step 6</b> | <p><b>incoming uri</b> {<b>from</b>   <b>request</b>   <b>to</b>   <b>via</b>} <i>tag</i></p> <p><b>Example:</b></p> <pre>Device(config-dial-peer)# incoming uri request 11</pre>                                                                                             | Specifies the voice class used to match the VoIP dial peer to the uniform resource identifier (URI) of an incoming call. Any request matching “uri 11” is destined to this dial peer. |
| <b>Step 7</b> | <p><b>destination uri</b> <i>tag</i></p> <p><b>Example:</b></p> <pre>Device(config-dial-peer)# destination uri 12</pre>                                                                                                                                                       | Specifies the voice class used to match a dial peer to the destination URI of an outgoing call. Any request matching “uri 12” is destined to this dial peer.                          |
| <b>Step 8</b> | <p><b>voice-class sip</b> <b>call-route</b> <b>url</b></p> <p><b>Example:</b></p> <pre>Device(config-dial-peer)# voice-class sip call-route url</pre>                                                                                                                         | Enables call routing based on the URL.                                                                                                                                                |
| <b>Step 9</b> | <p><b>voice-class sip</b> <b>profiles</b> <i>number</i></p> <p><b>Example:</b></p> <pre>Device(config-dial-peer)# voice-class sip profiles 10</pre>                                                                                                                           | Configures a SIP profile for a voice class.                                                                                                                                           |



|         | Command or Action                                                                                                                                                                                     | Purpose                                                                                                    |
|---------|-------------------------------------------------------------------------------------------------------------------------------------------------------------------------------------------------------|------------------------------------------------------------------------------------------------------------|
| Step 10 | <p><b>voice-class sip registration passthrough [registrar-index index]</b></p> <p><b>Example:</b></p> <pre>Device(config-dial-peer)# voice-class sip registration passthrough registrar-index 1</pre> | Configures the SIP registration pass-through options on the dial peer.                                     |
| Step 11 | <p><b>voice-class sip pass-thru headers</b></p> <p><b>Example:</b></p> <pre>Device(config-dial-peer)# voice-class sip pass-thru headers 10</pre>                                                      | Configures a list of headers for pass through by referring to a globally configured list.                  |
| Step 12 | <p><b>voice-class sip copy-list {tag   system}</b></p> <p><b>Example:</b></p> <pre>Device(config-dial-peer)# voice-class sip copy-list 10</pre>                                                       | Configures the list of entities to be sent to the peer call leg.                                           |
| Step 13 | <p><b>codec transparent</b></p> <p><b>Example:</b></p> <pre>Device(config-dial-peer)# codec transparent</pre>                                                                                         | Enables codec capabilities to be passed transparently between endpoints in a Cisco Unified Border Element. |

## Verifying CUCM Lineside Support

The **show** commands can be entered in any order.

### SUMMARY STEPS

1. **enable**
2. **show dial-peer voice *dial-peer-id* | section voice class sip extension**
3. **show dial-peer voice**
4. **show voice class phone-proxy**
5. **show voice class phone-proxy sessions**

### DETAILED STEPS

#### Step 1 enable

Enables privileged EXEC mode.

- Enter your password if prompted.

**Example:**

```
Device> enable
```

**Step 2** **show dial-peer voice *dial-peer-id* | section voice class sip extension****Example:**

```
CUBE# show dial-peer voice 5678 | section voice class sip extension
voice class sip extension = system,
```

Displays if **extension cucm** has not been configured for the dial peer.

**Example:**

```
CUBE# show dial-peer voice 5678 | section voice class sip extension
voice class sip extension = cucm,
```

Displays if **extension cucm** has been configured for the dial peer.

**Example:**

```
CUBE# show dial-peer voice 5678 | section voice class sip extension
voice class sip extension = none,
```

Displays if **extension cucm** has been removed for the dial peer using the **no** form of the command.

**Step 3** **show dial-peer voice****Example:**

```
Device# show dial-peer voice 100
voice class sip extension = system,
voice class sip contact-passing = system,
voice class sip requiri-passing = system,
voice class phone proxy name: phone_proxy_secure
voice class phone proxy config: complete
```

**Step 4** **show voice class phone-proxy****Example:**

```
Device# show voice class phone-proxy
Phone-Proxy 'phone_proxy':
Description:
 Access Secure: non-secure (default)
 Tftp-server address: 20.21.27.146
 Capf server address: 20.21.27.146
 CUCM service settings: preserve (default)
 CTL file name: ctl_file
 Session-timeout: 180 seconds
 Max-concurrent-sessions: 30
 Current sessions: 0
 TFTP sessions: 0
 HTTP download sessions: 0
 HTTP application sessions: 0
 CAPF sessions: 0
 Config status: complete
 SIP dial-peers associated:
 Name

 1

```

```

Phone-Proxy 'phone_proxy_secure':
Description:
 Access Secure: secure
Tftp-server address: 20.21.27.146
Capf server address: 20.21.27.146
CUCM service settings: preserve (default)
CTL file name: ctl_file
Session-timeout: 180 seconds
Max-concurrent-sessions: 30
Current sessions: 0
TFTP sessions: 0
HTTP download sessions: 0
HTTP application sessions: 0
CAPF sessions: 0
Config status: complete
SIP dial-peers associated:
 Name

 3
 dialpeer4

```

### Step 5 show voice class phone-proxy sessions

#### Example:

```
Device# show voice class phone-proxy sessions
```

```

Phone-Proxy 'phone_proxy_ipad':
Source Sessions of Dial-peer 5 Destination

|Access: 10.74.9.219 :45232 10.74.9.209 :6970
|
|Core : 20.21.29.209 :45300 20.21.27.146 :6970
|

```

## Example: Configuring a PKI Trustpoint

```

Device(config)# crypto key generate rsa label pp_rsa modulus 1024 general-keys
Device(config)# crypto pki trustpoint callmg23
Device(config-ca-trustpoint)# enrollment selfsigned
Device(config-ca-trustpoint)# subject-name CN=ASR1006-CCN-4
Device(config-ca-trustpoint)# subject-alt-name 6961_SEC.cisco.com 8941_SEC.cisco.com
8945_SEC.cisco.com 7975_SEC.cisco.com 7970_SEC.cisco.com
Device(config-ca-trustpoint)# revocation-check crl
Device(config-ca-trustpoint)# rsakeypair pp1

```

## Example: Importing the CUCM and CAPF Key

The following example shows how to import the CUCM and CAPF key after you have downloaded the CUCM key (the CallManager.pem file) and the CAPF key (the CAPF.pem file) from the Cisco Unified Communications Manager Operating System Administration web page.

```
Device(config)# crypto pki trustpoint cucm_trustpoint
Device(config-ca-trustpoint)# revocation-check none
Device(config-ca-trustpoint)# enrollment terminal
Device(config-ca-trustpoint)# crypto pki authenticate cucm_trustpoint
```

## Example: Creating a CTL File

```
Device(config)# voice-ctl-file ctl
Device(config-ctl-file)# record-entry selfsigned trustpoint self-trustpoint6s
Device(config-ctl-file)# record-entry capf trustpoint capf-trustpoint6s
Device(config-ctl-file)# record-entry cucm-tftp trustpoint cucm-trustpoint
Device(config-ctl-file)# complete
```

## Example: Configuring a Phone Proxy

```
Device(config)# voice-phone-proxy pp
Device(config-phone-proxy)# voice-phone-proxy pp
Device(config-phone-proxy)# voice-phone-proxy file-buffer size 30
Device(config-phone-proxy)# tftp-server address ipv4 172.110.36.2
Device(config-phone-proxy)# ctl-file ctl
Device(config-phone-proxy)# access-secure
Device(config-phone-proxy)# complete
```

## Example: Attaching a Phone Proxy to a Dial Peer

```
Device(config)# dial-peer voice 10 voip
Device(config-dial-peer)# phone-proxy pp1 signal-addr ipv4 10.0.0.8 cucm ipv4 198.51.100.1

Device(config-dial-peer)# session-protocol sipv2
Device(config-dial-peer)# session target registrar
Device(config-dial-peer)# session transport tcp tls
Device(config-dial-peer)# incoming uri request 11
Device(config-dial-peer)# destination uri 12
Device(config-dial-peer)# voice-class sip call-route url
Device(config-dial-peer)# voice-class sip profiles 10
Device(config-dial-peer)# voice-class sip registration passthrough registrar-index 1
Device(config-dial-peer)# voice-class sip passthrough headers 10
Device(config-dial-peer)# voice-class sip copy-list 10
Device(config-dial-peer)# codec transparent
```

## Example: Configuring CUCM Secure Line-Side

The details of the IP address used in the below example are as follows:

- CUBE IP address facing phone : 172.18.110.120
- CUBE IP address facing CUCM : 10.50.209.100
- CUCM IP address : 10.50.209.215

### Generate and Import Certificate on CUBE

```
Device(config)# crypto pki trustpoint selfsign
Device(config)# enrollment selfsigned
Device(config)# subject-name CN=CUBE, O=CISCO
Device(config)# revocation-check none
Device(config)# rsakeypair selfsign

Device(config)# crypto pki trustpoint ccm1
Device(config)# enrollment terminal
Device(config)# revocation-check none

Device(config)# crypto pki trustpoint Cisco_Manufacturing_CA
Device(config)# enrollment terminal
Device(config)# revocation-check none

Device(config)# crypto pki trustpoint selfsignx
Device(config)# enrollment terminal
Device(config)# subject-name cn=3925_pod5
Device(config)# revocation-check none
Device(config)# rsakeypair selfsignx

Device(config)# crypto pki certificate chain ccm1
Device(config)# certificate ca 55C2FCBFBAC552B7C6CED497D4AD33F8
[Certificate data omitted]

Device(config)# crypto pki certificate chain Cisco_Manufacturing_CA
Device(config)# certificate ca 6A6967B3000000000003
[Certificate data omitted]

Device(config)# crypto pki certificate chain selfsignx
Device(config)# certificate self-signed 01
[Certificate data omitted]
```

### Add the Cube Service, Call Flow and Message manipulation configuration.

```
Device(config)# voice service voip
Device(config)# no ip address trusted authenticate
Device(config)# allow-connections sip to sip
Device(config)# fax protocol t38 version 0 ls-redundancy 0 hs-redundancy 0 fallback none
Device(config)# sip
Device(config-sip)# session transport tcp
Device(config-sip)# header-passing
Device(config-sip)# registrar server
Device(config-sip)# nat auto
Device(config-sip)# pass-thru headers un supp
Device(config-sip)# pass-thru subscribe-notify-events all
Device(config-sip)# pass-thru content un supp
Device(config-sip)# registration passthrough
Device(config-sip)# extension cucm

Device(config)# voice class uri 1 sip
Device(config)# host ipv4:172.18.110.120
```

## Example: Configuring CUCM Secure Line-Side

```

Device(config)# voice class uri 2 sip
Device(config)# host ipv4:10.50.209.100

Device(config)# voice class uri 3 sip
Device(config)# host ipv4:10.50.209.215

Device(config)# interface GigabitEthernet0/0
Device(config-if)# ip address 10.50.209.100 255.255.255.0
Device(config-if)# duplex auto
Device(config-if)# speed auto

Device(config)# interface GigabitEthernet0/1
Device(config-if)# ip address 172.18.110.120 255.255.255.0
Device(config-if)# duplex auto
Device(config-if)# speed auto

Device(config)# dspfarm profile 1 transcode universal security
Device(config-dspfarm-profile)# codec g722-64
Device(config-dspfarm-profile)# codec g711ulaw
Device(config-dspfarm-profile)# codec g711alaw
Device(config-dspfarm-profile)# codec g729ar8
Device(config-dspfarm-profile)# codec g729abr8
Device(config-dspfarm-profile)# maximum sessions 24
Device(config-dspfarm-profile)# associate application CUBE

```

## Configure CTL and Phone Proxy

```

Device(config)#voice-ctl-file ctl_secure
Device(config-ctl-file)# record-entry capf trustpoint Cisco_Manufacturing_CA
Device(config-ctl-file)# record-entry selfsigned trustpoint selfsignx
Device(config-ctl-file)# record-entry cucm-tftp trustpoint ccml
Device(config-ctl-file)# complete

Device(config)# voice-phone-proxy phone_proxy
Device(config-phone-proxy)# tftp-server address ipv4 10.50.209.215 local-addr ipv4
10.50.209.100 acc-addr ipv4 172.18.110.120
Device(config-phone-proxy)# ctl-file ctl_secure
Device(config-phone-proxy)# access-secure
Device(config-phone-proxy)# service-map server-addr ipv4 10.50.209.215 port 8443 acc-addr
ipv4 172.18.110.120 port 8443
Device(config-phone-proxy)# service-map server-addr ipv4 10.50.209.215 port 8080 acc-addr
ipv4 172.18.110.120 port 8080
Device(config-phone-proxy)# service-map server-addr ipv4 10.50.209.215 port 3804 acc-addr
ipv4 172.18.110.120 port 3804
Device(config-phone-proxy)# complete

Device(config)# voice-phone-proxy tftp-address ipv4 10.50.209.100
Device(config-phone-proxy)# port-range 40000 50000
Device (Config)# voice-phone-proxy tftp-address ipv4 172.18.110.120
Device(config-phone-proxy)# port-range 40000 50000
Device(config-phone-proxy)# voice-phone-proxy file-buffer size 60

```

## Attaching Phone Proxy to dial Peers

```

Device(config)# dial-peer voice 1 voip
Device(config-dial-peer)# phone-proxy phone_proxy signal-addr ipv4 172.18.110.120 cucm ipv4
10.50.209.215
*** Access Dialpeer Facing Outside ***
Device(config-dial-peer)# session protocol sipv2
Device(config-dial-peer)# session target registrar
Device(config-dial-peer)# session transport tcp tls

```

```

Device(config-dial-peer)# destination uri 2
Device(config-dial-peer)# incoming uri request 1
Device(config-dial-peer)# voice-class sip extension cucm
Device(config-dial-peer)# voice-class sip conn-reuse
Device(config-dial-peer)# voice-class sip call-route url
Device(config-dial-peer)# voice-class sip registration passthrough registrar-index 1
Device(config-dial-peer)# dtmf-relay rtp-nte
Device(config-dial-peer)# srtp
Device(config-dial-peer)# codec transparent

Device(config)# dial-peer voice 2 voip
*** Core Dialpeer Facing CUCM ***
Device(config-dial-peer)# session protocol sipv2
Device(config-dial-peer)# session target ipv4:10.50.209.215
Device(config-dial-peer)# session transport tcp
Device(config-dial-peer)# destination uri 1
Device(config-dial-peer)# incoming uri via 3
Device(config-dial-peer)# voice-class sip call-route url
Device(config-dial-peer)# dtmf-relay rtp-nte
Device(config-dial-peer)# codec transparent

```

### Configuring SIP User Agent

```

Device(config)# sip-ua
Device(config-sip-ua)# timers connection aging 60
Device(config-sip-ua)# registrar 1 ipv4:10.50.209.215 expires 3600 refresh-ratio 100 tcp
Device(config-sip-ua)# crypto signaling default trustpoint selfsignx

```

## Example: Configuring CUCM Non-Secure Line-Side

The details of the IP address used in the below example are as follows:

- CUBE IP address facing phone : 172.18.110.120
- CUBE IP address facing CUCM : 10.50.209.100
- CUCM IP address : 10.50.209.215

### Generate and Import Certificate on CUBE

```

Device(config)# crypto pki trustpoint selfsign
Device(config)# enrollment selfsigned
Device(config)# subject-name CN=CUBE, O=CISCO
Device(config)# revocation-check none
Device(config)# rsakeypair selfsign

Device(config)# crypto pki trustpoint ccml
Device(config)# enrollment terminal
Device(config)# revocation-check none

Device(config)# crypto pki certificate chain selfsignx
Device(config)# certificate self-signed 01
[Certificate data omitted]

Device(config)# crypto pki certificate chain ccml
Device(config)# certificate ca 55C2FCBFBAC552B7C6CED497D4AD33F8
[Certificate data omitted]

```

Add the Cube Service, Call Flow and Message manipulation configuration.

## Example: Configuring CUCM Non-Secure Line-Side

```

Device(config)# voice service voip
Device(config)# no ip address trusted authenticate
Device(config)# allow-connections sip to sip
Device(config)# fax protocol t38 version 0 ls-redundancy 0 hs-redundancy 0 fallback none
Device(config)# sip
Device(config-sip)# header-passing
Device(config-sip)# registrar server
Device(config-sip)# nat auto
Device(config-sip)# pass-thru headers un supp
Device(config-sip)# pass-thru subscribe-notify-events all
Device(config-sip)# pass-thru content un supp
Device(config-sip)# registration passthrough

Device(config)# voice class uri 1 sip
Device(config)# host ipv4:172.18.110.120

Device(config)# voice class uri 2 sip
Device(config)# host ipv4:10.50.209.100

Device(config)# voice class uri 3 sip
Device(config)# host ipv4:10.50.209.215

Device(config)# interface GigabitEthernet0/0
Device(config-if)# ip address 10.50.209.100 255.255.255.0
Device(config-if)# duplex auto
Device(config-if)# speed auto

Device(config)# interface GigabitEthernet0/1
Device(config-if)# ip address 172.18.110.120 255.255.255.0
Device(config-if)# duplex auto
Device(config-if)# speed auto

```

## Configure CTL and Phone Proxy

```

Device(config)#voice-ctl-file ctl_secure
Device(config-ctl-file)# record-entry capf trustpoint Cisco_Manufacturing_CA
Device(config-ctl-file)# record-entry selfsigned trustpoint selfsignx
Device(config-ctl-file)# record-entry cucm-tftp trustpoint ccm1
Device(config-ctl-file)# complete

Device(config)# voice-phone-proxy phone_proxy
Device(config-phone-proxy)# tftp-server address ipv4 10.50.209.215 local-addr ipv4
10.50.209.100 acc-addr ipv4 172.18.110.120
Device(config-phone-proxy)# ctl-file ctl_secure
Device(config-phone-proxy)# access-secure
Device(config-phone-proxy)# service-map server-addr ipv4 10.50.209.215 port 8443 acc-addr
ipv4 172.18.110.120 port 8443
Device(config-phone-proxy)# service-map server-addr ipv4 10.50.209.215 port 8080 acc-addr
ipv4 172.18.110.120 port 8080
Device(config-phone-proxy)# service-map server-addr ipv4 10.50.209.215 port 3804 acc-addr
ipv4 172.18.110.120 port 3804
Device(config-phone-proxy)# complete

Device(config)# voice-phone-proxy tftp-address ipv4 10.50.209.100
Device(config-phone-proxy)# port-range 40000 50000
Device (Config)# voice-phone-proxy tftp-address ipv4 172.18.110.120
Device(config-phone-proxy)# port-range 40000 50000
Device(config-phone-proxy)# voice-phone-proxy file-buffer size 60

```

## Attaching Phone Proxy to dial Peers



```
Device(config)# dial-peer voice 1 voip
Device(config-dial-peer)# phone-proxy phone_proxy signal-addr ipv4 172.18.110.120 cucm ipv4
10.50.209.215
*** Access Dialpeer Facing Outside ***
Device(config-dial-peer)# session protocol sipv2
Device(config-dial-peer)# session target registrar
Device(config-dial-peer)# session transport tcp tls
Device(config-dial-peer)# destination uri 2
Device(config-dial-peer)# incoming uri request 1
Device(config-dial-peer)# voice-class sip extension cucm
Device(config-dial-peer)# voice-class sip conn-reuse
Device(config-dial-peer)# voice-class sip call-route url
Device(config-dial-peer)# voice-class sip registration passthrough registrar-index 1
Device(config-dial-peer)# dtmf-relay rtp-nte
Device(config-dial-peer)# codec transparent

Device(config)# dial-peer voice 2 voip
*** Core Dialpeer Facing CUCM ***
Device(config-dial-peer)# session protocol sipv2
Device(config-dial-peer)# session target ipv4:10.50.209.215
Device(config-dial-peer)# session transport tcp
Device(config-dial-peer)# destination uri 1
Device(config-dial-peer)# incoming uri via 3
Device(config-dial-peer)# voice-class sip call-route url
Device(config-dial-peer)# dtmf-relay rtp-nte
Device(config-dial-peer)# codec transparent
```

### Configuring SIP User Agent

```
Device(config)# sip-ua
Device(config-sip-ua)# timers connection aging 60
Device(config-sip-ua)# registrar 1 ipv4:10.50.209.215 expires 3600 refresh-ratio 100 tcp
```





## PART **XX**

# Security

- [SIP TLS Support on CUBE, on page 983](#)





# CHAPTER 75

## SIP TLS Support on CUBE

The Cisco Unified Border Element (CUBE) supports SIP-to-SIP calls with Transport Layer Security (TLS). TLS provides privacy and data integrity of SIP signaling messages between two applications that communicate. CUBE uses TLS to secure SIP signaling messages. TLS is layered on top of a reliable transport protocol such as TCP. CUBE can be configured at both the global and dial-peer levels for allowing TLS to establish sessions with remote endpoints.

- [Feature Information for SIP TLS Support on CUBE, on page 983](#)
- [Restrictions, on page 984](#)
- [Information About SIP TLS Support on CUBE, on page 985](#)
- [How to Configure SIP TLS Support on CUBE, on page 986](#)
- [SIP TLS Configuration Examples, on page 995](#)

## Feature Information for SIP TLS Support on CUBE

The following table provides release information about the feature or features described in this module. This table lists only the software release that introduced support for a given feature in a given software release train. Unless noted otherwise, subsequent releases of that software release train also support that feature.

Use Cisco Feature Navigator to find information about platform support and Cisco software image support. To access Cisco Feature Navigator, go to <https://cfng.cisco.com/>. An account on Cisco.com is not required.

| Feature Name                                                                         | Releases                                | Feature Information                                                                                                                                                                       |
|--------------------------------------------------------------------------------------|-----------------------------------------|-------------------------------------------------------------------------------------------------------------------------------------------------------------------------------------------|
| Server Name Indication (SNI)                                                         | Cisco IOS XE Amsterdam 17.3.1a          | Support for Server Name Indication (SNI), a TLS extension that allows a TLS client to indicate the name of the server that it is trying connect during the initial TLS handshake process. |
| Command— <b>voice class tls-profile tag</b>                                          | Cisco IOS XE Amsterdam 17.3.1a          | Support for voice class TLS profile configuration. The <i>tag</i> associates voice class TLS profile configuration to the command <b>crypto signaling</b> .                               |
| Server identity validation through Common Name (CN) and Subject Alternate Name (SAN) | Cisco IOS XE Gibraltar Release 16.11.1a | Support for server identity validation through Common Name (CN) and Subject Alternate Name (SAN) fields in the server certificate.                                                        |

| Feature Name                                           | Releases                                 | Feature Information                                                                                                                                                                                                                                                                                                                                                                                                                                                                                                                                                                                                              |
|--------------------------------------------------------|------------------------------------------|----------------------------------------------------------------------------------------------------------------------------------------------------------------------------------------------------------------------------------------------------------------------------------------------------------------------------------------------------------------------------------------------------------------------------------------------------------------------------------------------------------------------------------------------------------------------------------------------------------------------------------|
| Elliptical Curve Ciphers                               | Cisco IOS XE Gibraltar Release 16.10.1a  | Support for configuring Elliptic Curve for a TLS session.                                                                                                                                                                                                                                                                                                                                                                                                                                                                                                                                                                        |
| Change in the default SIP TLS Versions support on CUBE | Cisco IOS XE 16.9.1                      | Behavior of the command <b>transport tcp tls</b> is modified.<br>In the earlier releases, TLS version v1.0, v1.1 and v1.2 were enabled by default. From this release onwards, only versions v1.1 and v1.2 are enabled by default. TLS version v1.0 is excluded.                                                                                                                                                                                                                                                                                                                                                                  |
| SIP TLS Version 1.2 Support on CUBE                    | Cisco IOS 15.6(1)T<br>Cisco IOS XE 3.17S | Support is provided for SIP-to-SIP calls with Transport Layer Security (TLS) version 1.2.<br>The following cipher suites are introduced for release Cisco IOS 15.6(1)T: <ul style="list-style-type: none"> <li>• TLS_DHE_RSA_WITH_AES_128_CBC_SHA1</li> <li>• TLS_ECDHE_RSA_WITH_AES_128_GCM_SHA256</li> <li>• TLS_ECDHE_ECDSA_WITH_AES_128_GCM_SHA256</li> <li>• TLS_ECDHE_RSA_WITH_AES_256_GCM_SHA384</li> <li>• TLS_ECDHE_ECDSA_WITH_AES_256_GCM_SHA384</li> </ul> The following commands were introduced or modified: <b>transport tcp tls</b> , <b>crypto signaling default trustpoint cube</b> , and <b>srtp (voice)</b> . |
| SIP TLS Version 1.0 Support on CUBE                    | Cisco IOS 12.4(6)T                       | Support is provided for SIP-to-SIP calls with Transport Layer Security (TLS) version 1.0.<br>The following cipher suites are introduced for release Cisco IOS 12.4(6)T : <ul style="list-style-type: none"> <li>• SSL_RSA_WITH_RC4_128_MD5</li> <li>• TLS_RSA_WITH_AES_128_CBC_SHA</li> </ul> The following commands were introduced or modified: <b>transport tcp tls</b> and <b>crypto signaling default trustpoint cube</b> .                                                                                                                                                                                                 |

## Restrictions

- ECDSA ciphers are not supported on TLS version 1.0.

# Information About SIP TLS Support on CUBE

## Deployment

The following figure illustrates an example of CUBE with SIP TLS connections.

**Figure 95: CUBE with SIP TLS connections**

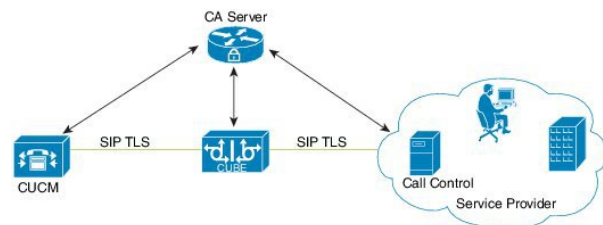

In a typical deployment, CUBE is placed between CUCM and the service provider. These devices are authenticated and enrolled with a Certificate Authority (CA) server that issues certificates. The CA server can be Cisco or a third party entity. When a call is made, a TLS handshake is initiated between CUCM and CUBE, and the IOS PKI infrastructure is used to exchange certificates signed by a common trusted CA during the handshake. During the TLS handshake, a dynamically generated symmetric key and cipher algorithms are negotiated between the devices. After the successful TLS handshake, the devices establish a SIP session between the service provider and CUBE. Keys exchanged during the TLS handshake process are used to encrypt or decrypt all SIP signaling messages.



**Note** The use of PKI on the Cisco IOS software requires that the clock on the devices be synchronized with the network time to ensure proper validation of certificates.

## TLS Cipher Suite Category

Before release Cisco IOS15.6(1)T, CUBE supported TLS v1.0 with the following cipher suites:

- SSL\_RSA\_WITH\_RC4\_128\_MD5
- TLS\_RSA\_WITH\_AES\_128\_CBC\_SHA

CUBE supports only the mandatory cipher suites for TLS implementation. From Cisco IOS15.6(1)T release onwards, CUBE supports TLS v1.2 which is backward compatible. Following are the cipher suites added:

- TLS\_DHE\_RSA\_WITH\_AES\_128\_CBC\_SHA1
- TLS\_ECDHE\_RSA\_WITH\_AES\_128\_GCM\_SHA256
- TLS\_ECDHE\_ECDSA\_WITH\_AES\_128\_GCM\_SHA256
- TLS\_ECDHE\_RSA\_WITH\_AES\_256\_GCM\_SHA384
- TLS\_ECDHE\_ECDSA\_WITH\_AES\_256\_GCM\_SHA384

Following cipher suites are added in the Cisco IOS XE Amsterdam 17.3.1a release:

- TLS\_RSA\_WITH\_AES\_256\_CBC\_SHA
- TLS\_DHE\_RSA\_WITH\_AES\_128\_CBC\_SHA
- TLS\_DHE\_RSA\_WITH\_AES\_256\_CBC\_SHA

Use the **srtp pass-thru** command to globally enable the transparent passthrough of all (supported and unsupported) crypto suites. If SRTP pass-thru feature is enabled, media interworking features such as transcoding, transrating, DTMF interworking, and so on, will not be supported. Ensure that you have symmetric configuration on both the incoming and outgoing dial-peers to avoid media-related issues.

## How to Configure SIP TLS Support on CUBE

### Configuring SIP TLS on CUBE



**Note** From IOS XE Release 16.6.1 onwards, the key-pair information is encrypted in all the router platforms.

When you downgrade the router from IOS XE version 16.6.1 or a later release to a pre-16.6.1 release, ensure that you disable the key encryption before the downgrade. Otherwise, the downgrade discards the encrypted keys. To disable the encryption, use the command **no service private-config-encryption** in global configuration mode.

#### SUMMARY STEPS

1. **enable**
2. **configure terminal**
3. **crypto key generate rsa** {general-keys | usage-keys}label *key-label*[**exportable** ]][**modulus** *modulus-size*][**storage device**:]
4. **crypto key generate ec** **keysize** {256 | 384}[**label** *label*][ *ec key-label*] ! *Applicable only for TLS version 1.2.*
5. **crypto pki trustpoint** *name*
6. **rsa**keypair *key-label* [*key-size* [*encryption-key-size*]]
7. **ec**keypair *keyname*] ! *Applicable only for TLS version 1.2.*
8. **serial-number** [**none**]
9. **ip-address** {*ip-address*|**interface**|**none**}
10. **subject-name** [*x.500-name*]
11. **enrollment** [**mode**][**retry period** *minutes*][**retry count** *number*]**url** *url*[**pem**]
12. **crl optional** or **revocation-check** *method1*[*method2*[*method3*]]
13. **password** *string*
14. **exit**
15. **crypto ca enroll** *name* or **crypto pki enroll** *name*
16. **crypto ca authenticate** *name* or **crypto pki authenticate** *name*
17. **crypto pki import** <trustpoint> **certificate**



18. **sip-ua**
19. **transport tcp tls [v1.0 | v1.1 | v1.2 ]**
20. **crypto signaling** {remote-addr ip address subnet mask | default} [ tls-profile tag | trustpoint trustpoint-name [ client-vtp trustpoint-name ] [ {ecdsa-cipher [curve-size 384] | strict-cipher} ] | cn-san-validate {server [client-vtp trustpoint-name] [ {ecdsa-cipher [curve-size 384] | strict-cipher} ] } ]! ECDSA ciphers are not supported on TLS version 1.0.
21. **voice service** {pots| voatm |vofr|voip}
22. **transport tcp tls**
23. **url** {sip| sips |tel}
24. **end**

## DETAILED STEPS

|               | Command or Action                                                                                                                                                                                                                        | Purpose                                                                                                                                                                                                                                                                                                                                                                                                                                                                                                                                                                                                                                                                                                                                                                                                                                                                                                                                                                                                                                                                                    |
|---------------|------------------------------------------------------------------------------------------------------------------------------------------------------------------------------------------------------------------------------------------|--------------------------------------------------------------------------------------------------------------------------------------------------------------------------------------------------------------------------------------------------------------------------------------------------------------------------------------------------------------------------------------------------------------------------------------------------------------------------------------------------------------------------------------------------------------------------------------------------------------------------------------------------------------------------------------------------------------------------------------------------------------------------------------------------------------------------------------------------------------------------------------------------------------------------------------------------------------------------------------------------------------------------------------------------------------------------------------------|
| <b>Step 1</b> | <b>enable</b><br><b>Example:</b><br><pre>Device&gt; enable</pre>                                                                                                                                                                         | Enables privileged EXEC mode. <ul style="list-style-type: none"> <li>• Enter your password if prompted.</li> </ul>                                                                                                                                                                                                                                                                                                                                                                                                                                                                                                                                                                                                                                                                                                                                                                                                                                                                                                                                                                         |
| <b>Step 2</b> | <b>configure terminal</b><br><b>Example:</b><br><pre>Router# configure terminal</pre>                                                                                                                                                    | Enters global configuration mode.                                                                                                                                                                                                                                                                                                                                                                                                                                                                                                                                                                                                                                                                                                                                                                                                                                                                                                                                                                                                                                                          |
| <b>Step 3</b> | <b>crypto key generate rsa</b> {general-keys   usage-keys}label key-label[exportable ][modulus modulus-size][storage device:]<br><b>Example:</b><br><pre>Router(config)# crypto key generate rsa general-keys label kp1 exportable</pre> | Generates RSA key pairs. Arguments and keywords are as follows: <ul style="list-style-type: none"> <li>• <b>general-keys</b>—Specifies that the general-purpose key pair should be generated.</li> <li>• <b>usage-keys</b>—Specifies that two RSA special-usage key pairs should be generated (that is, one encryption pair and one signature pair) instead of one general-purpose key pair.</li> <li>• <b>label key-label</b>—(Optional) Name that is used for an RSA key pair when they are being exported. If a key label is not specified, the fully qualified domain name (FQDN) of the router is used.</li> <li>• <b>exportable</b>—(Optional) Specifies that the RSA key pair can be exported to another Cisco device, such as a router.</li> <li>• <b>modulus modulus-size</b>—(Optional) IP size of the key modulus in a range 350–2048. If you do not enter the modulus keyword and specify a size, you will be prompted.</li> <li>• <b>storage device</b>:—(Optional) Specifies the key storage location. The name of the storage device is followed by a colon (:).</li> </ul> |

|               | Command or Action                                                                                                                                                                                                                                             | Purpose                                                                                                                                                                                                                                                                                                                                                                                                                                                                                                                                                                                       |
|---------------|---------------------------------------------------------------------------------------------------------------------------------------------------------------------------------------------------------------------------------------------------------------|-----------------------------------------------------------------------------------------------------------------------------------------------------------------------------------------------------------------------------------------------------------------------------------------------------------------------------------------------------------------------------------------------------------------------------------------------------------------------------------------------------------------------------------------------------------------------------------------------|
|               |                                                                                                                                                                                                                                                               | <ul style="list-style-type: none"> <li>• <b>kp1</b>— kp1 is a label name that you select.</li> </ul>                                                                                                                                                                                                                                                                                                                                                                                                                                                                                          |
| <b>Step 4</b> | <p><b>crypto key generate ec</b> <b>keysize</b> {256   384}[<b>label</b> <i>label</i>][<i>ec key-label</i>] ! <i>Applicable only for TLS version 1.2.</i></p> <p><b>Example:</b></p> <pre>Router(config)# crypto key generate ec keysize 384 &lt;cr&gt;</pre> | Generates EC key pairs.                                                                                                                                                                                                                                                                                                                                                                                                                                                                                                                                                                       |
| <b>Step 5</b> | <p>Required: <b>crypto pki trustpoint</b> <i>name</i></p> <p><b>Example:</b></p> <pre>Router(config)# crypto pki trustpoint cubel</pre>                                                                                                                       | <p>Declares the trustpoint that your router should use. Argument is as follows:</p> <ul style="list-style-type: none"> <li>• <i>name</i>—Creates a name for the trustpoint that you created.</li> <li>• <i>cubel</i>—Represents the trustpoint name that the user specifies.</li> </ul>                                                                                                                                                                                                                                                                                                       |
| <b>Step 6</b> | <p><b>rsa</b>keypair <i>key-label</i> [<i>key-size</i> [<i>encryption-key-size</i>]]</p> <p><b>Example:</b></p> <pre>Router(config)# rsa</pre>                                                                                                                | <p>Specifies which key pair to associate with the certificate. Arguments are as follows:</p> <ul style="list-style-type: none"> <li>• <i>key-label</i>—Name of the key pair, which is generated during enrollment if it does not exist or if the <b>auto-enroll regenerate</b> command is configured.</li> <li>• <i>key-size</i>—(Optional) Size of the desired RSA key. If not specified, the existing key size is used.</li> <li>• <i>encryption-key-size</i>—(Optional) Size of the second key, which is used to request separate encryption, signature keys, and certificates.</li> </ul> |
| <b>Step 7</b> | <p><b>eckeypair</b> <i>keyname</i>] ! <i>Applicable only for TLS version 1.2.</i></p> <p><b>Example:</b></p> <pre>Router(config)# eckeypair mykey</pre>                                                                                                       | Generates EC keys for ECDSA cipher suites.                                                                                                                                                                                                                                                                                                                                                                                                                                                                                                                                                    |
| <b>Step 8</b> | <p><b>serial-number</b> [<b>none</b>]</p> <p><b>Example:</b></p> <pre>Router(ca-trustpoint)# serial-number</pre>                                                                                                                                              | <p>Specifies whether the router serial number should be included in the certificate request. Keyword is as follows:</p> <ul style="list-style-type: none"> <li>• <b>none</b>—(Optional) Specifies that a serial number will not be included in the certificate request.</li> </ul>                                                                                                                                                                                                                                                                                                            |
| <b>Step 9</b> | <p><b>ip-address</b> {<i>ip-address</i> <b>interface</b> <b>none</b>}</p> <p><b>Example:</b></p> <pre>Router(ca-trustpoint)# ip-address 172.18.197.154</pre>                                                                                                  | <p>Specifies a dotted IP address or an interface that will be included as "unstructuredAddress" in the certificate request. Arguments and keyword are as follows:</p> <ul style="list-style-type: none"> <li>• <b>ip-address</b>—Specifies a dotted IP address that will be included as "unstructuredAddress" in the certificate request.</li> </ul>                                                                                                                                                                                                                                          |

|                | Command or Action                                                                                                                                                                                                                            | Purpose                                                                                                                                                                                                                                                                                                                                                                                                                                                                                                                                                                                                                                                                                                                                                                                                                                                                                                                                                                                                                                                                |
|----------------|----------------------------------------------------------------------------------------------------------------------------------------------------------------------------------------------------------------------------------------------|------------------------------------------------------------------------------------------------------------------------------------------------------------------------------------------------------------------------------------------------------------------------------------------------------------------------------------------------------------------------------------------------------------------------------------------------------------------------------------------------------------------------------------------------------------------------------------------------------------------------------------------------------------------------------------------------------------------------------------------------------------------------------------------------------------------------------------------------------------------------------------------------------------------------------------------------------------------------------------------------------------------------------------------------------------------------|
|                |                                                                                                                                                                                                                                              | <ul style="list-style-type: none"> <li>• <b>interface</b>—Specifies an interface, from which the router can get an IP address, that will be included as "unstructureAddress" in the certificate request.</li> <li>• <b>none</b>—Specifies that an IP address is not to be included in the certificate request.</li> </ul>                                                                                                                                                                                                                                                                                                                                                                                                                                                                                                                                                                                                                                                                                                                                              |
| <b>Step 10</b> | <p><b>subject-name</b> [<i>x.500-name</i>]</p> <p><b>Example:</b></p> <pre>Router(ca-trustpoint)# subject-name CN=172.18.197.154</pre>                                                                                                       | <p>Specifies the subject name in the certificate request. Argument is as follows:</p> <ul style="list-style-type: none"> <li>• <b>x.500-name</b>—(Optional) Specifies the subject name that is used in the certificate request.</li> </ul>                                                                                                                                                                                                                                                                                                                                                                                                                                                                                                                                                                                                                                                                                                                                                                                                                             |
| <b>Step 11</b> | <p><b>enrollment</b> [<b>mode</b>][<b>retry period</b> <i>minutes</i>][<b>retry count</b> <i>number</i>]<b>url</b> <i>url</i>[<b>pem</b>]</p> <p><b>Example:</b></p> <pre>Router (ca-trustpoint)# enrollment url http://172.18.193.103</pre> | <p>Specifies the enrollment parameters of a certificate authority (CA). Arguments and keywords are as follows:</p> <ul style="list-style-type: none"> <li>• <b>mode</b>—(Optional) Registration authority (RA) mode, if your CA system provides an RA. By default, RA mode is disabled.</li> <li>• <b>retry period minutes</b>—(Optional) Specifies the period in which the router waits before sending the CA another certificate request. The default is 1 minute between retries. (Specify from 1 through 60 minutes.)</li> <li>• <b>retry count number</b>—(Optional) Specifies the number of times a router resends a certificate request when it does not receive a response from the previous request. The default is 10 retries. (Specify from 1 through 100 retries.)</li> <li>• <b>url url</b>—URL of the file system where your router should send certificate requests. For enrollment method options, see the enrollment url command.</li> <li>• <b>pem</b>—(Optional) Adds privacy-enhanced mail (PEM) boundaries to the certificate request.</li> </ul> |
| <b>Step 12</b> | <p><b>crl optional</b> or <b>revocation-check</b> <i>method1</i>[<i>method2</i>[<i>method3</i>]]</p> <p><b>Example:</b></p> <pre>Router(ca-trustpoint)# crl optional or Router(ca-trustpoint)# revocation-check none</pre>                   | <p>Allows the certificates of other peers to be accepted without trying to obtain the appropriate CRL or checks the revocation status of a certificate. Arguments are as follows:</p> <ul style="list-style-type: none"> <li>• <i>method1</i> [<i>method2</i> [<i>method3</i>]]—Method used by the router to check the revocation status of the certificate.</li> </ul> <p>Available methods are as follows:</p> <ul style="list-style-type: none"> <li>• <b>crl</b>—Certificate checking is performed by a certificate revocation list (CRL). This is the default behavior.</li> <li>• <b>none</b>—Certificate checking is not required.</li> </ul>                                                                                                                                                                                                                                                                                                                                                                                                                   |

|                | Command or Action                                                                                                                                                                                                                                | Purpose                                                                                                                                                                                                                                                                                                                                                                                                                                      |
|----------------|--------------------------------------------------------------------------------------------------------------------------------------------------------------------------------------------------------------------------------------------------|----------------------------------------------------------------------------------------------------------------------------------------------------------------------------------------------------------------------------------------------------------------------------------------------------------------------------------------------------------------------------------------------------------------------------------------------|
|                |                                                                                                                                                                                                                                                  | <ul style="list-style-type: none"> <li>• <b>ocsp</b>—Certificate checking is performed by an online certificate status protocol (OCSP).</li> </ul> <p><b>Note</b> If the second and the third methods are specified, each method will be used only if the previous method returns an error, such as the server being down.</p>                                                                                                               |
| <b>Step 13</b> | <p><b>password</b> <i>string</i></p> <p><b>Example:</b></p> <pre>Router(ca-trustpoint)# password password</pre>                                                                                                                                  | <p>(Optional) Specifies the revocation password for the certificate. Argument is as follows:</p> <ul style="list-style-type: none"> <li>• <i>string</i>—Name of the password</li> </ul>                                                                                                                                                                                                                                                      |
| <b>Step 14</b> | <p><b>exit</b></p> <p><b>Example:</b></p> <pre>Router# exit</pre>                                                                                                                                                                                | Exists the current mode.                                                                                                                                                                                                                                                                                                                                                                                                                     |
| <b>Step 15</b> | <p><b>crypto ca enroll</b> <i>name</i> or <b>crypto pki enroll</b> <i>name</i></p> <p><b>Example:</b></p> <pre>Router(config)# crypto ca name cubel</pre> <p>or</p> <pre>Router(config)# crypto pki name cubel</pre>                             | <p>Obtains the certificates of your router from the certificate authority. The CA server issues two certificates to the trustpoint (CUBE): one to certify the CA server and the other to certify the trustpoint (CUBE). Argument is as follows:</p> <ul style="list-style-type: none"> <li>• <i>name</i>—Specifies the name of the CA. Use the same name when you declared the CA using the <b>crypto pki trustpoint</b> command.</li> </ul> |
| <b>Step 16</b> | <p><b>crypto ca authenticate</b> <i>name</i> or <b>crypto pki authenticate</b> <i>name</i></p> <p><b>Example:</b></p> <pre>Router(config)# crypto ca authenticate cubel</pre> <p>or</p> <pre>Router(config)# crypto pki authenticate cubel</pre> | <p>Authenticates the CA (by getting the certificate of the CA). Argument is as follows:</p> <ul style="list-style-type: none"> <li>• <i>name</i>—Specifies the name of the CA. This is the same name that is used when the CA was declared with the <b>crypto CA identity</b> command.</li> </ul> <p><b>Note</b> This is where you paste the remote root CA certificate (PEM file format).</p>                                               |
| <b>Step 17</b> | <b>crypto pki import</b> <trustpoint> <b>certificate</b>                                                                                                                                                                                         | Imports the certificate given by the CA.                                                                                                                                                                                                                                                                                                                                                                                                     |
| <b>Step 18</b> | <p><b>sip-ua</b></p> <p><b>Example:</b></p> <pre>Router(config)# sip-ua</pre>                                                                                                                                                                    | Enters SIP user-agent configuration mode.                                                                                                                                                                                                                                                                                                                                                                                                    |
| <b>Step 19</b> | <p><b>transport tcp tls</b> [v1.0   v1.1   v1.2 ]</p> <p><b>Example:</b></p>                                                                                                                                                                     | Configures the specified TLS version.                                                                                                                                                                                                                                                                                                                                                                                                        |

|                       | Command or Action                                                                                                                                                                                                                                                                                                                                                                                                                                                                                                                                                                                                      | Purpose                                                                                                                                                                                                                                                                                                                                                                                                                                                                                                                                                                                                                                                                                                                                                                                                                                                                                                                                                                                                                                                                                                                                                                                                                                                                                                                                                                                                                                                                                                                                                                                                                                                                                                                                                                                                           |
|-----------------------|------------------------------------------------------------------------------------------------------------------------------------------------------------------------------------------------------------------------------------------------------------------------------------------------------------------------------------------------------------------------------------------------------------------------------------------------------------------------------------------------------------------------------------------------------------------------------------------------------------------------|-------------------------------------------------------------------------------------------------------------------------------------------------------------------------------------------------------------------------------------------------------------------------------------------------------------------------------------------------------------------------------------------------------------------------------------------------------------------------------------------------------------------------------------------------------------------------------------------------------------------------------------------------------------------------------------------------------------------------------------------------------------------------------------------------------------------------------------------------------------------------------------------------------------------------------------------------------------------------------------------------------------------------------------------------------------------------------------------------------------------------------------------------------------------------------------------------------------------------------------------------------------------------------------------------------------------------------------------------------------------------------------------------------------------------------------------------------------------------------------------------------------------------------------------------------------------------------------------------------------------------------------------------------------------------------------------------------------------------------------------------------------------------------------------------------------------|
|                       | <pre>Router(config-sip-ua)# transport tcp tls v1.2</pre>                                                                                                                                                                                                                                                                                                                                                                                                                                                                                                                                                               | <p><b>Note</b> TLS v1.1 and TLS v1.2 are the default TLS versions that are configured. TLS v1.0 is also supported. However, to configure TLS v1.0, you must explicitly specify the TLS version.</p> <p>For more information on the TLS version configuration, see <a href="#">Transport command</a>.</p>                                                                                                                                                                                                                                                                                                                                                                                                                                                                                                                                                                                                                                                                                                                                                                                                                                                                                                                                                                                                                                                                                                                                                                                                                                                                                                                                                                                                                                                                                                          |
| <p><b>Step 20</b></p> | <p><b>crypto signaling</b>{<b>remote-addr</b> <i>ip address subnet mask</i>   <b>default</b>} [<b>tls-profile</b> <i>tag</i>   <b>trustpoint</b> <i>trustpoint-name</i> [<b>client-vtp</b> <i>trustpoint-name</i>] [<b>ecdsa-cipher</b> [<b>curve-size</b> 384]   <b>strict-cipher</b>]}   <b>cn-san-validate</b> {<b>server</b> [<b>client-vtp</b> <i>trustpoint-name</i>] [<b>ecdsa-cipher</b> [<b>curve-size</b> 384]   <b>strict-cipher</b>]} }! <i>ECDSA ciphers are not supported on TLS version 1.0.</i></p> <p><b>Example:</b></p> <pre>Router(config-sip-ua)# crypto signaling default trustpoint cubel</pre> | <p>Configures the SIP gateway to use its trustpoint when it establishes or accepts TLS connection with a remote device with an IP address.</p> <p>The trustpoint label refers to the CUBE's certificate that is generated with the Cisco IOS PKI commands as part of the enrollment proces. <b>strict-cipher</b> means that the SIP TLS process uses only those cipher suites that are mandated by the SIP RFC. When you use the <b>strict-cipher</b> command argument, avoids changes to the configuration if SIP should mandate newer ciphers. The SSL layer in Cisco IOS does not support TLS_RSA_WITH_3DES_EDE_CBC_SHA. Therefore, CUBE actively uses only the TLS_RSA_WITH_AES_128_CBC_SHA suite in strict mode.</p> <p>Keywords and arguments are as follows:</p> <ul style="list-style-type: none"> <li>• <b>remote-addr</b> <i>address</i>—Associates an IP address to a trustpoint.</li> <li>• <b>remote-addr</b> <i>subnet mask</i>—Associates a subnet mask to a trustpoint.</li> <li>• <b>default</b>—Configures a default trustpoint.</li> <li>• <b>trustpoint</b> <i>string</i>—Refers to the SIP gateways certificate generated as part of the enrollment process using Cisco IOS PKI commands</li> <li>• <b>ecdsa-cipher</b>—Examples are the following:<br/>       TLS_ECDHE_ECDSA_WITH_AES_128_GCM_SHA256<br/>       and<br/>       TLS_ECDHE_ECDSA_WITH_AES_256_GCM_SHA384.</li> </ul> <p><b>Note</b> <b>ecdsa-cipher</b> is applicable only for the <b>TLS version 1.2</b></p> <ul style="list-style-type: none"> <li>• <b>curve-size</b> - configures the specific size of elliptic curves to be used for a TLS session.<br/> <b>384</b>- configures 384-bit Elliptic Curve.</li> <li>• <b>strict-cipher</b>—Examples are the following:<br/>       TLS_RSA_WITH_AES_128_CBC_SHA,</li> </ul> |

|  | Command or Action | Purpose                                                                                                                                                                                                                                                                                                                                                                                                                                                                                                                                                                                                                                                                                                                                                                                                                                                                                                                                                                                                                                                                                                                                                                                                                                                                                                                                                                                                                                                                                                                                                                                                                                                                                                                                                                                                                                                                                                                                                                                                                                                                                                                                                                       |
|--|-------------------|-------------------------------------------------------------------------------------------------------------------------------------------------------------------------------------------------------------------------------------------------------------------------------------------------------------------------------------------------------------------------------------------------------------------------------------------------------------------------------------------------------------------------------------------------------------------------------------------------------------------------------------------------------------------------------------------------------------------------------------------------------------------------------------------------------------------------------------------------------------------------------------------------------------------------------------------------------------------------------------------------------------------------------------------------------------------------------------------------------------------------------------------------------------------------------------------------------------------------------------------------------------------------------------------------------------------------------------------------------------------------------------------------------------------------------------------------------------------------------------------------------------------------------------------------------------------------------------------------------------------------------------------------------------------------------------------------------------------------------------------------------------------------------------------------------------------------------------------------------------------------------------------------------------------------------------------------------------------------------------------------------------------------------------------------------------------------------------------------------------------------------------------------------------------------------|
|  |                   | <p>TLS_DHE_RSA_WITH_AES_128_CBC_SHA1, TLS_ECDHE_RSA_WITH_AES_128_GCM_SHA256, and TLS_ECDHE_RSA_WITH_AES_256_GCM_SHA384.</p> <ul style="list-style-type: none"> <li>• <b>cn-san-validate server</b>- Enables the server identity validation through Common Name (CN) and Subject Alternate Name (SAN) fields in the server certificate during client-side SIP/TLS connections. Validation of the CN and SAN fields of the server certificate ensures that the server-side domain is a valid entity. While setting up a TLS connection to a target server, CUBE validates the domain name that is configured as destination against the CN/SAN fields in the certificate provided by server. The TLS connection is established only if the domain name that is configured as destination, matches with one of the domain names in the CN/SAN fields of the server certificate that is configured. Once you configure <b>cn-san-validate {server}</b>, validation of the server identity happens for every new TLS connection.</li> <li>• The keyword <b>tls-profile tag</b> associates all the voice class configurations that are made through the command <b>voice class tls-profile tag</b>. In addition to all the TLS crypto configuration options available under the command <b>crypto signaling</b>, the <b>voice class tls-profile tag</b> command has a keyword <b>sni send</b>.</li> </ul> <p><b>sni send</b> enables Server Name Indication (SNI), a TLS extension that allows a TLS client to indicate the name of the server that it is trying connect during the initial TLS handshake process. Only the fully qualified DNS hostname of the server is sent in the client hello. SNI does not support IPv4 and IPv6 addresses in the client hello extension. After receiving a "hello" with the server name from the TLS client, the server uses appropriate certificate in the subsequent TLS handshake process. SNI is supported from TLS 1.2.</p> <p>For more information on associating <b>voice class tls-profile tag</b> command to <b>crypto signaling</b> command, see <a href="#">crypto signaling</a> and <a href="#">voice class tls-profile</a>.</p> |

|         | Command or Action                                                                                                         | Purpose                                                                                                                                                                                                                                                                                                                                                                                                                                                                                                                                                                                                                                                                                                                                                                                                                                                                    |
|---------|---------------------------------------------------------------------------------------------------------------------------|----------------------------------------------------------------------------------------------------------------------------------------------------------------------------------------------------------------------------------------------------------------------------------------------------------------------------------------------------------------------------------------------------------------------------------------------------------------------------------------------------------------------------------------------------------------------------------------------------------------------------------------------------------------------------------------------------------------------------------------------------------------------------------------------------------------------------------------------------------------------------|
|         |                                                                                                                           | <p><b>Note</b> From Cisco IOS XE Amsterdam 17.3.1a onwards, any new voice class TLS profile configuration option is available only under the command <b>voice class tls-profile tag</b>. You must perform voice class TLS profile configuration under the command <b>voice class tls-profile tag</b> and associate it to <b>crypto signaling</b> command. For example, <b>sni send</b> keyword is available only under the command <b>voice class tls-profile tag</b>.</p> <p>The <b>crypto signaling</b> command continues to support previously existing TLS crypto options. You can use either <b>voice class tls-profile tag</b> or <b>crypto signaling</b> command to configure trustpoint. However, from Cisco IOS XE Amsterdam 17.3.1a onwards, we recommend that you use the command <b>voice class tls-profile tag</b> to perform TLS profile configurations.</p> |
| Step 21 | <p><b>voice service</b> {pots  voatm  vofr voip}</p> <p><b>Example:</b></p> <pre>Router(config)# voice service voip</pre> | Specifies a voice encapsulation type and enters voice service VoIP configuration mode.                                                                                                                                                                                                                                                                                                                                                                                                                                                                                                                                                                                                                                                                                                                                                                                     |
| Step 22 | <p><b>transport tcp tls</b></p> <p><b>Example:</b></p> <pre>Router(config-voi-sip)# transport tcp tls</pre>               | Enters this command in SIP configuration mode to enable the TLS port on TCP 5061 to listen.                                                                                                                                                                                                                                                                                                                                                                                                                                                                                                                                                                                                                                                                                                                                                                                |
| Step 23 | <p><b>url</b> {sip  sips  tel}</p> <p><b>Example:</b></p> <pre>Router(config-serv-sip)# url sips</pre>                    | <p>Configures URLs to either the SIP, SIPS, or TEL format for your VoIP SIP calls. Keywords are as follows:</p> <ul style="list-style-type: none"> <li>• <b>sip</b>—Generate URLs in SIP format for VoIP calls. This is the default.</li> <li>• <b>sips</b>—Generate URLs in SIPS format for VoIP calls.</li> <li>• <b>tel</b>—Generate URLs in TEL format for VoIP calls.</li> </ul> <p><b>Note</b> This SIP gateway is now configured to use TLS with endpoints sharing the same CA.</p>                                                                                                                                                                                                                                                                                                                                                                                 |
| Step 24 | <p><b>end</b></p> <p><b>Example:</b></p> <pre>Router(conf-serv-sip)# end</pre>                                            | Ends the current mode.                                                                                                                                                                                                                                                                                                                                                                                                                                                                                                                                                                                                                                                                                                                                                                                                                                                     |

## Verifying SIP TLS Configuration

After a call is made, the **show sip-ua connections tcp tls** command is used to verify whether the transport used for the call is TLS.

Sample output for this command when TLS version is 1.0:

### Detail Output

```

=====
router#show sip-ua connections tcp tls detail
Total active connections : 1
No. of send failures : 0
No. of remote closures : 3
No. of conn. failures : 0
No. of inactive conn. ageouts : 0
Max. tls send msg queue size of 0, recorded for 0.0.0.0:0
TLS client handshake failures : 0
TLS server handshake failures : 0

-----Printing Detailed Connection Report-----
Note:
** Tuples with no matching socket entry
 - Do 'clear sip <tcp[tls]/udp> conn t ipv4:<addr>:<port>'
 to overcome this error condition
++ Tuples with mismatched address/port entry
 - Do 'clear sip <tcp[tls]/udp> conn t ipv4:<addr>:<port> id <connid>'
 to overcome this error condition

Remote-Agent:9.13.46.12, Connections-Count:1
Remote-Port Conn-Id Conn-State WriteQ-Size Local-Address
=====
 5061 1 Established 0 10.64.86.88
=====

```

Sample output for the **show sip-ua connections tcp tls** command when TLS version is 1.2:

### Detail Output

```

router# show sip-ua connections tcp tls detail
Total active connections : 2
No. of send failures : 0
No. of remote closures : 0
No. of conn. failures : 0
No. of inactive conn. ageouts : 0
Max. tls send msg queue size of 1, recorded for 209.165.201.1:5061
TLS client handshake failures : 0
TLS server handshake failures : 0

-----Printing Detailed Connection Report-----
Note:
** Tuples with no matching socket entry
 - Do 'clear sip <tcp[tls]/udp> conn t ipv4:<addr>:<port>'
 to overcome this error condition
++ Tuples with mismatched address/port entry
 - Do 'clear sip <tcp[tls]/udp> conn t ipv4:<addr>:<port> id <connid>'
 to overcome this error condition

Remote-Agent:209.165.201.1, Connections-Count:2
Remote-Port Conn-Id Conn-State WriteQ-Size Local-Address TLS-Version

```



```

=====
 5061 3 Established 0 - TLSv1.2
 36289 2 Established 0 - TLSv1.2

Cipher Curve
===== =====
ECDHE-ECDSA-AES256-GCM-SHA384 P-384
ECDHE-ECDSA-AES256-GCM-SHA384 P-384

----- SIP Transport Layer Listen Sockets -----
Conn-Id Local-Address
=====
 0 [0.0.0.0]:5061:

```

Alternatively, the debug ccsip messages command can be used to verify the “Via:” header for TLS is included. This output is a sample INVITE request of a call that uses SIP TLS and the “sips:” URI scheme:

```

INVITE sips:777@172.18.203.181 SIP/2.0
Via: SIP/2.0/TLS 172.18.201.173:5060;branch=z9hG4bK2C419
From: <sips:333@172.18.201.173>;tag=581BB98-1663
To: <sips:5555555@172.18.197.154>
Date: Wed, 28 Dec 2005 18:31:38 GMT
Call-ID: EB5B1948-770611DA-804F9736-BFA4AC35@172.18.201.173
Remote-Party-ID: "Bob" <sips:+14085559999@1.2.3.4>
Contact: <sips:123@host>
Allow: INVITE, OPTIONS, BYE, CANCEL, ACK, PRACK, COMET, REFER, SUBSCRIBE, NOTIFY, INFO
Max-Forwards: 70
Cseq: 104 INVITE
Expires: 60
Timestamp: 730947404
Content-Length: 298
Content-Type: application/sdp

v=0
o=CiscoSystemsSIP-GW-UserAgent 8437 1929 IN IP4 172.18.201.173
s=SIP Call
c=IN IP4 1.1.1.1
t=0 0
m=audio 18378 RTP/AVP 0 19
c=IN IP4 1.1.1.1
a=rtpmap:0 PCMU/8000
a=rtpmap:19 CN/8000
a=ptime:20

```

## SIP TLS Configuration Examples

### Example: SIP TLS Configuration

```

show running-config
Building configuration...

```

```

Current configuration : 10894 bytes
!
! Last configuration change at 23:19:20 IST Wed Aug 19 2015
! NVRAM config last updated at 20:25:45 IST Tue Aug 18 2015
!

```

```

version 15.6
service timestamps debug datetime msec localtime show-timezone
service timestamps log datetime msec localtime show-timezone
no service password-encryption
!
hostname CUBE
!
boot-start-marker
boot system flash:ctestimg
boot-end-marker
!
aqm-register-fnf
!
logging queue-limit 1000
logging buffered 9999999
no logging rate-limit
no logging console
!
no aaa new-model
ethernet lmi ce
clock timezone IST 5 30
!
!
!
!
!
ip traffic-export profile 1 mode capture
 bidirectional
 incoming access-list 123
 outgoing access-list 123
!
!
!
!
no ip domain lookup
ip cef
no ipv6 cef
!
multilink bundle-name authenticated
!
!
!
!
!
!
crypto pki trustpoint ecdsacert1
 enrollment terminal pem
 subject-name cn=plutododsn
 revocation-check none
 eckeypair myeckey
!
crypto pki trustpoint selfsign
 enrollment selfsigned
 subject-name cn=plutododsn
 revocation-check none
 rsakeypair selfsign
!
crypto pki trustpoint ccm155RSA
 enrollment terminal
 revocation-check none
!
!
crypto pki certificate chain ecdsacert1
certificate 07

```

```

30820248 308201CD A0030201 02020107 300A0608 2A8648CE 3D040303 30593112
30100603 5504030C 09706C75 746F3164 6F64310C 300A0603 55040B0C 03544143
310E300C 06035504 0A0C0543 6973636F 310B3009 06035504 06130242 45311830
16060355 04070C0F 74757269 6E672D65 7865632D 6C6E7830 1E170D31 35303831
38313235 3431345A 170D3136 30383137 31323534 31345A30 36311330 11060355
0403130A 706C7574 6F646F64 736E311F 301D0609 2A864886 F70D0109 02161063
656E7472 616C6973 65645F72 74723230 76301006 072A8648 CE3D0201 06052B81
04002203 62000446 4E28C72B 9A66C344 7D6EB2C7 51CE17F3 D125D12B 7043A98B
F21825DF 0621A34D 3119E23F DB2A5ACE 1C744F17 789450F5 1071E504 DA7DC56C
CDA24A8B 5318F11B EBA618A1 4BE2C66A 27857932 48485192 74923495 E762E3B4
5BDCDBD0 BC6B1FA3 818B3081 88301D06 03551D0E 04160414 BE2A3FDE F3CDA85E
A0EC7EA1 A47F3AEB 6B16D388 301F0603 551D2304 18301680 1460CAB8 AF1250CF
BB00C516 ACEEAF72 FDB6198D 6C303606 082B0601 05050701 01042A30 28302606
082B0601 05050730 01861A68 7474703A 2F2F2031 37332E33 392E3537 2E38333A
38303830 2F300E06 03551D0F 0101FF04 04030207 80300A06 082A8648 CE3D0403
03036900 30660231 00977017 6DCE34A4 3B0F78CF 2C69C7AD 2123B5F9 C10999E7
A3316D34 43E9C928 8FBF42A4 84583017 856D513D C5B66547 1E023100 AEF7EFE8
48AC2C81 884E8C8D 421A9B11 3177582D DBE9973F D67EA687 0CF08620 375628D0
F5F7FDFA 53052711 E493A754
quit
certificate ca 00
3082023B 308201C1 A0030201 02020100 300A0608 2A8648CE 3D040303 30593112
30100603 5504030C 09706C75 746F3164 6F64310C 300A0603 55040B0C 03544143
310E300C 06035504 0A0C0543 6973636F 310B3009 06035504 06130242 45311830
16060355 04070C0F 74757269 6E672D65 7865632D 6C6E7830 1E170D31 35303830
36303934 3730345A 170D3136 30383035 30393437 30345A30 59311230 10060355
04030C09 706C7574 6F31646F 64310C30 0A060355 040B0C03 54414331 0E300C06
0355040A 0C054369 73636F31 0B300906 03550406 13024245 31183016 06035504
070C0F74 7572696E 672D6578 65632D6C 6E783076 30100607 2A8648CE 3D020106
052B8104 00220362 0004D2EE C8BE0015 AE8DF590 3F0A8955 C1B3D80F 99B3CE51
241719ED 4D733BDC 061F92D0 36899A05 71E515B9 A86306B4 6DC49D66 87843054
71E3151B 293971A2 94B14074 893BB537 09D4BC9C BF57E3DC AD5FA66B 590DA475
B303068C 66899963 763CA35D 305B300C 0603551D 13040530 030101FF 300B0603
551D0F04 04030201 06301D06 03551D0E 04160414 60CAB8AF 1250CFBB 00C516AC
EEAF72FD B6198D6C 301F0603 551D2304 18301680 1460CAB8 AF1250CF BB00C516
ACEEAF72 FDB6198D 6C300A06 082A8648 CE3D0403 03036800 30650230 390E60B9
9AF19940 B0898320 AE96D8CB 52FB3B75 CE599444 EA3DBAC1 F4517F13 B96C26CB
3B719834 A99AF174 6EF9E35D 0231008E 337B0A8F 864F32D4 C85CC7CC 585FCD8B
6F5F4BCE 3B0313D1 E3B76598 0D9E43EB B11EFCF5 8C76318C 0F835560 0CD149
quit
crypto pki certificate chain selfsign
certificate self-signed 01
30820235 3082019E A0030201 02020101 300D0609 2A864886 F70D0101 05050030
36311330 11060355 0403130A 706C7574 6F646F64 736E311F 301D0609 2A864886
F70D0109 02161063 656E7472 616C6973 65645F72 74723230 1E170D31 35303831
38313434 3234355A 170D3230 30313031 30303030 30305A30 36311330 11060355
0403130A 706C7574 6F646F64 736E311F 301D0609 2A864886 F70D0109 02161063
656E7472 616C6973 65645F72 74723230 819F300D 06092A86 4886F70D 01010105
0003818D 00308189 02818100 A01400F8 9A599812 F5CC7347 1F9E223C E395073B
9138C777 7EAEA997 5EA3B937 4B858866 2A022ADA 7D29C4C6 DC9B01EB 0E9E77DF
782B099F 8F701221 A11C8B81 D82AB7F3 DBC1FFCB 809FC745 3FC6BD87 725F6B66
EBEBBD78 6597DDFB 700D3DA6 73C52342 568670EA 1DEB6619 2ED5EC71 99B2612A
BEC9B76E 38C442D9 DB9C2293 02030100 01A35330 51300F06 03551D13 0101FF04
05300301 01FF301F 0603551D 23041830 1680141D 5971FE06 1D126AA3 6767DBA6
C30E2EF0 2C044430 1D060355 1D0E0416 04141D59 71FE061D 126AA367 67DBA6C3
0E2EF02C 0444300D 06092A86 4886F70D 01010505 00038181 0033BC90 8AF1DFBD
B03AE032 ABBD80B7 7418402B 0BFB9E0B 341CB523 7077570C CD495BE3 47A1B35B
C878C693 A491B433 37BA1170 45F1DF85 9BC22CA8 94E25907 F91C7B75 450B0DE1
76AC2C6B 5517F42A 46260F76 4A1DF81F 733A14FE 918F43F4 9BABAA49 227B5014
986044E7 8E98E373 7A361696 F0AD3ACC C9B101DF 2F80CCF7 E3
quit
crypto pki certificate chain ccm155RSA
certificate ca 4E23E56C7339CC679FD444D77F7A463F
308203AB 30820293 A0030201 0202104E 23E56C73 39CC679F D444D77F 7A463F30

```

## Example: SIP TLS Configuration

```

0D06092A 864886F7 0D01010B 0500306A 310B3009 06035504 06130249 4E310E30
0C060355 040A0C05 63697363 6F310D30 0B060355 040B0C04 73727467 31143012
06035504 030C0B50 4C55544F 2D435543 4D313112 30100603 5504080C 096B6172
6E617461 6B613112 30100603 5504070C 0962616E 67616C6F 7265301E 170D3135
30383034 31333431 35315A17 0D323030 38303231 33343135 305A306A 310B3009
06035504 06130249 4E310E30 0C060355 040A0C05 63697363 6F310D30 0B060355
040B0C04 73727467 31143012 06035504 030C0B50 4C55544F 2D435543 4D313112
30100603 5504080C 096B6172 6E617461 6B613112 30100603 5504070C 0962616E
67616C6F 72653082 0122300D 06092A86 4886F70D 01010105 00038201 0F003082
010A0282 010100CC 39112782 D93A3501 8913EBEA 42522D27 E2C58D3F 4FC896D2
8F38F4A5 7CCC2519 9683142A 6B203E9F C7C92673 85D5A940 99B20FBD CC8F97D1
F42C1580 D34B8831 3BA74AE0 79AC0C74 E7BFAFCE 4D23F106 3D4EA333 16BA4768
66C5561C 5CE19946 DA731D9E 6E743FA0 5F25E445 8E5B6789 64076291 7E5EBODA
C482074E 56DA6841 245EEB96 F44C900D 85C5EDEC 32E89675 BC934EC3 8C0FC7D8
02BBCC06 93EE3698 A8B44527 93A73391 9C71869D BDEB96BF 06D68AC0 D47D810E
FCAB3C8F 13BC3D62 02591976 CD49436E 3E2D5B20 079A031E 3FDDEC1C DFBF8261
3CC5C6AF 7C6FC79C 0234D266 6C508DD7 CC72C8C6 239372F6 7D7CF5CD B56FFB26
DB4122E2 01E15F02 03010001 A34D304B 300B0603 551D0F04 04030202 B4301D06
03551D25 04163014 06082B06 01050507 03010608 2B060105 05070302 301D0603
551D0E04 1604142D DF3CC8F3 57F44974 38D8E8E8 20B15658 9C17F430 0D06092A
864886F7 0D01010B 05000382 01010038 060F1AC3 C3938667 8A3A0513 B5B2CE16
0DC6BAE5 5B1D6DD7 CEB68832 F92A4270 5FC7EC97 7AAF2AA 4FA288DD 66A94AB4
A466CA7E F974B9B8 630FAC21 AB95C3BB ECB7A082 AB0343BE 2F89399D AD94D4A5
6B477B44 88FB94BF FEE2E571 4917D0BB 2A5733B5 4F1F58BA CCCE710F 64365B39
3F1F9E8F 81A1B71B 61BD51EB C45A2FAD CA743432 A61C19AB E6C4B5F1 6E673A38
53421ECE 992505BD 5BAAF32A 954E37EA FE03B725 283A7F19 374A87E9 891E4E60
B8399050 0902EA25 99FD2A26 2BD3A2E9 74F01C53 EFB3D4D6 654D064E 56878F6C
21D8D184 88C24AD9 E655B78E 12EDB7EE 696B9B77 3E73A3F0 10DEBDF2 3CDF2BC9
606700D1 2D42389C EEE43B56 22977A
quit
voice-card 0
dspfarm
dsp services dspfarm
!
!
!
voice service voip
no ip address trusted authenticate
allow-connections sip to sip
fax protocol t38 version 0 ls-redundancy 0 hs-redundancy 0 fallback none
sip
bind control source-interface GigabitEthernet0/1
bind media source-interface GigabitEthernet0/1
asymmetric payload full
srtp negotiate cisco
!
!
!
!
voice iec syslog
!
!
!
!
mta send mail-from username $$
license udi pid CISCO2921/K9 sn FGL1538116L
hw-module pvdm 0/0
!
!
!
no memory lite
!
redundancy
!

```

```
!
!
!
!
interface Embedded-Service-Engine0/0
no ip address
shutdown
!
interface GigabitEthernet0/0
ip address 9.45.38.192 255.255.0.0
shutdown
duplex auto
speed auto
!
interface GigabitEthernet0/1
ip address 10.64.86.177 255.255.255.0
ip traffic-export apply 1 size 5000000
duplex auto
speed auto
 no clns route-cache
!
interface GigabitEthernet0/2
no ip address
shutdown
duplex auto
speed auto
!
ip forward-protocol nd
!
ip http server
no ip http secure-server
!
ip rtcp report interval 9000
ip route 0.0.0.0 0.0.0.0 10.64.86.1
ip route 10.0.0.0 255.0.0.0 10.64.86.1
!
!
!
access-list 123 permit udp any any
access-list 123 permit tcp any any
!
control-plane
!
call treatment on
!
!
!
!
mgcp behavior rsip-range tgcp-only
mgcp behavior comedia-role none
mgcp behavior comedia-check-media-src disable
mgcp behavior comedia-sdp-force disable
!
mgcp profile default
!
sccp local GigabitEthernet0/1
sccp ccm 10.64.86.154 identifier 1 version 7.0
!
!
!
dial-peer voice 1 voip
destination-pattern 6003
session protocol sipv2
```

```
session target ipv4:10.64.86.206:5061
session transport tcp tls
incoming called-number 7003
codec g711ulaw
!
dial-peer voice 2 voip
destination-pattern 7003
session protocol sipv2
session target ipv4:10.64.86.206:5061
session transport tcp tls
incoming called-number 6003
codec g711ulaw
!
!
sip-ua
 transport tcp tls v1.2
connection-reuse
crypto signaling default trustpoint ecdsacert1 ecdsa-cipher
!
!
!
gatekeeper
shutdown
!
!
!
line con 0
exec-timeout 0 0
speed 115200
line aux 0
line 2
no activation-character
no exec
transport preferred none
transport output pad telnet rlogin lapb-ta mop udptn v120 ssh
stopbits 1
line vty 0 4
login
transport input none
!
!
end
```



## PART **XXI**

### **Voice Quality in CUBE**

- [CUBE Call Quality Statistics Enhancement, on page 1003](#)
- [Voice Quality Monitoring, on page 1009](#)







## CHAPTER 76

# CUBE Call Quality Statistics Enhancement

Call quality statistics in CUBE, such as packet loss, jitter, and round trip delay can be added to the call detail record (CDR), and these voice metrics can be calculated in IOS. For more information, refer to [Voice Quality Enhancements on Cisco Unified Border Element](#).

The call quality statistics feature is enhanced to provide the following capabilities:

- Enable or disable Quality of Service (QoS) for CUBE.
- Enable or disable Real-time Transport Protocol (RTP) Control Protocol (RTCP) passthrough.
- Configure call quality criteria parameters.
- [Feature Information for Call Quality Statistics Enhancement, on page 1003](#)
- [Restrictions for Call Quality Statistics Enhancement, on page 1004](#)
- [Information About Call Quality Statistics Enhancement, on page 1004](#)
- [How to Configure Call Quality Parameters, on page 1005](#)
- [Configuration Example for Call Quality Statistics, on page 1007](#)

## Feature Information for Call Quality Statistics Enhancement

The following table provides release information about the feature or features described in this module. This table lists only the software release that introduced support for a given feature in a given software release train. Unless noted otherwise, subsequent releases of that software release train also support that feature.

Use Cisco Feature Navigator to find information about platform support and Cisco software image support. To access Cisco Feature Navigator, go to <https://cfng.cisco.com/>. An account on Cisco.com is not required.

Table 100: Feature Information for Call Quality Statistics Enhancement

| Feature Name                        | Releases           | Feature Information                                                                                                                                                                                                                                                                                                                                                                                                                                                                                                                                                                                                                                                     |
|-------------------------------------|--------------------|-------------------------------------------------------------------------------------------------------------------------------------------------------------------------------------------------------------------------------------------------------------------------------------------------------------------------------------------------------------------------------------------------------------------------------------------------------------------------------------------------------------------------------------------------------------------------------------------------------------------------------------------------------------------------|
| Call Quality Statistics Enhancement | Cisco IOS XE 3.14S | <p>Call quality statistics in CUBE, such as packet loss, jitter, and round trip delay can be added to the call detail record (CDR), and these voice metrics can be calculated in IOS. For more information, refer to <a href="#">Voice Quality Enhancements on Cisco Unified Border Element</a>.</p> <p>The call quality statistics feature is enhanced to provide the following capabilities:</p> <ul style="list-style-type: none"> <li>• Enable or disable Quality of Service (QoS) for CUBE.</li> <li>• Enable or disable Real-time Transport Protocol (RTP) Control Protocol (RTCP) passthrough.</li> <li>• Configure call quality criteria parameters.</li> </ul> |

## Restrictions for Call Quality Statistics Enhancement

- Only SIP-to-SIP call quality statistics calculation is supported.
- The RTCP field is not recalculated, as it is end-to-end statistics.
- The round trip delay is only retrieved by RTCP, which means the round trip delay is not calculated if there is no related RTCP.
- Only three codec types are supported for one media flow to calculate the jitter; considering the data path performance, these three codecs would be the maximum number in one cache line.
- Only one RTP synchronization source (SSRC) is supported concurrently per media flow, which is indicated in the m-line of the session description protocol (SDP).
- Round trip delay calculation for transcoding calls is not supported.

## Information About Call Quality Statistics Enhancement

Call quality configuration parameters include `max_dropout`, `max_reorder`, and `clock_rate`. A maximum of three codecs (`codec_number`, `payload_type`, `clock_rate`) per media flow is collected by the PI and sent to CPP, which uses these values in statistics calculation. Calculated statistics such as Jitter, Packet Loss, and Delay are then fetched from the CPP to the CDR. These statistics can be viewed in the command line interface.

The CDR has the following data per call leg of the call:

- Packet Loss—Calculated based on methods shown in RFC3550. The RTCP sender/receiver reports are recalculated, and not just copied from the inbound leg to the outbound leg.
- Delay—Calculated based on timestamp received or timestamp of packets sent.
- Jitter—Variation of delay.

For more information on how to calculate the voice quality metrics related to media(voice) quality, such as conversational mean opinion score (MOS), jitter, and so on, see <http://www.cisco.com/c/en/us/td/docs/ios-xml/ios/voice/cube/configuration/cube-book/voi-cube-call-monitoring.html>.

# How to Configure Call Quality Parameters

## Configuring Call Quality Criteria Parameters

### SUMMARY STEPS

1. **enable**
2. **configure terminal**
3. **voice service voip**
4. **call-quality**
5. **max-dropout** *number-of-packets*
6. **max-reorder** *number-of-packets*
7. **clock-rate** *payload-type-number frequency*
8. **clock-rate dynamic-default** *frequency*
9. **exit**
10. **rtcp all-pass-through**
11. **end**

### DETAILED STEPS

|        | Command or Action                                                                                                 | Purpose                                                                                                                          |
|--------|-------------------------------------------------------------------------------------------------------------------|----------------------------------------------------------------------------------------------------------------------------------|
| Step 1 | <b>enable</b><br><b>Example:</b><br>Device> enable                                                                | Enables privileged EXEC mode.<br><ul style="list-style-type: none"><li>• Enter your password if prompted.</li></ul>              |
| Step 2 | <b>configure terminal</b><br><b>Example:</b><br>Device# configure terminal                                        | Enters global configuration mode.                                                                                                |
| Step 3 | <b>voice service voip</b><br><b>Example:</b><br>Device(config)# voice service voip                                | Enters global VoIP configuration mode.                                                                                           |
| Step 4 | <b>call-quality</b><br><b>Example:</b><br>Device(conf-voi-serv)# call-quality                                     | Enters call quality configuration mode; this is the global call quality of service setup.                                        |
| Step 5 | <b>max-dropout</b> <i>number-of-packets</i><br><b>Example:</b><br>Device(conf-serv-call-quality)# max-dropout 300 | Configures the acceptable out of sequence future packets to drop. The range is from 2 to 2000 packets. The default value is 100. |

|                | Command or Action                                                                                                                         | Purpose                                                                                                                                                                                                                     |
|----------------|-------------------------------------------------------------------------------------------------------------------------------------------|-----------------------------------------------------------------------------------------------------------------------------------------------------------------------------------------------------------------------------|
| <b>Step 6</b>  | <b>max-reorder</b> <i>number-of-packets</i><br><b>Example:</b><br>Device(conf-serv-call-quality)# max-reorder 500                         | Configures the acceptable out of sequence late packets. The range is from 2 to 2000 packets. The default value is 100.                                                                                                      |
| <b>Step 7</b>  | <b>clock-rate</b> <i>payload-type-number frequency</i><br><b>Example:</b><br>Device(conf-serv-call-quality)# clock-rate 5 1500            | Sets the payload type number and frequency. Clock rate is the RTP timestamp field's sampling frequency.                                                                                                                     |
| <b>Step 8</b>  | <b>clock-rate dynamic-default</b> <i>frequency</i><br><b>Example:</b><br>Device(conf-serv-call-quality)# clock-rate dynamic-default 10000 | (Optional) Changes the default clock rate for all the dynamic payload types. The frequency range (in Hz) is from 1000 to 192000.<br><br>• You have several options to set the clock rate, such as for the different codecs. |
| <b>Step 9</b>  | <b>exit</b><br><b>Example:</b><br>Device(conf-serv-call-quality)# exit                                                                    | Exits to global VoIP configuration mode.                                                                                                                                                                                    |
| <b>Step 10</b> | <b>rtcp all-pass-through</b><br><b>Example:</b><br>Device(conf-voip-serv)# rtcp all-pass-through                                          | (Optional) Passes through all RTCP in data path.                                                                                                                                                                            |
| <b>Step 11</b> | <b>end</b><br><b>Example:</b><br>Device(conf-voip-serv)# end                                                                              | Returns to privileged EXEC mode.                                                                                                                                                                                            |

## Troubleshooting Call Quality Statistics

Use the following **debug** and **show** commands to enable the logs, which helps in debugging:

- **debug ccsip verbose**
- **debug voip fpi all**
- **debug platform hardware qfp active feature sbc dbe datapath all**
- **debug platform hard qfp act feature sbc dbe client all**
- **debug ccsip message**
- **debug ccsip info**
- **show call active voice**
- **show platform hardware qfp active feature sbc data path call *call-id***

The following are some show command outputs that would be useful in troubleshooting:

- **Device# show call active voice | include LostPackets**

LostPackets=0

LostPackets=36 ----> //Lost packets detail present in **show call active voice** output. View the complete command output based on the filters such as **call-id** to check the packet loss for a particular call leg.//

•Device# **show call active voice | include PlayDelayJitter**

PlayDelayJitter=0

PlayDelayJitter=38 -----> //Jitter detail present in **show call active voice** output. View the complete command output based on the filters such as **call-id** to check the Jitter for a particular call leg.//

## Configuration Example for Call Quality Statistics

```
voice service voip
 no ip address trusted authenticate
 callmonitor
 rtcp all-pass-through
 media statistics
 media bulk-stats
 allow-connections sip to sip
 call-quality
 max-dropout 2
 max-reorder 2
 sip
 g729 annexb-all
 no call service stop
```





## CHAPTER 77

# Voice Quality Monitoring

The Voice Quality Monitoring (VQM) feature gives information on the voice quality metrics related to media (voice) quality, such as conversational mean opinion score (MOS), packet loss rate, and so on. VQM enables you to monitor the quality of calls traversing your VoIP network, and you can diagnose the cause of voice quality issues and troubleshoot them.

The Voice Quality Statistics feature provides information about the quality of the Time-Division Multiplexing Internet Protocol (TDM-IP) voice call.

- [Feature Information for Voice Quality Monitoring](#), on page 1009
- [Prerequisites for Voice Quality Monitoring](#), on page 1010
- [Restrictions for Voice Quality Monitoring and Voice Quality Statistics](#), on page 1011
- [Information About Voice Quality Monitoring](#), on page 1011
- [How to Configure Voice Quality Monitoring](#), on page 1012
- [Configuration Examples for Voice Quality Monitoring](#), on page 1016

## Feature Information for Voice Quality Monitoring

The following table provides release information about the feature or features described in this module. This table lists only the software release that introduced support for a given feature in a given software release train. Unless noted otherwise, subsequent releases of that software release train also support that feature.

Use Cisco Feature Navigator to find information about platform support and Cisco software image support. To access Cisco Feature Navigator, go to <https://cfng.cisco.com/>. An account on Cisco.com is not required.

**Table 101: Feature Information for Voice Quality Monitoring and Voice Quality Statistics**

| Feature Name             | Releases                     | Feature Information                                                                                                                                                                        |
|--------------------------|------------------------------|--------------------------------------------------------------------------------------------------------------------------------------------------------------------------------------------|
| Voice Quality Statistics | Cisco IOS XE Everest 16.5.1b | Voice quality statistics provides information about the quality of the voice TDM-IP call. This feature is already implemented on ISR-G2, and the feature gap is filled in ISR 4000 series. |

| Feature Name             | Releases                   | Feature Information                                                                                                                                                                                                                                                                                                                                                      |
|--------------------------|----------------------------|--------------------------------------------------------------------------------------------------------------------------------------------------------------------------------------------------------------------------------------------------------------------------------------------------------------------------------------------------------------------------|
| Voice Quality Monitoring | Cisco IOS XE Denali 16.3.1 | The Voice Quality Monitoring (VQM) feature provides information on the voice quality metrics related to media (voice) quality, such as conversational mean opinion score (MOS), packet loss rate, and so on. VQM enables you to monitor the quality of calls traversing your VoIP network, and you can diagnose the cause of voice quality issues and troubleshoot them. |

## Prerequisites for Voice Quality Monitoring

The following commands must be executed to configure the voice quality metrics:

- **callmonitor**
- **rtcp all-pass-through**
- **media statistics**
- **media bulk-stats**
- **call-quality**
  - **max-dropout** *number-of-packets*—Configures the acceptable out of sequence future packets to drop. The range is 2–2000 packets. The default value is 100.
  - **max-reorder** *number-of-packets*—Configures the acceptable out of sequence late packets. The range is 2–2000 packets. The default value is 100.



---

**Note** The values of **max-dropout** and **max-reorder** must be configured based on the network loss and network latency. In a lossy or high latency network, it's recommended to configure higher values. In a loss less or low latency network, lower values are fine. Packet loss and packet reorder are calculated based on RFC3550.

---

### Sample Configuration

The following is a sample for the recommended voice quality monitoring configuration:

```
callmonitor
rtcpall-pass-through
media statistics
media bulk-stats
call-quality
max-dropout 100
max-reorder 100
```



# Restrictions for Voice Quality Monitoring and Voice Quality Statistics

- Only SIP-to-SIP call quality statistics calculation is supported.
- The RTCP field is not recalculated, as it is end-to-end statistics.
- The round trip delay is only retrieved by RTCP, which means the round trip delay is not calculated if there is no related RTCP.
- Only three codec types are supported for one media flow to calculate the jitter; considering the data path performance, these three codecs would be the maximum number in one cache line.
- Only one RTP synchronization source (SSRC) is supported concurrently per media flow, which is indicated in the m-line of the session description protocol (SDP).
- Round trip delay calculation for transcoding calls is not supported.
- VQM MOS values are not calculated for DSP based calls.
- MOS value shows 0 if endpoint does not send RTCP packets.
- The voice quality statistics covers only the TDM-IP call. The implementation focuses on filling the following statistics based on query response from DSP for TDM-SIP and TDM-H323 call:
  - RoundTripDelay
  - GapFillWithSilence
  - GapFillWithPrediction
  - GapFillWithInterpolation
  - GapFillWithRedundancy
  - HiWaterPlayoutDelay
  - LoWaterPlayoutDelay
  - PlayDelayJitter

## Information About Voice Quality Monitoring

The VQM (Voice Quality Monitor) gives information on the voice quality metrics. The VQM on Cisco IOS XE platforms enables statistics gathering based on the received RTCP packets. From these statistics, a voice quality measurement is developed to show the quality of the call. The output is in a simple format, using a system of good, poor, and bad types of ratings.

The following metrics exist in Call Detail Record (CDR) and Management Information Base (MIB) in CUBE, indicating voice quality:

1. MOSQe (conversational quality MOS)
2. Round-trip-delay.

3. Receive-delay (current jitter buffer size).
4. Packet-Loss-Rate.

The CDR is sent at the end of a call if AAA accounting is configured.

A CDR example is as follows:

```
<MOS-Con>4.4072</MOS-Con>
```

```
<round-trip-delay>1 ms</round-trip-delay>
```

```
<receive-delay>64 ms</receive-delay>
```

```
<voice-quality-total-packet-loss>0.0000 %</ voice-quality-total-packet-loss>
```

## VQM Metrics

The following are the metrics exported by VQM:

| IOS VQM, Voice/Audio Description Quality Metric | Description                                                                                                                                                                                                                              |
|-------------------------------------------------|------------------------------------------------------------------------------------------------------------------------------------------------------------------------------------------------------------------------------------------|
| MOS-Con                                         | The conversational quality MOS. Conversational quality indicates the impact of the quality of the transmission on the dynamics of conversational exchanges between two parties; such metrics take into account delay, echo, and recency. |
| round-trip-delay                                | The instantaneous round-trip delay. This may be obtained from the RTCP SR reports.                                                                                                                                                       |
| receive-delay                                   | The minimum delay that will be applied to the packets received when using an adaptive jitter buffer.                                                                                                                                     |
| voice-quality-total-packet-loss                 | The total number of packets lost by the jitter buffer in the RTP stream.                                                                                                                                                                 |

# How to Configure Voice Quality Monitoring

## Enabling Media Statistics Globally

Perform this task to globally enable media statistics in voice-service configuration mode to estimate the values for packet loss, jitter, and round-trip time.

### SUMMARY STEPS

1. **enable**
2. **configure terminal**
3. **voice service voip**
4. **media statistics**
5. **end**

## DETAILED STEPS

|        | Command or Action                                                                                | Purpose                                                                                                                                                                                                                                                                                                                                                                |
|--------|--------------------------------------------------------------------------------------------------|------------------------------------------------------------------------------------------------------------------------------------------------------------------------------------------------------------------------------------------------------------------------------------------------------------------------------------------------------------------------|
| Step 1 | <b>enable</b><br><b>Example:</b><br><pre>Device&gt; enable</pre>                                 | Enables privileged EXEC mode. <ul style="list-style-type: none"> <li>• Enter your password if prompted.</li> </ul>                                                                                                                                                                                                                                                     |
| Step 2 | <b>configure terminal</b><br><b>Example:</b><br><pre>Device# configure terminal</pre>            | Enters global configuration mode.                                                                                                                                                                                                                                                                                                                                      |
| Step 3 | <b>voice service voip</b><br><b>Example:</b><br><pre>Device(config)# voice service voip</pre>    | Enters voice service VoIP configuration mode.                                                                                                                                                                                                                                                                                                                          |
| Step 4 | <b>media statistics</b><br><b>Example:</b><br><pre>Device(conf-voi-serv)# media statistics</pre> | Enables media statistics to estimate the values of packet loss, jitter, and Round Trip Time (RTT) statistics. <ul style="list-style-type: none"> <li>• The statistics are displayed using the <b>show voice history</b> and <b>show call active voice</b> commands.</li> <li>• If the <b>media statistics</b> command is disabled, the values will be zero.</li> </ul> |
| Step 5 | <b>end</b><br><b>Example:</b><br><pre>Device(conf-voi-serv)# end</pre>                           | Returns to privileged EXEC mode.                                                                                                                                                                                                                                                                                                                                       |

## Verifying Voice Quality Monitoring

Perform this task to verify the configuration for voice quality monitoring. The **show** commands can be entered in any order.

## SUMMARY STEPS

1. **enable**
2. **show call active voice | include LostPackets**
3. **show call active voice | include ReceiveDelay**
4. **show call active voice brief | sec RTT**
5. **show call active voice stats | sec MC**

## DETAILED STEPS

---

### Step 1 enable

Enables privileged EXEC mode.

#### Example:

```
Device> enable
```

### Step 2 show call active voice | include LostPackets

Displays statistics on the CUBE if the Voice Quality Metrics feature is configured.

#### Example:

```
Device# show call active voice | include LostPackets

LostPackets=0
LostPackets=0
```

### Step 3 show call active voice | include ReceiveDelay

Displays statistics on the CUBE if the Voice Quality Metrics feature is configured.

#### Example:

```
Device# show call active voice | include ReceiveDelay

ReceiveDelay=0
ReceiveDelay=0
```

### Step 4 show call active voice brief | sec RTT

Displays a truncated version of call information for voice calls in CUBE if the Voice Quality Metrics feature is configured.

**Note** This command is not applicable for TDM-IP voice calls.

#### Example:

```
Device# show call active voice brief | sec RTT

IP 173.39.65.81:7078 SRTP: off rtt:12ms pl:0/0ms lost:0/0/0 delay:0/0/0ms g711ulaw
TextRelay: off Transcoded: No ICE: Off
IP 10.127.17.141:18920 SRTP: off rtt:12ms pl:0/0ms lost:0/0/0 delay:0/0/0ms g711ulaw
TextRelay: off Transcoded: No ICE: Off
```

### Step 5 show call active voice stats | sec MC

Displays R-Factor Statistics (G.107 MOS) on the CUBE if the Voice Quality Metrics feature is configured. A sample output is provided below for a voice call using G.711ulaw, VAD on, and at 5 percent packet loss rate.

#### Example:

```
Device# show call active voice stats | sec MC

DSP/RF: ML=, MC=, R1=, R2=, IF=, ID=, IE=, BL=, R0=, VR=
DSP/RF: ML=4.2346, MC=4.2346, R1=92, R2=92, IF=0, ID=0, IE=0, BL=0, R0=93, VR=2.0
DSP/RF: ML=4.2346, MC=4.2346, R1=92, R2=92, IF=0, ID=0, IE=0, BL=0, R0=93, VR=2.0
```

The following is an example output for the SNMP MIB:  
**cmqVoIPCallActiveRxPred107RMosConv.8520964.1 = 423 (MC)**

For more information on the SNMP MIB "`cmqVoIPCallActiveRxPred107RMosConv`", see [SNMP Object Navigator](#).

In the sample output, the following can be noted:

- ML for codec G.711ulaw is 4.2346.
- MC for codec G.711ulaw is 4.2346.
- IE for codec G.711 is 0.
- R0 is 93.

The following table defines the abbreviations used in the sample output.

**Table 102: Router Output Definitions for the `show call active voice stats` command**

| Type                                       | Abbreviation | Definition                               |
|--------------------------------------------|--------------|------------------------------------------|
| DSP/RF: R-Factor Statistics<br>(G.107 MOS) | ML           | R-factor MOS listening quality objective |
|                                            | MC           | R-factor MOS-CQE                         |
|                                            | R1           | R-factor for LQ profile1                 |
|                                            | R2           | R-factor for LQ                          |
|                                            | IF           | Effective codec impairment (IeEff )      |
|                                            | ID           | Delay factors                            |
|                                            | IE           | Codec baseline score (Ie)                |
|                                            | BL           | Codec baseline (Bpl)                     |
|                                            | R0           | Nominal value for R0 (default)           |
|                                            | VR           | R-Factor version                         |

## Troubleshooting Tips

Use the following debug commands to troubleshoot the Voice Quality Monitoring feature:

- `debug voip rtp packets`
- `debug performance monitor`
- `debug radius accounting`
- `debug aaa accounting`

# Configuration Examples for Voice Quality Monitoring

## Example: Configuring Media Statistics Globally

```
Device> enable
Device# configure terminal
Device(config)# voice service voip
Device(conf-voi-serv)# media statistics
Device(conf-voi-serv)# end
```

## Example: CDR Enabled MOS Output

At the end of a call, the MOSQe output is displayed in CDR only if the **debug radius accounting** is enabled.

The **show log | sec MOS-Con** command displays the MOS-Con value as shown below:

```
Device# show log | sec MOS-Con

*Jan 21 22:31:42.313: RADIUS: Cisco AVpair [1] 16 "MOS-Con=4.2312"
*Jan 21 22:31:42.313: RADIUS: Cisco AVpair [1] 16 "MOS-Con=4.2312"
```



## PART **XXII**

### **Smart Licensing**

- [CUBE Smart Licensing, on page 1019](#)







## CHAPTER 78

# CUBE Smart Licensing

Cisco Smart Licensing using Policy is a software licensing model that provides visibility of ownership and usage through the Cisco Smart Software Manager (CSSM) portal. CSSM is a central license repository that manages licenses across all Cisco products that you own, including CUBE. Devices send license usage to CSSM either directly or use an on-premises application. Your Smart Account Administrator controls your access to CSSM. Use your Cisco credentials to access the CSSM portal through <http://software.cisco.com>.

Smart Licensing applies to all platform technology (UCK9, Security, DNA) and CUBE feature licenses that the platform uses.

CSSM shows license usage across all devices that are registered to a virtual account. A Virtual Account License Inventory displays the quantity of licenses that are purchased, those licenses in use, and a balance. An **Insufficient Licenses** alert is displayed if the license balance is below 0.

For example, consider a smart account in CSSM with 50 CUBE trunk session licenses. If you have a single registered CUBE router using 20 trunk sessions, the CSSM licenses page shows **Purchased** as 50, **In Use** as 20, and **Balance** as 30.

For more information on Smart Software Manager, see the [Cisco Smart Software Manager User Guide](#).

- [Smart License Operation, on page 1019](#)
- [Smart Software Licensing Task Flow for CUBE, on page 1021](#)
- [Verify Smart Licensing Operation for CUBE, on page 1023](#)
- [CUBE High Availability Configurations, on page 1027](#)
- [Syslog Messages, on page 1033](#)

## Smart License Operation

Smart Licensing using Policy introduces a new paradigm for tracking license usage across your business. In earlier releases, license authorization was forward-looking, binding licenses to a device until the next authorization request. Actual license use during the proceeding reporting period is now sent to CSSM, allowing you to plan ongoing license requirements based on historical usage data.

Each time a change in license usage is detected, the account policy defines how soon the change should be reported to CSSM. Typically, this means that CUBE must send a report at least every 90 days, although it is recommended that reports are sent more frequently. CSSM acknowledges each submitted Resource Utilization Monitoring (RUM) report to ensure that the use is recorded reliably. If the router does not receive an acknowledgment within the minimum reporting period, call processing may be disabled. Call processing is resumed when a valid acknowledgment is received.

Submit the reports to CSSM directly or through a Smart Software Manager On-Prem server. The Cisco Smart Licensing Utility (CSLU) application can also collect usage reports, providing more flexibility in managing your license usage. When a device is not able to communicate directly with a licensing server, a signed usage report can be generated and manually uploaded to CSSM. The CSSM generated acknowledgment must be uploaded to the device within the license reporting policy period to ensure continued use.



---

**Note** Cisco routers configured to process calls between voice ports and IP destinations will report the use of these sessions to CSSM, where they are listed as a “CUBE v14 Voice Gateway Session”. This usage is reported using the CUBE\_T\_VGW Smart entitlement tag, which may also be viewed using the **show license all** command and is provided for your information only. This reporting feature does not enforce voice port or IP sessions and there would be no service interruption if the router is not registered to CSSM.

A quantity of purchased licenses equal to the number of reported sessions is automatically displayed in CSSM to avoid compliance warnings. There is no requirement or option to purchase CUBE v14 Voice Gateway Session licenses.

---



---

**Note** Cisco Smart Software Manager On-Prem Version 8 Release 202102 or later is required for any device using SLP. Refer to the SLP feature documentation for further information ([Smart Licensing Using Policy for Cisco Enterprise Routing Platforms](#)).

---



---

**Warning** When using any of the following Smart Licensing using Policy releases, CUBE shuts down if the router does not receive a report acknowledgment from CSSM before the acknowledgment deadline set by the account policy: 17.3.2, 17.3.3, 17.3.4a, 17.6.1a, or any 17.4 or 17.5 release. CUBE does not shut down in this way with later releases.

---

License usage is calculated dynamically in the same way as earlier releases, with measurements recorded periodically based on the periodicity timer. Measurements are stored locally until they are submitted to CSSM. This historical usage reporting allows for more accurate aggregation of use across multiple devices over time. The minimum value for the periodicity timer interval is 8 hours.

For example, consider a measurement periodicity of 8 hours and a reporting policy interval of 30 days. Call load is measured every second. The average of the top three readings during each minute is recorded to mitigate anomalies. Similarly, the average of the top three minute measurements is used to log usage over an hour. After 8 hours, the maximum hourly measurement is used to record usage locally for that period. The 90 measurements that are recorded over a 30 day reporting period are sent to CSSM or a CSLU in a single report.

If the peak license usage for the current period is different by more or less than 25% of the previously reported value, it is reported and the periodicity interval is reset. Use of CUBE Standard Trunk and CUBE Enhanced Trunk licenses are monitored separately.



---

**Note** Smart License Reservation (SLR) for CUBE licenses is not compatible with SLP. Even if a reservation is in place when upgrading, license use reporting will still be required in accordance with the device policy.

---



**Note** From Cisco IOS XE Bengaluru 17.6.1a onwards, calls that are forked using WebSockets are marked as consuming an Enhanced session license.

## Smart Software Licensing Task Flow for CUBE

IOS XE license use reports may be pushed to, or pulled by a licensing server. Refer to the workflows in [Smart Licensing Using Policy for Cisco Enterprise Routing Platforms](#) for more details.

### Obtain the Registration ID Token

#### Detailed Steps

1. Log in to your Smart Account in either CSSM or satellite.
2. Navigate to the Virtual Account with which you want to register the CUBE.
3. Generate a registration ID token.

### Configure Smart Licensing Transport Settings

**Step 1** `hostname` *hostname*

**Example:**

```
Device(config)# hostname cube
cube(config)#
```

Ensure that hostname and the PID of the platform are not the same. For example, if the hostname of an ASR1006 router is configured as "ASR1006", registration is unsuccessful.

**Step 2** `ip name-server` *IP Address*

**Example:**

```
cube(config)# ip name-server 10.0.0.1 10.0.0.10
```

Configures valid DNS servers to ensure the correct resolution of the CSSM or satellite hostname.

**Step 3** `ip http client source-interface` *interface name*

**Example:**

```
cube(config)# ip http client source-interface GigabitEthernet0/0/0
```

Binds the platform HTTP client to the interface used to access the CSSM or satellite.

**Step 4** `license smart transport smart`

**Example:**

```
cube(config)# license smart transport smart
```

Smart transport is the preferred method for sending usage reports.

**Step 5** `license smart proxy address` *hostname***Example:**

```
cube(config)# license smart proxy address proxy.cisco.com
```

If necessary, configure a proxy-server for the platform when a direct HTTP connection to CSSM is not permitted.

**Step 6** `license smart proxy port` *port-number***Example:**

```
cube(config)# license smart proxy port 80
```

If using an internet proxy, configure a proxy-server port number.

**Step 7** `license smart url default`**Example:**

```
cube(config)# license smart url default
```

Use the default URL for sending reports to CSSM.

## Associate the Host Platform with CSSM

From Cisco IOS XE Everest 16.11.1a to Cisco IOS XE Amsterdam 17.3.1a, you must register the host platform to either CSSM or SSM On-Prem to report license usage. From Cisco IOS XE Amsterdam 17.3.2 onwards, license use must be reported to CSSM or SSM On-Prem in accordance with the Smart Account reporting policy.

### Before you begin

1. Obtain the registration ID token from your Smart Account.
2. Configure Smart Licensing transport settings.

From Cisco IOS XE 16.10.1 through Cisco IOS XE Amsterdam 17.3.1a, use the following command for registering the CUBE with the CSSM or satellite.

**license smart register id\_token** *id\_token*

**Example:**

```
Router# license smart register id_token XXXXXXXXXTnVhaUZlRHorQjJERT0%3D
```

Use the following command to register the CUBE platform with CSSM.

**license smart trust id\_token** *id\_token...local [force]*

**Example:**

```
Router# license smart trust id_token ZDEwZDFiODktNWF.....
```

## Configure CUBE Licensed Features

### Step 1 voice service voip

#### Example:

```
Device(config)# voice service voip
```

Enters global VoIP configuration mode.

### Step 2 mode border-element [ license periodicity {hours <8-23> | days <1-30> }]

The periodicity keyword configures the CUBE license usage measurement interval. If you do not configure the periodicity keyword, license usage is measured once every 7 days.

## Verify Smart Licensing Operation for CUBE

This section shows CUBE license usage status and license usage history.

- **show cube status**—Displays CUBE license status.

```
cube#show cube status
CUBE-Version : 14.1
SW-Version : 17.3.2, Platform CSR1000V
HA-Type : none
```

- **show license status**—Displays the license policy and reporting status.



**Note** The acknowledgment deadline is presented in this output. Ensure that an acknowledgment is received before this time to ensure continued operation of the SIP service.

```
cube#show license status
Utility:
 Status: DISABLED

Data Privacy:
 Sending Hostname: yes
 Callhome hostname privacy: DISABLED
 Smart Licensing hostname privacy: DISABLED
 Version privacy: DISABLED

Transport:
 Type: Callhome

Policy:
 Policy in use: Merged from multiple sources.
 Installed Time: Jan 01 05:30:00 1970 IST
 Reporting ACK required: yes
 Perpetual Attributes:
 First report requirement (days): 365 (CISCO default)
 Reporting frequency (days): 90 (CISCO default)
 Report on change (days): 90 (Product default)
 Subscription Attributes:
```

```

First report requirement (days): 90 (CISCO default)
Reporting frequency (days): 90 (CISCO default)
Report on change (days): 80 (Product default)
Enforced License Attributes:
First report requirement (days): 90 (Customer Policy)
Reporting frequency (days): 90 (Customer Policy)
Report on change (days): 80 (Customer Policy)
Export License Attributes:
First report requirement (days): 90 (Customer Policy)
Reporting frequency (days): 90 (Customer Policy)
Report on change (days): 90 (Customer Policy)

Miscellaneous:
Custom Id: <empty>

Usage Reporting:
Last ACK received: <none>
Next ACK deadline: May 26 08:24:45 2020 IST
Reporting Interval: 30
Next ACK push check: <none>
Next report push: Jun 15 08:24:45 2020 IST
Last report push: <none>
Last report file write: <none>
Last report pull: <none>

Trust Code Installed: <none>

```

- **show voice sip license stats**—Displays CUBE trunk license usage history.

License usage is recorded in tabular and graphical format for all the three types of trunk call count (Enhanced, Standard, and Aggregate). Usage is recorded based on the peak value of concurrent calls for a defined interval of time:

- **Seconds Table**—This table stores concurrent calls at every second for the last 60 seconds.
- **Minutes Table**—This table stores regularized peak value of concurrent calls at every minute for the last 60 minutes. Regularized peak for a minute is the average of top 3 peak values that occurs in a minute.
- **Hours Table**—This table stores peak value for each hour for the last 72 hours.
- **Days Table**—This table stores peak value for each day for the last 72 days.

The following example outputs are truncated to display 60-second and 60-minute tables only.

```
cube#show voice sip license stats table
```

```
02:50:16 PM Wednesday Nov 13 2019 UTC
```

```

CUBE Trunk License Usage (last 60 seconds)
Period Average Max

1-5 0 0
6-10 0 0
11-15 0 0
16-20 0 0
21-25 0 0
26-30 0 0
31-35 0 0
36-40 0 0
41-45 0 0

```

```
46-50 0 0
51-55 0 0
56-60 0 0
```

```
CUBE Trunk License Usage (last 60 minutes)
Period Average Max

1-5 0 0
6-10 0 0
11-15 0 0
16-20 0 0
21-25 0 0
26-30 0 0
31-35 0 0
36-40 0 0
41-45 0 0
46-50 324 900
51-55 343 899
56-60 292 600
```

cube#show voice sip license stats

11:01:01 AM Thursday Aug 29 2019 IST

```
10
 9
 8
 7
 6
 5
 4
 3
 2
 1
0....5....1....1....2....2....3....3....4....4....5....5....6
 0 5 0 5 0 5 0 5 0 5 0 5 0
CUBE Trunk License Usage (last 60 seconds)
```

```

369863146641
8880900440044
3330922440011
910 **
820 #*
730 ##
640 *** **
550 **** ##
460 ##### *##*
370 *##### *##*
280 #####* #####
190 ##### #####
100 *#####*#####
 10 #####*#####
0....5....1....1....2....2....3....3....4....4....5....5....6
 0 5 0 5 0 5 0 5 0 5 0 5 0
CUBE Trunk License Usage (last 60 minutes)
* = maximum # = average
```

- **show voice sip license status**—Displays the license status.

```
cube#show voice sip license status

Host Name: cube
Current Time: Nov 25 2019 14:46:41 IST
SIP service: Up
License request interval: 5 Minute(s)
Next request at: Nov 25 2019 14:50:44 IST
Recent request(s) for CUBE Standard Trunk

Timestamp Count Result

Nov 25 2019 14:45:44 IST 10 Out of compliance
Nov 25 2019 14:40:44 IST 4 Authorized
Nov 25 2019 14:35:44 IST 2 Authorized
```

- **show license usage**—Displays the license usage.

```
cube#show license usage
License Authorization:
 Status: AUTHORIZED on Mar 04 15:11:54 2019 UTC

CSR 1KV APPX 500M (appx_500M):
 Description: CSR 1KV APPX 500M
 Count: 1
 Version: 1.0
 Status: AUTHORIZED
 Export status: NOT RESTRICTED

CUBE_Trunk_Standard_Session (CUBE_T_STD):
 Description: Cisco Unified Border Element (CUBE) Trunk Standard Session License
 Count: 10
 Version: 1.0
 Status: AUTHORIZED
 Export status: NOT RESTRICTED
```

- **show license summary**—Displays the license summary information.

```
Device#show license summary
Smart Licensing is ENABLED

Registration:
 Status: REGISTERED
 Smart Account: BU Production Test
 Virtual Account: CUBE Sat Test
 Export-Controlled Functionality: Allowed
 Last Renewal Attempt: None
 Next Renewal Attempt: Aug 17 12:57:04 2019 UTC

License Authorization:
 Status: AUTHORIZED
 Last Communication Attempt: SUCCEEDED
 Next Communication Attempt: Apr 03 15:11:54 2019 UTC

License Usage:
 License Entitlement tag Count Status

 CUBE_T_STD (CUBE_T_STD) 5 IN USE
```



```

uck9 (ISR_4351_UnifiedCommun...) 1 IN USE
CUBE_T_VGW (CUBE_T_VGW) 4 IN USE

```

The following commands are also available related to your Smart License:

- **show license all**—Displays all the information that is related to licensing.
  - **show license tech support**—Displays the license technical support information.
  - **show call-home smart-licensing** —Displays the destination URL that is configured.
  - **debug license feature cube all**
- ```

Request successful for license_type:<license_type_int> and count <usage_count>.

```

Example:

```

*May 18 10:12:45.178: //CUBE-SL/Info/cube_sl_send_entitlement_request: Request
successful for license_type: 0 and count 9.

```

```

Request successful for license <license_type_string>

```

Example:

```

*May 18 10:15:45.181: //CUBE-SL/Info/cube_license_request: Request successful
for license CUBE_T_STD

```

CUBE High Availability Configurations

Smart Licensing with CUBE Box-to-Box High Availability

Box-to-Box redundancy uses the Redundancy Group Infrastructure to form a high availability pair of platforms.

For Smart License configurations on the high availability pair of platforms, see [Smart Software Licensing Task Flow for CUBE, on page 1021](#). When reporting license usage, the Smart Agent includes details of its high availability group and, if it is in the active or standby state. These details allow the CSSM or satellite to group license requirements for the high availability pair.

Box-to-Box High Availability requires CUBE Trunk Redundant or Enhanced Session licenses. From Cisco IOS XE Amsterdam 17.2.1r onwards, license usage is based on dynamic call counting.

Before Failover

- Establish a trust relationship for both platforms in the high availability configuration with the same CSSM or satellite Smart Virtual Account.
- CSSM or satellite sets the reporting policy for each platform.
- Only the active platform submits license usage reports to CSSM.

After Failover

- The platform that switches to the active mode reports license usage to the CSSM.
- The new active platform starts a new license request interval timer. For example, if a periodicity of five days is configured and failover occurs after three days, the next request will occur five days later.

Verify Smart Licensing Operation for Box-to-Box High Availability

You can use all the commands that are given in the section [Verify Smart Licensing Operation for CUBE, on page 1023](#) to verify the licensing status in High Availability mode.

The following commands reflect Box-to-Box High Availability licensing information.

- **show cube status**—Displays CUBE license capacity and the High Availability mode.

```
cube-1# show cube status
CUBE-Version : 12.5.0
SW-Version : 16.11.1, Platform CSR1000V
HA-Type : hot-standby-chassis-to-chassis
Licensed-Capacity : 10
Calls blocked (Smart Licensing Eval Expired) : 0
```



Note Effective from Cisco IOS XE Amsterdam 17.2.1r, Licensed-Capacity and blocked call information is no longer included in the output.

- **show license usage**—Displays license usage and authorization status.

```
cube-1#show license usage
CUBE_Trunk_Standard_Session (CUBE_T_RED):
Description: Cisco Unified Border Element (CUBE) Trunk Redundant Session License
Count: 10
Version: 1.0
Status: AUTHORIZED
Export status: NOT RESTRICTED
cube-2#show license usage
CUBE_Trunk_Standard_Session (CUBE_T_RED):
Description: Cisco Unified Border Element (CUBE) Trunk Redundant Session License
Count: 10
Version: 1.0
Status: AUTHORIZED
Export status: NOT RESTRICTED
```

- **show license summary**—Displays the license summary information.

Following is the sample output from the active instance of CUBE.

```
Device_CUBE1# show license summary
License Usage:
License                               Entitlement tag   Count   Status
-----
CUBE_Redundant_Session (CUBE_T_RED)   20        AUTHORIZED
```

- **show license all**—Displays active and standby states.

```
c8kv#sh license all
Smart Licensing Status
=====
```

```
Smart Licensing is ENABLED

Export Authorization Key:
  Features Authorized:
    <none>

Utility:
  Status: DISABLED

Smart Licensing Using Policy:
  Status: ENABLED

Data Privacy:
  Sending Hostname: yes
  Callhome hostname privacy: DISABLED
  Smart Licensing hostname privacy: DISABLED
  Version privacy: DISABLED

Transport:
  Type: Smart
  URL: https://smartreceiver-stage.cisco.com/licservice/license
  Proxy:
    Not Configured

Miscellaneous:
  Custom Id: <empty>

Policy:
  Policy in use: Installed On Apr 20 13:26:18 2021 UTC
  Policy name: SLE Policy
  Reporting ACK required: yes (Customer Policy)
  Unenforced/Non-Export Perpetual Attributes:
    First report requirement (days): 30 (Customer Policy)
    Reporting frequency (days): 60 (Customer Policy)
    Report on change (days): 60 (Customer Policy)
  Unenforced/Non-Export Subscription Attributes:
    First report requirement (days): 120 (Customer Policy)
    Reporting frequency (days): 150 (Customer Policy)
    Report on change (days): 120 (Customer Policy)
  Enforced (Perpetual/Subscription) License Attributes:
    First report requirement (days): 0 (CISCO default)
    Reporting frequency (days): 90 (Customer Policy)
    Report on change (days): 60 (Customer Policy)
  Export (Perpetual/Subscription) License Attributes:
    First report requirement (days): 0 (CISCO default)
    Reporting frequency (days): 30 (Customer Policy)
    Report on change (days): 30 (Customer Policy)

Usage Reporting:
  Last ACK received: Oct 08 13:56:07 2021 UTC
  Next ACK deadline: Dec 07 13:56:07 2021 UTC
  Reporting push interval: 1 days
  Next ACK push check: Oct 22 20:44:57 2021 UTC
  Next report push: Oct 23 16:24:52 2021 UTC
  Last report push: Oct 22 16:24:52 2021 UTC
  Last report file write: <none>

Trust Code Installed: Apr 20 13:26:18 2021 UTC

License Usage
=====

network-advantage_1G (ESR_P_1G_A):
  Description: network-advantage_1G
```

```

Count: 1
Version: 1.0
Status: IN USE
Export status: NOT RESTRICTED
Feature Name: network-advantage_1G
Feature Description: network-advantage_1G
Enforcement type: NOT ENFORCED
License type: Perpetual

dna-advantage_1G (DNA_P_1G_A):
Description: dna-advantage_1G
Count: 1
Version: 1.0
Status: IN USE
Export status: NOT RESTRICTED
Feature Name: dna-advantage_1G
Feature Description: dna-advantage_1G
Enforcement type: NOT ENFORCED
License type: Subscription

CUBE_T_STD (CUBE_T_STD):
Description: CUBE_T_STD
Count: 121
Version: 1.0
Status: IN USE
Export status: NOT RESTRICTED
Feature Name: CUBE_T_STD
Feature Description: CUBE_T_STD
Enforcement type: NOT ENFORCED
License type: Perpetual

Product Information
=====
UDI: PID:C8000V,SN:93POM8FF9IZ

Agent Version
=====
Smart Agent for Licensing: 5.1.21_rel/96

License Authorizations
=====
Overall status:
  Active: PID:C8000V,SN:93POM8FF9IZ
          Status: SMART AUTHORIZATION INSTALLED on Sep 21 13:48:56 2021 UTC
          Last Confirmation code: 1fc54c75

Purchased Licenses:
  No Purchase Information Available#

```

Smart Licensing with CUBE Inbox High Availability

You can configure a Cisco ASR 1000 Series Router platform with two Route Processors for Inbox High Availability using Stateful Switchover (SSO). In this configuration, one Route Processor is active while the other is in standby mode.

For Smart License configuration, see [Smart Software Licensing Task Flow for CUBE, on page 1021](#). Only the active Route Processor in the SSO configuration reports license usage, so CSSM reserves one set of licenses for the platform.

Inbox High Availability requires CUBE Trunk Standard Session licenses.

Before Failover

- Smart License configuration is synchronized between the two Route Processors. Only the active Route Processor registers with CSSM or satellite.
- The CSSM or satellite authorizes license usage requests for the active Route Processor.



Note For Smart License using Policy, the CSSM or satellite license usage requests for the active Route Processor.

After Failover

- The Route Processor that switches to active mode, reports license usage to the CSSM or satellite.
- As the new report appears to come from the same device, the CSSM or satellite retains the original reservation for the platform.

Verify Smart Licensing Operation for Inbox High Availability

You can use all the commands that are given in the section [Verify Smart Licensing Operation for CUBE, on page 1023](#) to verify the licensing status in the High Availability mode.

The following commands reflect Inbox High Availability (HA) licensing information:

- **show cube status**—Displays CUBE license capacity and High Availability mode.



Note Effective from Cisco IOS XE Amsterdam 17.2.1r, Licensed-Capacity and blocked call information is no longer included in the output.

```
cube-1#sh cube status
CUBE-Version : 12.5.0
SW-Version : 16.11.1, Platform Platform ASR1006
HA-Type : hot-standby-card-to-card
Licensed-Capacity : 10
Calls blocked (Smart Licensing Not Configured) : 0
Calls blocked (Smart Licensing Eval Expired) : 0
```

- **show redundancy states**—Displays the redundancy state of the Route Processors.

```
cube-1# show redundancy states
my state = 13 -ACTIVE
peer state = 8 -STANDBY HOT
Mode = Duplex
Unit = Secondary
Unit ID = 49
Redundancy Mode (Operational) = sso
Redundancy Mode (Configured) = sso
Redundancy State = sso
Maintenance Mode = Disabled
Manual Swact = enabled
Communications = Up
client count = 131
client_notification_TMR = 30000 milliseconds
```

```
RF debug mask = 0x0
```

```
cube-2# show redundancy states
my state = 8 -STANDBY HOT
peer state = 13 -ACTIVE
Mode = Duplex
Unit = Primary
Unit ID = 48
Redundancy Mode (Operational) = sso
Redundancy Mode (Configured) = sso
Redundancy State = sso
Maintenance Mode = Disabled
Manual Swact = cannot be initiated from this the standby unit
Communications = Up
client count = 131
client_notification_TMR = 30000 milliseconds
RF debug mask = 0x0
```

- **show license summary**—Displays license summary information.

```
cube-1# show license summary
Smart Licensing is ENABLED
Registration:
Status: REGISTERED
Smart Account: BU Production Test 1
Virtual Account: CUBE_VA
Export-Controlled Functionality: Allowed
Last Renewal Attempt: None
Next Renewal Attempt: Jan 02 09:06:22 2019 IST
CUBE Smart Licensing
License Authorization:
Status: Authorized
Last Communication Attempt: SUCCEEDED
Next Communication Attempt: Aug 02 00:48:00 2018 IST
License Usage:
License                Entitlement tag                Count    Status
-----
ASR_1000_AdvEnterprise (ASR_1000_AdvEnterprise)  1        AUTHORIZED
CUBE_Standard_Session  (CUBE_T_STD)                    10       AUTHORIZED

cube-2# show license summary
Smart Licensing is ENABLED
Registration:
Status: REGISTERED
Smart Account: BU Production Test 1
Virtual Account: CUBE_VA
Export-Controlled Functionality: Allowed
Last Renewal Attempt: None
License Authorization:
Status: Authorized
Last Communication Attempt: SUCCEEDED
Next Communication Attempt: None
License Usage:
License                Entitlement tag                Count    Status
-----
ASR_1000_AdvEnterprise (ASR_1000_AdvEnterprise)  1        PENDING
```

Syslog Messages

- In B2BHA mode, syslog messages are generated by the active CUBE router and not the standby router. The following is a syslog output for an active CUBE router in B2BHA mode:

```
%CUBE-5-LICENSE_INFO: Requesting for 3 CUBE Enhanced trunk licenses
```



PART **XXIII**

Serviceability

- [VoIP Trace for CUBE, on page 1037](#)
- [Support for Session Identifier, on page 1043](#)



CHAPTER 79

VoIP Trace for CUBE

VoIP Trace is a Cisco Unified Border Element (CUBE) serviceability framework, which provides a binary trace facility for troubleshooting SIP call issues. The VoIP Trace framework records both successful and failed calls. All call trace data is stored in system memory. In addition, data for calls with IEC errors is also written to the logging location configured at the system level which includes logging to a buffer or a syslog server.

- [VoIP Trace for CUBE, on page 1037](#)
- [Prerequisites for Voip Trace, on page 1038](#)
- [Benefits of VoIP Trace, on page 1038](#)
- [Guide to using VoIP Trace Framework, on page 1039](#)
- [RTP Port Clear, on page 1040](#)
- [Feature Information for VoIP Trace, on page 1041](#)

VoIP Trace for CUBE

The VoIP Trace feature is enabled by default and can be used to help troubleshoot issues, even in deployments with high call volumes.

You can configure VoIP Trace for CUBE using the **trace** configuration sub-mode under **voice service voip** configuration mode:

```
router (config)#voice service voip
router(conf-voi-serv)#trace
router(conf-serv-trace)#?
Voip Trace submode commands:
default Set a command to its defaults
exit Exit from voice service voip trace mode
no Negate a command or set its defaults
shutdown Shut Voip Trace debugging
memory-limit Set limit based on memory used
```

Within the VoIP Trace sub-mode (**conf-serv-trace**), you can configure the following CLI commands:

- **memory-limit {platform | memory}**
- **[no] shutdown**

VoIP Trace is used for event logging and debugging of VoIP calls. Using the VoIP Trace framework, the following information is recorded:

- SIP messages for SIP trunk to SIP trunk calls

- Events and API calls from the SIP layer to other layers in CUBE.
- SIP Errors
- Call Control (Unified Communication flows processed by CUBE)
- FSM (Finite State Machine) states and events

VoIP Trace monitors and logs SIP signalling and call events in memory as they occur. In the event that a call error is detected, or calls fail with 3xx, 4xx or 5xx cause codes, these event details are written to the logging buffer after the call clears.



Note Traces for error calls are logged at the rate of up to five traces per second.

There's a configurable memory limit allocated for storage of traces in a VoIP Trace framework for CUBE. The configurable maximum memory limit is either available platform memory or 1000 MB, whichever is lower. By default, VoIP Trace will use up to 10% of the total memory available to the IOS processor at the time of configuring the command. For example, if CUBE is used on a platform with 8GB of memory, VoIP Trace will use up to 800MB for trace data. Once the trace memory limit is reached, older traces are overwritten and will no longer be available.

You can configure the trace memory limit using the CLI command **memory-limit {platform | memory }** under **trace** configuration sub-mode:

```
Router(conf-serv-trace)#memory-limit ?
<10-1000> Specify maximum memory limit in MB
platform Use 10 percent of available memory
```

To display the traces for a call, use the following show command:

- **show voip trace {call-id identifier | session-id identifier | sip-call-id identifier | correlator identifier | all | cover-buffers | statistics [detail]}**

Prerequisites for Voip Trace

Cisco IOS XE Amsterdam 17.3.2 or a later release supported by CUBE.

Benefits of VoIP Trace

The following are some of the benefits of VoIP Trace Serviceability framework:

- Enabled by default
- Minimal CLI configuration requirement
- Minimal processing impact
- Automatic call error identification and trace logging based on IEC Errors
- Request-based manual call identification and trace logging based on filters like call-ID, session-ID, and so on.

Guide to using VoIP Trace Framework

The following are some of the usage guidelines for the VoIP Trace Serviceability framework.

- Enable or disable your VoIP Trace serviceability framework using the following CLI commands:
 - Enable—Configure **trace** under **voice service voip** configuration mode to enable your VoIP Trace framework (**trace** is enabled by default).
 - Disable—Configure **shutdown** under **voip trace** configuration mode to disable your VoIP Trace framework. To enable VoIP Trace after it's disabled, configure the CLI command **no shutdown**.
- If you configure **shutdown** the VoIP Trace Serviceability framework:
 - Stops tracing for active calls.
 - Deletes all existing traces in the system memory.
- Monitors calls received after enabling VoIP Trace.
- Traces stored in memory can be displayed using the show command **show voip trace** {*call-id identifier* | *session-id identifier* | *sip-call-id identifier* | *correlator identifier* | **all** | **cover-buffers** | **statistics** [**detail**]}
 - The show command displays traces for both active and disconnected calls.
 - The show command displays information only for the SIP leg.
 - For media forking, VoIP Trace also displays information for forked legs.
- For the CLI command **memory-limit** [**platform** | *memory*]
 - Configure **memory-limit platform** to set 10% of the total memory available to the IOS processor at the time of configuring the command as VoIP Trace memory limit.
 - Configure **memory-limit memory** to set a custom VoIP Trace memory limit. Range is 10–1000 MB.
 - Configuration of custom memory-limit more than the available platform memory is not allowed. Configuration fails with an error message:

```
router(config)#voice service voip
router(conf-voi-serv)#trace
router(conf-serv-trace)#memory-limit 800
Error: Setting memory-limit more than available platform memory (732 MB) is not
allowed.
```

- Configuration of memory-limit more than the 10% of the available platform memory affects the system performance. Configuration is successful with a warning message:

```
router(config)#voice service voip
router(conf-voi-serv)#trace
router(conf-serv-trace)#memory-limit 100
Warning: Setting memory limit more than 10% of available platform memory (73
MB) will affect system performance.
```

- Reducing the memory-limit from an existing limit **resets** the VoIP Trace data. Take copy of the **show voip trace statistics detail** and **show voip trace all** output data before reducing the memory-limit.
 - A confirmation message is displayed when you reduce the memory-limit from an existing limit:

```
Reducing the memory-limit clears all VoIP Trace statistics and data.
If you wish to copy this data first, enter 'no' to cancel,
otherwise enter 'yes' to proceed.
```
- Increasing the memory-limit does not impact the VoIP Trace data.

**Note**

- Unable to trace incoming calls if active calls exhaust the memory-limit.
- To change the Timestamps displayed in the VoIP Trace, configure the following:

```
router(config)#monitor event-trace timestamps datetime ?
localtime      Use local time zone for timestamps
msec           Include milliseconds in timestamp
show-timezone  Add time zone information to timestamp
```

RTP Port Clear

When establishing a call, CUBE allocates several VoIP RTP ports. These ports are based on the media that are negotiated for the session. RTP ports can be allocated from the following three different tables:

- Global port table
- Media IP address-based table
- Media VRF-based table

The table that is used for allocating RTP ports is based on CUBE feature configuration. Ports are allocated from the VRF table first (if available), and then from the media table. If neither of these tables are available, the global table allocates ports.

Use the **show voip rtp stats** command to display the ports allocated from the different tables. In the current behavior, this command displays ports that are allocated only from the global port table. From Cisco IOS XE Bengaluru 17.4.1a onwards, this command displays ports that are allocated from all the three tables.

Sometimes, RTP ports can remain assigned after a call ends. Use the **clear voip rtp port** command to release such hung ports.

The **show voip rtp stats** command displayed only the port values from the global table, even if the ports are allocated from all the tables. From Cisco IOS XE Bengaluru 17.4.1a onwards, this command displays details of allocated ports from all the three tables.

The **clear voip rtp port table ID port number** command releases the hung ports. Here, *table ID* is the identifier of the table from which the *port number* is released.

A unique identifier is generated and printed for each table, which serves as a reference to **clear voip rtp port** command.

Feature Information for VoIP Trace

The following table provides release information about the feature or features described in this module. This table lists only the software release that introduced support for a given feature in a given software release train. Unless noted otherwise, subsequent releases of that software release train also support that feature.

Use Cisco Feature Navigator to find information about platform support and Cisco software image support. To access Cisco Feature Navigator, go to <https://cfng.cisco.com/>. An account on Cisco.com is not required.

Feature Name	Releases	Feature Information
VoIP Trace for CUBE Serviceability	Cisco IOS XE Amsterdam 17.3.2, Cisco IOS XE Bengaluru 17.4.1a	<p>VoIP Trace is a Cisco Unified Border Element (CUBE) Serviceability framework for Event Logging and Debug Classification.</p> <p>The following are the commands that are introduced as part of this feature:</p> <ul style="list-style-type: none"> • trace • memory-limit [<i>platform</i> <i>memory</i>] • shutdown • show voip trace {<i>call-id identifier</i> <i>session-id identifier</i> <i>sip-call-id identifier</i> <i>correlator identifier</i> all <i>cover-buffers</i> <i>statistics</i> [<i>detail</i>]}
RTP Port Clear	Cisco IOS XE Bengaluru 17.4.1a	<p>Sometimes, RTP ports can remain assigned after a call end. This feature enhancement releases such hung ports and makes available for other calls. This release of ports increases the efficiency of the device. The feature introduces the following commands:</p> <p>show voip rtp stats - The enhanced command enables you to print details for in-use ports of other port ranges (along with global port range).</p> <p>Cisco IOS Voice Command Reference - S commands</p> <p>clear voip rtp port<<i>table-id</i>><<i>port-num</i>> - Use this command to clear VoIP Real Time Protocol (RTP) which are leaked ports.</p> <p>Cisco IOS Voice Command Reference - A through C</p>



CHAPTER 80

Support for Session Identifier

Cisco Unified Border Element (CUBE) supports “Session Identifier” for end-to-end tracking of a SIP session in IP-based multimedia communication systems. Support for session identifier is in compliance with RFC 7206 and draft-ietf-inspid-session-id-15.

- [Feature Information for Session Identifier Support, on page 1043](#)
- [Restrictions, on page 1044](#)
- [Information About Session Identifier, on page 1044](#)
- [Configuring Support for Session Identifier, on page 1045](#)
- [Troubleshooting Tips, on page 1045](#)

Feature Information for Session Identifier Support

The following table provides release information about the feature or features described in this module. This table lists only the software release that introduced support for a given feature in a given software release train. Unless noted otherwise, subsequent releases of that software release train also support that feature.

Use Cisco Feature Navigator to find information about platform support and Cisco software image support. To access Cisco Feature Navigator, go to <https://cfng.cisco.com/>. An account on Cisco.com is not required.

Table 103: Feature Information for Session Identifier Support

Feature Name	Releases	Feature Information
Support for Session Identifier	Cisco IOS 15.6(2)T Cisco IOS XE Denali 16.3.1	This feature enables CUBE to support “Session Identifier” for end-to-end tracking of a SIP session in IP-based multimedia communication systems in compliance with RFC 7206 and draft-ietf-insipid-session-id-15. A new keyword session-id is added to the following commands: <ul style="list-style-type: none"> • show call active voice • show call active video • show call history voice • show call history video • show call active voice brief • show call active video brief

Restrictions

- Session Identifier is not supported for SIP-H.323, H.323-SIP, and H.323-H.323 calls.

Information About Session Identifier

CUBE supports “Session Identifier” that overcomes the limitations with the existing call-identifiers and allows end-to-end tracking of a SIP session. To support session identifier, “Session-ID” header is added in the SIP request and response messages.



Note "Session Identifier" refers to the value of the identifier, whereas "Session-ID" refers to the header field used to convey the identifier.

The Session-ID comprises of Universally Unique Identifier (UUID) for each user agent participating in a call. Each call consists of two UUID known as local UUID and remote UUID. Local UUID is the UUID generated from the originating user agent and remote UUID is generated from the terminating user agent. The UUID values are presented as strings of lower-case hexadecimal characters, with the most significant octet of the

UUID appearing first. Session Identifier comprises of 32 characters and remains same for the entire session. Refer to RFC 4122 for more information on UUID.

Example for Session ID header

```
Session-ID: ab30317f1a784dc48ff824d0d3715d86; remote=47755a9de7794ba387653f2099600ef2
```

In the above example:

Local UUID =

```
ab30317f1a784dc48ff824d0d3715d86
```

Remote UUID =

```
47755a9de7794ba387653f2099600ef2
```

Feature Behavior

- If all the user agents associated with CUBE support session-id, then CUBE allows pass-through of the Session ID header in all SIP request and response messages for the session.
- CUBE looks for the Session ID header present in the SIP messages and validates the SessionID header syntax as defined in draft-ietf-insipid-session-id-15. Session ID format earlier to draft-ietf-insipid-session-id-15 is considered as unsupported.
- If some of the user agents do not support session ID, CUBE generates local UUID on behalf of the user agent and sends the generated UUID in SIP request and response. CUBE generates UUID based on version 5 (SHA-1).
- If a Session ID is received in the format as defined in RFC 7329, CUBE considers it as unsupported. CUBE generates local UUID on behalf of the user agent and sends the generated UUID in SIP request and response.
- In a mid call scenario, where user a session is switched from supporting session identifier to non-supporting session identifier, CUBE saves the previous non-NULL session identifier and sends the saved non-NULL session identifier in re-invite messages as needed.
- For high availability, session ID is check pointed in active and re-created in standby.

Configuring Support for Session Identifier

Session Identifier support is enabled on CUBE by default. No additional configuration required.

Troubleshooting Tips

The following show commands helps you to troubleshoot any issues with session identifier.

- **show call active voice session-id WORD**

- **show call active voice brief session-id WORD**
- **show call active video session-id WORD**
- **show call active video brief session-id WORD**

WORD can be complete session identifier (local, remote, or both), or wildcard pattern of local or remote UUID. The valid wildcard patterns for search are *, 0-9, a-f, A-F.

The following session identifier is considered in the below examples:

```
SessionIDLocaluuid=db248b6cbdc547bbc6c6fdfb6916eeb
SessionIDRemoteuuid=4fd24d9121935531a7f8d750ad16e19
```

Valid Search Patterns

You can search for the session identifier using complete Session ID header as shown below:

```
Device# show call active voice session-id db248b6cbdc547bbc6c6fdfb6916eeb;
remote=4fd24d9121935531a7f8d750ad16e19
```

```
Telephony call-legs: 0
SIP call-legs: 1
H323 call-legs: 0
.
.
.
SessionIDLocaluuid=db248b6cbdc547bbc6c6fdfb6916eeb
SessionIDRemoteuuid=4fd24d9121935531a7f8d750ad16e19
.
.
SCCP call-legs: 0
Multicast call-legs: 0
Total call-legs: 1
```

You can search for the session identifier using complete local UUID as shown below:

```
Device# show call active voice session-id db248b6cbdc547bbc6c6fdfb6916eeb
Telephony call-legs: 0
SIP call-legs: 1
H323 call-legs: 0
.
.
.
SessionIDLocaluuid=db248b6cbdc547bbc6c6fdfb6916eeb
SessionIDRemoteuuid=4fd24d9121935531a7f8d750ad16e19
.
.
SCCP call-legs: 0
Multicast call-legs: 0
Total call-legs: 1
```

You can search for the session identifier using complete remote UUID as shown below:

```
Device# show call active voice session-id 4fd24d9121935531a7f8d750ad16e19
Telephony call-legs: 0
SIP call-legs: 1
H323 call-legs: 0
.
.
```

```

.
SessionIDLocaluuid=db248b6cbdc547bbc6c6fdfb6916eeb
SessionIDRemoteuuid=4fd24d9121935531a7f8d750ad16e19
.
.
.
SCCP call-legs: 0
Multicast call-legs: 0
Total call-legs: 1

```

You can search for session id using wildcard pattern match as shown below:

```

Device# Device# show call active voice session-id 4fd2*
Telephony call-legs: 0
SIP call-legs: 2
H323 call-legs: 0
.
.
.
SessionIDLocaluuid=4fd24d9121935531a7f8d750ad16e19
SessionIDRemoteuuid=db248b6cbdc547bbc6c6fdfb6916eeb
SessionIDLocaluuid=db248b6cbdc547bbc6c6fdfb6916eeb
SessionIDRemoteuuid=4fd24d9121935531a7f8d750ad16e19
.
.
.
SCCP call-legs: 0
Multicast call-legs: 0
Total call-legs: 2

```

```

Device# show call active voice session-id *f*16e*
Telephony call-legs: 0
SIP call-legs: 2
H323 call-legs: 0
.
.
.
SessionIDLocaluuid=4fd24d9121935531a7f8d750ad16e19
SessionIDRemoteuuid=db248b6cbdc547bbc6c6fdfb6916eeb
SessionIDLocaluuid=db248b6cbdc547bbc6c6fdfb6916eeb
SessionIDRemoteuuid=4fd24d9121935531a7f8d750ad16e19
.
.
.
SCCP call-legs: 0
Multicast call-legs: 0
Total call-legs: 2

```

```

Device# show call active voice brief session-id *
Telephony call-legs: 0
SIP call-legs: 2
H323 call-legs: 0
.
.
.
SessionIDLocaluuid=4fd24d9121935531a7f8d750ad16e19
SessionIDRemoteuuid=db248b6cbdc547bbc6c6fdfb6916eeb
SessionIDLocaluuid=db248b6cbdc547bbc6c6fdfb6916eeb
SessionIDRemoteuuid=4fd24d9121935531a7f8d750ad16e19
.
.
.

```

```

SCCP call-legs: 0
Multicast call-legs: 0
Total call-legs: 2

```

```

Device# show call active voice session-id *; remote=*
Telephony call-legs: 0
SIP call-legs: 2
H323 call-legs: 0
.
.
.
SessionIDLocaluuid=4fd24d9121935531a7f8d750ad16e19
SessionIDRemoteuuid=db248b6cbdc547bbc6c6fd6b6916eeb
SessionIDLocaluuid=db248b6cbdc547bbc6c6fd6b6916eeb
SessionIDRemoteuuid=4fd24d9121935531a7f8d750ad16e19
.
.
.
SCCP call-legs: 0
Multicast call-legs: 0
Total call-legs: 2

```

```

Device# show call active voice session-id 4fd24d9*;remote=*16eeb
Telephony call-legs: 0
SIP call-legs: 2
H323 call-legs: 0
.
.
.
SessionIDLocaluuid=4fd24d9121935531a7f8d750ad16e19
SessionIDRemoteuuid=db248b6cbdc547bbc6c6fd6b6916eeb
.
.
.
SCCP call-legs: 0
Multicast call-legs: 0
Total call-legs: 2

```

Invalid Search Patterns

The following wild card search patterns are invalid:

```

Device# show call active voice session-id ;remote=
Invalid Pattern. Pattern can have a string with ^[0-9a-fA-F*]+$ only OR a string with
^[0-9a-fA-F*];remote=[0-9a-fA-F*]+$ .

```

```

Device# show call active voice session-id *;remote=
Invalid Pattern. Pattern can have a string with ^[0-9a-fA-F*]+$ only OR a string with
^[0-9a-fA-F*];remote=[0-9a-fA-F*]+$ .

```

```

Device# show call active video session-id ;remote=*
Incorrect format for Session-ID Wildcard Pattern regular expression must be of the form
^[0-9A-Fa-f*]+$
Invalid Pattern. Pattern can have a string with ^[0-9a-fA-F*]+$ only OR a string with
^[0-9a-fA-F*];remote=[0-9a-fA-F*]+$ .

```

```

Device# show call active voice session-id 4fd24d9*remote=*16eeb
Incorrect format for Session-ID Wildcard Pattern regular expression must be of the form
^[0-9A-Fa-f*]+$
Invalid Pattern. Pattern can have a string with ^[0-9a-fA-F*]+$ only OR a string with

```

```
^[0-9a-fA-F*];remote=[0-9a-fA-F*]+$.
```

Search using Null session identifier

If one of the session identifier is null, you can search for the session identifiers using 0 as wildcard pattern. The following session identifier is considered in the below example:

```
SessionIDLocaluuid=00000000000000000000000000000000
SessionIDRemoteuuid=4fd24d9121935531a7f8d750ad16e19
```

```
Device# show call active voice session-id 0
Telephony call-legs: 0
SIP call-legs: 2
H323 call-legs: 0
.
.
.
SessionIDLocaluuid=00000000000000000000000000000000
SessionIDRemoteuuid=4fd24d9121935531a7f8d750ad16e19
.
.
.
SCCP call-legs: 0
Multicast call-legs: 0
Total call-legs: 2
```

Correlation between Session Identifier and Call Identifier

The following session identifier is considered in the below examples:

```
SessionIDLocaluuid=db248b6cbdc547bbc6c6fd6b6916eeb
SessionIDRemoteuuid=4fd24d9121935531a7f8d750ad16e19
```

You can search for session identifier using the local UUID as shown below:

```
Device# show call active voice session-id d82c680a3eaecd5c29ac6ceea225061
Telephony call-legs: 0
SIP call-legs: 2
H323 call-legs: 0
Call agent controlled call-legs: 0
SCCP call-legs: 0
Multicast call-legs: 0
.
.
.
.
VOIP:
ConnectionId[0x8CDAC180 0x10000 0x1B7 0x5B56400A]
IncomingConnectionId[0x8CDAC180 0x10000 0x1B7 0x5B56400A]
CallID=1022
GlobalCallId=[0xC3DAB665 0x770C11E5 0x80318550 0x5A000ED7]
SessionIDLocaluuid=d82c680a3eaecd5c29ac6ceea225061
SessionIDRemoteuuid=6497636d0b747785241cfbf5aa225064
CallReferenceId=0
CallServiceType=Unknown
RTP Loopback Call=FALSE
RemoteIPAddress=10.64.86.91
RemoteUDPPort=16614
RemoteSignallingIPAddress=10.64.86.91
```

```

RemoteSignallingPort=5060
RemoteMediaIPAddress=10.127.17.142
RemoteMediaPort=16614
CoderTypeRate=g711ulaw
.
.
.
GlobalCallId=[0xC3DAB665 0x770C11E5 0x80318550 0x5A000ED7]
SessionIDLocaluuid=6497636d0b747785241cfbf5aa225064
SessionIDRemoteuuid=d82c680a3eaecd5c29ac6ceea225061
RemoteIPAddress=10.64.86.91
RemoteUDPPort=21978
RemoteSignallingIPAddress=10.64.86.91
RemoteSignallingPort=5060
RemoteMediaIPAddress=10.127.17.188
RemoteMediaPort=21978

```

From the above output, you get to know that 1022 (highlighted) is the call identifier associated with the local session identifier **d82c680a3eaecd5c29ac6ceea225061**. You can now use this call identifier to get further details and debugging of the desired call as shown below:

```
Device# show sip-ua calls callid 1022
```

```

SIP CALL INFO of CCAPI callid 1022
Call 1
SIP Call ID           : 8cdac180-627159d8-9cd-5b56400a@10.64.86.91
State of the call     : STATE_ACTIVE (7)
Substate of the call  : SUBSTATE_NONE (0)
Calling Number        : 4443332212
Called Number         : 4443332211
Called URI            : sip:4443332211@10.64.86.132:5060
Bit Flags             : 0xC0401C 0x10000100 0x80004
CC Call ID            : 1022
Source IP Address (Sig) : 10.64.86.132
Destn SIP Req Addr:Port : [10.64.86.91]:5060
Destn SIP Resp Addr:Port : [10.64.86.91]:5060
Destination Name      : 10.64.86.91
Number of Media Streams : 1
Number of Active Streams: 1
RTP Fork Object       : 0x0
Media Mode             : flow-through
Media Stream 1
State of the stream   : STREAM_ACTIVE
Stream Call ID        : 1022
Stream Type           : voice-only (0)
Stream Media Addr Type : 1
Negotiated Codec      : g711ulaw (160 bytes)
Codec Payload Type    : 0
Negotiated Dtmf-relay : inband-voice
Dtmf-relay Payload Type : 0
QoS ID                : -1
Local QoS Strength    : BestEffort
Negotiated QoS Strength : BestEffort
Negotiated QoS Direction : None
Local QoS Status      : None
Media Source IP Addr:Port : [10.64.86.132]:16424
Media Dest IP Addr:Port  : [10.127.17.142]:16614

Options-Ping      ENABLED:NO      ACTIVE:NO

SIP CALL INFO of peer leg CCAPI callid 1023

```



```

Call 2
SIP Call ID           : C3DEFC15-770C11E5-80348550-5A000ED7@10.64.86.132
  State of the call   : STATE_ACTIVE (7)
  Substate of the call : SUBSTATE_NONE (0)
  Calling Number      : 4443332212
  Called Number       : 4443332211
  Called URI          : sip:4443332211@10.64.86.91:5060
  Bit Flags           : 0xC04018 0x90000100 0x80080
  CC Call ID          : 1023
  Source IP Address (Sig) : 10.64.86.132
  Destn SIP Req Addr:Port : [10.64.86.91]:5060
  Destn SIP Resp Addr:Port: [10.64.86.91]:5060
  Destination Name     : 10.64.86.91
  Number of Media Streams : 1
  Number of Active Streams: 1
  RTP Fork Object      : 0x0
  Media Mode           : flow-through
Media Stream 1
  State of the stream   : STREAM_ACTIVE
  Stream Call ID        : 1023
  Stream Type           : voice-only (0)
  Stream Media Addr Type : 1
  Negotiated Codec      : g711ulaw (160 bytes)
  Codec Payload Type    : 0
  Negotiated Dtmf-relay : inband-voice
  Dtmf-relay Payload Type : 0
  QoS ID                 : -1
  Local QoS Strength    : BestEffort
  Negotiated QoS Strength : BestEffort
  Negotiated QoS Direction : None
  Local QoS Status      : None
  Media Source IP Addr:Port: [10.64.86.132]:16426
  Media Dest IP Addr:Port : [10.127.17.188]:21978

```

Example for video Calls

The following session identifier is considered in the below example:

```

SessionIDLocaluuid=6f0a93a3a79451aeb6b6d83f79a3359f
SessionIDRemotenuid=a55b0f45861551b88f57d1fb5bb23f89

```



Note All the search patterns listed above for voice calls are also valid for video calls.

You can search for the session identifier using complete UUID (local, remote, or both) or use a wildcard pattern.

```
Device# show call active video session-id 6f*
```

```

Telephony call-legs: 0
SIP call-legs: 2
H323 call-legs: 0
Call agent controlled call-legs: 0
SCCP call-legs: 0
Multicast call-legs: 0
Total call-legs: 2

GENERIC:
SetupTime=56399650 ms (*16:58:12.964 IST Thu Aug 20 2015)
Index=1
PeerAddress=sipp

```

```
PeerSubAddress=  
PeerId=1  
PeerIfIndex=14  
LogicalIfIndex=0  
ConnectTime=56400660 ms (*16:58:13.974 IST Thu Aug 20 2015)  
CallDuration=00:00:56 sec  
CallState=4  
CallOrigin=2  
ChargedUnits=0  
InfoType=video  
TransmitPackets=0  
TransmitBytes=0  
ReceivePackets=0  
ReceiveBytes=0  
VOIP:  
ConnectionId[0x6083CB92 0x466511E5 0xFFFFFFFF8018F617 0xFFFFFFFFFA7C45A02]  
IncomingConnectionId[0x6083CB92 0x466511E5 0xFFFFFFFF8018F617 0xFFFFFFFFFA7C45A02]  
CallID=11  
GlobalCallId=[0x6083F24F 0x466511E5 0xFFFFFFFF801BF617 0xFFFFFFFFFA7C45A02]  
CallReferenceId=0  
CallServiceType=Unknown  
RTP Loopback Call=FALSE  
SessionIDLocaluuid=6f0a93a3a79451aeb6b6d83f79a3359f  
SessionIDRemoteuuid=a55b0f45861551b88f57d1fb5bb23f89  
RemoteIPAddress=10.64.86.70  
RemoteSignallingIPAddress=10.64.86.70  
RemoteSignallingPort=5061  
RemoteMediaIPAddress=10.64.86.70  
RemoteMediaPort=6003  
RoundTripDelay=0 ms  
tx_DtmfRelay=inband-voice  
FastConnect=FALSE
```



PART **XXIV**

Security Compliance

- [Common Criteria \(CC\) and The Federal Information Processing Standards \(FIPS\) Compliance, on page 1055](#)



CHAPTER 81

Common Criteria (CC) and The Federal Information Processing Standards (FIPS) Compliance

Cisco Unified Border Element is Common Criteria (CC) and The Federal Information Processing Standards (FIPS) certified. The certification is applicable to Cisco Unified Border Element on Cisco CSR 1000v Series Cloud Services Router platform only.

Common Criteria (CC)

Common Criteria (CC) is a global security to which security products are evaluated. Common Criteria product certifications are mutually recognized by 28 nations, thus an evaluation that is conducted in one country is recognized by the other countries.

The Common Criteria for Information Technology Security Evaluation is an international standard (ISO/IEC 15408) that guarantees product security. The organizations (Government or Enterprise IT) specify functional and assurance requirements, the vendors claim and develop specific product qualities. The testing facilities examine products to determine whether they meet those vendor claims. Common Criteria guarantees that the process of specification, execution and assessment of a product has been conducted in a stringent and standardized manner.

The Federal Information Processing Standards (FIPS)

The Federal Information Processing Standards (FIPS) Publication 140-2, *Security Requirements for Cryptographic Modules*, details the U.S. government requirements for cryptographic modules. FIPS 140-2 specifies that a cryptographic module should be a set of hardware, software, firmware, or some combination that implements cryptographic functions or processes, including cryptographic algorithms and, optionally, key generation, and is contained within a defined cryptographic boundary.

FIPS specifies certain crypto algorithms as secure, and it also identifies which algorithms should be used if a cryptographic module is to be called FIPS compliant.

- [Feature Information for Common Criteria \(CC\) and the Federal Information Standards \(FIPS\) Compliance, on page 1056](#)
- [Supported Hardware and Software for Virtual CUBE, on page 1056](#)
- [Common Criteria Configuration on Cisco CSR 1000v, on page 1056](#)
- [FIPS Configuration on Cisco CSR 1000v, on page 1068](#)

Feature Information for Common Criteria (CC) and the Federal Information Standards (FIPS) Compliance

The following table provides release information about the feature or features that are described in this module. This table lists only the software release that introduced support for a given feature in a given software release train. Unless noted otherwise, subsequent releases of that software release train also support that feature.

Use Cisco Feature Navigator to find information about platform support and software image support. Cisco Feature Navigator enables you to determine which software images support a specific software release, feature set, or platform. To access Cisco Feature Navigator, go to <http://www.cisco.com/go/cfn>. You need not require an account on Cisco.com.

Feature Name	Releases	Feature Information
Common Criteria (CC) and The Federal Information Standards (FIPS) Certification.	Cisco IOS XE Fuji Release 16.9.1	Common Criteria (CC) and The Federal Information Standards (FIPS) Certification for Cisco Unified Border Element on Cisco CSR 1000v Series Cloud Services Router.

Supported Hardware and Software for Virtual CUBE

For details on prerequisites for Virtual CUBE, see [Supported Hardware and Software for Virtual CUBE](#).

Common Criteria Configuration on Cisco CSR 1000v

Enable Common Criteria Mode

Before you begin

- Delete existing certificates.
- Remove existing crypto keys.
- Remove existing TLS configuration (TLS version and Cipher Suites).

Step 1 enable

Example:

```
Router# enable
```

Enables privileged EXEC mode.

- Enter your password if prompted.

Step 2 configure terminal

Example:

```
Router# configure terminal
```

Enters global configuration mode.

Step 3 **cc-mode****Example:**

```
Router(config)# cc-mode
```

Enables common criteria configuration mode.

What to do next

Common Criteria (CC) mode enforces certain security checks for cryptographic protocols such as Transport Layer Security (TLS). CUBE uses TLS to secure signaling over SIP and HTTP client for XCC providers. Configure SIP TLS and HTTP TLS in the Common Criteria (CC) mode.

SIP TLS Configuration

SIP TLS Configuration Task Flow

Following are the steps to configure SIP TLS on your Cisco CSR 1000v router in Common Criteria mode.

1. [Generate RSA Public Key, on page 1057](#)
2. [Configure Certificate Authority Server, on page 1058](#)
3. [Configure CSR Trustpoint, on page 1059](#)
4. [Configure Peer Trustpoint, on page 1060](#)
5. [Add Client Verification Trustpoint, on page 1061](#)
6. [Enforce Strict SRTP, on page 1062](#)

Generate RSA Public Key

Step 1 **enable****Example:**

```
Router#enable
```

Enables privileged EXEC mode.

- Enter your password if prompted.

Step 2 **configure terminal****Example:**

```
Router#configure terminal
```

Enters global configuration mode.

Step 3 `crypto key generate rsa label key-label modulus modulus-size`**Example:**

```
Router(config)#crypto key generate rsa general-keys label CUBE modulus 3072
```

Generates a public RSA key that is used with your CSR certificate.

- The *key-label* specifies the name that is used for an RSA key pair when they are exported.
- The *modulus-size* specifies the size of the key modulus. By default, the modulus of a Certification Authority (CA) key is 1024 bits. The size of the key modulus must be 2048 bits or higher, for it to be Common Criteria compliant.

Step 4 `exit`**Example:**

```
Router(config)#exit
```

Exits global configuration mode.

Configure Certificate Authority Server

Step 1 `enable`**Example:**

```
Router# enable
```

Enables privileged EXEC mode.

- Enter your password if prompted.

Step 2 `configure terminal`**Example:**

```
Router# configure terminal
```

Enters global configuration mode.

Step 3 `crypto pki server cs-label`**Example:**

```
Router(config)# crypto pki server CUBE
```

Defines a label for the Certificate Server and enters the certificate server configuration mode.

Note If you have generated the RSA key pair manually using the command `crypto key generate rsa label key-label modulus modulus-size`, the *cs-label* must match with the *key-label*, otherwise a certificate with the default key size of 1024 bits is generated.

Step 4 `database level complete`**Example:**

```
Router(cs-server)# database level complete
```

Writes each issued certificate to the certificate enrollment database.

Step 5 **grant auto****Example:**

```
Router(cs-server)# grant auto
```

Automatically grants reenrollment requests for subordinate Certificate Authority (CA) server or Registration Authority (RA) mode Certificate Authority (CA).

Step 6 **hash sha384****Example:**

```
Router(cs-server)# hash sha384
```

Sets the hash function SHA-384 for the signature that the Cisco IOS Certificate Authority (CA) uses to sign all the certificates that are issued by the server.

Step 7 **no shut****Example:**

```
Router(cs-server)#no shut
%Some server settings cannot be changed after CA certificate generation.
% Please enter a passphrase to protect the private key
% or type Return to exit
```

Password:

Re-enter password:

```
% Generating 3072 bit RSA keys, keys will be non-exportable...
[OK] (elapsed time was 0 seconds)
```

```
% Certificate Server enabled.
```

Enables or reenables the certificate server. If the subordinate certificate server is enabled for the first time, the certificate server generates the key and receives its signing certificate from the root certificate server.

After entering the passphrase (when prompted), the certificate server is enabled. This passphrase protects the private key.

Step 8 **exit****Example:**

```
Router(cs-server)# exit
```

Exits certificate server configuration mode.

Configure CSR Trustpoint

Step 1 **enable****Example:**

```
Router#enable
```

Enables privileged EXEC mode.

- Enter your password if prompted.

Step 2 **configure terminal****Example:**

```
Router#configure terminal
```

Enters global configuration mode.

Step 3 **crypto pki trustpoint *name*****Example:**

```
Router(config)#crypto pki trustpoint CUBE-TLS
```

Declares the trustpoint with the name specified and enters trustpoint configuration mode. This trustpoint is used by your Router application for the TLS communication.

Step 4 **hash sha384****Example:**

```
Router(ca-trustpoint)#hash sha384
```

Sets the hash function SHA-384 for the signature that the Cisco IOS Certificate Authority (CA) uses to sign all the certificates that are issued by the server.

A trustpoint with sample CSR certificate with subject-name "CN=Secure-Router" and "rsakeypair Router" is given below. The "rsakeypair label" must match with the label of the RSA keys that are generated in the earlier steps.

```
crypto pki trustpoint CUBE-TLS
 enrollment url http://X.X.X.X:80
 serial-number none
 fqdn none
 ip-address none
 subject-name CN=Secure-CUBE
 revocation-check none
 rsakeypair Router
```

Step 5 **exit****Example:**

```
Router(ca-trustpoint)# exit
```

Exits trustpoint configuration mode.

Configure Peer Trustpoint

Step 1 **enable****Example:**

```
Router#enable
```

Enables privileged EXEC mode.

- Enter your password if prompted.

Step 2 **configure terminal****Example:**

```
Router#configure terminal
```

Enters global configuration mode.

Step 3 **crypto pki trustpoint** *name*

Example:

```
Router(config)#crypto pki trustpoint xyzname
```

Declares the peer trustpoint with the name specified and enters trustpoint configuration mode.

Step 4 **enrollment terminal**

Example:

```
Router(ca-trustpoint)#enrollment terminal
```

Specifies manual certificate enrollment via the cut-and-paste method for trustpoint peers. The certificate request displayed on the console terminal can be manually copied.

Step 5 **revocation-check none**

Example:

```
Router(ca-trustpoint)#revocation-check none
```

Specifies that the certificate check is ignored.

Step 6 **exit**

Example:

```
Router(ca-trustpoint)#exit
```

Exits trustpoint configuration mode.

Add Client Verification Trustpoint

Step 1 **enable**

Example:

```
Router#enable
```

Enables privileged EXEC mode.

- Enter your password if prompted.

Step 2 **configure terminal**

Example:

```
Router#configure terminal
```

Enters global configuration mode.

Step 3 **sip-ua**

Example:

```
Router(config)#sip-ua
```

Enters SIP User Agent configuration mode to configure SIP-UA related commands.

Step 4 **crypto signaling remote-addr** *remote ip address remote ip mask* **trustpoint** *CUBE's trustpoint label* **client-vtp** *verification trustpoint*

Example:

```
Router(config-sip-ua)#crypto signaling remote-addr X.X.X.X 255.255.255.255 trustpoint CUBE-TLS
client-vtp CUBE-VERIFY
```

Assigns a client verification trustpoint to SIP-UA. This client verification trustpoint is used to send Distinguished Name (DN) of the Certificate Authority (CA) server in the CUBE's client certificate request.

Step 5 **exit**

Example:

```
Router(config-sip-ua)#exit
```

Exits sip-ua configuration mode.

Enforce Strict SRTP

Step 1 **enable**

Example:

```
Router#enable
```

Enables privileged EXEC mode.

- Enter your password if prompted.

Step 2 **configure terminal**

Example:

```
Router#configure terminal
```

Enters global configuration mode.

Step 3 **voice service voip**

Example:

```
Router(config)#voice service voip
```

Enters voice service configuration mode and specifies the encapsulation method as VoIP.

Step 4 **srtp**

Example:

```
Router(conf-voi-ser)#srtp
```

Enforces SRTP to secure the call flow through CUBE.

Step 5 **exit**

Example:

```
Router(conf-voi-ser)#exit
```

Exits voice service configuration mode.

HTTPS TLS Configuration

HTTPS TLS Configuration Task Flow

Following are the steps to configure HTTPS TLS on your Cisco CSR 1000v router in Common Criteria mode.

1. [Prepare Cisco CSR 1000v Router's HTTP Server to Run in CC Mode, on page 1063](#)
2. [Create Certificate Map for HTTPS Peer Trustpoint, on page 1064](#)
3. [Configure HTTPS TLS Version, on page 1065](#)
4. [Configure Supported Cipher Suites, on page 1066](#)
5. [Apply Certificate Map to HTTPS Peer Trustpoint, on page 1066](#)

Prepare Cisco CSR 1000v Router's HTTP Server to Run in CC Mode

Step 1 **enable**

Example:

```
Router#enable
```

Enables privileged EXEC mode.

- Enter your password if prompted.

Step 2 **configure terminal**

Example:

```
Router#configure terminal
```

Enters global configuration mode.

Step 3 **ip http server *name***

Example:

```
Router(config)#ip http server
```

Enables the HTTP server on the Cisco CSR 1000v router, allowing the use of Cisco web browser UI to monitor the router and issue commands to it.

Step 4 **ip http authentication local**

Example:

```
Router(config)#ip http authentication local
```

Specifies the authentication method for HTTP server users. The keyword **local** indicates that the username, password, and privilege level access combination that is specified in the local system configuration should be used for authentication and authorization.

Step 5 **ip http secure-server****Example:**

```
Router(config)#ip http secure-server
```

Enables a secure HTTP server on the Cisco CSR 1000v router.

Step 6 **ip http secure-trustpoint** *trustpoint-name***Example:**

```
Router(config)#ip http secure-trustpoint CUBE-TLS
```

Specifies the trustpoint that is used for obtaining signed certificates for a secure HTTP server on the Cisco CSR 1000v router.

Step 7 **ip http secure-client-auth****Example:**

```
Router(config)#ip http secure-client-auth
```

Configures the HTTP server to request an X.509v3 certificate from the client to authenticate the client during the connection process.

Step 8 **ip http secure-peer-verify-trustpoint** *client's issuer***Example:**

```
Router(config)#ip http secure-peer-verify-trustpoint secure-clientissuer
```

Configures the client verification trustpoint for the HTTP server on the Cisco CSR 1000v router. This peer verification trustpoint is used to send Distinguished Name (DN) of Certificate Authority (CA) in the client certificate request during the TLS handshake of HTTP.

Step 9 **exit****Example:**

```
Router(config)#exit
```

Exits the global configuration mode.

Create Certificate Map for HTTPS Peer Trustpoint

Step 1 **enable****Example:**

```
Router#enable
```

Enables privileged EXEC mode.

- Enter your password if prompted.

Step 2 **configure terminal****Example:**

```
Router#configure terminal
```

Enters global configuration mode.

Step 3 `crypto pki certificate map label sequence-number`

Example:

```
Router(config)#crypto pki certificate map cubemap 10
```

Creates a certificate map that defines certificate-based Access Control Lists (ACLs) and enters the certificate map configuration mode. The *sequence-number* orders the ACLs with the same label. ACLs with the same label are processed from the lowest to the highest sequence number. When an ACL is matched, the processing stops with a successful result.

Step 4 `alt-subject-name eq match-value`

Example:

```
Router(ca-certificate-map)#alt-subject-name peername
```

Specifies the certificate fields with their matching criteria in the certificate map configuration mode. The alternate subject name that is specified in the map must be present in SAN extension of the peer id certificate.

Step 5 `exit`

Example:

```
Router(ca-certificate-map)#exit
```

Exits certificate map configuration mode.

Configure HTTPS TLS Version

Step 1 `enable`

Example:

```
Router#enable
```

Enables privileged EXEC mode.

- Enter your password if prompted.

Step 2 `configure terminal`

Example:

```
Router#configure terminal
```

Enters global configuration mode.

Step 3 `ip http tls-version version`

Example:

```
Router(config)#ip http tls-version TLSv1.2
```

Configures the specified TLS version for HTTPS. Configure TLSv1.1 or TLSv1.2 to be Common Criteria compliant.

Step 4 `exit`

Example:

```
Router(config)#exit
```

Exits global configuration mode.

Configure Supported Cipher Suites

Step 1 enable

Example:

```
Router#enable
```

Enables privileged EXEC mode.

- Enter your password if prompted.

Step 2 configure terminal

Example:

```
Router#configure terminal
```

Enters global configuration mode.

Step 3 ip http secure-ciphersuite *supported cipher suites*

Example:

```
Router(config)#ip http secure-ciphersuite aes-128-cbc-sha aes-256-cbc-sha dhe-aes-128-cbc-sha  
rsa-aes-cbc-sha2 rsa-aes-gcm-sha2 dhe-aes-cbc-sha2 dhe-aes-gcm-sha2 ecdhe-rsa-aes-cbc-sha2  
ecdhe-rsa-aes-gcm-sha2 ecdhe-ecdsa-aes-gcm-sha2
```

Specifies the cipher suites that are used for encryption over the secure HTTP connection between the client and the HTTP server. Common Criteria supports the cipher suites that are given in the preceding example. Configure all the cipher suites if you are not aware of the client cipher support.

Step 4 exit

Example:

```
Router(config)#exit
```

Exits global configuration mode.

Apply Certificate Map to HTTPS Peer Trustpoint

Step 1 enable

Example:

```
Router#enable
```

Enables privileged EXEC mode.

- Enter your password if prompted.

Step 2 configure terminal

Example:

```
Router#configure terminal
```

Enters global configuration mode.

Step 3 `crypto pki trustpoint name`**Example:**

```
Router(config)#crypto pki trustpoint CUBE-HTTPS
```

Declares the HTTPS peer trustpoint for the Cisco CSR 1000v router.

Step 4 `match certificate map name`**Example:**

```
Router(ca-trustpoint)#match certificate cubemap
```

Associates the certificate map that is defined by using the **crypto pki certificate map** command with the HTTPS trustpoint. The *map name* argument in the **match certificate** command must match the *label* argument that is specified in the previously defined **crypto pki certificate map** command.

Step 5 `match eku attribute`**Example:**

```
Router(ca-trustpoint)#match eku client-auth server-auth
```

Allows the HTTPS peer which acts as a client and a server to validate a peer certificate only if the specified Extended Key Usage (EKU) attribute is present in the certificate. If the Cisco CSR 1000v router is a client, then you must configure server-auth. If Cisco CSR 1000v router is a server, then you must configure client-auth.

Step 6 `exit`**Example:**

```
Router(ca-trustpoint)#exit
```

Exits trustpoint configuration mode.

NTP Configuration Restrictions in Common Criteria Mode

In Common Criteria mode, the following restrictions are applicable to NTP configuration.

- Do not configure NTP version 1 and 2. Following are the NTP version commands.
 - **ntp server ip-address prefer source interface version version**
 - **ntp peer ip-address version version**
- Do not configure NTP broadcast. Following are the NTP broadcast commands.
 - **ntp broadcast delay delay-timer**
 - **ntp broadcast client**
 - **ntp broadcast destination ip-address**
 - **ntp broadcast destination ip-address key key**

- **ntp broadcast destination** *ip-address* **key** *key* **version** *version*
- **ntp broadcast version** *version*
- Do not configure NTP multicast command **ntp multicast version** *version*.

FIPS Configuration on Cisco CSR 1000v

Configuration Requirements for FIPS Compliance

There is no specific command to enable FIPS mode. For the Virtual CUBE on the Cisco CSR 1000v router to be FIPS-compliant, the following commands must be configured.

- **crypto key generate rsa modulus** *modulus-size*
The *modulus-size* varies from 360 bits to 4096 bits. The size of the RSA key must be 2048 bit or higher for FIPS compliance.
- The Hash Algorithms that are configured using the command **hash sha384** under the configured trustpoint and the crypto pki server on the CSR must use sha384 or greater, namely sha512.



PART **XXV**

Appendixes

- [Additional References, on page 1071](#)
- [Glossary, on page 1075](#)



CHAPTER 82

Additional References

The following sections provide references related to the CUBE Configuration Guide.

- [Related References, on page 1071](#)
- [Standards, on page 1072](#)
- [MIBs, on page 1072](#)
- [RFCs, on page 1072](#)
- [Technical Assistance, on page 1074](#)

Related References

Related Topic	Document Title
Feature Navigator	For information about platforms supported, and Cisco IOS software image support., search by Feature Name listed in Feature Information Table in www.cisco.com/go/cfn
Bug Search Tool Kit	For information about latest caveats and feature information, see Bug Search Tool
Cisco IOS commands	Cisco IOS Commands List, All Releases
Cisco IOS Voice commands	<i>Cisco IOS Voice Command Reference</i>
Cisco IOS Voice Configuration Library	For more information about Cisco IOS voice features, including feature documents, and troubleshooting information--at http://www.cisco.com/c/en/us/td/docs/ios-xml/ios/voice/config_library/15-mt/cube-15-mt-library.htm
Related Application Guides	<ul style="list-style-type: none">• <i>Cisco Unified Communications Manager and Cisco IOS Interoperability Guide</i>• <i>Cisco IOS SIP Configuration Guide</i>• Cisco Unified Communications Manager (CallManager) Programming Guides

Related Topic	Document Title
Troubleshooting and Debugging guides	<ul style="list-style-type: none"> • Cisco IOS Debug Command Reference, Release 15.3. • <i>Troubleshooting and Debugging VoIP Call Basics</i> at http://www.cisco.com/en/US/tech/tk1077/technologies_tech_note09186a0080094045.shtml • <i>VoIP Debug Commands</i> at http://www.cisco.com/en/US/docs/routers/access/1700/1750/software/configuration/guide/debug.html

Standards

Standard	Title
ITU-T G.711	—

MIBs

MIB	MIBs Link
<ul style="list-style-type: none"> • CISCO-PROCESS MIB • CISCO-MEMORY-POOL-MIB • CISCO-SIP-UA-MIB • DIAL-CONTROL-MIB • CISCO-VOICE-DIAL-CONTROL-MIB • CISCO-DSP-MGMT-MIB • IF-MIB • IP-TAP-MIB • TAP2-MIB • USER-CONNECTION-TAP-MIB 	<p>To locate and download MIBs for selected platforms, Cisco IOS XE software releases, and feature sets, use Cisco MIB Locator found at the following URL:</p> <p>http://www.cisco.com/go/mibs</p>

RFCs

RFC	Title
RFC 1889	<i>RTP: A Transport Protocol for Real-Time Applications</i>
RFC 2131	<i>Dynamic Host Configuration Protocol</i>

RFC	Title
RFC 2132	<i>DHCP Options and BOOTP Vendor Extensions</i>
RFC 2198	<i>RTP Payload for Redundant Audio Data</i>
RFC 2327	<i>SDP: Session Description Protocol</i>
RFC 2543	<i>SIP: Session Initiation Protocol</i>
RFC 2543-bis-04	<i>SIP: Session Initiation Protocol, draft-ietf-sip-rfc2543bis-04.txt</i>
RFC 2782	<i>A DNS RR for Specifying the Location of Services (DNS SRV)</i>
RFC 2806	<i>URLs for Telephone Calls</i>
RFC 2833	<i>RTP Payload for DTMF Digits, Telephony Tones and Telephony Signals</i>
RFC 3203	<i>DHCP reconfigure extension</i>
RFC 3261	<i>SIP: Session Initiation Protocol</i>
RFC 3262	<i>Reliability of Provisional Responses in Session Initiation Protocol (SIP)</i>
RFC 3264	<i>An Offer/Answer Model with the Session Description Protocol (SDP)</i>
RFC 3323	<i>A Privacy Mechanism for the Session Initiation Protocol (SIP)</i>
RFC 3325	<i>Private Extensions to the Session Initiation Protocol (SIP) for Asserted Identity within Trusted Networks</i>
RFC 3515	<i>The Session Initiation Protocol (SIP) Refer Method</i>
RFC 3361	<i>Dynamic Host Configuration Protocol (DHCP-for-IPv4) Option for Session Initiation Protocol (SIP) Servers</i>
RFC 3455	<i>Private Header (P-Header) Extensions to the Session Initiation Protocol (SIP) for the 3rd-Generation Partnership Project (3GPP)</i>
RFC 3608	<i>Session Initiation Protocol (SIP) Extension Header Field for Service Route Discovery During Registration</i>
RFC 3711	<i>The Secure Real-time Transport Protocol (SRTP)</i>
RFC 3925	<i>Vendor-Identifying Vendor Options for Dynamic Host Configuration Protocol version 4 (DHCPv4)</i>

Technical Assistance

Description	Link
<p>The Cisco Support website provides extensive online resources, including documentation and tools for troubleshooting and resolving technical issues with Cisco products and technologies.</p> <p>To receive security and technical information about your products, you can subscribe to various services, such as the Product Alert Tool (accessed from Field Notices), the Cisco Technical Services Newsletter, and Really Simple Syndication (RSS) Feeds.</p> <p>Access to most tools on the Cisco Support website requires a Cisco.com user ID and password.</p>	<p>http://www.cisco.com/cisco/web/support/index.html</p>



CHAPTER 83

Glossary

- [Glossary, on page 1075](#)

Glossary

AMR-NB —Adaptive Multi Rate codec - Narrow Band.

Allow header —Lists the set of methods supported by the UA generating the message.

bind — In SIP, configuring the source address for signaling and media packets to the IP address of a specific interface.

call —In SIP, a call consists of all participants in a conference invited by a common source. A SIP call is identified by a globally unique call identifier. A point-to-point IP telephony conversation maps into a single SIP call.

call leg —A logical connection between the router and another endpoint.

CLI —command-line interface.

Content-Type header —Specifies the media type of the message body.

CSeq header —Serves as a way to identify and order transactions. It consists of a sequence number and a method. It uniquely identifies transactions and differentiates between new requests and request retransmissions.

delta —An incremental value. In this case, the delta is the difference between the current time and the time when the response occurred.

dial peer —An addressable call endpoint.

DNS —Domain Name System. Used to translate H.323 IDs, URLs, or e-mail IDs to IP addresses. DNS is also used to assist in locating remote gatekeepers and to reverse-map raw IP addresses to host names of administrative domains.

DNS SRV —Domain Name System Server. Used to locate servers for a given service.

DSP —Digital Signal Processor.

DTMF —dual-tone multifrequency. Use of two simultaneous voice-band tones for dialing (such as touch-tone).

EFXS —IP phone virtual voice ports.

FQDN —fully qualified domain name. Complete domain name including the host portion; for example, *serverA.companyA.com* .

FXS—analog telephone voice ports.

gateway—A gateway allows SIP or H.323 terminals to communicate with terminals configured to other protocols by converting protocols. A gateway is the point where a circuit-switched call is encoded and repackaged into IP packets.

H.323—An International Telecommunication Union (ITU-T) standard that describes packet-based video, audio, and data conferencing. H.323 is an umbrella standard that describes the architecture of the conferencing system and refers to a set of other standards (H.245, H.225.0, and Q.931) to describe its actual protocol.

iLBC—internet Low Bitrate Codec.

INVITE—A SIP message that initiates a SIP session. It indicates that a user is invited to participate, provides a session description, indicates the type of media, and provides insight regarding the capabilities of the called and calling parties.

IP—Internet Protocol. A connectionless protocol that operates at the network layer (Layer 3) of the OSI model. IP provides features for addressing, type-of-service specification, fragmentation and reassemble, and security. Defined in RFC 791. This protocol works with TCP and is usually identified as TCP/IP. See TCP/IP.

ISDN—Integrated Services Digital Network.

Minimum Timer—Configured minimum value for session interval accepted by SIP elements (proxy, UAC, UAS). This value helps minimize the processing load from numerous INVITE requests.

Min-SE—Minimum Session Expiration. The minimum value for session expiration.

multicast—A process of transmitting PDUs from one source to many destinations. The actual mechanism (that is, IP multicast, multi-unicast, and so forth) for this process might be different for LAN technologies.

originator—User agent that initiates the transfer or Refer request with the recipient.

PDU—protocol data units. Used by bridges to transfer connectivity information.

PER—Packed Encoding Rule.

proxy—A SIP UAC or UAS that forwards requests and responses on behalf of another SIP UAC or UAS.

proxy server—An intermediary program that acts as both a server and a client for the purpose of making requests on behalf of other clients. Requests are serviced internally or by passing them on, possibly after translation, to other servers. A proxy interprets and, if necessary, rewrites a request message before forwarding it.

recipient—User agent that receives the Refer request from the originator and is transferred to the final recipient.

redirect server—A server that accepts a SIP request, maps the address into zero or more new addresses, and returns these addresses to the client. It does not initiate its own SIP request or accept calls.

re-INVITE—An INVITE request sent during an active call leg.

Request URI—Request Uniform Resource Identifier. It can be a SIP or general URL and indicates the user or service to which the request is being addressed.

RFC—Request For Comments.

RTP—Real-Time Transport Protocol (RFC 1889)

SCCP—Skinny Client Control Protocol.

SDP—Session Description Protocol. Messages containing capabilities information that are exchanged between gateways.

session —A SIP session is a set of multimedia senders and receivers and the data streams flowing between the senders and receivers. A SIP multimedia conference is an example of a session. The called party can be invited several times by different calls to the same session.

session expiration —The time at which an element considers the call timed out if no successful INVITE transaction occurs first.

session interval —The largest amount of time that can occur between INVITE requests in a call before a call is timed out. The session interval is conveyed in the Session-Expires header. The UAS obtains this value from the Session-Expires header of a 2xx INVITE response that it sends. Proxies and UACs determine this value from the Session-Expires header in a 2xx INVITE response they receive.

SIP —Session Initiation Protocol. An application-layer protocol originally developed by the Multiparty Multimedia Session Control (MMUSIC) working group of the Internet Engineering Task Force (IETF). Their goal was to equip platforms to signal the setup of voice and multimedia calls over IP networks. SIP features are compliant with IETF RFC 2543, published in March 1999.

SIP URL —Session Initiation Protocol Uniform Resource Locator. Used in SIP messages to indicate the originator, recipient, and destination of the SIP request. Takes the basic form of *user@host*, where *user* is a name or telephone number, and *host* is a domain name or network address.

SPI —service provider interface.

socket listener —Software provided by a socket client to receives datagrams addressed to the socket.

stateful proxy —A proxy in keepalive mode that remembers incoming and outgoing requests.

TCP —Transmission Control Protocol. Connection-oriented transport layer protocol that provides reliable full-duplex data transmissions. TCP is part of the TCP/IP protocol stack. See also TCP/IP and IP.

TDM —time-division multiplexing.

UA —user agent. A combination of UAS and UAC that initiates and receives calls. See **UAS** and **UAC**.

UAC —user agent client. A client application that initiates a SIP request.

UAS —user agent server. A server application that contacts the user when a SIP request is received and then returns a response on behalf of the user. The response accepts, rejects, or redirects the request.

UDP —User Datagram Protocol. Connectionless transport layer protocol in the TCP/IP protocol stack. UDP is a simple protocol that exchanges datagrams without acknowledgments or guaranteed delivery, requiring that error processing and retransmission be handled by other protocols. UDP is defined in RFC-768.

URI —Uniform Resource Identifier. Takes a form similar to an e-mail address. It indicates the user's SIP identity and is used for redirection of SIP messages.

URL —Universal Resource Locator. Standard address of any resource on the Internet that is part of the World Wide Web (WWW).

User Agent —A combination of UAS and UAC that initiates and receives calls. See **UAS** and **UAC**.

VFC —Voice Feature Card.

VoIP —Voice over IP. The ability to carry normal telephone-style voice over an IP-based Internet with POTS-like functionality, reliability, and voice quality. VoIP is a blanket term that generally refers to the Cisco standards-based approach (for example, H.323) to IP voice traffic.

